



HAL
open science

Percolation and first passage percolation : isoperimetric, time and flow constants

Barbara Dembin

► **To cite this version:**

Barbara Dembin. Percolation and first passage percolation : isoperimetric, time and flow constants. Mathematical Physics [math-ph]. Université Paris Cité, 2020. English. NNT : 2020UNIP7023 . tel-03175532

HAL Id: tel-03175532

<https://theses.hal.science/tel-03175532>

Submitted on 20 Mar 2021

HAL is a multi-disciplinary open access archive for the deposit and dissemination of scientific research documents, whether they are published or not. The documents may come from teaching and research institutions in France or abroad, or from public or private research centers.

L'archive ouverte pluridisciplinaire **HAL**, est destinée au dépôt et à la diffusion de documents scientifiques de niveau recherche, publiés ou non, émanant des établissements d'enseignement et de recherche français ou étrangers, des laboratoires publics ou privés.

THÈSE DE DOCTORAT DE L'UNIVERSITÉ DE PARIS

École doctorale: Sciences Mathématiques de Paris Centre (ED386)

Laboratoire de Probabilités, Statistique et Modélisation

PERCOLATION AND FIRST PASSAGE PERCOLATION:
ISOPERIMETRIC, TIME AND FLOW CONSTANTS

Par Barbara Dembin

Thèse de doctorat de Mathématiques appliquées

Dirigée par Marie Théret

Présentée et soutenue publiquement le 8 juillet 2020

Devant un jury composé de :

Marie Théret	Professeure	Université Paris Nanterre	DIRECTRICE DE THÈSE
Nathanaël Enriquez	Professeur	Université Paris-Sud	RAPPORTEUR
Christopher Hoffman	Professeur	University of Washington	RAPPORTEUR
Francis Comets	Professeur	Université de Paris	EXAMINATEUR
David Coupier	Professeur	Université de Valenciennes	EXAMINATEUR
Olivier Garet	Professeur	Université de Lorraine	EXAMINATEUR
Lucas Gerin	Professeur assistant	Ecole Polytechnique	EXAMINATEUR
Vincent Tassion	Professeur	ETH Zürich	EXAMINATEUR



Percolation et percolation de premier passage : constante isopérimétrique, constante de temps et constante de flux

Résumé : Dans cette thèse, nous étudions les modèles de percolation et percolation de premier passage dans le graphe \mathbb{Z}^d , $d \geq 2$. Dans une première partie, nous étudions les propriétés d'isopérimétrie du cluster infini \mathcal{C}_p de percolation pour $p > p_c$. Conditionnons par l'événement $\{0 \in \mathcal{C}_p\}$, la constante isopérimétrique ancrée $\varphi_p(n)$ correspond à l'infimum sur l'ensemble des sous-graphes connectés de \mathcal{C}_p , contenant 0 et de volume inférieur à n^d , du ratio entre la taille du bord et le volume. Nous montrons la convergence lorsque n tend vers l'infini de $n\varphi_p(n)$ vers une constante déterministe φ_p qui est solution d'un problème isopérimétrique anisotrope continu. Nous étudions également le comportement de la constante isopérimétrique ancrée en p_c , ainsi que la régularité de $p \mapsto \varphi_p$ pour $p > p_c$. Dans une deuxième partie, nous considérons une première interprétation du modèle de percolation de premier passage où chaque arête du graphe est munie indépendamment d'un temps de passage aléatoire distribué selon une loi G . La percolation de premier passage modélise des phénomènes de propagation, par exemple la propagation de l'eau dans une roche poreuse. Une loi des grands nombres est connue : pour chaque direction x , on peut définir une constante de temps $\mu_G(x)$ qui correspond à l'inverse de la vitesse asymptotique de propagation dans la direction x . Nous étudions les propriétés de régularité de $G \mapsto \mu_G$. En particulier, nous étudions comment la distance de graphe dans \mathcal{C}_p évolue avec p . Dans une troisième partie, nous considérons une deuxième interprétation du modèle de percolation de premier passage où chaque arête du graphe est munie indépendamment d'une capacité aléatoire distribuée selon une loi G . La capacité d'une arête est la quantité maximale d'eau qui peut circuler dans l'arête par seconde. Pour $v \in \mathbb{R}^d$ unitaire, une loi des grands nombres existe : on peut définir la constante de flux $\nu_G(v)$ dans la direction v comme étant le débit asymptotique maximal d'eau qui peut être envoyé dans la direction v par unité de surface. Nous montrons une loi des grands nombres pour le débit maximal d'eau qu'une source convexe compacte peut envoyer à l'infini. Le problème dual du flux maximal est celui des surfaces de coupures de capacité minimale, il s'agit d'ensembles d'arêtes séparant les sources des puits qui limitent la transmission du flux en agissant comme un goulot d'étranglement ; toutes leurs arêtes sont saturées. Dans le cas particulier où $G(\{0\}) > 1 - p_c$, nous montrons une loi des grands nombres pour la taille des surfaces de coupure minimale liées au flux maximal dans un cylindre plat où le haut et le bas du cylindre correspondent respectivement à la source et au puits.

Mots-clés : Percolation, percolation de premier passage, constante isopérimétrique, flux maximal, coupure minimale, constante de temps

Percolation and first passage percolation: isoperimetric, time and flow constants

Abstract: In this thesis, we study the models of percolation and first passage percolation on the graph \mathbb{Z}^d , $d \geq 2$. In a first part, we study isoperimetric properties of the infinite cluster \mathcal{C}_p of percolation of parameter $p > p_c$. Conditioning on the event $\{0 \in \mathcal{C}_p\}$, the anchored isoperimetric constant $\varphi_p(n)$ corresponds to the infimum over all connected subgraph of \mathcal{C}_p containing 0 of size at most n^d , of the boundary size to volume ratio. We prove that $n\varphi_p(n)$ converges when n goes to infinity towards a deterministic constant φ_p , which is the solution of an anisotropic isoperimetric problem in the continuous setting. We also study the behavior of the anchored isoperimetric constant at p_c , and the regularity of the map $p \mapsto \varphi_p$ for $p > p_c$. In a second part, we study a first interpretation of the first passage percolation model where to each edge of the graph, we assign independently a random passage time distributed according to a given law G . This interpretation of first passage percolation models propagation phenomenon such as the propagation of water in a porous medium. A law of large numbers is known: for any given direction x , we can define a time constant $\mu_G(x)$ that corresponds to the inverse of the asymptotic propagation speed in the direction x . We study the regularity properties of the map $G \mapsto \mu_G$. In particular, we study how the graph distance in \mathcal{C}_p evolves with p . In a third part, we consider a second interpretation of the first passage percolation model where to each edge we assign independently a random capacity distributed according to a given law G . The capacity of an edge is the maximal amount of water that can cross the edge per second. For a given vector v of unit norm, a law of large numbers is known: we can define the flow constant $\nu_G(v)$ in the direction v as the asymptotic maximal amount of water that can flow per second in the direction v per unit of surface. We prove a law of large numbers for the maximal flow from a compact convex source to infinity. The problem of maximal flow is dual to the problem of finding minimal cutset. A minimal cutset is a set of edges separating the sinks from the sources that limits the flow propagation by acting as a bottleneck: all its edges are saturated. In the special case where $G(\{0\}) > 1 - p_c$, we prove a law of large numbers for the size of minimal cutsets associated with the maximal flow in a flat cylinder, where its top and bottom correspond respectively to the source and the sink.

Keywords: Percolation, first passage percolation, isoperimetric constant, maximal flow, minimal cutset, time constant

Remerciements

Je souhaiterais tout d'abord remercier ma directrice de thèse, Marie Théret. Je me rends compte aujourd'hui de la chance que j'ai. Par sa gentillesse, sa pédagogie, sa disponibilité, elle a créé les conditions qui m'ont permis de m'épanouir pleinement dans mes recherches, de progresser et de gagner en confiance. J'ai été très impressionnée par sa vision globale et sa maîtrise technique. Je suis infiniment reconnaissante pour tous ses bons conseils et pour l'investissement qu'elle a fourni qui va bien au-delà des mathématiques.

Je tiens également à remercier Raphaël Cerf de m'avoir initié à la percolation pendant son excellent cours de M2. Je le remercie de m'avoir orienté vers Marie Théret pendant ma recherche de directeur de thèse. Je le remercie pour sa gentillesse et pour sa disponibilité au cours des quatre mois où il m'a accueilli à l'ENS. Nos discussions mathématiques m'auront beaucoup apporté. Sa rigueur, sa technique et sa détermination ont été une vraie source d'inspiration.

Je remercie Christopher Hoffman et Nathanaël Enriquez d'avoir accepté de rapporter cette thèse. Je les remercie pour le temps consacré à la relecture de ce manuscrit et pour leurs remarques pertinentes. Je remercie Francis Comets, David Coupier, Olivier Garet, Lucas Gerin et Vincent Tassion de me faire l'honneur de faire partie de mon jury.

Je remercie Vincent Tassion et Wendelin Werner pour leur bienveillance lors de ma venue à Zürich et de m'accueillir l'année prochaine. Merci également à Daniel, Hugo, Laurin et Vincent d'avoir égayé mes vendredis confinés par nos discussions.

Je voudrais également remercier tous les membres de l'ANR PPPP de m'avoir chaleureusement accueilli dans le groupe. Les rendez-vous ANR auront joué un rôle important dans ma thèse. J'y ai beaucoup appris dans une bonne ambiance. Un merci particulier à Jean-Baptiste Gouéré et Régine Marchand pour ces moments passés à travailler ensemble.

Je remercie tous les professeurs de mathématiques que j'ai eu dans ma scolarité et qui ont cru en moi. En particulier, je souhaiterais remercier ma professeur de lycée, Juliette Brun-Leloup de m'avoir apporté un soutien inconditionnel, elle a été un modèle pour moi. Merci aux professeurs de l'Ecole Polytechnique de m'avoir donné envie de faire des probabilités. Un grand merci également à toute l'équipe enseignante du M2 d'Orsay, en particulier Nicolas Curien, pour s'être si bien occupé de nous.

Je remercie infiniment tous ceux avec qui j'ai partagé mon bureau : Abdel, Clément, Marc, Simon, Ziad. Il est clair que sans eux, la thèse aurait été beaucoup moins amusante (et moins calorique). Un grand merci à Ziad et Marc qui ont toujours pris le temps de répondre à mes questions d'analyse. Je remercie également tous les autres doctorants du labo : Antoine, Araona, As-saf, Benjamin, Bohdan, Clément, Côme, Cyril, Enzo, Fabio, Guillaume, Hiroshi, Houzhi, Junchao, Laure, Lucas, Mi-Song, Mohan, Sothea, Sylvain, Yann, Yiyang. Je remercie Wei et l'Université de Chengdu pour l'invitation. Je remercie également mes autres oncles de thèse Nicolas et Maxime ainsi que tous ceux avec qui j'ai partagé un bureau à l'ENS : Chenlin, Jessica, Maxence, Mickaël, Paul, Théophile. Merci à tous ceux que j'ai pu rencontrer pendant diverses conférences. Un merci tout particulier à Ivailo et Wei (encore) avec qui j'ai eu la chance de travailler.

Un grand merci à Nathalie Bergame et Valérie Juve, l'équipe administrative de Paris Diderot, pour leur gentillesse, leur patience et leur efficacité.

Je souhaiterais vivement remercier l'Association Séphora Berrebi pour la bourse que j'ai reçue ainsi que pour toutes les actions qu'elle entreprend.

Je remercie tous mes amis et ma famille d'avoir été présents le long de ses trois années, de m'avoir permis de trouver un équilibre. Je les remercie d'avoir fait l'effort d'essayer de comprendre ce que je faisais.

Pour finir, je souhaiterais remercier Alejandro, le meilleur cobaye de présentation, pour tout ce qu'il m'a apporté ces dernières années.

Contents

CHAPTER 1 — Introduction	11
1 Percolation	11
1.1 Introduction of the model	11
1.2 Isoperimetry of the infinite cluster	12
2 First passage percolation: first interpretation	15
2.1 Time constant	15
2.2 Limit shape	19
2.3 Length of a geodesic	20
2.4 Regularity of the time constant	21
3 First passage percolation: second interpretation	22
3.1 Admissible streams, minimal cutsets and maximal flows	22
3.2 Flow constant	24
3.3 Size of a minimal cutset	29
3.4 Large deviations results for maximal flows	30
3.5 Maximal flow to infinity	32
4 Contributions	33
4.1 Isoperimetry of the infinite cluster	33
4.2 First passage percolation: first interpretation	39
4.3 First passage percolation : second interpretation	40
Part I Isoperimetry of the infinite cluster	45
CHAPTER 2 — Existence of the anchored isoperimetric profile of the infinite cluster in supercritical bond percolation	47
1 Introduction	47
2 Some definitions and useful results	52
2.1 Geometric notations	52
2.2 Sets of finite perimeter and surface energy	52
2.3 Approximation by convex polytopes	53
3 Construction of the norm	54
4 Upper large deviations	55
5 Construction of a continuous object	61
5.1 Some useful results on the minimizers	61
5.2 Construction of a continuous set	62
5.3 Closeness of measures	68
6 Lower large deviations and shape Theorem	72
6.1 Closeness to the set of Wulff shapes	72
6.2 Proof of theorem 1.5	83
6.3 Proof of theorem 1.2	86
CHAPTER 3 — Vanishing of the anchored isoperimetric profile in bond percolation at p_c	89
1 Introduction	89

2	Proofs	91
CHAPTER 4 — Anchored isoperimetric profile of the infinite cluster in supercritical bond percolation is Lipschitz continuous		95
1	Introduction	95
1.1	Flow constant	95
1.2	Anchored isoperimetric profile	96
2	Definition of the norm β_p	98
3	Regularity of the map $p \mapsto \beta_p$	99
4	Proof of theorems 1.3 and 1.5	100
5	Proof of theorem 3.1	103
Part II Regularity of the time constant		107
CHAPTER 5 — Regularity of the time constant for a supercritical Bernoulli percolation		109
1	Introduction	109
2	Definitions and preliminary results	112
3	Modification of a path	113
3.1	Definition of the renormalization process	113
3.2	Construction of bypasses	114
3.3	Deterministic estimate	117
4	Control of the probability that a box is good	118
5	Probabilistic estimates	120
6	Regularity of the time constant	125
CHAPTER 6 — The time constant is Lipschitz continuous strictly above p_c		131
1	Introduction	131
2	Definitions and preliminary results	135
3	Renormalization	136
3.1	Definition of the renormalization process	136
3.2	Construction of the detours	137
4	Control of the probability of being a bad box	144
5	Conclusion	152
5.1	Bernoulli case: Proof of theorem 1.2	152
5.2	General distributions case	156
Part III Flow constant		159
CHAPTER 7 — The maximal flow from a compact convex subset to infinity in first passage percolation on \mathbb{Z}^d		161
1	Introduction	161
2	The model	164
2.1	The environment	164
2.2	Maximal flow	164
2.3	The max-flow min-cut theorem	165
3	Some notations and useful results	165
3.1	Geometric notations	165
3.2	Sets of finite perimeter and surface energy	166
3.3	Approximation by convex polytopes	167
4	Background on maximal flow	168
5	Upper large deviations	169
5.1	The case of a cylinder	169
5.2	Proof of theorem 1.3	171

6	Existence of a minimal cutset	173
7	Lower large deviations	176
8	Identification of ϕ_A	182
CHAPTER 8 — Size of a minimal cutset in supercritical first passage percolation		185
1	Introduction	185
2	Definition, background and main results	186
2.1	Definition of maximal flows and minimal cutsets	186
2.2	Background on maximal flows	189
2.3	Background on the minimal length of a geodesic and the minimal size of a minimal cutset	190
2.4	Main result and idea of the proof	192
2.5	More notations and useful results	193
2.6	Concentration inequality	193
3	Definition of an alternative flow	194
4	Subadditive argument	195
5	From slabs to cylinders	200
6	Concentration	204

Chapter 1

Introduction

1 Percolation

1.1 Introduction of the model

The model of percolation was introduced in 1957 by Broadbent and Hammersley in [18]. It aims to study the circulation of water in a porous medium at a microscopic level. A porous medium is a rock with microscopic holes. We immerse the rock in the water. Given the density of holes, will the center of the rock be wet? The model of percolation was introduced to give a rigorous answer to this question. This model may be defined on the lattice \mathbb{Z}^d as follows. Let $d \geq 2$. We consider the graph $(\mathbb{Z}^d, \mathbb{E}^d)$ having for vertices \mathbb{Z}^d and for edges \mathbb{E}^d the set of pairs of nearest neighbors in \mathbb{Z}^d for the Euclidean norm. To each edge $e \in \mathbb{E}^d$ we assign a Bernoulli random variable $B(e)$ of parameter $p \in [0, 1]$ so that the family $(B(e), e \in \mathbb{E}^d)$ is independent. If $B(e) = 1$, we say that the edge $e \in \mathbb{E}^d$ is open, *i.e.*, the water can flow through e . Otherwise, we say that the edge is closed. The parameter p may be interpreted as the density of microscopic tubes that let the water flows through the rock. We can define the random graph \mathcal{G}_p having for vertices \mathbb{Z}^d and for edges the set $\{e \in \mathbb{E}^d : B(e) = 1\}$.

Notice that this model is translation invariant in law. Any point in \mathbb{Z}^d sees in law the same environment. Thus, without loss of generality, we can consider that 0 corresponds to the center of the rock. Because the tubes are microscopic, from the point of view of the center of the rock, the exterior of the rock is infinitely far away. If we denote by $\mathcal{C}_p(0)$ the connected component of 0 in \mathcal{G}_p , we consider that the center of the rock is wet if $\mathcal{C}_p(0)$ is infinite. We define the probability of percolation $\theta(p)$ as

$$\theta(p) = \mathbb{P}(|\mathcal{C}_p(0)| = \infty).$$

The value $\theta(p)$ corresponds to the probability that the center of the rock is wet. One can prove (by coupling) that the function $p \mapsto \theta(p)$ is non-decreasing. Roughly speaking, the larger the density p is, the more open edges there are, and so the bigger $\mathcal{C}_p(0)$ is. Define the critical parameter $p_c(d)$ as

$$p_c(d) = \sup \{ p : \theta(p) = 0 \}.$$

One can prove that $p_c(d) \in]0, 1[$. This model exhibits a phase transition at $p_c(d)$, *i.e.*, there is a change of behavior of the model whether $p > p_c(d)$ or $p < p_c(d)$:

- **Sub-critical regime:** When $p < p_c(d)$, we have $\theta(p) = 0$ and almost surely there is no infinite connected component in \mathcal{G}_p . The water only circulates at a microscopic scale.
- **Supercritical regime:** When $p > p_c(d)$, we have $\theta(p) > 0$ and almost surely there exists a unique infinite cluster \mathcal{C}_p in \mathcal{G}_p . The existence of an infinite connected component implies the circulation of the water through the medium at a macroscopic scale.

These results are classical and may be found for instance in the book of Grimmett [47].

Open question 1.1. For $d = 3$, prove the non-existence of an infinite connected component at $p_c(3)$.

This question has already been solved for $d = 2$ and large $d \geq 11$. This is probably one of the most important question of the domain but it is still out of reach.

In the sub-critical regime, all the connected components are finite. We have the following result on the size of the connected components (originally due to Aizenman-Barsky [8] and Menshikov [58], and revisited by Duminil-Copin, Tassion [36] and Duminil-Copin, Raoufi, Tassion [35]).

Theorem 1.2 (Theorems (6.1) and (6.75) in [47]). *Let $p < p_c(d)$, there exist positive constants C_1 and C_2 such that*

$$\forall n \geq 1 \quad \mathbb{P}(|\mathcal{C}_p(0)| \geq n) \leq C_1 \exp(-C_2 n).$$

In the supercritical regime, there exists a unique infinite cluster \mathcal{C}_p , there exists also finite connected components disjoint of \mathcal{C}_p . The existence of a very big finite connected component is very unlikely. We have the following theorem:

Theorem 1.3 (Cerf [19]). *Let $p > p_c(d)$, there exist positive constants C_1 and C_2 such that*

$$\forall n \geq 1 \quad \mathbb{P}(n^d \leq |\mathcal{C}_p(0)| < \infty) \leq C_1 \exp(-C_2 n^{d-1}).$$

Intuitively, to isolate n^d vertices of the cluster of $\mathcal{C}_p(0)$ from the whole infinite cluster, we need a closed surface that separates 0 to infinity. The more likely configurations on the event $\{n^d \leq |\mathcal{C}_p(0)| < \infty\}$ are the ones with the closed surface of "minimal energy". Understanding the geometry of surface of minimal energy is strongly linked to the study of isoperimetric problem which is the purpose of the following section.

1.2 Isoperimetry of the infinite cluster

1.2.1 Isoperimetry in the continuous setting

Isoperimetric problems are among the oldest problems in mathematics. They consist in finding sets that maximize the volume given a constraint on the perimeter or equivalently that minimize the perimeter to volume ratio given a constraint on the volume. These problems can be formulated in the anisotropic case. Given a norm ν on \mathbb{R}^d and S a continuous subset of \mathbb{R}^d having a regular boundary, we define the tension exerted on S at a point x in the boundary ∂S of S to be $\nu(n_S(x))n_S(x)$, where $n_S(x)$ is the exterior unit normal vector of S at x . The quantity $\nu(n_S(x))$ corresponds to the intensity of the tension that is exerted at x . We define the surface energy $\mathcal{I}_\nu(S)$ of S as the integral of the intensity of the surface tension over the boundary ∂S of S , *i.e.*,

$$\mathcal{I}_\nu(S) = \int_{\partial S} \nu(n_S(x)) \mathcal{H}^{d-1}(dx),$$

where \mathcal{H}^{d-1} denotes the Hausdorff measure in dimension $d - 1$. An anisotropic isoperimetric problem consists in finding sets that minimize the surface energy to volume ratio given a constraint on the volume. Namely,

$$\text{minimize } \frac{\mathcal{I}_\nu(S)}{\mathcal{L}^d(S)} \text{ subject to } \mathcal{L}^d(S) \leq 1$$

where \mathcal{L}^d is the d -dimensional Lebesgue measure. To solve this problem, in [70], Wulff introduced through the Wulff construction a shape achieving the infimum. This shape is called the Wulff crystal \widehat{W}_ν , it corresponds to the unit ball for a norm built upon ν . The set \widehat{W}_ν is defined by

$$\widehat{W}_\nu = \bigcap_{v \in \mathbb{S}^{d-1}} \{x \in \mathbb{R}^d : x \cdot v \leq \nu(v)\},$$

where \cdot denotes the standard scalar product on \mathbb{R}^d and \mathbb{S}^{d-1} is the unit sphere of \mathbb{R}^d . Later, Taylor proved in [66] that this shape properly rescaled is the unique minimizer, up to translations and modifications on a null set, of the associated anisotropic isoperimetric problem.

1.2.2 Isoperimetric constant of graphs

The study of isoperimetric problems in the discrete setting is more recent. In the continuous setting, we study the perimeter to volume ratio, in the context of graphs, the analogous problem is the study of the size of edge boundary to volume ratio. This can be encoded by the Cheeger constant. For a finite graph $\mathcal{G} = (V(\mathcal{G}), E(\mathcal{G}))$ with vertices $V(\mathcal{G})$ and edges $E(\mathcal{G})$, we define the edge boundary $\partial_{\mathcal{G}}A$ of a subset A of $V(\mathcal{G})$ as

$$\partial_{\mathcal{G}}A = \left\{ e = \langle x, y \rangle \in E(\mathcal{G}) : x \in A, y \notin A \right\}.$$

We denote by ∂A the edge boundary of A in $(\mathbb{Z}^d, \mathbb{E}^d)$ and by $|B|$ the cardinal of the finite set B . The isoperimetric constant, also called Cheeger constant, is defined as

$$\varphi_{\mathcal{G}} = \min \left\{ \frac{|\partial_{\mathcal{G}}A|}{|A|} : A \subset V(\mathcal{G}), 0 < |A| \leq \frac{|V(\mathcal{G})|}{2} \right\}.$$

The continuous version of this constant was introduced by Cheeger in his thesis [29] in order to obtain a lower bound for the smallest eigenvalue of the Laplacian. The discrete version of the Cheeger constant was introduced by Alon, Milman [9] and Gabber, Galil [37]. The isoperimetric constant of a graph gives information on its geometry.

Let $d \geq 2$. Let $p > p_c(d)$. We want to study the geometry of \mathcal{C}_p through its Cheeger constant. However, if we minimize the isoperimetric ratio over all possible subgraphs of \mathcal{C}_p without any constraint on the size, one can show that $\varphi_{\mathcal{C}_p} = 0$ almost surely. For that reason, we shall minimize the isoperimetric ratio over all possible subgraphs of \mathcal{C}_p given a constraint on the size. There are several ways to do it. We can for instance study the Cheeger constant of the graph $\mathcal{C}_n = \mathcal{C}_p \cap [-n, n]^d$ or of the largest connected component $\tilde{\mathcal{C}}_n$ of \mathcal{C}_n for $n \geq 1$. As we have $\varphi_{\mathcal{C}_p} = 0$ almost surely, the isoperimetric constants $\varphi_{\mathcal{C}_n}$ and $\varphi_{\tilde{\mathcal{C}}_n}$ go to 0 when n goes to infinity. Benjamini and Mossel [13], Mathieu and Remy [57], Rau [61], Berger, Biskup, Hoffman and Kozma [14], Pete [59] proved that $\varphi_{\tilde{\mathcal{C}}_n}$ is of order n^{-1} . Roughly speaking, by analogy with the full lattice, we expect that with high probability that subgraphs of $\tilde{\mathcal{C}}_n$ that minimize the isoperimetric ratio have an edge boundary size of order n^{d-1} and a size of order n^d , this is coherent with the fact that $\varphi_{\tilde{\mathcal{C}}_n}$ is of order n^{-1} . This led Benjamini to conjecture that for $p > p_c(d)$, the limit of $n\varphi_{\tilde{\mathcal{C}}_n}$ when n goes to infinity exists and is a positive deterministic constant. Dealing with the isoperimetric ratio within \mathcal{C}_n needs to be done with caution. Indeed, we do not want minimizers to be close to the boundary $\partial\mathcal{C}_n$ of \mathcal{C}_n because this boundary is artificial, it does not coincide with $\partial_{\mathcal{C}_p}\mathcal{C}_n$. There is another way to define the Cheeger constant of \mathcal{C}_p , that is more natural in the sense that we do not restrict minimizers to remain in the box $[-n, n]^d$. This is called the anchored isoperimetric profile φ_n and it is defined by:

$$\varphi_n = \varphi_n(p) = \min \left\{ \frac{|\partial_{\mathcal{C}_p}H|}{|H|} : 0 \in H \subset \mathcal{C}_p, H \text{ connected}, 0 < |H| \leq n^d \right\},$$

where we condition on the event $\{0 \in \mathcal{C}_p\}$. We say that H is a valid subgraph if $0 \in H \subset \mathcal{C}_p$, H is connected and $|H| \leq n^d$. We also define

$$\partial^{\circ}H = \left\{ e \in \partial H, e \text{ is open} \right\}.$$

Note that if $H \subset \mathcal{C}_p$, then $\partial_{\mathcal{C}_p}H = \partial^{\circ}H$. To better understand the difference between the two definitions, let us consider the following deterministic subgraph of $(\mathbb{Z}^d, \mathbb{E}^d)$,

$$F = \left(\{x \in \mathbb{Z}^d : \forall i \in \{2, \dots, d\} x_i = 0\}, \{e = \{x, y\} \in \mathbb{E}^d : \forall i \in \{2, \dots, d\} x_i = y_i = 0\} \right).$$

Denote by $F_n = F \cap [-n, n]^d$. It is easy to check that φ_{F_n} is of order $1/n$ whereas its anchored isoperimetric constant is of order $1/n^d$. Roughly speaking, the fact that the anchored isoperimetric constant is of order $1/n$ implies that the underlying graph looks like a d -dimensional object whereas this does not necessarily hold for φ_{F_n} , the isoperimetric constant restricted to the box. Even if these two definitions lead to equivalent results for $p > p_c(d)$, the difference is crucial at $p_c(d)$. For

each n , let \mathcal{G}_n be the set of the valid subgraphs that achieve the infimum in φ_n . In this context, a minimizer $G_n \in \mathcal{G}_n$ can go potentially very far from 0. The minimizer G_n properly rescaled does not belong anymore to a compact set. This lack of compactness is the main issue to overcome to prove that the limit of $n\varphi_n$ exists. It was done in dimension 2 by Biskup, Louidor, Procaccia and Rosenthal in [15], with a norm $\beta_{p,2}$ which is specific to the dimension 2. Let $d_{\mathcal{H}}$ denote the L^∞ -Hausdorff metric on compact sets, *i.e.*, for A, B compact sets in \mathbb{R}^2

$$d_{\mathcal{H}}(A, B) = \max \left(\sup_{x \in A} \inf_{y \in B} \|x - y\|, \sup_{y \in B} \inf_{x \in A} \|x - y\| \right).$$

They proved the following results:

Theorem 1.4 (Theorems 1.2 and 1.7 in [15]). *There exists a constant φ_p that corresponds to the solution of an isoperimetric problem associated with the norm $\beta_{p,2}$ such that $\mathbb{P}(\cdot | \in \mathcal{C}_p)$ -almost surely,*

$$\lim_{n \rightarrow \infty} n^{1/2} \varphi_{\sqrt{n}} = \theta(p)^{-1/2} \varphi_p.$$

Moreover, we have uniform convergence of the minimizers of $\varphi_{\sqrt{n}}$ towards the dilate $W_{p,2}$ of $\widehat{W}_{\beta_{p,2}}$ of volume 1 in the following sense

$$\lim_{n \rightarrow \infty} \max_{G_n \in \hat{\mathcal{U}}_{\mathcal{C}_p}(\sqrt{n})} \inf_{x \in \mathbb{R}^2} d_{\mathcal{H}} \left(n^{-1/2} G_n, x + \theta(p)^{-1/2} W_{p,2} \right) = 0$$

where $\hat{\mathcal{U}}_{\mathcal{C}_p}(n)$ is the set of minimizers for φ_n .

Remark 1.5. *Note that the definition of the anchored isoperimetric constant φ_n we give here is slightly different from the one of [15]. They constrain the size of subgraphs to be at most n , whereas in the definition given here the size can be at most n^d .*

This result was extended by Gold in dimension $d \geq 3$ in [44]. Gold worked on the modified Cheeger constant $\widehat{\varphi}_n$, defined by

$$\widehat{\varphi}_n = \min \left\{ \frac{|\partial_{\mathcal{C}_p} H|}{|H|} : H \subset \mathcal{C}_n, 0 < |H| \leq |\mathcal{C}_n|/d! \right\}.$$

Instead of considering the open edge boundary of subgraphs within \mathcal{C}_n , Gold considered the open edge boundary within the whole infinite cluster \mathcal{C}_p , this is more natural because \mathcal{C}_n has been artificially created by restricting \mathcal{C}_p to the box $[-n, n]^d$. The author also added a stronger constraint on the size of subgraphs of \mathcal{C}_n to ensure that minimizers do not touch the boundary of the box $[-n, n]^d$. The author built a norm $\beta_{p,d}$ that is directly related to the open edge boundary. In some sense, this norm represents a surface tension in the percolation setting. We will explain later how to build this norm that requires tools from first passage percolation. We will denote by \mathcal{I}_p the surface energy associated with $\beta_{p,d}$. We define the Wulff crystal $W_{p,d}$ as the dilate of $\widehat{W}_{\beta_{p,d}}$ such that $\mathcal{L}^d(W_{p,d}) = 2^d/d!$. Gold proved the following theorem:

Theorem 1.6 (Theorems 1.2 and 1.3 in [44]). *Let $d \geq 3$ and $p > p_c(d)$. We have*

$$\lim_{n \rightarrow \infty} n \widehat{\varphi}_n = \frac{\mathcal{I}_p(W_{p,d})}{\theta(p) \mathcal{L}^d(W_{p,d})} \quad \text{almost surely.}$$

Moreover, we have L^1 -convergence of the minimizers $\widehat{\mathcal{G}}_n$ of $\widehat{\varphi}_n$ towards $W_{p,d}$ in the following sense

$$\lim_{n \rightarrow \infty} \max_{G_n \in \widehat{\mathcal{G}}_n} \inf_{x \in \mathbb{R}^d} \frac{1}{n^d} \left\| \mathbf{1}_{G_n} - \mathbf{1}_{\mathcal{C}_n \cap (x+nW_{p,d})} \right\|_{L^1} = 0 \quad \text{almost surely.}$$

The isoperimetric constant $\widehat{\varphi}_n$ properly renormalized converges when n goes to infinity to the solution of an anisotropic isoperimetric problem associated to the norm $\beta_{p,d}$. Moreover, any subgraph $G_n \in \widehat{\mathcal{G}}_n$ converges towards the shape that solves the isoperimetric problem associated with $\beta_{p,d}$.

2 First passage percolation: first interpretation

The model of first passage percolation was first introduced by Hammersley and Welsh [49] in 1965 as a model for the spread of a fluid in a porous medium. To each edge $e \in \mathbb{E}^d$ we assign a random variable $t_G(e)$ with values in \mathbb{R}^+ or even $\mathbb{R}^+ \cup \{+\infty\}$ so that the family $(t_G(e), e \in \mathbb{E}^d)$ is independent and identically distributed according to a given distribution G . The random variable $t_G(e)$ may be interpreted in several different ways and so model different problems.

One of the most commonly studied interpretation of the model of first passage percolation is to say that the random variable $t_G(e)$ represents a passage time, *i.e.*, the time needed to cross the edge e . We can define a random pseudo-metric T on the graph: for any pair of vertices $x, y \in \mathbb{Z}^d$, the random variable $T(x, y)$ is the shortest time to go from x to y , that is,

$$T(x, y) = \inf \left\{ \sum_{e \in \gamma} t_G(e) : \gamma \text{ path from } x \text{ to } y \right\},$$

where a path γ from x to y is a finite sequence $(v_0, e_1, v_1, \dots, e_n, v_n)$ of vertices $(v_i)_{i=0, \dots, n} \in (\mathbb{Z}^d)^{n+1}$ and edges $(e_i)_{i=1, \dots, n} \in (\mathbb{E}^d)^n$ where $v_0 = x$, $v_n = y$ and for any $1 \leq i \leq n$, $e_i = \langle v_{i-1}, v_i \rangle \in \mathbb{E}^d$ ($\langle v_{i-1}, v_i \rangle$ represents the edge whose endpoints are v_{i-1} and v_i). We define $|\gamma| = n$ the length of the path γ .

2.1 Time constant

2.1.1 Subadditive ergodic theorem

A natural question is to understand how this random pseudo-metric behaves. In particular, what is the asymptotic behavior of the quantity $T(0, nx)$ when n goes to infinity? Under some assumptions on the distribution G , one can prove that asymptotically when n is large, the random variable $T(0, nx)$ behaves like $n \mu_G(x)$ where $\mu_G(x)$ is a deterministic constant depending only on the distribution G and the point $x \in \mathbb{Z}^d$, *i.e.*,

$$\lim_{n \rightarrow \infty} \frac{T(0, nx)}{n} = \mu_G(x) \quad \text{almost surely and in } L^1$$

when this limit exists. This constant $\mu_G(x)$ is the so-called time constant in the direction x . This constant may be interpreted as an inverse speed in the direction x . The convergence of this quantity comes from the fact that the family $(T(nx, mx))_{1 \leq n \leq m}$ is sub-additive. Sub-additivity is a central notion in statistical mechanics. To get a better understanding of this notion, we can start with the deterministic setting with Fekete's lemma (whose proof is not complicated):

Lemma 2.1 (Fekete's lemma). *Let $(u_n)_{n \geq 1}$ be a sub-additive sequence of real numbers, that is, a sequence such that*

$$\forall n \geq 1 \quad \forall m \geq 1 \quad u_{n+m} \leq u_n + u_m.$$

Then,

$$\lim_{n \rightarrow \infty} \frac{u_n}{n} = \inf_{n \geq 1} \frac{u_n}{n} \in \mathbb{R} \cup \{-\infty\}.$$

We claim that the sequence of real numbers $(\mathbb{E}[T(0, nx)])_{n \geq 1}$ is sub-additive. Indeed, using the triangular inequality and taking the expectation, we get

$$\begin{aligned} \forall n \geq 1 \quad \forall m \geq 1 \quad \mathbb{E}[T(0, (n+m)x)] &\leq \mathbb{E}[T(0, nx)] + \mathbb{E}[T(nx, (n+m)x)] \\ &= \mathbb{E}[T(0, nx)] + \mathbb{E}[T(0, mx)] \end{aligned}$$

where we use in the last equality that the model is invariant in law under translations by a vector in \mathbb{Z}^d . It follows using Fekete's lemma that the limit of $\mathbb{E}[T(0, nx)]/n$ when n goes to infinity exists and is finite when $\mathbb{E}[T(0, x)] < \infty$. The proof of the convergence of $T(0, nx)/n$ requires more powerful tools. We need the following theorem that comes from ergodic theory (this version of the theorem is due to Liggett [56]):

Theorem 2.2 (Kingman's subadditive ergodic theorem). *Let $(X_{n,m}, 0 \leq n < m)$ be a collection of random variables such that*

- (i) $X_{l,n} \leq X_{l,m} + X_{m,n}$ whenever $0 \leq l < m < n$,
- (ii) For each $m \geq 0$, the joint distributions of $(X_{m,m+k}, k \geq 1)$ are the same as those of $(X_{m+1,m+k+1}, k \geq 1)$
- (iii) For each $k \geq 1$, the sequence $(X_{nk,(n+1)k}, n \geq 0)$ is stationary and ergodic.
- (iv) For each $n \geq 1$, $\mathbb{E}[|X_{0,n}|] < \infty$ and $\mathbb{E}[X_{0,n}] \geq -cn$ for some constant c .

Then

$$\lim_{n \rightarrow \infty} \frac{X_{0,n}}{n} = \lim_{n \rightarrow \infty} \frac{\mathbb{E}[X_{0,n}]}{n} = \inf_{n \geq 1} \frac{\mathbb{E}[X_{0,n}]}{n} \quad \text{a.s. and in } L^1.$$

Let $x \in \mathbb{Z}^d$, consider the sequence $(T(nx, mx), 0 \leq n < m)$. Thanks to the triangular inequality, this sequence satisfies the condition (i). Because the environment $(t_G(e))_{e \in \mathbb{E}^d}$ is i.i.d., the sequence also satisfies the conditions (ii) and (iii). When the distribution G has a first moment, i.e., $\mathbb{E}[t_G(e)] < \infty$, then

$$\mathbb{E}[T(0, nx)] \leq \|nx\|_1 \mathbb{E}[t_G(e)] < +\infty$$

and condition (iv) is satisfied. It follows that

$$\lim_{n \rightarrow \infty} \frac{T(0, nx)}{n} = \lim_{n \rightarrow \infty} \frac{\mathbb{E}[T(0, nx)]}{n} = \mu_G(x) \quad \text{a.s. and in } L^1.$$

The subadditive ergodic theorem is a powerful tool but it has two main limitations: it cannot be applied to irrational $x \in \mathbb{R}^d$ (even with an extension of the definition of $T(nx, mx)$, because of properties (ii) and (iii)) and it cannot be applied to a distribution G without a first moment. We review here the state of the art of how these issues have been circumvented.

2.1.2 Extend μ_G to \mathbb{R}^d

Let us assume G is integrable, i.e.,

$$\int_{\mathbb{R}_+} x dG(x) < +\infty.$$

Let us start with rational points in \mathbb{R}^d . Let $x \in \mathbb{Q}^d$ and $N \geq 1$ such that $Nx \in \mathbb{Z}^d$. It follows that

$$\mu_G(Nx) = \lim_{n \rightarrow \infty} \frac{T(0, nNx)}{n} = N \lim_{n \rightarrow \infty} \frac{T(0, nNx)}{Nn} = N \lim_{n \rightarrow \infty} \frac{T(0, nx)}{n} = N\mu_G(x).$$

Hence,

$$\mu_G(x) = \frac{\mu_G(Nx)}{N}.$$

By the same arguments, one can prove that

$$\forall r \in \mathbb{Q} \quad \forall x \in \mathbb{Q}^d \quad \mu_G(rx) = r\mu_G(x). \quad (2.1)$$

Now that μ_G is defined on \mathbb{Q}^d , we need to prove that the map $x \mapsto \mu_G(x)$ in order to define μ_G is continuous on the whole \mathbb{R}^d . Denote by $(\vec{e}_1, \dots, \vec{e}_d)$ the canonical basis of \mathbb{R}^d . Let $x \in \mathbb{Q}^d$, we can write

$$x = \sum_{i=1}^d \lambda_i \vec{e}_i, \quad \lambda_i \in \mathbb{Q}, 1 \leq i \leq d.$$

By triangular inequality and inequality (2.1), we have

$$\mu_G(x) \leq \sum_{i=1}^d |\lambda_i| \mu_G(\vec{e}_i).$$

Since μ_G is invariant under permutation of the coordinate axes, it yields that

$$\mu_G(x) \leq \sum_{i=1}^d |\lambda_i| \mu_G(\vec{e}_i) \leq \|x\|_1 \mu_G(\vec{e}_1).$$

Moreover, by triangular inequality, we have

$$\forall x, y \in \mathbb{Q}^d \quad \mu_G(y) \leq \mu_G(x) + \mu_G(y - x).$$

It follows that

$$\forall x, y \in \mathbb{Q}^d \quad |\mu_G(y) - \mu_G(x)| \leq \mu_G(y - x) \leq \mu_G(\vec{e}_1) \|y - x\|_1.$$

The latter inequality enables to extend μ_G to \mathbb{R}^d by continuity and density of \mathbb{Q}^d in \mathbb{R}^d . We can prove that for any $r \geq 0$ and $x \in \mathbb{R}^d$, we have $\mu_G(rx) = r\mu_G(x)$.

2.1.3 Define μ_G for general distributions

Actually, it is possible to apply theorem 2.2 with a weaker condition than the integrability of G . Kesten proved in theorem 2.18 in [51] that under the condition that

$$\mathbb{E}[\min(t_1, \dots, t_{2d})] \leq +\infty \tag{2.2}$$

where $(t_i, 1 \leq i \leq 2d)$ are i.i.d. copies of $t_G(e)$, we can apply theorem 2.2. The condition (2.2) is necessary for $T(0, nx)$ to be integrable since any path that achieves the infimum in $T(0, nx)$ has to cross an edge incident to 0 and nx . One can prove that the condition (2.2) is a sufficient condition for $T(0, nx)$ to be integrable. Besides, this condition is also necessary to obtain the almost sure convergence of $T(0, nx)/n$. Indeed, let us assume that

$$\mathbb{E}[\min(t_1, \dots, t_{2d})] = \infty.$$

Let us denote by X_n the smallest passage times of the edges incident to $2ne_1$. It follows that $(X_n, n \geq 1)$ is an i.i.d. sequence such that $\mathbb{E}[X_1] = +\infty$. Let $c > 0$. We have

$$\sum_{n \geq 1} \mathbb{P}(X_n > cn) = \sum_{n \geq 1} \mathbb{E}[\mathbb{1}_{X_1 > cn}] = \mathbb{E} \left[\sum_{n \geq 1} \mathbb{1}_{X_1 > cn} \right] \geq \mathbb{E} \left[\frac{X_1}{c} - 1 \right] = +\infty.$$

Since the events $\{X_n > cn\}$ are independent for $n \geq 1$, it follows by Borel-Cantelli's lemma that

$$\limsup_{n \rightarrow \infty} \frac{X_n}{n} > c$$

and

$$\forall c > 0 \quad \limsup_{n \rightarrow \infty} \frac{T(0, ne_1)}{n} \geq \limsup_{n \rightarrow \infty} \frac{T(0, 2ne_1)}{2n} \geq \limsup_{n \rightarrow \infty} \frac{X_n}{n} > c.$$

We would like to define μ_G even if the distribution G does not have good integrability properties. As we have seen above, the problem comes from the fact that a path between 0 and nx cannot avoid edges incident to 0 and nx . To circumvent this issue, we need to consider an auxiliary distance \tilde{T} with good integrability properties to be able to apply theorem 2.2. Next, we compare \tilde{T} and T to be able to deduce weaker convergence theorem for T . The auxiliary distance \tilde{T} will boil down to consider paths between points in the neighborhood of 0 and nx in such a way that we avoid edges with large passage times.

Let M be large enough such that $G([M, +\infty]) < p_c(d) \leq 1/2$. Since $G([0, M]) > 1 - p_c(d) \geq p_c(d)$, there exists an infinite cluster \mathcal{C}_M made of edges whose passage times are smaller than M . The idea of Cox and Kesten [33] is to build a good shell $S(x)$ for x , which is a set of edges such that any path from x to infinity has to use at least one edge of $S(x)$. Moreover, the passage times of edges in $S(x)$ is strictly smaller than M and $S(x) \cap \mathcal{C}_M \neq \emptyset$. We refer to [33] for a precise definition of $S(x)$.

Remark 2.3. *The construction of such shells is possible because $G([M, +\infty]) < p_c(d)$. When $G([M, +\infty]) > p_c(d)$, with positive probability there exists a path from 0 to infinity made with edges of passage time larger than M , in this case, we cannot build a shell $S(0)$.*

Finally, we set

$$\forall x, y \in \mathbb{Z}^d \quad \tilde{T}(x, y) = \inf \{T(r) : r \text{ is a path that joins } S(x) \text{ to } S(y)\}.$$

Since $S(0), S(nx) \cap \mathcal{C}_M \neq \emptyset$, there exists a path r in \mathcal{C}_M that joins $S(0)$ and $S(nx)$. One can then prove that with high probability we can choose r such that $|r| \leq Cn\|x\|_2$ (see [10]) and

$$\tilde{T}(0, nx) \leq T(r) \leq M|r| \leq CMn\|x\|_2$$

for some positive constant C . It follows that the sequence $(\tilde{T}(nx, mx), 0 \leq n \leq m)$ satisfies property (iv) of theorem 2.2. It is easy to check that the other properties are also satisfied. Hence, there exists a constant $\tilde{\mu}_G$ such that

$$\forall x \in \mathbb{Z}^d \quad \lim_{n \rightarrow \infty} \frac{\tilde{T}(0, nx)}{n} = \lim_{n \rightarrow \infty} \frac{\mathbb{E}[\tilde{T}(0, n)]}{n} = \tilde{\mu}_G(x) \quad \text{a.s. and in } L^1.$$

For distributions G that satisfy condition (2.2), the time to go from 0 to $S(0)$ and to go from $S(nx)$ to nx is upper bounded by $C_1 \log n$ with high probability, where C_1 is a positive constant. Besides, with high probability the total size of the shells $S(0)$ and $S(nx)$ are upper-bounded by $C_2 \log n$ where C_2 is a positive constant. It follows that

$$\lim_{n \rightarrow \infty} \frac{|\tilde{T}(0, nx) - T(0, nx)|}{n} = 0 \quad \text{a.s.}$$

So actually, $\mu_G = \tilde{\mu}_G$ and we can write μ_G instead of $\tilde{\mu}_G$.

With this technique, we can still not give a sense to μ_G for distributions G with a large atom in $+\infty$. An edge with infinite passage time corresponds to a closed edge in the classical model of percolation, that is an edge we cannot cross because it takes an infinite time to cross it. In particular, the study of the pseudo-metric T for a distribution $p\delta_1 + (1-p)\delta_\infty$ for $p > p_c(d)$ is equivalent to the study of the graph distance in \mathcal{G}_p (the graph made of open edges in the percolation of parameter p). In that context, if $1-p > p_c(d)$, then one cannot find an M such that $G([M, +\infty]) < p_c(d)$.

There is another way to define μ_G for any distribution such that $G(\{+\infty\}) < 1 - p_c(d)$. To get around the fact that the passage time between two points can take infinite values, we introduce a regularized time \hat{T} . Instead of considering the time between two points x and y , we will consider the time of regularized version of x and y . We can define the regularized time constant as in [28]. Let M be large enough such that $G([0, M]) > p_c(d)$. We denote by \mathcal{C}_M the infinite cluster made of edges of passage time smaller than M . We define \hat{x} as the vertex of \mathcal{C}_M which minimizes $\|x - \hat{x}\|_1$, with a deterministic rule to break ties. We next set

$$\forall x, y \in \mathbb{Z}^d \quad \hat{T}(x, y) = T(\hat{x}, \hat{y}). \quad (2.3)$$

Let us denote by $D^{\mathcal{C}_M}$ the graph distance in \mathcal{C}_M , *i.e.*,

$$\forall x, y \in \mathcal{C}_M \quad D^{\mathcal{C}_M}(x, y) = \inf \{|\gamma| : \gamma \text{ is a path between } x \text{ and } y \text{ in } \mathcal{C}_M\}.$$

It follows that for $x, y \in \mathbb{Z}^d$,

$$\hat{T}(x, y) = T(\hat{x}, \hat{y}) \leq MD^{\mathcal{C}_M}(x, y) < \infty.$$

The latter inequality ensures that condition (iv) of theorem 2.2 holds since $D^{\mathcal{C}_M}(0, nx)$ is with high probability smaller than $Cn\|x\|_1$ with C a positive constant (see [10]). For distributions G that satisfy condition (2.2), one can prove that

$$\lim_{n \rightarrow \infty} \frac{|\hat{T}(0, nx) - T(0, nx)|}{n} = 0 \quad \text{a.s.}$$

It follows that for distributions G that satisfy condition (2.2), the limit $\hat{\mu}_G$ we obtain using theorem 2.2 for the sequence $(\hat{T}(nx, mx), 0 \leq n \leq m)$ coincides with μ_G .

Actually one can prove that $\hat{\mu}_G$ does not depend on \mathcal{C}_M , the infinite cluster we use to regularize the time, we could have used a different infinite cluster. This is done in lemma 2.11 in [42].

In [39], Garet and Marchand give another way to deal with infinite passage times. They presented it as a model of first passage percolation in random environment: instead of considering a first passage percolation with a distribution on $[0, +\infty]$, they consider first a Bernoulli percolation on \mathbb{E}^d of parameter $p > p_c(d)$, and then they associate to each remaining edge e a finite passage time $t_G(e)$ such that the family $(t_G(e), e \in \mathbb{E}^d)$ is stationary and ergodic. If $x, y \in \mathbb{Z}^d$ don't belong to the same open cluster of percolation, then $T(x, y) = +\infty$. To be able to define a limit of $T(0, nx)/n$ when n goes to infinity for $x \in \mathbb{Q}^d$, they work with $\bar{\mathbb{P}}$ the probability conditioned on the event $\{0 \in \mathcal{C}_p\}$. For a given rational direction $x \in \mathbb{Q}^d$, they consider a sequence $(x_n, n \geq 1)$ of points in \mathbb{Z}^d in the direction of x (that is proportional to x) that belong to \mathcal{C}_p such that $\|x_n\|_2$ goes to infinity when n goes to infinity. They proved that the limit of $T(0, x_n)$ properly renormalized when n goes to infinity converges $\bar{\mathbb{P}}$ -almost surely towards a deterministic constant $\mu'_G(x)$.

2.2 Limit shape

In [51], Kesten proved the following theorem.

Theorem 2.4 (Kesten [51]). *The time constant μ_G is a norm on \mathbb{R}^d if and only if $G(\{0\}) < p_c(d)$.*

When $G(\{0\}) > p_c(d)$, it is not hard to understand why $\mu_G = 0$: there exists an infinite cluster \mathcal{C} of edges of null passage time. With high probability, the geodesic between 0 and nx is made of null passage time edges except at most $C \log n$ edges, where C is a positive constant. It follows that

$$\lim_{n \rightarrow \infty} \frac{T(0, nx)}{n} = 0 \quad \text{almost surely and in } L^1.$$

The case $G(\{0\}) = p_c(d)$ is much more delicate to handle. For $t \geq 0$, denote $\mathcal{B}(t)$ the set of points that can be reached starting from 0 before time t , *i.e.*,

$$\mathcal{B}(t) = \left\{ x \in \mathbb{Z}^d : T(0, x) \leq t \right\} + \left[-\frac{1}{2}, \frac{1}{2} \right]^d.$$

This may represent the spread of an infection, the infection starts at the point 0 before time t and propagates from neighbors to neighbors. The set $\mathcal{B}(t) \cap \mathbb{Z}^d$ represents the vertices that have been infected at time t . Fix $x \in \mathbb{Q}^d$. We have for large enough t depending on x , $T(0, tx/\mu_G(x)) \approx \mu_G(tx/\mu_G(x)) = t$. This means that for t large enough the furthest point attained in the direction of x by $\mathcal{B}(t)$ is close to $tx/\mu_G(x)$. If the convergence is uniform in all directions, then an asymptotic shape emerges. This was first proved by Cox and Durrett in [32].

Theorem 2.5 (Cox-Durrett [32]). *Let G be a distribution on \mathbb{R}^+ such that $G(\{0\}) < p_c(d)$ and*

$$\mathbb{E}[\min(t_1^d, \dots, t_{2d}^d)] < \infty \tag{2.4}$$

where $t_i, i = 1, \dots, 2d$, are independent copies of $t_G(e)$. Then there exists a deterministic convex compact shape \mathcal{B}_{μ_G} in \mathbb{R}^d such that

$$\forall \varepsilon > 0 \quad \text{a.s.} \quad \exists t_0 > 0 \quad \forall t \geq t_0 \quad (1 - \varepsilon)\mathcal{B}_{\mu_G} \subset \frac{\mathcal{B}(t)}{t} \subset (1 + \varepsilon)\mathcal{B}_{\mu_G}.$$

Furthermore, \mathcal{B}_{μ_G} is the unit ball for the norm μ_G , it has non-empty interior and is symmetric about the axes of \mathbb{R}^d .

To prove this theorem, we need to interpolate between the rational directions to obtain the linear growth of $\mathcal{B}(t)$ for the irrational directions. We can apply the subadditive ergodic theorem to a fixed rational direction to obtain the linear growth of $\mathcal{B}(t)$ in that direction. It follows that with probability one, the linear growth holds simultaneously for the countable dense set of rational

directions. To be able to interpolate, we need also a control on the time between two points depending on their distance in the original graph.

Note that the condition (2.4) for G is necessary to obtain the theorem. However, this shape theorem still holds in a weaker sense for distributions G that do not have good integrability property using the pseudo-metric \widehat{T} (that was defined in (2.3)). Define :

$$\widehat{\mathcal{B}}(t) = \{x \in \mathbb{Z}^d : \widehat{T}(0, x) \leq t\} + \left[-\frac{1}{2}, \frac{1}{2}\right]^d.$$

In [28], Cerf and Th  ret obtained a strong theorem for $\widehat{\mathcal{B}}(t)$.

Theorem 2.6 (Cerf-Th  ret [28]). *Suppose that $G([0, +\infty]) > p_c(d)$ and $G(\{0\}) < p_c(d)$, then*

$$\forall \varepsilon > 0, \text{ a.s.}, \exists t_0 \in \mathbb{R}^+ \text{ s.t. } \forall t \geq t_0 \quad (1 - \varepsilon)\mathcal{B}_{\mu_G} \subset \frac{\widehat{\mathcal{B}}(t)}{t} \subset (1 + \varepsilon)\mathcal{B}_{\mu_G}.$$

They also proved a weak shape theorem for $\mathcal{B}(t)$.

Theorem 2.7 (Cerf-Th  ret [28]). *Suppose that $G([0, +\infty]) > p_c(d)$ and $G(\{0\}) < p_c(d)$. Denote \mathcal{C}_∞ the infinite cluster for the percolation $(\mathbb{1}_{t_G(e) < \infty}, e \in \mathbb{E}^d)$. On the event $\{0 \in \mathcal{C}_\infty\}$, we have a.s. the following weak convergence:*

$$\frac{1}{t^d} \sum_{x \in \mathcal{B}(t) \cap \mathbb{Z}^d} \delta_{x/t} \xrightarrow[t \rightarrow \infty]{} \theta(G([0, +\infty])\mathbb{1}_{\mathcal{B}_{\mu_G}}) \mathcal{L}^d.$$

There are a lot of open questions about this limit shape. Since there are not the purpose of this thesis, we refer to [11] for open questions related to the limit shape.

2.3 Length of a geodesic

Let us first quickly present the background on the minimal length of a geodesic. We denote by $N_G(x, y)$ the minimal length of a geodesic between x and y :

$$N_G(x, y) = \inf \{ |\gamma| : \gamma \text{ is a geodesic between } x \text{ and } y \}.$$

One can ask how does $N_G(0, nx)$ grow when n goes to infinity. It is expected to grow at speed n . This result was first proved by Zhang and Zhang in dimension 2 in [74] when $G(\{0\}) > p_c(d)$ (thus $\mu_G = 0$). They proved the following theorem.

Theorem 2.8 (Zhang-Zhang [74]). *Let $d = 2$. Let G be a distribution on \mathbb{R}_+ such that $G(\{0\}) > p_c(d)$. We have*

$$\lim_{n \rightarrow \infty} \frac{N_G((0, 0), (0, n))}{n} = \lambda_{G(\{0\})} \text{ a.s. and in } L^1$$

where $\lambda_{G(\{0\})}$ depends only on $G(\{0\})$.

Zhang later extended this result to all dimensions under the condition that $G(\{0\}) > p_c(d)$ in [71]. When $G(\{0\}) < p_c(d)$, the question of the convergence of $N_G(0, nx)/n$ is still open. However, we know that with high probability $N_G(0, nx)$ is of order n . This result is due to Kesten, it is a corollary of Proposition (5.8) in [51].

Theorem 2.9 (Kesten [51]). *Let G be a distribution such that $G(\{0\}) < p_c(d)$, then there exist positive constants A, B, C depending on d and G only such that*

$$\forall n \geq 1 \quad \mathbb{P} \left(\begin{array}{l} \text{There exists a path } r \text{ starting from } 0 \\ \text{such that } |r| \geq n \text{ and } T(r) < Cn \end{array} \right) \leq A \exp(-Bn).$$

Open question 2.10. *Prove the convergence of $N_G(0, nx)/n$ when n goes to infinity when $G(\{0\}) < p_c(d)$.*

2.4 Regularity of the time constant

Since μ_G does not have an explicit expression, it is natural to ask how μ_G is affected by small perturbations of the distribution G . Besides, the regularity result on μ_G gives also information on the limit shape, namely, how the limit shape changes under small perturbations of G . As mentioned in [11] before Theorem 2.7.: "If one could derive strong results in this direction, perhaps the establishment of various conjectures about the limit shape (e.g., curvature) could be made easier, or reduced to finding some special class of distributions for which the properties are explicitly derivable." To be able to deduce results on the stability of the curvature under small perturbations, we need to obtain regularity on the second derivative of $G \mapsto \mu_G$.

To prove the continuity of the map $G \mapsto \mu_G$, we often need to use the same technology we have used to prove the existence of the time constant μ_G . The question of the continuity of the map $G \mapsto \mu_G$ started in dimension 2 with the article of Cox [31].

He proved the continuity of this map under the hypothesis of uniform integrability: if G_n weakly converges toward G and if there exists an integrable law F such that for all $n \in \mathbb{N}$, F stochastically dominates G_n , then $\mu_{G_n} \rightarrow \mu_G$. In [33], Cox and Kesten proved the continuity of this map in dimension 2 without any integrability condition. A key step to prove the continuity is the proof of the following lemma:

Lemma 2.11. *Let G be a distribution on $\mathbb{R}_+ \cup \{+\infty\}$ such that $G([0, +\infty]) > p_c(d)$. For $M > 0$, let $G^M = G\mathbf{1}_{[0, M]} + G([M, +\infty])\delta_M$, then*

$$\forall x \in \mathbb{Z}^d \quad \lim_{M \rightarrow \infty} \mu_{G^M}(x) = \mu_G(x).$$

The idea of Cox and Kesten was to consider a geodesic for truncated passage times $\min(t_G(e), M)$ for a large $M > 0$, and along it to avoid clusters of closed edges, *i.e.*, edges with a passage time larger than M . They bypass these closed edges in their associated good shell (that were loosely defined for the existence of μ_G in section 2.1.3). Note that by construction, the edges in the boundary of the shells have passage time smaller than M . Thanks to combinatorial considerations, they were able to obtain a precise control on the length of these bypasses. This idea was later extended to all the dimensions $d \geq 2$ by Kesten in [51], by taking a M large enough such that the percolation of the edges with a passage time larger than M is highly sub-critical, *i.e.*, $G([M, +\infty]) < p_c(d)$. For such a M , the edges of passage time large than M are in a sub-critical regime of percolation on \mathbb{Z}^d : the clusters of edges of passage time larger than M are all almost surely finite. To each edge we can associate a shell made of edges of passage time smaller than M . However, this idea does not work anymore when we allow passage time to take infinite values. Indeed, if $G(\{+\infty\}) > p_c(d)$, we cannot find a positive $M > 0$ such that $G([M, +\infty]) < p_c(d)$. In [42], Garet, Marchand, Procaccia and Th  ret circumvent this issue and proved the continuity of the map $G \rightarrow \mu_G$ for general laws on $[0, +\infty]$ without any moment condition but satisfying $G([0, +\infty]) > p_c(d)$.

Theorem 2.12 (Garet-Marchand-Procaccia-Th  ret [42]). *Let $(G_n)_{n \in \mathbb{N}}$, and G be probability measures on $[0, +\infty]$ such that G_n weakly converges toward G (we write $G_n \xrightarrow{d} G$), that is to say for all continuous bounded functions $f : [0, +\infty] \rightarrow [0, +\infty[$, we have*

$$\lim_{n \rightarrow +\infty} \int_{[0, +\infty]} f dG_n = \int_{[0, +\infty]} f dG.$$

Equivalently, we say that $G_n \xrightarrow{d} G$ if and only if $\lim_{n \rightarrow +\infty} G_n([t, +\infty]) = G([t, +\infty])$ for all $t \in [0, +\infty]$ such that $x \rightarrow G([x, +\infty])$ is continuous at t . If moreover for all $n \in \mathbb{N}$, $G_n([0, +\infty]) > p_c(d)$ and $G([0, +\infty]) > p_c(d)$, then

$$\lim_{n \rightarrow \infty} \sup_{x \in \mathbb{S}^{d-1}} |\mu_{G_n}(x) - \mu_G(x)| = 0$$

where \mathbb{S}^{d-1} is the unit sphere for the Euclidean norm.

Again, the key step of this theorem lies in the proof of lemma 2.11 for distributions G on $[0, +\infty]$ such that $G([0, +\infty]) > p_c(d)$. They consider a geodesic for truncated passage times $\min(t_G(e), M)$ for $M > 0$. Here, instead of bypassing closed edges at a microscopic scale, they do it at a macroscopic scale by building macroscopic shells (see figure 1.1). This idea finds its inspiration in the works of Antal and Pisztora [60] and Cox and Kesten [33]. They have to consider an appropriate renormalization and obtain a macroscopic lattice with good and bad sites. Good and bad sites correspond to boxes of size N in the microscopic lattice. They do their bypasses using good sites at a macroscopic scale that have good connectivity properties at a microscopic scale. The remainder of the proof consists in getting probabilistic estimates of the length of the bypass by upper-bounding the total size of connected bad components at a macroscopic scale that the geodesic crosses.

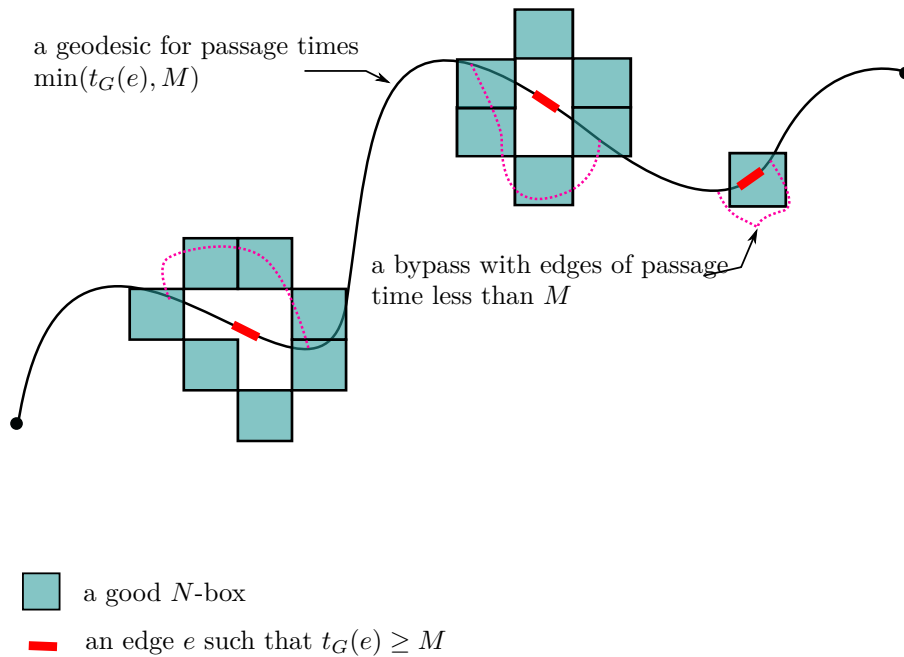

Figure 1.1 – Bypassing edges with passage time larger than M of a geodesic for truncated times at a macroscopic scale

3 First passage percolation: second interpretation

There exists another interpretation of the first passage percolation model whose study started much later. It was introduced by Grimmett and Kesten in [45]. Now we interpret the random variable $t_G(e)$ as a maximum flow rate, *i.e.*, it corresponds to the maximal amount of water that can cross the edge e per second. The study of this model enables to understand the maximal amount of water per second -that we will call maximal flow- that can be spread through in a given domain of the network.

3.1 Admissible streams, minimal cutsets and maximal flows

Let us give a more formal setting for the study of maximal flows. Let $\Omega = (V_\Omega, E_\Omega)$ be a finite subgraph of $(\mathbb{Z}^d, \mathbb{E}^d)$. We can see Ω as a piece of rock through which water can flow. Let \mathfrak{S}_1 and \mathfrak{S}_2 be two disjoint subsets of V_Ω representing respectively the sources through which the water can enter and the sinks through which the water can exit. A stream f is a function defined on \mathbb{E}^d that describes the way water flows in the lattice. Namely, for each edge e , the quantity $f(e)$ gives information on the rate of flow through the edge e and the orientation of the circulation of the

water. Let the function $f : \mathbb{E}^d \rightarrow \mathbb{R}^d$ be a possible stream inside Ω between \mathfrak{G}_1 and \mathfrak{G}_2 . For all $e \in \mathbb{E}^d$, $\|f(e)\|_2$ represents the amount of water that flows through e per second and $f(e)/\|f(e)\|_2$ represents the direction in which the water flows through e . If we write $e = \langle x, y \rangle$ where x, y are neighbors in the graph $(\mathbb{Z}^d, \mathbb{E}^d)$, then the unit vector $f(e)/\|f(e)\|_2$ is either the vector \vec{xy} or \vec{yx} . We say that our stream f inside Ω from \mathfrak{G}_1 to \mathfrak{G}_2 is G -admissible if and only if it satisfies the following constraints.

- *The node law* : for every vertex x in $V_\Omega \setminus (\mathfrak{G}_1 \cup \mathfrak{G}_2)$, we have

$$\sum_{y \in \mathbb{Z}^d : e = \langle x, y \rangle \in E_\Omega} \|f(e)\|_2 \left(\mathbf{1}_{\frac{f(e)}{\|f(e)\|_2} = \vec{xy}} - \mathbf{1}_{\frac{f(e)}{\|f(e)\|_2} = \vec{yx}} \right) = 0,$$

i.e., there is no loss of fluid inside Ω .

- *The capacity constraint*: for every edge e in E_Ω , we have

$$0 \leq \|f(e)\|_2 \leq t_G(e),$$

i.e., the amount of water that flows through e per second is limited by its capacity $t_G(e)$.

Note that as the capacities are random, the set of G -admissible streams inside Ω between \mathfrak{G}_1 and \mathfrak{G}_2 is also random. For each G -admissible stream f , we define its flow by

$$\text{flow}(f) = \sum_{x \in \mathfrak{G}_1} \sum_{y \in \mathbb{Z}^d : e = \langle x, y \rangle \in E_\Omega} \|f(e)\|_2 \left(\mathbf{1}_{\frac{f(e)}{\|f(e)\|_2} = \vec{xy}} - \mathbf{1}_{\frac{f(e)}{\|f(e)\|_2} = \vec{yx}} \right).$$

This corresponds to the amount of water that enters in Ω through \mathfrak{G}_1 per second. By the node law, as there is no loss of fluid, $\text{flow}(f)$ is also equal to the amount of water that escapes from Ω through \mathfrak{G}_2 per second:

$$\text{flow}(f) = \sum_{x \in \mathfrak{G}_2} \sum_{y \in \mathbb{Z}^d : e = \langle x, y \rangle \in E_\Omega} \|f(e)\|_2 \left(\mathbf{1}_{\frac{f(e)}{\|f(e)\|_2} = \vec{yx}} - \mathbf{1}_{\frac{f(e)}{\|f(e)\|_2} = \vec{xy}} \right).$$

The maximal flow from \mathfrak{G}_1 to \mathfrak{G}_2 in Ω for the capacities $(t_G(e))_{e \in \mathbb{E}^d}$, denoted by $\phi_G(\mathfrak{G}_1 \rightarrow \mathfrak{G}_2$ in $\Omega)$, is the supremum of the flow over all admissible streams through Ω :

$$\phi_G(\mathfrak{G}_1 \rightarrow \mathfrak{G}_2 \text{ in } \Omega) = \sup \left\{ \text{flow}(f) : \begin{array}{l} f \text{ is a } G\text{-admissible stream inside} \\ \Omega \text{ between } \mathfrak{G}_1 \text{ and } \mathfrak{G}_2 \end{array} \right\}.$$

Dealing with admissible streams is not so easy, but hopefully we can use an alternative definition of the maximal flow which is more convenient. Let $E \subset E_\Omega$ be a set of edges. We say that E cuts \mathfrak{G}_1 from \mathfrak{G}_2 in Ω (or is a cutset, for short) if there is no path from \mathfrak{G}_1 to \mathfrak{G}_2 in $(V_\Omega, E_\Omega \setminus E)$. More precisely, E cuts \mathfrak{G}_1 from \mathfrak{G}_2 in Ω if for any path γ from \mathfrak{G}_1 to \mathfrak{G}_2 in Ω , we have $\gamma \cap E \neq \emptyset$. We associate with any set of edges E its capacity $\text{cap}(E)$ defined by

$$\text{cap}(E) = \sum_{e \in E} t_G(e).$$

The max-flow min-cut theorem, see [16], a result of graph theory, states that

$$\phi_G(\mathfrak{G}_1 \rightarrow \mathfrak{G}_2 \text{ in } \Omega) = \min \{ \text{cap}(E) : E \text{ cuts } \mathfrak{G}_1 \text{ from } \mathfrak{G}_2 \text{ in } \Omega \}.$$

The idea behind this theorem is quite intuitive. By the node law, the flow is always smaller than the capacity of any cutset. Conversely, consider a maximal flow through Ω , some of the edges are jammed. We say that e is jammed if the amount of water that flows through e is equal to the capacity $t_G(e)$. These jammed edges form a cutset, otherwise we would be able to find a path γ from \mathfrak{G}_1 to \mathfrak{G}_2 of non-jammed edges, and we could increase the amount of water that flows through γ which contradicts the fact that the flow is maximal. Thus, the maximal flow is limited by the capacity of these jammed edges: the maximal flow is given by one of the $\text{cap}(E)$ where E cuts \mathfrak{G}_1 from \mathfrak{G}_2 in Ω . It follows that the maximal flow is equal to the minimal capacity of a cutset.

In [52], Kesten interpreted the study of maximal flow as a higher dimensional version of the study of geodesics in first passage percolation. A geodesic may be considered as an object of dimension 1, it is a path with minimal passage time. On the contrary, the maximal flow is associated (via the max-flow min-cut theorem) with cutsets of minimal capacity: those cutsets are objects of dimension $d - 1$, that can be seen as surfaces. To better understand the interpretation in term of surfaces, we can associate with each edge e a small plaquette e^* . The plaquette e^* is an hypersquare of dimension $d - 1$ whose sides have length one and are parallel to the edges of the graphs, such that e^* is normal to e and cuts it in its middle (see figure 1.2). We associate with the plaquette e^* the same capacity $t_G(e)$ as with the edge e . We also define the dual of a set of edge E by $E^* = \{e^*, e \in E\}$. Roughly speaking, if the set of edges E cuts \mathfrak{G}_1 from \mathfrak{G}_2 in Ω , the surface of plaquettes E^* disconnects \mathfrak{G}_1 from \mathfrak{G}_2 in Ω (see figure 1.2). Although this interpretation in terms of surfaces seems more intuitive than cutsets, it is really technical to handle, and we will never use it and not even try to give a rigorous definition of a surface of plaquettes. However, note that in dimension 2, a surface of plaquettes is very similar to a path in the dual graph of \mathbb{Z}^2 and thus the study of minimal cutsets is very similar to the study of geodesics and simpler to study.

3.2 Flow constant

We are interested in the maximal flow ϕ_G that can cross a cylinder oriented according to $\vec{v} \in \mathbb{S}^{d-1}$ from its top to its bottom. A first issue is to understand if the maximal flow in the box properly renormalized converges when the size of the box grows to infinity. This boils down to understand the maximal amount of water that can flow in the direction \vec{v} per second per unit of surface. We consider distributions G on $\mathbb{R}_+ \cup \{+\infty\}$ such that $G(\{+\infty\}) < p_c(d)$, *i.e.*, the edges of infinite capacity are in the sub-critical regime of percolation on \mathbb{Z}^d . Let us first define rigorously the maximal flow from the top to the bottom of a cylinder. Let A be a non-degenerate hyperrectangle, *i.e.*, a rectangle of dimension $d - 1$ in \mathbb{R}^d . Let \vec{v} be one of the two unit vectors normal to A . Let $h > 0$, we denote by $\text{cyl}(A, h)$ the cylinder of basis A and height h defined by

$$\text{cyl}(A, h) = \{x + t\vec{v} : x \in A, t \in [0, h]\}.$$

We denote by ∂A the relative boundary of A . We define $\text{cyl}(\partial A, h)$ as

$$\text{cyl}(\partial A, h) = \{x + t\vec{v} : x \in \partial A, t \in [0, h]\}.$$

The dependence on \vec{v} is implicit in the notation $\text{cyl}(A, h)$ and $\text{cyl}(\partial A, h)$. We have to define discretized versions of the bottom $B(A, h)$ and the top $T(A, h)$ of the cylinder $\text{cyl}(A, h)$. We define them by

$$B(A, h) := \left\{ x \in \mathbb{Z}^d \cap \text{cyl}(A, h) : \begin{array}{l} \exists y \notin \text{cyl}(A, h), \langle x, y \rangle \in \mathbb{E}^d \\ \text{and } \langle x, y \rangle \text{ intersects } A \end{array} \right\}$$

and

$$T(A, h) := \left\{ x \in \mathbb{Z}^d \cap \text{cyl}(A, h) : \begin{array}{l} \exists y \notin \text{cyl}(A, h), \langle x, y \rangle \in \mathbb{E}^d \\ \text{and } \langle x, y \rangle \text{ intersects } A + h\vec{v} \end{array} \right\}.$$

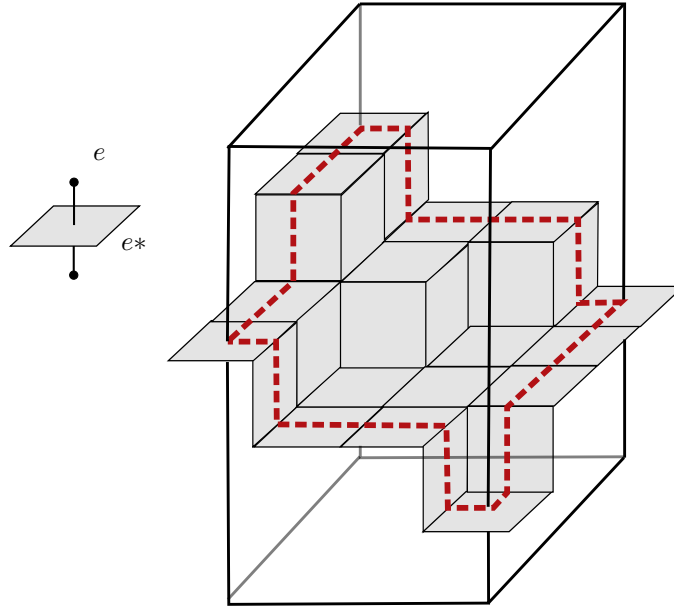

Figure 1.2 – The dual of a cutset between the top and the bottom of a box

We denote by $\Phi_G(A, h)$ the maximal flow from the top to the bottom of the cylinder $\text{cyl}(A, h)$ in the direction \vec{v} , defined by

$$\Phi_G(A, h) = \phi_G(T(A, h) \rightarrow B(A, h) \text{ in } \text{cyl}(A, h)).$$

In 1987, Kesten studied maximal flows in dimension 3 in [52] for straight boxes, *i.e.*, in the direction $\vec{v} = \vec{v}_0 := (0, 0, 1)$ and basis $A = [0, k] \times [0, l] \times \{0\}$ with $k \geq l \geq 0$. He proved the following theorem.

Theorem 3.1 (Kesten [52]). *Let $d = 3$. Let G be a distribution that admits an exponential moment and such that $G(\{0\})$ is small enough. Let $k \geq l$ and $m = m(k, l) \geq 1$. If $m(k, l)$ goes to infinity when k and l go to infinity in such a way there exists $\delta \in]0, 1[$, such that*

$$\lim_{k, l \rightarrow \infty} \frac{1}{k^\delta} \log m(k, l) = 0,$$

then

$$\lim_{k, l \rightarrow \infty} \frac{\Phi_G([0, k] \times [0, l] \times \{0\}, m(k, l))}{kl} = \nu_G \quad \text{with probability 1 and in } L^1$$

where ν_G is a constant depending only on d and G .

The proof is very technical and tries to give a rigorous meaning to the notion of surface. Moreover, it strongly relies on the fact that the symmetry of the straight boxes preserves the lattice, there is no hope to extend this technique to tilted cylinders. In [73], Zhang generalized the result of Kesten for $d \geq 3$ and $G(\{0\}) < 1 - p_c(d)$.

To be able to define the flow constant in any direction, we would like to use a subadditive ergodic theorem. However, the maximal flow $\phi_G(A, h)$ is not well suited to use ergodic subadditive theorems, because we cannot glue two cutsets from the top to the bottom of two adjacent cylinders together to build a cutset from the top to the bottom of the union of these two cylinders. Indeed, the intersection of these two cutsets with the adjacent face of the two cylinders will very likely not coincide.

To fix this issue, we need to introduce another maximal flow through the cylinder for which the subadditivity would be recover. To define this flow, we will first define another version of the cylinder which is more convenient. We define the cylinder $\text{cyl}'(A, h)$ by

$$\text{cyl}'(A, h) = \{x + t\vec{v} : x \in A, t \in [-h, h]\}.$$

The set $\text{cyl}'(A, h) \setminus A$ has two connected components denoted by $C_1(A, h)$ and $C_2(A, h)$. We have to define a discretized version of the boundaries of these two sets. For $i = 1, 2$, we denote by $C'_i(A, h)$ the discrete boundary of $C_i(A, h)$ defined by

$$C'_i(A, h) = \{ x \in \mathbb{Z}^d \cap C_i(A, h) : \exists y \notin \text{cyl}'(A, h), \langle x, y \rangle \in \mathbb{E}^d \}.$$

We call informally $C'_i(A, h)$, $i = 1, 2$, the upper and lower half part of the boundary of $\text{cyl}'(A, h)$. We denote by $\tau_G(A, h)$ the maximal flow from the upper half part to the lower half part of the boundary of the cylinder, *i.e.*,

$$\tau_G(A, h) = \phi_G(C'_1(A, h) \rightarrow C'_2(A, h) \text{ in } \text{cyl}'(A, h)).$$

By the max-flow min-cut theorem, the flow $\tau_G(A, h)$ is equal to the minimal capacity of a set of edges E that cuts $C'_1(A, h)$ from $C'_2(A, h)$ inside the cylinder $\text{cyl}'(A, h)$ (see figure 1.3). If we consider the dual set E^* of E , the intersection of E^* with the boundary of the cylinder has to be close to the relative boundary ∂A of the hyperrectangle A .

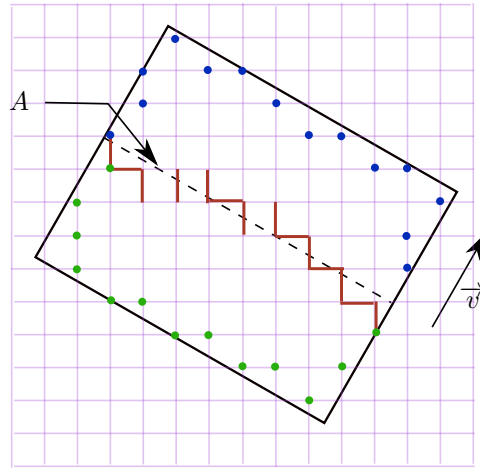

Figure 1.3 – The blue dots (respectively green dots) correspond to the discretization from the inside of the upper half boundary (resp. lower half boundary) of the cylinder of basis A oriented in the direction \vec{v} . The set of edges in red is a cutset between the upper and lower half of the boundary in the cylinder. Any path between a blue and a green dot that remains inside the cylinder has to cross at least one red edge.

The simplest case to study maximal flows is for a straight cylinder, *i.e.*, when $\vec{v} = \vec{v}_0 := (0, 0, \dots, 1)$ and $A = A(\vec{k}, \vec{l}) = \prod_{i=1}^{d-1} [k_i, l_i] \times \{0\}$ with $k_i \leq 0 < l_i \in \mathbb{Z}$. In this case, the family of variables $(\tau_G(A(\vec{k}, \vec{l}), h))_{\vec{k}, \vec{l}}$ is subadditive since minimal cutsets in adjacent cylinders can be glued together along the common side of these cylinders. By applying ergodic subadditive theorems in the multi-parameter case (see Krengel and Pyke [54] and Smythe [65]), we obtain the following result.

Proposition 3.2. *Let G be an integrable probability measure on \mathbb{R}_+ . Let $A = \prod_{i=1}^{d-1} [k_i, l_i] \times \{0\}$ with $k_i \leq 0 < l_i \in \mathbb{Z}$. Let $h : \mathbb{N} \rightarrow \mathbb{R}^+$ such that $\lim_{n \rightarrow \infty} h(n) = +\infty$. Then there exists a constant $\nu_G(\vec{v}_0)$, that does not depend on A and h but depends on G and d , such that*

$$\lim_{n \rightarrow \infty} \frac{\tau_G(nA, h(n))}{\mathcal{H}^{d-1}(nA)} = \nu_G(\vec{v}_0) \text{ a.s. and in } L^1.$$

The constant $\nu_G(\vec{v}_0)$ is called the flow constant.

Remark 3.3. *The fact that the constant $\nu_G(\vec{v}_0)$ does not depend on A and h is not a straightforward consequence of the multi-parameter ergodic subadditive theorem. However it is not hard to prove it.*

Next, a natural question to ask is whether we can define a flow constant for any direction. When we consider tilted cylinders, we cannot recover perfect subadditivity because of the discretization of the boundary. Moreover, the use of ergodic subadditive theorems is not possible when the direction \vec{v} we consider is not rational, *i.e.*, when there does not exist an integer M such that $M\vec{v}$ has integer coordinates. Indeed, in that case there exists no vector \vec{u} normal to \vec{v} such that the model is invariant under the translation of vector \vec{u} . These issues were overcome by Rossignol and Th  ret in [62] where they proved the following law of large numbers.

Theorem 3.4 (Rossignol-Th  ret [62]). *Let G be an integrable probability measure on \mathbb{R}_+ . For any $\vec{v} \in \mathbb{S}^{d-1}$, there exists a constant $\nu_G(\vec{v}) \in \mathbb{R}_+$ such that for any non-degenerate hyperrectangle A normal to \vec{v} , for any function $h : \mathbb{N} \rightarrow \mathbb{R}^+$ such that $\lim_{n \rightarrow \infty} h(n) = +\infty$, we have*

$$\lim_{n \rightarrow \infty} \frac{\tau_G(nA, h(n))}{\mathcal{H}^{d-1}(nA)} = \nu_G(\vec{v}) \text{ in } L^1.$$

If moreover the origin of the graph belongs to A , or if $\int_0^{+\infty} x^{1+1/(d-1)} dG(x) < \infty$, then

$$\lim_{n \rightarrow \infty} \frac{\tau_G(nA, h(n))}{\mathcal{H}^{d-1}(nA)} = \nu_G(\vec{v}) \text{ a.s..}$$

*If the cylinder is flat, *i.e.*, if $\lim_{n \rightarrow \infty} h(n)/n = 0$, then the same convergence also holds for $\Phi_G(nA, h(n))$.*

Moreover, either $\nu_G(\vec{v})$ is null for all $\vec{v} \in \mathbb{S}^{d-1}$ or $\nu_G(\vec{v}) > 0$ for all $\vec{v} \in \mathbb{S}^{d-1}$.

To prove this result, it is not possible to directly use an ergodic theorem, so the idea is to prove in the spirit of the first step of the proof of an ergodic theorem that $\mathbb{E}[\tau_G(nA, h(n))]/\mathcal{H}^{d-1}(nA)$ converges towards a constant when n goes to infinity and then prove concentration estimates for the random variable $\tau_G(nA, h(n))$, *i.e.*, that with high probability the random variable $\tau_G(nA, h(n))$ is close to its expectation $\mathbb{E}[\tau_G(nA, h(n))]$.

Remark 3.5. *When the cylinder is tilted and not flat, the limit of $\Phi_G(nA, h(n))/\mathcal{H}^{d-1}(nA)$ and $\tau_G(nA, h(n))/\mathcal{H}^{d-1}(nA)$ when n goes to infinity may likely not coincide. This has been proven for the dimension 2 by Rossignol and Th  ret in [63]. Intuitively, when the cylinder is flat the minimal surface looks like nA and at first order τ_G and Φ_G coincide. On the opposite, if the cylinder is not flat, there is a bigger region in which a cutset for $\Phi_G(nA, h(n))$ can be, the minimal surface for $\Phi_G(nA, h(n))$ can very likely not coincide at all with nA , whereas at first order, the minimal surface for $\tau_G(nA, h(n))$ still coincide with nA : since the corresponding cutsets are anchored near $\partial(nA)$, they stick to nA at first order.*

The answer to the following question is still unanswered:

Open question 3.6. *Let $d \geq 3$. When the cylinder is tilted and not flat, prove that the limit when n goes to infinity of $\Phi_G(nA, h(n))/\mathcal{H}^{d-1}(nA)$ is strictly smaller than $\nu_G(\vec{v})$.*

The existence of this limit is known when $h(n) = Cn$ as a special case of [27]. Proving this result requires to solve a deterministic optimization problem.

In [72], Zhang found a necessary and sufficient condition on G under which $\nu_G(\vec{v})$ is positive. He proved the following result.

Theorem 3.7 (Zhang [72]). *Let G be an integrable probability measure on \mathbb{R}_+ . Then, $\nu_G(\vec{v}) > 0$ if and only if $G(\{0\}) < 1 - p_c(d)$.*

Let us give an intuition of this result. If $G(\{0\}) > 1 - p_c(d)$ then the edges of positive capacity are in a sub-critical regime of bond percolation on \mathbb{Z}^d . With high probability, there exists no path in $\text{cyl}'(nA, h(n))$ from the upper to the lower half part of its boundary such that all its edges have positive capacity. It follows, that there exists a cutset of null capacity and so $\tau_G(nA, h(n)) = 0$. Thus, the fact that $\nu_G(\vec{v}) = 0$ is linked with the fact that the edges of positive capacity do not percolate. The main difficult part of this result is to study the critical case, *i.e.*, $G(\{0\}) = 1 - p_c(d)$.

Note that ν_G cannot be defined using τ_G for G without good integrability properties. We are faced with the same issue that we encountered for the time constant. Indeed, when we define the time constant with $T(0, nx)$ for $x \in \mathbb{Z}^d$, we cannot avoid edges incident to 0 and nx . The same issue arises here, with $\tau_G(nA, h(n))$, we cannot avoid edges around $\partial(nA)$ so if these edges have large capacities we won't have the integrability properties that we need in order to use subadditive arguments. To overcome this issue, Rossignol and Th  ret introduced in [64] another alternative flow with subadditive property. They are able to define the flow constant ν_G for any direction and dimension for distributions G on $[0, +\infty]$ under the hypothesis $G(\{+\infty\}) < p_c(d)$. They proved the following law of large numbers for the maximal flow from the top to the bottom of flat cylinders.

Theorem 3.8 (Rossignol-Th  ret [64]). *For any probability measure G on $[0, +\infty]$ such that $G(\{+\infty\}) < p_c(d)$, for any $\vec{v} \in \mathbb{S}^{d-1}$, there exists a constant $\nu_G(\vec{v}) \in \mathbb{R}_+$ such that for any non-degenerate hyperrectangle A normal to \vec{v} , for any function h such that $h(n)/\log n \rightarrow \infty$ and $h(n)/n \rightarrow 0$ when n goes to infinity, we have*

$$\lim_{n \rightarrow \infty} \frac{\Phi_G(nA, h(n))}{\mathcal{H}^{d-1}(nA)} = \nu_G(\vec{v}) \text{ a.s..}$$

Moreover, for every $\vec{v} \in \mathbb{S}^{d-1}$,

$$\nu_G(\vec{v}) > 0 \iff G(\{0\}) < 1 - p_c(d).$$

Instead of directly considering maximal flows in cylinder, Rossignol and Th  ret studied a different flow which is more convenient for two reasons: the flow introduced is subadditive and has good integrability properties. Moreover, it is close to the flow τ_G .

Let $\vec{v} \in \mathbb{S}^{d-1}$, and let A be any non-degenerate hyperrectangle normal to \vec{v} . We denote by $\text{hyp}(A)$ the hyperplane spanned by A defined by

$$\text{hyp}(A) = \{ x + \vec{w} : x \in A, \vec{w} \cdot \vec{v} = 0 \}$$

where \cdot denotes the usual scalar product on \mathbb{R}^d . For any $h > 0$, we denote by $\text{slab}(A, h, \vec{v})$ (resp. $\text{slab}(A, \infty, \vec{v})$) the slab of basis the hyperplane spanned by A and of height h (resp. of infinite height), *i.e.*, the subset of \mathbb{R}^d defined by

$$\text{slab}(A, h, \vec{v}) = \{ x + r\vec{v} : x \in \text{hyp}(A), r \in [0, h] \}.$$

Suppose that $G(\{+\infty\}) < p_c(d)$. Let $M \geq 0$ such that $G([M, +\infty]) < p_c(d)$. We define the random height $H_{G,M}(A)$ as follows

$$H_{G,M}(A) = \inf \left\{ h \geq \mathcal{H}^{d-1}(A)^{\frac{1}{2(d-1)}} : \begin{array}{l} \exists E \text{ cutset from } A \text{ to } \text{hyp}(A + h\vec{v}) \text{ in} \\ \text{slab}(A, h, \vec{v}) \text{ such that } \forall e \in E \ t_G(e) \leq M \end{array} \right\}.$$

We can now define the alternative flow $\Phi_{G,M}(A)$:

$$\Phi_{G,M}(A) = \inf \left\{ \text{cap}(E) : \begin{array}{l} E \text{ cutset from } A \text{ to } \text{hyp}(A + H_{G,M}(A)\vec{v}) \\ \text{in } \text{slab}(A, H_{G,M}(A), \vec{v}) \end{array} \right\}.$$

The idea is that the height $H_{G,M}(A)$ is large enough so that minimal cutsets from A to $\text{hyp}(A + H_{G,M}(A)\vec{v})$ in the slab can avoid edges with too large capacities. This ensures that the flow $\Phi_{G,M}$ has good integrability property: there exists $C > 0$ such that with high probability

$$\Phi_{G,M}(A) \leq CM\mathcal{H}^{d-1}(A).$$

Let us give an intuition of why this flow is subadditive. First notice that

$$A_1 \subset A_2 \implies H_{G,M}(A_1) \leq H_{G,M}(A_2).$$

To lighten the notations, from now on we write H instead of $H_{G,M}$. Let \vec{v} be a unit vector. Consider two hyperrectangles A and B of disjoint interior normal to \vec{v} such that the union $A \cup B$

is also an hyperrectangle. Let E_A be a cutset from A to $\text{hyp}(A + H(A)\vec{v})$ in $\text{slab}(A, H(A), \vec{v})$. Let E_B be a cutset from B to $\text{hyp}(B + H(B)\vec{v})$ in $\text{slab}(B, H(B), \vec{v})$. It is easy to check that $E_A \cup E_B$ is a cutset that separates $A \cup B$ from $\text{hyp}(A \cup B + H(A \cup B)\vec{v})$ in $\text{slab}(A \cup B, H(A \cup B), \vec{v})$ (see figure 1.4). Therefore, we have

$$\Phi_{G,M}(A \cup B) \leq \text{cap}(E_A \cup E_B) \leq \text{cap}(E_A) + \text{cap}(E_B) \leq \Phi_{G,M}(A) + \Phi_{G,M}(B).$$

This yields the subadditivity.

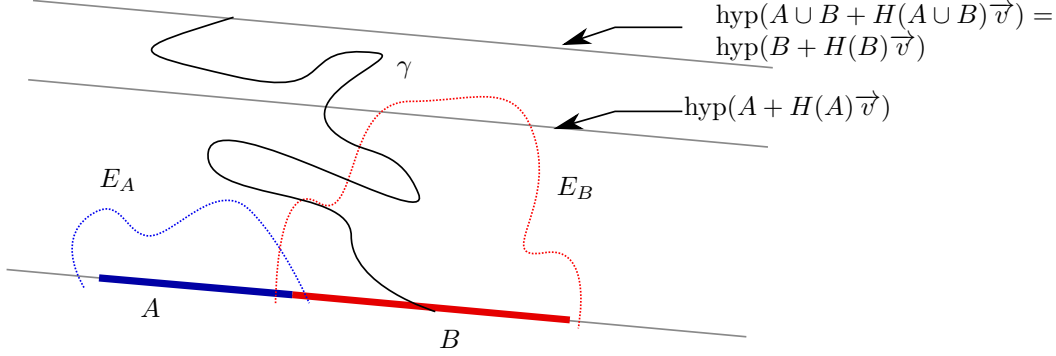

Figure 1.4 – Representation of E_A and E_B . Here $H(A \cup B) = H(B)$.

We can prove that with high probability, the random height $H(nA)$ is negligible compared to n and minimal cutsets for $\Phi_{G,M}(nA)$ and $\Phi_G(nA, h(n))$ have at first order the same capacity. It follows that

$$\lim_{n \rightarrow \infty} \frac{\Phi_{G,M}(nA)}{\mathcal{H}^{d-1}(nA)} = \lim_{n \rightarrow \infty} \frac{\Phi_G(nA, h(n))}{\mathcal{H}^{d-1}(nA)}.$$

Remark 3.9. *The flow $\Phi_{G,M}$ is the perfect trade-off between the flows Φ_G and τ_G . Indeed, the advantage of τ_G is that the corresponding cutsets are anchored near the boundary of ∂A and so it is a subadditive quantity. However being anchored near the boundary of ∂A requires that cutsets must contain the edges near ∂A , this is an issue when G does not have good integrability property. For the cutsets corresponding to the flow Φ_G it is the opposite: the trace of the cutset on the boundary is free so it can avoid edges with large capacities but we cannot recover subadditivity. Here the cutsets corresponding to $\Phi_{G,M}$ are anchored near ∂A in a looser way: the cutsets may avoid edges with large capacities around ∂A and it has a subadditive property.*

The flow constant ν_G satisfies a weak triangle inequality see proposition 3.4. in [64].

Proposition 3.10 (Weak triangle inequality for ν_G). *Let (ABC) be a non-degenerate triangle in \mathbb{R}^d and let $\vec{v}_A, \vec{v}_B, \vec{v}_C$ be the exterior normal unit vectors to the sides $[BC], [AC], [AB]$ in the plane spanned by A, B, C . Then,*

$$\mathcal{H}^1([BC])\nu_G(\vec{v}_A) \leq \mathcal{H}^1([AC])\nu_G(\vec{v}_B) + \mathcal{H}^1([AB])\nu_G(\vec{v}_C).$$

3.3 Size of a minimal cutset

Among all the cutsets of minimal capacity we are interested in the ones with the minimal cardinality:

$$\psi_G(A, h, \vec{v}) := \inf \left\{ |E| : \begin{array}{l} E \text{ cuts the top from the bottom of} \\ \text{cyl}(A, h) \text{ and } E \text{ has capacity } \Phi_G(A, h) \end{array} \right\}.$$

The quantity ψ_G is the analog of N_G in this context.

The study of the quantity $\psi_G(A, h, \vec{v})$ was initiated by Kesten in [52] in dimension 3 for straight boxes and distributions G such that $G(\{0\}) < p_0$ where p_0 is a small constant. Let $k, l, m \in \mathbb{N}$, we define the straight box $B(k, l, m) = [0, k] \times [0, l] \times [0, m]$. Kesten proved the following result.

Theorem 3.11 (Kesten [52]). *Let $k, l, m \in \mathbb{N}$. There exists a $p_0 > 1/27$ such that for all distributions G on \mathbb{R}_+ such that $G(\{0\}) < p_0$, there exist constants θ, C_1 and C_2 depending on G such that for all $n \geq 0$,*

$$\mathbb{P} \left(\begin{array}{l} \text{there exists a dual set } E^* \text{ of at least } n \text{ plaquettes that cuts} \\ \text{the top from the bottom of the box } B(k, l, m), \text{ which} \\ \text{contains the point } (-\frac{1}{2}, -\frac{1}{2}, \frac{1}{2}) \text{ and such that } \text{cap}(E^*) \leq \theta n \end{array} \right) \leq C_1 e^{-C_2 n}.$$

Zhang in [73] extended this result in all dimensions and for distributions G such that $G(\{0\}) < 1 - p_c(d)$ and with an exponential moment. He obtained the following result.

Theorem 3.12 (Zhang [73]). *Let G be a distribution on \mathbb{R}_+ such that for some $\eta > 0$,*

$$\int_{\mathbb{R}_+} \exp(\eta x) dG(x) < \infty$$

and $G(\{0\}) < 1 - p_c(d)$. Let $k_1, \dots, k_{d-1} \in \mathbb{N}$ and h with $\log h \leq k_1 \cdots k_{d-1}$. Let $A = \prod_{i=1}^{d-1} [0, k_i] \times \{0\}$. There exist constants $\beta \geq 1$ depending on G and d, C_1 and C_2 depending on G, d and β such that for all $\lambda > \beta \mathcal{H}^{d-1}(A)$,

$$\mathbb{P}(\psi_G(A, h, \vec{v}) > \lambda) \leq C_1 \exp(-C_2 \lambda).$$

Roughly speaking, his proof strategy is the following. If $\psi_G(A, h, \vec{v})$ is large, he can slightly modify the configuration to create blocking surfaces, *i.e.*, large surfaces of edges of null capacities. This is very unlikely when $G(\{0\}) < 1 - p_c(d)$ as edges of positive capacities percolate: it is indeed unlikely to obtain two adjacent big clusters of edges of positive capacity that are not connected because of this blocking surface. This proof relies crucially on the hypothesis $G(\{0\}) < 1 - p_c(d)$ and cannot be adapted to the case $G(\{0\}) \geq 1 - p_c(d)$. Moreover, this proof does not able to prove the existence of the limit of ψ_G properly renormalized when the size of the cylinder goes to infinity.

3.4 Large deviations results for maximal flows

3.4.1 Upper large deviations results

We present here some result on upper large deviations for the maximal flows $\Phi_G(nA, h(n))$ in cylinders and $\tau_G(nA, h(n))$. The theorem 4 in [68] states upper large deviations results for the variable $\Phi_G(nA, h(n))$ above the value $\nu_G(\vec{v})$.

Theorem 3.13 (Théret [68]). *Let us consider a distribution G on \mathbb{R}_+ that admits an exponential moment. Let \vec{v} be a unit vector and A be an hyperrectangle orthogonal to \vec{v} , let $h : \mathbb{N} \rightarrow \mathbb{R}_+$ be a height function such that $\lim_{n \rightarrow \infty} h(n) = +\infty$. We have for every $\lambda > \nu_G(\vec{v})$*

$$\liminf_{n \rightarrow \infty} -\frac{1}{\mathcal{H}^{d-1}(nA)h(n)} \log \mathbb{P} \left(\frac{\Phi_G(nA, h(n))}{\mathcal{H}^{d-1}(nA)} \geq \lambda \right) > 0.$$

Let us give an intuition of the speed of deviation. If $\Phi_G(nA, h(n))$ is abnormally large, there are two possible scenarios. Either there are an order n^{d-1} of paths from the top to the bottom of the cylinder that use edges of slightly abnormally large capacity, or there are a fewer number of paths from the top to the bottom of the cylinder with edges whose capacities are extremely big (with a capacity that goes to infinity with n). Both scenarios enable to transmit more water from the top to the bottom than the expected value. Actually, when G has an exponential moment, the first scenario is the most likely one. Since the paths from the top to the bottom have a cardinality of order at least $h(n)$, this implies that a positive fraction of edges inside the cylinder have a slightly abnormally large capacity. This accounts for the speed of deviation of volume order.

The corresponding large deviation principle has been obtained in the case of straight cylinders by Théret in [67].

Theorem 3.14 (Théret [67]). *Let $h : \mathbb{N} \rightarrow \mathbb{R}_+$ be a height function such that*

$$\lim_{n \rightarrow \infty} \frac{h(n)}{\log n} = +\infty.$$

Set $A = [0, 1]^{d-1} \times \{0\}$. Then for every $\lambda \geq 0$, the limit

$$\psi(\lambda) = \lim_{n \rightarrow \infty} -\frac{1}{n^{d-1}h(n)} \log \mathbb{P}(\Phi_G(nA, h(n)) \geq \lambda n^{d-1})$$

exists and is independent of h . Moreover, the function ψ is convex on \mathbb{R}_+ , finite and continuous on the set $\{\lambda : G([\lambda, +\infty]) > 0\}$. If G has a first moment then ψ vanishes on $[0, \nu_G((0, \dots, 0, 1))]$. If G has an exponential moment then ψ is strictly positive on $]\nu_G((0, \dots, 0, 1)), +\infty[$, and the sequence

$$\left(\frac{\Phi_G(nA, h(n))}{n^{d-1}} \right)_{n \geq 1}$$

satisfies a large deviation principle with speed $n^{d-1}h(n)$ and governed by the good rate function ψ .

This result crucially depends on the symmetry of the lattice with regards to reflexion along the vertical faces of the cylinders. The proof strategy may not be extended to tilted cylinders. The upper large deviations results for τ are a bit different because the speed of deviation depends on the tail of the distribution G . Indeed if the edges around ∂A have very large capacities it will increase the flow τ in a non negligible way. Since the minimal cutsets corresponding to $\tau_G(A, h)$ are anchored around ∂A , their capacity depends a lot on these edges. Théret proved in Theorem 3 in [68] upper large deviations of the variable τ .

Theorem 3.15 (Théret [68]). *Let \vec{v} be a unit vector and A be an hyperrectangle orthogonal to \vec{v} , let $h : \mathbb{N} \rightarrow \mathbb{R}_+$ be a height function such that $\lim_{n \rightarrow \infty} h(n) = +\infty$. The upper large deviations of $\tau_G(nA, h(n)) / \mathcal{H}^{d-1}(nA)$ depend on the tail of the distribution of the capacities. We have*

(i) *If the law G has bounded support, then for every $\lambda > \nu_G(\vec{v})$ we have*

$$\liminf_{n \rightarrow \infty} -\frac{1}{\mathcal{H}^{d-1}(nA) \min(h(n), n)} \log \mathbb{P}\left(\frac{\tau_G(nA, h(n))}{\mathcal{H}^{d-1}(nA)} \geq \lambda\right) > 0.$$

(ii) *If the law G is exponential of parameter 1, then there exists n_0 such that for every $\lambda > \nu_G(\vec{v})$ there exists a positive constant D depending on d and λ such that*

$$\forall n \geq n_0 \quad \mathbb{P}\left(\frac{\tau_G(nA, h(n))}{\mathcal{H}^{d-1}(nA)} \geq \lambda\right) \geq \exp(-D\mathcal{H}^{d-1}(nA)).$$

(iii) *If the law G satisfies*

$$\forall \theta > 0 \quad \int_{\mathbb{R}_+} e^{\theta x} dG(x) < \infty,$$

then for every $\lambda > \nu_G(\vec{v})$ we have

$$\lim_{n \rightarrow \infty} \frac{1}{\mathcal{H}^{d-1}(nA)} \log \mathbb{P}\left(\frac{\tau_G(nA, h(n))}{\mathcal{H}^{d-1}(nA)} \geq \lambda\right) = -\infty.$$

Let us give an intuition of why the speed is n^d when $h(n) \geq n$. Since the cutsets are anchored in $\partial(nA)$, they cannot deviate too far away from nA : as a result, most of the edges outside $\text{cyl}(nA, n)$ do not have an influence on $\tau_G(nA, h(n))$. Note that there is no existing result of large deviation principle for maximal flows τ_G or Φ_G for tilted cylinder.

3.4.2 Lower large deviations results

The order of large deviations is different in the case of lower large deviations which is of surface order. Intuitively, to create a lower large deviations event, it is enough to decrease the capacities of the edges along a surface. In [62], Rossignol and Th  ret proved the following theorem concerning lower large deviations of the variable $\tau_G(nA, h(n))$ below $\nu_G(\vec{v})$.

Theorem 3.16 (Rossignol-Th  ret [62]). *Suppose that G is integrable and such that $G(\{0\}) < 1 - p_c(d)$. Let $h : \mathbb{N} \rightarrow \mathbb{R}_+$ be a height function such that $\lim_{n \rightarrow \infty} h(n) = +\infty$. For every $\varepsilon > 0$ there exists a constant $K(d, G, \varepsilon)$ such that for every unit vector \vec{v} and every non-degenerate hyperrectangle A orthogonal to \vec{v} there exists a constant $K'(d, G, A, \varepsilon)$ such that*

$$\mathbb{P}\left(\frac{\tau_G(nA, h(n))}{\mathcal{H}^{d-1}(nA)} \leq \nu_G(\vec{v}) - \varepsilon\right) \leq K'(d, G, A, \varepsilon) \exp(-K(d, G, \varepsilon) \mathcal{H}^{d-1}(A) n^{d-1}).$$

Rossignol and Th  ret also proved a large deviation principle associated to τ in Theorem 3.10 in [62].

3.5 Maximal flow to infinity

Let us consider a compact convex subset A of \mathbb{R}^d . We interpret the set A as a source of water. We are interested in the maximal amount of water that can flow from the boundary ∂A of A to infinity per second. This issue is in fact analogous to the study of the smallest capacity denoted by $\text{mincut}(A, \infty)$ over sets of edges separating A from infinity: the amount of water that A can send to infinity will be limited by a surface of minimal capacity that surrounds A and will act like a bottleneck. We define $\mathcal{C}(A)$ the continuous capacity of ∂A as

$$\mathcal{C}(A) = \int_{\partial A} \nu_G(n_A(x)) d\mathcal{H}^{d-1}(x).$$

This problem was first studied in dimension 2 by Garet in [38], he proved the following theorem.

Theorem 3.17 (Garet [38]). *Let $d = 2$. Let G be a distribution that admits an exponential moment. Let $\varepsilon > 0$, there exist positive constants C_1 and C_2 such that*

$$\forall n \geq 1 \quad \mathbb{P}\left(\left|\frac{\text{mincut}(nA, \infty)}{n} - \mathcal{C}(A)\right| \geq \varepsilon\right) \leq C_1 \exp(-C_2 n).$$

The proof splits into two parts. The first part, the easiest one, consists in proving the upper large deviation part that is upper-bounding

$$\mathbb{P}(\text{mincut}(nA, \infty) \geq (1 + \varepsilon)\mathcal{C}(A)n).$$

To do so, on a high probability event we can build a set of edges separating nA from infinity whose capacity is arbitrarily close to $\mathcal{C}(A)n$. The lower large deviations, that is upper-bounding

$$\mathbb{P}(\text{mincut}(nA, \infty) \leq (1 - \varepsilon)\mathcal{C}(A)n)$$

is more delicate. It consists in two steps. The first step is to prove that A minimizes \mathcal{C} over all sets containing A , *i.e.*, for any S such that $A \subset S$ then $\mathcal{C}(A) \leq \mathcal{C}(S)$. This property holds because A is a convex set. On the lower deviation event, we need to localize a region where a cutset (or equivalently the time of a path since $d = 2$) is too low. This section requires ingenious combinatorial estimates to sum on all possible minimal cutsets.

Remark 3.18. *In dimension 2, the flow constant ν_G is equal to the time constant μ_G . Indeed, in dimension 2, the dual of a minimal cutset for the flow τ_G corresponds to a geodesic between two points in the dual lattice. Garet used this equivalence and worked with the time constant.*

4 Contributions

In this section we present the results obtained during the thesis. The presentation of the results follow the structure of the manuscript. The manuscript is split into three parts. In part I, we present results on the isoperimetry of the infinite cluster. In part II, we present results on the time constant and in part III, we present results on the flow constant.

4.1 Isoperimetry of the infinite cluster

4.1.1 Chapter 2 - Existence of the anchored isoperimetric profile

This chapter corresponds to the paper [5] that has been published in *ALEA*. Let $p > p_c(d)$. We want to study the geometry of \mathcal{C}_p through its Cheeger constant. We recall the definition of the anchored isoperimetric profile $\varphi_n(p)$. This is another way to define the Cheeger constant of \mathcal{C}_p , that is more natural in the sense that we do not restrict minimizers to remain in the box $[-n, n]^d$. It is defined as follows:

$$\varphi_n(p) = \min \left\{ \frac{|\partial_{\mathcal{C}_p} H|}{|H|} : 0 \in H \subset \mathcal{C}_p, H \text{ connected}, 0 < |H| \leq n^d \right\},$$

where we condition on the event $\{0 \in \mathcal{C}_p\}$. We say that H is a valid subgraph if $0 \in H \subset \mathcal{C}_p$, H is connected and $|H| \leq n^d$. The study of the minimizers in the definition of $\varphi_n(p)$ is closely related to the study of the Wulff crystal in [19]. Minimizing the open edge boundary to volume ratio is equivalent to finding the interface of lowest energy that isolates a volume n^d of the cluster of 0 from the outside world. Roughly speaking, the event $\{n^d \leq |\mathcal{C}_p(0)| < \infty\}$ is very unlikely. On this unlikely event, the cluster $\mathcal{C}_p(0)$ is isolated from the outside world by a closed interface of edges. Conditioning on this event, the more likely configurations are the ones with an interface of lowest energy, *i.e.*, minimizing the surface tension. In both cases, at macroscopic order, the minimizers of $\varphi_n(p)$ and the cluster $\mathcal{C}_p(0)$ conditioned on the event $\{n^d \leq |\mathcal{C}_p(0)| < \infty\}$ are identical with high probability.

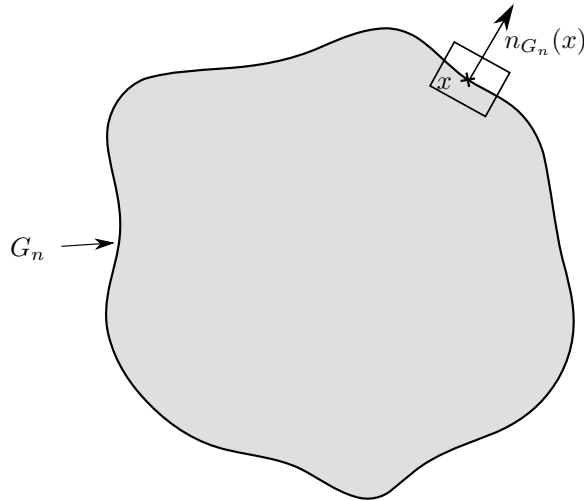

Figure 1.5 – A small box on the boundary ∂G_n of a minimizer G_n of $\varphi_n(p)$

Minimizing the open edge boundary is the analogue of minimizing a surface tension in the continuous setting. We shall build a norm β_p that represents the tension that is exerted on the surface, *i.e.*, any point x in a surface S having $n_S(x)$ as a normal unit exterior vector has a tension $\beta_p(n_S(x))n_S(x)$ that is exerted at the point x . This the same norm than the norm $\beta_{p,d}$ used by Gold in [44]. To build this norm, let G_n be a minimizer of $\varphi_n(p)$. We zoom on the boundary of G_n , we look at what happens in a small but macroscopic cube centered at a point x in the boundary ∂G_n (see figure 1.5). The cube is located in such a way that its bottom intersects G_n

and its top intersects $\mathbb{Z}^d \setminus G_n$, and it is rotated so that its normal vector coincides with the normal exterior vector of G_n at the point x . Since this cube is small, the portion of G_n in that cube does not affect much $|G_n|$, the total volume of G_n . Thus, if one would like to minimize the open edge boundary to volume ratio, one needs to minimize the number of open edges of ∂G_n in that cube. This problem is equivalent to finding a set of edges that separates the top from the bottom of the cube with a minimal number of open edges and by the max-flow min-cut theorem, it is thus equivalent to the study of maximal flow. We denote by $\tau_p(n, \vec{v})$ the capacity of the minimal cutset that cuts the upper half from the lower half of the boundary of the cube of side-length n oriented according to \vec{v} for the distribution $G = p\delta_1 + (1-p)\delta_0$. Thanks to [64], we know that $\tau_p(n, \vec{v})/n^{d-1}$ almost surely converges towards a deterministic constant, that we denote by $\beta_p(\vec{v})$: $\beta_p(\vec{v})$ is the flow constant $\nu_G(\vec{v})$ associated with the distribution $G = p\delta_1 + (1-p)\delta_0$. Moreover, we know that β_p is a norm because $G(\{0\}) < 1 - p_c(d)$. In [5], we prove the following theorem.

Theorem 4.1. *Let $d \geq 2$, $p > p_c(d)$. Let W_p be the dilate of \widehat{W}_{β_p} such that $\mathcal{L}^d(W_p) = 1/\theta(p)$. Then, conditionally on $\{0 \in \mathcal{C}_p\}$,*

$$\lim_{n \rightarrow \infty} n\varphi_n(p) = \frac{\mathcal{I}_p(W_p)}{\theta(p)\mathcal{L}^d(W_p)} = \mathcal{I}_p(W_p) \text{ a.s.}$$

Moreover, we have L^1 -convergence of the minimizers \mathcal{G}_n of $\varphi_n(p)$ towards W_p in the following sense

$$\lim_{n \rightarrow \infty} \max_{\mathcal{G}_n \in \mathcal{G}_n} \inf_{x \in \mathbb{R}^d} \frac{1}{n^d} |G_n \Delta (n(x + W_p) \cap \mathcal{C}_p)| = 0 \quad \mathbb{P}(\cdot | 0 \in \mathcal{C}_p)\text{-a.s.}$$

To prove the first statement of this theorem, we study separately upper large deviations and lower large deviations. The techniques for the study of the upper large deviations are standard, we can exhibit a valid subgraph whose isoperimetric ratio is arbitrarily close to $\varphi_n(p)$ with high probability. This is done using estimates on upper large deviations for the flow constant in cylinder (see theorem 3.15).

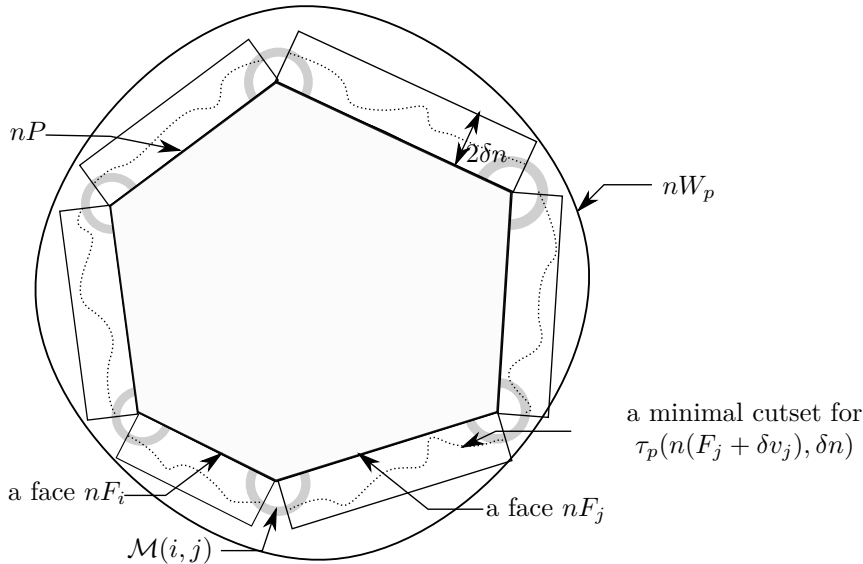

Figure 1.6 – Construction of a valid subgraph with isoperimetric ratio close to $\varphi_n(p)$

We shall build a valid subgraph that has an isoperimetric ratio close to $\varphi_n(p)$. To do so, we approximate the Wulff shape W_p from the inside by a convex polytope P , this is possible since the set W_p is convex. We shall build a cutset Γ_n that cuts nP from infinity, whose number of open edges is close to $n^{d-1}\mathcal{I}_p(P)$ and that is located close to ∂nP with high probability. For each face F of P and v its associated exterior unit normal vector, we consider the cylinder $\text{cyl}(n(F + \delta v), \delta n)$

of basis $n(F + \delta v)$ and of height $\delta n > 0$. We build E by merging the cutsets from the top to the bottom of minimal capacity in the cylinders $\text{cyl}(n(F + \delta)v, \delta n)$. The union of these cutsets is not yet a cutset itself because of the potential holes between these cutsets. We fix this issue by adding extra edges to fill the holes. In figure 1.6, the set $\mathcal{M}(i, j)$ represents a set of edges that will fill the gap between the faces nF_i and nF_j . We control next the number of extra edges we have added, *i.e.*, the size of the sets $\mathcal{M}(i, j)$. We next build a valid subgraph $H_n \subset \mathbb{Z}^d$ from Γ_n by taking all the vertices of $\mathcal{C}_p \cap nP$ that are connected to 0 without using edges in Γ_n . We prove that with high probability, $|H_n|$ is of order $\theta(p)n^d \mathcal{L}^d(P)$. We can bound $|\partial_{\mathcal{C}_p} H_n|$ from above by the number of open edges in Γ_n and so we control the isoperimetric ratio of H_n . Finally, we have

$$\mathbb{P}(n\varphi_n(p) > \varphi_p(1 + \varepsilon)) \leq \mathbb{P}\left(n \frac{|\partial_{\mathcal{C}_p} H_n|}{|H_n|} \geq \varphi_p(1 + \varepsilon)\right).$$

We conclude using upper large deviations estimates for τ_p in a cylinder of polyhedral basis derived from the corresponding estimates in cylinders of hyperrectangle basis.

The next step is to obtain the large deviations result from below that is the most difficult part. To study the upper large deviations, we needed to go from a continuous object to a discrete object. For the lower large deviations, we do the opposite. We start with $G_n \in \mathcal{G}_n$ and we build a continuous object P_n . Our goal is to build a continuous object of finite perimeter. Although it seems natural to take the continuous object $P_n = n^{-1}(G_n + [-1/2, 1/2]^d)$, this turns out to be a bad choice because the exterior boundary of ∂G_n may be very entangled and its size may be of higher order than n^{d-1} . We also have to deal with the presence of holes in G_n that correspond to holes of the infinite cluster \mathcal{C}_p . These holes are present with a positive density and contribute to the size of the boundary of G_n . Using a smoothing procedure by doing a coarse graining as in [73], and by filling the small holes in G_n , we obtain a continuous object P_n that has a perimeter less than some positive constant β with high probability and such that the measure associated to G_n is close in some sense to the measure $\theta(p)\mathbb{1}_{P_n} \mathcal{L}^d$.

Here, conditionally on the event that the origin belongs to the infinite cluster, we only restrict minimizers to be anchored at the origin, connected and of size at most n^d . Although this definition is more natural than the definition used by Gold in [44], the proof is more technical due to the lack of compactness: the minimizers properly renormalized by a factor n are no longer contained in the compact set $[-1, 1]^d$. To solve this issue, we use the method developed by Cerf for the study of the Wulff crystal. Consider G_n a minimizer of the isoperimetric constant and P_n its associated continuous object, although P_n is not contained in a compact set, we can cover almost all P_n by a finite number of disjoint balls centered at points of \mathbb{Z}^d of radii in \mathbb{N} . Namely, for any $\delta > 0$, there exists a set E (see figure 1.7) corresponding to the finite union of the disjoint balls such that

$$\frac{\mathcal{L}^d(P_n \cap E)}{\mathcal{L}^d(P_n)} \geq 1 - \delta.$$

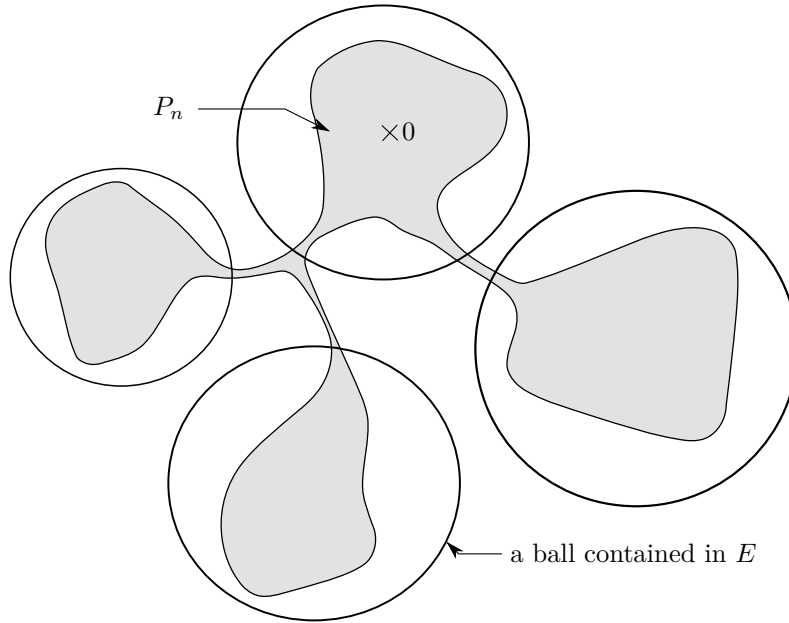
Figure 1.7 – Covering almost all P_n by balls

The number of possible such balls is at most polynomial in n , so this term will be counterbalanced by the probability of the unlikely event we estimate (that decays exponentially fast with n).

$$\{F \subset E : F \text{ is a Borel set of perimeter smaller than } \beta\}.$$

The latter set is compact endowed with the topology associated to the distance $d(F, F') = \mathcal{L}^d(F \Delta F')$. Using a covering of this compact set, this enables us to localize $P_n \cap E$ (and so $(G_n/n) \cap E$) close to some continuous set F . If the isoperimetric ratio of G_n is too small, this implies that somewhere around the boundary of F , the surface tension that exerts on the boundary of G_n/n is locally lower than its expectation. We can relate this unlikely event to lower large deviations on maximal flows in order to upper-bound the probability of this unlikely event.

4.1.2 Chapter 3 - Vanishing of the isoperimetric constant at $p_c(d)$

This chapter corresponds to a joint work with Raphaël Cerf that has been published in *ECP* [2]. The most well-known open question in percolation theory is to prove that the percolation probability vanishes at $p_c(d)$ in dimension three. In fact, the interesting quantities associated to the model are very difficult to study at the critical point or in its vicinity. In [2], with Raphaël Cerf, we studied a very modest intermediate question. We consider the anchored isoperimetric profile of the infinite open cluster, defined for $p > p_c(d)$. We extend adequately the definition for $p = p_c(d)$, in finite boxes: to do so, we need to extend the definition of the anchored isoperimetric profile so that it is well defined at $p_c(d)$. We say that H is a valid subgraph of $\mathcal{C}_p(0)$, the open cluster of 0, if H is connected and $0 \in H \subset \mathcal{C}_p(0)$ and $0 < |H| \leq n^d$. We define $\tilde{\varphi}_n(p)$ for every $p \in [0, 1]$ as

$$\tilde{\varphi}_n(p) = \min \left\{ \frac{|\partial_{\mathcal{C}_p(0)} H|}{|H|} : H \text{ valid subgraph of } \mathcal{C}_p(0), 0 < |H| \leq n^d \right\}.$$

In particular, if 0 is not connected to $\partial[-n/2, n/2]^d$ by a p -open path, then $|\mathcal{C}_p(0)| < n^d$ and taking $H = \mathcal{C}_p(0)$, we see that $\tilde{\varphi}_n(p)$ is equal to 0. The techniques of [5] to prove the existence of this limit rely on coarse-graining estimates which can be employed only in the supercritical regime. Therefore we are not able so far to extend the convergence of $n\tilde{\varphi}_n$ when n goes to infinity at the critical point $p_c(d)$. Naturally, we expect that $n\tilde{\varphi}_n(p_c(d))$ converges towards 0 as n goes

to infinity, unfortunately we are only able to prove a weaker statement. We prove a partial result which implies that, if the limit $n\tilde{\varphi}_n(p_c(d))$ when n goes to infinity exists, it has to vanish.

Theorem 4.2. *With probability one, we have*

$$\liminf_{n \rightarrow \infty} n\tilde{\varphi}_n(p_c(d)) = 0.$$

Note that this result becomes trivial if $\theta(p_c(d)) = 0$. We prove this theorem by contradiction. If the statement of the theorem does not hold, then the cluster $\mathcal{C}_{p_c(d)}(0)$ of 0 satisfies a d -dimensional anchored isoperimetric inequality. There exists a positive constant c such that with positive probability, for any $n \geq 1$, we have $n\tilde{\varphi}_n(p_c(d)) > c$. We first define an exploration process of the cluster of 0 that remains inside the box $[-n, n]^d$. The exploration process is very basic. We start at 0, at the first step we reveal the open edges incident to 0. The set of activated points correspond to the set of neighbors of 0 connected by an open edge. At each step, the set of activated vertices corresponds to the set of vertices that were revealed at the previous step and such that they have unrevealed incident edges. At each step, we reveal the state of the edges incident to the activated vertices (see figure 1.8). Actually, if at the beginning of a step the revealed cluster is \mathcal{C} the set of open edges we will reveal during this exploration step is $\partial_{\mathcal{C}_{p_c(d)}(0)}\mathcal{C}$. Since \mathcal{C} is a valid subgraph, we have

$$\frac{|\partial_{\mathcal{C}_{p_c(d)}(0)}\mathcal{C}|}{|\mathcal{C}|} \geq \tilde{\varphi}_n(p_c(d)) > \frac{c}{n}.$$

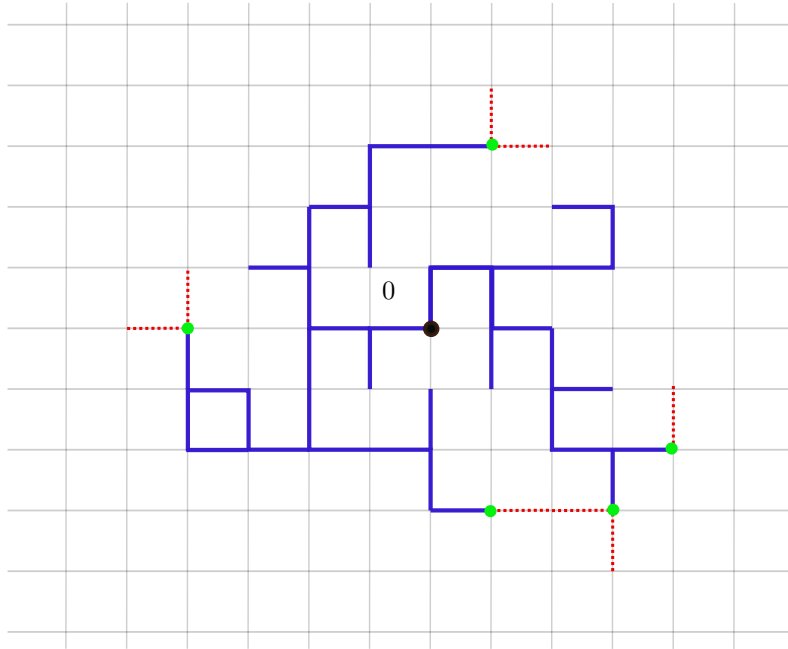

Figure 1.8 – Exploration of the cluster of 0. In blue the edges of $\mathcal{C}_{p_c(d)}(0)$ that are revealed during the first eight steps of the exploration process. In green the activated vertices, that is the explored vertices with unrevealed incident edges. In red, the edges that have been revealed during the 9th step of the exploration.

It follows that the number of sites that are revealed at each step in the exploration of the cluster $\mathcal{C}_{p_c(d)}(0)$ will be of order n^{d-1} when \mathcal{C} will be of order n^d . Then, we can prove that the intersection of the cluster that we have explored with the boundary of the box $[-n, n]^d$ is of order n^{d-1} . Since during the exploration process we remain strictly inside the box, we have at least an order of n^{d-1} points in the boundary connected to 0 by a path that is contained in a half-space. Furthermore, there is no percolation in a half-space at $p_c(d)$, consequently the probability that there exists a path of length larger than n that remains in a half-space goes to 0 with n . It follows that the

number of vertices in the boundary of the box $[-n, n]^d$ connected to 0 inside the box should be negligible compared to n^{d-1} , we obtain a contradiction. This result says that if there is an infinite cluster at $p_c(d)$, then its geometry is different than the one of the infinite cluster for $p > p_c(d)$.

4.1.3 Chapter 4 - Regularity of the isoperimetric constant

This chapter corresponds to the paper [4] that has been published in *ECP*. The regularity properties of the anchored isoperimetric profile was first studied by Garet, Marchand, Procaccia, Th  ret in [42]. They proved that the modified Cheeger constant in dimension 2 is continuous on $(p_c(2), 1]$. In [4], we prove a better regularity in p for dimensions $d \geq 2$ and deduce a regularity on the limit shape. The first theorem asserts that the anchored isoperimetric profile is Lipschitz continuous on every compact interval $[p_0, p_1] \subset (p_c(d), 1)$.

Theorem 4.3 (Regularity of the anchored isoperimetric profile). *Let $d \geq 2$. Let $p_c(d) < p_0 < p_1 < 1$. There exists a positive constant κ depending only on d , p_0 and p_1 , such that for all $p, q \in [p_0, p_1]$, conditionally on the event $\{0 \in \mathcal{C}_{p_0}\}$,*

$$\lim_{n \rightarrow \infty} n |\varphi_n(q) - \varphi_n(p)| \leq \kappa |q - p|.$$

Remark 4.4. *We did not manage to obtain here that the anchored isoperimetric profile is Lipschitz continuous on $[p_0, 1]$ for a technical reason that is due to a coupling we use in the proof of Theorem 4.3. However, this restriction is likely irrelevant. Furthermore, we think that the restriction given by p_0 is relevant.*

Let $p \in [0, 1]$. We recall that $\tau_p(n, \vec{v})$ is the capacity of the minimal cutset that cuts the upper half from the lower half of the boundary of the cube of side-length n oriented according to \vec{v} for the distribution $p\delta_1 + (1-p)\delta_0$, and

$$\beta_p(\vec{v}) = \lim_{n \rightarrow \infty} \frac{\tau_p(n, \vec{v})}{n^{d-1}} \text{ a.s.}$$

The second theorem studies the Hausdorff distance between two dilated Wulff crystals \widehat{W}_{β_p} and \widehat{W}_{β_q} of volume 1 associated with norms β_p and β_q .

Theorem 4.5 (Regularity of the anchored isoperimetric profile). *Let $d \geq 2$. Let $p_c(d) < p_0 < p_1 < 1$. There exists a positive constant κ' depending only on d , p_0 and p_1 , such that for all $p, q \in [p_0, p_1]$,*

$$d_{\mathcal{H}}(\widehat{W}_{\beta_p}, \widehat{W}_{\beta_q}) \leq \kappa' |q - p|,$$

where $d_{\mathcal{H}}$ is the Hausdorff distance between non empty compact sets of \mathbb{R}^d .

The key element to prove these two theorems is to prove the regularity of the map $p \mapsto \beta_p$. By a straightforward corollary of [64], we obtain that the map $p \mapsto \beta_p$ is continuous on $(p_c(d), 1]$. We can even obtain a Lipschitz property.

Theorem 4.6 (Regularity of the flow constant). *Let $p_c(d) < p_0 < p_1 < 1$. There exists a positive constant κ depending only on d , p_0 and p_1 , such that for all $p \leq q$ in $[p_0, p_1]$,*

$$\sup_{x \in \mathbb{S}^{d-1}} |\beta_p(x) - \beta_q(x)| \leq \kappa |q - p|.$$

The proof of this theorem strongly relies on an adaptation of Zhang's proof in [73].

Let $p_0 > p_c(d)$ and let $q > p \geq p_0$. Our strategy is the following, we easily get that $\beta_p \leq \beta_q$ by properly coupling the percolations of parameters p and q such that $p_c(d) < p < q$. The second inequality requires more work. We denote by $E_{n,p}$ the random cutset of minimal size that achieves the minimum in the definition of $\tau_p(n, \vec{v})$. By definition, as $E_{n,p}$ is a cutset, we can bound by above $\tau_q(n, \vec{v})$ by the number of edges in $E_{n,p}$ that are q -open, which we expect to be at most $\tau_p(n, \vec{v}) + C(q-p)|E_{n,p}|$ where C is a constant. We next need to get a control on $|E_{n,p}|$ which is uniform in $p \in [p_0, 1]$ of the kind $c_d n^{d-1}$ where c_d depends only on d and p_0 . In [73], Zhang obtained a control on the size of the smallest minimal cutset corresponding to maximal flows in

general first passage percolation, but his control depends on the distribution G of the variables $(t_G(e))_{e \in \mathbb{E}^d}$ associated with the edges. We only consider probability measures $G_p = p\delta_1 + (1-p)\delta_0$ for $p > p_c(d)$, but we need to adapt Zhang's proof in this particular case to obtain a control that does not depend on p anymore.

4.2 First passage percolation: first interpretation

4.2.1 Chapter 5 - Regularity of the time constant

This chapter corresponds to the paper [3] that has been submitted. In continuation of the work [42], we study the regularity of the map $p \mapsto \mu_{G_p}$ where $G_p = p\delta_1 + (1-p)\delta_\infty$. This problem is equivalent to study the regularity in p of the graph distance between two faraway vertices in the infinite cluster \mathcal{C}_p of supercritical percolation of parameter p . In [3], we manage to control the gap between μ_{G_p} and μ_{G_q} to prove the following theorem.

Theorem 4.7. *Let $p_0 > p_c(d)$, there exists a positive constant C (depending on p_0) such that*

$$\forall p, q \in [p_0, 1] \quad |\mu_{G_p} - \mu_{G_q}| \leq C|q - p| \log |q - p|.$$

To study the regularity of the map $p \mapsto \mu_{G_p}$, our aim is to control the difference between the graph distance in the infinite cluster \mathcal{C}_p of a Bernoulli percolation of parameter $p > p_c(d)$ on \mathbb{E}^d with the graph distance in \mathcal{C}_q where $q \geq p$. The key part of the proof lies in the modification of a path. We couple the two percolations such that a p -open edge is also q -open but the converse does not necessarily hold. Let $x \in \mathbb{Z}^d$. We assume that 0 and x belong to \mathcal{C}_p , this event happens with positive probability. We consider a q -open geodesic γ between 0 and x . Some of the edges of this path are p -closed, we want to build upon this path a p -open path by bypassing the p -closed edges. In order to bypass them, we use the idea of [42] and we build our bypasses at a macroscopic scale. This idea finds its inspiration in the works of Antal and Pisztora [60] and Cox and Kesten [33]. We have to consider an appropriate renormalization and we obtain a macroscopic lattice with good and bad sites. Good and bad sites correspond to boxes of size $2N$ in the microscopic lattice. We will do our bypasses using good sites at a macroscopic scale that will have good connectivity properties at a microscopic scale (see figure 1.3). Let e be a p -closed edge in γ . We distinguish two different cases; either e is in a good box and we can bypass e using the good connectivity of the box by a path smaller than βN (where β is a positive constant and N is the size of our renormalization blocks), or e is inside a bad box. In that case, we note C the connected component of bad boxes containing e . The macroscopic boundary of C will be made of good boxes and we will bypass e using the boundary of C . The length of the bypass will be at most $2d\beta|C|N$. We can build upon γ a path $\tilde{\gamma}$ between 0 and x that is p -open. The set $\tilde{\gamma} \setminus \gamma$ corresponds to the bypasses, we have

$$D^{\mathcal{C}_p}(0, x) - D^{\mathcal{C}_q}(0, x) \leq |\tilde{\gamma} \setminus \gamma| \leq \beta N |\{e \in \gamma : e \text{ is } p\text{-closed}\}| + 2dN \sum_{\substack{C \text{ bad component:} \\ C \cap \gamma \neq \emptyset}} |C|.$$

The quantity $|\{e \in \gamma : e \text{ is } p\text{-closed}\}|$ is with high probability at most $C_0 \|x\| (q - p)$ where C_0 is a positive constant depending only on p_0 and d . The remainder of the proof consists in getting probabilistic estimates of the length of the bypasses. In this article we improve the estimates obtained in [42]. We quantify the renormalization to be able to give quantitative bounds on continuity. Namely, we give an explicit expression of the appropriate size of a N -box: for $N = \log |q - p|$ with high probability when $\|x\|$ is large, we have

$$\sum_{\substack{C \text{ bad component:} \\ C \cap \gamma \neq \emptyset}} |C| \leq c_1 (q - p) \|x\|$$

where c_1 is a positive constant depending only on d and p_0 . To prove this estimate, we use the idea of corridor that appeared in the work of Cox and Kesten [33] to have a better control on combinatorial terms and derive a more precise control of the length of the bypasses than the one obtained in [42]. Combining the previous inequalities, we obtain with positive probability that

$$D^{\mathcal{C}_p}(0, x) - D^{\mathcal{C}_q}(0, x) \leq \beta C_0 \log |q - p| (q - p) \|x\| + 2dc_1 \log |q - p| (q - p) \|x\|.$$

Dividing by $\|x\|$ and letting $\|x\|$ goes to infinity in such a way $x/\|x\| \rightarrow \vec{v} \in \mathbb{S}^{d-1}$, we obtain that $\mu_{G_q}(\vec{v}) - \mu_{G_p}(\vec{v}) \leq c_0(q-p) \log(q-p)$. This result can be extended to irrational directions. Besides, we can prove that $\mu_{G_q} \leq \mu_{G_p}$ using a coupling and the result follows.

4.2.2 Chapter 6 - An improvement on the regularity result

This chapter corresponds to a joint work with Raphaël Cerf [1] that is still in preparation. In the proof of theorem 4.7, the renormalization was responsible for the presence of a logarithmic term. The issue comes from the fact that all edges are bypassed at the same scale whereas some of them may be bypassed at a smaller scale. In [1], we fix this issue by introducing several scales and we improve the previous result by proving that the function $p \mapsto \mu_{G_p}$ is in fact Lipschitz continuous strictly above p_c .

Theorem 4.8. *Let $p_0 > p_c(d)$. There exists a constant κ_d depending only on d and p_0 such that*

$$\forall p, q \in [p_0, 1] \quad \sup_{x \in \mathbb{S}^{d-1}} |\mu_{G_p}(x) - \mu_{G_q}(x)| \leq \kappa_d |q - p|.$$

To fix the issues that were encountered in [3], we use a new approach. Our aim is to understand how the chemical distance in Bernoulli percolation depends upon the percolation parameter p . The key part of the proof lies in a multiscale modification of an arbitrary path. Let us fix two parameters p, q such that $q > p > p_c(d)$. We couple two percolation configurations at level p and q in such way that a p -open edge is also q -open. Let $x \in \mathbb{Z}^d$. We assume that 0 and x belong to \mathcal{C}_p , this event happens with positive probability. We consider the geodesic γ joining 0 and x for the bond percolation of parameter q . Some of the edges in γ are p -closed, we want to build upon this path a p -open path. To do so, we need to bypass the p -closed edges in γ . Roughly speaking, the idea is to prove that, for $\|x\|$ large enough, with high probability, the average size of a bypass is smaller than a constant C and that the number of edges to bypass in γ is at most $(q-p)\|x\|$. Therefore, with high probability the total length of the bypasses is smaller than $C(q-p)\|x\|$. Whereas in [3], all the edges were bypassed at the same scale, here we use a multiscale renormalization and each edge is bypassed at the appropriate scale. The crucial point is to perform each bypass at an adequate scale and to pay the right price for it. By properly choosing the different scales of the renormalization process, we can build a family of shells $(\text{shell}(e))_{e \in \gamma}$ made of good boxes at scale 1 such that the total cardinality of the shells $\sum_{e \in \gamma} |\text{shell}(e)|$ is at most $C\|x\|$ with high probability. These shells of good boxes will possess all the desired properties to build p -open bypasses of edges in γ . The shells are built without revealing the p -states of the edges in γ so that they are independent of the p -states of the edges in γ . In the end, we will not use all the shells but only the shells associated to p -closed edges in γ . In the coupling, the probability that a q -open edge is p -closed is $q-p$. Therefore, we expect that the total length of the bypasses

$$\sum_{e \in \gamma} |\text{shell}(e)| \mathbb{1}_{e \text{ is } p\text{-closed}}$$

is at most $C(q-p)\|x\|$. We conclude as in the proof of theorem 4.7.

4.3 First passage percolation : second interpretation

4.3.1 Chapter 7 - Maximal flow to infinity

This chapter corresponds to the paper [6] that has been published in the *Annals of Probability*. In [6], we study the maximal flow between a compact convex subset A of \mathbb{R}^d and infinity for $d \geq 2$ in the rescaled lattice \mathbb{Z}^d/n . Note that unlike the study of minimal cutset in a box, the existence of a minimal cutset between A and infinity is not straightforward. We can prove the existence of a minimal cutset between A and infinity in the rescaled lattice by adapting some arguments of Zhang in [73]. We recall that $\mathcal{C}(A)$ denotes the continuous capacity of the boundary ∂A of A , *i.e.*,

$$\mathcal{C}(A) = \int_{\partial A} \nu_G(n_A(x)) d\mathcal{H}^{d-1}(x)$$

where $n_A(x)$ is the exterior unit normal vector of A at $x \in \partial A$. In [6], we extend the result of Garet [38] to $d \geq 3$. We recall that $\text{mincut}(nA, \infty)$ denotes the infimum of the capacity over sets of edges separating nA from infinity

Theorem 4.9. *Let $d \geq 3$. Let G be a distribution on \mathbb{R}_+ that admits an exponential moment. Let A be a compact convex subset of \mathbb{R}^d . Let $\varepsilon > 0$. There exists positive constants C_1 and C_2 depending on A , d , G and ε such that*

$$\mathbb{P}(|\text{mincut}(nA, \infty) - \mathcal{C}(A)n^{d-1}| \geq \varepsilon n^{d-1}) \leq C_1 \exp(-C_2 n^{d-1}).$$

By applying Borel-Cantelli Lemma, we obtain the following corollary.

Corollary 4.10. *We have*

$$\lim_{n \rightarrow \infty} \frac{\text{mincut}(nA, \infty)}{n^{d-1}} = \mathcal{C}(A) \quad \text{almost surely.}$$

We prove this theorem by studying separately the upper large deviations and lower large deviations. The proof of the upper large deviations follows the same strategy than the proof of Garet. Using large deviation estimates on the maximal flow in a cylinder, we can build a cutset separating A from infinity whose capacity is arbitrarily close to $\mathcal{C}(A)n^{d-1}$ with high probability. To do so, we approximate A by a polyhedral subset P such that $A \subset P$ and $\mathcal{C}(P)$ is close to $\mathcal{C}(A)$. Finally, we build a cutset Γ_n that cuts nA from infinity such that the capacity of Γ_n is close to $n^{d-1}\mathcal{C}(P)$ following a similar strategy as in the study of upper large deviations in [5] (see figure 1.7). Since Γ_n is a cutset we have $\text{cap}(\Gamma_n) \geq \text{mincut}(nA, \infty)$. For any $\varepsilon > 0$, we can build Γ_n such that $\text{cap}(\Gamma_n) \leq (1 + \varepsilon)n^{d-1}\mathcal{C}(A)$ with high probability and it follows that

$$\text{mincut}(nA, \infty) \leq (1 + \varepsilon)n^{d-1}\mathcal{C}(A)$$

with high probability.

To study the lower large deviations, we work on the rescaled lattice \mathbb{Z}^d/n . We denote by \mathcal{E}_n a minimal cutset between A and infinity in the rescaled lattice. The main difficulty we had to deal with is the lack of compactness, the cutset \mathcal{E}_n properly renormalized cannot be almost surely contained in a compact. Garet handled this issue by doing ingenious combinatorial estimates on possible minimal cutsets. However, in dimensions $d \geq 3$, even ingenious combinatorial estimates cannot work because the combinatorial term cannot be counterbalanced by the probability term. To overcome this issue, we try to proceed as in the work of Cerf and Th  ret [24]. The idea is to create from the minimal cutset \mathcal{E}_n a continuous subset E_n of \mathbb{R}^d whose edge boundary (*i.e.*, the edges that have one extremity in the continuous subset and the other one outside) corresponds to the cutset \mathcal{E}_n . As we can control the number of edges in a minimal cutset thanks to the work of Zhang [73], we can consider a minimal cutset \mathcal{E}_n in the rescale lattice from A to infinity of minimal capacity and that has at most cn^{d-1} edges with high probability, for some positive constant c . Thanks to this crucial result, the continuous set E_n we build has a perimeter at most c . In [24], as the two authors work in a compact region Ω , the continuous object they obtain lives in the compact space consisting of all subsets of Ω of perimeter smaller than or equal to c . In our context, as our cutset \mathcal{E}_n can go potentially very far from A , we cannot build from \mathcal{E}_n a continuous set that belongs to some compact space and therefore we cannot use the same method as in [24]. However, as the capacity of \mathcal{E}_n is smaller than $n^{d-1}\mathcal{C}(A)$, we expect that \mathcal{E}_n remains not too far from the boundary ∂A of A . We can observe unlikely events just by inspecting what happens in a bounded region, namely in the ball $B(0, R)$ (that contains A) for a deterministic R depending on A . This enables us to study only the portion of the cutset \mathcal{E}_n in $B(0, R)$ and to define a continuous version of this portion that belongs the following set with high probability:

$$\{F \subset B(0, R) : F \text{ is a Borel set of perimeter smaller than } c + \mathcal{H}^{d-1}(\partial B(0, R))\}.$$

The latter set is compact endowed with the topology associated to the distance $d(F, F') = \mathcal{L}^d(F \Delta F')$. Note that the choice of R is such that the artificial boundary $E_n \cap \partial B(0, R)$ we create is small enough such that the capacity of the boundary of $E_n \cap B(0, R)$ is still abnormally small. Using a covering of the latter compact set enables us to localize $E_n \cap B(0, R)$ and so

$\mathcal{E}_n \cap B(0, R)$ close to some continuous set F . The finite covering of this compact set replace the combinatorial estimates. Starting from there, we can follow the strategy of [24]. We try to localize a small region of \mathcal{E}_n where the flow is abnormally small and relate this to lower large deviations for the maximal flow in a cylinder (see theorem 3.16).

Let $p > p_c(d)$. Let us consider the distribution $G = p\delta_1 + (1-p)\delta_0$ and a compact convex subset $A \subset \mathbb{R}^d$ such that $0 \in A$. Following the proof of Garet in [38], we can deduce from theorem 4.9 the following corollary on Bernoulli percolation.

Corollary 4.11. *The maximal cardinality $\text{dis}(A)$ for a collection of disjoint open paths from A to infinity satisfies*

$$\forall \varepsilon > 0 \quad \exists C_1, C_2 > 0 \quad \forall n \geq 0 \quad \mathbb{P} \left(\frac{\text{dis}(nA)}{\mathcal{C}(A)n^{d-1}} \notin (1 - \varepsilon, 1 + \varepsilon) \right) \leq C_1 \exp(-C_2 n^{d-1}).$$

4.3.2 Chapter 8 - Size of a minimal cutset

This chapter corresponds to a joint work with Marie Thérét [7] that has been published in *Annales de l'IHP*. In [7], Thérét and I prove a similar statement than theorem 2.8 for the size of minimal cutsets. We consider a distribution G such that $G(\{0\}) > 1 - p_c(d)$ (thus $\nu_G = 0$), *i.e.*, the edges of positive passage time are in the sub-critical regime of percolation on \mathbb{Z}^d . Therefore, minimal cutsets in a box are mainly made of edges of null capacity. We denote by $\psi_G(n, \vec{v})$ the minimal size of a minimal cutset in the box of side-length n oriented in the direction \vec{v} , that is,

$$\psi_G(n, \vec{v}) = \inf \left\{ |E| : \begin{array}{l} E \text{ is a minimal cutset in the cylinder of basis of} \\ \text{side-length } n \text{ and height } h(n) \text{ oriented in the direction } \vec{v} \end{array} \right\}$$

where $h(n)$ satisfies $\log n \ll h(n) \ll n$. We study the asymptotic behavior of the minimal cardinal $\psi_G(n, \vec{v})$ among cutsets of minimal capacity when the size of the box goes to infinity, that is n goes to infinity. Using sub-additive arguments, Marie Thérét and I prove a law of large numbers for this quantity in [7].

Theorem 4.12. *Let $d \geq 2$. Let G be a probability measure on $[0, +\infty]$ such that $G(\{0\}) > 1 - p_c(d)$. Let $\vec{v} \in \mathbb{S}^{d-1}$. Let $h : \mathbb{N} \rightarrow \mathbb{R}_+$ be an height function which satisfies $\log n \ll h(n) \ll n$. There exists a finite constant $\zeta_{G(\{0\})}(\vec{v})$ such that*

$$\lim_{n \rightarrow \infty} \frac{\psi_G(n, \vec{v})}{n^{d-1}} = \zeta_{G(\{0\})}(\vec{v}) \text{ a.s..}$$

The constant $\zeta_{G(\{0\})}(\vec{v})$ depends only the direction \vec{v} , $G(\{0\})$ and d but not on h .

The idea was to introduce an alternative flow that is inspired by [64]. There are two issues to recover subadditivity: we need to study cutsets that may be merged together into a cutset and that have null capacity. Although the cutsets corresponding to the flow τ in adjacent cylinders may be glued together easily, these cutsets do not have null capacity in general: the union of two cutsets of minimal capacity is a cutset but does not have minimal capacity. The flow τ is subadditive but not the minimal cardinality of the minimal corresponding cutsets. The alternative flow we build is such that the maximal flow is always null and if we merge two adjacent cutsets for this flow it is still a cutset. It yields that if we merge two minimal cutsets, the union is necessarily a minimal cutset. Note that without the hypothesis $G(\{0\}) > 1 - p_c(d)$, minimal cutsets have positive capacity and the union of two minimal cutsets may not be a minimal cutset. Let $x \in \mathbb{Z}^d$, we denote by $\mathcal{C}_{G,0}(x)$ the connected component of x in the percolation $(\mathbb{1}_{t_G(e) > 0})_{e \in \mathbb{E}^d}$, which can be seen as an edge set and as a vertex set. Since $\mathbb{P}(t_G(e) > 0) < p_c(d)$, the finite clusters $\mathcal{C}_{G,0}(x)$, $x \in \mathbb{Z}^d$ are small. For A an hyperrectangle, \vec{v} a unit vector normal to A and $h > 0$, we define the random height $H_G(A, h)$ as follows

$$H_G(A, h) = \inf \left\{ h_0 \geq h : \text{hyp}(A + h_0 \vec{v}) \cap \bigcup_{x \in \mathbb{Z}^d : \mathcal{C}_{G,0}(x) \cap A \neq \emptyset} \mathcal{C}_{G,0}(x) = \emptyset \right\}.$$

One can prove that the set

$$E = \bigcup_{x \in \mathbb{Z}^d : \mathcal{C}_{G,0}(x) \cap A \neq \emptyset} \partial_e \mathcal{C}_{G,0}(x)$$

cuts A from $\text{hyp}(A + H_G(A, h) \vec{v})$ in $\text{slab}(A, H_G(A, h), \vec{v})$ and has null capacity (see figure 1.9). Hence, the height $H_G(A, h)$ is high enough to ensure that minimal cutset between A and $\text{hyp}(A + H_G(A, h) \vec{v})$ in $\text{slab}(A, H_G(A, h), \vec{v})$ has null capacity.

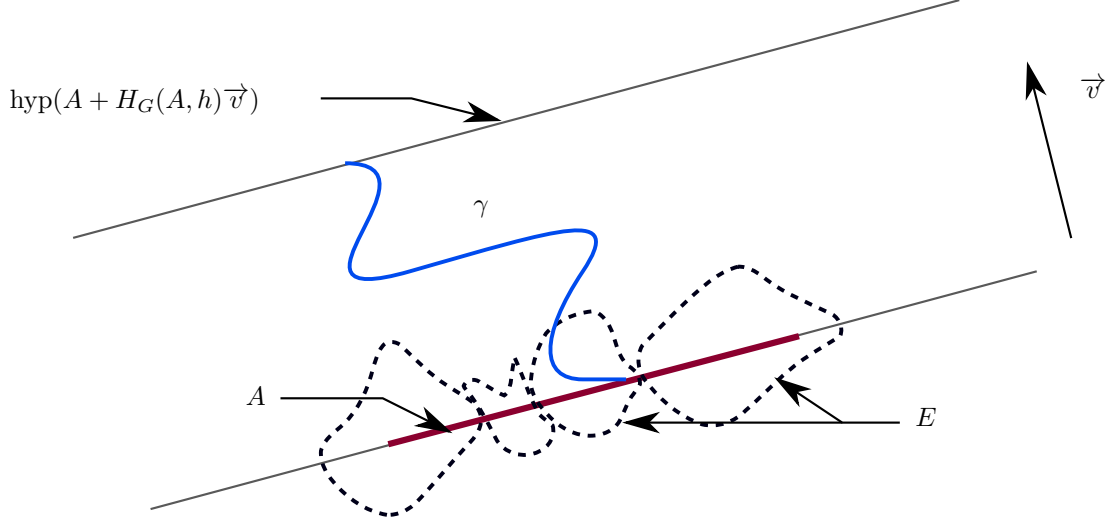

Figure 1.9 – Representation of the dual of the set E

Moreover, with high probability using theorem 1.2, we have

$$|E| \leq \sum_{x \in \mathbb{Z}^d : \mathcal{C}_{G,0}(x) \cap A \neq \emptyset} |\partial_e \mathcal{C}_{G,0}(x)| \leq \sum_{x \in \mathbb{Z}^d : \mathcal{C}_{G,0}(x) \cap A \neq \emptyset} c_d |\mathcal{C}_{G,0}(x)| \leq C \mathcal{H}^{d-1}(A)$$

where C is a positive constant depending on $G(\{0\})$ and d . Among all the cutsets that achieve the minimal capacity, we are interested in the ones with the smallest size. We denote by $\chi_G(A, h, \vec{v})$ the following quantity :

$$\chi_G(A, h, \vec{v}) = \inf \left\{ |E| : \begin{array}{l} E \text{ cuts } A \text{ from } \text{hyp}(A + H_G(A, h) \vec{v}) \\ \text{in } \text{slab}(A, H_G(A, h), \vec{v}) \text{ and } \text{cap}(E) = 0 \end{array} \right\}. \quad (4.1)$$

This quantity is subadditive and has good integrability properties since

$$\chi_G(A, h, \vec{v}) \leq |E| \leq C \mathcal{H}^{d-1}(A).$$

Let $h : \mathbb{N} \rightarrow \mathbb{R}_+$ be a height function such that $\lim_{n \rightarrow \infty} h(n) = \infty$. If \vec{v} is not rational, we cannot apply a subadditive theorem. To overcome this issue, we first prove in the spirit of the first step of the proof of an ergodic theorem that $\mathbb{E}[\chi_G(nA, h(n) \vec{v})] / \mathcal{H}^{d-1}(nA)$ converges towards a deterministic constant $\zeta(\vec{v})$ that does not depend on A nor h . Then we prove that when $h(n)$ is negligible compared to n but large compared to $\log n$, the quantities $\mathbb{E}[\psi_G(n, \vec{v})]$ and $\mathbb{E}[\chi_G(nA, h(n), \vec{v})]$ are very close so that $\psi_G(n, \vec{v}) / n^{d-1}$ converges towards $\zeta(\vec{v})$. By using a generalization of Efron-Stein inequality for higher moments, we can prove that $\psi_G(n, \vec{v})$ is close to its expectation. It follows that $\psi_G(n, \vec{v}) / n^{d-1}$ converges almost surely when n goes to infinity towards the same deterministic constant $\zeta(\vec{v})$.

Remark 4.13. *Actually for technical reasons the real definition of χ_G we use in the proof is a bit more complicated.*

Part I

Isoperimetry of the infinite cluster

Chapter 2

Existence of the anchored isoperimetric profile of the infinite cluster in supercritical bond percolation

Let $d \geq 2$. We consider an i.i.d. supercritical bond percolation on \mathbb{Z}^d , every edge is open with a probability $p > p_c(d)$, where $p_c(d)$ denotes the critical point. We condition on the event that 0 belongs to the infinite cluster \mathcal{C}_∞ and we consider connected subgraphs of \mathcal{C}_∞ having at most n^d vertices and containing 0. Among these subgraphs, we are interested in the ones that minimize the open edge boundary size to volume ratio. These minimizers properly rescaled converge towards a translate of a deterministic shape and their open edge boundary size to volume ratio properly rescaled converges towards a deterministic constant.

Contents

1	Introduction	47
2	Some definitions and useful results	52
2.1	Geometric notations	52
2.2	Sets of finite perimeter and surface energy	52
2.3	Approximation by convex polytopes	53
3	Construction of the norm	54
4	Upper large deviations	55
5	Construction of a continuous object	61
5.1	Some useful results on the minimizers	61
5.2	Construction of a continuous set	62
5.3	Closeness of measures	68
6	Lower large deviations and shape Theorem	72
6.1	Closeness to the set of Wulff shapes	72
6.2	Proof of theorem 1.5	83
6.3	Proof of theorem 1.2	86

1 Introduction

Isoperimetric problems are among the oldest problems in mathematics. They consist in finding sets that maximize the volume given a constraint on the perimeter or equivalently that minimize the perimeter to volume ratio given a constraint on the volume. These problems can be formulated in the anisotropic case. Given a norm ν on \mathbb{R}^d and S a continuous subset of \mathbb{R}^d , we define the tension exerted at a point x in the boundary ∂S of S to be $\nu(n_S(x))n_S(x)$, where $n_S(x)$ is the

exterior unit normal vector of S at x . The quantity $\nu(n_S(x))$ corresponds to the intensity of the tension that is exerted at x . We define the surface energy of S as the integral of the intensity of the surface tension $\nu(n_S(x))$ over the boundary ∂S . An anisotropic isoperimetric problem consists in finding sets that minimize the surface energy to volume ratio given a constraint on the volume. To solve this problem, in [70], Wulff introduced through the Wulff construction a shape achieving the infimum. This shape is called the Wulff crystal, it corresponds to the unit ball for a norm built upon ν . Later, Taylor proved in [66] that this shape properly rescaled is the unique minimizer, up to translations and modifications on a null set, of the associated isoperimetric problem.

The study of isoperimetric problems in the discrete setting is more recent. In the continuous setting, we study the perimeter to volume ratio, in the context of graphs, the analogous problem is the study of the size of edge boundary to volume ratio. This can be encoded by the Cheeger constant. For a finite graph $\mathcal{G} = (V(\mathcal{G}), E(\mathcal{G}))$, we define the edge boundary $\partial_{\mathcal{G}}A$ of a subset A of $V(\mathcal{G})$ as

$$\partial_{\mathcal{G}}A = \left\{ e = \langle x, y \rangle \in E(\mathcal{G}) : x \in A, y \notin A \right\}.$$

We denote by ∂A the edge boundary of A in $(\mathbb{Z}^d, \mathbb{E}^d)$ and by $|B|$ the cardinal of the finite set B . The isoperimetric constant, also called Cheeger constant, is defined as

$$\varphi_{\mathcal{G}} = \min \left\{ \frac{|\partial_{\mathcal{G}}A|}{|A|} : A \subset V(\mathcal{G}), 0 < |A| \leq \frac{|V(\mathcal{G})|}{2} \right\}.$$

The continuous version of this constant was introduced by Cheeger in his thesis [29] in order to obtain a lower bound for the smallest eigenvalue of the Laplacian. The discrete version of the Cheeger constant was introduced by Alon, Milman [9] and Gabber, Galil [37]. The isoperimetric constant of a graph gives information on its geometry.

Let $d \geq 2$. We consider an i.i.d. supercritical bond percolation on \mathbb{Z}^d , every edge is open with a probability $p > p_c(d)$, where $p_c(d)$ denotes the critical parameter for this percolation. We know that there exists almost surely a unique infinite open cluster \mathcal{C}_{∞} [48]. In this paper, we want to study the geometry of \mathcal{C}_{∞} through its Cheeger constant. However, if we minimize the isoperimetric ratio over all possible subgraphs of \mathcal{C}_{∞} without any constraint on the size, one can show that $\varphi_{\mathcal{C}_{\infty}} = 0$ almost surely. For that reason, we shall minimize the isoperimetric ratio over all possible subgraphs of \mathcal{C}_{∞} given a constraint on the size. There are several ways to do it. We can for instance study the Cheeger constant of the graph $\mathcal{C}_n = \mathcal{C}_{\infty} \cap [-n, n]^d$ or of the largest connected component $\tilde{\mathcal{C}}_n$ of \mathcal{C}_n for $n \geq 1$. As we have $\varphi_{\mathcal{C}_{\infty}} = 0$ almost surely, the isoperimetric constants $\varphi_{\mathcal{C}_n}$ and $\varphi_{\tilde{\mathcal{C}}_n}$ go to 0 when n goes to infinity. Benjamini and Mossel [13], Mathieu and Remy [57], Rau [61], Berger, Biskup, Hoffman and Kozma [14], Pete [59] proved that $\varphi_{\tilde{\mathcal{C}}_n}$ is of order n^{-1} . Roughly speaking, by analogy with the full lattice, we expect that subgraphs of $\tilde{\mathcal{C}}_n$ that minimize the isoperimetric ratio have an edge boundary size of order n^{d-1} and a size of order n^d , this is coherent with the fact that $\varphi_{\tilde{\mathcal{C}}_n}$ is of order n^{-1} . This led Benjamini to conjecture that for $p > p_c(d)$, the limit of $n\varphi_{\tilde{\mathcal{C}}_n}$ when n goes to infinity exists and is a positive deterministic constant.

This conjecture was solved in dimension 2 by Biskup, Louidor, Procaccia and Rosenthal in [15] and by Gold in dimension $d \geq 3$ in [44]. They worked on a modified Cheeger constant. Instead of considering the open edge boundary of subgraphs within \mathcal{C}_n , they considered the open edge boundary within the whole infinite cluster \mathcal{C}_{∞} , this is more natural because \mathcal{C}_n has been artificially created by restricting \mathcal{C}_{∞} to the box $[-n, n]^d$. They also added a stronger constraint on the size of subgraphs of \mathcal{C}_n to ensure that minimizers do not touch the boundary of the box $[-n, n]^d$. Moreover, the subgraphs achieving the minimum, properly rescaled, converge towards a deterministic shape that is the Wulff crystal. Namely, it is the shape solving the continuous anisotropic isoperimetric problem associated with a norm β_p corresponding to the surface tension in the percolation setting. The quantity $n\varphi_{\mathcal{C}_n}$ converges towards the solution of a continuous isoperimetric problem.

Dealing with the isoperimetric ratio within \mathcal{C}_n needs to be done with caution. Indeed, we do not want minimizers to be close to the boundary of \mathcal{C}_n because this boundary does not exist in \mathcal{C}_{∞} . There is another way to define the Cheeger constant of \mathcal{C}_{∞} , that is more natural in the sense that we do not restrict minimizers to remain in the box $[-n, n]^d$. This is called the anchored

isoperimetric profile φ_n and it is defined by:

$$\varphi_n = \min \left\{ \frac{|\partial_{\mathcal{C}_\infty} H|}{|H|} : 0 \in H \subset \mathcal{C}_\infty, H \text{ connected}, 0 < |H| \leq n^d \right\},$$

where we condition on the event $\{0 \in \mathcal{C}_\infty\}$. We say that H is a valid subgraph if $0 \in H \subset \mathcal{C}_\infty$, H is connected and $|H| \leq n^d$. We also define

$$\partial^\circ H = \left\{ e \in \partial H, e \text{ is open} \right\}.$$

Note that if $H \subset \mathcal{C}_\infty$, then $\partial_{\mathcal{C}_\infty} H = \partial^\circ H$. To better understand the difference between the two definitions, let us consider the following deterministic subgraph of $(\mathbb{Z}^d, \mathbb{E}^d)$,

$$H = (\{x \in \mathbb{Z}^d : \forall i \in \{2, \dots, d\} x_i = 0\}, \{e = \{x, y\} \in \mathbb{E}^d : \forall i \in \{2, \dots, d\} x_i = y_i = 0\}).$$

Denote by $H_n = H \cap [-n, n]^d$. It is easy to check that φ_{H_n} is of order $1/n$ whereas its anchored isoperimetric constant is of order $1/n^d$. Roughly speaking, the fact that the anchored isoperimetric constant is of order $1/n$ implies that the underlying graph looks like a d -dimensional object whereas this does not necessarily hold for φ_{H_n} , the isoperimetric constant restricted to the box. Even if these two definitions lead to equivalent results for $p > p_c(d)$, the difference will be crucial when studying this constant at $p_c(d)$ in chapter 3.

For each n , let \mathcal{G}_n be the set of the valid subgraphs that achieve the infimum in φ_n . In this context, a minimizer $G_n \in \mathcal{G}_n$ can go potentially very far from 0. The minimizer G_n properly rescaled does not belong anymore to a compact set. This lack of compactness is the main issue to overcome to prove that the limit exists. It was done in dimension 2 in [15], with a specific norm that cannot be extended to higher dimensions. We need to introduce some definitions to be able to define properly a limit shape in dimension $d \geq 2$. In order to build a continuous limit shape, we shall define a continuous analogue of the open edge boundary. In fact, we will see that the open edge boundary may be interpreted in term of a surface tension \mathcal{I} , in the following sense. Given a norm τ on \mathbb{R}^d and a subset E of \mathbb{R}^d having a regular boundary, we define $\mathcal{I}_\tau(E)$ as

$$\mathcal{I}_\tau(E) = \int_{\partial E} \tau(n_E(x)) \mathcal{H}^{d-1}(dx),$$

where \mathcal{H}^{d-1} denotes the Hausdorff measure in dimension $d-1$. The quantity $\mathcal{I}_\tau(E)$ represents the surface tension of E for the norm τ . At the point x , the tension has intensity $\tau(n_E(x))$ in the direction of the normal unit exterior vector $n_E(x)$. We denote by \mathcal{L}^d the d -dimensional Lebesgue measure. We can associate with the norm τ the following isoperimetric problem:

$$\text{minimize } \frac{\mathcal{I}_\tau(E)}{\mathcal{L}^d(E)} \text{ subject to } \mathcal{L}^d(E) \leq 1.$$

We use the Wulff construction to build a minimizer for this anisotropic isoperimetric problem. We define the set \widehat{W}_τ as

$$\widehat{W}_\tau = \bigcap_{v \in \mathbb{S}^{d-1}} \{x \in \mathbb{R}^d : x \cdot v \leq \tau(v)\},$$

where \cdot denotes the standard scalar product and \mathbb{S}^{d-1} is the unit sphere of \mathbb{R}^d . The set $\widehat{W}_\tau / \mathcal{L}^d(\widehat{W}_\tau)$ is a minimizer for the isoperimetric problem associated with τ . We will build in section 3 an appropriate norm β_p for our problem that will be directly related to the open edge boundary ratio. We will denote by \mathcal{I}_p the surface tension associated with β_p . We define the Wulff crystal W_p as the dilate of \widehat{W}_{β_p} such that $\mathcal{L}^d(W_p) = 1/\theta_p$, where $\theta_p = \mathbb{P}(0 \in \mathcal{C}_\infty)$.

In this paper, we adapt the proof of Gold to any dimension $d \geq 2$ to give a self-contained proof of the existence of the limit for the anchored isoperimetric profile. Note that this proof also holds in dimension 2, it gives an alternative proof of [15] with a simpler norm. The interest of this result is to prove the existence of the isoperimetric constant for a more natural definition. Although proving the existence of the anchored isoperimetric profile involves more technical difficulties, the anchored isoperimetric profile itself is a simpler object to study. Cerf and Dembin studied the anchored isoperimetric profile φ_n at p_c in [2]. Studying the behavior of $\varphi_{\mathcal{C}_n}$ at p_c would have required much more work. The aim of this paper is the proof of the two following Theorems. The first theorem asserts the existence of the limit of $n\varphi_n$.

Theorem 1.1. *Let $d \geq 2$, $p > p_c(d)$ and let β_p be the norm that will be properly defined in section 3. Let W_p be the Wulff crystal for this norm, i.e., the dilate of \widehat{W}_{β_p} such that $\mathcal{L}^d(W_p) = 1/\theta_p$. Then, conditionally on $\{0 \in \mathcal{C}_\infty\}$,*

$$\lim_{n \rightarrow \infty} n\varphi_n = \frac{\mathcal{I}_p(W_p)}{\theta_p \mathcal{L}^d(W_p)} = \mathcal{I}_p(W_p) \text{ a.s..}$$

The second theorem shows that the graphs G_n realizing the minimum converge in probability towards a translate of W_p .

Theorem 1.2. *Let $d \geq 2$ and $p > p_c(d)$. Let $\varepsilon > 0$. There exists positive constants C_1 and C_2 depending on d , p and ε such that, for all $n \geq 1$,*

$$\mathbb{P} \left(\max_{G_n \in \mathcal{G}_n} \inf_{x \in \mathbb{R}^d} \frac{1}{n^d} |G_n \Delta (n(x + W_p) \cap \mathcal{C}_\infty)| \geq \varepsilon \mid 0 \in \mathcal{C}_\infty \right) \leq C_1 e^{-C_2 n^{1-3/2d}},$$

where Δ denotes the symmetric difference.

Remark 1.3. *We emphasize the fact that when we restrict theorems 1.1 and 1.2 to dimension two, we obtain a weaker version of already existing results. Namely, in [15], the authors used methods specific to dimension two in order to derive a uniform convergence in the shape theorem. Whereas here, we only obtain L^1 -convergence.*

To prove Theorem 1.1, we first prove a large deviations result from above for $n\varphi_n$ stated in the following Theorem.

Theorem 1.4. *Let $d \geq 2$. Let $p > p_c(d)$. For all $\varepsilon > 0$, there exist positive constants C_1 and C_2 depending on p , d , ε such that, for all $n \geq 1$,*

$$\mathbb{P} \left(n\varphi_n \geq (1 + \varepsilon) \frac{\mathcal{I}_p(W_p)}{\theta_p(d) \mathcal{L}^d(W_p)} \mid 0 \in \mathcal{C}_\infty \right) \leq C_1 \exp(-C_2 n).$$

The proof of Theorem 1.4 is inspired by the proof of Theorem 5.4 in [44]. We shall build a valid subgraph that has an isoperimetric ratio close to φ_n . In order to do so, we approximate the Wulff shape W_p from the inside by a convex polytope P . We shall build a cutset Γ_n that cuts nP from infinity whose number of open edges is close to $n^{d-1} \mathcal{I}_p(P)$ with high probability. For each face F of P and v its associated exterior unit normal vector, we consider the cylinder $\text{cyl}(F + \varepsilon v, \varepsilon)$ of basis $F + \varepsilon v$ and of height $\varepsilon > 0$. We build E by merging the cutsets from the top to the bottom of minimal capacity of the cylinders $\text{cyl}(F + \varepsilon v, \varepsilon)$. The union of these cutsets is not yet a cutset itself because of the potential holes between these cutsets. We fix this issue by adding extra edges to fill the holes. We control next the number of extra edges we have added. We also need to control the capacity of the cutsets in a cylinder of polyhedral basis. We next build a valid subgraph $H_n \subset \mathbb{Z}^d$ from Γ_n by taking all the vertices of $\mathcal{C}_\infty \cap nP$ that are connected to 0 without using edges in Γ_n . We expect that $|H_n|$ is of order $\theta_p(d) n^d \mathcal{L}^d(P)$. We can bound $|\partial_{\mathcal{C}_\infty} H_n|$ from above thanks to the number of open edges in Γ_n and so we control the isoperimetric ratio of H_n . Finally, we control the upper large deviations for this number of open edges thanks to the upper large deviations for the flow in a cylinder of polyhedral basis. The next step is to obtain the large deviations result from below.

Theorem 1.5. *Let $d \geq 2$. Let $p > p_c(d)$. For all $\varepsilon > 0$, there exist positive constants C_1 and C_2 depending on p , d , ε such that, for all $n \geq 1$,*

$$\mathbb{P} \left(n\varphi_n \leq (1 - \varepsilon) \frac{\mathcal{I}_p(W_p)}{\theta_p(d) \mathcal{L}^d(W_p)} \mid 0 \in \mathcal{C}_\infty \right) \leq C_1 \exp(-C_2 n^{1-3/2d}).$$

Remark 1.6. *The deviation order in Theorem 1.5 is not optimal due to technical details of the proof. In this work we do not make any attempt to get the proper order of deviation. Our aim is mainly to obtain Theorems 1.1 and 1.2. The study of the large deviations order would be an interesting problem in itself.*

Theorem 1.1 follows from Theorem 1.4 and Theorem 1.5 by a straightforward application of the Borel-Cantelli Lemma. Proving the large deviations result from below is the most difficult part of this work. To be able to compare discrete objects with continuous ones, we shall encode each optimizer $G_n \in \mathcal{G}_n$ as a measure μ_n defined as

$$\mu_n = \frac{1}{n^d} \sum_{x \in V(G_n)} \delta_{x/n}.$$

We first need to build from a minimizer G_n an appropriate continuous object P_n . To do so, we use the same method as in [44]. The main issue is that the boundary of G_n may be very tangled, we will have to build a smoother boundary of size of order n^{d-1} . This will enable us to build a continuous object P_n of finite perimeter such that, with high probability, its associated measure is close to μ_n in some sense to be specified later.

Let F be a Borelian set of \mathbb{R}^d . We define its associated measure ν_F :

$$\forall E \in \mathcal{B}(\mathbb{R}^d), \quad \nu_F(E) = \theta_p \mathcal{L}^d(F \cap E).$$

We now define the set \mathcal{W} of the measures associated with the translates of the Wulff shape as

$$\mathcal{W} = \{ \nu_{x+W_p} : x \in \mathbb{R}^d \}.$$

Note that μ_n belongs to $\mathcal{M}(\mathbb{R}^d)$, the set of finite measures on \mathbb{R}^d . We cannot use a metric as in [44] where μ_n was a measure on $[-1, 1]^d$. In fact, we will not use a metric here. We first show that all the minimizers $G_n \in \mathcal{G}_n$ are with high probability in a local neighborhood of \mathcal{W} for a weak topology. This is the key step before proving Theorem 1.5.

Theorem 1.7. *Let $d \geq 2$ and $p > p_c(d)$. Let $u :]0, +\infty[\rightarrow]0, +\infty[$ be a non-decreasing function such that $\lim_{t \rightarrow 0} u(t) = 0$. For all $\zeta > 0$, there exist positive constants C_1 and C_2 depending on d, p, u and ζ such that for all $n \geq 1$, for any finite set \mathfrak{F}_n of uniformly continuous functions that satisfies:*

$$\forall f \in \mathfrak{F}_n \quad \|f\|_\infty \leq 1 \quad \text{and} \quad \forall x, y \in \mathbb{R}^d \quad |f(x) - f(y)| \leq u(\|x - y\|_2),$$

we have

$$\mathbb{P} \left(\exists G_n \in \mathcal{G}_n, \forall \nu \in \mathcal{W}, \sup_{f \in \mathfrak{F}_n} |\mu_n(f) - \nu(f)| > \zeta \mid 0 \in \mathcal{C}_\infty \right) \leq C_1 e^{-C_2 n^{1-3/2d}}.$$

The main difficulty of this paper lies in the proof of this theorem. In our context, an issue that was not present in [44] arises. Whereas the support of the measure μ_n was included in a fixed compact set in [44], this is not the case here because we do not constrain $G_n \in \mathcal{G}_n$ to remain in the box $[-n, n]^d$. To fix this issue, we will use the method developed in [19]. We will first localize the set G_n in a finite number of balls of radius of order n up to a set of small fractional volume. We will study G_n only inside these balls, *i.e.*, the intersection of G_n with these balls. The intersection of G_n with the boundary of these balls will create an additional surface tension. However, this surface tension is not related to the open boundary edges of G_n but to the fact that we have cut G_n along these boundaries. Therefore, we should not take this surface tension into account for the isoperimetric constant. In fact, we will cut G_n in such a way to ensure that we do not create too much surface tension, *i.e.*, we will cut in regions where G_n is not concentrated. To conclude, we will link the probability that the measure μ_n corresponding to $G_n \in \mathcal{G}_n$ is far from a weak neighborhood of \mathcal{W} with the probability that the surface tension of G_n is locally abnormally small.

Finally, to prove Theorem 1.2, we exhibit a set \mathcal{F}_n of uniformly continuous functions such that we can bound from above the symmetric difference $|G_n \Delta (n(x + W_p) \cap \mathcal{C}_\infty)|$ by $\sup_{f \in \mathfrak{F}_n} |\mu_n(f) - \nu(f)|$ for some $\nu \in \mathcal{W}$ and then apply the result of Theorem 1.7.

The rest of the paper is organized as follows. In section 2, we give some definitions and useful results. We do the construction of the norm β_p in section 3. In section 4, we prove the upper large deviations in Theorem 1.4. We build a continuous object P_n from a minimizer $G_n \in \mathcal{G}_n$ and prove that its associated measure is close in some sense to the measure μ_n of G_n in section 5. Finally, in section 6, we prove Theorem 1.7 that is a preliminary work before proving the lower large deviations Theorem 1.5 and the convergence of G_n properly rescaled towards a limit shape in Theorem 1.2.

2 Some definitions and useful results

2.1 Geometric notations

For $x = (x_1, \dots, x_d)$, we define

$$\|x\|_2 = \sqrt{\sum_{i=1}^d x_i^2} \quad \text{and} \quad \|x\|_\infty = \max_{1 \leq i \leq d} |x_i|.$$

We say that $x, y \in \mathbb{Z}^d$ are $*$ -connected if $\|x - y\|_\infty = 1$. We say that $\gamma = (x_0, \dots, x_n)$ is an $*$ -path of \mathbb{Z}^d if for any $0 \leq i \leq n - 1$, the points x_i and x_{i+1} belong to \mathbb{Z}^d and are $*$ -connected. We say that Γ is $*$ -connected or a lattice animal if any $x, y \in \Gamma$ are connected by an $*$ -path in Γ . We denote by Animals_x the set of lattice animals containing the point $x \in \mathbb{Z}^d$.

Lemma 2.1. [Kesten [51], p82 or Grimmett [48], p85] Let $x \in \mathbb{Z}^d$. For all positive integer l ,

$$|\{\Gamma \in \text{Animals}_x, |\Gamma| = l\}| \leq (7^d)^l.$$

Let $S \subset \mathbb{R}^d$ and $r > 0$, we define $d_2(x, S) = \inf_{y \in S} \|x - y\|_2$ and $\mathcal{V}(S, r)$ the open r -neighborhood of S by

$$\mathcal{V}(S, r) = \left\{ x \in \mathbb{R}^d : d_2(x, S) < r \right\}.$$

Let $x \in \mathbb{R}^d$, $r > 0$ and a unit vector v . We denote by $B(x, r)$ the closed ball of radius r centered at x , by $\text{disc}(x, r, v)$ the closed disc centered at x of radius r normal to v , and by $B^+(x, r, v)$ (respectively $B^-(x, r, v)$) the upper (resp. lower) half part of $B(x, r)$ along the direction of v , *i.e.*,

$$B^+(x, r, v) = \left\{ y \in B(x, r) : (y - x) \cdot v \geq 0 \right\},$$

and

$$B^-(x, r, v) = \left\{ y \in B(x, r) : (y - x) \cdot v \leq 0 \right\}.$$

We denote by α_d the \mathcal{L}^d measure of a unit ball in \mathbb{R}^d . We denote by \mathcal{H}^{d-1} the Hausdorff measure in dimension $d - 1$. In particular, the \mathcal{H}^{d-1} measure of a $d - 1$ dimensional unit disc in \mathbb{R}^d is equal to α_{d-1} . Let A be a non-degenerate hyperrectangle, *i.e.*, a rectangle of dimension $d - 1$ in \mathbb{R}^d . Let \vec{v} be one of the two unit vectors normal to A . Let $h > 0$, we denote by $\text{cyl}(A, h)$ the cylinder of basis A and height h defined by

$$\text{cyl}(A, h) = \left\{ x + t\vec{v} : x \in A, t \in [-h, h] \right\}.$$

The dependence on \vec{v} is implicit in the notation $\text{cyl}(A, h)$. Note that these definitions of cylinder may be extended in the case where A is of linear dimension $d - 1$, *i.e.*, A is included in an hyperplane of \mathbb{R}^d , which is the affine span of A .

2.2 Sets of finite perimeter and surface energy

The perimeter of a Borel set S of \mathbb{R}^d in an open set O is defined as

$$\mathcal{P}(S, O) = \sup \left\{ \int_S \text{div} f(x) d\mathcal{L}^d(x) : f \in C_c^\infty(O, B(0, 1)) \right\},$$

where $C_c^\infty(O, B(0, 1))$ is the set of the functions of class C^∞ from \mathbb{R}^d to $B(0, 1)$ having a compact support included in O , and div is the usual divergence operator. The perimeter $\mathcal{P}(S)$ of S is defined as $\mathcal{P}(S, \mathbb{R}^d)$. The topological boundary of S is denoted by ∂S . The reduced boundary $\partial^* S$ of S is a subset of ∂S such that, at each point x of $\partial^* S$, it is possible to define a normal vector $n_S(x)$ to S in a measure-theoretic sense, and moreover $\mathcal{P}(S) = \mathcal{H}^{d-1}(\partial^* S)$. Let ν be a norm on \mathbb{R}^d . We define its associated Wulff crystal \mathcal{W}_ν as

$$\mathcal{W}_\nu = \left\{ x \in \mathbb{R}^d : \forall y, y \cdot x \leq \nu(y) \right\}.$$

With the help of the Wulff crystal, we define the surface energy of a general set.

Definition 2.2. Let ν be a norm on \mathbb{R}^d . The surface energy $\mathcal{I}_\nu(S, O)$ of a Borel set S of \mathbb{R}^d in an open set O is defined as

$$\mathcal{I}_\nu(S, O) = \sup \left\{ \int_S \operatorname{div} f(x) d\mathcal{L}^d(x) : f \in C_c^1(O, \mathcal{W}_\nu) \right\}.$$

We will note simply $\mathcal{I}_\nu(S) = \mathcal{I}_\nu(S, \mathbb{R}^d)$.

Proposition 2.3 (Proposition 14.3 in [19]). The surface energy $\mathcal{I}_\nu(S, O)$ of a Borel set S of \mathbb{R}^d of finite perimeter in an open set O is equal to

$$\mathcal{I}_\nu(S, O) = \int_{\partial^* S \cap O} \nu(n_S(x)) d\mathcal{H}^{d-1}(x).$$

We recall the following fundamental result.

Proposition 2.4 (Isoperimetric inequality). There exist two positive constants b_{iso} , c_{iso} which depend only on the dimension d , such that for any Cacciopoli set E , any ball $B(x, r) \subset \mathbb{R}^d$,

$$\min(\mathcal{L}^d(E \cap B(x, r)), \mathcal{L}^d((\mathbb{R}^d \setminus E) \cap B(x, r))) \leq b_{iso} \mathcal{P}(E, \mathring{B}(x, r))^{d/d-1},$$

$$\min(\mathcal{L}^d(E), \mathcal{L}^d(\mathbb{R}^d \setminus E)) \leq c_{iso} \mathcal{P}(E)^{d/d-1}.$$

We refer to [43], for more details on Cacciopoli sets, isoperimetric inequality and other definitions in geometric measure theory.

2.3 Approximation by convex polytopes

We recall here an important result, which allows us to approximate adequately a set of finite perimeter by a convex polytope.

Definition 2.5 (Convex polytope). Let $P \subset \mathbb{R}^d$. We say that P is a convex polytope if there exist v_1, \dots, v_m unit vectors and $\varphi_1, \dots, \varphi_m$ real numbers such that

$$P = \bigcap_{1 \leq i \leq m} \left\{ x \in \mathbb{R}^d : x \cdot v_i \leq \varphi_i \right\}.$$

We denote by F_i the face of P associated with v_i , i.e.,

$$F_i = P \cap \left\{ x \in \mathbb{R}^d : x \cdot v_i = \varphi_i \right\}.$$

Any convex subset can be approximated from the outside and from the inside by a convex polytope with almost the same surface energy.

Lemma 2.6. Let ν be a norm on \mathbb{R}^d . Let A be a bounded convex set. For each $\varepsilon > 0$, there exist convex polytopes P and Q such that $P \subset A \subset Q$ and $\mathcal{I}_\nu(Q) - \varepsilon \leq \mathcal{I}_\nu(A) \leq \mathcal{I}_\nu(P) + \varepsilon$.

Proof. Let A be a bounded convex set. Let $\varepsilon > 0$. Let $(x_k)_{k \geq 1}$ be a dense family in ∂A . For $n \geq 1$, we define P_n as the convex hull of x_1, \dots, x_n , i.e., the smallest convex that contains the points x_1, \dots, x_n . As A is convex, we have $P_n \subset A$ and P_n converges towards A when n goes to infinity for the \mathcal{L}^1 topology. The functional \mathcal{I}_ν is lower semi-continuous, thus

$$\mathcal{I}_\nu(A) \leq \liminf_{n \rightarrow \infty} \mathcal{I}_\nu(P_n),$$

so there exists n large enough such that

$$\mathcal{I}_\nu(A) \leq \mathcal{I}_\nu(P_n) + \varepsilon$$

and we take $P = P_n$. The existence of Q was shown in Lemma 5.1. in [21] for the Wulff shape. The proof may be easily adapted to a general convex bounded set A . □

3 Construction of the norm

Minimizing the open edge boundary is the analogue of minimizing a surface tension in the continuous setting. We shall build a norm β_p that represents the tension that is exerted on the surface, *i.e.*, any point x in a surface S having $n_S(x)$ as a normal unit exterior vector has a tension $\beta_p(n_S(x))n_S(x)$ that exerts at the point x . To build this norm, let us consider $G_n \in \mathcal{G}_n$. We zoom on the boundary of G_n , we look at what happens in a small but macroscopic cube centered at a point x in the boundary ∂G_n (see figure 2.1). The cube is located in such a way that its bottom intersects G_n and its top intersects $\mathbb{Z}^d \setminus G_n$, and it is rotated so that its normal vector coincides with the normal exterior vector at the point x . As this cube is small, the portion of G_n in that cube does not affect much $|G_n|$, the total volume of G_n . Thus, if one would like to minimize the open edges to volume ratio, one needs to minimize the number of open edges of ∂G_n in that cube. This problem is equivalent to finding a set of edges that separates the top from the bottom of the cube with a minimal number of open edges.

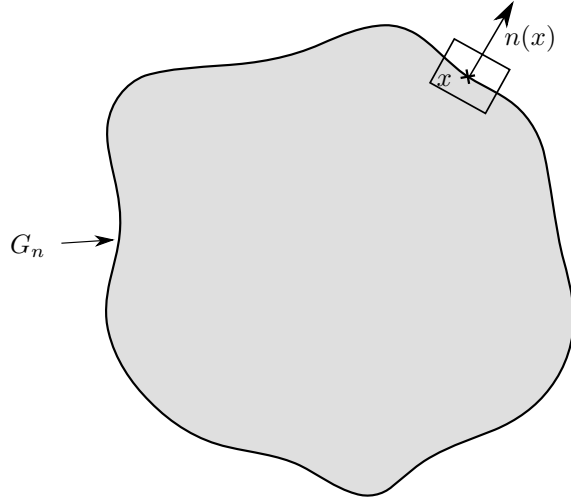

Figure 2.1 – A small box on the boundary ∂G_n of a minimizer $G_n \in \mathcal{G}_n$

Let us give now a more precise definition of the norm β_p . We consider a bond percolation on \mathbb{Z}^d of parameter $p > p_c(d)$ with $d \geq 2$. We introduce many notations used for instance in [62] concerning flows through cylinders. Let A be a non-degenerate hyperrectangle, *i.e.*, a rectangle of dimension $d - 1$ in \mathbb{R}^d . Let \vec{v} be one of the two unit vectors normal to A . Let $h > 0$, we denote by $\text{cyl}(A, h)$ the cylinder of basis A and height $2h$ defined by

$$\text{cyl}(A, h) = \left\{ x + t\vec{v} : x \in A, t \in [-h, h] \right\}.$$

The set $\text{cyl}(A, h) \setminus A$ has two connected components, denoted by $C_1(A, h)$ and $C_2(A, h)$. For $i = 1, 2$, we denote by $C'_i(A, h)$ the discrete boundary of $C_i(A, h)$ defined by

$$C'_i(A, h) = \left\{ x \in \mathbb{Z}^d \cap C_i(A, h) : \exists y \notin \text{cyl}(A, h), \langle x, y \rangle \in \mathbb{E}^d \right\}.$$

We say that a set of edges E cuts $C'_1(A, h)$ from $C'_2(A, h)$ in $\text{cyl}(A, h)$ if any path γ from $C'_1(A, h)$ to $C'_2(A, h)$ in $\text{cyl}(A, h)$ contains at least one edge of E . We call such a set a cutset. For any set of edges E , we denote by $|E|_o$ the number of open edges in E . We shall call it the capacity of E . We define

$$\tau_p(A, h) = \min \left\{ |E|_o : E \text{ cuts } C'_1(A, h) \text{ from } C'_2(A, h) \text{ in } \text{cyl}(A, h) \right\}.$$

Note that this is a random quantity as $|E|_o$ is random, and that the cutsets in this definition are pinned near the boundary of A . Finding cutsets of minimal capacity is equivalent to the study of

maximal flows, see [16]. To each edge e , we can associate the random variable $t(e) = \mathbf{1}_{e \text{ is open}}$. In the study of maximal flows, we interpret each $t(e)$ as the capacity of the edge e , *i.e.*, the maximal amount of water that can flow through e per unit of time. We are interested in the maximal amount of water that can flow through the cylinder given the constraint on the capacity. We refer to [64] for a rigorous definition of maximal flows. In the following, we will use the term flow to speak about the quantity τ_p . The following proposition is a corollary of Proposition 3.5 in [62], it enables us to give a rigorous definition of the norm β_p .

Proposition 3.1 (Definition of the norm β_p). *Let $d \geq 2$, $p > p_c(d)$, A be a non-degenerate hyperrectangle and \vec{v} one of the two unit vectors normal to A . Let h be a height function such that $\lim_{n \rightarrow \infty} h(n) = \infty$. The limit*

$$\beta_p(\vec{v}) = \lim_{n \rightarrow \infty} \frac{\mathbb{E}[\tau_p(nA, h(n))]}{\mathcal{H}^{d-1}(nA)}$$

exists and is finite. Moreover, this limit is independent of A and h and β_p is a norm.

The norm β_p is called the flow constant. Roughly speaking, $\beta_p(\vec{v})$ corresponds to the expected maximal amount of water that can flow in the direction \vec{v} on average. Actually, we can obtain a stronger convergence. A straightforward application of Theorem 3.8 in [62] gives the existence of the following almost sure limit:

$$\lim_{n \rightarrow \infty} \frac{\tau_p(nA, h(n))}{\mathcal{H}^{d-1}(nA)} = \beta_p(\vec{v}).$$

We define

$$\beta_{min} = \inf_{\vec{v} \in \mathbb{S}^{d-1}} \beta_p(\vec{v}), \quad \beta_{max} = \sup_{\vec{v} \in \mathbb{S}^{d-1}} \beta_p(\vec{v}).$$

As β_p is a norm on \mathbb{R}^d , we have $\beta_{min} > 0$ and $\beta_{max} < \infty$. We will need the following upper large deviations result which is a straightforward application of Theorem 3 in [68].

Theorem 3.2. *Let $d \geq 2$ and $p > p_c(d)$. For every unit vector \vec{v} , for every non-degenerate hyperrectangle A normal to \vec{v} , for every $h > 0$ and for every $\lambda > \beta_p(\vec{v})$, there exist C_1 and C_2 depending only on λ and G , such that, for all $n \geq 0$,*

$$\mathbb{P}(\tau_p(nA, hn) \geq \lambda \mathcal{H}^{d-1}(A)n^{d-1}) \leq C_1 \exp(-C_2 hn^d).$$

To ease the reading and lighten the notations, the value of the constants may change from appearance to appearance.

4 Upper large deviations

The aim of this section is to prove Theorem 1.4. A convex polytope of dimension $d - 1$ is a convex polytope F which is contained in an hyperplane of \mathbb{R}^d and such that $\mathcal{H}^{d-1}(F) > 0$. We have the following Lemma.

Lemma 4.1. *Let $p > p_c(d)$. Let F be a convex polytope of dimension $d - 1$. Let v be a unit vector normal to F . There exist positive real numbers C_1 and C_2 depending on F , p and d such that for all $n \geq 1$, for all $\lambda > \beta_p(v)\mathcal{H}^{d-1}(F)$, for all $h > 0$*

$$\mathbb{P}(\tau_p(nF, nh) \geq \lambda n^{d-1}) \leq C_1 \exp(-C_2 hn^d).$$

Proof. Let $p > p_c(d)$. Let F be a convex polytope of dimension $d - 1$ and v a unit vector normal to F . We shall cover F by a finite family of hypersquares and control the probability that the flow is abnormally big in $\text{cyl}(nF, nh)$ by the probability that the flow is abnormally big in one of the cylinders of square basis. Let $\lambda > \beta_p(v)\mathcal{H}^{d-1}(F)$. Let $\kappa > 0$ be a real number that we will choose later. We denote by $S(\kappa)$ an hypersquare of dimension $d - 1$ of side length κ and normal to v . We want to cover the following region of F by hypersquares isometric to $S(\kappa)$:

$$D(\kappa, F) = \left\{ x \in F : d(x, \partial F) > 2\sqrt{d}\kappa \right\}.$$

There exists a finite family $(S_i)_{i \in I}$ of closed hypersquares isometric to $S(\kappa)$ included in F having pairwise disjoint interiors, such that $D(\kappa, F) \subset \cup_{i \in I} S_i$ (see figure 2.2). Moreover, there exists a constant c_d depending only on the dimension d such that

$$\mathcal{H}^{d-1}(F \setminus D(\kappa, F)) \leq c_d \mathcal{H}^{d-2}(\partial F) \kappa. \quad (4.1)$$

We have then

$$|I| \leq \frac{\mathcal{H}^{d-1}(F)}{\mathcal{H}^{d-1}(S(\kappa))}. \quad (4.2)$$

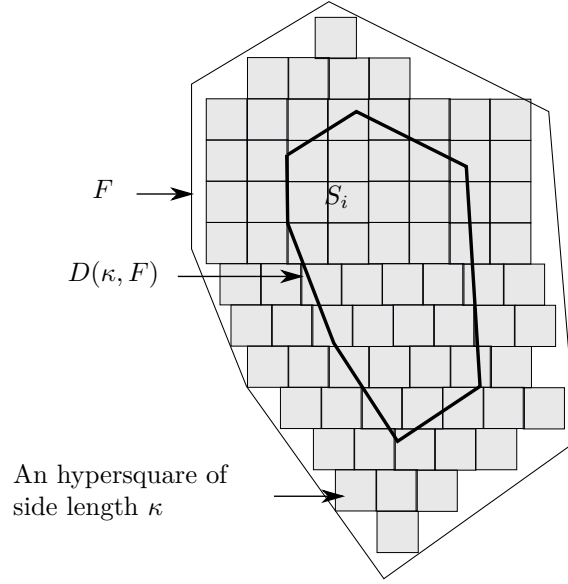

Figure 2.2 – Covering P with hypersquares

Let $h > 0$. We would like to build a cutset between $C'_1(nF, nh)$ and $C'_2(nF, nh)$ out of minimal cutsets for the flows $\tau_p(nS_i, nh)$, $i \in I$. Note that a cutset that achieves the infimum defining $\tau_p(nS_i, nh)$ is pinned near the boundary ∂nS_i . However, if we pick up two hypersquares S_i and S_j that share a common side, due to the discretization, their corresponding minimal cutsets for the flow τ_p do not necessarily have the same trace on the common face of the associated cylinders $\text{cyl}(nS_i, nh)$ and $\text{cyl}(nS_j, nh)$. We shall fix this problem by adding extra edges around the boundaries of the hypersquares ∂S_i in order to glue properly the cutsets. We will need also to add extra edges around $n(F \setminus D(\kappa, F))$ in order to build a cutset between $C'_1(nF, nh)$ and $C'_2(nF, nh)$. For $i \in I$, let E_i be a minimal cutset for $\tau_p(nS_i, nh)$, i.e., $E_i \subset \mathbb{E}^d$ cuts $C'_1(nS_i, nh)$ from $C'_2(nS_i, nh)$ in $\text{cyl}(nS_i, nh)$ and $|E_i|_o = \tau_p(nS_i, nh)$. We fix $\zeta = 4d$. Let E_0 be the set of edges of \mathbb{E}^d included in \mathcal{E}_0 , where we define

$$\mathcal{E}_0 = \left\{ x \in \mathbb{R}^d : d\left(x, nF \setminus \bigcup_{i \in I} nS_i\right) \leq \zeta \right\} \cup \bigcup_{i \in I} \left\{ x \in \mathbb{R}^d : d(x, \partial nS_i) \leq \zeta \right\}.$$

The set of edges $E_0 \cup \bigcup_{i \in I} E_i$ separates $C'_1(nF, nh)$ from $C'_2(nF, nh)$ in the cylinder $\text{cyl}(nF, nh)$, therefore,

$$\tau_p(nF, nh) \leq |E_0|_o + \sum_{i \in I} |E_i|_o \leq \text{card}(E_0) + \sum_{i \in I} \tau_p(nS_i, nh). \quad (4.3)$$

There exists a constant c'_d depending only on d such that, using inequalities (4.1) and (4.2),

$$\begin{aligned} \text{card}(E_0) &\leq c'_d (\kappa n^{d-1} \mathcal{H}^{d-2}(\partial F) + |I| \mathcal{H}^{d-2}(\partial S(\kappa)) n^{d-2}) \\ &\leq c'_d \left(\kappa n^{d-1} \mathcal{H}^{d-2}(\partial F) + \frac{\mathcal{H}^{d-1}(F)}{\mathcal{H}^{d-1}(S(\kappa))} \mathcal{H}^{d-2}(\partial S(\kappa)) n^{d-2} \right) \\ &\leq c'_d \left(\kappa n^{d-1} \mathcal{H}^{d-2}(\partial F) + \frac{\mathcal{H}^{d-1}(F)}{\kappa} n^{d-2} \right). \end{aligned}$$

Thus, for n large enough,

$$\text{card}(E_0) \leq 2c'_d \kappa \mathcal{H}^{d-2}(\partial F) n^{d-1}. \quad (4.4)$$

There exists $s > 0$ such that $\lambda > (1+s)\beta_p(v)\mathcal{H}^{d-1}(F)$. We choose κ small enough such that

$$2c'_d \kappa \mathcal{H}^{d-2}(\partial F) < \frac{s}{2} \beta_{\min} \mathcal{H}^{d-1}(F). \quad (4.5)$$

Inequalities (4.4) and (4.5) yield that

$$\text{card}(E_0) \leq \frac{s}{2} \beta_p(v) n^{d-1} \mathcal{H}^{d-1}(F). \quad (4.6)$$

Thanks to inequality (4.6), we obtain

$$\begin{aligned} \mathbb{P}(\tau_p(nF, nh) \geq \lambda n^{d-1}) &\leq \mathbb{P} \left(\text{card}(E_0) + \sum_{i \in I} \tau_p(nS_i, nh) \geq (1+s)\beta_p(v)\mathcal{H}^{d-1}(F)n^{d-1} \right) \\ &\leq \sum_{i \in I} \mathbb{P}(\tau_p(nS_i, nh) \geq (1+s/2)\beta_p(v)\mathcal{H}^{d-1}(S_i)n^{d-1}). \end{aligned} \quad (4.7)$$

Thanks to Theorem 3.2, there exist positive real numbers C_1, C_2 such that, for all $i \in I$,

$$\mathbb{P}(\tau_p(nS_i, nh) \geq (1+s/2)\beta_p(v)\mathcal{H}^{d-1}(S_i)n^{d-1}) \leq C_1 \exp(-C_2 hn^d). \quad (4.8)$$

By combining inequalities (4.7) and (4.8), we obtain

$$\mathbb{P}(\tau_p(nF, nh) \geq \lambda n^{d-1}) \leq |I| C_1 \exp(-C_2 hn^d),$$

and the result follows. \square

We can now proceed to the proof of Theorem 1.4.

Proof of Theorem 1.4. Let $\varepsilon > 0$ and $\varepsilon' > 0$. By Lemma 2.6, there exists a convex polytope P such that $P \subset W_p$, $\mathcal{I}_p(P) \leq (1+\varepsilon')\mathcal{I}_p(W_p)$ and $\mathcal{L}^d(P) \geq (1-\varepsilon')\mathcal{L}^d(W_p)$. Up to multiplying P by a constant $\alpha < 1$ close to 1, we can assume without loss of generality that $\mathcal{L}^d(P) < \mathcal{L}^d(W_p)$. We have, for small enough ε' (depending on ε),

$$\begin{aligned} \mathbb{P} \left(n\varphi_n \geq (1+\varepsilon) \frac{\mathcal{I}_p(W_p)}{\theta_p(d)\mathcal{L}^d(W_p)} \mid 0 \in \mathcal{C}_\infty \right) &\leq \mathbb{P} \left(n\varphi_n \geq (1+\varepsilon/2) \left(\frac{1+\varepsilon'}{1-\varepsilon'} \right) \frac{\mathcal{I}_p(W_p)}{\theta_p(d)\mathcal{L}^d(W_p)} \mid 0 \in \mathcal{C}_\infty \right) \\ &\leq \mathbb{P} \left(n\varphi_n \geq (1+\varepsilon/2) \frac{\mathcal{I}_p(P)}{\theta_p(d)\mathcal{L}^d(P)} \mid 0 \in \mathcal{C}_\infty \right). \end{aligned} \quad (4.9)$$

Let us denote by F_1, \dots, F_m the faces of P and let v_1, \dots, v_m be the associated exterior unit vectors. Let $\delta > 0$. For $i \in \{1, \dots, m\}$, we define

$$C_i = \text{cyl}(F_i + \delta v_i, \delta).$$

All the C_i are of disjoint interiors because P is convex. Indeed, assume there exists $z \in \overset{\circ}{C}_i \cap \overset{\circ}{C}_j$ for some $i \neq j$. Then there exist unique $x \in F_i, y \in F_j$ and $h, h' < 2\delta$ such that $z = x + hv_i = y + h'v_j$. The points x and y correspond to the orthogonal projection of z on P . As P is convex, the orthogonal projection on P is unique and so $x = y = z$. This contradicts the fact that z belongs to the interior of C_i . We now aim to build a cutset that cuts nP from infinity out of cutsets of minimal capacities for $\tau_p(n(F_i + \delta v_i), n\delta)$, $i \in \{1, \dots, m\}$. The union of these cutsets is not enough to form a cutset from nP to infinity because there are holes between these cutsets. We shall add edges around the boundaries $\partial(n(F_i + \delta v_i))$ to close these holes (see figure 2.3). As the distance between two adjacent boundaries $\partial(n(F_i + \delta v_i))$ decreases with δ , by taking δ small enough, the size of the bridges and so their capacities are not too big. We recall that the capacity of a set, namely the number of open edges in the set, may be bounded from above by its size. Next, we control the maximal flow through the cylinders or equivalently the capacity of minimal cutsets in the cylinders with the help of Lemma 4.1.

For $i \in \{1, \dots, m\}$, let E'_i be a minimal cutset for $\tau_p(n(F_i + \delta v_i), n\delta)$, *i.e.*, E'_i cuts $C'_1(n(F_i + \delta v_i), \delta)$ from $C'_2(n(F_i + \delta v_i), \delta)$ and $|E'_i|_o = \tau_p(n(F_i + \delta v_i), \delta n)$. We shall add edges to control the space between E'_i and the boundary $\partial(n(F_i + \delta v_i))$. Let $\zeta = 4d$. Let $i, j \in \{1, \dots, m\}$ such that F_i and F_j share a common side. We define

$$\mathcal{M}(i, j) = (\mathcal{V}(nF_i \cap nF_j, n\delta + \zeta) \setminus \mathcal{V}(nF_i \cap nF_j, n\delta - \zeta)) \cap (nP)^c.$$

Let $M_{i,j}$ denote the set of the edges in \mathbb{E}_n^d included in $\mathcal{M}(i, j)$ (see figure 2.3). There exists a constant c'_d depending only on the dimension d such that for all $i, j \in \{1, \dots, m\}$ such that F_i and F_j share a common side,

$$\text{card}(M_{i,j}) \leq c_d \delta^{d-1} n^{d-1}. \quad (4.10)$$

We set

$$M = \bigcup_{i,j} M_{i,j},$$

where the union is over $i, j \in \{1, \dots, m\}$ such that $i \neq j$ and F_i, F_j share a common side. The set $\Gamma_n = M \cup \bigcup_{i=1}^m E'_i$ cuts nP from infinity. We define H_n to be the set of the vertices connected to 0 by open paths which do not use an edge of Γ_n , *i.e.*,

$$H_n = \left\{ x \in \mathbb{Z}^d, x \text{ is connected to } 0 \text{ with open edges in } \mathbb{E}^d \setminus \Gamma_n \right\}.$$

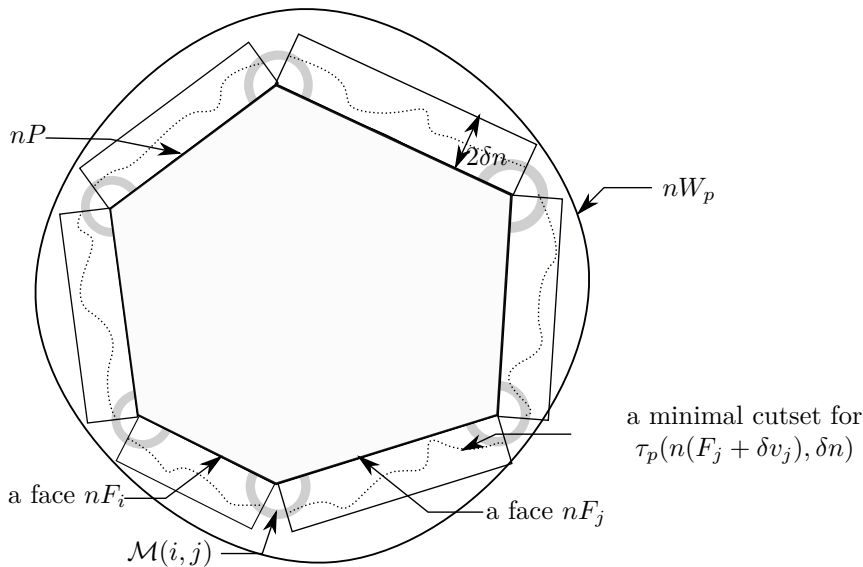

Figure 2.3 – Construction of a cutset Γ_n from nP to infinity

By definition, the set H_n is connected. As we condition on the event $\{0 \in \mathcal{C}_\infty\}$, the set H_n is a subgraph of \mathcal{C}_∞ . As P is a polytope,

$$\mathcal{I}_p(P) = \sum_{i=1}^m \beta_p(v_i) \mathcal{H}^{d-1}(F_i).$$

Moreover, we have

$$|\partial_{\mathcal{C}_\infty} H_n| = |\partial^\circ H_n| \leq |\Gamma_n|_o,$$

where the last inequality comes from the fact that, by construction of H_n , if $e \in \partial H_n \setminus \Gamma_n$, then e is necessarily closed. Using (4.10), we have

$$\begin{aligned} |\Gamma_n|_o &\leq \text{card}(M) + \sum_{i=1}^m |E'_i|_o \\ &\leq c_d m^2 \delta^{d-1} n^{d-1} + \sum_{i=1}^m \tau_p(n(F_i + \delta v_i), \delta n). \end{aligned} \quad (4.11)$$

We choose δ small enough so that

$$m^2 c_d \delta^{d-1} < \delta \mathcal{I}_p(P) / 2 \quad \text{and} \quad \mathcal{L}^d(\mathcal{V}(\partial P, 3\delta)) \leq \delta \mathcal{L}^d(P). \quad (4.12)$$

Let us now estimate the probability that $|\Gamma_n|_o$ is abnormally big. Using inequalities (4.11) and (4.12), we get

$$\begin{aligned} &\mathbb{P}(|\Gamma_n|_o \geq (1 + \delta) \mathcal{I}_p(P) n^{d-1} \mid 0 \in \mathcal{C}_\infty) \\ &\leq \frac{1}{\theta_p} \mathbb{P}\left(\text{card}(M) + \sum_{i=1}^m \tau_p(n(F_i + \delta v_i), \delta n) \geq (1 + \delta) \sum_{i=1}^m \beta_p(v_i) \mathcal{H}^{d-1}(F_i) n^{d-1}\right) \\ &\leq \frac{1}{\theta_p} \mathbb{P}\left(\sum_{i=1}^m \tau_p(n(F_i + \delta v_i), \delta n) \geq (1 + \delta/2) \sum_{i=1}^m \beta_p(v_i) \mathcal{H}^{d-1}(F_i) n^{d-1}\right) \\ &\leq \frac{1}{\theta_p} \sum_{i=1}^m \mathbb{P}(\tau_p(n(F_i + \delta v_i), \delta n) \geq (1 + \delta/2) \beta_p(v_i) \mathcal{H}^{d-1}(F_i) n^{d-1}). \end{aligned} \quad (4.13)$$

By Lemma 4.1, there exist positive constants C_1, C_2 depending on d, p, P and δ such that, for all $1 \leq i \leq m$,

$$\mathbb{P}(\tau_p(n(F_i + \delta v_i), \delta n) \geq (1 + \delta/2) \beta_p(v_i) \mathcal{H}^{d-1}(F_i) n^{d-1}) \leq C_1 \exp(-C_2 \delta n^d). \quad (4.14)$$

Finally, combining inequalities (4.13) and (4.14), we obtain

$$\mathbb{P}(|\Gamma_n|_o \geq (1 + \delta) \mathcal{I}_p(P) n^{d-1} \mid 0 \in \mathcal{C}_\infty) \leq \frac{m C_1}{\theta_p} \exp(-C_2 \delta n^d). \quad (4.15)$$

We shall now estimate the number of vertices in H_n in order to check that H_n is a valid subgraph. For that purpose, we use a renormalization argument. Let $k > 0$. We partition \mathbb{R}^d into disjoint cubes of side length $1/k$. We define B'_j as the union of B_j and all its $3^d - 1$ *-neighbors (the cubes B having at least one vertex at L^1 distance less than 1 from B_j). We consider B_1, \dots, B_{l_1} the cubes such that B'_1, \dots, B'_{l_1} are contained in $P \setminus \mathcal{V}(\partial P, 2\delta)$ and $B_{l_1+1}, \dots, B_{l_2}$ the cubes such that $B'_{l_1+1}, \dots, B'_{l_2}$ intersect $\mathcal{V}(\partial P, 2\delta)$. We can choose k large enough such that

$$\mathcal{L}^d\left(\bigcup_{i=l_1+1}^{l_2} B_i\right) \leq \mathcal{L}^d(\mathcal{V}(\partial P, 3\delta)) \leq \delta \mathcal{L}^d(P). \quad (4.16)$$

We say that a cube B_j is good if the following event $\mathcal{E}_n^{(j)}$ occurs:

- There exists a unique open cluster of diameter larger than n/k in nB'_j .

— We have $\frac{|\mathcal{C}_\infty \cap nB_j|}{\mathcal{L}^d(nB_j)} \in (\theta_p - \delta, \theta_p + \delta)$.

There exist positive constants C_1 and C_2 depending on d, p, k and δ such that

$$\mathbb{P}(\mathcal{E}_n^{(j)c}) \leq C_1 \exp(-C_2 n). \quad (4.17)$$

For a proof of the control of the probability of the first property see Theorem 7.68 in [48] or [60], for the second property see [60]. If the cube B_j is good, we denote by C_j its unique open cluster of diameter larger than n/k in nB'_j , for $1 \leq j \leq l_1$. On the event $\bigcap_{1 \leq j \leq l_1} \mathcal{E}_n^{(j)} \cap \{0 \in \mathcal{C}_\infty\}$, the set $\bigcup_{j=1}^{l_1} C_j$ is connected without using edges of Γ_n and contains 0, therefore, it is a subgraph of H_n . Furthermore, we claim that, on this event, we have $\mathcal{C}_\infty \cap (\bigcup_{1 \leq j \leq l_1} nB_j) \subset H_n$. Indeed, let us assume that there exists $x \in \mathcal{C}_\infty \cap (\bigcup_{1 \leq j \leq l_1} nB_j)$ that does not belong to H_n . Both 0 and x belong to \mathcal{C}_∞ , therefore, x is connected to 0 by a path $\gamma = (x_0, e_1, \dots, e_l, x_l)$ with $x_0 = 0$ and $x_l = x$ that uses edges in Γ_n . We define

$$r = \sup \{ i \geq 1, e_i \in \Gamma_n \}.$$

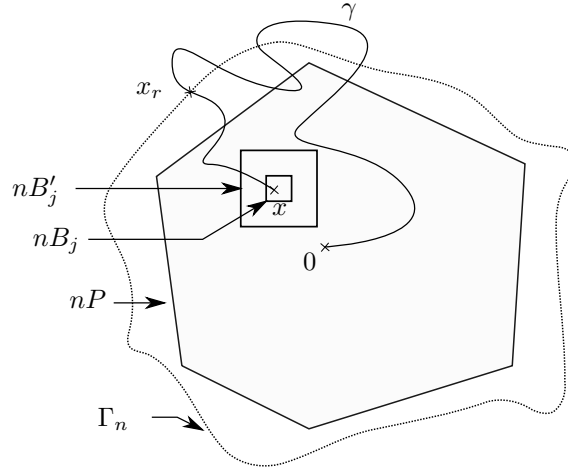

Figure 2.4 – Vertices in H_n

By construction, as $e_l \notin \Gamma_n$, we have $r < l$. Let us denote $\gamma' = (x_r, e_{r+1}, \dots, x_l)$. The path γ' is not connected to H_n without using edges in Γ_n (see figure 2.4). Let j be such that $x \in nB_j$, by construction x_r is outside nB'_j . Moreover, on the event $\mathcal{E}_n^{(j)}$, the cube nB'_j contains a unique cluster of diameter larger than n/k . As the path γ' starts outside nB'_j and ends inside nB_j , its intersection with nB'_j has a diameter larger than n/k . Besides, the path γ' is not connected to H_n in nB'_j by an open path, so the cube nB'_j contains two open clusters of diameter larger than n/k . This is a contradiction with the first property of a good cube. Therefore, on the event $\bigcap_{1 \leq j \leq l_1} \mathcal{E}_n^{(j)} \cap \{0 \in \mathcal{C}_\infty\}$,

$$\begin{aligned} |H_n| &\geq |\mathcal{C}_\infty \cap (\bigcup_{1 \leq j \leq l_1} nB_j)| \\ &\geq (\theta_p - \delta) \sum_{i=1}^{l_1} \mathcal{L}^d(nB_i). \end{aligned} \quad (4.18)$$

Thanks to inequalities (4.16) and (4.18), we obtain

$$|H_n| \geq (\theta_p - \delta)(1 - \delta)\mathcal{L}^d(nP). \quad (4.19)$$

To ensure that H_n is a valid subgraph, it remains to check that $|H_n| \leq n^d$, yet we have

$$\begin{aligned} |H_n| &\leq (\theta_p + \delta) \sum_{i=1}^{l_1} \mathcal{L}^d(nB_i) + \sum_{i=l_1+1}^{l_2} \mathcal{L}^d(nB_i) \\ &\leq (\theta_p + \delta)n^d \mathcal{L}^d(P) + n^d \delta \mathcal{L}^d(P) \\ &\leq (\theta_p + 2\delta)n^d \mathcal{L}^d(P). \end{aligned}$$

As $\mathcal{L}^d(P) < \mathcal{L}^d(W_p)$, we can choose δ small enough such that

$$|H_n| \leq \theta_p \mathcal{L}^d(W_p) n^d \leq n^d.$$

Finally, on the event

$$\bigcap_{1 \leq j \leq l_1} \mathcal{E}_n^{(j)} \cap \{ |\Gamma_n|_o \leq (1 + \delta) \mathcal{I}_p(P) n^{d-1} \} \cap \{ 0 \in \mathcal{C}_\infty \},$$

combining (4.11) and (4.19), we obtain, for small enough δ ,

$$n\varphi_n \leq n \frac{|\Gamma_n|_o}{|H_n|} \leq (1 + \delta) \frac{\mathcal{I}_p(P)}{(\theta_p - \delta)(1 - \delta) \mathcal{L}^d(P)} \leq (1 + \varepsilon/2) \frac{\mathcal{I}_p(P)}{\theta_p \mathcal{L}^d(P)}.$$

Combining the result of Lemma 4.1 and inequalities (4.9), (4.15) and (4.17), we obtain

$$\mathbb{P} \left(n\varphi_n \geq (1 + \varepsilon) \frac{\mathcal{I}_p(W_p)}{\theta_p(d) \mathcal{L}^d(W_p)} \mid 0 \in \mathcal{C}_\infty \right) \leq \frac{l_1 C_1}{\theta_p} \exp(-C_2 n) + \frac{m C_1}{\theta_p} \exp(-C_2 \delta n^d).$$

This yields the result. \square

5 Construction of a continuous object

The aim of this section is to build a continuous object P_n from a minimizer $G_n \in \mathcal{G}_n$.

5.1 Some useful results on the minimizers

The following lemma ensures that the size of the minimizers $G_n \in \mathcal{G}_n$ are of order n^d .

Lemma 5.1. *Let $d \geq 2$ and $p > p_c(d)$. There exist positive constants D_1, D_2 and η_1 depending only on d and p such that, for all $n \geq 1$,*

$$\mathbb{P} \left(\exists G_n \in \mathcal{G}_n, |G_n| \leq \eta_1 n^d \mid 0 \in \mathcal{C}_\infty \right) \leq D_1 \exp(-D_2 n^{(d-1)/2d}).$$

To prove Lemma 5.1, we adapt the proof of Lemma A.8 in [44]. We need the following proposition that ensures that the open edge boundary of a large subgraph is not too small.

Proposition 5.2 (Berger-Biskup-Hoffman-Kozma, Proposition 5.2. in [14]). *Let $d \geq 2$ and $p > p_c(d)$. There exist positive constants c_1, c_2 and c_3 depending only on d and p such that, for all $t \geq 0$,*

$$\mathbb{P} \left(\begin{array}{l} \text{There exists an open connected graph containing } 0 \\ \text{such that } |G| \geq t^{d/(d-1)}, |\partial^\circ G| \leq c_3 |G|^{(d-1)/d} \end{array} \right) \leq c_1 \exp(-c_2 t).$$

Proof of Lemma 5.1. Thanks to Theorem 1.4, there exist positive constants c'_1, c'_2 and c'_3 depending only on p and d such that for all $n \geq 1$,

$$\mathbb{P} \left(\varphi_n \geq c'_3 n^{-1} \mid 0 \in \mathcal{C}_\infty \right) \leq c'_1 \exp(-c'_2 n).$$

Let $G_n \in \mathcal{G}_n$. If $|G_n| \leq \sqrt{n}$, as $G_n \subset \mathcal{C}_\infty$ the set $\partial^\circ G_n$ is non empty on the event $\{0 \in \mathcal{C}_\infty\}$ and so $\varphi_n \geq n^{-1/2}$. This is impossible for large n . We now assume $|G_n| > \sqrt{n}$. Using Proposition

5.2 with $t = n^{(d-1)/2d}$, conditioning on $\{0 \in \mathcal{C}_\infty\}$, we obtain that $|\partial^\circ G_n| \geq c_3 |G_n|^{(d-1)/d}$ with probability at least $1 - c_1 \exp(-c_2 n^{(d-1)/2d}) / \theta_p$. Moreover, on the event $\{\varphi_n \leq c'_3 n^{-1}\} \cap \{0 \in \mathcal{C}_\infty\}$, we obtain

$$c_3 |G_n|^{-1/d} \leq \frac{|\partial^\circ G_n|}{|G_n|} = \varphi_n \leq c'_3 n^{-1}.$$

So we set $\eta_1 = (c_3/c'_3)^d$. Finally,

$$\begin{aligned} \mathbb{P}\left(\exists G_n \in \mathcal{G}_n, |G_n| \leq \eta_1 n^d \mid 0 \in \mathcal{C}_\infty\right) &\leq \mathbb{P}\left(\varphi_n \geq c'_3 n^{-1} \mid 0 \in \mathcal{C}_\infty\right) + \frac{c_1}{\theta_p} \exp(-c_2 n^{(d-1)/2d}) \\ &\leq c'_1 \exp(-c'_2 n) + \frac{c_1}{\theta_p} \exp(-c_2 n^{(d-1)/2d}). \end{aligned}$$

This yields the result. \square

5.2 Construction of a continuous set

To study the upper large deviations, we needed to go from a continuous object to a discrete object. In this section, we do the opposite. From now on, we will always condition on the event $\{0 \in \mathcal{C}_\infty\}$. We start with $G_n \in \mathcal{G}_n$ and we build a continuous object P_n . Our goal is to build a continuous object of finite perimeter which is close to $n^{-(d-1)} |\partial^\circ G_n|$. Although it seems natural to take the continuous object $P_n = n^{-1}(G_n + [-1/2, 1/2]^d)$, this turns out to be a bad choice because the boundary ∂G_n may be very tangled and its size may be of higher order than n^{d-1} . We will build from G_n a graph F_n with a smoother boundary $\Gamma_n \subset \mathbb{E}^d$ in order to build the continuous object P_n . At this point, there is some work left. If we consider the subgraph F_n that contains all the vertices in \mathcal{C}_∞ enclosed in Γ_n , the symmetric difference $F_n \Delta G_n$ may be big due to the presence of holes in G_n , more precisely portions of \mathcal{C}_∞ enclosed in Γ_n but not contained in G_n (see Figure 2.5). Indeed, if these holes are too large, the symmetric difference $F_n \Delta G_n$ will be large too. However, we cannot keep all the holes in G_n to build F_n because when we will pass to a continuous object P_n , these holes will considerably increase the perimeter of P_n so that P_n may have a too large perimeter. The solution is to fill only the small holes to obtain F_n so that the perimeter of P_n remains of the correct order and the symmetric difference $F_n \Delta G_n$ remains small. In order to do so, we shall perform Zhang's construction in [73] to obtain a smooth boundary Γ_n for G_n but also to surgically remove these large holes from G_n by cutting along a smooth boundary. This work was done in [44]. We will only partially sketch Zhang's construction and we refer to [73] for a rigorous proof and more details about the construction. Although we did the same construction as Gold in [44], we do not use the same argument to conclude. Gold used a procedure called webbing to link all the different contours together in order to obtain a single connected object, this simplifies the combinatorial estimates. Here, we do not perform the webbing procedure, instead we use adequate combinatorial estimates. Avoiding the webbing procedure enables us to extend the result to dimension 2.

Let us define a renormalization process. For a large integer k , that will be chosen later, we set $B_k = [-k, k]^d \cap \mathbb{Z}^d$ and define the following family of k -cubes, for $\mathbf{i} \in \mathbb{Z}^d$,

$$B_k(\mathbf{i}) = \tau_{\mathbf{i}(2k+1)}(B_k),$$

where τ_b denotes the shift in \mathbb{Z}^d with vector $b \in \mathbb{Z}^d$. The lattice \mathbb{Z}^d is the disjoint union of this family: $\mathbb{Z}^d = \sqcup_{\mathbf{i} \in \mathbb{Z}^d} B_k(\mathbf{i})$. We introduce larger boxes B'_k , for $\mathbf{i} \in \mathbb{Z}^d$, we define

$$B'_k(\mathbf{i}) = \tau_{\mathbf{i}(2k+1)}(B_{3k}).$$

Underscore will be used to denote sets of cubes. For any set of k -cubes \underline{A} , the set \underline{A}' denotes the set of the corresponding $3k$ -cubes. Let $G_n \in \mathcal{G}_n$. We first use Zhang's construction to build a smooth cutset Γ_n that separates G_n from infinity. We denote by \underline{A} the set of k -cubes that intersect $\partial_e G_n$, the exterior edge boundary of G_n . We then modify the current configuration ω into a configuration ω' by closing all the open edges in ∂G_n . This procedure is only formal as we will eventually reopen these edges. Zhang's construction enables us to extract a set of cubes $\underline{\Gamma} \subset \underline{A}$ such that $\underline{\Gamma}$ is $*$ -connected and in the configuration ω' , the union of the $3k$ -cubes of $\underline{\Gamma}'$

contains a closed cutset Γ_n that isolates G_n from infinity and a rare event occurs in every cube of $\underline{\Gamma}$. These rare events are due to the existence of a closed cutset that creates a large interface of closed edges, this is a very unlikely event when $p > p_c(d)$. Of course, when we will eventually switch back to the configuration ω , these rare events will not occur anymore in some cubes.

Several connected components of $\mathcal{C}_\infty \setminus G_n$ in $\mathbb{Z}^d \setminus \Gamma_n$ are enclosed in Γ_n (see Figure 2.5). We say that a connected component C of \mathcal{C}_∞ is surrounded by Γ_n if any path from C to infinity has to use an edge of Γ_n . We will say that C is large if $|C| \geq n^{1-1/2(d-1)}$. We enumerate the large connected components L_1, \dots, L_m and the small connected component S_1, \dots, S_N . We denote by $m(G_n)$ the number of large connected components of $\mathcal{C}_\infty \setminus G_n$ enclosed in Γ_n .

Remark 5.3. *We insist here on the fact that these large components are not holes of the infinite cluster but holes of G_n (see Figure 2.5). Intuitively, we do not expect that a minimizer contains such holes because the graph obtained by filling all these holes have a smaller isoperimetric ratio. Indeed, by filling these holes, we reduce the open edge boundary and increase the volume. However, by filling these holes, the volume may exceed n^d and the graph we obtain by filling these holes may not be admissible. That is the reason why we cannot easily discard the presence of these large holes inside G_n . To obtain the proper order of large deviations, one would have to fix this issue.*

We then build $F_n \subset \mathcal{C}_\infty$ by filling the small connected components S_1, \dots, S_N of G_n , i.e.,

$$F_n = G_n \cup \bigcup_{i=1}^N S_i. \quad (5.1)$$

At this point, the boundary $\partial F_n \setminus \partial_e F_n$ of F_n may be still tangled around the large components. In the configuration ω' , for each $1 \leq j \leq m$, there exists a closed cutset that separates L_j from infinity. We can apply Zhang's construction to each component L_j in order to build a smooth closed cutset $\widehat{\Gamma}_n^{(j)}$ and its corresponding set of k -cubes $\widehat{\underline{\Gamma}}_n^{(j)}$. Thanks to Zhang's construction, the set of cubes $\widehat{\underline{\Gamma}}_n^{(j)}$ is $*$ -connected and in the configuration ω' , a rare event occurs in each of its cubes. We denote the boundary of F_n by $\widetilde{\Gamma}_n$ and its associated set of k -cubes $\widetilde{\underline{\Gamma}}_n$ as

$$\widetilde{\Gamma}_n = \Gamma_n \cup \bigcup_{i=1}^m \widehat{\Gamma}_n^{(i)}, \quad \widetilde{\underline{\Gamma}}_n = \underline{\Gamma}_n \cup \bigcup_{i=1}^m \widehat{\underline{\Gamma}}_n^{(i)}.$$

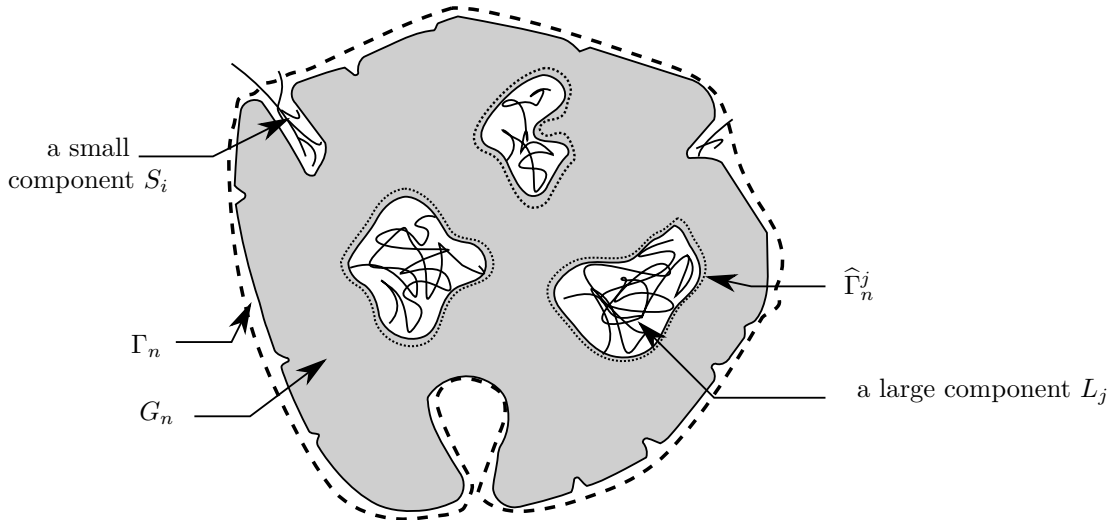

Figure 2.5 – Construction of $\widetilde{\Gamma}_n$ for a $G_n \in \mathcal{G}_n$

The set of k -cubes $\widetilde{\underline{\Gamma}}_n$ is not $*$ -connected. It only contains cubes where a rare event occurs in the configuration ω' . Although for some cubes these events do not occur anymore in the configuration

ω , we can bound from below the number of cubes that remain unchanged by $|\tilde{\Gamma}_n| - |\partial^\circ G_n|$. In these cubes, rare events still occur when we switch back to the original configuration ω . Using a Peierls argument, we can deduce that, with high probability, $|\tilde{\Gamma}_n|$ and $|\partial^\circ G_n|$ are of same order when k is taken large enough. To perform the combinatorial estimates we will need the two following propositions.

Proposition 5.4 (Lemmas 6, 7 in [73]). *Let $d \geq 2$ and let $p > p_c(d)$. There exist positive constants C_1 and C_2 depending only on p and d such that for each k -cube B_k ,*

$$\mathbb{P}(\text{a rare event occurs in } B_k) \leq C_1 e^{-C_2 k}.$$

Moreover, this rare event depends only on the configuration of the $3k$ -cube B'_k .

Remark 5.5. *We do not define here what these rare events are, we refer to [73] for a precise definition of these rare events. For our purpose we only need to know that the decay is exponential in k . We say that a cube is abnormal if a rare event occurs in this cube.*

Proposition 5.6. *Let $d \geq 2$ and $p > p_c(d)$. There exist positive constants c_1, c_2 and c_3 such that*

$$\mathbb{P}\left(\exists G_n \in \mathcal{G}_n, m(G_n) > c_3 n^{d-2+3/2d} \mid 0 \in \mathcal{C}_\infty\right) \leq c_1 \exp(-c_2 n^{1-3/2d}).$$

Proof. Thanks to Theorem 1.4, there exist positive constants C'_1, C'_2 and C'_3 depending only on p and d such that for all $n \geq 1$,

$$\mathbb{P}\left(\varphi_n \geq C'_3 n^{-1} \mid 0 \in \mathcal{C}_\infty\right) \leq C'_1 \exp(-C'_2 n).$$

Let $G_n \in \mathcal{G}_n$. We have with probability at least $1 - C'_1 \exp(-C'_2 n)$ that

$$|\partial^\circ G_n| \leq C'_3 n^{-1} |G_n| \leq C'_3 n^{d-1}.$$

Thanks to Proposition 5.2, there exist positive constants c'_1, c'_2 and c'_3 depending only on p and d such that, for all $t \geq 0$, we have

$$\mathbb{P}\left(\begin{array}{l} \text{There exists an open connected graph containing } 0 \\ \text{such that } |G| \geq t^{d/(d-1)}, |\partial^\circ G| \leq c'_3 |G|^{(d-1)/d} \end{array} \right) \leq c'_1 \exp(-c'_2 t). \quad (5.2)$$

In the following, we set $t = n^{(1-1/2(d-1))(d-1)/d} = n^{1-3/2d}$. First notice that by construction, each L_j is contained in $[-n^d, n^d]^d \cap \mathbb{Z}^d$. We have

$$\begin{aligned} & \mathbb{P}\left(\exists G_n \in \mathcal{G}_n, \exists i \in \{1, \dots, m(G_n)\}, |\partial^\circ L_i| \leq c'_3 n^{(1-1/2(d-1))d/(d-1)} \mid 0 \in \mathcal{C}_\infty\right) \\ & \leq \mathbb{P}\left(\exists G_n \in \mathcal{G}_n, \exists i \in \{1, \dots, m(G_n)\}, |\partial^\circ L_i| \leq c'_3 |L_i|^{d/(d-1)} \mid 0 \in \mathcal{C}_\infty\right) \\ & \leq \frac{1}{\theta_p} \mathbb{P}\left(\begin{array}{l} \text{There exists an open connected graph } G \text{ contained in} \\ [-n^d, n^d]^d \cap \mathbb{Z}^d \text{ such that } |G| \geq t^{d/(d-1)}, |\partial^\circ G| \leq c'_3 |G|^{(d-1)/d} \end{array}\right) \\ & \leq \frac{1}{\theta_p} \sum_{x \in [-n^d, n^d]^d \cap \mathbb{Z}^d} \mathbb{P}\left(\begin{array}{l} \text{There exists an open connected graph } G \text{ containing} \\ x \text{ such that } |G| \geq t^{d/(d-1)}, |\partial^\circ G| \leq c'_3 |G|^{(d-1)/d} \end{array}\right). \end{aligned}$$

Using the translation invariance together with inequality (5.2), we obtain

$$\begin{aligned} & \mathbb{P}\left(\exists G_n \in \mathcal{G}_n, \exists i \in \{1, \dots, m(G_n)\}, |\partial^\circ L_i| \leq c'_3 n^{(1-\varepsilon)d/(d-1)} \mid 0 \in \mathcal{C}_\infty\right) \\ & \leq \frac{(2n^d)^d}{\theta_p} \mathbb{P}\left(\begin{array}{l} \text{There exists an open connected graph } G \text{ containing } 0 \\ \text{such that } |G| \geq t^{d/(d-1)}, |\partial^\circ G| \leq c'_3 |G|^{(d-1)/d} \end{array}\right) \\ & \leq \frac{(2n^d)^d}{\theta_p} c'_1 \exp(-c'_2 n^{1-3/2d}). \end{aligned}$$

By construction, for all $i \in \{1, \dots, m(G_n)\}$, we have $\partial^\circ L_i \subset \partial^\circ G_n$ and for all $j \in \{1, \dots, m(G_n)\}$ such that $i \neq j$, we have $\partial^\circ L_i \cap \partial^\circ L_j = \emptyset$. Thus, with high probability,

$$m(G_n) \leq \frac{|\partial^\circ G_n|}{c'_3 n^{(1-\varepsilon)d/(d-1)}} \leq \frac{C'_3 n^{d-1}}{c'_3 n^{1-3/2d}} \leq \frac{C'_3}{c'_3} n^{d-2+3/2d}.$$

Finally, by setting $c_3 = C'_3/c'_3$, we obtain

$$\begin{aligned} & \mathbb{P}\left(\exists G_n \in \mathcal{G}_n, m(G_n) > c_3 n^{d-2+3/2d} \mid 0 \in \mathcal{C}_\infty\right) \\ & \leq \mathbb{P}\left(\varphi_n \geq c'_3 n^{-1} \mid 0 \in \mathcal{C}_\infty\right) + \mathbb{P}\left(\begin{array}{c} \exists G_n \in \mathcal{G}_n, \exists i \in \{1, \dots, m(G_n)\}, \\ |\partial^\circ L_i| \leq c'_3 n^{(1-\varepsilon)d/(d-1)}, \end{array} \mid 0 \in \mathcal{C}_\infty\right) \\ & \leq C'_1 \exp(-C'_2 n) + \frac{(2n^d)^d}{\theta_p} c'_1 \exp(-c'_2 n^{1-3/2d}). \end{aligned}$$

This yields the result. \square

Using the control on the number of large components $m(G_n)$ of \mathcal{C}_∞ enclosed in Γ_n and a Peierls argument, we obtain the following control of $|\tilde{\Gamma}_n|$:

Proposition 5.7. *Let $d \geq 2$ and $p > p_c(d)$. There exist positive constants β_0, C_1, C_2 depending only on d and p such that, for all $n \geq 1$, for all $\beta \geq \beta_0$,*

$$\mathbb{P}\left(\max_{G_n \in \mathcal{G}_n} |\tilde{\Gamma}_n| \geq \beta n^{d-1} \mid 0 \in \mathcal{C}_\infty\right) \leq C_1 \exp(-C_2 n^{1-3/2d}).$$

Proof. Let k be a large integer that we will choose later. We consider a renormalization process of parameter k . Let $G_n \in \mathcal{G}_n$. First notice that as $\tilde{\Gamma}_n \subset \bigcup_{B \in \tilde{\Gamma}_n} B'$, we have

$$|\tilde{\Gamma}_n| \leq (6k)^d |\tilde{\underline{\Gamma}}_n|.$$

Thus, it is enough to control the quantity $|\tilde{\underline{\Gamma}}_n|$ to prove Proposition 5.7. We can rewrite $\tilde{\underline{\Gamma}}_n$ as

$$\tilde{\underline{\Gamma}}_n = \bigcup_{i=1}^{m'} \underline{A}_i \text{ with } m' \leq m(G_n)$$

where the \underline{A}_i are pairwise disjoint $*$ -connected sets of cubes. Thanks to Theorem 1.4, there exist positive constants C'_1, C'_2 and C'_3 depending only on p and d such that for all $n \geq 1$,

$$\mathbb{P}\left(\varphi_n \geq C'_3 n^{-1} \mid 0 \in \mathcal{C}_\infty\right) \leq C'_1 \exp(-C'_2 n). \quad (5.3)$$

Let $G_n \in \mathcal{G}_n$. We have with probability at least $1 - C'_1 \exp(-C'_2 n)$ that

$$|\partial^\circ G_n| \leq C'_3 n^{d-1}.$$

We choose β large enough such that

$$C'_3 \leq \frac{\beta}{2 \cdot 4^d},$$

so that

$$|\partial^\circ G_n| \leq C'_3 n^{d-1} \leq \frac{\beta}{2 \cdot 4^d} n^{d-1}.$$

We now want to sum over the possible realizations of $\tilde{\underline{\Gamma}}_n$. Using Proposition 5.6 together with

inequality (5.3), we get

$$\begin{aligned}
& \mathbb{P}\left(\exists G_n \in \mathcal{G}_n, |\tilde{\Gamma}_n| \geq \beta n^{d-1} \mid 0 \in \mathcal{C}_\infty\right) \\
& \leq \mathbb{P}\left(\exists G_n \in \mathcal{G}_n, \sum_{i=1}^{m'} |A_i| \geq \beta n^{d-1}, m' \leq c'_3 n^{d-2+3/2d}, \left| \partial^\circ G_n \right| \leq \frac{\beta}{2 \cdot 4^d} n^{d-1}, \mid 0 \in \mathcal{C}_\infty\right) \\
& \quad + c_1 \exp(-c_2 n^{1-3/2d}) + C'_1 \exp(-C'_2 n) \\
& \leq \sum_{j \geq \beta n^{d-1}} \sum_{m'=1}^{c'_3 n^{d-2+3/2d}} \sum_{\substack{j_1+\dots+j_{m'}=j \\ j_1>0, \dots, j_{m'}>0}} \sum_{x_1, \dots, x_{m'} \in [-n^d, n^d]^d} \sum_{\substack{A_1 \in \text{Animals}_{x_1} \\ |A_1|=j_1}} \dots \\
& \quad \dots \sum_{\substack{A_{m'} \in \text{Animals}_{x_{m'}} \\ |A_{m'}|=j_{m'}}} \mathbb{P}\left(\exists G_n \in \mathcal{G}_n, \tilde{\Gamma}_n = \bigcup_{i=1}^{m'} A_i, |\partial^\circ G_n| \leq \frac{\beta}{2 \cdot 4^d} n^{d-1} \mid 0 \in \mathcal{C}_\infty\right) \\
& \quad + c_1 \exp(-c_2 n^{1-3/2d}) + C'_1 \exp(-C'_2 n). \tag{5.4}
\end{aligned}$$

Let us assume $\tilde{\Gamma}_n = \bigcup_{i=1}^{m'} A_i$. We can extract from $\tilde{\Gamma}_n$ a set of k -cubes $\tilde{\Gamma}'_n$ such that $|\tilde{\Gamma}'_n| \geq |\tilde{\Gamma}_n|/4^d$ and for any $\mathbf{i} \neq \mathbf{j}$ such that $B_k(\mathbf{i}), B_k(\mathbf{j}) \in \tilde{\Gamma}'_n$ we have $B'_k(\mathbf{i}) \cap B'_k(\mathbf{j}) = \emptyset$. As the rare event depends only on the configuration in the $3k$ -cube $B'_k(\mathbf{j})$, the two following events $\{\text{a rare event occurs in } B_k(\mathbf{i})\}$ and $\{\text{a rare event occurs in } B_k(\mathbf{j})\}$ are independent. Using Proposition 5.4, we obtain

$$\begin{aligned}
& \mathbb{P}\left(\exists G_n \in \mathcal{G}_n, \tilde{\Gamma}_n = \bigcup_{i=1}^{m'} A_i, |\partial^\circ G_n| \leq \frac{\beta}{2 \cdot 4^d} n^{d-1} \mid 0 \in \mathcal{C}_\infty\right) \\
& \leq \mathbb{P}\left(\exists G_n \in \mathcal{G}_n, \tilde{\Gamma}_n = \bigcup_{i=1}^{m'} A_i, |\tilde{\Gamma}'_n| \geq j/4^d, |\partial^\circ G_n| \leq \frac{\beta}{2 \cdot 4^d} n^{d-1} \mid 0 \in \mathcal{C}_\infty\right) \\
& \leq \mathbb{P}\left(\exists G_n \in \mathcal{G}_n, \tilde{\Gamma}_n = \bigcup_{i=1}^{m'} A_i, |\partial^\circ G_n| \leq \frac{\beta}{2 \cdot 4^d} n^{d-1}, \left| \{B \subset \tilde{\Gamma}'_n, B \text{ abnormal}\} \right| \geq j/4^d - |\partial^\circ G_n| \mid 0 \in \mathcal{C}_\infty\right) \\
& \leq \mathbb{P}\left(\exists G_n \in \mathcal{G}_n, \tilde{\Gamma}_n = \bigcup_{i=1}^{m'} A_i, \left| \{B \subset \tilde{\Gamma}'_n, B \text{ abnormal}\} \right| \geq j/(2 \cdot 4^d)\right) \cdot \frac{1}{\theta_p} \\
& \leq \frac{4^d}{\theta_p} \sum_{l \geq j/(2 \cdot 4^d)} (C_1 e^{-C_2 k})^l \leq \frac{2 \cdot 4^d}{\theta_p} (C_1 e^{-C_2 k})^{j/(2 \cdot 4^d)}
\end{aligned}$$

where k will be chosen large enough such that $C_1 e^{-C_2 k} \leq 1/2$. So together with inequality (5.4) and using Lemma 2.1, we obtain

$$\begin{aligned}
& \mathbb{P}\left(\exists G_n \in \mathcal{G}_n, |\tilde{\Gamma}_n| \geq \beta n^{d-1} \mid 0 \in \mathcal{C}_\infty\right) \\
& \leq \sum_{j \geq \beta n^{d-1}} \sum_{m'=1}^{c'_3 n^{d-2+3/2d}} \sum_{\substack{j_1+\dots+j_{m'}=j \\ j_1>0, \dots, j_{m'}>0}} \sum_{x_1, \dots, x_{m'} \in [-n^d, n^d]^d} \sum_{\substack{A_1 \in \text{Animals}_{x_1} \\ |A_1|=j_1}} \dots \\
& \quad \dots \sum_{\substack{A_{m'} \in \text{Animals}_{x_{m'}} \\ |A_{m'}|=j_{m'}}} \frac{2 \cdot 4^d}{\theta_p} (C_1 e^{-C_2 k})^{j/(2 \cdot 4^d)} + c_1 e^{-c_2 n^{1-3/2d}} + C'_1 e^{-C'_2 n} \\
& \leq \frac{2 \cdot 4^d}{\theta_p} \sum_{j \geq \beta n^{d-1}} (C_1 e^{-C_2 k})^{\frac{j}{2 \cdot 4^d}} \sum_{m'=1}^{c'_3 n^{d-2+3/2d}} \sum_{\substack{j_1+\dots+j_{m'}=j \\ j_1>0, \dots, j_{m'}>0}} (2n)^{d^2 m'} 7^{dj_1} \dots 7^{dj_{m'}}
\end{aligned}$$

$$\begin{aligned}
& + c_1 e^{-c_2 n^{1-3/2d}} + C'_1 e^{-C'_2 n} \\
& \leq \frac{2 \cdot 4^d}{\theta_p} \sum_{j \geq \beta n^{d-1}} 7^{dj} (C_1 e^{-C_2 k})^{j/(2 \cdot 4^d)} c'_3 n^{d-2+3/2d} \sum_{m'=1}^{c'_3 n^{d-2+3/2d}} (2n^d)^{dm'}. \\
& \quad \times \left| \left\{ (j_1, \dots, j_{m'}) : \begin{array}{l} j_1 + \dots + j_{m'} = j, \\ j_1 > 0, \dots, j_{m'} > 0 \end{array} \right\} \right| + c_1 e^{-c_2 n^{1-3/2d}} + C'_1 e^{-C'_2 n} \\
& \leq \frac{2 \cdot 4^d}{\theta_p} (2n^d)^{d(c'_3 n^{d-2+3/2d}+2)} \sum_{j \geq \beta n^{d-1}} (2 \cdot 7^d)^j (C_1 e^{-C_2 k})^{j/(2 \cdot 4^d)} \\
& \quad + c_1 e^{-c_2 n^{1-3/2d}} + C'_1 e^{-C'_2 n}.
\end{aligned}$$

We now choose k large enough such that

$$C_1 e^{-C_2 k} \leq \frac{1}{2} \quad \text{and} \quad \left((2 \cdot 7^d)^{2 \cdot 4^d} C_1 e^{-C_2 k} \right)^{1/(2 \cdot 4^d)} \leq e^{-1}.$$

Finally, we get

$$\begin{aligned}
& \mathbb{P} \left(\exists G_n \in \mathcal{G}_n, |\tilde{\Gamma}_n| \geq \beta n^{d-1} \mid 0 \in \mathcal{C}_\infty \right) \\
& \leq \frac{2(2n^d)^{d(c'_3 n^{d-2+3/2d}+2)} 4^d}{\theta_p} \sum_{j \geq \beta n^{d-1}} \left((2 \cdot 7^d)^{2 \cdot 4^d} C_1 e^{-C_2 k} \right)^{j/(2 \cdot 4^d)} \\
& \quad + c_1 e^{-c_2 n^{1-3/2d}} + C'_1 e^{-C'_2 n} \\
& \leq \frac{4^{d+1} \exp(2d^2 c'_3 n^{d-2+3/2d} \log n - \beta n^{d-1})}{\theta_p} + c_1 e^{-c_2 n^{1-3/2d}} + C'_1 e^{-C'_2 n}.
\end{aligned}$$

This yields the result for $\beta \geq \beta_0$ where β_0 is such that for all $n \geq 0$, we have $\beta_0 > (4d^2 c'_3 \log n)/n^{1-3/2d}$. \square

We can now build the relevant continuous object P_n . Given a finite set of edges S , we define

$$\text{hull}(S) = \left\{ x \in \mathbb{Z}^d : \text{any path from } x \text{ to infinity has to use an edge of } S \right\}$$

and

$$H_n = \text{hull}(\Gamma_n) \setminus \left(\bigcup_{i=1}^m \text{hull}(\widehat{\Gamma}_n^{(i)}) \right).$$

We define P_n and its associated measure ν_n as

$$P_n = \frac{1}{n} \left(H_n + \left[-\frac{1}{2}, \frac{1}{2} \right]^d \right),$$

$$\forall E \in \mathcal{B}(\mathbb{R}^d), \nu_n(E) = \theta_p \mathcal{L}^d(P_n \cap E).$$

We obtain a control on the size of the perimeter of P_n by a straightforward application of Proposition 5.7:

Corollary 5.8. *Let $d \geq 2$ and $p > p_c(d)$. There exist positive constants β_0, C_1, C_2 depending only on d and p such that for all $n \geq 1$, for all $\beta > \beta_0$,*

$$\mathbb{P} \left(\max_{G_n \in \mathcal{G}_n} \mathcal{P}(nP_n) \geq \beta n^{d-1} \mid 0 \in \mathcal{C}_\infty \right) \leq C_1 e^{-c_2 n^{1-3/2d}}.$$

The following Lemma will be useful to compare the measure ν_n with the measure associated to F_n .

Lemma 5.9. *Let $G_n \in \mathcal{G}_n$ and F_n as defined in (5.1). We have $F_n = H_n \cap \mathcal{C}_\infty$.*

Proof. Let $G_n \in \mathcal{G}_n$. Let $x \in H_n \cap \mathcal{C}_\infty$, then x belongs to $\mathcal{C}_\infty \cap \text{hull } \Gamma_n$ but is not in any of the large connected components L_1, \dots, L_m . Therefore, x belongs to G_n or to one of the small components S_1, \dots, S_N and so $x \in F_n$.

Conversely, let $x \in F_n$. It is clear that $x \in \text{hull}(\Gamma_n)$. Let us assume $x \in G_n$ and that there exists i such that $x \in \text{hull}(\widehat{\Gamma}_n^{(i)})$. As G_n is connected there exists an open path γ in G_n that joins x with $G_n \setminus \widehat{\Gamma}_n^{(i)}$. As the edges of $\widehat{\Gamma}_n^{(i)} \setminus \partial^\circ L_i$ are closed, γ must use an edge of $\partial^\circ L_i$ and so go through a vertex of L_i . That is a contradiction as the path γ uses only vertices in G_n . Let us now assume that $x \in S_j$ and $x \in \text{hull}(\widehat{\Gamma}_n^{(i)})$ for some i and j . As $x \in \mathcal{C}_\infty$, x is connected to infinity by an open path γ' . However, by the same arguments, to exit $\text{hull}(\widehat{\Gamma}_n^{(i)})$, the path γ' has to go through a vertex of L_i . Thus, there exist an open path in $\mathcal{C}_\infty \setminus G_n$ that joins x to L_i . That is a contradiction as $x \notin L_i$.

Finally, $F_n \subset H_n \cap \mathcal{C}_\infty$. □

5.3 Closeness of measures

We shall show that for any ball of constant radius centered at a point $x \in \mathbb{Z}^d$, the measures ν_n and μ_n restricted to this ball are close to each other in some weak sense.

Proposition 5.10. *Let $p > p_c(d)$ and $r > 0$. Let $u :]0, +\infty[\rightarrow]0, +\infty[$ be a non-decreasing function such that $\lim_{t \rightarrow 0} u(t) = 0$. For all $\delta > 0$, there exist C_1 and C_2 depending on d, p, u and δ such that for all $n \geq 1$, for any finite set \mathfrak{F}_n of uniformly continuous functions that satisfies:*

$$\forall f \in \mathfrak{F}_n \quad \|f\|_\infty \leq 1 \quad \text{and} \quad \forall x, y \in \mathbb{R}^d \quad |f(x) - f(y)| \leq u(\|x - y\|_2),$$

we have

$$\mathbb{P} \left(\max_{G_n \in \mathcal{G}_n} \sup_{f \in \mathfrak{F}_n} |\mu_n(f \mathbf{1}_{B(x,r)}) - \nu_n(f \mathbf{1}_{B(x,r)})| > \delta \mid 0 \in \mathcal{C}_\infty \right) \leq C_1 e^{-C_2 n^{1-3/2d}}.$$

Remark 5.11. *We state here the result in a general form. In the following, we will apply this Proposition for the particular case of sets of functions that are translates of the same function. The function u is an upper bound on the modulus of continuity of the functions in \mathfrak{F}_n . If we think of \mathfrak{F}_n as a set that grows with n , this condition may be interpreted as a sufficient condition to obtain compactness for the set \mathfrak{F}_n in the limit.*

To prove this result, we will need the following proposition that is a corollary of the results in [60]:

Proposition 5.12. *Let $d \geq 2$ and $p > p_c(d)$. Let $r > 0$, and let $Q \subset \mathbb{R}^d$ be a cube of side length $2r$. Let $\delta > 0$. There exist positive constants c_1 and c_2 depending on d, p and δ such that*

$$\mathbb{P} \left(\frac{|\mathcal{C}_\infty \cap Q|}{\mathcal{L}^d(Q)} \notin (\theta_p - \delta, \theta_p + \delta) \right) \leq c_1 \exp(-c_2 r^{d-1}).$$

Proof of Proposition 5.10. Let $\delta > 0$ and $\varepsilon > 0$ that we will choose later. Let $u :]0, +\infty[\rightarrow]0, +\infty[$ be a non-decreasing function such that $\lim_{t \rightarrow 0} u(t) = 0$. Let $n \geq 1$. Let \mathfrak{F}_n be a finite set of uniformly continuous function that satisfies:

$$\forall f \in \mathfrak{F}_n \quad \|f\|_\infty \leq 1 \quad \text{and} \quad \forall x, y \in \mathbb{R}^d \quad |f(x) - f(y)| \leq u(\|x - y\|_2),$$

We fix a minimizer $G_n \in \mathcal{G}_n$. We define

$$\tilde{\mu}_n = \frac{1}{n^d} \sum_{x \in V(F_n)} \delta_{x/n}.$$

Thanks to Theorem 1.4, there exists a constant η_3 depending only on the dimension such that

$$\mathbb{P} \left(n\varphi_n \geq \eta_3 \mid 0 \in \mathcal{C}_\infty \right) \leq C_1 \exp(-C_2 n).$$

Let $G_n \in \mathcal{G}_n$, with probability at least $1 - C_1 \exp(-C_2 n)$, we have

$$\frac{n|\partial^\circ G_n|}{|G_n|} \leq \eta_3,$$

and so $|\partial^\circ G_n| \leq \eta_3 n^{d-1}$. As each small component S_j is such that $\partial^\circ S_j \cap \partial^\circ G_n \neq \emptyset$, the number N of small components is at most $\eta_3 n^{d-1}$ and by definition of F_n ,

$$|F_n \setminus G_n| \leq \sum_{j=1}^N |S_j| \leq \eta_3 n^{d-1/2(d-1)}.$$

Finally, with probability at least $1 - C_1 \exp(-C_2 n)$, for all $f \in \mathfrak{F}_n$,

$$|\mu_n(f) - \tilde{\mu}_n(f)| \leq \frac{1}{n^d} \|f\|_\infty |F_n \setminus G_n| \leq \eta_3 n^{-1/2(d-1)},$$

and

$$\mathbb{P} \left(\max_{G_n \in \mathcal{G}_n} \sup_{f \in \mathfrak{F}_n} |\mu_n(f \mathbf{1}_{B(x,r)}) - \tilde{\mu}_n(f \mathbf{1}_{B(x,r)})| > \eta_3 n^{-1/2(d-1)} \right) \leq C_1 e^{-C_2 n} \quad (5.5)$$

where \mathbb{P} represents the probability measure conditioned on the event $\{0 \in \mathcal{C}_\infty\}$. Let $x \in \mathbb{R}^d$ and let $r > 0$. Let $f \in \mathfrak{F}_n$. We now would like to estimate the quantity

$$|\tilde{\mu}_n(f \mathbf{1}_{B(x,r)}) - \nu_n(f \mathbf{1}_{B(x,r)})|.$$

We adapt the proof of 16.2 in [20]. We use again a renormalization argument but at a different scale L . We consider the lattice rescaled by this factor L . We say that a cluster C is crossing in a box B if for any two opposite faces of B , the cluster C contains an open path in B that joins these two faces. Let $\varepsilon > 0$. For $\underline{y} \in \mathbb{Z}^d$, we define $B_n(\underline{y}) = (2L\underline{y}/n) + [-L/n, L/n]^d$ and $B'_n(\underline{y}) = (2L\underline{y}/n) + [-3L/n, 3L/n]^d$. Let $X(\underline{y})$ be the indicator function of the event $\mathcal{E}_n(\underline{y})$. This event occurs if

- Inside $nB'_n(\underline{y})$, there is a unique crossing cluster C' that crosses the 3^d sub-boxes of $nB'_n(\underline{y})$. Moreover, C' is the only cluster in $nB'_n(\underline{y})$ of diameter larger than L .
- Inside $nB_n(\underline{y})$, there is a crossing cluster C^* such that

$$|C^*| \geq (\theta_p - \varepsilon) \mathcal{L}^d(nB_n(\underline{y})).$$

- We have $|\{x \in nB_n(\underline{y}) : x \longleftrightarrow \partial(nB_n(\underline{y}))\}| \leq (\theta_p + \varepsilon) \mathcal{L}^d(nB_n(\underline{y}))$.

On the event $\mathcal{E}_n(\underline{y})$, any cluster $C \subset nB_n(\underline{y})$ that is connected by an open path to $\partial(nB'_n(\underline{y}))$ is the unique crossing cluster, *i.e.*, $C = C' = C^*$ and so it also satisfies

$$\frac{|C|}{\mathcal{L}^d(nB_n(\underline{y}))} \in [\theta_p - \varepsilon, \theta_p + \varepsilon].$$

The family $(X(\underline{y}))_{\underline{y} \in \mathbb{Z}^d}$ is a site percolation process on the macroscopic lattice. The states of the sites are not independent from each other but there is only a short range dependency. Indeed, for any \underline{y} and \underline{z} such that $|\underline{y} - \underline{z}|_\infty \geq 3$, we have that $X(\underline{y})$ and $X(\underline{z})$ are independent. We define the connected component $\mathcal{C}(\underline{y})$ of \underline{y} as

$$\mathcal{C}(\underline{y}) = \left\{ \underline{z} \in \mathbb{Z}^d : \underline{z} \text{ is connected to } \underline{y} \text{ by a macroscopic open path} \right\}.$$

Let

$$\underline{D} = \{ \underline{y} \in \mathbb{Z}^d : B_n(\underline{y}) \subset B(x, r) \}.$$

We have

$$|\underline{D}| L^d \leq n^d \mathcal{L}^d(B(x, r)). \quad (5.6)$$

There exists an integer $n_0 = n_0(u(\varepsilon))$ such that, for $n \geq n_0(u(\varepsilon))$, we have $L/n \leq u(\varepsilon)$ so that

$$\mathcal{L}^d \left(B(x, r) \setminus \bigcup_{\underline{y} \in \underline{D}} B_n(\underline{y}) \right) \leq \varepsilon \mathcal{L}^d(B(x, r)),$$

$$\forall w, z \in \mathbb{R}^d, \|w - z\|_2 \leq \frac{L}{n} \Rightarrow |f(w) - f(z)| \leq \varepsilon.$$

The last statement comes from the fact that f belongs to \mathfrak{F}_n . By decomposing $|\tilde{\mu}_n(f\mathbf{1}_{B(x,r)}) - \nu_n(f\mathbf{1}_{B(x,r)})|$ on cubes of size L/n , we obtain:

$$\begin{aligned} & |\tilde{\mu}_n(f\mathbf{1}_{B(x,r)}) - \nu_n(f\mathbf{1}_{B(x,r)})| \\ & \leq 2\mathcal{L}^d \left(B(x, r) \setminus \bigcup_{\underline{y} \in \underline{D}} B_n(\underline{y}) \right) + \sum_{\underline{y} \in \underline{D}} \left| \int_{B_n(\underline{y})} f d\tilde{\mu}_n - \int_{B_n(\underline{y})} f d\nu_n \right| \\ & \leq 4\varepsilon \mathcal{L}^d(B(x, r)) + \sum_{\underline{y} \in \underline{D}} |\tilde{\mu}_n(B_n(\underline{y})) - \nu_n(B_n(\underline{y}))|. \end{aligned} \quad (5.7)$$

Let $\underline{y} \in \underline{D}$. We need to distinguish several cases:

- If $B_n(\underline{y}) \cap P_n = \emptyset$, then $\nu_n(B_n(\underline{y})) = \tilde{\mu}_n(B_n(\underline{y})) = 0$. From now on we will only consider cubes such that $B_n(\underline{y}) \cap P_n \neq \emptyset$.
- If $B_n(\underline{y}) \not\subset P_n$, then we bound

$$|\tilde{\mu}_n(B_n(\underline{y})) - \nu_n(B_n(\underline{y}))| \leq \frac{1}{n^d} |B_n(\underline{y})|$$

and as $B_n(\underline{y}) \cap P_n \neq \emptyset$, the cube intersects the boundary of P_n . Thus,

$$B_n(\underline{y}) \subset \left\{ z \in \mathbb{R}^d : d_\infty(z, \partial P_n \cap B(x, r)) \leq \frac{L}{n} \right\}.$$

Moreover,

$$\begin{aligned} & \mathcal{L}^d \left(\left\{ z \in \mathbb{R}^d : d_\infty(z, \partial P_n \cap B(x, r)) \leq \frac{L}{n} \right\} \right) \\ & \leq \left| \{ x \in H_n, \exists y \in \mathbb{Z}^d \setminus H_n, \|x - y\|_1 = 1 \} \cap B(nx, nr + d) \right| \left(\frac{2L+2}{n} \right)^d \\ & \leq \mathcal{P}(nP_n, B(nx, nr + d)) \left(\frac{3L}{n} \right)^d \\ & \leq \mathcal{P}(P_n, B(x, r + d)) \frac{(3L)^d}{n}. \end{aligned}$$

- If $B_n(\underline{y}) \subset P_n$ and $|\mathcal{C}(\underline{y})| = \infty$, then the crossing cluster C^* of $B_n(\underline{y})$ is a portion of \mathcal{C}_∞ and

$$\nu_n(B_n(\underline{y})) = \theta_p \frac{\mathcal{L}^d(nB_n(\underline{y}))}{n^d} \text{ and } \tilde{\mu}_n(B_n(\underline{y})) = \frac{|(nB_n(\underline{y})) \cap C^*|}{n^d}.$$

Thus, we have

$$\tilde{\mu}_n(B_n(\underline{y})) \in [(\theta_p - \varepsilon)\mathcal{L}^d(B_n(\underline{y})), (\theta_p + \varepsilon)\mathcal{L}^d(B_n(\underline{y}))]$$

and

$$|\tilde{\mu}_n(B_n(\underline{y})) - \nu_n(B_n(\underline{y}))| \leq \varepsilon \mathcal{L}^d(B_n(\underline{y})).$$

- If $B_n(\underline{y}) \subset P_n$ and $|\mathcal{C}(\underline{y})| < \infty$, then we bound

$$|\tilde{\mu}_n(B_n(\underline{y})) - \nu_n(B_n(\underline{y}))| \leq \mathcal{L}^d(B_n(\underline{y})) \mathbf{1}_{|\mathcal{C}(\underline{y})| < \infty}.$$

By summing the previous inequalities over $\underline{y} \in \underline{D}$, thanks to inequality (5.6) and (5.7), we obtain

$$\begin{aligned} & |\tilde{\mu}_n(f\mathbf{1}_{B(x,r)}) - \nu_n(f\mathbf{1}_{B(x,r)})| \\ & \leq \mathcal{L}^d(B(x,r)) \left(5\varepsilon + \frac{1}{|\underline{D}|} \sum_{\underline{y} \in \underline{D}} \mathbf{1}_{|c(\underline{y})| < \infty} \right) + \mathcal{P}(P_n, B(x, r+d)) \frac{(3L)^d}{n}. \end{aligned}$$

Let $c(r) = 6\mathcal{L}^d(B(0, r)) + 3^d$, we get

$$\begin{aligned} & \mathbb{P} \left(\max_{G_n \in \mathcal{G}_n} \sup_{f \in \mathfrak{F}_n} |\tilde{\mu}_n(f\mathbf{1}_{B(x,r)}) - \nu_n(f\mathbf{1}_{B(x,r)})| > c(r)\varepsilon \right) \\ & \leq \frac{1}{\theta_p} \mathbb{P} \left(\frac{1}{|\underline{D}|} \sum_{\underline{y} \in \underline{D}} \mathbf{1}_{|c(\underline{y})| < \infty} \geq \varepsilon \right) + \mathbb{P} \left(\max_{G_n \in \mathcal{G}_n} \mathcal{P}(P_n, B(x, r+d)) \geq \varepsilon \frac{n}{L^d} \right). \end{aligned} \quad (5.8)$$

Besides, using Corollary 5.8, for n large enough, we obtain

$$\mathbb{P} \left(\max_{G_n \in \mathcal{G}_n} \mathcal{P}(P_n, B(x, r+d)) \geq \varepsilon \frac{n}{L^d} \right) \leq \mathbb{P} \left(\max_{G_n \in \mathcal{G}_n} \mathcal{P}(P_n) \geq \beta \right) \leq c_1 e^{-c_2 n^{1-3/2d}}. \quad (5.9)$$

Let Λ be the cube centered at x of side length $2r$. We define

$$\underline{\Lambda} = \left\{ \underline{y} \in \mathbb{Z}^d : B_n(\underline{y}) \subset \Lambda \right\}.$$

As $B(x, r) \subset \Lambda$, we have $\underline{D} \subset \underline{\Lambda}$ and

$$\frac{1}{|\underline{D}|} \sum_{\underline{y} \in \underline{D}} \mathbf{1}_{|c(\underline{y})| < \infty} \leq \frac{(2d)^d}{|\underline{\Lambda}|} \sum_{\underline{y} \in \underline{\Lambda}} \mathbf{1}_{|c(\underline{y})| < \infty}. \quad (5.10)$$

Let $q \in [0, 1]$ be such that $\theta_q > 1 - \varepsilon / (2(2d)^d)$. As the family $(X(\underline{y}))_{\underline{y} \in \mathbb{Z}^d}$ is identically distributed, has a short range dependency and is such that $\mathbb{P}(X(\underline{0}) = 1)$ goes to 1 when L goes to infinity (see for instance Chapter 9 in [19]), then we can apply Liggett Schonmann and Stacey's result [55]: for L large enough, the family $(X(\underline{y}), \underline{y} \in \mathbb{Z}^d)$ stochastically dominates $(\tilde{X}(\underline{y}), \underline{y} \in \mathbb{Z}^d)$ a family of independent Bernoulli variable of parameter q . We denote by $\tilde{\mathcal{C}}_\infty$ the unique infinite cluster of the Bernoulli field $(\tilde{X}(\underline{y}))_{\underline{y} \in \mathbb{Z}^d}$. Using inequality (5.10) and the stochastic domination, we get

$$\begin{aligned} \mathbb{P} \left(\frac{1}{|\underline{D}|} \sum_{\underline{y} \in \underline{D}} \mathbf{1}_{|c(\underline{y})| < \infty} \geq \varepsilon \right) & \leq \mathbb{P} \left(\frac{(2d)^d}{|\underline{\Lambda}|} \sum_{\underline{y} \in \underline{\Lambda}} \mathbf{1}_{|c(\underline{y})| < \infty} \geq \varepsilon \right) \\ & \leq \mathbb{P} \left(\frac{1}{|\underline{\Lambda}|} \sum_{\underline{y} \in \underline{\Lambda}} \mathbf{1}_{\underline{y} \notin \tilde{\mathcal{C}}_\infty} \geq \frac{\varepsilon}{(2d)^d} \right) \\ & \leq \mathbb{P} \left(\frac{|\underline{\Lambda} \cap \tilde{\mathcal{C}}_\infty|}{|\underline{\Lambda}|} \notin \left(\theta_q - \frac{\varepsilon}{2(2d)^d}, \theta_q + \frac{\varepsilon}{2(2d)^d} \right) \right). \end{aligned}$$

Using Proposition 5.12, we obtain

$$\mathbb{P} \left(\frac{1}{|\underline{D}|} \sum_{\underline{y} \in \underline{D}} \mathbf{1}_{|c(\underline{y})| < \infty} \geq \varepsilon \right) \leq c'_1 \exp \left(-c'_2 \left(\frac{rn}{L} \right)^{d-1} \right). \quad (5.11)$$

We set $\varepsilon = \delta / (2c(r))$. Finally, thanks to inequalities (5.5), (5.8), (5.9) and (5.11), we have for

$n \geq n_0(u(\varepsilon))$

$$\begin{aligned} & \mathbb{P} \left(\max_{G_n \in \mathcal{G}_n} \sup_{f \in \mathfrak{F}_n} |\tilde{\mu}_n(f \mathbb{1}_{B(x,r)}) - \nu_n(f \mathbb{1}_{B(x,r)})| > \delta \right) \\ & \leq \mathbb{P} \left(\max_{G_n \in \mathcal{G}_n} \sup_{f \in \mathfrak{F}_n} |\mu_n(f) - \tilde{\mu}_n(f)| > \delta/2 \right) \\ & \quad + \mathbb{P} \left(\max_{G_n \in \mathcal{G}_n} \sup_{f \in \mathfrak{F}_n} |\tilde{\mu}_n(f \mathbb{1}_{B(x,r)}) - \nu_n(f \mathbb{1}_{B(x,r)})| > c(r)\varepsilon \right) \\ & \leq C_1 \exp(-C_2 n) + \frac{c'_1}{\theta_p} \exp \left(-c'_2 \left(\frac{rn}{L} \right)^{d-1} \right) + c_1 e^{-c_2 n^{1-3/2d}}. \end{aligned}$$

The result follows. \square

6 Lower large deviations and shape Theorem

6.1 Closeness to the set of Wulff shapes

The aim of this section is to prove Theorem 1.7.

Proof of Theorem 1.7. Let $\varepsilon > 0$. Let $\xi > 0$ that we will choose later depending on ε . We define λ such that

$$1 - \lambda = \frac{1}{1 + \xi}.$$

We denote by \mathcal{W}_ξ :

$$\mathcal{W}_\xi = \left\{ \nu_{W+x} : \begin{array}{l} x \in \mathbb{R}^d, W \text{ is a dilate of } W_p \text{ such that} \\ \mathcal{L}^d((1-\lambda)W_p) \leq \mathcal{L}^d(W) \leq \mathcal{L}^d((1+2\xi)W_p) \end{array} \right\}.$$

Let $u :]0, +\infty[\rightarrow]0, +\infty[$ be a non-decreasing function such that $\lim_{t \rightarrow 0} u(t) = 0$. Let $n \geq 1$. Let \mathfrak{F}_n be a finite set of uniformly continuous function that satisfies for all $f \in \mathfrak{F}_n$,

$$\|f\|_\infty \leq 1 \quad \text{and} \quad \forall x, y \in \mathbb{R}^d, |f(x) - f(y)| \leq u(\|x - y\|_2).$$

We define the weak neighborhood $\mathcal{V}(\mathcal{W}_\xi, \mathfrak{F}_n, \varepsilon)$ of \mathcal{W}_ξ given \mathfrak{F}_n and ε as

$$\mathcal{V}(\mathcal{W}_\xi, \mathfrak{F}_n, \varepsilon) = \left\{ \nu \in \mathcal{M}(\mathbb{R}^d) : \exists \mu \in \mathcal{W}_\xi, \sup_{f \in \mathfrak{F}_n} |\nu(f) - \mu(f)| \leq \varepsilon \right\}.$$

Our goal is to show that μ_n is in the set $\mathcal{V}(\mathcal{W}_\xi, \mathfrak{F}_n, \varepsilon)$ with high probability.

Step (i): Let $G_n \in \mathcal{G}_n$. Thanks to Proposition 5.10, the measures μ_n and ν_n associated with P_n and G_n are locally close to each other. In the following, it will be more convenient to work with the continuous object P_n instead of G_n . We can localize almost all the volume of P_n in a random region that is a union of balls of constant radius. We follow the method in Chapter 17 in [19]. We can cover P_n in \mathbb{R}^d , up to a small fractional volume, by a finite number of random disjoint balls of constant size. Thanks to the isoperimetric inequalities, we can then control the volume of P_n outside of these balls. Let $\delta > 0$ be a real number that we will choose later. We denote by X :

$$X = \{x \in \mathbb{Z}^d : \mathcal{L}^d(B(x,1) \cap P_n) \geq \delta\}.$$

On the event $\{|\tilde{\Gamma}_n| \leq \beta n^{d-1}\}$, the set X is included in $B(0, \beta n^{d-2})$ and is therefore finite. As each point in \mathbb{R}^d belongs to at most 2^d balls among the $B(x,1)$, $x \in \mathbb{Z}^d$, then using Proposition 2.4

$$\delta |X| \leq \sum_{x \in X} \mathcal{L}^d(B(x,1) \cap P_n) \leq 2^d \mathcal{L}^d(P_n) \leq 2^d c_{iso} \mathcal{P}(P_n)^{\frac{d}{d-1}} \leq 2^d c_{iso} \beta^{\frac{d}{d-1}}$$

and finally $|X| \leq M$ where $M = 2^d c_{iso} \beta^{\frac{d}{d-1}} / \delta$. We now would like to control the volume of P_n outside the balls $B(x, 1)$ in X , *i.e.*, to bound the measure of $P_n \setminus \bigcup_{x \in X} B(x, 1)$. For $x \in \mathbb{Z}^d \setminus X$, by the isoperimetric inequality in Proposition 2.4, we obtain as in section 17 in [19]

$$\begin{aligned}
\mathcal{L}^d \left(P_n \setminus \bigcup_{x \in X} B(x, 1) \right) &\leq \sum_{x \in \mathbb{Z}^d \setminus X} \mathcal{L}^d(P_n \cap B(x, 1)) \\
&\leq \delta^{1/d} b_{iso}^{\frac{d}{d-1}} \sum_{x \in \mathbb{Z}^d \setminus X} \mathcal{P}(P_n, \dot{B}(x, 1)) \\
&= \delta^{1/d} b_{iso}^{\frac{d}{d-1}} \sum_{x \in \mathbb{Z}^d \setminus X} \mathcal{H}^{d-1}(\partial^* P_n \cap \dot{B}(x, 1)) \\
&\leq 2^d \delta^{1/d} b_{iso}^{\frac{d}{d-1}} \mathcal{H}^{d-1}(\partial^*(P_n)) = 2^d \delta^{1/d} b_{iso}^{\frac{d}{d-1}} \mathcal{P}(P_n) \\
&\leq 2^d \delta^{1/d} b_{iso}^{\frac{d}{d-1}} \beta.
\end{aligned} \tag{6.1}$$

We note $\eta = 2^d \delta^{1/d} b_{iso}^{\frac{d}{d-1}} \beta$. Therefore, if $\mathcal{P}(P_n) \leq \beta$, then $X \subset B(0, \beta n^{d-2})$, $|X| \leq M$ and $\mathcal{L}^d(P_n \setminus \bigcup_{x \in X} B(x, 1)) \leq \eta$.

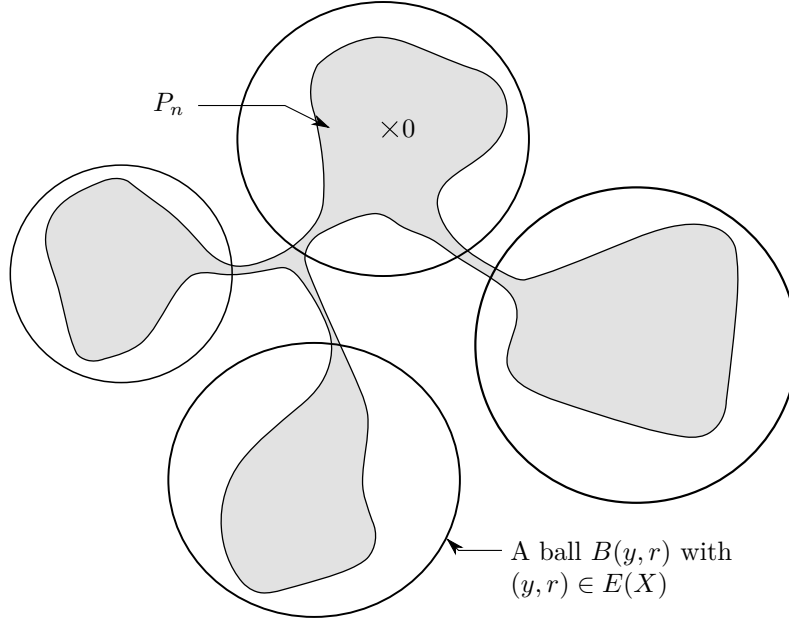

Figure 2.6 – Covering almost all the volume of P_n by balls of constant radius

We next would like to perform a kind of surgery between the balls. To do so, we shall first build from the balls $(B(x, 1))_{x \in X}$ a family of balls that covers $\bigcup_{x \in X} B(x, 1)$ and such that the balls are far apart (see Figure 2.6). This is the purpose of Lemma 17.1. in [19]. We obtain a subset

$$E(X) = \{(y_1, r_1), \dots, (y_m, r_m)\} \subset X \times \{1, \dots, 3^{|X|}\}$$

such that $|E(X)| \leq |X|$ and

- $\forall (a, r) \in E(X), B(a, r) \cap X \neq \emptyset$
- $\bigcup_{x \in X} B(x, 1) \subset \bigcup_{(a, r) \in E(X)} B(a, r)$
- $\forall (a, r), (b, s) \in E(X), (a, r) \neq (b, s) \Rightarrow B(a, r+1) \cap B(b, s+1) = \emptyset$

We set

$$\varphi_{W_p} = \frac{\mathcal{I}_p(W_p)}{\theta_p \mathcal{L}^d(W_p)}.$$

Let $\delta' > 0$ be a real number that we will choose later. By applying Corollary 5.8 and Theorem 1.4, we obtain by conditioning on $E(X)$,

$$\begin{aligned} & \mathbb{P}\left(\exists G_n \in \mathcal{G}_n, \mu_n \notin \mathcal{V}(\mathcal{W}_\xi, \mathfrak{F}_n, \varepsilon) \mid 0 \in \mathcal{C}_\infty\right) \\ & \leq \mathbb{P}\left(\max_{G_n \in \mathcal{G}_n} \mathcal{P}(nP_n) \geq \beta n^{d-1}\right) + \mathbb{P}(n\varphi_n > (1 + \delta')\varphi_{W_p}) \\ & \quad + \mathbb{P}(\exists G_n \in \mathcal{G}_n, \mu_n \notin \mathcal{V}(\mathcal{W}_\xi, \mathfrak{F}_n, \varepsilon), \mathcal{P}(P_n) \leq \beta, n\varphi_n \leq (1 + \delta')\varphi_{W_p}) \\ & \leq b_1 \exp(-b_2 n^{1-3/2d}) + b'_1 \exp(-b'_2 n) \\ & \quad + \sum_{1 \leq m \leq M} \sum_{y_1, \dots, y_m} \sum_{r_1, \dots, r_m} \mathbb{P}\left(\begin{array}{l} \exists G_n \in \mathcal{G}_n, \mu_n \notin \mathcal{V}(\mathcal{W}_\xi, \mathfrak{F}_n, \varepsilon), \\ E(X) = \{(y_1, r_1), \dots, (y_m, r_m)\} \\ \mathcal{P}(P_n) \leq \beta, n\varphi_n \leq (1 + \delta')\varphi_{W_p} \end{array}\right), \end{aligned} \quad (6.2)$$

where the second summation is over y_1, \dots, y_m in $\mathbb{Z}^d \cap B(0, \beta n^{d-2})$ and the third summation is over r_1, \dots, r_m in $\{1, \dots, 3^M\}$. The number of ways to choose m and r_1, \dots, r_m is bounded from above by a constant depending only on M , while the number of ways of choosing the centers y_1, \dots, y_m is polynomial in n . We next control the probability inside the sums. We will only focus on what happens inside the balls.

Step (ii): Let $\{(y_1, r_1), \dots, (y_m, r_m)\}$ be a value for the random set $E(X)$ which occurs with positive probability. We define $\Omega = \Omega(E(X))$ as

$$\Omega = \bigcup_{i=1}^m \mathring{B}(y_i, r_i + 1),$$

and the restriction \bar{P}_n of P_n to the balls determined by $E(X)$:

$$\bar{P}_n = P_n \cap \left(\bigcup_{i=1}^m \mathring{B}(y_i, r_i + 1) \right).$$

Thus, using inequality (6.1), we have

$$\mathcal{L}^d(P_n \setminus \bar{P}_n) \leq \eta. \quad (6.3)$$

We show now that $\nu_{\bar{P}_n}(f)$ is close to $\mu_n(f)$ with high probability on the event

$$\{E(X) = \{(y_1, r_1), \dots, (y_m, r_m)\}\}.$$

It is easy to check that $\mathfrak{F}_n \cup \{1\}$ associated with the function u satisfies the conditions required in Proposition 5.10. So that applying Proposition 5.10 for every $r \in \{1, \dots, 3^M\}$, there exist positive constants c_1, c_2 depending on M, u , and δ such that for all $x \in \mathbb{Z}^d$

$$\max_{r \in \{1, \dots, 3^M\}} \mathbb{P}\left(\max_{G_n \in \mathcal{G}_n} \sup_{f \in \mathfrak{F}_n \cup \{1\}} |\nu_n(f \mathbb{1}_{B(x,r)}) - \mu_n(f \mathbb{1}_{B(x,r)})| > \frac{\eta}{M}\right) \leq c_1 e^{-c_2 n^{1-3/2d}}.$$

Thus, using inequality (6.3), we obtain

$$\begin{aligned} & \mathbb{P}\left(\max_{G_n \in \mathcal{G}_n} \sup_{f \in \mathfrak{F}_n \cup \{1\}} |\nu_{\bar{P}_n}(f) - \mu_n(f)| > 2\eta, E(X) = \{(y_1, r_1), \dots, (y_m, r_m)\}\right) \\ & \leq \sum_{i=1}^m \mathbb{P}\left(\max_{G_n \in \mathcal{G}_n} \sup_{f \in \mathfrak{F}_n \cup \{1\}} |\nu_{\bar{P}_n}(f \mathbb{1}_{B(y_i, r_i)}) - \mu_n(f \mathbb{1}_{B(y_i, r_i)})| > \eta/M\right) \\ & \leq M \max_{r \in \{1, \dots, 3^M\}} \mathbb{P}\left(\max_{G_n \in \mathcal{G}_n} \sup_{f \in \mathfrak{F}_n \cup \{1\}} |\nu_n(f \mathbb{1}_{B(y_1, r)}) - \mu_n(f \mathbb{1}_{B(y_1, r)})| > \eta/M\right) \\ & \leq M c_1 e^{-c_2 n^{1-3/2d}}. \end{aligned} \quad (6.4)$$

In particular, on the event $\{E(X) = \{(y_1, r_1), \dots, (y_m, r_m)\}\}$, with probability at least $1 - Mc_1 \exp(-c_2 n^{1-3/2d})$, we have

$$\left| \theta_p \mathcal{L}^d(\bar{P}_n) - \frac{|G_n|}{n^d} \right| \leq 2\eta. \quad (6.5)$$

Moreover, by Lemma 5.1, there exist positive constants η_1 , D_1 and D_2 such that

$$\mathbb{P} \left(\min_{G_n \in \mathcal{G}_n} |G_n| \leq \eta_1 n^d \right) \leq D_1 \exp(-D_2 n^{(d-1)/2d}).$$

We recall that η is a function of δ . We will choose δ small enough such that

$$\eta \leq \min \left(\frac{\eta_1}{4}, \frac{\xi^d}{2}, \frac{\varepsilon}{8}, \frac{\eta_1}{3\theta_p} \right). \quad (6.6)$$

Other conditions will be imposed later on δ .

On the event $\{\min_{G_n \in \mathcal{G}_n} |G_n| > \eta_1 n^d\}$, using inequalities (6.5) and (6.6), we obtain

$$\mathcal{L}^d(\bar{P}_n) \geq \frac{1}{\theta_p} \left(\frac{|G_n|}{n^d} - 2\eta \right) \geq \frac{1}{\theta_p} (\eta_1 - 2\eta) \geq \frac{\eta_1}{2\theta_p} \quad (6.7)$$

and as $\mathcal{L}^d(W_p) = 1/\theta_p$, using inequality (6.5), we have

$$\mathcal{L}^d(\bar{P}_n) \leq \frac{1}{\theta_p} \left(\frac{|G_n|}{n^d} + 2\eta \right) \leq \frac{1}{\theta_p} (1 + \xi^d) = \mathcal{L}^d(W_p)(1 + \xi^d) \leq \mathcal{L}^d((1 + \xi)W_p). \quad (6.8)$$

For $\nu \in \mathcal{W}_\xi$, we have

$$\sup_{f \in \mathfrak{F}_n} |\nu_{\bar{P}_n}(f) - \nu(f)| \geq \sup_{f \in \mathfrak{F}_n} |\mu_n(f) - \nu(f)| - \sup_{f \in \mathfrak{F}_n} |\mu_n(f) - \nu_{\bar{P}_n}(f)|,$$

so that, together with inequalities (6.4) and (6.6), with high probability,

$$\mu_n \notin \mathcal{V}(\mathcal{W}_\xi, \mathfrak{F}_n, \varepsilon) \implies \nu_{\bar{P}_n} \notin \mathcal{V}(\mathcal{W}_\xi, \mathfrak{F}_n, 3\varepsilon/4).$$

Thus, combining with inequalities (6.7) and (6.8), we have

$$\begin{aligned} & \mathbb{P} \left(\begin{array}{l} \exists G_n \in \mathcal{G}_n, \mu_n \notin \mathcal{V}(\mathcal{W}_\xi, \mathfrak{F}_n, \varepsilon), \mathcal{P}(P_n) \leq \beta, \\ E(X) = \{(y_1, r_1), \dots, (y_m, r_m)\}, n\varphi_n \leq (1 + \delta')\varphi_{W_p} \end{array} \right) \\ & \leq \mathbb{P} \left(\begin{array}{l} \exists G_n \in \mathcal{G}_n, \nu_{\bar{P}_n} \notin \mathcal{V}(\mathcal{W}_\xi, \mathfrak{F}_n, 3\varepsilon/4), n\varphi_n \leq (1 + \delta')\varphi_{W_p}, \\ \frac{\eta_1}{2\theta_p} \leq \mathcal{L}^d(\bar{P}_n) \leq \mathcal{L}^d((1 + \xi)W_p), E(X) = \{(y_1, r_1), \dots, (y_m, r_m)\} \end{array} \right) \\ & + Mc_1 e^{-c_2 n^{1-3/2d}} + D_1 \exp(-D_2 n^{(d-1)/2d}). \end{aligned} \quad (6.9)$$

We do not cover \bar{P}_n directly but we cover separately each $\bar{P}_n \cap B(y_k, r_k + 1)$ for $k \in \{1, \dots, m\}$. For any $r \in \{1, \dots, 3^M\}$, we define the space

$$\mathcal{C}_\beta^{(r)} = \left\{ F \subset \mathring{B}(0, r + 1), \mathcal{P}(F, \mathring{B}(0, r + 1)) \leq \beta \right\}$$

endowed with the topology L^1 associated to the distance $d(F, F') = \mathcal{L}^d(F \Delta F')$, where Δ is the symmetric difference between sets. For this topology, the space $\mathcal{C}_\beta^{(r)}$ is compact. Suppose that we associate to each $F \in \mathcal{C}_\beta^{(r)}$ a positive number $\varepsilon_F \leq \min(\eta, \mathcal{L}^d(\xi W_p))/M$. The collection of open sets

$$\left\{ H \text{ Borel subset of } \mathring{B}(0, r + 1) : \mathcal{L}^d(H \Delta F) < \varepsilon_F \right\}, F \in \mathcal{C}_\beta^{(r)},$$

is then an open covering of $\mathcal{C}_\beta^{(r)}$. By compactness, we can extract a finite covering $(F_i^{(r)}, \varepsilon_{F_i^{(r)}})_{1 \leq i \leq N^{(r)}}$ of $\mathcal{C}_\beta^{(r)}$. By union bound, we obtain

$$\begin{aligned} \mathbb{P} \left(\begin{array}{l} \exists G_n \in \mathcal{G}_n, \nu_{\bar{P}_n} \notin \mathcal{V}(\mathcal{W}_\xi, \mathfrak{F}_n, 3\varepsilon/4), n\varphi_n \leq (1 + \delta')\varphi_{W_p}, \\ \frac{\eta_1}{2\theta_p} \leq \mathcal{L}^d(\bar{P}_n) \leq \mathcal{L}^d((1 + \xi)W_p), E(X) = \{(y_1, r_1), \dots, (y_m, r_m)\} \end{array} \right) \\ \leq \sum_{i_1=1}^{N^{(r_1)}} \cdots \sum_{i_m=1}^{N^{(r_m)}} \mathbb{P}(\mathcal{F}_{i_1, \dots, i_m}) \end{aligned} \quad (6.10)$$

where

$$\mathcal{F}_{i_1, \dots, i_m} = \left\{ \begin{array}{l} \exists G_n \in \mathcal{G}_n : \forall 1 \leq k \leq m, \\ \mathcal{L}^d((F_{i_k}^{(r_k)} + y_k)\Delta(\bar{P}_n \cap B(y_k, r_k + 1))) \leq \varepsilon_{F_{i_k}^{(r_k)}}, \\ \nu_{\bar{P}_n} \notin \mathcal{V}(\mathcal{W}_\xi, \mathfrak{F}_n, 3\varepsilon/4), n\varphi_n \leq (1 + \delta')\varphi_{W_p}, \\ \frac{\eta_1}{2\theta_p} \leq \mathcal{L}^d(\bar{P}_n) \leq \mathcal{L}^d((1 + \xi)W_p), \\ E(X) = \{(y_1, r_1), \dots, (y_m, r_m)\} \end{array} \right\}.$$

So we need to study the quantity $\mathbb{P}(\mathcal{F})$ for a generic m -uplet $(F_1, \dots, F_m) \in \mathcal{C}_\beta^{(r_1)} \times \cdots \times \mathcal{C}_\beta^{(r_m)}$ and their associated $\varepsilon_{F_1}, \dots, \varepsilon_{F_m}$. By definition of the Cheeger constant φ_n , we obtain

$$\mathbb{P}(\mathcal{F}) = \mathbb{P} \left(\begin{array}{l} \forall 1 \leq i \leq m, \\ \mathcal{L}^d((F_i + y_i)\Delta(\bar{P}_n \cap B(y_i, r_i + 1))) \leq \varepsilon_{F_i}, \\ \nu_{\bar{P}_n} \notin \mathcal{V}(\mathcal{W}_\xi, \mathfrak{F}_n, 3\varepsilon/4), \\ |\partial^\circ G_n| \leq (1 + \delta')n^{-1}|G_n|\varphi_{W_p}, \\ \frac{\eta_1}{2\theta_p} \leq \mathcal{L}^d(\bar{P}_n) \leq \mathcal{L}^d((1 + \xi)W_p), \\ E(X) = \{(y_1, r_1), \dots, (y_m, r_m)\} \end{array} \right).$$

To lighten the notations, we set

$$F = \bigcup_{i=1}^m (F_i + y_i).$$

We have

$$\begin{aligned} \mathcal{L}^d(F\Delta\bar{P}_n) &= \sum_{i=1}^m \mathcal{L}^d((\bar{P}_n \cap B(y_i, r_i + 1))\Delta(F_i + y_i)) \\ &\leq \sum_{i=1}^m \varepsilon_{F_i} \leq \min(\eta, \mathcal{L}^d(\xi W_p)). \end{aligned} \quad (6.11)$$

Whereas the surface tension of F in the interior of these balls corresponds to the surface tension of our minimizer G_n , the surface tension of F along the boundary of the balls $B(y_j, r_j + 1)$ does not correspond to the surface tension of G_n because we have artificially created it. Roughly speaking, F is the continuous object corresponding to the graph G_n intersected with the $nB(y_j, r_j + 1)$. This new graph has extra surface tension compared to G_n due to the fact that we have built it by cutting G_n along the boundary of these balls. However, our hope is to cut along the boundary of these balls in such a way that the surface tension we create is negligible. We do not work on G_n but on the continuous object F , but we have to keep in mind that these two objects are close. The idea is to cut F in the regions $B(y_i, r_i + 1) \setminus B(y_i, r_i)$, $i \in \{1, \dots, m\}$. These regions contain a negligible volume of G_n and so of F , we want to cut F in these regions along a surface of negligible perimeter and so of negligible surface tension. By Lemma 14.4 in [19], for $i \in \{1, \dots, m\}$, for \mathcal{H}^1 almost all t in $]0, 1[$,

$$\mathcal{I}(F \cap B(y_i, r_i + t)) \leq \mathcal{I}(F \cap \mathring{B}(y_i, r_i + t)) + \beta_{max} \mathcal{H}^{d-1}(F \cap \partial B(y_i, r_i + t)). \quad (6.12)$$

Let T be a subset of $]0, 1[$ where all the above inequalities hold simultaneously. We recall that for any $i \in \{1, \dots, m\}$, $\varepsilon_{F_i} \leq \eta/M$. We have $\mathcal{H}^1(T) = 1$ and when we integrate in polar coordinates,

using inequality (6.11),

$$\begin{aligned}
\int_T \sum_{i=1}^m \mathcal{H}^{d-1}(F \cap \partial B(y_i, r_i + t)) dt &= \sum_{i=1}^m \mathcal{L}^d(F \cap B(y_i, r_i + 1) \setminus B(y_i, r_i)) \\
&\leq \sum_{i=1}^m \mathcal{L}^d((F_i + y_i) \setminus B(y_i, r_i)) \\
&\leq \mathcal{L}^d\left(\bar{P}_n \setminus \bigcup_{i=1}^m B(y_i, r_i)\right) + \mathcal{L}^d(\bar{P}_n \Delta F) \\
&\leq 2\eta.
\end{aligned}$$

Thus, there exists $t \in T$ such that

$$\sum_{i=1}^m \mathcal{H}^{d-1}(F \cap \partial B(y_i, r_i + t)) \leq 3\eta. \quad (6.13)$$

We next set

$$\bar{F} = F \cap \left(\bigcup_{i=1}^m B(y_i, r_i + t) \right).$$

Using inequality (6.13), we get

$$\begin{aligned}
\mathcal{P}(\bar{F}) &\leq \mathcal{P}\left(\bar{F}, \bigcup_{i=1}^m \dot{B}(y_i, r_i + t)\right) + \sum_{i=1}^m \mathcal{H}^{d-1}(F \cap \partial B(y_i, r_i + t)) \\
&\leq \mathcal{P}\left(\bar{F}, \bigcup_{i=1}^m \dot{B}(y_i, r_i + t)\right) + 3\eta,
\end{aligned} \quad (6.14)$$

and using Proposition 2.3,

$$\mathcal{I}_p(\bar{F}) \leq \mathcal{I}_p\left(\bar{F}, \bigcup_{i=1}^m \dot{B}(y_i, r_i + t)\right) + 3\beta_{max}\eta. \quad (6.15)$$

On the event \mathcal{F} , using inequality (6.11), we obtain

$$\begin{aligned}
\mathcal{L}^d(F) &\leq \mathcal{L}^d(\bar{F}) + \mathcal{L}^d\left(F \setminus \bigcup_{i=1}^m B(y_i, r_i)\right) \\
&\leq \mathcal{L}^d(\bar{F}) + \mathcal{L}^d(F \Delta \bar{P}_n) + \mathcal{L}^d\left(\bar{P}_n \setminus \bigcup_{i=1}^m B(y_i, r_i)\right) \leq \mathcal{L}^d(\bar{F}) + 2\eta.
\end{aligned} \quad (6.16)$$

Finally, using inequalities (6.14) and (6.16), we obtain

$$\mathcal{I}_p\left(\bar{F}, \bigcup_{i=1}^m \dot{B}(y_i, r_i + t)\right) \geq \beta_{min} \mathcal{P}\left(\bar{F}, \bigcup_{i=1}^m \dot{B}(y_i, r_i + t)\right) \geq \beta_{min}(\mathcal{P}(\bar{F}) - 3\eta). \quad (6.17)$$

and using again inequality (6.11),

$$\mathcal{L}^d(F) \geq \mathcal{L}^d(\bar{P}_n) - \mathcal{L}^d(\bar{P}_n \Delta F) \geq \frac{\eta_1}{2\theta_p} - \eta. \quad (6.18)$$

Using the isoperimetric inequalities of Proposition 2.4 and inequalities (6.16) and (6.18), we get

$$\mathcal{P}(\bar{F}) \geq \left(\frac{\mathcal{L}^d(\bar{F})}{c_{iso}}\right)^{1-1/d} \geq \left(\frac{\mathcal{L}^d(F) - 2\eta}{c_{iso}}\right)^{1-1/d} \geq \left(\frac{\eta_1 - 6\eta\theta_p}{2\theta_p c_{iso}}\right)^{1-1/d}. \quad (6.19)$$

Next, we choose δ small enough to obtain a η that satisfies the following inequalities:

$$3\beta_{max}\eta \leq \frac{\lambda\beta_{min}}{2} \left(\left(\frac{\eta_1 - 6\eta\theta_p}{2\theta_p c_{iso}} \right)^{1-1/d} - 3\eta \right), \quad (6.20)$$

and also

$$\eta_1 \geq 6\eta\theta_p.$$

With this choice of δ , we obtain with high probability, using inequalities (6.15), (6.17) and (6.19),

$$\mathcal{I}_p(\bar{F}) \leq (1 + \lambda/2)\mathcal{I}_p \left(\bar{F}, \bigcup_{i=1}^m \mathring{B}(y_i, r_i + t) \right) \leq (1 + \lambda/2)\mathcal{I}_p(F, \Omega). \quad (6.21)$$

Let $G_n \in \mathcal{G}_n$, on the event \mathcal{F} , we have

$$\left| \theta_p \mathcal{L}^d(\bar{P}_n) - \frac{|G_n|}{n^d} \right| \leq 2\eta.$$

So that, together with inequality (6.16),

$$\begin{aligned} |G_n| &\leq n^d(\theta_p \mathcal{L}^d(F) + \theta_p \mathcal{L}^d(\bar{P}_n \Delta F) + 2\eta) \\ &\leq n^d(\theta_p \mathcal{L}^d(\bar{F}) + \varepsilon_F + 4\eta) \\ &\leq n^d \theta_p \mathcal{L}^d(\bar{F}) \left(1 + \frac{5\eta}{\theta_p \mathcal{L}^d(\bar{F})} \right). \end{aligned}$$

Let us now choose δ small enough so that

$$\frac{5\eta}{\eta_1/2 - 3\eta\theta_p} \leq \delta'. \quad (6.22)$$

Using inequalities (6.16) and (6.18), we obtain

$$|G_n| \leq n^d \theta_p \mathcal{L}^d(\bar{F}) \left(1 + \frac{5\eta}{\eta_1/2 - 3\eta\theta_p} \right) \leq n^d \theta_p \mathcal{L}^d(\bar{F})(1 + \delta').$$

Finally, let r be such that $\mathcal{L}^d(\bar{F}) = \mathcal{L}^d(rW_p)$, we get

$$(1 + \delta')n^{-1}|G_n| \varphi_{W_p} \leq (1 + \delta')^2 n^{d-1} \frac{\varphi_{W_p}}{\varphi_{\bar{F}}} \mathcal{I}_p(\bar{F}) \leq (1 + \delta')^2 \frac{\mathcal{I}_p(rW_p)}{\mathcal{I}_p(\bar{F})} r n^{d-1} \mathcal{I}_p(\bar{F}).$$

We now choose δ' small enough such that

$$(1 + \delta')^2(1 - \lambda) \leq 1 - \frac{\lambda}{2}. \quad (6.23)$$

Using inequality (6.11), we obtain

$$\mathcal{L}^d(\bar{F}) \leq \mathcal{L}^d(\bar{P}_n) + \mathcal{L}^d(\bar{P}_n \Delta F) \leq \mathcal{L}^d((1 + \xi)W_p) + \mathcal{L}^d(\xi W_p) \leq \mathcal{L}^d((1 + 2\xi)W_p)$$

and so $r \leq 1 + 2\xi$. We distinguish now two cases:

- If $r \leq 1 - \lambda$, using inequality (6.23)

$$(1 + \delta')^2 \frac{\mathcal{I}_p(rW_p)}{\mathcal{I}_p(\bar{F})} r n^{d-1} \mathcal{I}_p(\bar{F}) \leq (1 - \lambda/2) n^{d-1} \mathcal{I}_p(\bar{F})$$

where we used the fact that the Wulff crystal is a minimizer for \mathcal{I}_p , *i.e.*, that $\mathcal{I}_p(rW_p) \leq \mathcal{I}_p(\bar{F})$.

- Let us assume that $r \in (1 - \lambda, 1 + 2\xi]$. We recall that on the event \mathcal{F} , for all $\nu \in \mathcal{W}_\xi$,

$$\sup_{f \in \mathfrak{F}_n} |\nu_{\bar{P}_n}(f) - \nu(f)| \geq 3\varepsilon/4.$$

Thus, for all $x \in \mathbb{R}^d$, for $f \in \mathfrak{F}_n$ we have

$$\begin{aligned} |\nu_{\bar{P}_n}(f) - \nu_{rW_p+x}(f)| &\leq \left| \int_{\bar{P}_n \setminus (rW_p+x)} f(x) d\mathcal{L}^d(x) - \int_{(rW_p+x) \setminus \bar{P}_n} f(x) d\mathcal{L}^d(x) \right| \\ &\leq \int_{\bar{P}_n \setminus (rW_p+x)} |f(x)| d\mathcal{L}^d(x) + \int_{(rW_p+x) \setminus \bar{P}_n} |f(x)| d\mathcal{L}^d(x) \\ &\leq \int_{\bar{P}_n \setminus (rW_p+x)} 1 d\mathcal{L}^d(x) + \int_{(rW_p+x) \setminus \bar{P}_n} 1 d\mathcal{L}^d(x) \\ &\leq \mathcal{L}^d(\bar{P}_n \Delta (rW_p + x)), \end{aligned}$$

and so,

$$\mathcal{L}^d(\bar{P}_n \Delta (rW_p + x)) \geq \sup_{f \in \mathfrak{F}_n} |\nu_{\bar{P}_n}(f) - \nu_{rW_p+x}(f)| \geq 3\varepsilon/4$$

and as η satisfies inequality (6.6), we obtain

$$\mathcal{L}^d(\bar{F} \Delta (rW_p + x)) \geq \mathcal{L}^d(\bar{P}_n \Delta (rW_p + x)) - \mathcal{L}^d(\bar{F} \Delta \bar{P}_n) \geq 3\varepsilon/4 - \eta \geq \varepsilon/2.$$

Moreover, as rW_p is a minimizer for the isoperimetric problem, there exists a constant $c(\varepsilon) > 0$, that is a non-decreasing function of ε depending also on p and r , that goes to 0 when ε goes to 0, such that

$$\inf \left\{ \mathcal{I}(E) : \forall x \in \mathbb{R}^d, \mathcal{L}^d(E \Delta (x + rW_p)) \geq \varepsilon/2, \mathcal{L}^d(E) = \mathcal{L}^d(rW_p) \right\} \geq \mathcal{I}_p(rW_p)(1 + c(\varepsilon)).$$

Finally,

$$\frac{\mathcal{I}_p(rW_p)}{\mathcal{I}_p(\bar{F})} \leq \frac{1}{1 + c(\varepsilon)}$$

and so,

$$(1 + \delta')^2 \frac{\mathcal{I}_p(rW_p)}{\mathcal{I}_p(\bar{F})} r n^{d-1} \mathcal{I}_p(\bar{F}) \leq \frac{(1 + \delta')^2}{1 + c(\varepsilon)} (1 + 2\xi) n^{d-1} \mathcal{I}_p(\bar{F}).$$

We choose ξ small enough depending on ε such that

$$\frac{1 + 2\xi}{1 + c(\varepsilon)} \leq 1 - \lambda = \frac{1}{1 + \xi}.$$

This is equivalent to choose ξ such that

$$3\xi + 2\xi^2 \leq c(\varepsilon). \quad (6.24)$$

We obtain using inequality (6.23)

$$(1 + \delta')^2 \frac{\mathcal{I}_p(rW_p)}{\mathcal{I}_p(\bar{F})} r n^{d-1} \mathcal{I}_p(\bar{F}) \leq (1 - \lambda/2) n^{d-1} \mathcal{I}_p(\bar{F}).$$

Finally, combining the two cases, with ε and δ' properly chosen and inequality (6.21), we obtain

$$\mathbb{P}(\mathcal{F}) \leq \mathbb{P} \left(\begin{array}{l} \forall 1 \leq i \leq m, \\ \exists G_n \in \mathcal{G}_n : \quad \mathcal{L}^d((\bar{P}_n \cap B(y_i, r_i + 1)) \Delta (F_i + y_i)) \leq \varepsilon_{F_i}, \\ \quad |\partial^\circ G_n| \leq \left(1 - \frac{\lambda^2}{4}\right) n^{d-1} \mathcal{I}_p(F, \Omega), \\ \quad E(X) = \{(y_1, r_1), \dots, (y_m, r_m)\} \end{array} \right). \quad (6.25)$$

Step (iii): The remaining of the proof follows the same ideas as in [25]. We link the probability defined in the right hand side of (6.25) with the probability that the flow is abnormally small in some local region of $\partial F \cap \Omega$. We now want to cover ∂F by balls of small radius such that ∂F is "almost flat" in each ball, this is the purpose of the following Lemma:

Lemma 6.1. [Lemma 1 in [25]] Let $R > 0$. Let F be a subset of $\mathring{B}(0, R)$ of finite perimeter. For every positive constants δ' and η' , there exists a finite family of closed disjoint balls $(B(x_i, \rho_i))_{i \in I \cup K}$ and vectors $(v_i)_{i \in I \cup K}$, such that, letting $B_i = B(x_i, \rho_i)$ and $B_i^- = B^-(x_i, \rho_i, v_i)$, we have for all $i \in I$

$$x_i \in \partial^* F \cap \mathring{B}(0, R), \rho_i \in]0, 1[, B_i \subset \mathring{B}(0, R), \mathcal{L}^d((F \cap B_i) \Delta B_i^-) \leq \delta' \alpha_d \rho_i^d,$$

and

$$\left| \mathcal{I}_p(F, \mathring{B}(0, R)) - \sum_{i \in I} \alpha_{d-1} \rho_i^{d-1} (\nu(n_F(x_i))) \right| \leq \eta'.$$

We recall that α_d is the volume of the d -dimensional unit Euclidean ball.

We apply Lemma 6.1 to each $F_k \subset \mathring{B}(0, r_k + 1)$, with $\delta_2 > 0$ that will be chosen later and $\eta' = \lambda^4 \mathcal{I}_p(F, \Omega) / 16M$. We obtain for each k , a family

$$(B_i^{(k)}(x_i^{(k)}, \rho_i^{(k)}, v_i^{(k)}))_{i \in I^{(k)}}$$

that does not depend on y_1, \dots, y_m , so that

$$\left| \mathcal{I}_p(F_k, \mathring{B}(0, r_k + 1)) - \sum_{i \in I} \alpha_{d-1} (\rho_i^{(k)})^{d-1} (\nu(n_{F_k}(x_i^{(k)})) \right| \leq \eta'. \quad (6.26)$$

We now choose

$$\varepsilon_{F_k} \leq \min \left(\min_{i \in I^{(k)}} \alpha_d (\rho_i^{(k)})^d \delta_2, \frac{\eta}{M}, \frac{\mathcal{L}^d(\xi W_p)}{M} \right), \quad (6.27)$$

for a fixed δ_2 that we will choose later. Besides, as the balls $B(y_k, r_k + 1)$ are disjoint, for $k \in \{1, \dots, m\}$, we have

$$\mathcal{I}_p(F, \Omega) = \sum_{k=1}^m \mathcal{I}_p(F \cap B(y_k, r_k + 1), \Omega) = \sum_{k=1}^m \mathcal{I}_p(F_k, \mathring{B}(0, r_k + 1)).$$

Using inequality (6.26), we obtain

$$\left| \mathcal{I}_p(F, \Omega) - \sum_{k=1}^m \sum_{i \in I^{(k)}} \alpha_{d-1} (\rho_i^{(k)})^{d-1} \nu(n_{F_k}(x_i^{(k)})) \right| \leq m\eta' \leq \lambda^4 \mathcal{I}_p(F, \Omega) / 16.$$

So, we get

$$\mathcal{I}_p(F, \Omega) \leq \frac{1}{1 - \lambda^4 / 16} \left(\sum_{k=1}^m \sum_{i \in I^{(k)}} \alpha_{d-1} (\rho_i^{(k)})^{d-1} \nu(n_{F_k}(x_i^{(k)})) \right)$$

and

$$\left(1 - \frac{\lambda^2}{4} \right) \mathcal{I}_p(F, \Omega) \leq \frac{1 - \lambda^2 / 4}{1 - \lambda^4 / 16} \left(\sum_{k=1}^m \sum_{i \in I^{(k)}} \alpha_{d-1} (\rho_i^{(k)})^{d-1} \nu(n_{F_k}(x_i^{(k)})) \right).$$

Whence setting $w = \lambda^2 / (4 + \lambda^2) < 1$,

$$\left(1 - \frac{\lambda^2}{4} \right) \mathcal{I}_p(F, \Omega) \leq (1 - w) \left(\sum_{k=1}^m \sum_{i \in I^{(k)}} \alpha_{d-1} (\rho_i^{(k)})^{d-1} \nu(n_{F_k}(x_i^{(k)})) \right). \quad (6.28)$$

Since the balls $(B_i^{(k)} + y_k)_{1 \leq k \leq m, i \in I^{(k)}}$ are pairwise disjoint, we have

$$|\partial^\circ G_n| \geq \sum_{k=1}^m \sum_{i \in I^{(k)}} |(\partial^\circ G_n) \cap (n(B_i^{(k)} + y_k))|. \quad (6.29)$$

Using inequalities (6.28) and (6.29), we get

$$\begin{aligned} & \mathbb{P} \left(\begin{array}{l} \mathcal{L}^d((\bar{P}_n \cap B(y_i, r_i + 1))\Delta(F_i + y_i)) \leq \varepsilon_{F_i}, 1 \leq i \leq m, \\ \exists G_n \in \mathcal{G}_n, \quad |\partial^\circ G_n| \leq (1 - \lambda^2/4)n^{d-1}\mathcal{I}_p(F, \Omega), \\ E(X) = \{(y_1, r_1), \dots, (y_m, r_m)\} \end{array} \right) \\ & \leq \mathbb{P} \left(\begin{array}{l} \exists G_n \in \mathcal{G}_n, \mathcal{L}^d((\bar{P}_n \cap B(y_i, r_i + 1))\Delta(F_i + y_i)) \leq \varepsilon_{F_i}, 1 \leq i \leq m, \\ \sum_{k=1}^m \sum_{i \in I^{(k)}} |(\partial^\circ G_n) \cap (n(B_i^{(k)} + y_k))| \\ \leq (1-w)n^{d-1} \left(\sum_{k=1}^m \sum_{i \in I^{(k)}} \alpha_{d-1}(\rho_i^{(k)})^{d-1} \nu(n_{F_k}(x_i^{(k)})) \right) \end{array} \right). \end{aligned} \quad (6.30)$$

Let $k \in \{1, \dots, m\}$. We aim to control $\text{card}((G_n \cap n(B_i^{(k)} + y_k))\Delta(n(B_i^{(k)} + y_k)^- \cap \mathbb{Z}^d))$. To do so, it is more convenient to work with the graph F_n . In the following, we drop the superscript (k) for clarity. With high probability, we have

$$\begin{aligned} & \text{card}((G_n \cap n(B_i^{(k)} + y_k))\Delta(n(B_i^{(k)} + y_k)^- \cap \mathbb{Z}^d)) \\ & \leq \text{card}((F_n \cap n(B_i + y_k))\Delta(n(B_i + y_k)^- \cap \mathbb{Z}^d)) + \text{card}(F_n \setminus G_n) \\ & \leq \text{card}((F_n \cap n(B_i + y_k))\Delta(n(B_i + y_k)^- \cap \mathbb{Z}^d)) + \eta_3 n^{d-1/2(d-1)}. \end{aligned}$$

As $B_i + y_k \subset B(y_k, r_k + 1)$, we have

$$\begin{aligned} & \mathcal{L}^d((nP_n \cap n(B_i + y_k))\Delta(n(B_i + y_k)^-)) \leq \mathcal{L}^d((nF_k \cap nB_i)\Delta(nB_i^-)) \\ & \quad + n^d \mathcal{L}^d(P_n \Delta(F_k + y_k)) \\ & \leq n^d \alpha_d \rho_i^d \delta_2 + \varepsilon_{F_k} \leq 2n^d \alpha_d \rho_i^d \delta_2. \end{aligned}$$

By the same arguments as in section 5.2 in [25],

$$\begin{aligned} & \text{card}((F_n \cap n(B_i + y_k))\Delta(n(B_i + y_k)^-)) \\ & \leq \mathcal{L}^d(((nP_n \cap n(B_i + y_k))\Delta(n(B_i + y_k)^-) \cap \mathbb{Z}^d + [-1/2, 1/2]^d)) \\ & \leq 2n^d \alpha_d \rho_i^d \delta_2 + n^{d-1} 4d(\mathcal{H}^{d-1}(\partial B_i) + \mathcal{H}^{d-1}(\partial B_i^-)). \end{aligned}$$

Finally, for n large enough,

$$\text{card}((G_n \cap n(B_i + y_k))\Delta(n(B_i + y_k)^- \cap \mathbb{Z}^d)) \leq 4n^d \alpha_d \rho_i^d \delta_2.$$

Thus, using inequality (6.30), for large enough n ,

$$\begin{aligned} & \mathbb{P} \left(\begin{array}{l} \exists G_n \in \mathcal{G}_n, \mathcal{L}^d((\bar{P}_n \cap B(y_i, r_i + 1))\Delta(F_i + y_i)) \leq \varepsilon_{F_i}, 1 \leq i \leq m, \\ |\partial^\circ G_n| \leq (1 - \lambda^2/4)n^{d-1}\mathcal{I}_p(F, \Omega), E(X) = \{(y_1, r_1), \dots, (y_m, r_m)\} \end{array} \right) \\ & \leq \sum_{k=1}^m \sum_{i \in I^{(k)}} \mathbb{P} \left(\begin{array}{l} \exists G_n \in \mathcal{G}_n, \\ |(G_n \cap n(B_i + y_k))\Delta(n(B_i^- + y_k)) \cap \mathbb{Z}^d| \leq 4\delta_2 \alpha_d \rho_i^d n^d, \\ |(\partial^\circ G_n) \cap n(B_i + y_k)| \\ \leq (1-w)n^{d-1} \left(\alpha_{d-1} \rho_i^{d-1} \nu(n_{F_k}(x_i^{(k)})) \right) \end{array} \right) \\ & \leq \frac{1}{\theta_p} \sum_{k=1}^m \sum_{i \in I^{(k)}} \mathbb{P}(G(x_i^{(k)} + y_k, \rho_i^{(k)}, n_{F_k}(x_i^{(k)}), w, \delta_2)) \end{aligned} \quad (6.31)$$

where $G(x, r, v, w, \delta_2)$ is the event that there exists a set $U \subset B \cap \mathbb{Z}^d$ such that:

$$\text{card}(U \Delta(nB^-(x, r, v) \cap \mathbb{Z}^d)) \leq 4\delta_2 \alpha_d r^d n^d$$

and

$$|(\partial^\circ G_n) \cap nB| \leq (1-w)\alpha_{d-1} r^{d-1} \nu(v) n^{d-1}.$$

This event depends only on the edges inside $B(x, r, v)$ and is invariant under integer translation. So that,

$$\begin{aligned} & \mathbb{P} \left(\begin{array}{l} \exists G_n \in \mathcal{G}_n, \mathcal{L}^d((\bar{P}_n \cap B(y_i, r_i + 1))\Delta(F_i + y_i)) \leq \varepsilon_{F_i}, 1 \leq i \leq m, \\ |\partial^\circ G_n| \leq (1 - \lambda^2/4)n^{d-1}\mathcal{I}_p(F, \Omega), E(X) = \{(y_1, r_1), \dots, (y_m, r_m)\} \end{array} \right) \\ & \leq \frac{1}{\theta_p} \sum_{k=1}^m \sum_{i \in I^{(k)}} \mathbb{P}(G(x_i^{(k)}, \rho_i^{(k)}, n_{F_k}(x_i^{(k)}), w, \delta_2)). \end{aligned} \quad (6.32)$$

This event is a rare event. Indeed, if this event occurs, we can show that the capacity of the minimal cutset that separates the upper half part of $B(x, r, v)$ (upper half part according to the direction v) from the lower half part is abnormally small. To do so, we build from the set U an almost flat cutset in the ball. The fact that $\text{card}(U \Delta B^-(x, r, v))$ is small implies that $\partial_e U$ is almost flat and is close to $\text{disc}(x, r, v)$. However, this does not prevent the existence of long thin strands that might escape the ball and prevent U from being a cutset in the ball. The idea is to cut these strands by adding edges at a fixed height. We have to choose the appropriate height to ensure that the extra edges we needed to add to cut these strands are not too many, so that we can control their capacity. The new set of edges we create by adding to U these edges will be in a sense a cutset. The last thing to do is then to cover the $\text{disc}(x, r, v)$ by hyperrectangles in order to use the estimate that the flow is abnormally small in a cylinder. This work was done in section 6 in [25]. It is possible to choose δ_2 depending on F_1, \dots, F_m, G and w such that for all $k \in \{1, \dots, m\}$, there exist positive constants $C_{1,i}^{F_k}$ and $C_{2,i}^{F_k}$ depending on G, d, F_k, i and w so that for all $i \in I^{(k)}$,

$$\mathbb{P}(G(x_i, \rho_i, n_{F_k}(x_i), w, \delta_2)) \leq C_{1,i}^{F_k} \exp(-C_{2,i}^{F_k} n^{d-1}).$$

Note that this upper bound is uniform on y_1, \dots, y_m but still depends on r_1, \dots, r_m . Together with inequalities (6.25) and (6.32), we obtain

$$\begin{aligned} \underline{\mathbb{P}}(\mathcal{F}) &\leq \mathbb{P} \left(\begin{array}{l} \exists G_n \in \mathcal{G}_n, \mathcal{L}^d((\overline{P}_n \cap B(y_i, r_i + 1)) \Delta (F_i + y_i)) \leq \varepsilon_{F_i}, 1 \leq i \leq m, \\ |\partial^\circ G_n| \leq (1 - \lambda^2/4) n^{d-1} \mathcal{I}_p(F, \Omega), \\ E(X) = \{(y_1, r_1), \dots, (y_m, r_m)\} \end{array} \right) \\ &\leq \frac{1}{\theta_p} \sum_{k=1}^m \sum_{i \in I^{(k)}} C_{1,i}^{F_k} \exp(-C_{2,i}^{F_k} n^{d-1}). \end{aligned}$$

So there exist positive constants $C_1^{F_1}, \dots, C_1^{F_m}$ and $C_2^{F_1}, \dots, C_2^{F_m}$ such that

$$\underline{\mathbb{P}}(\mathcal{F}) \leq \sum_{k=1}^m C_1^{F_k} \exp(-C_2^{F_k} n^{d-1}). \quad (6.33)$$

Combining inequalities (6.2), (6.9), (6.10) and (6.33), we obtain for small enough δ_2 ,

$$\begin{aligned} &\mathbb{P}(\exists G_n \in \mathcal{G}_n, \mu_n \notin \mathcal{V}(\mathcal{W}_\xi, \mathfrak{F}_n, \varepsilon) \mid 0 \in \mathcal{C}_\infty) \\ &\leq b_1 e^{-b_2 n^{1-3/2d}} + b'_1 e^{-b'_2 n} + \sum_{m=1}^M \sum_{y_1, \dots, y_m} \sum_{r_1, \dots, r_m} \sum_{i_1=1}^{N(r_1)} \cdots \sum_{i_m=1}^{N(r_m)} \underline{\mathbb{P}}(\mathcal{F}_{i_1, \dots, i_m}) \\ &\quad + M 3^{M^2} C_d n^{M(d-2)} \left(M c_1 e^{-c_2 n^{1-3/2d}} + D_1 e^{-D_2 n^{(d-1)/2d}} \right) \\ &\leq b_1 e^{-b_2 n^{1-3/2d}} + b'_1 e^{-b'_2 n} \\ &\quad + \sum_{m=1}^M \sum_{y_1, \dots, y_m} \sum_{r_1, \dots, r_m} \sum_{i_1=1}^{N(r_1)} \cdots \sum_{i_m=1}^{N(r_m)} \sum_{k=1}^m \frac{C_1^{F_{i_k}^{(r_k)}}}{\theta_p} e^{-C_2^{F_{i_k}^{(r_k)}} n^{d-1}} \\ &\quad + M 3^{M^2} C_d n^{M(d-2)} \left(M c_1 e^{-c_2 n^{1-3/2d}} + D_1 e^{-D_2 n^{(d-1)/2d}} \right) \\ &\leq b_1 e^{-b_2 n^{1-3/2d}} + b'_1 e^{-b'_2 n} \\ &\quad + \sum_{m=1}^M \sum_{y_1, \dots, y_m} 3^{M^2} \max_{r_1, \dots, r_m} \left\{ \sum_{i_1=1}^{N(r_1)} \cdots \sum_{i_m=1}^{N(r_m)} \sum_{k=1}^m \frac{C_1^{F_{i_k}^{(r_k)}}}{\theta_p} e^{-C_2^{F_{i_k}^{(r_k)}} n^{d-1}} \right\} \\ &\quad + M 3^{M^2} C_d n^{M(d-2)} \left(M c_1 e^{-c_2 n^{1-3/2d}} + D_1 e^{-D_2 n^{(d-1)/2d}} \right) \\ &\leq b_1 e^{-b_2 n^{1-3/2d}} + b'_1 e^{-b'_2 n} \\ &\quad + C_d n^{M(d-2)} \sum_{m=1}^M 3^{M^2} \max_{r_1, \dots, r_m} \left\{ \sum_{i_1=1}^{N(r_1)} \cdots \sum_{i_m=1}^{N(r_m)} \sum_{k=1}^m \frac{C_1^{F_{i_k}^{(r_k)}}}{\theta_p} e^{-C_2^{F_{i_k}^{(r_k)}} n^{d-1}} \right\} \end{aligned}$$

$$+ M3^{M^2} C_d n^{M(d-2)} \left(M c_1 e^{-c_2 n^{1-3/2d}} + D_1 e^{-D_2 n^{(d-1)/2d}} \right) \quad (6.34)$$

where C_d is a constant depending only on the dimension and the maximum is over $r_1, \dots, r_m \in \{1, \dots, 3^M\}$. We recall that M, N and the number of ways of choosing r_1, \dots, r_m are finite and independent of n .

Remark 6.2. *To obtain inequality (6.34), it is crucial to use a covering of \mathcal{C}_β that is uniform in y_1, \dots, y_m .*

Let us assume $\mu_n \notin \mathcal{V}(\mathcal{W}, \mathfrak{F}_n, 2\varepsilon)$. Let $\nu \in \mathcal{W}_\xi$, we can write $\nu = \nu_{x+rW_p}$ with $x \in \mathbb{R}^d$ and $r \in [1 - \lambda, 1 + 2\xi]$. We have for all $f \in \mathfrak{F}_n$

$$\begin{aligned} |\nu_{x+W_p}(f) - \nu_{x+rW_p}(f)| &\leq \max(\mathcal{L}^d(W_p \setminus (1-\lambda)W_p), \mathcal{L}^d((1+2\xi)W_p \setminus W_p)) \\ &\leq c(p, d, \xi) \end{aligned} \quad (6.35)$$

where $c(p, d, \xi)$ is a constant that goes to 0 when ξ goes to 0. So that

$$\sup_{f \in \mathfrak{F}_n} |\nu_{x+W_p}(f) - \nu_{x+rW_p}(f)| \leq c(p, d, \xi).$$

As $\mu_n \notin \mathcal{V}(\mathcal{W}, \mathfrak{F}_n, 2\varepsilon)$, we have

$$\sup_{f \in \mathfrak{F}_n} |\mu_n(f) - \nu_{x+W_p}(f)| > 2\varepsilon.$$

So that up to choosing a smaller ξ , we have

$$c(p, d, \xi) \leq \varepsilon \quad (6.36)$$

and so

$$\begin{aligned} \mathbb{P}(\exists G_n \in \mathcal{G}_n, \forall \nu \in \mathcal{W}, \sup_{f \in \mathfrak{F}_n} |\mu_n(f) - \nu_{x+W_p}(f)| > 2\varepsilon) \\ \leq \mathbb{P}(\exists G_n \in \mathcal{G}_n, \forall \nu \in \mathcal{W}_\xi, \sup_{f \in \mathfrak{F}_n} |\mu_n(f) - \nu_{x+W_p}(f)| > \varepsilon). \end{aligned}$$

Finally, using (6.34), there exist positive constants C_1 and C_2 depending on ε, u, p and d such that for all $n \geq 1$,

$$\mathbb{P}(\exists G_n \in \mathcal{G}_n, \mu_n \notin \mathcal{V}(\mathcal{W}, \mathfrak{F}_n, 2\varepsilon) \mid 0 \in \mathcal{C}_\infty) \leq C_1 e^{-c_2 n^{1-3/2d}}$$

and the result follows.

To conclude, let us sum up the order in which the constants are chosen. We first choose $\varepsilon > 0$. Next, we choose ξ small enough such that it satisfies both inequalities (6.24) and (6.36), and δ' such that it satisfies inequality (6.23). Next, we choose δ such that $\eta(\delta)$ satisfies inequalities (6.6), (6.20) and (6.22). We choose δ_2 depending on w (and so on ε) and G . The parameter δ_2 has to satisfy some inequalities that we do not detail here, we refer to section 7 in [25]. Finally, to each r in $\{1, \dots, 3^M\}$, to each $F \in \mathcal{C}_\beta^{(r)}$, we choose ε_F in such a way it satisfies inequality (6.27). \square

6.2 Proof of theorem 1.5

In this section we prove Theorem 1.5. Thanks to Theorem 1.7, we know that with high probability μ_n is close to the set \mathcal{W} and so it is close to the measure of a translate of the Wulff shape. In fact, as μ_n has its support included in $B(0, n^{d-1})$, the measure μ_n is close to \mathcal{W}_n , the set of measures defined as:

$$\mathcal{W}_n = \left\{ \nu_{x+W_p}, x \in B(0, n^{d-1}) \right\}.$$

The continuous set \mathcal{W}_n can be approximated by a finite set $\widetilde{\mathcal{W}}$ containing a polynomial number of measures such that μ_n is close to $\widetilde{\mathcal{W}}$ and so is close to at least one measure in $\widetilde{\mathcal{W}}$. Let $\varepsilon > 0$ and let $w > 0$ be a real number depending on ε that we will choose later. We first use Lemma

6.1, to cover W_p by a finite number of balls of small radius such that W_p is almost flat in each ball. Let δ_2 that will be chosen later and let $(B(x_k, \rho_k, \nu_k))_{k \in J}$ be a family associated to $W_p, \delta_2, \varepsilon$ that satisfies the conditions stated in Lemma 6.1. We will use this covering for all the translates of the Wulff shape. We set $\varepsilon_W = \min_{k \in J} \alpha_d \rho_k^d \delta_2$. We now cover \mathcal{W}_n by a polynomial in n number of balls of radius less than ε_W . Let $\xi > 0$ small enough such that

$$\forall x, y \in \mathbb{R}^d, \|x - y\|_2 \leq \xi \implies \mathcal{L}^d((x + W_p)\Delta(y + W_p)) \leq \frac{\varepsilon_W}{4}.$$

By construction, μ_n has its support included in $B(0, n^{d-1})$. We can cover $B(0, n^{d-1})$ by a polynomial in n number of balls of radius ξ . More precisely, there exist $z_1, \dots, z_{M'} \in B(0, n^{d-1})$, such that M' is polynomial in n and

$$B(0, n^{d-1}) \subset \bigcup_{i=1}^{M'} B(z_i, \xi).$$

We set

$$\widetilde{\mathcal{W}} = \{ \nu_{z_i + W_p}, i = 1, \dots, M' \}.$$

Let $\delta > 0$ we will choose later. We define W_p^δ and $W_p^{-\delta}$ as

$$W_p^\delta = \{x \in \mathbb{R}^d : d_2(x, W_p) \leq \delta\} \text{ and } W_p^{-\delta} = \{x \in W_p : d_2(x, \partial W_p) \geq \delta\}.$$

Let us define g as

$$g(x) = \begin{cases} \min(d_2(x, W_p)/\delta, 1) & \text{if } x \in \mathbb{R}^d \setminus W_p \\ -\min(d_2(x, \partial W_p)/\delta, 1) & \text{if } x \in W_p \end{cases}.$$

The function g is uniformly continuous and satisfies $\|g\|_\infty \leq 1$. For each $i \in \{1, \dots, M'\}$, we define g_i by $g_i(x) = g(x - z_i)$ for $x \in \mathbb{R}^d$, and $\mathfrak{F} = \{g_i, 1 \leq i \leq M'\} \cup \{1\}$. The set \mathfrak{F} is a set made of translates of g and the constant function equal to 1. If the measure μ_n is in the local weak neighborhood $\mathcal{V}(\mathcal{W}, \mathfrak{F}, \frac{\varepsilon_W}{4})$, then there exists ν_{x+W_p} in $\mathcal{V}(\mathcal{W}_n, \mathfrak{F}, \frac{\varepsilon_W}{4})$ such that

$$\sup_{f \in \mathfrak{F}} |\nu_{x+W_p}(f) - \mu_n(f)| \leq \frac{\varepsilon_W}{4}.$$

Moreover there exists an $i \in \{1, \dots, M'\}$ such that $x \in B(z_i, \xi)$ and so

$$\sup_{f \in \mathfrak{F}} |\nu_{x+W_p}(f) - \nu_{z_i+W_p}(f)| \leq \mathcal{L}^d((x + W_p)\Delta(z_i + W_p)) \leq \frac{\varepsilon_W}{4}$$

and also

$$\mu_n \in \mathcal{V}(\widetilde{\mathcal{W}}, \mathfrak{F}, \varepsilon_W/2).$$

Let us choose $r > 0$ large enough so that the ball $B(0, r - 2d)$ contains W_p . For $x \in \mathbb{R}^d$, we define $\lfloor x \rfloor$ to be the closest point to x in \mathbb{Z}^d for the Euclidean distance. For any $i \in \{1, \dots, M'\}$, we have

$$W + z_i \subset B(\lfloor z_i \rfloor, r).$$

Let us define the function u such that for all $\iota > 0$,

$$u(\iota) = \min \left(\sup \{ \delta > 0, \forall x, y \in \mathbb{R}^d, \|x - y\|_2 \leq \delta \implies |g(x) - g(y)| \leq \iota \}, 1 \right).$$

As the function g is uniformly continuous, the function u is positive. Moreover, as \mathfrak{F} is made of translated of g and the constant function equal to 1, it is clear that this set satisfies the condition stated in Proposition 5.10 associated with the function u . Using Proposition 5.10 with the function u , there exist positive constants C_1, C_2 depending only on r, u, p and ε_W such that for all $i \in \{1, \dots, M'\}$

$$\mathbb{P} \left(\max_{G_n \in \mathcal{G}_n} \sup_{f \in \mathfrak{F}} |\mu_n(f \mathbb{1}_{B(\lfloor z_i \rfloor, r)}) - \nu_n(f \mathbb{1}_{B(\lfloor z_i \rfloor, r)})| > \varepsilon_W/4 \right) \leq C_1 e^{-c_2 n^{1-3/2d}}. \quad (6.37)$$

The point of choosing such a set \mathfrak{F} is that we can deduce from the fact that the quantity $\sup_{f \in \mathfrak{F}} |\mu_n(f) - \nu_{W+z_i}(f)|$ is small that the associated symmetric difference $\mathcal{L}^d((P_n \cap B(\lfloor z_i \rfloor, r)) \Delta (z_i + W_p))$ is small. Indeed, we have

$$\begin{aligned}
& \mathcal{L}^d((P_n \cap B(\lfloor z_i \rfloor, r)) \Delta (z_i + W_p)) \\
&= \int_{(P_n \cap B(\lfloor z_i \rfloor, r)) \setminus (z_i + W_p)} 1 d\mathcal{L}^d(x) + \int_{(z_i + W_p) \setminus P_n} 1 d\mathcal{L}^d(x) \\
&\leq \int_{(P_n \cap B(\lfloor z_i \rfloor, r)) \setminus (z_i + W_p)} g_i(x) d\mathcal{L}^d(x) - \int_{(z_i + W_p) \setminus P_n} g_i(x) d\mathcal{L}^d(x) + \mathcal{L}^d(W_p^\delta \setminus W_p^{-\delta}) \\
&= |\nu_n(g_i \mathbf{1}_{B(\lfloor z_i \rfloor, r)}) - \nu_{W+z_i}(g_i \mathbf{1}_{B(\lfloor z_i \rfloor, r)})| + \mathcal{L}^d(W_p^\delta \setminus W_p^{-\delta}) \\
&\leq \sup_{f \in \mathfrak{F}} |\mu_n(f \mathbf{1}_{B(\lfloor z_i \rfloor, r)}) - \nu_n(f \mathbf{1}_{B(\lfloor z_i \rfloor, r)})| + \sup_{f \in \mathfrak{F}} |\mu_n(f \mathbf{1}_{B(\lfloor z_i \rfloor, r)}) - \nu_{W+z_i}(f \mathbf{1}_{B(\lfloor z_i \rfloor, r)})| \\
&\quad + \mathcal{L}^d(W_p^\delta \setminus W_p^{-\delta}). \tag{6.38}
\end{aligned}$$

So we choose δ small enough so that

$$\mathcal{L}^d(W_p^\delta \setminus W_p^{-\delta}) \leq \frac{\varepsilon_W}{4}. \tag{6.39}$$

Moreover, we have

$$\begin{aligned}
& \mathbb{P} \left(\exists G_n \in \mathcal{G}_n, |\partial^\circ G_n| \leq (1-w)\mathcal{I}_p(W_p)n^{d-1}, \mu_n \in \mathcal{V}(\widetilde{W}, \mathfrak{F}, \varepsilon_W/2) \right) \\
&\leq \sum_{i=1}^{M'} \mathbb{P} \left(\begin{array}{c} \exists G_n \in \mathcal{G}_n, |\partial^\circ G_n| \leq (1-w)\mathcal{I}_p(W_p)n^{d-1}, \\ \sup_{f \in \mathfrak{F}} |\mu_n(f) - \nu_{W+z_i}(f)| \leq \varepsilon_W/2 \end{array} \mid 0 \in \mathcal{C}_\infty \right). \tag{6.40}
\end{aligned}$$

Using inequalities (6.37), (6.38) and (6.39), we obtain

$$\begin{aligned}
& \mathbb{P} \left(\exists G_n \in \mathcal{G}_n, \begin{array}{c} |\partial^\circ G_n| \leq (1-w)\mathcal{I}_p(W_p)n^{d-1}, \\ \sup_{f \in \mathfrak{F}} |\mu_n(f) - \nu_{W+z_i}(f)| \leq \varepsilon_W/2 \end{array} \mid 0 \in \mathcal{C}_\infty \right) \\
&\leq \mathbb{P} \left(\exists G_n \in \mathcal{G}_n, \begin{array}{c} |\partial^\circ G_n| \leq (1-w)\mathcal{I}_p(W_p)n^{d-1}, \\ \sup_{f \in \mathfrak{F}} |\mu_n(f \mathbf{1}_{B(\lfloor z_i \rfloor, r)}) - \nu_{W+z_i}(f \mathbf{1}_{B(\lfloor z_i \rfloor, r)})| \leq \varepsilon_W/2 \end{array} \right) \\
&\leq \mathbb{P} \left(\exists G_n \in \mathcal{G}_n, \begin{array}{c} |\partial^\circ G_n| \leq (1-w)\mathcal{I}_p(W_p)n^{d-1}, \\ \mathcal{L}^d((P_n \cap B(\lfloor z_i \rfloor, r)) \Delta (z_i + W_p)) \leq \varepsilon_W \end{array} \right) + C_1 e^{-c_2 n^{1-3/2d}}. \tag{6.41}
\end{aligned}$$

Finally, we proceed as in inequality (6.32) in the proof of Theorem 1.7:

$$\begin{aligned}
& \mathbb{P} \left(\exists G_n \in \mathcal{G}_n, \begin{array}{c} |\partial^\circ G_n| \leq (1-w)\mathcal{I}_p(W_p)n^{d-1}, \\ \mathcal{L}^d((P_n \cap B(\lfloor z_i \rfloor, r)) \Delta (z_i + W_p)) \leq \varepsilon_W \end{array} \mid 0 \in \mathcal{C}_\infty \right) \\
&\leq \frac{1}{\theta_p} \sum_{k \in J} \mathbb{P}(G(z_i + x_k, \rho_k, n_{W_p}(x_k), w, \delta_2)). \tag{6.42}
\end{aligned}$$

It is possible to choose δ_2 depending on W , G and w (see again section 6 in [25]) such that there exist positive constants $C_{1,k}$ and $C_{2,k}$ depending on G , d , W , k and w so that for all $k \in J$,

$$\mathbb{P}(G(x_k, \rho_k, n_{W_p}(x_k), w, \delta_2)) \leq C_{1,k} \exp(-C_{2,k} n^{d-1}).$$

So combining inequalities (6.40), (6.41) and (6.42), we obtain

$$\begin{aligned}
& \mathbb{P} \left(\exists G_n \in \mathcal{G}_n, |\partial^\circ G_n| \leq (1-w)\mathcal{I}_p(W_p)n^{d-1}, \mu_n \in \mathcal{V}(\widetilde{W}, \mathfrak{F}, \varepsilon_W/2) \right) \\
&\leq M' \left(C_1 e^{-c_2 n^{1-3/2d}} + \frac{1}{\theta_p} \sum_{k \in J} C_{1,k} \exp(-C_{2,k} n^{d-1}) \right). \tag{6.43}
\end{aligned}$$

Moreover, we have

$$\begin{aligned}
& \mathbb{P} \left(\exists G_n \in \mathcal{G}_n, \frac{|G_n|}{n^d} \geq (1+w)\theta_p \mathcal{L}^d(W_p), \mu_n \in \mathcal{V}(\widetilde{\mathcal{W}}, \mathfrak{F}, \varepsilon_W/2) \right) \\
& \leq \sum_{i=1}^{M'} \mathbb{P} \left(\exists G_n \in \mathcal{G}_n, \frac{|G_n|}{n^d} \geq (1+w)\theta_p \mathcal{L}^d(W_p), \left| \mu_n(1) - \nu_{W+z_i}(1) \right| \leq \varepsilon_W/2 \mid 0 \in \mathcal{C}_\infty \right) \\
& \leq \sum_{i=1}^{M'} \mathbb{P} \left(\exists G_n \in \mathcal{G}_n, \frac{|G_n|}{n^d} \geq (1+w)\theta_p \mathcal{L}^d(W_p), \left| \frac{|G_n|}{n^d} - \theta_p \mathcal{L}^d(W_p) \right| \leq \varepsilon_W/2 \mid 0 \in \mathcal{C}_\infty \right) \quad (6.44)
\end{aligned}$$

where we recall that $\theta_p \mathcal{L}^d(W_p) = 1$, so up to choosing a smaller ε_W , we assume that $\varepsilon_W \leq 2w$ so that the probability in the sum is equal to 0. Finally, combining inequalities (6.43) and (6.44), we obtain

$$\begin{aligned}
\mathbb{P} \left(n\varphi_n \geq \frac{1-w}{1+w} \frac{\mathcal{I}_p(W_p)}{\theta_p \mathcal{L}^d(W_p)} \mid 0 \in \mathcal{C}_\infty \right) & \leq \mathbb{P} \left(\exists G_n \in \mathcal{G}_n, \mu_n \notin \mathcal{V}(\widetilde{\mathcal{W}}, \mathfrak{F}, \varepsilon_W/2) \right) \\
& + M' \left(C_1 \exp(-C_2 n) + \frac{1}{\theta_p} \sum_{k \in J} C_{1,k} \exp(-C_{2,k} n^{d-1}) \right). \quad (6.45)
\end{aligned}$$

Thanks to Theorem 1.7, there exist positive constants C'_1, C'_2 , depending on p, u, ε_W and d such that

$$\mathbb{P} \left(\exists G_n \in \mathcal{G}_n, \mu_n \notin \mathcal{V}(\widetilde{\mathcal{W}}, \mathfrak{F}, \varepsilon_W/2) \mid 0 \in \mathcal{C}_\infty \right) \leq C'_1 \exp(-C'_2 n^{1-3/2d}).$$

By choosing w small enough, we obtain

$$\begin{aligned}
& \mathbb{P} \left(n\varphi_n \geq (1-\varepsilon) \frac{\mathcal{I}_p(W_p)}{\theta_p \mathcal{L}^d(W_p)} \mid 0 \in \mathcal{C}_\infty \right) \\
& \leq C'_1 \exp(-C'_2 n^{1-3/2d}) + M' \left(C_1 \exp(-C_2 n) + \sum_{k \in J} C_{1,k} \exp(-C_{2,k} n^{d-1}) \right).
\end{aligned}$$

As M' is polynomial in n , the result follows.

6.3 Proof of theorem 1.2

Let $\varepsilon > 0$. As in the proof of theorem 1.5, there exists an integer M' that is polynomial in n and $z_1, \dots, z_{M'}$ points of $B(0, n^{d-1})$ such that for any finite set \mathfrak{F} of continuous functions of infinite norm at most 1, if $\mu_n \in \mathcal{V}(\mathcal{W}, \mathfrak{F}, \varepsilon)$ then $\mu_n \in \mathcal{V}(\widetilde{\mathcal{W}}, \mathfrak{F}, 2\varepsilon)$ where $\widetilde{\mathcal{W}} = \{\nu_{z_i+W_p}, i = 1, \dots, M'\}$. Let $\delta > 0$ we will choose later. Let us define f and g as

$$f(x) = \min(d_2(x, \mathbb{R}^d \setminus W_p^\delta) / \delta, 1), \text{ for } x \in \mathbb{R}^d$$

and

$$g(x) = \min(d_2(x, W_p) / \delta, 1), \text{ for } x \in \mathbb{R}^d.$$

The functions f and g are uniformly continuous and satisfy $\|f\|_\infty \leq 1$ and $\|g\|_\infty \leq 1$. For each $i \in \{1, \dots, M'\}$, we define f_i by $f_i(x) = f(x - z_i)$ and g_i by $g_i(x) = g(x - z_i)$ for $x \in \mathbb{R}^d$. We define

$$\mathfrak{F} = \{f_i, 1 \leq i \leq M'\} \cup \{g_i, 1 \leq i \leq M'\}.$$

Let $G_n \in \mathcal{G}_n$. Let $i \in \{1, \dots, M'\}$. We have

$$|G_n \Delta((n(W_p + z_i)) \cap \mathcal{C}_\infty)| = |G_n \setminus n(W_p + z_i)| + |(n(W_p + z_i) \cap \mathcal{C}_\infty) \setminus G_n|. \quad (6.46)$$

Using a renormalization argument as in the proof of Theorem 1.4, there exist positive constants C_1 and C_2 depending on p, ε and d such that for all $i \in \{1, \dots, M'\}$,

$$\mathbb{P} \left(\left| \frac{|(n(W + z_i)) \cap \mathcal{C}_\infty|}{n^d} - \theta_p \mathcal{L}^d(W_p) \right| \geq \varepsilon \mid 0 \in \mathcal{C}_\infty \right) \leq C_1 \exp(-C_2 n).$$

As $G_n \cap (n(W_p + z_i)) \subset (n(W_p + z_i)) \cap \mathcal{C}_\infty$, we have with probability at least $1 - C_1 \exp(-C_2 n)$,

$$\begin{aligned} |(n(W_p + z_i)) \cap \mathcal{C}_\infty \setminus G_n| &= |(n(W_p + z_i)) \cap \mathcal{C}_\infty| - |G_n \cap (n(W_p + z_i))| \\ &\leq \theta_p \mathcal{L}^d(W_p) n^d + n^d \varepsilon - n^d \mu_n(f_i) + |n((W_p^\delta + z_i) \setminus (W_p + z_i)) \cap \mathbb{Z}^d|. \end{aligned}$$

We can find a constant $c(\delta)$ depending only on δ , p and d , such that $c(\delta)$ goes to 0 when δ goes to 0 and for all $z \in \mathbb{R}^d$

$$|n((W_p^\delta + z) \setminus (W_p + z)) \cap \mathbb{Z}^d| \leq c(\delta) n^d,$$

so that,

$$\begin{aligned} |(n(W_p + z_i)) \cap \mathcal{C}_\infty \setminus G_n| &\leq n^d |\nu_{W_p + z_i}(f_i) - \mu_n(f_i)| + (\varepsilon + c(\delta)) n^d \\ &\leq n^d \sup_{h \in \mathfrak{F}} |\nu_{W_p + z_i}(h) - \mu_n(h)| + (\varepsilon + c(\delta)) n^d. \end{aligned} \quad (6.47)$$

Moreover, noticing that $\nu_{W_p + z_i}(g_i) = 0$, we obtain

$$\begin{aligned} |G_n \setminus n(W + z_i)| &\leq n^d \mu_n(g_i) + |n((W_p^\delta + z_i) \setminus (W_p + z_i)) \cap \mathbb{Z}^d| \\ &\leq n^d |\mu_n(g_i) - \nu_{W_p + z_i}(g_i)| + n^d c(\delta) \\ &\leq n^d \sup_{h \in \mathfrak{F}} |\nu_{W_p + z_i}(h) - \mu_n(h)| + n^d c(\delta). \end{aligned} \quad (6.48)$$

Combining inequalities (6.46), (6.47) and (6.48), with high probability, we have

$$\begin{aligned} \inf_{z \in \mathbb{R}^d} \frac{1}{n^d} |G_n \Delta((n(W_p + z)) \cap \mathcal{C}_\infty)| &\leq \min_{1 \leq i \leq M'} \frac{1}{n^d} |G_n \Delta((n(W_p + z_i)) \cap \mathcal{C}_\infty)| \\ &\leq \min_{\nu \in \tilde{\mathcal{W}}} \left\{ \sup_{h \in \mathfrak{F}} |\nu(h) - \mu_n(h)| + \sup_{h \in \mathfrak{F}} |\nu(h) - \mu_n(h)| \right\} + \varepsilon + 2c(\delta) \\ &\leq 2 \min_{\nu \in \tilde{\mathcal{W}}} \sup_{h \in \mathfrak{F}} |\nu(h) - \mu_n(h)| + \varepsilon + 2c(\delta). \end{aligned}$$

Let us define for any $\iota > 0$,

$$u_g(\iota) = \min \left(\sup \left\{ \delta > 0, \forall x, y \in \mathbb{R}^d, \|x - y\|_2 \leq \delta \implies |g(x) - g(y)| \leq \iota \right\}, 1 \right),$$

$$u_f(\iota) = \min \left(\sup \left\{ \delta > 0, \forall x, y \in \mathbb{R}^d, \|x - y\|_2 \leq \delta \implies |f(x) - f(y)| \leq \iota \right\}, 1 \right)$$

and $u = \min(u_f, u_g)$. This function is positive because the function f and g are uniformly continuous. It is easy to check that \mathfrak{F} satisfies the condition required in Theorem 1.7 associated with the function u . Thus, there exist positive constants c_1 and c_2 depending on p , u , ε and d such that

$$\mathbb{P} \left(\exists G_n \in \mathcal{G}_n, \inf_{\nu \in \tilde{\mathcal{W}}} \sup_{h \in \mathfrak{F}} |\nu(h) - \mu_n(h)| \geq \varepsilon \mid 0 \in \mathcal{C}_\infty \right) \leq c_1 e^{-c_2 n^{1-3/2d}}$$

and so

$$\mathbb{P} \left(\exists G_n \in \mathcal{G}_n, \min_{\nu \in \tilde{\mathcal{W}}} \sup_{h \in \mathfrak{F}} |\nu(h) - \mu_n(h)| \geq 2\varepsilon \mid 0 \in \mathcal{C}_\infty \right) \leq c_1 e^{-c_2 n^{1-3/2d}}.$$

We now choose δ small enough such that $c(\delta) \leq \varepsilon$ so that

$$\begin{aligned} \mathbb{P} \left(\exists G_n \in \mathcal{G}_n, \inf_{z \in \mathbb{R}^d} \frac{1}{n^d} |G_n \Delta((n(W_p + z)) \cap \mathcal{C}_\infty)| \geq 7\varepsilon \mid 0 \in \mathcal{C}_\infty \right) \\ \leq c_1 e^{-c_2 n^{1-3/2d}} + M' C_1 \exp(-C_2 n). \end{aligned}$$

As M' is polynomial in n , this yields the result.

Acknowledgements

I wish to express my gratitude to Raphaël Cerf for showing me this problem and for giving me the opportunity to work with him for an internship. I thank him for our fruitful discussions and his patience. This research was partially supported by the ANR project PPPP (ANR-16-CE40-0016).

Chapter 3

Vanishing of the anchored isoperimetric profile in bond percolation at p_c

This chapter is a joint work with Raphaël Cerf.

We consider the anchored isoperimetric profile of the infinite open cluster, defined for $p > p_c$, whose existence has been recently proved in [5]. We extend adequately the definition for $p = p_c$, in finite boxes. We prove a partial result which implies that, if the limit defining the anchored isoperimetric profile at p_c exists, it has to vanish.

Contents

1	Introduction	89
2	Proofs	91

1 Introduction

The most well-known open question in percolation theory is to prove that the percolation probability vanishes at p_c in dimension three. In fact, the interesting quantities associated to the model are very difficult to study at the critical point or in its vicinity. We study here a very modest intermediate question. We consider the anchored isoperimetric profile of the infinite open cluster, defined for $p > p_c$, whose existence has been recently proved in [5]. We extend adequately the definition for $p = p_c$, in finite boxes. We prove a partial result which implies that, if the limit defining the anchored isoperimetric profile at p_c exists, it has to vanish.

The Cheeger constant. For a graph \mathcal{G} with vertex set V and edge set E , we define the edge boundary $\partial_{\mathcal{G}}A$ of a subset A of V as

$$\partial_{\mathcal{G}}A = \left\{ e = \langle x, y \rangle \in E : x \in A, y \notin A \right\}.$$

We denote by $|B|$ the cardinal of the finite set B . The Cheeger constant of the graph \mathcal{G} is defined as

$$\varphi_{\mathcal{G}} = \min \left\{ \frac{|\partial_{\mathcal{G}}A|}{|A|} : A \subset V, 0 < |A| \leq \frac{|V|}{2} \right\}.$$

This constant was introduced by Cheeger in his thesis [29] in order to obtain a lower bound for the smallest eigenvalue of the Laplacian.

The anchored isoperimetric profile $\varphi_n(p)$. Let $d \geq 2$. We consider an i.i.d. supercritical bond percolation on \mathbb{Z}^d , every edge is open with a probability $p > p_c(d)$, where $p_c(d)$ denotes the

critical parameter for this percolation. We know that there exists almost surely a unique infinite open cluster \mathcal{C}_∞ [48]. We say that H is a valid subgraph of \mathcal{C}_∞ if H is connected and $0 \in H \subset \mathcal{C}_\infty$. We define the anchored isoperimetric profile $\varphi_n(p)$ of \mathcal{C}_∞ as follows. We condition on the event $\{0 \in \mathcal{C}_\infty\}$ and we set

$$\varphi_n(p) = \min \left\{ \frac{|\partial_{\mathcal{C}_\infty} H|}{|H|} : H \text{ valid subgraph of } \mathcal{C}_\infty, 0 < |H| \leq n^d \right\}.$$

The following theorem from [5] asserts the existence of the limit of $n\varphi_n(p)$ when $p > p_c(d)$.

Theorem 1.1. *Let $d \geq 2$ and $p > p_c(d)$. There exists a positive real number $\varphi(p)$ such that, conditionally on $\{0 \in \mathcal{C}_\infty\}$,*

$$\lim_{n \rightarrow \infty} n\varphi_n(p) = \varphi(p) \text{ almost surely.}$$

We wish to study how this limit behaves when p is getting closer to p_c . To do so, we need to extend the definition of the anchored isoperimetric profile so that it is well defined at $p_c(d)$. We say that H is a valid subgraph of $\mathcal{C}(0)$, the open cluster of 0, if H is connected and $0 \in H \subset \mathcal{C}(0)$. We define $\widehat{\varphi}_n(p)$ for every $p \in [0, 1]$ as

$$\widehat{\varphi}_n(p) = \min \left\{ \frac{|\partial_{\mathcal{C}(0)} H|}{|H|} : H \text{ valid subgraph of } \mathcal{C}(0), 0 < |H| \leq n^d \right\}.$$

In particular, if 0 is not connected to $\partial[-n/2, n/2]^d$ by a p -open path, then $|\mathcal{C}(0)| < n^d$ and taking $H = \mathcal{C}(0)$, we see that $\widehat{\varphi}_n(p)$ is equal to 0. Thanks to theorem 1.1, we have

$$\forall p > p_c \quad \lim_{n \rightarrow \infty} n\widehat{\varphi}_n(p) = \theta(p)\delta_{\varphi(p)} + (1 - \theta(p))\delta_0,$$

where $\theta(p)$ is the probability that 0 belongs to an infinite open cluster. The techniques of [5] to prove the existence of this limit rely on coarse-graining estimates which can be employed only in the supercritical regime. Therefore we are not able so far to extend the above convergence at the critical point p_c . Naturally, we expect that $n\widehat{\varphi}_n(p_c)$ converges towards 0 as n goes to infinity, unfortunately we are only able to prove a weaker statement.

Theorem 1.2. *With probability one, we have*

$$\liminf_{n \rightarrow \infty} n\widehat{\varphi}_n(p_c) = 0.$$

We shall prove this theorem by contradiction. We first define an exploration process of the cluster of 0 that remains inside the box $[-n, n]^d$. If the statement of the theorem does not hold, then the cluster of 0 satisfies a d -dimensional anchored isoperimetric inequality. It follows that the number of sites that are revealed in the exploration of the cluster of 0 will grow fast enough of order n^{d-1} . Then, we can prove that the intersection of the cluster that we have explored with the boundary of the box $[-n, n]^d$ is of order n^{d-1} . Using the fact that there is no percolation in a half-space, we obtain a contradiction. Before starting the precise proof, we recall some results from [5] on the meaning of the limiting value $\varphi(p)$.

The Wulff theorem. We denote by \mathcal{L}^d the d -dimensional Lebesgue measure and by \mathcal{H}^{d-1} denotes the $(d-1)$ -Hausdorff measure in dimension d . Given a norm τ on \mathbb{R}^d and a subset E of \mathbb{R}^d having a regular enough boundary, we define $\mathcal{I}_\tau(E)$, the surface tension of E for the norm τ , as

$$\mathcal{I}_\tau(E) = \int_{\partial E} \tau(n_E(x)) \mathcal{H}^{d-1}(dx).$$

We consider the anisotropic isoperimetric problem associated with the norm τ :

$$\text{minimize } \frac{\mathcal{I}_\tau(E)}{\mathcal{L}^d(E)} \text{ subject to } \mathcal{L}^d(E) \leq 1. \quad (1.1)$$

The famous Wulff construction provides a minimizer for this anisotropic isoperimetric problem. We define the set \widehat{W}_τ as

$$\widehat{W}_\tau = \bigcap_{v \in \mathbb{S}^{d-1}} \{x \in \mathbb{R}^d : x \cdot v \leq \tau(v)\},$$

where \cdot denotes the standard scalar product and \mathbb{S}^{d-1} is the unit sphere of \mathbb{R}^d . Up to translation and Lebesgue negligible sets, the set

$$\frac{1}{\mathcal{L}^d(\widehat{W}_\tau)^{1/d}} \widehat{W}_\tau$$

is the unique solution to the problem (1.1).

Representation of $\varphi(p)$. In [5], we build an appropriate norm β_p for our problem that is directly related to the open edge boundary. We define the Wulff crystal W_p as the dilate of \widehat{W}_{β_p} such that $\mathcal{L}^d(W_p) = 1/\theta(p)$, where $\theta(p) = \mathbb{P}(0 \in \mathcal{C}_\infty)$. We denote by \mathcal{I}_p the surface tension associated with the norm β_p . In [5], we prove that

$$\forall p > p_c(d) \quad \varphi(p) = \mathcal{I}_p(W_p).$$

2 Proofs

We prove next the following lemma, which is based on two important results due to Zhang [72] and Rossignol and Th  ret [64]. To alleviate the notation, the critical point $p_c(d)$ is denoted simply by p_c .

Lemma 2.1. *We have*

$$\lim_{\substack{p \rightarrow p_c \\ p > p_c}} \left(\theta(p) \delta_{\mathcal{I}_p(W_p)} + (1 - \theta(p)) \delta_0 \right) = \delta_0.$$

Proof. If $\lim_{p \rightarrow p_c} \theta(p) = 0$, then the result is clear. Otherwise, let us assume that

$$\lim_{\substack{p \rightarrow p_c \\ p > p_c}} \theta(p) = \delta > 0.$$

Let B be a subset of \mathbb{R}^d having a regular boundary and such that $\mathcal{L}^d(B) = 1/\delta$. As the map $p \mapsto \theta(p)$ is non-decreasing and $\mathcal{L}^d(W_p) = 1/\theta(p)$, we have

$$\forall p > p_c \quad \mathcal{L}^d(W_p) \leq \mathcal{L}^d(B).$$

Moreover as W_p is the dilate of the minimizer associated to the isoperimetric problem (1.1), we have

$$\forall p > p_c \quad \mathcal{I}_p(W_p) \leq \mathcal{I}_p(B).$$

In [72], Zhang proved that $\beta_{p_c} = 0$. In [64], Rossignol and Th  ret proved the continuity of the flow constant. Combining these two results, we get that

$$\lim_{\substack{p \rightarrow p_c \\ p > p_c}} \beta_p = \beta_{p_c} = 0 \quad \text{and so} \quad \lim_{\substack{p \rightarrow p_c \\ p > p_c}} \mathcal{I}_p(B) = 0.$$

Finally, we obtain

$$\lim_{\substack{p \rightarrow p_c \\ p > p_c}} \mathcal{I}_p(W_p) = 0.$$

This yields the result. □

Proof of theorem 1.2. We assume by contradiction that

$$\mathbb{P} \left(\liminf_{n \rightarrow \infty} n \widehat{\varphi}_n(p_c) = 0 \right) < 1.$$

Therefore there exist positive constants c and δ such that

$$\mathbb{P}\left(\liminf_{n \rightarrow \infty} n\widehat{\varphi}_n(p_c) > c\right) = \lim_{n \rightarrow \infty} \mathbb{P}\left(\inf_{k \geq n} k\widehat{\varphi}_k(p_c) > c\right) = \delta. \quad (2.1)$$

Therefore, there exists a positive integer n_0 such that

$$\mathbb{P}\left(\inf_{k \geq n_0} k\widehat{\varphi}_k(p_c) > c\right) \geq \frac{\delta}{2}. \quad (2.2)$$

In what follows, we condition on the event

$$\left\{ \inf_{k \geq n_0} k\widehat{\varphi}_k(p_c) > c \right\}.$$

Note that on this event, 0 is connected to infinity by a p_c -open path. For H a subgraph of \mathbb{Z}^d , we define

$$\partial^\circ H = \left\{ e \in \partial H, e \text{ is open} \right\}.$$

Note that if $H \subset \mathcal{C}_\infty$, then $\partial_{\mathcal{C}_\infty} H = \partial^\circ H$. Moreover, if H is equal to $\mathcal{C}(0)$, the open cluster of 0 , then $\partial_{\mathcal{C}(0)} H = \partial^\circ H = \emptyset$. We define next an exploration process of the cluster of 0 . We set $\mathcal{C}_0 = \{0\}$, $\mathcal{A}_0 = \emptyset$. Let us assume that $\mathcal{C}_0, \dots, \mathcal{C}_l$ and $\mathcal{A}_0, \dots, \mathcal{A}_l$ are already constructed. We define

$$\mathcal{A}_{l+1} = \left\{ x \in \mathbb{Z}^d : \exists y \in \mathcal{C}_l \quad \langle x, y \rangle \in \partial^\circ \mathcal{C}_l \right\}$$

and

$$\mathcal{C}_{l+1} = \mathcal{C}_l \cup \mathcal{A}_{l+1}.$$

We have

$$\partial^\circ \mathcal{C}_l \subset \left\{ \langle x, y \rangle \in \mathbb{E}^d : x \in \mathcal{A}_{l+1} \right\}$$

so that $|\partial^\circ \mathcal{C}_l| \leq 2d|\mathcal{A}_{l+1}|$. Since \mathcal{A}_{l+1} and \mathcal{C}_l are disjoint, we have

$$|\mathcal{C}_{l+1}| = |\mathcal{C}_l| + |\mathcal{A}_{l+1}| \geq |\mathcal{C}_l| + \frac{|\partial^\circ \mathcal{C}_l|}{2d}. \quad (2.3)$$

Let us set $\alpha = 1/n_0^d$ so that $|\mathcal{C}_0| = \alpha n_0^d$. Let k be the smallest integer greater than $2^{d+1}d/c$. We recall that c and n_0 were defined in (2.1) and (2.2). Let us prove by induction on n that

$$\forall n \geq n_0 \quad |\mathcal{C}_{(n-n_0)k}| \geq \alpha n^d. \quad (2.4)$$

This is true for $n = n_0$. Let us assume that this inequality is true for some integer $n \geq n_0$. If $|\mathcal{C}_{(n+1-n_0)k}| \geq n^d$, then we are done. Suppose that $|\mathcal{C}_{(n+1-n_0)k}| < n^d$. In this case, for any integer $l \leq k$, we have also $|\mathcal{C}_{(n-n_0)k+l}| < n^d$, and since $\mathcal{C}_{(n-n_0)k+l}$ is a valid subgraph of $\mathcal{C}(0)$ and $\widehat{\varphi}_n(p_c) > c/n$, we conclude that

$$\frac{|\partial^\circ \mathcal{C}_{(n-n_0)k+l}|}{|\mathcal{C}_{(n-n_0)k+l}|} \geq \frac{c}{n}$$

and so $|\partial^\circ \mathcal{C}_{(n-n_0)k+l}| \geq \alpha c n^{d-1}$. Thanks to inequality (2.3) applied k times, we have

$$|\mathcal{C}_{(n+1-n_0)k}| \geq \alpha \left(n^d + \frac{ck}{2d} n^{d-1} \right).$$

As $k \geq 2^{d+1}d/c$, we get

$$|\mathcal{C}_{(n+1-n_0)k}| \geq \alpha(n^d + 2^d n^{d-1}) \geq \alpha(n+1)^d.$$

This concludes the induction.

Let $\eta > 0$ be a constant that we will choose later. In [12], Barsky, Grimmett and Newman proved that there is no percolation in a half-space at criticality. An important consequence of the result of Grimmett and Marstrand [46] is that the critical value for bond percolation in a

half-space equals to the critical parameter $p_c(d)$ of bond percolation in the whole space, *i.e.*, we have

$$\mathbb{P}(0 \text{ is connected to infinity by a } p_c\text{-open path in } \mathbb{N} \times \mathbb{Z}^{d-1}) = 0,$$

so that for n large enough,

$$\mathbb{P}(\exists \gamma \text{ a } p_c\text{-open path starting from } 0 \text{ in } \mathbb{N} \times \mathbb{Z}^{d-1} \text{ such that } |\gamma| \geq n) \leq \eta.$$

In what follows, we will consider an integer n such that the above inequality holds. By construction the set \mathcal{C}_n is inside the box $[-n, n]^d$. Starting from this cluster, we are going to resume our exploration but with the constraint that we do not explore anything outside the box $[-n, n]^d$. We set $\mathcal{C}'_0 = \mathcal{C}_n$ and $\mathcal{A}'_0 = \emptyset$. Let us assume $\mathcal{C}'_0, \dots, \mathcal{C}'_l$ and $\mathcal{A}'_0, \dots, \mathcal{A}'_l$ are already constructed. We define

$$\mathcal{A}'_{l+1} = \{x \in [-n, n]^d : \exists y \in \mathcal{C}'_l \quad \langle x, y \rangle \in \partial^o \mathcal{C}'_l\}$$

and

$$\mathcal{C}'_{l+1} = \mathcal{C}'_l \cup \mathcal{A}'_{l+1}.$$

We stop the process when $\mathcal{A}'_{l+1} = \emptyset$. As the number of vertices in the box $[-n, n]^d$ is finite, this process of exploration will eventually stop for some integer l . We have that $|\mathcal{C}'_l| \leq n^d$ and $n\hat{\varphi}_k(p_c) > c$ so that

$$|\partial^o \mathcal{C}'_l| \geq \frac{c}{n} |\mathcal{C}'_l| \geq \frac{c}{n} |\mathcal{C}_n|.$$

Moreover, for $n \geq kn_0$, we have, thanks to inequality (2.4),

$$|\mathcal{C}_n| \geq |\mathcal{C}_{\lfloor \frac{n}{k} \rfloor k}| \geq |\mathcal{C}_{(\lfloor \frac{n}{k} \rfloor - n_0)k}| \geq \alpha \left(\left\lfloor \frac{n}{k} \right\rfloor \right)^d.$$

We suppose that n is large enough so that $n \geq kn_0$ and $\lfloor \frac{n}{k} \rfloor \geq n/2k$. Combining the two previous display inequalities, we conclude that

$$|\partial^o \mathcal{C}'_l| \geq \frac{c\alpha}{2^d k^d} n^{d-1}.$$

Therefore, for n large enough, there exists one face of $[-n, n]^d$ such that there are at least $c\alpha n^{d-1}/(2^d k^d 2d)$ vertices that are connected to 0 by a p_c -open path that remains inside the box $[-n, n]^d$ and so

$$\mathbb{P} \left(\begin{array}{l} \text{there exists one face of } [-n, n]^d \text{ with at least} \\ c\alpha n^{d-1}/(2^d k^d 2d) \text{ vertices that are connected to } 0 \text{ by a} \\ p_c\text{-open path that remains inside the box } [-n, n]^d \end{array} \right) \geq \frac{\delta}{2}. \quad (2.5)$$

Let us denote by X_n the number of vertices in the face $\{-n\} \times [-n, n]^{d-1}$ that are connected to 0 by a p_c -open path inside the box $[-n, n]^d$. We have

$$\begin{aligned} \mathbb{E}(X_n) &\leq |(\{-n\} \times [-n, n]^{d-1}) \cap \mathbb{Z}^d| \mathbb{P} \left(\begin{array}{l} \exists \gamma \text{ a } p_c\text{-open path starting} \\ \text{from } 0 \text{ in } \mathbb{N} \times \mathbb{Z}^{d-1} \text{ such that} \\ |\gamma| \geq n \end{array} \right) \\ &\leq (2n+1)^{d-1} \eta. \end{aligned} \quad (2.6)$$

Moreover, we have

$$\mathbb{E}(X_n) \geq \frac{c\alpha}{2^d 2^d k^d} n^{d-1} \mathbb{P} \left(X_n > \frac{c\alpha}{2^d 2^d k^d} n^{d-1} \right). \quad (2.7)$$

Finally, combining inequalities (2.6) and (2.7), we get

$$\mathbb{P} \left(X_n > \frac{c\alpha}{2^d 2^d k^d} n^{d-1} \right) \leq \frac{2d\eta 3^{d-1} 2^d k^d}{c\alpha}.$$

Therefore, we can choose η small enough such that

$$\mathbb{P} \left(X_n > \frac{c\alpha}{2^d 2^d k^d} n^{d-1} \right) \leq \frac{\delta}{10d}$$

and so using the symmetry of the lattice

$$\begin{aligned} & \mathbb{P} \left(\begin{array}{l} \text{there exists one face of } [-n, n]^d \text{ such there are at least} \\ c\alpha n^{d-1}/(2^d k^d 2d) \text{ vertices that are connected to } 0 \text{ by a } p_c\text{-open} \\ \text{path that remains inside the box } [-n, n]^d \end{array} \right) \\ & \leq 2d \mathbb{P} \left(X_n > \frac{c\alpha}{2d 2^d k^d} n^{d-1} \right) \leq \frac{\delta}{5}. \end{aligned}$$

This contradicts inequality (2.5) and yields the result. \square

Chapter 4

Anchored isoperimetric profile of the infinite cluster in supercritical bond percolation is Lipschitz continuous

We consider the standard model of i.i.d. first passage percolation on \mathbb{Z}^d given a distribution G on \mathbb{R}_+ . We consider a cube oriented in the direction \vec{v} whose sides have length n . We study the maximal flow from the top half to the bottom half of the boundary of this cube. We already know that the maximal flow renormalized by n^{d-1} converges towards the flow constant $\nu_G(\vec{v})$. We prove here that the map $p \mapsto \nu_{p\delta_1+(1-p)\delta_0}$ is Lipschitz continuous on all intervals $[p_0, p_1] \subset (p_c(d), 1)$ where $p_c(d)$ denotes the critical parameter for i.i.d. bond percolation on \mathbb{Z}^d . For $p > p_c(d)$, we know that there exists almost surely a unique infinite open cluster \mathcal{C}_p [48]. We are interested in the regularity properties in p of the anchored isoperimetric profile of the infinite cluster \mathcal{C}_p . For $d \geq 2$, using the result on the regularity of the flow constant, we prove here that the anchored isoperimetric profile defined in [5] is Lipschitz continuous on all intervals $[p_0, p_1] \subset (p_c(d), 1)$.

Contents

1	Introduction	95
1.1	Flow constant	95
1.2	Anchored isoperimetric profile	96
2	Definition of the norm β_p	98
3	Regularity of the map $p \mapsto \beta_p$	99
4	Proof of theorems 1.3 and 1.5	100
5	Proof of theorem 3.1	103

1 Introduction

1.1 Flow constant

The model of first passage percolation was first introduced by Hammersley and Welsh [49] in 1965 as a model for the spread of a fluid in a porous medium. In this model, mathematicians studied intensively geodesics, *i.e.*, fastest paths between two points in the grid. The study of maximal flows in first passage percolation started later in 1984 in dimension 2 with an article of Grimmett and Kesten [45]. In 1987, Kesten studied maximal flows in dimension 3 in [52]. The study of maximal flows is associated with the study of random cutsets that can be seen as $(d - 1)$ -dimensional surfaces. Their study presents more technical difficulties than the study of geodesics. Thus, the interpretation of first passage percolation in terms of maximal flows has been less studied.

Let us consider a large box in \mathbb{Z}^d oriented according to a direction \vec{v} , to each edge we assign a random i.i.d. capacity with distribution G . We interpret this capacity as a rate of flow, *i.e.*, it corresponds to the maximal amount of water that can cross the edge per second. Next, we consider the top half and bottom half of the boundary of the box. We are interested in the maximal flow that can cross the box from its top half to its bottom half per second. A first issue is to understand if the maximal flow in the box properly renormalized converges when the size of the box grows to infinity. This question was addressed in [52], [62] and [73] where one can find laws of large numbers and large deviations estimates for this maximal flow when the dimensions of the box grow to infinity under some moments assumptions on the capacities. The maximal flow properly renormalized converges towards the so-called flow constant $\nu_G(\vec{v})$. In [64], Rossignol and Th  ret proved the same results without any moment assumption on G , they even allow the capacities to take infinite value as long as $G(\{+\infty\}) < p_c(d)$ where $p_c(d)$ denotes the critical parameter of i.i.d. bond percolation on \mathbb{Z}^d . Moreover, the two authors have shown that the flow constant is continuous with regard to the distribution of the capacities. Let us denote $\beta_p = \nu_{p\delta_1+(1-p)\delta_0}$ for $p > p_c(d)$. Thanks to the result of Zhang in [72], we know that β_p is a norm. This norm will be properly defined in section 2. In this paper, we prove that the map $p \mapsto \beta_p$ is Lipschitz continuous on every compact interval included in $(p_c, 1)$.

Theorem 1.1 (Regularity of the flow constant). *Let $p_c(d) < p_0 < p_1 < 1$. There exists a positive constant κ depending only on d, p_0 and p_1 , such that*

$$\forall p, q \in [p_0, p_1] \quad \sup_{x \in \mathbb{S}^{d-1}} |\beta_p(x) - \beta_q(x)| \leq \kappa |q - p|.$$

The proof of this theorem will strongly rely on an adaptation of the proof of theorem 1 Zhang in [73].

1.2 Anchored isoperimetric profile

The study of isoperimetric problems in the discrete setting is more recent than in the continuous setting. In the continuous setting, we study the perimeter to volume ratio; in the context of graphs, the analogous problem is the study of the size of edge boundary to volume ratio. This can be encoded by the Cheeger constant. For a finite graph $\mathcal{G} = (V(\mathcal{G}), E(\mathcal{G}))$, we define the edge boundary $\partial_{\mathcal{G}}A$ of a subset A of $V(\mathcal{G})$ as

$$\partial_{\mathcal{G}}A = \left\{ e = \langle x, y \rangle \in E(\mathcal{G}) : x \in A, y \notin A \right\}.$$

We denote by $|B|$ the cardinality of the finite set B . The isoperimetric constant of \mathcal{G} , also called Cheeger constant, is defined as

$$\varphi_{\mathcal{G}} = \min \left\{ \frac{|\partial_{\mathcal{G}}A|}{|A|} : A \subset V(\mathcal{G}), 0 < |A| \leq \frac{|V(\mathcal{G})|}{2} \right\}.$$

This constant was introduced by Cheeger in his thesis [29] in order to obtain a lower bound for the smallest eigenvalue of the Laplacian. The isoperimetric constant of a graph gives information on its geometry.

Let $d \geq 2$. We consider an i.i.d. supercritical bond percolation on the graph $(\mathbb{Z}^d, \mathbb{E}^d)$ having for vertices \mathbb{Z}^d and for edges \mathbb{E}^d the set of pair of nearest neighbors in \mathbb{Z}^d for the Euclidean norm. Every edge $e \in \mathbb{E}^d$ is open with probability $p > p_c(d)$. We know that there exists almost surely a unique infinite open cluster \mathcal{C}_p [48]. In this paper, we want to study how the geometry of \mathcal{C}_p varies with p through its Cheeger constant. However, if we minimize the isoperimetric ratio over all possible subgraphs of \mathcal{C}_p without any constraint on the size, one can prove that $\varphi_{\mathcal{C}_p} = 0$ almost surely. For that reason, we shall minimize the isoperimetric ratio over all possible subgraphs of \mathcal{C}_p given a constraint on the size. There are several ways to do it. We can for instance study the Cheeger constant of the graph $\mathcal{C}_n = \mathcal{C}_p \cap [-n, n]^d$ or of the largest connected component $\tilde{\mathcal{C}}_n$ of \mathcal{C}_n for $n \geq 1$. Since we have $\varphi_{\mathcal{C}_p} = 0$ almost surely, the isoperimetric constants $\varphi_{\mathcal{C}_n}$ and $\varphi_{\tilde{\mathcal{C}}_n}$ go to 0 when n goes to infinity. Roughly speaking, by analogy with the full lattice, we expect that

subgraphs of $\tilde{\mathcal{C}}_n$ that minimize the isoperimetric ratio have edge boundary size of order n^{d-1} and size of order n^d with high probability.

In [15], Biskup, Louidor, Procaccia and Rosenthal defined a modified Cheeger constant $\tilde{\varphi}_{\mathcal{C}_n}$ and proved that $n\tilde{\varphi}_{\mathcal{C}_n}$ converges towards a deterministic constant in dimension 2. In [44], Gold proved the same result in dimension $d \geq 3$. Instead of considering the open edge boundary of subgraphs within \mathcal{C}_n , they considered the open edge boundary within the whole infinite cluster \mathcal{C}_p , this is more natural because \mathcal{C}_n has been artificially created by restricting \mathcal{C}_p to the box $[-n, n]^d$. They also added a stronger constraint on the size of subgraphs of \mathcal{C}_n to ensure that minimizers do not touch the boundary of the box $[-n, n]^d$. Moreover, they proved that the subgraphs achieving the minimum, properly rescaled, converge towards a deterministic shape that is the Wulff crystal. Namely, it is the shape solving the continuous anisotropic isoperimetric problem associated with the norm β_p corresponding to the surface tension in the percolation setting. The quantity $n\tilde{\varphi}_{\mathcal{C}_n}$ converges towards the solution of a continuous isoperimetric problem.

This modified Cheeger constant was inspired by the anchored isoperimetric profile $\varphi_n(p)$. This is another way to define the Cheeger constant of \mathcal{C}_p , that is more natural in the sense that we do not restrict minimizers to remain in the box $[-n, n]^d$. It is defined as follows:

$$\varphi_n(p) = \min \left\{ \frac{|\partial_{\mathcal{C}_p} H|}{|H|} : 0 \in H \subset \mathcal{C}_p, H \text{ connected}, 0 < |H| \leq n^d \right\},$$

where we condition on the event $\{0 \in \mathcal{C}_p\}$. We say that H is a valid subgraph if $0 \in H \subset \mathcal{C}_p$, H is connected and $|H| \leq n^d$.

We need to introduce some definitions to be able to define properly a limit shape in dimension $d \geq 2$. In order to build a continuous limit shape, we shall define a continuous analogue of the cardinality of the open edge boundary. In fact, the cardinality of the open edge boundary may be interpreted in terms of a surface energy associate with the norm β_p . Given a subset E of \mathbb{R}^d having a regular boundary, we define \mathcal{I}_p as

$$\mathcal{I}_p(E) = \int_{\partial E} \beta_p(n_E(x)) \mathcal{H}^{d-1}(dx),$$

where \mathcal{H}^{d-1} denotes the Hausdorff measure in dimension $d-1$ and $n_E(x)$ is the normal unit exterior vector of E at x . The quantity $\mathcal{I}_p(E)$ represents the surface energy of E for the norm β_p . At the point x , the tension has intensity $\beta_p(n_E(x))$ in the direction of $n_E(x)$. To understand the link between β_p and the open edge boundary, we refer to sections 3 in [44] or [5]. We denote by \mathcal{L}^d the d -dimensional Lebesgue measure. We can associate with the norm β_p the following isoperimetric problem:

$$\text{minimize } \frac{\mathcal{I}_p(E)}{\mathcal{L}^d(E)} \text{ subject to } \mathcal{L}^d(E) \leq 1.$$

We use the Wulff construction to build a minimizer for this anisotropic isoperimetric problem (see [70]). We define the set \widehat{W}_p as

$$\widehat{W}_p = \bigcap_{v \in \mathbb{S}^{d-1}} \{x \in \mathbb{R}^d : x \cdot v \leq \beta_p(v)\},$$

where \cdot denotes the standard scalar product and \mathbb{S}^{d-1} is the unit sphere of \mathbb{R}^d . Taylor proved in [66] that the set \widehat{W}_p properly rescaled is the unique minimizer, up to translations and modifications on a null set, of the associated isoperimetric problem.

In [5], Dembin proves the existence of the limit of $n\varphi_n(p)$ and that it converges towards the solution of the continuous isoperimetric problem associated with the norm β_p .

Proposition 1.2. *Let $d \geq 2$, $p > p_c(d)$ and let β_p be the norm that will be properly defined in section 2. Let W_p be a dilate of the Wulff crystal \widehat{W}_p for the norm β_p such that $\mathcal{L}^d(W_p) = 1/\theta_p$ where $\theta_p = \mathbb{P}(0 \in \mathcal{C}_p)$. Then, conditionally on the event $\{0 \in \mathcal{C}_p\}$,*

$$\lim_{n \rightarrow \infty} n\varphi_n(p) = \frac{\mathcal{I}_p(W_p)}{\theta_p \mathcal{L}^d(W_p)} = \mathcal{I}_p(W_p) \text{ a.s.}$$

In this paper, we aim to study the regularity properties of the anchored isoperimetric profile. This was first studied by Garet, Marchand, Procaccia, Th  ret in [42], they proved that the modified Cheeger constant in dimension 2 is continuous on $(p_c(2), 1]$. We aim here to prove the two following theorems. Theorem 1.3 asserts that the anchored isoperimetric profile is Lipschitz continuous on every compact interval $[p_0, p_1] \subset (p_c(d), 1)$.

Theorem 1.3 (Regularity of the anchored isoperimetric profile). *Let $d \geq 2$. Let $p_c(d) < p_0 < p_1 < 1$. There exists a positive constant ν depending only on d, p_0 and p_1 , such that*

$$\forall p, q \in [p_0, p_1] \quad |\mathcal{I}_p(W_p) - \mathcal{I}_q(W_q)| \leq \nu|q - p|.$$

Remark 1.4. *Actually, the map $p \mapsto \mathcal{I}_p(W_p)$ is also continuous at 1, this is not a consequence of theorem 1.3 but it comes from the fact that the map $p \rightarrow \beta_p$ is continuous on $(p_c(d), 1]$. This result is a corollary of theorem 2.6. in [64].*

Theorem 1.5 studies the Hausdorff distance between two Wulff crystals associated with norms β_p and β_q .

Theorem 1.5 (Regularity of the anchored isoperimetric profile). *Let $d \geq 3$. Let $p_c(d) < p_0 < p_1 < 1$. There exists a positive constant ν' depending only on d, p_0 and p_1 , such that*

$$\forall p, q \in [p_0, p_1] \quad d_{\mathcal{H}}(\widehat{W}_p, \widehat{W}_q) \leq \nu'|q - p|,$$

where $d_{\mathcal{H}}$ is the Hausdorff distance between non empty compact sets of \mathbb{R}^d .

Theorem 1.2 is the key element to prove these two theorems.

Remark 1.6. *In this paper, we choose to work on the anchored isoperimetric profile instead of the modified Cheeger constant because the norm we use is the same for all dimensions $d \geq 2$. The existence of the modified Cheeger constant in dimension 2 uses another norm specific to this dimension (see [15]). In [44], Gold proved the existence of the modified Cheeger constant for $d \geq 3$ with the same norm β_p . Actually, we believe that his proof also holds in dimension 2 up to using similar combinatorial arguments as in [5]. Therefore, the theorem 1.3 may be shown for the modified Cheeger constant in dimension $d \geq 2$ using the same ingredients as in this paper.*

Here is the structure of the paper. In section 2, we define the norm β_p . We prove that the map $p \mapsto \beta_p$ is Lipschitz continuous in section 3. We prove the main results on the regularity of the anchored isoperimetric profile (theorems 1.3 and 1.5) in section 4. Finally, we write an adaptation of the proof of Zhang [73] in section 5 that is necessary to prove theorem 1.2.

2 Definition of the norm β_p

We introduce now many notations used for instance in [62] concerning flows through cylinders. Let A be a non-degenerate hyperrectangle, that is to say a rectangle of dimension $d - 1$ in \mathbb{R}^d . Let \vec{v} be one of the two unit vectors normal to A . Let $h > 0$, we denote by $\text{cyl}(A, h)$ the cylinder with base A and height $2h$ defined by

$$\text{cyl}(A, h) = \{x + t\vec{v} : x \in A, t \in [-h, h]\}.$$

The set $\text{cyl}(A, h) \setminus A$ has two connected components, denoted by $C_1(A, h)$ and $C_2(A, h)$. For $i = 1, 2$, we denote by $C'_i(A, h)$ the discrete boundary of $C_i(A, h)$ defined by

$$C'_i(A, h) = \{x \in \mathbb{Z}^d \cap C_i(A, h) : \exists y \notin \text{cyl}(A, h), \langle x, y \rangle \in \mathbb{E}^d\}.$$

We say that the set of edges E cuts $C'_1(A, h)$ from $C'_2(A, h)$ in $\text{cyl}(A, h)$ if any path γ from $C'_1(A, h)$ to $C'_2(A, h)$ in $\text{cyl}(A, h)$ contains at least one edge of E . We call such a set a cutset. For any cutset E , let $|E|_{o,p}$ denote the number of p -open edges in E . We shall call it the p -capacity of E . Define

$$\tau_p(A, h) = \min \{|E|_{o,p} : E \text{ cuts } C'_1(A, h) \text{ from } C'_2(A, h) \text{ in } \text{cyl}(A, h)\}.$$

Note that it is a random quantity as $|E|_{o,p}$ is random, and that the cutsets in this definition are anchored at the border of A . This quantity is related to the fact that graphs that achieve the infimum in the definition of $\varphi_n(p)$ try to minimize their open edge boundary. To build a norm upon this quantity, we use the fact that the quantity $\tau_p(A, h)$ properly renormalized converges towards a deterministic constant when the size of the cylinder goes to infinity. The following proposition is a corollary of proposition 3.5 in [62].

Proposition 2.1 (Definition of the norm β_p). *Let $d \geq 2$, $p > p_c(d)$, A be a non-degenerate hyperrectangle and \vec{v} one of the two unit vectors normal to A . Let h be a height function such that $\lim_{n \rightarrow \infty} h(n) = \infty$. The limit*

$$\beta_p(\vec{v}) = \lim_{n \rightarrow \infty} \frac{\mathbb{E}[\tau_p(nA, h(n))]}{\mathcal{H}^{d-1}(nA)}$$

exists and is finite. Moreover, the limit is independent of A and h and the homogeneous extension of β_p to \mathbb{R}^d is a norm.

As the limit does not depend on A and h , in what follows for simplicity, we will take $h(n) = n$ and $A = S(\vec{v})$ where $S(\vec{v})$ is an hyper-square centered at 0, isometric to $[-1, 1]^{d-1} \times \{0\}$ and normal to \vec{v} . We will denote by $B(n, \vec{v})$ the cube $\text{cyl}(nS(\vec{v}), n)$ and by $\tau_p(n, \vec{v})$ the quantity $\tau_p(nS(\vec{v}), n)$.

3 Regularity of the map $p \mapsto \beta_p$

Let $p_0 > p_c(d)$ and let $q > p \geq p_0$. Our strategy is the following, we easily get that $\beta_p \leq \beta_q$ by properly coupling the percolations of parameters $p_c(d) < p < q$. The second inequality requires more work. We denote by $E_p(n, \vec{v})$ the random cutset of minimal size that achieves the minimum in the definition of $\tau_p(n, \vec{v})$. By definition, as $E_p(n, \vec{v})$ is a cutset, we can bound $\tau_q(n, \vec{v})$ from above by the number of edges in $E_p(n, \vec{v})$ that are q -open, which we expect to be at most $\tau_p(n, \vec{v}) + C(q-p)|E_p(n, \vec{v})|$ where C is a constant. We next need to get a control of $|E_p(n, \vec{v})|$ which is uniform in $p \in [p_0, 1]$ of the kind $c_0 n^{d-1}$ where c_0 depends only on p_0 and d . In [73], Zhang obtained a control on the size of the smallest minimal cutset that separates the top from the bottom of a cylinder in the general first passage percolation model, but his control depends on the distribution G of the passage times. We only consider probability measures $G_p = p\delta_1 + (1-p)\delta_0$ for $p > p_c(d)$, but we need to adapt Zhang's proof in this particular case to obtain a control that does not depend on p nor \vec{v} anymore and a control for cutsets that separates the bottom half from the top half of the boundary of the cylinder. More precisely, let us denote by $\mathcal{N}_p(n, \vec{v})$ the total number of edges in $E_p(n, \vec{v})$. We have the following control on $\mathcal{N}_p(n, \vec{v})$.

Theorem 3.1 (Adaptation of theorem 2 in [73]). *Let $p_0 > p_c(d)$. There exist constants C_1, C_2 and α that depend only on d and p_0 such that*

$$\forall p \in [p_0, 1] \quad \forall \vec{v} \in \mathbb{S}^{d-1} \quad \forall n \geq 1 \quad \mathbb{P}_p(\mathcal{N}_p(n, \vec{v}) > \alpha n^{d-1}) \leq C_1 \exp(-C_2 n^{d-1}).$$

We postpone the proof of theorem 3.1 to section 5. We have now the key ingredients to prove that the map $p \mapsto \beta_p$ is Lipschitz continuous.

Proof of Theorem 1.1. Let $p_c < p_0 < p_1 < 1, \vec{v} \in \mathbb{S}^{d-1}$, and p, q such that $p_0 \leq p < q \leq p_1$. First, we fix a cube $B(n, \vec{v})$ and we couple the percolations of parameters p and q in the standard way, i.e., we consider the i.i.d. family $(U(e))_{e \in \mathbb{E}^d}$ distributed according to the uniform law on $[0, 1]$ and we say that an edge e is p -open (resp. q -open) if $U(e) \geq p$ (resp. $U(e) \geq q$). Thanks to this coupling, we easily obtain that $\tau_p(n, \vec{v}) \leq \tau_q(n, \vec{v})$ and by dividing by $\mathcal{H}^{d-1}(nS(\vec{v})) = (2n)^{d-1}$, taking the expectation and letting n go to infinity we conclude that

$$\beta_p(\vec{v}) \leq \beta_q(\vec{v}). \tag{3.1}$$

Let $E_p(n, \vec{v})$ be a random cutset of minimal size that achieves the minimum in the definition of $\tau_p(n, \vec{v})$. We consider now another coupling. The idea is to introduce a coupling of the

percolations of parameter p and q such that if an edge is p -open then it is q -open and $E_p(n, \vec{v})$ is independent of the q -state of any edge. Unfortunately, we cannot find such a coupling but we can introduce a coupling that almost has this property. To do so, for each edge $e \in \mathbb{E}^d$, we consider two independent Bernoulli random variables $U(e)$ and $V(e)$ of parameters p and $(q-p)/(1-p)$. We say that an edge e is p -open if $U(e) = 1$ and that it is q -open if $U(e) = 1$ or $V(e) = 1$. Indeed,

$$\mathbb{P}(\{U(e) = 1\} \cup \{V(e) = 1\}) = p + (1-p)\frac{q-p}{1-p} = q.$$

Let $\delta > 0$. We have,

$$\begin{aligned} & \mathbb{P}\left(\tau_q(n, \vec{v}) > \tau_p(n, \vec{v}) + \left(\frac{q-p}{1-p} + \delta\right) \alpha n^{d-1}, \mathcal{N}_p(n, \vec{v}) < \alpha n^{d-1}\right) \\ & \leq \mathbb{P}\left(\tau_q(n, \vec{v}) - \tau_p(n, \vec{v}) > \left(\frac{q-p}{1-p} + \delta\right) |E_p(n, \vec{v})|\right) \\ & \leq \sum_{\mathfrak{E}} \mathbb{P}\left(E_p(n, \vec{v}) = \mathfrak{E}, |\{e \in \mathfrak{E} : (U(e), V(e)) = (0, 1)\}| > \left(\frac{q-p}{1-p} + \delta\right) |\mathfrak{E}|\right) \\ & \leq \sum_{\mathfrak{E}} \mathbb{P}\left(E_p(n, \vec{v}) = \mathfrak{E}, |\{e \in \mathfrak{E} : V(e) = 1\}| > \left(\frac{q-p}{1-p} + \delta\right) |\mathfrak{E}|\right) \\ & \leq \sum_{\mathfrak{E}} \mathbb{P}(E_p(n, \vec{v}) = \mathfrak{E}) \mathbb{P}\left(|\{e \in \mathfrak{E} : V(e) = 1\}| > \left(\frac{q-p}{1-p} + \delta\right) |\mathfrak{E}|\right) \\ & \leq \exp(-2\delta^2 n^{d-1}) \end{aligned} \tag{3.2}$$

where the sum is over sets \mathfrak{E} that cut $C'_1(nS(\vec{v}), n)$ from $C'_2(nS(\vec{v}), n)$ in $B(n, \vec{v})$ and where we use in the last inequality Chernoff bound and the fact that $|E_p(n, \vec{v})| \geq n^{d-1}$ (uniformly in \vec{v}). Finally, using inequality (3.2) and theorem 3.1, we get

$$\begin{aligned} \mathbb{E}[\tau_q(n, \vec{v})] & \leq \mathbb{E}[\tau_q(n, \vec{v}) \mathbf{1}_{\mathcal{N}_p(n, \vec{v}) < \alpha n^{d-1}}] + \mathbb{E}[\tau_q(n, \vec{v}) \mathbf{1}_{\mathcal{N}_p(n, \vec{v}) \geq \alpha n^{d-1}}] \\ & \leq \mathbb{E}[\tau_p(n, \vec{v})] + \left(\frac{q-p}{1-p} + \delta\right) \alpha n^{d-1} + |B(n, \vec{v})| \left(e^{-2\delta^2 n^{d-1}} + C_1 e^{-C_2 n^{d-1}}\right) \\ & \leq \mathbb{E}[\tau_p(n, \vec{v})] + \left(\frac{q-p}{1-p} + \delta\right) \alpha n^{d-1} + C_d (2n)^d \left(e^{-2\delta^2 n^{d-1}} + C_1 e^{-C_2 n^{d-1}}\right), \end{aligned}$$

where C_d is a constant depending only on d . Dividing by $(2n)^{d-1}$ and by letting n go to infinity, we obtain

$$\beta_q(\vec{v}) \leq \beta_p(\vec{v}) + \left(\frac{q-p}{1-p} + \delta\right) \frac{\alpha}{2^{d-1}} \tag{3.3}$$

and by letting δ go to 0,

$$\beta_q(\vec{v}) \leq \beta_p(\vec{v}) + \kappa(q-p) \tag{3.4}$$

where $\kappa = \alpha/(2^{d-1}(1-p_1))$. Combining inequalities (3.1) and (3.4), we obtain that

$$\sup_{\vec{v} \in \mathbb{S}^{d-1}} |\beta_q(\vec{v}) - \beta_p(\vec{v})| \leq \kappa|q-p|.$$

□

4 Proof of theorems 1.3 and 1.5

Proof of theorem 1.3. Let $p_c < p_0 < p_1 < 1$. We recall that, for $p > p_c(d)$, W_p denotes the Wulff crystal for the norm β_p such that $\mathcal{L}^d(W_p) = 1/\theta_p$. In this section we aim to prove that the map

$p \mapsto \mathcal{I}_p(W_p)$ is Lipschitz continuous on $[p_0, p_1]$. Notice that as the map $p \mapsto \theta_p$ is non-decreasing, we have

$$\forall p, q \in (p_c(d), 1] \quad p < q \implies \mathcal{L}^d(W_p) \geq \mathcal{L}^d(W_q)$$

and using the fact that W_q is a minimizer for \mathcal{I}_q for sets of equal volume, it follows that

$$\forall p, q \in (p_c(d), 1] \quad p < q \implies \mathcal{I}_q(W_p) \geq \mathcal{I}_q(W_q). \quad (4.1)$$

Moreover, the map $p \mapsto \theta_p$ is infinitely differentiable on $[p_0, p_1]$, see for instance theorem 8.92 in [48]. Therefore, there exists a constant L depending on p_0, p_1 and d such that

$$\forall p, q \in [p_0, p_1] \quad |\theta_p - \theta_q| \leq L|q - p|. \quad (4.2)$$

Let us compute now some useful inequalities. For any set $E \subset \mathbb{R}^d$ with Lipschitz boundary, by theorem 1.1, we have for any $p, q \in [p_0, p_1]$

$$\begin{aligned} |\mathcal{I}_p(E) - \mathcal{I}_q(E)| &= \left| \int_{\partial E} (\beta_p(n_E(x)) - \beta_q(n_E(x))) \mathcal{H}^{d-1}(dx) \right| \\ &\leq \int_{\partial E} |\beta_p(n_E(x)) - \beta_q(n_E(x))| \mathcal{H}^{d-1}(dx) \leq \kappa|q - p| \mathcal{H}^{d-1}(\partial E) \end{aligned} \quad (4.3)$$

where κ is the constant associated with p_0 and p_1 in the statement of theorem 1.1. We recall that the map $p \rightarrow \beta_p$ is uniformly continuous on $[p_0, p_1]$. We denote by β^{min} and β^{max} its minimal and maximal value, i.e., we have

$$\forall \vec{\nu} \in \mathbb{S}^{d-1} \quad \forall p \in [p_0, p_1] \quad \beta^{min} \leq \beta_p(\vec{\nu}) \leq \beta^{max}.$$

Together with inequality (4.1) and the fact that the Wulff crystal is a minimizer for an isoperimetric problem, we get for $p \in [p_0, p_1]$

$$\mathcal{I}_p(W_p) \leq \mathcal{I}_p(W_{p_0}) = \int_{\partial W_{p_0}} \beta_p(n_{W_{p_0}}(x)) \mathcal{H}^{d-1}(dx) \leq \beta^{max} \mathcal{H}^{d-1}(\partial W_{p_0}). \quad (4.4)$$

We also have

$$\mathcal{H}^{d-1}(\partial W_p) = \int_{\partial W_p} \mathcal{H}^{d-1}(dx) \leq \int_{\partial W_p} \frac{\beta_p(n_{W_p}(x))}{\beta^{min}} \mathcal{H}^{d-1}(dx) \leq \frac{\mathcal{I}_p(W_p)}{\beta^{min}}$$

and so together with inequality (4.4), we get

$$\forall p \in [p_0, p_1] \quad \mathcal{H}^{d-1}(\partial W_p) \leq \mathcal{H}^{d-1}(\partial W_{p_0}) \frac{\beta^{max}}{\beta^{min}}. \quad (4.5)$$

Finally, we obtain combining inequalities (4.1), (4.3) and (4.5),

$$\mathcal{I}_p(W_p) \geq \mathcal{I}_q(W_p) - \kappa|q - p| \mathcal{H}^{d-1}(\partial W_p) \geq \mathcal{I}_q(W_q) - \kappa|q - p| \mathcal{H}^{d-1}(\partial W_{p_0}) \frac{\beta^{max}}{\beta^{min}}. \quad (4.6)$$

As $\mathcal{L}^d(W_p) = \mathcal{L}^d(W_q) \cdot \theta_q / \theta_p = \mathcal{L}^d(W_q (\theta_q / \theta_p)^{1/d})$ and as W_p is the minimizer for the isoperimetric problem associated with the norm β_p , we have

$$\mathcal{I}_p(W_p) \leq \mathcal{I}_p \left(\left(\frac{\theta_q}{\theta_p} \right)^{1/d} W_q \right) \leq \left(\frac{\theta_q}{\theta_p} \right)^{(d-1)/d} \mathcal{I}_p(W_q) \leq \frac{\theta_q}{\theta_p} \mathcal{I}_p(W_q)$$

and so using inequalities (4.2), (4.3), (4.4) and (4.5)

$$\begin{aligned} \mathcal{I}_p(W_p) &\leq \frac{\theta_q}{\theta_p} (\mathcal{I}_q(W_q) + \kappa|q - p| \mathcal{H}^{d-1}(\partial W_q)) \\ &\leq \left(1 + \frac{L}{\theta_{p_0}} |q - p| \right) \left(\mathcal{I}_q(W_q) + \kappa|q - p| \mathcal{H}^{d-1}(\partial W_{p_0}) \frac{\beta^{max}}{\beta^{min}} \right) \\ &\leq \mathcal{I}_q(W_q) + \beta^{max} \mathcal{H}^{d-1}(\partial W_{p_0}) \left(\frac{L}{\theta_{p_0}} + \frac{\kappa}{\beta^{min}} \left(1 + \frac{L}{\theta_{p_0}} \right) \right) |q - p|. \end{aligned} \quad (4.7)$$

Thus combining inequalities (4.6) and (4.7) together with Theorem 1.2, we get

$$|\mathcal{I}_p(W_p) - \mathcal{I}_q(W_q)| \leq \nu|q - p| \quad (4.8)$$

where we set

$$\nu = \beta^{\max} \mathcal{H}^{d-1}(\partial W_{p_0}) \left(\frac{L}{\theta_{p_0}} + \frac{\kappa}{\beta^{\min}} \left(1 + \frac{L}{\theta_{p_0}} \right) \right).$$

□

Proof of theorem 1.5. Let $p_c < p_0 < p_1 < 1$ and $p, q \in [p_0, p_1]$. We consider β_p^* the dual norm of β_p , defined by

$$\forall x \in \mathbb{R}^d, \beta_p^*(x) = \sup\{x \cdot z : \beta_p(z) \leq 1\}.$$

Then β_p^* is a norm. The Wulff crystal \widehat{W}_p associated with β_p is in fact the unit ball associated with β_p^* . Note that the supremum in the definition of β_p^* is always achieved for a z such that $\beta_p(z) = 1$. Let $x \in \mathbb{S}^{d-1}$. Let $y \in \mathbb{S}^{d-1}$ be the direction that achieves the supremum for $\beta_p^*(x)$, thus we have

$$\beta_p^*(x) = x \cdot \frac{y}{\beta_p(y)}$$

and so using theorem 1.2,

$$\beta_p^*(x) - \beta_q^*(x) \leq x \cdot \frac{y}{\beta_p(y)} - x \cdot \frac{y}{\beta_q(y)} \leq \frac{\|x\|_2 \|y\|_2}{\beta_p(y)\beta_q(y)} |\beta_p(y) - \beta_q(y)| \leq \frac{\kappa}{(\beta^{\min})^2} |q - p|$$

where β^{\min} was defined in the proof of theorem 1.3. We proceed similarly for $\beta_q^*(x) - \beta_p^*(x)$. Finally, we obtain

$$\sup_{x \in \mathbb{S}^{d-1}} |\beta_p^*(x) - \beta_q^*(x)| \leq \frac{\kappa}{(\beta^{\min})^2} |q - p|. \quad (4.9)$$

We recall the following definition of the Hausdorff distance between two subsets E and F of \mathbb{R}^d :

$$d_{\mathcal{H}}(E, F) = \inf \{r \in \mathbb{R}^+ : E \subset F^r \text{ and } F \subset E^r\}$$

where $E^r = \{y : \exists x \in E \quad \|y - x\|_2 \leq r\}$. Thus, we have

$$d_{\mathcal{H}}(\widehat{W}_p, \widehat{W}_q) \leq \sup_{y \in \mathbb{S}^{d-1}} \left\| \frac{y}{\beta_p^*(y)} - \frac{y}{\beta_q^*(y)} \right\|_2.$$

Note that $y/\beta_p^*(y)$ (resp. $y/\beta_q^*(y)$) is in the unit sphere for the norm β_p^* (resp. β_q^*). Let $x \in \mathbb{S}^{d-1}$. Using the definition of β^* , we obtain

$$\frac{1}{\beta^{\max}} \leq x \cdot \frac{x}{\beta_p(x)} \leq \beta_p^*(x).$$

Finally, using inequality (4.9), we obtain

$$\begin{aligned} d_{\mathcal{H}}(\widehat{W}_p, \widehat{W}_q) &\leq \sup_{y \in \mathbb{S}^{d-1}} \left| \frac{1}{\beta_p^*(y)} - \frac{1}{\beta_q^*(y)} \right| \\ &\leq \sup_{y \in \mathbb{S}^{d-1}} \frac{1}{\beta_q^*(y)\beta_p^*(y)} |\beta_p^*(y) - \beta_q^*(y)| \\ &\leq \sup_{y \in \mathbb{S}^{d-1}} (\beta^{\max})^2 |\beta_p^*(y) - \beta_q^*(y)| \leq \frac{\kappa(\beta^{\max})^2}{(\beta^{\min})^2} |q - p|. \end{aligned} \quad (4.10)$$

The result follows. □

5 Proof of theorem 3.1

The proof of theorem 3.1 is going to be simpler than the proof of theorem 2 in [73], because passage times in our context can take only values 0 or 1, *i.e.*, to each edge we associate an i.i.d random variable of distribution $G_p = p\delta_1 + (1-p)\delta_0$ whereas Zhang considers in [73] more general distributions. Our setting is equivalent to bond percolation of parameter p by saying that an edge is closed if its passage time is 0, and open if its passage time is 1. Let us briefly explain the idea behind that theorem. Let $p \geq p_0$. We work on bond percolation of parameter p (equivalently on first passage percolation with distribution $G_p = p\delta_1 + (1-p)\delta_0$). We aim at bounding the size of the smallest minimal cutset that cuts the set $C'_1(nS(\vec{v}), n)$ from $C'_2(nS(\vec{v}), n)$ in $B(n, \vec{v})$. To do so we do a renormalization at a scale t in order to build a "smooth" minimal cutset. The collection $(B_t(u))_{u \in \mathbb{Z}^d}$ is a partition of \mathbb{Z}^d into boxes of size t and $\bar{B}_t(u) = \bigcup_{v \sim^* u} B_t(u)$ where $v \sim^* u$ if $\|u - v\|_\infty = 1$. Let us now introduce some useful definitions. A connected cluster C is

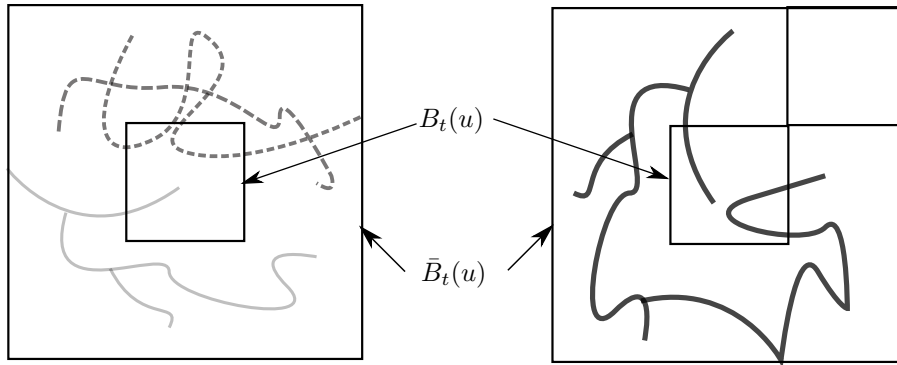

Figure 4.1 – On the left a box $B_t(u)$ with a disjoint property, on the right a box with a blocked property

said to be p -crossing for a box B , if for all d directions, there is a p -open path in $C \cap B$ connecting the two opposite faces of B . We define the diameter of a finite cluster \mathcal{C} as

$$\text{Diam}(\mathcal{C}) := \max_{\substack{i=1, \dots, d \\ x, y \in \mathcal{C}}} |x_i - y_i|.$$

Let $T_{m,t}(p)$ be the event that B_t has a p -crossing cluster and contains some other p -open cluster D having diameter at least m . We say that $B_t(u)$ has a p -disjoint property if there exist two disconnected p -open clusters in $\bar{B}_t(u)$, both with vertices in $B_t(u)$ and in the boundary of $\bar{B}_t(u)$. We say that $B_t(u)$ has a p -blocked property if there is a p -open cluster C in $\bar{B}_t(u)$ with vertices in $B_t(u)$ and in the boundary of $\bar{B}_t(u)$, but without vertices in a t -cube of $\bar{B}_t(u)$. We say that a p -atypical event occurs in $B_t(u)$ if it has a p -blocked property or a p -disjoint property (see Figure 4.1).

As the original proof is very technical, the adaptation of the proof is also technical. There are two points that need to be adapted from Zhang's proof. First, Zhang controls the size of a minimal cutset from the top to the bottom of a box in theorem 2 but here we need to control the size of a minimal cutset from the top half $C'_1(nS(\vec{v}), n)$ to the bottom half $C'_2(nS(\vec{v}), n)$ of a box $B(n, \vec{v})$. The second point is that Zhang has a control on the size that holds for a fixed p , but we need here to have a uniform control of the size for $p \in [p_0, 1]$.

Adaptation of the proof of theorem 1 in [73] to get theorem 3.1. We keep the same notations as in [73]. The following adaptation is not self-contained. Let $p_0 > p_c(d)$ and $\vec{v} \in \mathbb{S}^{d-1}$. In [73], the author bounds the size of the smallest minimal cutset that cuts a given cylinder $B(k, m)$ from infinity. However, his construction of a linear cutset in section 2 of [73] is not specific to the set $B(k, m)$ and can be defined in the same way for any set of vertices. In particular we can replace

$B(k, m)$ by $C'_1(nS(\vec{v}), n)$ and ∞ by $C'_2(nS(\vec{v}), n)$ (as it is done by Zhang in Theorem 2 in [73] with the top and the bottom of a cylinder). Note that given the configuration of passage times, the construction of Zhang's is totally deterministic. As we only focus on edges inside $B(n, \vec{v})$, we can assume that all edges outside $B(n, \vec{v})$ are closed.

We denote by $\mathcal{C}(n)$ the set that corresponds to $C(k, m)$ defined in Lemma 1 in [73]:

$$\mathcal{C}(n) = \{v \in \mathbb{Z}^d : v \text{ is connected to } C'_1(nS(\vec{v}), n) \text{ by an open path} \}.$$

We denote by $\mathcal{G}(n)$ the event that $\mathcal{C}(n) \cap C'_2(nS(\vec{v}), n) = \emptyset$ (it corresponds to $\mathcal{G}(k, m)$ in [73]). On this event, the exterior edge boundary $\Delta_e \mathcal{C}(n)$ of $\mathcal{C}(n)$ is a closed cutset that cuts $C'_1(nS(\vec{v}), n)$ from $C'_2(nS(\vec{v}), n)$. The problem is that the cutset $\Delta_e \mathcal{C}(n)$ may be very entangled. We use renormalization to be able to build a smooth closed cutset upon $\Delta_e \mathcal{C}(n)$. We denote by \underline{A} the set of t -cubes that intersect $\Delta_e \mathcal{C}(n)$. By Zhang construction, we can extract from \underline{A} a set of cubes Γ_t such that Γ_t is $*$ -connected and the union $\bar{\Gamma}_t$ of the $3t$ -cubes in Γ_t (the cubes in Γ_t and their $*$ -neighbors) contains a closed cutset that separates the set $C'_1(nS(\vec{v}), n)$ from $C'_2(nS(\vec{v}), n)$. Moreover, each cube in Γ_t has a $*$ -neighbor where a p -atypical event occurs.

The set $E = \{(x, y) \in B(n, \vec{v}) : x \in C'_1(nS(\vec{v}), n)\}$ cuts the set $C'_1(nS(\vec{v}), n)$ from the set $C'_2(nS(\vec{v}), n)$ in $B(n, \vec{v})$ and there exists a constant c_d depending only on d but not on \vec{v} such that $|E| \leq c_d n^{d-1}$. Thus, we obtain that

$$\tau_p(n, \vec{v}) \leq |E| \leq c_d n^{d-1}.$$

We denote by $E_p(n, \vec{v})$ the cutset that achieves the infimum in $\tau_p(n, \vec{v})$ and such that $|E_p(n, \vec{v})| = \mathcal{N}_p(n, \vec{v})$ ($E_p(n, \vec{v})$ corresponds to $W(k, m)$ the minimal cutset between the top and the bottom of $B(k, m)$ in [73]). For a configuration ω , we denote by $e_1, \dots, e_{J(\omega)}$ the p -open edges in $E_p(n, \vec{v})$. We have $J(\omega) = \tau_p(n, \vec{v})(\omega) \leq c_d n^{d-1}$. We denote by $\sigma(\omega)$ the configuration which coincides with ω except in edges $e_1, \dots, e_{J(\omega)}$ that are closed for $\sigma(\omega)$. Thus, the set $E_p(n, \vec{v})(\sigma(\omega))$ is a p -closed (for the configuration $\sigma(\omega)$) cutset that cuts $C'_1(nS(\vec{v}), n)$ from $C'_2(nS(\vec{v}), n)$ in $B(n, \vec{v})$. Note that the set of edges $E_p(n, \vec{v})(\sigma(\omega))$ is determined by the configuration ω whereas we consider the state of its edges is given by the configuration $\sigma(\omega)$. We recall that all the edges outside $B(n, \vec{v})$ are closed so that the event $\mathcal{G}(n)$ occurs in the configuration $\sigma(\omega)$ and we can use the construction of section 2 in [73] for the configuration $\sigma(\omega)$: there exists a set of cube Γ_t such that $\bar{\Gamma}_t$ contains a p -closed (for $\sigma(\omega)$) cutset Γ that cuts $C'_1(nS(\vec{v}), n)$ from $C'_2(nS(\vec{v}), n)$ (see Lemma 4 in [73]). The set $\Gamma \cap B(n, \vec{v})$ is a closed cutset that separates $C'_1(nS(\vec{v}), n)$ from $C'_2(nS(\vec{v}), n)$ in $B(n, \vec{v})$.

We now change $\sigma(\omega)$ back to ω . For $i \in \{1, \dots, J(\omega)\}$, the state of the edge e_i changes from closed to open. We write $\Gamma(\omega)$ when we consider the edge set Γ (the edge set Γ is determined by $\sigma(\omega)$ with its edges capacities determined by the configuration ω). The set $\Gamma(\omega)$ exists as an edge set, it is still a cutset but it is no longer closed, all edges in $\Gamma(\omega) \setminus \{e_1, \dots, e_{J(\omega)}\}$ are closed. Therefore, $|\Gamma(\omega)|_{o,p} \leq J(\omega)$, but by definition of $E_p(n, \vec{v})$, we have $J(\omega) = |E_p(n, \vec{v})(\omega)|_{o,p} \leq |\Gamma(\omega)|_{o,p} \leq J(\omega)$ and so $|\Gamma(\omega)|_{o,p} = J(\omega)$ and $\{e_1, \dots, e_{J(\omega)}\} \subset \Gamma$. Moreover, for each ω , by definition of $\mathcal{N}_p(n, \vec{v})(\omega)$, we get that $|\Gamma(\omega)| \geq \mathcal{N}_p(n, \vec{v})(\omega)$.

Note that for the t -cubes $B_t(u) \in \Gamma_t$ such that $\bar{B}_t(u)$ intersects the boundary of $B(n, \vec{v})$, we cannot be sure that there exists a t -cube in $\bar{B}_t(u)$ where a p -atypical event occurs. Thus, we need to obtain a control of the numbers of such cubes. Since edges outside $B(n, \vec{v})$ are closed, the set $\Delta_e \mathcal{C}(n) \setminus B(n, \vec{v})$ is included in the exterior edge boundary $\Delta_e B(n, \vec{v})$ of $B(n, \vec{v})$. Therefore, the cubes $B_t(u)$ in Γ_t such that $\bar{B}_t(u)$ is not contained in the strict interior of $B(n, \vec{v})$ satisfy $\bar{B}_t(u) \cap \Delta_e B(n, \vec{v}) \neq \emptyset$. We deduce that there are at most $C_{d,t} n^{d-1}$ such cubes in Γ_t where $C_{d,t}$ is a constant depending only on the dimension d and t . Thus, if the number of t -cubes in Γ_t is greater than βn^{d-1} , then the number of t -cubes $B_t(u)$ in Γ_t that do not intersect the boundary of $B(n, \vec{v})$ and such that $\bar{B}_t(u)$ do not contain any edge among e_1, \dots, e_J is greater than $(\beta - C_{d,t} - 3^d c_d) n^{d-1}$. All these t -cubes have at least one $*$ -neighbor with a blocked or disjoint property for the configuration ω .

In the proof of theorem 1 in [73], Zhang sums over all possible sets Γ_t . To do so, he needs to find at least one cube $B_t(v)$ that belongs to Γ_t and then he will be able to sum over all possible $*$ -connected sets that contained $B_t(v)$ of a given size. In our case, any cube $B_t(u)$ that intersects the boundary $\Delta_e C'_1(nS(\vec{v}), n) \setminus B(n, \vec{v})$ belongs to \underline{A} as it also intersects $\Delta_e \mathcal{C}(n)$ and by Zhang

construction, we can prove that the cube $B_t(u)$ also belongs to Γ_t . Thanks to this remark, we avoid the part of Zhang's proof where he tries to find a vertex z in the intersection between the cutset $W(k, m)$ and a line L in order to find a cube that is in Γ_t . Thus, the term $\exp(\beta^{-1}n)$ in (6.19) in [73] is not necessary in our case. This leads to small modifications of constants in the proof of [73]. The remainder of the proof is the same except that we need a uniform decay for $p \in [p_0, 1]$ of the probability of a p -atypical event in B_t instead of using the control in [73]. We need to prove the following lemma:

Lemma 5.1 (Uniform decay of the probability an atypical event occurs). *Let $p_0 > p_c(d)$. There exist positive constants $C_1(p_0)$ and $C_2(p_0)$ depending only on p_0 and d such that*

$$\forall p \geq p_0 \quad \forall t \geq 1 \quad \mathbb{P}(\text{a } p\text{-atypical event occurs in } B_t) \leq C_1(p_0) \exp(-C_2(p_0)t). \quad (5.1)$$

We would like to highlight the fact that in lemmas 6 and 7 in [73], Zhang proves the same result but with constants C_1 and C_2 depending on p . Obtaining a decay that is uniform for $p \in [p_0, 1]$ is the key element to adapt the proof of Zhang and show that the constant α in the statement of the theorem 3.1 does depend only on p_0 and d . □

Let us now prove lemma 5.1. We need to adapt some existing proofs in order to obtain a decay which is uniform in p .

Proof of lemma 5.1. First, note that if B_t has a p -disjoint property and \bar{B}_t has a p -crossing cluster, then one of the two disjoint clusters is different from the p -crossing cluster. Therefore, there is a p -open cluster of diameter greater than t different from the p -crossing cluster, so the event $T_{t,3t}(p)$ occurs in the box \bar{B}_t . Similarly, let us assume that B_t has a p -blocked property and \bar{B}_t and all of its sub-boxes (*i.e.*, boxes $B_t(v)$ such that $B_t(v) \subset \bar{B}_t$) have a p -crossing cluster. We denote by C the p -open cluster in the definition of the p -blocked property. Thus, there is at least one cluster among C and the p -crossing clusters of the sub-boxes that are disjoint from the p -crossing cluster of \bar{B}_t and so the event $T_{t,3t}(p)$ occurs in the box \bar{B}_t . Thus,

$$\begin{aligned} \mathbb{P}(\text{a } p\text{-atypical event occurs in } B_t) &\leq \mathbb{P}(\bar{B}_t \text{ does not have a } p\text{-crossing cluster}) \\ &\quad + 3^d \mathbb{P}(B_t \text{ does not have a } p\text{-crossing cluster}) + \mathbb{P}(T_{t,3t}(p)) \end{aligned} \quad (5.2)$$

As the event $\{B_t \text{ doesn't have a } p\text{-crossing cluster}\}$ is non-increasing in p , we have

$$\mathbb{P}(B_t \text{ doesn't have a } p\text{-crossing cluster}) \leq \mathbb{P}(B_t \text{ doesn't have a } p_0\text{-crossing cluster}).$$

The probability for a box B_t not to have a p_0 -crossing cluster is decaying exponentially fast with t^{d-1} , see for instance theorem 7.68 in [48]. Therefore, there exist positive constants $c_1(p_0)$ and $c_2(p_0)$ such that

$$\mathbb{P}(B_t \text{ does not have a } p\text{-crossing cluster}) \leq c_1(p_0) \exp(-c_2(p_0)t^{d-1}). \quad (5.3)$$

It remains to prove that there exist positive constants $\kappa(p_0)$ and $\mu(p_0)$ depending only on p_0 such that for all $p \geq p_0$, for all positive integers m and N

$$\mathbb{P}(T_{m,N}(p)) \leq \kappa N^{2d} \exp(-\mu m). \quad (5.4)$$

In dimension $d \geq 3$, we refer to the proof of lemma 7.104 in [48]. The proof of lemma 7.104 requires the proof of lemma 7.78. The probability controlled in lemma 7.78 is clearly non decreasing in the parameter p . Thus, if we choose $\delta(p_0)$ and $L(p_0)$ as in the proof of lemma 7.78 for $p_0 > p_c(d)$, then these parameters can be kept unchanged for some $p \geq p_0$. Thanks to lemma 7.104, we obtain

$$\begin{aligned} \forall p \geq p_0 \quad \mathbb{P}(T_{m,N}(p)) &\leq d(2N+1)^{2d} \exp\left(\left(\frac{m}{L(p_0)+1} - 1\right) \log(1 - \delta(p_0))\right) \\ &\leq \frac{d \cdot 3^d}{1 - \delta(p_0)} N^{2d} \exp\left(-\frac{\log(1 - \delta(p_0))}{L(p_0)+1} m\right). \end{aligned}$$

We get the result with

$$\kappa = \frac{d \cdot 3^d}{1 - \delta(p_0)} \quad \text{and} \quad \mu = \frac{-\log(1 - \delta(p_0))}{L(p_0) + 1} > 0.$$

In dimension 2, the result is obtained by Couroonné and Messikh in the more general setting of FK-percolation, see theorem 9 in [30]. We proceed similarly as in dimension $d \geq 3$, the constant appearing in this theorem first appeared in proposition 6. The probability of the event considered in this proposition is clearly increasing in the parameter of the underlying percolation which have parameter $1 - p$, it is an event for the subcritical regime of the Bernoulli percolation. Let us fix a $p_0 > p_c(2) = 1/2$, then $1 - p_0 < p_c(2)$ and we can choose the parameter $c(1 - p_0)$ and keep it unchanged for some $1 - p \leq 1 - p_0$. In theorem 9, we get the expected result with $c(1 - p_0)$ for a $p \geq p_0$ and $g(n) = n$. Finally, combining inequalities (5.2), (5.3) and (5.4), we get

$$\begin{aligned} & \mathbb{P}(\text{a } p\text{-atypical event occurs in } B_t) \\ & \leq c_1(p_0) \exp(-c_2(p_0)(3t)^{d-1}) + 3^d c_1(p_0) \exp(-c_2(p_0)t^{d-1}) + \kappa(p_0)(3t)^{2d} \exp(-\mu(p_0)t). \end{aligned}$$

The result follows. □

Part II

Regularity of the time constant

Chapter 5

Regularity of the time constant for a supercritical Bernoulli percolation

We consider an i.i.d. supercritical bond percolation on \mathbb{Z}^d , every edge is open with a probability $p > p_c(d)$, where $p_c(d)$ denotes the critical parameter for this percolation. We know that there exists almost surely a unique infinite open cluster \mathcal{C}_p [48]. We are interested in the regularity properties of the chemical distance for supercritical Bernoulli percolation. The chemical distance between two points $x, y \in \mathcal{C}_p$ corresponds to the length of the shortest path in \mathcal{C}_p joining the two points. The chemical distance between 0 and nx grows asymptotically like $n\mu_p(x)$. We aim to study the regularity properties of the map $p \rightarrow \mu_p$ in the supercritical regime. This may be seen as a special case of first passage percolation where the distribution of the passage time is $G_p = p\delta_1 + (1-p)\delta_\infty$, $p > p_c(d)$. It is already known that the map $p \rightarrow \mu_p$ is continuous (see [42]).

Contents

1	Introduction	109
2	Definitions and preliminary results	112
3	Modification of a path	113
3.1	Definition of the renormalization process	113
3.2	Construction of bypasses	114
3.3	Deterministic estimate	117
4	Control of the probability that a box is good	118
5	Probabilistic estimates	120
6	Regularity of the time constant	125

1 Introduction

The model of first passage percolation was first introduced by Hammersley and Welsh [49] as a model for the spread of a fluid in a porous medium. Let $d \geq 2$. We consider the graph $(\mathbb{Z}^d, \mathbb{E}^d)$ having for vertices \mathbb{Z}^d and for edges \mathbb{E}^d the set of pairs of nearest neighbors in \mathbb{Z}^d for the Euclidean norm. To each edge $e \in \mathbb{E}^d$ we assign a random variable $t(e)$ with values in \mathbb{R}^+ so that the family $(t(e), e \in \mathbb{E}^d)$ is independent and identically distributed according to a given distribution G . The random variable $t(e)$ may be interpreted as the time needed for the fluid to cross the edge e . We can define a random pseudo-metric T on this graph: for any pair of vertices $x, y \in \mathbb{Z}^d$, the random variable $T(x, y)$ is the shortest time to go from x to y . Let $x \in \mathbb{Z}^d \setminus \{0\}$. One can ask what is the asymptotic behavior of the quantity $T(0, x)$ when $\|x\|$ goes to infinity. Under some assumptions on the distribution G , one can prove that asymptotically when n is large, the random variable

$T(0, nx)$ behaves like $n \cdot \mu_G(x)$ where $\mu_G(x)$ is a deterministic constant depending only on the distribution G and the point x . The constant $\mu_G(x)$ corresponds to the limit of $T(0, nx)/n$ when n goes to infinity, when this limit exists. This result was proved by Cox and Durrett in [32] in dimension 2 under some integrability conditions on G , they also proved that μ_G is a semi-norm. Kesten extended this result to any dimension $d \geq 2$ in [51], and he proved that μ_G is a norm if and only if $G(\{0\}) < p_c(d)$. In the study of first passage percolation, μ_G is usually called the time constant. The constant $\mu_G(x)$ may be seen as the inverse of the speed of spread of the fluid in the direction of x .

It is possible to extend this model by doing first passage percolation on a random environment. We consider an i.i.d. supercritical bond percolation on the graph $(\mathbb{Z}^d, \mathbb{E}^d)$. Every edge $e \in \mathbb{E}^d$ is open with a probability $p > p_c(d)$, where $p_c(d)$ denotes the critical parameter for this percolation. We know that there exists almost surely a unique infinite open cluster \mathcal{C}_p [48]. We can define the model of first passage percolation on the infinite cluster \mathcal{C}_p . To do so, we consider a probability measure G on $[0, +\infty]$ such that $G([0, \infty]) = p$. In this setting, the p -closed edges correspond to the edges with an infinite value and so the cluster \mathcal{C}_p made of the edges with finite passage time corresponds to the infinite cluster of a supercritical Bernoulli percolation of parameter p . The existence of a time constant for such distributions was first obtained in the context of stationary integrable ergodic field by Garet and Marchand in [39] and was later shown for an independent field without any integrability condition by Cerf and Th  ret in [28].

The question of the continuity of the map $G \rightarrow \mu_G$ started in dimension 2 with the article of Cox [31]. He showed the continuity of this map under the hypothesis of uniform integrability: if G_n weakly converges toward G and if there exists an integrable law F such that for all $n \in \mathbb{N}$, F stochastically dominates G_n , then $\mu_{G_n} \rightarrow \mu_G$. In [33], Cox and Kesten prove the continuity of this map in dimension 2 without any integrability condition. Their idea was to consider a geodesic for truncated passage times $\min(t(e), M)$, and along it to avoid clusters of p -closed edges, that is to say edges with a passage time larger than some $M > 0$, by bypassing them with a short path in the boundary of this cluster. Note that by construction, the edges of the boundary have passage time smaller than M . Thanks to combinatorial considerations, they were able to obtain a precise control on the length of these bypasses. This idea was later extended to all the dimensions $d \geq 2$ by Kesten in [51], by taking a M large enough such that the percolation of the edges with a passage time larger than M is highly subcritical: for such a M , the size of the clusters of p -closed edges can be controlled. However, this idea does not work anymore when we allow passage time to take infinite values. In [42], Garet, Marchand, Procaccia and Th  ret proved the continuity of the map $G \rightarrow \mu_G$ for general laws on $[0, +\infty]$ without any moment condition. More precisely, let $(G_n)_{n \in \mathbb{N}}$, and G probability measures on $[0, +\infty]$ such that G_n weakly converges toward G (we write $G_n \xrightarrow{d} G$), that is to say for all continuous bounded functions $f : [0, +\infty] \rightarrow [0, +\infty)$, we have

$$\lim_{n \rightarrow +\infty} \int_{[0, +\infty]} f dG_n = \int_{[0, +\infty]} f dG.$$

Equivalently, we say that $G_n \xrightarrow{d} G$ if and only if $\lim_{n \rightarrow +\infty} G_n([t, +\infty]) = G([t, +\infty])$ for all $t \in [0, +\infty]$ such that $x \rightarrow G([x, +\infty])$ is continuous at t . If moreover for all $n \in \mathbb{N}$, $G_n([0, +\infty]) > p_c(d)$ and $G([0, +\infty]) > p_c(d)$, then

$$\lim_{n \rightarrow \infty} \sup_{x \in \mathbb{S}^{d-1}} |\mu_{G_n}(x) - \mu_G(x)| = 0$$

where \mathbb{S}^{d-1} is the unit sphere for the Euclidean norm.

In this paper, we focus on distributions of the form $G_p = p\delta_1 + (1-p)\delta_\infty$, $p > p_c(d)$. We denote by \mathcal{C}'_p be the subgraph of \mathbb{Z}^d whose edges are open for the Bernoulli percolation of parameter p . The travel time given a law G_p between two points x and $y \in \mathbb{Z}^d$ coincides with the so-called chemical distance that is the graph distance between x and y in \mathcal{C}'_p . Namely, for $x, y \in \mathbb{Z}^d$, we define the chemical distance $D^{\mathcal{C}'_p}(x, y)$ as the length of the shortest p -open path joining x and y . Note that if x and y are not in the same cluster of \mathcal{C}'_p , $D^{\mathcal{C}'_p}(x, y) = +\infty$. Actually, when x and y are in the same cluster, $D^{\mathcal{C}'_p}(x, y)$ is of order $\|y - x\|_1$. In [10], Antal and Pisztora obtained the

following large deviation upper bound:

$$\limsup_{\|y\|_1 \rightarrow \infty} \frac{1}{\|y\|_1} \log \mathbb{P}[0 \leftrightarrow y, D_p^{C'_p}(0, y) > \rho] < 0.$$

This result implies that there exists a constant ρ depending on the parameter p and the dimension d such that

$$\limsup_{\|y\|_1 \rightarrow \infty} \frac{1}{\|y\|_1} D_p^{C'_p}(0, y) \mathbf{1}_{0 \leftrightarrow y} \leq \rho, \mathbb{P}_p \text{ a.s.}$$

These results were proved using renormalization arguments. They were improved later in [39] by Garet and Marchand, for the more general case of a stationary ergodic field. They proved that $D_p^{C'_p}(0, x)$ grows linearly in $\|x\|_1$. More precisely, for each $y \in \mathbb{Z}^d \setminus \{0\}$, they proved the existence of a constant $\mu_p(y)$ such that

$$\lim_{\substack{n \rightarrow \infty \\ 0 \leftrightarrow ny}} \frac{D_p^{C'_p}(0, ny)}{n} = \mu_p(y), \mathbb{P}_p \text{ a.s.}$$

The constant μ_p is called the time constant. The map $p \rightarrow \mu_p$ can be extended to \mathbb{Q}^d by homogeneity and to \mathbb{R}^d by continuity. It is a norm on \mathbb{R}^d . This convergence holds uniformly in all directions, this is equivalent of saying that an asymptotic shape emerges. Indeed, the set of points that are at a chemical distance from 0 smaller than n asymptotically looks like $n\mathcal{B}_{\mu_p}$, where \mathcal{B}_{μ_p} denotes the unit ball associated with the norm μ_p . In another paper [40], Garet and Marchand studied the fluctuations of $D_p^{C'_p}(0, y)/\mu_p(y)$ around its mean and obtained the following large deviation result:

$$\forall \varepsilon > 0, \limsup_{\|x\|_1 \rightarrow \infty} \frac{\ln \mathbb{P}_p \left(0 \leftrightarrow x, \frac{D_p^{C'_p}(0, y)}{\mu_p(y)} \notin (1 - \varepsilon, 1 + \varepsilon) \right)}{\|x\|_1} < 0.$$

In the same paper, they showed another large deviation result that, as a corollary, proves the continuity of the map $p \rightarrow \mu_p$ in $p = 1$. In [41], Garet and Marchand obtained moderate deviations of the quantity $|D_p^{C'_p}(0, y) - \mu_p(y)|$. As a corollary of the work of Garet, Marchand, Procaccia and Th  ret in [42] we obtain the continuity of the map $p \rightarrow \mu_p$ in $(p_c(d), 1]$. Our paper is a continuation of [42], our aim is to obtain better regularity properties for the map $p \rightarrow \mu_p$ than just continuity. We prove the following theorem.

Theorem 1.1 (Regularity of the time constant). *Let $p_0 > p_c(d)$. There exists a constant κ_d depending only on d and p_0 , such that for all $p \leq q$ in $[p_0, 1]$*

$$\sup_{x \in \mathbb{S}^{d-1}} |\mu_p(x) - \mu_q(x)| \leq \kappa_d(q - p) |\log(q - p)|.$$

To study the regularity of the map $p \rightarrow \mu_p$, our aim is to control the difference between the chemical distance in the infinite cluster \mathcal{C}_p of a Bernoulli percolation of parameter $p > p_c(d)$ with the chemical distance in \mathcal{C}_q where $q \geq p$. The key part of the proof lies in the modification of a path. We couple the two percolations such that a p -open edge is also q -open but the converse does not necessarily hold. We consider a q -open path for some $q \geq p > p_c(d)$. Some of the edges of this path are p -closed, we want to build upon this path a p -open path by bypassing the p -closed edges. In order to bypass them, we use the idea of [42] and we build our bypasses at a macroscopic scale. This idea finds its inspiration in the works of Antal and Pisztora [60] and Cox and Kesten [33]. We have to consider an appropriate renormalization and we obtain a macroscopic lattice with good and bad sites. Good and bad sites correspond to boxes of size $2N$ in the microscopic lattice. We will do our bypasses using good sites at a macroscopic scale that will have good connectivity properties at a microscopic scale. The remainder of the proof consists in getting probabilistic estimates of the length of the bypass. In this article we improve the estimates obtained in [42]. We quantify the renormalization to be able to give quantitative bounds on continuity. Namely, we give an explicit expression of the appropriate size of a N -box. We use the idea of corridor that

appeared in the work of Cox and Kesten [33] to have a better control on combinatorial terms and derive a more precise control of the length of the bypasses than the one obtained in [42].

We recall that \mathcal{B}_{μ_p} denotes the unit ball associated with the norm μ_p . From Theorem 1.1, we can easily deduce the following regularity of the asymptotic shapes.

Corollary 1.2 (Regularity of the asymptotic shapes). *Let $p_0 > p_c(d)$. There exists a constant κ'_d depending only on d and p_0 , such that for all $p \leq q$ in $[p_0, 1]$,*

$$d_{\mathcal{H}}(\mathcal{B}_{\mu_q}, \mathcal{B}_{\mu_p}) \leq \kappa'_d(q-p)|\log(q-p)|$$

where $d_{\mathcal{H}}$ is the Hausdorff distance between non-empty compact sets of \mathbb{R}^d .

Here is the structure of the paper. In section 2, we introduce some definitions and preliminary results that are going to be useful in what follows. The section 3 presents the renormalization process and how we modify a q -open path to turn it into a p -open path and how we can control the length of the bypasses. In section 4 and 5, we get probabilistic estimates on the length of the bypasses. Finally, in section 6 we prove the main Theorem 1.1 and its Corollary 1.2.

Remark 1.3. *The section 3 is a simplified version of the renormalization process that was already present in [42]. The simplification comes from the fact that we are not interested in general distributions but only on distributions G_p for $p > p_c(d)$ which have the advantage of taking only two values 1 or $+\infty$. The original part of this work is the quantification of the renormalization and the combinatorial estimates of section 5.*

2 Definitions and preliminary results

Let $d \geq 2$. Let us recall the different distances in \mathbb{R}^d . Let $x = (x_1, \dots, x_d) \in \mathbb{R}^d$, we define

$$\|x\|_1 = \sum_{i=1}^d |x_i|, \quad \|x\|_2 = \sqrt{\sum_{i=1}^d x_i^2} \quad \text{and} \quad \|x\|_\infty = \max\{|x_i|, i = 1, \dots, d\}.$$

Let \mathcal{G} be a subgraph of $(\mathbb{Z}^d, \mathbb{E}^d)$ and $x, y \in \mathcal{G}$. A path γ from x to y in \mathcal{G} is a sequence $\gamma = (v_0, e_1, \dots, e_n, v_n)$ such that $v_0 = x$, $v_n = y$ and for all $i \in \{1, \dots, n\}$, the edge $e_i = \langle v_{i-1}, v_i \rangle$ belongs to \mathcal{G} . We say that x and y are connected in \mathcal{G} if there exists such a path. We denote by $|\gamma| = n$ the length of γ . We define

$$D^{\mathcal{G}}(x, y) = \inf\{|\gamma| : \gamma \text{ is a path from } x \text{ to } y \text{ in } \mathcal{G}\}$$

the chemical distance between x and y in \mathcal{G} . If x and y are not connected in \mathcal{G} , $D^{\mathcal{G}}(x, y) = \infty$. In the following, \mathcal{G} will be \mathcal{C}'_p the subgraph of \mathbb{Z}^d whose edges are open for the Bernoulli percolation of parameter $p > p_c(d)$. To get around the fact that the chemical distance can take infinite values we introduce regularized chemical distance. Let $\mathcal{C} \subset \mathcal{C}'_p$ be a connected cluster, we define $\tilde{x}^{\mathcal{C}}$ as the vertex of \mathcal{C} which minimizes $\|x - \tilde{x}^{\mathcal{C}}\|_1$ with a deterministic rule to break ties. As $\mathcal{C} \subset \mathcal{C}'_p$, we have

$$D^{\mathcal{C}'_p}(\tilde{x}^{\mathcal{C}}, \tilde{y}^{\mathcal{C}}) \leq D^{\mathcal{C}}(\tilde{x}^{\mathcal{C}}, \tilde{y}^{\mathcal{C}}) < \infty.$$

Typically, \mathcal{C} is going to be the infinite cluster for Bernoulli percolation with a parameter $p_0 \leq p$ (thus $\mathcal{C}_{p_0} \subset \mathcal{C}'_p$).

We can define the regularized time constant as in [41] or as a special case of [28].

Proposition 2.1. *Let $p > p_c(d)$. There exists a deterministic function $\mu_p : \mathbb{Z}^d \rightarrow [0, +\infty)$, such that for every $p_0 \in (p_c(d), p]$:*

$$\forall x \in \mathbb{Z}^d \quad \lim_{n \rightarrow \infty} \frac{D^{\mathcal{C}'_p}(\tilde{0}^{\mathcal{C}_{p_0}}, \tilde{n}x^{\mathcal{C}_{p_0}})}{n} = \mu_p(x) \text{ a.s. and in } L^1.$$

It is important to check that μ_p does not depend on p_0 , i.e., on the cluster \mathcal{C}_{p_0} we use to regularize. This is done in Lemma 2.11 in [42]. As a corollary, we obtain the monotonicity of the map $p \rightarrow \mu_p$ which is non increasing, see Lemma 2.12 in [42].

Corollary 2.2. *For all $p_c(d) < p \leq q$ and for all $x \in \mathbb{Z}^d$,*

$$\mu_p(x) \geq \mu_q(x).$$

We will also need this other definition of path that corresponds to the context of site percolation. Let \mathcal{G} be a subset of \mathbb{Z}^d and $x, y \in \mathcal{G}$. We say that the sequence $\gamma = (v_0, \dots, v_n)$ is a \mathbb{Z}^d -path from x to y in \mathcal{G} if $v_0 = x$, $v_n = y$ and for all $i \in \{1, \dots, n\}$, $v_i \in \mathcal{G}$ and $\|v_i - v_{i-1}\|_1 = 1$.

3 Modification of a path

In this section we present the renormalization process. We are here at a macroscopic scale, we define good boxes to be boxes with useful properties to build our modified paths.

3.1 Definition of the renormalization process

Let $p > p_c(d)$ be the parameter of an i.i.d. Bernoulli percolation on the edges of \mathbb{Z}^d . For a large integer N , that will be chosen later, we set $B_N = [-N, N]^d \cap \mathbb{Z}^d$ and define the following family of N -boxes, for $\mathbf{i} \in \mathbb{Z}^d$,

$$B_N(\mathbf{i}) = \tau_{\mathbf{i}(2N+1)}(B_N)$$

where τ_b denotes the shift in \mathbb{Z}^d with vector $b \in \mathbb{Z}^d$. \mathbb{Z}^d is the disjoint union of this family: $\mathbb{Z}^d = \sqcup_{\mathbf{i} \in \mathbb{Z}^d} B_N(\mathbf{i})$. We need to introduce larger boxes that will help us to link N -boxes together. For $\mathbf{i} \in \mathbb{Z}^d$, we define

$$B'_N(\mathbf{i}) = \tau_{\mathbf{i}(2N+1)}(B_{3N}).$$

To define what a good box is, we have to list properties that a good box should have to ensure that we can build a modification of the path as we have announced in the introduction. We have to keep in mind that all the properties must occur with probability close to 1 when N goes to infinity. Before defining what a good box is, let us recall some definitions. A connected cluster C is crossing for a box B , if for all d directions, there is an open path in $C \cap B$ connecting the two opposite faces of B . We define the diameter of a finite cluster C as

$$\text{Diam}(C) := \max_{\substack{i=1, \dots, d \\ x, y \in C}} |x_i - y_i|.$$

Definition 3.1. *We say that the macroscopic site \mathbf{i} is p -good if the following events occur:*

- (i) *There exists a unique p -cluster C in $B'_N(\mathbf{i})$ with diameter larger than N ;*
- (ii) *This p -cluster C is crossing for each of the 3^d N -boxes included in $B'_N(\mathbf{i})$;*
- (iii) *For all $x, y \in B'_N(\mathbf{i})$, if x and y belong to C then $D^{C'}_p(x, y) \leq 12\beta N$, for an appropriate β that will be defined later.*

C is called the crossing p -cluster of the p -good box $B_N(\mathbf{i})$.

Let us define a percolation by site on the macroscopic grid given by the state of the boxes, *i.e.*, we say that a macroscopic site \mathbf{i} is open if the box $B_N(\mathbf{i})$ is p -good, otherwise we say the site is closed. Note that the state of the boxes are not independent, there is a short range dependence.

On the macroscopic grid \mathbb{Z}^d , we consider the standard definition of closest neighbors, that is to say x and y are neighbors if $\|x - y\|_1 = 1$. Let C be a connected set of macroscopic sites, we define its exterior vertex boundary

$$\partial_v C = \left\{ \begin{array}{l} \mathbf{i} \in \mathbb{Z}^d \setminus C : \mathbf{i} \text{ has a neighbour in } C \text{ and is connected} \\ \text{to infinity by a } \mathbb{Z}^d\text{-path in } \mathbb{Z}^d \setminus C \end{array} \right\}.$$

For a bad macroscopic site \mathbf{i} , let us denote by $C(\mathbf{i})$ the connected cluster of bad macroscopic sites containing \mathbf{i} . If $C(\mathbf{i})$ is finite, the set $\partial_v C(\mathbf{i})$ is not connected in the standard definition but it is with a weaker definition of neighbors. We say that two macroscopic sites \mathbf{i} and \mathbf{j} are $*$ -neighbors if and only if $\|\mathbf{i} - \mathbf{j}\|_\infty = 1$. Therefore, $\partial_v C(\mathbf{i})$ is an $*$ -connected set of good macroscopic sites see for instance Lemma 2 in [69]. We adopt the convention that $\partial_v C(\mathbf{i}) = \{\mathbf{i}\}$ when \mathbf{i} is a good site.

3.2 Construction of bypasses

Let us consider $p_c(d) < p \leq q$, we fix N in this section. Let us consider a q -open path γ . In this paper, we will consider two different couplings. We do not specify here what coupling we use. However, for these two couplings a p -open edge is necessarily q -open. Thus, some edges in γ might be p -closed. We denote by γ_o the set of p -open edges in γ , and by γ_c the set of p -closed edges in γ . Our aim is to build a bypass for each edge in γ_c using only p -open edges. The proof will follow the proof of Lemma 3.2 in [42] up to some adaptations.

As the bypasses are going to be made at a macroscopic scale, we need to consider the N -boxes that γ crosses. We denote by $\Gamma \subset \mathbb{Z}^d$ the connected set of all the N -boxes visited by γ . The set Γ is connected in the standard definition. We denote by Bad the random set of bad connected components on the macroscopic percolation given by the states of the N -boxes. The following Lemma states that we can bypass all the p -closed edges in γ and gives a control on the total size of these bypasses.

Lemma 3.2. *Let us consider $y, z \in \mathcal{C}_p$ such that the N -boxes of y and z belong to an infinite cluster of p -good boxes. Let us consider a q -open path γ joining y to z . Then there exists a p -open path γ' between y and z that has the following properties:*

- (1) $\gamma' \setminus \gamma$ is a set of disjoint self avoiding p -open paths that intersect $\gamma' \cap \gamma$ at their endpoints;
- (2) $|\gamma' \setminus \gamma| \leq \rho_d N \left(\sum_{C \in Bad: C \cap \Gamma \neq \emptyset} |C| + |\gamma_c| \right)$, where ρ_d is a constant depending only on the dimension d .

Remark 3.3. *Note that here we don't need to introduce a parameter p_0 and require that the bypasses are p_0 open as in [42]. Indeed, this condition was required because finite passage times of edges were not bounded. This is the reason why it was needed in [42] to bypass p -closed edges with p_0 -open edges. These p_0 -open edges were precisely edges with passage time smaller than some constant M_0 . In our context, we can get rid of this technical aspect because passage times when finite may only take the value 1.*

Before proving Lemma 3.2, we need to prove the following lemma that gives a control on the length of a path between two points in a $*$ -connected set of good boxes.

Lemma 3.4. *Let \mathcal{I} be a set of $n \in \mathbb{N}^*$ macroscopic sites such that $(B_N(\mathbf{i}))_{\mathbf{i} \in \mathcal{I}}$ is a $*$ -connected set of p -good N -boxes. Let $x \in B_N(\mathbf{j})$ be in the p -crossing cluster of $B_N(\mathbf{j})$ with $\mathbf{j} \in \mathcal{I}$ and $y \in B_N(\mathbf{k})$ be in the p -crossing cluster of $B_N(\mathbf{k})$ with $\mathbf{k} \in \mathcal{I}$. Then, we can find a p -open path joining x and y of length at most $12\beta Nn$ (with the same constant β as in Definition 3.1).*

Proof of Lemma 3.4. Since \mathcal{I} is a $*$ -connected set of macroscopic sites, there exists a self-avoiding macroscopic $*$ -connected path $(\varphi_i)_{1 \leq i \leq r} \subset \mathcal{I}$ such that $\varphi_1 = \mathbf{j}$, $\varphi_r = \mathbf{k}$. Thus, we get that $r \leq |\mathcal{I}| = n$. As all the sites in \mathcal{I} are good, all the N -boxes corresponding to the sites $(\varphi_i)_{1 \leq i \leq r}$ are good.

For each $2 \leq i \leq r - 1$, we define x_i to be a point in the p -crossing cluster of the box $B_N(\varphi_i)$ chosen according to a deterministic rule. We define $x_1 = x$ and $x_r = y$. For each $1 \leq i < r$, x_i and x_{i+1} both belong to $B'_N(\varphi_i)$. Using property (iii) of a p -good box, we can build a p -open path $\gamma(i)$ from x_i to x_{i+1} of length at most $12\beta N$. By concatenating the paths $\gamma(1), \dots, \gamma(r - 1)$ in this order, we obtain a p -open path joining x to y of length at most $12\beta Nn$. □

Proof of Lemma 3.2. Let us consider $y, z \in \mathcal{C}_p$ such that the N -boxes of y and z belong to an infinite cluster of p -good boxes. Let γ be a q -open path joining y to z . The idea is the following. We want to bypass all the p -closed edges of γ . Let us consider an edge $e \in \gamma_c$ and $B_N(\mathbf{i})$ its associated N -box. There are two different cases:

- If $B_N(\mathbf{i})$ is a good box, we can build a p -open bypass of e at a microscopic scale by staying in a fixed neighborhood of $B_N(\mathbf{i})$. We will use the third property of good boxes to control the length of the bypass that will be at most $12\beta N$.
- If $B_N(\mathbf{i})$ is a bad box, we must build a p -open bypass at a macroscopic scale in the exterior vertex boundary $\partial_v C(\mathbf{i})$ that is an $*$ -connected component of good boxes. We will use Lemma 3.4 to control the length of this bypass.

Let $\varphi_0 = (\varphi_0(j))_{1 \leq j \leq r_0}$ be the sequence of N -boxes γ visits. From the sequence φ_0 , we can extract the sequence of N -boxes containing at least one p -closed edge of γ . We only keep the indices of the boxes containing the smallest extremity of a p -closed edge of γ for the lexicographic order. We obtain a sequence $\varphi_1 = (\varphi_1(j))_{1 \leq j \leq r_1}$. Notice that $r_1 \leq r_0$ and $r_1 \leq |\gamma_c|$. Before building our bypasses, we have to get rid of some pathological cases. We are going to proceed to further extractions. Note that two $*$ -connected components of $(\partial_v C(\varphi_1(j)))_{1 \leq j \leq r_1}$ can be $*$ -connected together, in that case they count as a unique connected component. Namely, the set $E = \cup_{1 \leq j \leq r_1} \partial_v C(\varphi_1(j))$ has at most r_1 $*$ -connected component $(S_{\varphi_2(j)})_{1 \leq j \leq r_2}$. Up to reordering, we can assume that the sequence $(S_{\varphi_2(j)})_{1 \leq j \leq r_2}$ is ordered in such a way that $S_{\varphi_2(1)}$ is the first $*$ -connected component of E visited by γ among the $(S_{\varphi_2(j)})_{1 \leq j \leq r_2}$, $S_{\varphi_2(2)}$ is the second and so on. Next, we consider the case of nesting, that is to say when there exist $j \neq k$ such that $S_{\varphi_2(j)}$

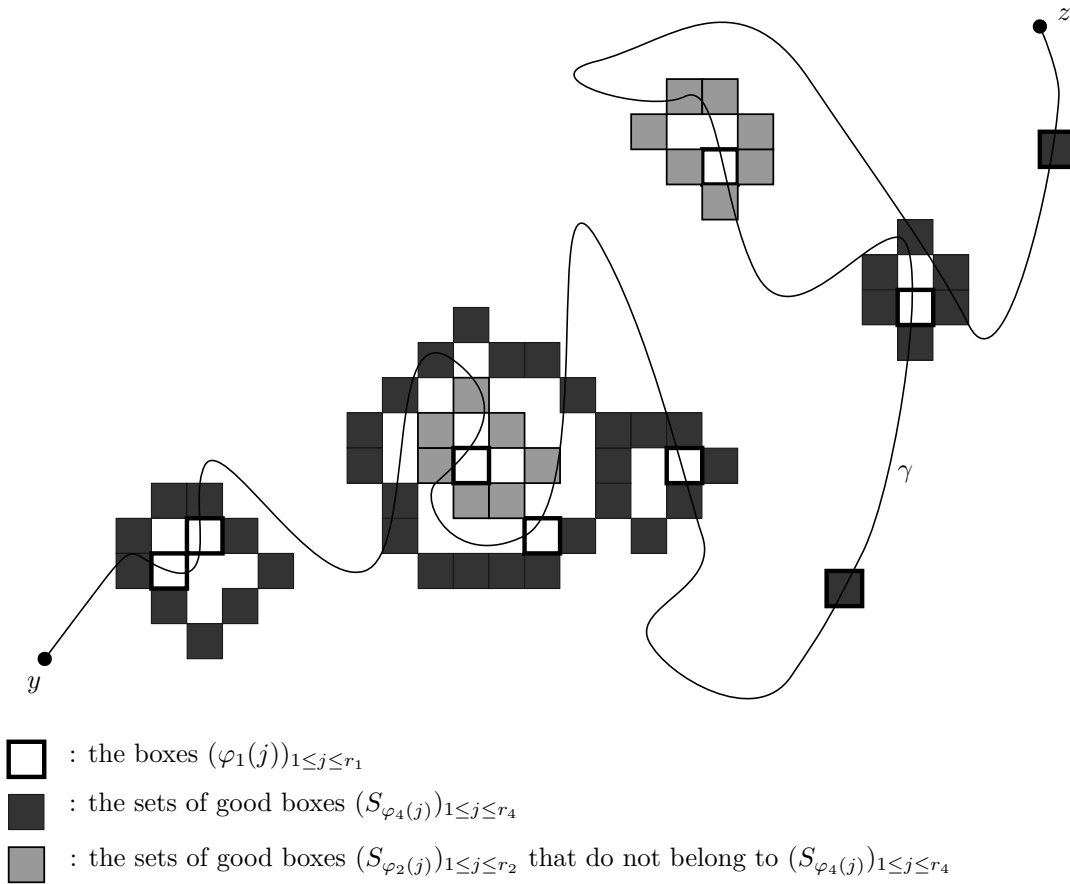

Figure 5.1 – Construction of the path γ' - First step

is in the interior of $S_{\varphi_2(k)}$. In that case, we only keep the largest connected component $S_{\varphi_2(k)}$: we obtain another subsequence $(S_{\varphi_3(j)})_{1 \leq j \leq r_3}$ with $r_3 \leq r_2$. Finally, we want to exclude a last case, when between the moment we enter for the first time in a given connected component and the last time we leave this connected component, we have explored other connected components of $(S_{\varphi_3(j)})_{1 \leq j \leq r_3}$. That is to say we want to remove the macroscopic loops γ makes between different visits of the same $*$ -connected components $S_{\varphi_3(j)}$ (see Figure 5.1). We iteratively extract from $(S_{\varphi_3(j)})_{1 \leq j \leq r_3}$ a sequence $(S_{\varphi_4(j)})_{1 \leq j \leq r_4}$ in the following way: $S_{\varphi_4(1)} = S_{\varphi_3(1)}$, assume $(S_{\varphi_4(j)})_{1 \leq j \leq k}$ is constructed $\varphi_4(k+1)$ is the smallest indice $\varphi_3(j)$ such that γ visits $S_{\varphi_3(j)}$ after its last visit to $S_{\varphi_4(k)}$. We stop the process when we cannot find such j . Of course, $r_4 \leq r_3$. The sequence $(S_{\varphi_4(j)})_{1 \leq j \leq r_4}$ is a sequence of sets of good N -boxes that are all visited by γ .

Let us introduce some notations (see Figure 5.2), we write $\gamma = (x_0, \dots, x_n)$. For all $k \in \{1, \dots, r_4\}$, we denote by $\Psi_{in}(k)$ (respectively $\Psi_{out}(k)$) the first moment that γ enters in $S_{\varphi_4(1)}$

(resp. last moment that γ exits from $S_{\varphi_4(1)}$). More precisely, we have

$$\Psi_{in}(1) = \min \{ j \geq 1, x_j \in S_{\varphi_4(1)} \}$$

and

$$\Psi_{out}(1) = \max \{ j \geq \Psi_{in}(1), x_j \in S_{\varphi_4(1)} \}.$$

Assume $\Psi_{in}(1), \dots, \Psi_{in}(k)$ and $\Psi_{out}(1), \dots, \Psi_{out}(k)$ are constructed then

$$\Psi_{in}(k+1) = \min \{ j \geq \Psi_{out}(k), x_j \in S_{\varphi_4(k+1)} \}$$

and

$$\Psi_{out}(k+1) = \max \{ j \geq \Psi_{in}(k+1), x_j \in S_{\varphi_4(k+1)} \}.$$

Let $B_{in}(j)$ be the N -box in $S_{\varphi_4(j)}$ containing $x_{\Psi_{in}(j)}$, $B_{out}(j)$ be the N -box in $S_{\varphi_4(j)}$ containing $x_{\Psi_{out}(j)}$. Let $\gamma(j)$ be the section of γ from $x_{\Psi_{out}(j)}$ to $x_{\Psi_{in}(j+1)}$ for $1 \leq j < r_4$, let $\gamma(0)$ (resp $\gamma(r_4)$) be the section of γ from y to $x_{\Psi_{in}(1)}$ (resp. from $x_{\Psi_{out}(r_4)}$ to z).

We have to study separately the beginning and the end of the path γ . Note that as the N -boxes of y and z both belong to an infinite cluster of good boxes, their box cannot be nested in a bigger $*$ -connected components of good boxes of the collection $(S_{\varphi_4(j)})_{1 \leq j \leq r_4}$. Thus, if $B_N(\mathbf{k})$, the N -box of y , contains a p -closed edge of γ , necessarily $S_{\varphi_4(1)}$ contains $B_N(\mathbf{k})$, $B_{in}(1) = B_N(\mathbf{k})$ and $x_{\Psi_{in}(1)} = y$. Similarly, if $B_N(\mathbf{l})$, the N -box of z , contains a p -closed edge of γ , necessarily $S_{\varphi_4(r_4)}$ contains $B_N(\mathbf{l})$, $B_{out}(r_4) = B_N(\mathbf{l})$ and $x_{\Psi_{out}(r_4)} = z$.

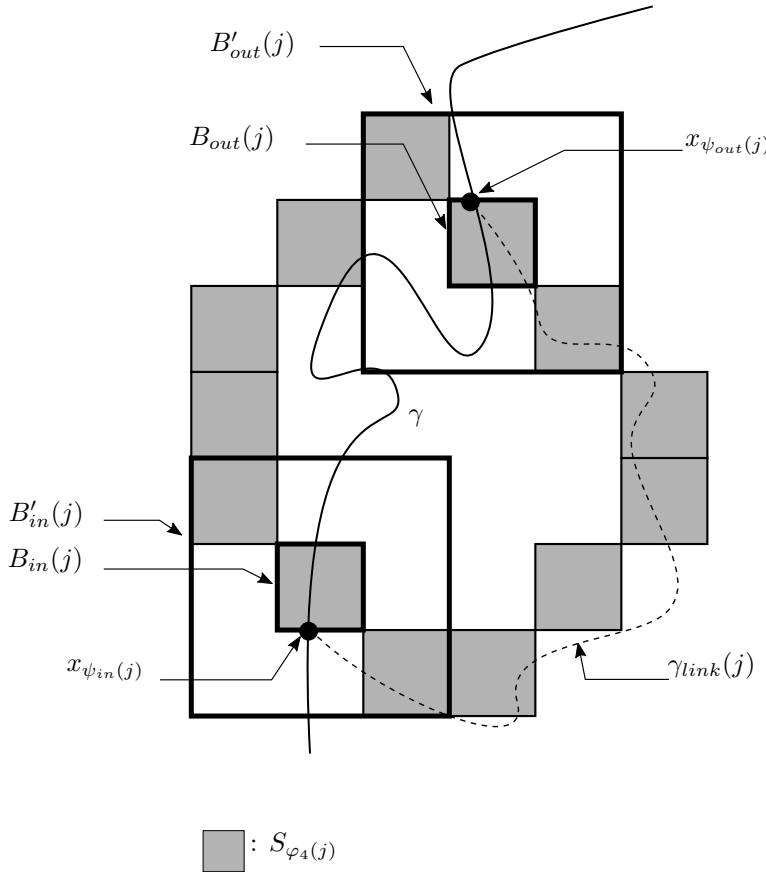

Figure 5.2 – Construction of the path γ' - Second step

In order to apply Lemma 3.4, let us show that for every $j \in \{1, \dots, r_4\}$, $x_{\Psi_{in}(j)}$ (resp. $x_{\Psi_{out}(j)}$) belongs to the p -crossing cluster of $B_{in}(j)$ (resp. $B_{out}(j)$). Let us study separately the case of $x_{\Psi_{in}(1)}$ and $x_{\Psi_{out}(r_4)}$. If $x_{\Psi_{in}(1)} = y$ then $x_{\Psi_{in}(1)}$ belongs to the p -crossing cluster of $B_{in}(j)$.

Suppose that $x_{\Psi_{in}(1)} \neq y$. As $y \in \mathcal{C}_p$ and y is connected to $x_{\Psi_{in}(1)}$ by a p -open path, $x_{\Psi_{in}(1)}$ is also in \mathcal{C}_p . By the property (i) of a good box applied to $B_{in}(1)$, we get that $x_{\Psi_{in}(1)}$ is in the p -crossing cluster of $B_{in}(1)$. We study the case of $x_{\Psi_{out}(r_4)}$ similarly. To study $x_{\Psi_{in}(j)}$ (resp. $x_{\Psi_{out}(j)}$) for $j \in \{2, \dots, r_4 - 1\}$, we use the fact that by construction, thanks to the extraction φ_2 , two different elements of $(S_{\varphi_4(j)})_{1 \leq j \leq r_4}$ are not $*$ -connected. Therefore, for $1 \leq j < r_4$, we have

$$\|x_{\Psi_{in}(j+1)} - x_{\Psi_{out}(j)}\|_1 \geq N$$

and so the section $\gamma(j)$ of γ from $x_{\Psi_{out}(j)}$ to $x_{\Psi_{in}(j+1)}$ has a diameter larger than N and contains only p -open edges. As $B_{out}(j)$ and $B_{in}(j+1)$ are good boxes, we obtain, using again property (i) of good boxes, that $x_{\Psi_{out}(j)}$ and $x_{\Psi_{in}(j+1)}$ belong to the p -crossing cluster of their respective boxes.

Finally, by Lemma 3.4, for every $j \in \{1, \dots, r_4\}$, there exists a p -open path $\gamma_{link}(j)$ joining $x_{\Psi_{in}(j)}$ and $x_{\Psi_{out}(j)}$ of length at most $12\beta N |S_{\varphi_4(j)}|$. We obtain a p -open path γ' joining y and z by concatenating $\gamma(0), \gamma_{link}(1), \gamma(1), \dots, \gamma_{link}(r_4), \gamma(r_4)$ in this order. Up to removing potential loops, we can suppose that each $\gamma_{link}(j)$ is a self-avoiding path, that all the $\gamma_{link}(j)$ are disjoint and that each $\gamma_{link}(j)$ intersects only $\gamma(j-1)$ and $\gamma(j)$ at their endpoints. Let us estimate the quantity $|\gamma' \setminus \gamma|$, as $\gamma' \setminus \gamma \subset \cup_{i=1}^{r_4} \gamma_{link}(i)$, we obtain:

$$\begin{aligned} |\gamma' \setminus \gamma| &\leq \sum_{j=1}^{r_4} |\gamma_{link}(j)| \\ &\leq \sum_{j=1}^{r_4} 12\beta N |S_{\varphi_4(j)}| \\ &\leq 12\beta N |\gamma_c| + 12\beta N \sum_{C \in \text{Bad}; C \cap \Gamma \neq \emptyset} |\partial_v C| \end{aligned}$$

where the last inequality comes from the fact that each $S_{\varphi_4(j)}$ is the union of elements of $\{\partial_v C : C \in \text{Bad}; C \cap \Gamma \neq \emptyset\}$ and of good boxes that contain edges of γ_c . We conclude by noticing that $|\partial_v C| \leq 2d|C|$. □

3.3 Deterministic estimate

When $q - p$ is small, we want to control the probability that the total length of the bypasses $\gamma' \setminus \gamma$ of p -closed edges is large. We can notice in Lemma 3.2 that we need to control the bad connected components of the macroscopic site percolation. This will be done in section 5. We will also need a deterministic control on $|\Gamma|$ which is the purpose of the following Lemma (this Lemma is an adaptation of Lemma 3.4 of [42]).

Lemma 3.5. *For every path γ of \mathbb{Z}^d , for every $N \in \mathbb{N}^*$, there exists a $*$ -connected macroscopic path $\tilde{\Gamma}$ such that*

$$\gamma \subset \bigcup_{i \in \tilde{\Gamma}} B'_N(i) \text{ and } |\tilde{\Gamma}| \leq 1 + \frac{|\gamma| + 1}{N}.$$

Proof. Let $\gamma = (x_i)_{1 \leq i \leq n}$ be a path of \mathbb{Z}^d where x_i is the i -th vertex of γ . Let Γ be the set of N -boxes that γ visits. We are going to define iteratively the macroscopic path $\tilde{\Gamma}$. Let $p(1) = 1$ and \mathbf{i}_1 be the macroscopic site such that $x_1 \in B_N(\mathbf{i}_1)$. We suppose that $\mathbf{i}_1, \dots, \mathbf{i}_k$ and $p(1), \dots, p(k)$ are constructed. Let us define

$$p(k+1) = \min \{j > p(k) : x_j \notin B'_N(\mathbf{i}_k)\}.$$

If this set is not empty, we set \mathbf{i}_{k+1} to be the macroscopic site such that

$$x_{p(k+1)} \in B_N(\mathbf{i}_{k+1}).$$

Otherwise, we stop the process, and we get that for every $j \in \{p(k), \dots, n\}$, $x_j \in B'_N(\mathbf{i}_k)$. As n is finite, the process will eventually stop and the two sequences $(p(1), \dots, p(r))$ and $(\mathbf{i}_1, \dots, \mathbf{i}_r)$

are finite. Note that the \mathbf{i}_j are not necessarily all different. We define $\tilde{\Gamma} = (\mathbf{i}_1, \dots, \mathbf{i}_r)$. By construction,

$$\gamma \subset \bigcup_{\mathbf{i} \in \tilde{\Gamma}} B'_N(\mathbf{i}).$$

Notice that for every $1 \leq k < r$, $\|x_{p(k+1)} - x_{p(k)}\|_1 \geq N$, thus $p(k+1) - p(k) \geq N$. This leads to $N(r-1) \leq p(r) - p(1) \leq n$, and finally,

$$|\tilde{\Gamma}| \leq 1 + \frac{|\gamma| + 1}{N}.$$

□

Remark 3.6. *This Lemma implies that if Γ is the set of N -boxes that γ visits then*

$$|\Gamma| \leq 3^d |\tilde{\Gamma}| \leq 3^d \left(1 + \frac{|\gamma| + 1}{N} \right).$$

4 Control of the probability that a box is good

We need in what follows to control the quantity $\sum |C|$ where the sum is over all $C \in \text{Bad}$ such that $C \cap \Gamma \neq \emptyset$. We would like to obtain a control which is uniform in the parameter of percolation p . To do so, we are going to introduce a parameter $p_0 > p_c(d)$ and show that exponential decay is uniform for all $p \geq p_0$. Indeed, the speed will only depend on p_0 .

Theorem 4.1. *Let $p_0 > p_c(d)$. There exist positive constants $A(p_0)$ and $B(p_0)$ such that for all $p \geq p_0$ and for all $N \geq 1$*

$$\mathbb{P}(B_N \text{ is } p\text{-bad}) \leq A(p_0) \exp(-B(p_0)N).$$

Note that the property (ii) of the definition of p -good box is a non-decreasing event in p . Thus, it will be easy to bound uniformly the probability that property (ii) is not satisfied by something depending only on p_0 . However, for properties (i) and (iii) a uniform bound is more delicate to obtain. Before proving Theorem 4.1, we need the two following lemmas that deal with properties (i) and (iii). Let $T_{m,N}(p)$ be the event that B_N has a p -crossing cluster and contains some other p -open cluster C having diameter at least m .

Lemma 4.2. *Let $p_0 > p_c(d)$, there exist $\nu = \nu(p_0, d) > 0$ and $\kappa = \kappa(p_0, d)$ such that for all $p \geq p_0$*

$$\mathbb{P}(T_{m,N}(p)) \leq \kappa N^{2d} \exp(-\nu m). \quad (4.1)$$

The following Lemma is an improvement of the result of Antal and Pisztora in [10] that controls the probability that two connected points have a too large chemical distance. In the original result, the constants depend on p , we slightly modify its proof so that constants are the same for all $p \geq p_0$. This improvement is required to obtain a decay that is uniform in p .

Lemma 4.3. *Let $p_0 > p_c(d)$, there exist $\beta = \beta(p_0) > 0$, $\hat{A} = \hat{A}(p_0)$ and $\hat{B} = \hat{B}(p_0) > 0$ such that for all $p \geq p_0$*

$$\forall x \in \mathbb{Z}^d \quad \mathbb{P}(\beta \|x\|_1 \leq D_p^{C'}(0, x) < +\infty) \leq \hat{A} \exp(-\hat{B} \|x\|_1). \quad (4.2)$$

Remark 4.4. *Note that this is not an immediate corollary of [10]. Although increasing the parameter of percolation p reduces the chemical distance, it also increases the probability that two vertices are connected. Therefore the event that we aim to control is neither non-increasing neither non-decreasing in p .*

Before proving these two lemmas, we are first going to prove Theorem 4.1.

Proof of Theorem 4.1. Let us fix $p_0 > p_c(d)$. Let us denote by $(iii)'$ the property that for all $x, y \in B'_N(\mathbf{i})$, if $\|x - y\|_\infty \geq N$ and if x and y belong to the p -crossing cluster \mathcal{C} then $D^{C'_p}(x, y) \leq 6\beta N$. Note that properties (ii) and $(iii)'$ imply property (iii) . Indeed, thanks to (ii) , we can find $z \in \mathcal{C} \cap B'_N(\mathbf{i})$ such that $\|x - z\|_\infty \geq N$ and $\|y - z\|_\infty \geq N$. Therefore, by applying $(iii)'$,

$$\begin{aligned} D^{C'_p}(x, y) &\leq D^{C'_p}(x, z) + D^{C'_p}(z, y) \\ &\leq 12\beta N. \end{aligned}$$

Thus, we can bound the probability that a N -box is bad by the probability that it does not satisfy one of the properties (i) , (ii) or $(iii)'$. Since we want to control the probability of B_N being a p -bad box uniformly in p , we will emphasize the dependence of (i) , (ii) and $(iii)'$ in p by writing $(i)_p$, $(ii)_p$ and $(iii)'_p$. First, let us prove that the probability that a N -box does not satisfy property $(ii)_p$, i.e., the probability for a box not to have a p -crossing cluster, is decaying exponentially, see for instance Theorem 7.68 in [48]. There exist positive constants $\kappa_1(p_0)$ and $\kappa_2(p_0)$ such that for all $p \geq p_0$

$$\begin{aligned} \mathbb{P}(B_N \text{ does not satisfies } (ii)_p) &\leq \mathbb{P}(B_N \text{ does not satisfies } (ii)_{p_0}) \\ &\leq \kappa_1(p_0) \exp(-\kappa_2(p_0)N^{d-1}). \end{aligned} \quad (4.3)$$

Next, let us bound the probability that a N -box does not satisfy property $(iii)'_p$. Using Lemma 4.3, for $p \geq p_0$,

$$\begin{aligned} \mathbb{P}(B_N \text{ does not satisfy } (iii)'_p) &\leq \sum_{x \in B'_N} \sum_{y \in B'_N} \mathbf{1}_{\|x-y\|_\infty \geq N} \mathbb{P}\left(6\beta N \leq D^{C'_p}(x, y) < +\infty\right) \\ &\leq \sum_{x \in B'_N} \sum_{y \in B'_N} \mathbf{1}_{\|x-y\|_\infty \geq N} \mathbb{P}\left(\beta\|x-y\|_\infty \leq D^{C'_p}(x, y) < +\infty\right) \\ &\leq \sum_{x \in B'_N} \sum_{y \in B'_N} \mathbf{1}_{\|x-y\|_\infty \geq N} \hat{A} \exp(-\hat{B}N) \\ &\leq (6N+1)^{2d} \hat{A} \exp(-\hat{B}N). \end{aligned}$$

Finally, by Lemma 4.2,

$$\begin{aligned} \mathbb{P}(B_N \text{ is } p\text{-bad}) &\leq \mathbb{P}(B_N \text{ does not satisfies } (ii)_p) + \mathbb{P}(B_N \text{ satisfies } (ii)_p \text{ but not } (i)_p) \\ &\quad + \mathbb{P}(B_N \text{ does not satisfy } (iii)'_p) \\ &\leq \kappa_1 \exp(-\kappa_2 N^{d-1}) + 3^d \kappa N^{2d} \exp\left(-\nu \frac{N}{3^d}\right) + (6N+1)^{2d} \hat{A} \exp(-\hat{B}N) \\ &\leq A(p_0) e^{-B(p_0)N}. \end{aligned}$$

For the second inequality, we used inequality (4.3) and the fact that the event that the 3^d N -boxes of B'_N are crossing and there exist another p -open cluster of diameter larger than N in B'_N is included in the event there exists a N -box in B'_N that has a crossing property and contains another p -open cluster of diameter at least $N/3^d$. The last inequality holds for $N \geq C_0(p_0)$, where $C_0(p_0)$, $A(p_0) > 0$ and $B(p_0) > 0$ depends only on p_0 and on the dimension d . \square

Proof of Lemma 4.2. In dimension $d \geq 3$, we refer to the proof of Lemma 7.104 in [48]. The proof of Lemma 7.104 requires the proof of Lemma 7.78. The probability controlled in Lemma 7.78 is clearly non decreasing in the parameter p . Thus, if we choose $\delta(p_0)$ and $L(p_0)$ as in the proof of Lemma 7.78 for $p_0 > p_c(d)$, then these parameters can be kept unchanged for some $p \geq p_0$. Thanks to Lemma 7.104, we obtain

$$\begin{aligned} \forall p \geq p_0, \mathbb{P}(T_{m,N}(p)) &\leq d(2N+1)^{2d} \exp\left(\left(\frac{m}{L(p_0)+1} - 1\right) \log(1 - \delta(p_0))\right) \\ &\leq \frac{d \cdot 3^d}{1 - \delta(p_0)} N^{2d} \exp\left(-\frac{-\log(1 - \delta(p_0))}{L(p_0)+1} m\right). \end{aligned}$$

We get the result with $\kappa = \frac{d \cdot 3^d}{1 - \delta(p_0)}$ and $\nu = \frac{-\log(1 - \delta(p_0))}{L(p_0) + 1} > 0$.

In dimension 2, the result is obtained by Couronné and Messikh in the more general setting of FK-percolation in Theorem 9 in [30]. We proceed similarly as in dimension $d \geq 3$, the constant appearing in this theorem first appeared in Proposition 6. The probability of the event considered in this proposition is clearly increasing in the parameter of the underlying percolation, it is an event for the subcritical regime of the Bernoulli percolation. Let us fix a $p_0 > p_c(2) = 1/2$, then $1 - p_0 < p_c(2)$ and we can choose the parameter $c(1 - p_0)$ and keep it unchanged for some $1 - p \leq 1 - p_0$. In Theorem 9, we get the expected result with $c(1 - p_0)$ for a $p \geq p_0$ and $g(n) = n$. \square

We explain now how to modify the proof of [10] to obtain the uniformity in p .

Proof of Lemma 4.3. Let $p_0 > p_c(d)$ and $p \geq p_0$. First note that the constant ρ appearing in [10] corresponds to our β . the proof of Lemma 2.3 in [10] can be adapted (as we did above in the proof of Lemma 4.2) to choose constants c_3, c_4, c_6 and c_7 that depend only on p_0 and d , we do not get into details again. Thanks to this, N may be chosen in the expression (4.47) of [10] such that it only depends on p_0 and d and so is ρ . This concludes the proof. \square

5 Probabilistic estimates

We can now use the stochastic minoration by a field of independent Bernoulli variables to control the probability that the quantity $\sum |C|$ is big, where the sum is over all $C \in \text{Bad}$ such that $C \cap \Gamma \neq \emptyset$. The proof of the following Lemma is in the spirit of the work of Cox and Kesten in [33] and relies on combinatorial considerations. These combinatorial considerations were not necessary in [42].

We consider a path γ and its associated lattice animal Γ . We need in the proof of the following Lemma to define $\tilde{\Gamma}$ as a path of macroscopic sites, that is to say a path $(\mathbf{i}_k)_{k \leq r}$ in the macroscopic grid such that $\cup_{k \leq r} B_N(\mathbf{i}_k) = \Gamma$ (this path may not be self-avoiding). We can choose for instance the sequence of sites that γ visits. However, it is difficult to control the size of this sequence by the size of Γ . That is the reason why we consider the path of the macroscopic grid $\tilde{\Gamma}$ that was introduced in Lemma 3.5.

Proposition 5.1. *Let $p_0 > p_c(d)$ and $\varepsilon \in (0, 1 - p_c(d))$. There exist a constant $C_\varepsilon \in (0, 1)$ depending only on ε and a positive constant C_1 depending on p_0, d and β , such that if we set $N = C_1 |\log \varepsilon|$, then for all $p \geq p_0$, for every $n \in \mathbb{N}^*$*

$$\mathbb{P} \left(\exists \gamma \text{ starting from } 0 \text{ such that } |\tilde{\Gamma}| \leq n, \quad \sum_{C \in \text{Bad}: C \cap \Gamma \neq \emptyset} |C| \geq \varepsilon n \right) \leq C_\varepsilon^n$$

where Γ is the lattice animal associated with the path γ and $\tilde{\Gamma}$ the macroscopic path given by Lemma 3.5.

Proof. Let us consider a path γ starting from 0, its associated lattice animal Γ , i.e., the set of boxes γ visits and its associated path on the macroscopic grid $\tilde{\Gamma} = (\tilde{\Gamma}(k))_{0 \leq k \leq r}$ as defined in Lemma 3.5. We first want to include $\tilde{\Gamma}$ in a subset of the macroscopic grid. Of course, $\tilde{\Gamma}$ is included in the hypercube of side-length $2r$ centered at $\tilde{\Gamma}(0)$, but we need to have a more precise control. Let $K \geq 1$ be an integer that we will choose later. Let v be a site, we denote by $S(v)$ the hypercube of side-length $2K$ centered at v and by $\partial S(v)$ its inner boundary:

$$S(v) = \{w \in \mathbb{Z}^d : \|w - v\|_\infty \leq K\} \quad \text{and} \quad \partial S(v) = \{w \in \mathbb{Z}^d : \|w - v\|_\infty = K\}.$$

We define $v(0) = \tilde{\Gamma}(0)$, $p_0 = 0$. If p_0, \dots, p_k and $v(0), \dots, v(k)$ are constructed, we define if any

$$p_{k+1} = \min \left\{ i \in \{p_k + 1, \dots, r\} : \tilde{\Gamma}(i) \in \partial S(v(k)) \right\} \quad \text{and} \quad v(k+1) = \tilde{\Gamma}(p_{k+1}).$$

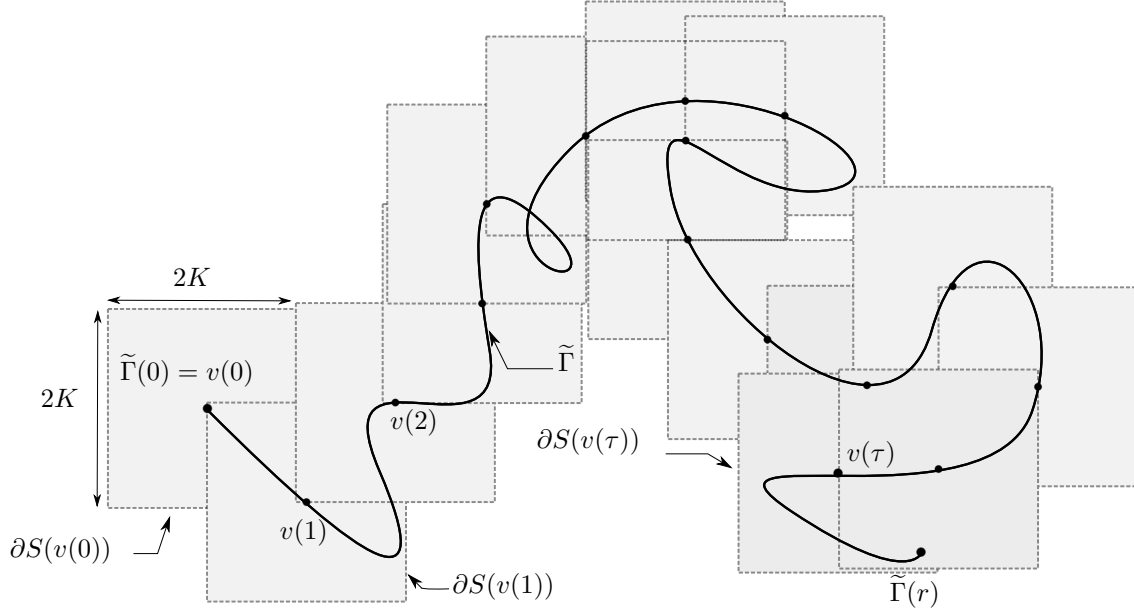
Figure 5.3 – Construction of $v(0), \dots, v(\tau)$

If there is no such index we stop the process. Since $p_{k+1} - p_k \geq K$, there are at most $1 + r/K$ such p_k . Notice that $1 + r/K \leq 1 + n/K$ on the event $\{|\tilde{\Gamma}| \leq n\}$. We define $\tau = 1 + n/K$. On the event $\{|\tilde{\Gamma}| \leq n\}$, the macroscopic path $\tilde{\Gamma}$ is contained in the union of those hypercubes:

$$D(v(0), \dots, v(\tau)) = \bigcup_{i=0}^{\tau} S(v(i)).$$

If we stop the process for a $k < \tau$, we artificially complete the sequence until attaining τ by setting for $k < j \leq \tau$, $v(j) = v(k)$. See figure 5, the corridor $D(v(0), \dots, v(\tau))$ is represented by the grey section. By construction, for all $1 \leq k \leq r$, there exists a $j \leq \tau$ such that $\tilde{\Gamma}(k)$ is in the strict interior of $S(v(j))$, so we have

$$\Gamma \subset \bigcup_{k=1}^r \left\{ \mathbf{j}, \mathbf{j} \text{ is } * \text{-connected to } \tilde{\Gamma}(k) \right\} \subset D(v(0), \dots, v(\tau)).$$

Thus, we obtain

$$\begin{aligned} & \mathbb{P} \left(\exists \gamma \text{ starting from } 0 \text{ such that } |\tilde{\Gamma}| \leq n, \sum_{C \in \text{Bad}: C \cap \Gamma \neq \emptyset} |C| \geq \varepsilon n \right) \\ & \leq \mathbb{P} \left(\bigcup_{v(0), \dots, v(\tau)} \left\{ \sum_{C \in \text{Bad}: C \cap \Gamma \neq \emptyset} |C| \geq \varepsilon n, \Gamma \subset D(v(0), \dots, v(\tau)) \right\} \right) \\ & \leq \sum_{v(0), \dots, v(\tau)} \mathbb{P} \left(\sum_{C \in \text{Bad}: C \cap \Gamma \neq \emptyset} |C| \geq \varepsilon n, \Gamma \subset D(v(0), \dots, v(\tau)) \right) \\ & \leq \sum_{v(0), \dots, v(\tau)} \mathbb{P} \left(\sum_{\substack{C \in \text{Bad}: \\ C \cap D(v(0), \dots, v(\tau)) \neq \emptyset}} |C| \geq \varepsilon n \right) \end{aligned}$$

$$\leq \sum_{v(0), \dots, v(\tau)} \sum_{j \geq \varepsilon n} \mathbb{P} \left(\sum_{\substack{C \in \text{Bad}: \\ C \cap D(v(0), \dots, v(\tau)) \neq \emptyset}} |C| = j \right)$$

where the first sum is over the sites $v(0), \dots, v(\tau)$ satisfying $v(0) = \Gamma(1)$ and for all $0 \leq k < \tau$, $v(k+1) \in \partial S(v(k)) \cup \{v(k)\}$. Since $\partial S(v) \cup \{v\}$ contains at most $(c_d K)^{d-1}$ sites where $c_d \geq 1$ is a constant depending only on the dimension, the sum over the sites $v(0), \dots, v(\tau)$ contains at most

$$(c_d K)^{(d-1)\tau} \leq (c_d K)^{\frac{2n(d-1)}{K}} := C_2^n$$

terms for n large enough. For any fixed $v(0), \dots, v(\tau)$, $D(v(0), \dots, v(\tau))$ contains at most

$$(\tau+1)(2K+1)^d \leq (n/K+2)(2K+1)^d \leq 2n(3K)^d := C_3 n$$

macroscopic sites. Let us recall that for a bad macroscopic site \mathbf{i} , $C(\mathbf{i})$ denotes the connected cluster of bad macroscopic sites containing \mathbf{i} . Let us notice that the following event

$$\left\{ \sum_{\substack{C \in \text{Bad}: \\ C \cap D(v(0), \dots, v(\tau)) \neq \emptyset}} |C| = j \right\}$$

is included in the event: there exist an integer $\rho \leq C_3 n$ and distinct bad macroscopic sites $\mathbf{i}_1, \dots, \mathbf{i}_\rho \in D(v(0), \dots, v(\tau))$, disjoint connected components $\bar{C}_1, \dots, \bar{C}_\rho$ such that for all $1 \leq k \leq \rho$, $C(\mathbf{i}_k) = \bar{C}_k$ and $\sum_{k=1}^{\rho} |\bar{C}_k| = j$. Therefore, for any fixed $v(0), \dots, v(\tau)$,

$$\begin{aligned} & \mathbb{P} \left(\sum_{\substack{C \in \text{Bad}: \\ C \cap D(v(0), \dots, v(\tau)) \neq \emptyset}} |C| = j \right) \\ &= \sum_{\rho=1}^{C_3 n} \sum_{\substack{\mathbf{i}_1 \in D(v(0), \dots, v(\tau)) \\ \mathbf{i}_\rho \in D(v(0), \dots, v(\tau)) \\ \forall k \neq l, \mathbf{i}_k \neq \mathbf{i}_l}} \sum_{\substack{j_1, \dots, j_\rho \geq 1 \\ j_1 + \dots + j_\rho = j}} \sum_{\substack{C_1 \in \text{Animals}_{\mathbf{i}_1}^{j_1} \\ \dots \\ C_\rho \in \text{Animals}_{\mathbf{i}_\rho}^{j_\rho}}} \mathbb{P} \left(\begin{array}{l} \forall 1 \leq k \leq \rho \\ C(\mathbf{i}_k) = \bar{C}_k, \\ \sum_{k=1}^{\rho} |\bar{C}_k| = j \end{array} \right) \end{aligned} \quad (5.1)$$

where $\text{Animals}_{\mathbf{v}}^k$ is the set of connected macroscopic sites of size k containing the site \mathbf{v} . We have $|\text{Animals}_{\mathbf{v}}^k| \leq (7^d)^k$ (see for instance Grimmett [48], p85). There are at most $\binom{C_3 n}{\rho}$ ways of choosing the sites $\mathbf{i}_1, \dots, \mathbf{i}_\rho$. Thus, if we fix the sites $\mathbf{i}_1, \dots, \mathbf{i}_\rho$ the number of possible choices of the connected components $\bar{C}_1, \dots, \bar{C}_\rho$ such that for all $1 \leq k \leq \rho$, $C(\mathbf{i}_k) = \bar{C}_k$ and $\sum_{k=1}^{\rho} |\bar{C}_k| = j$ is at most:

$$\sum_{\substack{j_1, \dots, j_\rho \geq 1 \\ j_1 + \dots + j_\rho = j}} (7^d)^{j_1} \dots (7^d)^{j_\rho} = (7^d)^j \sum_{\substack{j_1, \dots, j_\rho \geq 1 \\ j_1 + \dots + j_\rho = j}} 1.$$

Next we need to estimate, for given sites $\mathbf{i}_1, \dots, \mathbf{i}_\rho$ and disjoint connected components $\bar{C}_1, \dots, \bar{C}_\rho$, the probability that for all $1 \leq k \leq \rho$, $C(\mathbf{i}_k) = \bar{C}_k$. For all sites $\mathbf{i} \in \cup_{k=1}^{\rho} \bar{C}_k$, the N -box $B_N(\mathbf{i})$ is bad. There is a short range of dependence between the state of the boxes. However, by definition of a p -good box, the state of $B_N(\mathbf{i})$ only depends on boxes $B_N(\mathbf{j})$ such that $\|\mathbf{i} - \mathbf{j}\|_\infty \leq 13\beta$. Thus, if $\|\mathbf{i} - \mathbf{j}\|_\infty \geq 27\beta$ the state of the boxes $B_N(\mathbf{i})$ and $B_N(\mathbf{j})$ are independent. We can deterministically extract from $\cup_{k=1}^{\rho} \bar{C}_k$ a set of macroscopic site \mathcal{E} such that $|\mathcal{E}| \geq j/(27\beta)^d$ and for any $\mathbf{i} \neq \mathbf{j} \in \mathcal{E}$, the state of the boxes $B_N(\mathbf{i})$ and $B_N(\mathbf{j})$ are independent. Therefore, we have using Proposition 4.1

$$\begin{aligned} \mathbb{P} \left(\forall 1 \leq k \leq \rho, C(\mathbf{i}_k) = \bar{C}_k, \sum_{k=1}^{\rho} |\bar{C}_k| = j \right) &\leq \mathbb{P}(\forall \mathbf{i} \in \mathcal{E}, B_N(\mathbf{i}) \text{ is } p\text{-bad}) \\ &\leq \mathbb{P}(B_N(\mathbf{0}) \text{ is } p\text{-bad})^{j/(27\beta)^d} \\ &\leq (A(p_0) \exp(-B(p_0)N(\varepsilon)))^{j/(27\beta)^d}. \end{aligned} \quad (5.2)$$

In what follows, we set $\alpha = \alpha(\varepsilon) = (A(p_0) \exp(-B(p_0)N(\varepsilon)))^{1/(27\beta)^d}$ in order to lighten the notations. We aim to find an expression of $\alpha(\varepsilon)$ such that we get the upper bound stated in the Proposition. The expression of $N(\varepsilon)$ will be determined by the choice of $\alpha(\varepsilon)$. Combining inequalities (5.1) and (5.2), we obtain

$$\mathbb{P} \left(\sum_{\substack{C \in \text{Bad}: \\ C \cap D(v(0), \dots, v(\tau)) \neq \emptyset}} |C| = j \right) \leq \binom{C_3 n}{\rho} (7^d \alpha)^j \sum_{\substack{j_1, \dots, j_\rho \geq 1 \\ j_1 + \dots + j_\rho = j}} 1$$

and so

$$\begin{aligned} \mathbb{P} \left(\exists \gamma \text{ starting from } 0 \text{ such that } |\tilde{\Gamma}| \leq n, \sum_{C \in \text{Bad}: C \cap \Gamma \neq \emptyset} |C| \geq \varepsilon n \right) \\ \leq C_2^n \sum_{j \geq \varepsilon n} (7^d \alpha)^j \sum_{\rho=1}^{C_3 n} \binom{C_3 n}{\rho} \sum_{\substack{j_1, \dots, j_\rho \geq 1 \\ j_1 + \dots + j_\rho = j}} 1. \end{aligned}$$

Notice that

$$\sum_{\rho=1}^{C_3 n} \binom{C_3 n}{\rho} \sum_{\substack{j_1, \dots, j_\rho \geq 1 \\ j_1 + \dots + j_\rho = j}} 1 = \sum_{\substack{j_1, \dots, j_{C_3 \cdot n} \geq 0 \\ j_1 + \dots + j_{C_3 \cdot n} = j}} 1 = \binom{C_3 n + j - 1}{j}.$$

To bound those terms we will need the following inequality, for $r \geq 3$, $N \in \mathbb{N}^*$ and a real z such that $0 < ez(1 + \frac{r}{N}) < 1$:

$$\sum_{j=N}^{\infty} z^j \binom{r+j-1}{j} \leq \nu \frac{(ez(1 + \frac{r}{N}))^N}{1 - ez(1 + \frac{r}{N})} \quad (5.3)$$

where ν is an absolute constant. This inequality was present in [33] but without proof, for completeness we will give a proof of (5.3) at the end of the proof of Proposition 5.1. Using inequality (5.3) and assuming $0 < e7^d \alpha(\varepsilon)(1 + \frac{C_3}{\varepsilon}) < 1$, we get,

$$\begin{aligned} \mathbb{P} \left(\exists \gamma \text{ starting from } 0 \text{ such that } |\tilde{\Gamma}| \leq n, \sum_{C \in \text{Bad}: C \cap \Gamma \neq \emptyset} |C| \geq \varepsilon n \right) \\ \leq C_2^n \sum_{j \geq \varepsilon n} (7^d \alpha)^j \binom{C_3 n + j - 1}{j} \\ \leq \nu C_2^n \frac{[e7^d \alpha(\varepsilon)(1 + \frac{C_3}{\varepsilon})]^{\varepsilon n}}{1 - e7^d \alpha(\varepsilon)(1 + \frac{C_3}{\varepsilon})}. \end{aligned}$$

Let us recall that $C_2 = (c_d K)^{2(d-1)/K}$ and $C_3 = 2(3K)^d$. We have to choose $K(\varepsilon)$, $\alpha(\varepsilon)$ and a constant $0 < C_\varepsilon < 1$ such that $C_2 [e7^d \alpha(\varepsilon)(1 + \frac{C_3}{\varepsilon})]^\varepsilon < C_\varepsilon$ that is to say

$$(c_d K)^{\frac{2(d-1)}{K}} \left[e7^d \alpha(\varepsilon) \left(1 + \frac{2(3K)^d}{\varepsilon} \right) \right]^\varepsilon < C_\varepsilon. \quad (5.4)$$

Note that the condition (5.4) implies the condition $0 < e7^d \alpha(\varepsilon)(1 + \frac{C_3}{\varepsilon}) < 1$. We fix K the unique

integer such that $\frac{1}{\varepsilon} \leq K < \frac{1}{\varepsilon} + 1 \leq \frac{2}{\varepsilon}$. We recall that $\varepsilon < 1$. Thus,

$$\begin{aligned}
& (c_d K)^{\frac{2(d-1)}{K}} \left[e7^d \alpha(\varepsilon) \left(1 + \frac{2(3K)^d}{\varepsilon} \right) \right]^\varepsilon \\
& \leq (c_d K)^{\frac{2d}{K}} \left[e7^d \alpha(\varepsilon) \frac{4(3K)^d}{\varepsilon} \right]^\varepsilon \\
& \leq \exp \left[\frac{2d}{K} \log(c_d K) + \varepsilon \log \left(e7^d \alpha(\varepsilon) \frac{4(3K)^d}{\varepsilon} \right) \right] \\
& \leq \exp \left[2d\varepsilon \log \left(\frac{2c_d}{\varepsilon} \right) + \varepsilon \log \left(e7^d \alpha(\varepsilon) \frac{4(3\frac{2}{\varepsilon})^d}{\varepsilon} \right) \right] \\
& \leq \exp \left[-2d\varepsilon \log \varepsilon + d\varepsilon \log(2c_d) + \varepsilon \log \left(4e(42)^d \alpha(\varepsilon) \frac{1}{\varepsilon^{d+1}} \right) \right].
\end{aligned}$$

We set

$$\alpha(\varepsilon) = (2c_d)^d \frac{\varepsilon^r}{4e(42)^d}$$

where r is the smallest integer such that $r \geq 3d + 2$. We obtain

$$\begin{aligned}
(c_d K)^{\frac{d}{K}} \left[e7^d \alpha(\varepsilon) \left(1 + \frac{2(3K)^d}{\varepsilon} \right) \right]^\varepsilon & \leq \exp((r - (3d + 1))\varepsilon \log \varepsilon) \\
& \leq \exp(\varepsilon \log \varepsilon) < 1.
\end{aligned}$$

Therefore there exists a positive constant C_1 depending on β, d, p_0 such that

$$N(\varepsilon) = C_1 |\log \varepsilon|.$$

It remains now to prove inequality (5.3) to conclude. To show this inequality, we need a version of Stirling's formula with bounds: for all $n \in \mathbb{N}^*$, one has

$$\sqrt{2\pi} n^{n+\frac{1}{2}} e^{-n} \leq n! \leq e n^{n+\frac{1}{2}} e^{-n},$$

thus,

$$\begin{aligned}
\sum_{j=N}^{\infty} z^j \binom{r+j-1}{j} & = \sum_{j=N}^{\infty} z^j \frac{(r+j-1)!}{j!(r-1)!} \\
& \leq \sum_{j=N}^{\infty} z^j \frac{e(r+j-1)^{r+j-\frac{1}{2}} e^{-(r+j-1)}}{2\pi j^{j+\frac{1}{2}} (r-1)^{r-\frac{1}{2}} e^{-(r+j-1)}} \\
& = \sum_{j=N}^{\infty} \frac{e}{2\pi} z^j \left(\frac{r+j-1}{j} \right)^j \left(\frac{r+j-1}{r-1} \right)^{r-\frac{1}{2}} j^{-\frac{1}{2}} \\
& \leq \sum_{j=N}^{\infty} \frac{e}{2\pi} z^j \left(1 + \frac{r}{N} \right)^j \left(1 + \frac{j}{r-1} \right)^{r-1} \left(\frac{1}{j} + \frac{1}{r-1} \right)^{\frac{1}{2}} \\
& \leq \sum_{j=N}^{\infty} \frac{e}{2\pi} z^j \left(1 + \frac{r}{N} \right)^j e^{(r-1) \log(1+j/(r-1))} \\
& \leq \sum_{j=N}^{\infty} \frac{e}{2\pi} (ez)^j \left(1 + \frac{r}{N} \right)^j = \frac{e}{2\pi} \frac{(ez(1 + \frac{r}{N}))^N}{1 - ez(1 + \frac{r}{N})}
\end{aligned}$$

where we use in the last inequality the fact that for all $x > 0$, $\log(1+x) \leq x$. □

6 Regularity of the time constant

In this section, we prove the main result Theorem 1.1 and its Corollary 1.2. Before proving this Theorem, we need to prove two lemmas. The following Lemma enables to control the number of p -closed edges $|\gamma_c|$ in a geodesic γ between two given points y and z in the infinite cluster \mathcal{C}_p . We denote by F_x the event that $0, x \in \mathcal{C}_p$ and the N -boxes containing 0 and x belong to an infinite cluster of p -good boxes.

Lemma 6.1. *Let $p_c(d) < p \leq q$. Let us consider $x \in \mathbb{Z}^d$. Then, for $\delta > 0$*

$$\mathbb{P} \left(F_x, D^{\mathcal{C}_p}(0, x) > D^{\mathcal{C}_q}(0, x) \left(1 + \rho_d N \left(\frac{q-p}{q} + \delta \right) \right) + \rho_d N \sum_{\substack{C \in \text{Bad}: \\ C \cap \Gamma \neq \emptyset}} |C| \right) \leq e^{-2\delta^2 \|x\|_1} .$$

where Γ is the lattice animal of N -boxes visited by an optimal path γ between 0 and x in \mathcal{C}_q .

Proof. On the event F_x , we have $0, x \in \mathcal{C}_p \subset \mathcal{C}_q$ so there exists a q -open path joining 0 to x , let γ be an optimal one. Necessarily, we have $|\gamma| \geq \|x\|_1$. We consider the modification γ' given by Lemma 3.2. As γ' is p -open,

$$\begin{aligned} D^{\mathcal{C}_p}(0, x) &< |\gamma'| \leq |\gamma \cap \gamma'| + |\gamma' \setminus \gamma| \\ &\leq |\gamma| + \rho_d \left(N |\gamma_c| + N \sum_{C \in \text{Bad}: C \cap \Gamma \neq \emptyset} |C| \right) \\ &\leq D^{\mathcal{C}_q}(0, x) + \rho_d \left(N |\gamma_c| + N \sum_{C \in \text{Bad}: C \cap \Gamma \neq \emptyset} |C| \right) . \end{aligned} \quad (6.1)$$

We want to control the size of γ_c . For that purpose, we want to introduce a coupling of the percolations q and p , such that if any edge is p -open then it is q -open, and we want the random path γ , which is an optimal q -open path between 0 and x , to be independent of the p -state of any edge, i.e., any edge is p -open or p -closed independently of γ . This is not the case when we use the classic coupling with a unique uniform random variable for each edge. Here we introduce two sources of randomness to ease the computations by making the choice of γ independent from the p -state of its edges. We proceed in the following way: with each edge we associate two independent Bernoulli random variables V and Z of parameters respectively q and p/q . Then $W = Z \cdot V$ is also a Bernoulli random variable of parameter p . This implies

$$\mathbb{P}(W = 0 | V = 1) = \mathbb{P}(Z = 0 | V = 1) = \mathbb{P}(Z = 0) = 1 - \frac{p}{q} = \frac{q-p}{q} .$$

Thus, we can now bound the following quantity by summing on all possible self-avoiding paths for γ . For short, we use the abbreviation s.a. for self-avoiding.

$$\begin{aligned} &\mathbb{P} \left(|\gamma_c| \geq |\gamma| \left(\frac{q-p}{q} + \delta \right) \right) \\ &= \sum_{k=\|x\|_1}^{\infty} \sum_{\substack{|r|=k \\ \text{r s.a. path}}} \mathbb{P} \left(\gamma = r, |\gamma_c| \geq |\gamma| \left(\frac{q-p}{q} + \delta \right) \right) \\ &= \sum_{k=\|x\|_1}^{\infty} \sum_{\substack{|r|=k \\ \text{r s.a. path}}} \mathbb{P} \left(\gamma = r, |\{e \in r : e \text{ is } p\text{-closed}\}| \geq k \left(\frac{q-p}{q} + \delta \right) \right) \\ &= \sum_{k=\|x\|_1}^{\infty} \sum_{\substack{|r|=k \\ \text{r s.a. path}}} \mathbb{P} \left(\gamma = r, |\{e \in r : Z(e) = 0\}| \geq k \left(\frac{q-p}{q} + \delta \right) \right) \end{aligned}$$

$$\begin{aligned}
&= \sum_{k=\|x\|_1}^{\infty} \sum_{\substack{|r|=k \\ \text{r s.a. path}}} \mathbb{P}(\gamma = r) \mathbb{P}\left(\left|\{e \in r : Z(e) = 0\}\right| \geq k \left(\frac{q-p}{q} + \delta\right)\right) \\
&\leq \sum_{k=\|x\|_1}^{\infty} \sum_{\substack{|r|=k \\ \text{r s.a. path}}} \mathbb{P}(\gamma = r) e^{-2\delta^2 k} \leq e^{-2\delta^2 \|x\|_1}
\end{aligned} \tag{6.2}$$

where we use Chernoff bound in the second to last inequality (see Theorem 1 in [50]). On the event $F_x \cap \left\{|\gamma_c| < |\gamma| \left(\frac{q-p}{q} + \delta\right)\right\}$, by (6.1), we get

$$\begin{aligned}
D^{\mathcal{C}_p}(0, x) &\leq D^{\mathcal{C}_q}(0, x) + \rho_d \left(N|\gamma| \left(\frac{q-p}{q} + \delta\right) + N \sum_{C \in \text{Bad}: C \cap \Gamma \neq \emptyset} |C| \right) \\
&= D^{\mathcal{C}_q}(0, x) \left(1 + \rho_d N \left(\frac{q-p}{q} + \delta\right) \right) + \rho_d N \sum_{C \in \text{Bad}: C \cap \Gamma \neq \emptyset} |C|
\end{aligned}$$

and the conclusion follows. \square

The proof of the following Lemma is the last step before proving Theorem 1.1.

Lemma 6.2. *Let $p_0 > p_c(d)$ and $\varepsilon \in (0, 1 - p_0)$, we set $N(\varepsilon)$ as in Proposition 5.1. There exists $\mathbf{p} := \mathbf{p}(\varepsilon, p_0) > 0$ such that for all $q \geq p \geq p_0$, for all $x \in \mathbb{Z}^d$ with $\|x\|_1$ large enough,*

$$\mathbb{P}\left(D^{\mathcal{C}_p}(\tilde{0}^{\mathcal{C}_p}, \tilde{x}^{\mathcal{C}_p}) \leq D^{\mathcal{C}_q}(\tilde{0}^{\mathcal{C}_p}, \tilde{x}^{\mathcal{C}_p}) \left(1 + \rho_d \frac{q-p}{q} N(\varepsilon)\right) + \eta_d \varepsilon \|x\|_1\right) \geq \mathbf{p}(\varepsilon, p_0)$$

where $\eta_d > 0$ is a constant depending only on d .

Proof. Let us fix $\varepsilon > 0$ and $N(\varepsilon)$ as in Proposition 5.1. Fix an $x \in \mathbb{Z}^d$ such that $\|x\|_1 \geq 3dN(\varepsilon)$. We denote by $B_{N(\varepsilon)}(0)$ (respectively $B_{N(\varepsilon)}(x)$) the $N(\varepsilon)$ -box containing 0 (rep. x) and by $\underline{\mathcal{C}}_p$ the union of infinite cluster of p -good boxes. We recall that

$$F_x = \{0 \in \mathcal{C}_p, x \in \mathcal{C}_p\} \cap \{B_{N(\varepsilon)}(0) \in \underline{\mathcal{C}}_p, B_{N(\varepsilon)}(x) \in \underline{\mathcal{C}}_p\}.$$

We have

$$\begin{aligned}
&\mathbb{P}\left(D^{\mathcal{C}_p}(\tilde{0}^{\mathcal{C}_p}, \tilde{x}^{\mathcal{C}_p}) \geq D^{\mathcal{C}_q}(\tilde{0}^{\mathcal{C}_p}, \tilde{x}^{\mathcal{C}_p}) \left(1 + \rho_d \frac{q-p}{q} N(\varepsilon)\right) + 3\varepsilon\beta\rho_d \|x\|_1\right) \\
&\leq \mathbb{P}\left(F_x, D^{\mathcal{C}_p}(0, x) \geq D^{\mathcal{C}_q}(0, x) \left(1 + \rho_d \frac{q-p}{q} N(\varepsilon)\right) + 3\varepsilon\beta\rho_d \|x\|_1\right) + \mathbb{P}(F_x^c).
\end{aligned} \tag{6.3}$$

We have

$$\mathbb{P}(F_x^c) \leq \mathbb{P}(\{0 \in \mathcal{C}_p, x \in \mathcal{C}_p\}^c) + \mathbb{P}(\{B_{N(\varepsilon)}(0) \in \underline{\mathcal{C}}_p, B_{N(\varepsilon)}(x) \in \underline{\mathcal{C}}_p\}^c).$$

Using FKG inequality, we have

$$\mathbb{P}(0 \in \mathcal{C}_p, x \in \mathcal{C}_p) \geq \mathbb{P}(0 \in \mathcal{C}_p)\mathbb{P}(x \in \mathcal{C}_p) \geq \theta_{p_0}^2.$$

Let us define $Y_{\mathbf{i}} = \mathbb{1}_{\{B_{N(\varepsilon)}(\mathbf{i}) \text{ is } p\text{-good}\}}$. First note that the field $(Y_{\mathbf{i}})_{\mathbf{i} \in \mathbb{Z}^d}$ has a finite range of dependence that depends on β and d . Using the stochastic comparison in [55], for every \mathbf{p}_1 , there exists a positive constant α depending on β , d and \mathbf{p}_1 such that if $\mathbb{P}(Y_{\mathbf{0}} = 0) \leq \alpha$ then the field $(Y_{\mathbf{i}})_{\mathbf{i} \in \mathbb{Z}^d}$ stochastically dominates a family of independent Bernoulli random variables with parameter \mathbf{p}_1 . Let us choose \mathbf{p}_1 large enough such that

$$1 - \theta_{\text{site}, \mathbf{p}_1}^2 \leq \frac{\theta_{p_0}^2}{2}$$

where $\theta_{site, \mathbf{p}_1}$ denotes the probability for a site to belong to the infinite cluster of i.i.d. Bernoulli site percolation of parameter \mathbf{p}_1 . Thanks to Theorem 4.1, there exists a positive integer N_0 depending only on α , p_0 and d such that for every $N \geq N_0$,

$$\mathbb{P}(Y_{\mathbf{0}} = 0) \leq \alpha.$$

For every $\varepsilon \leq 1 - p_0$, we have $|\log \varepsilon| \geq |\log(1 - p_0)|$. Up to taking a larger constant C_1 in the expression of $N(\varepsilon)$ stated in Proposition 5.1, *i.e.*, $N(\varepsilon) = C_1 |\log \varepsilon|$, we can assume without loss of generality that $N(\varepsilon) \geq N_0$ so that using the stochastic domination and FKG we obtain

$$\mathbb{P}(B_{N(\varepsilon)}(0) \in \underline{\mathcal{C}}_p, B_{N(\varepsilon)}(x) \in \underline{\mathcal{C}}_p) \geq \theta_{site, \mathbf{p}_1}^2.$$

Finally, we get

$$\mathbb{P}(F_x^c) \leq 1 - \theta_{p_0}^2 + 1 - \theta_{site, \mathbf{p}_1}^2 \leq 1 - \frac{\theta_{p_0}^2}{2}. \quad (6.4)$$

On the event F_x , we have $0, x \in \mathcal{C}_p \subset \mathcal{C}_q$, we can consider γ a geodesic from 0 to x in \mathcal{C}_q , and let Γ be the set of N -boxes that γ visits.

By Lemma 6.1, we have for every $\delta > 0$

$$\begin{aligned} & \mathbb{P}\left(F_x, D^{\mathcal{C}_p}(0, x) \geq D^{\mathcal{C}_q}(0, x) \left(1 + \rho_d \frac{q-p}{q} N(\varepsilon)\right) + 3\varepsilon\beta\rho_d \|x\|_1\right) \\ & \leq \mathbb{P}\left(F_x, \rho_d N(\varepsilon) \left(D^{\mathcal{C}_q}(0, x)\delta + \sum_{C \in \text{Bad}: C \cap \Gamma \neq \emptyset} |C|\right) \geq 3\varepsilon\beta \|x\|_1\right) \\ & \quad + \mathbb{P}\left(F_x, D^{\mathcal{C}_p}(0, x) > D^{\mathcal{C}_q}(0, x) \left(1 + \rho_d N(\varepsilon) \left(\frac{q-p}{q} + \delta\right)\right) + \rho_d N(\varepsilon) \sum_{\substack{C \in \text{Bad}: \\ C \cap \Gamma \neq \emptyset}} |C|\right) \\ & \leq \mathbb{P}\left(F_x, |\gamma| \leq \beta \|x\|_1, \sum_{C \in \text{Bad}: C \cap \Gamma \neq \emptyset} |C| \geq \frac{3\varepsilon\beta \|x\|_1}{N(\varepsilon)} - \delta |\gamma|\right) \\ & \quad + \mathbb{P}(F_x, |\gamma| > \beta \|x\|_1) + e^{-2\delta^2 \|x\|_1} \\ & \leq \mathbb{P}\left(F_x, |\gamma| \leq \beta \|x\|_1, \sum_{C \in \text{Bad}: C \cap \Gamma \neq \emptyset} |C| \geq \beta \|x\|_1 \left(\frac{3\varepsilon}{N(\varepsilon)} - \delta\right)\right) \\ & \quad + \mathbb{P}(F_x, |\gamma| > \beta \|x\|_1) + e^{-2\delta^2 \|x\|_1}. \end{aligned} \quad (6.5)$$

We set $\delta = \varepsilon/N(\varepsilon)$. We know by Lemma 3.5 that $|\tilde{\Gamma}| \leq 1 + (|\gamma| + 1)/N(\varepsilon)$. Moreover as $|\gamma| \geq 3dN(\varepsilon)$, we have $|\tilde{\Gamma}| \leq 2|\gamma|/N(\varepsilon)$. Using Proposition 5.1,

$$\begin{aligned} & \mathbb{P}\left(F_x, |\gamma| \leq \beta \|x\|_1, \sum_{C \in \text{Bad}: C \cap \Gamma \neq \emptyset} |C| \geq \beta \|x\|_1 \left(\frac{3\varepsilon}{N(\varepsilon)} - \delta\right)\right) \\ & \leq \mathbb{P}\left(\exists \gamma \text{ starting from } 0 \text{ such that } |\tilde{\Gamma}| \leq \frac{2\beta \|x\|_1}{N(\varepsilon)}, \sum_{C \in \text{Bad}: C \cap \Gamma \neq \emptyset} |C| \geq \varepsilon \frac{2\beta \|x\|_1}{N(\varepsilon)}\right) \leq C_\varepsilon^{2\beta \|x\|_1 / N(\varepsilon)} \end{aligned} \quad (6.6)$$

where $C_\varepsilon < 1$. Moreover, by Lemma 4.3, we get

$$\mathbb{P}(F_x, |\gamma| > \beta \|x\|_1) \leq \mathbb{P}(\beta \|x\|_1 \leq D^{\mathcal{C}_q}(0, x) < +\infty) \leq \hat{A} \exp(-\hat{B} \|x\|_1). \quad (6.7)$$

Finally, combining (6.3), (6.4), (6.5), (6.6) and (6.7), we obtain that

$$\begin{aligned} & \mathbb{P}\left(D^{\mathcal{C}_p}(\tilde{0}^{\mathcal{C}_p}, \tilde{x}^{\mathcal{C}_p}) \geq D^{\mathcal{C}_q}(\tilde{0}^{\mathcal{C}_p}, \tilde{x}^{\mathcal{C}_p}) \left(1 + \rho_d \frac{q-p}{q} N(\varepsilon)\right) + 3\varepsilon\beta\rho_d \|x\|_1\right) \\ & \leq 1 - \frac{\theta_{p_0}^2}{2} + C_\varepsilon^{2\beta \|x\|_1 / N(\varepsilon)} + \hat{A} e^{-\hat{B} \|x\|_1} + e^{-2\varepsilon^2 \|x\|_1 / N(\varepsilon)^2} \\ & \leq 1 - \mathbf{p}(\varepsilon, p_0) \end{aligned}$$

for an appropriate choice of $\mathbf{p}(\varepsilon, p_0) > 0$ and for every x such that $\|x\|_1$ is large enough. \square

Proof of Theorem 1.1. Let $\varepsilon > 0$, $\delta > 0$, $p_0 > p_c(d)$ and $x \in \mathbb{Z}^d$, consider $N(\varepsilon) = C_1 |\log \varepsilon|$ as in Proposition 5.1, $\mathbf{p} = \mathbf{p}(\varepsilon, p_0)$ as in Lemma 6.2 and $q \geq p \geq p_0$. With the convergence of the regularized times given by Proposition 2.1, we can choose n large enough such that

$$\begin{aligned} \mathbb{P} \left(\mu_p(x) - \delta \leq \frac{D^{c_p}(\tilde{0}^{c_p}, \tilde{n}x^{c_p})}{n} \right) &\geq 1 - \frac{\mathbf{p}}{3} \\ \mathbb{P} \left(\frac{D^{c_q}(\tilde{0}^{c_q}, \tilde{n}x^{c_q})}{n} \leq \mu_q(x) + \delta \right) &\geq 1 - \frac{\mathbf{p}}{3} \\ \mathbb{P} \left(D^{c_p}(\tilde{0}^{c_p}, \tilde{n}x^{c_p}) \leq D^{c_q}(\tilde{0}^{c_q}, \tilde{n}x^{c_q}) \left(1 + \rho_d \frac{q-p}{q} N(\varepsilon) \right) + \eta_d \varepsilon n \|x\|_1 \right) &\geq \mathbf{p}. \end{aligned}$$

The intersection of these three events has positive probability, we obtain on this intersection

$$\mu_p(x) - \delta \leq (\mu_q(x) + \delta) \left(1 + \rho_d \frac{q-p}{q} N(\varepsilon) \right) + \eta_d \varepsilon \|x\|_1.$$

By taking the limit when δ goes to 0 we get

$$\mu_p(x) \leq \mu_q(x) \left(1 + \rho_d \frac{q-p}{q} N(\varepsilon) \right) + \eta_d \varepsilon \|x\|_1.$$

By Corollary 2.2, we know that the map $p \rightarrow \mu_p$ is non-increasing. We also know that $\mu_p(x) \leq \|x\|_1 \mu_p(e_1)$ for $e_1 = (1, 0, \dots, 0)$, for any $p > p_c(d)$ and any $x \in \mathbb{Z}^d$. Thus, for every $\varepsilon > 0$,

$$\begin{aligned} \mu_p(x) - \mu_q(x) &\leq \mu_q(x) \rho_d \frac{q-p}{q} N(\varepsilon) + \eta_d \varepsilon \|x\|_1 \\ &\leq \mu_{p_0}(e_1) \|x\|_1 \rho_d \frac{q-p}{p_c(d)} N(\varepsilon) + \eta_d \varepsilon \|x\|_1 \\ &\leq \eta'_d(p_0) \|x\|_1 (N(\varepsilon)(q-p) + \varepsilon) \end{aligned}$$

where $\eta'_d(p_0)$ is a constant depending on d and p_0 . Using the expression of $N(\varepsilon)$ stated in Proposition 5.1, we obtain

$$\mu_p(x) - \mu_q(x) \leq \eta'_d \|x\|_1 (C_1 |\log \varepsilon| (q-p) + \varepsilon). \quad (6.8)$$

By setting $\varepsilon = q-p$ in the inequality, we get

$$\mu_p(x) - \mu_q(x) \leq \eta''_d \|x\|_1 (q-p) |\log(q-p)|$$

where $\eta''_d > 0$ depends only on p_0 and d . Thanks to Corollary 2.2, we have $\mu_p(x) - \mu_q(x) \geq 0$, so that

$$|\mu_p(x) - \mu_q(x)| \leq \eta''_d \|x\|_1 (q-p) |\log(q-p)|. \quad (6.9)$$

By homogeneity, (6.9) also holds for all $x \in \mathbb{Q}^d$. Let us recall that for all $x, y \in \mathbb{R}^d$ and $p \geq p_c(d)$,

$$|\mu_p(x) - \mu_p(y)| \leq \mu_p(e_1) \|x - y\|_1, \quad (6.10)$$

see for instance Theorem 1 in [28]. Moreover, there exists a finite set (y_1, \dots, y_m) of rational points of \mathbb{S}^{d-1} such that

$$\mathbb{S}^{d-1} \subset \bigcup_{i=1}^m \left\{ x \in \mathbb{S}^{d-1} : \|y_i - x\|_1 \leq (q-p) |\log(q-p)| \right\}.$$

Let $x \in \mathbb{S}^{d-1}$ and y_i such that $\|y_i - x\|_1 \leq (q-p)|\log(q-p)|$. Using inequality (6.10), we get

$$\begin{aligned} & |\mu_p(x) - \mu_q(x)| \\ & \leq |\mu_p(x) - \mu_p(y_i)| + |\mu_p(y_i) - \mu_q(y_i)| + |\mu_q(y_i) - \mu_q(x)| \\ & \leq \mu_p(e_1)\|y_i - x\|_1 + \eta_d''\|y_i\|_1(q-p)|\log(q-p)| + \mu_q(e_1)\|y_i - x\|_1 \\ & \leq (2\mu_{p_0}(e_1) + \eta_d'')(q-p)|\log(q-p)|. \end{aligned}$$

This yields the result. \square

Proof of Corollary 1.2. Let $p_0 > p_c(d)$. We consider the constant κ_d appearing in the Theorem 1.1. Let $p \leq q$ in $[p_0, 1]$. We recall the following definition of the Hausdorff distance between two subsets E and F of \mathbb{R}^d :

$$d_{\mathcal{H}}(E, F) = \inf \left\{ r \in \mathbb{R}^+ : E \subset F^r \text{ and } F \subset E^r \right\}$$

where $E^r = \{y : \exists x \in E, \|y - x\|_2 \leq r\}$. Thus, we have

$$d_{\mathcal{H}}(\mathcal{B}_{\mu_p}, \mathcal{B}_{\mu_q}) \leq \sup_{y \in \mathbb{S}^{d-1}} \left\| \frac{y}{\mu_p(y)} - \frac{y}{\mu_q(y)} \right\|_2.$$

Note that $y/\mu_p(y)$ (resp. $y/\mu_q(y)$) is in the unit sphere for the norm μ_p (resp. μ_q). Let us define $\mu_p^{\min} = \inf_{x \in \mathbb{S}^{d-1}} \mu_p(x)$. As the map $p \rightarrow \mu_p$ is uniformly continuous on the sphere \mathbb{S}^{d-1} (see Theorem 1.2 in [42],) the map $p \rightarrow \mu_p^{\min}$ is also continuous and $\mu^{\min} = \inf_{p \in [p_0, 1]} \mu_p^{\min} > 0$. Finally

$$\begin{aligned} d_{\mathcal{H}}(\mathcal{B}_{\mu_p}, \mathcal{B}_{\mu_q}) & \leq \sup_{y \in \mathbb{S}^{d-1}} \left| \frac{1}{\mu_p(y)} - \frac{1}{\mu_q(y)} \right| \\ & \leq \sup_{y \in \mathbb{S}^{d-1}} \frac{1}{\mu_q(y)\mu_p(y)} |\mu_p(y) - \mu_q(y)| \\ & \leq \sup_{y \in \mathbb{S}^{d-1}} \frac{1}{(\mu^{\min})^2} |\mu_p(y) - \mu_q(y)| \\ & \leq \frac{\kappa_d}{(\mu^{\min})^2} (q-p)|\log(q-p)|. \end{aligned}$$

This yields the result. \square

Remark 6.3. *At this stage, we were not able to obtain Lipschitz continuity for $p \rightarrow \mu_p$. The difficulty comes from the fact that we do not know the correlation between γ and the state of the boxes that γ visits. At first sight, it may seem that the renormalization is responsible for the appearance of the log terms in Theorem 1.1. However, when p is very close to 1, we can avoid renormalization and bypass p -closed edges at a microscopic scale as in [32] but even in that case, we cannot obtain Lipschitz continuous regularity with the kind of combinatorial computations made in section 5. A similar issue arises, it is hard to deal with the correlation between p -closed edges of γ and the length of the microscopic bypasses.*

Chapter 6

The time constant is Lipschitz continuous strictly above p_c

This chapter is a joint work in preparation with Raphaël Cerf.

We consider the standard model of i.i.d. first passage percolation on \mathbb{Z}^d given a distribution G on $[0, +\infty]$ ($+\infty$ is allowed). When $G([0, +\infty]) < p_c(d)$, it is known that the time constant μ_G exists. We are interested in the regularity properties of the map $G \mapsto \mu_G$. We first study the specific case of distributions of the form $G_p = p\delta_1 + (1-p)\delta_\infty$ for $p > p_c(d)$. In this case, the travel time between two points is equal to the length of the shortest path between the two points in a bond percolation of parameter p . We show that the function $p \mapsto \mu_{G_p}$ is Lipschitz continuous on every interval $[p_0, 1]$, where $p_0 > p_c(d)$. We extend this result to more general distributions G on $[0, +\infty]$. We define classes of distributions on which the map $G \mapsto \mu_G$ is Lipschitz continuous for a specific distance.

Contents

1	Introduction	131
2	Definitions and preliminary results	135
3	Renormalization	136
3.1	Definition of the renormalization process	136
3.2	Construction of the detours	137
4	Control of the probability of being a bad box	144
5	Conclusion	152
5.1	Bernoulli case: Proof of theorem 1.2	152
5.2	General distributions case	156

1 Introduction

The model of first passage percolation was first introduced by Hammersley and Welsh [49] as a model for the spread of a fluid in a porous medium. Let $d \geq 2$. We consider the graph $(\mathbb{Z}^d, \mathbb{E}^d)$ having for vertices \mathbb{Z}^d and for edges \mathbb{E}^d the set of the pairs of nearest neighbors in \mathbb{Z}^d for the Euclidean norm. To each edge $e \in \mathbb{E}^d$, we assign a random variable $t(e)$ with values in \mathbb{R}^+ such that the family $(t(e), e \in \mathbb{E}^d)$ is independent and identically distributed with distribution G . The random variable $t(e)$ may be interpreted as the time needed for the fluid to cross the edge e . We define a random pseudo-metric T on this graph: for any pair of vertices $x, y \in \mathbb{Z}^d$, the random variable $T(x, y)$ is the shortest time to go from x to y . We are interested in the asymptotic behavior of the quantity $T(0, x)$ when $\|x\|$ goes to infinity. Under some assumptions on the distribution G , one can prove that

$$\lim_{n \rightarrow \infty} \frac{1}{n} T(0, nx) = \mu_G(x),$$

where $\mu_G(x)$ is a deterministic constant depending only on the distribution G and the point x . This result was proved by Cox and Durrett in [32] in dimension 2 under some integrability conditions on G , they also proved that μ_G is a semi-norm. Kesten extended this result to dimensions $d \geq 2$ in [51], and he proved that μ_G is a norm if and only if $G(\{0\}) < p_c(d)$. The constant $\mu_G(x)$ may be seen as the inverse of the speed of spread of the fluid in the direction of x . It is usually called the time constant.

It is possible to extend this model by doing first passage percolation in a random environment. We consider an i.i.d. supercritical bond percolation on the graph $(\mathbb{Z}^d, \mathbb{E}^d)$. Every edge $e \in \mathbb{E}^d$ is open with probability $p > p_c(d)$, where $p_c(d)$ denotes the critical parameter for this percolation. We know that there exists almost surely a unique infinite open cluster \mathcal{C}_p [48]. We can define the model of first passage percolation on the infinite cluster \mathcal{C}_p . To do so, we consider a probability measure G on $[0, +\infty]$ such that $G([0, \infty]) = p$. In this setting, the p -closed edges correspond to the edges with an infinite value while the infinite cluster made of the edges with finite passage times corresponds to the infinite cluster \mathcal{C}_p of a supercritical Bernoulli percolation of parameter p . The existence of a time constant for such distributions was first obtained in the context of a stationary integrable ergodic field by Garet and Marchand in [39] and was later shown for an independent field without any integrability condition by Cerf and Th  ret in [28].

The question of the continuity of the map $G \mapsto \mu_G$ was first addressed in dimension 2 with the article of Cox [31]. He showed the continuity of this map under the following hypothesis of uniform integrability: if G_n converges weakly towards G and if there exists an integrable law F such that, for all $n \in \mathbb{N}$, F stochastically dominates G_n , then μ_{G_n} converges towards μ_G . In [33], Cox and Kesten proved the continuity of this map in dimension 2 without any integrability condition. Their idea was to consider a geodesic for the truncated passage times $\min(t(e), M)$ for some $M > 0$, and then to avoid the clusters of $G([0, M])$ -closed edges crossed by the geodesic, that is the clusters of edges with a passage time larger than some $M > 0$. The clusters of $G([0, M])$ -closed edges intersecting the geodesic are then bypassed with a bypass included in their boundaries. Note that, by construction, the edges in the boundaries of $G([0, M])$ -closed clusters have a passage time smaller than M . Thanks to combinatorial considerations, Cox and Kesten were able to obtain a precise control on the length of these bypasses. This idea was later extended to all the dimensions $d \geq 2$ by Kesten in [51], by taking a M large enough such that the percolation of the edges with a passage time larger than M is highly subcritical: for such a M , the size of the clusters of p -closed edges can be controlled. However, this idea does not work any more when we allow passage times to take infinite values. In [42], Garet, Marchand, Procaccia and Th  ret proved the continuity of the map $G \mapsto \mu_G$ for general laws on $[0, +\infty]$ without any moment condition. More precisely, they proved the following. Let $(G_n)_{n \in \mathbb{N}}$ and G be probability measures on $[0, +\infty]$ such that G_n converges weakly towards G , that is, for all continuous bounded functions $f : [0, +\infty] \rightarrow [0, +\infty]$, we have

$$\lim_{n \rightarrow +\infty} \int_{[0, +\infty]} f dG_n = \int_{[0, +\infty]} f dG.$$

This convergence will be simply denoted by $G_n \xrightarrow{d} G$. Equivalently, we have that $G_n \xrightarrow{d} G$ if and only if for any $t \in [0, +\infty]$ such that $x \mapsto G([x, +\infty])$ is continuous at t , we have

$$\lim_{n \rightarrow +\infty} G_n([t, +\infty]) = G([t, +\infty]).$$

If moreover $G_n([0, +\infty]) > p_c(d)$ for all $n \in \mathbb{N}$, and $G([0, +\infty]) > p_c(d)$, then

$$\lim_{n \rightarrow \infty} \sup_{x \in \mathbb{S}^{d-1}} |\mu_{G_n}(x) - \mu_G(x)| = 0,$$

where \mathbb{S}^{d-1} is the unit sphere of \mathbb{R}^d for the Euclidean norm.

The regularity result on μ_G yields also some information on the limit shape, namely, on the way the limit shape changes under small perturbations. As mentioned in [11] before Theorem 2.7: " *If one could derive strong results in this direction, perhaps the establishment of various conjectures about the limit shape (e.g., curvature) could be made easier, or reduced to finding some special class of distributions for which the properties are explicitly derivable.* " To be able to deduce a result on the stability of the curvature under small perturbations, we would need to obtain a

regularity result on the second derivative of $G \mapsto \mu_G$. Therefore, there is still a lot of work to do in that direction. Our goal here is to improve the existing regularity result. We wish to go beyond the mere continuity and to obtain a Lipschitz property. We consider first the specific case of distributions of the form

$$G_p = p\delta_1 + (1 - p)\delta_\infty, \quad p > p_c(d).$$

Let \mathcal{G}_p be the subgraph of \mathbb{Z}^d whose edges are open for the Bernoulli percolation of parameter p . The travel time for the law G_p between two points x and y in \mathbb{Z}^d coincides with the chemical distance between x and y , that is the graph distance between x and y in \mathcal{G}_p . Namely, we define the chemical distance $D^{\mathcal{G}_p}(x, y)$ as the length of the shortest p -open path joining x and y . As a corollary of the work of Garet, Marchand, Procaccia and Th  ret in [42], we see that the map $p \mapsto \mu_{G_p}$ is continuous over $]p_c(d), 1]$. In [3], Dembin obtained a better regularity property.

Theorem 1.1 (Theorem 1 in [3]). *Let $p_0 > p_c(d)$. There exists a constant κ_d depending only on d and p_0 , such that*

$$\forall p, q \in [p_0, 1] \quad \sup_{x \in \mathbb{S}^{d-1}} |\mu_{G_p}(x) - \mu_{G_q}(x)| \leq \kappa_d |q - p| |\log |q - p||.$$

To prove this theorem, Dembin used a renormalization process in which she controlled the scale of the renormalization. The renormalization was responsible for the presence of a logarithmic term. In this paper, we improve this result by proving that the function $p \mapsto \mu_{G_p}$ is in fact Lipschitz continuous.

Theorem 1.2. *Let $p_0 > p_c(d)$. There exists a constant κ_d depending only on d and p_0 , such that*

$$\forall p, q \in [p_0, 1] \quad \sup_{x \in \mathbb{S}^{d-1}} |\mu_{G_p}(x) - \mu_{G_q}(x)| \leq \kappa_d |q - p|.$$

To fix the issues that were encountered in [3], we use a new approach. Our aim is to understand how the chemical distance in Bernoulli percolation depends upon the percolation parameter p . The key part of the proof lies in a multiscale modification of an arbitrary path. Let us fix two parameters p, q such that $q > p > p_c(d)$. We couple two percolation configurations at level p and q in such way that a p -open edge is also q -open. We consider the geodesic γ joining 0 and $x \in \mathbb{Z}^d$ for the bond percolation of parameter q . Some of the edges in γ are p -closed, we want to build upon this path a p -open path. To do so, we need to bypass the p -closed edges in γ . Roughly speaking, the idea is to prove that, for $\|x\|$ large enough, with high probability, the average size of a bypass is smaller than a constant C and that the number of edges to bypass in γ is at most $(q - p)\|x\|$. Therefore, with high probability the total length of the bypasses is less than $C(q - p)\|x\|$. Whereas in [3], all the edges were bypassed at the same scale, here we use a multiscale renormalization and each edge is bypassed at the appropriate scale. The crucial point is to perform each bypass at an adequate scale and to pay the right price for it. By properly choosing the different scales of the renormalization process, we can build a family of shells $(\text{shell}(e))_{e \in \gamma}$ made of good boxes at scale 1 such that the total cardinality of the shells $\sum_{e \in \gamma} |\text{shell}(e)|$ is at most $C\|x\|$ with high probability. These shells of good boxes will possess all the desired properties to build p -open bypasses of edges in γ . The shells are built without revealing the p -states of the edges in γ so that they are independent of the p -states of the edges in γ . In the end, we will not use all the shells but only the shells associated to p -closed edges in γ . In the coupling, the probability that a q -open edge is p -closed is $q - p$. Therefore, we expect that the total length of the bypasses

$$\sum_{e \in \gamma} |\text{shell}(e)| \mathbb{1}_{e \text{ is } p\text{-closed}}$$

is at most $C(q - p)\|x\|$.

We extend next theorem 1.2 to general distributions.

Theorem 1.3. *Let $p_1 < p_c(d)$, $p_0 > p_c(d)$, $M > 0$, $\varepsilon_0 > 0$ and $\varepsilon \mapsto \delta(\varepsilon)$ be a non-decreasing function. We define $\mathfrak{C}_{p_0, p_1, M, \varepsilon_0, \delta}$ as*

$$\mathfrak{C}_{p_0, p_1, M, \varepsilon_0, \delta} = \left\{ \begin{array}{l} G \text{ distribution on } [0, +\infty] : G(\{0\}) \leq p_1, \\ G([0, +\infty]) > p_0, \forall \varepsilon < \varepsilon_0 \quad G(]0, \varepsilon]) \leq \delta(\varepsilon), \\ G([0, M]) \geq (1 - \frac{\delta_0(p_0)}{2})G([0, +\infty]) \end{array} \right\},$$

where $\delta_0 = \delta_0(p_0)$ is a positive constant depending on p_0 and d . For F a distribution on $[0, +\infty]$, we denote by \bar{F} the distribution F conditioned to $[0, +\infty[$, defined by

$$\forall x \in \mathbb{R}^+ \quad \bar{F}([0, x]) = \frac{F([0, x])}{F([0, +\infty])}$$

and by \bar{F}^{-1} the pseudo inverse of \bar{F} , defined by

$$\forall t \in [0, 1] \quad \bar{F}^{-1}(t) = \inf \{ x \in \mathbb{R} : \bar{F}(x) \geq t \}.$$

The map $G \mapsto \mu_G$ is Lipschitz continuous on $\mathfrak{C}_{p_0, p_1, M, \varepsilon_0, \delta}$ in the following sense. There exists a constant κ depending on the parameters of the class $\mathfrak{C}_{p_0, p_1, M, \varepsilon_0, \delta}$ such that

$$\forall F, G \in \mathfrak{C}_{p_0, p_1, M, \varepsilon_0, \delta} \\ \sup_{x \in \mathbb{S}^{d-1}} |\mu_G(x) - \mu_F(x)| \leq \kappa (|F(\{+\infty\}) - G(\{+\infty\})| + \sup_{t \in [0, 1]} |\bar{F}^{-1}(t) - \bar{G}^{-1}(t)|).$$

In order to understand better where this class of distributions comes from, let us consider two distributions G and F on $[0, +\infty[$ and the standard coupling of these two distributions, in which a uniform random variable on $[0, 1]$ is associated to each edge. Let us consider the geodesic γ_G for the distribution G between 0 and $x \in \mathbb{Z}^d$. The time $T_F(0, x)$ to go from 0 to x for the distribution F is bounded from above by

$$T_G(0, x) + |\gamma_G| \sup_{t \in [0, 1]} |F^{-1}(t) - G^{-1}(t)|.$$

Conversely, the same inequality holds for $T_G(0, x)$. We seek a class \mathfrak{C} of distributions on which the size of γ_G is uniformly bounded from above, *i.e.*, for which there exists a constant C such that, for all distributions G in \mathfrak{C} , we have $|\gamma_G| \leq C\|x\|$ with high probability when $\|x\|$ goes to infinity. The inequality $|\gamma_G| \leq C\|x\|$ ensures that

$$\frac{|T_G(0, x) - T_F(0, x)|}{\|x\|} \leq C \sup_{t \in [0, 1]} |F^{-1}(t) - G^{-1}(t)|.$$

When we consider distributions that may take infinite values, we add another difficulty. For some edges in γ_G the passage time for the law F may be infinite. To overcome this issue, we apply the same strategy as in the proof of theorem 1.2: we bypass these edges with edges of passage time smaller than some constant M for the law F . The number of edges that we need to bypass is of order at most $|F(\{+\infty\}) - G(\{+\infty\})||\gamma_G|$ and the average size of a bypass is constant. This accounts for the term $|F(\{+\infty\}) - G(\{+\infty\})|$ in the statement of theorem 1.3.

We do not claim that the constraints on the distributions given by the class \mathfrak{C} are optimal. However, for each condition, we can exhibit a family of distributions for which it is unclear whether we can obtain a uniform control on the size of the geodesic:

- The family $((p_c - 1/n)\delta_0 + (1 - p_c + 1/n)\delta_M)_{n \geq 1}$ for some large $M > 0$ accounts for the condition $G(\{0\}) < p_1$.
- The family $(p_c\delta_{1/n} + (1 - p_c)\delta_M)_{n \geq 1}$ for some large $M > 0$ accounts for the condition $\forall \varepsilon < \varepsilon_0, G([0, \varepsilon]) \leq \delta(\varepsilon)$.
- The family $((p_c + 1/n)\delta_1 + (1 - p_c - 1/n)\delta_\infty)_{n \geq 1}$ accounts for the condition $G([0, +\infty]) > p_0$.
- The family $(p_c\delta_1 + (1 - p_c)\delta_n)_{n \geq 1}$ accounts for the condition

$$G([0, M]) \geq (1 - \delta_0/2)G([0, +\infty]).$$

At p_c , we know that the size of a geodesic is super linear in dimension 2 [34] and the nature of the problem is very different.

Here is the structure of the paper. In section 2, we introduce some definitions and preliminary results. The section 3 presents the multiscale renormalization process and the construction of the shells. In this section, we explain how we modify a q -open path to turn it into a p -open path with a control on the length of the bypasses. In section 4, we derive probabilistic estimates on the total size of the shells. Finally, in section 5, we prove theorem 1.2 and theorem 1.3.

2 Definitions and preliminary results

Let $d \geq 2$. Let $x = (x_1, \dots, x_d) \in \mathbb{R}^d$, we define

$$\|x\|_1 = \sum_{i=1}^d |x_i|, \quad \|x\|_2 = \sqrt{\sum_{i=1}^d x_i^2} \quad \text{and} \quad \|x\|_\infty = \max_{1 \leq i \leq d} |x_i|.$$

Let A and B be two finite subsets of \mathbb{Z}^d , we define the distance $\mathfrak{d}(A, B)$ between the sets A and B as

$$\mathfrak{d}(A, B) = \inf \left\{ \|a - b\|_1, a \in A, b \in B \right\}.$$

We extend this definition to sets of edges $A, B \subset \mathbb{E}^d$. Let \tilde{A} (respectively \tilde{B}) be the set of the endpoints of the edges in A (respectively B), we set

$$\mathfrak{d}(A, B) = \mathfrak{d}(\tilde{A}, \tilde{B}).$$

Let $G \subset \mathbb{Z}^d$ and $x, y \in G$. We say that the sequence $\gamma = (v_0, \dots, v_n)$ is a $*$ -path from x to y in G if $v_0 = x$, $v_n = y$ and for all $i \in \{1, \dots, n\}$, $v_i \in G$ and $\|v_i - v_{i-1}\|_\infty = 1$. We say that x and y are $*$ -connected in G if such a path exists. Let \mathcal{G} be a subgraph of $(\mathbb{Z}^d, \mathbb{E}^d)$ and let $x, y \in \mathcal{G}$. A path γ from x to y in \mathcal{G} is a sequence $\gamma = (v_0, e_1, \dots, e_n, v_n)$ such that $v_0 = x$, $v_n = y$ and for all $i \in \{1, \dots, n\}$, the edge $e_i = \langle v_{i-1}, v_i \rangle$ belongs to \mathcal{G} . The length of such a path is n and it is denoted by $|\gamma|$. We say that x and y are connected in \mathcal{G} if such a path exists. We define the chemical distance between x and y in \mathcal{G} by

$$D^{\mathcal{G}}(x, y) = \inf \left\{ |r| : r \text{ is a path from } x \text{ to } y \text{ in } \mathcal{G} \right\}.$$

If x and y are not connected in \mathcal{G} , then we have $D^{\mathcal{G}}(x, y) = \infty$. In what follows, the graph \mathcal{G} will be the subgraph \mathcal{G}_p of \mathbb{Z}^d whose edges are open for the Bernoulli percolation of parameter $p > p_c(d)$. To get around the fact that the chemical distance can take infinite values, we introduce a regularized chemical distance. We denote by \mathcal{C}_p the unique infinite connected component of \mathcal{G}_p . Let \mathcal{C} be a subset of \mathcal{C}_p , we define $\tilde{x}^{\mathcal{C}}$ as the vertex of \mathcal{C} which minimizes $\|x - \tilde{x}^{\mathcal{C}}\|_1$, with a deterministic rule to break ties. Typically, we will take for \mathcal{C} the infinite cluster of a configuration of Bernoulli percolation with a parameter smaller than p so that $\mathcal{C} \subset \mathcal{C}_p \subset \mathcal{G}_p$ and therefore

$$D^{\mathcal{G}_p}(\tilde{x}^{\mathcal{C}}, \tilde{y}^{\mathcal{C}}) \leq D^{\mathcal{C}}(\tilde{x}^{\mathcal{C}}, \tilde{y}^{\mathcal{C}}) < \infty.$$

We can define the regularized time constant as in [41] or as a special case of [28].

Proposition 2.1. *Let $p > p_c(d)$. There exists a deterministic function $\mu_p : \mathbb{Z}^d \rightarrow [0, +\infty[$ such that, for every $p_0 \in (p_c(d), p]$,*

$$\forall x \in \mathbb{Z}^d \quad \lim_{n \rightarrow \infty} \frac{D^{\mathcal{C}_p}(\tilde{0}^{\mathcal{C}_{p_0}}, \tilde{n}x^{\mathcal{C}_{p_0}})}{n} = \mu_p(x) \quad \text{a.s. and in } L^1.$$

It is important to check that μ_p does not depend on \mathcal{C}_{p_0} , the infinite cluster we use to regularize the chemical distance. This is done in lemma 2.11 in [42]. As a corollary, we obtain the monotonicity of the map $p \mapsto \mu_p$, see lemma 2.12 in [42].

Corollary 2.2. *For all $p_c(d) < p \leq q$, we have*

$$\forall x \in \mathbb{Z}^d \quad \mu_p(x) \geq \mu_q(x).$$

The following lemma is an improvement of the result of Antal and Pisztora in [10] controlling the probability that two connected points have a too large chemical distance. In the original result, the constants depend on p , the adaptation of the proof is written in lemma 4.2. in [3].

Lemma 2.3. *Let $p_0 > p_c(d)$. There exist $\beta = \beta(p_0) \geq 1$, $\hat{A} = \hat{A}(p_0)$ and $\hat{B} = \hat{B}(p_0) > 0$ such that, for all $p \geq p_0$,*

$$\forall x \in \mathbb{Z}^d \quad \mathbb{P}(\beta \|x\|_1 \leq D^{\mathcal{C}_p}(0, x) < +\infty) \leq \hat{A} \exp(-\hat{B} \|x\|_1).$$

3 Renormalization

In this section, we present the multiscale renormalization process, the construction of the shells and the method to build bypasses. Let $q > p \geq p_0 > p_c(d)$ be fixed. We consider two configurations of Bernoulli percolation on the edges of \mathbb{Z}^d , one with parameter p and one with parameter q .

3.1 Definition of the renormalization process

For a positive integer N , we define the N -box

$$B_N = \left[-\frac{N}{2}, \frac{N}{2} \right]^d \cap \mathbb{Z}^d$$

and the family of translated N -boxes:

$$\forall \mathbf{i} \in \mathbb{Z}^d \quad B_N(\mathbf{i}) = \mathbf{i}N + B_N.$$

The lattice \mathbb{Z}^d is the disjoint union of this family: $\mathbb{Z}^d = \sqcup_{\mathbf{i} \in \mathbb{Z}^d} B_N(\mathbf{i})$. We introduce also larger boxes that will help us to link N -boxes together. We define

$$\forall \mathbf{i} \in \mathbb{Z}^d \quad B'_N(\mathbf{i}) = \mathbf{i}N + B_{3N}.$$

Let B be a box. A connected cluster C of the configuration restricted to B is said to be crossing, if for any pair of opposite faces of B , there is an open path in C connecting them. We define the diameter of a cluster C as

$$\text{Diam}(C) := \max_{x, y \in C} \|x - y\|_\infty.$$

We construct the multiscale renormalization process by induction. Let $(l_k)_{k \in \mathbb{N}^*}$ with $l_1 \geq 3$ be an increasing sequence of integers which will be specified later. This sequence will define the successive scales. For a positive integer k , we define N_k as

$$N_k = l_1 \cdots l_k.$$

We also define the box \underline{B}_{k+1} of side length l_{k+1} at scale k that is made of sites at scale k . More precisely, for $\mathbf{i} \in \mathbb{Z}^d$, we define

$$\underline{B}_{k+1}(\mathbf{i}) = B_{l_{k+1}}(\mathbf{i}) \quad \text{and} \quad \underline{B}'_{k+1}(\mathbf{i}) = B'_{l_{k+1}}(\mathbf{i}).$$

Thus, we have $|\underline{B}_{k+1}(\mathbf{i})| = l_{k+1}^d$ and $|\underline{B}'_{k+1}(\mathbf{i})| = N_{k+1}^d$. The definition of what a good box is will differ at scale 1 and at larger scales. We first have to define what a good box is at scale 1. To do so, we list the properties that a good box should have to ensure that we can build a suitable modification of a path. We have to keep in mind that all the properties must occur with probability converging to 1 when $N_1 = l_1$ goes to infinity. Let $\beta = \beta(p_0)$ be the constant defined in lemma 2.3.

Definition 3.1. *We say that the site \mathbf{i} is (p, q) -good at the scale 1 if the following events occur:*

- (i) *There exists a unique p -cluster \mathcal{C} in $B'_{N_1}(\mathbf{i})$ with diameter larger than N_1 ;*
- (ii) *This p -cluster \mathcal{C} is crossing for each of the 3^d N_1 -boxes included in $B'_{N_1}(\mathbf{i})$;*
- (iii) *For all $x, y \in B'_{N_1}(\mathbf{i})$, if x and y belong to \mathcal{C} , then $D^{\mathcal{G}_p}(x, y) \leq 12\beta N_1$;*
- (iv) *If γ is a q -open path in $B'_{N_1}(\mathbf{i})$ such that $|\gamma| \geq N_1$, then γ and the p -cluster \mathcal{C} in $B'_{N_1}(\mathbf{i})$ have a vertex in common.*

The cluster \mathcal{C} is called the crossing p -cluster of the (p, q) -good site \mathbf{i} . We say that the box $B_{N_1}(\mathbf{i})$ is (p, q) -good at scale 1 if the site \mathbf{i} is (p, q) -good at scale 1.

We introduce next the notion of a cluster of bad sites.

Definition 3.2. Let $k \geq 1$. Let us assume that we have already defined what a (p, q) -good box is at scale k . For a (p, q) -bad site $\mathbf{j} \in \mathbb{Z}^d$ at scale k , we denote by $C^{(k)}(\mathbf{j})$ the connected cluster of the (p, q) -bad sites at scale k which contains \mathbf{j} (if \mathbf{j} is a (p, q) -good site, then $C^{(k)}(\mathbf{j})$ is empty). Equivalently, the cluster $C^{(k)}(\mathbf{j})$ is the set of the vertices of \mathbb{Z}^d which are connected to \mathbf{j} by a path visiting only sites which are bad at scale k .

We define now by induction what is a good site at scale k .

Definition 3.3. Let $k \geq 1$. Let us assume that we have already defined what a (p, q) -good site is for scales from 1 to k . Let $\mathbf{i} \in \mathbb{Z}^d$. We say that the site \mathbf{i} is (p, q) -good at scale $k + 1$ if

$$\forall \mathbf{j} \in \underline{B}'_{k+1}(\mathbf{i}) \quad |C^{(k)}(\mathbf{j})| \leq l_{k+1}.$$

We say that the box $\underline{B}_{k+1}(\mathbf{i})$ is (p, q) -good at scale $k + 1$ if the site \mathbf{i} is (p, q) -good at scale $k + 1$.

To abbreviate, we will often say good site instead of (p, q) -good site. On the grid \mathbb{Z}^d , we use the standard definition of closest neighbor, *i.e.*, we say that x and y are neighbors if $\|x - y\|_1 = 1$. Let C be a connected set of sites of \mathbb{Z}^d , we define its exterior vertex boundary

$$\partial_v C = \left\{ \mathbf{i} \in \mathbb{Z}^d \setminus C : \begin{array}{l} \mathbf{i} \text{ has a neighbour in } C \text{ and is connected} \\ \text{to infinity by a path in } \mathbb{Z}^d \setminus C \end{array} \right\}.$$

The set $\partial_v C$ is not \mathbb{Z}^d -connected in general, however it is $*$ -connected (see for instance lemma 2 in [69]). Besides, we have

$$|\partial_v C| \leq 2d|C|.$$

We adopt the convention that $\partial_v C^{(k)}(\mathbf{i}) = \{\mathbf{i}\}$ when \mathbf{i} is a good site at scale k . We shall define a multiscale site percolation process given by the states of the boxes at the different scales. Note that, on a given scale, the states of the boxes are not independent but there is a short range dependence.

3.2 Construction of the detours

We will consider different couplings between the percolation processes with parameters p and q . These couplings are variants of the usual coupling built with the help of i.i.d. random variables uniformly distributed on $[0, 1]$. For the time being, we do not specify which coupling we use. The most important property of the coupling is that a p -open edge is always q -open. Let us consider a q -open path γ between 0 and a point $x \in \mathbb{Z}^d$. Some edges in γ might be p -closed and our goal is to bypass these p -closed edges. To each edge e in γ we will associate a shell made of good boxes at scale 1 such that the edge e lies in the interior of the shell. The properties of the good boxes will guarantee that the edge e can be bypassed by a p -open path lying in the internal boundary of its associated shell. To control the lengths of the bypasses, we shall bound from above the total size of the required shells, depending on the bad sites that γ crosses. Let us first rigorously define what a shell is. Let C be a $*$ -connected set. We define the interior $\text{int}(C)$ of C by

$$\text{int}(C) = \left\{ \mathbf{i} \in \mathbb{Z}^d \setminus C : \begin{array}{l} \mathbf{i} \text{ is not connected to infinity} \\ \text{by a } \mathbb{Z}^d\text{-path in } \mathbb{Z}^d \setminus C \end{array} \right\}.$$

Definition 3.4. Let $e \in \mathbb{E}^d$. A set C of $*$ -connected good boxes at scale 1 is a shell for e if it satisfies

$$\partial_v \text{int}(C) = C \quad \text{and} \quad e \in \bigcup_{\mathbf{i} \in \text{int}(C)} (B_{N_1}(\mathbf{i}) \cap \mathbb{E}^d).$$

The condition $\partial_v \text{int}(C) = C$ says that C is indeed a sort of shell. The second condition says that e is in the interior of the shell.

For $k \geq 1$ and a path γ , we denote by $n_k(\gamma)$ the number of bad boxes at scale k that γ crosses, *i.e.*,

$$n_k(\gamma) = \left| \left\{ \mathbf{i} \in \mathbb{Z}^d, \mathbf{i} \text{ is bad at scale } k \text{ and } \gamma \cap B_{N_k}(\mathbf{i}) \neq \emptyset \right\} \right|.$$

The following proposition builds shells for edges in a path γ and bounds from above the sum of the squares of the sizes of these shells in function of the number of the bad sites that γ visits at every scale. Note that we do not build shells for edges around the extremities of γ . Due to technical details, for the edges at the extremities of γ , we cannot guarantee that we can build shells such that γ enters and exits each shell at least once.

Proposition 3.5 (Construction of the shells). *Let $p_c(d) < p < q$. Let $x \in \mathbb{Z}^d$. Let us assume that $0, x \in \mathcal{C}_q$. We consider a q -open path γ between 0 and x . Let $M = M(\gamma)$ be the smallest positive integer such that $n_M(\gamma) = 0$. We set*

$$\bar{\gamma} = \gamma \setminus (B_{4N_M} \cup (x + B_{4N_M})).$$

(If M is too large or infinite, then $\bar{\gamma}$ is empty). To each edge $e \in \bar{\gamma}$, we can associate a shell $\text{shell}(e)$ such that we have

$$\mathfrak{d}\left(\bigcup_{\mathbf{i} \in \text{shell}(e)} B_{N_1}(\mathbf{i}), \{e\}\right) \geq (14\beta + 2d)N_1,$$

$$\mathfrak{d}\left(\bigcup_{\mathbf{i} \in \text{int}(\text{shell}(e))} B_{N_1}(\mathbf{i}), \{0, x\}\right) \geq N_1,$$

$$\sum_{e \in \bar{\gamma}} |\text{shell}(e)|^2 \leq 3^{2d} 4d^2 \left((3d)^4 |\gamma| N_3^2 N_2^{2d} + \sum_{k=3}^{M-1} n_k(\gamma) N_{k+1}^2 N_k^{3d} (3d)^{2k} d \right).$$

Proof of proposition 3.5. Let γ be a q -open path joining 0 and x and let M and $\bar{\gamma}$ be defined as in the statement of the proposition. Let $e \in \bar{\gamma}$. For $k \geq 1$, we denote by \mathbf{e}_k the site of \mathbb{Z}^d such that the box $B_{N_k}(\mathbf{e}_k)$ contains the smallest extremity of e in the lexicographic order. Let us assume that there exists an integer $k \in \{2, \dots, M-1\}$ such that $\mathbf{e}_3, \dots, \mathbf{e}_k$ are (p, q) -bad at their respective scales but \mathbf{e}_{k+1} is (p, q) -good at the scale $k+1$ (if \mathbf{e}_3 is good then $k=2$). We define B' , Λ_k , $\tilde{\Lambda}_k$ and $\bar{\Lambda}_k$ by

$$B' = \{\mathbf{i} \in \mathbb{Z}^d : \|\mathbf{i} - \mathbf{e}_k\|_\infty \leq 1\}, \quad \Lambda_k = \bigcup_{\mathbf{i} \in \partial_v B'} C^{(k)}(\mathbf{i}) \cup B',$$

$$\tilde{\Lambda}_k = \bigcup_{\mathbf{i} \in \Lambda_k} \underline{B}_k(\mathbf{i}) \quad \text{and} \quad \bar{\Lambda}_k = \bigcup_{\mathbf{i} \in \Lambda_k} B_{N_k}(\mathbf{i}).$$

The sets B' and Λ_k are made of sites at scale k . The set $\tilde{\Lambda}_k$ is made of sites at scale $k-1$. The set $\bar{\Lambda}_k$ is made of sites belonging to the initial lattice \mathbb{Z}^d . Since \mathbf{e}_{k+1} is a good site at scale $k+1$ and $\partial_v B' \subset \underline{B}'_{k+1}(\mathbf{e}_{k+1})$, we have

$$\forall \mathbf{i} \in \partial_v B' \quad |C^{(k)}(\mathbf{i})| \leq l_{k+1},$$

and, using the fact that $|\partial_v B'| \leq 2d|B'|$, we obtain

$$|\Lambda_k| \leq (2dl_{k+1} + 1)|B'| \leq 3^{d+1} dl_{k+1}.$$

Moreover, we claim that the set $\partial_v \Lambda_k$ is made of good sites at scale k . Let $\mathbf{i} \in \partial_v \Lambda_k$. Since

$$\partial_v \Lambda_k \subset \bigcup_{\mathbf{l} \in \partial_v B'} \partial_v C^{(k)}(\mathbf{l}),$$

there exists $\mathbf{l} \in \partial_v B'$ such that $\mathbf{i} \in \partial_v C^{(k)}(\mathbf{l})$ and so \mathbf{i} is indeed a good site at scale k .

Let us assume that $l_2 \geq (14\beta + 2d)$. By construction of B' and since $e \in \bar{\Lambda}_k$, we have

$$\mathfrak{d}(\{e\}, \mathbb{Z}^d \setminus \bar{\Lambda}_k) \geq N_k \geq N_2 \geq (14\beta + 2d)N_1. \quad (3.1)$$

The set Λ_k is included in the box $B_{2(l_{k+1}+2)}(\mathbf{e}_k)$ of sites at scale k . Thus, we have

$$\begin{aligned} \mathfrak{d}(\{e\}, \partial_v \bar{\Lambda}_k) &\leq \sup_{x \in B_{2(l_{k+1}+2)N_k}} \mathfrak{d}(x, \mathbb{Z}^d \setminus B_{2(l_{k+1}+2)N_k}) \\ &= \mathfrak{d}(0, \mathbb{Z}^d \setminus B_{2(l_{k+1}+2)N_k}(\mathbf{0})) \leq (l_{k+1} + 2)N_k = N_{k+1} + 2N_k. \end{aligned}$$

Moreover, as $e \in \bar{\gamma}$, we have $\mathfrak{d}(\{e\}, \{0, x\}) \geq 2N_M$ and using the fact that $e \in \bar{\Lambda}_k$, we have

$$\mathfrak{d}(\{e\}, \{0, x\}) \leq \mathfrak{d}(\{e\}, \partial_v \bar{\Lambda}_k) + \mathfrak{d}(\partial_v \bar{\Lambda}_k, \{0, x\}) \leq \mathfrak{d}(\{e\}, \partial_v \bar{\Lambda}_k) + \mathfrak{d}(\bar{\Lambda}_k, \{0, x\}),$$

thus

$$\mathfrak{d}(\bar{\Lambda}_k, \{0, x\}) \geq 2N_M - N_{k+1} - 2N_k.$$

We define next iteratively a sequence of sets $\Lambda_k, \tilde{\Lambda}_k, \dots, \Lambda_1, \tilde{\Lambda}_1$. Let $j \geq 2$. Let us assume that

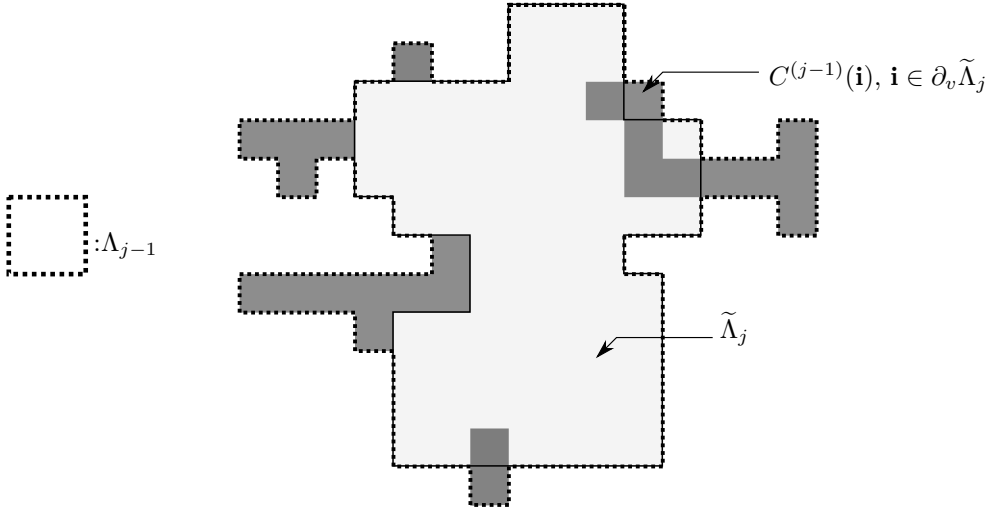

Figure 6.1 – Construction of Λ_{j-1}

we have already defined $\Lambda_k, \tilde{\Lambda}_k, \dots, \Lambda_j, \tilde{\Lambda}_j$. We define $\Lambda_{j-1}, \tilde{\Lambda}_{j-1}$ (see Figure 6.1) and $\bar{\Lambda}_{j-1}$ by

$$\Lambda_{j-1} = \bigcup_{\mathbf{i} \in \partial_v \tilde{\Lambda}_j} C^{(j-1)}(\mathbf{i}) \cup \tilde{\Lambda}_j, \quad \tilde{\Lambda}_{j-1} = \bigcup_{\mathbf{i} \in \Lambda_{j-1}} \underline{B}_{j-1}(\mathbf{i})$$

and

$$\bar{\Lambda}_{j-1} = \bigcup_{\mathbf{i} \in \Lambda_{j-1}} B_{N_{j-1}}(\mathbf{i}).$$

Let us prove by decreasing induction that, for $1 \leq j \leq k$, the following holds:

- (i) We have $|\Lambda_j| \leq 3^d (3d)^{k+1-j} l_{k+1} (N_k/N_j)^{d+1}$.
- (ii) The set $\partial_v \Lambda_j$ is made of good sites at scale j .
- (iii) We have $\mathfrak{d}(\bar{\Lambda}_j, \{0, x\}) \geq 2N_M - 2N_k - \sum_{l=j+1}^{k+1} N_l$.

These properties are true for k . Let us now assume that these properties hold for some integer $2 \leq j \leq k$. Let $\mathbf{i} \in \partial_v \tilde{\Lambda}_j$ be a site such that $C^{(j-1)}(\mathbf{i}) \neq \emptyset$. There exists $\mathbf{l} \in \tilde{\Lambda}_j$ such that \mathbf{i} is a neighbor of \mathbf{l} . Let $\underline{\mathbf{l}}$ (respectively $\underline{\mathbf{i}}$) be such that $\mathbf{l} \in \underline{B}_j(\underline{\mathbf{l}})$ (respectively $\mathbf{i} \in \underline{B}_j(\underline{\mathbf{i}})$). Since $\mathbf{i} \notin \tilde{\Lambda}_j$ and $\mathbf{l} \in \tilde{\Lambda}_j$, then we have $\underline{\mathbf{i}} \notin \Lambda_j$ and $\underline{\mathbf{l}} \in \Lambda_j$. Since the sites $\underline{\mathbf{i}}$ and $\underline{\mathbf{l}}$ are neighbors, it follows that $\underline{\mathbf{i}} \in \partial_v \Lambda_j$. Thanks to (ii), the site $\underline{\mathbf{i}}$ is a good site at scale j and so we have $|C^{(j-1)}(\mathbf{i})| \leq l_j$ and

$$|\Lambda_{j-1}| \leq (2dl_j + 1)|\tilde{\Lambda}_j| \leq 3dl_j^{d+1}|\Lambda_j|.$$

Iterating this inequality, we obtain property (i):

$$|\Lambda_{j-1}| \leq 3^d (3d)^{k+2-j} l_{k+1} \left(\frac{N_k}{N_{j-1}} \right)^{d+1}.$$

Let $\mathbf{i}' \in \partial_v \Lambda_{j-1}$. There exists $\mathbf{I}' \in \partial_v \tilde{\Lambda}_j$ such that $\mathbf{i}' \in \partial_v C^{(j-1)}(\mathbf{I}')$ and so \mathbf{i}' is a good site at scale $j-1$ and the property (ii) holds.

We have $\bar{\Lambda}_j \subset \bar{\Lambda}_{j-1}$ and

$$\mathfrak{d}(\bar{\Lambda}_j, \{0, x\}) \leq \min_{y \in \partial_v \bar{\Lambda}_{j-1}} \mathfrak{d}(\bar{\Lambda}_j, y) + \mathfrak{d}(y, \{0, x\}). \quad (3.2)$$

We claim that

$$\forall y \in \partial_v \bar{\Lambda}_{j-1} \quad \mathfrak{d}(\bar{\Lambda}_j, y) \leq N_j + 1. \quad (3.3)$$

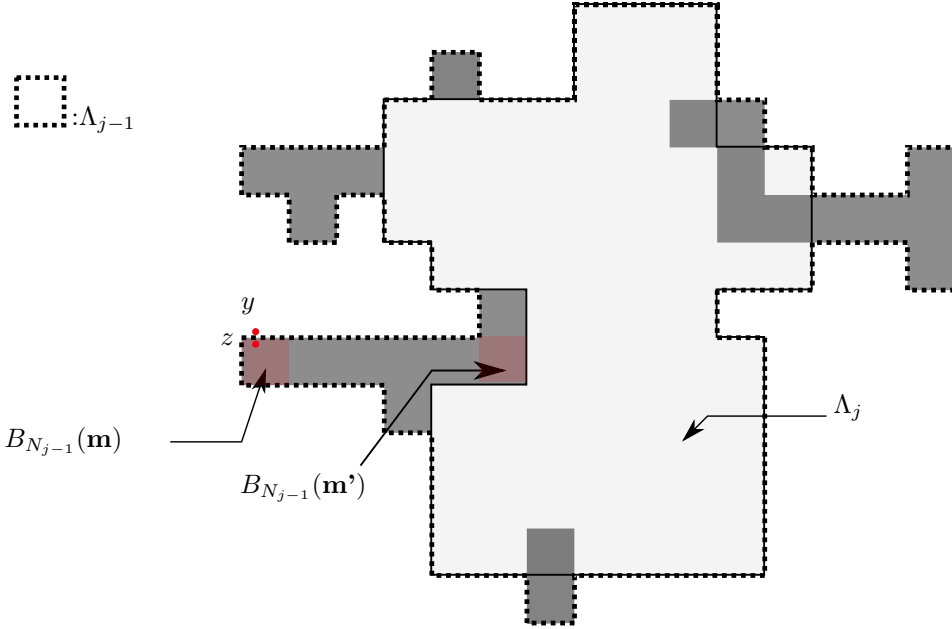

Figure 6.2 – Representation of y, z and \mathbf{m}, \mathbf{m}'

Let $y \in \partial_v \bar{\Lambda}_{j-1}$. Let z such that $z \in \bar{\Lambda}_{j-1}$ and $\|y - z\|_\infty = 1$. Let $\mathbf{m} \in \mathbb{Z}^d$ such that $z \in B_{N_{j-1}}(\mathbf{m})$ (see figure 6.2). Since $y \in \partial_v \bar{\Lambda}_{j-1}$, there exists $\mathbf{m}' \in \partial_v \tilde{\Lambda}_j$ such that $\mathbf{m} \in C^{(j-1)}(\mathbf{m}')$. Thanks to property (ii) of the induction hypothesis, we have $|C^{(j-1)}(\mathbf{m}')| \leq l_j$. It follows that

$$\mathfrak{d}(\bar{\Lambda}_j, y) \leq \mathfrak{d}(\bar{\Lambda}_j, z) + \mathfrak{d}(z, y) \leq |C^{(j-1)}(\mathbf{m}')| N_{j-1} + 1 \leq l_j N_{j-1} + 1 \leq N_j + 1.$$

Combining inequalities (3.2) and (3.3), we obtain

$$\begin{aligned} \mathfrak{d}(\bar{\Lambda}_j, \{0, x\}) &\leq N_j + 1 + \mathfrak{d}(\partial_v \bar{\Lambda}_{j-1}, \{0, x\}) \\ &= N_j + 1 + \mathfrak{d}(\bar{\Lambda}_{j-1}, \{0, x\}) - 1 \\ &\leq N_j + \mathfrak{d}(\bar{\Lambda}_{j-1}, \{0, x\}). \end{aligned} \quad (3.4)$$

Combining inequalities (3.4) and property (iii) of the induction hypothesis, it follows that

$$\mathfrak{d}(\bar{\Lambda}_{j-1}, \{0, x\}) \geq \mathfrak{d}(\bar{\Lambda}_j, \{0, x\}) - N_j \geq 2N_M - 2N_k - \sum_{l=j}^{k+1} N_l. \quad (3.5)$$

The property (iii) follows and this concludes the induction. We set finally

$$\text{shell}(e) = \partial_v \Lambda_1.$$

Thanks to property (i), we get

$$|\text{shell}(e)| \leq 2d3^d(3d)^k l_{k+1} \left(\frac{N_k}{N_1} \right)^{d+1}. \quad (3.6)$$

Since $\bar{\Lambda}_k \subset \bar{\Lambda}_1$, we deduce from inequality (3.1) that

$$\mathfrak{d} \left(\{e\}, \bigcup_{\mathbf{i} \in \text{shell}(e)} B_{N_1}(\mathbf{i}) \right) \geq (14\beta + 2d)N_1.$$

Moreover, property (iii) for $l = 1$, together with the facts that $k \leq M - 1$ and $l_M \geq M + 2$ (since the sequence $(l_k)_{k \geq 1}$ is increasing), imply that

$$\begin{aligned} \mathfrak{d}(\bar{\Lambda}_1, \{0, x\}) &\geq 2N_M - 2N_{M-1} - (M-1)N_{M-1} - N_M \\ &= (l_M - M - 1)N_{M-1} \geq N_{M-1} \geq N_1. \end{aligned}$$

Therefore, the path γ enters and exits $\partial_v \Lambda_1$ at least once. For $e \in \bar{\gamma}$, we denote by $k(e) \geq 2$ the largest integer k such that $\mathbf{e}_3, \dots, \mathbf{e}_k$ are (p, q) -bad at their respective scales (if \mathbf{e}_3 is good, then we set $k(e) = 2$). By construction, we have that $k(e) < M(\gamma)$. For $k \geq 3$, the number of edges $e \in \bar{\gamma}$ such that $k(e) = k$ is at most $n_k(\gamma)|B_{N_k} \cap \mathbb{E}^d| = n_k(\gamma)dN_k^d$. The number of edges in $\bar{\gamma}$ such that $k(e) = 2$ is at most $|\gamma|$. Finally, using inequality (3.6), we have

$$\begin{aligned} \sum_{e \in \bar{\gamma}} |\text{shell}(e)| &\leq \sum_{k=2}^{M-1} |\{e \in \bar{\gamma} : k(e) = k\}| 2d3^d(3d)^k l_{k+1} \left(\frac{N_k}{N_1} \right)^{d+1} \\ &\leq 2d3^d \left((3d)^2 |\gamma| N_3 N_2^d + \sum_{k=3}^{M-1} n_k(\gamma) N_{k+1} N_k^{2d} (3d)^k d \right) \end{aligned}$$

and similarly

$$\begin{aligned} \sum_{e \in \bar{\gamma}} |\text{shell}(e)|^2 &\leq \sum_{k=2}^{M-1} |\{e \in \bar{\gamma} : k(e) = k\}| \left(2d3^d(3d)^k l_{k+1} \left(\frac{N_k}{N_1} \right)^{d+1} \right)^2 \\ &\leq 4d^2 3^{2d} \left((3d)^4 |\gamma| N_3^2 N_2^{2d} + \sum_{k=3}^{M-1} n_k(\gamma) N_{k+1}^2 N_k^{3d} (3d)^{2k} d \right). \end{aligned}$$

This concludes the proof. \square

Note that in the proof of proposition 3.5, even if the site \mathbf{e}_1 or \mathbf{e}_2 is good, we do not bypass the edges of its box at that scale because we have to make sure that the bypass we build do not use the edge e . To avoid this problem, we build $\text{shell}(e)$ in such a way that it is far enough from the edge e .

Once the shells are built, we build the bypasses. Given a set E of edges in γ we would like to bypass, we control the total length of the bypasses with the help of the total size of the shells associated to the edges in E .

Proposition 3.6 (Construction of the bypasses). *Let $p_c(d) < p < q$. Let $x \in \mathbb{Z}^d$. Let us assume that $0, x \in \mathcal{C}_q$. We consider a q -open path γ between 0 and x . Let M be the smallest positive integer such that $n_M(\gamma) = 0$ and let $\bar{\gamma}$ and $(\text{shell}(e))_{e \in \bar{\gamma}}$ be defined as in proposition 3.5. Let E be a subset of $\bar{\gamma}$. There exists a path γ' between 0 and x such that $\gamma' \cap E = \emptyset$, the edges in $\gamma' \setminus \gamma$ are p -open and*

$$|\gamma' \setminus \gamma| \leq 12\beta N_1 \sum_{e \in E} |\text{shell}(e)|.$$

We will need the following lemma to prove proposition 3.6. To guarantee that we bypass an edge e without using e with the renormalization scheme, we build our bypass far enough from the edge e . The following lemma enables us to build a p -open path between two points in a $*$ -connected set \mathcal{I} of good boxes at scale 1 in such a way that it avoids a given set of vertices A . When applying this lemma, we will take for the set A the set of the endpoints of the edges we wish to bypass. The lemma provides a control on the length of the bypass depending on $|\mathcal{I}|$.

Lemma 3.7. [Adaptation of lemma 3.2 in [3]] *Let A be a subset of \mathbb{Z}^d . Let \mathcal{I} be a finite $*$ -connected set such that*

$$\mathfrak{d}\left(A, \bigcup_{\mathbf{i} \in \mathcal{I}} B_{N_1}(\mathbf{i})\right) > (14\beta + 2d)N_1.$$

Suppose that all the sites in \mathcal{I} are (p, q) -good at scale 1. Let $\mathbf{j}, \mathbf{k} \in \mathcal{I}$, $x \in B'_{N_1}(\mathbf{j})$ be in the p -crossing cluster of $B_{N_1}(\mathbf{j})$ and $y \in B'_{N_1}(\mathbf{k})$ be in the p -crossing cluster of $B_{N_1}(\mathbf{k})$. There exists a p -open path joining x and y of length at most $12\beta N_1 |\mathcal{I}|$ that does not visit any point of A .

Proof of lemma 3.7. Since \mathcal{I} is a $*$ -connected set of sites, there exists a self-avoiding $*$ -connected path $(\mathbf{i}_l)_{1 \leq l \leq r} \subset \mathcal{I}$ such that $\mathbf{i}_1 = \mathbf{j}$, $\mathbf{i}_r = \mathbf{k}$. Necessarily, we have $r \leq |\mathcal{I}|$. As all the sites in \mathcal{I} are good at scale 1, all the sites in $(\mathbf{i}_l)_{1 \leq l \leq r}$ are good at scale 1. We define $x_1 = x$ and $x_r = y$. For $l \in \{2, \dots, r-1\}$, we choose a point x_l in the p -crossing cluster of the box $B_{N_1}(\mathbf{i}_l)$. The point x (respectively y) is at distance at most $2dN_1$ from $B_{N_1}(\mathbf{j})$ (respectively $B_{N_1}(\mathbf{k})$), therefore the points x and y are at distance at least $14\beta N_1$ from A . For $l \in \{2, \dots, r-1\}$, the point x_l belongs to $B_{N_1}(\mathbf{i}_l)$ and so it is at distance at least $14\beta N_1$ from the set A . For $l \in \{1, \dots, r-1\}$, both points x_l and x_{l+1} belong to $B'_{N_1}(\mathbf{i}_l)$. Using property (iii) of a p -good box, we can build a p -open path $\gamma(l)$ from x_l to x_{l+1} of length at most $12\beta N_1$. As the points x_l and x_{l+1} are both at distance at least $14\beta N_1$ from A , the path $\gamma(l)$ does not go through a vertex in A . By concatenating the paths $\gamma(1), \dots, \gamma(r-1)$ in this order, we obtain a p -open path joining x to y of length at most $12\beta N_1 |\mathcal{I}|$ that does not visit any point in A . \square

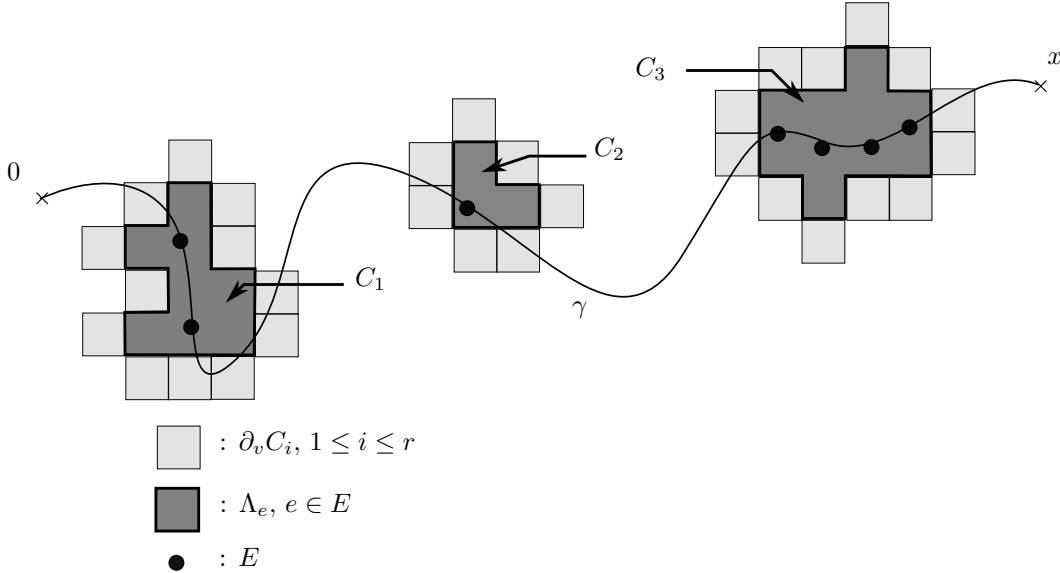

Figure 6.3 – Construction of C_1, \dots, C_r

Proof of proposition 3.6. Let $(\text{shell}(e))_{e \in \bar{\gamma}}$ be the family of the shells built in proposition 3.5. For any $e \in E$, we denote

$$\Lambda_e = \text{int}(\text{shell}(e)), \quad \bar{\Lambda}_e = \bigcup_{\mathbf{i} \in \Lambda_e} B_{N_1}(\mathbf{i}).$$

We write

$$\bigcup_{e \in E} \Lambda_e = \bigcup_{k=1}^r C_k$$

where C_1, \dots, C_r are disjoint connected components of sites, ordered in such a way that C_1 is the first component visited by γ , C_2 is the second and so on (see Figure 6.3). We set, for $k \in \{1, \dots, r\}$,

$$\overline{C}_k = \bigcup_{\mathbf{i} \in C_k} B_{N_1}(\mathbf{i}), \quad \overline{\partial_v C}_k = \bigcup_{\mathbf{i} \in \partial_v C_k} B_{N_1}(\mathbf{i}).$$

Thanks to the second inequality of proposition 3.5, for every $e \in E$, we have $\mathfrak{d}(\{0, x\}, \overline{\Lambda}_e) \geq N_1$ and thus, for every $k \in \{1, \dots, r\}$, we have also $\mathfrak{d}(\{0, x\}, \overline{C}_k) \geq N_1$. This implies that γ enters and exits each connected component C_k at least once. Let us introduce some further notations (see Figure 6.4). We write $\gamma = (x_0, \dots, x_n)$. We define

$$\tau_{in}(1) = \min \{ j \geq 1 : x_j \in \overline{\partial_v C}_1 \},$$

$$\tau_{out}(1) = \max \{ j \geq \tau_{in}(1) : x_j \in \overline{\partial_v C}_1 \}.$$

Let $k \in \{1, \dots, r\}$. Suppose that $\tau_{in}(1), \dots, \tau_{in}(k)$ and $\tau_{out}(1), \dots, \tau_{out}(k)$ are defined. We define then

$$\tau_{in}(k+1) = \min \{ j \geq \tau_{out}(k) : x_j \in \overline{\partial_v C}_{k+1} \},$$

$$\tau_{out}(k+1) = \max \{ j \geq \tau_{in}(k+1) : x_j \in \overline{\partial_v C}_{k+1} \}.$$

Let us fix $k \in \{1, \dots, r\}$. Let $B_{in}(k)$ be the N_1 -box in $\partial_v C_k$ containing $x_{\tau_{in}(k)}$, $B_{out}(k)$ be the N_1 -box in $\partial_v C_k$ containing $x_{\tau_{out}(k)}$. Since $B_{in}(k)$ (respectively $B_{out}(k)$) is a good box, it contains a unique crossing cluster \mathcal{C}_{in} (respectively \mathcal{C}_{out}). Moreover, we have $|\gamma \cap B'_{in}(k)| \geq N_1$ (respectively $|\gamma \cap B'_{out}(k)| \geq N_1$), thus by property (iv) of a good box, there exists a vertex $y_{in}(k)$ in $\gamma \cap B'_{in}(k) \cap \mathcal{C}_{in}$ (respectively $y_{out}(k)$ in $\gamma \cap B'_{out}(k) \cap \mathcal{C}_{out}$). We select such a vertex according to some deterministic rule. Thanks to the first inequality of proposition 3.5, we have

$$\forall e \in E \quad \mathfrak{d}(\{e\}, \overline{\partial_v C}_k) \geq \mathfrak{d}(\{e\}, \partial_v \overline{\Lambda}_e) \geq (14\beta + 2d)N_1,$$

whence

$$\mathfrak{d}(E, \overline{\partial_v C}_k) \geq (14\beta + 2d)N_1.$$

We apply lemma 3.7 by taking the extremities of the edges of E for the set A and $\partial_v C_k$ for the set \mathcal{I} : there exists a p -open path $\gamma_{link}(k)$ joining $y_{in}(k)$ and $y_{out}(k)$ of length at most $12\beta N_1 |\partial_v C_k|$ which does not visit any edge in E . For k in $\{1, \dots, r-1\}$, we denote by $\gamma(k)$ the portion of γ between $y_{out}(k)$ and $y_{in}(k+1)$. Let $\gamma(0)$ (respectively $\gamma(r)$) be the portion of γ from y to $y_{in}(1)$ (respectively from $y_{out}(r)$ to z). We obtain a path γ' joining y and z by concatenating the paths $\gamma(0), \gamma_{link}(1), \gamma(1), \dots, \gamma_{link}(r), \gamma(r)$ in this order. We can extract from γ' a self-avoiding path γ'' . By construction, the edges in $\gamma'' \setminus \gamma$ are p -open. Let us estimate the number of edges in $\gamma'' \setminus \gamma$. Since

$$\gamma'' \setminus \gamma \subset \bigcup_{k=1}^r \gamma_{link}(k),$$

then

$$|\gamma'' \setminus \gamma| \leq \sum_{k=1}^r |\gamma_{link}(k)| \leq \sum_{k=1}^r 12\beta N_1 |\partial_v C_k| \leq 12\beta N_1 \sum_{e \in E} |\text{shell}(e)|.$$

This yields the desired result. \square

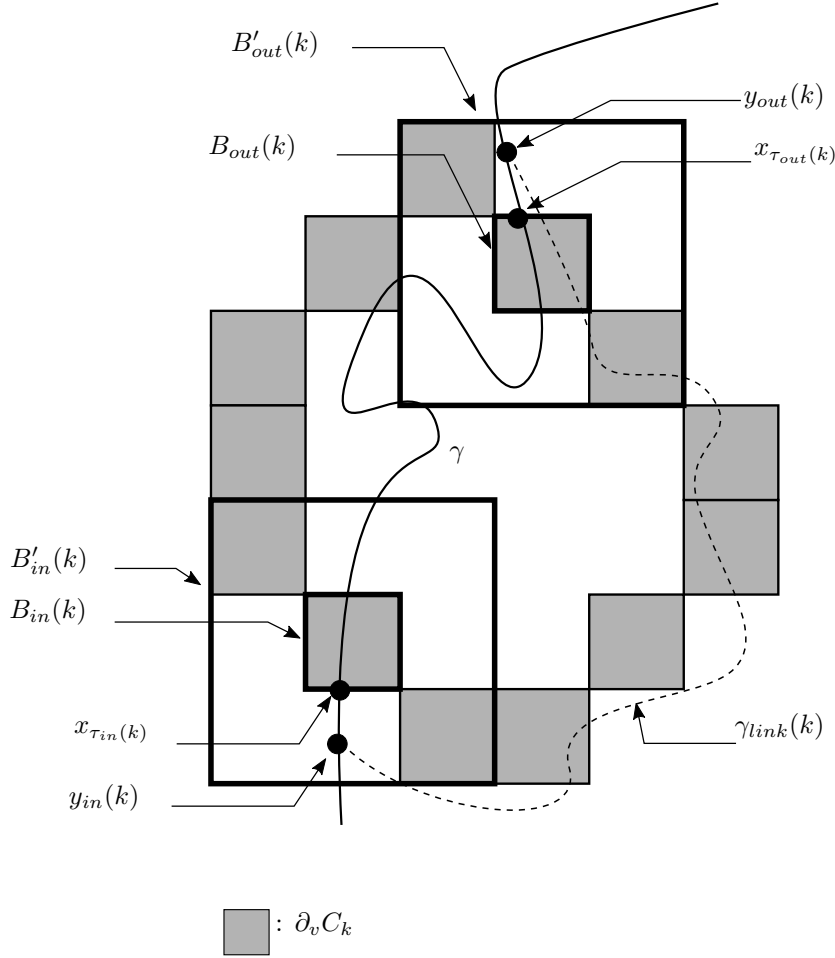
Figure 6.4 – Construction of $\gamma_{link}(k)$, $1 \leq k \leq r$

4 Control of the probability of being a bad box

In this section, we prove that the probability of being a (p, q) -bad N_1 -box at scale 1 decays exponentially fast with N_1 . The main difficulty is to get an exponential decay which is uniform in p . For that purpose, we introduce a parameter $p_0 > p_c(d)$ and we obtain an exponential decay which is uniform for all $p \geq p_0$. We recall that (p, q) -good boxes at scale 1 were defined in definition 3.1.

Theorem 4.1. *Let $p_0 > p_c(d)$. There exist constants $N_0(p_0)$, $\delta_0(p_0)$ and $C(p_0)$ such that*

$$\forall p \geq p_0 \quad \forall N \geq N_0 \quad \forall q \in [p, p + \delta_0] \\ \mathbb{P}(B_N \text{ is } (p, q)\text{-bad at scale 1}) \leq \exp(-C(p_0)N).$$

Proof. We prove here only the exponential decay for the property (iv), as the exponential decay for the other properties (i), (ii), (iii) were already proven in [3]. We refer also to the proof of lemma 3.5 in [42]. For given parameters p, q satisfying $p_c(d) < p_0 \leq p \leq q \leq 1$, we denote by $\mathbb{P}_{p,q}$ the probability associated to two coupled Bernoulli percolations of parameters p, q . As usual, the coupling is such that the edges are independent and every p -open edge is also q -open. We define A_N as the event that there exists a p -crossing cluster \mathcal{C} in B'_N and a q -open path $\gamma \subset B'_N$ such that $|\gamma| = N$ and γ does not intersect \mathcal{C} . The following inequality was proven in [42]:

$$\mathbb{P}_{p,q}(A_N) \leq \mathbb{P}_{p,p}(A_N) \exp\left(N \log\left(1 + \frac{q-p}{p}\right)\right).$$

The quantity $\mathbb{P}_{p,p}(A_N)$ decays exponentially with N , as it satisfies property (ii) but not (i) (see lemma 3.5. in [42]). Thus there exist positive constants $\kappa_1(p_0)$ and $\kappa_2(p_0)$ depending on p_0 and N_0 such that

$$\forall N \geq 1 \quad \mathbb{P}_{p,p}(A_N) \leq \kappa_1(p_0) \exp(-\kappa_2(p_0)N).$$

Now there exists a constant $\delta_0 > 0$ depending only on p_0 such that, if the parameters q and p are such that $p_0 \leq p \leq q$ and $q - p \leq \delta_0$, then

$$\kappa_2(p_0) > \log \left(1 + \frac{\delta_0}{p_0} \right) \geq \log \left(1 + \frac{q-p}{p_0} \right),$$

and so

$$\mathbb{P}_{p,q}(B_N \text{ is a } (p, q)\text{-bad box}) \leq A(p_0) \exp(-B(p_0)N),$$

with $A(p_0) = \kappa_1(p_0)$ and $B(p_0) = \kappa_2(p_0) - \log(1 + (q - p)/p_0)$. The result follows. \square

We prove in the following theorem that it is possible to tune the scales l_k , $k \geq 1$, in such a way that the probability of being a bad site at scale $k \geq 1$ decays at least exponentially fast with N_k . We recall that good sites at scale $k \geq 2$ were defined in definition 3.3.

Theorem 4.2. *Let $p_0 > p_c(d)$. There exist positive constants $\delta_0(p_0)$, $C(p_0)$, R and l_0 such that, for any non-decreasing sequence of scales $(l_k)_{k \geq 1}$ satisfying $l_1 \geq l_0$, we have*

$$\begin{aligned} \forall p \geq p_0 \quad \forall q \in [p, p + \delta_0] \quad \forall k \geq 1 \\ \mathbb{P}(\mathbf{0} \text{ is } (p, q)\text{-bad at scale } k) \leq \exp \left(-C(p_0) \frac{N_k}{(2R)^{d(k-1)}} \right). \end{aligned}$$

Proof. Let $p_0 > p_c(d)$. We start with scale 1. Let $N_0(p_0), \delta_0(p_0), B(p_0)$ associated to p_0 as in theorem 4.1. Let R be the smallest integer larger than 52β . We choose $l_1 \geq \max(N_0, (2R)^d)$ large enough to ensure that

$$d \log 7 \leq C(p_0) \frac{l_1}{4R^d} \tag{4.1}$$

and

$$\forall l \geq l_1 \quad \log 2 + d \log(3l) \leq d(\log 7)l. \tag{4.2}$$

For $\mathbf{i} \in \mathbb{Z}^d$, the event $\{\mathbf{i} \text{ is good at scale } 1\}$ depends only on the edges in $B_{26\beta N_1}(\mathbf{i})$. Thus, for $\mathbf{i}, \mathbf{j} \in \mathbb{Z}^d$, if $\|\mathbf{i} - \mathbf{j}\|_\infty \geq R \geq 52\beta$, the events

$$\{\mathbf{i} \text{ is good at scale } 1\} \quad \text{and} \quad \{\mathbf{j} \text{ is good at scale } 1\}$$

are independent. Thanks to theorem 4.1, there exist positive constants $C(p_0)$, $N_0(p_0)$ and $\delta_0(p_0)$ such that

$$\forall q \in [p, p + \delta_0] \quad \forall N \geq N_0 \quad \mathbb{P}(B_N \text{ is } (p, q)\text{-bad}) \leq \exp(-C(p_0)N).$$

Let now $k \geq 1$ be fixed and suppose that the first k scales l_1, \dots, l_k have been chosen, and that the following inequality holds:

$$\mathbb{P}(\mathbf{0} \text{ is } (p, q)\text{-bad at scale } k) \leq \exp \left(-C(p_0) \frac{N_k}{(2R)^{d(k-1)}} \right), \tag{4.3}$$

and that two sites \mathbf{i}, \mathbf{j} at scale k are independent whenever $\|\mathbf{i} - \mathbf{j}\|_\infty \geq R$. For the scale $k + 1$, we have

$$\begin{aligned} & \mathbb{P}(\mathbf{0} \text{ is } (p, q)\text{-bad at scale } k + 1) \\ &= \mathbb{P} \left(\exists \mathbf{i} \in \underline{B}'_{k+1}(\mathbf{0}) : |C^{(k)}(\mathbf{i})| > l_{k+1} \right) \\ &\leq \sum_{\mathbf{i} \in \underline{B}'_{k+1}(\mathbf{0})} \sum_{m > l_{k+1}} \sum_{\Gamma \in \text{Animals}(m)} \mathbb{P}(\forall \mathbf{j} \in \mathbf{i} + \Gamma \quad \mathbf{j} \text{ is bad at scale } k), \end{aligned}$$

where $\text{Animals}(m)$ is the set of $*$ -connected sets of cardinality m containing the site $\mathbf{0}$. We have the following bound (see for instance Grimmett [48], p85):

$$|\text{Animals}(m)| \leq 7^{dm}.$$

Using the translation invariance of the model, we obtain

$$\begin{aligned} & \mathbb{P}(\mathbf{0} \text{ is } (p, q)\text{-bad at scale } k+1) \\ & \leq |\underline{B}'_{k+1}(\mathbf{0})| \sum_{m > l_{k+1}} \sum_{\Gamma \in \text{Animals}(m)} \mathbb{P}(\forall \mathbf{j} \in \Gamma \quad \mathbf{j} \text{ is bad at scale } k). \end{aligned}$$

To bound from above the previous probability, we will use the fact that distant sites at scale k are independent. The following lemma allows us to extract from Γ a subset Γ_0 in which sites are at mutual distances larger or equal than R .

Lemma 4.3. *Let Γ be a finite subset of \mathbb{Z}^d . There exists a subset Γ_0 of Γ such that $|\Gamma_0| \geq |\Gamma|/R^d$ and*

$$\forall \mathbf{i}, \mathbf{j} \in \Gamma_0 \quad \mathbf{i} \neq \mathbf{j} \implies \|\mathbf{i} - \mathbf{j}\|_\infty \geq R.$$

Proof. The following collection of sets forms a partition of \mathbb{Z}^d :

$$i + R\mathbb{Z}^d, \quad i \in B_R.$$

Therefore the set Γ can be partitioned as follows:

$$\Gamma = \bigcup_{i \in B_R} ((i + R\mathbb{Z}^d) \cap \Gamma).$$

Since $|B_R| = R^d$, then there exists i_0 such that the set $\Gamma_0 = (i_0 + R\mathbb{Z}^d) \cap \Gamma$ satisfies the conditions stated in the lemma. \square

Let Γ be a fixed lattice animal. Let Γ_0 be a subset of Γ that satisfies the conditions stated in lemma 4.3. Let $\mathbf{i} \neq \mathbf{j} \in \Gamma_0$. By the induction hypothesis, the events $\{\mathbf{i} \text{ is good at scale } k\}$ and $\{\mathbf{j} \text{ is good at scale } k\}$ are independent. Using the inequality of the induction hypothesis, we have thus

$$\begin{aligned} & \mathbb{P}(\mathbf{0} \text{ is } (p, q)\text{-bad at scale } k+1) \\ & \leq (3l_{k+1})^d \sum_{m > l_{k+1}} \sum_{\Gamma \in \text{Animals}(m)} \mathbb{P}(\forall \mathbf{j} \in \Gamma \quad \mathbf{j} \text{ is bad at scale } k) \\ & \leq (3l_{k+1})^d \sum_{m > l_{k+1}} \sum_{\Gamma \in \text{Animals}(m)} \mathbb{P}(\forall \mathbf{j} \in \Gamma_0 \quad \mathbf{j} \text{ is bad at scale } k) \\ & \leq (3l_{k+1})^d \sum_{m > l_{k+1}} \sum_{\Gamma \in \text{Animals}(m)} \exp\left(-C(p_0) \frac{N_k}{(2R)^{d(k-1)}} \frac{m}{R^d}\right) \\ & \leq (3l_{k+1})^d \sum_{m > l_{k+1}} 7^{dm} \exp\left(-C(p_0) \frac{N_k}{(2R)^{d(k-1)}} \frac{m}{R^d}\right). \end{aligned}$$

Since $l_1 \geq (2R)^d$ and $l_1 \leq \dots \leq l_k$, then $N_k \geq (2R)^{dk}$. Using (4.1), we see that

$$\forall m \geq 1 \quad 7^{dm} \exp\left(-C(p_0) \frac{N_k}{4(2R)^{d(k-1)}} \frac{m}{R^d}\right) \leq 1 \tag{4.4}$$

and

$$\exp\left(-C(p_0) \frac{3N_k}{4(2R)^{d(k-1)}} \frac{m}{R^d}\right) \leq \frac{1}{7^{3d}} \leq \frac{1}{2}.$$

It follows that

$$\begin{aligned} \mathbb{P}(\mathbf{0} \text{ is } (p, q)\text{-bad at scale } k+1) & \\ & \leq (3l_{k+1})^d \sum_{m>l_{k+1}} \exp\left(-C(p_0) \frac{3N_k}{4(2R)^{d(k-1)}} \frac{m}{R^d}\right) \\ & \leq 2(3l_{k+1})^d \exp\left(-C(p_0) \frac{3N_k}{4(2R)^{d(k-1)}} \frac{l_{k+1}}{R^d}\right). \end{aligned} \quad (4.5)$$

The condition (4.2) on l_1 and the fact that $l_1 \leq \dots \leq l_{k+1}$ imply that

$$\log 2 + d \log(3l_{k+1}) \leq d(\log 7)l_{k+1}. \quad (4.6)$$

Thanks to inequalities (4.4) and (4.6), we obtain

$$2(3l_{k+1})^d \exp\left(-C(p_0) \frac{N_{k+1}}{4(2R)^{d(k-1)} R^d}\right) \leq 1. \quad (4.7)$$

Finally, combining inequalities (4.5) and (4.7), we obtain

$$\mathbb{P}(\mathbf{0} \text{ is } (p, q)\text{-bad at scale } k+1) \leq \exp\left(-C(p_0) \frac{N_{k+1}}{(2R)^{dk}}\right).$$

This yields the inequality at rank $k+1$.

For $\mathbf{i} \in \mathbb{Z}^d$, the event $\{\mathbf{i} \text{ is good at scale } k+1\}$ depends on the states of the sites in

$$\mathfrak{B}_{k+1}(\mathbf{i}) = \{\mathbf{l} \in \mathbb{Z}^d : \|\mathbf{l} - \mathbf{j}\|_\infty \leq 2l_{k+1}, \mathbf{j} \in \underline{B}'_{k+1}(\mathbf{i})\}.$$

Indeed, for $\mathbf{j} \in \underline{B}'_{k+1}(\mathbf{i})$, in order to determine whether $|C^{(k)}(\mathbf{j})| \leq l_{k+1}$ or not, we only need to reveal the states of the sites in $\mathfrak{B}_{k+1}(\mathbf{i})$. By the induction hypothesis, two sites \mathbf{l}, \mathbf{m} at scale k are independent whenever $\|\mathbf{l} - \mathbf{m}\|_\infty \geq R$. Now, if $\|\mathbf{i} - \mathbf{j}\|_\infty \geq R$, then

$$\forall \mathbf{l} \in \mathfrak{B}_{k+1}(\mathbf{i}) \quad \forall \mathbf{m} \in \mathfrak{B}_{k+1}(\mathbf{j}) \quad \|\mathbf{l} - \mathbf{m}\|_\infty \geq Rl_{k+1} - 8l_{k+1} \geq R$$

and the events $\{\mathbf{i} \text{ is good at scale } k+1\}$ and $\{\mathbf{j} \text{ is good at scale } k+1\}$ are independent. This concludes the induction. \square

For $k \geq 1$, we define the trace $\gamma^{(k)}$ of γ on the lattice at scale k as

$$\gamma^{(k)} = \{\mathbf{i} \in \mathbb{Z}^d : B_{N_k}(\mathbf{i}) \cap \gamma \neq \emptyset\}.$$

The following lemma gives a deterministic control on the length of this trace.

Lemma 4.4. [lemma 3.4 in [42]] For any path γ in \mathbb{Z}^d , we have

$$\forall k \geq 1 \quad |\gamma^{(k)}| \leq 3^d \left(1 + \frac{|\gamma| + 1}{N_k}\right).$$

The following proposition shows that we can choose adequately the sequence $(N_k)_{k \geq 1}$ in order to control the quantity that appears in proposition 3.5.

Proposition 4.5. Let $p_0 > p_c(d)$. There exist positive constants $l_0(p_0)$, n_0 , $\delta_0(p_0)$, $A_1(p_0)$ such that, if we define the sequence of scales $(l_k)_{k \geq 1}$ by setting $N_1 = l_0$ and

$$\forall k \geq 1 \quad N_{k+1} = N_k^{2d}$$

and we define $M = M(\gamma)$ as the smallest integer such that $n_M(\gamma) = 0$, then we have

$$\begin{aligned} & \forall p \geq p_0 \quad \forall q \in [p, p + \delta_0] \quad \forall n \geq n_0 \\ & \mathbb{P} \left(\begin{array}{l} \text{There exists a path } \gamma \text{ starting} \\ \text{from } 0 \text{ such that } |\gamma| \leq n \text{ and} \\ \sum_{k=3}^M n_k(\gamma) N_{k+1}^2 N_k^{3d} (3d)^{2k} \geq n \\ \text{or } N_{M(\gamma)} > n^{1/3d} \end{array} \right) \leq \exp\left(-A_1(p_0) n^{\frac{1}{6d^2+1}}\right). \end{aligned}$$

Proof of proposition 4.5. Let $p_0 > p_c(d)$. Let $\delta_0(p_0)$, $C(p_0)$, l_0 be the constants given by theorem 4.2. We can assume that $l_0 \geq 2(3d)^2$ (if this is not the case, we replace l_0 by $\max(l_0, 2(3d)^2)$). Let $p > p_0$ and $q \in [p, p + \delta_0]$. Let $(N_k)_{k \geq 1}$ be the sequence defined in the statement of the proposition. We have $l_1 \geq l_0$ and $l_1 \geq 2(3d)^2$. We set

$$\forall k \geq 1 \quad \delta_k = \frac{1}{N_{k+1}^2 N_k^{3d+1}}.$$

We have then

$$\sum_{k=3}^{M(\gamma)-1} (3d)^{2k} N_{k+1}^2 N_k^{3d} \delta_k = \sum_{k=3}^{M(\gamma)-1} \frac{(3d)^{2k}}{N_k} \leq \sum_{k=3}^{\infty} \left(\frac{(3d)^2}{l_1} \right)^k \leq \sum_{k=3}^{\infty} \left(\frac{1}{2} \right)^k < 1.$$

We choose n_0 large enough so that $N_1 \leq n_0^{1/3d}$. Let $n \geq n_0$. Let \bar{M} be the largest integer such that $N_{\bar{M}} \leq n^{1/3d}$. Therefore $N_{\bar{M}+1} = (N_{\bar{M}})^{2d} \leq n^{2/3} < n$. We have

$$\begin{aligned} & \mathbb{P} \left(\begin{array}{l} \text{There exists a path } \gamma \text{ starting from 0 such that } |\gamma| \leq n \\ \text{and } \sum_{k=3}^{M(\gamma)-1} n_k(\gamma) (3d)^{2k} N_{k+1}^2 N_k^{3d} \geq n \text{ or } N_{M(\gamma)} > n^{1/3d} \end{array} \right) \\ & \leq \mathbb{P} \left(\begin{array}{l} \text{There exists a path } \gamma \text{ starting from 0 such that } |\gamma| \leq n \text{ and} \\ \sum_{k=3}^{M(\gamma)-1} n_k(\gamma) (3d)^{2k} N_{k+1}^2 N_k^{3d} \geq \sum_{k=3}^{M(\gamma)-1} (3d)^{2k} N_{k+1}^2 N_k^{3d} \delta_k n \\ \text{or } M(\gamma) > \bar{M} \end{array} \right) \\ & \leq \mathbb{P} \left(\begin{array}{l} \text{There exists a path } \gamma \text{ starting from 0 such that } |\gamma| \leq n \text{ and} \\ \sum_{k=3}^{M(\gamma)-1} n_k(\gamma) (3d)^{2k} N_{k+1}^2 N_k^{3d} \geq \sum_{k=3}^{M(\gamma)-1} (3d)^{2k} N_{k+1}^2 N_k^{3d} \delta_k n \\ \text{and } M(\gamma) \leq \bar{M} \end{array} \right) \\ & \quad + \mathbb{P} \left(\begin{array}{l} \text{There exists a path } \gamma \text{ starting from 0} \\ \text{such that } |\gamma| \leq n \text{ and } M(\gamma) > \bar{M} \end{array} \right) \\ & \leq \sum_{k=3}^{\bar{M}-1} \mathbb{P} \left(\begin{array}{l} \text{There exists a path } \gamma \text{ starting from 0} \\ \text{such that } |\gamma| \leq n \text{ and } n_k(\gamma) \geq \delta_k n \end{array} \right) \\ & \quad + \mathbb{P} \left(\begin{array}{l} \text{There exists a path } \gamma \text{ starting from 0} \\ \text{such that } |\gamma| \leq n \text{ and } n_{\bar{M}}(\gamma) \neq 0 \end{array} \right). \end{aligned} \quad (4.8)$$

Let $k \in \{3, \dots, M(\gamma) - 1\}$. To control the probability that there exists a path γ such that $n_k(\gamma)$ exceeds $\delta_k n$, a natural strategy would be to sum over all the possible traces $\gamma^{(k)}$ of γ at scale k . However, this would lead to a combinatorial term that grows too fast with n . Instead of summing over all possible traces $\gamma^{(k)}$ at scale k , we sum over all possible traces $\gamma^{(k+2)}$ at scale $k+2$ (summing over all possible traces $\gamma^{(k+1)}$ at scale $k+1$ also leads to a too large combinatorial term). Let Γ be a set of sites at scale $k+2$, we denote by $\underline{\Gamma}_{(k)}$ the set of the sites at scale k which are contained in Γ , *i.e.*,

$$\underline{\Gamma}_{(k)} = \bigcup_{\mathbf{i} \in \Gamma} \bigcup_{\mathbf{j} \in \underline{B}_{k+2}(\mathbf{i})} B_{k+1}(\mathbf{j}).$$

Let γ be a path starting from 0 such that $|\gamma| \leq n$. With the previous notation, we have that

$$\gamma^{(k)} \subset \underline{\gamma^{(k+2)}}_{(k)}.$$

We can therefore bound from above the number of bad sites $n_k(\gamma)$ at scale k that γ crosses by the number of bad sites at scale k contained in $\underline{\gamma^{(k+2)}}_{(k)}$. We denote this number by $n_k^{k+2}(\gamma^{(k+2)})$, namely,

$$n_k^{k+2}(\gamma^{(k+2)}) = \left| \left\{ \mathbf{i} \in \underline{\gamma^{(k+2)}}_{(k)} : \mathbf{i} \text{ is bad at scale } k \right\} \right|.$$

We denote by $\lfloor x \rfloor$ the greatest integer smaller than or equal to the real number x . Using lemma 4.4 together with the fact that $N_{k+2} < n$, we obtain

$$|\gamma^{(k+2)}| \leq 3^d \left(1 + \frac{|\gamma| + 1}{N_{k+2}} \right) \leq 3^d \left(1 + \frac{2n}{N_{k+2}} \right) \leq 3^{d+1} \frac{n}{N_{k+2}}.$$

We have thus

$$\begin{aligned}
& \mathbb{P} \left(\begin{array}{l} \text{There exists a path } \gamma \text{ starting from } 0 \\ \text{such that } |\gamma| \leq n \text{ and } n_k(\gamma) \geq \delta_k n \end{array} \right) \\
& \leq \mathbb{P} \left(\begin{array}{l} \text{There exists a path } \gamma \text{ starting from } 0 \\ \text{such that } |\gamma| \leq n, n_k^{k+2}(\gamma^{(k+2)}) \geq \delta_k n \end{array} \right) \\
& \leq \mathbb{P} \left(\bigcup_{\Gamma \in \text{Animals} \left(\lfloor \frac{3^{d+1}n}{N_{k+2}} \rfloor \right)} \left\{ \begin{array}{l} \text{There exists a path } \gamma \text{ starting from } 0 \text{ such} \\ \text{that } |\gamma| \leq n, n_k^{k+2}(\Gamma) \geq \delta_k n, \gamma^{(k+2)} \subset \Gamma \end{array} \right\} \right) \\
& \leq \sum_{\Gamma \in \text{Animals} \left(\lfloor \frac{3^{d+1}n}{N_{k+2}} \rfloor \right)} \mathbb{P} \left(\begin{array}{l} \text{There exists a path } \gamma \text{ starting from } 0 \text{ such} \\ \text{that } |\gamma| \leq n, n_k(\underline{\Gamma}_{(k)}) \geq \delta_k n \text{ and } \gamma^{(k+2)} \subset \Gamma \end{array} \right) \\
& \leq \sum_{\Gamma \in \text{Animals} \left(\lfloor \frac{3^{d+1}n}{N_{k+2}} \rfloor \right)} \mathbb{P}(n_k(\underline{\Gamma}_{(k)}) \geq \delta_k n). \tag{4.9}
\end{aligned}$$

Let Γ be a fixed $*$ -connected set of sites at scale $k+2$ containing 0 and of size $\lfloor 3^{d+1}n/N_{k+2} \rfloor$. We have

$$|\underline{\Gamma}_{(k)}| \leq (l_{k+2}l_{k+1})^d |\Gamma| \leq (l_{k+2}l_{k+1})^d \left\lfloor \frac{3^{d+1}n}{N_{k+2}} \right\rfloor.$$

On the event $\{n_k(\underline{\Gamma}_{(k)}) \geq \delta_k n\}$, using the same arguments as in lemma 4.3, we can extract a subset $\tilde{\Gamma}$ of $\underline{\Gamma}_{(k)}$ such that $n_k(\tilde{\Gamma}) \geq \delta_k n/R^d$ and

$$\forall \mathbf{i}, \mathbf{j} \in \tilde{\Gamma} \quad \mathbf{i} \neq \mathbf{j} \implies \|\mathbf{i} - \mathbf{j}\|_\infty \geq R \geq 3.$$

This implies that the events $\{\mathbf{i}$ is good at scale $k\}$ and $\{\mathbf{j}$ is good at scale $k\}$ are independent for $\mathbf{i} \neq \mathbf{j} \in \tilde{\Gamma}$. From the proof of lemma 4.3 and the way $\tilde{\Gamma}$ is constructed, we see that there are at most R^d choices for the set $\tilde{\Gamma}$. Let us set

$$\mathbf{p} = \mathbb{P}(\mathbf{0} \text{ is bad at scale } k).$$

Let $(X_i)_{i \geq 1}$ be a sequence of i.i.d. Bernoulli random variables with parameter \mathbf{p} . From the previous discussion, we have

$$\begin{aligned}
& \mathbb{P} \left(n_k(\underline{\Gamma}_{(k)}) \geq \delta_k n \right) \\
& \leq \mathbb{P} \left(n_k(\tilde{\Gamma}) \geq \frac{\delta_k n}{R^d} \right) \\
& \leq R^d \mathbb{P} \left(\sum_{i=1}^{(l_{k+2}l_{k+1})^d \left\lfloor \frac{3^{d+1}n}{N_{k+2}} \right\rfloor} X_i \geq \frac{\delta_k n}{R^d} \right) \\
& \leq R^d \mathbb{P} \left(\sum_{i=1}^{(l_{k+2}l_{k+1})^d \left\lfloor \frac{3^{d+1}n}{N_{k+2}} \right\rfloor} X_i \geq \frac{\delta_k N_{k+2}}{3(3Rl_{k+1}l_{k+2})^d} (l_{k+2}l_{k+1})^d \left\lfloor \frac{3^{d+1}n}{N_{k+2}} \right\rfloor \right). \tag{4.10}
\end{aligned}$$

Let us set

$$\delta' = \frac{\delta_k N_{k+2}}{3(3Rl_{k+1}l_{k+2})^d} = \frac{1}{3(3R)^d N_{k+2}^{d-1} N_{k+1}^2 N_k^{2d+1}} < \frac{1}{2}.$$

Using theorem 4.2, we have

$$\frac{\delta'}{\mathbf{p}} \geq \frac{1}{3(3R)^d N_{k+2}^{d-1} N_{k+1}^2 N_k^{2d+1}} \exp \left(\frac{C(p_0)N_k}{(2R)^{d(k-1)}} \right).$$

Since $N_{k+1} = N_k^{2d}$, we have

$$\begin{aligned} \frac{\delta'}{\mathbf{p}} &\geq \frac{1}{3(3R)^d N_k^{4d^2(d-1)+6d+1}} \exp\left(\frac{C(p_0)N_k}{(2R)^{d(k-1)}}\right) \\ &= \frac{1}{3(3R)^d l_0^{(2d)^k(4d^2(d-1)+6d+1)}} \exp\left(\frac{C(p_0)l_0^{(2d)^k}}{(2R)^{d(k-1)}}\right). \end{aligned}$$

We can choose l_0 large enough depending on d , β and p_0 such that

$$\forall k \geq 1 \quad \frac{\delta'}{\mathbf{p}} \geq 8.$$

As $\delta' > \mathbf{p}$, we can use the Cramér-Chernoff inequality, we obtain

$$\begin{aligned} \mathbb{P} \left(\sum_{i=1}^{(l_{k+2}l_{k+1})^d \lfloor \frac{3^{d+1}n}{N_{k+2}} \rfloor} X_i \geq \delta' (l_{k+2}l_{k+1})^d \lfloor \frac{3^{d+1}n}{N_{k+2}} \rfloor \right) \\ \leq \exp \left(-(l_{k+2}l_{k+1})^d \lfloor \frac{3^{d+1}n}{N_{k+2}} \rfloor \left(\delta' \log \frac{\delta'}{\mathbf{p}} + (1 - \delta') \log \frac{1 - \delta'}{1 - \mathbf{p}} \right) \right). \end{aligned}$$

Using the convexity of the function $x \mapsto -\log(1-x)$, we have

$$\forall x \in [0, 1/2] \quad -\log(1-x) \leq 2(\log 2)x.$$

Since $\delta' < 1/2$, we have

$$-(1 - \delta') \log \frac{1 - \delta'}{1 - \mathbf{p}} \leq -\log(1 - \delta') \leq 2(\log 2)\delta'.$$

We have also $N_{k+2} \leq n^{2/3}$, whence

$$\left\lfloor \frac{3^{d+1}n}{N_{k+2}} \right\rfloor \geq \frac{3^d n}{N_{k+2}}.$$

As $\delta'/\mathbf{p} > 8$, we have

$$\begin{aligned} \exp \left(-(l_{k+2}l_{k+1})^d \left\lfloor \frac{3^{d+1}n}{N_{k+2}} \right\rfloor \left(\delta' \log \frac{\delta'}{\mathbf{p}} + (1 - \delta') \log \frac{1 - \delta'}{1 - \mathbf{p}} \right) \right) \\ \leq \exp \left(-(l_{k+2}l_{k+1})^d \left\lfloor \frac{3^{d+1}n}{N_{k+2}} \right\rfloor (3(\log 2)\delta' - 2(\log 2)\delta') \right) \\ \leq \exp \left(-\frac{(3l_{k+2}l_{k+1})^d}{N_{k+2}} (\log 2)\delta' n \right) \leq \exp \left(-(\log 2) \frac{\delta_k}{3R^d} n \right). \end{aligned}$$

Coming back to (4.10), we have then

$$\mathbb{P}(n_k(\underline{\Gamma}_{(k)}) \geq \delta_k n) \leq R^d \exp \left(-(\log 2) \frac{\delta_k}{3R^d} n \right).$$

Finally, inequality (4.9) and the previous inequality yield

$$\begin{aligned} \mathbb{P} \left(\begin{array}{l} \text{There exists a path } \gamma \text{ starting from } 0 \\ \text{such that } |\gamma| \leq n \text{ and } n_k(\gamma) \geq \delta_k n \end{array} \right) \\ \leq \sum_{\Gamma \in \text{Animals} \left(\left\lfloor \frac{3^{d+1}n}{N_{k+2}} \right\rfloor \right)} R^d \exp \left(-(\log 2) \frac{\delta_k}{3R^d} n \right) \\ \leq R^d (7^d)^{\frac{3^{d+1}n}{N_{k+2}}} \exp \left(-(\log 2) \frac{\delta_k}{3R^d} n \right). \end{aligned} \quad (4.11)$$

Since $d \geq 2$, we have

$$N_{k+2} = N_k^{4d^2} \geq N_k^{7d+2} = N_{k+1}^2 N_k^{3d+1} N_k = N_k / \delta_k \geq l_0 / \delta_k.$$

We can assume that l_0 satisfies furthermore

$$\frac{d(\log 7) 3^{d+1}}{l_0} \leq \frac{\log 2}{6R^d}.$$

If it is not the case we take a larger l_0 . We have then

$$\begin{aligned} \mathbb{P} \left(\begin{array}{l} \text{There exists a path } \gamma \text{ starting from } 0 \\ \text{such that } |\gamma| \leq n \text{ and } n_k(\gamma) \geq \delta_k n \end{array} \right) \\ \leq R^d \exp \left(-\frac{\log 2}{6R^d N_{k+1}^2 N_k^{3d+1} n} \right). \end{aligned} \quad (4.12)$$

By construction, $N_{\overline{M}+1} = (N_{\overline{M}})^{2d} > n^{1/3d}$ and so $N_{\overline{M}} > n^{1/6d^2}$. We are going to bound from above the number of bad $N_{\overline{M}}$ -boxes that γ crosses by the number of bad $N_{\overline{M}}$ -boxes in the box B_{4n} . Using theorem 4.2, we have

$$\begin{aligned} \mathbb{P} \left(\begin{array}{l} \text{There exists a path } \gamma \text{ starting from } 0 \\ \text{such that } |\gamma| \leq n \text{ and } n_{\overline{M}}(\gamma) \neq 0 \end{array} \right) \\ \leq \mathbb{P} \left(\begin{array}{l} \text{There exists } \mathbf{i} \in \mathbb{Z}^d \text{ such that } B_{N_{\overline{M}}}(\mathbf{i}) \subset B_{4n} \\ \text{and the box } B_{N_{\overline{M}}}(\mathbf{i}) \text{ is bad} \end{array} \right) \\ \leq \left(\frac{4n+1}{2N_{\overline{M}}+1} \right)^d \exp \left(-C(p_0) \frac{N_{\overline{M}}}{(2R)^{d(\overline{M}-1)}} \right) \\ \leq (4n+1)^d \exp \left(-C(p_0) \frac{n^{1/6d^2}}{(2R)^{d(\overline{M}-1)}} \right). \end{aligned} \quad (4.13)$$

Since $N_{\overline{M}} = l_0^{(2d)\overline{M}} \leq n^{1/3d}$, there exist positive constants C and C' depending on l_0 , d and p_0 such that

$$\overline{M} \leq C \log \log n \quad \text{and} \quad (2R)^{d(\overline{M}-1)} \leq (\log n)^{C'}.$$

Thus, there exist positive constants C_1 and C_2 depending on d and p_0 such that, for all $n \geq n_0$,

$$\mathbb{P} \left(\begin{array}{l} \text{There exists a path } \gamma \text{ starting from } 0 \\ \text{such that } |\gamma| \leq n \text{ and } n_{\overline{M}}(\gamma) \neq 0 \end{array} \right) \leq C_1 \exp(-C_2 n^{1/(6d^2+1)}). \quad (4.14)$$

We recall that $N_{k+1} \leq N_{\overline{M}}$ and $N_k = N_{k+1}^{1/2d} \leq N_{\overline{M}}^{1/2d}$. Since $N_{\overline{M}} \leq n^{1/3d}$, combining inequalities (4.8), (4.12) and (4.14), we obtain that for $l_1 \geq l_0$, for $n \geq n_0$,

$$\begin{aligned} \mathbb{P} \left(\begin{array}{l} \text{There exists a path } \gamma \text{ starting from } 0 \text{ such that } |\gamma| \leq n \\ \text{and } \sum_{k=3}^{M(\gamma)-1} n_k(\gamma) N_{k+1}^2 N_k^{3d} (3d)^{2k} \geq n \text{ or } N_{M(\gamma)} > n^{1/3d} \end{array} \right) \\ \leq \sum_{k=3}^{\overline{M}-1} R^d \exp \left(-\frac{\log 2}{6R^d N_{k+1}^2 N_k^{3d+1} n} \right) + C_1 \exp(-C_2 n^{1/(6d^2+1)}) \\ \leq \sum_{k=3}^{\overline{M}-1} R^d \exp \left(-\frac{\log 2}{6R^d} \frac{n}{n^{2/3d+(3d+1)/6d^2}} \right) + C_1 \exp(-C_2 n^{1/(6d^2+1)}) \\ \leq R^d C (\log \log n) \exp \left(-\frac{\log 2}{6R^d} n^{1/3} \right) + C_1 \exp(-C_2 n^{1/(6d^2+1)}). \end{aligned}$$

This yields the desired result. \square

5 Conclusion

In this section, we prove the main theorems 1.2 and 1.3.

5.1 Bernoulli case: Proof of theorem 1.2

Let $p_0 > p_c(d)$. Let $\delta_0(p_0)$ be given by theorem 4.2. Let p, q be such that $p_0 \leq p < q \leq p + \delta_0(p_0)$. Let $x \in \mathbb{Z}^d \setminus \{0\}$. Let $(N_k)_{k \geq 1}$ be a sequence, n_0 and $M(\gamma)$ as given by proposition 4.5. Let us denote

$$\lambda = 3^{2d} 4d^2 \beta \frac{(3d)^4 N_3^2 N_2^{2d} + d}{p_0}.$$

Let $n \geq n_0$. Let us assume that 0 and nx belong to \mathcal{C}_{p_0} . This implies that 0 and nx belong also to \mathcal{C}_q . We denote by γ a geodesic between 0 and nx in \mathcal{C}_q , *i.e.*, γ is a q -open path such that $|\gamma| = D^{\mathcal{C}_q}(0, nx)$. If there are several possible choices for γ , we choose one according to some deterministic rule. Using proposition 4.5, we have

$$\begin{aligned} & \mathbb{P} \left(D^{\mathcal{C}_p} \left(\tilde{0}^{\mathcal{C}_{p_0}}, \tilde{nx}^{\mathcal{C}_{p_0}} \right) - D^{\mathcal{C}_q} \left(\tilde{0}^{\mathcal{C}_{p_0}}, \tilde{nx}^{\mathcal{C}_{p_0}} \right) \geq 25N_1\beta\lambda(q-p)\|x\|_1 n \right) \\ & \leq \mathbb{P} \left(\begin{array}{l} 0 \in \mathcal{C}_{p_0}, nx \in \mathcal{C}_{p_0}, |\gamma| \leq \beta n \|x\|_1, \\ D^{\mathcal{C}_p}(0, nx) - D^{\mathcal{C}_q}(0, nx) \geq 25N_1\beta\lambda(q-p)\|x\|_1 n \end{array} \right) \\ & \quad + (1 - \mathbb{P}(0 \in \mathcal{C}_{p_0}, nx \in \mathcal{C}_{p_0})) + \mathbb{P}(\beta n \|x\|_1 < D^{\mathcal{C}_q}(0, nx) < \infty) \\ & \leq \mathbb{P} \left(\begin{array}{l} 0 \in \mathcal{C}_{p_0}, nx \in \mathcal{C}_{p_0}, |\gamma| \leq \beta n \|x\|_1, \\ D^{\mathcal{C}_p}(0, nx) - D^{\mathcal{C}_q}(0, nx) \geq 25N_1\beta\lambda(q-p)\|x\|_1 n, \\ \sum_{k=3}^{M(\gamma)-1} n_k(\gamma) N_{k+1}^2 N_k^{3d} (3d)^{2k} < \beta n \|x\|_1, N_{M(\gamma)} \leq n^{1/3d} \end{array} \right) \\ & \quad + (1 - \mathbb{P}(0 \in \mathcal{C}_{p_0}, nx \in \mathcal{C}_{p_0})) + \mathbb{P}(\beta n \|x\|_1 < D^{\mathcal{C}_q}(0, nx) < \infty) \\ & \quad + \exp(-A_1 n^{1/(6d^2+1)}). \end{aligned} \tag{5.1}$$

Using the FKG inequality, we have

$$\mathbb{P}(0 \in \mathcal{C}_{p_0}, nx \in \mathcal{C}_{p_0}) \geq \mathbb{P}(0 \in \mathcal{C}_{p_0})^2 > 0. \tag{5.2}$$

Using lemma 2.3, we have

$$\mathbb{P}(\beta n \|x\|_1 < D^{\mathcal{C}_q}(0, nx) < \infty) \leq \widehat{A} \exp(-\widehat{B}n). \tag{5.3}$$

We set

$$\tilde{\gamma} = \gamma \setminus (B_{4n^{1/3d}} \cup (B_{4n^{1/3d}} + nx)).$$

Note that on the event $\{N_{M(\gamma)} \leq n^{1/3d}\}$, we have $\tilde{\gamma} \subset \bar{\gamma}$. On the event

$$\left\{ \sum_{k=3}^{M(\gamma)-1} n_k(\gamma) N_{k+1}^2 N_k^{3d} (3d)^{2k} \leq \beta n \|x\|_1, |\gamma| \leq \beta n \|x\|_1 \right\},$$

using proposition 3.5, we obtain

$$\begin{aligned} \sum_{e \in \tilde{\gamma}} |\text{shell}(e)|^2 & \leq 3^{2d} 4d^2 \left((3d)^4 |\gamma| N_3^2 N_2^{2d} + \sum_{k=3}^{M(\gamma)-1} n_k(\gamma) N_{k+1}^2 N_k^{3d} (3d)^{2k} d \right) \\ & \leq 3^{2d} 4d^2 \beta \|x\|_1 ((3d)^4 N_3^2 N_2^{2d} + d) n \leq \lambda \|x\|_1 p_0 n. \end{aligned}$$

Hence

$$\begin{aligned} & \mathbb{P} \left(\begin{array}{l} 0 \in \mathcal{C}_{p_0}, nx \in \mathcal{C}_{p_0}, |\gamma| \leq \beta n \|x\|_1, \\ D^{\mathcal{C}_p}(0, nx) - D^{\mathcal{C}_q}(0, nx) \geq 25N_1\beta\lambda(q-p)\|x\|_1 n, \\ \sum_{k=3}^{M(\gamma)-1} n_k(\gamma) N_{k+1}^2 N_k^{3d} (3d)^{2k} < \beta n \|x\|_1, N_{M(\gamma)} \leq n^{1/3d} \end{array} \right) \\ & \leq \mathbb{P} \left(\begin{array}{l} 0 \in \mathcal{C}_{p_0}, nx \in \mathcal{C}_{p_0}, |\gamma| \leq \beta n \|x\|_1, \\ D^{\mathcal{C}_p}(0, nx) - D^{\mathcal{C}_q}(0, nx) \geq 25N_1\beta\lambda(q-p)\|x\|_1 n, \\ \sum_{e \in \tilde{\gamma}} |\text{shell}(e)|^2 \leq \lambda p_0 \|x\|_1 n, N_{M(\gamma)} \leq n^{1/3d} \end{array} \right). \end{aligned} \tag{5.4}$$

We would like to introduce a coupling of the percolation processes with parameters q and p such that, if an edge is p -open, then it is q -open, and we would like that the random path γ and the shells associated to the edges in γ are in some sense independent from the p -state of the edges in $\tilde{\gamma}$. This is not the case when we use the classical coupling with a unique uniform random variable associated to each edge. For a fixed path r , given a family of shells associated with the edges of r and a subset E of \tilde{r} , we do not use the p -state of the edges in r to build the bypasses of the edges in E , because the existence of p -open bypasses for the edges in E does not depend on the p -states of the edges in r . Indeed, a bypass is a p -open path of edges which connects two vertices of r but which does not go through an edge of r . To clarify the computations, we introduce three sources of randomness in order to ensure that the choice of γ and its shells are independent from the p -states of the edges in $\tilde{\gamma}$. To each edge we associate three independent Bernoulli random variables V , W and Z of respective parameters q , p/q and p/q . The random variables ZV and ZW are Bernoulli random variables of parameter p and we have

$$\mathbb{P}(ZV = 0 | V = 1) = \mathbb{P}(Z = 0 | V = 1) = \mathbb{P}(Z = 0) = 1 - \frac{p}{q} = \frac{q-p}{q}.$$

The q -states of the edges is given by the family $(V_e)_{e \in \mathbb{E}^d}$. Once we know the q -states of the edges, we find a geodesic γ . The p -states of the edges outside γ is given by the family $(V_e Z_e)_{e \in \mathbb{E}^d}$, while the p -states of the edges belonging to γ is given by the family $(V_e W_e)_{e \in \mathbb{E}^d}$. More precisely, on the event $\{\gamma = r\}$, an edge $e \in \tilde{r}$ is p -open if $W_e = 1$, whereas an edge e in $\mathbb{E}^d \setminus \tilde{r}$ is p -open if $V_e Z_e = 1$. We denote by \mathcal{E} the set of the p -closed edges in $\tilde{\gamma}$. The event $\{\gamma = r\}$ depends only on the family $(V_e)_{e \in \mathbb{E}^d}$, the event $\{\text{shell}(e) = S_e\}$ depends on the families of random variables $(V_e)_{e \in \mathbb{E}^d}$ and $(Z_e)_{e \in \mathbb{E}^d}$. Finally the event $\{\mathcal{E} = E\}$ depends on the random variables $(W_e)_{e \in \tilde{r}}$. We sum over all possible realizations of γ , $(\text{shell}(e))_{e \in \tilde{\gamma}}$ and \mathcal{E} :

$$\begin{aligned} & \mathbb{P} \left(\begin{array}{l} 0 \in \mathcal{C}_{p_0}, nx \in \mathcal{C}_{p_0}, |\gamma| \leq \beta n \|x\|_1, \\ D^{\mathcal{C}_p}(0, nx) - D^{\mathcal{C}_q}(0, nx) \geq 25N_1 \beta \lambda (q-p) \|x\|_1 n, \\ \sum_{e \in \tilde{\gamma}} |\text{shell}(e)|^2 \leq \lambda p_0 \|x\|_1 n, N_{M(\gamma)} \leq n^{1/3d} \end{array} \right) \\ &= \sum_{\substack{r \text{ path} \\ |r| \leq \beta n \|x\|_1}} \sum_{\substack{S_e, e \in \tilde{r} \\ \sum_{e \in \tilde{r}} |S_e|^2 \\ \leq \lambda p_0 \|x\|_1 n}} \sum_{E \subset \tilde{r}} \mathbb{P} \left(\begin{array}{l} \gamma = r, \mathcal{E} = E, \forall e \in \tilde{r} \quad \text{shell}(e) = S_e \\ D^{\mathcal{C}_p}(0, nx) - |r| \geq 25N_1 \beta \lambda (q-p) \|x\|_1 n, \\ N_{M(\gamma)} \leq n^{1/3d} \end{array} \right). \end{aligned} \quad (5.5)$$

By proposition 3.6, we can build a path r' such that r' does not contain any edge of E , the edges in $r' \setminus r$ are p -open and

$$|r' \setminus r| \leq 12\beta N_1 \sum_{e \in E} |S_e|.$$

We recall that we work on the event $\{N_{M(\gamma)} \leq n^{1/3d}\}$. At this stage, the edges in

$$r' \cap (B_{4n^{1/3d}} \cup (B_{4n^{1/3d}} + nx))$$

are not necessarily p -open. We denote by y (respectively z) the first intersection of r' with $\partial B_{4n^{1/3d}}$ (respectively the last intersection of r' with $\partial B_{4n^{1/3d}} + nx$). Let $C_p(w)$ denotes the p -open cluster of $w \in \mathbb{Z}^d$. From the previous construction, we see that $C_p(y)$ and $C_p(z)$ have cardinality at least $n - 8n^{1/3d}$. Using the result of Kesten and Zhang in [53], we get

$$\begin{aligned} \mathbb{P}(y \notin C_p) &\leq \mathbb{P}(n - 4n^{1/3d} < |C_p(y)| < \infty) \\ &\leq \sum_{y \in \partial B_{4n^{1/3d}}} \mathbb{P}(n - 8n^{1/3d} < |C_p(y)| < \infty) \\ &\leq |\partial B_{4n^{1/3d}}| C_1 \exp(-C_2 n^{(d-1)/d}). \end{aligned} \quad (5.6)$$

Therefore, with probability at least $1 - 2|\partial B_{4n^{1/3d}}|C_1 \exp(-C_2 n^{(d-1)/d})$, the vertices y and z belong to \mathcal{C}_p . Applying lemma 2.3, we have

$$\begin{aligned} & \mathbb{P}(\exists y \in \partial B_{4n^{1/3d}}, \beta \|y\|_1 \leq D^{C_p}(0, y) < \infty) \\ & \leq \sum_{y \in \partial B_{4n^{1/3d}}} \mathbb{P}(\beta \|y\|_1 \leq D^{C_p}(0, y) < \infty) \leq |\partial B_{4n^{1/3d}}| \widehat{A} \exp(-2\widehat{B}n^{1/3d}). \end{aligned} \quad (5.7)$$

Thus with probability at least $1 - 2|\partial B_{4n^{1/3d}}| \widehat{A} \exp(-2\widehat{B}n^{1/3d})$, we can join 0 and y (respectively z and nx) by a p -open path r^{first} (respectively r^{last}) of length at most $4d\beta n^{1/3d}$. By concatenating r^{first} , the portion of r' between y and z , and r^{last} in this order, we obtain a p -open path r'' that joins 0 and nx such that

$$|r'' \setminus r| \leq |r^{first}| + |r^{last}| + |r' \setminus r| \leq 8d\beta n^{1/3d} + 12\beta N_1 \sum_{e \in E} |S_e|. \quad (5.8)$$

Therefore, combining inequalities (5.5), (5.6), (5.7) and (5.8), we get for n large enough

$$\begin{aligned} & \mathbb{P} \left(\begin{array}{l} 0 \in \mathcal{C}_{p_0}, nx \in \mathcal{C}_{p_0}, |\gamma| \leq \beta n \|x\|_1, \\ D^{C_p}(0, nx) - D^{C_q}(0, nx) \geq 25N_1\beta\lambda(q-p)\|x\|_1 n, \\ \sum_{e \in \tilde{\gamma}} |\text{shell}(e)|^2 \leq \lambda p_0 \|x\|_1 n, N_{M(\gamma)} \leq n^{1/3d} \end{array} \right) \\ & \leq \sum_{\substack{r \text{ path} \\ |r| \leq \beta n \|x\|_1}} \sum_{\substack{S_e, e \in \tilde{r} \\ \sum_{e \in \tilde{r}} |S_e|^2 \\ \leq \lambda p_0 \|x\|_1 n}} \sum_{E \subset \tilde{r}} \mathbb{P} \left(\begin{array}{l} \gamma = r, \mathcal{E} = E, \forall e \in \tilde{r} \quad \text{shell}(e) = S_e \\ 12N_1 \sum_{e \in E} |S_e| \geq 24N_1(q-p)\lambda\|x\|_1 n \end{array} \right) \\ & \quad + 2|\partial B_{4n^{1/3d}}| (C_1 \exp(-C_2 n^{(d-1)/d}) + \widehat{A} \exp(-2\widehat{B}n^{1/3d})). \end{aligned} \quad (5.9)$$

Using the definition of our coupling, we get

$$\begin{aligned} & \sum_{\substack{r \text{ path} \\ |r| \leq \beta n \|x\|_1}} \sum_{\substack{S_e, e \in \tilde{r} \\ \sum_{e \in \tilde{r}} |S_e|^2 \leq \lambda p_0 \|x\|_1 n}} \sum_{E \subset \tilde{r}} \mathbb{P} \left(\begin{array}{l} \gamma = r, \mathcal{E} = E, \forall e \in \tilde{r} \quad \text{shell}(e) = S_e \\ \sum_{e \in \mathcal{E}} |S_e| \geq 2\lambda(q-p)\|x\|_1 n \end{array} \right) \\ & \leq \sum_{\substack{r \text{ path} \\ |r| \leq \beta n \|x\|_1}} \sum_{\substack{S_e, e \in \tilde{r} \\ \sum_{e \in \tilde{r}} |S_e|^2 \\ \leq \lambda p_0 \|x\|_1 n}} \mathbb{P} \left(\begin{array}{l} \gamma = r, \forall e \in \tilde{r} \quad \text{shell}(e) = S_e \\ \sum_{e \in \tilde{r}} (1 - W_e) |S_e| \geq 2\lambda(q-p)\|x\|_1 n \end{array} \right) \\ & = \sum_{\substack{r \text{ path} \\ |r| \leq \beta n \|x\|_1}} \sum_{\substack{S_e, e \in \tilde{r} \\ \sum_{e \in \tilde{r}} |S_e|^2 \\ \leq \lambda p_0 \|x\|_1 n}} \mathbb{P}(\gamma = r, \forall e \in \tilde{r} \quad \text{shell}(e) = S_e) \\ & \quad \times \mathbb{P} \left(\sum_{e \in \tilde{r}} (1 - W_e) |S_e| \geq 2\lambda(q-p)\|x\|_1 n \right). \end{aligned} \quad (5.10)$$

In the last step, we used the fact that the random variables $(W_e, e \in \tilde{r})$ are independent from the event $\{\gamma = r\}$ and the shells $(\text{shell}(e), e \in \tilde{r})$. Let us set

$$U = \sum_{e \in \tilde{r}} (1 - W_e) |S_e|.$$

We have

$$\mathbb{E}(U) = \frac{q-p}{q} \sum_{e \in \tilde{r}} |S_e| \leq \lambda(q-p)\|x\|_1 n \quad (5.11)$$

and

$$\mathrm{Var}(U) \leq \mathrm{Var}(1 - W) \sum_{e \in \tilde{r}} |S_e|^2 \leq \lambda \frac{p_0}{4} \|x\|_1 n. \quad (5.12)$$

Using the Markov inequality and inequalities (5.11) and (5.12), we get

$$\begin{aligned} \mathbb{P} \left(\sum_{e \in \tilde{r}} (1 - W_e) |S_e| \geq 2\lambda(q - p) \|x\|_1 n \right) &\leq \mathbb{P}(|U - \mathbb{E}(U)| \geq \lambda(q - p) \|x\|_1 n) \\ &\leq \frac{\mathrm{Var}(U)}{(\lambda(q - p) \|x\|_1 n)^2} \leq \frac{p_0}{4\lambda(q - p)^2 \|x\|_1 n}. \end{aligned} \quad (5.13)$$

Finally, combining inequalities (5.1), (5.2), (5.3), (5.9), (5.10) and (5.13), we deduce the existence of a real number $\mathbf{p}(p_0, p, q) > 0$ such that, for n large enough,

$$\mathbb{P} \left(D^{\mathcal{C}_p} \left(\tilde{0}^{\mathcal{C}_{p_0}}, \tilde{n}\tilde{x}^{\mathcal{C}_{p_0}} \right) - D^{\mathcal{C}_q} \left(\tilde{0}^{\mathcal{C}_{p_0}}, \tilde{x}^{\mathcal{C}_{p_0}} \right) \leq 25N_1\beta\lambda(q - p) \|x\|_1 n \right) \geq \mathbf{p}(p_0, p, q).$$

Let $\delta > 0$. Thanks to the convergence of the regularized times given by proposition 2.1, we can also choose n large enough such that

$$\begin{aligned} \mathbb{P} \left(\mu_p(x) - \delta \leq \frac{D^{\mathcal{C}_p} \left(\tilde{0}^{\mathcal{C}_{p_0}}, \tilde{n}\tilde{x}^{\mathcal{C}_{p_0}} \right)}{n} \right) &\geq 1 - \frac{\mathbf{p}(p_0, p, q)}{3}, \\ \mathbb{P} \left(\frac{D^{\mathcal{C}_q} \left(\tilde{0}^{\mathcal{C}_{p_0}}, \tilde{n}\tilde{x}^{\mathcal{C}_{p_0}} \right)}{n} \leq \mu_q(x) + \delta \right) &\geq 1 - \frac{\mathbf{p}(p_0, p, q)}{3}. \end{aligned}$$

The intersection of the three previous events has positive probability. On this intersection, we have

$$\mu_p(x) - \delta \leq \mu_q(x) + \delta + 25N_1\beta\lambda(q - p) \|x\|_1.$$

This inequality occurs with positive probability, yet all the quantities in it are deterministic. By taking the limit when δ goes to 0, we get

$$\mu_p(x) \leq \mu_q(x) + 25N_1\beta\lambda(q - p) \|x\|_1.$$

Thus for all $p \geq p_0$ and $p < q \leq p + \delta_0$, there exists a positive constant $C'(p_0)$ such that

$$\forall x \in \mathbb{Z}^d \quad \mu_p(x) - \mu_q(x) \leq C'(p_0)(q - p) \|x\|_1.$$

We recall that the map $p \mapsto \mu_p$ is non-increasing. We consider now the case $q > p + \delta_0$. We write $q - p = k\delta_0 + r$ with $k \in \mathbb{N}$ and $0 \leq r < \delta_0$. We obtain

$$\begin{aligned} \mu_p(x) - \mu_q(x) &= \sum_{i=0}^{k-1} \mu_{p+i\delta_0}(x) - \mu_{p+(i+1)\delta_0}(x) + \mu_{q-r}(x) - \mu_q(x) \\ &\leq \sum_{i=0}^{k-1} C'(p_0)\delta_0 \|x\|_1 + C'(p_0)r \|x\|_1 = C'(p_0)(k\delta_0 + r) \|x\|_1 \\ &= C'(p_0)(q - p) \|x\|_1. \end{aligned} \quad (5.14)$$

By homogeneity, (5.14) also holds for all $x \in \mathbb{Q}^d$. Let us recall that for all $x, y \in \mathbb{R}^d$ and $p \geq p_c(d)$, we have (see for instance theorem 1 in [28])

$$|\mu_p(x) - \mu_p(y)| \leq \mu_p(e_1) \|x - y\|_1. \quad (5.15)$$

Moreover, by compactness of \mathbb{S}^{d-1} , there exists a finite set (y_1, \dots, y_m) of rational points of \mathbb{S}^{d-1} such that

$$\mathbb{S}^{d-1} \subset \bigcup_{i=1}^m \left\{ x \in \mathbb{S}^{d-1} : \|y_i - x\|_1 \leq (q-p) \right\}.$$

Let $x \in \mathbb{S}^{d-1}$ and y_i such that $\|y_i - x\|_1 \leq (q-p)$, using inequality (5.15), we get

$$\begin{aligned} |\mu_p(x) - \mu_q(x)| &\leq |\mu_p(x) - \mu_p(y_i)| + |\mu_p(y_i) - \mu_q(y_i)| + |\mu_q(y_i) - \mu_q(x)| \\ &\leq \mu_p(e_1)\|y_i - x\|_1 + C'(p_0)(q-p) + \mu_q(e_1)\|y_i - x\|_1 \\ &\leq (2\mu_{p_0}(e_1) + C'(p_0))(q-p), \end{aligned}$$

where we use the monotonicity of the map $p \rightarrow \mu_p$ in the last inequality. Finally, for any $p, q \in [p_0, 1]$,

$$\sup_{x \in \mathbb{S}^{d-1}} |\mu_p(x) - \mu_q(x)| \leq (2\mu_{p_0}(e_1) + C'(p_0))|q-p|.$$

This yields the result.

5.2 General distributions case

In this section, we prove theorem 1.3. The following proposition relies on a result of Kesten (proposition (5.8) in [51]).

Proposition 5.1. *Let $p_1 < p_c(d)$, $p_0 > p_c(d)$, $M > 0$, $\varepsilon_0 > 0$ and $\varepsilon \mapsto \delta(\varepsilon)$ be a non-decreasing function such that $\delta(\varepsilon_0) \leq 1 - p_1$. Let $\mathfrak{C}_{p_0, p_1, M, \varepsilon_0, \delta}$ be the class of functions defined in theorem 1.3. There exist positive constants A , B and C depending on these parameters such that, for any distribution G in $\mathfrak{C}_{p_0, p_1, M, \varepsilon_0, \delta}$,*

$$\forall n \geq 1 \quad \mathbb{P} \left(\begin{array}{l} \text{There exists a path } r \text{ starting from } 0 \\ \text{such that } |r| \geq n \text{ and } T_G(r) < Cn \end{array} \right) \leq A \exp(-Bn).$$

Proof of theorem 1.3. Let H be the distribution such that $H(\{0\}) = p_1$, for every $\varepsilon \leq \varepsilon_0$, we have $H([0, \varepsilon]) = \delta(\varepsilon)$ and $H(\{\varepsilon_0\}) = 1 - H([0, \varepsilon_0])$. Using proposition 5.8 in [51], there exist positive constants A , B and C depending on the distribution H such that

$$\forall n \geq 1 \quad \mathbb{P} \left(\begin{array}{l} \text{There exists a path } r \text{ starting from } 0 \\ \text{such that } |r| \geq n \text{ and } T_H(r) < Cn \end{array} \right) \leq A \exp(-Bn).$$

By construction, any distribution G in $\mathfrak{C}_{p_0, p_1, M, \varepsilon_0, \delta}$ stochastically dominates H . Let $n \geq 1$. Using the stochastic domination, we have

$$\begin{aligned} &\mathbb{P} \left(\begin{array}{l} \text{There exists a path } r \text{ starting from } 0 \\ \text{such that } |r| \geq n \text{ and } T_G(r) < Cn \end{array} \right) \\ &\leq \mathbb{P} \left(\begin{array}{l} \text{There exists a path } r \text{ starting from } 0 \\ \text{such that } |r| \geq n \text{ and } T_H(r) < Cn \end{array} \right) \leq A \exp(-Bn). \end{aligned}$$

This yields the result. \square

The proof of theorem 1.3 uses the same strategy as the proof of theorem 1.2, so we will only sketch the arguments.

Proof. Let $p_1 < p_c(d)$, $p_0 > p_c(d)$, $M > 0$, $\varepsilon_0 > 0$ and $\varepsilon \mapsto \delta(\varepsilon)$ be a function. Let G and F be two distributions on $[0, +\infty[$ in $\mathfrak{C}_{p_0, p_1, M, \varepsilon_0, \delta}$. Let $p < q \in [p_0, 1]$. We define G_p and F_q as

$$G_p = pG + (1-p)\delta_\infty \quad \text{and} \quad F_q = qF + (1-q)\delta_\infty.$$

We write $q-p = k\delta_0/2 + r$ with $k \in \mathbb{N}$ and $0 \leq r < \delta_0/2$. We have

$$\begin{aligned} &|\mu_{F_q}(x) - \mu_{G_p}(x)| \\ &\leq |\mu_{F_q}(x) - \mu_{G_{q-r}}(x)| + \sum_{i=0}^{k-1} |\mu_{G_{p+(i+1)\delta_0/2}}(x) - \mu_{G_{p+i\delta_0/2}}(x)|. \end{aligned} \quad (5.16)$$

Let $i \in \{0, \dots, k-1\}$. We introduce next a coupling between $G_{p+i\delta_0/2}$ and $G_{p+(i+1)\delta_0/2}$. To each edge $e \in \mathbb{E}^d$, we associate three random variables: one uniform random variable $U(e)$ on $[0, 1]$, two Bernoulli random variables $V(e)$ and $W(e)$ of parameters $p + (i+1)\delta_0/2$ and $\delta_0/2$. We set

$$t_{G_{p+(i+1)\delta_0/2}}(e) = \begin{cases} G^{-1}(U(e)) & \text{if } V(e) = 1 \\ +\infty & \text{otherwise} \end{cases}$$

and

$$t_{G_{p+i\delta_0/2}}(e) = \begin{cases} G^{-1}(U(e)) & \text{if } V(e)W(e) = 1 \\ +\infty & \text{otherwise,} \end{cases}.$$

With this coupling, we have

$$\forall e \in \mathbb{E}^d \quad t_{G_{p+i\delta_0/2}}(e) \geq t_{G_{p+(i+1)\delta_0/2}}(e),$$

thus $\mu_{G_{p+i\delta_0/2}}$ stochastically dominates $\mu_{G_{p+(i+1)\delta_0/2}}$. Since $G \in \mathfrak{C}_{p_0, p_1, M, \varepsilon_0, \delta}$, we have $G([0, M]) \geq 1 - \delta_0/2$ and therefore

$$\begin{aligned} G_{p+(i+1)\delta_0/2}([0, \infty]) - G_{p+i\delta_0/2}([0, M]) \\ \leq p + (i+1)\frac{\delta_0}{2} - \left(p + i\frac{\delta_0}{2}\right) \left(1 - \frac{\delta_0}{2}\right) \leq \delta_0. \end{aligned}$$

Let $n \geq 1$. Let us assume that 0 and nx belong to $\mathcal{C}_{p_0, M}$, the infinite cluster made of edges e such that $t_{G_{p_0}}(e) \leq M$. Let γ be a geodesic between 0 and nx for the passage times $(t_{G_{p+(i+1)\delta_0/2}}(e))_{e \in \mathbb{E}^d}$. For some edges $e \in \gamma$, we have $t_{G_{p+i\delta_0/2}}(e) = \infty$. We would like to bypass these edges using only edges $e \in \mathbb{E}^d$ such that $t_{G_{p+i\delta_0/2}}(e) \leq M$. We control the length of the bypasses using the same strategy as in the Bernoulli case. Up to choosing a smaller δ_0 , we can assume that

$$G_{p+i\delta_0/2}([0, M]) = \left(p + i\frac{\delta_0}{2}\right) \left(1 - \frac{\delta_0}{2}\right) \geq p_0 \left(1 - \frac{\delta_0}{2}\right) > p_c(d).$$

We say that the edge e is $G_{p+i\delta_0/2}([0, M])$ -open (respectively $G_{p+(i+1)\delta_0/2}([0, \infty])$ -open) if

$$t_{G_{p+i\delta_0/2}}(e) \leq M \quad (\text{respectively } t_{G_{p+(i+1)\delta_0/2}}(e) < \infty).$$

The shells are now made of $(G_{p+i\delta_0/2}([0, M]), G_{p+(i+1)\delta_0/2}([0, \infty]))$ -good boxes. Let $(\text{shell}(e))_{e \in \gamma}$ be a family of shells as in proposition 3.5. We can build γ' and γ'' as in the Bernoulli case, where γ'' is a path between 0 and nx whose edges have finite passage times for the distribution $G_{p+i\delta_0/2}$. With this coupling, the passage times coincide for the two distributions on $\gamma'' \cap \gamma$. Thus, we have

$$\begin{aligned} T_{G_{p+i\delta_0/2}}(\gamma'') \\ \leq T_{G_{p+i\delta_0/2}}(\gamma^{(first)}) + T_{G_{p+i\delta_0/2}}(\gamma^{(last)}) + T_{G_{p+i\delta_0/2}}(\gamma \cap \gamma'') + T_{G_{p+i\delta_0/2}}(\gamma' \setminus \gamma) \\ \leq 4dM\beta n^{1/3d} + T_{G_{p+(i+1)\delta_0/2}}(\gamma) + 12\beta N_1 M \sum_{e \in \bar{\gamma}} |\text{shell}(e)| \mathbf{1}_{W(e)=0}. \end{aligned}$$

We need then to control the length of γ . We have

$$G_{p+(i+1)\delta_0/2}([0, M]) \geq p_0.$$

Since 0 and nx belong to $\mathcal{C}_{p_0, M}$, then 0 and nx also belong to $\mathcal{C}_{p+(i+1)\delta_0/2, M}$, the infinite cluster made of edges e such that $t_{G_{p+(i+1)\delta_0/2}}(e) \leq M$. Using lemma 2.3, we obtain that, with high probability,

$$D^{\mathcal{C}_{p+(i+1)\delta_0/2, M}}(0, nx) \leq \beta n \|x\|_1,$$

which implies further that

$$T_{G_{p+(i+1)\delta_0/2}}(\gamma) \leq M\beta n \|x\|_1.$$

Since $G_{p+(i+1)\delta_0/2}$ belongs to $\mathfrak{C}_{p_0, p_1, M, \varepsilon_0, \delta}$, we have, with high probability,

$$|\gamma| \leq \frac{M}{C} \beta n \|x\|_1,$$

where C is the constant defined in proposition 5.1 corresponding to the class $\mathfrak{C}_{p_0, p_1, M, \varepsilon_0, \delta}$. As in the Bernoulli case, we have, with high probability,

$$\sum_{e \in \bar{\gamma}} |\text{shell}(e)| \mathbf{1}_{W(e)=0} \leq \frac{\delta_0 M}{2} \frac{A'(p_0) \beta n \|x\|_1}{C}.$$

In the same way than in the Bernoulli case, we conclude that there exists a positive constant κ that depends on $p_1, p_0, \varepsilon_0, M, \delta$ and d such that

$$\sup_{x \in \mathbb{S}^{d-1}} |\mu_{G_{p+i\delta_0/2}}(x) - \mu_{G_{p+(i+1)\delta_0/2}}(x)| \leq \kappa \frac{\delta_0}{2}.$$

Therefore

$$\sum_{i=0}^{k-1} |\mu_{G_{p+i\delta_0/2}}(x) - \mu_{G_{p+(i+1)\delta_0/2}}(x)| \leq \kappa k \frac{\delta_0}{2}.$$

The last step of the proof consists in controlling the quantity $|\mu_{F_q}(x) - \mu_{G_{q-r}}(x)|$. We use again the same strategy. We introduce a specific coupling. To each edge $e \in \mathbb{E}^d$, we associate three random variables: a uniform random variable $U(e)$ on $[0, 1]$, two Bernoulli random variables $V(e)$ and $W(e)$ of parameters q and r . We set

$$t_{F_q}(e) = \begin{cases} F^{-1}(U(e)) & \text{if } V(e) = 1 \\ +\infty & \text{otherwise} \end{cases}$$

and

$$t_{G_{q-r}}(e) = \begin{cases} G^{-1}(U(e)) & \text{if } V(e)W(e) = 1 \\ +\infty & \text{otherwise.} \end{cases}$$

We consider the geodesic γ between 0 and nx for the passage times $(t_{F_q}(e))_{e \in \mathbb{E}^d}$. For some edges $e \in \gamma$, we have $t_{G_{q-r}}(e) = \infty$. We shall bypass these edges using only edges $e \in \mathbb{E}^d$ such that $t_{G_{q-r}}(e) \leq M$. We build γ'' as before. The main difference is that, for edges in $\gamma'' \cap \gamma$, the passage times for the distributions F_q and G_{q-r} do not coincide any more. For $e \in \gamma'' \cap \gamma$, we have

$$|t_{F_q}(e) - t_{G_{q-r}}(e)| = |F^{-1}(U(e)) - G^{-1}(U(e))| \leq \sup_{t \in [0,1]} |F^{-1}(t) - G^{-1}(t)|.$$

Thus, we obtain

$$\begin{aligned} T_{G_{q-r}}(0, nx) &\leq T_{G_{q-r}}(\gamma'') \leq T_{G_{q-r}}(\gamma'' \cap \gamma) + T_{G_{q-r}}(\gamma'' \setminus \gamma) \\ &\leq T_{F_q}(\gamma) + |\gamma| \sup_{t \in [0,1]} |F^{-1}(t) - G^{-1}(t)| + 12\beta N_1 M \sum_{e \in \bar{\gamma}} |\text{shell}(e)| \mathbf{1}_{W(e)=0}, \end{aligned}$$

where the shells are made of $(G_{q-r}([0, M]), F_q([0, \infty]))$ -good boxes. We can show as above that there exists a positive constant κ' depending on the parameters of the class \mathfrak{C} such that

$$\sup_{x \in \mathbb{S}^{d-1}} (\mu_{G_{q-r}}(x) - \mu_{F_q}(x)) \leq \kappa' \left(\sup_{t \in [0,1]} |F^{-1}(t) - G^{-1}(t)| + r \right).$$

To prove the converse inequality, we consider the geodesic π between 0 and nx for the law G_{q-r} . Given the coupling, any edge in π has finite passage time for the law F_q . Therefore, we have

$$T_{F_q}(0, nx) \leq T_{F_q}(\pi) \leq T_{G_{q-r}}(\pi) + |\pi| \sup_{t \in [0,1]} |F^{-1}(t) - G^{-1}(t)|. \quad (5.17)$$

We obtain the converse inequality and therefore

$$\sup_{x \in \mathbb{S}^{d-1}} |\mu_{G_{q-r}}(x) - \mu_{F_q}(x)| \leq \kappa' \left(\sup_{t \in [0,1]} |F^{-1}(t) - G^{-1}(t)| + r \right). \quad (5.18)$$

Finally, combining inequalities (5.16) and (5.18), we get

$$\sup_{x \in \mathbb{S}^{d-1}} |\mu_{F_q}(x) - \mu_{G_p}(x)| \leq \max(\kappa, \kappa') \left(|q - p| + \sup_{t \in [0,1]} |F^{-1}(t) - G^{-1}(t)| \right).$$

This yields the result. \square

Part III

Flow constant

Chapter 7

The maximal flow from a compact convex subset to infinity in first passage percolation on \mathbb{Z}^d

We consider the standard first passage percolation model on \mathbb{Z}^d with a distribution G on \mathbb{R}^+ that admits an exponential moment. We study the maximal flow between a compact convex subset A of \mathbb{R}^d and infinity. The study of maximal flow is associated with the study of sets of edges of minimal capacity that cut A from infinity. We prove that the rescaled maximal flow between nA and infinity $\phi(nA)/n^{d-1}$ almost surely converges towards a deterministic constant depending on A . This constant corresponds to the capacity of the boundary ∂A of A and is the integral of a deterministic function over ∂A . This result was shown in dimension 2 and conjectured for higher dimensions by Garet in [38].

Contents

1	Introduction	161
2	The model	164
2.1	The environment	164
2.2	Maximal flow	164
2.3	The max-flow min-cut theorem	165
3	Some notations and useful results	165
3.1	Geometric notations	165
3.2	Sets of finite perimeter and surface energy	166
3.3	Approximation by convex polytopes	167
4	Background on maximal flow	168
5	Upper large deviations	169
5.1	The case of a cylinder	169
5.2	Proof of theorem 1.3	171
6	Existence of a minimal cutset	173
7	Lower large deviations	176
8	Identification of ϕ_A	182

1 Introduction

The model of first passage percolation was first introduced by Hammersley and Welsh [49] in 1965 as a model for the spread of a fluid in a porous medium. In this model, mathematicians studied intensively geodesics, *i.e.*, fastest paths between two points in the grid. The study of maximal flows in first passage percolation started later in 1984 in dimension 2 with an article of Grimmett and Kesten [45]. In 1987, Kesten studied maximal flows in dimension 3 in [52].

The study of maximal flows is associated with the study of random cutsets that can be seen as $(d - 1)$ -dimensional surfaces. Their study presents more technical difficulties than the study of geodesics. Thus, the interpretation of first passage percolation in terms of maximal flows has been less studied.

To each edge in the graph \mathbb{Z}^d , we assign a random i.i.d. capacity with distribution G on \mathbb{R}^+ that admits an exponential moment. We interpret this capacity as a rate of flow, *i.e.*, it corresponds to the maximal amount of water that can cross the edge per second. Let us consider a compact convex subset A of \mathbb{R}^d . We interpret the set A as a source of water. We are interested in the maximal amount of water that can flow from the boundary ∂A of A to infinity per second. This issue is in fact analogous to the study of the smallest capacity $\text{mincut}(A, \infty)$ over sets of edges separating A from infinity. This issue was first studied in dimension 2 by Garet in [38], he proved that the rescaled maximal flow between nA and infinity $\phi(nA)/n$ almost surely converges towards an integral of a deterministic function ν over ∂A .

Several issues arise when we study this problem in higher dimensions. Garet proves his result in [38] by proving separately upper and lower large deviations. Although the proof of the upper large deviations may be adapted to higher dimensions, the proof of lower large deviations strongly relies on combinatorial estimates that fail in higher dimensions. Moreover, in dimension 2, the function ν is actually simpler to study. Thanks to the duality, it is related to the study of geodesics, whereas in higher dimensions, we cannot avoid the study of random surfaces to define the function ν . To get a better understanding of this deterministic function in higher dimensions, we first study the maximal flow in a box. Let us consider a large box in \mathbb{Z}^d oriented along a given direction v . Next, we consider the two opposite sides of the box normal to v that we call top and bottom. We are interested in the maximal flow that can cross the box from its top to its bottom per second. More precisely, we can ask if this maximal flow properly renormalized converges when the size of the box grows to infinity. This question was addressed in [52], [62] and [73] where one can find laws of large numbers and large deviation estimates for this maximal flow when the dimensions of the box grow to infinity under some moments assumptions on the capacities and on the direction v . The maximal flow properly renormalized converges towards the so-called flow constant $\nu(v)$. In [64], Rossignol and Th  ret proved the same results without any moment assumption on G for any direction v . Roughly speaking, the flow constant $\nu(v)$ corresponds to the expected maximal amount of water that can flow per second in the direction of v . Let us consider a point x in ∂A with its associated normal unit exterior vector $n_A(x)$ and infinitesimal surface $S(x)$ around x . When we consider nA , an enlarged version of A , the surface $S(x)$ becomes $nS(x)$ and the expected maximal amount of water that can flow in the box of basis $nS(x)$ in the direction $n_A(x)$ is of order $n^{d-1}\nu(n_A(x))C_S$ where C_S is a constant depending on the area of the surface. Heuristically, when we sum over points in ∂A , we obtain that the maximal flow between nA and infinity $\phi(nA)$ is roughly n^{d-1} times the integral of ν over ∂A . We define

$$\mathcal{I}(A) = \int_{\partial A} \nu(n_A(x)) d\mathcal{H}^{d-1}(x).$$

The quantity $\mathcal{I}(A)$ may be interpreted as the capacity of ∂A .

The aim of this paper is to prove the following theorem that was conjectured by Garet in [38].

Theorem 1.1. *Let $d \geq 3$. Let A be a compact convex subset of \mathbb{R}^d . Let G be a probability measure on $[0, +\infty[$ such that $G(\{0\}) < 1 - p_c(d)$. Let ν be the flow constant associated to G . For each $\varepsilon > 0$, there exist positive constants C_1 and C_2 depending only on ε and G , such that for all $n \geq 0$,*

$$\mathbb{P} \left(\left| \frac{\text{mincut}(nA, \infty)}{n^{d-1}} - \mathcal{I}(A) \right| \geq \varepsilon \right) \leq C_1 \exp(-C_2 n^{d-1}).$$

As a corollary, $\text{mincut}(nA, \infty)/n^{d-1}$ converges in probability towards ϕ_A when n goes to infinity. Roughly speaking, the rescaled maximal flow that can go from nA to infinity is limited by the capacity of ∂A , or equivalently, the rescaled minimal capacity of a cutset between nA and infinity is equal to the capacity of ∂A . In addition, we shall prove that there exists a minimal cutset E between the set nA and infinity, *i.e.*, such that the capacity of E is equal to $\phi(nA)$ and E separates nA from infinity. This is far from obvious, but it is a natural consequence of Zhang's

result [73]. Indeed, for a fixed n , there may exist a sequence of sets $(\mathcal{E}_p)_{p \in \mathbb{N}}$ of growing size such that $\mathcal{E}_p \subset \mathbb{E}^d$ cuts A from infinity and

$$\lim_{p \rightarrow \infty} V(\mathcal{E}_p) = \text{mincut}(nA, \infty).$$

There is no direct argument that allows to extract a sequence from $(\mathcal{E}_p)_{p \in \mathbb{N}}$ which would converge to a cutset realizing the minimum. When we consider cutsets in a bounded region, the existence of a cutset achieving the infimum becomes trivial as the number of possible cutsets is finite. We define the edge boundary of A as

$$\partial_e A = \{ e = \langle x, y \rangle \in \mathbb{E}^d : x \in A \cap \mathbb{Z}^d, y \in \mathbb{Z}^d \setminus A \}.$$

Theorem 1.2 (Existence of a minimal cutset and control of its size). *Let A be a compact convex subset of \mathbb{R}^d containing the origin. Let G be a probability measure on $[0, +\infty[$ such that $G(\{0\}) < 1 - p_c(d)$ and G admits an exponential moment.*

1. *With probability 1, there exists a minimal cutset from A to infinity in the original lattice $(\mathbb{Z}^d, \mathbb{E}^d)$.*
2. *There exist constants β_0, C_1, C_2 and λ depending only on d and G such that for any $\beta > \beta_0$, for any $n \geq \lambda |\partial_e A|$,*

$$\mathbb{P}(\text{All the minimal cutsets } E \text{ are such that } |E| \geq \beta n) \leq C_1 e^{-C_2 \beta n}.$$

We prove Theorem 1.1 by proving separately the upper large deviations above the constant $\mathcal{I}(A)$ in Theorem 1.3 and the lower large deviations below the constant ϕ_A in Theorem 1.4. It will be more convenient in the following to work in the graph $(\mathbb{Z}_n^d, \mathbb{E}_n^d)$ having for vertices $\mathbb{Z}_n^d = \mathbb{Z}^d/n$ and for edges \mathbb{E}_n^d , the set of pairs of points of \mathbb{Z}^d at distance $1/n$ from each other. In this setting, the set A remains fixed and the lattice shrinks. We denote by $\text{mincut}_n(A, \infty)$, the minimal capacity over sets of edges in \mathbb{E}_n^d separating A from infinity.

Theorem 1.3 (Upper large deviations). *Let A be a compact convex subset of \mathbb{R}^d containing the origin. Let G be a probability measure on $[0, +\infty[$ such that $G(\{0\}) < 1 - p_c(d)$ and G admits an exponential moment. For each $\lambda > \mathcal{I}(A)$, there exist positive constants C_1 and C_2 depending only on λ, A and G , such that for all $n \geq 0$,*

$$\mathbb{P}(\text{mincut}_n(A, \infty) \geq \lambda n^{d-1}) \leq C_1 \exp(-C_2 n^{d-1}).$$

The proof of Theorem 1.3 is inspired by the proof of the enhanced large deviations upper bound in [38] and the proof of the upper large deviations for the maximal flow through a domain of \mathbb{R}^d done in [22]. Roughly speaking, the idea is to build a cutset E from A to infinity whose capacity is close to $\mathcal{I}(A)n^{d-1}$ and next to bound the probability that $\text{mincut}_n(A, \infty)$ is abnormally big, *i.e.*, greater than $\mathcal{I}(A)n^{d-1}$, by the probability that the capacity of E is abnormally big. To do so, we first approximate A from the outside by a convex polytope P . For each face F of P and v its associated exterior unit normal vector, we consider the cylinder $\text{cyl}(F + \varepsilon v, \varepsilon)$ of basis $F + \varepsilon v$ and of height $\varepsilon > 0$ and a cutset from the top to the bottom of the cylinder having minimal capacity. We build E by merging the cutsets associated to all the faces of the polytope. The union of these cutsets is not yet a cutset itself because of the potential holes between these cutsets. We fix this issue by adding extra edges to fill the holes. We next control the number of extra edges we have added. We also need to control the capacity of the cutsets in a cylinder of polyhedral basis to obtain the desired control.

Theorem 1.4 (Lower large deviations). *Let A be a compact convex subset of \mathbb{R}^d . Let G be a probability measure on $[0, +\infty[$ such that G admits an exponential moment and $G(\{0\}) < 1 - p_c(d)$. We define*

$$\phi_A = \inf \{ \mathcal{I}(S) : A \subset S \text{ and } S \text{ is compact} \}.$$

For each $\lambda < \phi_A$, there exist positive constants C_1 and C_2 depending only on λ, A , and G , such that for all $n \geq 0$,

$$\mathbb{P}(\text{mincut}_n(A, \infty) \leq \lambda n^{d-1}) \leq C_1 \exp(-C_2 n^{d-1}).$$

To study the lower large deviations, we try to proceed as in the work of Cerf and Th  ret in [25]. The idea is to create from a cutset $E \subset \mathbb{E}_n^d$ that cuts A from infinity a continuous subset of \mathbb{R}^d whose edge boundary (*i.e.*, the edges that have one extremity in the continuous subset and the other one outside) corresponds to the cutset E . As we can control the number of edges in a minimal cutset thanks to the work of Zhang [73], we can consider a cutset from A to infinity of minimal capacity and that has at most cn^{d-1} edges with high probability, for some positive constant c . Thanks to this crucial result, the continuous set we build has a perimeter at most c . In [25], as the two authors work in a compact region Ω , the continuous object they obtain live in the compact space consisting of all subsets of Ω of perimeter less than or equal to c . In our context, as our cutset E can go potentially very far from A , we cannot build from E a continuous set that belongs to some compact space and therefore we cannot use the same method as in [25]. However, as the capacity of E is small, we expect it to remain close to the boundary of ∂A . We should observe unlikely events just by inspecting what happens near the boundary of A . This will enable us to study only the portion of the cutset E near ∂A and to define a continuous version of this portion that belongs to a compact set. Starting from there, we can follow the strategy of [25].

Finally, we prove in Proposition 1.5 that the two constants $\mathcal{I}(A)$ and ϕ_A appearing in Theorems 1.3 and 1.4 are equal. This yields the result stated in Theorem 1.1.

Proposition 1.5. *Let A be a compact convex subset of \mathbb{R}^d . The minimal capacity ϕ_A for the flow from A to infinity is achieved by $\mathcal{I}(A)$, the capacity of the boundary of A , *i.e.*,*

$$\phi_A = \inf \{ \mathcal{I}(S), A \subset S \text{ and } S \text{ is compact} \} = \mathcal{I}(A).$$

The rest of the paper is organized as follows. In section 2, we present the model. In section 3 and 4, we give all the necessary definitions and background. In section 5, we prove the upper large deviations Theorem 1.3. We prove the existence of a minimal cutset Theorem 1.2 in section 6 and the lower large deviations Theorem 1.4 in section 7. Finally, we conclude the proof of Theorem 1.1 by proving Proposition 1.5 in section 8.

2 The model

2.1 The environment

Let $n \geq 1$ be an integer. We consider the graph $(\mathbb{Z}_n^d, \mathbb{E}_n^d)$ having for vertices $\mathbb{Z}_n^d = \mathbb{Z}^d/n$ and for edges \mathbb{E}_n^d , the set of pairs of points of \mathbb{Z}^d at distance $1/n$ from each other. We use the subscript n to emphasize the dependence on the lattice $(\mathbb{Z}_n^d, \mathbb{E}_n^d)$. With each edge $e \in \mathbb{E}_n^d$ we associate a random variable $t(e)$ with value in \mathbb{R}^+ . The family $(t(e))_{e \in \mathbb{E}_n^d}$ is independent and identically distributed with a common law G . Throughout the paper, we work with a distribution G on \mathbb{R}^+ satisfying the following hypothesis.

Hypothesis. The distribution G is such that $G(\{0\}) < 1 - p_c(d)$ and G admits an exponential moment, *i.e.*, there exists $\theta > 0$ such that

$$\int_{\mathbb{R}^+} \exp(\theta x) dG(x) < +\infty.$$

2.2 Maximal flow

For $x = (x_1, \dots, x_d)$, we define

$$\|x\|_2 = \sqrt{\sum_{i=1}^d x_i^2}.$$

We denote by \cdot the standard scalar product in \mathbb{R}^d . A stream is a function $f : \mathbb{E}_n^d \rightarrow \mathbb{R}^d$ such that the vector $f(e)$ is colinear with the geometric segment associated with e . For $e \in \mathbb{E}_n^d$, $\|f(e)\|_2$ represents the amount of water that flows through e per second and $f(e)/(n\|f(e)\|_2)$ represents the direction in which the water flows through e . Let A be a compact convex subset of \mathbb{R}^d . We say that a stream f between A and infinity is admissible if and only if it satisfies the following constraints.

· *The node law* : for every vertex x in $\mathbb{Z}_n^d \setminus A$, we have

$$\sum_{y \in \mathbb{Z}_n^d : e = \langle x, y \rangle \in \mathbb{E}_n^d} f(e) \cdot \vec{xy} = 0.$$

· *The capacity constraint*: for every edge $e \in \mathbb{E}_n^d$, we have

$$0 \leq \|f(e)\|_2 \leq t(e).$$

The node law expresses that there is no loss or creation of fluid outside A . The capacity constraint imposes that the amount of water that flows through an edge e per second is limited by its capacity $t(e)$. As the capacities are random, the set of admissible streams between A and infinity is also random. For each admissible stream f , we define its flow in the lattice $(\mathbb{Z}_n^d, \mathbb{E}_n^d)$ by

$$\text{flow}(f) = \sum_{x \in A \cap \mathbb{Z}_n^d} \sum_{y \in \mathbb{Z}_n^d : e = \langle x, y \rangle \in \mathbb{E}_n^d} f(e) \cdot \vec{xy}.$$

This corresponds to the amount of water that enters in $\mathbb{R}^d \setminus A$ through ∂A per second for the stream f . The maximal flow between A and infinity for the capacities $(t(e))_{e \in \mathbb{E}_n^d}$, denoted by $\phi_n(A \rightarrow \infty)$, is the supremum of the flows of all admissible streams between A and infinity:

$$\phi_n(A \rightarrow \infty) = \sup \left\{ \text{flow}(f) : \begin{array}{l} f \text{ is an admissible stream between} \\ A \text{ and infinity in the lattice } (\mathbb{Z}_n^d, \mathbb{E}_n^d) \end{array} \right\}.$$

2.3 The max-flow min-cut theorem

Dealing with admissible streams is not so easy, however we can use an alternative interpretation of the maximal flow which is more convenient. Let $E \subset \mathbb{E}_n^d$ be a set of edges. We say that E separates A from infinity (or is a cutset, for short), if every path from A to infinity goes through an edge in E . We associate with any set of edges E its capacity $V(E)$ defined by

$$V(E) = \sum_{e \in E} t(e).$$

The max-flow min-cut theorem, a classical result of graph theory [16], states that

$$\phi_n(A \rightarrow \infty) = \inf \left\{ V(E) : E \text{ separates } A \text{ from infinity in } (\mathbb{Z}_n^d, \mathbb{E}_n^d) \right\}.$$

We recall that $\text{mincut}_n(A, \infty)$ is the infimum of the capacities of all cutsets from A to infinity in the lattice $(\mathbb{Z}_n^d, \mathbb{E}_n^d)$. Note that it is not even obvious whether this infimum is attained. This theorem originally concerns finite graphs but it can be extended to infinite graphs (see for instance section 6.1. in [38]). We extend the notation ϕ_n to any connected subgraph $\mathcal{G} \subset \mathbb{Z}_n^d$ and $\mathfrak{G}_1, \mathfrak{G}_2$ disjoint subsets of \mathcal{G} :

$$\phi_n(\mathfrak{G}_1 \rightarrow \mathfrak{G}_2 \text{ in } \mathcal{G}) = \inf \left\{ V(E) : E \text{ separates } \mathfrak{G}_1 \text{ from } \mathfrak{G}_2 \text{ in } \mathcal{G} \right\}.$$

3 Some notations and useful results

3.1 Geometric notations

Let $S \subset \mathbb{R}^d$. We define the distance between a point and S by

$$\forall x \in \mathbb{R}^d \quad d_2(x, S) = \inf_{y \in S} \|x - y\|_2$$

and for $r > 0$, we define the open r -neighborhood $\mathcal{V}(S, r)$ of S by

$$\mathcal{V}(S, r) = \left\{ x \in \mathbb{R}^d : d_2(x, S) < r \right\}.$$

Let $x \in \mathbb{R}^d$, $r > 0$ and a unit vector v . We denote by $B(x, r)$ the closed ball of radius r centered at x , by $\text{disc}(x, r, v)$ the closed disc centered at x of radius r normal to v , and by $B^+(x, r, v)$ (respectively $B^-(x, r, v)$) the upper (resp. lower) half part of $B(x, r)$ along the direction of v , *i.e.*,

$$B^+(x, r, v) = \left\{ y \in B(x, r) : (y - x) \cdot v \geq 0 \right\},$$

and

$$B^-(x, r, v) = \left\{ y \in B(x, r) : (y - x) \cdot v \leq 0 \right\}.$$

We denote by \mathcal{L}^d the d -dimensional Lebesgue measure. We denote by α_d the \mathcal{L}^d measure of a unit ball in \mathbb{R}^d . We denote by \mathcal{H}^{d-1} the Hausdorff measure of dimension $d-1$. In particular, the \mathcal{H}^{d-1} measure of a $d-1$ dimensional unit disc in \mathbb{R}^d is equal to α_{d-1} . Let A be a non-degenerate hyperrectangle, *i.e.*, A is included in an hyperplane of \mathbb{R}^d and of codimension 1. Let \vec{v} be one of the two unit vectors normal to A . Let $h > 0$, we denote by $\text{cyl}(A, h)$ the cylinder of basis A and height h defined by

$$\text{cyl}(A, h) = \left\{ x + t\vec{v} : x \in A, t \in [-h, h] \right\}.$$

The dependence on \vec{v} is implicit in the notation $\text{cyl}(A, h)$. We also define the infinite cylinder of basis A in a direction \vec{u} (not necessarily normal to A):

$$\text{cyl}(A, \vec{u}, \infty) = \left\{ x + t\vec{u} : x \in A, t \geq 0 \right\}.$$

Note that these definitions of cylinder may be extended in the case where A is a set of linear dimension $d-1$, *i.e.*, A is included in an hyperplane of \mathbb{R}^d , which is the affine span of A .

3.2 Sets of finite perimeter and surface energy

The perimeter of a Borel set S of \mathbb{R}^d in an open set O is defined as

$$\mathcal{P}(S, O) = \sup \left\{ \int_S \text{div} f(x) d\mathcal{L}^d(x) : f \in C_c^\infty(O, B(0, 1)) \right\}$$

where $C_c^\infty(O, B(0, 1))$ is the set of the functions of class C^∞ from \mathbb{R}^d to $B(0, 1)$ having a compact support included in O , and div is the usual divergence operator. The perimeter $\mathcal{P}(S)$ of S is defined as $\mathcal{P}(S, \mathbb{R}^d)$. The topological boundary of S is denoted by ∂S . The reduced boundary $\partial^* S$ of S is a subset of ∂S such that, at each point x of $\partial^* S$, it is possible to define a normal vector $n_S(x)$ to S in a measure-theoretic sense, and moreover $\mathcal{P}(S) = \mathcal{H}^{d-1}(\partial^* S)$. We denote by ν the flow constant that is a function from the unit sphere \mathbb{S}^{d-1} of \mathbb{R}^d to \mathbb{R}^+ as defined in [64]. We denote by ν_{max} and ν_{min} its maximal and minimal values on the sphere. The flow constant $\nu(v)$ corresponds to the expected maximal amount of water that can flow per second in the direction of v . A more rigorous definition will be given later. We can define the associated Wulff crystal \mathcal{W}_ν :

$$\mathcal{W}_\nu = \left\{ x \in \mathbb{R}^d : \forall y, y \cdot x \leq \nu(y) \right\}.$$

The homogeneous extension of ν is convex (we refer to proposition 4.2 for a precise statement). As a consequence, we have the following proposition.

Proposition 3.1 (Proposition 14.1 in [19]). *The function ν is the support function of its Wulff crystal \mathcal{W}_ν , that is,*

$$\forall v \in \mathbb{S}^{d-1} \quad \nu(v) = \sup \{ x \cdot v : x \in \mathcal{W}_\nu \}.$$

With the help of the Wulff crystal, we can define the surface energy of a general set.

Definition 3.2. *The surface energy $\mathcal{I}(S, O)$ of a Borel set S of \mathbb{R}^d in an open set O is defined as*

$$\mathcal{I}(S, O) = \sup \left\{ \int_S \text{div} f(x) d\mathcal{L}^d(x) : f \in C_c^1(O, \mathcal{W}_\nu) \right\}.$$

We will note simply $\mathcal{I}(S) = \mathcal{I}(S, \mathbb{R}^d)$.

Proposition 3.3 (Proposition 14.3 in [19]). *The surface energy $\mathcal{I}(S, O)$ of a Borel set S of \mathbb{R}^d of finite perimeter in an open set O is equal to*

$$\mathcal{I}(S, O) = \int_{\partial^* S \cap O} \nu(n_S(x)) d\mathcal{H}^{d-1}(x).$$

We recall the two following fundamental results.

Proposition 3.4 (Isoperimetric inequality). *There exist two positive constants b_{iso} , c_{iso} which depend only on the dimension d , such that, for any Cacciopoli set E , any ball $B(x, r) \subset \mathbb{R}^d$,*

$$\begin{aligned} \min(\mathcal{L}^d(E \cap B(x, r)), \mathcal{L}^d((\mathbb{R}^d \setminus E) \cap B(x, r))) &\leq b_{iso} \mathcal{P}(E, \mathring{B}(x, r))^{d/d-1}, \\ \min(\mathcal{L}^d(E), \mathcal{L}^d(\mathbb{R}^d \setminus E)) &\leq c_{iso} \mathcal{P}(E)^{d/d-1} \end{aligned}$$

where for $X \subset \mathbb{R}^d$, \mathring{X} denotes the interior of the set X .

Theorem 3.5 (Gauss-Green theorem). *For any compactly supported \mathcal{C}^1 vector field f from \mathbb{R}^d to \mathbb{R}^d , any Caccioppoli set E ,*

$$\int_E \operatorname{div} f(x) d\mathcal{L}^d(x) = \int_{\partial^* E} f(x) \cdot n_E(x) d\mathcal{H}^{d-1}(x).$$

3.3 Approximation by convex polytopes

We recall here an important result, which allows to approximate adequately a set of finite perimeter by a convex polytope.

Definition 3.6 (Convex polytope). *We say that a subset P of \mathbb{R}^d is a convex polytope if there exist v_1, \dots, v_m unit vectors and $\varphi_1, \dots, \varphi_m$ real numbers such that*

$$P = \bigcap_{1 \leq i \leq m} \left\{ x \in \mathbb{R}^d : x \cdot v_i \leq \varphi_i \right\}.$$

We denote by F_i the face of P associated with v_i , i.e.,

$$F_i = P \cap \left\{ x \in \mathbb{R}^d : x \cdot v_i = \varphi_i \right\}.$$

Any compact convex subset of \mathbb{R}^d can be approximated from the outside and from the inside by a convex polytope with almost the same surface energy.

Lemma 3.7. *Let A be a bounded convex set in \mathbb{R}^d . For each $\varepsilon > 0$, there exist convex polytopes P and Q such that $P \subset A \subset Q$ and*

$$\mathcal{I}(Q) - \varepsilon \leq \mathcal{I}(A) \leq \mathcal{I}(P) + \varepsilon.$$

Proof. Let A be a bounded convex set in \mathbb{R}^d . Let $\varepsilon > 0$. Let $(x_k)_{k \geq 1}$ be a dense family in ∂A . For $n \geq 1$, we define P_n as the convex hull of x_1, \dots, x_n , i.e., the smallest convex set that contains the points x_1, \dots, x_n . As A is convex, we have $P_n \subset A$ and P_n converges towards A when n goes to infinity for the \mathcal{L}^1 topology. The functional \mathcal{I} is lower semi-continuous, thus

$$\mathcal{I}(A) \leq \liminf_{n \rightarrow \infty} \mathcal{I}(P_n),$$

so there exists n large enough such that

$$\mathcal{I}(A) \leq \mathcal{I}(P_n) + \varepsilon$$

and we take $P = P_n$. The existence of Q was shown by Cerf and Pisztora in Lemma 5.1 in [21] for the Wulff shape. The proof may be easily adapted to a general convex bounded set A . The proof of Lemma 5.1 only uses the fact that the function ν is continuous and that the set A is convex. \square

4 Background on maximal flow

We now consider two specific maximal flows through a cylinder for first passage percolation on \mathbb{Z}_n^d where the law of capacities is given by the distribution G . We are interested in the cutsets in a cylinder. Let us first define the maximal flow from the top to the bottom of a cylinder. Let A be a non-degenerate hyperrectangle and let \vec{v} be one of the two unit vectors normal to A . Let $h \geq 0$. In order to define the flow from the top to the bottom, we have to define discretized versions of the bottom $B_n(A, h)$ and the top $T_n(A, h)$ of the cylinder $\text{cyl}(A, h)$ in the lattice $(\mathbb{Z}_n^d, \mathbb{E}_n^d)$. We define

$$B_n(A, h) := \left\{ x \in \mathbb{Z}_n^d \cap \text{cyl}(A, h) : \begin{array}{l} \exists y \notin \text{cyl}(A, h), \langle x, y \rangle \in \mathbb{E}_n^d \\ \text{and } \langle x, y \rangle \text{ intersects } A - h\vec{v} \end{array} \right\}$$

and

$$T_n(A, h) := \left\{ x \in \mathbb{Z}_n^d \cap \text{cyl}(A, h) : \begin{array}{l} \exists y \notin \text{cyl}(A, h), \langle x, y \rangle \in \mathbb{E}_n^d \\ \text{and } \langle x, y \rangle \text{ intersects } A + h\vec{v} \end{array} \right\}.$$

We denote by $\phi_n(A, h)$ the maximal flow from the top to the bottom of the cylinder $\text{cyl}(A, h)$ in the direction \vec{v} in the lattice $(\mathbb{Z}_n^d, \mathbb{E}_n^d)$, defined by

$$\phi_n(A, h) = \phi_n\left(T_n(A, h) \rightarrow B_n(A, h) \text{ in } \text{cyl}(A, h)\right).$$

This definition of the flow is not well suited to subadditive arguments, because we cannot glue together two cutsets from the top to the bottom of two adjacent cylinders in order to get a cutset from the top to the bottom of the union of these two cylinders. The reason is that the trace of a cutset from the top to the bottom of a cylinder on the boundary of the cylinder is totally free. We go around this problem by introducing another flow through the cylinder which is genuinely subadditive. The set $\text{cyl}(A, h) \setminus A$ has two connected components, denoted by $C_1(A, h)$ and $C_2(A, h)$. We define discretized versions of the boundaries of these two sets in the lattice $(\mathbb{Z}_n^d, \mathbb{E}_n^d)$. For $i = 1, 2$, we define

$$C'_{i,n}(A, h) = \left\{ x \in \mathbb{Z}_n^d \cap C_i(A, h) : \exists y \notin \text{cyl}(A, h), \langle x, y \rangle \in \mathbb{E}_n^d \right\}.$$

We call informally $C'_{i,n}(A, h)$, $i = 1, 2$, the upper and lower half part of the boundary of $\text{cyl}(A, h)$. We denote by $\tau_n(A, h)$ the maximal flow from the upper half part to the lower half part of the boundary of the cylinder, *i.e.*,

$$\tau_n(A, h) = \phi_n\left(C'_{1,n}(A, h) \rightarrow C'_{2,n}(A, h) \text{ in } \text{cyl}(A, h)\right).$$

By the max-flow min-cut theorem, the maximal flow $\tau_n(A, h)$ is equal to the minimal capacity of a set of edges $E \subset \mathbb{E}_n^d$ that cuts $C'_{1,n}(A, h)$ from $C'_{2,n}(A, h)$ inside the cylinder $\text{cyl}(A, h)$. We have the following law of large number.

Theorem 4.1 (Rossignol-Théret [62]). *Let G be an integrable probability measure on \mathbb{R}_+ . For any $v \in \mathbb{S}^{d-1}$, there exists a constant $\nu(v) \in \mathbb{R}_+$ such that for any non-degenerate hyperrectangle A normal to \vec{v} , for any $h > 0$, we have*

$$\lim_{n \rightarrow \infty} \frac{\tau_n(A, h)}{\mathcal{H}^{d-1}(A)n^{d-1}} = \nu(v) \text{ in } L^1.$$

The constant $\nu(v)$ is the so-called flow constant in the direction v . The flow constant ν satisfies a weak triangle inequality see proposition 3.4. in [64].

Proposition 4.2 (Weak triangle inequality for ν). *Let (ABC) be a non-degenerate triangle in \mathbb{R}^d and let v_A, v_B, v_C be the exterior normal unit vectors to the sides $[BC], [AC], [AB]$ in the plane spanned by A, B, C . Then,*

$$\mathcal{H}^1([BC])\nu(v_A) \leq \mathcal{H}^1([AC])\nu(v_B) + \mathcal{H}^1([AB])\nu(v_C).$$

The homogeneous extension ν_0 of ν to \mathbb{R}^d defined by $\nu_0(0) = 0$ and

$$\forall w \in \mathbb{R}^d \setminus \{0\} \quad \nu_0(w) = \|w\|_2 \nu\left(\frac{w}{\|w\|_2}\right)$$

is a convex function.

We will need the following upper large deviation result.

Theorem 4.3 (Upper large deviations of the maximal flow in a cylinder). *Let G be a probability measure on $[0, +\infty[$ such that $G(\{0\}) < 1 - p_c(d)$ and G admits an exponential moment, i.e., there exists $\theta > 0$ such that $\int_{\mathbb{R}^+} \exp(\theta x) dG(x) < +\infty$. For every unit vector v , for every non-degenerate hyperrectangle A normal to v , for every $h > 0$ and for every $\lambda > \nu(v)$, there exist positive real numbers C_1 and C_2 depending only on λ and G , such that, for all $n \geq 1$,*

$$\mathbb{P}(\tau_n(A, h) \geq \lambda \mathcal{H}^{d-1}(A) n^{d-1}) \leq C_1 \exp(-C_2 n^{d-1}).$$

This theorem may be proven by adapting the arguments in the proof of Theorem 3 in [68]. To ease the reading, constants may change from appearance to appearance.

5 Upper large deviations

The goal of this section is to prove Theorem 1.3.

5.1 The case of a cylinder

In this section, we will use Theorem 4.3 which is the main probabilistic estimate needed to prove Theorem 1.3. A convex polytope of dimension $d - 1$ is a convex polytope F which is contained in an hyperplane of \mathbb{R}^d and such that $\mathcal{H}^{d-1}(F) > 0$. We have the following Lemma.

Lemma 5.1. *Let F be a convex polytope of dimension $d - 1$. Let v be a unit vector normal to F . Let $h > 0$. Let $\lambda > \nu(v) \mathcal{H}^{d-1}(F)$. There exist positive real numbers C_1 and C_2 depending on F , G , λ and d such that, for all $n \geq 1$*

$$\mathbb{P}(\tau_n(F, h) \geq \lambda n^{d-1}) \leq C_1 \exp(-C_2 n^{d-1})$$

Proof. Let F be a convex polytope of dimension $d - 1$ and v a unit vector normal to F . We shall cover F by a finite family of hypersquares and control the probability that the flow is abnormally big in $\text{cyl}(F, h)$ by the probability that the flow is abnormally big in one of the cylinders of square basis. Let $\lambda > \nu(v) \mathcal{H}^{d-1}(F)$. Let $\kappa > 0$ be a real number that we will choose later. We denote by $S(\kappa)$ an hypersquare of dimension $d - 1$ of side length κ and normal to v . We shall cover the following subset of F by hypersquares isometric to $S(\kappa)$:

$$D(\kappa, F) = \left\{ x \in F : d(x, \partial F) > 2\sqrt{d}\kappa \right\}.$$

There exists a finite family $(S_i)_{i \in I}$ of subsets of F , which are translates of $S(\kappa)$ having pairwise disjoint interiors and such that $D(\kappa, F) \subset \cup_{i \in I} S_i$ (see figure 7.1). Moreover, we have

$$|I| \leq \frac{\mathcal{H}^{d-1}(F)}{\mathcal{H}^{d-1}(S(\kappa))} \tag{5.1}$$

and there exists a constant c_d depending only on the dimension such as

$$\mathcal{H}^{d-1}(F \setminus D(\kappa, F)) \leq c_d \mathcal{H}^{d-2}(\partial F) \kappa.$$

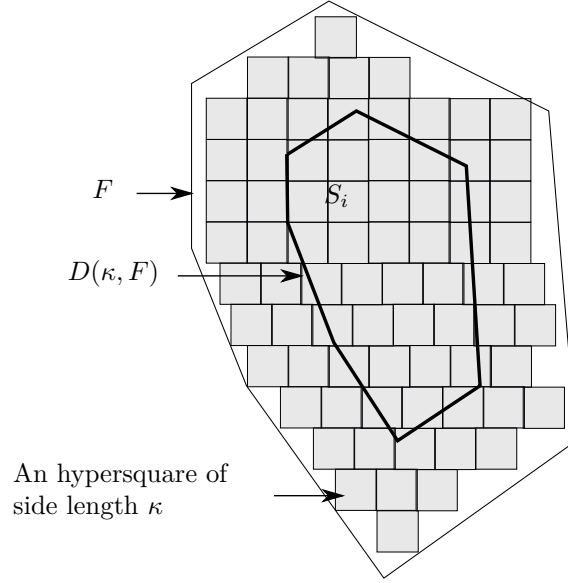
Figure 7.1 – Covering P with hypersquares

Let $h > 0$. We want to build a cutset between $C'_1(F, h)$ and $C'_2(F, h)$ out of minimal cutsets for the flows $\tau_n(S_i, h)$, $i \in I$. Note that a cutset that achieves the infimum defining $\tau_n(S_i, h)$ is anchored near the boundary ∂S_i . However, if we pick up two hypersquares S_i and S_j that share a common side, their corresponding minimal cutsets for the flow τ_n do not necessarily have the same trace on the common face of the associated cylinders $\text{cyl}(S_i, h)$ and $\text{cyl}(S_j, h)$. We shall fix this problem by adding extra edges in order to glue properly the cutsets. Due to the discretization, we will need also to add extra edges around the boundaries of the hypersquares ∂S_i and in the region $F \setminus D(\kappa, F)$ in order to build a cutset. For $i \in I$, let E_i be a minimal cutset for $\tau_n(S_i, h)$, i.e., $E_i \subset \mathbb{E}_n^d$ separates $C'_1(S_i, h)$ from $C'_2(S_i, h)$ in $\text{cyl}(S_i, h)$ and $V(E_i) = \tau_n(S_i, h)$. We fix $\zeta = 4d/n$. Let E_0 be the set of the edges of \mathbb{E}_n^d included in \mathcal{E}_0 , where we define

$$\mathcal{E}_0 = \left\{ x \in \mathbb{R}^d : d(x, F \setminus \cup_{i \in I} S_i) \leq \zeta \right\} \cup \bigcup_{i \in I} \left\{ x \in \mathbb{R}^d : d(x, \partial S_i) \leq \zeta \right\}.$$

The set of edges $E_0 \cup \bigcup_{i \in I} E_i$ separates $C'_1(F, h)$ from $C'_2(F, h)$ in $\text{cyl}(F, h)$ therefore

$$\tau_n(F, h) \leq V(E_0) + \sum_{i \in I} V(E_i) = V(E_0) + \sum_{i \in I} \tau_n(S_i, h). \quad (5.2)$$

There exists a constant c'_d depending only on d such that:

$$|E_0| \leq c'_d \left(\kappa n^{d-1} \mathcal{H}^{d-2}(\partial F) + |I| \mathcal{H}^{d-2}(\partial S(\kappa)) n^{d-2} \right).$$

Using (5.1), we obtain

$$\begin{aligned} |E_0| &\leq c'_d \left(\kappa n^{d-1} \mathcal{H}^{d-2}(\partial F) + \frac{\mathcal{H}^{d-1}(F)}{\mathcal{H}^{d-1}(S(\kappa))} \mathcal{H}^{d-2}(\partial S(\kappa)) n^{d-2} \right) \\ &\leq c'_d \left(\kappa n^{d-1} \mathcal{H}^{d-2}(\partial F) + 2d \frac{\mathcal{H}^{d-1}(F)}{\kappa} n^{d-2} \right). \end{aligned}$$

Thus, for n large enough,

$$|E_0| \leq 2c'_d \kappa \mathcal{H}^{d-2}(\partial F) n^{d-1}. \quad (5.3)$$

There exists $s > 0$ such that $\lambda > (1 + s)\nu(v)\mathcal{H}^{d-1}(F)$. Thanks to inequality (5.2), we obtain

$$\begin{aligned} \mathbb{P}(\tau_n(F, h) \geq \lambda n^{d-1}) &\leq \mathbb{P}\left(V(E_0) + \sum_{i \in I} \tau_n(S_i, h) \geq (1 + s)\nu(v)\mathcal{H}^{d-1}(F)n^{d-1}\right) \\ &\leq \sum_{i \in I} \mathbb{P}(\tau_n(S_i, h) \geq (1 + s/2)\nu(v)\mathcal{H}^{d-1}(S_i)n^{d-1}) \\ &\quad + \mathbb{P}\left(V(E_0) \geq \frac{s}{2}\nu(v)n^{d-1}\mathcal{H}^{d-1}(F)\right) \\ &\leq \sum_{i \in I} \mathbb{P}(\tau_n(S_i, h) \geq (1 + s/2)\nu(v)\mathcal{H}^{d-1}(S_i)n^{d-1}) \\ &\quad + \mathbb{P}\left(\sum_{i=1}^{2c'_d\kappa\mathcal{H}^{d-2}(\partial F)n^{d-1}} t_i \geq \frac{s}{2}\nu(v)n^{d-1}\mathcal{H}^{d-1}(F)\right), \end{aligned} \quad (5.4)$$

where $(t_i)_{i \in \mathbb{N}}$ is a family of i.i.d. random variables of common probability distribution G . We use inequality (5.3) in the last inequality. We can choose κ small enough so that

$$2c'_d\kappa\mathcal{H}^{d-2}(\partial F)\mathbb{E}(t_i) < s\nu_{\min}\mathcal{H}^{d-1}(F)/2.$$

Moreover, as G admits an exponential moment, the Cramér theorem in \mathbb{R} gives the existence of positive constants D and D' depending on G , F , s and d such that, for any $n \geq 1$,

$$\mathbb{P}\left(\sum_{i=1}^{2c'_d\kappa\mathcal{H}^{d-2}(\partial F)n^{d-1}} t_i \geq \frac{s}{2}\nu(v)n^{d-1}\mathcal{H}^{d-1}(F)\right) \leq D \exp(-D'n^{d-1}). \quad (5.5)$$

Thanks to Theorem 4.3, there exist positive real numbers C_1, C_2 depending on s such that for $i \in I$, for any $n \geq 1$,

$$\mathbb{P}(\tau_n(S_i, h) \geq (1 + s/2)\nu(v)\mathcal{H}^{d-1}(S_i)n^{d-1}) \leq C_1 \exp(-C_2n^{d-1}). \quad (5.6)$$

By combining inequalities (5.4) and (5.5) and (5.6), we obtain

$$\mathbb{P}(\tau_n(F, h) \geq \lambda n^{d-1}) \leq D \exp(-D'n^{d-1}) + |I|C_1 \exp(-C_2n^{d-1}),$$

and the result follows. \square

5.2 Proof of theorem 1.3

Let A be a compact convex subset of \mathbb{R}^d . Let $\lambda > \mathcal{I}(A)$ and let $s > 0$ be such that $\lambda > (1 + s)\mathcal{I}(A)$. By Lemma 3.7, there exists a convex polytope P such that $A \subset P$ and

$$(1 + s)\mathcal{I}(A) \geq (1 + s/2)\mathcal{I}(P). \quad (5.7)$$

Let us denote by F_1, \dots, F_m the faces of P and let v_1, \dots, v_m be the associated exterior unit vectors. Let $\varepsilon > 0$. For $i \in \{1, \dots, m\}$, we define $C_i = \text{cyl}(F_i + \varepsilon v_i, \varepsilon)$. The sets C_i , $1 \leq i \leq m$, have pairwise disjoint interiors. Indeed, assume that there exists $z \in \overset{\circ}{C}_i \cap \overset{\circ}{C}_j$ for some $i \neq j$. Then there exist unique $x \in F_i$, $y \in F_j$ and $h, h' < 2\varepsilon$ such that $z = x + hv_i = y + h'v_j$. In fact, the point x (respectively y) is the orthogonal projection of z on the face F_i (resp. F_j). As P is convex, the orthogonal projection of z on P is unique so $x = y$ and $x \in F_i \cap F_j$. In particular, the point x is in the boundary of F_i . This contradicts the fact that z belongs to the interior of C_i . We aim now to build a cutset that cuts P from infinity out of cutsets of minimal capacities for $\tau_n(F_i + \varepsilon v_i, \varepsilon)$, $i \in \{1, \dots, m\}$. The union of these cutsets is not enough to form a cutset from P to infinity because there might be holes between these cutsets. For $i \in \{1, \dots, m\}$, a minimal cutset for $\tau_n(F_i + \varepsilon v_i, \varepsilon)$ is pinned around the boundary of $\partial(F_i + \varepsilon v_i)$. We need to add bridges around $\partial(F_i + \varepsilon v_i)$ to close the potential holes between these cutsets (see figure 7.2). As the distance between two adjacent $\partial(F_i + \varepsilon v_i)$ decreases with ε , by taking ε small enough, the size

and as $A \subset P$, we have $\text{mincut}_n(A, \infty) \leq \text{mincut}_n(P, \infty)$. Then, using inequalities (5.7) and (5.8), we obtain

$$\begin{aligned} \mathbb{P}(\text{mincut}_n(A, \infty) \geq \lambda n^{d-1}) &\leq \mathbb{P}(\text{mincut}_n(A, \infty) \geq (1+s)n^{d-1}\mathcal{I}(A)) \\ &\leq \mathbb{P}(\text{mincut}_n(P, \infty) \geq (1+s/2)n^{d-1}\mathcal{I}(P)) \\ &\leq \mathbb{P}\left(V(M) + \sum_{i=1}^m \tau_n(F_i + \varepsilon v_i, \varepsilon) \geq (1+s/2)n^{d-1}\mathcal{I}(P)\right) \\ &\leq \mathbb{P}(V(M) > s\mathcal{I}(P)n^{d-1}/4) \\ &\quad + \sum_{i=1}^m \mathbb{P}(\tau_n(F_i + \varepsilon v_i, \varepsilon) \geq (1+s/4)n^{d-1}\mathcal{I}(F_i)\nu(v_i)). \end{aligned} \quad (5.9)$$

Moreover, we have

$$\mathbb{P}(V(M) > s\mathcal{I}(P)n^{d-1}/4) \leq \mathbb{P}\left(\sum_{i=1}^{c_d m^2 \varepsilon^{d-1} n^{d-1}} t_i \geq s\mathcal{I}(P)n^{d-1}/4\right), \quad (5.10)$$

where $(t_i)_{i \in \mathbb{N}}$ is a family of i.i.d. random variables of common probability distribution G . We choose ε small enough so that

$$c_d m^2 \varepsilon^{d-1} \mathbb{E}(t_i) < s\mathcal{I}(P)/4.$$

Since G admits an exponential moment, then the Cramér theorem in \mathbb{R} gives the existence of positive constants D and D' depending on G , P , s and d such that

$$\mathbb{P}\left(\sum_{i=1}^{c_d m^2 \varepsilon^{d-1} n^{d-1}} t_i \geq s\mathcal{I}(P)/2n^{d-1}\right) \leq D \exp(-D'n^{d-1}). \quad (5.11)$$

By Lemma 5.1, there exist positive real numbers C_1 and C_2 depending on P , s , G and d such that for all $i \in \{1, \dots, m\}$,

$$\mathbb{P}(\tau_n(F_i + \varepsilon v_i, \varepsilon) \geq (1+s/4)n^{d-1}\mathcal{I}(F_i)\nu(v_i)) \leq C_1 \exp(-C_2 n^{d-1}). \quad (5.12)$$

We conclude by combining inequalities (5.9), (5.10), (5.11) and (5.12) that

$$\mathbb{P}(\text{mincut}_n(A, \infty) \geq \lambda n^{d-1}) \leq D \exp(-D'n^{d-1}) + m C_1 \exp(-C_2 n^{d-1}).$$

This yields the desired conclusion.

6 Existence of a minimal cutset

In this section, we recall the fundamental result of Zhang which enables to control the cardinality of one specific cutset. We use this opportunity to point out an important fact, namely we prove in addition that there exists a minimal cutset E between a convex A and infinity. We here prove Theorem 1.2 using the work of Zhang [73].

Throughout the proof we work on the lattice $(\mathbb{Z}^d, \mathbb{E}^d)$. Let A be a convex compact subset of \mathbb{R}^d . As any path from A to infinity has to go through an edge of $\partial_e A$, the set $\partial_e A$ cuts A from infinity and $\text{mincut}(A, \infty) \leq V(\partial_e A)$. Let E be a cutset between A and infinity such that $V(E) \leq V(\partial_e A)$. We want to control the probability that E has too many edges. To do that we distinguish three types of edges that we will handle differently. Let ε be a positive constant that we will adjust later. We define:

- The ε^+ edges are the edges $e \in E$ such that $t(e) > \varepsilon$. We denote by $N^+(E)$ the number of ε^+ edges in E . We can control $N^+(E)$ thanks to the fact that $V(E) \leq V(\partial_e A)$ and so $\varepsilon N^+(E) \leq V(\partial_e A)$.

- The ε^- edges that are the edges $e \in E$ such that $0 < t(e) \leq \varepsilon$. We denote by $N^-(E)$ the number of ε^- edges in E . As the probability of being an ε^- edge goes to 0 when ε goes to 0, we

can choose ε so that, with high probability, $N^-(E)$ does not exceed a certain proportion of $|E|$, the number of edges in E .

- The closed edges or zero edges that are the edges of null passage times. Once we have controlled the number of ε^+ and ε^- edges, the size of E cannot be too big otherwise the number of closed edges, would be also big and this would mean that there exist large surfaces of closed edges which is an unlikely event when $G(\{0\}) < 1 - p_c(d)$.

We start now with these estimates. Let $n \geq 1$. Let E be a cutset from A to infinity such that $V(E) \leq V(\partial_e A)$ and $|E| = n$. We start by controlling the ε^+ edges by controlling the capacity of $\partial_e A$:

$$\begin{aligned} & \mathbb{P}\left(\exists E \subset \mathbb{E}^d, E \text{ cuts } A \text{ from infinity, } V(E) \leq V(\partial_e A) \text{ and } |E| = n\right) \\ & \leq \mathbb{P}\left(\exists E \subset \mathbb{E}^d, E \text{ cuts } A \text{ from infinity, } V(E) \leq \varepsilon^2 n \text{ and } |E| = n\right) + \mathbb{P}\left(V(\partial_e A) \geq \varepsilon^2 n\right) \\ & \leq \mathbb{P}\left(\exists E \subset \mathbb{E}^d, E \text{ cuts } A \text{ from infinity, } N^+(E) \leq \varepsilon n \text{ and } |E| = n\right) + \mathbb{P}\left(V(\partial_e A) \geq \varepsilon^2 n\right). \end{aligned} \quad (6.1)$$

As G admits an exponential moment, we obtain

$$\begin{aligned} \mathbb{P}\left(V(\partial_e A) \geq \varepsilon^2 n\right) &= \mathbb{P}\left(\theta V(\partial_e A) \geq \theta \varepsilon^2 n\right) \\ &\leq \exp(-\theta \varepsilon^2 n) \mathbb{E}(\exp(\theta V(\partial_e A))) \\ &= \exp(-\theta \varepsilon^2 n) \left(\int_{\mathbb{R}^+} \exp(\theta x) dG(x)\right)^{|\partial_e A|}. \end{aligned} \quad (6.2)$$

We take

$$\lambda = 2 \ln \left(\int_{\mathbb{R}^+} \exp(\theta x) dG(x) \right) / \theta \varepsilon^2.$$

For $n > \lambda |\partial_e A|$, we have, using (6.2),

$$\mathbb{P}\left(V(\partial_e A) \geq \varepsilon^2 n\right) \leq \exp\left(-\frac{1}{2} \theta \varepsilon^2 n\right). \quad (6.3)$$

Combining inequalities (6.1) and (6.3), we get

$$\begin{aligned} & \mathbb{P}\left(\exists E \subset \mathbb{E}^d, E \text{ cuts } A \text{ from infinity, } V(E) \leq V(\partial_e A) \text{ and } |E| = n\right) \\ & \leq \mathbb{P}\left(\exists E \subset \mathbb{E}^d, E \text{ cuts } A \text{ from infinity, } N^+(E) \leq \varepsilon n \text{ and } |E| = n\right) + \exp\left(-\frac{1}{2} \theta \varepsilon^2 n\right). \end{aligned} \quad (6.4)$$

We control next the number of ε^- edges. We define $\delta_1 = \delta_1(\varepsilon) = G([0, \varepsilon])$ the probability that an edge e is an ε^- edge. The probability $\delta_1(\varepsilon)$ goes to 0 when ε goes to 0. We bound the number of cutsets of size n with the help of combinatorial arguments. As in the original proof of Zhang, we fix a vertex belonging to an edge of E . Since E is a cutset, then at least one edge of E has an extremity on the vertical line $L = \{(0, \dots, 0, x_d), x_d \in \mathbb{R}\}$. Moreover, the set E is finite. Let $z = (0, \dots, 0, x_d)$ be the highest vertex of L belonging to an extremity of an edge of E . Since $|E| \leq n$, then certainly $x_d \leq n$. We denote by \widehat{E} the set of the vertices of \mathbb{Z}^d that are connected to a vertex in A without using an edge in E , *i.e.*,

$$\widehat{E} = \left\{ x \in \mathbb{Z}^d : \begin{array}{l} \text{there exists a path from } x \text{ to } A \text{ which} \\ \text{does not go through an edge in } E \end{array} \right\}$$

We denote by $\partial_v \widehat{E}$ the exterior vertex boundary of \widehat{E} , defined as

$$\partial_v \widehat{E} = \left\{ x \in \mathbb{Z}^d \setminus \widehat{E} : \begin{array}{l} x \text{ has a neighbour in } \widehat{E} \text{ and there exists} \\ \text{a path from } x \text{ to infinity in } \mathbb{R}^d \setminus \widehat{E} \end{array} \right\}.$$

This set is the analogue of $\partial_e \widehat{Z}(k, m)$ in [73]. By Lemma 10 in [73], the set $\partial_v \widehat{E}$ is \mathbb{Z}^d connected, it contains z and moreover

$$|\partial_v \widehat{E}| \leq 3^{d+1}n.$$

Once the vertex z is fixed, the set $\partial_v \widehat{E}$ is a \mathbb{Z}^d connected set and we can apply the bound (4.24) in [47], there are at most $7^{d3^{d+1}n}$ possible choices for $\partial_v \widehat{E}$. We recall that each vertex has at most $2d$ adjacent edges. Once the set $\partial_v \widehat{E}$ is fixed, we bound the number of possible choices for the set E by

$$\sum_{k=1}^{3^{d+1}n} \binom{3^{d+1}n}{k} (2d)^k \leq (2d+1)^{3^{d+1}n}.$$

Let D be a positive constant that will be adjusted later. By summing on the coordinate x_d of z , on the choice of $\partial_v E$ and E , we have

$$\begin{aligned} & \mathbb{P}(\exists E \subset \mathbb{E}^d, E \text{ cuts } A \text{ from infinity, } N^-(E) \geq -(D/\ln \delta_1)|E| \text{ and } |E| = n) \\ & \leq \sum_{i=0}^n \mathbb{P} \left(\begin{array}{l} \exists E \subset \mathbb{E}^d, E \text{ cuts } A \text{ from infinity,} \\ N^-(E) \geq -(D/\ln \delta_1)n, x_d = i \text{ and } |E| = n \end{array} \right) \\ & \leq n7^{d3^{d+1}n} (2d+1)^{3^{d+1}n} \max_{\Gamma} \mathbb{P}(|\Gamma| = n, N^-(\Gamma) \geq -Dn/\ln \delta_1), \end{aligned} \tag{6.5}$$

where the maximum is over all the cutsets Γ from A to infinity with n edges. For δ_1 small enough and D large enough, depending only on the dimension d , we have

$$\mathbb{P}(|\Gamma| = n, N^-(\Gamma) \geq -Dn/\ln \delta_1) \leq 2 \exp(-Dn/2). \tag{6.6}$$

We refer to the proof of Theorem 1 in [73] for the proof of this result. Thus, by taking δ_1 small enough and D large enough and combining (6.5) and (6.6), there exist two constants C_1 and C_2 depending only on G , d and δ_1 such that

$$\mathbb{P}(\exists E \subset \mathbb{E}^d, E \text{ cuts } A \text{ from infinity, } N^-(E) \geq -(D/\ln \delta_1)|E| \text{ and } |E| = n) \leq C_1 \exp(-C_2n). \tag{6.7}$$

Finally, combining inequalities (6.4) and (6.7), we obtain

$$\begin{aligned} & \mathbb{P}(\exists E \subset \mathbb{E}^d, E \text{ cuts } A \text{ from infinity, } V(E) \leq V(\partial_e A) \text{ and } |E| = n) \\ & \leq \mathbb{P} \left(\begin{array}{l} \exists E \subset \mathbb{E}^d, E \text{ cuts } A \text{ from infinity, } |E| = n, \\ N^+(E) \leq \varepsilon n \text{ and } N^-(E) \leq -(Dn)/\ln \delta_1 \end{array} \right) + C_1 \exp(-C_2n) + \exp \left(-\frac{1}{2} \theta \varepsilon^2 n \right). \end{aligned} \tag{6.8}$$

We have controlled the numbers of ε^+ edges and ε^- edges in the cut. We have now to control the number of closed edges in the cut. We denote by J the number of edges in E of positive capacities. On the event

$$\left\{ |E| = n, N^+(E) \leq \varepsilon n, N^-(E) \leq -(Dn)/\ln \delta_1 \right\},$$

we have

$$J \leq N^+(E) + N^-(E) \leq (\varepsilon - D/\ln \delta_1)n. \tag{6.9}$$

Thanks to inequalities (6.8) and (6.9), we obtain for $n \geq \lambda|\partial_e A|$,

$$\begin{aligned} & \mathbb{P}(\exists E \subset \mathbb{E}^d, E \text{ cuts } A \text{ from infinity, } V(E) \leq V(\partial_e A) \text{ and } |E| = n) \\ & \leq \mathbb{P}(\exists E \subset \mathbb{E}^d, E \text{ cuts } A \text{ from infinity, } |E| = n \text{ and } J \leq (\varepsilon - D/\ln \delta_1)n) \\ & \quad + C_1 \exp(-C_2n) + \exp \left(-\frac{1}{2} \theta \varepsilon^2 n \right). \end{aligned}$$

The remaining of the proof consists in controlling the zero edges. We will not write the details but only sketch the main ideas of the control. We say that an edge is closed if it has null

capacity, otherwise we say that the edge is open. Let us consider the set $\mathcal{C}(A)$ that contains all the vertices that are connected to A by an open path. On the event that there exists a cutset of null capacity that cuts A to infinity, the set $\mathcal{C}(A)$ is finite and its edge boundary $\partial_e \mathcal{C}(A)$ is a cutset of null capacity. However, this cutset may be very tangled and may contain too many edges. From this cutset, we want to build a "smoother" cutset, which has smaller cardinality. We use a renormalization procedure at a scale t (which is defined later), and we exhibit a set of boxes Γ_t that contains a cutset of null capacity and such that each box of Γ_t has at least one $*$ -neighbor in which an atypical event occurs (an event of probability that goes to 0 when t goes to infinity). As these events are atypical, it is unlikely that Γ_t contains too many boxes.

As we are in a supercritical Bernoulli percolation, *i.e.*, $G(\{0\}) < 1 - p_c(d)$, it is very unlikely that a cutset from A to infinity has null capacity and that $\mathcal{C}(A)$ is finite. To achieve the construction of Γ_t , we modify the configuration ω . We first choose ε small enough such that

$$J \leq (\varepsilon - D/\ln \delta_1) n \leq \frac{n}{(2(36dt))^{3d}}.$$

For the edges e_1, \dots, e_J in E such that $t(e_i) > 0$, we modify ω by setting $t(e_i) = 0$ for $i \in \{1, \dots, J\}$. This modification of ω is only formal, it is a trick to build Γ_t . Later we will switch back the capacities to their original values, the boxes of Γ_t that does not contain any e_1, \dots, e_J remain unchanged, yet atypical events still occur in the vicinity of these boxes. The number of boxes in Γ_t that have changed when we switch back to the configuration ω is bounded by the number of edges J that we have closed. We obtain an upper bound on $|\Gamma_t|$ with the help of Peirls estimates on the number of boxes where an atypical event occurs. We finally control the probability that there exists a cutset of size n with $J \leq n/(2(36dt))^{3d}$. These tricky computations are detailed in Zhang's paper [73], so we do not reproduce them here. In the end, we obtain the following estimate: there exist constants C'_1 and C'_2 depending on ε , A and G such that

$$\mathbb{P} \left(\begin{array}{l} \exists E \subset \mathbb{E}^d, E \text{ cuts } A \text{ from infinity,} \\ V(E) \leq V(\partial_e A) \text{ and } |E| = n \end{array} \right) \leq C'_1 \exp(-C'_2 n).$$

By the Borel-Cantelli Lemma, we conclude that, for n large enough, there does not exist any cutset E from A to infinity of size larger than n and such that $V(E) \leq V(\partial_e A)$. Thus, there exists almost surely a minimal cutset from A to infinity and for $n \geq \lambda |\partial_e A|$,

$$\begin{aligned} & \mathbb{P}(\exists E \subset \mathbb{E}^d, E \text{ is a minimal cutset from } A \text{ to infinity and } |E| \geq n) \\ & \leq \sum_{k=n}^{\infty} \mathbb{P} \left(\begin{array}{l} \exists E \subset \mathbb{E}^d, E \text{ cuts } A \text{ from infinity,} \\ V(E) \leq V(\partial_e A) \text{ and } |E| = k \end{array} \right) \leq C \exp(-C'n) \end{aligned}$$

where C, C' are positive constants depending only on G, A and d .

7 Lower large deviations

In this section we prove Theorem 1.4. If $\phi_A = 0$, we do not have to study the lower large deviations. We suppose that $\phi_A > 0$. Let $\lambda < \phi_A$. We denote by $\mathcal{E}_n \subset \mathbb{E}_n^d$ a cutset from A to infinity of minimal capacity, *i.e.*, $V(\mathcal{E}_n) = \text{mincut}_n(A, \infty)$ and having minimal cardinality (if there is more than one such set we pick one according to a deterministic rule). The existence of such a cut is ensured by Theorem 1.2. The aim of this section is to bound from above the probability $\mathbb{P}(V(\mathcal{E}_n) \leq \lambda n^{d-1})$.

With high probability, the cut \mathcal{E}_n does not have too many edges. In the lattice $(\mathbb{Z}_n^d, \mathbb{E}_n^d)$, the cardinality of $\partial_e A$ is of order n^{d-1} , and by applying Theorem 1.2, we obtain the existence of constants β, C_1 and C_2 depending on A, G and d such that

$$\mathbb{P}(|\mathcal{E}_n| \geq \beta n^{d-1}) \leq C_1 \exp(-C_2 n^{d-1}).$$

In the proof, we will use the relative isoperimetric inequality in \mathbb{R}^d . To do so, we define continuous versions of the discrete random sets. We define the set $\widetilde{E}_n \subset \mathbb{Z}_n^d$ by

$$\widetilde{E}_n = \left\{ x \in \mathbb{Z}_n^d \setminus A_n : \begin{array}{l} \text{there exists a path from } x \text{ to } A \text{ visiting} \\ \text{only edges that are not in } \mathcal{E}_n \end{array} \right\}.$$

Let C be the unit cube in \mathbb{R}^d . We define a continuous version E_n of \widetilde{E}_n by

$$E_n = \bigcup_{x \in \widetilde{E}_n} \left(x + \frac{C}{n} \right) \setminus A.$$

If $|\mathcal{E}_n| \leq \beta n^{d-1}$ then $\mathcal{P}(E_n, \mathbb{R}^d \setminus A) \leq \beta$ and $\mathcal{P}(E_n) \leq \beta + \mathcal{P}(A)$. Moreover if $|\mathcal{E}_n| \leq \beta n^{d-1}$ then $E_n \subset \mathcal{V}(A, 2d\beta n^{d-2})$.

The set E_n is a random bounded subset of \mathbb{R}^d . However, the diameter of E_n might be very large, of polynomial order in n , and there is no compact region of \mathbb{R}^d that almost surely contains E_n . Therefore, we cannot proceed as in [25]. However, as the capacity of \mathcal{E}_n is small, we expect it to remain close to the boundary of ∂A . As moving too far away from ∂A is too expensive for \mathcal{E}_n , we should observe unlikely events just by inspecting what happens near the boundary of A . Let R be a real number we will choose later such that $A \subset B(0, R)$. We set

$$\Omega = \mathring{B}(0, R) \cap A^c.$$

Note that the set Ω is open. In the following, we will only work with the portion of \mathcal{E}_n in Ω . For F a Borel subset of \mathbb{R}^d such that $\mathcal{P}(F, \mathbb{R}) < +\infty$, we define

$$\mathcal{I}_\Omega(F) = \int_{\partial^* F \cap \Omega} \nu(n_F(x)) d\mathcal{H}^{d-1}(x) + \int_{\partial^* A \cap \partial^*(\Omega \setminus F)} \nu(n_A(x)) d\mathcal{H}^{d-1}(x).$$

The quantity $\mathcal{I}_\Omega(F)$ may be interpreted as the capacity of the subset $F \cup A$ in Ω . By definition, we know that $\phi_A \leq \mathcal{I}(A \cup F)$ but it is not easy to compare ϕ_A with $\mathcal{I}_\Omega(F)$ because $\mathcal{I}_\Omega(F)$ does not take into account the capacity of $\partial F \setminus \Omega$. In other words, the capacity in $\Omega \cup A$ does not coincide with the capacity in \mathbb{R}^d . To go around this problem, we shall remove some regions of F in the neighborhood of $\partial\Omega$, thereby obtaining a new set \widetilde{F} , whose closure is included in Ω , and which therefore satisfies $\mathcal{I}(\widetilde{F}) = \mathcal{I}_\Omega(\widetilde{F})$. The delicate point is to build the set \widetilde{F} in such a way that $\mathcal{I}(\widetilde{F})$ is only slightly larger than $\mathcal{I}_\Omega(F)$. We will perform a geometrical surgery by choosing cutting surfaces which do not create too much extra perimeter.

We introduce the space

$$\mathcal{C}_\beta = \left\{ F \text{ Borel subset of } \Omega : \mathcal{P}(F, \Omega) \leq \beta \right\}$$

endowed with the topology L^1 associated to the following distance

$$d(F, F') = \mathcal{L}^d(F \Delta F'),$$

where Δ is the symmetric difference between sets. For this topology, the space \mathcal{C}_β is compact. Let us set

$$\overline{E}_n = E_n \cap \Omega.$$

The set \overline{E}_n belongs to \mathcal{C}_β . Suppose that we associate to each $F \in \mathcal{C}_\beta$ a positive number ε_F . The collection of open sets

$$\left\{ H \text{ Borel subset of } \Omega : \mathcal{L}^d(H \Delta F) < \varepsilon_F \right\}, F \in \mathcal{C}_\beta,$$

is then an open covering of \mathcal{C}_β . By compactness, we can extract a finite covering $(F_i, \varepsilon_{F_i})_{1 \leq i \leq N}$ of \mathcal{C}_β . This compactness argument enables us to localize the random set \overline{E}_n near a fixed set F_i of \mathcal{C}_β . The number ε_F associated to F will depend on the set F . We will explain later in the proof how it is chosen. For the time being, we start the argument with a covering (F, ε_F) of \mathcal{C}_β . Let $\delta > 0$ be a real number to be adjusted later. To be able to operate the geometrical surgery, we will localize a region of Ω that contains a volume of \overline{E}_n less than δ . As A is compact, there exists a real number $\rho > 0$ such that

$$A \subset \mathring{B}(0, \rho) \text{ and } \mathcal{L}^d(B(0, \rho)) \geq 3c_{iso}(\mathcal{P}(A) + \beta)^{\frac{d}{d-1}}. \quad (7.1)$$

Moreover, using Proposition 3.4, we get

$$\mathcal{L}^d(E_n) \leq \mathcal{L}^d(E_n \cup A) \leq b_{iso}(\mathcal{P}(A) + \beta)^{d/d-1}. \tag{7.2}$$

Let us define for $i \geq 0$ the i -th annulus \mathcal{A}_i :

$$\mathcal{A}_i = B(0, \rho + i + 1) \setminus B(0, \rho + i).$$

We also define

$$\mathbf{i} = \min \left\{ i \geq 1 : \mathcal{L}^d(E_n \cap \mathcal{A}_i) \leq \delta \right\}.$$

We write \mathbf{i} in bold to emphasize that it is a random index. Thanks to inequality (7.2), we obtain

$$\mathbf{i} \leq b_{iso}(\mathcal{P}(A) + \beta)^{d/d-1}/\delta$$

and the minimum in the definition of \mathbf{i} is always attained. We set

$$M = b_{iso}(\mathcal{P}(A) + \beta)^{d/d-1}/\delta$$

and

$$R = \rho + 1 + M.$$

Thus, the region $\mathcal{A}_{\mathbf{i}}$ is included in Ω and contains a volume of \bar{E}_n less than δ . We sum over $(F_i, \varepsilon_{F_i})_{1 \leq i \leq N}$ of \mathcal{C}_β and condition on \mathbf{i} and we get

$$\begin{aligned} \mathbb{P}(V(\mathcal{E}_n) \leq \lambda n^{d-1}) &\leq \mathbb{P}(|\mathcal{E}_n| \geq \beta n^{d-1}) + \mathbb{P}(V(\mathcal{E}_n) \leq \lambda n^{d-1}, |\mathcal{E}_n| \leq \beta n^{d-1}) \\ &\leq C_1 \exp(-C_2 \beta n^{d-1}) + \sum_{i=1}^N \sum_{1 \leq j \leq M} \mathbb{P} \left(\begin{array}{l} \mathcal{L}^d(\bar{E}_n \Delta F_i) \leq \varepsilon_{F_i}, \\ V(\mathcal{E}_n) \leq \lambda n^{d-1}, \mathbf{i} = j \end{array} \right), \end{aligned} \tag{7.3}$$

We control next the probability inside the sums for a generic F in \mathcal{C}_β and for j a value for the random set \mathbf{i} which occurs with positive probability. By definition of \mathbf{i} , we have

$$\mathcal{L}^d(E_n \cap \mathcal{A}_j) \leq \delta.$$

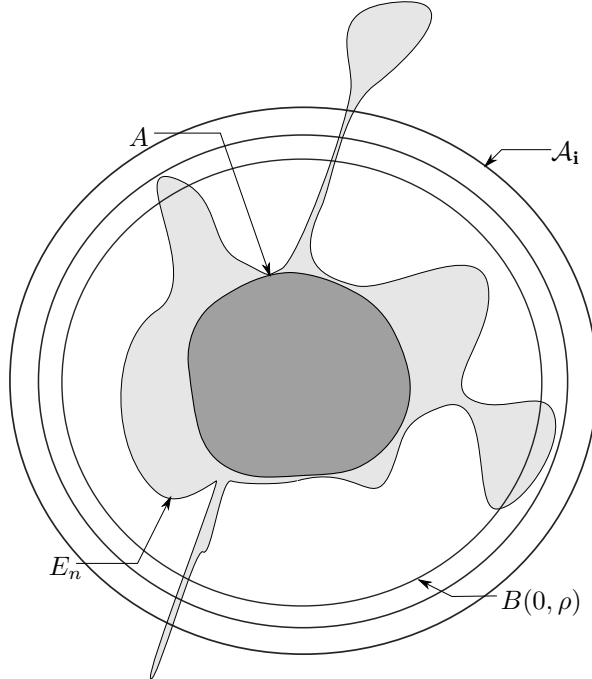

Figure 7.3 – The set E_n and its associated $\mathcal{A}_{\mathbf{i}}$

We want to build from F a set \tilde{F} of finite perimeter such that its boundary $\partial\tilde{F} \setminus A$ is in Ω and $\mathcal{I}_\Omega(\tilde{F})$ is close to $\mathcal{I}_\Omega(F)$. Of course, cutting F inside Ω creates some extra capacity along the cutting. The idea is to cut F in the annulus \mathcal{A}_j . As the volume of F in this region is small, we shall be able to find cutting surfaces having small perimeter. If we choose ε_F small enough such that $\varepsilon_F \leq \delta$ for all $F \in \mathcal{C}_\beta$, it follows that

$$\mathcal{L}^d(F \cap \mathcal{A}_j) \leq \delta + \varepsilon_F \leq 2\delta.$$

By Lemma 14.4 in [19], for $i \in J$, for \mathcal{H}^1 almost all t in $]0, 1[$,

$$\mathcal{I}(F \cap B(0, \rho + j + t)) \leq \mathcal{I}(F \cap \mathring{B}(0, \rho + j + t)) + \nu_{max} \mathcal{H}^{d-1}(F \cap \partial B(0, \rho + j + t)). \quad (7.4)$$

Let T be the subset of $]0, 1[$ for which the above inequality holds. We have $\mathcal{H}^1(T) = 1$. Integrating in polar coordinates, we get

$$\begin{aligned} \int_T \mathcal{H}^{d-1}(F \cap \partial B(0, \rho + j + t)) &= \mathcal{L}^d(F \cap B(0, \rho + j + 1) \setminus B(0, \rho + j)) \\ &\leq \mathcal{L}^d(F \cap \mathcal{A}_j) \leq 2\delta. \end{aligned}$$

Thus, there exists $t \in T$ such that

$$\mathcal{H}^{d-1}(F \cap \partial B(0, \rho + j + t)) \leq 3\delta. \quad (7.5)$$

We next define

$$\tilde{F} = F \cap B(0, \rho + j + t).$$

By construction, we have $\partial\tilde{F} \setminus A \subset \Omega$. Combining inequalities (7.4) and (7.5), we obtain

$$\phi_A \leq \mathcal{I}_\Omega(\tilde{F}) \leq \mathcal{I}(F, \mathring{B}(0, \rho + j + t)) + \nu_{max} 3\delta \leq \mathcal{I}_\Omega(F) + 3\delta\nu_{max} \quad (7.6)$$

We show next that is possible to choose δ such that, uniformly over F , we have $s\mathcal{I}_\Omega(F) \geq 3\delta\nu_{max}$. We have

$$\mathcal{I}_\Omega(F) \geq \int_{\partial^*(F \cup A) \cap \mathring{B}(0, \rho)} \nu(n_{A \cup F}(x)) d\mathcal{H}^{d-1}(x) \geq \nu_{min} \mathcal{P}(F \cup A, \mathring{B}(0, \rho)).$$

We apply the isoperimetric inequality relative to the ball $B(0, \rho)$:

$$\mathcal{P}(F \cup A, \mathring{B}(0, \rho)) \geq \left(\frac{\min(\mathcal{L}^d((A \cup F) \cap B(0, \rho)), \mathcal{L}^d((\mathbb{R}^d \setminus (A \cup F)) \cap B(0, \rho)))}{b_{iso}} \right)^{\frac{d-1}{d}}.$$

Since F is in \mathcal{C}_β , we have $\mathcal{L}^d(A \cup F) \leq c_{iso}(\mathcal{P}(A) + \beta)^{\frac{d}{d-1}}$. Together with inequality (7.1), we conclude that

$$\mathcal{P}(F \cup A, \mathring{B}(0, \rho)) \geq \left(\frac{\mathcal{L}^d(A)}{b_{iso}} \right)^{\frac{d-1}{d}}.$$

There exists $s > 0$ such that $\lambda \leq (1 - s)\phi_A$. We choose δ such that

$$2\delta\nu_{max} = s\nu_{min} \left(\frac{\mathcal{L}^d(A)}{b_{iso}} \right)^{\frac{d-1}{d}}. \quad (7.7)$$

Using inequality (7.6), we have then, for any F in \mathcal{C}_β ,

$$\mathcal{L}^d(\overline{E}_n \Delta F) \leq \delta \implies s\mathcal{I}_\Omega(F) \geq 3\delta\nu_{max} \implies \lambda \leq (1 - s)\phi_A \leq (1 - s^2)\mathcal{I}_\Omega(F).$$

So we get,

$$\begin{aligned} \mathbb{P}(V(\mathcal{E}_n) \leq \lambda n^{d-1}, \mathcal{L}^d(\overline{E}_n \Delta F) \leq \varepsilon_F, \mathbf{i} = j) \\ \leq \mathbb{P}(V(\mathcal{E}_n \cap \Omega) \leq (1 - s^2)\mathcal{I}_\Omega(F)n^{d-1}, \mathcal{L}^d(\overline{E}_n \Delta F) \leq \varepsilon_F). \end{aligned} \quad (7.8)$$

The remaining of the proof follows the same ideas as in [25]. We study the quantity

$$\mathbb{P}(V(\mathcal{E}_n \cap \Omega) \leq (1 - s^2)\mathcal{I}_\Omega(F)n^{d-1}, \mathcal{L}^d(\bar{E}_n \Delta F) \leq \varepsilon_F)$$

for a generic F in \mathcal{C}_β and its corresponding ε_F . We will need the following lemma to cover F by balls of small radius such that ∂F is "almost flat" in each ball. This lemma is purely geometric, the covering depends only on the set F .

Lemma 7.1. [Lemma 1 in [25]] *Let F be a subset of Ω of finite perimeter such that $\partial F \cap \partial\Omega = \emptyset$. For every positive constants δ' and η' , there exists a finite family of closed disjoint balls $(B(x_i, \rho_i))_{i \in I \cup K}$ and vectors $(v_i)_{i \in I \cup K}$, such that,*

$$\forall i \in I, x_i \in \partial^* F \cap \Omega, \rho_i \in]0, 1[, B_i \subset \Omega \setminus A, \mathcal{L}^d((F \cap B_i) \Delta B_i^-) \leq \delta' \alpha_d \rho_i^d,$$

and letting $B_i = B(x_i, \rho_i)$ and $B_i^- = B^-(x_i, \rho_i, v_i)$, we have

$$\forall i \in K, x_i \in \partial^* A \cap \partial^*(\Omega \setminus F), \rho_i \in]0, 1[, \partial\Omega \cap B_i \subset \partial^* A \setminus \partial^* F, \\ \mathcal{L}^d((A \cap B_i) \Delta B_i^-) \leq \delta' \alpha_d \rho_i^d,$$

and finally

$$\left| \mathcal{I}_\Omega(F) - \sum_{i \in I} \alpha_{d-1} \rho_i^{d-1} (\nu(n_F(x_i))) - \sum_{i \in K} \alpha_{d-1} \rho_i^{d-1} (\nu(n_A(x_i))) \right| \leq \eta.$$

First notice that

$$\phi_A \leq \int_{\partial^* A} \nu(n_A(x)) d\mathcal{H}^{d-1}(x) < +\infty.$$

We choose $\eta = s^4 \mathcal{I}_\Omega(F)$ and $\delta' > 0$ will be chosen later. Let $(B_i)_{i \in I \cup K}$ be a family as in Lemma 7.1, we obtain

$$\mathcal{I}_\Omega(F) \leq \frac{1}{1 - s^4} \left(\sum_{i \in I} \alpha_{d-1} \rho_i^{d-1} (\nu(n_F(x_i))) + \sum_{i \in K} \alpha_{d-1} \rho_i^{d-1} (\nu(n_A(x_i))) \right)$$

whence, setting $w = s^2/(1 + s^2)$,

$$(1 - s^2)\mathcal{I}_\Omega(F) \leq (1 - w) \left(\sum_{i \in I} \alpha_{d-1} \rho_i^{d-1} (\nu(n_F(x_i))) + \sum_{i \in K} \alpha_{d-1} \rho_i^{d-1} (\nu(n_A(x_i))) \right).$$

Since the balls $(B_i)_{i \in I \cup K}$ are pairwise disjoint, we have

$$V(\mathcal{E}_n \cap \Omega) \geq \sum_{i \in I \cup K} V(\mathcal{E}_n \cap B_i).$$

It follows that

$$\mathbb{P}(V(\mathcal{E}_n \cap \Omega) \leq (1 - s^2)\mathcal{I}_\Omega(F)n^{d-1}, \mathcal{L}^d(\bar{E}_n \Delta F) \leq \varepsilon_F) \\ \leq \mathbb{P} \left(\begin{array}{l} \sum_{i \in I \cup K} V(\mathcal{E}_n \cap B_i) \leq (1 - w)n^{d-1} \left(\sum_{i \in I} \alpha_{d-1} \rho_i^{d-1} (\nu(n_F(x_i))) \right. \\ \left. + \sum_{i \in K} \alpha_{d-1} \rho_i^{d-1} (\nu(n_A(x_i))) \right) \text{ and } \mathcal{L}^d(\bar{E}_n \Delta F) \leq \varepsilon_F \end{array} \right). \quad (7.9)$$

We now choose

$$\varepsilon_F \leq \min_{i \in I \cup K} \alpha_d \rho_i^d \delta' \quad (7.10)$$

We wish to control $\text{card}((E_n \cap B_i) \Delta B_i^-) \cap \mathbb{Z}_n^d$, it is equivalent to evaluate

$$n^d \mathcal{L}^d((E_n \cap B_i) \Delta B_i^-) \cap \mathbb{Z}_n^d + [-1/2n, 1/2n]^d).$$

This was done in [25]. We will not redo the computations here, but only state the results: for n large enough, for $i \in I$,

$$\text{card}((E_n \cap B_i) \Delta B_i^-) \cap \mathbb{Z}_n^d \leq 4\delta' \alpha_d \rho_i^d n^d.$$

We recall that $\tilde{E}_n = E_n \cap \mathbb{Z}_n^d$. We define

$$\tilde{E}'_n = \tilde{E}_n \cup (A \cap \mathbb{Z}_n^d) \text{ and } E'_n = \tilde{E}'_n + [-1/(2n), 1/(2n)]^d.$$

For n large enough, for $i \in K$, it was proven in section 5.2 in [25] that

$$\text{card}((E'_n \cap B_i) \Delta B_i^+) \cap \mathbb{Z}_n^d \leq 4\delta' \alpha_d \rho_i^d n^d.$$

Thus, for n large enough, thanks to inequality (7.9),

$$\begin{aligned} \mathbb{P}(V(\mathcal{E}_n) \leq \lambda n^{d-1}, \mathcal{L}^d(\bar{E}_n \Delta F) \leq \varepsilon_F) \\ \leq \sum_{i \in I} \mathbb{P} \left(\begin{array}{l} V(\partial_e \tilde{E}_n \cap B_i) \leq (1-w) \alpha_{d-1} \rho_i^{d-1} (\nu(n_F(x_i)) n^{d-1}), \\ \text{card}((\tilde{E}_n \cap B_i) \Delta (B_i^- \cap \mathbb{Z}_n^d)) \leq 4\delta' \alpha_d \rho_i^d n^d \end{array} \right) \\ + \sum_{i \in K} \mathbb{P} \left(\begin{array}{l} V(\partial_e \tilde{E}'_n \cap B_i) \leq (1-w) \alpha_{d-1} \rho_i^{d-1} (\nu(n_A(x_i)) n^{d-1}), \\ \text{card}((\tilde{E}'_n \cap B_i) \Delta (B_i^- \cap \mathbb{Z}_n^d)) \leq 4\delta' \alpha_d \rho_i^d n^d \end{array} \right) \\ \leq \sum_{i \in I \cup K} \mathbb{P}(G(x_i, \rho_i, v_i, w, \delta')), \end{aligned} \quad (7.11)$$

where $G(x, r, v, w, \delta')$ is the event that there exists a set $U \subset B(x, r) \cap \mathbb{Z}_n^d$ such that:

$$\text{card}(U \Delta B^-(x, r, v)) \leq 4\delta' \alpha_d r^d n^d$$

and

$$V(\partial_e U \cap B(x, r)) \leq (1-w) \alpha_{d-1} r^{d-1} (\nu(n_F(x)) n^{d-1}).$$

This event depends only on the edges inside $B(x, r, v)$. This event is a rare event. Indeed, if this event occurs, we can show that the maximal flow from the upper half part of $B(x, r, v)$ (upper half part according to the direction v) and the lower half part is abnormally small. To do so, we build from the set U an almost flat cutset in the ball. The fact that $\text{card}(U \Delta B^-(x, r, v))$ is small implies that $\partial_e U$ is almost flat and is close to $\text{disc}(x, r, v)$. However, this does not prevent the existence of long thin strands that might escape the ball and prevent U from being a cutset in the ball. The idea is to cut these strands by adding edges at a fixed height. We have to choose the appropriate height to ensure that the extra edges we need to add to cut these strands are not too many, so that we can control their capacity. The new set of edges we create by adding to U these edges will be in a sense a cutset. The last thing to do is then to cover $\text{disc}(x, r, v)$ by hyperrectangles in order to use the estimate that the flow is abnormally small in a cylinder. This work was done in section 6 in [25]. It is possible to choose δ' depending on F, G and w such that there exist positive constants $C_{1,k}^F$ and $C_{2,k}^F$ depending on G, d, F, k and w so that for all $k \in I \cup K$,

$$\mathbb{P}(G(x_k, \rho_k, v_k, w, \delta')) \leq C_{1,k}^F \exp(-C_{2,k}^F n^{d-1}).$$

Using inequality (7.11), we obtain

$$\mathbb{P}(V(\mathcal{E}_n) \leq \lambda n^{d-1}, \mathcal{L}^d(\bar{E}_n \Delta F) \leq \varepsilon_F) \leq \sum_{k \in I \cup K} C_{1,k}^F \exp(-C_{2,k}^F n^{d-1}). \quad (7.12)$$

Combining inequalities (7.3), (7.8) and (7.12), we obtain that, for small enough δ' ,

$$\begin{aligned} \mathbb{P}(V(\mathcal{E}_n) \leq \lambda n^{d-1}) &\leq C_1 \exp(-C_2 \beta n^{d-1}) + \sum_{j=1}^N \sum_{i=1}^M \sum_{k \in I^{F_j} \cup K^{F_j}} C_{1,k}^{F_j} \exp(-C_{2,k}^{F_j} n^{d-1}) \\ &\leq C_1 \exp(-C_2 \beta n^{d-1}) + M \sum_{j=1}^N \sum_{k \in I^{F_j} \cup K^{F_j}} C_{1,k}^{F_j} \exp(-C_{2,k}^{F_j} n^{d-1}). \end{aligned}$$

As M , N , $|I^{F_j}|$ and $|K^{F_j}|$, for $1 \leq j \leq N$, are finite and independent of n , we obtain the expected result and this proves Theorem 1.4.

To conclude, let us sum up the order in which the constants are chosen. We first choose δ such that it satisfies equality (7.7). Next, we choose δ' depending on λ and G . The parameter δ' has to satisfy some inequalities that we do not detail here, we refer to section 7 in [25]. Finally, to each F in \mathcal{C}_β , we choose ε_F such that it satisfies both $\varepsilon_{F_i} \leq \delta$ and inequality (7.10).

8 Identification of ϕ_A

In this section, we prove Proposition 1.5, the last ingredient needed to prove Theorem 1.1.

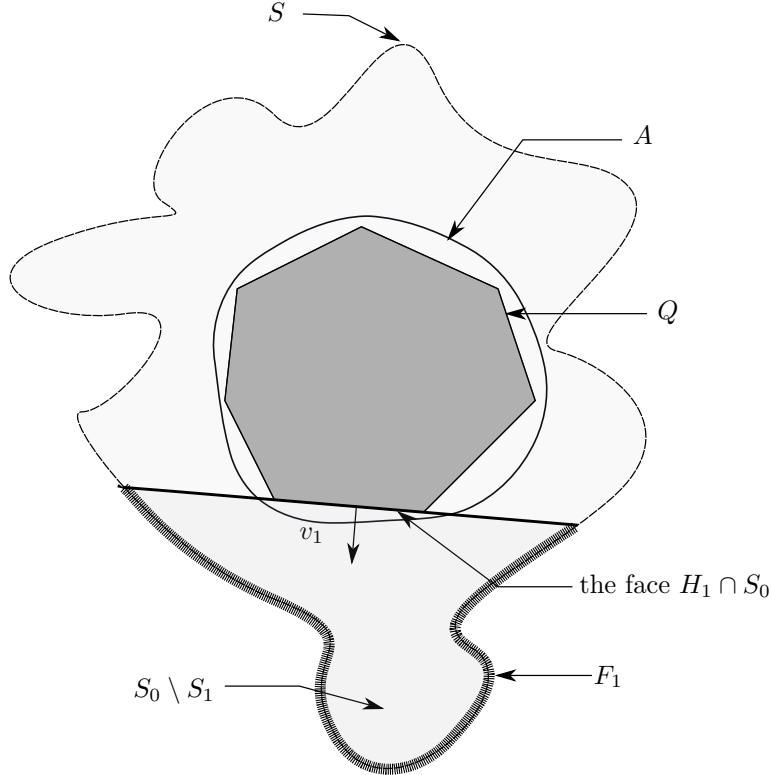

Figure 7.4 – Construction of S_1 for a bounded set S such that $A \subset S$

Proof of Proposition 1.5. Let A be a compact convex subset of \mathbb{R}^d . We shall show that any bounded set S that contains A satisfies $\mathcal{I}(A) \leq \mathcal{I}(S)$. Let S be such a set, we can assume that S has finite perimeter otherwise the inequality is trivial. Let $\varepsilon > 0$. As A is convex, by Lemma 3.7, there exists a convex polytope P such that $P \subset A$ and $\mathcal{I}(A) \leq \mathcal{I}(P) + \varepsilon$. There exist v_1, \dots, v_m unit vectors and $\varphi_1, \dots, \varphi_m$ real numbers such that

$$P = \bigcap_{1 \leq i \leq m} \left\{ x \in \mathbb{R}^d : x \cdot v_i \leq \varphi_i \right\}.$$

We denote by H_i the hyperplane associated with v_i , i.e.,

$$H_i = \left\{ x \in \mathbb{R}^d : x \cdot v_i = \varphi_i \right\}$$

and H_i^- the associated half-space containing P , i.e.,

$$H_i^- = \left\{ x \in \mathbb{R}^d : x \cdot v_i \leq \varphi_i \right\}.$$

We shall successively chop off portions from S thereby reducing its surface energy by using the family of half-spaces $(H_i^-, 1 \leq i \leq m)$. We define by induction this sequence of sets. We set $S_0 = S$. Let us assume S_i is already defined for some $i < m$, we set

$$S_{i+1} = S_i \cap H_{i+1}^-.$$

We next show that $\mathcal{I}(S_i) \geq \mathcal{I}(S_{i+1})$ for all $0 \leq i \leq m$. We shall apply the Gauss-Green theorem to each S_i in order to compare the capacity of the face $H_{i+1} \cap S_i$ with the capacity of $F_i = \partial S_i \setminus H_{i+1}^-$ (see figure 7.4). For $i \in \{0, \dots, m-1\}$, let $y_{i+1} \in \mathcal{W}_\nu$ such that y_{i+1} achieves the supremum in

$$\sup_{x \in \mathcal{W}_\nu} \{x \cdot v_{i+1}\}.$$

There exists a \mathcal{C}^1 vector field $f_{i+1} : \mathbb{R}^d \rightarrow \mathcal{W}_\nu$ having compact support such that $f_{i+1}(x) = y_{i+1} \in \mathcal{W}_\nu$ on $\mathcal{V}(S_i, 1)$. We recall that S_i is bounded and we do not go into the details of the existence of such a vector field. Applying Theorem 3.5 to $S_i \setminus S_{i+1}$ and f_i , we obtain

$$\int_{S_i \setminus S_{i+1}} \operatorname{div} f_{i+1}(x) = \int_{\partial^*(S_i \setminus S_{i+1})} f_{i+1}(x) \cdot n_{S_i \setminus S_{i+1}}(x) d\mathcal{H}^{d-1}(x).$$

By definition of y_{i+1} and proposition 3.1, we obtain

$$\int_{H_{i+1} \cap S_i} y_{i+1} \cdot (-v_{i+1}) d\mathcal{H}^{d-1}(x) = -\nu(v_{i+1}) \mathcal{H}^{d-1}(H_{i+1} \cap S_i).$$

As f_{i+1} is constant on $S_i \setminus S_{i+1}$, we get

$$0 = \int_{F_i} f_{i+1}(x) \cdot n_S(x) d\mathcal{H}^{d-1}(x) - \nu(v_{i+1}) \mathcal{H}^{d-1}(H_{i+1} \cap S_i),$$

and therefore

$$\begin{aligned} \nu(v_{i+1}) \mathcal{H}^{d-1}(S_i \cap H_{i+1}) &= \int_{F_i} f_{i+1}(x) \cdot n_S(x) d\mathcal{H}^{d-1}(x) \\ &\leq \int_{F_i} \nu(n_S(x)) d\mathcal{H}^{d-1}(x). \end{aligned}$$

The last inequality comes from the fact that $f_{i+1}(x) \in \mathcal{W}_\nu$, therefore we have

$$f_i(x) \cdot n_S(x) \leq \nu(n_S(x))$$

for any x in \mathbb{R}^d . Finally we obtain as $P \subset A \subset S$ that $S_m = P$ and so $\mathcal{I}(P) \leq \mathcal{I}(S)$, hence

$$\mathcal{I}(A) \leq \mathcal{I}(P) + \varepsilon \leq \mathcal{I}(S) + \varepsilon.$$

As this inequality is true for any $\varepsilon > 0$, we conclude that $\mathcal{I}(A) \leq \mathcal{I}(S)$ and the result follows. \square

Combining Theorem 1.3, Theorem 1.4 and Proposition 1.5, we obtain Theorem 1.1.

Acknowledgments

I thank my advisor Marie Th eret for presenting me this problem. I also wish to express my gratitude to Rapha el Cerf who has given me the opportunity to work with him for an internship. I thank him for our stimulating discussions and for always finding time to talk. This research was partially supported by the ANR project PPPP (ANR-16-CE40-0016).

Chapter 8

Size of a minimal cutset in supercritical first passage percolation

This chapter is a joint work with Marie Th  ret.

We consider the standard model of i.i.d. first passage percolation on \mathbb{Z}^d given a distribution G on $[0, +\infty]$ (including $+\infty$). We suppose that $G(\{0\}) > 1 - p_c(d)$, *i.e.*, the edges of positive passage time are in the subcritical regime of percolation on \mathbb{Z}^d . We consider a cylinder of basis an hyperrectangle of dimension $d - 1$ whose sides have length n and of height $h(n)$ with $h(n)$ negligible compared to n (*i.e.*, $h(n)/n \rightarrow 0$ when n goes to infinity). We study the maximal flow from the top to the bottom of this cylinder. We already know that the maximal flow renormalized by n^{d-1} converges towards the flow constant which is null in the case $G(\{0\}) > 1 - p_c(d)$. The study of maximal flow is associated with the study of sets of edges of minimal capacity that cut the top from the bottom of the cylinder. If we denote by ψ_n the minimal cardinality of such a set of edges, we prove here that ψ_n/n^{d-1} converges almost surely towards a constant.

Contents

1	Introduction	185
2	Definition, background and main results	186
2.1	Definition of maximal flows and minimal cutsets	186
2.2	Background on maximal flows	189
2.3	Background on the minimal length of a geodesic and the minimal size of a minimal cutset	190
2.4	Main result and idea of the proof	192
2.5	More notations and useful results	193
2.6	Concentration inequality	193
3	Definition of an alternative flow	194
4	Subadditive argument	195
5	From slabs to cylinders	200
6	Concentration	204

1 Introduction

The model of first passage percolation was first introduced by Hammersley and Welsh [49] in 1965 as a model for the spread of a fluid in a porous medium. In this model, mathematicians studied intensively geodesics, *i.e.*, fastest paths between two points in the grid. The study of maximal flows in first passage percolation started later in 1984 in dimension 2 with an article of Grimmett and Kesten [45]. In 1987, Kesten studied maximal flows in dimension 3 in [52]. The study of maximal flows is associated with the study of random cutsets that can be seen as

$(d - 1)$ -dimensional surfaces. Their study presents more technical difficulties than the study of geodesics. Thus, the interpretation of first passage percolation in term of maximal flows has been less studied.

Let us consider a large box in \mathbb{Z}^d , to each edge we assign a random i.i.d. capacity with distribution G . We interpret this capacity as a rate of flow, *i.e.*, it corresponds to the maximal amount of water that can cross the edge per second. Next, we consider two opposite sides of the box that we call top and bottom. We are interested in the maximal flow that can cross the box from its top to its bottom per second. A first issue is to understand if the maximal flow in the box properly renormalized converges when the size of the box grows to infinity. This question was addressed in [52], [62] and [73] where one can find laws of large numbers and large deviation estimates for this maximal flow when the dimensions of the box grow to infinity under some moments assumptions on the capacities. The maximal flow properly renormalized converges towards the so-called flow constant. In [64], Rossignol and Th  ret proved the same results without any moment assumption on G , they even allow the capacities to take infinite value as long as $G(\{+\infty\}) < p_c(d)$ where $p_c(d)$ denotes the critical parameter of i.i.d. bond percolation on \mathbb{Z}^d . We can interpret infinite capacities as a defect of the medium, *i.e.*, there are some edges where the capacities are of bigger order. Moreover, the two authors have shown that the flow constant is continuous with regard to the distribution of the capacities.

The flow constant is associated with the study of surfaces with minimal capacity. These surfaces must disconnect the top from the bottom of the box in a sense we will precise later. We want to know if the minimal size of these surfaces of minimal capacity grows at the same order as the size of the bottom of the box. When $G(\{0\}) < 1 - p_c(d)$, Zhang proved in [73], under an exponential moment condition, that there exists a constant such that the probability that all the surfaces of minimal capacity are bigger than this constant times the size of the bottom of the cylinder, decays exponentially fast when the size of the box grows to infinity. The main result of this paper is that under the assumption $G(\{0\}) > 1 - p_c(d)$, the minimal size of a surface of minimal capacity divided by the size of the bottom of the cylinder converges towards a constant when the size of the box grows to infinity.

The rest of the paper is organized as follows. In section 2, we give all the necessary definitions and background, we state our main theorem and give the main ideas of the proof. In section 3, we define an alternative flow which is more adapted for using subadditive arguments. The proof is made of three steps that correspond to sections 4, 5 and 6.

2 Definition, background and main results

2.1 Definition of maximal flows and minimal cutsets

We keep many notations used in [64]. We consider the graph $(\mathbb{Z}^d, \mathbb{E}^d)$ where \mathbb{E}^d is the set of edges that link all the nearest neighbors for the Euclidean norm in \mathbb{Z}^d . We consider a distribution G on $[0, +\infty]$. To each edge e in \mathbb{E}^d we assign a random variable $t_G(e)$ with distribution G . The variable $t_G(e)$ is called the capacity (or the passage time) of e . The family $(t_G(e))_{e \in \mathbb{E}^d}$ is independent.

Let $\Omega = (V_\Omega, E_\Omega)$ be a finite subgraph of $(\mathbb{Z}^d, \mathbb{E}^d)$. We can see Ω as a piece of rock through which water can flow. Let \mathfrak{G}_1 and \mathfrak{G}_2 be two disjoint subsets of V_Ω representing respectively the sources through which the water can enter and the sinks through which the water can exit.

Let the function $f : \mathbb{E}^d \rightarrow \mathbb{R}^d$ be a possible stream inside Ω between \mathfrak{G}_1 and \mathfrak{G}_2 . For all $e \in \mathbb{E}^d$, $\|f(e)\|_2$ represents the amount of water that flows through e per second and $f(e)/\|f(e)\|_2$ represents the direction in which the water flows through e . If we write $e = \langle x, y \rangle$ where x, y are neighbors in the graph $(\mathbb{Z}^d, \mathbb{E}^d)$, then the unit vector $f(e)/\|f(e)\|_2$ is either the vector \vec{xy} or \vec{yx} . We say that our stream f inside Ω from \mathfrak{G}_1 to \mathfrak{G}_2 is G -admissible if and only if it satisfies the following constraints.

• *The node law* : for every vertex x in $V_\Omega \setminus (\mathfrak{G}_1 \cup \mathfrak{G}_2)$, we have

$$\sum_{y \in \mathbb{Z}^d : e = \langle x, y \rangle \in E_\Omega} \|f(e)\|_2 \left(\mathbf{1}_{\frac{f(e)}{\|f(e)\|_2} = \vec{xy}} - \mathbf{1}_{\frac{f(e)}{\|f(e)\|_2} = \vec{yx}} \right) = 0,$$

i.e., there is no loss of fluid inside Ω .

- *The capacity constraint*: for every edge e in E_Ω , we have

$$0 \leq \|f(e)\|_2 \leq t_G(e),$$

i.e., the amount of water that flows through e per second is limited by its capacity $t_G(e)$.

Note that as the capacities are random, the set of G -admissible streams inside Ω between \mathfrak{G}_1 and \mathfrak{G}_2 is also random. For each G -admissible stream f , we define its flow by

$$\text{flow}(f) = \sum_{x \in \mathfrak{G}_1} \sum_{y \in \mathbb{Z}^d: e=\langle x,y \rangle \in E_\Omega} \|f(e)\|_2 \left(\mathbb{1}_{\frac{f(e)}{\|f(e)\|_2} = \vec{xy}} - \mathbb{1}_{\frac{f(e)}{\|f(e)\|_2} = \vec{yx}} \right).$$

This corresponds to the amount of water that enters in Ω through \mathfrak{G}_1 per second. By the node law, as there is no loss of fluid, $\text{flow}(f)$ is also equal to the amount of water that escapes from Ω through \mathfrak{G}_2 per second:

$$\text{flow}(f) = \sum_{x \in \mathfrak{G}_2} \sum_{y \in \mathbb{Z}^d: e=\langle x,y \rangle \in E_\Omega} \|f(e)\|_2 \left(\mathbb{1}_{\frac{f(e)}{\|f(e)\|_2} = \vec{yx}} - \mathbb{1}_{\frac{f(e)}{\|f(e)\|_2} = \vec{xy}} \right).$$

The maximal flow from \mathfrak{G}_1 to \mathfrak{G}_2 in Ω for the capacities $(t_G(e))_{e \in E_\Omega}$, denoted by $\phi_G(\mathfrak{G}_1 \rightarrow \mathfrak{G}_2$ in $\Omega)$, is the supremum of the flows of all admissible streams through Ω :

$$\phi_G(\mathfrak{G}_1 \rightarrow \mathfrak{G}_2 \text{ in } \Omega) = \sup \left\{ \text{flow}(f) : \begin{array}{l} f \text{ is a } G\text{-admissible stream inside} \\ \Omega \text{ between } \mathfrak{G}_1 \text{ and } \mathfrak{G}_2 \end{array} \right\}.$$

Dealing with admissible streams is not so easy, but hopefully we can use an alternative definition of maximal flow which is more convenient. Let $E \subset E_\Omega$ be a set of edges. We say that E cuts \mathfrak{G}_1 from \mathfrak{G}_2 in Ω (or is a cutset, for short) if there is no path from \mathfrak{G}_1 to \mathfrak{G}_2 in $(V_\Omega, E_\Omega \setminus E)$. More precisely, let γ be a path from \mathfrak{G}_1 to \mathfrak{G}_2 in Ω , we can write γ as a finite sequence $(v_0, e_1, v_1, \dots, e_n, v_n)$ of vertices $(v_i)_{i=0, \dots, n} \in V_\Omega^{n+1}$ and edges $(e_i)_{i=1, \dots, n} \in E_\Omega^n$ where $v_0 \in \mathfrak{G}_1$, $v_n \in \mathfrak{G}_2$ and for any $1 \leq i \leq n$, $e_i = \langle v_{i-1}, v_i \rangle \in E_\Omega$. Then, E cuts \mathfrak{G}_1 from \mathfrak{G}_2 in Ω if for any path γ from \mathfrak{G}_1 to \mathfrak{G}_2 in Ω , we have $\gamma \cap E \neq \emptyset$. Note that γ can be seen as a set of edges or a set of vertices and we define $|\gamma| = n$. We associate with any set of edges E its capacity $T_G(E)$ defined by

$$T_G(E) = \sum_{e \in E} t_G(e).$$

The max-flow min-cut theorem, see [16], a result of graph theory, states that

$$\phi_G(\mathfrak{G}_1 \rightarrow \mathfrak{G}_2 \text{ in } \Omega) = \min \{ T_G(E) : E \text{ cuts } \mathfrak{G}_1 \text{ from } \mathfrak{G}_2 \text{ in } \Omega \}.$$

The idea behind this theorem is quite intuitive. When we consider a maximal flow through Ω , some of the edges are jammed. We say that e is jammed if the amount of water that flows through e is equal to the capacity $t_G(e)$. These jammed edges form a cutset, otherwise we would be able to find a path γ from \mathfrak{G}_1 to \mathfrak{G}_2 of non-jammed edges, and we could increase the amount of water that flows through γ which contradicts the fact that the flow is maximal. Thus, the flow is always smaller than the capacity of any cutset. It can be proved that the maximal flow is equal to the minimal capacity of a cutset.

In [52], Kesten interpreted the study of maximal flow as a higher dimensional version of the classical problem of first passage percolation which is the study of geodesics. A geodesic may be considered as an object of dimension 1, it is a path with minimal passage time. On the contrary, the maximal flow is associated (via the max-flow min-cut theorem) with cutsets of minimal capacity: those cutsets are objects of dimension $d - 1$, that can be seen as surfaces. To better understand the interpretation in term of surfaces, we can associate with each edge e a small plaquette e^* . The plaquette e^* is an hypersquare of dimension $d - 1$ whose sides have length one and are parallel to the edges of the graphs, such that e^* is normal to e and cuts it in its middle. We associate with the plaquette e^* the same capacity $t_G(e)$ as with the edge e . We also define the dual of a set of

edge E by $E^* = \{e^*, e \in E\}$. Roughly speaking, if the set of edges E cuts \mathfrak{G}_1 from \mathfrak{G}_2 in Ω , the surface of plaquettes E^* disconnects \mathfrak{G}_1 from \mathfrak{G}_2 in Ω . Although this interpretation in terms of surfaces seems more intuitive than cutsets, it is really technical to handle, and we will never use it and not even try to give a rigorous definition of a surface of plaquettes. Note that, in dimension 2, a surface of plaquettes is very similar to a path in the dual graph of \mathbb{Z}^2 and thus the study of minimal cutsets is very similar to the study of geodesics.

We consider now two specific maximal flows through a cylinder for first passage percolation on \mathbb{Z}^d where the law of capacities is given by a distribution G such as $G([-\infty, 0]) = 0$ and $G(\{0\}) > 1 - p_c(d)$, *i.e.*, the edges of positive capacity are in the sub-critical regime of percolation on \mathbb{Z}^d . We are interested in the study of cutsets in a cylinder. Among all the minimal cutsets, we are interested with the ones with minimal size. Let us first define the maximal flow from the top to the bottom of a cylinder. Let A be a non-degenerate hyperrectangle, *i.e.*, a rectangle of dimension $d - 1$ in \mathbb{R}^d . We denote by \mathcal{H}^{d-1} the Hausdorff measure in dimension $d - 1$: for $A = \prod_{i=1}^{d-1} [k_i, l_i] \times \{c\}$ with $k_i < l_i$, $c \in \mathbb{R}$ we have $\mathcal{H}^{d-1}(A) = \prod_{i=1}^{d-1} (l_i - k_i)$. Let \vec{v} be one of the two unit vectors normal to A . Let $h > 0$, we denote by $\text{cyl}(A, h)$ the cylinder of basis A and height h defined by

$$\text{cyl}(A, h) = \{x + t\vec{v} : x \in A, t \in [0, h]\}.$$

We denote by ∂A the relative boundary of A . We define $\text{cyl}(\partial A, h)$ as

$$\text{cyl}(\partial A, h) = \{x + t\vec{v} : x \in \partial A, t \in [0, h]\}.$$

The dependence on \vec{v} is implicit in the notation $\text{cyl}(A, h)$ and $\text{cyl}(\partial A, h)$. We have to define discretized versions of the bottom $B(A, h)$ and the top $T(A, h)$ of the cylinder $\text{cyl}(A, h)$. We define them by

$$B(A, h) := \left\{ x \in \mathbb{Z}^d \cap \text{cyl}(A, h) : \begin{array}{l} \exists y \notin \text{cyl}(A, h), \langle x, y \rangle \in \mathbb{E}^d \\ \text{and } \langle x, y \rangle \text{ intersects } A \end{array} \right\}$$

and

$$T(A, h) := \left\{ x \in \mathbb{Z}^d \cap \text{cyl}(A, h) : \begin{array}{l} \exists y \notin \text{cyl}(A, h), \langle x, y \rangle \in \mathbb{E}^d \\ \text{and } \langle x, y \rangle \text{ intersects } A + h\vec{v} \end{array} \right\}.$$

We denote by $\Phi_G(A, h)$ the maximal flow from the top to the bottom of the cylinder $\text{cyl}(A, h)$ in the direction \vec{v} , defined by

$$\Phi_G(A, h) = \phi_G(T(A, h) \rightarrow B(A, h) \text{ in } \text{cyl}(A, h)).$$

This definition of the flow is not well suited to use ergodic subadditive theorems, because we cannot glue two cutsets from the top to the bottom of two adjacent cylinders together to build a cutset from the top to the bottom of the union of these two cylinders. Indeed, the intersection of these two cutsets with the adjacent face will very likely not coincide. We can fix this issue by introducing another flow through the cylinder for which the subadditivity would be recover. To define this flow, we will first define another version of the cylinder which is more convenient. We define the cylinder $\text{cyl}'(A, h)$ by

$$\text{cyl}'(A, h) = \{x + t\vec{v} : x \in A, t \in [-h, h]\}.$$

The set $\text{cyl}'(A, h) \setminus A$ has two connected components denoted by $C_1(A, h)$ and $C_2(A, h)$. We have to define a discretized version of the boundaries of these two sets. For $i = 1, 2$, we denote by $C'_i(A, h)$ the discrete boundary of $C_i(A, h)$ defined by

$$C'_i(A, h) = \{x \in \mathbb{Z}^d \cap C_i(A, h) : \exists y \notin \text{cyl}'(A, h), \langle x, y \rangle \in \mathbb{E}^d\}.$$

We call informally $C'_i(A, h)$, $i = 1, 2$, the upper and lower half part of the boundary of $\text{cyl}'(A, h)$. We denote by $\tau_G(A, h)$ the maximal flow from the upper half part to the lower half part of the boundary of the cylinder, *i.e.*,

$$\tau_G(A, h) = \phi_G(C'_1(A, h) \rightarrow C'_2(A, h) \text{ in } \text{cyl}'(A, h)).$$

By the max-flow min-cut theorem, the flow $\tau_G(A, h)$ is equal to the minimal capacity of a set of edges E that cuts $C'_1(A, h)$ from $C'_2(A, h)$ inside the cylinder $\text{cyl}'(A, h)$. If we consider the dual set E^* of E , the intersection of E^* with the boundary of the cylinder has to be close to the relative boundary ∂A of the hyperrectangle A .

Remark 2.1. *Note that here we will work only with the cylinder $\text{cyl}(A, h)$ whereas the authors of [64] work mainly with the cylinder $\text{cyl}'(A, h)$.*

2.2 Background on maximal flows

The simplest case to study maximal flows is for a straight cylinder, *i.e.*, when $\vec{v} = \vec{v}_0 := (0, 0, \dots, 1)$ and $A = A(\vec{k}, \vec{l}) = \prod_{i=1}^{d-1} [k_i, l_i] \times \{0\}$ with $k_i \leq 0 < l_i \in \mathbb{Z}$. In this case, the family of variables $(\tau_G(A(\vec{k}, \vec{l}), h))_{\vec{k}, \vec{l}}$ is subadditive since minimal cutsets in adjacent cylinders can be glued together along the common side of these cylinders. By applying ergodic subadditive theorems in the multi-parameter case (see Krengel and Pyke [54] and Smythe [65]), we obtain the following result.

Proposition 2.2. *Let G be an integrable probability measure on $[0, +\infty[$, *i.e.*, $\int_0^{+\infty} x dG(x) < \infty$. Let $A = \prod_{i=1}^{d-1} [k_i, l_i] \times \{0\}$ with $k_i \leq 0 < l_i \in \mathbb{Z}$. Let $h : \mathbb{N} \rightarrow \mathbb{R}^+$ such that $\lim_{n \rightarrow \infty} h(n) = +\infty$. Then there exists a constant $\nu_G(\vec{v}_0)$, that does not depend on A and h but depends on G and d , such that*

$$\lim_{n \rightarrow \infty} \frac{\tau_G(nA, h(n))}{\mathcal{H}^{d-1}(nA)} = \nu_G(\vec{v}_0) \text{ a.s. and in } L^1.$$

The constant $\nu_G(\vec{v}_0)$ is called the flow constant. Next, a natural question to ask is whether we can define a flow constant for any direction. When we consider tilted cylinders, we cannot recover perfect subadditivity because of the discretization of the boundary. Moreover, the use of ergodic subadditive theorems is not possible when the direction \vec{v} we consider is not rational, *i.e.*, when there does not exist an integer M such that $M\vec{v}$ has integer coordinates. Indeed, in that case there exists no vector \vec{u} normal to \vec{v} such that the model is invariant under the translation of vector \vec{u} . These issues were overcome by Rossignol and Thérêt in [62] where they proved the following law of large numbers.

Theorem 2.3. *Let G be an integrable probability measure on $[0, +\infty[$, *i.e.*, $\int_0^{+\infty} x dG(x) < \infty$. For any $\vec{v} \in \mathbb{S}^{d-1}$, there exists a constant $\nu_G(\vec{v}) \in [0, +\infty[$ such that for any non-degenerate hyperrectangle A normal to \vec{v} , for any function $h : \mathbb{N} \rightarrow \mathbb{R}^+$ such that $\lim_{n \rightarrow \infty} h(n) = +\infty$, we have*

$$\lim_{n \rightarrow \infty} \frac{\tau_G(nA, h(n))}{\mathcal{H}^{d-1}(nA)} = \nu_G(\vec{v}) \text{ in } L^1.$$

If moreover the origin of the graph belongs to A , or if $\int_0^{+\infty} x^{1+1/(d-1)} dG(x) < \infty$, then

$$\lim_{n \rightarrow \infty} \frac{\tau_G(nA, h(n))}{\mathcal{H}^{d-1}(nA)} = \nu_G(\vec{v}) \text{ a.s..}$$

*If the cylinder is flat, *i.e.*, if $\lim_{n \rightarrow \infty} h(n)/n = 0$, then the same convergence also holds for $\Phi_G(nA, h(n))$.*

Moreover, either $\nu_G(\vec{v})$ is null for all $\vec{v} \in \mathbb{S}^{d-1}$ or $\nu_G(\vec{v}) > 0$ for all $\vec{v} \in \mathbb{S}^{d-1}$.

In [72], Zhang found a necessary and sufficient condition on G under which $\nu_G(\vec{v})$ is positive. He proved the following result.

Theorem 2.4. *Let G be an integrable probability measure on $[0, +\infty[$. Then, $\nu_G(\vec{v}) > 0$ if and only if $G(\{0\}) < 1 - p_c(d)$.*

Let us give an intuition of this result. If $\tau_G(nA, h(n)) > 0$, then there exists a path in $\text{cyl}'(nA, h(n))$ from the upper to the lower half part of its boundary such that all its edges have positive capacity. Indeed, if there does not exist such a path, there exists a cutset of null capacity and it contradicts $\tau_G(nA, h(n)) > 0$. Thus, the fact that $\nu_G(\vec{v}) > 0$ is linked with the fact that the edges of positive

capacity percolate, *i.e.*, $G(\{0\}) < 1 - p_c(d)$. The main difficult part of this result is to study the critical case, *i.e.*, $G(\{0\}) = 1 - p_c(d)$.

In [64], Rossignol and Th  ret extended the previous results without any moment condition on G , they even allow G to have an atom in $+\infty$ as long as $G(\{+\infty\}) < p_c(d)$. They proved the following law of large numbers for the maximal flow from the top to the bottom of flat cylinders.

Theorem 2.5. *For any probability measure G on $[0, +\infty]$ such that $G(\{+\infty\}) < p_c(d)$, for any $\vec{v} \in \mathbb{S}^{d-1}$, there exists a constant $\nu_G(\vec{v}) \in [0, +\infty[$ such that for any non-degenerate hyperrectangle A normal to \vec{v} , for any function h such that $h(n)/\log n \rightarrow \infty$ and $h(n)/n \rightarrow 0$ when n goes to infinity, we have*

$$\lim_{n \rightarrow \infty} \frac{\Phi_G(nA, h(n))}{\mathcal{H}^{d-1}(nA)} = \nu_G(\vec{v}) \text{ a.s..}$$

Moreover, for every $\vec{v} \in \mathbb{S}^{d-1}$,

$$\nu_G(\vec{v}) > 0 \iff G(\{0\}) < 1 - p_c(d).$$

Remark 2.6. *Note that if $G(\{0\}) > 1 - p_c(d)$, then $G(\{+\infty\}) < p_c(d)$ and the flow constant is well defined according to Theorem 2.5.*

In [52], Kesten proved a result similar to Proposition 2.2 for the rescaled maximal flow in a straight cylinder $\Phi_G(nA, h(n))/\mathcal{H}^{d-1}(nA)$. He worked in dimension 3 and considered the more general case where the lengths of the sides of the cylinder go to infinity but at different speeds in every direction, under the technical assumption that $G(\{0\})$ is smaller than some small constant. He worked with dual sets, and he had to define properly the notion of surface. He had to deal with the fact that the flow Φ_G is not subadditive. His work was very technical and cannot be easily adapted to tilted cylinders because the arguments crucially depend on some symmetries of the model for straight cylinders. Zhang extended Kesten's result in higher dimensions and without any hypothesis on $G(\{0\})$ in [73]. The asymptotic behavior of maximal flows $\Phi_G(nA, h(n))$ through tilted and non-flat cylinders was studied by Cerf and Th  ret in [23, 24, 26, 27]. In those papers, they even considered maximal flow through more general domains than cylinders.

The results we have gathered here concerning maximal flows are the analogues of known results for the time constant in the study of geodesics in first passage percolation (see for instance Kesten's lecture note [51]). We summarize here a few of them. In this paragraph, we interpret the random variable $t_G(e)$ as the time needed to cross the edge e . The passage time $T_G(\gamma)$ of a path γ corresponds to the time needed to cross all its edges, *i.e.*, $T_G(\gamma) = \sum_{e \in \gamma} t_G(e)$, and a geodesic between two points x and y of \mathbb{Z}^d is a path that achieves the following infimum:

$$T_G(x, y) = \inf \{ T_G(\gamma) : \gamma \text{ is a path from } x \text{ to } y \}.$$

As the time needed to cross the edges are random, a geodesic is a random path. Under some moment conditions, for all $x \in \mathbb{Z}^d$, $T_G(0, nx)/n$ converges a.s. to a time constant $\mu_G(x)$. The time constant μ_G is either identically null or can be extended by homogeneity and continuity into a norm on \mathbb{R}^d . Kesten investigated the positivity of μ_G and obtained that $\mu_G > 0$ if and only if $G(\{0\}) < p_c(d)$, see Theorem 1.15 in [51]. Intuitively if the edges of null passage time percolate, there exists an infinite cluster \mathcal{C} made of edges of null passage time. A geodesic from 0 to nx tries to reach the infinite cluster \mathcal{C} as fast as possible, then travels in the cluster \mathcal{C} at infinite speed and exits the cluster at the last moment to go to nx . Under some good moment assumptions, the time needed to go from 0 to \mathcal{C} and from \mathcal{C} to nx is negligible compared to n . We can show in this case that $\mu_G(x) = 0$.

2.3 Background on the minimal length of a geodesic and the minimal size of a minimal cutset

Let us first present the background on the minimal length of a geodesic. We denote by $N_G(x, y)$ the minimal length of a geodesic between x and y :

$$N_G(x, y) = \inf \{ |\gamma| : \gamma \text{ is a geodesic between } x \text{ and } y \}.$$

One can ask how does $N_G(0, nx)$ grow when n goes to infinity. If $G(\{0\}) > p_c(d)$, it is expected to grow at speed n . This result was first proved by Zhang and Zhang in dimension 2 in [74].

Theorem 2.7. *Let $d = 2$ and let G be a distribution on $[0, +\infty[$ such that $G(\{0\}) > 1/2$. We have*

$$\lim_{n \rightarrow \infty} \frac{N_G((0, 0), (0, n))}{n} = \lambda_{G(\{0\})} \text{ a.s. and in } L^1$$

where $\lambda_{G(\{0\})}$ depends only on $G(\{0\})$.

Zhang later extended this result to all dimensions under the condition that $G(\{0\}) > p_c(d)$ in [71].

Remark 2.8. *These works can be extended to all directions. To extend it to rational directions we can use a subadditive ergodic theorem and instead of considering the points 0 and nx , it is more convenient to consider their regularized version $\tilde{0}$ and \tilde{nx} , i.e., their projection on the infinite cluster of null passage time (see [28]). We can show that $\lim_{n \rightarrow \infty} N_G(0, nx)/n = \lim_{n \rightarrow \infty} N_G(\tilde{0}, \tilde{nx})/n$. By continuity, we can also extend it to irrational directions.*

When $G(\{0\}) < p_c(d)$, the question of the convergence of $N_G(0, nx)/n$ is still open. However, we know that with high probability $N_G(0, nx)$ is of order n . This result is due to Kesten. As a corollary of Proposition (5.8) in [51], we have

Theorem 2.9. *Let G be a distribution on $[0, +\infty[$ such that $G(\{0\}) < p_c(d)$. There exist positive constants C_1, C_2 and λ depending on G such that for all $n \geq 0$,*

$$\mathbb{P} \left(\begin{array}{l} \text{There exists a path } r \text{ starting from } 0 \\ \text{such that } |r| \geq n \text{ and } T_G(r) < \lambda n \end{array} \right) \leq C_1 \exp(C_2 n).$$

If G admits an exponential moment, we can get an exponential control on the probability

$$\mathbb{P}(T_G(0, nx) > Cn)$$

for a large enough C depending on G and so we obtain that there exist positive real numbers A and B such that for every $x \in \mathbb{Z}^d$,

$$\mathbb{P} \left(N_G(0, nx) \geq \frac{C}{\lambda} n \|x\| \right) \leq A \exp(-Bn \|x\|).$$

When $G(\{0\}) = p_c(d)$, $N_G(0, nx)$ is expected to grow super linearly in n . However, this critical case is much more difficult to study, and results have been obtained only for $d = 2$ (see for instance Damron and Tang's paper [34])

We now come back to the study of minimal cutsets. By the max-flow min-cut theorem, we know that $\Phi_G(A, h)$ is equal to the minimal capacity of cutsets that cut the top from the bottom of $\text{cyl}(A, h)$. Among all the cutsets of minimal capacity we are interested in the ones with the minimal cardinality:

$$\psi_G(A, h, \vec{v}) := \inf \left\{ \text{card}_e(E) : \begin{array}{l} E \text{ cuts the top from the bottom of} \\ \text{cyl}(A, h) \text{ and } E \text{ has capacity } \Phi_G(A, h) \end{array} \right\}$$

where $\text{card}_e(E)$ denotes the number of edges in the edge set E . The quantity ψ_G is the analog of N_G in this context.

The study of the quantity $\psi_G(A, h, \vec{v})$ was initiated by Kesten in [52] in dimension 3 for straight boxes and distributions G such that $G(\{0\}) < p_0$ where p_0 is a small constant. Let $k, l, m \in \mathbb{N}$, we define the straight box $B(k, l, m) = [0, k] \times [0, l] \times [0, m]$.

Theorem 2.10. *Let $k, l, m \in \mathbb{N}$. There exists a $p_0 > 1/27$ such that for all distributions G on $[0, +\infty[$ such that $G(\{0\}) < p_0$, there exist constants θ, C_1 and C_2 depending on G such that for all $n \geq 0$,*

$$\mathbb{P} \left(\begin{array}{l} \text{there exists a dual set } E^* \text{ of at least } n \text{ plaquettes that cuts} \\ \text{the top from the bottom of the box } B(k, l, m), \text{ which} \\ \text{contains the point } (-\frac{1}{2}, -\frac{1}{2}, \frac{1}{2}) \text{ and such that } T_G(E^*) \leq \theta n \end{array} \right) \leq C_1 e^{-C_2 n}.$$

Zhang in [73] extended this result in all dimensions and for distributions G such that $G(\{0\}) < 1 - p_c(d)$ and with an exponential moment. He obtained the following result.

Theorem 2.11. *Let G be a distribution on $[0, +\infty[$ such that for some $\eta > 0$, $\int_0^{+\infty} \exp(\eta x) dG(x) < \infty$ and $G(\{0\}) < 1 - p_c(d)$. Let $k_1, \dots, k_{d-1} \in \mathbb{N}$ and h with $\log h \leq k_1 \cdots k_{d-1}$. Let $A = \prod_{i=1}^{d-1} [0, k_i] \times \{0\}$. There exist constants $\beta \geq 1$ depending on G and d , C_1 and C_2 depending on G , d and β such that for all $\lambda > \beta \mathcal{H}^{d-1}(A)$,*

$$\mathbb{P}(\psi_G(A, h, \vec{v}) > \lambda) \leq C_1 \exp(-C_2 \lambda).$$

Roughly speaking, his proof strategy is the following. If $\psi_G(A, h, \vec{v})$ is large, he can slightly modify the configuration to create blocking surfaces, *i.e.*, large surfaces of edges of null capacities. This is very unlikely when $G(\{0\}) < 1 - p_c(d)$ as edges of positive capacities percolate: it is indeed unlikely to obtain two adjacent big clusters of edges of positive capacity that are not connected because of this blocking surface. This proof relies crucially on the hypothesis $G(\{0\}) < 1 - p_c(d)$ and cannot be adapted to the case $G(\{0\}) > 1 - p_c(d)$. Moreover, this proof does not able to prove the existence of the limit of ψ_G properly renormalized when the dimension of the cylinder goes to infinity.

The aim of this article is to understand the behavior of $\psi_G(A, h, \vec{v})$ in the supercritical case, that is $G(\{0\}) > 1 - p_c(d)$ (the critical case $G(\{0\}) = 1 - p_c(d)$ is expected to be much more delicate to study as it is for N_G).

2.4 Main result and idea of the proof

In what follows, if a function $h : \mathbb{N} \rightarrow \mathbb{R}_+$ satisfies $h(n)/\log n \rightarrow \infty$ and $h(n)/n \rightarrow 0$ when n goes to infinity, we say that h satisfies condition (\star) . The main result of this paper is the following.

Theorem 2.12. *Let $d \geq 2$. Let G be a probability measure on $[0, +\infty]$ such that $G(\{0\}) > 1 - p_c(d)$. Let $\vec{v} \in \mathbb{S}^{d-1}$. There exists a finite constant $\zeta_{G(\{0\})}(\vec{v})$ such that for all function h satisfying condition (\star) , for all non-degenerate hyperrectangle A normal to \vec{v} ,*

$$\lim_{n \rightarrow \infty} \frac{\psi_G(nA, h(n), \vec{v})}{\mathcal{H}^{d-1}(nA)} = \zeta_{G(\{0\})}(\vec{v}) \text{ a.s.}$$

The constant $\zeta_{G(\{0\})}(\vec{v})$ depends only the direction \vec{v} , $G(\{0\})$ and d and not on A itself nor h .

To prove Theorem 2.12, we need to introduce an alternative flow in section 3 that is inspired from [64]. There are two issues: we need to study cutsets that may be merged together into a cutset and that have null capacity. Although the cutsets corresponding to the flow τ in adjacent cylinders may be glued together easily, these cutsets do not have null capacity in general: the union of two cutsets of minimal capacity is a cutset but does not have minimal capacity. The flow τ is subadditive but not the minimal cardinality of the minimal corresponding cutsets. The alternative flow we build in section 3 is such that the maximal flow is always null and if we merge two adjacent cutsets for this flow it is still a cutset. The aim is to work only with cutsets of null capacity so when we merge two cutsets together the union has null capacity and is therefore of minimal capacity.

Let χ_G be the minimal cardinality of a minimal cutset for the alternative flow we will define in section 3. First, we show the convergence for the expected value of χ_G , properly renormalized, by using subadditive arguments in section 4. The proof enables us to say that the limit does not depend on h nor on A . Next, we prove that the alternative flow we have defined is actually very similar to the flow through the cylinder. We prove in section 5 that the limit obtained in 4 is equal to the limit of the renormalized expected value of ψ_G . In section 6, we use a concentration inequality on ψ_G to show that this random variable is close to its expectation and thus we prove Theorem 2.12.

2.5 More notations and useful results

For $z = (z_1, \dots, z_d) \in \mathbb{R}^d$, we define the Euclidian distance $\|z\|_2$ of z by

$$\|z\|_2 = \sqrt{\sum_{i=1}^d z_i^2}.$$

For $r > 0$, we define the r -neighborhood $\mathcal{V}(H, r)$ of a subset H of \mathbb{R}^d by

$$\mathcal{V}(H, r) = \{x \in \mathbb{R}^d, d(x, H) < r\}$$

where

$$d(x, H) = \inf \{ \|x - y\|_2, y \in H \}.$$

For any vertex set $\mathcal{C} \subset \mathbb{Z}^d$, we define its diameter $\text{Diam}(\mathcal{C})$ by

$$\text{Diam}(\mathcal{C}) = \sup \{ \|x - y\|_2 : x, y \in \mathcal{C} \},$$

its cardinality $\text{card}_v(\mathcal{C})$ by the number of vertices in \mathcal{C} , and its exterior edge boundary $\partial_e \mathcal{C}$ by

$$\partial_e \mathcal{C} = \{ \langle x, y \rangle \in \mathbb{E}^d : x \in \mathcal{C}, y \notin \mathcal{C} \text{ and there exists a path from } y \text{ to infinity in } \mathbb{Z}^d \setminus \mathcal{C} \}.$$

The notation $\langle x, y \rangle$ corresponds to the edge of endpoints x and y . We recall that for any edge set $E \subset \mathbb{E}^d$, $\text{card}_e(E)$ denotes the number of edges in E . There exists a constant c_d such that for any finite connected set \mathcal{C} of vertices, $\text{card}_e(\partial_e \mathcal{C}) \leq c_d \text{card}_v(\mathcal{C})$. Note that when there is no ambiguity we will denote by $|E|$ the cardinality of the set E . We define the exterior $\text{ext}(E)$ of a set of edges E :

$$\text{ext}(E) = \{ x \in \mathbb{Z}^d : \text{there exists a path from } x \text{ to infinity in } \mathbb{E}^d \setminus E \}.$$

Let $x \in \mathbb{Z}^d$, we denote by $\mathcal{C}_{G,0}(x)$ the connected component of x in the percolation $(\mathbb{1}_{t_G(e) > 0})_{e \in \mathbb{E}^d}$, which can be seen as an edge set and as a vertex set. The following theorem is a classical result on percolation that enables us to control the probability that an open cluster $\mathcal{C}_{G,0}(x)$ is big in the subcritical regime, *i.e.*, when $\mathbb{P}(t_G(e) > 0) < p_c(d)$ (see for instance Theorem (6.1) and (6,75) in [47]).

Theorem 2.13. *Let us assume $G(\{0\}) > 1 - p_c(d)$. There exist two positive constants κ_1 and κ_2 depending only on $G(\{0\})$ such that for all $x \in \mathbb{Z}^d$, $n \in \mathbb{N}$,*

$$\mathbb{P}(\text{card}_v(\mathcal{C}_{G,0}(x)) > n) \leq \kappa_1 \exp(-\kappa_2 n). \quad (2.1)$$

2.6 Concentration inequality

We introduce here notations and a concentration result that will be useful in section 6. The following concentration result is a generalization of Efron-Stein inequality for higher moments. Let $X = (X_1, \dots, X_n)$ be a vector of independent random variables taking values in a set \mathcal{X} and $f : \mathcal{X}^n \rightarrow \mathbb{R}$ be a measurable function. Let $Z = f(X)$. Let X'_1, \dots, X'_n be independent copies of X_1, \dots, X_n . We introduce the random variable V^- as

$$V^- = \sum_{i=1}^n \mathbb{E}[(Z - Z'_i)_-^2 | X]$$

where $Z'_i = f(X_1, \dots, X'_i, \dots, X_n)$ and for any real number t , $t_+ = \max(0, t)$ and $t_- = \max(0, -t)$. We have the following result by taking $q = 4$ in Theorem 15.5 and Theorem 15.7 (and also by replacing Z by $-Z$ in Theorem 15.7) in [17].

Theorem 2.14. *There exists a positive constant C such that*

$$\mathbb{E}[(Z - \mathbb{E}Z)_-^4] \leq C \mathbb{E}[(V^-)^2].$$

Moreover, suppose that for every $i \in \{1, \dots, n\}$, $(Z - Z'_i)_- \leq M$ for a random variable M . Then, we have

$$\mathbb{E}[(Z - \mathbb{E}Z)_+^4] \leq C \max(\mathbb{E}[(V^-)^2], \mathbb{E}[M^4]).$$

3 Definition of an alternative flow

Instead of directly considering a smallest minimal cutset for the cylinder, we are going to study a different object which is more convenient for our purpose.

Let $\vec{v} \in \mathbb{S}^{d-1}$, and let A be any non-degenerate hyperrectangle normal to \vec{v} . We denote by $\text{hyp}(A)$ the hyperplane spanned by A defined by

$$\text{hyp}(A) = \{ x + \vec{w} : x \in A, \vec{w} \cdot \vec{v} = 0 \}$$

where \cdot denotes the usual scalar product on \mathbb{R}^d . For any $h > 0$, we denote by $\text{slab}(A, h, \vec{v})$ (resp. $\text{slab}(A, \infty, \vec{v})$) the slab of basis the hyperplane spanned by A and of height h (resp. of infinite height), *i.e.*, the subset of \mathbb{R}^d defined by

$$\text{slab}(A, h, \vec{v}) = \{ x + r\vec{v} : x \in \text{hyp}(A), r \in [0, h] \}$$

(resp. $\text{slab}(A, \infty, \vec{v}) = \{ x + r\vec{v} : x \in \text{hyp}(A), r \geq 0 \}$). We are going to consider a thicker version of A , namely $\text{cyl}(A, d)$, that we will denote by \bar{A} for short. Let $W(A, h, \vec{v})$ be the following set of vertices in \mathbb{Z}^d , which is a discretized version of $\text{hyp}(A + h\vec{v})$:

$$W(A, h, \vec{v}) := \left\{ \begin{array}{l} x \in \mathbb{Z}^d \cap \text{slab}(A, h, \vec{v}) : \\ \exists y \in \mathbb{Z}^d \cap (\text{slab}(A, \infty, \vec{v}) \setminus \text{slab}(A, h, \vec{v})), \langle x, y \rangle \in \mathbb{E}^d \end{array} \right\}.$$

We say that a path $\gamma = (x_0, e_1, x_1, \dots, e_n, x_n)$ goes from \bar{A} to $\text{hyp}(A + h\vec{v})$ in $\text{slab}(A, h, \vec{v})$ if :

- $\forall i \in \{0, \dots, n\}, x_i \in \text{slab}(A, h, \vec{v})$
- $x_0 \in \bar{A}$
- $x_n \in W(A, h, \vec{v})$.

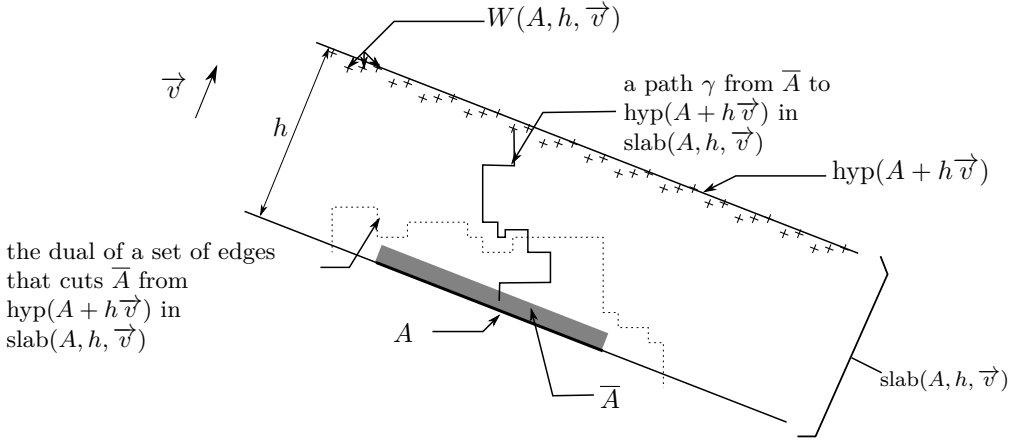

Figure 8.1 – Dual of a set of edges that cuts \bar{A} from $\text{hyp}(A + h\vec{v})$ in $\text{slab}(A, h, \vec{v})$.

We say that a set of edges E cuts \bar{A} from $\text{hyp}(A + h\vec{v})$ in $\text{slab}(A, h, \vec{v})$ if E contains at least one edge of any path γ that goes from \bar{A} to $\text{hyp}(A + h\vec{v})$ in $\text{slab}(A, h, \vec{v})$, see Figure 8.1.

If all the clusters $\mathcal{C}_{G,0}(x)$ for $x \in \bar{A}$ have a diameter less than $h/2$, then there exists a set of edges that cuts \bar{A} from $\text{hyp}(A + h\vec{v})$ in $\text{slab}(A, h, \vec{v})$ of null capacity (take for instance the intersection of the set $\bigcup_{x \in \bar{A} \cap \mathbb{Z}^d} \partial_e \mathcal{C}_{G,0}(x)$ with $\text{slab}(A, h, \vec{v})$). Working with cutsets of null capacity is interesting because the union of two cutsets of null capacity is of null capacity and therefore achieves the minimal capacity among all cutsets. This is not the case if one of them has positive capacity. Thus instead of considering a deterministic h , we are going to consider a random height $H_{G,h}(A)$ as

$$H_{G,h}(A) = \inf \left\{ t \geq h : \left(\bigcup_{x \in \text{cyl}(A, h/2) \cap \mathbb{Z}^d} \mathcal{C}_{G,0}(x) \right) \cap W(A, t, \vec{v}) = \emptyset \right\}.$$

The definition of $H_{G,h}(A)$ ensures the existence of a null cutset between \bar{A} and $\text{hyp}(A + H_{G,h}(A)\vec{v})$ for $h \geq 2d$.

Lemma 3.1. *Let G be a distribution on $[0, +\infty]$ such that $G(\{0\}) > 1 - p_c(d)$. Let $\vec{v} \in \mathbb{S}^{d-1}$. Let A be a non-degenerate hyperrectangle normal to \vec{v} and $h > 2d$ a positive real number. The set*

$$E = \bigcup_{x \in \bar{A} \cap \mathbb{Z}^d} \partial_e \mathcal{C}_{G,0}(x)$$

cuts \bar{A} from $\text{hyp}(A + H_{G,h}(A)\vec{v})$ in $\text{slab}(A, H_{G,h}(A), \vec{v})$ and has null capacity.

Proof. Let $\vec{v} \in \mathbb{S}^{d-1}$, let A be a non-degenerate hyperrectangle and $h > 2d$. Let γ be a path from $x \in \bar{A}$ to $y \in W(A, H_{G,h}(A), \vec{v})$ in $\text{slab}(A, H_{G,h}(A), \vec{v})$. By definition of $H_{G,h}(A)$, we have $W(A, H_{G,h}(A), \vec{v}) \cap (\cup_{z \in \bar{A}} \mathcal{C}_{G,0}(z)) = \emptyset$, thus $y \in \text{ext}(\partial_e \mathcal{C}_{G,0}(x))$ and γ must contain an edge in $\partial_e \mathcal{C}_{G,0}(x)$. We conclude that E is indeed a cutset between \bar{A} and $\text{hyp}(A + H_{G,h}(A)\vec{v})$ in $\text{slab}(A, H_{G,h}(A), \vec{v})$. As all edges in the exterior edge boundary of a $\mathcal{C}_{G,0}(x)$ have null capacity, the set E is a cutset of null capacity. \square

Remark 3.2. *This definition of $H_{G,h}(A)$ may seem complicated, but the idea behind is simple. The aim was initially to build a random height $H_{G,h}(A)$ in such a way the minimal cutset between A and $\text{hyp}(A + H_{G,h}(A)\vec{v})$ has null capacity. This idea finds its inspiration from the construction of the subadditive object in section 4 in [64]. However, because of technical issues that appear in the section 4, we could not choose $H_{G,h}(A)$ as the smallest height such that there exists a cutset of null capacity between A and $\text{hyp}(A + H_{G,h}(A)\vec{v})$. The definition of $H_{G,h}(A)$ needs to also depend on the finite clusters $\mathcal{C}_{G,0}(z)$ of $z \in \text{cyl}(A, h/2)$.*

For the rest of this section, we will work with cutsets of null capacity and we do not need to check if cutsets have minimal capacity. Among all the cutsets that achieve the minimal capacity, we are interested in the ones with the smallest size. We denote by $\chi_G(A, h, \vec{v})$ the following quantity :

$$\chi_G(A, h, \vec{v}) = \inf \left\{ \text{card}_e(E) : \begin{array}{l} E \text{ cuts } \bar{A} \text{ from } \text{hyp}(A + H_{G,h}(A)\vec{v}) \\ \text{in } \text{slab}(A, H_{G,h}(A), \vec{v}) \text{ and } T_G(E) = 0 \end{array} \right\}. \quad (3.1)$$

Remark 3.3. *Because of another technical difficulty that appears in section 4 we choose to make appear \bar{A} instead of A in the definition of $\chi_G(A, h, \vec{v})$. We need the cutset not to be too close from A in the proof of Proposition 4.1, taking \bar{A} instead of A prevents this situation from happening.*

As a corollary of Lemma 3.1, we know that $\chi_G(A, h, \vec{v})$ is finite. Let $E = \bigcup_{x \in \bar{A} \cap \mathbb{Z}^d} \partial_e \mathcal{C}_{G,0}(x)$. We have the following control

$$\chi_G(A, h, \vec{v}) \leq \text{card}_e(E) \leq \sum_{x \in \bar{A} \cap \mathbb{Z}^d} \text{card}_e(\partial_e \mathcal{C}_{G,0}(x)) \leq \sum_{x \in \bar{A} \cap \mathbb{Z}^d} c_d \text{card}_v(\mathcal{C}_{G,0}(x)). \quad (3.2)$$

Thanks to Theorem 2.13, as $G(\{0\}) > 1 - p_c(d)$, almost surely for all $x \in \mathbb{Z}^d$, the cluster $\mathcal{C}_{G,0}(x)$ is finite thus $\chi_G(A, h, \vec{v}) \leq \sum_{x \in \bar{A} \cap \mathbb{Z}^d} c_d \text{card}_v(\mathcal{C}_{G,0}(x)) < +\infty$ a.s..

We expect $\chi_G(A, h, \vec{v})$ to grow at order $\mathcal{H}^{d-1}(A)$ when the side lengths of A go to infinity. We aim first to prove that $\lim_{n \rightarrow \infty} \mathbb{E}(\chi_G(nA, h(n), \vec{v})) / \mathcal{H}^{d-1}(nA)$ exists, is finite and does not depend on A nor on h but only on \vec{v} and $G(\{0\})$.

4 Subadditive argument

In this section, we prove the convergence of $\mathbb{E}(\chi_G(nA, h(n), \vec{v})) / \mathcal{H}^{d-1}(nA)$, see Proposition 4.1 below. This proof relies on subadditive arguments. However, we do not use a subadditive ergodic theorem for two reasons: we want to study this convergence for all directions (included irrational ones) and all hyperrectangles, and we aim to show that the limit does not depend on the hyperrectangle A nor on the height function h .

Proposition 4.1. *Let G be a distribution on $[0, +\infty]$ such that $G(\{0\}) > 1 - p_c(d)$. For every function h satisfying condition (\star) , for every $\vec{v} \in \mathbb{S}^{d-1}$, for every non-degenerate hyperrectangle A normal to \vec{v} , the limit*

$$\zeta_{G(\{0\})}(\vec{v}) := \lim_{n \rightarrow \infty} \frac{\mathbb{E}(\chi_G(nA, h(n), \vec{v}))}{\mathcal{H}^{d-1}(nA)}$$

exists and is finite. It depends only the direction \vec{v} , on $G(\{0\})$ and on d but not on A itself nor h .

The proof of this proposition is inspired by the proof of Proposition 3.5. in [62]. This idea was already present in [19]. In fact we mimic the beginning (*i.e.*, the easy part) of the proof of the subadditive ergodic theorem.

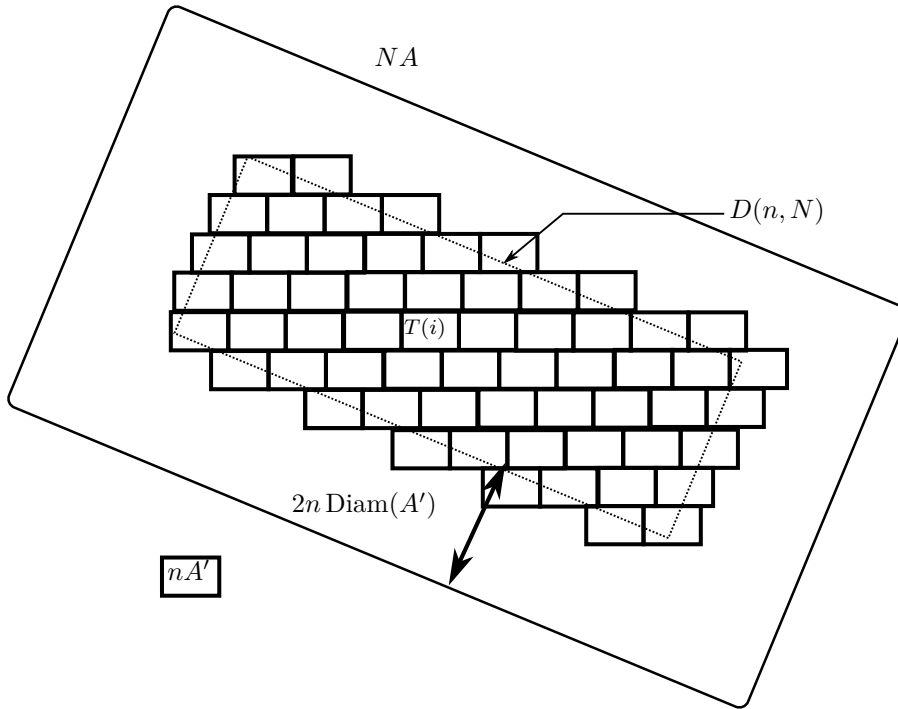

Figure 8.2 – Decomposition of NA in translates of nA'

Proof. Let $\vec{v} \in \mathbb{S}^{d-1}$. Let us consider two non-degenerate hyperrectangles A and A' which are both orthogonal to the unit vector \vec{v} , and two height functions $h, h' : \mathbb{N} \rightarrow \mathbb{R}^+$ that respect condition (\star) . As $\lim_{n \rightarrow \infty} h(n) = \lim_{n \rightarrow \infty} h'(n) = \infty$, if we take $n \in \mathbb{N}$, there exists an $N_0(n)$ such that for all $N \geq N_0(n)$, we have $h(N) \geq h'(n) + 2d + 1$ and $N \text{Diam}(A) > n \text{Diam}(A')$. Our goal is to cover the biggest hyperrectangle NA by translates of nA' . We do not want to cover the whole hyperrectangle NA but at least the following subset of NA :

$$D(n, N) := \{ x \in NA \mid d(x, \partial(NA)) > 2n \text{Diam } A' \},$$

where $\partial(NA)$ denotes the relative boundary of NA .

There exists a finite collection of hyperrectangles $(T(i))_{i \in I}$ such that $T(i)$ is a translate of nA' , each $T(i)$ intersects $D(n, N)$, the collection $(T(i))_{i \in I}$ have pairwise disjoint interiors, and their union $\cup_{i \in I} T(i)$ contains the set $D(n, N)$ (see Figure 8.2). By definition of $D(n, N)$, we also have that the union $\cup_{i \in I} T(i)$ is contained in NA .

The quantities $\mathbb{E}(\chi_G(T(i), h'(n), \vec{v}))$ and $\mathbb{E}(\chi_G(nA', h'(n), \vec{v}))$ are not necessarily equal. Indeed, $T(i)$ is the translate of nA' by a non-integer vector in general. Thus, instead of considering $T(i)$, let us consider $T'(i)$ which is the image of nA' by an integer translation, and $T'(i)$ is the

translated of $T(i)$ by a small vector. We want to choose $T'(i)$ such that $T'(i) \subset \text{slab}(NA, h, \vec{v})$. More precisely, for all $i \in I$, there exist two vectors $\vec{t}_i \in \mathbb{R}^d$ and $\vec{t}'_i \in \mathbb{Z}^d$ such that

$$\|\vec{t}_i\|_\infty < 1, \quad \vec{t}_i \cdot \vec{v} \geq 0, \quad T'(i) = T(i) + \vec{t}_i \quad \text{and} \quad T'(i) = nA' + \vec{t}'_i.$$

As for all $i \in I$, $\vec{t}_i \cdot \vec{v} < \sqrt{d}$, the union $\cup_{i \in I} T'(i)$ is contained in $\text{slab}(NA, d, \vec{v})$ (see Figure 8.3). Since for all $i \in I$, $T'(i) \in \text{slab}(NA, d, \vec{v})$ and $h'(n) + 2d < h(N)$, then we have

$$\text{cyl}(T'(i), h'(n)/2) \subset \text{cyl}(NA, h(N)/2),$$

and by definition of the random height

$$\text{slab}(T'(i), H_{G, h'(n)}(T'(i)), \vec{v}) \subset \text{slab}(NA, H_{G, h(N)}(NA), \vec{v}).$$

The family $(\chi_G(T'(i), h'(n), \vec{v}))_{i \in I}$ is identically distributed but not independent. For all $i \in I$, let E_i be a set that satisfies the infimum in the definition of $\chi_G(T'(i), h'(n), \vec{v})$. We want to build from the family $(E_i)_{i \in I}$ a set of null capacity that cuts \overline{NA} from $\text{hyp}(NA + H_{G, h(N)}(NA))$ in $\text{slab}(NA, H_{G, h(N)}(NA), \vec{v})$ on the event

$$\mathcal{F}_{n, N} = \bigcap_{x \in \text{cyl}(NA, h(n)/2+d)} \left\{ \text{card}_v(\mathcal{C}_{G, 0}(x)) < \frac{h(N)}{4} \right\}. \quad (4.1)$$

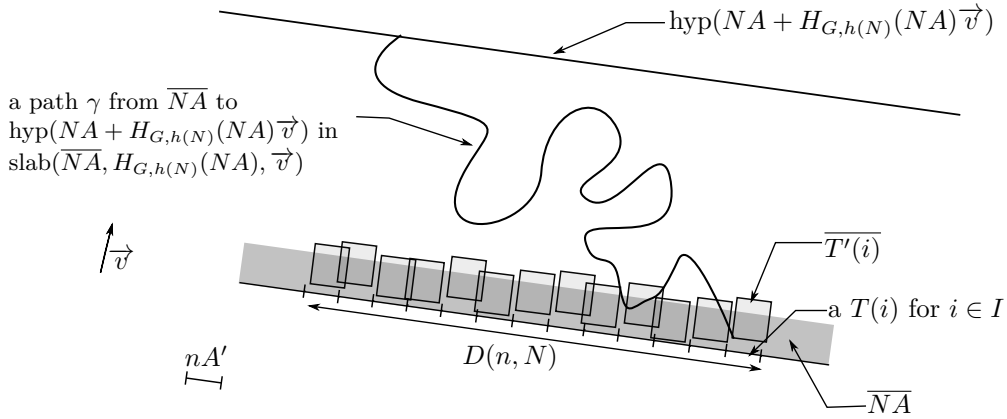

Figure 8.3 – Representation of the $T'(i)$ for $i \in I$.

We fix $r = 4d$. Let V_0^1 (respectively V_0^2, V_0^3, V_0) be the set of vertices included in \mathcal{E}_0^1 (resp. $\mathcal{E}_0^2, \mathcal{E}_0^3, \mathcal{E}_0$), where we define

$$\mathcal{E}_0^1 = \bigcup_{i \in I} \mathcal{V}(\partial T'(i), r), \quad \mathcal{E}_0^2 = \mathcal{V}(NA \setminus D(n, N), r),$$

$$\mathcal{E}_0^3 = \mathcal{V}(\text{cyl}(\partial(NA), h(N)/2), r) \quad \text{and} \quad \mathcal{E}_0 = \mathcal{E}_0^1 \cup \mathcal{E}_0^2 \cup \mathcal{E}_0^3.$$

The set

$$E = \bigcup_{i \in I} E_i \cup \bigcup_{x \in V_0} \partial_e \mathcal{C}_{G, 0}(x)$$

cuts \overline{NA} from $\text{hyp}(NA + H_{G, h(N)}(NA), \vec{v})$ in $\text{slab}(NA, H_{G, h(N)}(NA), \vec{v})$ and is of null capacity on the event $\mathcal{F}_{n, N}$. We postpone the proof of this result until the end of the proof of Proposition 4.1, see Lemma 4.2. Thus, we can upperbound the quantity $\chi_G(NA, h(N), \vec{v})$ by the size of E

on the event $\mathcal{F}_{n,N}$ and by the size of $\bigcup_{x \in \overline{NA} \cap \mathbb{Z}^d} \partial_e \mathcal{C}_{G,0}(x)$ on the event $\mathcal{F}_{n,N}^c$ (by Lemma 3.1):

$$\begin{aligned} \chi_G(NA, h(N), \vec{v}) &\leq \chi_G(NA, h(N), \vec{v}) \mathbf{1}_{\mathcal{F}_{n,N}} + \chi_G(NA, h(N), \vec{v}) \mathbf{1}_{\mathcal{F}_{n,N}^c} \\ &\leq \sum_{i \in I} |E_i| + \sum_{x \in V_0} |\partial_e \mathcal{C}_{G,0}(x)| + \left(\sum_{x \in \overline{NA} \cap \mathbb{Z}^d} |\partial_e \mathcal{C}_{G,0}(x)| \right) \mathbf{1}_{\mathcal{F}_{n,N}^c} \\ &\leq \sum_{i \in I} \chi_G(T'(i), h'(n), \vec{v}) + \sum_{x \in V_0} |\partial_e \mathcal{C}_{G,0}(x)| + \left(\sum_{x \in \overline{NA} \cap \mathbb{Z}^d} |\partial_e \mathcal{C}_{G,0}(x)| \right) \mathbf{1}_{\mathcal{F}_{n,N}^c}. \end{aligned}$$

Taking the expectation we get

$$\begin{aligned} &\frac{\mathbb{E}(\chi_G(NA, h(N), \vec{v}))}{\mathcal{H}^{d-1}(NA)} \\ &\leq \sum_{i \in I} \frac{\mathbb{E}(\chi_G(T'(i), h'(n), \vec{v}))}{\mathcal{H}^{d-1}(NA)} + \sum_{x \in V_0} \frac{\mathbb{E}(|\partial_e \mathcal{C}_{G,0}(x)|)}{\mathcal{H}^{d-1}(NA)} + \sum_{x \in \overline{NA} \cap \mathbb{Z}^d} \frac{\mathbb{E}(|\partial_e \mathcal{C}_{G,0}(x)| \mathbf{1}_{\mathcal{F}_{n,N}^c})}{\mathcal{H}^{d-1}(NA)} \\ &\leq |I| \frac{\mathbb{E}(\chi_G(nA', h'(n), \vec{v}))}{\mathcal{H}^{d-1}(NA)} + \frac{\text{card}_v(V_0)}{\mathcal{H}^{d-1}(NA)} \mathbb{E}(|\partial_e \mathcal{C}_{G,0}(0)|) + \sum_{x \in \overline{NA} \cap \mathbb{Z}^d} \frac{\sqrt{\mathbb{E}(|\partial_e \mathcal{C}_{G,0}(x)|^2) \mathbb{P}(\mathcal{F}_{n,N}^c)}}{\mathcal{H}^{d-1}(NA)} \\ &\leq \frac{\mathbb{E}(\chi_G(nA', h'(n), \vec{v}))}{\mathcal{H}^{d-1}(nA')} + \frac{\text{card}_v(V_0)}{\mathcal{H}^{d-1}(NA)} \mathbb{E}(|\partial_e \mathcal{C}_{G,0}(0)|) + \text{card}(\overline{NA} \cap \mathbb{Z}^d) \frac{\sqrt{\mathbb{E}(|\partial_e \mathcal{C}_{G,0}(0)|^2) \mathbb{P}(\mathcal{F}_{n,N}^c)}}{\mathcal{H}^{d-1}(NA)} \end{aligned} \quad (4.2)$$

where we use in the second inequality Cauchy-Schwartz' inequality. By definition of $\mathcal{F}_{n,N}$ (see (4.1)) and using Theorem 2.13, we obtain the following upperbound:

$$\begin{aligned} \mathbb{P}(\mathcal{F}_{n,N}^c) &\leq \sum_{x \in \text{cyl}(NA, h(n)/2 + d) \cap \mathbb{Z}^d} \mathbb{P}(\text{card}_v(\mathcal{C}_{G,0}(x)) \geq h(N)/4) \\ &\leq \text{card}_v(\text{cyl}(NA, h(n)/2 + d) \cap \mathbb{Z}^d) \mathbb{P}(\text{card}_v(\mathcal{C}_{G,0}(0)) \geq h(N)/4) \\ &\leq c'_d \mathcal{H}^{d-1}(NA) h(n) \kappa_1 \exp(-\kappa_2 h(N)/4) \end{aligned}$$

where c'_d is a constant depending only on the dimension d . We recall that as $G(\{0\}) > 1 - p_c(d)$, by Theorem 2.13, we have $\mathbb{E}(|\partial_e \mathcal{C}_{G,0}(0)|) < \infty$ and $\mathbb{E}(|\partial_e \mathcal{C}_{G,0}(0)|^2) < \infty$. Moreover, as $h(N)/\log(N)$ goes to infinity when N goes to infinity, the third term in the right hand side of (4.2) goes to 0 when N goes to infinity. We now want to control the size of V_0 . There exists a constant c_d depending only on the dimension d such that:

$$\begin{aligned} \text{card}_v(V_0^1) &\leq c_d \frac{\mathcal{H}^{d-1}(NA)}{\mathcal{H}^{d-1}(nA')} \mathcal{H}^{d-2}(\partial(nA')), \\ \text{card}_v(V_0^2) &\leq c_d \mathcal{H}^{d-2}(\partial(NA)) \text{Diam}(nA') \end{aligned}$$

and

$$\text{card}_v(V_0^3) \leq c_d \mathcal{H}^{d-2}(\partial(NA)) h(N).$$

Thus,

$$\text{card}_v(V_0) \leq c_d \left(\frac{\mathcal{H}^{d-1}(NA)}{\mathcal{H}^{d-1}(nA')} \mathcal{H}^{d-2}(\partial(nA')) + \mathcal{H}^{d-2}(\partial(NA)) (\text{Diam}(nA') + h(N)) \right)$$

and finally since $h(N)/N$ goes to 0 as N goes to infinity we obtain

$$\lim_{n \rightarrow \infty} \lim_{N \rightarrow \infty} \frac{\text{card}_v(V_0)}{\mathcal{H}^{d-1}(NA)} = 0.$$

By first sending N to infinity and then n to infinity in inequality (4.2), we get that

$$\limsup_{N \rightarrow \infty} \frac{\mathbb{E}(\chi_G(NA, h(N), \vec{v}))}{\mathcal{H}^{d-1}(NA)} \leq \liminf_{n \rightarrow \infty} \frac{\mathbb{E}(\chi_G(nA', h'(n), \vec{v}))}{\mathcal{H}^{d-1}(nA')}.$$

By setting $A = A'$ and $h = h'$, we deduce the existence of the following limit

$$\lim_{n \rightarrow \infty} \frac{\mathbb{E}(\chi_G(nA, h(n), \vec{v}))}{\mathcal{H}^{d-1}(nA)}$$

and the inequality

$$\lim_{n \rightarrow \infty} \frac{\mathbb{E}(\chi_G(nA, h(n), \vec{v}))}{\mathcal{H}^{d-1}(nA)} \leq \lim_{n \rightarrow \infty} \frac{\mathbb{E}(\chi_G(nA', h'(n), \vec{v}))}{\mathcal{H}^{d-1}(nA')}.$$

Exchanging the role of A, h and A', h' , we conclude that the two limits are equal. Note that χ_G does not depend on all the distribution G but only on $G(\{0\})$. Indeed, let us couple $(t_G(e))_{e \in \mathbb{E}^d}$ with a family $(\hat{t}(e))_{e \in \mathbb{E}^d}$ of Bernoulli of parameter $1 - G(\{0\})$ in the following way: for an edge $e \in \mathbb{E}^d$, $\hat{t}(e) = \mathbb{1}_{t_G(e) > 0}$. With this coupling, the value of χ_G is the same for the two families of capacities. Therefore, the limit does not depend on A nor h but only on the direction \vec{v} , on $G(\{0\})$ and on d , we denote it by $\zeta_{G(\{0\})}(\vec{v})$. Moreover, thanks to inequality (3.2), we know that there exists a constant c'_d depending only on the dimension d such that

$$\frac{\mathbb{E}(\chi_G(nA, h(n), \vec{v}))}{\mathcal{H}^{d-1}(nA)} \leq c'_d \mathbb{E}(\text{card}_v(\mathcal{C}_{G,0}(0))) < \infty,$$

thus $\zeta_{G(\{0\})}(\vec{v})$ is finite. \square

To complete the proof of Proposition 4.1, it remains to prove that the set E is a cutset on the event $\mathcal{F}_{n,N}$. We do not recall the notations that were introduced in the proof of Proposition 4.1.

Lemma 4.2. *The set $E = (\cup_{i \in I} E_i) \cup (\cup_{x \in V_0} \partial_e \mathcal{C}_{G,0}(x))$ is a cutset of null capacity that cuts \overline{NA} from $\text{hyp}(NA + H_{G,h(N)}(NA), \vec{v})$ in $\text{slab}(NA, H_{G,h(N)}(NA), \vec{v})$ on the event $\mathcal{F}_{n,N}$.*

Proof. Let γ be a path from $x \in \overline{NA}$ to $y \in W(NA, H_{G,h(N)}(NA), \vec{v})$ in $\text{slab}(NA, H_{G,h(N)}(NA), \vec{v})$, we denote it by $\gamma = (v_0, e_1, v_1, \dots, e_m, v_m)$ where $v_0 = x$ and $v_m = y$. Let us consider p the last moment when γ exits \overline{NA} , i.e.,

$$p = \inf \left\{ i \in \{0, \dots, m\} : \forall j > i, v_j \notin \overline{NA} \right\}.$$

We distinguish several cases.

Case (i): If the edge e_{p+1} cuts $\text{cyl}(\partial(NA), d) \cup (NA \setminus D(n, N) + d\vec{v})$, then $v_p \in V_0^2$. Besides, we have $v_p \in \text{cyl}(NA, h(N)/2)$ and by definition of $H_{G,h(N)}(NA)$, the point y is not contained in $\mathcal{C}_{G,0}(v_p)$. Therefore, we have $\gamma \cap \partial_e \mathcal{C}_{G,0}(v_p) \neq \emptyset$ and so as $v_p \in V_0$, we get that $\gamma \cap E \neq \emptyset$.

Case (ii): We consider now the case where the edge e_{p+1} cuts $(D(n, N) + d\vec{v}) \setminus (\cup_{i \in I} \overline{T'(i)})$, we define π the orthogonal projection on $\text{hyp}(NA)$ and $z = e_{p+1} \cap \text{hyp}(NA + d\vec{v})$. As $\pi(z) \in D(n, N)$, there exists an $i \in I$ such that $\pi(z) \in T(i)$, $\pi(z) \notin \pi(T'(i))$ and so $\pi(z) \in T(i) \setminus \pi(T'(i))$. Moreover, as $T'(i) = T(i) + \vec{t}_i$ where $\|\vec{t}_i\|_\infty < 1$, we get that $\pi(z) \in \mathcal{V}(\pi(\partial T'(i)), d) \cap \text{hyp}(NA)$ and $v_p \in \mathcal{V}(\partial T'(i), r) \subset \mathcal{E}_0^1$. Therefore, we have $v_p \in V_0$ and we can conclude as in the previous case that $\gamma \cap E \neq \emptyset$.

Case (iii): We consider the case where there exists an $i \in I$ such that $v_p \notin \overline{T'(i)}$ and the edge e_{p+1} cuts $\overline{T'(i)} \cap \text{hyp}(NA + d\vec{v})$. Therefore the vertex v_p is close to the boundary of $\overline{T'(i)}$. Actually, the vertex v_p is close to the lateral boundary $\text{cyl}(\partial T'(i), d)$ of $\overline{T'(i)}$. Indeed, as $T'(i) \subset \text{slab}(NA, \sqrt{d}, \vec{v})$, the vertex v_p cannot be "under" $T'(i)$, i.e., in $\text{slab}(NA, \vec{t}_i \cdot \vec{v}, \vec{v})$. Therefore, the vertex v_p belongs to $\mathcal{V}(\partial T'(i), d) \subset \mathcal{E}_0^1$, we conclude as in the previous cases that

$\gamma \cap E \neq \emptyset$.

Case (iv): Finally, we consider the case where there exists an $i \in I$ such that the edge e_{p+1} cuts $\overline{T'(i)} \cap \text{hyp}(NA + d\vec{v})$ and $v_p \in \overline{T'(i)}$ (see Figure 8.4). Let us consider the first time after p when γ cuts $\text{hyp}(T'(i) + H_{G,h'(n)}(T'(i))\vec{v}) \cup \text{cyl}(\partial(NA), h(N)/2)$. On the event $\mathcal{F}_{n,N}$, we have the three following events:

$$\begin{aligned} \text{slab}(T'(i), H_{G,h'(n)}(T'(i)), \vec{v}) &\subset \text{slab}(NA, h(N)/2, \vec{v}), \\ v_{p+1} &\in \text{slab}(T'(i), H_{G,h'(n)}(T'(i)), \vec{v}) \cap \text{cyl}(NA, h(N)/2), \\ y &\notin \text{slab}(T'(i), H_{G,h'(n)}(T'(i)), \vec{v}) \cap \text{cyl}(NA, h(N)/2). \end{aligned}$$

Moreover, by definition of v_p , the path γ cannot exit $\text{slab}(T'(i), H_{G,h'(n)}(T'(i)), \vec{v})$ by $\text{hyp}(T'(i))$, otherwise, γ would come back in \overline{NA} . Therefore, the index

$$l = \inf \{ j > p : e_j \text{ cuts } \text{hyp}(T'(i) + H_{G,h'(n)}(T'(i))\vec{v}) \cup \text{cyl}(\partial(NA), h(N)/2) \}$$

is well defined. If the edge e_l cuts $\text{cyl}(\partial(NA), h(N)/2)$, then $v_{l-1} \in V_0^3$ and by definition of $H_{G,h(N)}(NA)$, we get $y \notin \mathcal{C}_{G,0}(v_{l-1})$ and it follows that

$$\gamma \cap \partial_e \mathcal{C}_{G,0}(v_{l-1}) \neq \emptyset.$$

Otherwise, the edge e_l cuts $\text{hyp}(T'(i) + H_{G,h'(n)}(T'(i))\vec{v})$ and $v_{l-1} \in W(T'(i), H_{G,h'(n)}(T'(i)), \vec{v})$. Therefore, the portion of γ from v_p to v_{l-1} is a path from $\overline{T'(i)}$ to $\text{hyp}(T'(i) + H_{G,h'(n)}(T'(i))\vec{v})$ that stays in $\text{slab}(T'(i), H_{G,h'(n)}(T'(i)), \vec{v})$ (by definition of v_{l-1}). Thus by definition of E_i , we have $\gamma \cap E_i \neq \emptyset$.

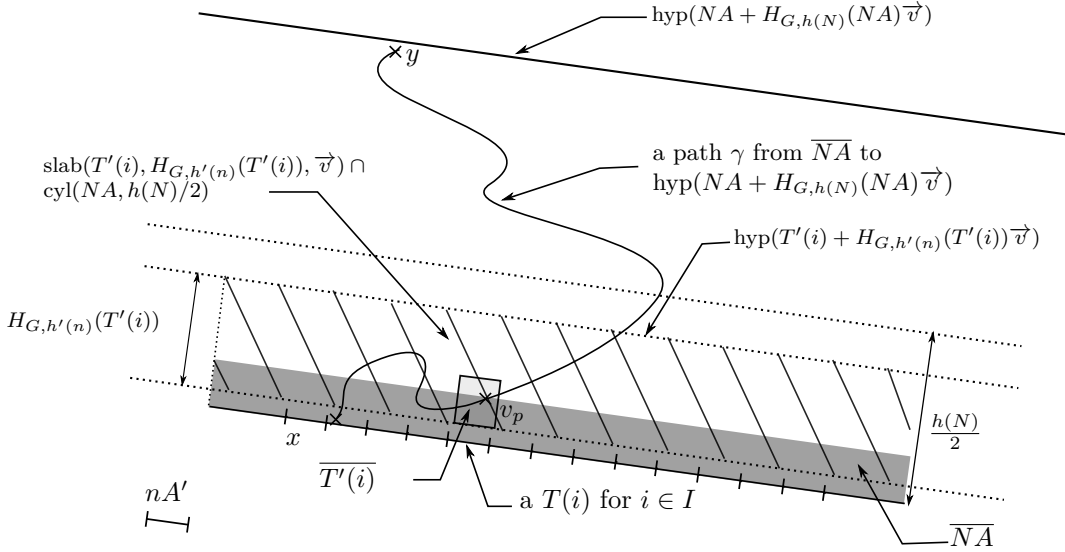

Figure 8.4 – A path from \overline{NA} to $\text{hyp}(NA + H_{G,h(N)}(NA)\vec{v})$ in $\text{slab}(NA, H_{G,h(N)}(NA), \vec{v})$ such that $v_p \in \overline{T'(i)}$ for an $i \in I$.

Therefore, we conclude that, on the event $\mathcal{F}_{n,N}$, the set E cuts \overline{NA} from $\text{hyp}(NA + H_{G,h(N)}(NA))$ in $\text{slab}(NA, H_{G,h(N)}(NA), \vec{v})$. Since for all $i \in I$, the set E_i has null capacity and for any $x \in \mathbb{Z}^d$, the set $\partial_e \mathcal{C}_{G,0}(x)$ contains only edges with null capacity, the set E itself has null capacity. \square

5 From slabs to cylinders

We recall that the quantity of interest is the flow through the cylinder, and that we have studied the flow from a thick rectangle to an hyperplane for technical reasons. In this section we

are going to show that these flows are quite similar, more precisely we want to show the following proposition.

Proposition 5.1. *Let G be a distribution on $[0, +\infty]$ such that $G(\{0\}) > 1 - p_c(d)$. For any $\vec{v} \in \mathbb{S}^{d-1}$, for any non-degenerate hyperrectangle A normal to \vec{v} , for any height function h that satisfies condition (\star) ,*

$$\lim_{n \rightarrow \infty} \frac{\mathbb{E}(\chi_G(nA, h(n), \vec{v}))}{\mathcal{H}^{d-1}(nA)} = \lim_{n \rightarrow \infty} \frac{\mathbb{E}(\psi_G(nA, h(n), \vec{v}))}{\mathcal{H}^{d-1}(nA)} = \zeta_{G(\{0\})}(\vec{v}).$$

Proof. Let A be a non-degenerate hyperrectangle and h a height function satisfying condition (\star) . Let \vec{v} be one of the two unit vectors normal to A . We prove Proposition 5.1 in two steps. In the first step, we obtain an upper bound for $\mathbb{E}(\chi_G(nA, h(n), \vec{v}))$ by building a cutset of null capacity between the top and the bottom of $\text{cyl}(nA, h(n))$ from a cutset in $\text{slab}(nA, h(n), \vec{v})$ that achieves the infimum in $\psi_G(nA, h(n), \vec{v})$. In the second step, we obtain a lower bound for $\mathbb{E}(\chi_G(nA, h(n), \vec{v}))$ by doing the reverse, *i.e.*, we build a cutset between a translate of nA and $\text{hyp}(nA + h(n)\vec{v})$, from a cutset in $\text{cyl}(nA, h(n))$ that achieves the infimum in the definition of $\chi_G(nA, h(n), \vec{v})$.

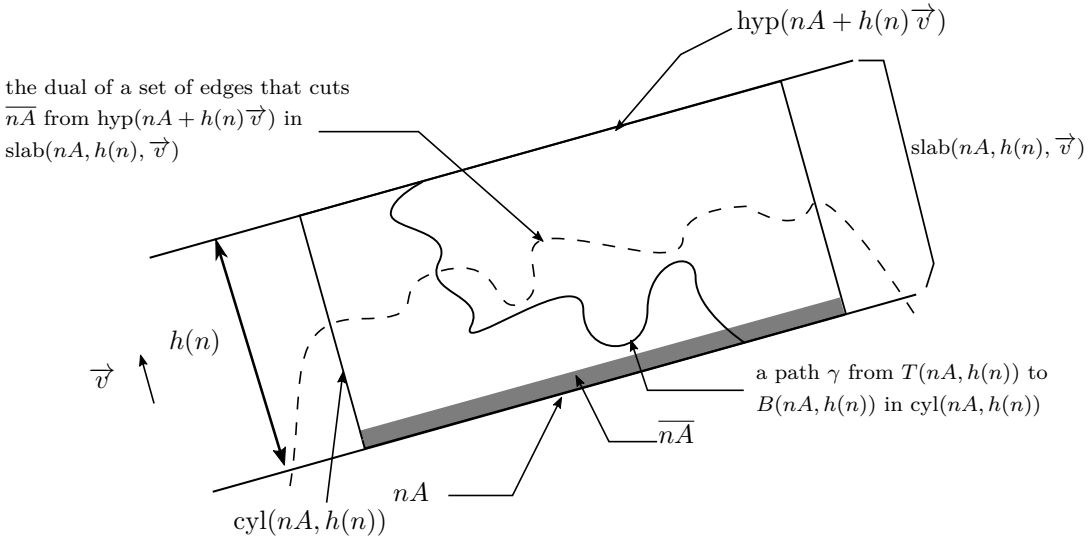

Figure 8.5 – A cutset that cuts \overline{nA} from $\text{hyp}(nA + h(n)\vec{v})$ in $\text{slab}(nA, h(n), \vec{v})$ and the top from the bottom of the cylinder $\text{cyl}(nA, h(n))$ on the event \mathcal{E}_n .

Step (i): We denote by \mathcal{E}_n the following event

$$\mathcal{E}_n = \bigcap_{x \in \text{cyl}(nA, h(n)/2) \cap \mathbb{Z}^d} \left\{ \text{card}_v(\mathcal{C}_{G,0}(x)) < \frac{h(n)}{2} \right\}.$$

On the event \mathcal{E}_n , we have that $H_{G, h(n)}(nA) = h(n)$. By definition, we have $B(nA, h(n)) \subset \overline{nA} \cap \mathbb{Z}^d$ and $T(nA, h(n)) \subset W(nA, h(n), \vec{v})$. On the event \mathcal{E}_n , as any path from the top to the bottom of $\text{cyl}(nA, h(n))$ is also a path from $\text{hyp}(nA + h(n)\vec{v})$ to \overline{nA} in $\text{slab}(nA, h(n), \vec{v})$, any cutset that cuts $\text{hyp}(nA + h(n)\vec{v})$ from \overline{nA} is also a cutset from the top to the bottom in the cylinder (see Figure 8.5). Finally, any cutset that achieves the infimum in $\chi_G(nA, h(n), \vec{v})$ is a cutset of null capacity (and therefore of minimal capacity) for the flow from the top to the bottom in cylinder $\text{cyl}(nA, h(n))$. Thus, on the event \mathcal{E}_n ,

$$\psi_G(nA, h(n), \vec{v}) \leq \chi_G(nA, h(n), \vec{v}).$$

Finally, for a constant C_d depending only on the dimension d .

$$\begin{aligned} \frac{\mathbb{E}(\psi_G(nA, h(n), \vec{v}))}{\mathcal{H}^{d-1}(nA)} &\leq \frac{\mathbb{E}(\psi_G(nA, h(n), \vec{v})\mathbb{1}_{\mathcal{E}_n})}{\mathcal{H}^{d-1}(nA)} + \frac{\mathbb{E}(\psi_G(nA, h(n), \vec{v})\mathbb{1}_{\mathcal{E}_n^c})}{\mathcal{H}^{d-1}(nA)} \\ &\leq \frac{\mathbb{E}(\chi_G(nA, h(n), \vec{v}))}{\mathcal{H}^{d-1}(nA)} + \frac{\text{card}_e(\text{cyl}(nA, h(n)) \cap \mathbb{E}^d) \cdot \mathbb{P}(\mathcal{E}_n^c)}{\mathcal{H}^{d-1}(nA)} \\ &\leq \frac{\mathbb{E}(\chi_G(nA, h(n), \vec{v}))}{\mathcal{H}^{d-1}(nA)} + C_d h(n)^2 \mathcal{H}^{d-1}(nA) \kappa_1 \exp(-\kappa_2 h(n)/2), \end{aligned}$$

where we use in the last inequality Theorem 2.13. As h satisfies condition (\star) the second term of the right hand side goes to 0 when n goes to infinity and we obtain

$$\limsup_{n \rightarrow \infty} \frac{\mathbb{E}(\psi_G(nA, h(n), \vec{v}))}{\mathcal{H}^{d-1}(nA)} \leq \lim_{n \rightarrow \infty} \frac{\mathbb{E}(\chi_G(nA, h(n), \vec{v}))}{\mathcal{H}^{d-1}(nA)} = \zeta_{G(\{0\})}(\vec{v}). \quad (5.1)$$

Step (ii): There exists an hyperrectangle T' , a small vector \vec{t} and an integer vector \vec{u} such that $T' = nA + \vec{u}$, $T' = nA - d\vec{v} + \vec{t}$, $\|\vec{t}\|_\infty < 1$ and $\vec{t} \cdot \vec{v} \leq 0$. Therefore, we have $-d - \sqrt{d} \leq \vec{u} \cdot \vec{v} < -d$ and $\overline{T'} \subset \text{slab}(A, \infty, \vec{v})^c$. We now want to build a set of edges of null capacity that cuts $\overline{T'}$ from $\text{hyp}(T' + H_{G, h(n) - \vec{u} \cdot \vec{v}}(T') \vec{v})$ starting from a cutset between the top and the bottom of the cylinder $\text{cyl}(nA, h(n))$. We define

$$\mathcal{E}'_n = \bigcap_{x \in \mathcal{V}(\text{cyl}(nA, h(n)/2), 2d) \cap \mathbb{Z}^d} \left\{ \text{card}_v(\mathcal{C}_{G,0}(x)) < \frac{h(n)}{2} \right\}.$$

On the event \mathcal{E}'_n , the minimal capacity of a cutset for the flow from the top to the bottom of the cylinder $\text{cyl}(nA, h(n))$ is null (the set of null capacity $\cup_{x \in \overline{nA} \cap \mathbb{Z}^d} \partial_e \mathcal{C}_{G,0}(x)$ is a cutset and as the cylinder $\text{cyl}(T', (h(n) - \vec{u} \cdot \vec{v})/2)$ is included in $\mathcal{V}(\text{cyl}(nA, h(n)/2), 2d)$, we obtain $H_{G, h(n) - \vec{u} \cdot \vec{v}}(T') = h(n) - \vec{u} \cdot \vec{v}$ so that $\text{hyp}(T' + H_{G, h(n) - \vec{u} \cdot \vec{v}}(T') \vec{v}) = \text{hyp}(nA + h(n) \vec{v})$). We denote by E one of the sets that achieve the infimum in $\psi_G(nA, h(n), \vec{v})$. In order to build a set that cuts $\overline{T'}$ from $\text{hyp}(nA + h(n) \vec{v})$ from E , we need to add to E edges to prevent flow from escaping through the vertical sides of $\text{cyl}(nA, h(n))$. Let V be a set that contains a discretized version of the vertical sides of $\text{cyl}(nA, h(n))$. More precisely, we define by $V = \mathcal{V}(\text{cyl}(\partial(nA), h(n)), 2d) \cap \mathbb{Z}^d$. On the event \mathcal{E}'_n , the following set

$$F = E \cup \left(\bigcup_{x \in V} \partial_e \mathcal{C}_{G,0}(x) \right)$$

cuts $\overline{T'}$ from $\text{hyp}(nA + h(n) \vec{v})$ and is of null capacity (see Figure 8.6). We postpone the proof of this fact until the end of the proof of Proposition 5.1, see Lemma 5.2. For a constant C'_d depending on d , we obtain

$$\begin{aligned} &\frac{\mathbb{E}(\chi_G(T', h(n) - \vec{u} \cdot \vec{v}, \vec{v}))}{\mathcal{H}^{d-1}(nA)} \\ &\leq \frac{\mathbb{E}(\chi_G(T', h(n) - \vec{u} \cdot \vec{v}, \vec{v})\mathbb{1}_{\mathcal{E}'_n})}{\mathcal{H}^{d-1}(nA)} + \frac{\mathbb{E}(\chi_G(T', h(n) - \vec{u} \cdot \vec{v}, \vec{v})\mathbb{1}_{\mathcal{E}'_n^c})}{\mathcal{H}^{d-1}(nA)} \\ &\leq \frac{\mathbb{E}(|F|)}{\mathcal{H}^{d-1}(nA)} + \frac{\mathbb{E}(\sum_{x \in \overline{T'} \cap \mathbb{Z}^d} |\partial_e(\mathcal{C}_{G,0}(x))|\mathbb{1}_{\mathcal{E}'_n^c})}{\mathcal{H}^{d-1}(nA)} \\ &\leq \frac{\mathbb{E}(\psi_G(nA, h(n), \vec{v})) + C'_d h(n) \mathcal{H}^{d-2}(\partial(nA)) \mathbb{E}(|\partial_e(\mathcal{C}_{G,0}(0))|)}{\mathcal{H}^{d-1}(nA)} \\ &\quad + \frac{C'_d \mathcal{H}^{d-1}(T') \sqrt{\mathbb{E}(|\partial_e(\mathcal{C}_{G,0}(0))|^2)} C_d h(n) \mathcal{H}^{d-1}(nA) \kappa_1 \exp(-\kappa_2 h(n))}{\mathcal{H}^{d-1}(nA)} \\ &\leq \frac{\mathbb{E}(\psi_G(nA, h(n), \vec{v}))}{\mathcal{H}^{d-1}(nA)} + \frac{C'_d h(n) \mathcal{H}^{d-2}(\partial(nA)) \mathbb{E}(|\partial_e(\mathcal{C}_{G,0}(0))|)}{\mathcal{H}^{d-1}(nA)} \\ &\quad + C''_d \sqrt{\mathcal{H}^{d-1}(nA) \mathbb{E}(|\partial_e(\mathcal{C}_{G,0}(0))|^2)} h(n) \kappa_1 \exp(-\kappa_2 h(n)) \end{aligned} \quad (5.2)$$

where we use in the second inequality the control of $\chi_G(T', h(n) - \vec{u} \cdot \vec{v}, \vec{v})$ obtained in Lemma 3.1 and Cauchy-Schwartz' inequality in the third inequality.

As $\mathcal{H}^{d-1}(nA)$ is of order n^{d-1} , $\mathcal{H}^{d-2}(\partial(nA))$ is of order n^{d-2} and h satisfies condition (\star) , the second and the third terms of the right hand side of the inequality (5.2) go to 0 as n goes to infinity. Moreover, thanks to Proposition 4.1, using the invariance of the model by the translation by an integer vector and the fact that the limit $\zeta_{G(\{0\})}(\vec{v})$ does not depend on the height function,

$$\begin{aligned} \lim_{n \rightarrow \infty} \frac{\mathbb{E}(\chi_G(T', h(n) - \vec{u} \cdot \vec{v}, \vec{v}))}{\mathcal{H}^{d-1}(T')} &= \lim_{n \rightarrow \infty} \frac{\mathbb{E}(\chi_G(nA, h(n) - \vec{u} \cdot \vec{v}, \vec{v}))}{\mathcal{H}^{d-1}(T')} \\ &= \lim_{n \rightarrow \infty} \frac{\mathbb{E}(\chi_G(nA, h(n), \vec{v}))}{\mathcal{H}^{d-1}(nA)} = \zeta_{G(\{0\})}(\vec{v}). \end{aligned}$$

Thus, we obtain from (5.2)

$$\zeta_{G(\{0\})}(\vec{v}) = \lim_{n \rightarrow \infty} \frac{\mathbb{E}(\chi_G(nA, h(n), \vec{v}))}{\mathcal{H}^{d-1}(nA)} \leq \liminf_{n \rightarrow \infty} \frac{\mathbb{E}(\psi_G(nA, h(n), \vec{v}))}{\mathcal{H}^{d-1}(nA)}. \quad (5.3)$$

Combining inequalities (5.1) and (5.3), we get that

$$\lim_{n \rightarrow \infty} \frac{\mathbb{E}(\chi_G(nA, h(n), \vec{v}))}{\mathcal{H}^{d-1}(nA)} = \lim_{n \rightarrow \infty} \frac{\mathbb{E}(\psi_G(nA, h(n), \vec{v}))}{\mathcal{H}^{d-1}(nA)} = \zeta_{G(\{0\})}(\vec{v}).$$

□

To complete the proof of Proposition 5.1, it remains to prove that the set F is a cutset on the event \mathcal{E}'_n . We recall that all the notations were introduced in the proof of Proposition 5.1.

Lemma 5.2. *On the event \mathcal{E}'_n , the following set*

$$F = E \cup \left(\bigcup_{x \in V} \partial_e \mathcal{C}_{G,0}(x) \right)$$

cuts $\overline{T'}$ from $\text{hyp}(nA + h(n)\vec{v})$ and is of null capacity (see Figure 8.6).

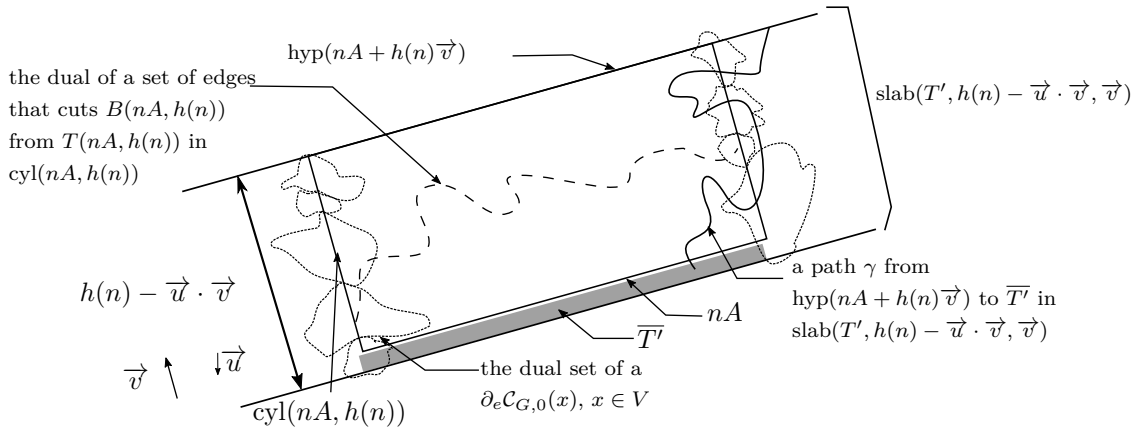

Figure 8.6 – Construction of a cutset from $\overline{T'}$ to $\text{hyp}(nA + h(n)\vec{v})$ from a cutset from the top to the bottom in the cylinder $\text{cyl}(nA, h(n))$ on the event \mathcal{E}'_n

Proof. Let $\gamma = (y = v_0, e_1, v_1, \dots, e_m, v_m = x)$ be a path from $y \in W(nA, h(n), \vec{v})$ to $x \in \overline{T'}$ that stays in $\text{slab}(T', h(n) - \vec{u} \cdot \vec{v}, \vec{v})$. Let us consider the first moment p when γ exits $\text{slab}(nA, h(n), \vec{v})$, i.e.,

$$p = \inf \{ i \in \{0, \dots, m\}, v_i \notin \text{slab}(nA, h(n), \vec{v}) \}.$$

We distinguish several cases.

- Suppose that $v_{p-1} \in B(nA, h(n))$ and $\gamma' = (v_0, e_1, \dots, e_{p-1}, v_{p-1})$, the portion of γ between v_0 and v_{p-1} , stays in cylinder $\text{cyl}(nA, h(n))$. Then γ' is a path from the top to the bottom of $\text{cyl}(nA, h(n))$ that stays in $\text{cyl}(nA, h(n))$, thus $\gamma' \cap E \neq \emptyset$ and $\gamma \cap E \neq \emptyset$.

- Suppose that $v_{p-1} \in B(nA, h(n))$ and that γ' does not stay in the cylinder $\text{cyl}(nA, h(n))$. Thus γ' must intersect the boundary of the cylinder $\text{cyl}(nA, h(n))$. As γ' stays in $\text{slab}(nA, h(n), \vec{v})$, γ' can only intersect the vertical sides of the cylinder, *i.e.*, $\text{cyl}(\partial(nA), h(n))$, we obtain $\gamma' \cap V \neq \emptyset$. There exists $z \in V$ such that $\gamma' \cap \{z\} \neq \emptyset$. On the event \mathcal{E}'_n , γ' cannot be included in $\mathcal{C}_{G,0}(z)$. Indeed, if $\gamma' \subset \mathcal{C}_{G,0}(z)$, then $\gamma' \subset \mathcal{C}_{G,0}(x)$ and $\mathcal{C}_{G,0}(x)$ has a diameter at least $h(n)$, it is impossible on the event \mathcal{E}'_n . Therefore we obtain $\gamma' \cap \partial_e \mathcal{C}_{G,0}(z) \neq \emptyset$ and $\gamma \cap F \neq \emptyset$.

- Suppose now that $v_{p-1} \notin B(nA, h(n))$, thus $v_{p-1} \notin \text{cyl}(nA, h(n))$. If $x \in V$, we conclude as in the previous case that on the event \mathcal{E}'_n , $\gamma \cap \partial_e \mathcal{C}_{G,0}(x) \neq \emptyset$ and $\gamma \cap F \neq \emptyset$. Otherwise, if $x \notin V$, then $x \in \text{cyl}(nA - 2d\vec{v}, h(n) + 2d)$. Since we have $v_{p-1} \notin \text{cyl}(nA - 2d\vec{v}, h(n) + 2d)$ and the path γ stays in $\text{slab}(nA - 2d\vec{v}, h(n) + 2d, \vec{v})$, it follows that γ cuts $\text{cyl}(\partial(nA - 2d\vec{v}), h(n) + 2d)$ and $\gamma \cap V \neq \emptyset$. We conclude as in the previous cases that $\gamma \cap F \neq \emptyset$.

On the event \mathcal{E}'_n , we obtain that $\gamma \cap F \neq \emptyset$. Moreover, the set E has null capacity so it is also the case for the set F . Thus, the set F cuts $\overline{T'}$ from $\text{hyp}(nA + h(n)\vec{v})$ and has null capacity on the event \mathcal{E}'_n . \square

6 Concentration

We aim here to prove Theorem 2.12. To prove this theorem, we will need Proposition 5.1 and the concentration inequality stated in Proposition 2.14 for ψ_G that is a function of the capacity of the edges inside the cylinder.

Remark 6.1. *The advantage of using a concentration inequality on ψ_G rather than on χ_G is that ψ_G depends on the capacity of a finite deterministic set of edges whereas χ_G depends on an infinite set of edges (the edges in $\text{slab}(A, \infty, \vec{v})$). Therefore ψ_G is more appropriate to apply this concentration inequality.*

Proof of Theorem 2.12. Let $p < p_c(d)$. Let $\vec{v} \in \mathbb{S}^{d-1}$. Let A be a non-degenerate hyperrectangle normal to \vec{v} and h an height function that satisfies condition (\star) . We consider the cylinder $\text{cyl}(nA, h(n))$ and we enumerate its edges as e_1, \dots, e_{m_n} . We define

$$(t_G(e_1), \dots, t_G(e_{m_n}), t'_G(e_1), \dots, t'_G(e_{m_n}))$$

a family of independent random variables distributed according to distribution G . The quantity $\psi_G(nA, h(n), \vec{v})$ is a random variable that depends only on the capacities of the edges e_1, \dots, e_{m_n} . We define

$$X = (t_G(e_1), \dots, t_G(e_{m_n})), \\ \forall i \in \{1, \dots, m_n\} \quad X^{(i)} = (t_G(e_1), \dots, t'_G(e_i), \dots, t_G(e_{m_n}))$$

and f the function defined by $\psi_G(nA, h(n), \vec{v}) = f(X) = Z$. We define $Z'_i = f(X^{(i)})$. We denote by \mathcal{F}_n and \mathcal{G}_n the following events that depend on $t_G(e_1), \dots, t_G(e_{m_n})$,

$$\mathcal{F}_n = \left\{ \sum_{x \in B(nA, h(n)) \cap \mathbb{Z}^d} \text{card}_v(\mathcal{C}_{G,0}(x)) \leq Cn^{d-1} \right\}$$

and

$$\mathcal{G}_n = \bigcap_{x \in \text{cyl}(nA, h(n)) \cap \mathbb{Z}^d} \left\{ \text{card}_v(\mathcal{C}_{G,0}(x)) \leq \min\left(\frac{h(n)}{4}, n^{1/5}\right) \right\}.$$

Since $\mathbb{P}(\text{card}_v(\mathcal{C}_{G,0}(x)) > n) \leq \kappa_1 \exp(-\kappa_2 n)$ (see Theorem 2.13), we can find C large enough such that there exist positive constants C_1 and C_2 depending on A such that

$$\mathbb{P}(\mathcal{F}_n^c) \leq C_1 \exp(-C_2 n^{d-1}). \quad (6.1)$$

This fact is proven in the proof of Proposition 2.3 in [64]. Moreover, using again Theorem 2.13, we obtain

$$\mathbb{P}(\mathcal{G}_n^c) \leq m_n \kappa_1 \exp\left(-\kappa_2 \min\left(\frac{h(n)}{4}, n^{1/5}\right)\right). \quad (6.2)$$

On the event \mathcal{G}_n , the minimal capacity of a cutset from the top to the bottom of the cylinder $\text{cyl}(nA, h(n))$ is null. Let $i \in \{1, \dots, m_n\}$, let us assume that $f(X) < f(X^{(i)})$. If $t'_G(e_i) < t_G(e_i)$, then we have $t_G(e_i) > 0$. On the event \mathcal{G}_n , there exists a cutset of null capacity E (thus E does not contain e_i) that achieves the infimum in $f(X)$. It is still a cutset of null capacity in $\text{cyl}(nA, h(n))$ for the distribution $X^{(i)}$. Thus, we obtain the following contradiction $f(X^{(i)}) \leq |E| = f(X)$, so if $f(X) < f(X^{(i)})$ then $t'_G(e_i) \geq t_G(e_i)$ on the event \mathcal{G}_n .

Let us now assume that $f(X) < f(X^{(i)})$, then we have $t_G(e_i) \leq t'_G(e_i)$ on the event \mathcal{G}_n . Let us denote by R_n the intersection of all the minimal cutsets that achieve the infimum in $\psi_G(nA, h(n), \vec{v})$. If $e_i \notin R_n$, then there exists a cutset E that does not contain e_i and that achieves the infimum in $\psi_G(nA, h(n), \vec{v})$, i.e., $f(X) = |E|$. On the event \mathcal{G}_n , all the cutsets that achieve the infimum in $f(X)$ are of null capacity. Since E is a cutset of null capacity that does not contain the edge e_i , it is still a cutset of null capacity in $\text{cyl}(nA, h(n))$ for the capacities $X^{(i)}$. Thus, $f(X^{(i)}) \leq f(X)$, which is a contradiction. Thus on \mathcal{G}_n , if $f(X) < f(X^{(i)})$ then $t_G(e_i) \leq t'_G(e_i)$ and $e_i \in R_n$. We denote by E a cutset that achieves the infimum in $f(X)$. We have $e_i \in E$, let us define

$$\tilde{E} = (E \cup \partial_e \mathcal{C}_{G,0}(e_i^+) \cup \partial_e \mathcal{C}_{G,0}(e_i^-)) \setminus \{e_i\}$$

where we write $e_i = \langle e_i^-, e_i^+ \rangle$. This set has null capacity for both distributions X and $X^{(i)}$. Let us prove that on the event \mathcal{G}_n , the set \tilde{E} cuts the top from the bottom of cylinder $\text{cyl}(nA, h(n))$.

Let γ be a path from $x \in T(nA, h(n))$ to $y \in B(nA, h(n))$. If $e_i \notin \gamma$ then as E is a cutset, we have that $\gamma \cap E \setminus \{e_i\} \neq \emptyset$ thus $\gamma \cap \tilde{E} \neq \emptyset$. We now assume that $e_i \in \gamma$. On the event \mathcal{G}_n , γ cannot be included in $\mathcal{C}_{G,0}(e_i^+) \cup \mathcal{C}_{G,0}(e_i^-)$. Thus, either $x \notin \mathcal{C}_{G,0}(e_i^+) \cup \mathcal{C}_{G,0}(e_i^-)$ or $y \notin \mathcal{C}_{G,0}(e_i^+) \cup \mathcal{C}_{G,0}(e_i^-)$. We study only the case $y \notin \mathcal{C}_{G,0}(e_i^+) \cup \mathcal{C}_{G,0}(e_i^-)$, the other case is studied similarly. We denote by g the edge γ takes to finally exit $\mathcal{C}_{G,0}(e_i^+) \cup \mathcal{C}_{G,0}(e_i^-)$, i.e., if we write $\gamma = (v_0, e'_1, v_1, \dots, e'_m, v_m)$ and we denote by

$$p = \max \{ j : v_j \in \mathcal{C}_{G,0}(e_i^+) \cup \mathcal{C}_{G,0}(e_i^-) \}$$

then $g = e'_{p+1}$. By definition of p , we must have $g \neq e_i$ and $g \in \partial_e \mathcal{C}_{G,0}(e_i^+) \cup \partial_e \mathcal{C}_{G,0}(e_i^-) \setminus \{e_i\}$. As $g \in \tilde{E}$, we finally obtain that $\gamma \cap \tilde{E} \neq \emptyset$ and that on the event \mathcal{G}_n , \tilde{E} is indeed a cutset in the cylinder of null capacity for the distribution $X^{(i)}$.

Thus on the event \mathcal{G}_n and when $f(X) < f(X^{(i)})$, we have $f(X^{(i)}) \leq |\tilde{E}|$ and $e_i \in R_n$ so that

$$\begin{aligned} f(X^{(i)}) - f(X) &\leq \text{card}_e(\mathcal{C}_{G,0}(e_i^+) \cup \mathcal{C}_{G,0}(e_i^-)) \mathbb{1}_{e_i \in R_n} \\ &\leq c_d [\text{card}_v(\mathcal{C}_{G,0}(e_i^+)) + \text{card}_v(\mathcal{C}_{G,0}(e_i^-))] \mathbb{1}_{e_i \in R_n} \leq 2c_d n^{1/5} \mathbb{1}_{e_i \in R_n}. \end{aligned} \quad (6.3)$$

Therefore, we have

$$\begin{aligned} V^- &= \sum_{i=1}^{m_n} \mathbb{E}[(f(X) - f(X^{(i)}))_-^2 | X] \leq \left(\sum_{i=1}^{m_n} (2c_d n^{1/5})^2 \mathbb{1}_{e_i \in R_n} \mathbb{1}_{\mathcal{G}_n} \right) + m_n^3 \mathbb{1}_{\mathcal{G}_n^c} \\ &\leq (2c_d n^{1/5})^2 |R_n| \mathbb{1}_{\mathcal{G}_n} + m_n^3 \mathbb{1}_{\mathcal{G}_n^c}. \end{aligned} \quad (6.4)$$

Notice that $\mathbb{1}_{\mathcal{G}_n} \mathbb{1}_{\mathcal{G}_n^c} = 0$. On the event \mathcal{F}_n , we have $|R_n| \leq Cn^{d-1}$ and so

$$\mathbb{E}[(V^-)^2] \leq (2c_d n^{1/5})^4 \mathbb{E}[|R_n|^2] + m_n^6 \mathbb{P}(\mathcal{G}_n^c) \leq (2c_d n^{1/5})^4 (C^2 n^{2(d-1)} + m_n^2 \mathbb{P}(\mathcal{F}_n^c)) + m_n^6 \mathbb{P}(\mathcal{G}_n^c). \quad (6.5)$$

Using inequality (6.3), we have for all $i \in \{1, \dots, m_n\}$

$$(f(X) - f(X^{(i)}))_- \leq 2c_d n^{1/5} \mathbb{1}_{\mathcal{G}_n} + m_n \mathbb{1}_{\mathcal{G}_n^c} := M.$$

We have

$$\mathbb{E}[M^4] \leq (2c_d n^{1/5})^4 + m_n^4 \mathbb{P}(\mathcal{G}_n^c). \quad (6.6)$$

Using Theorem 2.14, we obtain

$$\mathbb{E}[(Z - \mathbb{E}Z)_-^4] \leq C\mathbb{E}[(V^-)^2] \quad (6.7)$$

and

$$\mathbb{E}[(Z - \mathbb{E}Z)_+^4] \leq C \max(\mathbb{E}[(V^-)^2], \mathbb{E}[M^4]). \quad (6.8)$$

Combining inequalities (6.1), (6.2), (6.5), (6.6), (6.7) and (6.8), we obtain that

$$\mathbb{E}[(Z - \mathbb{E}Z)^4] = O\left(n^{2(d-1)+4/5}\right).$$

Let $\varepsilon > 0$. Using Markov inequality we obtain

$$\mathbb{P}\left(\left|\frac{\psi_G(nA, h(n), \vec{v})}{\mathcal{H}^{d-1}(nA)} - \mathbb{E}\left(\frac{\psi_G(nA, h(n), \vec{v})}{\mathcal{H}^{d-1}(nA)}\right)\right| > \varepsilon\right) \leq \frac{\mathbb{E}[(Z - \mathbb{E}Z)^4]}{\mathcal{H}^{d-1}(nA)^4 \varepsilon^4}.$$

As the right hand side of the previous inequality is of order at most $n^{-2(d-1)+4/5}$, we can conclude that for $d \geq 2$, the sum

$$\sum_{n=1}^{\infty} \mathbb{P}\left(\left|\frac{\psi_G(nA, h(n), \vec{v})}{\mathcal{H}^{d-1}(nA)} - \mathbb{E}\left(\frac{\psi_G(nA, h(n), \vec{v})}{\mathcal{H}^{d-1}(nA)}\right)\right| > \varepsilon\right)$$

is finite. By Borel-Cantelli Lemma, we deduce that almost surely

$$\limsup_{n \rightarrow \infty} \left|\frac{\psi_G(nA, h(n), \vec{v})}{\mathcal{H}^{d-1}(nA)} - \mathbb{E}\left(\frac{\psi_G(nA, h(n), \vec{v})}{\mathcal{H}^{d-1}(nA)}\right)\right| \leq 0,$$

and finally,

$$\lim_{n \rightarrow \infty} \frac{\psi_G(nA, h(n), \vec{v})}{\mathcal{H}^{d-1}(nA)} = \zeta_{G(\{0\})}(\vec{v}) \text{ a.s.}$$

This yields the result. \square

Remark 6.2. *With the standard Efron-Stein inequality, we did not manage to obtain a bound that is summable in dimension 2. That is the reason why we investigated for a higher moment (the fourth moment turned out to be enough). Note that, an exponential type concentration inequality does not work with the bound of V^- we obtained in (6.4) since the probability $\mathbb{P}(\mathcal{G}_n^c)$ does not counterbalance the term $\exp(m_n^3)$.*

Acknowledgments The authors would like to thank an anonymous referee for his valuable comments and Raphaël Rossignol for helpful discussions on concentration inequalities.

Publications and preprints

- [1] Raphaël Cerf and Barbara Dembin. The time constant is Lipschitz continuous strictly above p_c . *In preparation*, 2020.
- [2] Raphaël Cerf and Barbara Dembin. Vanishing of the anchored isoperimetric profile in bond percolation at p_c . *Electron. Commun. Probab.*, 25:7 pp., 2020.
- [3] Barbara Dembin. Regularity of the time constant for a supercritical Bernoulli percolation. *arXiv e-prints*, page arXiv:1803.03141, Mar 2018.
- [4] Barbara Dembin. Anchored isoperimetric profile of the infinite cluster in supercritical bond percolation is lipschitz continuous. *Electron. Commun. Probab.*, 25:13 pp., 2020.
- [5] Barbara Dembin. Existence of the anchored isoperimetric profile in supercritical bond percolation in dimension two and higher. *ALEA Lat. Am. J. Probab. Math. Stat.*, 17:205–252, 2020.
- [6] Barbara Dembin. The maximal flow from a compact convex subset to infinity in first passage percolation on \mathbb{Z}^d . *Ann. Probab.*, 48(2):622–645, 03 2020.
- [7] Barbara Dembin and Marie Thérét. Size of a minimal cutset in supercritical first passage percolation. *Ann. Inst. H. Poincaré Probab. Statist.*, 56(2):1419–1439, 05 2020.

Bibliography

- [8] Michael Aizenman and David J. Barsky. Sharpness of the phase transition in percolation models. *Comm. Math. Phys.*, 108(3):489–526, 1987.
- [9] N Alon and V.D Milman. λ_1 , isoperimetric inequalities for graphs, and superconcentrators. *Journal of Combinatorial Theory, Series B*, 38(1):73 – 88, 1985.
- [10] Peter Antal and Agoston Pisztora. On the chemical distance for supercritical Bernoulli percolation. *Ann. Probab.*, 24(2):1036–1048, 1996.
- [11] Antonio Auffinger, Michael Damron, and Jack Hanson. *50 years of first-passage percolation*, volume 68 of *University Lecture Series*. American Mathematical Society, Providence, RI, 2017.
- [12] David J. Barsky, Geoffrey R. Grimmett, and Charles M. Newman. Percolation in half-spaces: equality of critical densities and continuity of the percolation probability. *Probab. Theory Related Fields*, 90(1):111–148, 1991.
- [13] I. Benjamini and E. Mossel. On the mixing time of a simple random walk on the super critical percolation cluster. *Probability theory and related fields*, 125(3):408–420, 2003.
- [14] N. Berger, M. Biskup, C.E. Hoffman, and G. Kozma. Anomalous heat-kernel decay for random walk among bounded random conductances. *Annales de l’Institut Henri Poincaré, Probabilités et Statistiques*, 44(2):374–392, 2008.
- [15] Marek Biskup, Oren Louidor, Eviatar B. Procaccia, and Ron Rosenthal. Isoperimetry in two-dimensional percolation. *Comm. Pure Appl. Math.*, 68(9):1483–1531, 2015.
- [16] Béla Bollobás. *Graph theory*, volume 63 of *Graduate Texts in Mathematics*. Springer-Verlag, New York, 1979. An introductory course.
- [17] Stéphane Boucheron, Gábor Lugosi, and Pascal Massart. *Concentration inequalities*. Oxford University Press, Oxford, 2013. A nonasymptotic theory of independence, With a foreword by Michel Ledoux.
- [18] S. R. Broadbent and J. M. Hammersley. Percolation processes. I. Crystals and mazes. *Proc. Cambridge Philos. Soc.*, 53:629–641, 1957.
- [19] Raphaël Cerf. The Wulff crystal in Ising and percolation models. In *École d’Été de Probabilités de Saint Flour*, number 1878 in Lecture Notes in Mathematics. Springer-Verlag, 2006.
- [20] Raphaël Cerf and Ágoston Pisztora. Phase coexistence in Ising, Potts and percolation models. *Ann. Inst. H. Poincaré Probab. Statist.*, 37(6):643–724, 2001.
- [21] Raphaël Cerf and Ágoston Pisztora. On the wulff crystal in the ising model. *Ann. Probab.*, 28(3):947–1017, 06 2000.
- [22] Raphaël Cerf and Marie Théret. Law of large numbers for the maximal flow through a domain of \mathbb{R}^d in first passage percolation. *Trans. Amer. Math. Soc.*, 363(7):3665–3702, 2011.
- [23] Raphaël Cerf and Marie Théret. Law of large numbers for the maximal flow through a domain of \mathbb{R}^d in first passage percolation. *Trans. Amer. Math. Soc.*, 363(7):3665–3702, 2011.
- [24] Raphaël Cerf and Marie Théret. Lower large deviations for the maximal flow through a domain of \mathbb{R}^d in first passage percolation. *Probab. Theory Related Fields*, 150(3-4):635–661, 2011.

- [25] Raphaël Cerf and Marie Th  ret. Lower large deviations for the maximal flow through a domain of \mathbb{R}^d in first passage percolation. *Probability Theory and Related Fields*, 150:635–661, 2011.
- [26] Rapha  l Cerf and Marie Th  ret. Upper large deviations for the maximal flow through a domain of \mathbb{R}^d in first passage percolation. *Ann. Appl. Probab.*, 21(6):2075–2108, 2011.
- [27] Rapha  l Cerf and Marie Th  ret. Maximal stream and minimal cutset for first passage percolation through a domain of \mathbb{R}^d . *Ann. Probab.*, 42(3):1054–1120, 2014.
- [28] Rapha  l Cerf and Marie Th  ret. Weak shape theorem in first passage percolation with infinite passage times. *Ann. Inst. H. Poincar   Probab. Statist.*, 52(3):1351–1381, 08 2016.
- [29] Jeff Cheeger. A lower bound for the smallest eigenvalue of the laplacian. In *Proceedings of the Princeton conference in honor of Professor S. Bochner*, pages 195–199, 1969.
- [30] Olivier Couronn   and Reda J  rg Messikh. Surface order large deviations for 2D FK-percolation and Potts models. *Stochastic Processes and their Applications*, 113(1):81 – 99, 2004.
- [31] J. Theodore Cox. The time constant of first-passage percolation on the square lattice. *Adv. in Appl. Probab.*, 12(4):864–879, 1980.
- [32] J. Theodore Cox and Richard Durrett. Some limit theorems for percolation processes with necessary and sufficient conditions. *Ann. Probab.*, 9(4):583–603, 1981.
- [33] J. Theodore Cox and Harry Kesten. On the continuity of the time constant of first-passage percolation. *J. Appl. Probab.*, 18(4):809–819, 1981.
- [34] Michael Damron and Pengfei Tang. Superlinearity of geodesic length in 2D critical first-passage percolation. *To appear in Festschrift for Chuck Newman*, page arXiv:1610.02593, October 2016.
- [35] Hugo Duminil-Copin, Aran Raoufi, and Vincent Tassion. Sharp phase transition for the random-cluster and potts models via decision trees. *Annals of Mathematics*, 189(1):75–99, 2019.
- [36] Hugo Duminil-Copin and Vincent Tassion. A new proof of the sharpness of the phase transition for Bernoulli percolation on \mathbb{Z}^d . *Enseign. Math.*, 62(1-2):199–206, 2016.
- [37] Ofer Gabber and Zvi Galil. Explicit constructions of linear-sized superconcentrators. *Journal of Computer and System Sciences*, 22(3):407 – 420, 1981.
- [38] O. Garet. Capacitive flows on a 2d random net. *Annals of Applied Probability*, 19(2):641–660, 2009.
- [39] Olivier Garet and R  gine Marchand. Asymptotic shape for the chemical distance and first-passage percolation on the infinite Bernoulli cluster. *ESAIM Probab. Stat.*, 8:169–199 (electronic), 2004.
- [40] Olivier Garet and R  gine Marchand. Large deviations for the chemical distance in supercritical Bernoulli percolation. *Ann. Probab.*, 35(3):833–866, 2007.
- [41] Olivier Garet and R  gine Marchand. Moderate deviations for the chemical distance in Bernoulli percolation. *ALEA Lat. Am. J. Probab. Math. Stat.*, 7:171–191, 2010.
- [42] Olivier Garet, R  gine Marchand, Eviatar B. Procaccia, and Marie Th  ret. Continuity of the time and isoperimetric constants in supercritical percolation. *Electron. J. Probab.*, 22:35 pp., 2017.
- [43] Enrico Giusti. *Minimal surfaces and functions of bounded variation*, volume 80 of *Monographs in Mathematics*. Birkh  user Verlag, Basel, 1984.
- [44] Julian Gold. Isoperimetry in supercritical bond percolation in dimensions three and higher. *Ann. Inst. Henri Poincar   Probab. Stat.*, 54(4):2092–2158, 2018.
- [45] G. Grimmett and H. Kesten. First-passage percolation, network flows and electrical resistances. *Z. Wahrsch. Verw. Gebiete*, 66(3):335–366, 1984.
- [46] G. R. Grimmett and J. M. Marstrand. The supercritical phase of percolation is well behaved. *Proc. Roy. Soc. London Ser. A*, 430(1879):439–457, 1990.

- [47] Geoffrey Grimmett. *Percolation*. Springer-Verlag, 1989.
- [48] Geoffrey Grimmett. *Percolation*, volume 321 of *Grundlehren der Mathematischen Wissenschaften [Fundamental Principles of Mathematical Sciences]*. Springer-Verlag, Berlin, second edition, 1999.
- [49] J. M. Hammersley and D. J. A. Welsh. First-passage percolation, subadditive processes, stochastic networks, and generalized renewal theory. In *Proc. Internat. Res. Semin., Statist. Lab., Univ. California, Berkeley, Calif*, pages 61–110. Springer-Verlag, New York, 1965.
- [50] Wassily Hoeffding. Probability inequalities for sums of bounded random variables. 58:13 – 30, 03 1963.
- [51] Harry Kesten. Aspects of first passage percolation. In *École d’été de probabilités de Saint-Flour, XIV—1984*, volume 1180 of *Lecture Notes in Math.*, pages 125–264. Springer, Berlin, 1986.
- [52] Harry Kesten. Surfaces with minimal random weights and maximal flows: a higher dimensional version of first-passage percolation. *Illinois Journal of Mathematics*, 31(1):99–166, 1987.
- [53] Harry Kesten and Yu Zhang. The probability of a large finite cluster in supercritical bernoulli percolation. *Ann. Probab.*, 18(2):537–555, 04 1990.
- [54] U. Krengel and R. Pyke. Uniform pointwise ergodic theorems for classes of averaging sets and multiparameter subadditive processes. *Stochastic Process. Appl.*, 26(2):289–296, 1987.
- [55] T. M. Liggett, R. H. Schonmann, and A. M. Stacey. Domination by product measures. *The Annals of Probability*, 25(1):71–95, 1997.
- [56] Thomas M. Liggett. An improved subadditive ergodic theorem. *Ann. Probab.*, 13(4):1279–1285, 11 1985.
- [57] P. Mathieu and E. Remy. Isoperimetry and heat kernel decay on percolation clusters. *The Annals of Probability*, 32(1A):100–128, 2004.
- [58] M. V. MENSHIKOV. Coincidence of critical points in percolation problems. *Soviet Mathematics Doklady*, 33:856–859, 1986.
- [59] G. Pete. A note on percolation on \mathbb{Z}^d : isoperimetric profile via exponential cluster repulsion. *Electron. Commun. Probab.*, 13:no. 37, 377–392, 2008.
- [60] Ágoston Pisztora. Surface order large deviations for Ising, Potts and percolation models. *Probability Theory and Related Fields*, 104(4):427–466, 1996.
- [61] Clément Rau. Sur le nombre de points visités par une marche aléatoire sur un amas infini de percolation. *Bulletin de la Société Mathématique de France*, 135(1):135–169, 2007.
- [62] Raphaël Rossignol and Marie Thérét. Lower large deviations and laws of large numbers for maximal flows through a box in first passage percolation. *Annales de l’I.H.P. Probabilités et statistiques*, 46(4):1093–1131, 2010.
- [63] Raphaël Rossignol and Marie Thérét. Lower large deviations for the maximal flow through tilted cylinders in two-dimensional first passage percolation. *ESAIM Probab. Stat.*, 17:70–104, 2013.
- [64] Raphaël Rossignol and Marie Thérét. Existence and continuity of the flow constant in first passage percolation. *Electron. J. Probab.*, 23:Paper No. 99, 42, 2018.
- [65] R. T. Smythe. Multiparameter subadditive processes. *Ann. Probability*, 4(5):772–782, 1976.
- [66] J. Taylor. Unique structure of solutions to a class of nonelliptic variational problems. *Proc. Symp. Pure Math. AMS*, 27:419–427, 1975.
- [67] Marie Thérét. Upper large deviations for the maximal flow in first-passage percolation. *Stochastic Process. Appl.*, 117(9):1208–1233, 2007.
- [68] Marie Thérét. Upper large deviations for maximal flows through a tilted cylinder. *ESAIM Probab. Stat.*, 18:117–129, 2014.
- [69] Adam Timar. Bondary-connectivity via graph theory. 141, 11 2007.

- [70] G. Wulff. *Zur Frage der Geschwindigkeit des Wachstums und der Auflösung der Kristallflächen*, volume 34. 1901.
- [71] Yu Zhang. Supercritical behaviors in first-passage percolation. *Stochastic Processes and their Applications*, 59(2):251 – 266, 1995.
- [72] Yu Zhang. Critical behavior for maximal flows on the cubic lattice. *Journal of Statistical Physics*, 98(3-4):799–811, 2000.
- [73] Yu Zhang. Limit theorems for maximum flows on a lattice. *Probability Theory and Related Fields*, May 2017.
- [74] Yu Zhang and Yi Ci Zhang. A limit theorem for N_{0n}/n in first-passage percolation. *Ann. Probab.*, 12(4):1068–1076, 1984.