



**HAL**  
open science

# Mechanisms and PK/PD modelling of MCR-1-induced adaptive resistance in Enterobacteriaceae

Hariyanto Ih

► **To cite this version:**

Hariyanto Ih. Mechanisms and PK/PD modelling of MCR-1-induced adaptive resistance in Enterobacteriaceae. Infectious diseases. Université de Poitiers, 2020. English. NNT : 2020POIT1806 . tel-03176476

**HAL Id: tel-03176476**

**<https://theses.hal.science/tel-03176476>**

Submitted on 22 Mar 2021

**HAL** is a multi-disciplinary open access archive for the deposit and dissemination of scientific research documents, whether they are published or not. The documents may come from teaching and research institutions in France or abroad, or from public or private research centers.

L'archive ouverte pluridisciplinaire **HAL**, est destinée au dépôt et à la diffusion de documents scientifiques de niveau recherche, publiés ou non, émanant des établissements d'enseignement et de recherche français ou étrangers, des laboratoires publics ou privés.

# THESE

Pour l'obtention du Grade de

DOCTEUR DE L'UNIVERSITE DE POITIERS

(Faculté Médecine et Pharmacie)  
(Diplôme National - Arrêté du 25 mai 2016)

Ecole Doctorale « *Sciences Biologiques & Santé* »

Secteur de Recherche : Pharmacologie et sciences du médicament

Présentée par:

**Hariyanto IH**

\*\*\*\*\*

## **Mechanisms and PK/PD modelling of MCR-1-induced adaptive resistance in Enterobacteriaceae**

\*\*\*\*\*

Directeur de Thèse :

**Pr William COUET**

**Dr Julien M BUYCK**

\*\*\*\*\*

Soutenue le 18 Décembre 2020

Devant la Commission d'Examen

\*\*\*\*\*

### **JURY**

<b>Pr Françoise VAN BAMBEKE</b> , <i>Université Catholique de Louvain (Belgique)</i>	Rapporteur
<b>Pr Jean-Winoc DECOUSSER</b> , <i>Université Paris-Est Créteil</i>	Rapporteur
<b>Pr Titik NURYASTUTI</b> , <i>Universitas Gadjah Mada (Indonésie)</i>	Examineur
<b>Pr Sandrine MARCHAND</b> , <i>Université de Poitiers</i>	Examineur
<b>Pr William COUET</b> , <i>Université de Poitiers</i>	Directeur de thèse
<b>Dr Julien M BUYCK</b> , <i>Université de Poitiers</i>	Co-directeur de thèse



# ACKNOWLEDGEMENT

---

I would like to express my deepest appreciation to my advisor **Pr William COUET** for his continuous support of my PhD program, for your guidance and your constructive criticism. He has been a great mentor in mapping my PhD journey and advising on a research topic. Thanks for giving me an opportunity to join research team INSERM U1070 and working under your supervision.

I would also like to extend my deepest gratitude to my co-advisor **Dr Julien M BUYCK**, for teaching me all about microbiology, his close supervision in biology molecular, for editing my thesis and for widening my research from various perspective. I am extremely grateful for your patience, motivation and your helpful advice. The completion of my dissertation would not have been possible without your helpful contribution.

My sincere gratitude goes to **Pr Françoise VAN BAMBEKE** and **Pr Jean-Winoc DECOUSSER** for accepting to be the evaluator my PhD thesis. I would also like to thank to **Pr Titik NURYASTUTI** honoring me as his presence in the jury of my thesis.

I would like to extend my sincere thanks to **Pr Sandrine MARCHAND** for her scientific support during my article writing, and for accepting to be president of jury of my thesis. I thank her for constant help during my study in the lab. Rigour and advice.

I also had great pleasure of working with all the members of the U 1070:

To Dr Nicolas GREGOIRE, for a great support during PK/PD modeling part of my thesis.

To Dr Alexia CHAUZY, for helping me in the modeling part and answering my many stupid questions. It was a pleasure working with you.

To Dr Frederic TEWES, Dr Blandine RAMMAERT, and Dr Julien BRILLAULT for a great discussion and their precious advises.

To Eduardo, for your knowledge in PK/PD and for bearing several stupid questions regarding PK/PD

To Betty, for helping me during my first year in the lab. To Rana, Grace, Shachi, and Luc for their support and maintaining a good environment in our room.

To Jennifer, Romain, Kevin, Jérémy, Théo, Emma, Bruna, Muriel, Patrice, Julian, Christophe, Agnes, Helene, Isabelle, Etienne, Vincent, and all the members of the lab, for all the fun we have had in the last few years. Their warm welcome and good humor made those four years of thesis as the most enjoyable years.

To all my friends from Indonesian student association (PPI) of French and Poitiers, for the fun and their help during my stay in French.

A very special gratitude goes out to all down at Indonesian Endowment Fund for Education (LPDP) and BUDI-LN from ministry of finance and Directorate General of Higher Education of the Republic of Indonesia, for helping and providing the funding for the study and the research. Special thanks to **Pr Gérard MAUCO**, who gave me the golden opportunity to do my PhD.

I am forever grateful to my parents, my sisters, and all my family member in Indonesia, for their support and their encouragement which helped me in completion of this dissertation.

I dedicate this work to all of them...

# ABSTRACT

---

Due to the lack of new antibiotics facing the increasing emergence of resistances, it is important to understand the mechanism and dynamics of these phenomenon. Lipopolysaccharide (LPS) is the polymyxin main target and the most contributing component to polymyxin resistance. Plasmid-mediated colistin resistance MCR-1 (Mobile Colistin Resistance) carrying by *Escherichia coli* and *Klebsiella pneumoniae* encodes a phosphoethanolamine transferase leads to the addition of phosphoethanolamine to lipid A of LPS. However, chromosomally-encoded LPS-modifying phosphoethanolamine transferase and loss of LPS are the two primary mechanisms that have been described in colistin-resistant *Acinetobacter baumannii* to date. Polymyxin-resistance occurred during polymyxin treatment, but the mechanism and dynamics how these strains acquired resistance is poorly understood. Sequential time-kill (TK) were developed as an alternative approach to discriminate heterogenous subpopulations (S/R) versus adaptive resistance (AR) during colistin and polymyxin B exposure.

In this thesis we:

1. Confirm that sequential TK could discriminate between a single homogenous population of bacteria without or with adaptation (AR) and two independent subpopulations with different antibiotic susceptibilities (S/R) demonstrated by pharmacokinetics/pharmacodynamics (PK/PD) modelling.
2. Determine the molecular impact of MCR-1 in the progressive adaptation of *E. coli* and *K. pneumoniae* over chromosomal genes involved to LPS modification by using the sequential TK approach.
3. Determine the mechanisms involved in polymyxin resistance in two clinical strains of *A. baumannii*, isolated from a patient before and after treated with colistin.

These studies not only provide a simple approach to discriminate between two PK/PD models, but also an indication that the MCR-1 presence favor another resistance mechanism leading to high-level resistance to polymyxin. By the similar approach, we determine how colistin-susceptible and resistant *A. baumannii* isolates respond under polymyxin pressure, including the genes involved. Furthermore, polymyxin B showed a lower capacity to induce high-level of resistance than colistin for all bacterial species.

**Keywords:** colistin, polymyxin B, *E. coli*, *K. pneumoniae*, *A. baumannii*, sequential time-kill

## Caractérisation des mécanismes et modelling PK/PD de la résistance adaptative induite par MCR-1 chez les *Enterobacteriaceae*

Du fait du manque de nouveaux antibiotiques et de l'augmentation des résistances, il est important de comprendre les mécanismes et la dynamique de ces phénomènes. La modification du lipopolysaccharide (LPS) est le principal mécanisme contribuant à la résistance des bactéries aux polymyxines. Le plasmide portant le gène MCR-1 (Mobile Colistin Resistance) retrouvé chez *Escherichia coli* et *Klebsiella pneumoniae* code une phosphoethanolamine transférase capable de modifier le LPS par une addition de phosphoethanolamine sur le lipide A du LPS alors que chez *Acinetobacter baumannii* résistant aux polymyxines il a été décrit à la fois des modifications du LPS par une phosphoethanolamine et une perte du LPS. Cependant, les interactions entre les différents mécanismes exprimés par ces bactéries à Gram-négatif pour devenir résistantes à la colistine et à la polymyxine B sont encore peu décrit. Les courbes de bactéricidies séquentielles ont été utilisées comme une approche alternative pour discriminer l'hétérorésistance de la population bactérienne (2 sous populations S/R) d'une résistance adaptative (AR) durant le traitement par la colistine ou la polymyxine B.

Au cours de ce travail de thèse, nous avons :

1. Confirmé que l'approche des courbes de bactéricidies séquentielles peut discriminer trois modèles pharmacocinétique/pharmacodynamique (PK/PD) semi-mécanistiques décrivant : une population stable hétérorésistante (S/R), une population bactérienne sans adaptation et une population bactérienne instable et homogène dont la résistance s'adapte au cours du temps (AR).
2. Déterminé l'impact de la présence du plasmide MCR-1 sur les mécanismes de résistance chromosomique impliqués dans la résistance adaptative de *E. coli* and *K. pneumoniae* aux polymyxines.
3. Déterminé les mécanismes impliqués dans la résistance aux polymyxines dans deux souches cliniques d'*A. baumannii*, isolées avant et après traitement d'un patient à la colistine.

Dans ce travail, une nouvelle approche de courbes de bactéricidies séquentielles a été utilisée et validée afin de pouvoir différencier différents modèles PK/PD semi-

mécanistiques. De plus, ce travail a montré que la présence du plasmide MCR-1 favorisait l'activation d'autres mécanismes chromosomiques conduisant à de hauts niveaux de résistances aux polymyxines. Enfin, la polymyxine B montrait une plus faible capacité à induire ces mécanismes chromosomiques conduisant à de hauts niveaux de résistance.

**Mots clés** : colistine, polymyxine B, *E. coli*, *K. pneumoniae*, *A. baumannii*, courbe de bactéricidies séquentielles



---

# TABLE OF CONTENTS

---

<i>Acknowledgement</i> .....	3
<i>Abstract</i> .....	5
<i>Résumé</i> .....	6
<i>List of Publications</i> .....	10
<i>List of Communications</i> .....	11
<i>List of Abbreviations</i> .....	12
<i>List of Figures</i> .....	15
<i>List of Tables</i> .....	16
<b>CHAPTER 1. GENERAL INTRODUCTION</b> .....	<b>17</b>
Emergence of polymyxin resistance in Gram-negative bacteria.....	19
<b>CHAPTER 2. LITERATURE REVIEW</b> .....	<b>23</b>
I. Polymyxins: <i>The Arising of “Old” Class Antibiotics</i> .....	25
1. Discovery of the family “polymyxin”.....	26
1.1. Colistin and polymyxin B.....	27
2. Mechanisms of action and antibacterial spectrum.....	30
2.1. Lipopolysaccharide structure of Gram-negative bacteria.....	30
2.2. Polymyxins: <i>Mode of Action</i> .....	32
2.3. Antibacterial spectrum.....	34
3. Antimicrobial susceptibility testing of polymyxins.....	35
3.1. Clinical breakpoints.....	36
4. Clinical use.....	38
4.1. Colistin.....	38
A. Commercial preparation.....	38
B. Clinical practice.....	38
4.2. Polymyxin B.....	39
A. Commercial preparation.....	39
B. Clinical practice.....	40
II. Gram-negative Bacteria: <i>Emergence of Multidrug Resistance Pathogen</i> .....	43
1. Enterobacteriaceae.....	43
1.1. Pathogenic <i>Escherichia coli</i> .....	44
A. Epidemiology of <i>E. coli</i> infections.....	45
B. Antimicrobial resistance in <i>E. coli</i> .....	46
2.1. <i>Klebsiella pneumoniae</i> .....	48
A. Epidemiology of <i>K. pneumoniae</i> infections.....	49
B. Antimicrobial resistance in <i>K. pneumoniae</i> .....	51

2. Non-fermentative bacilli : <i>Acinetobacter baumannii</i> .....	54
2.1. Epidemiology of <i>A. baumannii</i> infections .....	55
2.2. Antimicrobial resistance in <i>A. baumannii</i> .....	56
III. Polymyxin Resistance in Gram-negative Bacteria .....	59
1. Chromosomally-mediated polymyxin resistance .....	60
1.1. Lipopolysaccharide-lipid A modification .....	60
A. Addition of of 4-amino-4-deoxy-L-arabinose (L-Ara4N) .....	64
B. Addition of phosphoethanolamine (PEtN) .....	65
C. Addition of galactosamine (GalN) .....	66
D. Other regulatory system .....	67
1.2. Loss of lipopolysaccharide .....	68
1.3. Capsule formation .....	70
1.4. Efflux in polymyxin resistance and outer membrane protein .....	70
1.5. Polymyxin-inactivating enzyme .....	71
1.6. Colistin heteroresistance .....	72
2. Plasmid-mediated colistin resistance .....	73
2.1. Description of mobilized colistin resistance (MCR) .....	73
2.2. Prevalence of <i>mcr-1</i> .....	75
2.3. Structure of the <i>mcr-1</i> gene and plasmid .....	76
2.4. Clinical impact and <i>in vitro</i> study of MCR-1 .....	79
IV. PK/PD of Antibiotics .....	81
1. MIC-based approaches .....	82
2. <i>In vitro</i> time-course-based approaches: Time-kill kinetic studies .....	83
2.1. Bacterial submodel (pharmacodynamic model) .....	83
2.2. Pharmacokinetic model .....	84
2.3. Pharmacokinetic-pharmacodynamic model .....	84
 PROBLEMS AND OBJECTIVE OF THE STUDY .....	 87
<b>CHAPTER 3. EXPERIMENTAL WORK .....</b>	<b>89</b>
ARTICLE 1. SEQUENTIAL TIME-KILL STUDY TO DISCRIMINATE PK/PD MODEL .....	91
ARTICLE 2. SEQUENTIAL TIME-KILL STUDY OF <i>K. PNEUMONIAE</i> WITH COLISTIN .....	101
ARTICLE 3. STUDY OF <i>E. COLI</i> WITH COLISTIN AND POLYMYXIN B .....	133
ARTICLE 4. ADAPTIVE RESISTANCE OF <i>A. BAUMANNII</i> TO COLISTIN AND POLYMYXIN B .....	159
 DISCUSSION AND PERSPECTIVE .....	 191
 REFERENCES .....	 198

## LIST OF PUBLICATIONS

---

- Alexia Chauzy\*, **Hariyanto Ih\***, Matthieu Jacobs, Sandrine Marchand, Nicolas Grégoire, William Couet, Julien M Buyck. 2020. *Sequential time-kill: a simple experimental trick to discriminate between PK/PD models with distinct heterogenous sub-populations versus homogenous population with adaptive resistance*. Antimicrobial agents and chemotherapy. 64 (8): e00788-20. DOI: 10.1128/AAC.00788-20.  
*\*Alexia Chauzy and Hariyanto Ih contributed equally to this work and are listed in alphabetical order*
- **Hariyanto Ih**, Alexia Chauzy, Sandrine Marchand, Nicolas Grégoire, William Couet, Julien M Buyck. *Pharmacodynamic modelling of sequential time-kill data exhibiting MCR-1 klebsiella pneumoniae adaptive resistance towards colistin with arnT gene overexpression*. In submission
- **Hariyanto Ih**, Sandrine Marchand, Nicolas Grégoire, William Couet, Julien M Buyck. *Characterization of lipopolysaccharide-modifying genes involved in polymyxin resistance in Escherichia coli carrying MCR-1 by sequential time-kill approach*. In manuscript.
- **Hariyanto Ih**, Sandrine Marchand, Nicolas Grégoire, William Couet, Julien M Buyck. *Sequential time-kill to distinguish polymyxin-induce resistance and heteroresistant in colistin-resistant Acinetobacter baumannii*. In manuscript.

# LIST OF COMMUNICATIONS

---

- **ORAL** presentation at the 30<sup>th</sup> European Congress of Clinical Microbiology and Infectious Diseases (**ECCMID**) | Paris | April 2020 - Sequential time-kill experiments to characterize lipopolysaccharide-modifying genes involved in polymyxin resistance in *Escherichia coli* and *Klebsiella pneumoniae* carrying MCR-1  
*Hariyanto Ih, Nicolas Grégoire, William Couet, Sandrine Marchand and Julien M Buyck.*
- **POSTER** presentation at 30<sup>th</sup> European Congress of Clinical Microbiology and Infectious Diseases (**ECCMID**) | Paris | April 2020 - Sequential time-kill curve to distinguish polymyxin-induced resistance and heteroresistance in *Acinetobacter baumannii*.  
*Hariyanto Ih, Nicolas Grégoire, William Couet, Sandrine Marchand and Julien M Buyck.*
- **ORAL** presentation at 39<sup>ème</sup> Réunion Interdisciplinaire de Chimiothérapie Anti-Infectieuse (**RICAI**) | Paris | December 2019 - Rôle de MCR-1 dans la résistance adaptative aux polymyxines.  
*Hariyanto Ih, Nicolas Grégoire, William Couet, Sandrine Marchand and Julien M Buyck.*
- **ORAL** presentation at 15<sup>th</sup> Congrès National de la Société Française de Microbiologie (**SFM**) | Paris | October 2019 - Genetic characterization of lipopolysaccharide-modifying genes involved in polymyxin resistance in *Escherichia coli* and *Klebsiella pneumoniae* carrying MCR-1 by sequential time-kill experiments approach.  
*Hariyanto Ih, Nicolas Grégoire, William Couet and Julien M Buyck*
- **ORAL** presentation at 10<sup>th</sup> International Seminar of Indonesian Society for Microbiology (**10<sup>th</sup> ISISM**) & 12<sup>th</sup> Congress of Indonesian Society for Microbiology (**12<sup>th</sup> CISM**) | Solo, Indonesia | August 2019 - Genetic characterization of lipopolysaccharide-modifying genes involved in polymyxin resistance in *Escherichia coli* and *Klebsiella pneumoniae* carrying MCR-1 by sequential time-kill experiments approach.  
*Hariyanto Ih, Nicolas Grégoire, William Couet and Julien M Buyck*
- **POSTER** presentation at 29<sup>th</sup> European Congress of Clinical Microbiology and Infectious Diseases (**ECCMID**) | Amsterdam | April 2019 - Sequential time-kill experiments to characterize adaptative resistance to polymyxins in Gram-negative bacteria carrying MCR-1.  
*Hariyanto Ih, Nicolas Grégoire, William Couet and Julien M Buyck. 2019.*

## LIST OF ABBREVIATIONS

---

AMR	:	Antimicrobial resistance
ATP	:	Adenosine triphosphate
AUC	:	Area under the curve
CA-SFM	:	<i>Comité de l'Antibiogramme - Société Française de Microbiologie</i>
CFU	:	Colony-forming unit
cKp	:	Classical <i>Klebsiella pneumoniae</i>
BLA	:	Beta-lactamase
Cl <sub>cr</sub>	:	Creatinine clearance
CLSI	:	Clinical and Laboratory Standards Institute
CMS	:	Colistin methanesulphonate/ colistimethate sodium
CoQ1	:	Coenzyme-Q1 or Ubiquinone-1
CPS	:	Capsule polysaccharide
C <sub>ss,avg</sub>	:	Average drug concentration at steady state
Dab	:	Diaminobutyric acid
D-Leu	:	D-leucine
D-Phe	:	D-phenylalanine
ECDC	:	European Centre for Disease Prevention and Control
ECVs	:	Epidemiological cutoff values
EHEC	:	Enterohemorrhagic <i>Escherichia coli</i>
EPEC	:	Enteropathogenic <i>Escherichia coli</i>
ETEC	:	Enterotoxigenic <i>Escherichia coli</i>
E-test	:	Epsilometer test
EU/EEA	:	European Union/ European Economic Area

EUCAST	:	European Committee on Antimicrobial Susceptibility Testing
ExPEC	:	Extraintestinal pathogenic <i>E. coli</i>
FAD	:	flavin adenine dinucleotide
GalN	:	Galactosamine
GNB	:	Gram-negative bacteria
HUS	:	Haemolytic uremic syndrome
HvKp	:	Hypervirulent <i>Klebsiella pneumoniae</i>
ICU	:	Intensive care unit
Ile	:	Isoleucine
ISO	:	International Organization for Standardization
IU	:	International units
IV	:	Intravenous
KDO	:	2-keto-3-deoxyoctonoic acid
KPC	:	<i>Klebsiella pneumoniae</i> carbapenemase
L-Ara4N	:	4-amino-4-deoxy-L-arabinose
LPS	:	Lipopolysaccharide
MALDI-TOF	:	Matrix-Assisted Laser Desorption Ionization-Time of Flight
MCR	:	Mobilized colistin resistance
MDR	:	Multi-drug resistance
MIC	:	Minimum inhibitory concentration
MS	:	Mass spectrometry
NADH	:	Nicotinamide adenine dinucleotide (NAD) + hydrogen (H)
NAG	:	N-acetyl glucosamine
NDH-2	:	Type-II NADH Dehydrogenase
NDM	:	New Delhi metallo- $\beta$ -lactamase

NH <sub>2</sub>	:	Azanide
Nva	:	Norvaline
OECD	:	Organisation for Economic Co-operation and Development
OM	:	Outer membrane
OXA	:	Oxacillinase
PAPs	:	Population Analysis profiles
PEtN	:	Phosphoethanolamine
PK/PD/TD	:	Pharmacokinetics/ Pharmacodynamics/ Toxicodynamic
RT-qPCR	:	Quantitative reverse transcription-polymérase chain reaction
ST	:	Sequence type
STEAEC	:	Shiga toxin-producing enteroaggregative <i>E. coli</i>
TCS	:	Two-component system
Thr	:	Threonine
TK/ TKC	:	Time-Kill/ Time-Kill Curve
UDP	:	Uridine diphosphate
UPEC	:	Uropathogenic <i>E. coli</i>
UTIs	:	Urinary tract infections
Val	:	Valine
VIM	:	Verona integron-encoded metallo-β-lactamase
WHO	:	World health organization
XDR	:	Extensively drug resistant

## LIST OF FIGURES

---

<b>Figure 1.</b> General schematic of the outer membrane of <i>E. coli</i> K-12 .....	30
<b>Figure 2.</b> Detailed structure of Lipid A from <i>Escherichia coli</i> .....	31
<b>Figure 3.</b> Lipid A and Polymyxin B structures and its likely-mode interaction with outer membrane.....	33
<b>Figure 4.</b> Priority pathogen list identified by WHO.....	44
<b>Figure 5.</b> Distribution of <i>E. coli</i> isolates fully susceptible and resistance to one or more antimicrobial groups in EU/EEA countries in 2018.....	47
<b>Figure 6.</b> Distribution of <i>K. pneumoniae</i> isolates fully susceptible and resistance to one or more antimicrobial groups in EU/EEA countries in 2018.....	52
<b>Figure 7.</b> Distribution of <i>Acinetobacter</i> species fully susceptible and resistance to one, two and three antimicrobial groups (fluoroquinolones, aminoglycosides and carbapenems) in EU/EEA countries in 2018 .....	57
<b>Figure 8.</b> Lipid A modification by the addition of phosphoethanolamine, aminoarabinose and/or galactosamine that lead to polymyxin resistance .....	61
<b>Figure 9.</b> Regulation pathways of LPS modifications involving PhoP/PhoQ and PmrA/PmrB two-component system.....	62
<b>Figure 10.</b> Modification of lipid A causing resistance to polymyxin .....	66
<b>Figure 11.</b> General features of MCR variants including their phylogenetic relationship with other MCR.....	75
<b>Figure 12.</b> The prevalence of mobile colistin resistance ( <i>mcr</i> ) have been identified in various countries .....	76
<b>Figure 13.</b> 2,600-bp-long sequence of the <i>mcr-1</i> cassette .....	77
<b>Figure 14.</b> Circular maps of four dominant groups plasmids harboring the <i>mcr-1</i> gene...	78
<b>Figure 15.</b> Schematic presentation of PK/PD modeling .....	81
<b>Figure 16.</b> Six different PD models to reflect PD models for antibiotics.....	86



## LIST OF TABLES

---

<b>Table 1.</b> The chemical structures of polymyxin B and colistin (polymyxin E) .....	29
<b>Table 2.</b> Antibacterial spectrum of colistin and polymyxin B .....	34
<b>Table 3.</b> Polymyxin breakpoints according to the CLSI and EUCAST guidelines .....	36
<b>Table 4.</b> Estimation of hvKp proportion among <i>K. pneumoniae</i> infections .....	50
<b>Table 5.</b> Lipopolysaccharides remodeling employed by Gram-negative bacteria .....	69

# ***CHAPTER 1***

## ***GENERAL INTRODUCTION***



## EMERGENCE OF POLYMYXIN RESISTANCE IN GRAM-NEGATIVE BACTERIA

Antibiotic resistance has become a major threat to public health today, both in world-wide and Europe region, and has been classified as one of the three greatest threat for human health (1). Throughout European countries, the prevalence of antibiotic resistance widely increases (2). Based on the data presented by European Antimicrobial Resistance Surveillance Network (EARS-Net), 33 000 deaths each year in Europe are caused by resistant pathogens, mostly Gram-negative bacteria (GNB) (3). Infections caused by Gram-negative bacteria are recognized to be the most difficult infections to treat because of their ability to develop additional resistance mechanisms over the intrinsic drug resistance (4). Combine resistance to several antibiotics continues to increase in some Gram-Negative bacteria (*Escherichia coli*, *Pseudomonas aeruginosa*, *Acinetobacter baumannii*, and *Klebsiella pneumoniae*), consequently reducing the available treatment options (5). The EU members collaborated to assess the situation related to this emerging multidrug resistance Gram-negative bacteria (MDR (-)) by adopted a new European One Health Action Plan against antimicrobial resistance (AMR), such as implementing national measures for the prudent use of antimicrobials, promoting collaborative research using EU funding and shaping the global agenda on AMR. (2).

A list of priority pathogens identified by World Health Organization (WHO) revealed carbapenem-resistant Gram-negative *A. baumannii* and Enterobacteriaceae, mainly *E. coli* and *K. pneumoniae*, as a first priority in urgent need for new treatment since the effective therapeutic options are rapidly lose their efficacy against life-threatening infections cause by these pathogens (6). Multidrug resistance in *E. coli* has become the major concern whereas this bacteria may cause diverse and serious disease, such as urinary tract infections and bacteremia, and acquired resistant to many antibiotics, including  $\beta$ -lactam,

carbapenems, aminoglycosides, and fluoroquinolones by accumulating specific resistance genes (7). Another major pathogen, *K. pneumoniae* which may cause serious hospital-acquired infections, such as bacteremia, urinary tract infections and pneumonia, is a first carbapenem-resistant was reported in Enterobacteriaceae and exhibits a resistance rate more than 50% in European countries to all broad spectrum of antimicrobial agents including beta-lactam, fluoroquinolones, third-generation cephalosporins and aminoglycosides (8). *A. baumannii* strains, an opportunistic pathogen associated bacteremia, pneumonia, meningitis and urinary tract infections, were reported resistant to multiple classes of antibiotics, including  $\beta$ -lactam, fluoroquinolones, tetracyclines, and aminoglycosides and has reached more than 70% in both OECD and non-OECD countries (9, 10). Worryingly, developing new antibiotics is less attractive for many large pharmaceutical companies. And most of the latest antibiotic found in the last 30 years like teixobactin, a peptide-like secondary metabolite, does not act against GNB (11). Thus, colistin and polymyxin B, polypeptide antibiotics belonging to the class of polymyxins, are reconsidered and expected to be the last resort to overcome these infections of multidrug resistant GNB (12, 13).

Colistin (also known as polymyxin E) and polymyxin B have a narrow antibacterial spectrum, mainly against common Gram-negative bacteria in which the bactericidal activity is mediated by their electrostatic-based interaction with the Lipid A component of lipopolysaccharides (LPS) (12). Since the early 2000s, polymyxins widely attracted clinical and research interest to ensure their optimum dosing and safety for the clinical uses due to their narrow therapeutic window (14). However, being increasingly used as a last-line clinical therapeutic option, the resistance rate of *E. coli*, *K. pneumoniae*, and *A. baumannii* to polymyxins has been pushed (7, 15). Lipopolysaccharides modification by the addition of 4-amino-4-deoxy-L-arabinose (L-Ara4N) and phosphoethanolamine (PEtN) in the lipid A is the most common resistance mechanisms developed by polymyxin-resistant Enterobacteriaceae, mainly *E. coli* and *K. pneumoniae* that decrease the net charge of lipid

A leading to decreased polymyxin affinity (16). Two-component systems (TCSs) involving PmrA/PmrB and PhoP/PhoQ have a role in these mechanisms wherein their activation is triggered by environmental stimuli and specific mutations, and subsequently, result in the alteration of LPS-modifying genes expression (17). Different from Enterobacteriaceae, non-fermentative bacilli *A. baumannii* provide two primary mechanisms in polymyxin resistance, including LPS modification by the alteration of lipid A and the complete loss of LPS as a result of inactivation of lipid A biosynthesis genes, *lpxA*, *lpxC*, and *lpxD*, lead to polymyxin resistance (18, 19).

For several years, polymyxin resistance has been known by the involving of chromosomal mutations but in 2015, Plasmid-mediated colistin resistance MCR-1 was firstly reported in China (20). Since strains containing MCR-1 isolated from human and animal have been detected all over the world (21). It was reported in *E. coli* study that *mcr-1* gene not only mediated polymyxins resistance by encoded the expression of PEtN in lipid A, as its primary mechanism, but also disturb the biosynthesis and transport of efflux pump lipoprotein which involved in polymyxin resistance (22). However, molecular impact of MCR-1 presence to lipopolysaccharide modification genes regulated by two-component systems is poorly described.



## ***CHAPTER 2***

# **LITERATURE REVIEW**





## I. POLYMYXINS: *The Arising of “Old” Class Antibiotics*

Polymyxins was approved for clinical use in the late 1950s and it is one of the primary classes of antibiotics with activity against most Gram-negative bacteria. The clinical use of colistin and polymyxin B was limited in 1970s due to their serious toxicity after parenteral administration, including nephrotoxicity and neurotoxicity. Between 1980s and 1990s its parenteral use was almost completely discontinued and they were then replaced by novel, more active and less toxic antimicrobial agent, such as aminoglycosides, quinolones and  $\beta$ -lactams (12, 13, 23). However, the increasing multidrug-resistant (MDR) Gram-negative pathogens together with the decrease of new antimicrobial agents in this last two decades has forced physician to reintroduce polymyxins antibiotics as a last-line therapeutic option against life-threatening infection (24, 25). As a consequence, since mid-1990s, colistin and polymyxin B are used as the last resort for the treatment of infections caused by carbapenem-resistant Enterobacteriaceae, *Acinetobacter baumannii*, and *Pseudomonas aeruginosa* that are resistant to all aminoglycosides, quinolones and  $\beta$ -lactams (14, 17). However, over the last 15 years, research and clinical interest to colistin and polymyxin B have increased and have attracted government and other public grant bodies to establish its preclinical and clinical research due to the increase of its use in clinical practice. Thus, to harmonize the information about its use, first international conference on polymyxins in Prato, Italy, in 2013 resulting 'Prato Polymyxin Consensus' was held, and subsequently maintained each year (26). Moreover, the international consensus guidelines for the optimal use of the polymyxins is finally available and published in 2019 showing a serious effort to optimize the clinical use of polymyxins (27).

---

## 1. DISCOVERY OF THE FAMILY “POLYMYXIN”

The polymyxins is a cyclic lipopeptide antibiotic that was originally isolated in 1947 from the soil bacterium *Paenibacillus polymyxa* subsp. *Colistinus* (previously known as *Bacillus polymyxa*) concurrently by three different research group (28–30). First published in United States of America by Benedict and Langlykee in July 1947 and then in the same month by Stansly et al., they were describing a secondary metabolite compound isolated and purified from *Paenibacillus polymyxa*, an antimicrobial substance which they named as “**Polymyxin**”. They found that this compound on agar could inhibited the growth zone of *Salmonella schottmuelleri* that often cause paratyphoid fever in poor and rural communities across North America during 1930s. One month later in 1947, Ainsworth and co-workers from England had published their research about the identification of an antibiotic compound from the soil organism identified as *Bacillus aerosporus* that they called as “**Aerosporin**”. “Polymyxin” and “Aerosporin” had selective antibacterial activity with activity against Gram-negative bacteria, and furthermore, later publication in a year after had identified that these two compounds showing the similar basic peptide (31). Subsequently, further research to identify the pharmacological properties and microbial activity of both compounds had described that the antibiotic called “**Aerosporin**” and “**Polymyxin**” had **a similar antibacterial spectrum and biological activity. It was concluded that these two antibiotics belonged to the same class of antimicrobial compounds** (32, 33).

A consensus had reached by an international agreement that for all antibiotics derived from *Paenibacillus polymyxa* was named as **Polymyxin** (34). Consequently, “Aerosporin” was renamed as **polymyxin A** and “Polymyxin” was renamed as **polymyxin D**. Moreover, during this period other polymyxins isolated from same *Paenibacillus polymyxa* were characterized as **polymyxin B, polymyxin C, and polymyxin E** (also known as **Colistin**) (35). Although each polymyxin group has similar chemical structures and show similar antimicrobial activity, they exhibited striking differences in their cell toxicity. It was performed

that polymyxin A, C and D showed severe reversible nephrotoxicity, while polymyxin B and polymyxin E (colistin) were less toxic after *in vivo* examination in dog and rabbit (36). **Generally, the polymyxin toxicity is associated by their N-terminal fatty acyl segment** (37). Further studies were performed then several reports had explained indicating the less renal injury were shown by colistin and polymyxin B among five polymyxins groups, and likely, this is a reason of only colistin and polymyxin B were available and preferably adopted in clinical practice until present (36, 38).

---

### 1.1. COLISTIN AND POLYMYXIN B

All polymyxins from each group were generalized by their similar pentacationic polypeptides structures like illustrated in **Table 1**, which are consisting of a cyclic heptapeptide amide-linked loop between the amino group of the side chain of **diaminobutyric acid (Dab)** residue at position 4 and carboxyl group of the C-terminal threonine residue, a linear tripeptide and a fatty acid tail linked to normal N-terminal of the tripeptide (14). **Polymyxin B** is generally defined by the presence of **D-phenylalanine residue at position 6**, L-leucine residue at position 7 and L-Dab residue at position 3 (Table 1). To date, seven individual polymyxin B components have been identified with **polymyxin B<sub>1</sub>** and **polymyxin B<sub>2</sub>** are **always the major lipopeptide components** with two minor components form the same “group” in its commercial formulations and the total of these major components content should be not less than 80% (39–41).

Interestingly with colistin, when it was firstly described, colistin was considered as a different entity from polymyxin antibiotics (42), until further chemical investigating determined that it has very similar structure with polymyxin E and it was concluded that they were a same compound (43). Colistin differ from polymyxin B in the amino acid component where the presence of **D-phenylalanine residue at position 6 of polymyxin B is replaced by D-leucine in colistin** (Table 1). To date, 11 individual colistin components have been

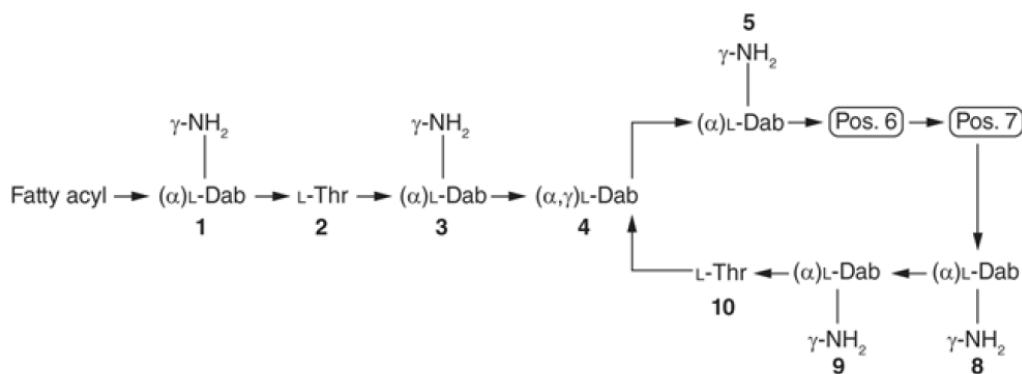
identified, and like polymyxin B, colistin consists of multicomponent with **colistin A (polymyxin E<sub>1</sub>) and colistin B (polymyxin E<sub>2</sub>) are the major lipopeptide** (44). It must constitute  $\geq 77\%$  of the total content of colistin A and colistin B together with three other minor components according to the British (BP) and European Pharmacopeias (Ph. Eur.). Either colistin or polymyxin B are natural products prepared by fermentation, so the proportion from each component can vary from each brand and even among the batches from the same manufacturer. The commercial formulations differ between polymyxin B and colistin will be discussed in detail in “*clinical use*” part, include their impacts on *in vivo* disposition.

Overall, polymyxins are molecules that contain rich of hydrophobic part and hydrophilic parts make them as **amphipathic compounds**.

- Hydrophobic and hydrophilic domains were separated by exo-cyclic linear tripeptide sequence and **cyclic ring heptapeptide giving these molecules as amphipathic structure that important for its antimicrobial activity**.
- **Dab residues (NH<sub>2</sub>) carrying positive charged of polymyxin** as hydrophilic part of polymyxin will bind to negative charged phosphate group of lipid A outer membrane and the hydrophobic part of polymyxins, **N-terminal fatty acyl group and hydrophobic residues (position 6 or 7), will make an hydrophobic contacts with fatty-acyl chains of lipid A**.
- These interactions will destabilized the Gram-negative bacteria outer membrane leading to the lysis of bacteria cells (45). Furthermore, this mechanism will be further detailed in the part of ‘*mechanism of action*’.
- Not only accounted for its antimicrobial activity, but also **the hydrophobic properties of the N-terminal fatty acyl group are presumably as the source of the nephrotoxicity of polymyxin** (13, 46).

**Table 1.** The chemical structures of polymyxin B and colistin (polymyxin E)

(adapted from Velkov et al., 2013 (14) ).



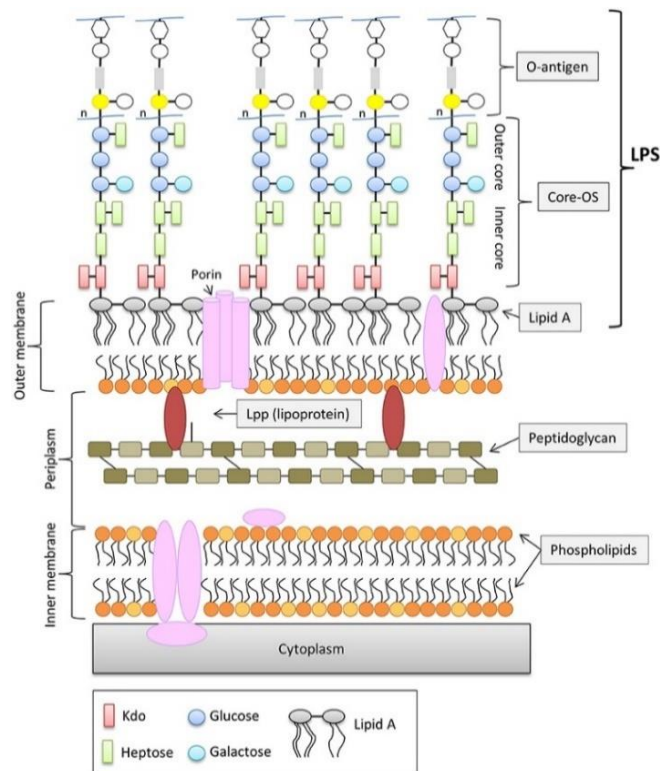
Polymyxin		Fatty acyl group	Pos. 6	Pos. 7
<b>Polymyxin B</b>	B <sub>1</sub>	(S)-6-methyloctanoyl	D-Phe	Leu
	B <sub>1</sub> - Ile	(S)-6-methyloctanoyl	D-Phe	Ile
	B <sub>2</sub>	6-methylheptanoyl	D-Phe	Leu
	B <sub>3</sub>	Octanoyl	D-Phe	Leu
	B <sub>4</sub>	Heptanoyl	D-Phe	Leu
	B <sub>5</sub>	Nonanoyl	D-Phe	Leu
	B <sub>6</sub>	3-hydroxy-6-methyloctanoyl	D-Phe	Leu
<b>Colistin/ polymyxin E</b>	E <sub>1</sub>	(S)-6-methyloctanoyl	D-Leu	Leu
	E <sub>1</sub> - Ile	(S)-6-methyloctanoyl	D-Leu	Ile
	E <sub>1</sub> - Val	(S)-6-methyloctanoyl	D-Leu	Val
	E <sub>1</sub> - Nva	(S)-6-methyloctanoyl	D-Leu	Nva
	E <sub>2</sub>	6-methylheptanoyl	D-Leu	Leu
	E <sub>2</sub> - Ile	6-methylheptanoyl	D-Leu	Ile
	E <sub>2</sub> - Val	6-methylheptanoyl	D-Leu	Val
	E <sub>3</sub>	Octanoyl	D-Leu	Leu
	E <sub>4</sub>	Heptanoyl	D-Leu	Leu
	E <sub>7</sub>	7-methyloctanoyl	D-Leu	Leu
	E <sub>8</sub> - Ile	7-methylnonanoyl	D-Leu	Ile

Pos.: Amino acid position

## 2. MECHANISMS OF ACTION AND ANTIBACTERIAL SPECTRUM

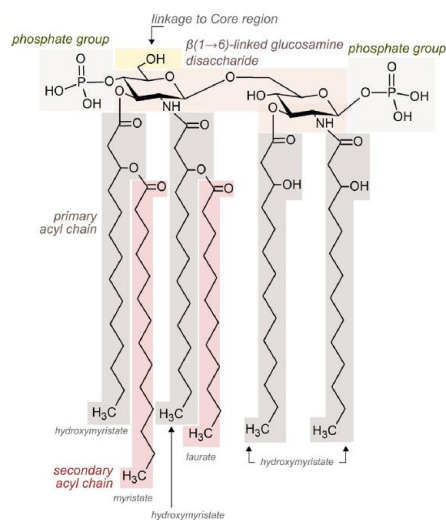
### 2.1. LIPOPOLYSACCHARIDE STRUCTURE OF GRAM-NEGATIVE BACTERIA

Different from Gram-positive bacteria, the cell envelope of Gram-negative bacteria (GNB) consists of the inner membrane, peptidoglycan, and are surrounded by an additional membrane, named outer membrane (OM) (Fig. 1). The outer membrane of Gram-negative bacteria play an important role to protect them from the external substances, including antimicrobial agents, whereas polyanionic lipopolysaccharide (LPS) of the outer membrane has an important role to regulate the compounds permeability (47). The Lipopolysaccharide molecule are divided into three parts, such as O-antigen, core polysaccharides and a hydrophobic component referred to as lipid A.



**Figure 1.** General schematic of the outer membrane of *E. coli* K-12 (adapted from Ebbensgaard et al., 2018 (48) ).

Lipopolysaccharide, the major compound in the outer membrane are important for the bacteria survival where their detailed structure could differ from one bacterial species to another and even could be different in the same bacterial species, which is given by their genetic information, but consistent for their basic structure (49). O-antigen repeats (O polysaccharide) are displayed on the surface of bacterial cells that made of a chain from several types of repeating sugar and act as hydrophilic polysaccharide (48, 49). Second part of LPS is core polysaccharide or core-R-antigen which consists of short chain of sugar, including glucose, galactose, heptose and 2-keto-3-deoxyoctonoic acid (KDO). Heptose and KDO are two unusual sugars and are usually present in the core oligosaccharide so it has been used as well as an indicator in LPS assays (50). The third part, **lipid A, is the lipid part of LPS and bind to core polysaccharide via six position of N-acetyl glucosamine (NAG) of lipid A**. Lipid A consists of a phosphorylated NAG dimer with 6 or 7 saturated fatty acid attached. In contrast to the O-antigen, Lipid A structure is highly conserved among GNB (48). As a major part to stabilize outer membrane structure, lipid A has role as main part of LPS endotoxin activity as well and recognized as a pathogen-associated molecule by immune-cells systems (49).



**Figure 2.** Detailed structure of Lipid A from *Escherichia coli* (adapted from Steimle et al., 2016 (51) ).

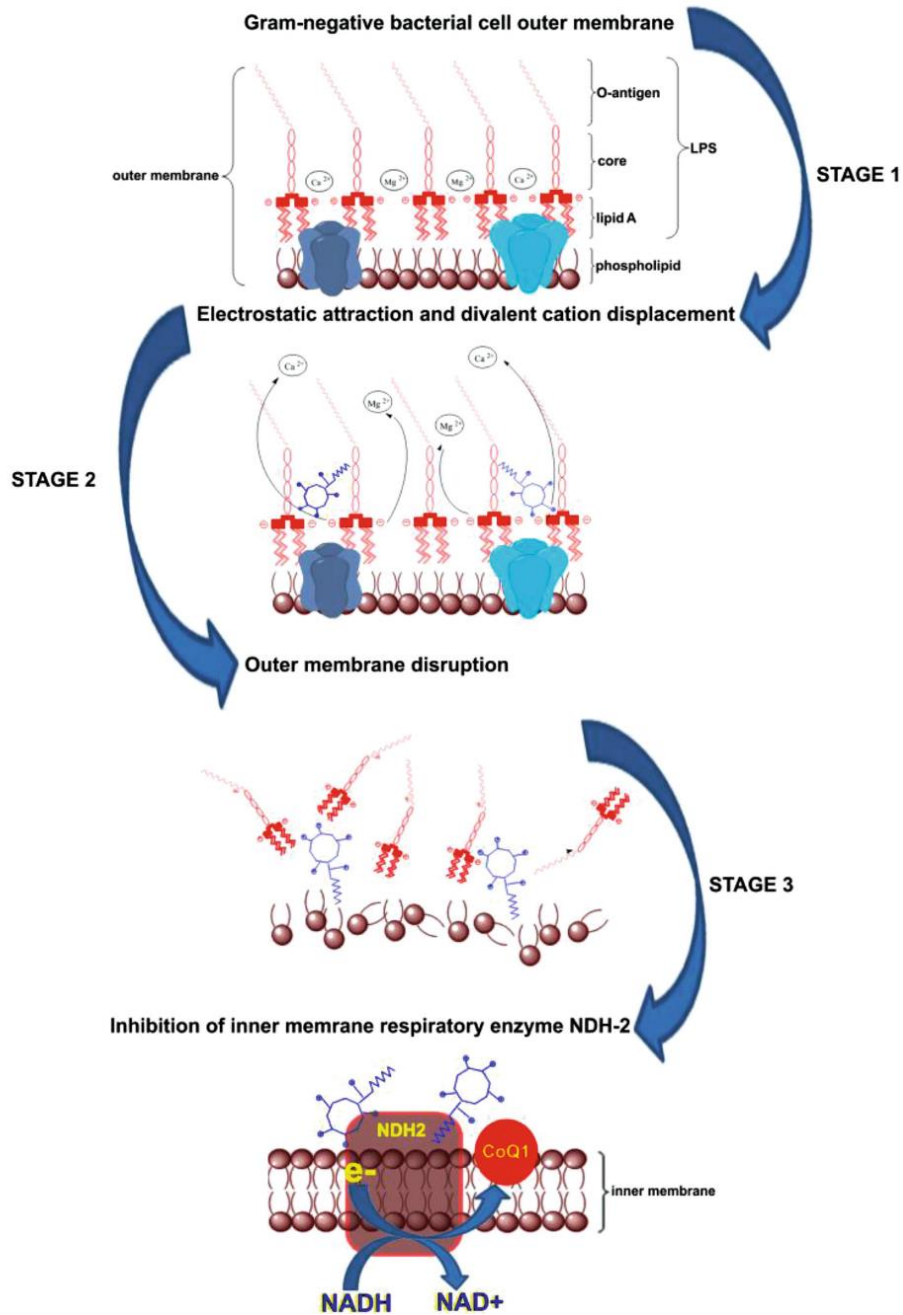
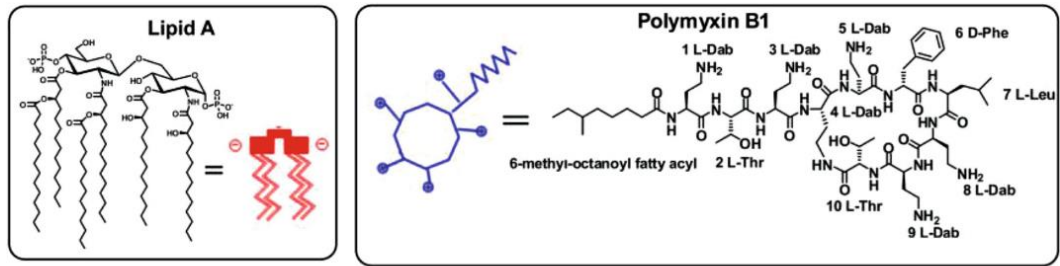


---

## 2.2. POLYMYXINS: *Mode of Action*

Lipid A has a key role in polymyxins antimicrobial action by their charged-based interaction. **Dab residues (NH<sub>2</sub>) carrying positive charged as hydrophilic part of polymyxin will bind to negative charged phosphate group of lipid A outer membrane, while the hydrophobic part of polymyxins, N-terminal fatty-acyl group and hydrophobic residues (position 6 / 7) will make a hydrophobic contact with fatty-acyl chains of lipid A.** These electrostatic and hydrophobic binding combination will produce a strong interaction between polymyxin molecule and LPS by forming an envelope-like fold conformation (45). Furthermore, **the positive charge of polymyxin will displace the membrane-stabilizing magnesium (Mg<sup>2+</sup>) and calcium (Ca<sup>2+</sup>) ions, which are important as a stabilizer for the outer membrane by bridging the adjacent lipid A molecules.** Displacing of these divalent cations will have an impact on destabilization of the outer membrane, increase cell permeability, leakage of cell-contents, lysis cell, and finally, bacterial cell death (45, 52–54). Bacteria cells lysis has a consequence at risk producing amount of endotoxins causing-fever agents and it was reported that colistin has a potent action to inhibit it by neutralizing the endotoxin (52).

The outer membrane is not the only target of polymyxins. As we can see in Figure 3, **secondary mode of action involved in their bactericidal activity is the ability to inhibit of bacterial respiration.** Based on available evidence, colistin and polymyxin B could inhibit NDH-2, a type II NADH-quinone oxidoreductases. It was suggested that the *N*-terminal fatty acyl chain and the positive charges of the polymyxin molecule are playing an important role for NDH-2 inhibitory activity (45, 55). NDH-2 in inner membrane of bacteria cells contains a non-covalently bound flavin adenine dinucleotide (FAD) prosthetic group and catalyzes the oxidation of NADH to NAD<sup>+</sup> coupled to reduction of quinone, which plays a key role in the production of energy (ATP Production) and bacterial respiration (55, 56).



**Figure 3.** Lipid A and Polymyxin B structures and its likely-mode interaction with outer membrane

(adapted from Z. Li & Velkov, 2019 (57) ).

## 2.3. ANTIBACTERIAL SPECTRUM

The structural similarities between colistin and polymyxin B are given by both compounds, many aspects, such as clinical uses, toxicity, mode of action, and antimicrobial spectrum activity are shared by both as well (58). For antimicrobial activity, they exhibit a narrow antibacterial spectrum, mainly against common Gram-negative bacteria.

**Table 2.** Antibacterial spectrum of colistin and polymyxin B

(adapted from Li et al., 2019 (12) ).

	<b>Enterobacteria- ceae</b>	<b>Non-fermentative GNB</b>	<b>Others</b>	<b>Mycobacterium</b>
<b>Susceptible</b>	<i>E. coli</i> , <i>K. pneumoniae</i> , <i>Citrobacter spp.</i> , <i>Enterobacter spp.</i> , <i>Salmonella spp.</i> , <i>Shigella spp.</i>	<i>Acinetobacter baumannii</i> , <i>Pseudomonas aeruginosa</i> , <i>Stenotrophomonas maltophilia</i>	<i>Haemophilus spp.</i> , <i>Bordetella pertussis</i> , <i>Legionella spp.</i> , <i>Aeromonas species (except Ae. Jandaei)</i>	<i>M. xenopi</i> <i>M. intracellulare</i> <i>M. tuberculosis</i> <i>M. fortuitum</i> <i>M. phlei</i> <i>M. smegmatis</i>
<b>Resistant</b>	<i>Proteus spp.</i> , <i>Providentia spp.</i> , <i>Serratia spp.</i> , <i>Brucella spp.</i>	<i>Burkholderia cepacia complex</i> , <i>P. pseudomallei</i> , <i>Moraxella catarrhalis</i> ,	Gram-positive bacteria, <i>Vibrio spp.</i> , <i>Morganella morganii</i> , <i>Helicobacter pylori</i> , <i>Neisseria spp.</i> (meningococci and gonococci), <i>Edwardsiella tarda</i> .	

---

### 3. ANTIMICROBIAL SUSCEPTIBILITY TESTING OF POLYMYXINS

Several studies have been published related to MIC distribution of colistin and polymyxin B against *E. coli*, *K. pneumoniae*, *A. baumannii* and *P. aeruginosa* by variety of method, including Etest® and agar dilution (60–62). Later, MIC determination for colistin and polymyxin B by disk diffusion methods was not recommended after a comparative study showing that disk diffusion testing methods failed to reliably detect polymyxin-resistant strains in clinical isolates of *Acinetobacter* spp, *Pseudomonas aeruginosa*, and Enterobacteriaceae (63, 64). Indeed, polymyxins as a polypeptide antibiotics have a difficulty to diffuse in agar resulting in small zones of inhibition (63). Although, a variety of studies exhibited a good result for the gradient diffusion test, such as E-test method (65–67), several studies revealed that this method failed to detect the resistance to the polymyxins of clinical carbapenem-resistant isolates of *A. baumannii* and Enterobacteriaceae (68). Likely with agar diffusion, this problem might be due to the polymyxin difficulty to diffuse in agar.

**A joint working group was established by Clinical and Laboratory Standards Institute (CLSI) and European Committee on Antimicrobial Susceptibility Testing (EUCAST) to recommend the most appropriate MIC determination** regarding by several methodological issues of *in vitro* susceptibility testing in polymyxins. The issues have been comprehensively investigated and it was agreed that ISO-Standard broth microdilution method (20776-1) is the best reference testing for Enterobacteriaceae, *Acinetobacter* spp., and *Pseudomonas aeruginosa* (64).

### 3.1. CLINICAL BREAKPOINTS

If a standard reference method has already been established, there is no consensus between these two professional organizations related to colistin and polymyxin B breakpoints. Before 2019, only *P. aeruginosa* and *A. baumannii* colistin and polymyxin B MIC breakpoints with no interpretive criteria for Enterobacteriaceae were provided by CLSI, which is only epidemiological cutoff values (ECVs) were used as clinical breakpoints. After a pharmacokinetic/ pharmacodynamic (PK/PD) review, outcomes and MIC distribution data, breakpoints for colistin and polymyxin B are available for Enterobacteriaceae, *P. aeruginosa* and *A. baumannii* but no interpretative criteria for polymyxin B in EUCAST guideline (69, 70). But based on breakpoints recommendations of *la Société Française de Microbiologie* (French Microbiology Society), interpretative criteria for polymyxin B were available based on colistin data (71). Only intermediate and resistant without susceptible category was suggested in CLSI guideline regarding to the limited clinical efficacy of colistin and polymyxin B even for isolates with MIC values <2 mg/L based on the clinical and PK/PD recommendation (further detail will be explained in “clinical use” part).

**Table 3.** Polymyxin breakpoints according to the CLSI and EUCAST guidelines

Microorganisms	Polymyxin	CLSI <sup>1</sup>			CA-SFM/ EUCAST <sup>2</sup>		
		MIC breakpoint (mg/L) <sup>3</sup>			MIC breakpoint (mg/L) <sup>3</sup>		
		S	I	R	S	I	R
Enterobacteriaceae	Polymyxin B	-	≤2	≥4	≤2	-	>2
	Colistin	-	≤2	≥4	≤2	-	>2
<i>Acinetobacter</i> spp.	Polymyxin B	-	≤2	≥4	≤2	-	>2
	Colistin	-	≤2	≥4	≤2	-	>2
<i>Pseudomonas</i> spp.	Polymyxin B	-	≤2	≥4	≤2	-	>2
	Colistin	-	≤2	≥4	≤2	-	>2

<sup>1</sup>Clinical and Laboratory Standards Institute, 2019 (69)

<sup>2</sup>Société Française de Microbiologie and European Committee on Antimicrobial Susceptibility Testing, 2020 (71)

<sup>3</sup>S, susceptible; I, intermediate; R, resistant; -, not determined

---

**Broth microdilution method was agreed as a standard reference method with following notes (64):**

- Cation-adjusted Mueller-Hinton Broth as the reference media
- No additives may be included (including polysorbate-80 or other surfactants)
- Trays must be made of plain polystyrene
- Sulphate salts of polymyxins must be used since an inactive *prodrug* of methanesulfonate derivative of colistin breaks down slowly in solution.

---

## 4. CLINICAL USE

---

### 4.1. COLISTIN

---

#### A. COMMERCIAL PREPARATION

---

At first introduction into clinical practice, colistin was commercially offered as a greater or equal antibacterial potency compared to polymyxin B but less toxic as its sulphomethylated derivative, sodium colistin methanesulphonate (CMS, colistimethate sodium, sodium colistimethate, penta-sodium colistimethanesulphate, sulphomethyl colistin) (58). **A common problem of polypeptide compounds is an induction of site painful irritation during subcutaneous or intramuscular injection that could be overcome by sulphomethylated derivatives**, which firstly introduced by Stansly and his co-worker in 1947. Sulphomethylation of colistin was firstly applied by Koyama in 1957 and still administered intravenously in the clinic until now (12, 72). Commercially, colistin is available in two forms, **colistin sulphate** (hereafter referred to as **colistin**) and **colistin methanesulfonate (CMS)**.

#### B. CLINICAL PRACTICE

---

Colistin is widely used as intravenous formulations as CMS, an inactive *prodrug*, to treat infections caused by MDR and extensively drug resistant (XDR) Gram-negative pathogens (27). CMS can be administered intramuscularly although is not commonly used in clinical practice regarding to its severe pain at the injection site and its variable absorption (12). Colistin has also been formulated for oral administration route for selective intestinal infection and is used as topical administration for bacterial skin, eye and ear infections (12). **However, colistin and its *prodrug* CMS are the only polymyxins approved for clinical use in the European countries based on the completes review of polymyxins-based medicine by European Medicines Agency (73).**

Compare to polymyxin B, CMS is preferred to treat urinary tract infection, because the conversion to colistin from its *prodrug* mostly in the urinary tract, but as consequently has a potential risk to renal injury as well (74). In addition, Intravenous CMS is indicated for the treatment of serious infections due to aerobic Gram-negative bacteria in patients with limited treatment options while inhalation of CMS is limited to chronic pulmonary infections due to *P. aeruginosa* with cystic fibrosis in adults with recommend dose is 1 to 2 million IU given 2 to 3 times a day and children 0.5 to 1 million IU twice daily (73).

**A target plasma colistin  $C_{ss,avg}$  of 2 mg/L for systemic administration of CMS was recommended based on three considerations** (75). First, it based on colistin binding in plasma which is around 50%. Second, to achieve its bactericidal activity with an MIC of 2 mg/L against an isolate on the thigh infection model. And third, both risk incidence and severity of **acute kidney injury (AKI)** are increased for concentration greater than 2 mg/L (27). Finally, to achieve this desired target average steady-state plasma concentration, determining the initial daily maintenance dose is required, and subsequently, monitoring creatinine clearance ( $Cl_{cr}$ ) and daily dose adjustment are also required (27).

---

## 4.2. POLYMYXIN B

### A. COMMERCIAL PREPARATION

---

**Polymyxin B is commercially available as polymyxin B sulphate** and not indicated for oral use and likewise. No sulphomethylated derivative of polymyxin B is available in clinical use. Like we explained in the previous chapter, sulphomethylated derivative of polymyxins are required to reduce the pain of injection site cause by lipopeptide agents. In 1961, the sodium salt of sulphomethylated derivative of polymyxin B has been used intramuscularly and intraventricularly in 5 patients with *P. aeruginosa* secondary meningitis infection. It was found as well that no toxicity observed, and all five patients cured (76). However, this derivative has never been applied into clinical practice until present for unknown reason



(Kwa et al., 2007). Polymyxin B is not prepared as a *prodrug*. In clinical use, polymyxin B sulphate can be used as intramuscular, intravenous, inhalation, intrathecal and topical routes preparations (58).

## B. CLINICAL PRACTICE

---

Like colistin, polymyxin B is available to treat infections cause by MDR and XDR Gram-negative bacteria by intravenous administration as the most often use in clinical (77). Intramuscular route is rarely used since it may cause local pain and not appropriate in polymyxin B nowadays. This antimicrobial is less active against lung infection but preferable used in invasive infections for routine systemic use regarding it shown an excellent PK profile compare to colistin with lower risk to cause nephrotoxicity (27). As a background, pharmacokinetic/ pharmacodynamic/ toxicodynamic (PK/PD/TD) of polymyxin B has never been defined before since it was firstly discovered. A very similar structure and antimicrobial spectrum shared by colistin and polymyxin B have made a conclusion that they have similar pharmacokinetic profile. The study always focused on CMS, the *prodrug* of colistin, and its result cannot be extrapolated as polymyxin B result whereas polymyxin B is administered as its active compound. Furthermore, a further study has found that polymyxin B exhibited a superior PK characteristic compare to CMS where it is reliable and rapidly achievable to maintain a desired concentration in human plasma, which is important for critically ill patients (27).

**The risk of renal injury is less found in polymyxin B compare to colistin and this is a potential advantage for its clinical use over CMS (78).** No need dose adjustment of polymyxin B for the patient with renal impairment because this drug is not eliminated in the kidneys, and in addition, a clinical PK studies show that polymyxin B clearance does not depend on creatinine clearance ( $Cl_{cr}$ ). Moreover, a large clinical study was started in 2016

and first result estimate published in 2020<sup>1</sup>. This is a first study about PK/PD/TD profiles of IV Polymyxin B on patients with pneumonia and/or bloodstream infection.

- Overall, colistin and polymyxin B exhibit an indistinguishable *in vitro* PD activity with identical potencies of antibacterial spectrum against MDR and XDR Gram-negative pathogens as shown by their MICs
- *In vitro* and murine thigh and lung infection models have been used to elucidate the PK/PD index of colistin while the available data for polymyxin B are fewer even rare. Free-drug area under the concentration-time curve to MIC ratio (*f*AUC:MIC) is the best PK/PD index to determine antibacterial activity, showing **a higher tolerated systemic dose of polymyxin B is needed to obtain 1 log<sub>10</sub> bacterial killing compare to colistin** (27). The highest tolerated dose of polymyxin B to obtain 2 log<sub>10</sub> reduction in bacterial count was not achieved whereas **it can be achieved by colistin with the dose still appropriate to reach C<sub>ss,avg</sub> of 2 mg/L as a target plasma of colistin** (27).
- In contrast in human, **polymyxin B shown an excellent PK characteristic compare to colistin**, since polymyxin B is administered as its active compound with lower risk to cause nephrotoxicity although CMS is preferred to treat urinary tract infection because the conversion to colistin from its *prodrug* mostly in the urinary tract (27).

As a recommendation, clinicians should have access to these both parenteral products so they can choose the better option in any particular circumstances.

---

<sup>1</sup> <https://clinicaltrials.gov/> Identifier : NCT02682355.



## II. GRAM-NEGATIVE BACTERIA: *Emergence of Multidrug Resistance Pathogen*

Antimicrobial resistance is the ability of a microorganism to resist the action of one or more antimicrobial agents (5). Each year, more than 670.000 infections due to bacteria with antimicrobial resistance occur in European Union countries causing 33.000 deaths and costs about 1.1 billion euros for the health care systems of European countries (79). A list of priority pathogens identified by WHO revealed that carbapenem-resistant Gram-negative *Acinetobacter baumannii* and Enterobacteriaceae, mainly *Escherichia coli* and *Klebsiella pneumoniae*, as a first priority in urgent need for new treatment since the effective therapeutic options are rapidly lose their efficacy against life-threatening infections cause by these pathogens (Fig. 4) (5, 6).

*P. aeruginosa*, *A. baumannii*, *K. pneumoniae* and *E. coli* are the most common GNB that may cause healthcare-acquired infections and they may develop resistance to almost classes of antibiotics by multiple mechanisms (11). In this part, we focused on two Gram-negative Enterobacteriaceae, particularly *E. coli* and *K. pneumoniae*, and a non-fermentative bacillus isolate, *A. baumannii*.

---

### 1. ENTEROBACTERIACEAE

*E. coli* and *K. pneumoniae* are by far the most common Enterobacteriaceae that can cause both hospital- and community-acquired infections (3). **Resistance percentages were generally higher in *K. pneumoniae* than in *E. coli***, and moreover, the emergence of carbapenems-resistant Enterobacteriaceae and Extended-spectrum- $\beta$ -lactamase (ESBL)-producing Enterobacteriaceae are rising over the last decade thereby classified them as the pathogen that urgent and serious to treat (80, 81). In this part we detailed more about

pathogenic *E. coli* and *K. pneumoniae*, including the epidemiology and their resistance to several antimicrobial agents.

### Priority 1: CRITICAL<sup>#</sup>

*Acinetobacter baumannii*, carbapenem-resistant  
*Pseudomonas aeruginosa*, carbapenem-resistant  
*Enterobacteriaceae*\*, carbapenem-resistant, 3<sup>rd</sup> generation cephalosporin-resistant

### Priority 2: HIGH

*Enterococcus faecium*, vancomycin-resistant  
*Staphylococcus aureus*, methicillin-resistant, vancomycin intermediate and resistant  
*Helicobacter pylori*, clarithromycin-resistant  
*Campylobacter*, fluoroquinolone-resistant  
*Salmonella spp.*, fluoroquinolone-resistant  
*Neisseria gonorrhoeae*, 3<sup>rd</sup> generation cephalosporin-resistant, fluoroquinolone-resistant

### Priority 3: MEDIUM

*Streptococcus pneumoniae*, penicillin-non-susceptible  
*Haemophilus influenzae*, ampicillin-resistant  
*Shigella spp.*, fluoroquinolone-resistant

\*Enterobacteriaceae include: *K. pneumoniae*, *E. coli*, *Enterobacter spp.*, *Serratia spp.*, *Proteus spp.*, and *Providencia spp.*, *Morganella spp.*

**Figure 4.** Priority pathogen list identified by WHO for new antibiotic research and development (World Health Organization, 2017 (6) ).

---

## 1.1. PATHOGENIC *ESCHERICHIA COLI*

First identified in 1885, *Escherichia coli* has become one of the most bacterial species that comprehensively studied. They are easy to grow and easy to manipulate in the laboratory scale, such as genetic manipulation, and naturally acquired mobile genetic elements (82, 83). Apart from their beneficial as flora normal for human and animal intestine, some *E. coli*

strains have evolved pathogenic mechanisms and may cause the disease in human and animal as well (82, 83). Habitat and genetic exchange are the primary reasons why *E. coli* can progress to many different forms of disease symptoms and outcome (83). Virulence factors and secreted protease, that are differently produced from one strain to another and are crucial determinants for the progression of these bacteria to cause a wide variety of disease (84). Based on their infection site, pathogenic *E. coli* are determined into two group, namely enteric or intestinal pathogenic *E. coli* that may cause diarrroghenic syndrome or other intestinal disease, and extraintestinal pathogenic *E. coli* (ExPEC) as a causes of extraintestinal disease, such as urinary tract infection (UTI), haemolytic uremic syndrome (HUS) and meningitis (82–85).

#### A. EPIDEMIOLOGY OF *E. COLI* INFECTIONS

---

*E. coli* is one of Gram-negative bacteria that might cause nosocomial infections. They cause 12-50% of hospital-acquired infections and associated with 4% cases of diarrheagenic syndrome. In United States, *E. coli* is the primary cause of both community-acquired acquired and nosocomial urinary tract infection (UTI) with up to 50% prevalence mostly in female because of the urinary tract anatomical structure difference with male (85, 86), while in tropical countries, EPEC is the leading cause of childhood diarrhea (86). ETEC is the most common pathogen that cause traveler's diarrhea for the visitors in several developing countries (86). Neonatal meningitis-causing *E. coli* cause 8% mortality rate and most of the survivors have developed neurological complications and septicemia associated with *E. coli* has similar mortality and morbidity rate same as with aerobic Gram-negative bacilli (86). In Europe, *E. coli* outbreaks were mostly caused by EHEC (87). STEAEC strains were reported mostly in Central Europe and responsible for Germany outbreak during 2011 with more than 900 of HUS. Urinary tract infections caused by MDR UPEC strains have been increased in Europe, with the most prevalence cases are Spain and Italy (87).

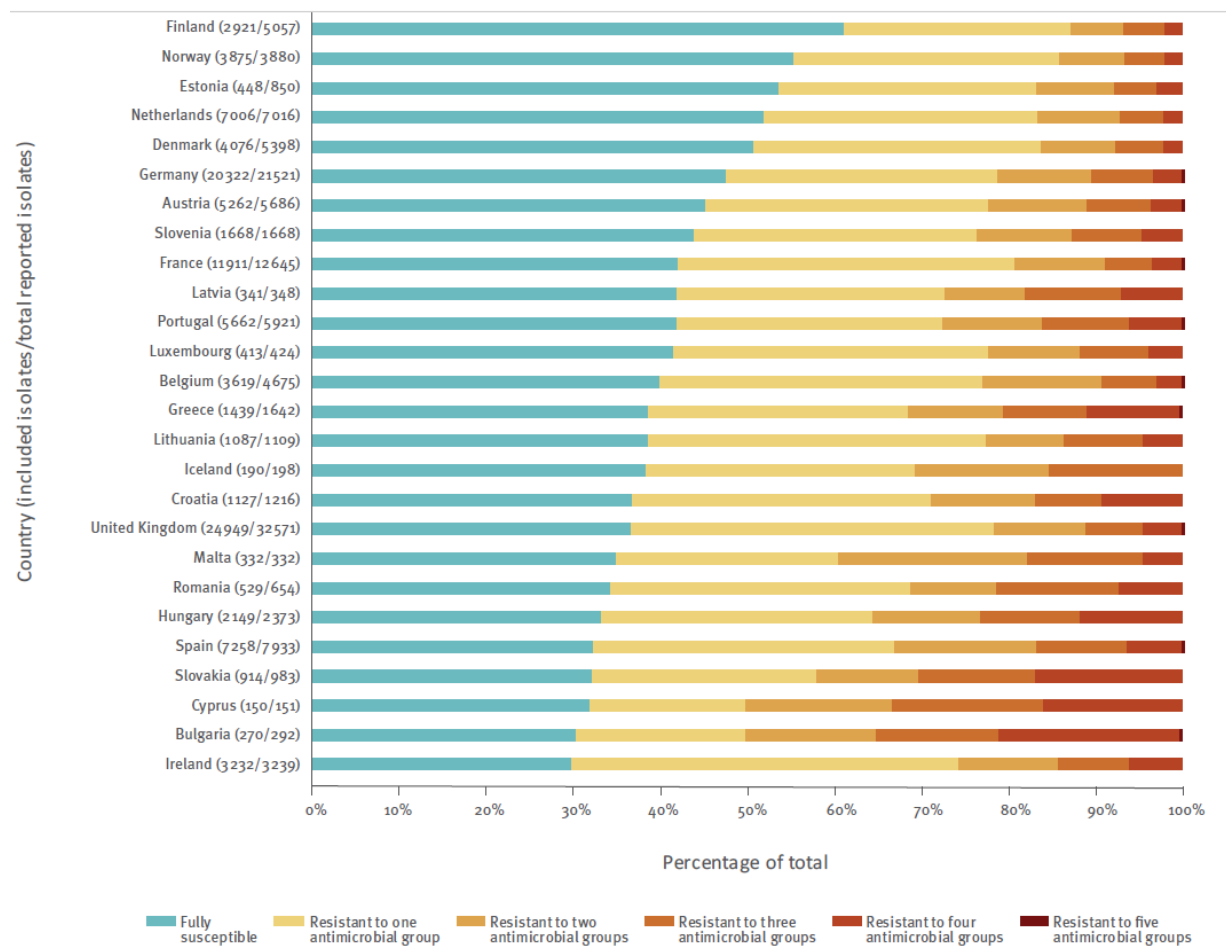
In France, an epidemiological studies of carbapenemase-producing *E. coli* shown that most carbapenem resistant strains were found in urine samples (67.9%), followed by blood, bile and wound samples at 7.5%, 7.5% and 5.6%, respectively (88). Among the 140 studied isolates collected from Paris and suburbs, the Northeast of France and the southeast of France, 74.3% of isolates produced an OXA-48-like carbapenemase which are categorized as susceptible to imipenem according to EUCAST breakpoints but still controversial for *in vivo* results (88). The other isolates produced class B metallo- $\beta$ -lactamases, NDM-type (20.7%) and VIM-type (3.6), and KPC-3 carbapenemase (0.7%). Fifty different sequence types (STs) have been identified from the total isolates showing a large diversity of these carbapenemase-producing *E. coli* isolates (88). However, all isolates susceptible to colistin (100%) and only 95% and 96% of the isolates are susceptible to Fosfomycin and nitrofurantoin, respectively (88). Among carbapenemase-producing *E. coli* cases, OXA-48-producing *K. pneumoniae* was found, suggesting an *in vivo* transfer in patient's gut and support the previous findings that dissemination across diversified species among *Enterobacteriaceae* is possible (88). **Among Enterobacteriaceae isolates, *E. coli* remains the second most common strains producing carbapenemase (31.5%) behind *K. pneumoniae* (38.5%) (88).**

## B. ANTIMICROBIAL RESISTANCE IN *E. COLI*

---

Broad spectrum antimicrobial agents are recommended and often used to treat community- and hospital-acquired infections cause by *E. coli*, such as  $\beta$ -lactams (particularly third generation cephalosporins), fluoroquinolones, aminoglycosides and trimethoprim-sulfamethoxazole, although nitrofurantoin and fosfomycin are used in several countries where the failure rate of fluoroquinolone treatments is high (89, 90). But since late 1990s the emergence of antibiotic resistance is on rise, the management of therapy is becoming complicated (3, 90). This species has an ability to accumulate genes encoding resistance, mostly through horizontal gene transfer. It was reported that the acquisition of genes

encoding extended-spectrum  $\beta$ -lactamases (resistance to broad-spectrum cephalosporins), plasmid-mediated quinolone resistance (resistance to fluoroquinolone), 16S rRNA methylases (resistance to aminoglycoside) and an increasing threat is carbapenemases, which may confer resistance to carbapenems and all available  $\beta$ -lactam antibiotics (3, 7, 90). Furthermore, the ability of Enterobacteriaceae to spread these resistance genes via cross-transfer of plasmid between inter-species and between animal and human made it worse to play a role in emergence of multidrug GNB.



Data are only displayed for countries providing this information for 50% or more of the isolates.

\* Only data from Isolates tested against all included antimicrobial groups (aminopenicillins, fluoroquinolones, third-generation cephalosporins, aminoglycosides and carbapenems) were included in the analysis.

**Figure 5.** Distribution of *E. coli* isolates fully susceptible and resistance to one or more antimicrobial groups in EU/EEA countries in 2018 declared by European Centre for Disease Prevention and Control (ECDC), 2019 (3)



Figure 5 reported *E. coli* resistance in European countries between 2015-2018 over five antimicrobial group under regular surveillance, including aminopenicillins, fluoroquinolones, third-generation cephalosporins, aminoglycosides and carbapenems. Over than half (58.3%) of *E. coli* isolates were resistant to at least one antibiotic family with the highest percentage is aminopenicillins (57.4%) followed by fluoroquinolones, third-generation cephalosporins, and aminoglycosides at 25.3%, 15.1% and 11.1%, respectively, while carbapenems resistance remains rare. Higher resistance percentages generally reported from southern and eastern Europe. More than half *E. coli* infections in European countries were caused by antimicrobial-resistant *E. coli* with large inter-country variations in the use of broad-spectrum antimicrobials (3).

---

## 2.1. *KLEBSIELLA PNEUMONIAE*

First described in 1882, *Klebsiella pneumoniae* was a species isolated from the lungs of patients who died from pneumoniae (91). Similar with *E. coli*, this species is considered as commensal and opportunistic pathogen that is widely found in the mouth, skin and intestine. *K. pneumoniae* is the third leading cause of hospital-acquired infection (HAIs) since it is often found in hospital setting and medical devices as well (92). Furthermore, *K. pneumoniae* can be found in urinary tract, respiratory tract and blood causing UTIs, pneumoniae and bloodstream infections (91–93). In most case, *K. pneumoniae* infections occur during hospitalized or in patients with immunocompromised (94).

Colonization of gastrointestinal tract is an important reservoir for *K. pneumoniae* in healthcare-associated infections (95, 96). Disease-associated immunosuppression have been identified as another risk factor for community- and hospital-acquired infection of *K.*

*pneumoniae* such as cancer, diabetes mellitus and alcoholism (97–99). Electrolyte and fluid disorder, neurologic disorder, and prior hospital admission have been identified as well as risk factor associated with hospital-acquired infection (96).

*K. pneumoniae* employs several virulence factors (VFs) for survival, mostly on their surface structure, and in evading the host immune defense during infection, such as capsule polysaccharide, lipopolysaccharide, outer membrane protein (OmpA and OmpK36), and the efflux pump AcrAB (91, 92). LPS variations have been found that play a role in the emergence of *K. pneumoniae* resistance to antimicrobial peptide such as polymyxin antibiotic that will be further detailed in the chapter 3 of “*polymyxins resistance*” (100). The emergence of hypervirulent *K. pneumoniae* (hvKp) infections are on rise at last 3 decades (91, 101). hvKp is an evolving pathotype of classical *K. pneumoniae* (cKp) and more virulent (101). Clinicians are familiar with cKp as an opportunistic pathogen but hvKp is the best describe as a virulent pathogen.

#### A. EPIDEMIOLOGY OF *K. PNEUMONIAE* INFECTIONS

---

*Klebsiella pneumoniae* is the third leading cause of hospital-acquired infections after *Clostridium difficile* and *Staphylococcus aureus* in the United States (9.9%) and the third cause of hospital-acquired pneumonia for ICUs patients receiving ventilator after 48 hours hospitalized, still in the same country (102). This species is also the second leading cause of bloodstream infection with mortality rate around 20-30% or 1.3 per 100,000 people in US (93, 102). UTI is the most common infection caused by *K. pneumoniae* either associated with diabetes mellitus or catheter-associated UTIs (103). *K. pneumoniae* was also reported to be responsible for 13% of wound/surgical site infections (102).

The prevalence of Kp infections in Western countries range from 5-35%, while in Asian countries were various from 18% to 87.7% in stool from health adults (95, 104). Nasopharyngeal colonized by *K. pneumoniae* in healthy humans are 1-5% in western

countries while in Indonesia it was found 7% in children <10 years and increase with age (15% in adults) (105). In Indonesia, *K. pneumoniae* was the most common bacterial agent identified and potential increase the incidence of infection (14%) (105). However, obtaining data from hvKp is quite challenging since the specific biomarkers are not always used to determine it from cKp. In Korea, hvKp colonization was found 4.6% in healthy humans (based on K1 capsule and ST23) and It was found 1.3% in Australia. hvKp colonization rates were found various in Asian countries, from 0-16.7% based on K1 and K2 capsule types which are not really specific for determination (104). However, the hvKp prevalences are being reported increasing worldwide and with this awareness, the valid biomarkers are hopefully established in the future in order to help the clinical therapy decisions leading to good therapy outcome (106). The hvKp proportion data in various geographic locales are summarized in Table 3.

**Table 4.** Estimation of hvKp <sup>a</sup> proportion among *K. pneumoniae* infections  
(Adapted from Russo & Marr, 2019 (107) ).

Country	Time frame	Isolate source/characteristic	No./total (%) of hvKp infections
Australia	2001-2014	Urine	3/193 (1.6)
Australia	2001-2014	Mixed clinical (minus urine)	19/141 (13.5)
Canada (Alberta)	2001-2007	Community-acquired blood isolates	9/134 (6.7)
Canada (Quebec)	2009-2013	Blood isolates	1/110 (0.9)
China	2015	ST11, carbapenem resistant	11/387 (3)
China	2008-2012	Blood isolates	32/70 (46)
China	2014-2016	Carbapenem-resistant isolates	32/66 (48.5)
China	2014-2016	Carbapenem-sensitive isolates	31/45 (68.9)
India	2014-2015	Urine, respiratory, and blood isolates	3/370 (0.8)
India	2014-2015	Carbapenem-resistant blood isolates	6/86 (7)

Japan	2011-2012	Sputum and urine isolates	22/130 (16.9)
Nepal	2008-2012	Mixed clinical	1/131 (0.76)
Spain (Barcelona)	2007-2013	Blood isolates	37/878 (4.2)
UK (Oxford)	2008-2011	Blood isolates	4/69 (5.8)
USA (Texas)	2009-2010	Clinical isolates	4/64 (6.3)
USA	2013	Carbapenem-resistant blood isolates	0/97 (0)
USA	2007-2013	Urine isolates	1/191 (0.5)
USA	1937-2014	Mixed clinical isolates (minus urine)	26/490 (5.3)
Vietnam	2003-2009	Mixed clinical isolates	16/41 (39)

<sup>a</sup> Defined by the presence of *iuc* or *rmpA* or *rmpA2*

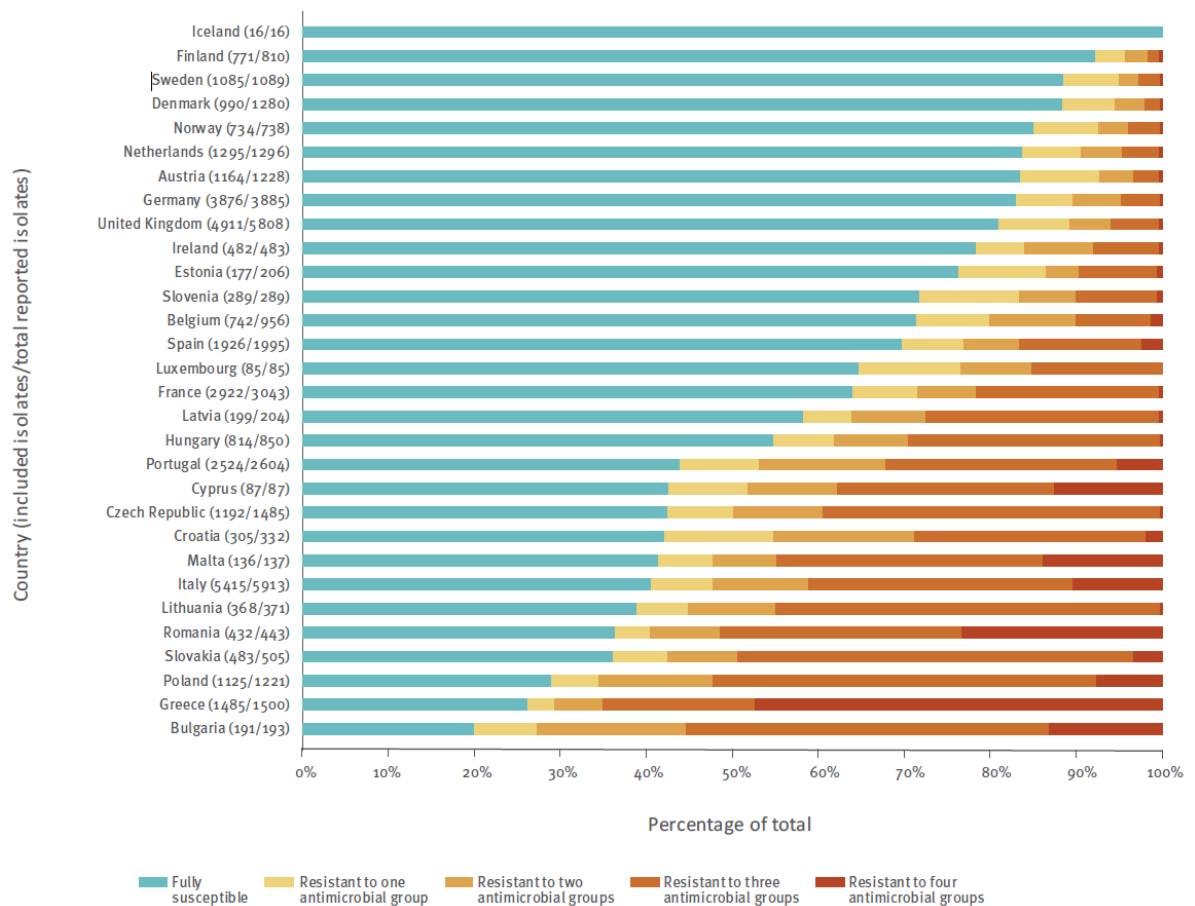
In France, hvKp has emerged in last decade and these infections caused multi-organ failure compare to non-hvKp infections (108, 109). A 5 years observation study in a France hospital displayed that more than half (55,9%) *K. pneumoniae* infections were acquired in the ICU (108). 45.5% of these acquired-infections are associated with ventilator-acquired pneumoniae and 46.1% of acquired-ICU *K. pneumoniae* infections were caused by hvKp (108). This study also revealed that the initial infections of hvKp and non-hvKp were mostly in lung in patients with immunodepression and type-2 diabetes characteristic, and currently, hvKp are emerging as the main pathogen with liver abscesses (108, 109).

## B. ANTIMICROBIAL RESISTANCE IN *K. PNEUMONIAE*

---

To date, it is impossible for clinical microbiology laboratories to differentiate between classical Kp and hvKp isolates that cause the infections leading to the failure therapy outcome. This is important since the rapid initiation of a therapy to prevent or to minimize the subsequent spread of hvKp infection corresponding to a specific infection site, such as meningitis and endophthalmitis, is needed (101). Similar to *E. coli*, therapy for *K.*

*pneumoniae* infections become more challenging with the plasmid-mediated antimicrobial resistance acquired by MDR or XDR classical Kp and these plasmid-mediated resistances can be acquired and integrated by hvKp strains. Many novel variations of ESBL were found in *K. pneumoniae* and subsequently were displayed in *E. coli* isolates. Broad-spectrum  $\beta$ -lactams (except ampicillin and ticarcillin that are intrinsically not active in *K. pneumoniae* strains), aminoglycosides, trimethoprim-sulfamethoxazole, tetracycline, fluoroquinolones and carbapenems are commonly used to treat susceptible isolates (101). For carbapenem-resistant strains, ceftazidime-avibactam, colistin and tigecycline were commonly used although these agents were active *in vitro* but in some cases were not effective against KPC2-producing XDR hvKp strain during a lethal ICU outbreak (110).



**Figure 6.** Distribution of *K. pneumoniae* isolates fully susceptible and resistance to one or more antimicrobial groups in EU/EEA countries in 2018 declared by European Centre for Disease Prevention and Control (ECDC), 2019 (3)

In European countries, more than third of *K. pneumoniae* isolates are resistant to at least one antibiotic (Figure 6) with the highest resistance percentage showed by third-generations cephalosporins (31.7%), then by fluoroquinolones, aminoglycosides and carbapenems at 31.6%, 22.7% and 7.5%, respectively (3). Fluoroquinolones and carbapenems resistance trend were significantly increased during 2015 until 2018. In last 2018, the resistance population over three combined antimicrobials, including fluoroquinolones, third-generation cephalosporins and aminoglycosides were reported increased in European countries at 19.6% but these did not differ significantly compared to the three years before. Similar with *E. coli* data, there were large inter-country variations among European countries for antimicrobial groups under regular surveillance. Higher resistance percentage generally reported from southern and eastern Europe than from northern Europe (Figure 8) with the highest percentage of carbapenems resistance were reported from these countries as well. Similar to *E. coli*, antimicrobial stewardship among European countries are needed to establish and targets for the reduction of antibiotic use in human should be considered, regarding to the wide inter-country variations of the resistance population among these countries.

---

## 2. NON-FERMENTATIVE BACILLI : *ACINETOBACTER BAUMANNII*

Among *Acinetobacter* pathogenic species, *Acinetobacter baumannii* is the most successful Gram-negative pathogens responsible for 2-10% hospital-acquired infections of all Gram-negative bacteria and one of the most important opportunistic pathogens responsible for skin, bloodstream, urinary tract and other soft tissues infections (111, 112). Since the first identification in 1986, *A. baumannii* has been described as a soil organism and were thought to not be able to cause significant human disease, but later it has started attracting the attention during the Iraq war when US veteran and soldiers with traumatic wound have been reported showing the lethal infection caused by *A. baumannii* also referred as “Iraqibacter” strain (83, 112, 113). This Multidrug-resistant (MDR) Iraq strains has been brought along to the United States by wounded soldiers and has rapidly become an opportunist disease-causing in Walter Reed hospital then rapidly spread to the other hospital around the country (114). It is not clear whether this Iraq strain was unusually virulent, or it just happened during the war since there is nothing known about their virulence factor during that time and other susceptible strain were presented at the same time (83, 114).

As an opportunistic Gram-negative pathogen, the most interesting part of *A. baumannii* is their ability to persist in nosocomial environment since this ability is the initial step how they develop to opportunistic infection. Health-care environments include the routine disinfection and desiccation period are commonly routine sterilization, but *A. baumannii* develop several mechanisms to resist disinfection, desiccation and oxidative stress (115). *Acinetobacter baumannii* employs several virulence factors but relatively few have been identified compare to the other Gram-negative bacteria, such as porin, capsular polysaccharide, lipopolysaccharide, phospholipase, outer membrane vesicles (OMVs) while more studies have focused on their siderophore-mediated acquires iron acquisition systems and biofilm formations (112, 114).

---

## 2.1. EPIDEMIOLOGY OF *A. BAUMANNII* INFECTIONS

As one of primary cause nosocomial infection in patients hospitalized in intensive care unit (ICU), *A. baumannii* is responsible for almost 90% among all *Acinetobacter* infections that caused ventilator-associated pneumoniae, septicemia, meningitis, peritonitis, UTIs and wound infections (114, 116). Among these, hospital-acquired pneumoniae and bloodstream infections are the most common clinical manifestation of *A. baumannii* in ICUs. The patients with risk factors, such as in patients with lower respiratory tract infections and intravascular devices followed by immunosuppression, ventilator-associated respiratory failure, previous antibiotic therapy are particularly exposed (116–118).

Overall, epidemiology in several European countries have shown various results. Prevalence studies in the UK and Germany shown that *A. baumannii* isolates are rarely found in the healthy patients but predominates in hospital infections (119). In Switzerland, around 9.2% (58 per 632 cases) of carbapenem-resistant or intermediate strains were identified from 2005-2016 whereas various results have been shown from each region but stable over the studied period (120). A study in France from December 2010 until August 2011 collected from 1,213 healthcare facilities have been identified that the most frequent infections associated carbapenems-resistant *A. baumannii* isolates were respiratory (34%), blood (19%), and cutaneous (19%) infections with colonization were mostly found in gastrointestinal tract (46%) and respiratory (36%) (121). Intensive care units are the hospital ward where the most cases have been found (53%) in France, followed by medical wards, chirurgial wards and burn care centers with 21%, 15% and 1.5%, respectively. The mortality rate was reported of 17.7% from the same studies periods (121).

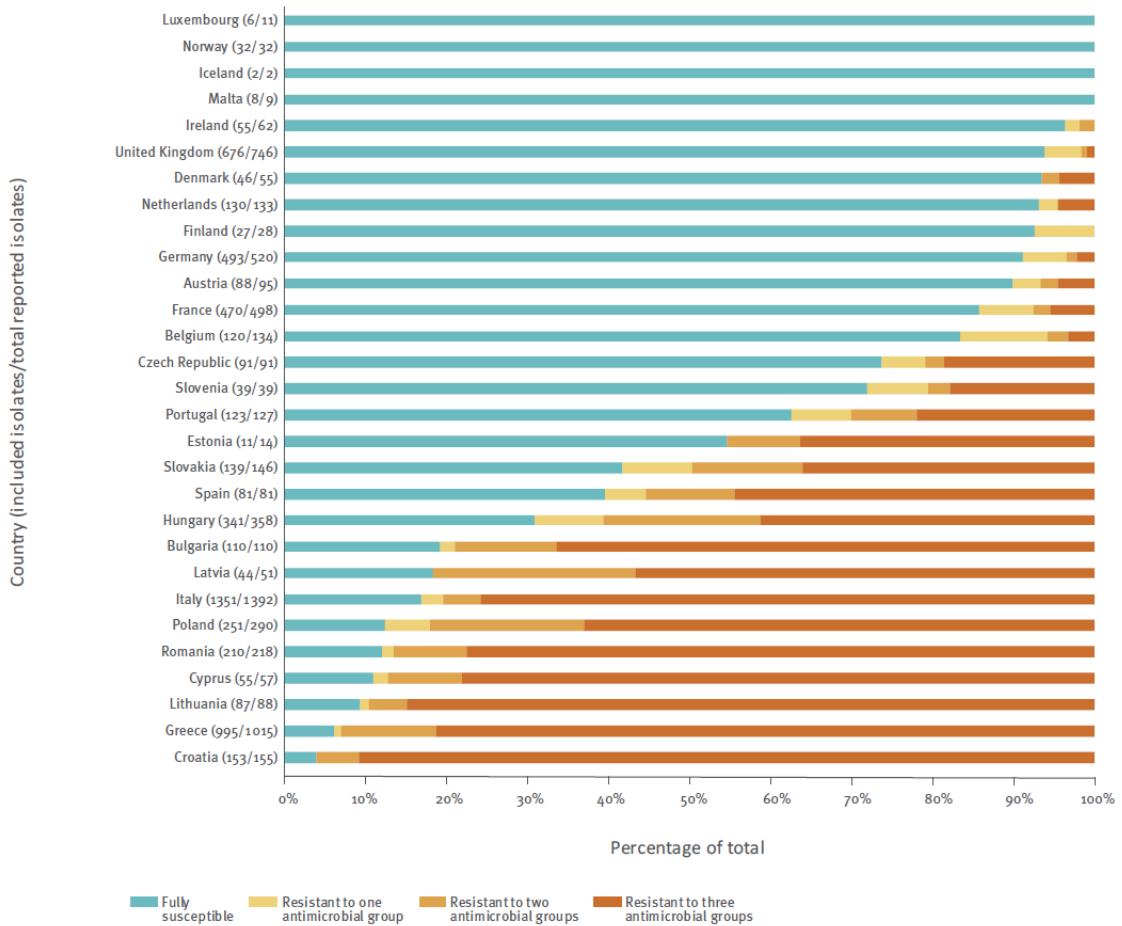


---

## 2.2. ANTIMICROBIAL RESISTANCE IN *A. BAUMANNII*

The emergence of carbapenem-resistant *A. baumannii* are on rise with the cases rates are more than 90% all over the world and responsible for the high significantly mortality rate compares to the carbapenem-susceptible *A. baumannii* strains (122). In France, the carbapenem-resistant *A. baumannii* population is polyclonal with eleven sequence types have been identified so far. Around 82% of the total isolates harbored the BLA<sub>OXA-23</sub> gene which is responsible for imipenem resistance (121). Polymyxins (colistin and polymyxin B), tigecycline, minocycline, sulbactam and amikacin often used as a current therapeutic option for carbapenems-resistant isolates (122). Drug combinations of these drugs have been used as well for carbapenems-resistant *A. baumannii* infections whereas no significant superior results either in preventing the resistance or its clinically outcome compare to monotherapy have been provided (123, 124).

From the Figure 7, the resistance to one or two antimicrobial group was less common compare to fully susceptible isolates or combined resistance to all three antimicrobial groups (fluoroquinolones, aminoglycosides and carbapenems). For the single resistance to one antimicrobial group, the highest mean resistance percentage was reported from fluoroquinolones with 36.2%, followed by aminoglycosides and carbapenems that respectively shown similar percentages to 31.9% (3). A large variation was exhibited among European countries with higher resistance were generally reported from Baltic countries and southern and eastern Europe. However, based on the rapid risk assessment of ECDC in 2016, the high-standard infection control and antimicrobial stewardship program has been improved as an effort to face the significant threat of carbapenem-resistant *Acinetobacter baumannii* in all EU/EEA countries (125).



**Figure 7.** Distribution of *Acinetobacter* species fully susceptible and resistance to one, two and three antimicrobial groups (fluoroquinolones, aminoglycosides and carbapenems) in EU/EEA countries in 2018 declared by European Centre for Disease Prevention and Control (ECDC), 2019 (3)



### III. POLYMYXIN RESISTANCE IN GRAM-NEGATIVE BACTERIA

The global spread of multidrug resistant (MDR) among Gram-negative bacteria has led to the resuscitation of polymyxins, including colistin and polymyxin B (17, 126, 127). In the last two decades, polymyxins have been limited to be used as a last resort treatment for infections, particularly by carbapenem-resistant *P. aeruginosa*, *Acinetobacter baumannii*, *Klebsiella pneumoniae* and *Escherichia coli* (12, 16, 128).

However, with the increased use of polymyxins, the emergence of polymyxin-resistant Gram-negative pathogens are on rise and increasing worldwide (17, 38, 126). The prevalence of colistin resistance varied between regions and over time with the majority reports was less than 10% (129). China is considered as the world's highest users of colistin in agriculture, while Germany, Portugal, Italy, and Estonia have shown a higher user than other European countries (130). A global survey of polymyxin use was disseminated to relevant experts worldwide from 56 different countries (131). Around 45/56 countries (80%) had used of colistin in clinical practice while the rest had no access to colistin. Majority of respondents use colistin (64.1%) but only a few use polymyxin B (1.4%). This survey reveals that colistin is commonly used underdosage with only 21.2% of respondents administered a colistin-loading dose in their treatment, mainly in Europe and North America (131). The exposure of suboptimal dosage of colistin is a risk factor for the emergence of polymyxin-resistant strains in Gram-negative bacteria (38).

**Initiating therapy with loading dose was recommended to achieve a target average colistin plasma concentration at steady state ( $C_{ss,avg}$ ) of 2 mg/L, where  $C_{ss,avg}$  lower than 2 mg/L may reduce the bacteria susceptibility to colistin (27, 132).**

Although polymyxins have already been considered as highly nephrotoxic and neurotoxic the correct formulations, dose adjustment or discontinuation on adverse symptoms, avoidance of coadministration with other neurotoxic or nephrotoxic agents and good critical care, they could provide lower nephron and neural toxicities, and moreover, positive clinical outcomes (26, 133). Recently, the first ever consensus recommendations for colistin and polymyxin B clinical usage were recently published to guide their optimal clinical use (27).

However, bacteria are able to adapt and employ several strategies to protect themselves from damaged caused by polymyxins. Modification of lipid A of lipopolysaccharide (LPS), efflux pump expression, reduce porin pathway and capsule formation are several mechanisms these bacteria using to respond and to resist polymyxins (16, 54). Uniquely, *A. baumannii* developed resistance to polymyxin by complete loss of lipopolysaccharides as the initial binding target (18, 19). Most of these mechanisms has been known chromosomally encoded until several studies reported that polymyxin resistance can be caused by horizontal gene transfer as well (20, 134). Their resistance mechanisms will be described in this chapter to enhance the understanding of their regulatory mechanisms.

---

## 1. CHROMOSOMALLY-MEDIATED POLYMYXIN RESISTANCE

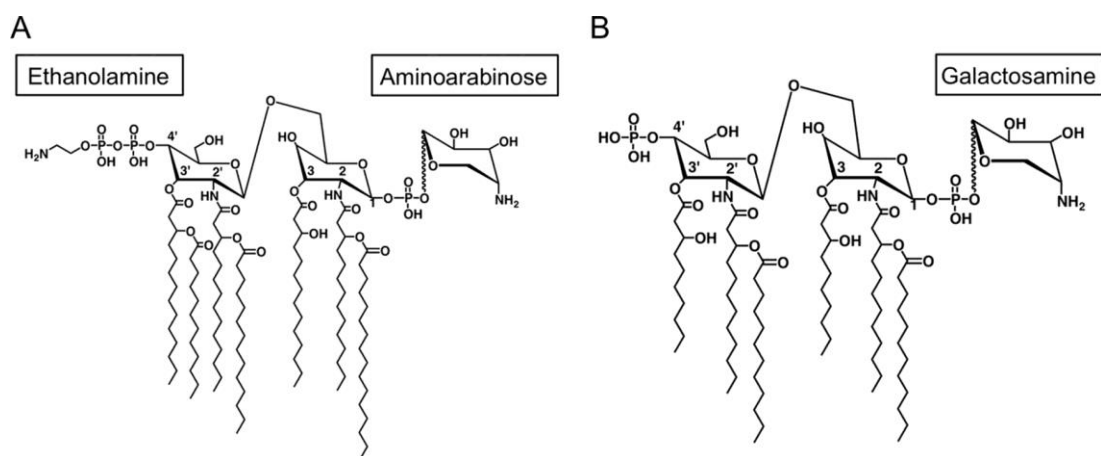
---

### 1.1. LIPOPOLYSACCHARIDE-LIPID A MODIFICATION

---

As explained in the first chapter, bactericidal activity of polymyxins is mediated by interaction from positive charged Dab residues (NH<sub>2</sub>) of polymyxin to negative charged phosphate group of lipid A component of lipopolysaccharide lead to the lysis of bacterial cells. Accordingly, modification of the lipopolysaccharide (LPS) molecules is the primary cause of polymyxin resistance in Gram-negative bacteria (16, 54, 135). LPS can be extensively modified by the addition of **4-amino-4-deoxy-L-Arabinose (L-Ara4N)** and

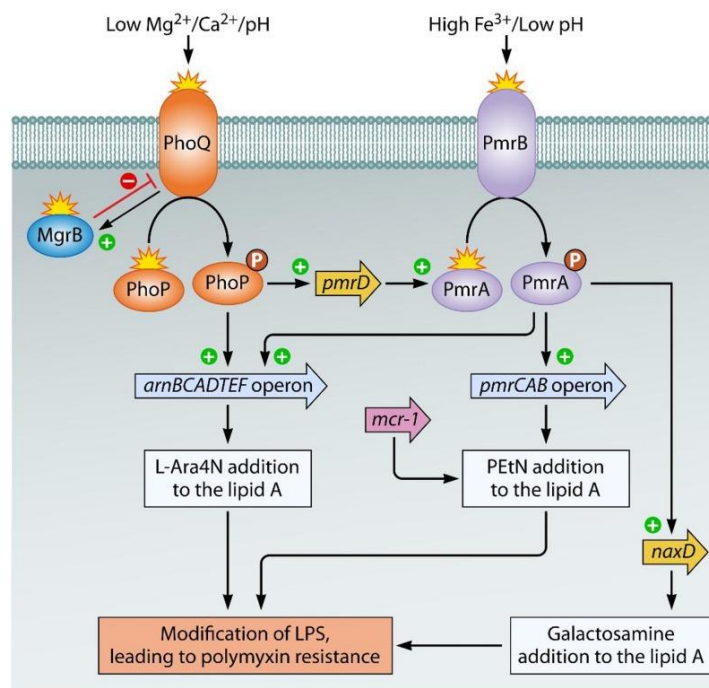
**phosphoethanolamine (PEtN)**, thus reducing the negative charge of lipid A and in consequence the binding of polymyxins (49, 136). Generally, the addition of L-Ara4N is preferentially added at the 4' phosphate position and PEtN is added to the 1-phosphate of lipid A, but in some cases, either one or two L-Ara4N and/or PEtN could modified 4' phosphate and 1-phosphate. The addition of **Galactosamine (GalN)** in 1-phosphate, a compound is structurally similar to L-Ara4N, can modify the LPS structure as well and decrease the negative charge on the lipid A that recently was found in clinical isolates of *A. baumannii* (137).



**Figure 8.** Lipid A modification by the addition of phosphoethanolamine, aminoarabinose and/or galactosamine that lead to polymyxin resistance (adapted from Pelletier et al., 2013 (137) ).

Two-component systems play a major important role to induce polymyxin resistance in Gram-negative bacteria. **The activation of PhoP/PhoQ and PmrA/PmrB two-component systems (TCSs)** is known to contribute this polymyxin resistance by constitutive activation and subsequent overexpression of LPS-modifying genes which is triggered by environmental stimuli and specific mutations within the TCSs (16, 138). Two-component regulatory systems are signal transduction machineries by using reversible phosphorylation between two proteins, a sensor kinase and a response regulator, to mediate the adaptation of changing environmental conditions (138, 139). **PmrB** protein is required for iron sensing

so the activation in extracellular if high ferric ( $\text{Fe}^{3+}$ ), aluminium ( $\text{Al}^{3+}$ ), the presence of cationic peptide, or low pH level condition (e.g., pH 5.5) was necessary and its location in periplasmic can phosphorylate the regulatory of **PmrA** protein. **PhoQ** histidine kinase is activated as a low concentration of  $\text{Mg}^{2+}$  or  $\text{Ca}^{2+}$  response, cationic peptide and low pH (e.g., pH 5.5) then activates the response regulator **PhoP** by phosphorylation, which can further activate PmrA/B regulator via *pmrD* over-transcription leading to up-regulate various of LPS-modifying genes, such as *pmrCAB* (also called *eptA*) operon and *arnBCADTEF* (also called *pmrHFIJKLM* or *pmrF* or *arnT*) operons, and promote the addition of PEtN and L-Ara4N, respectively (13, 140, 141). Normally, the expression of *mgrB* gene represses the expression of PhoQ-encoding gene leading to negative regulation of the PhoP/PhoQ two-component system (142). But the inactivation of this gene may cause the overexpression of the PhoP/PhoQ two-component system as commonly found in *K. pneumoniae* strains, thus causing LPS modifications (143).



**Figure 9.** Regulation pathways of LPS modifications involving PhoP/PhoQ and PmrA/PmrB two-component system (adapted from Ezadi et al., 2019 (68) )

PhoQ and PmrB protein sensor kinase contains 2 transmembrane regions, a domain in cytoplasmic and periplasmic domain. As a study found in *S. enterica*, The PhoQ and PmrB periplasmic domain are directly responding the extracellular  $Mg^{2+}$  and  $Fe^{3+}$ , respectively. There are 2 high affinity  $Mg^{2+}$  transporters, *mgtA* and *mgtCB*, which transcription is controlled by PhoPQ regulatory system (144). These 2 transporters will be overexpressed in low  $Mg^{2+}$  condition, followed by PhoP expression, and as consequent, the expression of other 40 protein is modulated by PhoP, including LPS-modifying genes (144). In contrast, no other regulation pathways related to PmrB during high  $Fe^{3+}$  (145). Iron directly bind to the periplasmic domain of PmrB, then phosphorylate PmrA then modified LPS to protect bacteria from toxicity. Metal ions, such as  $Fe^{3+}$  and  $Al^{3+}$ , bind the negatively-charged surface of GNB resulting in bacteria cell death as like polymyxin effect (145). Thus, PmrAB regulates the surface modifications to decrease iron binding to the bacterial cell, so the bacteria are able to grow in the presence of toxic level.

In many cases, the presence of antimicrobial peptides, including polymyxins, could directly stimuli PhoQ respond through a highly acidic surface of the PhoQ sensor domain, increased PhoP phosphorylation and bring a resistant phenotype (146, 147). However, *P. aeruginosa* PhoQ has not able to sense the presence of antimicrobial peptide, and rather sensed by other TCSs ParRS and CprRS (148, 149). Moreover in *P. aeruginosa*, not only PhoPQ, but PmrAB system also directly responds to low  $Mg^{2+}$  condition but not high level  $Fe^{3+}$  condition (147). In *A. baumannii*, PmrB is required for low pH-induced polymyxin resistance and not induced by high levels of  $Fe^{3+}$  (150).

**Lipopolysaccharide-lipid A could be extensively modified by the addition:**

- 4-amino-4-deoxy-L-Arabinose (L-Ara4N)
  - Phosphoethanolamine (PEtN)
  - Galactosamine (GalN)



## A. ADDITION OF OF 4-AMINO-4-DEOXY-L-ARABINOSE (L-Ara4N)

---

In some bacteria, such as *K. Pneumoniae*, the PhoP/PhoQ system can directly activates the *arnBCADTEF* operon, which is normally should be activated by PmrA first, leading to the addition of L-Ara4N (16). In contrast with *E. coli*, the addition of L-Ara4N to lipid A seems to be controlled only by the PmrAB TCSs which activates the *arnBCADTEF* operon and similarly found in colistin resistant *P. aeruginosa* isolates, since both strains are not responding the low Mg<sup>2+</sup> concentration to modify their LPS (151, 152). This activation could be induced in response to low Mg<sup>2+</sup> and the presence of antimicrobial peptide, such as colistin and polymyxin B (147, 151). Moreover, in another study, PhoQ Mutations that inactivate PhoQ sensor kinase lead to increased PhoP activity were found in *P. aeruginosa* and increased L-Ara4N addition to lipid A (141). It was found that the mutation of PmrB sensor kinase can promotes L-Ara4N addition as well and increased resistance to polymyxin (147).

**The addition of L-Ara4N in *K. pneumoniae*, *E. coli* and *P. aeruginosa* is dependent on the expression of *arnBCADTEF* single operon. Polymyxin resistance in *A. baumannii* due to L-Ara4N addition have not been identified until present**

A study in *Salmonella enterica* has found that the LPS modification by L-Ara4N addition also can modify by the activation of *pmrE* (or *Ugd*) gene which activates by the phosphorylated PmrA from PmrA/B TCSs (153). Not only PmrA, it has been identified that *pmrE* gene can additionally phosphorylated by another gene, namely *etK* (153). Regarding polymyxin resistance, the LPS modification by L-Ara4N addition confers a higher level of resistance than PEtN modifications only which increased the resistance up to 250-fold in the mutant expressing L-Ara4N in the lipid A only (154, 155). Thus, in LPS modification, the *arnT* operon play an important role in high-level polymyxin resistance than *pmrC* and *cptE* which only mediated PEtN addition.

## B. ADDITION OF PHOSPHOETHANOLAMINE (PEtN)

---

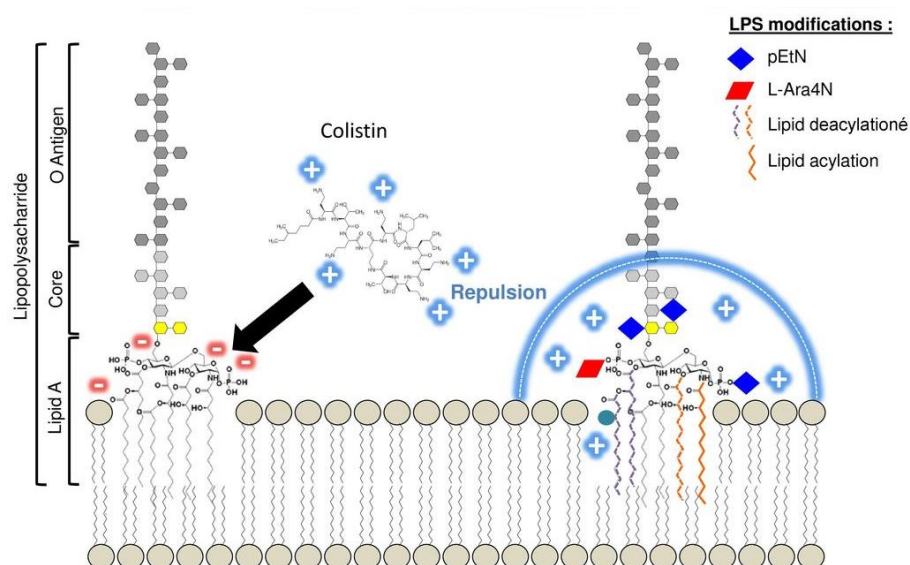
PEtN expression firstly has been identified in *S. enterica* that encodes by **PmrC** (also known as EptA or PagB) via PmrA/B TCS activation. **In contrast with L-Ara4N that plays a greater role in polymyxin resistance, the PEtN substitution to lipid A via *pmrC* gene inactivation only provide the polymyxin resistance up to 5-fold than the wild-type strain showing the low-level polymyxin resistance** (156). But similarly by L-Ara4N, the addition of PEtN in either 4' position or 1 position of lipid A is possible in the absence of L-Ara4N (137). In *A. baumannii*, PEtN addition to the lipid A has been reported responsible to the polymyxin resistance via PEtN transferase PmrC activated by PmrA/PmrB TCSs (157, 158). It was found in *A. baumannii* mutants with substitution in *pmrAB* genes that colistin resistance was increased of between 4- and 128-fold due to PEtN substitution of the lipid A without showing any high ferric ( $\text{Fe}^{3+}$ ) level dependent (150, 157, 158).

The emergence of colistin-resistant clinical isolates of *A. baumannii* due to failed colistin treatment has been shown with changes in PmrA and/or PmrB sequences followed by the overexpression of *pmrC* after colistin exposure (159). Fitness cost of *A. baumannii* were correlated with these mutations showed reduced *in vitro* growth and *in vivo* growth in animal model without decreasing the level of disease in mice (160).

Moreover, the roles of PhoP/PhoQ roles related to polymyxin resistance in *A. baumannii* isolates have not been identified, though these two proteins play important roles in the PEtN and L-Ara4N substitution of lipid A. Additionally, not only by *pmrCAB* operon, the phosphorylated heptose residue as LPS core can be further modified by PEtN regulated by ***cptA*** gene which is activated by phosphorylated PmrA as found in *S. enterica* (16, 155).

### C. ADDITION OF GALACTOSAMINE (GalN)

**Galactosamine is a novel structure modifying LPS that has been identified in colistin-resistant of *A. baumannii* isolates (137).** This compound has found as a second amino sugar that present on the terminal phosphate residues of lipid A alongside with PEtN in resistant strains of *A. baumannii* from patients treated with colistin. These modifications have been determined as a colistin-induce lipid A modifications since no modification were identified before colistin treatments by MALDI-TOF MS (137). The expression of NaxD deacetylase, a protein encoded by *naxD* gene, was identified as a mediator of this modification, and it was demonstrated that *naxD* gene is regulated by PmrA/PmrB regulatory system (161). However, lipid A modification by GalN has similarly found in *Francisella tularensis* encoded by two genes, *flmK* and *flmF2* (162). The *flmK* gene has been identified as an orthologue of *E. coli* *arnT* and the *flmF2* is an orthologue of *E. coli* *arnC* where those involved in the substitution of L-Ara4N to lipid A in polymyxin-resistant *E. coli* strains (162).



**Figure 10.** Modification of lipid A causing resistance to polymyxin (adapted from Dortet et al., 2016) (163) ).

## D. OTHER REGULATORY SYSTEM

---

Another regulator, namely CrrA/CrrB (colistin resistance regulation) operon which encodes two protein, CrrA regulator protein and CrrB sensor kinase, have been identified as well to play an important role in polymyxin resistance though its physiological role remains unknown (13). The CrrAB genes was particularly found in *K. pneumoniae* genomes but not in *E. coli* (164). However, a study explained that inactivation of CrrB gene may cause the activation of *arnBCADTEF operon*, *pmrC* and *pmrE* genes via *pmrAB* overexpression, and as a consequent, the expression of L-Ara4N and PEtN (164). Mutation in CrrB protein by six amino substitution have been reported as being responsible for its inactivation (164, 165).

Another two-component regulator associated polymyxin-adaptive resistance, ParR/ParS, was described in *P. aeruginosa* (148). This system was required to upregulate the expression of *arnBCADTEF* operon in the presence of sub-MICs polymyxins leading to resistance to colistin and polymyxin B (148). These *arn* genes participates in the LPS modification by 4-aminoarabinose (L-Ara4N) addition to lipid A, but different with PhoP/PhoQ, it is not required for ParR/ParS to activate *arn* operon under Mg<sup>2+</sup>-limiting conditions where peptide sensor ParS might induced by certain peptides (148). Moreover, different with PmrA/PmrB, expression of ParR/ParS is not under the control of PhoP/PhoQ as well described in *P. aeruginosa* (148).

Others TCS that contribute to the regulation of polymyxin resistance in *P. aeruginosa* have been identified as well, such as cationic peptide resistance (CprR/CprS) and ColR/ColS (166, 167). Similar with ParRS regulator, the CprRS regulated the addition of L-Ara4N to lipid A by activate the *arn/pmr* operon in response to specific antimicrobial peptide via CprS sensor kinase, such as polymyxin, indolicidin and pleuricidin, but did not affect the response to low Mg<sup>2+</sup> and/or High Fe<sup>3+</sup> (166). In contrast, ColRS has been shown to increase of the

PEtN transferase by activate *pmrC* (*EptA*) and decrease L-Ara4N via *arnT* gene in response to Zn<sup>2+</sup> presence (167).

---

## 1.2. LOSS OF LIPOPOLYSACCHARIDE

**Loss of lipopolysaccharide (LPS) is one of the remodeling LPS mechanisms that currently has only been found in *A. baumannii*.** Mutations, including substitution or deletion of nucleotides, in the three genes involved in the lipid A biosynthesis pathways, namely *lpxA*, *lpxC* and *lpxD*, have been reported that is responsible for this mechanism (18, 19). Two insertional of insertion sequence (IS) elements, such as *ISAb11* and *IS4*-family elements, in the three lipid A biosynthesis genes have been inactivated the biosynthesis pathways resulting in the complete loss of LPS and contribute to the occurrence of heteroresistance phenotype of *A. baumannii* strains (18, 19). Mutations specifically in *lpxC* and *lpxD* genes have been reported involved in *A. baumannii* resistant to polymyxin B and the mutation in *lpsB* gene (encoding glycosyltransferase for LPS core biosynthesis) has been identified for the lack of LPS production (168, 169). The resistant mutants with the lack of LPS display a high-level colistin resistance in *A. baumannii* with > 128 mg/L of colistin MICs, and moreover, this loss of LPS showed a significant decreasing of bacterial fitness compare to the PEtN modification caused by *pmrAB* mutations only (160). It is poorly understood how *A. baumannii* is able to survive in the LPS deficiency condition. However, LPS-deficient *lpxA* mutants shown the overexpression of proteins involved lipoprotein and phospholipid transport and the production of the surface polysaccharide acetylglucosamine that possibly important for *A. baumannii* survival during the absence of LPS (170).

Overall, All the strategies employed by Gram-negative bacteria related to the remodeling of LPS either its modification or complete loss of LPS are explained in Table 4 including the genes and operon that responsible for these mechanisms.

**Table 5.** Lipopolysaccharides remodeling employed by Gram-negative bacteria to achieve polymyxin resistance

Resistance mechanisms	Genes involved	Bacteria	References
Activation of LPS-modifying genes by two-component systems	<i>pmrA/pmrB</i> and/or <i>phoP/phoQ</i>	<i>E. coli</i> , <i>K. pneumoniae</i> , <i>P. aeruginosa</i> , <i>A. baumannii</i> and <i>S. enterica</i>	(139, 141, 147, 158, 171–173)
Inactivation of <i>phoP/phoQ</i> negative feedback regulator	<i>mgrB</i>	<i>K. pneumoniae</i>	(143, 174)
Lipid A modification by phosphoethanolamine (PEtN) addition	<i>pmrC</i> , <i>cptA</i>	<i>E. coli</i> , <i>K. pneumoniae</i> , <i>A. baumannii</i> and <i>S. enterica</i>	(140, 156, 157)
Lipid A modification with Aminoarabinose (L-Ara4N) addition	<i>arnBCADTEF</i> operon and <i>pmrE</i>	<i>S. enterica</i> , <i>E. coli</i> , <i>K. pneumoniae</i> , <i>P. aeruginosa</i> .	(153, 175–177)
Increased acylation of Lipid A enhancing its modification with aminoarabinose	<i>lpxM</i>	<i>S. enterica</i> , <i>E. coli</i> , <i>K. pneumoniae</i> ,	(178, 179)
Modification of lipid A with PEtN	<i>cptA</i>	<i>S. enterica</i>	(155)
Decrease the negative charge of lipid A by inhibit its phosphorylation	<i>lpxT</i>	<i>S. enterica</i>	(180)
Modification of KDO (3-deoxy-D-manno-octulosonic acid) with PEtN	<i>eptB</i>	<i>E. coli</i>	(181)
Loss of lipopolysaccharide	<i>lpxA</i> , <i>lpxC</i> , <i>lpxD</i>	<i>A. baumannii</i>	(18, 19)

---

### 1.3. CAPSULE FORMATION

The capsule polysaccharide (CPS) has been shown in *Klebsiella pneumoniae* and *Pseudomonas aeruginosa* to protect these both strains from antimicrobial peptides contributing to polymyxin resistance (182, 183). By electrostatic interactions between the anionic of CPS and cationic of polymyxins, release CPS is able to trap or bind to polymyxins leading to the reducing of polymyxin quantity to reach the cell surface of bacteria (183). The significant contribution of CPS to polymyxin resistance compared to the other mechanisms and which genes have been involved is still debated. But interestingly, *ugd* (also known as *pmrE*) gene that has a role in L-Ara4N biosynthesis, also known playing a role in UDP-glucuronic acid production which is an essential sugar used in the creation of CPS (184).

---

### 1.4. EFFLUX IN POLYMYXIN RESISTANCE AND OUTER MEMBRANE PROTEIN

Only a few studies have explained the contribution of efflux pumps in polymyxin resistance, such as **AcrAB**, **KpnEF** and **RosAB** efflux pumps. Mutant *acrAB* (a member of RND multidrug efflux pump family) were significantly more susceptible to polymyxin B compare to the wild-type isolate and reduce the pneumonia incidence in a murine model, as described in *K. pneumoniae* (185). *acrAB* genes encode a periplasmic lipoprotein which is important as a bridge the outer and inner membrane for its integration (185). It was similarly shown in the  $\Delta kpnEF$  (an SMR efflux pump family) mutant of *K. pneumoniae* that the mutant strains were significantly more susceptible to colistin compare to wild-type strain, and interestingly, exhibit an impairment of capsule polysaccharide synthesis (186). A *rosAB* (an MFS type efflux pump) mutant in *Yersinia enterocolitica* with lacking RosA and RosB protein was significantly more susceptible to polymyxin B and these mutations are affecting to the disturbance O-antigen biosynthesis as LPS core oligosaccharide. Generally, efflux pumps prevent the antimicrobial action by pumping the antibiotics out of the cell. However, little is

known about the specific role of these efflux pumps in the antimicrobial peptide, including colistin and polymyxin B, but presumably, they play an indirect role in polymyxin resistance.

For the outer membrane porins, their contributions remain still unclear and the involvement of porin in polymyxin resistance might be indirect. In *P. aeruginosa*, PhoP/PhoQ systems regulates the **OprH** outer membrane porin that is encoded by the first gene of *oprH* of the *phoPQ* operon (187). The loss of expression of *oprH*, *phoP* and *phoQ* by the inactivation of PhoP reduced polymyxin B resistance in *P. aeruginosa* (187). The mutation of **OmpU** porin in *Vibrio cholerae* increased the susceptibility to polymyxin B through the mechanism that currently unclear (188). Mutation of **porB** genes also increase polymyxin susceptibility in *Neisseria meningitidis* but it is still unclear whether PorB work alone or together with Mtr efflux to confers this resistance since transposon insertion in three genes *mtrC*, *mtrD* and *mtrE* that critical for MtrCDE efflux pumps were found (189).

---

## 1.5. POLYMYXIN-INACTIVATING ENZYME

To date, there are two studies that confirm the presence of bacterial enzyme that can inactivate colistin, produced by two Gram-positive bacteria, namely *Paenibacillus (bacillus) polymyxa* and *bacillus licheniformis* (190, 191). *Paenibacillus polymyxa* is known as the Gram-positive bacterium that produces colistin but at the same time produce a putative serine protease, referred as **colistinase**, that able to degrade colistin by cleavage of diaminobutyric acid (Dab-Dab bond) (Table 1) at side chain-cyclic peptide ring (190). While in *bacillus licheniformis*, it was found that alkaline protease **Apr** is responsible for colistin inactivation. Apr cleaves between the tripeptide side chain and the cyclic heptapeptide ring, and also between L-Thr and L-Dab in the cyclic heptapeptide ring (Table 1) (191). Although, these proteases have not been associated with colistin resistance in Gram-negative



bacteria, it is possible that polymyxins could be digested by secreted protease from other microorganisms, thereby affecting the clinical efficacy of colistin and polymyxin B.

---

## 1.6. COLISTIN HETERORESISTANCE

Heteroresistance is defined as the condition where subpopulations of bacteria within the same population are showing various responses to antibiotics. In other words, the subpopulations of bacteria that have a higher MIC to a specific antibiotic than most of the population are able to generate detectable colonies with long enough time of culture (192, 193). This phenomenon was first introduced in 1947 to describe the heterogenous antibiotic resistance of Gram-negative bacteria *Haemophilus influenzae*, but the term “heteroresistance” itself began to be used in 1970 (193). Several antimicrobial susceptibility testing methods and standard criteria to define isolates as susceptible, resistant or intermediate to any antibiotic have been developed by several international clinical laboratory standard bodies and are generally agreed worldwide. Unfortunately, the methods to define the heteroresistance that are inexpensive and standardized are lacking. Furthermore, heteroresistance is different from resistance, persistence and tolerance that are similar phenomena of survival in the antibiotic presence (192). However, both could be differentiated by their surviving profiles after duration longer antibiotic treatment, without a change in the MIC (192).

Emergence of polymyxin heteroresistance was associated with the exposure of suboptimal dosage of colistin (38). Colistin use is known to be a risk factor for the emergence of polymyxin-resistant strains in Gram-negative bacteria and heteroresistant subpopulations were found in the patients that have been previously treated with colistin (194, 195). Colistin heteroresistance of *A. baumannii* isolates is given by the loss of LPS phenotypes displaying high-level colistin resistance (18). Selection by serial increasing concentration of colistin

plates in a population analysis profile study, heteroresistance of *A. baumannii* clinical isolates have been shown up to 128-fold MIC colistin increased compare to susceptible populations (196). In polymyxin B experiments, heteroresistant Enterobacteriaceae showed an increase of MICs up to 32 mg/L without showing any reversibility to being susceptible after 20 days of passages defined these resistant phenotypes are stable (12).

---

## 2. PLASMID-MEDIATED COLISTIN RESISTANCE

---

### 2.1. DESCRIPTION OF MOBILIZED COLISTIN RESISTANCE (MCR)

---

Plasmid-mediated colistin resistance **MCR-1** was firstly reported in 2015 in clinical isolates of *Escherichia coli* and *Klebsiella pneumoniae* in china, and since, it has been detected all over the world (20, 21, 134, 135, 197).

**Mobilized colistin resistance (*mcr*) genes are plasmid-borne phosphoethanolamine transferases that confer resistance to colistin via phosphoethanolamine-modified bis-phosphorylated hexa-acylated lipid A in *E. coli* (198)**

To date, nine known *mcr* homologues have been identified (*mcr-1* to *mcr-9*) on a numbered different plasmids (199). Since its first report, a large number of studies have been published on *mcr-1* and it is clear that though this gene are undetectable for decades, it has a worldwide distribution and is commonly found in food animals than in humans (198).

Later, a second *mcr* gene that has been rarely identified, ***mcr-2***, was firstly reported in Belgium. It shares 76.75% nucleotide identity with *mcr-1* and it is nine bases shorter than *mcr-1* (200). The 1,626-bp-long sequences of ***mcr-3*** has been widely characterized in *E. coli* and mainly identified in Asia, Europe and North America and shared 45% and 47%

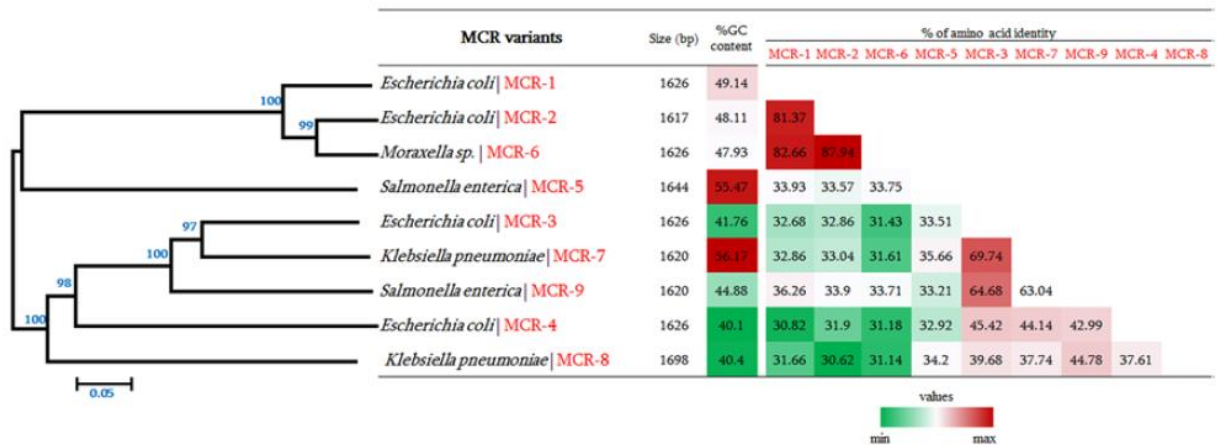
nucleotide sequence identity to *mcr-1* and *mcr-2*, respectively, but interestingly shared 99.8-100% amino acid sequence to PEtN transferases found in Enterobacteriaceae (201).

The ***mcr-4*** (1,626 bp) and ***mcr-5*** (1,644 bp) genes were first identified in *salmonella* and *E. coli* from European countries and subsequently further detected in *Enterobacter cloacae* and *E. coli* from Singapore and Japan (202, 203). The *mcr-4* encoded large amino acid sequences with 34%, 35% and 46% identity to PEtN transferases of MCR-1, MCR-2 and MCR-3, respectively (203), while MCR-5 is distinct with protein identities of 36.11%, 35.29%, 34.72% and 33.71% to MCR-1, MCR-2, MCR-3 and MCR-4, respectively (202).

Two another *mcr* homologues, ***mcr-6*** (was firstly identified as *mcr-2.2*) and ***mcr-7***, were found deposited into genbank with 1,617 bp and 1,620 long sequences, respectively. The *mcr-6* gene found in *Moraxella pluranimalium* shared 87.9% amino acid sequences of PEtN transferases identity to MCR-2 but had only colistin MIC of 1-2 mg/l (204). The MCR-7 (defined as MCR-7.1) protein that was detected in *K. pneumoniae* isolated from chicken in China is distinct with amino acid identities of 35%, 34%, 70%, 45%, 36% and 33% from MCR-1, MCR-2, MCR-3, MCR-4, MCR-5 AND MCR-6 (205).

In contrast, ***mcr-8*** gene that was characterized in 2018 in *K. pneumoniae* isolated from pneumoniae sputum of ICU patients in China shares only 31.08%, 30.26%, 39.96%, 37.85%, 33.51%, 30.43%, and 37.46% nucleotide identity to *mcr-1*, *mcr-2*, *mcr-3*, *mcr-4*, *mcr-5*, *mcr-6* and *mcr-7* (206).

Although eight *mcr* homologues (*mcr-1* to -8) mostly have been identified in Enterobacteriaceae, the latest novel *mcr* homologue, namely ***mcr-9***, was recently reported in a *Salmonella enterica* serotype Typhimurium and may confer colistin resistance after cloned into colistin susceptible *E. coli* NEB5 $\alpha$  (199). The amino acid sequences of *mcr-9* are highly similar at the structural level with those of *mcr-3*, *mcr-4* and *mcr-7* based on lipooligosaccharide phosphoethanolamine transferase EptA (199).

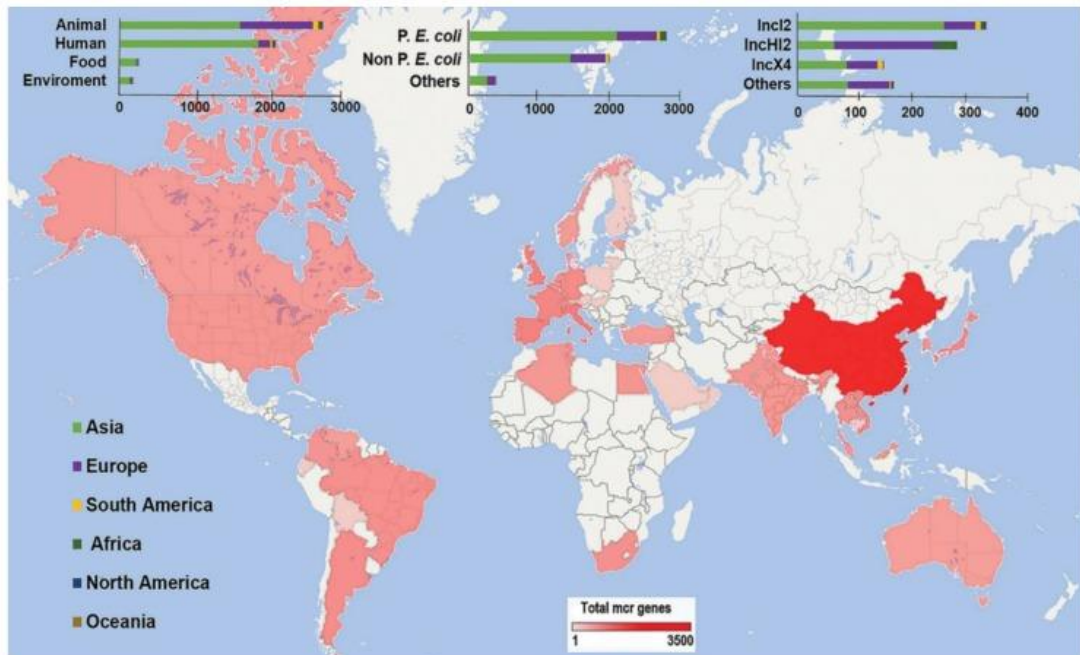


**Figure 11.** General features of MCR variants including their phylogenetic relationship with other MCR

(Adapted from [Khedher et al., 2020](#) (207) ).

## 2.2. PREVALENCE OF *mcr-1*

Several studies showed that the prevalence of *mcr*-producing isolates remains comparatively vary in several countries (208). The average prevalence was 4.7% that was reported from 47 countries across six continents (209). A very low prevalence of *mcr-1* and *mcr-1*-producing isolates was found in Switzerland among Enterobacteriaceae isolates from urinary tract infections and there were no *mcr-1* positive isolates were found in a large collection of bacteremia isolates in the same country (210, 211). In contrast, up to 50% of *mcr-1* positive *E. coli* isolates were identified from swine with diarrhea and edema in Japan. In Germany, A high frequency of *mcr-1* positive *E. coli* has been found in food isolates, mainly in turkey (10.7%) and broilers (5.6%) (212). China was reported as the country with the highest number of *mcr-1*-positive strains with the highest prevalence bacteria was found in *E. coli* (54%) (209). Still from the same country, the prevalence of pathogenic *mcr-1*-positive *E. coli* was found higher in food-animal than in humans and food products, suggesting the role of food borne transmission (209). In China, colistin was formally banned from animal feeds since 2017 and only used to human therapy due to the significant increase of *mcr-1* prevalence (213).



**Figure 12.** The prevalence of mobile colistin resistance (*mcr*) have been identified in various countries (Adapted from Elbediwi et al., 2019 (209) ).

### 2.3. STRUCTURE OF THE *mcr-1* GENE AND PLASMID

A detailed *mcr-1* cassette which is also the similar *mcr-1* was used in our study is shown in Figure 11 with the start codon of *mcr-1* was identified at position 79 and a promoter region, namely *P-mcr-1*, being separated by 16-bp sequences within the sequences -35 (TGGAT) and -10 (TATAAT) (214). The promoter is part of the mobile gene cassette that drive the expression of *mcr-1*, thereby making this element autonomous for its transcription. The same study further showed that *mcr-1* gene were widely spread on different plasmid backbones with identical 2,600-bp-long sequences, defined as *mcr-1* cassettes, were shared in different *E. coli* clonal backgrounds (214). The process of acquisition of the *mcr-1* gene from its original, which is still unknown, in different plasmid backbones remains unknown and need to be determined.

```

CAAATTATAAATACTCTCAAGTGTATATTCAGTATGGGATTGCGCAATGATTGCCTAATAAAAATTTCTGAAATATTTCTG
                                     -35      P1-mcr-1      -10      +1
TATCGCATAAATTTTTATATCAGATAAATTGTACTGGATTCTTAAAAAATTGCAGTATAAATTGCCGCAATTATCCCACC
GTTTATTTTTTGGAGTAGTTTCTCATGATGCAGCATACTTCTGTGTGGTACCGACGC-----//-----
                M M Q H T S V W Y R R
                --> mcr-1

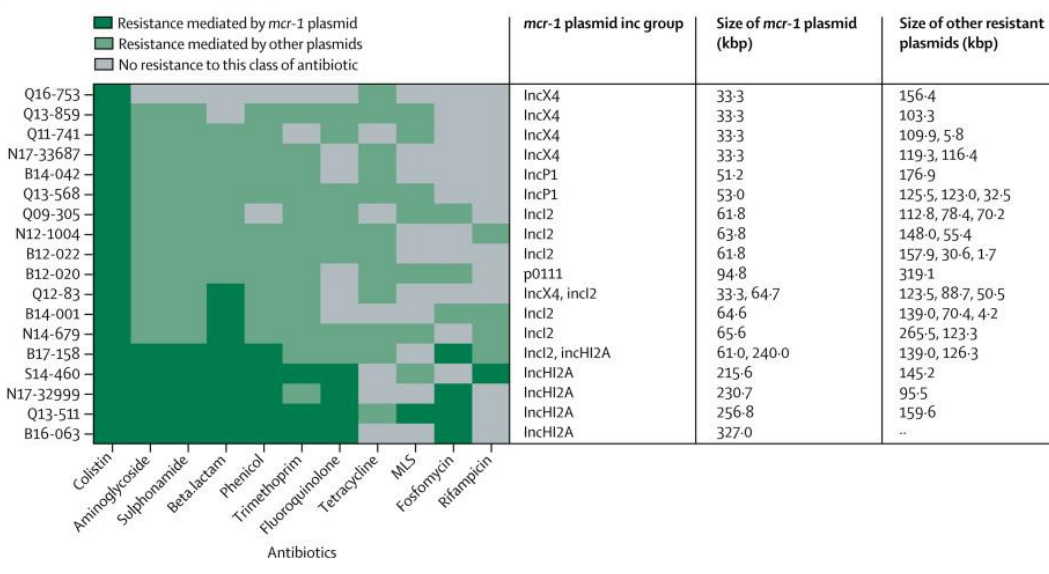
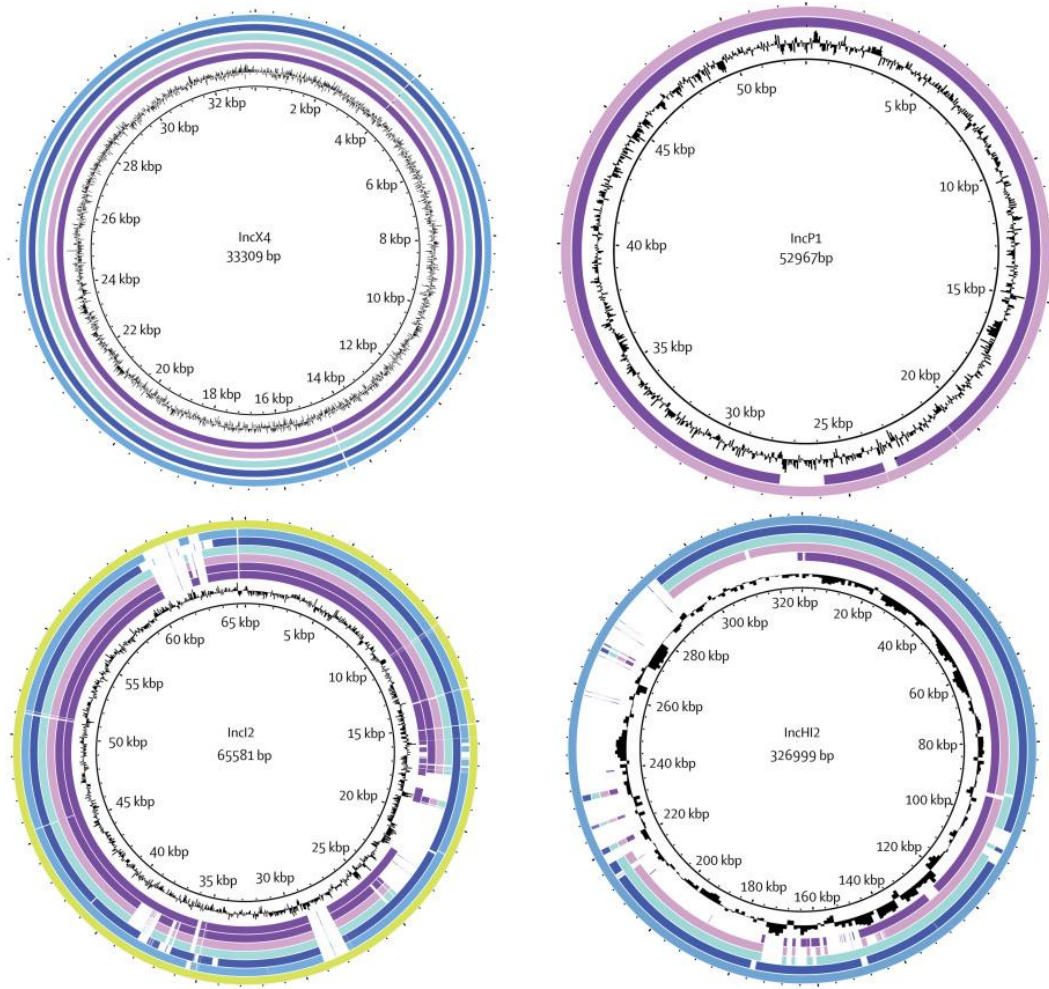
TGATGTCACCGCGGACAAAGTCAAAGACCGCACCGCATTTCATCCGCTTGATTTCTCCCTGTATTTTTTCCAAACCCACCGC
    D V T A D K V K D R T A F I R *

-----//640 bp //-----
GGCTGCTATAAGATGATTATTGGCGATCATTTTTTGGCCATACGGTGGTGTGCGATGATGCTTGCCTGGGCGATGTCGGC
AGGGCTTGCCTGGGTGTTTTTTAAGAAGGGTGAACAAGTT

```

**Figure 13.** 2,600-bp-long sequence of the *mcr-1* cassette harbored 1,626 bp of *mcr-1* gene with the start and stop codons of *mcr-1* are shown in bold and the promoter sequences ( $P_{1-mcr-1}$ ) are indicated (adapted from Poirel et al., 2016 (214))

However, a study over 300 *mcr-1*-positive *E. coli* have found that from 20 circular *mcr-1*-encoding plasmids obtained, most of *mcr-1* occurred in three dominant Inc groups, including IncX4, IncI2 and IncHI2 (215). Only IncHI2 large plasmids could be integrated with other resistance plasmids and may confer to multiple drug resistances (Fig. 14) (215). The *mcr-1*-positive *E. coli* could transfer *mcr-1* genes at high frequency ( $10^{-5}$  to  $10^{-7}$  cells per recipient cell) and the presence of *ISAp1* elements in the upstream make this gene rapidly transfer to diverse organism (216). Interestingly, loss of *ISAp1* elements in the plasmid-harboring *mcr-1* may provide the loss of *mcr-1* mobilization capacity, and IncHI2 plasmids harbored more *ISAp1* copies, suggesting that this type of plasmid could be more dangerous in *mcr-1* dissemination (215).



**Figure 14.** Circular maps of four dominant groups plasmids harboring the *mcr-1* gene (Adapted from Jiang et al., 2020 (215)).

---

## 2.4. CLINICAL IMPACT AND *IN VITRO* STUDY OF MCR-1

Although the emergence of *mcr-1* caused global concern, little is known about its clinical implications and its transmission characteristic. Cohort studies focusing on the human infection were rare where the majority of studies were investigating the prevalence of *mcr-1*-harbouring bacteria. Here, we only found two systematic case-control studies focusing on *mcr-1*-positive clinical isolates which provide the prevalence, risk factor and effect on mortality (213, 215). A large prevalence study in China detected the *mcr-1* gene were only found in *E. coli* (1%) and *K. pneumoniae* (<1%) from total 10,688 Enterobacteriaceae, 3,549 *Acinetobacter* and 3,261 *P. aeruginosa* clinical isolates of 18,698 inpatients (213). Interestingly, *mcr-1*-positive *E. coli* isolate from healthy patients were also detected (213). The same study has found that majority of *mcr-1* positive *E. coli* causing skin and soft tissue, bloodstream and UTIs recovered, meaning that these isolates are less pathogen (213). A very recent study has a same conclusion shown that the prevalence of *mcr-1* positive *E. coli* have been increased over the year, though the number has remained low among clinical patients in China with contributed relatively small to patient mortality (215). Mortality rates in *mcr-1*-positive *E. coli* infection was not differ with *mcr-1*-negative groups, suggesting that *mcr-1*-positive *E. coli* infection does not substantially affect to patient outcomes (215). Overall, health-care contact was the most probable risk factor for *mcr-1*-positive *E. coli* infection (215).

**No historical data related colistin and polymyxin B used in the previous three months or during the patient treatment due to *mcr-1*-positive *E. coli* infection in these both studies, thereby the clinical impact of *mcr-1* on the selection of high-level polymyxin resistance isolates associated with polymyxin exposure is hard to conclude**

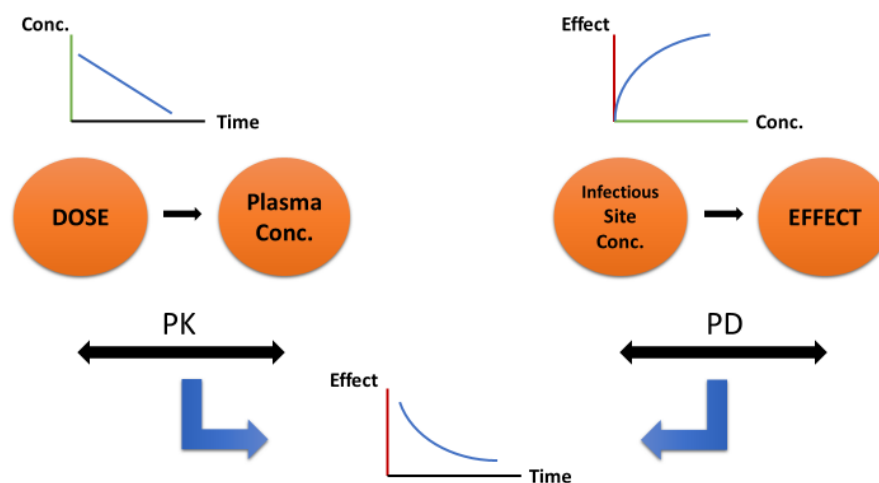


Most of *mcr-1*-positive *E. coli* clinical isolates (96%) showed resistance to colistin with MICs 4-16 mg/L, and the remaining (4%) were susceptible (215). In addition, most of *mcr-1* positive *E. coli* isolates are resistant to ciprofloxacin, cefotaxime and cefepime (213). Another study shown that 95% of *mcr-1* positive *E. coli* isolate harbored several of resistant genes that may confer resistance to aminoglycosides, sulphonamides,  $\beta$ -lactams, phenicols and fluoroquinolones (215). As shown in Figure 14, compare with small plasmids, such as IncX4 or IncI2, large plasmid encoding *mcr-1* IncHI2 are able to recruit other resistance genes and become multiply drug-resistant, which could raise the difficulties of treatment (215).

An *in vitro* study of *mcr-1* effects on colistin resistance and on lipopolysaccharide structures of Gram-negative pathogens have found that PEtN modifications of lipid A was observed in all four species *E. coli*, *K. pneumoniae*, *A. baumannii*, and *P. aeruginosa* **after *mcr-1*-carrying recombinant plasmids were successfully introduced into laboratory and clinical isolates tested** (198). **It led to high-level colistin resistance in *E. coli*, *K. pneumoniae* and *A. baumannii* but only moderately resistance in *P. aeruginosa*** (198). The *mcr-1* confers their colistin susceptibility and increased colistin MIC up to 32-fold, 256-fold, >128-fold and 4-fold in *E. coli*, *K. pneumoniae*, *A. baumannii*, and *P. aeruginosa*, respectively (198). This indicates that native promotor of *mcr-1* found in *E. coli* is not only functionally across diversified species among *Enterobacteriaceae*, such as *K. pneumoniae*, but also the other two species tested, including *A. baumannii* and *P. aeruginosa* (214). This also suggest that *K. pneumoniae* and *A. baumannii* would be acquiescent to *mcr-1* that may confer them into high-level colistin resistant pathogens compare to *E. coli* as its original reservoir, and moreover, this dissemination across species could be a threat to manage in the future.

## IV. PK/PD OF ANTIBIOTICS

In general, pharmacokinetic (PK) is defined as “how the body handles the drug”, while pharmacodynamics is “how the drugs affects the body”. But in terms of bacterial killing, PD would be more adequately phrased as “how the drug affects the bacteria” (217). PK/PD of antibiotics differ from other drugs, where the ideal antibiotic is targeting the bacteria instead of directly affect their host and cause side effects. In PK/PD modeling, the relationship among dose, concentration, desired effect and side effects is described and quantitated, and this approach is used in the development and improvement of antibiotic dosing regimens (217).



**Figure 15.** Schematic presentation of PK/PD modeling as combination of pharmacokinetic and pharmacodynamics  
(adapted from Derendorf & Meibohm, 1999 (218))

Related to the bacterial resistance issue, PK/PD modeling has been proven useful in the dosing regimens selection to overcome resistance development with good desire clinical outcome at the same time (219). In this chapter, two major modeling approaches associated to antimicrobial PKPD will be discussed, including minimum inhibitory concentration (MIC)-based and *in vitro* time-course-based approaches.

---

## 1. MIC-BASED APPROACHES

For many years, the MIC has been used extensively for determining bacterial susceptibility to an antibiotic. Agar diffusion or broth dilution are two methods most used on MIC test since they are easy to perform. In general, broth dilution method is used to determine MIC of antibiotics, by inoculated a bacterial inoculum of  $5 \times 10^5$  CFU/mL into specific media with a range of the antibiotic concentrations based on two-fold dilution, at 37 °C, over 18-24h incubation period (220).

The relationship between drug exposure and MIC is a primary basic on this PK/PD approach with three standard PK/PD indices have been determined;

$$fT > \text{MIC}; fC_{max}/\text{MIC}; \text{ and } f\text{AUC}/\text{MIC}$$

$f$  refers to the free drug concentration. The duration of time in the 24-h period wherein the drug concentration above the MIC is  $fT > \text{MIC}$ .  $C_{max}$  is the peak drug concentration. AUC refers to the area under drug concentration-time curve over the 24-h. These indices are based on free drug concentration, where only the unbound drug can exert its pharmacological effect. If the efficacy is time dependent, the goal is to maintain the free drug concentration above the MIC for an extended period of time. But, if the effect is concentration dependent, the dosing strategy is simply to attain sufficient  $C_{max}$  or drug exposure above MIC (221).

Though MIC has been used to guide dosing for various classes of antibiotics, this approach has several limitations (220). First, it is a static parameter evaluated only which is not possible to characterize the effectiveness of an antibiotic when its concentrations change over time. Not only potentially lead to treatment failure, when bacteria are exposed to a low concentration of antibiotics, it may foster the emergence of resistant populations. Second, the MIC may not be consistent across the species and strains which is also possibly lead to treatment failure. Third, with only 24-h time point measurement, bactericidal or

bacteriostatic effect with different drug concentrations cannot be determined from the MIC approach, since both killing pattern can converge to the same MIC value over this time period. Last, because only free drug concentration was considered in MIC test, it is needed to consider protein binding when extrapolate *in vitro* results to human studies.

---

## 2. IN VITRO TIME-COURSE-BASED APPROACHES: TIME-KILL KINETIC STUDIES

The *in vitro* time-kill (TK) offers unique opportunities to characterize bacterial response versus time after multiple-dosing of antibiotic exposure (217). Time-kill experiments has been used to generate *in vitro* data in static conditions, as the basis for developing antibiotics PK/PD models that links of free drug concentration to the bacterial response, whereas dynamic (hollow-fiber) time-kill data, that supposedly to mimic the *in vivo* half-life of the drugs in humans, are used to validate the model and to predict the clinical outcome (220). Basically, antibiotic PK/PD models are driven by *in vitro* data with 3 following models: bacterial submodel, pharmacokinetic model, and the full model combined from PK and bacterial submodel (PK/PD model).

---

### 2.1. BACTERIAL SUBMODEL (PHARMACODYNAMIC MODEL)

Bacterial submodel is characterized by the growth and natural killing of the bacteria versus time which involves a single bacterial compartment ( $B$ ) with a first-order rate constant for bacterial multiplication ( $k_{growth}$ ) and a first-order rate for the death of bacteria ( $k_{death}$ ).

$$\frac{dB}{dt} = k_{growth} \times B - k_{death} \times B \quad (1)$$

Equation (1) explains the observed exponential growth of bacteria seen in time-kill experiments without the addition of drug (217). In the absence of antibiotics, the exponential grow will be shown until high concentrations of bacteria are reached and stationary level is approached.

---

## 2.2. PHARMACOKINETIC MODEL

PK describes the change of antibiotic concentration ( $C$ ) over time ( $t$ ) during the experiment. In static time-kill, the antibiotic concentration is commonly expected constant. But some drugs show instability under the experimental conditions and the concentration is estimated to decline from an initial concentration ( $C_0$ ) and can be determined using one-compartment PK model.

$$C_{(t)} = C_0 \times e^{-k_e \times t} \quad (2)$$

$k_e$  represents elimination rate constant and the half-life ( $t_{1/2}$ ) can be determined using  $k_e$ ,

$$\text{where } t_{1/2} = \frac{\ln(2)}{k_e}$$

The elimination rate constant can also be derived from volume of distribution ( $V_d$ ) and clearance ( $Cl$ ), where  $k_e = Cl / V_d$

Due to more complex distribution and drug disposition, time-kill profile should be better described by two-compartmental model with a central and a peripheral compartment. When antibiotic concentration is measured, the parameters of PK model can be estimated and predicted concentrations can be used to drive PK/PD model.

---

## 2.3. PHARMACOKINETIC-PHARMACODYNAMIC MODEL

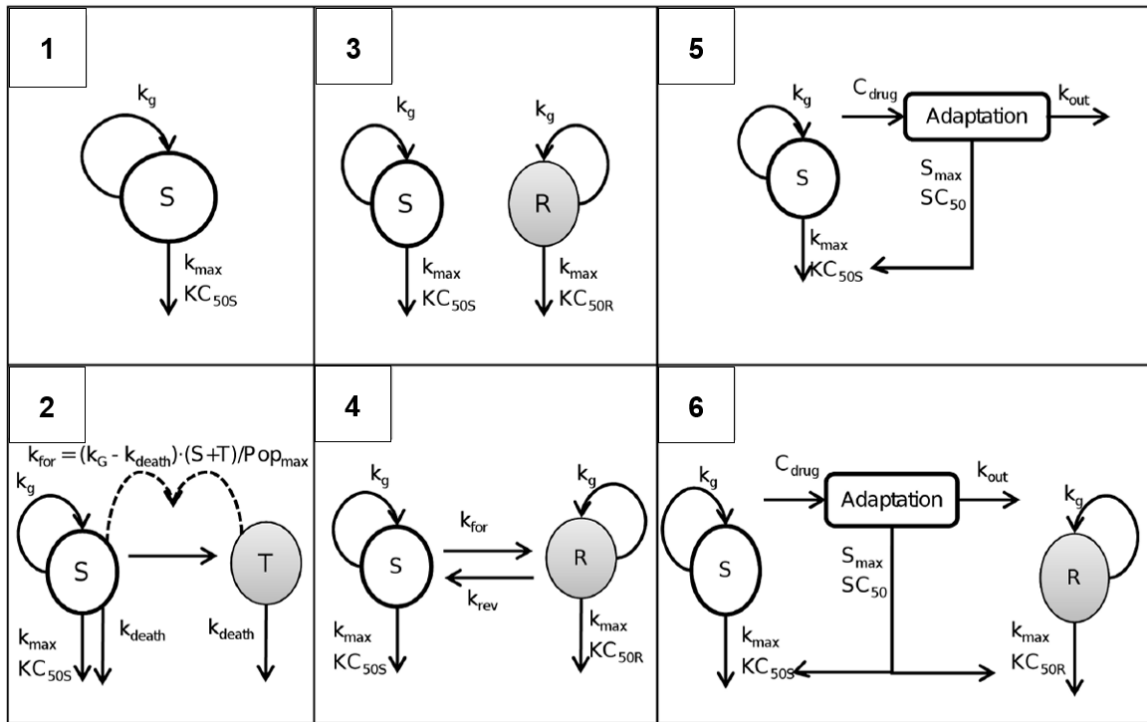
The bacterial submodel and the PK model are combined to drive the full PK/PD model, and equations are determined to characterize the antibiotic effects on the bacteria. Antibiotic effect is modeled using  $E_{max}$ . The antibacterial effect could be assumed either to inhibit the bacterial growth rate (Eq. 3) or to enhance the bacterial kill (Eq. 4 and 5). The effect can be modeled as a proportional effect (Eq. 4) or an additive effect (Eq. 5).

$$\frac{dB}{dt} = k_{growth} \times \left( 1 - \frac{E_{max} \times C_{(t)}^{\gamma}}{EC_{50}^{\gamma} + EC_{(t)}^{\gamma}} \right) \times B - k_{death} \times B \quad (3)$$

$$\frac{dB}{dt} = k_{growth} \times B - k_{death} \times \left( 1 + \frac{E_{max} \times C_{(t)}^Y}{EC_{50}^Y + EC_{(t)}^Y} \right) \times B \quad (4)$$

$$\frac{dB}{dt} = k_{growth} \times B - k_{death} \times B - \left( \frac{E_{max} \times C_{(t)}^Y}{EC_{50}^Y + EC_{(t)}^Y} \right) \times B \quad (5)$$

PK/PD models can describe antibiotic resistance, and if the mechanism of resistance is known, the appropriate modeling structure can be chosen. Figure 16 represents the six different PD models to reflect relevant PD models for antibiotics. These models were used to simulate *in vitro* experimental results based on static and dynamic condition (222). If model 1 and 2 represent a single bacterial population susceptible to antibiotics, model 3, 4 and 6 represent heteroresistance of the initial inoculum and model 5 and 6 combine with adaptive resistance (Fig. 16). In case of pre-existing resistant bacterial subpopulation, two different bacterial compartments representing antibiotic sensitive (S) and resistant (R) should be assumed. In case of appearance of adaptation phenomena, an adaptive resistance (AR) is modeled using a binding function with two states, adaptive resistance being off and being on. In a simple word, the AR was set to off, but the increasing of antibiotic concentrations might increase the degree of resistance. In the static time-kill experiments, PD models with two stable heterogenous subpopulations (S/R) are most often demonstrate superiority over models relying on adaptation phenomena (222). Although these models should be validated in dynamic conditions (i.e., hollow-fiber), these experimental handling are more complex and expensive compare with time-kill experiments. Therefore, in this study, we offer a new approach, namely sequential TK, to discriminate between PK/PD models with S/R versus adaptive resistance. It is expected to be a simple and inexpensive approach to generate.



**Figure 16.** Six different PD models to reflect PD models for antibiotics.

A susceptible bacterial population without adaptive resistance (1) or with the capacity to convert into a resting stage (2); presence pre-existing susceptible and resistant populations without (3) or with (4) inter-conversion; a model with adaptive resistance (5); and a model with two pre-existing populations with adaptive resistance (6) (adapted from

Jacobs et al., 2016 (222))

## PROBLEMS AND OBJECTIVE OF THE STUDY

As explained in the previous chapter, the emergence of multi-drug resistance of Gram-negative *E. coli*, *K. pneumoniae*, and *A. baumannii* over the last-resort antibiotic polymyxins is increased (17, 38). Isolates obtained before and after colistin treatment demonstrated that colistin use correlated with increased resistance to polymyxin (223). Moreover, colistin heteroresistance subpopulation isolates were particularly found in the patients that previously treated with colistin (18, 194). The chromosomal genes involved in the mechanisms of polymyxin resistance have been established. However, the influences of plasmid harboring *mcr-1* gene, particularly carried by *E. coli* and *K. pneumoniae*, to induce additional genomic resistance and to facilitates the selection of high-level polymyxin resistance is poorly described. In another story, instead of by *mcr-1* helping, *Acinetobacter baumannii* is adding a different strategy to protect themselves from damage caused by polymyxins via completely losing its lipid A as the initial binding target of polymyxins (19, 170). Again, how this strain acquired polymyxin resistance during treatment is poorly understood.

*In vitro* static time-kill (TK) is a simple pharmacodynamics (PD) experiment to simulate bacterial CFU versus time after the multiple-dose of antibiotic exposures. This is a simple and inexpensive approach to evaluate the rate and extent killing due to of colistin and polymyxin B against Gram-negative bacteria. After an initial decay of CFU, a regrowth is frequently observed thereby time-kill data were often used for PD model qualification with two stable heterogenous subpopulations model, i.e., sensitive (S) and resistant (R), which often demonstrate over drug induced adaptive resistance (AR) model (222). Since no precise mechanistic information provide by this approach, these models could be



challenged by dynamic (hollow-fiber) conditions, but these experimental handling are more complex and expensive than TK experiments.

Therefore, we offer an alternative by performing two consecutive time-kill (referred to as “sequential TK”) to discriminate between the bacterial regrowth due to heterogenous subpopulations (S/R) or adaptive resistance (AR). After the (R) selection and (S) disappearance during the first TK, the (R) subpopulations are supposed to be stable with time without any regrowth after a second TK is conducted. Otherwise, a second regrowth would rather suggest a continuous adaptation with time. To provide the molecular information, these experiments will be supported by biomolecular investigations, including DNA sequencing and quantitative PCR, to observe nucleotide changes (mutations) and to analyses the expression level of the specific target gene.

Overall, these studies have been divided in three parts:

1. First step, we confirmed experimentally that sequential TK could discriminate between stable heterogenous subpopulation (S/R) and a single homogenous population of bacteria without or with adaptive resistance (AR) demonstrated by pharmacokinetics/pharmacodynamics (PK/PD) models. Modelling was conducted after the first TK and then simultaneously after sequential TK to compare the prediction models between a single and sequential TK analysis.
2. By using the sequential TK approach, we determined the molecular impact of MCR-1 in the progressive adaptation of *E. coli* and *K. pneumoniae* to polymyxins by characterizing the chromosomal genes involved in lipopolysaccharide modification.
3. With similar approach, we characterized the genes involved in polymyxin resistance, either genes related to LPS modification or LPS biosynthesis over two consecutive MDR *A. baumannii*, ColS and ColR, isolated from the same patient. ColS was isolated before colistin treatment, and ColR is a strain acquired resistance to colistin during the treatment.

## ***CHAPTER 3***

# ***EXPERIMENTAL WORK***



# ARTICLE 1

-

## Sequential Time-kill study to discriminate PK/PD Model



**Les courbes de bactéricidies séquentielles, une astuce expérimentale simple pour distinguer deux modèles pharmacocinétique/pharmacodynamique présentant deux sous populations hétérogènes distinctes ou une population homogène avec résistance adaptative**

Des expériences ont été menées avec la **polymyxine B** et deux souches isogéniques de ***Klebsiella pneumonia*** (le type sauvage, KP\_WT, et son transconjugant portant le gène mobile de résistance à la colistine, KP\_MCR-1) pour démontrer que la réalisation de deux expériences consécutives des courbes de bactéricidies (TK séquentielles) représente une approche simple pour discriminer différents modèles pharmacocinétiques/pharmacodynamiques avec deux sous-populations hétérogènes ou avec une seule population présentant une résistance adaptative.





# Sequential Time-Kill, a Simple Experimental Trick To Discriminate between Pharmacokinetics/Pharmacodynamics Models with Distinct Heterogeneous Subpopulations versus Homogenous Population with Adaptive Resistance

A. Chauzy,<sup>a</sup> H. Ih,<sup>a,c</sup> M. Jacobs,<sup>a\*</sup>  S. Marchand,<sup>a,b</sup> N. Grégoire,<sup>a,b</sup>  W. Couet,<sup>a,b</sup>  J. M. Buyck<sup>a</sup>

<sup>a</sup>INSERM U1070 Pharmacologie des Anti-Infectieux, UFR de Médecine Pharmacie, Université de Poitiers, Poitiers, France

<sup>b</sup>Laboratoire de Toxicologie-Pharmacocinétique, CHU de Poitiers, Poitiers, France

<sup>c</sup>Pharmacy Department, Faculty of Medicine, Universitas Tanjungpura, Pontianak, Indonesia

A. Chauzy and H. Ih contributed equally to this work and are listed in alphabetical order.

**ABSTRACT** Experiments were conducted with polymyxin B and two *Klebsiella pneumoniae* isogenic strains (the wild type, KP\_WT, and its transconjugant carrying the mobile colistin resistance gene, KP\_MCR-1) to demonstrate that conducting two consecutive time-kill experiments (sequential TK) represents a simple approach to discriminate between pharmacokinetics/pharmacodynamics models with two heterogeneous subpopulations or adaptive resistance.

**KEYWORDS** *Klebsiella pneumoniae*, PK/PD model, antibiotic resistance, pharmacodynamics, polymyxin B, sequential time-kill

Semimechanistic pharmacokinetics/pharmacodynamics (PK/PD) modeling is a modern approach that offers unique opportunities to simulate CFU versus time after antibiotic exposures corresponding to various multiple-dosing strategies (1). Time-kill (TK) experiments constitute a simple and inexpensive approach to generate *in vitro* data in static conditions for antibiotics PK/PD modeling. After an initial decay of CFU with time, regrowth is frequently observed that can be described by a number of models. However, in the absence of precise mechanistic information, PD models with two stable, heterogeneous subpopulations, i.e., sensitive (S) and resistant (R) (referred to as S/R), would most often demonstrate superiority over models relying on adaptation phenomena (2). Although these models should then be challenged in dynamic (hollow-fiber) conditions, these experimental settings are much more expensive and complex to handle than TK experiments. However, conducting two consecutive TK experiments (sequential TK) may offer a pragmatic alternative. Indeed, the S/R model assumes that initial decay is due to the (S) disappearance and regrowth to (R) selection. However, the (S) and (R) subpopulations are supposed to be stable with time, so no regrowth would be expected after conducting a second TK experiment with the resistant subpopulation bacteria that regrew after the first TK experiment. Such a second regrowth would rather suggest progressive adaptation. Our objective was to confirm experimentally that sequential TK would offer a simple approach to discriminate between regrowth due to heterogeneous subpopulations and adaptive resistance (AR).

Two isogenic isolates were used in this study: a wild-type *Klebsiella pneumoniae* R2292 (KP\_WT) and its transconjugant carrying the mobile colistin resistance gene MCR-1 (KP\_MCR-1), kindly provided by P. Nordmann (University of Fribourg, Switzerland). This strain was built by transferring the MCR-1 plasmid from MCR-1-positive *Escherichia coli* isolates as donors (3). TK experiments were conducted in duplicate in

**Citation** Chauzy A, Ih H, Jacobs M, Marchand S, Grégoire N, Couet W, Buyck JM. 2020. Sequential time-kill, a simple experimental trick to discriminate between pharmacokinetics/ pharmacodynamics models with distinct heterogeneous subpopulations versus homogenous population with adaptive resistance. *Antimicrob Agents Chemother* 64:e00788-20. <https://doi.org/10.1128/AAC.00788-20>.

**Copyright** ©2020 American Society for Microbiology. All Rights Reserved.

Address correspondence to W. Couet, [william.couet@univ-poitiers.fr](mailto:william.couet@univ-poitiers.fr).

\* Present address: M. Jacobs, Technologie Servier, Vignat Orleans, France.

**Received** 23 April 2020

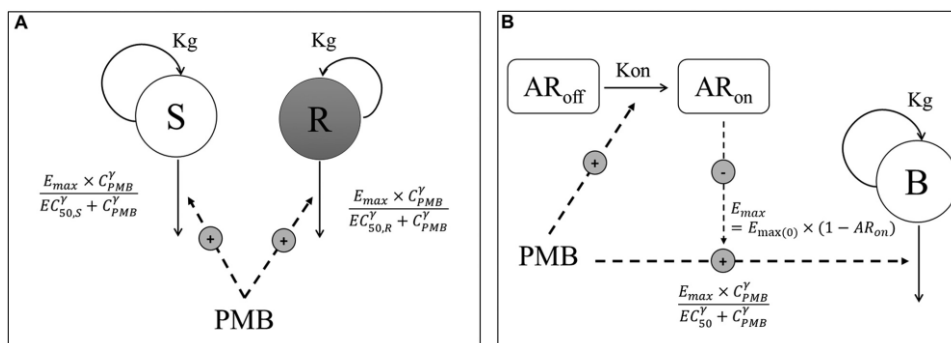
**Returned for modification** 26 May 2020

**Accepted** 5 June 2020

**Accepted manuscript posted online** 8 June 2020

**Published** 22 July 2020



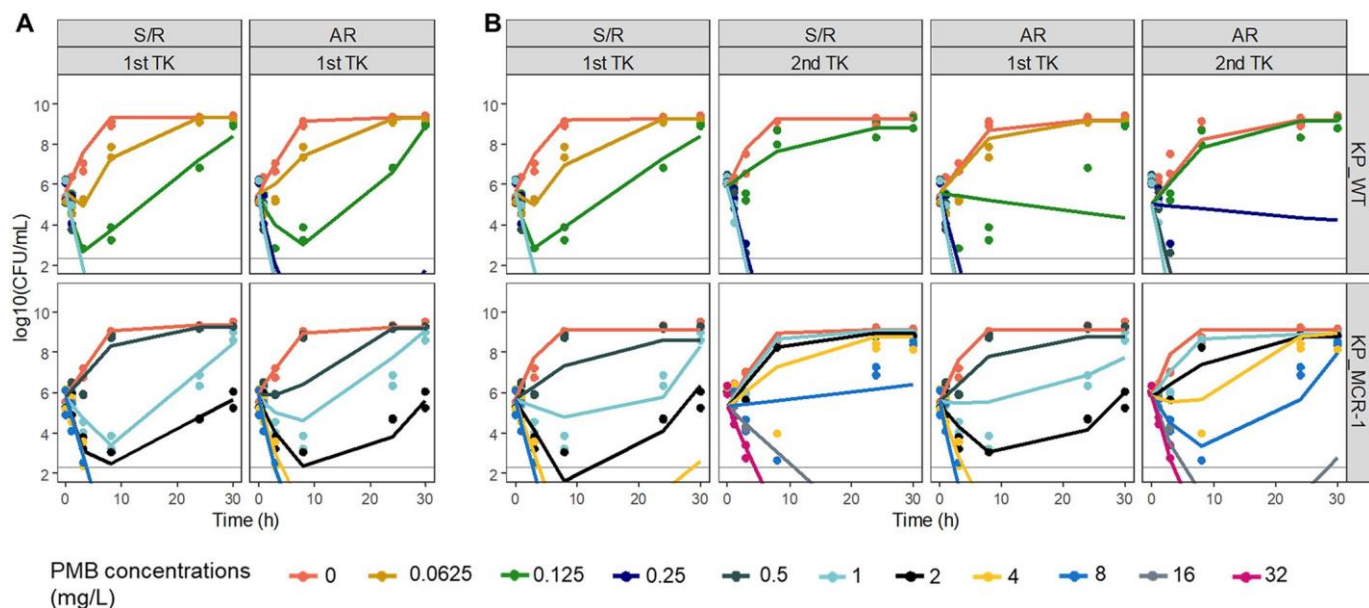


**FIG 1** Schematic illustrations of the S/R model (A) and AR model (B).  $C_{PMB}$ , PMB concentration; S, compartment with PMB-sensitive bacteria; R, compartment with resistant bacteria; B, compartment with homogenous bacterial population;  $K_g$ , rate constant for multiplication of bacteria;  $E_{max}$ , maximum kill rate constant;  $E_{max(0)}$ , maximum kill rate constant when no adaptive resistance has developed;  $EC_{50}$ , PMB concentration producing 50% of  $E_{max(0)}$ ;  $EC_{50,S}$  and  $EC_{50,R}$ , PMB concentration producing 50% of  $E_{max}$  for (S) and (R) bacteria, respectively;  $\mu$ , sigmoidicity factor;  $AR_{off}$  and  $AR_{on}$ , compartments describing adaptive resistance being off and on, respectively;  $K_{on}$ , rate constant for development of adaptive resistance.

cation-adjusted Mueller-Hinton broth over 30 h at an initial inoculum close to  $10^6$  CFU/ml in the presence of polymyxin B (PMB) ranging from 0.0625 to 1 mg/liter for KP\_WT and 0.5 to 8 mg/liter for KP\_MCR-1. At 30 h, bacteria that regrew up to  $10^8$  CFU/ml were harvested by centrifugation and resuspended to immediately begin the second TK experiment at an initial inoculum close to  $10^6$  CFU/ml again, with PMB concentrations ranging from 0.0625 to 1 mg/liter for KP\_WT and 1 to 32 mg/liter for KP\_MCR-1. Modeling was conducted after the first TK and then simultaneously after the two sequential TK experiments for both strains, using NONMEM 7.4 with Laplacian numerical algorithm and the M3 method for handling observations below the limit of quantification (4). Each model incorporated a logistic growth expression to describe bacterial population dynamics. PMB bactericidal effect was modeled according to an  $E_{max}$  function for both strains. Two different model structures were investigated to characterize the emergence of resistance. The first model, S/R, includes two independent subpopulations of bacteria with different susceptibilities and regrowth explained by a higher  $EC_{50}$  (concentration that produces 50% of  $E_{max}$ ) value for the (R) than the (S) subpopulation (Fig. 1A) (5–7). The fraction of (S) and (R) bacteria in the initial inoculum was estimated as a parameter, and fitness cost resulting in a lower growth rate for the (R) subpopulation was investigated. The second model, AR, includes a single homogenous bacterial population with adaptive resistance (Fig. 1B). At the beginning of the experiment, all bacteria were assumed to be nonadapted, but an adaptation developed over time in the presence of PMB, affecting  $E_{max}$  (8). The fraction of (S) and (R) or adapted bacteria, depending on the model, at the end of the first TK experiment was used as the initial condition for the second TK experiment. Model selection was based on objective function value and goodness-of-fit plots. For nonnested models, the Bayesian information criterion (BIC) was calculated and compared between models.

Genes assumed to be involved in polymyxin resistance, i.e., *pmrA*, *pmrB*, *phoP*, *phoQ*, *pmrC*, *pmrE*, *lpxM*, *arnT*, *cptA*, *lpxT*, *eptB*, and *mcr-1*, were sequenced. Expression was analyzed by real-time quantitative PCR (RT-qPCR) and analyzed with the  $2^{-\Delta\Delta CT}$  method, by normalizing the relative expression of selected genes to the expression of *rpsL* used as an internal control (9), to determine their expression levels before and after the first and second TK experiments for both strains.

An initial CFU decay followed by regrowth was observed in both strains after the first single TK experiment, at PMB concentrations of 0.125 mg/liter for KP\_WT and 1.0 and 2.0 mg/liter for KP\_MCR-1 (Fig. 2). The S/R and AR models provided relatively good data fitting, although, as expected, statistical comparisons favored the S/R model (see BIC values in Table 1) (2). However, differences were observed between strains during the second TK experiment. In the presence of KP\_WT, PMB apparent activity was slightly



**FIG 2** Comparison of predictions from the S/R and AR models after analysis of a single TK experiment (A) or after simultaneous analysis of the sequential TK data (B) for 2 isogenic isolates. (Top) *K. pneumoniae* R2292 (KP\_WT); (bottom) its MCR-1 transconjugant (KP\_MCR-1). For KP\_WT, PMB concentrations ranging from 0.0625 to 1 mg/liter were used for the 2 sequential TK experiments. For KP\_MCR-1, PMB concentrations ranging from 0.5 to 8 and 1 to 32 mg/liter were used for the first and second TK experiments, respectively. Symbols, experimental data ( $n=2$ ); color-matched lines, model predictions; gray solid lines, limit of quantification.

reduced, no initial CFU decay was observed at a concentration of 0.125 mg/liter anymore, but no regrowth was observed after the rapid decay observed at 0.25 mg/liter, consistent with (S) and (R) stable heterogeneous subpopulations (Fig. 2B, top). Accordingly, the S/R model was still able to describe the experimental data after simultaneous analysis of the two sequential TK experiments and to quantify the phenotypic difference between the two subpopulations with precision, with the reduced apparent activity for the (R) population reflected by an  $EC_{50,R}$  that was slightly higher than that for the (S) population ( $EC_{50,S}$ ) (0.132 versus 0.065 mg/liter). In contrast, with KP\_MCR-1, regrowth was observed at concentrations of 1 and 2 mg/liter after the first TK experiment and again after the second TK experiment, but at slightly higher concentrations of 4 and 8 mg/liter (Fig. 2B, bottom), indicating that PMB continued to lose efficacy during the second TK experiment. This sustained changing activity with time is not consistent with a stable (R) subpopulation but rather suggests continuous adaptation with time. Only the AR model was able to provide a relatively good fit of these sequential TK data for KP\_MCR-1.

However, these models were not really supported by RT-qPCR investigations. No mutation was observed with KP\_WT to support the two heterogeneous subpopulations for the S/R model. With KP\_MCR-1, an overexpression was observed for the *mcr-1* gene but with the same magnitude (5.5-fold) at the end of the first and second TK experiments compared with time zero, which is not consistent with continuous progressive adaptation during the first and second TK experiments. In this study, only two simple models, representative of the two basic situations, i.e., stable heterogeneous subpopulations (S/R) versus unstable homogenous population (AR), were tested. Although they provided relatively good fit, these models were not supported by the mechanistic experiments, suggesting that real life is likely to be more complex, with combined heterogeneity and instability issues requiring more complex models (1). Furthermore, mutant selection or adaptation phenomena may occur slowly and only be observable after several days of hollow-fiber experiments, which remain the most demanding but best approach for *in vitro* semimechanistic PK/PD modeling of antibiotics (10–12). Yet, although this study suffers from limitations, it shows that sequential TK experiments

TABLE 1 Statistical comparison of various parameters for S/R and AR models

Parameter <sup>a</sup>	Model results [estimate and relative standard error <sup>b</sup> (%) for strain:							
	KP_WT				KP_MCR-1			
	1 TK		Sequential TK		1 TK		Sequential TK	
	S/R	AR	S/R	AR	S/R	AR	S/R	AR
BIC	23.4	39.5	35.1	208.8	14.1	47.1	163.7	86.5
INOC (log <sub>10</sub> CFU/ml)	5.60 (2.1)	5.52 (2.5)	5.63 (2.0)	5.55 (4.1)	5.78 (1.8)	5.9 (2.5)	5.64 (2.9)	5.56 (2.2)
INOC <sub>2</sub> (log <sub>10</sub> CFU/ml)			5.93 (0.9)	5.03 (3.2)			5.3 (2.6)	5.85 (1.9)
B <sub>max</sub> (log <sub>10</sub> CFU/ml)	9.29 (1.2)	9.32 (1.1)	9.24 (1.3)	9.19 (2.0)	9.34 (1.6)	9.24 (1.4)	9.1 (1.6)	9.13 (1.0)
muff (log <sub>10</sub> CFU/ml)	−3.69 (9.0)		−3.49 (10.4)		−4.46 (8.9)		−10.5 (7.8)	
K <sub>g</sub> (h <sup>−1</sup> )	1.54 (8.1)	1.15 (15.2)	1.42 (10.4)	0.935 (20.1)	(S), 1.03 (12.8); (R), 0.568 (8.0) <sup>c</sup>	0.959 (15.9)	(S), 1.64 (20.0); (R), 1.19 (8.4) <sup>c</sup>	1.58 (7.9)
E <sub>max</sub> (h <sup>−1</sup> )	4.40 (5.9)		4.36 (4.8)		3.24 (6.4)		5.41 (10.3)	
E <sub>max(0)</sub> (h <sup>−1</sup> )		5.18 (8.2)		4.92 (13.7)		5.28 (10.8)		7.43 (7.0)
EC <sub>50</sub> (mg/liter)		0.121 (5.7)		0.371 (14.3)		1.85 (23.3)		6.98 (14.6)
EC <sub>50,S</sub> (mg/liter)	0.0631 (2.2)		0.065 (15.6)		0.932 (7.2)		1.87 (31.0)	
EC <sub>50,R</sub> (mg/liter)	0.141 (1.3)		0.162 (4.5)		3.9 (13.8)		31.1 (18.1)	
μ	10 (fixed) <sup>d</sup>	2.39 (15.1)	5.01 (15.3)	3.33 (33.4)	3.8 (18.7)	1 (fixed) <sup>e</sup>	1 (fixed) <sup>e</sup>	1 (fixed) <sup>e</sup>
K <sub>on</sub> (h <sup>−1</sup> )		0.0956 (17.5) <sup>f</sup>		0.001 (1.2) <sup>f</sup>		0.0856 (17.2) <sup>f</sup>		0.0547 (7.5) <sup>g</sup>
K <sub>on50</sub> (mg/liter)								2.89 (7.4)
6								3.63 (9.8)
o (log <sub>10</sub> CFU/ml)	0.255 (19.3)	0.382 (20.4)	0.29 (10.7)	1.97 (14.9)	0.226 (17.0)	0.498 (18.1)	0.825 (13.3)	0.469 (8.4)

<sup>a</sup>INOC, bacterial count at time 0 (before the start of the 1st TK); INOC<sub>2</sub>, bacterial count at 30 h (before the start of the 2nd TK); B<sub>max</sub>, maximum bacterial population size supported by the system; muff, fraction of resistant bacteria (R) at time 0; K<sub>g</sub>, apparent growth rate constant; E<sub>max</sub>, maximum kill rate constant; E<sub>max(0)</sub>, maximum kill rate constant when no adaptive resistance has developed; EC<sub>50</sub>, PMB concentration that produces 50% of E<sub>max(0)</sub>; EC<sub>50,S</sub> and EC<sub>50,R</sub>, PMB concentrations that produce 50% of E<sub>max</sub> for the (S) and (R) subpopulations, respectively; μ, Hill coefficient in PMB effect relationship; K<sub>on</sub>, rate constant for development of adaptive resistance to PMB; K<sub>on50</sub>, PMB concentration yielding 50% of K<sub>on</sub>; 6, Hill coefficient for rate constant for development of AR; o, additive residual error on log<sub>10</sub> scale for total bacteria count.

<sup>b</sup>Relative standard error obtained by sampling importance resampling.

<sup>c</sup>The sensitive (S) and resistant (R) subpopulations were assumed to grow at different rates, with the estimation of 2 different K<sub>g</sub> for (S) and (R) resulting in a significant decrease in the objective function value given by NONMEM.

<sup>d</sup>The Hill coefficient for this relationship, initially estimated to fall between 10 and 20, was fixed to 10 to improve model stability (13).

<sup>e</sup>PMB bactericidal effect was modeled using an ordinary E<sub>max</sub> model, with the estimation of Hill coefficient resulting in a nonsignificant decrease in the objective function value given by NONMEM.

<sup>f</sup>K<sub>on</sub> was estimated in the presence of PMB but was not dependent on its concentration.

<sup>g</sup>The resistance onset rate was determined by the PMB concentration through a sigmoid E<sub>max</sub> model. K<sub>on</sub> corresponds to the maximal rate constant for development of AR in this case.

constitute a simple approach to disqualify S/R models selected after traditional TK experiments and that these S/R models should not be used without further validation to predict treatment outcomes after multiple dosing.

## ACKNOWLEDGMENTS

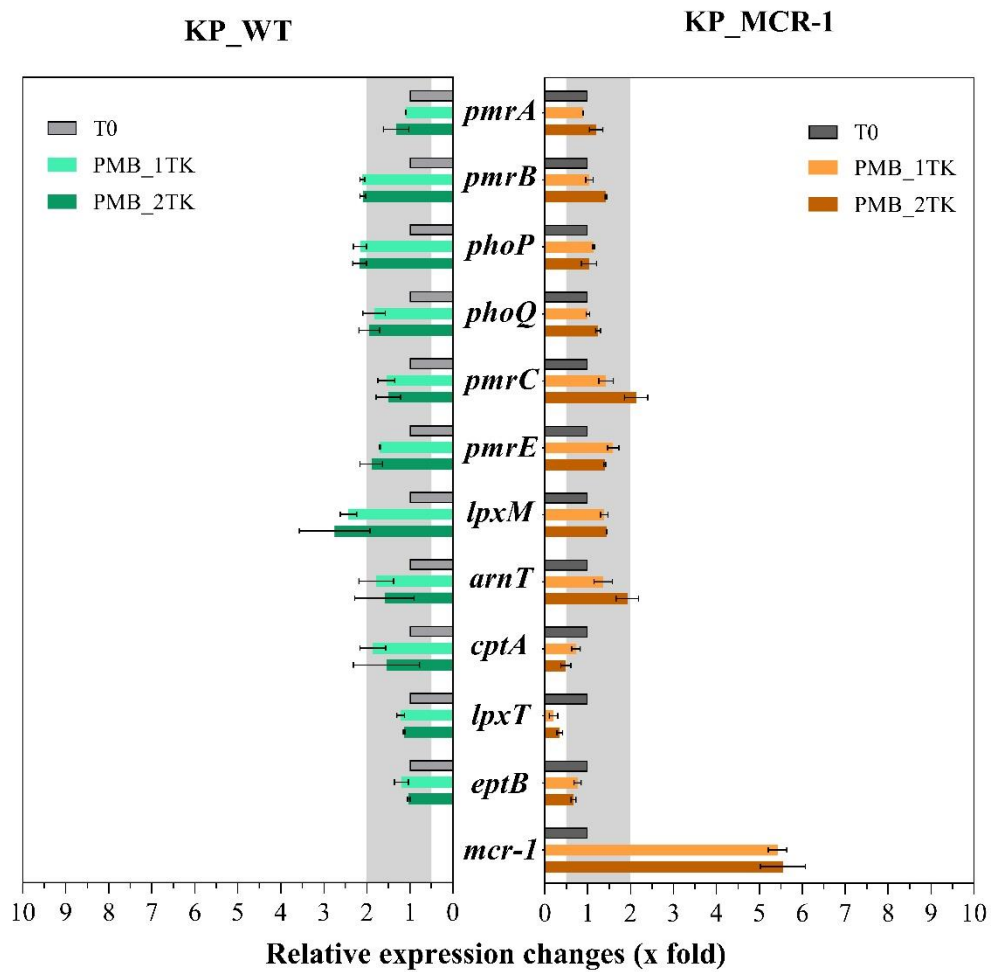
This work was funded by INSERM U1070 Laboratory, Université de Poitiers, and an LPDP scholarship (Indonesia Endowment Fund for Education).

## REFERENCES

- Nielsen EI, Friberg LE. 2013. Pharmacokinetic-pharmacodynamic modeling of antibacterial drugs. *Pharmacol Rev* 65:1053–1090. <https://doi.org/10.1124/pr.111.005769>.
- Jacobs M, Grégoire N, Couet W, Bulitta JB. 2016. Distinguishing antimicrobial models with different resistance mechanisms via population pharmacodynamic modeling. *PLoS Comput Biol* 12:e1004782. <https://doi.org/10.1371/journal.pcbi.1004782>.
- Poirel L, Kieffer N, Brink A, Coetze J, Jayol A, Nordmann P. 2016. Genetic features of MCR-1-producing colistin-resistant *Escherichia coli* isolates in South Africa. *Antimicrob Agents Chemother* 60:4394–4397. <https://doi.org/10.1128/AAC.00444-16>.
- Beal SL. 2001. Ways to fit a PK model with some data below the quantification limit. *J Pharmacokinetic Pharmacodyn* 28:481–504. <https://doi.org/10.1023/A:1012299115260>.
- Jumbe N, Louie A, Leary R, Liu W, Deziel MR, Tam VH, Bachhawat R, Freeman C, Kahn JB, Bush K, Dudley MN, Miller MH, Drusano GL. 2003. Application of a mathematical model to prevent in vivo amplification of antibiotic-resistant bacterial populations during therapy. *J Clin Invest* 112:275–285. <https://doi.org/10.1172/JCI16814>.
- Campion JJ, McNamara PJ, Evans ME. 2005. Pharmacodynamic modeling of ciprofloxacin resistance in *Staphylococcus aureus*. *Antimicrob Agents Chemother* 49:209–219. <https://doi.org/10.1128/AAC.49.1.209-219.2005>.
- Meagher AK, Forrest A, Dalhoff A, Stass H, Schentag JJ. 2004. Novel pharmacokinetic-pharmacodynamic model for prediction of outcomes with an extended-release formulation of ciprofloxacin. *Antimicrob Agents Chemother* 48:2061–2068. <https://doi.org/10.1128/AAC.48.6.2061-2068.2004>.
- Mohamed AF, Nielsen EI, Cars O, Friberg LE. 2012. Pharmacokinetic-pharmacodynamic model for gentamicin and its adaptive resistance with predictions of dosing schedules in newborn infants. *Antimicrob Agents Chemother* 56:179–188. <https://doi.org/10.1128/AAC.00694-11>.
- Schmittgen TD, Livak KJ. 2008. Analyzing real-time PCR data by the comparative C(T) method. *Nat Protoc* 3:1101–1108. <https://doi.org/10.1038/nprot.2008.73>.
- Chung P, McNamara PJ, Campion JJ, Evans ME. 2006. Mechanism-based pharmacodynamic models of fluoroquinolone resistance in *Staphylococ-*

- cus aureus*. Antimicrob Agents Chemother 50:2957–2965. <https://doi.org/10.1128/AAC.00736-05>.
11. Tsuji BT, Bulitta JB, Brown T, Forrest A, Kelchlin PA, Holden PN, Peloquin CA, Skerlos L, Hanna D. 2012. Pharmacodynamics of early, high-dose linezolid against vancomycin-resistant enterococci with elevated MICs and pre-existing genetic mutations. J Antimicrob Chemother 67: 2182–2190. <https://doi.org/10.1093/jac/dks201>.
  12. Landersdorfer CB, Rees VE, Yadav R, Rogers KE, Kim TH, Bergen PJ, Cheah S-E, Boyce JD, Peleg AY, Oliver A, Shin BS, Nation RL, Bulitta JB. 2018. Optimization of a meropenem-tobramycin combination dosage regimen against hypermutable and nonhypermutable *Pseudomonas aeruginosa* via mechanism-based modeling and the hollow-fiber infection model. Antimicrob Agents Chemother 62:e02055-17. <https://doi.org/10.1128/AAC.02055-17>.
  13. Bulitta JB, Yang JC, Yohann L, Ly NS, Brown SV, D'Hondt RE, Jusko WJ, Forrest A, Tsuji BT. 2010. Attenuation of colistin bactericidal activity by high inoculum of *Pseudomonas aeruginosa* characterized by a new mechanism-based population pharmacodynamic model. Antimicrob Agents Chemother 54:2051–2062. <https://doi.org/10.1128/AAC.00881-09>.

SUPPLEMENTAL MATERIAL



**FIG S1** Genes relative expression of wild-type (KP\_WT) and *K. pneumoniae* carrying MCR-1 (KP\_MCR-1) over PMB from the surviving bacteria in the tail of survival curve from 1<sup>st</sup> TK (30 h) and 2<sup>nd</sup> TK (60 h) (referred as 1TK and 2TK, respectively). Gene expressions were compared and normalized to their initial isolate before contact to antibiotics (T0). Data are means and error bars represented SD of 3 independent replicates.

## ARTICLE 2

-

Sequential time-kill study of *K. pneumoniae* with colistin



## **Modélisation pharmacodynamique des courbes de bactéricidies séquentielles présentant une résistance adaptative du MCR-1 *Klebsiella pneumoniae* a la colistine avec surexpression du gène *arnT***

On considère généralement que les souches bactériennes porteuses du gène MCR-1 de résistance à la colistine mobile (*mcr*) présentent une résistance de faible niveau, mais que la résistance adaptative peut alors se développer rapidement. Des courbes de bactéricidie séquentielles (TK) ont été menées pour étudier la résistance adaptative à la colistine (CST) d'une souche transconjugante de *Klebsiella pneumoniae* portant le plasmide MCR-1 (KP\_MCR-1), en utilisant la souche de type sauvage (KP\_WT) pour comparaison. L'expression et les mutations des gènes impliqués dans la résistance à la CST ont été étudiées. KP\_WT à la CST a été caractérisée par une CMI égale à 0,25 mg / L stable avec le temps. KP\_MCR-1 était initialement moins sensible, avec une CMI à 2 mg / L, mais une résistance adaptative s'est rapidement développée avec des CMI estimées à 16 et 64 mg / L à la fin du premier et de la deuxième TK, respectivement. D'un point de vue mécanistique, le résultat le plus spectaculaire était une surexpression d'environ 20 fois du gène *arnT* pendant l'exposition au CST dans KP\_MCR-1 mais pas dans KP\_WT, aucune mutation n'a été trouvée dans les gènes de modification du LPS. D'un point de vue pharmacodynamique (PD), une CMI instantanée dérivée d'un modèle (MIC<sub>instant</sub>) a été proposée pour mieux caractériser la résistance adaptative rapide à la CST dans KP\_MCR-1. En conclusion, cette étude a montré que la présence du gène *mcr-1* induit une diminution relativement modeste de la sensibilité initiale à la CST chez *K. pneumoniae*, mais qu'elle est également responsable d'une résistance adaptative prononcée conduisant à une résistance élevée à la CST. La CMI de la CST contre que la CMI de KP\_MCR-1 estimée avant le début du traitement surestime considérablement l'efficacité réelle de la CST après plusieurs jours de traitement, ce qui peut induire une sélection posologique inappropriée et un échec des traitements.





**Pharmacodynamic modelling of sequential time-kill data exhibiting MCR-1 *Klebsiella pneumoniae* adaptive resistance towards colistin with *arnT* gene overexpression**

Hariyanto Ih<sup>a,c</sup>, Alexia Chauzy<sup>a</sup>, Nicolas Grégoire<sup>a,b</sup>, Sandrine Marchand<sup>a,b</sup>, William Couet<sup>a,b#</sup>, Julien M. Buyck<sup>a</sup>

<sup>a</sup> INSERM U1070 « Pharmacologie des anti-infectieux », UFR de Médecine Pharmacie, Université de Poitiers, Poitiers, France

<sup>b</sup> Laboratoire de Toxicologie-Pharmacocinétique, CHU de Poitiers, Poitiers, France

<sup>c</sup> Universitas Tanjungpura, Pharmacy Department, Faculty of Medicine, Pontianak, Indonesia

# Corresponding author:

William Couet

Université de Poitiers

INSERM U1070 « Pharmacologie des anti-infectieux »

Pôle Biologie Santé

1 rue Georges Bonnet – BP 633

86022 Poitiers Cedex, France

[william.couet@univ-poitiers.fr](mailto:william.couet@univ-poitiers.fr)

+33 (0) 5 49 45 43 79 (telephone)

## ABSTRACT

It is usually considered that bacterial strains carrying the mobile colistin resistance (*mcr*) gene MCR-1 exhibit low-level resistance, but that adaptive resistance may then develop rapidly. Two-consecutive time-kill (TK) experiments were conducted to investigate adaptive resistance of a transconjugant *Klebsiella pneumoniae* strain carrying MCR-1 plasmid (KP\_MCR-1) to colistin (CST), using the wild-type strain (KP\_WT) for comparison. The expression and mutations of genes involved in CST resistance were investigated. KP\_WT susceptibility to CST was characterized by a MIC equal to 0.25 mg/L, that did not change with time. KP\_MCR-1 was initially less sensitive, with an MIC at 2 mg/L, but adaptive resistance rapidly developed with MICs estimated at 16 and 64 mg/L at the end of the first and second TK, respectively. From a mechanistic standpoint, the most spectacular finding was an approximately 20-fold overexpression of the LPS-modifying gene *arnT*, in KP\_MCR-1 but not in KP\_WT, during CST exposure. No mutation was found in LPS-modification genes. From a pharmacodynamic (PD) standpoint, a model-derived instantaneous MIC ( $MIC_{instant}$ ) was proposed to better capture the rapid adaptive resistance towards CST in KP\_MCR-1. In conclusion, this study has shown that the presence of the *mcr-1* gene induces a relatively modest decrease of the initial susceptibility to CST in *K. pneumoniae*, but that it is also responsible for pronounced adaptive resistance leading to high-level CST resistance. MIC of CST against KP\_MCR-1 estimated before treatment initiation, dramatically overestimates the real CST efficacy after several days of treatment, which may induce inappropriate dosing selection and treatments failure.

## INTRODUCTION

The increasing prevalence of multidrug-resistant Gram-negative bacteria infections and the absence of novel antibiotics have forced physicians to re-evaluate ‘the old’ antibiotics such as colistin, to be used as last resort drugs (1–4). Unfortunately, Gram-negative bacteria are able to develop several strategies to protect themselves from damage caused by polymyxins (5). During time-kill (TK) experiments, regrowth are frequently observed after few hours, attesting for an apparent loss of antimicrobial activity with time. These regrowth can be described by the so-called S/R model comprising two heterogeneous subpopulations, sensitive (S) and resistant (R), with antimicrobial susceptibility constant with time, or by a variety of adaptive models with a single homogeneous population with sensitivity changing with time. Unfortunately, model discrimination is very difficult after traditional TK experiments, and simulations have shown that the S/R model is likely to be selected even using data generated with an adaptation model (6). Yet conducting two TK experiments consecutively would allow differentiation between S/R and adaptation models, as recently done to characterize the rapid decrease of polymyxin B activity against a *Klebsiella pneumoniae* strain bearing MCR-1 (7). Although this approach presents limitations, it can be easily applied to provide cheap and quick information. The objective of this new study was first to confirm the potential of this innovative approach with colistin, and second to characterize the mechanism responsible for this rapidly developing adaptive resistance of polymyxins in *Klebsiella pneumoniae* strain bearing MCR-1.

## RESULTS

Without previous exposure to CST, MIC against KP\_MCR-1 was 8-fold higher than against KP\_WT, and noticeably MICs against KP\_MCR-1 estimated at the end of the 1<sup>st</sup> and 2<sup>nd</sup> TK were considerably increased, but unchanged against KP\_WT (Table 1).

### Sequential time-kill experiments

TK results (Fig. 1) are consistent with observations made by comparing MICs. First, they confirm the reduced initial CST antimicrobial activity against KP\_MCR-1 by comparison with KP\_WT, as clearly evidenced for example by comparing the results obtained during the 1<sup>st</sup> TK with a CST concentration equal to 1 mg/L (Fig. 1A and 1C). Second, they confirm that CST antimicrobial efficacy against KP\_WT is basically unchanged after the 1<sup>st</sup> and then 2<sup>nd</sup> TK, as clearly illustrated at a concentration of 0.125 mg/L (Fig. 1A and 1B), whereas the activity against KP\_MCR-1 decreases dramatically between the 1<sup>st</sup> and 2<sup>nd</sup> TK, as can be seen at CST concentrations of 4 or 8 mg/L (Fig. 1C and 1D). Accordingly, KP\_WT data were best fitted using a simple PD model with only one homogenous population of bacteria with CST activity unchanged with time (Fig. 2A), whereas an adaptation model (AR) (Fig. 2C) best described KP-MCR-1 TK data. In both cases a time delay function improved data fitting. Parameters values are presented in Table 2.

### Genes expression

No mutation was found in LPS-modifying genes at the end of the 1<sup>st</sup> and 2<sup>nd</sup> TK compared to the respective initial strain KP\_WT and KP\_MCR-1 (data not shown). Initial expression of LPS-modifying genes did not differ significantly between KP\_WT and KP\_MCR-1, and gene overexpression after exposure to CST was only observed with KP\_MCR-1 (Fig. 3). Apart from *mcr-1* that was up-regulated by more than 5-fold at the end of the 1<sup>st</sup> and 2<sup>nd</sup> TK,

3 genes (*cptA*, *eptB* and *lpxT*) seemed to be moderately down-regulated only at the end of the 2<sup>nd</sup> TK, and 3 genes (*pmrA*, *pmrC* and *pmrE*) were transiently up-regulated by more than 5-fold at the end of the 1<sup>st</sup> TK. Yet the most spectacular overexpression was observed with *arnT* that was up-regulated by more than 20-fold at the end of the 1<sup>st</sup> and 2<sup>nd</sup> TK (Fig. 3).

## DISCUSSION

These new results obtained with CST are essentially consistent with those previously published with polymyxin B using the same *K. pneumoniae* strain and experimental setting (7). Yet because KP\_WT susceptibility to CST was unchanged between the 1<sup>st</sup> and 2<sup>nd</sup> TK, a simple PD model with a single population and no effect of time on antimicrobial efficacy, was sufficient to describe the data, instead of the model S/R with two sub-populations (S/R) previously used with polymyxin B (7). Furthermore, in agreement with this single population model, no mutations in LPS-modifying genes were observed and no resistant subpopulations were detected with PAPs (data not shown). Another minor difference with the previous study (7), is that the modeling was slightly improved by incorporating a delay in the growth of the bacteria, related to the fact that bacteria were not in their logarithmic growth phase at time 0 (8).

Yet this new study shows that whereas the presence of the *mcr-1* gene induces a relatively modest decrease of the initial susceptibility to CST for this particular strain of *K. pneumoniae*, as previously reported by Nang *et al.* (9), it is responsible for pronounced adaptive resistance leading to high-level CST resistance, not observed with KP\_WT. Since the KP\_MCR-1 strain is a transconjugant strain with a MCR-1 plasmid of *E. coli* origin (10), this result indicates that native promoter of *mcr-1* found in *E. coli* is functional across

diversified species among *Enterobacteriaceae*, such as *K. pneumoniae*, as similarly shown in a previous *in vitro* study (11).

Among differences in the expression of LPS-modifying genes during CST exposure, a relationship seems to exist between *arnT* overexpression leading to an addition of 4-amino-4-deoxy-L-arabinose (L-Ara4N) on the lipid A of the LPS (12), and decreased susceptibility to CST observed in KP\_MCR-1. ArnT protein upregulation due to two-component systems PmrA/B and PhoP/Q activation is responsible for CST resistance in most clinical *K. pneumoniae* isolates (13), and the level of this upregulation dictates CST MICs, consistent with our results (14). Regarding polymyxin resistance, the LPS modification by L-Ara4N addition confers higher level of resistance than phosphoethanolamine (PEtN) modifications only, which increased the resistance up to 250-fold in the mutant expressing L-Ara4N (15, 16).

Our results suggest that the expression of *mcr-1* could facilitate another mechanism like L-Arabinose addition to LPS depending of *arnT* overexpression under CST pressure, which is different from a previous study showing that *arnT* is overexpressed only on *K. pneumoniae* clinical isolate deleted for *mcr-1* exposed to polymyxin B but not in the presence of *mcr-1* gene (17).

However, regulation of polymyxin resistance in *K. pneumoniae* is complex, since PmrA/B and PhoP/Q can directly activate the *arn* operon, which is usually controlled only by PmrA/B as observed in *E. coli* and *P. aeruginosa* (18–20). In this study, differences in the expression of *phoP/Q* were weak and other genes like *cptA* (a PEtN transferase), *lpxT* (phosphorylates lipid A) and *eptB* (a PEtN transferase) were down-expressed in KP\_MCR-1 during sequential TK. As previously described in *mgrB* mutant (14, 21), other genes like *pmrC* and

*pmrE* have a minor role in CST-resistant *K. pneumoniae* compared to the modification of LPS by *arn* operon.

Although previous studies have shown emergence of mutations after contact with CST in the presence of *mcr-1* in *E. coli* (22, 23), no mutation was found in LPS-modification genes in this study. Thus, additional mutations and/or differences in the expression of other genes are not to be excluded and could be investigated for further studies by “-omics” approach like next generation sequencing or RNAseq methods.

From a dynamic standpoint, the reduction of CST antimicrobial activity against KP\_MCR-1 with time can first be appreciated by comparing initial MICs values, higher for KP\_MCR-1 (2 mg/L) than for KP\_WT (0.25 mg/L), but unchanged after the 1<sup>st</sup> and then 2<sup>nd</sup> TK in the case of KP\_WT, and dramatically increased at the end of the 1<sup>st</sup> and then 2<sup>nd</sup> TK with KP\_MCR-1, attesting for rapid loss of antimicrobial activity (Table 1). Yet due to geometric dilutions, at such high values, MICs do not provide a precise estimate of antimicrobial susceptibility. Furthermore, MICs correspond to averaged values over a 24h period of time and therefore do not reflect antimicrobial activity at a specific time-point, as would be required when adaptive resistance occurs quickly. PD modeling offers better characterization of the effect of *mcr-1* expression on the rapid loss of *K. pneumoniae* susceptibility with time and illustrates some potential consequences in terms of dosing regimen optimization.

The AR model (Fig. 2C) predicts that CST antimicrobial efficacy decreases with time as a consequence of an increased percentage of ARon (% ARon) bacteria (and corresponding decreased percentage of ARoff). In order to better capture this changing antimicrobial activity with time and make that change more explicit, we have defined an “instantaneous MIC” (MIC<sub>instant</sub>). This corresponds to the CST concentration at which CFU would change from  $5 \times 10^5$  to  $10^7$  log CFU/mL, over 24h, for any given percentage of ARon (and therefore



ARoff). The relationship between  $MIC_{instant}$  and %ARon is shown on Fig. 4A. At time zero, when  $AR_{off} = 100\%$  and therefore  $AR_{on} = 0$ ,  $MIC_{instant}$  is equal to 1.5 mg/L, consistent with and slightly lower than 2 mg/L, the experimentally determined MIC over 24h. Noticeably the initial increase of  $MIC_{instant}$  with %ARon is relatively slow from 1.5 to 3 mg/L when %ARon increases from zero to 50%, and until %ARon reaches approximately 75%-80% when an abrupt increase of  $MIC_{instant}$  is observed (Fig. 4A). The AR model can also predict the variation of %ARon with time, and because this is affected by CST concentration, we have chosen to conduct these simulations (Fig.4B) at a CST concentration corresponding to the experimentally determined MIC (2 mg/L). It appears that %ARon increase with time is not linear but the corresponding curve flattens down with time, with %ARon being close to 50% after 24h and to 75% after 48h. Eventually these two curves (Fig. 4A and 4B) can be combined to predict the variation of  $MIC_{instant}$  with time (Fig. 4C). In order to be consistent with previous Figures, these new simulations have been conducted again for a CST concentration equal to 2 mg/L. Consistent with the initially slow and then rapid increase of  $MIC_{instant}$  with %ARon (Fig. 4A),  $MIC_{instant}$  increases more rapidly at later times (from 3 mg/L at 24h to 8 mg/L at 48h) than at early times (from 1.5 mg/L at time zero to 3 mg/L at 24h). However, the late  $MIC_{instant}$  versus time profile (Fig. 4C) is less abrupt than the  $MIC_{instant}$  versus %ARon one (Fig. 4A) due to the fact that %ARon increases less proportionally than time (Fig. 3B). These  $MIC_{instant}$  values must be interpreted carefully as they are derived from a model that properly described sequential TK data, but which is obviously an oversimplification of a more complex reality. These results obtained in static conditions (TK) should now be confirmed in dynamic conditions (hollow-fibers experiments) and over a longer duration in order to tentatively predict what could happen after several days of treatment, as it is the case in clinical practice. However,  $MIC_{instant}$  provides practical quantification of the rapid adaptive resistance to CST developed by

KP\_MCR-1 but not KP\_WT, with potentially important consequences in clinics. In the case of KP\_WT, CST antimicrobial activity does not seem to vary with time and therefore the initial MIC value determined experimentally constitutes a valid tool for dosing regimen selection. By contrast the estimated MIC of CST against KP\_MCR-1 represents an initial antimicrobial activity that should dramatically overestimate the real CST efficacy after several days of treatment. This may induce inappropriate dosing selection and treatments failure.

In conclusion, this study has shown that adaptive resistance to CST occurs in a *Klebsiella pneumoniae* strain carrying the mobile colistin resistance (*mcr*) gene MCR-1 but not in the control strain. From a mechanistic standpoint this decreased susceptibility to CST should mostly be due to *arnT* up-regulation. From a dynamic standpoint, the PD model with adaptation that successfully described the experimental data, suggests that the reduction of CST antimicrobial activity should initially be progressive before becoming very rapid. Because of its potential major consequences in clinical practice, this observation should be confirmed and possibly refined, in different experimental conditions.

## MATERIALS AND METHODS

**Bacterial strain.** Colistin-susceptible *Klebsiella pneumoniae* R2292 wild-type (KP\_WT), and its isogenic MCR-1 transconjugant strain carrying the mobile colistin resistance (*mcr*) gene MCR-1 (KP\_MCR-1) were kindly provided by P. Nordmann (University of Fribourg, Switzerland). Their construction process was described previously (10).

**Antimicrobial susceptibility assays.** Colistin (CST) MICs against KP\_WT and KP\_MCR-1 were determined at time zero and at the end of the first time-kill (30h) and second time-kill (60h). by microdilution methods in cation-adjusted Mueller-Hinton broth (MHB-CA)

according to joint CLSI - EUCAST protocol (24) and results were interpreted using EUCAST guidelines (25).

**Sequential time-kill (TK).** Individual tubes of 15 mL of MHB-CA containing CST at concentrations ranging from 0.0625 to 1 mg/L for KP\_WT and 0.5 to 8 mg/L for KP\_MCR-1 were inoculated with the bacterial suspension ( $\sim 1 \times 10^6$  CFU/mL) and incubated at  $35^\circ \pm 2^\circ\text{C}$ , under shaking conditions (150 rpm) up to 30 hours. Bacteria were quantified at 0, 1, 3, 8, 24 and 30 hours by spiral plating on MH agar plates after appropriate serial dilutions (Interscience<sup>®</sup> spiral). CFUs were enumerated with an automatic colony counter (Interscience Scan 300) after 24 hours of incubation at  $37^\circ\text{C}$ . The theoretical detection limit was 200 CFU/mL i.e.  $2.3 \log_{10}$  CFU/mL. After the 1<sup>st</sup> TK (at 30 h), bacteria that regrew up to  $10^8$  CFU/mL in the presence of antibiotic were harvested, washed out and then re-inoculated at  $10^6$  CFU/mL as initial concentration to perform the 2<sup>nd</sup> TK with CST concentrations ranging from 0.0625 to 1 mg/L for KP\_WT and 2 to 64 mg/L for KP\_MCR-1.

**Population analysis profiles (PAPs).** One hundred  $\mu\text{L}$  of bacterial cell suspension (used for inoculation) were plated on Mueller-Hinton agar plates containing various CST concentrations (0, 0.125, 0.25, 0.5, 1, 2, 4, 8, 10, 16 mg/L) after serial dilutions as described previously (26). CFUs were enumerated as described before.

**RT-qPCR.** Expression of lipopolysaccharides-modifying genes involved in polymyxin resistance (*pmrA*, *pmrB*, *phoP*, *phoQ*, *pmrC*, *pmrE*, *lpxM*, *arnT*, *cptA*, *lpxT* and *eptB*) and *mcr-1* were analyzed quantitatively by Two-step Real-Time PCR method. Initially, RNAs of KP\_WT and KP\_MCR-1 isolates, isolated before and after consecutive TK, were extracted and purified. Then, quantity and purity of RNA were determined and reverse transcription (RT) was performed starting from 2  $\mu\text{g}$  of isolated RNA. cDNA template was

diluted one tenth in PCR grade water. qPCR was done using the specific primers (Table S1). Then, 20  $\mu$ L of the real-time PCR mixture were analyzed and relative expression of genes was normalized to the expression of housekeeping genes *rpsL* by  $2^{-\Delta\Delta CT}$  method. Genes differentially expression were analyzed with the criteria threshold of twofold change (27, 28)

**PCR amplification and sequencing.** The *pmrA*, *pmrB*, *phoP*, *phoQ*, *mgrB*, *arnT*, and *pmrC* genes involved in polymyxin resistance were amplified using specific oligonucleotides (Table S1). The amplified DNA fragments were purified and were processed by Sanger sequencing. Genomic DNA of all isolates was visualized and identified using SnapGene software (v3.1.1).

**PD modeling.** Sequential TK curves were simultaneously analyzed using NONMEM 7.4 with Laplacian numerical algorithm and the M3 method for handling observations below the limit of quantification (29). Three models were compared to fit TK curves data obtained with KP\_WT and KP\_MCR-1: one with a single homogenous population and no adaptation for data fitting in the absence of regrowth (Fig. 2A), and two others including either two independent subpopulations with different antibiotic susceptibilities (S/R model, Fig. 2B) or a single homogenous bacterial population with adaptive resistance (AR model, Fig. 2C) for data fitting in the presence of regrowth, as previously done with polymyxin B (7). However, the previous models were slightly improved by incorporating a delay in the growth of the bacteria. Details and equations of these in vitro PD models are available in the Supplementary Material.

**Simulations.** Instantaneous MIC ( $MIC_{instant}$ ) for any given percentage of ARon ( $\%ARon = ARon / (ARon + ARoff)$ ), was defined as the CST concentration at which CFU would change over 24h from  $5 \times 10^5$  to  $10^7$  CFU/mL assumed to be the lowest number of micro-organisms

that can be detected visually (i.e. results in cloudiness) for most common bacteria (30). The final AR model used to describe KP\_MCR-1 data, was used to simulate MIC<sub>instant</sub> versus %AR<sub>on</sub>, %AR<sub>on</sub> versus time and eventually MIC<sub>instant</sub> versus time. MIC<sub>instant</sub> values were predicted by varying the initial conditions for the fraction of adapted bacteria (%AR<sub>on</sub>) and by fixing the rate constant for development of adaptive resistance (K<sub>on</sub>) to 0 h<sup>-1</sup>. The degree of adaptation increasing with drug concentration, the variations of %AR<sub>on</sub> and MIC<sub>instant</sub> with time were simulated for a CST concentration of 2 mg/L, corresponding to the experimentally determined MIC.

## **ACKNOWLEDGMENTS**

This work was funded by INSERM U1070 laboratory. The authors thank the LPDP scholarship (Indonesia Endowment Fund for Education) for the financial support of H. Ih.

## **REFERENCES**

1. Nation RL, Li J, Cars O, Couet W, Dudley MN, Kaye KS, Mouton JW, Paterson DL, Tam VH, Theuretzbacher U, Tsuji BT, Turnidge JD. 2015. Framework for optimisation of the clinical use of colistin and polymyxin B: the Prato polymyxin consensus. *The Lancet Infectious Diseases* 15:225–234.
2. Ni W, Li Y, Guan J, Zhao J, Cui J, Wang R, Liu Y. 2016. Effects of Efflux Pump Inhibitors on Colistin Resistance in Multidrug-Resistant Gram-Negative Bacteria. *Antimicrobial Agents and Chemotherapy* 60:3215–3218.
3. Deris ZZ, Akter J, Sivanesan S, Roberts KD, Thompson PE, Nation RL, Li J, Velkov T. 2014. A secondary mode of action of polymyxins against Gram-negative bacteria involves the inhibition of NADH-quinone oxidoreductase activity. *J Antibiot* 67:147–151.

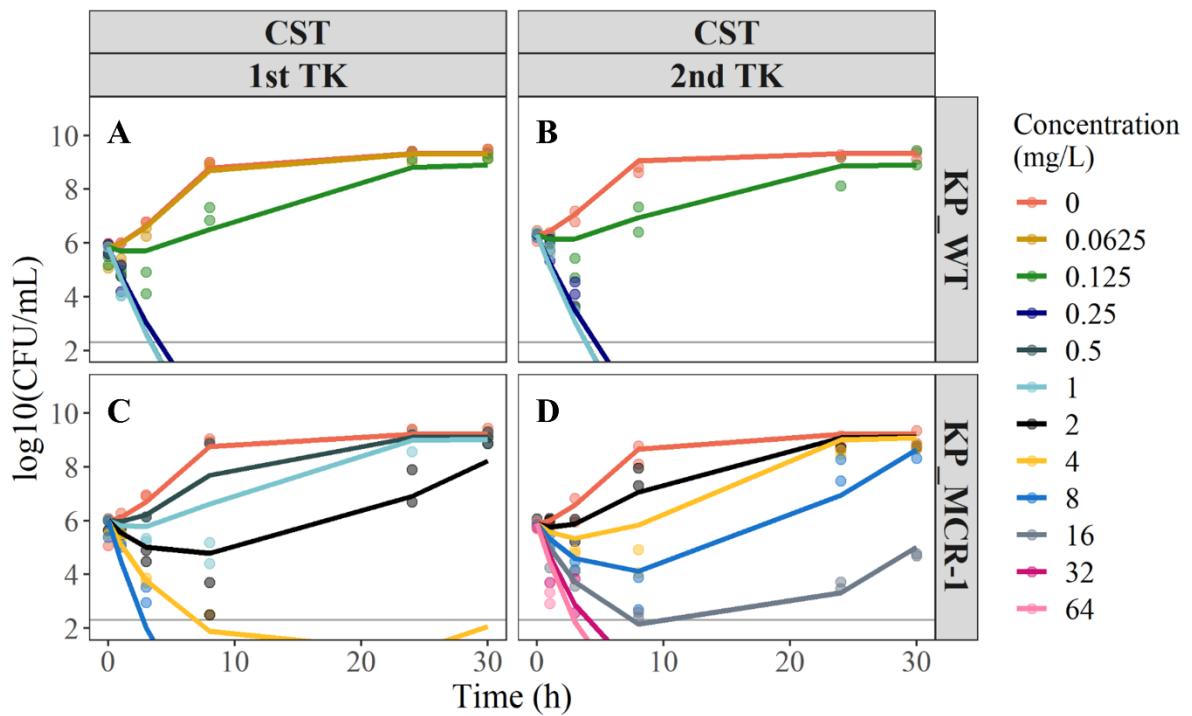
4. Grégoire N, Aranzana-Climent V, Magréault S, Marchand S, Couet W. 2017. Clinical Pharmacokinetics and Pharmacodynamics of Colistin. *Clinical Pharmacokinetics* 56:1441–1460.
5. Trimble MJ, Mlynářčik P, Kolář M, Hancock REW. 2016. Polymyxin: Alternative Mechanisms of Action and Resistance. *Cold Spring Harb Perspect Med* 6:a025288.
6. Jacobs M, Grégoire N, Couet W, Bulitta JB. 2016. Distinguishing Antimicrobial Models with Different Resistance Mechanisms via Population Pharmacodynamic Modeling. *PLoS Comput Biol* 12:e1004782–e1004782.
7. Chauzy A, Ih H, Jacobs M, Marchand S, Grégoire N, Couet W, Buyck JM. 2020. Sequential Time-Kill, a Simple Experimental Trick to Discriminate between Pharmacokinetics/Pharmacodynamics Models with Distinct Heterogeneous Subpopulations versus Homogenous Population with Adaptive Resistance. *Antimicrob Agents Chemother* 64:e00788-20, /aac/64/8/AAC.00788-20.atom.
8. Nolting A, Costa TD, Rand KH, Derendorf H. 1996. Pharmacokinetic-Pharmacodynamic Modeling of the Antibiotic Effect of Piperacillin in Vitro. *Pharmaceutical Research* 13:91–96.
9. Nang SC, Morris FC, McDonald MJ, Han M-L, Wang J, Strugnell RA, Velkov T, Li J. 2018. Fitness cost of mcr-1-mediated polymyxin resistance in *Klebsiella pneumoniae*. *Journal of Antimicrobial Chemotherapy* 73:1604–1610.
10. Poirel L, Kieffer N, Brink A, Coetze J, Jayol A, Nordmann P. 2016. Genetic Features of MCR-1-Producing Colistin-Resistant *Escherichia coli* Isolates in South Africa. *Antimicrobial Agents and Chemotherapy* 60:4394–4397.

11. Liu Y-Y, Chandler CE, Leung LM, McElheny CL, Mettus RT, Shanks RMQ, Liu J-H, Goodlett DR, Ernst RK, Doi Y. 2017. Structural Modification of Lipopolysaccharide Conferred by in Gram-Negative ESKAPE Pathogens. *Antimicrobial Agents and Chemotherapy* 61.
12. Tavares-Carreón F, Fathy Mohamed Y, Andrade A, Valvano MA. 2016. ArnT proteins that catalyze the glycosylation of lipopolysaccharide share common features with bacterial N-oligosaccharyltransferases. *Glycobiology* 26:286–300.
13. Macesic N, Nelson B, Mcconville TH, Giddins MJ, Green DA, Stump S, Gomez-Simmonds A, Annavajhala MK, Uhlemann A-C. 2020. Emergence of Polymyxin Resistance in Clinical *Klebsiella pneumoniae* Through Diverse Genetic Adaptations: A Genomic, Retrospective Cohort Study. *Clinical Infectious Diseases* 70:2084–2091.
14. Cheung CHP, Dulyayangkul P, Heesom KJ, Avison MB. 2020. Proteomic Investigation of the Signal Transduction Pathways Controlling Colistin Resistance in *Klebsiella pneumoniae*. *Antimicrob Agents Chemother* 64:e00790-20.
15. Tamayo R, Choudhury B, Septer A, Merighi M, Carlson R, Gunn JS. 2005. Identification of *cptA*, a *PmrA*-regulated locus required for phosphoethanolamine modification of the *Salmonella enterica* serovar typhimurium lipopolysaccharide core. *J Bacteriol* 187:3391–3399.
16. Dentovskaya SV, Anisimov AP, Kondakova AN, Lindner B, Bystrova OV, Svetoch TE, Shaikhutdinova RZ, Ivanov SA, Bakhteeva IV, Titareva GM, Knirel YuA. 2011. Functional characterization and biological significance of *Yersinia pestis* lipopolysaccharide biosynthesis genes. *Biochemistry (Moscow)* 76:808–822.

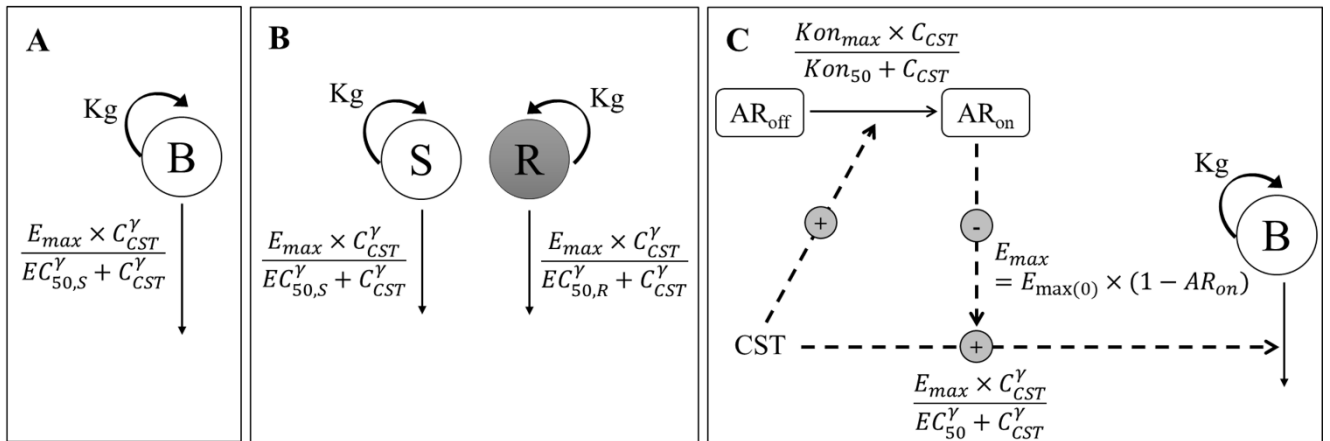
17. Nang SC, Han M-L, Yu HH, Wang J, Torres VVL, Dai C, Velkov T, Harper M, Li J. 2019. Polymyxin resistance in *Klebsiella pneumoniae*: multifaceted mechanisms utilized in the presence and absence of the plasmid-encoded phosphoethanolamine transferase gene *mcr-1*. *Journal of Antimicrobial Chemotherapy* 74:3190–3198.
18. Olaitan AO, Morand S, Rolain J-M. 2014. Mechanisms of polymyxin resistance: acquired and intrinsic resistance in bacteria. *Frontiers in Microbiology* 5.
19. McPhee JB, Lewenza S, Hancock REW. 2003. Cationic antimicrobial peptides activate a two-component regulatory system, PmrA-PmrB, that regulates resistance to polymyxin B and cationic antimicrobial peptides in *Pseudomonas aeruginosa*. *Molecular Microbiology* 50:205–217.
20. Winfield MD, Groisman EA. 2004. Phenotypic differences between *Salmonella* and *Escherichia coli* resulting from the disparate regulation of homologous genes. *Proc Natl Acad Sci U S A* 101:17162.
21. Kidd TJ, Mills G, Sá-Pessoa J, Dumigan A, Frank CG, Insua JL, Ingram R, Hopley L, Bengoechea JA. 2017. A *Klebsiella pneumoniae* antibiotic resistance mechanism that subdues host defences and promotes virulence. *EMBO Molecular Medicine* 9:430–447.
22. Zhang H, Zhao D, Quan J, Hua X, Yu Y. 2018. *mcr-1* facilitated selection of high-level colistin resistant mutants in *Escherichia Coli*. *Clinical Microbiology and Infection* <https://doi.org/10.1016/j.cmi.2018.12.014>.



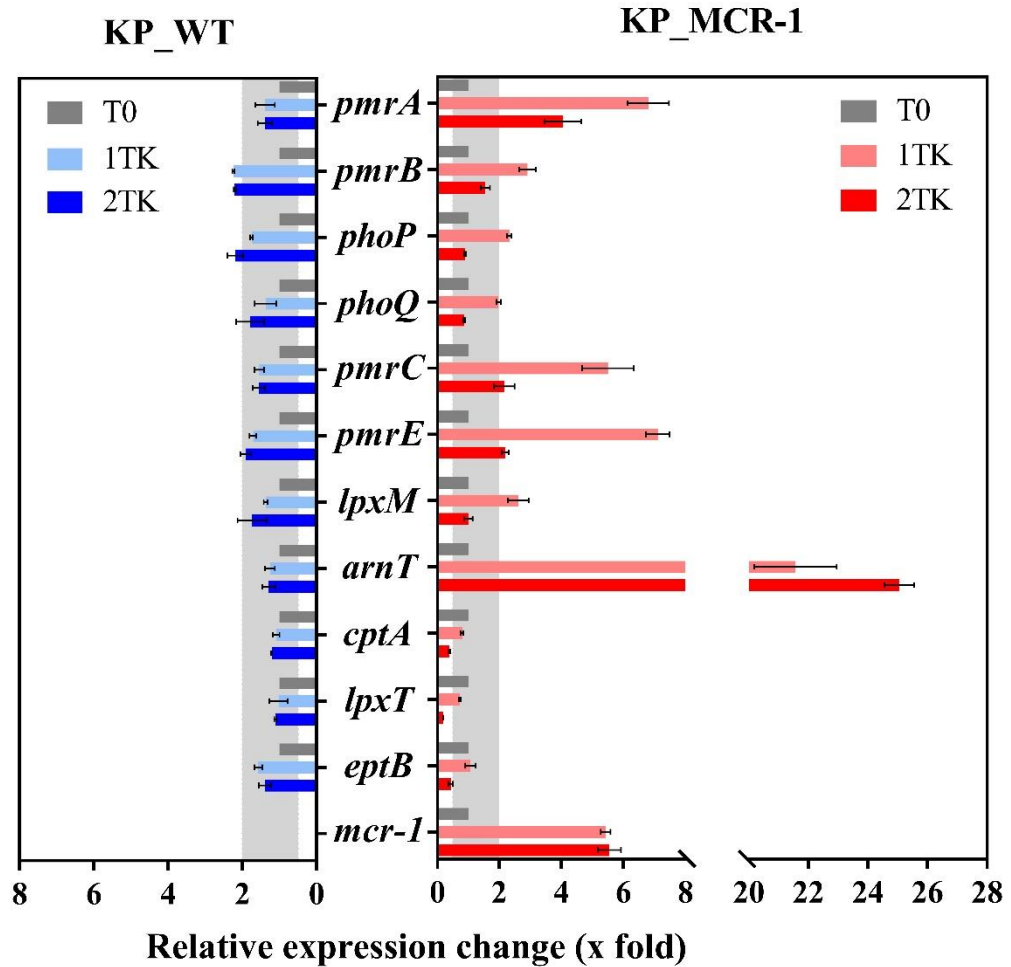
23. Li H, Wang Y, Meng Q, Wang Y, Xia G, Xia X, Shen J. 2018. Comprehensive proteomic and metabolomic profiling of mcr-1 mediated colistin resistance in *Escherichia coli*. bioRxiv <https://doi.org/10.1101/434548>.
24. European Committee on Antimicrobial Susceptibility Testing. 2016. Recommendations for MIC determination of colistin (polymyxin E) As recommended by the joint CLSI - EUCAST Polymyxin Breakpoints Working Group.
25. CA-SFM/ EUCAST. 2020. Comité de l'antibiogramme de la Société Française de Microbiologie: Recommandations 2020 V.1.1 Avril.
26. Li J, Rayner CR, Nation RL, Owen RJ, Spelman D, Tan KE, Liolios L. 2006. Heteroresistance to Colistin in Multidrug-Resistant *Acinetobacter baumannii*. *Antimicrobial Agents and Chemotherapy* 50:2946–2950.
27. Farshadzadeh Z, Taheri B, Rahimi S, Shoja S, Pourhajibagher M, Haghghi MA, Bahador A. 2018. Growth Rate and Biofilm Formation Ability of Clinical and Laboratory-Evolved Colistin-Resistant Strains of *Acinetobacter baumannii*. *Frontiers in Microbiology* 9.
28. Etienne W, Meyer MH, Peppers J, Meyer RA. 2004. Comparison of mRNA gene expression by RT-PCR and DNA microarray. *BioTechniques* 36:618–626.
29. Beal SL. 2001. Ways to Fit a PK Model with Some Data Below the Quantification Limit. *Journal of Pharmacokinetics and Pharmacodynamics* 28:481–504.
30. Mouton JW, Vinks AA. 2005. Pharmacokinetic/Pharmacodynamic Modelling of Antibacterials In Vitro and In Vivo Using Bacterial Growth and Kill Kinetics. *Clinical Pharmacokinetics* 44:201–210.



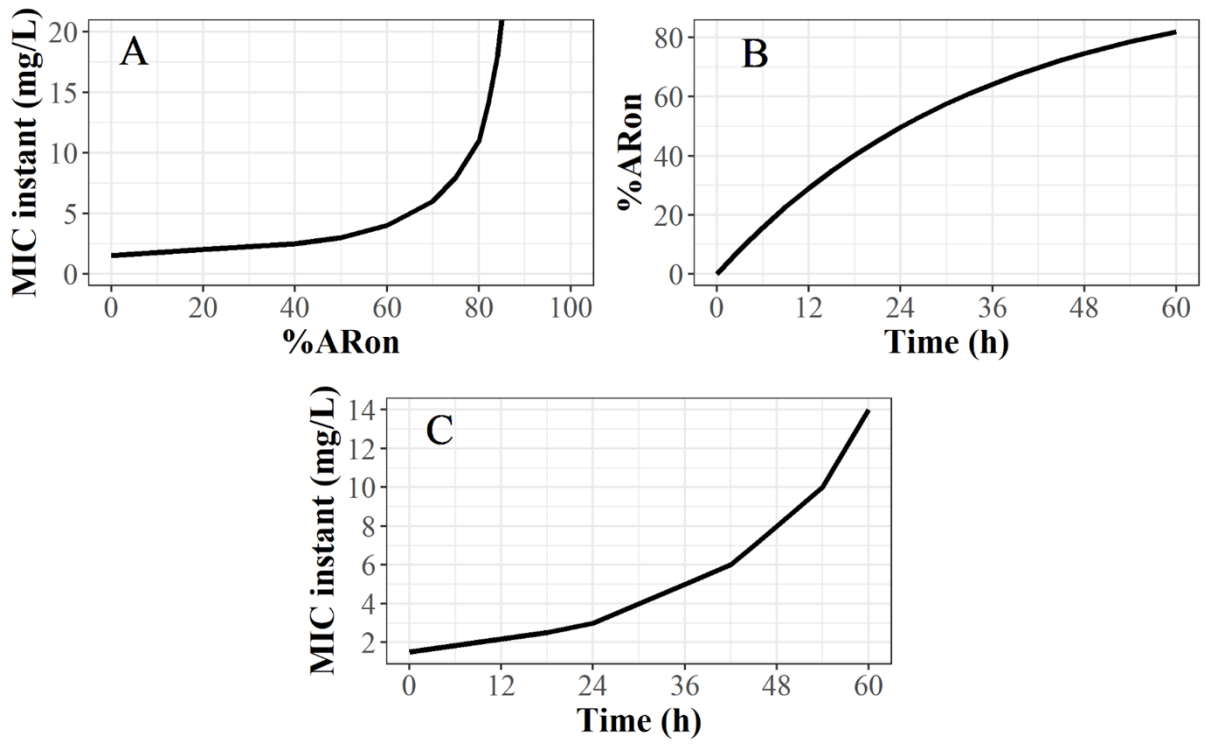
**FIG 1** Sequential time-kill (TK) results of colistin (CST) against 2 isogenic isolates. (Top) wild-type *K. pneumoniae* (KP\_WT) after consecutively first TK (A) and second TK (B); (Bottom) MCR-1 transconjugants of *K. pneumoniae* (KP\_MCR-1) after first TK (C) and second TK (D). Symbols, experiment data (n = 2); color-matched lines, model predictions; gray solid lines, limit of quantification.



**FIG 2** Schematic illustrations of the three models tested to describe TK data for KP\_WT and KP\_MCR-1. (A) Model with a single homogenous population of bacteria and no adaptation; (B) S/R model including two independent subpopulations with different antibiotic susceptibilities; (C) AR model including a single homogenous bacterial population with adaptive resistance.  $C_{CST}$ , CST concentration; S, compartment with CST sensitive bacteria; R, compartment with resistant bacteria; B, compartment with homogeneous bacterial population;  $K_g$ , rate constant for multiplication of bacteria;  $E_{max}$ , maximum kill rate constant;  $E_{max(0)}$ , maximum kill rate constant when no adaptive resistance has developed;  $EC_{50}$ , concentration producing 50% of  $E_{max(0)}$ ;  $EC_{50,S}$  and  $EC_{50,R}$ , CST concentration producing 50% of  $E_{max}$  for sensitive and resistant bacteria, respectively;  $\gamma$ , sigmoidicity factor;  $AR_{off}$  and  $AR_{on}$ , compartments describing adaptive resistance being off and on, respectively;  $Kon_{max}$ , maximum rate constant for development of adaptive resistance;  $Kon_{50}$ , CST concentration yielding 50% of  $Kon_{max}$ .



**FIG 3** LPS-modifying genes relative expression change in wild-type (KP\_WT) and MCR-1 transconjugants (KP\_MCR-1) of *K. pneumoniae* from the surviving bacteria in the tail of survival curve from first time-kill (1TK) and second time-kill (2TK) experiments over colistin (CST). Limit threshold foldchange is indicated by grey area. Gene expressions were normalized to respectively initial strains before contact with colistin (T0). Data are means and error bars represented SD of 3 independent replicates.



**FIG 4** Simulations of the instantaneous MIC ( $MIC_{instant}$ ) versus %ARon (A), %ARon versus time (B) and  $MIC_{instant}$  versus time (C) for a CST concentration of 2 mg/L.

**TABLE 1** Susceptibility data of colistin against wild-type *K. pneumoniae* (KP\_WT) and *K. pneumoniae* carrying MCR-1 (KP\_MCR-1) isolates, before (0 h) and after sequential time-kill (TK)<sup>a</sup>

Strain	MIC (mg/L)
KP_WT	0.25
KP_WT_1TK	0.25
KP_WT_2TK	0.25
KP_MCR-1	2
KP_MCR-1_1TK	16
KP_MCR-1_2TK	64
<sup>a</sup> 1TK and 2TK indicate that the surviving bacteria were isolated from the tail of survival curve from first TK (30 h) and second TK (60 h), respectively.	

**TABLE 2** Parameter estimates for the PD model based on KP\_WT and KP\_MCR-1 sequential time-kill kinetics in the presence of CST

Parameter	Description	Estimate (RSE%)	
		KP_WT	KP_MCR-1
B <sub>max</sub> (log <sub>10</sub> cfu/mL)	Maximum bacterial population size supported by the system	9.23 (0.7)	9.22 (1.3)
K <sub>g</sub> (h <sup>-1</sup> )	Apparent growth rate constant	1.14 (4.1)	1.16 (16.6)
β (h <sup>-1</sup> )	Rate constant characterizing the delay in the growth of bacteria	0.338 (15.2)	0.276 (60.5)
E <sub>max</sub> (h <sup>-1</sup> )	Maximum kill rate constant	3.09 (7.7)	-
E <sub>max(0)</sub> (h <sup>-1</sup> )	Maximum kill rate constant when no adaptive resistance has developed	-	10.5 (16.5)
EC <sub>50</sub> (mg/L)	Drug concentration that produces 50% of E <sub>max</sub> for KP_WT or 50% of E <sub>max(0)</sub> for KP_MCR-1	0.162 (7.8)	13.7 (19.6)
γ	Hill coefficient in drug effect relationship	4.76 (31.7)	1 (fixed)
K <sub>on_max</sub> (h <sup>-1</sup> )	Maximum rate constant for development of adaptive resistance to antibiotic	-	0.067 (19.9)
K <sub>on50</sub> (mg/L)	Drug concentration yielding 50% of K <sub>on</sub>	-	2.69 (44.2)
σ (log <sub>10</sub> cfu/mL)	Additive residual error on log <sub>10</sub> scale for total bacteria count	0.248 (21.7)	0.352 (10)

RSE (Relative Standard Error)

## SUPPLEMENTAL MATERIAL

**TABLE S1** Primer used in this study

Strain	Primer	Sequence (5' to 3')	Reference
<i>K. pneumoniae</i>	RT-qPCR		
	rpsL F	TGCGTAAAGTTTGCCGTGTG	(1, 2)
	rpsL R	GCC GTA CTT GGA GCG AGC CTG	
	pmrA - F	GAT GAA GAC GGG CTG CAT TT	(3)
	pmrA - R	ACC GCT AAT GCG ATC CTC AA	
	pmrB - F	CTGCCAGCTGATAAGCGTCTT	(3)
	pmrB - R	TTCTGGTTGTTGTGCCCTTCG	
	PhoP - F	ATTGAAGAGGTTGCCGCCCCG	(1)
	PhoP - R	GCTTGATCGGCTGGTCATTCACC	
	PhoQ - F	TATGCTGGCGAGATGGGAAAACG	(1)
	PhoQ - R	CAGCCAGGGAACATCACGCT	
	pmrC - F	GGTTTTGGCGGTATTCGTCTG	This Study
	pmrC - R	CACAATGCTGTTGGAAGGGC	
	pmrE - F	CCCTGTTTACCGACTCCACC	This Study
	pmrE - R	ACCAAAGGACGGGTTGTTGT	
	arnT - F	CCGCTCAATTTCCGTTTGCT	This study
	arnT - R	AACCGGCAATCGGTTTTTTCG	
	cptA - F	GTTTTCCCTGCTGCTTCACG	This study
	cptA - R	AGTTTTATCTCCCCGCGACG	
	lpxT - F	CGACGTCGTTAACTTCCCCACT	This study
	lpxT - R	GCGGGAAAGCAAAGACCACAA	
	eptB - F	GCTGGTTTATGAACGTCGCC	This study
	eptB - R	TCACCGAAGCGATAATCCCCG	
	lpxM - F	CAAACCTCGGTCGTCTGGTAGG	This study
	lpxM - R	GGGCAAGGATTTTCTGCGGAT	
		Sequencing	
	pmrA - F	CGCCATGTAGAGAGGCTGGTT	This study
	pmrA - R	AGTTGCAAACAGAGCCATGGTC	



pmrB - F	ACC TAC GCG AAA AGA TTG GC	(3)	
pmrB - R	GAT GAG GAT AGC GCC CAT GC		
phoP - F	TGCTAGGGAGAACAGCCATGC		This study
phoP - R	CGGGAAGATATGCCGCAACAG		
phoQ - F1	ATACCCACAGGACGTCATCACC		
phoQ - R1	CGAGTGGTGTGGGATTGAGC	(3)	
phoQ - F2	GCGCGAACTGGAGGAACATC		
phoQ - R2	CTGCAGGTGTCTGACAGGGATTA		
mgrB - F	GGTTTAAGAAGGCCGTGCTATCC	(3)	
mgrB - R	GAAGGCGTTCATTCTACCACCC		
arnT - F1	CTGGCTCGGACGTGAACAATT		
arnT - R1	TGTAGTACCAGAACGGCGCTT		this study
arnT - F2	AGCGTTTTGCTGAAAAAGACGC		
arnT - R2	CCTGTTTCTGGCAGAGCTGTC		
pmrC - F1	AATAGGGCTGGCACTATACCCT		
pmrC - R1	CACAATGCTGTTGGAAGGGC		
pmrC - F2	ACAAAGAGCTGGTGAAATCCCTG		this study
pmrC - R2	ATTAACCCCTGCAACAGCAGC		

## Pharmacodynamic model

### *Bacterial growth sub-model*

A logistic growth model (4, 5) with one compartment for each bacterial subpopulation was used to describe the *in vitro* bacterial population dynamics. An empirical first-order rate constant ( $\beta$ ) was estimated to characterize the observed delay in the growth of the bacteria (6) according to:

$$\frac{dB_n}{dt} = Kg \times (1 - e^{-\beta \times t}) \times \left(1 - \frac{B_{tot}}{B_{max}}\right) \times B_n \quad (\text{Equation 1})$$

$$B_{tot} = B_1 + B_2 + \dots + B_n \quad (\text{Equation 2})$$

Where  $n$  is the number of bacterial subpopulations,  $B_n$  (CFU/mL) is the  $n$ -th bacterial subpopulation,  $Kg$  ( $h^{-1}$ ) is the apparent growth rate constant,  $\beta$  ( $h^{-1}$ ) the rate constant characterizing the growth delay and  $B_{max}$  (CFU/mL) the maximum bacterial count reached in the system. Parameters related to the bacteria growth ( $Kg$ ,  $\beta$  and  $B_{max}$ ) were first estimated using only the control data and then fixed for the estimation of the parameters related to the antimicrobial effect of CST and development of resistance.

### *Drug effect sub-model*

The logistic growth model was modified to incorporate colistin bactericidal activity, such as:

$$\frac{dB_n}{dt} = Kg \times (1 - e^{-\beta \times t}) \times \left(1 - \frac{B_{tot}}{B_{max}}\right) \times B_n - K_{CST} \times B_n \quad (\text{Equation 3})$$

Where multiple functions for  $K_{CST}$  (h<sup>-1</sup>) were tested: a linear function ( $K_{CST} = k_{slope} \times [CST]$ ), a power function ( $K_{CST} = k_{slope} \times [CST]^Y$ ), an Emax function ( $K_{CST} = \frac{Emax \times [CST]}{EC_{50} + [CST]}$ ) or a sigmoidal Emax function ( $K_{CST} = \frac{Emax \times [CST]^Y}{EC_{50}^Y + [CST]^Y}$ ).

Models including 1 and 2 subpopulations with different antibiotic susceptibilities (i.e. different estimated values for  $EC_{50}$ ) were tested to characterize the emergence of resistance.

### *Adaptive resistance sub-model*

A model including a single homogenous bacterial population with adaptive resistance to CST was tested as an alternative to the previous model with distinct bacterial populations, to model the emergence of resistance. Compartments ARon and ARoff representing the fraction of adapted and non-adapted bacteria respectively were added in the model and  $K_{CST}$  was reduced proportionally to ARon.

$$\frac{dARon}{dt} = Kon \times ARoff - Koff \times ARon \quad (\text{Equation 4})$$

$$\frac{dARoff}{dt} = Koff \times ARon - Kon \times ARoff \quad (\text{Equation 5})$$

$$\frac{dB_n}{dt} = Kg \times (1 - e^{-\beta \times t}) \times \left(1 - \frac{B_{tot}}{B_{max}}\right) \times B_n - K_{CST}(1 - ARon) \times B_n \quad (\text{Equation 6})$$

At the beginning of the experiment all bacteria are assumed to be non-adapted (ARon = 0 and ARoff = 1). Multiple functions for Kon (h<sup>-1</sup>) were tested: a linear function ( $Kon = Kon_{slope} \times [CST]$ ), a power function ( $Kon = Kon_{slope} \times [CST]^\delta$ ), an Emax function ( $Kon = \frac{Kon_{max} \times [CST]}{Kon_{50} + [CST]}$ ) or a sigmoidal Emax function ( $Kon = \frac{Kon_{max} \times [CST]^\delta}{Kon_{50}^\delta + [CST]^\delta}$ ).

### *Estimation and evaluation methods*

Model selection was based on objective function value (OFV), relative standard errors (RSEs) of the parameter estimates and goodness of fit plots. When two models were nested, a decrease in OFV of at least 3.84 (chi square 1df  $p = 0.05$ ) was needed to select the most complex model. The residual errors, the difference between the observed and model-predicted values at each time point, were additive on a log scale for bacteria counts ( $\log_{10}$  cfu/mL).

Observations below the limit of quantification were handled using the M3 method (7).

All analysis were conducted using NONMEM 7.4 (ICON Development Solutions, Ellicott City, MD, USA) with the Laplacian numerical algorithm.

### **References**

1. Cannatelli A, D'Andrea MM, Giani T, Di Pilato V, Arena F, Ambretti S, Gaibani P, Rossolini GM. 2013. In Vivo Emergence of Colistin Resistance in *Klebsiella pneumoniae* Producing KPC-Type Carbapenemases Mediated by Insertional Inactivation of the PhoQ/PhoP mgrB Regulator. *Antimicrobial Agents and Chemotherapy* 57:5521–5526.
2. Jayol A, Nordmann P, Brink A, Poirel L. 2015. Heteroresistance to Colistin in *Klebsiella pneumoniae* Associated with Alterations in the PhoPQ Regulatory System. *Antimicrobial Agents and Chemotherapy* 59:2780–2784.
3. Jayol A, Poirel L, Brink A, Villegas M-V, Yilmaz M, Nordmann P. 2014. Resistance to Colistin Associated with a Single Amino Acid Change in Protein PmrB among

- Klebsiella pneumoniae* Isolates of Worldwide Origin. *Antimicrobial Agents and Chemotherapy* 58:4762–4766.
4. Nielsen EI, Friberg LE. 2013. Pharmacokinetic-Pharmacodynamic Modeling of Antibacterial Drugs. *Pharmacol Rev* 65:1053–1090.
  5. Sy SKB, Derendorf H. 2014. Pharmacometrics in Bacterial Infections, p. 229–258. *In* Schmidt, S, Derendorf, H (eds.), *Applied Pharmacometrics*. Springer New York, New York, NY.
  6. Nolting A, Costa TD, Rand KH, Derendorf H. 1996. Pharmacokinetic-Pharmacodynamic Modeling of the Antibiotic Effect of Piperacillin in Vitro. *Pharmaceutical Research* 13:91–96.
  7. Beal SL. 2001. Ways to Fit a PK Model with Some Data Below the Quantification Limit. *Journal of Pharmacokinetics and Pharmacodynamics* 28:481–504.

## ARTICLE 3

-

Study of *E. coli* with colistin and  
polymyxin B



## **Caractérisation des gènes modifiant les lipopolysaccharides impliqués dans la résistance aux polymyxines chez *Escherichia coli* porteur de MCR-1 par approche les courbes de bactéricidies séquentielles**

Les résistances aux polymyxines, antibiotiques de dernier recours, sont en augmentation. Il a été précédemment rapporté que le plasmide MCR-1 codant pour une phosphoéthanolamine transférase conduisait à une résistance de bas niveau. Cette étude a examiné le rôle du MCR-1 dans la résistance adaptative à la polymyxine d'*E. coli* par une approche de courbes de bactéricidies séquentielles. Les courbes de bactéricidies (TK) ont été menées contre *E. coli* de type sauvage (EC\_WT) et son transconjugant portant le plasmide MCR-1 (EC\_MCR-1) avec des concentrations en série de colistine et de polymyxine B. En parallèle, l'expression et les mutations de gènes impliqués dans la résistance aux polymyxines ont été étudiées. Les TK séquentielles ont illustré la présence de deux populations hétérogènes stables dans EC\_WT par rapport à une seule population avec une résistance adaptative dans EC\_MCR-1. La résistance a augmenté progressivement jusqu'à 8 fois à la CST et 4 fois à la PMB pour EC\_MCR-1 après la deuxième TK (60 h). L'étude de l'expression des gènes impliqués dans la modification des lipopolysaccharides pour EC\_MCR-1 a montré une augmentation avant le contact avec les antibiotiques puis une diminution après les TK séquentielles. Les souches de type sauvage n'ont pas montré de résistance adaptative aux polymyxines tandis que la présence de MCR-1 suggère une adaptation continue avec le temps. Ces résultats suggèrent que le plasmide MCR-1 favorise la sélection d'un autre mécanisme de résistance conduisant à développer une résistance de haut niveau aux polymyxines.





**Characterization of lipopolysaccharide-modifying genes involved in polymyxin resistance in *Escherichia coli* carrying MCR-1 by sequential time-kill approach**

Hariyanto Ih<sup>1, 3</sup>, Nicolas Grégoire<sup>1, 2</sup>, Sandrine Marchand<sup>1, 2</sup>, William Couet<sup>1, 2</sup>, Julien M. Buyck<sup>1 \*</sup>

<sup>1</sup>INSERM U1070 « Pharmacologie des anti-infectieux », UFR de Médecine Pharmacie, Université de Poitiers, Poitiers, France

<sup>2</sup>Laboratoire de Toxicologie-Pharmacocinétique, CHU de Poitiers, Poitiers, France

<sup>3</sup> Universitas Tanjungpura, Pharmacy Department, Faculty of Medicine, Pontianak, Indonesia

\*Corresponding author: Dr. Julien M. Buyck

Mailing adresse : INSERM U1070, PBS, Bâtiment B36, Secteur  $\alpha$ , Niveau 2, 1 Rue Georges Bonnet, TSA 51106, 8073, Poitiers Cedex 9.

Phone : +33-(0)5-49-45-43-79 Fax : +33 (0)5-49-45-43-78

E-mail : [julien.buyck@univ-poitiers.fr](mailto:julien.buyck@univ-poitiers.fr)

## ABSTRACT

Resistances to the last resort drugs polymyxins are on rise. It was previously reported that MCR-1 plasmid encoding a phosphoethanolamine transferase lead to low-level resistance. This study investigated the role of MCR-1 in the adaptive resistance to polymyxin of *Escherichia coli* with sequential time-kill approach. Time-kill (TK) experiments were conducted sequentially towards wild-type *E. coli* (EC\_WT) and its transconjugant carrying MCR-1 plasmid (EC\_MCR-1) with serial concentrations of colistin (CST) and polymyxin B (PMB). After the first TK, regrowth bacteria in presence of antibiotic were used for the inoculation of the second TK. In parallel, the expression and the mutations of genes involved in polymyxin resistance were investigated. Sequential TK illustrated the presence of two stable heterogenous populations in EC\_WT versus a single population with adaptation in EC\_MCR-1. EC\_WT susceptibility to CST and PMB was characterized by a MIC equal to 0.25 mg/L, that did not change with time, while the MICs of EC\_MCR-1 was increased up to 8-fold to CST and 4-fold to PMB, after second TK. The investigation of the expression of genes involved in lipopolysaccharide modification for EC\_MCR-1 showed an increase before antibiotic pressure, then decreased after sequential TK. Wild-type strains did not show adaptive resistance to polymyxins while MCR-1 suggest a continuous adaptation with time. These findings suggest that plasmid MCR-1 associated with LPS-modifying genes downregulation during sequential TK and favor selection high-level resistance to polymyxins.

## INTRODUCTION

Lipopolysaccharides is the most contributing component to polymyxin resistance where it can be extensively modified by the addition of either 4-amino-4-deoxy-L-arabinose (L-Ara4N) in the 4'-phosphate or phosphoethanolamine (PEtN) in 1-phosphate of lipid A, thus reducing the negative charge of lipid A and consequently, the binding of polymyxins (1, 2). Most of these LPS modifications has been identified being encoded chromosomally involving a large panel of genes and operons regulated by PmrA/PmrB and PhoP/PhoQ two-component systems (3). The activation of these regulatory LPS-modifying genes are triggered by environmental stimuli and specific mutations that result in the alteration of their expression (4–6). The chromosomal genes involvement is known since decades as a primary mechanism inducing polymyxin resistance until it was recently reported that it can also be caused by horizontal gene transfer (7–9). First found in 2011 in *Escherichia coli* from animal isolates, plasmid-mediated colistin resistance MCR-1 (mobile colistin resistance) in *E. coli* from human isolates was reported in 2015, and thence forward it have been detected all over the world (10, 11). It was reported in *E. coli* study that plasmid harboring *mcr-1* gene mediated polymyxin resistance induced the addition of PEtN on lipid A (12, 13). The MCR-1-positive isolates usually exhibited a low-level colistin resistance with MIC values of 2 to 8 mg/L (14, 15). However, if MCR-1 plasmids are known to induce low-level of resistance to polymyxins that could probably limit the risk for therapeutic dead end, the influence of this plasmid to induce additional genomic resistance and potentially high-level of polymyxins resistance is poorly described. The aim of this study is to characterize, by an original approach of sequential time kill curves developed recently (16), the role of MCR-1 in the development of additional adaptive resistance mechanisms leading to high-level polymyxin resistance in *E. coli*. This study provides the molecular impact of the MCR-1

presence during time kill studies against colistin and polymyxin B towards chromosomal genes involved in lipopolysaccharide modification.

## RESULTS

### **MCR-1 is associated with increasing resistance of *E. coli* during consecutive colistin and polymyxin B exposure**

During sequential time-kill, a rapid decay followed by a regrowth was observed during first TK with concentrations below 0.125 mg/L for wild-type *E. coli* J53 exposed to colistin (CST) or polymyxin B (PMB) (Fig. 1A and 1C). No initial decay was observed during second TK, then a rapid regrowth was observed at a concentration 0.125 mg/L in CST and PMB.

In contrast to wild-type strains, *E. coli* carrying MCR-1 (EC\_MCR-1) showed an adaptation during the exposure to polymyxin antibiotics (Fig. 1B and 1D). The TK profile is however comparable with its wild-type strains with an initial rapid decay then a regrowth for concentrations close to the initial measured MIC. As example, for *E. coli* exposed to CST, the regrowth at time 30 h is 2 mg/L during the 1<sup>st</sup> TK then increase up to 4 mg/L after 2<sup>nd</sup> TK (60 h) with the late regrowth at 8 mg/L (Fig. 1B). Considering now the concentration 4 mg/L, the profile was modified with strong initial decay below the detection limit and late regrowth during 1<sup>st</sup> TK, a marked initial decay then a higher regrowth during the 2<sup>nd</sup> TK, suggesting a progressive loss of susceptibility to colistin with time. In line with CST results, increased resistance was shown by EC\_MCR-1 with PMB as well. The results showed that the maximum regrowth concentration is 1 mg/L in 1<sup>st</sup> TK, then increased up to 2 mg/L in 2<sup>nd</sup> TK with a late regrowth at 4 mg/L of PMB concentration (Fig. 1D).

Before sequential TK, EC\_MCR-1 have shown a low-level of resistance to CST and PMB with respective MICs 2 mg/L for CST and PMB compared to 0.25 mg/L for wild-type strains (Table 2). Then, to check the stability of resistance of strains that regrowth after different polymyxins exposure, MICs to CST and PMB were determined, for each condition where regrowth was observed. The presence of MCR-1 was able to increase polymyxin resistance for *E. coli*. Indeed, the MICs after 2<sup>nd</sup> TK in *E. coli* carrying MCR-1 (EC\_MCR-1\_2TK) evaluated at 16 mg/L and 8 mg/L for CST and PMB, respectively (Table 1).

### **Influence of MCR-1 on expression of genes involved in LPS modification without polymyxins**

To determine the initial modification induced by MCR-1 insertion in wild-type strains before contact with polymyxins, a biomolecular analysis of sequence and expression on genes known to be involved in LPS modifications were done. The gene sequences of *pmrA*, *pmrB*, *phoP*, *phoQ*, *mgrB*, *pmrC* and *arnT* in EC\_MCR-1 were compared to its wild-type isogenic strain and no mutation was found (data not shown). However, the expression of regulator genes (*pmrA*, *pmrB*, *phoP*, *phoQ*) and of effector genes (*pmrC*, *pmrE*, *lpxM*, *arnT*, *cptA*, *lpxT*, and *eptB*) in EC\_MCR-1 were globally up-regulated compared to the wild-type strains before the contact with polymyxin antibiotics (Fig. 2).

### **Expression of lipopolysaccharide modification genes during polymyxins exposure**

Regrowth bacterial population after each TK were harvested to study modifications in sequence and expression of genes involved in polymyxin resistance. For *E. coli* carrying MCR-1 strains, no modification in gene sequences were found comparing to their initial strains before even after the sequential TK (data not shown). However, the regrowth bacteria exposed to polymyxin antibiotics showed different expression of genes involved in LPS

modifications. All genes excepted *mcr-1* were down-expressed after the 1<sup>st</sup> and 2<sup>nd</sup> TK in presence of polymyxins (Fig. 3). Contrary to the findings in wild-type isogenic strains (EC\_WT), the average relative expression changes not more than 2-fold, except for the downregulation of *phoP* gene and high overexpression of *lpxM* gene (Fig. 3). Overall, the similar genetic expression that shown by EC\_WT after consecutive TK is in line with sequential TK results showing the presence of stable heterogenous subpopulations.

## DISCUSSION

In the present study, the impact of plasmid-mediated colistin resistance MCR-1 leading to high-level polymyxins resistance has been evaluated during colistin and polymyxin B exposure in isogenic strains of *E. coli*. As starting point to identify the ability of these bacteria to regrow in presence of polymyxins, time-kill (TK) approach was performed sequentially over wild-type and the MCR-1 transconjugant strains with increasing concentrations of colistin and polymyxin B started from below the MICs to high concentrations (several times the MIC). Indeed, evaluation of resistance by measuring MIC in microdilution is limiting since initial decay and bacterial regrowth is frequently observed during TK experiments leading to detect resistant sub-populations and/or development of adaptative resistance during antibiotic exposure which is known to be a risk factor for the isolation of colistin-resistant subpopulation in Gram-negative bacteria, as it has been shown in MCR-1 transconjugants (1, 17, 18). Sequential TK in which the regrowth bacteria in the tail of the 1<sup>st</sup> time-kill curve were used as an initial inoculum for the next TK is offering a simple approach to discriminate between regrowth due to heterogeneous sub-populations or adaptative resistance as we described recently (16). Then the modification of genes involved in LPS modifications underlying the development of polymyxin resistance were

characterized during polymyxins exposure and the influence of the presence of plasmid MCR-1 was evaluated.

### **Wild-type strains were not able to develop resistance during polymyxins exposure while the presence of MCR-1 lead to polymyxin adaptation**

The sequential TK results suggested that wild-type strains were not able to adapt their resistance to polymyxins since no regrowth was observed above the concentration of 0.25 mg/L corresponding to the MICs of CST and PMB as shown in Fig. 1. However, the growth profiles were different between 1<sup>st</sup> and 2<sup>nd</sup> TK at concentration equal to 0.125 mg/L. During 1<sup>st</sup> TK, EC\_WT showed fast and similar initial killing and then, start to regrowth in 3 hours after inoculation, whereas during the 2<sup>nd</sup> TK the bacteria from 1<sup>st</sup> TK exhibited an immediate growth and this dissimilarity suggested the presence of two stable heterogeneous subpopulations with different susceptibilities called “S” (for susceptible) and “R” (for resistant). Thus the initial decay corresponds to killing of the more susceptible subpopulation and the regrowth corresponds to selection of the resistant subpopulation (16). The resistant subpopulation is generally considered as stable and have to express one or several resistance mechanisms allowing to grow in presence of antibiotic. We observed an overexpression of *lpxM* gene in *E. coli* subpopulation (Fig. 3) showing this gene might be responsible for the presence of these “R” phenotype. The *lpxM* (or *msbB*) gene encodes the enzyme responsible for the addition of the secondary acyl chains (myristoyl group) to lipid A, which results in the formation of hexa-acylated lipid A (19). An *lpxM* mutant of *E. coli* which produce penta-acylated lipid A has been found more sensitive to polymyxins than the wild-type with hexa-acylated lipid A (19, 20). Moreover, 10<sup>6</sup> to 10<sup>3</sup> log CFU/mL presumably as “R” population in wild-type strains were observed at concentration between 0.25 and 0.5 mg/L of CST and



PMB confirmed by PAPs results (Fig. 4) which is consistent with the existence of a heterogenous subpopulation.

Polymyxin antibiotics exhibited rapid and concentration-dependent bacterial killing for EC\_MCR-1 during 1<sup>st</sup> TK as well as for wild-type strains. Subsequently, sequential TK showed that the presence of MCR-1 was associated with a progressive increase of resistance to colistin and polymyxin B, where a higher concentration of CST and PMB is required to inhibit the growth during the 2<sup>nd</sup> TK and suggest continuous adaptation with time. This profile provides a good representative of the unstable homogenous population adaptive resistance (AR) model as describe in our sequential TK study (16). These results in accordance with previous studies showing that the presence of MCR-1 played an important role in increasing MICs values leading to high-level colistin resistance (HLCR) and increased the HLCR mutation rates in *E. coli* strains (15, 22).

An important point associated with the regrowth during TK is to assess the CST and PMB degradation. However, no degradation was measured by LC-MS analysis (data not shown) for polymyxin antibiotics during sequential TK experiment meaning that the regrowth is only due to increased number of resistant bacteria.

### **Adaptation of *E. coli* carrying MCR-1 to polymyxins associated with LPS-modifying genes downregulation**

The expression of *pmrA*, *pmrB*, *phoP*, *phoQ*, *pmrC*, *pmrE*, *lpxM*, *arnT*, *cptA*, *lpxT*, and *eptB* was over-expressed in EC\_MCR-1 compare to their isogenic wild-type (Fig. 2), but they were down-regulated after colistin or polymyxin B exposure (Fig. 3). It is in accordance with previous study showing that most of genes involved in glycerophospholipid metabolism were significantly up-regulated in *E. coli* carrying MCR-1 compared to the control (wild-

type *E. coli*) under condition of blank media growth, but were down-regulated in presence of polymyxins (22). In the same proteomic and metabolomic studies, *mcr-1* gene induced a down-expression of most genes leading to *mcr-1*-mediated colistin resistance under drug selection pressure then disturbing protein metabolism involved in polymyxin resistance pathway (22). The underlying mechanisms remains unclear since we did not find any mutation in the regulator genes that we have investigated whereas another study have previously shown emergence of some mutations with contact to colistin (15). Therefore, in future work, whole genome sequencing analysis might extend the explanations of which genes have role either in the upregulation of the genes involved in LPS modifications or their down-regulation.

However, it remains unclear to which degree the down-expressed of polymyxin-resistant genes are attributed to high-level polymyxin resistance in *E. coli* carrying MCR-1. The progressive resistance shown by EC\_MCR-1 either might be due partially to the slight increase in relative expression level of *mcr-1* genes (1.32- and 1.38-fold after 2<sup>nd</sup> TK of CST and PMB, respectively) or might be induce by metabolism alteration by MCR-1 to adapt to polymyxin resistance as similarly described in previous study (15, 22). It might be informative for future studies to investigate the structural changes of lipid A to understand the relationship between modification of gene expression and LPS structural modifications that occurs during exposure to polymyxins antibiotics.

## **MATERIALS AND METHODS**

**Bacterial strain.** Colistin-susceptible Gram-negative bacteria, wild-type *Escherichia coli* J53 (EC\_WT) and its MCR-1 transconjugant strains carrying *mcr-1*-positive plasmid (EC\_MCR-1) were kindly provided by P. Nordmann (University of Fribourg, Switzerland). Their construction process was described previously (14, 23).

**MIC determination.** Susceptibility testing of colistin (CST, Lot. SLBG4834V; Sigma-Aldrich, Saint Quentin Fallavier, France) and polymyxin B (PMB, Lot. 016M4099V; Sigma-Aldrich) were performed by microdilution methods in cation-adjusted Mueller-Hinton broth (MHB-CA; Lot. BCBW8159; Sigma-Aldrich) according to joint CLSI - EUCAST protocol (24) and results were interpreted using CA-SFM/EUCAST guideline (25).

**Sequential time-kill (TK).** Individual tubes of 15 mL of MHB-CA containing CST and PMB at concentrations ranging from 0.0625 to 1 mg/L for EC\_WT and 0.5 to 8 mg/L for EC\_MCR-1, were inoculated with the bacterial suspension ( $\sim 1 \times 10^6$  CFU/mL) and incubated at  $35^\circ \pm 2^\circ\text{C}$ , under shaking conditions (150 rpm) up to 30 hours. Bacteria were quantified at 0, 1, 3, 8, 24 and 30 hours by spiral plating on MH agar plates after appropriate serial dilutions (Interscience<sup>®</sup> spiral). CFUs were enumerated with an automatic colony counter (Interscience Scan 300) after 24 hours of incubation at  $37^\circ\text{C}$ . The theoretical detection limit was to 200 CFU/mL i.e.  $2.3 \log_{10}$  CFU/mL. After the 1<sup>st</sup> TK, the regrowth bacteria in the presence of antibiotic were harvested, washed out and then re-inoculated at  $10^6$  CFU/mL as initial concentration of bacteria to perform the 2<sup>nd</sup> TK with CST and PMB concentrations ranging from 0.0625 to 1 mg/L for EC\_WT and 1 to 64 mg/L for KP\_MCR-1

**Population analysis profiles (PAPs).** To decipher heterogeneity of initial bacterial population, PAPs was conducted in three replicates for EC\_WT and EC\_MCR-1. One hundred  $\mu\text{L}$  of bacterial cell suspension (after 24-h cultures) were plated on Mueller-Hinton agar plates containing various concentrations (0, 0.125, 0.25, 0.5, 1, 2, 4, 8, 10, 16 mg/L) of CST and PMB after serial dilutions as described previously (26). CFUs were enumerated as described before.

**RT-qPCR.** Expression of LPS-modifying genes (*pmrA*, *pmrB*, *phoP*, *phoQ*, *pmrC*, *pmrE*, *lpxM*, *arnT*, *cptA*, *lpxT* and *eptB*) and *mcr-1* were analysed quantitatively by Two-step Real-

Time PCR method. Initially, RNAs of EC\_WT and EC\_MCR-1, from time 0 and all their regrowth strains from each TKC study, were isolated and purified using a commercially available kit (NucleoSpin<sup>®</sup> RNA Plus; MACHEREY-NAGEL; Düren, Germany) following manufacturer recommendations. Then quantity and purity of RNA was determined with a NanoDrop and reverse transcription (RT) was performed starting from 2 µg of isolated RNA using Applied Biosystems<sup>™</sup> High-Capacity cDNA Reverse Transkription Kit (ThermoFisher Scientific). cDNA template was diluted one tenth in PCR grade water (Solis BioDyne, Tartu, Estonia). qPCR was done using 5x HOT FIREPol<sup>®</sup> EvaGreen<sup>®</sup> qPCR supermix (Solis BioDyne, Tartu, Estonia) and the specific primers that was checked using primer BLAST software at NCBI (Table S1). Then, 20 µL of the real-time PCR mixture were analyzed by Applied Biosystems<sup>™</sup> 7500 Real-Time PCR Systems (ThermoFisher Scientific). Relative expression of genes was normalized by to the expression of housekeeping genes *gapA*. The efficiency of amplification and the relative expression were analyzed  $2^{-\Delta\Delta CT}$  method.

***PCR amplification and sequencing.*** Whole cell DNA was extracted by using a commercial kit (NucleoSpin<sup>®</sup> DNA RapidLyse; MACHEREY-NAGEL; Düren, Germany) according to the manufacturer protocols. The *pmrA*, *pmrB*, *phoP*, *phoQ*, *mgrB*, *arnT*, and *pmrC* genes allegedly involved in colistin and polymyxin B resistance were amplified using specific oligonucleotides (Table S1). The amplified DNA fragments were purified by PCR clean-up and gel extraction kit (MACHEREY-NAGEL; Düren, Germany). Genomic DNA of all isolates was visualized and identified using SnapGene software (v3.1.1).

## ACKNOWLEDGMENTS

This work was funded by INSERM U1070 laboratory. The authors thank the LPDP scholarship (Indonesia Endowment Fund for Education) for the financial support of H. Ih.

## REFERENCES

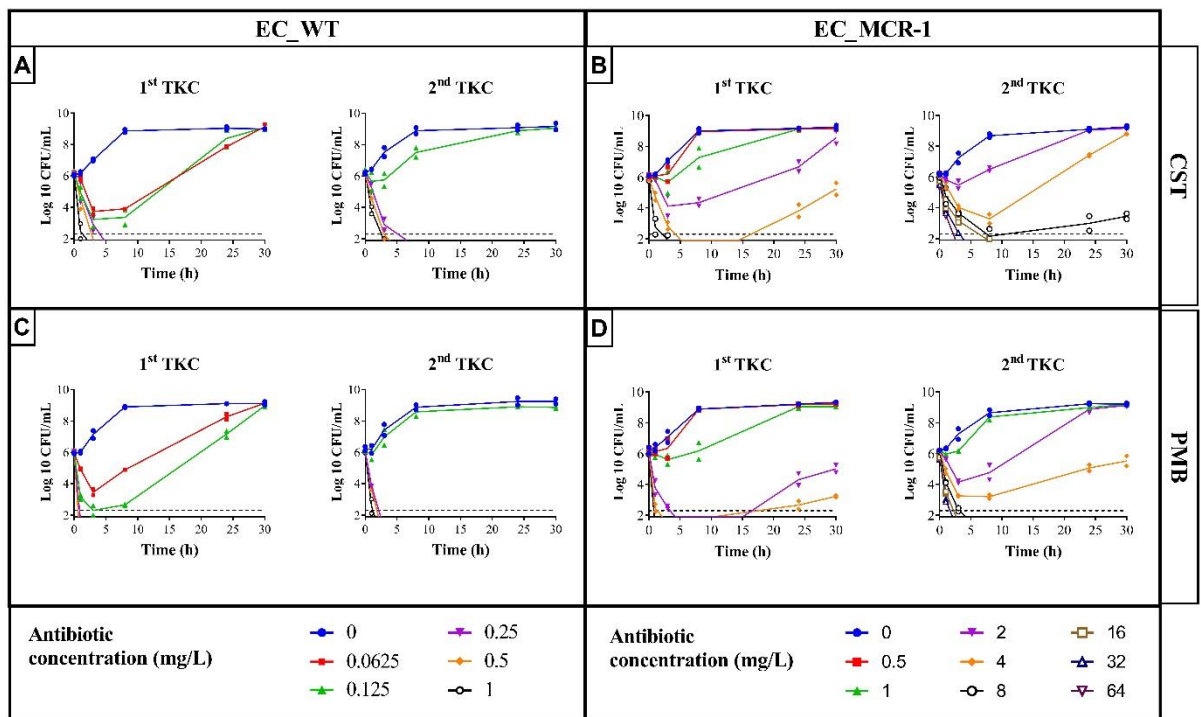
1. Jayol A, Nordmann P, Brink A, Poirel L. 2015. Heteroresistance to Colistin in *Klebsiella pneumoniae* Associated with Alterations in the PhoPQ Regulatory System. *Antimicrobial Agents and Chemotherapy* 59:2780–2784.
2. Wang X, Quinn PJ. 2010. Lipopolysaccharide: Biosynthetic pathway and structure modification. *Progress in Lipid Research* 49:97–107.
3. Poirel L, Jayol A, Nordmann P. 2017. Polymyxins: Antibacterial Activity, Susceptibility Testing, and Resistance Mechanisms Encoded by Plasmids or Chromosomes. *Clinical Microbiology Reviews* 30:557–596.
4. Froelich JM, Tran K, Wall D. 2006. A *pmrA* Constitutive Mutant Sensitizes *Escherichia coli* to Deoxycholic Acid. *Journal of Bacteriology* 188:1180–1183.
5. Cannatelli A, Giani T, Aiezza N, Di Pilato V, Principe L, Luzzaro F, Galeotti CL, Rossolini GM. 2017. An allelic variant of the PmrB sensor kinase responsible for colistin resistance in an *Escherichia coli* strain of clinical origin. *Scientific Reports* 7.
6. Kox LF, Wösten MM, Groisman EA. 2000. A small protein that mediates the activation of a two-component system by another two-component system. *The EMBO Journal* 19:1861–1872.
7. Liu Y-Y, Wang Y, Walsh TR, Yi L-X, Zhang R, Spencer J, Doi Y, Tian G, Dong B, Huang X, Yu L-F, Gu D, Ren H, Chen X, Lv L, He D, Zhou H, Liang Z, Liu J-H, Shen J. 2016. Emergence of plasmid-mediated colistin resistance mechanism MCR-1 in animals and human beings in China: a microbiological and molecular biological study. *The Lancet Infectious Diseases* 16:161–168.

8. Zurfluh K, Kieffer N, Poirel L, Nordmann P, Stephan R. 2016. Features of the *mcr-1* Cassette Related to Colistin Resistance. *Antimicrobial Agents and Chemotherapy* 60:6438–6439.
9. Miller AK, Brannon MK, Stevens L, Johansen HK, Selgrade SE, Miller SI, Høiby N, Moskowitz SM. 2011. *PhoQ* Mutations Promote Lipid A Modification and Polymyxin Resistance of *Pseudomonas aeruginosa* Found in Colistin-Treated Cystic Fibrosis Patients. *Antimicrob Agents Chemother* 55:5761.
10. Quan J, Li X, Chen Y, Jiang Y, Zhou Z, Zhang H, Sun L, Ruan Z, Feng Y, Akova M, Yu Y. 2017. Prevalence of *mcr-1* in *Escherichia coli* and *Klebsiella pneumoniae* recovered from bloodstream infections in China: a multicentre longitudinal study. *The Lancet Infectious Diseases* 17:400–410.
11. Poirel L, Nordmann P. 2016. Emerging plasmid-encoded colistin resistance: the animal world as the culprit? *J Antimicrob Chemother* 71:2326–2327.
12. Liu Y-Y, Chandler CE, Leung LM, McElheny CL, Mettus RT, Shanks RMQ, Liu J-H, Goodlett DR, Ernst RK, Doi Y. 2017. Structural Modification of Lipopolysaccharide Conferred by in Gram-Negative ESKAPE Pathogens. *Antimicrobial Agents and Chemotherapy* 61.
13. Hu M, Guo J, Cheng Q, Yang Z, Chan EWC, Chen S, Hao Q. 2016. Crystal Structure of *Escherichia coli* originated MCR-1, a phosphoethanolamine transferase for Colistin Resistance. *Scientific Reports* 6:38793.

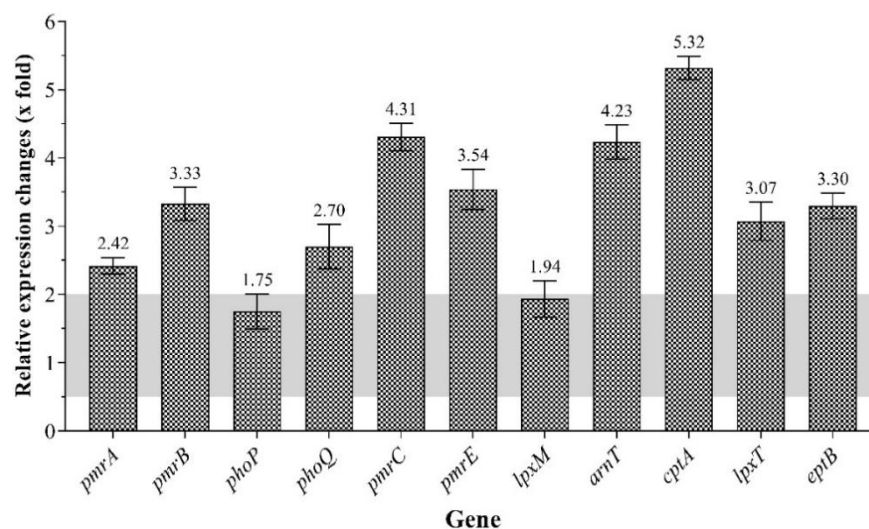
14. Poirel L, Kieffer N, Brink A, Coetze J, Jayol A, Nordmann P. 2016. Genetic Features of MCR-1-Producing Colistin-Resistant *Escherichia coli* Isolates in South Africa. *Antimicrobial Agents and Chemotherapy* 60:4394–4397.
15. Zhang H, Zhao D, Quan J, Hua X, Yu Y. 2018. *mcr-1* facilitated selection of high-level colistin resistant mutants in *Escherichia Coli*. *Clinical Microbiology and Infection* <https://doi.org/10.1016/j.cmi.2018.12.014>.
16. Chauzy A, Ih H, Jacobs M, Marchand S, Grégoire N, Couet W, Buyck JM. 2020. Sequential Time-Kill, a Simple Experimental Trick To Discriminate between Pharmacokinetics/Pharmacodynamics Models with Distinct Heterogeneous Subpopulations versus Homogenous Population with Adaptive Resistance. *Antimicrob Agents Chemother* 64:e00788-20, /aac/64/8/AAC.00788-20.atom.
17. Falagas ME, Rafailidis PI, Matthaïou DK. 2010. Resistance to polymyxins: Mechanisms, frequency and treatment options. *Drug Resistance Updates* 13:132–138.
18. Jacobs M, Grégoire N, Couet W, Bulitta JB. 2016. Distinguishing Antimicrobial Models with Different Resistance Mechanisms via Population Pharmacodynamic Modeling. *PLoS Comput Biol* 12:e1004782–e1004782.
19. Clements A, Tull D, Jenney AW, Farn JL, Kim S-H, Bishop RE, McPhee JB, Hancock REW, Hartland EL, Pearse MJ, Wijburg OLC, Jackson DC, McConville MJ, Strugnell RA. 2007. Secondary Acylation of *Klebsiella pneumoniae* Lipopolysaccharide Contributes to Sensitivity to Antibacterial Peptides. *Journal of Biological Chemistry* 282:15569–15577.

20. Tran AX, Lester ME, Stead CM, Raetz CRH, Maskell DJ, McGrath SC, Cotter RJ, Trent MS. 2005. Resistance to the Antimicrobial Peptide Polymyxin Requires Myristoylation of Escherichia coli and Salmonella typhimurium Lipid A. *Journal of Biological Chemistry* 280:28186–28194.
21. Liu J, Huang Z, Ruan B, Wang H, Chen M, Rehman S, Wu P. 2020. Quantitative proteomic analysis reveals the mechanisms of polymyxin B toxicity to Escherichia coli. *Chemosphere* 259:127449.
22. Li H, Wang Y, Meng Q, Wang Y, Xia G, Xia X, Shen J. 2018. Comprehensive proteomic and metabolomic profiling of mcr-1 mediated colistin resistance in Escherichia coli. *bioRxiv* <https://doi.org/10.1101/434548>.
23. Poirel L, Savov E, Nazli A, Trifonova A, Todorova I, Gergova I, Nordmann P. 2014. Outbreak Caused by NDM-1- and RmtB-Producing Escherichia coli in Bulgaria. *Antimicrob Agents Chemother* 58:2472–2474.
24. European Committee on Antimicrobial Susceptibility Testing. 2016. Recommendations for MIC determination of colistin (polymyxin E) As recommended by the joint CLSI - EUCAST Polymyxin Breakpoints Working Group.
25. CA-SFM/ EUCAST. 2020. Comité de l'antibiogramme de la Société Française de Microbiologie: Recommandations 2020 V.1.1 Avril.
26. Li J, Rayner CR, Nation RL, Owen RJ, Spelman D, Tan KE, Liolios L. 2006. Heteroresistance to Colistin in Multidrug-Resistant Acinetobacter baumannii. *Antimicrobial Agents and Chemotherapy* 50:2946–2950.





**FIG 1** Sequential time-kill (TK) of colistin (CST) and polymyxin B (PMB) against wild-type *E. coli* (EC\_WT) and *E. coli* carrying MCR-1 plasmid (EC\_MCR-1). Data presented are duplicate.

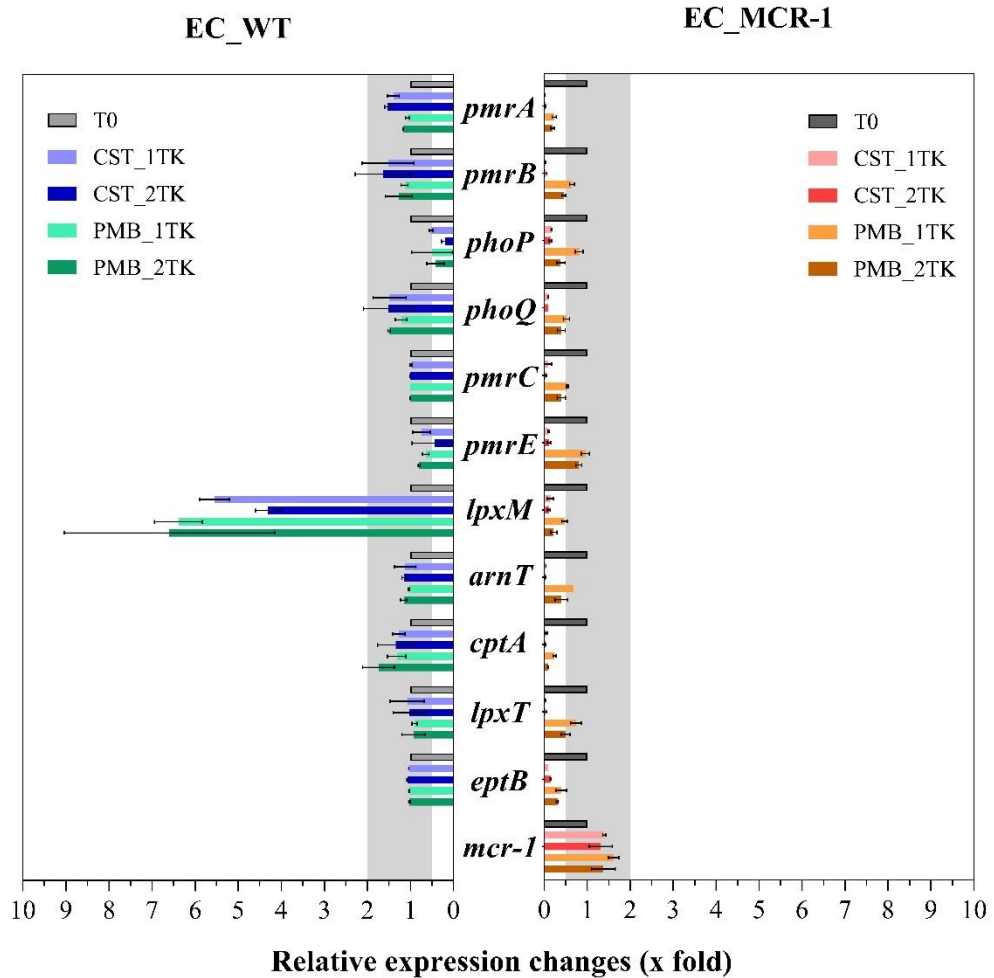


**FIG 2** Relative expression of LPS-modifying genes in *E. coli* carrying MCR-1 (EC\_MCR-1) before contact with polymyxin antibiotics. Gene expressions were compared and normalized to the wild-type strains. Data are means and error bars represented SD of 3 independent replicates.

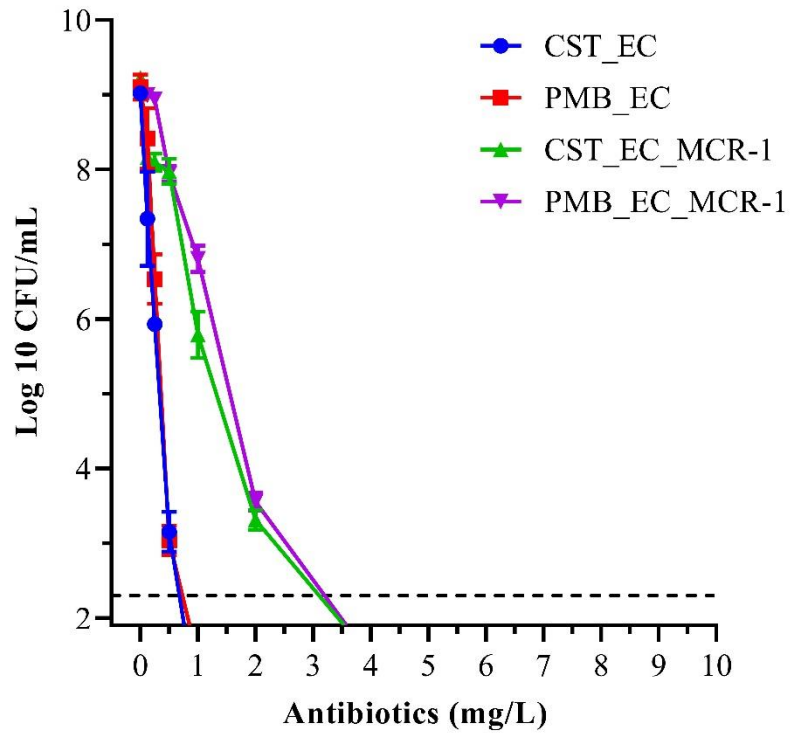
**TABLE 1** Susceptibility data of colistin (CST) and polymyxin B (PMB) against wild type *E. coli* (EC\_WT) and *E. coli* carrying MCR-1 (EC\_MCR-1), before (0 h) and after sequential time-kill curve (TK)<sup>a</sup>

Strain	MIC <sub>CST</sub> (mg/L)	MIC <sub>PMB</sub> (mg/L)
EC_WT	0.25	0.25
EC_WT_1TK	0.25	0.25
EC_WT_2TK	0.25	0.25
EC_MCR-1	2	2
EC_MCR-1_1TK	8	4
EC_MCR-1_2TK	16	8

<sup>a</sup> 1TK and 2TK indicate that the surviving bacteria were isolated from the tail of TKC in first TK (30 h) and second TK (60 h), respectively.



**FIG 3** Genes relative expression of wild-type *E. coli* (EC\_WT) and its MCR-1 transconjugants (EC\_MCR-1) over CST and PMB from the surviving bacteria in the tail of survival curve from 1<sup>st</sup> TK (30 h) and 2<sup>nd</sup> TK (60 h) (referred as 1TK and 2TK, respectively). Gene expressions were compared and normalized to their initial isolate before contact to antibiotics (T0). Data are means and error bars represented SD of 3 independent replicates.



**FIG 4** Population analysis profiles (PAPs) of wild type *E. coli* (EC) and *E. coli* carrying MCR-1 (EC\_MCR-1) exposed to serial concentrations of colistin (CST) and polymyxin B (PMB). Data are means  $\pm$  SD of 3 independent replicates

## SUPPLEMENTAL MATERIALS

**TABLE S1** Primer used in this study

Strain	Primer	Sequence (5' to 3')	Reference	
<i>E. coli</i> J53	RT-qPCR			
	gapA - F	CGACAAATATGCTGGCCAGG	(1)	
	gapA - R	GTAGTAGCGTGAACGGTGGT		
	pmrA - F	TTGCAGGGACTGATTCTGGC	(2)	
	pmrA - R	ACCAGGCTGTAATGACCTGC		
	pmrB - F	CCATCGGGGCCATTTTGTG	This study	
	pmrB - R	AGGCTGACCATAAAGACGCC		
	PhoP - F	TGTCGATCTCGGATTGCCAG	This study	
	PhoP - R	GGGAGCGAAATGACCTGTGA		
	PhoQ - F	AAACGTCTACCCGGCAACAT	This study	
	PhoQ - R	CTGGATTGAGCAATTCGCGG		
	pmrC - F	CCGCGCTGAATCTACCTGAT	This study	
	pmrC - R	GAGGCGGATAGCGGTTGTAA		
	pmrE - F	TTACCGTCACGCGTTGCTAT	This study	
	pmrE - R	GGTTGGAGTGGCGATGATGA		
	lpxM - F	TTCCGTGATCCCATTCTGGC	This study	
	lpxM - R	TCTGGAAAGCAGAGCGACAG		
	arnT - F	CGGCCTCTTCGCGTTTATTG	This study	
	arnT - R	CAGATGGGGCACAATCCAGT		
	cptA - F	GGTTGGGCACTGCTCTACTT	This study	
	cptA - R	AACAGAACGCTCTGCGAGAA		
	lpxT - F	TCATGGATTCTGGTTGCCGA	This study	
	lpxT - R	CATCGCCAGCAGTGAACAAC		
	eptB - F	TTTCTGCGTTGGGGCTGTAT	This study	
	eptB - R	GCAGTGAGAGTTTGGTTGCG		
		Sequencing		
		pmrA - F	TACCAGGCTGCGGATGATATTCT	This study
		pmrA - R	TAGTTTTTCCTCATTCGCGACCAG	
		pmrB - F	CGCGGCTTTGGCTATATGCTG	This study
		pmrB - R	TTAACTACCGTGTTTCAGCGTGC	
	phoP - F	CCCCATAACCACATAATCGCG	This study	
	phoP - R	TTGCCAACAGAAAACGTACCCG		
	phoQ - F	CCAAGAAGTGATTACCACCGTTCG	This study	

phoQ - R	CTGCAACCGATTATAACGGATGCT	
mgrB - F	GTTAGGCGCTGTTTAACTAACGCA	This study
mgrB - R	CGCTATTCTACCACTGCTGGAGA	
arnT - F1	ATATTGCCGGACGTGAAGGC	
arnT - R1	CAGAACGGAGCTCTATGTTGGG	This study
arnT - F2	CAACGCTTTGCACTGGATGATG	
arnT - R2	CGCTAAGCAAGCTGGCAAAG	
pmrC - F1	GGCTTAATTTTGCTTTGCGAGCAT	
pmrC - R1	GCGGTATTAGGAAATAGACCACG	This study
pmrC - F2	CCGCGCTGAATCTACCTGAT	
pmrC - R2	CGCCAGAATCAGTCCCTGCAATAA	

## REFERENCES

1. Cannatelli A, Giani T, Aiezza N, Di Pilato V, Principe L, Luzzaro F, Galeotti CL, Rossolini GM. 2017. An allelic variant of the PmrB sensor kinase responsible for colistin resistance in an *Escherichia coli* strain of clinical origin. *Scientific Reports* 7.
2. Quesada A, Porrero MC, Téllez S, Palomo G, García M, Domínguez L. 2015. Polymorphism of genes encoding PmrAB in colistin-resistant strains of *Escherichia coli* and *Salmonella enterica* isolated from poultry and swine. *Journal of Antimicrobial Chemotherapy* 70:71–74.



## ARTICLE 4

-

Adaptive resistance of *A. baumannii*  
to colistin and polymyxin B





## Utilisation des courbes de bactéricidies séquentielles pour distinguer la résistance induite par la polymyxine et l'hétérorésistance chez *Acinetobacter baumannii* aux polymyxines

La résistance aux polymyxines est de plus en plus fréquemment rapportée. Dans cette étude, une méthode de courbes de bactéricidies séquentielles (TK séquentielles) a été utilisée pour décrire la résistance adaptative à la colistine (CST) et à la polymyxine B (PMB) de deux isolats cliniques d'*A. Baumannii*, un colistin-sensible (CoIS) et un colistin-résistant après traitement à la colistine (CoIR). Les modifications des gènes impliqués dans la résistance aux polymyxines ont été caractérisées par séquençage et RT-qPCR. Les TK séquentielles ont été réalisées en utilisant CST et PMB à une concentration de 0,25x à 64x MIC. En parallèle, l'hétérorésistance a été quantifiée par des profils d'analyse de population (PAP). Parallèlement, les bactéries ont été analysées par séquençage et RT-qPCR pour déterminer le changement des gènes impliqués dans les modifications des lipopolysaccharides (LPS) (*pmrA*, *pmrB*, *pmrC*, *lpxM*) et la biosynthèse des LPS (*lpxA*, *lpxC*, *lpxD*). Les repousses de bactéries de la souche CoIR ont été observées jusqu'à 16 fois la CMI pour la CST après le 2ème TK mais seulement jusqu'à 4 fois la CMI pour la PMB. Avant le contact avec les polymyxines, les séquences des gènes de *pmrA*, *pmrC*, *lpxM*, *lpxA*, *lpxC* et *lpxD* pour les deux isolats étaient identiques à l'exception de *pmrB* qui montraient l'ajout de 10 acides aminés. La souche CoIR présentait également une surexpression de *pmrA* (5 fois), *pmrB* (8 fois) et *pmrC* (3,9 fois). Les PAPs ont confirmé la présence d'une sous-population résistante avec une expression génétique différente dans CoIR mais pas dans CoIS. Aucune autre mutation n'a été trouvée dans CoIS et CoIR après le 2ème TK. Cependant, une surexpression significative de *lpxC* a été montrée pour CoIR après la 2ème TK, uniquement avec la CST (5 fois) mais pas avec la PMB. Nous avons également montré que la résistance de haut niveau à la CST de la souche CoIR était vraisemblablement causée par une perte de production de LPS.



**Sequential time-kill to distinguish between polymyxin-induced resistance and heteroresistant in colistin-resistant *Acinetobacter baumannii***

Hariyanto Ih<sup>1,3</sup>, Nicolas Grégoire<sup>1,2</sup>, Sandrine Marchand<sup>1,2</sup>, William Couet<sup>1,2</sup>, Julien M. Buyck<sup>1\*</sup>

<sup>1</sup> INSERM U1070 « Pharmacologie des anti-infectieux », UFR de Médecine Pharmacie, Université de Poitiers, Poitiers, France

<sup>2</sup> Laboratoire de Toxicologie-Pharmacocinétique, CHU de Poitiers, Poitiers, France

<sup>3</sup> Universitas Tanjungpura, Pharmacy Department, Faculty of Medicine, Pontianak, Indonesia

\*Corresponding author: Dr. Julien M. Buyck

Mailing adresse : INSERM U1070, PBS, Bâtiment B36, Secteur α, Niveau 2, 1 Rue Georges Bonnet, TSA 51106, 8073, Poitiers Cedex 9.

Phone : +33-(0)5-49-45-43-79 Fax : +33 (0)5-49-45-43-78

E-mail : [julien.buyck@univ-poitiers.fr](mailto:julien.buyck@univ-poitiers.fr)

## ABSTRACT

Resistance to polymyxins is increasingly reported. In this study, sequential time-kill (TK) were used to describe the adaptive resistance to colistin (CST) and polymyxin B (PMB) in two *A. baumannii* clinical isolates, a colistin-susceptible (ColS) and a colistin-resistant after colistin treatment (ColR). Modifications of genes involved in polymyxin resistance were characterized by sequencing and RT-qPCR. Sequential TK were performed using CST and PMB at concentration from 0.25x to 64x MIC. In parallel, heteroresistance was quantified by population analysis profiles (PAPs). Alongside, bacteria were analyzed by sequencing and RT-qPCR to determine the change of genes involved in lipopolysaccharide (LPS) modifications (*pmrA*, *pmrB*, *pmrC*, *lpxM*) and LPS biosynthesis (*lpxA*, *lpxC*, *lpxD*). High-level colistin resistant population was shown by ColR after 2<sup>nd</sup> TK with the highest regrowth up to 16-fold MIC for CST but only 4-fold for PMB observed from their respective MICs value. Before sequential TK was performed, genes sequences of *pmrA*, *pmrC*, *lpxM*, *lpxA*, *lpxC*, and *lpxD* for both isolates were identical except for *pmrB* that shown the addition of 10-amino acid followed by an overexpression of *pmrA* (5-fold), *pmrB* (8-fold) and *pmrC* (3.9-fold) for ColR. PAPs confirmed the presence of resistant subpopulation with dissimilarity genetic expression in ColR. No other mutations were found in ColS and ColR after 2<sup>nd</sup> TK. However, an overexpression of *lpxC* (4.77-fold) was shown by ColR regrowth isolates after 2<sup>nd</sup> TK with CST, but only 2-fold in PMB. ColS was able to develop resistance under CST pressure while it remains susceptible to PMB. We also showed that selected high-level colistin resistant in ColR was presumably caused by heteroresistance population associated to loss of LPS production.

## INTRODUCTION

*Acinetobacter baumannii* has been reported as one of the most pathogen causing infection problems globally (1) and considered as one of three organisms that clinically responsible for the increasing of the prevalence in both nosocomial and community-acquired infections (2, 3). Most of the infections cause by this pathogen occur in critically ill patients in the intensive care unit (ICU) settings with bloodstream infections as the most common clinical manifestations (4, 5). Furthermore, *A. baumannii* has been responsible for almost ventilator-associated pneumoniae, meningitis, peritonitis, urinary tract infections and wound infections (6, 7). The emergence of carbapenem-resistant *A. baumannii* (CRAB) are on rise with the mortality rates may approach 60% in some parts of the world (8) whereas recent trends exhibit many infections are caused by CRAB or even multidrug-resistant (MDR) *A. baumannii* (9). Polymyxins, such as colistin and polymyxin B, are the most reliably effective antimicrobial *in vitro* against CRAB and MDR *A. baumannii* isolates (10). Colistimethate sodium or CMS, a prodrug of colistin, is widely used as a current therapeutic option for carbapenem-resistant and MDR *A. baumannii* infections (11, 12) although polymyxin B is a promising alternative since it provide superior *in vitro* results and less nephrotoxic compare to colistin (13–16). Currently, with an increase in the use of CMS to treat CRAB infections, colistin resistance is emerging (17, 18). The modification of the lipid A of Lipopolysaccharide (LPS) with phosphoethanolamine (PEtN) and loss of LPS are two primary mechanisms that have been described in colistin-resistant *A. baumannii* to date (19–21). PEtN addition to the lipid A has been reported responsible to the polymyxin resistance via PEtN transferase PmrC activated by PmrA/PmrB two-component regulatory systems (22, 23) and mutations in the three genes involved in the lipid A biosynthesis pathways, namely *lpxA*, *lpxC* and *lpxD*, have been reported responsible for complete loss of LPS (21,

24). Colistin-resistant *A. baumannii* occurred among the patients who had received the CMS treatment over carbapenem-resistant and colistin-susceptible *A. baumannii* infection (25) but how this strain acquired colistin resistance is poorly understood. Moreover, colistin heteroresistance subpopulation of *A. baumannii* isolates were particularly found in the patients that previously treated with colistin (21, 26). Sequential time-kill (TK) experiments is a simple method to discriminate between a stable heterogenous subpopulations (S/R) and adaptive resistance related to antimicrobial treatments (27). We use this approach in heteroresistance subpopulation selection and predict the adaptive resistance after multiple dosing of colistin and polymyxin B exposure in *A. baumannii* clinical isolates. In this study, we also characterize the genes involved either in LPS modification or LPS biosynthesis.

## RESULTS

### Sequential time-kill with MICs determination

Two consecutive MDR *A. baumannii* isolated from the same patient, a colistin-susceptible *A. baumannii* (ColS) and colistin-resistant *A. baumannii* (ColR) isolate, were used in this study. Colistin (CST) and polymyxin B (PMB) exhibit different time-killing profile against ColS during sequential TK without different initial MICs value between these two antibiotics (0.125 mg/L). PMB shown a better bactericide activity compare to CST where no bacterial population are shown from 3 hours since the 1<sup>st</sup> TK was initiated at the presence of 0.25 mg/L of PMB (Fig. 1A). Then 2<sup>nd</sup> TK was performed using the regrowth bacteria of 0.5 mg/L of CST and 0.125 mg/L of PMB, as the initial inoculum, and apparently, CST slowly loose its efficacy during the 2<sup>nd</sup> TK with the late regrowth can be seen at 2 mg/L of CST on the plate (~3log<sub>10</sub> CFU/mL), but no population have been presented in PMB over 0.125 mg/L of PMB concentrations (Fig 1A). MIC determination over these regrowth isolates lead to the similar conclusion whereas the MIC<sub>CST</sub> was gradually increase up to 2 mg/L for ColS\_2TK isolate but MIC range are stable at 0.125-0.25 mg/L in PMB (Table 1).

However, different initial MICs value was shown by CST and PMB over ColR, an acquired-resistant isolate after colistin treatment, isolated from the same patients with ColS infections. MICs of ColR isolates range from 4-8 mg/L and 2 mg/L over CST and PMB, respectively. As shown in Fig. 1B, the regrowth slightly continues over  $\sim 10^7$  CFU/mL at 16 mg/L of CST and 4 mg/L of PMB after 30 h. During the 2<sup>nd</sup> TK, ColR has regrowth up to 64 mg/L of CST (16-fold MIC) with observed MIC<sub>CST</sub>  $\geq 128$  mg/L (ColR\_2TK) as presented in table 1. In contrast with PMB, the regrowth was observed up to 8 mg/L (4-fold MIC) with MIC<sub>PMB</sub> 16 mg/L over ColR\_2TK. In addition, there is no antibiotic degradation were found after 30 hours of consecutive time-kill experiments which is confirmed by LC-MS analysis (data are not shown) that explained the decrease a killing rate is not caused by degradation of the drug with time.

### **Population analysis profiles**

PAPs has confirmed the presence of high-level colistin resistant (HLCR) subpopulation in ColR isolates but no resistant subpopulation was found in ColS based on the limit of quantification (LoQ) cutoff point. Figure 2 shows that ColR\_Subpopulation grew in the presence of 64 mg/L of CST and PMB. Furthermore, susceptibility assay has confirmed that this subpopulation had MIC<sub>CST</sub> of 128 mg/L but MIC<sub>PMB</sub> 16 mg/L (Table 1).

### **Genes characterization**

Sequencing analysis revealed that *pmrA*, *pmrC*, *lpxA*, *lpxC*, *lpxD* gene sequences in both isolates (ColS vs ColR) were identical except the duplication of 30 nucleotides in the *pmrB* gene “c.48CAGTGTCATCTTAGGTTGTATTTAATTTT[1]” was found in ColR compare with ColS (Fig. S1). Then, RT-qPCR identified upregulation of the *pmrA*, *pmrB* and *pmrC* (5.34-, 7.91-, and 3.84-fold, respectively) in the resistant isolate ColR compare



with that of the isogenic susceptible isolate ColS. In contrast, expression of the *lpxM*, *lpxA*, *lpxC* and *lpxD* did not differ significantly (Fig. 3).

To explore the difference between the ColR and ColR\_Subpopulation, we compared their genes expression level and the data are normalized to the sensitive strains ColS. Genes characterization involved in polymyxin resistance revealed upregulation of *pmrA*, *pmrB* and *pmrC* of 5.34-, 7.91- and 3.84-fold, respectively, in ColR and 5.05-, 6.91- and 3.95-fold, respectively, in ColR\_Subpopulation (Fig. 3). In contrast with ColR, *lpxM*, *lpxA* and *lpxC* were up-regulated in ColR\_Subpopulation up to 2.45-, 3.90- and 3.68-fold. These results suggest that ColR\_Subpopulation provide another resistance mechanism to polymyxins which effectively increased their resistance level.

Next, we investigated the genes expression over the ColS and ColR regrowth isolates from the 1<sup>st</sup> and 2<sup>nd</sup> TK to explore their expression change under consecutively exposed to high concentration of CST and PMB. The *pmrA*, *pmrB* and *pmrC* gene are significantly down-regulated under CST and PMB pressure for all regrowth isolates (Fig. 4). In ColR, *lpxM* gene was persistently expressed in the limit threshold, but it equally downregulated in ColS.

We observed three genes involved in LPS biosynthesis pathway in ColR, including *lpxA*, *lpxC* and *lpxD* genes. *lpxA* and *lpxD* genes expression did not differ compare with T0, but more than 2-fold overexpression was found in *lpxC* gene with the highest expression shown in CST (Fig. 4). The *lpxC* gene was up-regulated up to 3.77- and 4.77-fold in CST after 1<sup>st</sup> and 2<sup>nd</sup> TK, respectively, but only 2.18- and 2.05-fold in PMB after the 1<sup>st</sup> and 2<sup>nd</sup> TK (Fig. 4).

These results suggest that polymyxin antibiotic selection could affect the LPS modifying genes expression, such as *pmrA/pmrB* and *pmrC* genes, and may disturb the biosynthesis of LPS by change the *lpxC* expression level *in vitro*. However, we did not find any genes

sequences modification in *pmrA*, *pmrB*, *pmrC*, *lpxM*, *lpxA*, *lpxC* and *lpxD* genes of these all regrowth isolates compare to each their isogenic wild-type.

## DISCUSSION

### **The emergence of colistin-resistant *A. baumannii* isolates associated with colistin suboptimal dosage during clinical usage**

Colistin use is known as a risk factor for the emergence of polymyxin-resistant strains in Gram-negative bacteria and that was associated with the exposure of suboptimal dosage of colistin (28). Therefore, dose of ~9-10.9 million IU/day was administered as the initial daily maintenance of CMS in patients with normal renal functions (creatinine clearance ( $Cl_{cr}$ )  $\geq$  90 mL/minute) recommended by international consensus guidelines for the optimal use of the polymyxins, then dose adjustment with renal function monitoring is recommended with the lowest daily dose (patient with  $Cl_{cr}$  0 mL/minute) is 3.95 million IU/day to achieve a target average colistin plasma concentration at steady state ( $C_{ss,avg}$ ) of 2 mg/L (16). Here, we used two consecutive MDR *A. baumannii* clinical isolates from the same patients (with no information about patient renal clearance) that acquired resistance to colistin during treatment (29). After protected specimen brushes confirmed a positive susceptible-colistin *A. baumannii* isolate (ColS), patient was treated with CMS 3 million IU/day for 8 days, and subsequently, antibiotics were stopped following clinical improvement. Patient became febrile several weeks after, and afterwards, a positive colistin-resistant *A. baumannii* isolate (ColR) was identified with  $MIC_{CST} > 128$  mg/L. We found a *pmrB* mutation in ColR isolate, including duplication of 30 nucleotides in the middle of *pmrB* gene leading to the *pmrA*, *pmrB* and *pmrC* gene overexpression (Fig. 3 and Fig. S1), which is presumably responsible for its colistin resistance by PEtN addition to lipid A (17). The emergence of colistin-resistant clinical isolates of *A. baumannii* due to failed colistin treatment has been shown

with changes in PmrA and/or PmrB sequences followed by the overexpression of *pmrC* gene after colistin exposure (17, 30). Accordingly, the maintenance dose 3 million IU/day that was administered to the patient with ColS infection would lead to  $C_{ss,avg}$  lower than 2 mg/L reducing its susceptibility to colistin (31). We speculate that the positive ColR isolate is associated either by bacterial adaptation due to colistin suboptimal dosage or the presence of heteroresistant subpopulation since ColS infection was discovered, but no resistant subpopulation has been found in ColS confirmed by PAPs study, as shown in Fig. 2.

**Sequential time-kill confirmed the progressive adaptation in ColS and ColR to colistin with time, however no adaptation in ColS and less adaptation in ColR to polymyxin B**

In this study, we use sequential TK method where this is a simple approach to discriminate the bacterial regrowth after the antibiotic exposure due to heterogenous sub-populations (S/R) or adaptive resistance (AR) (27). By this approach, we demonstrate that ColS isolate *in vitro* is able to adapt to CST and potentially develop as resistance isolates. A higher concentration of CST is required to inhibit the growth during 2<sup>nd</sup> TK and suggest continuous adaptation with time. This profile provides a good representative of the unstable homogenous population with adaptive resistance as described in our previous sequential TK study (27). The similar profile was shown by ColR isolate under sequential TK of CST where the regrowth bacteria has developed to high level colistin resistance isolate (16-fold MIC) compare to their initial condition (before TK). However, the CST observation that fast triggered antibiotic persistence *in vitro* and can be followed by the evolution of resistance suggests that resistance may be evolving rapidly in the host as well, as we found in these clinical isolates (32, 33).

Our study demonstrated that PMB sulfate *in vitro* less induce polymyxin resistance rather than CST. Superior *in vitro* results are seen for PMB compare to CST against two isolates of

*A. baumannii* which agreed with previous polymyxin study (13–15). This hopefully support the developing research of PMB in clinical using since a large clinical PK/PD include its toxicodynamic study of intravenous PMB is being conducted to optimize the clinical use of PMB (34).

We believe that allowing the activation of stress response is how bacteria respond to antibiotics (35). Without further characterization, the spontaneous resistance (where bacteria may switch back to normal cells after antibiotic treatment) and drug-induced persistence are difficult to distinguish. However, their MICs are unchanged though we perform daily dilution and sub-culturing the culture for 2 months observation (data are not shown) compare with susceptibility data in Table 1. It confirmed no bacteria recovering due to post-antibiotic effect, that reflects phenomena linked to resistance (33).

**Overexpression of *lpxC* gene observed in ColR isolates after sequential TK and two pre-existing population with different polymyxin susceptibility were observed in ColR**

An overexpression of *lpxC* genes and *pmrA*, *pmrB* and *pmrC* downregulation suggested that polymyxin pressure could alterate gene expression level and developed to another resistance mechanism compare to initial strain. A previous multiomics studies where the *lpxC* mutation caused loss of LPS, showed altered global gene expression, such as RND efflux pump overexpression and down-regulated of FabZ and  $\beta$ -lactamase, leading to high-level colistin resistance (HLCR) in MDR *A. baumannii* (36). Another previous study have shown that the resistant mutants with the lack of LPS display a HLCR in *A. baumannii* with MICs of colistin >128 mg/L, and showed a significant decreasing of bacterial fitness compare to the PEtN modification only (37). Fitness cost in *A. baumannii* is associated with colistin resistant related to growth defect (38). Still, this cannot explain why an initial CFU decay was observed in the resistant mutants during the 2<sup>nd</sup> TK (Fig. 1) during selective pressure while

the bacterial control in blank liquid media has a stable growth. Contrary found to the previous finding of sequential TK studies in *E. coli* and *K. pneumoniae* that shown no initial CFU decay either for (R) subpopulation bacteria or AR mutant (Article 1, 2 and 3). However, when comparing the expression of genes related to LPS modification in this study to those of *E. coli* studies, it must be pointed out that similar gene regulation was shown, which is exposure of these bacteria to polymyxins could down-regulated LPS-modifying *pmrA/pmrB* and *pmrC* gene expression *in vitro* (Article 3).

Interestingly, a heterogenous subpopulation in ColR isolate was identified which have not been found in the previous study (29). Compare with ColR, ColR\_Subpopulation were differently expressed in their *lpxM*, *lpxA* and *lpxC* gene expression (Fig. 3) that may confirm the presence of two different resistant phenotypes in ColR strain. Mutation specifically in *lpxA*, *lpxC* and *lpxD* genes have been inactivated the LPS biosynthesis pathways resulting in the complete loss of LPS and contribute to the occurrence of heteroresistance phenotype of *A. baumannii* strains (21, 24). Heteroresistance subpopulations were particularly found in the patients that previously treated with colistin (26, 39) that may explain the presence of another HLCR subpopulation in ColR isolate. No sequencing data were provided to support this hypothesis, thereby, further work, such as whole genome sequencing and confirmation of LPS production, is certainly required to investigate these initial findings. Despite the limitations that found in this study, our results provide additional information about polymyxin resistance in *A. baumannii*, and overall, sequential TK may be considered as a promising method to disqualify AR mutant to predict treatments outputs after multiple dosing as used in our previous study.

## MATERIALS AND METHODS

**Bacterial strain.** Two clinical carbapenem-resistant *A. baumannii* isolates, colistin-susceptible *A. baumannii* (ColS) and colistin-resistant *A. baumannii* (ColR), were kindly provided by T. Naas from Institut Pasteur, Université Paris-Sud, Paris, France. Two consecutive MDR *A. baumannii* were isolated from the same patient wherein ColS was isolated before colistin treatment and ColR, strain acquired resistance to colistin during the treatment, was isolated after antibiotics were stopped (29).

**Antibiotic susceptibility testing.** MICs determination of colistin (CST, Lot. SLBG4834V; Sigma-Aldrich, Saint Quentin Fallavier, France) and polymyxin B (PMB, Lot. 016M4099V; Sigma-Aldrich, Saint Quentin Fallavier, France) were determined by microdilution methods in cation-adjusted Mueller-Hinton broth (MHB-CA; Lot. BCBW8159; Sigma-Aldrich, Saint Quentin Fallavier, France) in accordance with joint CLSI – EUCAST as recommended protocol for MIC determination of colistin and results were interpreted according to update EUCAST guidelines and were described as the mean of three replications (40, 41).

**Sequential time-kill curve (TKC).** Sequential time-kill curve (sTKC) assay of *Acinetobacter baumannii* ColS and ColR over colistin (CST) and polymyxin B (PMB) were performed in duplicate by conducting two time-kill (TK) assays consecutively. The survival bacteria that regrew over  $\sim 10^7$  CFU/mL over 30h in the presence of the highest concentration of antibiotic in the first TKC were harvested by centrifugation then re-suspended to start immediately used for the second TK at an initial inoculum  $\sim 10^6$  CFU/mL. In the 1<sup>st</sup> TK, the antibiotic was added to an overnight culture of ColS or ColR of  $\sim 10^6$  CFU/mL to yield concentrations ranging from 0.03125 mg/L to 0.5 (for ColS) and from 0.5 mg/L to 16 mg/L (for ColR) then incubated at 37 °C and 150 rpm. Samples were collected at 0; 1; 3; 8; 24 and 30 h after antibiotic addition for colonies counting and after appropriate dilutions with saline, 100  $\mu$ L

samples were spirally plated on Mueller-Hinton agar by using spiral plating (Interscience® spiral). Colonies were counted with an automatic colony counter (Interscience® Scan 300) after 24 hours of incubation. The regrowth isolates were harvested and immediately used as initial inoculum for the 2<sup>nd</sup> TK with CST and PMB concentration ranging from 0.125 mg/L to 2 mg/L (for ColS) and from 4 mg/L to 256 mg/L (for ColR).

**Population analysis profiles (PAPs).** To determine the presence of heteroresistance among the population, PAPs was performed in two replicates for ColS and ColR *A. baumannii* isolates over colistin and polymyxin B. After 24-h cultures, 100 µL of bacterial cell suspension were plated on Mueller-Hinton agar plates containing gradient of polymyxins concentration (0, 0.125, 0.25, 0.5, 1, 2, 4, 8, 10, 16, 32, 64 mg/L) after serial dilutions, and by use of spiral plating techniques for CFU counting (42). Heteroresistance was considered when polymyxins exhibiting the population growth at or higher than 8-fold MIC (43).

**RT-qPCR.** Lipopolysaccharide-modifying genes, *pmrA*, *pmrB*, *pmrC*, *lpxM*, and lipid A biosynthesis genes, *lpxA*, *lpxC*, *lpxD*, were analysed to determine their expression level in ColS and ColR *A. baumannii* isolates under three different conditions: before contact with antibiotic, after first TKC and after second TKC. RNAs from each isolate were extracted and purified using a commercially available kit (NucleoSpin® RNA Plus; MACHEREY-NAGEL; Düren, Germany) according to manufacturer recommendations. Reverse transcription (RT) was performed by reacting 2 µg of total RNA in 20 µL reaction of Applied Biosystems™ High-Capacity cDNA Reverse Transkription Kit (ThermoFisher Scientific). cDNA obtained from RT was diluted one tenth in water PCR grade (Solis BioDyne, Tartu, Estonia) then used as DNA template. qPCR was performed in 20 µL total reaction volume containing cDNA, specific primers and 5x HOT FIREPol® EvaGreen® qPCR supermix (Solis BioDyne, Tartu, Estonia). Primers for RT-qPCR were designed using primer BLAST

software at NCBI and Primer3 (Table S1). RNAs isolates and water PCR were used as control. Real time PCR mixture were analyzed by Applied Biosystems™ 7500 Real-Time PCR Systems (ThermoFisher Scientific). Relative expression of genes was normalized by to the expression of housekeeping gene 16S RNA as an internal control. The fold changes of gene expression were analyzed by  $2^{-\Delta\Delta CT}$  method. Genes differentially expression were analyzed with the criteria threshold of twofold change (44, 45).

***PCR amplification and sequencing.*** Genes sequencing related polymyxin resistance in *A. baumannii*, specifically *pmrA*, *pmrB*, *pmrC* (*eptA*), *lpxA*, *lpxC*, *lpxD* were carried out by sanger sequencing at *Service de génétique* of Poitiers University Hospital. Whole cell DNA from ColS and ColR *A. baumannii* isolates under three conditions: before sTKC, after first TKC, and after second TKC, was extracted by using a commercial kit (NucleoSpin® DNA RapidLyse; MACHEREY-NAGEL; Düren, Germany). All genes were amplified with PCR using specific primers that was checked using primer BLAST software at NCBI as shown in table S1. Amplified PCR product were purified by PCR clean-up and gel extraction kit (MACHEREY-NAGEL; Düren, Germany) then sequenced. Genomic DNA of all isolates was visualized and compared using the molecular biology software SnapGene®.

## ACKNOWLEDGMENTS

Part of this research was presented at the 30<sup>th</sup> European Congress of Clinical Microbiology and Infectious Diseases (ECCMID), 18 to 21 April 2020, Paris, France. This work was funded by INSERM U1070 laboratory. The authors thank the LPDP scholarship (Indonesia Endowment Fund for Education) for the financial support of H. Ih.



## REFERENCES

1. Chen C-T, Wang Y-C, Kuo S-C, Shih F-H, Chen T-L, How C-K, Yang Y-S, Lee Y-T. 2018. Community-acquired bloodstream infections caused by *Acinetobacter baumannii*: A matched case–control study. *Journal of Microbiology, Immunology and Infection* 51:629–635.
2. Arzanlou M, Chai WC, Venter H. 2017. Intrinsic, adaptive and acquired antimicrobial resistance in Gram-negative bacteria. *Essays in Biochemistry* 61:49–59.
3. Peleg AY, Seifert H, Paterson DL. 2008. *Acinetobacter baumannii*: Emergence of a Successful Pathogen. *Clinical Microbiology Reviews* 21:538–582.
4. Fournier PE, Richet H, Weinstein RA. 2006. The Epidemiology and Control of *Acinetobacter baumannii* in Health Care Facilities. *Clinical Infectious Diseases* 42:692–699.
5. Vincent J-L, Rello J, Marshall J, Silva E, Anzueto A, Martin CD, Moreno R, Lipman J, Gomersall C, Sakr Y, Reinhart K, EPIC II Group of Investigators. 2009. International Study of the Prevalence and Outcomes of Infection in Intensive Care Units. *JAMA* 302:2323–2329.
6. Boral B, Unaldi Ö, Ergin A, Durmaz R, Eser ÖK, Zarakolu P, Ersöz G, Kaya A, Haciseyitoglu D, Ak Ö, Gencer S, Sarigüzel FM, Çelik İ, Uyanik MH, Özden K, Acikgöz ZC, Guner R, Akcali A, Sener A, Adiloglu A, Bulut C, Yalinay M, Dizbay M, Aydemir S, Sipahi OR, the *Acinetobacter* Study Group. 2019. A prospective multicenter study on the evaluation of antimicrobial resistance and molecular epidemiology of multidrug-resistant *Acinetobacter baumannii* infections in intensive

- care units with clinical and environmental features. *Annals of Clinical Microbiology and Antimicrobials* 18:19.
7. Peleg AY, Hooper DC. 2010. Hospital-Acquired Infections Due to Gram-Negative Bacteria. *N Engl J Med* 362:1804–1813.
  8. Wong D, Nielsen TB, Bonomo RA, Pantapalangkoor P, Luna B, Spellberg B. 2017. Clinical and Pathophysiological Overview of Acinetobacter Infections: a Century of Challenges. *Clin Microbiol Rev* 30:409.
  9. Viehman JA, Nguyen MH, Doi Y. 2014. Treatment Options for Carbapenem-Resistant and Extensively Drug-Resistant Acinetobacter baumannii Infections. *Drugs* 74:1315–1333.
  10. Antunes LCS, Visca P, Towner KJ. 2014. Acinetobacter baumannii: evolution of a global pathogen. *Pathogens and Disease* 71:292–301.
  11. Mohamed AF, Karaiskos I, Plachouras D, Karvanen M, Pontikis K, Jansson B, Papadomichelakis E, Antoniadou A, Giamarellou H, Armaganidis A, Cars O, Friberg LE. 2012. Application of a Loading Dose of Colistin Methanesulfonate in Critically Ill Patients: Population Pharmacokinetics, Protein Binding, and Prediction of Bacterial Kill. *Antimicrob Agents Chemother* 56:4241.
  12. Garonzik SM, Li J, Thamlikitkul V, Paterson DL, Shoham S, Jacob J, Silveira FP, Forrest A, Nation RL. 2011. Population Pharmacokinetics of Colistin Methanesulfonate and Formed Colistin in Critically Ill Patients from a Multicenter Study Provide Dosing Suggestions for Various Categories of Patients. *Antimicrob Agents Chemother* 55:3284.

13. Yazdansetad S, Najari E, Ghaemi EA, Javid N, Hashemi A, Ardebili A. 2019. Carbapenem-resistant *Acinetobacter baumannii* isolates carrying blaOXA genes with upstream ISAbal: First report of a novel OXA subclass from Iran. *Journal of Global Antimicrobial Resistance* 18:95–99.
14. Shoja S, Moosavian M, Rostami S, Farahani A, Peymani A, Ahmadi K, Ebrahimifard N. 2017. Dissemination of carbapenem-resistant *Acinetobacter baumannii* in patients with burn injuries. *Journal of the Chinese Medical Association* 80:245–252.
15. Thamlikitkul V, Tiengrim S, Seenama C. 2014. In vitro activity of polymyxin B against carbapenem-resistant *Acinetobacter baumannii*. *J Med Assoc Thai* 97:1254–1258.
16. Tsuji BT, Pogue JM, Zavascki AP, Paul M, Daikos GL, Forrest A, Giacobbe DR, Viscoli C, Giamarellou H, Karaiskos I, Kaye D, Mouton JW, Tam VH, Thamlikitkul V, Wunderink RG, Li J, Nation RL, Kaye KS. 2019. International Consensus Guidelines for the Optimal Use of the Polymyxins: Endorsed by the American College of Clinical Pharmacy (ACCP), European Society of Clinical Microbiology and Infectious Diseases (ESCMID), Infectious Diseases Society of America (IDSA), International Society for Anti-infective Pharmacology (ISAP), Society of Critical Care Medicine (SCCM), and Society of Infectious Diseases Pharmacists (SIDP). *Pharmacotherapy* 39:10–39.
17. Lesho E, Yoon E-J, McGann P, Snesrud E, Kwak Y, Milillo M, Onmus-Leone F, Preston L, St. Clair K, Nikolich M, Viscount H, Wortmann G, Zapor M, Grillot-Courvalin C, Courvalin P, Clifford R, Waterman PE. 2013. Emergence of Colistin-Resistance in Extremely Drug-Resistant *Acinetobacter baumannii* Containing a Novel

pmrCAB Operon During Colistin Therapy of Wound Infections. *The Journal of Infectious Diseases* 208:1142–1151.

18. López-Rojas R, McConnell MJ, Jiménez-Mejías ME, Domínguez-Herrera J, Fernández-Cuenca F, Pachón J. 2013. Colistin Resistance in a Clinical *Acinetobacter baumannii* Strain Appearing after Colistin Treatment: Effect on Virulence and Bacterial Fitness. *Antimicrobial Agents and Chemotherapy* 57:4587–4589.
19. Olaitan AO, Morand S, Rolain J-M. 2014. Mechanisms of polymyxin resistance: acquired and intrinsic resistance in bacteria. *Frontiers in Microbiology* 5.
20. Pelletier MR, Casella LG, Jones JW, Adams MD, Zurawski DV, Hazlett KRO, Doi Y, Ernst RK. 2013. Unique Structural Modifications Are Present in the Lipopolysaccharide from Colistin-Resistant Strains of *Acinetobacter baumannii*. *Antimicrob Agents Chemother* 57:4831.
21. Moffatt JH, Harper M, Harrison P, Hale JDF, Vinogradov E, Seemann T, Henry R, Crane B, St. Michael F, Cox AD, Adler B, Nation RL, Li J, Boyce JD. 2010. Colistin Resistance in *Acinetobacter baumannii* Is Mediated by Complete Loss of Lipopolysaccharide Production. *Antimicrobial Agents and Chemotherapy* 54:4971–4977.
22. Arroyo LA, Herrera CM, Fernandez L, Hankins JV, Trent MS, Hancock REW. 2011. The pmrCAB Operon Mediates Polymyxin Resistance in *Acinetobacter baumannii* ATCC 17978 and Clinical Isolates through Phosphoethanolamine Modification of Lipid A. *Antimicrob Agents Chemother* 55:3743.

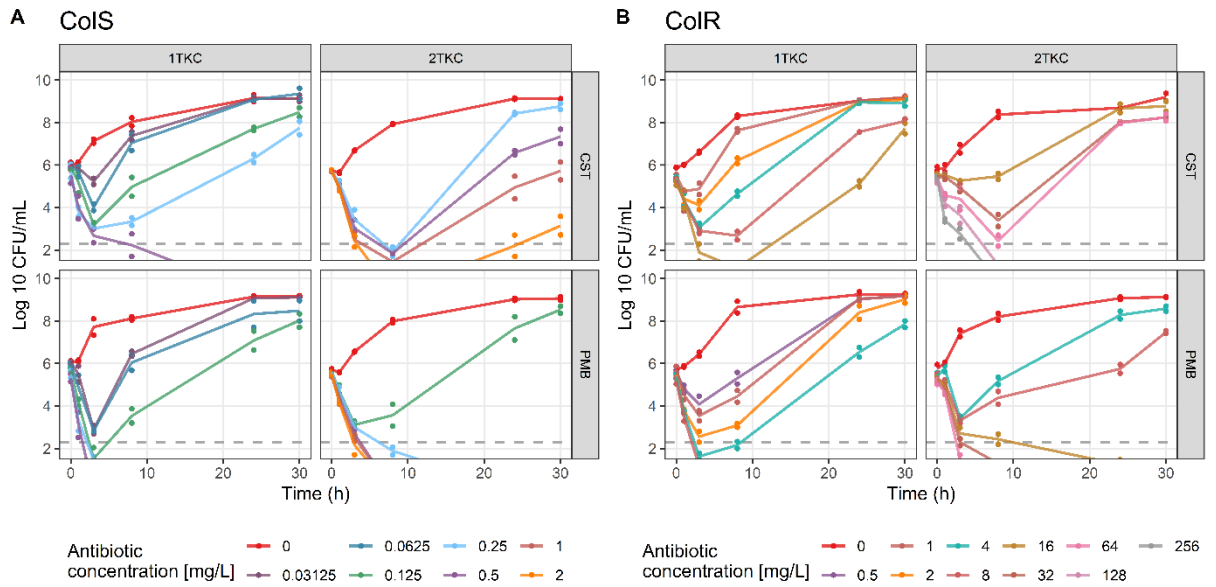
23. Beceiro A, Llobet E, Aranda J, Bengoechea JA, Doumith M, Hornsey M, Dhanji H, Chart H, Bou G, Livermore DM, Woodford N. 2011. Phosphoethanolamine Modification of Lipid A in Colistin-Resistant Variants of *Acinetobacter baumannii* Mediated by the pmrAB Two-Component Regulatory System. *Antimicrobial Agents and Chemotherapy* 55:3370–3379.
24. Moffatt JH, Harper M, Adler B, Nation RL, Li J, Boyce JD. 2011. Insertion Sequence IS iAba11i Is Involved in Colistin Resistance and Loss of Lipopolysaccharide in *Acinetobacter baumannii*. *Antimicrobial Agents and Chemotherapy* 55:3022–3024.
25. Qureshi ZA, Hittle LE, O’Hara JA, Rivera JI, Syed A, Shields RK, Pasculle AW, Ernst RK, Doi Y. 2015. Colistin-Resistant *Acinetobacter baumannii*: Beyond Carbapenem Resistance. *Clinical Infectious Diseases* 60:1295–1303.
26. Hawley JS, Murray CK, Jorgensen JH. 2008. Colistin Heteroresistance in *Acinetobacter* and Its Association with Previous Colistin Therapy. *Antimicrob Agents Chemother* 52:351.
27. Chauzy A, Ih H, Jacobs M, Marchand S, Grégoire N, Couet W, Buyck JM. 2020. Sequential time-kill: a simple experimental trick to discriminate between PK/PD models with distinct heterogeneous sub-populations versus homogenous population with adaptive resistance. *Antimicrob Agents Chemother* AAC.00788-20.
28. Falagas ME, Rafailidis PI, Matthaïou DK. 2010. Resistance to polymyxins: Mechanisms, frequency and treatment options. *Drug Resistance Updates* 13:132–138.
29. Jaidane N, Naas T, Mansour W, Radhia BB, Jerbi S, Boujaafar N, Bouallegue O, Bonnin RA. 2018. Genomic analysis of in vivo acquired resistance to colistin and

- rifampicin in *Acinetobacter baumannii*. *International Journal of Antimicrobial Agents* 51:266–269.
30. Marano V, Marascio N, Pavia G, Lamberti AG, Quirino A, Musarella R, Casalnuovo F, Mazzitelli M, Trecarichi EM, Torti C, Matera G, Liberto MC. 2020. Identification of *pmrB* mutations as putative mechanism for colistin resistance in *A. baumannii* strains isolated after in vivo colistin exposure. *Microbial Pathogenesis* 142:104058.
31. Couet W, Grégoire N, Marchand S, Mimosz O. 2012. Colistin pharmacokinetics: the fog is lifting. *Clinical Microbiology and Infection* 18:30–39.
32. Van den Bergh B, Michiels JE, Wenseleers T, Windels EM, Boer PV, Kestemont D, De Meester L, Verstrepen KJ, Verstraeten N, Fauvart M, Michiels J. 2016. Frequency of antibiotic application drives rapid evolutionary adaptation of *Escherichia coli* persistence. *Nature Microbiology* 1:16020.
33. Balaban NQ, Helaine S, Lewis K, Ackermann M, Aldridge B, Andersson DI, Brynildsen MP, Bumann D, Camilli A, Collins JJ, Dehio C, Fortune S, Ghigo J-M, Hardt W-D, Harms A, Heinemann M, Hung DT, Jenal U, Levin BR, Michiels J, Storz G, Tan M-W, Tenson T, Van Melderen L, Zinkernagel A. 2019. Definitions and guidelines for research on antibiotic persistence. *Nat Rev Microbiol* 17:441–448.
34. Optimizing Clinical Use of Polymyxin B - Full Text View - [ClinicalTrials.gov](#).
35. Dörr T, Vulić M, Lewis K. 2010. Ciprofloxacin Causes Persister Formation by Inducing the TisB toxin in *Escherichia coli*. *PLOS Biology* 8:e1000317.

36. Hua X, Liu L, Fang Y, Shi Q, Li X, Chen Q, Shi K, Jiang Y, Zhou H, Yu Y. 2017. Colistin Resistance in *Acinetobacter baumannii* MDR-ZJ06 Revealed by a Multiomics Approach. *Frontiers in Cellular and Infection Microbiology* 7.
37. Beceiro A, Moreno A, Fernández N, Vallejo JA, Aranda J, Adler B, Harper M, Boyce JD, Bou G. 2014. Biological Cost of Different Mechanisms of Colistin Resistance and Their Impact on Virulence in *Acinetobacter baumannii*. *Antimicrob Agents Chemother* 58:518.
38. Lindgren PK, Cars O, Annerstedt C. 2014. Colistin resistance in *Acinetobacter baumannii* is associated with a biological fitness cost and increased susceptibility to multiple drugs [Abstract]. Abstract obtained from 24th European Congress of Clinical Microbiology and Infectious Diseases (ECCMID), No. P0213. Barcelona, Spain.
39. Matthaiou DK, Michalopoulos A, Rafailidis PI, Karageorgopoulos DE, Papaioannou V, Ntani G, Samonis G, Falagas ME. 2008. Risk factors associated with the isolation of colistin-resistant Gram-negative bacteria: A matched case-control study. *Critical Care Medicine* 36.
40. European Committee on Antimicrobial Susceptibility Testing. 2016. Recommendations for MIC determination of colistin (polymyxin E) As recommended by the joint CLSI - EUCAST Polymyxin Breakpoints Working Group.
41. European Committee on Antimicrobial Susceptibility Testing. 2018. Breakpoint tables for interpretation of MICs and zone diameters. Version 81.
42. El-Halfawy OM, Valvano MA. 2015. Antimicrobial Heteroresistance: an Emerging Field in Need of Clarity. *Clinical Microbiology Reviews* 28:191–207.

43. El-Halfawy OM, Valvano MA. 2013. Chemical Communication of Antibiotic Resistance by a Highly Resistant Subpopulation of Bacterial Cells. *PLOS ONE* 8:e68874.
44. Farshadzadeh Z, Taheri B, Rahimi S, Shoja S, Pourhajibagher M, Haghghi MA, Bahador A. 2018. Growth Rate and Biofilm Formation Ability of Clinical and Laboratory-Evolved Colistin-Resistant Strains of *Acinetobacter baumannii*. *Frontiers in Microbiology* 9.
45. Etienne W, Meyer MH, Peppers J, Meyer RA. 2004. Comparison of mRNA gene expression by RT-PCR and DNA microarray. *BioTechniques* 36:618–626.





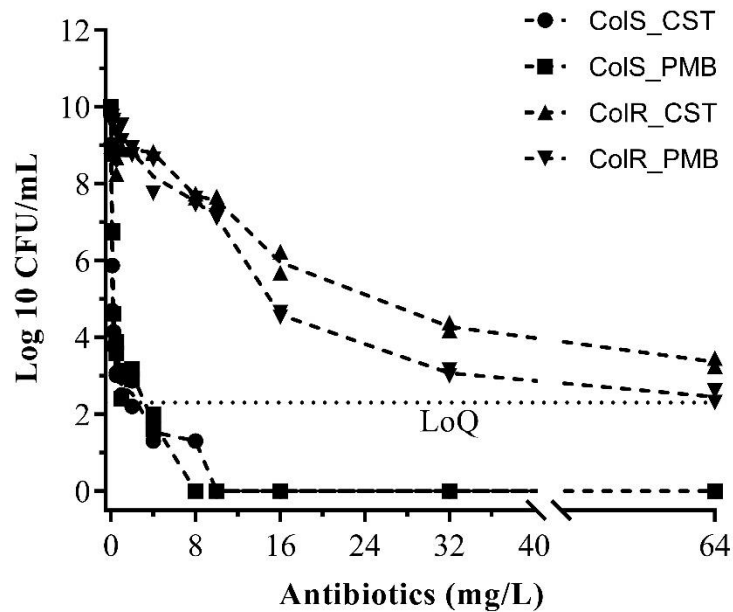
**FIG 1 (A)** Sequential time-kill (TK) of colistin-susceptible *A. baumannii* (ColS) over colistin (CST) and polymyxin B (PMB); **(B)** Sequential TK of CST and PMB against colistin-resistant *A. baumannii* isolates (ColR). ColS were performed with initial MIC of 0.125 mg/L for both antibiotics while CST and PMB have different MICs over ColR (MIC<sub>cst</sub> 4 mg/L and MIC<sub>pmb</sub> 2 mg/L). The surviving bacteria in the tail of survival curve of 1<sup>st</sup> TK that regrowth above 6 log<sub>10</sub> were used as bacteria inoculum for the 2<sup>nd</sup> TK. Data are representing from two replicates.

**TABLE 1** Susceptibility data of colistin (CST) and polymyxin B (PMB) against colistin-susceptible (ColS) and colistin-resistant (ColR) *A. baumannii* clinical isolates, before and after sequential time-kill (TK) <sup>a</sup>.

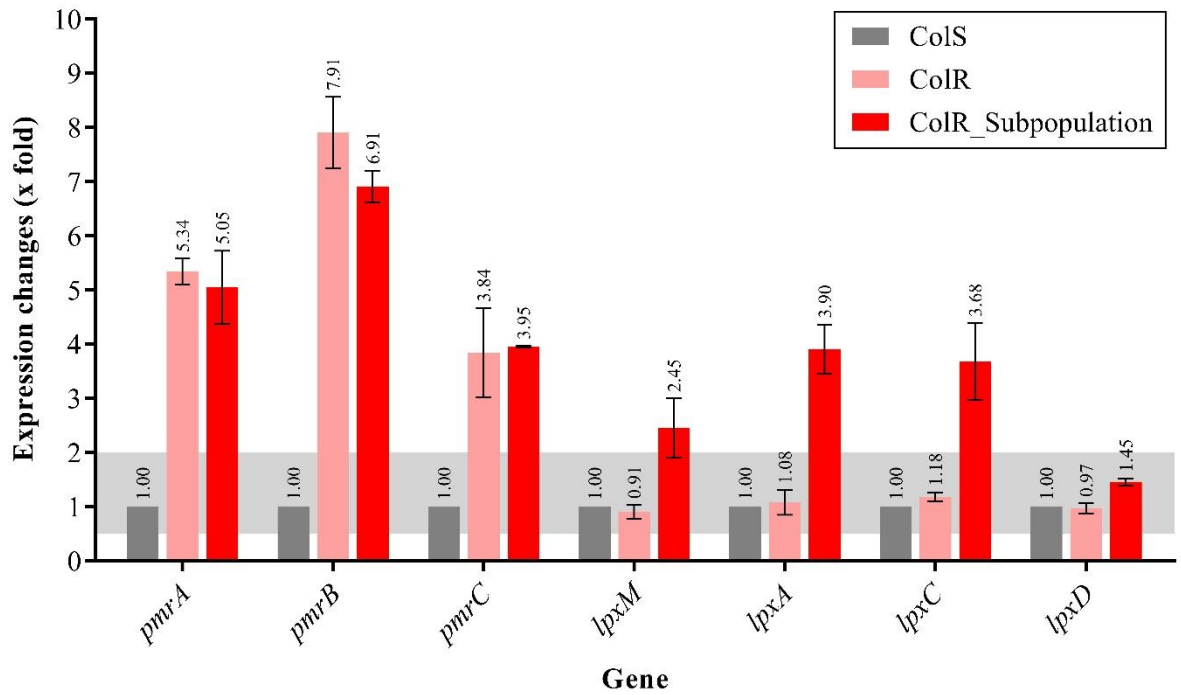
Strain	MIC <sub>CST</sub> (mg/L)	MIC <sub>PMB</sub> (mg/L)
ColS	0,125	0,125
ColS_1TK	0,25	0,125
ColS_2TK	2	0,25
ColR	4-8	2
ColR_Subpopulation <sup>b</sup>	128	16
ColR_1TK	64	8
ColR_2TK	≥128	16

<sup>a</sup> 1TK and 2TK indicate the strains were isolated from the surviving bacteria in the tail of survival curve after first and second time-kill experiments, respectively.

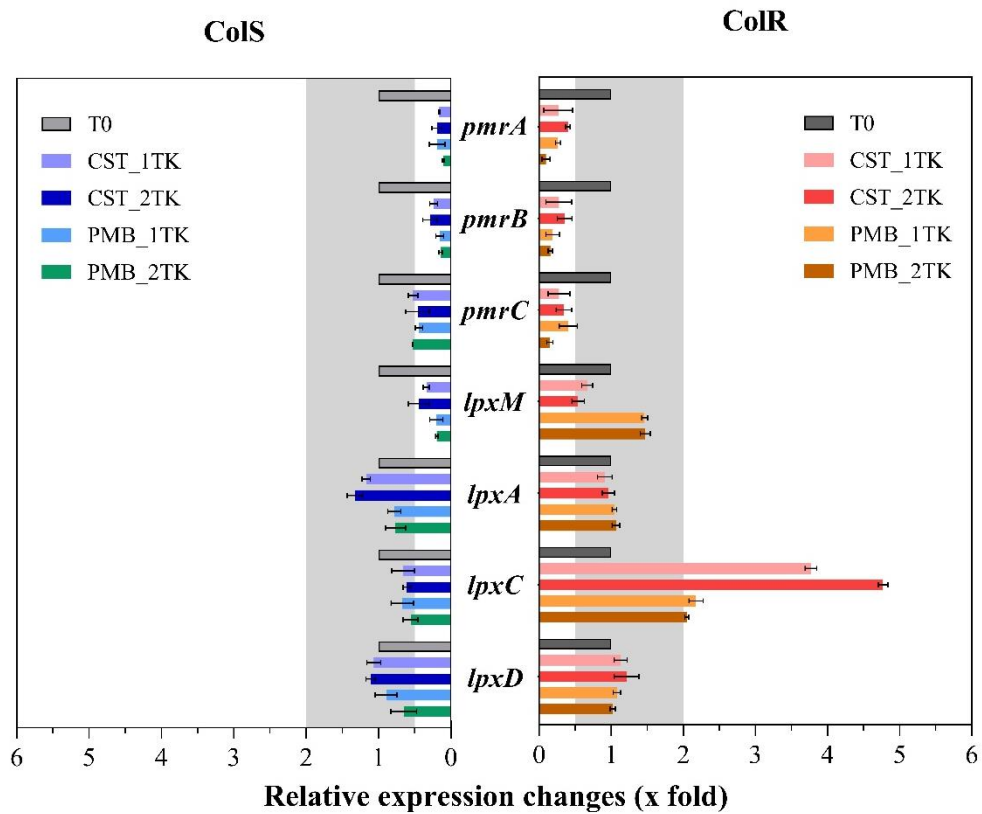
<sup>b</sup> Subpopulation was isolated from ColR isolates grew on the PAP plates in the presence of 64 mg/L of CST



**FIG 2** Population analysis profiles (PAPs) of ColS and ColR at various concentrations (0, 0.125, 0.25, 0.5, 1, 2, 4, 8, 10, 16, 32 and 64 mg/L) of colistin (CST) and polymyxin B (PMB). PAPs was conducted before isolates contact to antibiotics. Data represent mean from two replicates.

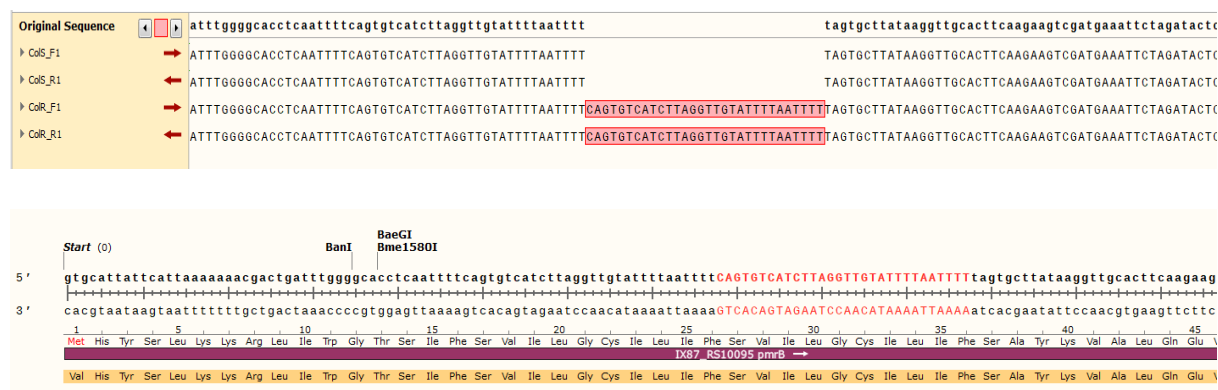


**FIG 3** Relative expression of *pmrA*, *pmrB*, *pmrC*, *lpxM*, *lpxA*, *lpxC* and *lpxD* genes considering the colistin-resistant *A. baumannii* (ColR) clinical isolates and its high-level colistin resistant subpopulation (ColR\_Subpopulation) isolated from 64 mg/L of colistin MH agar in PAPs compared to the colistin-susceptible clinical isolates (ColS). Limit threshold foldchange is indicated by grey area. Values are presented as mean and error bars represented SD for three biological replicates.



**FIG 4** Relative expression of *pmrA*, *pmrB*, *pmrC*, *lpxM*, *lpxA*, *lpxC* and *lpxD* genes as the colistin-susceptible (ColS) and colistin-resistant (ColR) of *A. baumannii* isolates after consecutively 1<sup>st</sup> and 2<sup>nd</sup> TK experiments over colistin (CST) and polymyxin B (PMB), compared and normalized to their initial isolates before contact with antibiotics. Limit threshold foldchange is indicated by grey area. Data are presented as mean and error bars represented SD for three biological replicates.

## SUPPLEMENTAL MATERIALS



**FIG S1** Sequence alignments of *pmrB* of colistin-resistant *A. baumannii* (ColR) clinical isolates. The duplication of 30 nucleotides is indicated in red.

**TABLE S1** Primer used in *A. baumannii* study

	Primer	Sequence (5' to 3')	Reference
RT-qPCR	16S rRNA - F	TCAGCTCGTGTCTCGTGAGATG	(1)
	16S rRNA - R	CCGTAAGGGCCATGATGACT	
	pmrA - F	AGATCCGTCAAAGAGCAGCAA	This Study
	pmrA - R	TGCATGAATACGGGCAAGCA	
	pmrB - F	CGACTGATTTGGGGCACCT	This study
	pmrB - R	CTCAGCTGTCCTTTCCGCTA	
	pmrC - F	TCGCGTTGAGCAATAACCAGA	This study
	pmrC - R	GCAGGTCCATGACTACCCAC	
	lpxM - F	TTAGCCGCCAACCCATTCAA	This study
	lpxM - R	ATCGCTATACGCTGCTGAGG	
	lpxA - F	TGATCCATCTGCAGTGATTGCT	This study
	lpxA - R	GGCAAACCTTCGCCAACACTT	
	lpxC - F	ACCGTGGATGGAGGGATTGT	This study
	lpxC - R	TTCCTAAACCGGCAATCGCA	
	lpxD - F	TAAAGTAAGCCGTGCGGGTG	This study
	lpxD - R	GGGCAGTGCTTTCTATGCCT	

Sequencing	pmrA - F	ACTGGACATGTTGCACTCTTGT	This study
	pmrA - R	GTGCCCAAATCAGTCGTTTTT	
	pmrB – F1	GGCTACCGTTTGGGGCAAT	This study
	pmrB – R1	GAGCAGCATCGGCAATAAATTGC	
	pmrB – F2	TGAACCGTCTTTTTGAGCGCAT	This study
	pmrB – R2	GACAGGCTGGGTCGTTTGG	
	pmrC - F	TCATTATAGCCATTTGGCTAGGTGC	(2)
	pmrC - R	CTCGCTTTAGTTTACATGGGCACAA	
	lpxA - F	GTAGCAGCAACCGCTGAGATTATG	This study
	lpxA - R	AGCCAATATCCAAAATCTGAAGAAGCA	
	lpxC – F	GCGTACAATCTATTGAAAGGCAGTG	This study
	lpxC – R	TTAGCCAAGCTTTACTACGTTTGGC	
	lpxD – F	GACTGTTGCCTATGACGCTAAGT	This study
	lpxD – R	GCATTGGTAATTCAGGGATGGCA	

## REFERENCES

1. Sepahvand S, Davarpanah MA, Roudgari A, Bahador A, Karbasizade V, Kargar jahromi Z. 2017. Molecular evaluation of colistin-resistant gene expression changes in *Acinetobacter baumannii* with real-time polymerase chain reaction. *Infection and Drug Resistance* Volume 10:455–462.
2. Beceiro A, Llobet E, Aranda J, Bengoechea JA, Doumith M, Hornsey M, Dhanji H, Chart H, Bou G, Livermore DM, Woodford N. 2011. Phosphoethanolamine Modification of Lipid A in Colistin-Resistant Variants of *Acinetobacter baumannii* Mediated by the pmrAB Two-Component Regulatory System. *Antimicrobial Agents and Chemotherapy* 55:3370–3379.



## DISCUSSION AND PERSPECTIVE

Polymyxins, mainly colistin and polymyxin B, are being used as the last-line therapy option to treat multidrug-resistant Gram-negative bacteria (52, 224). Determining the intrinsic, mutational, adaptive and horizontally acquired mechanisms related to polymyxin resistance are of the main interest that have arisen in the clinic or laboratory. The two-component regulatory systems, PhoP/PhoQ and/or PmrA/PmrB, are the response regulator that known to induce polymyxin resistance in most Gram-negative bacteria by LPS modification that is the main target of polymyxins (16, 138). Until it has been reported that polymyxin resistance can be caused by horizontal gene transfer known as plasmid MCR-1, that was firstly reported in two Enterobacteriaceae: *Escherichia coli* and *Klebsiella pneumoniae* (20). The primary aim of this study was to describe the molecular impact of chromosomal genes involved in lipopolysaccharide modifications on the selection of polymyxin resistance of two Enterobacteriaceae *E. coli* and *K. pneumoniae* carrying plasmid-mediated colistin resistance MCR-1 and two consecutive MDR *A. baumannii* isogenic isolates (susceptible and resistant to colistin, respectively). We used for our investigation an original approach of sequential time-kill curves.

---

### 1. SEQUENTIAL TIME-KILL

Time-kill is an *in vitro* study of the effect of static antibiotic concentrations with time. This study allows more precise description of antibacterial effect of an antibiotic on a given bacterial population compared to MIC-based approach. Bacterial regrowth is frequently observed during single time-kill experiments either as a consequence of standard microbroth MIC limitations in detecting small resistant population or a successful adaptation over polymyxins pressure (38, 136, 222). This single time-kill approach could be coupled



with mathematical PK/PD modelling that constitute a simple experimental approach to simulate colony forming units (CFU) versus time after exposures to antibiotic (225). This generally allows to determine mathematical model where the regrowth is due to two pre-existing populations, referred as sensitive and resistant (S/R), adaptive resistance (AR) or even more complex model with two pre-existing populations with adaptive resistance. However, it is difficult to discriminate the different model, thus the simplest S/R model is preferred to the others independently of the real physiological response (222). These models should be challenged in dynamic conditions, such as hollow-fiber experiments, where the bacteria are in contact with antibiotic concentrations varying during time like in a patient, but this approach is difficult to set up, expensive and time consuming.

Thereby, we used a simple approach as two consecutive time-kill (TK), referred as sequential TK that is in between: easy to carry out, not expensive and informative enough to improve the mathematical models. Over this approach, no regrowth would be expected after conducting the second TK in heterogenous subpopulations (S/R) by used (R) subpopulation bacteria that regrew after the first TK, otherwise, a second regrowth during the second TK would suggest the progressive adaptation over drugs (226). Compare with single TK, this approach successfully discriminates between models with two heterogenous subpopulations (S/R model) and a homogenous population with adaptive resistance (AR model) as published in article 1, while in article 2, PD models with single susceptible population with no adaptation and AR model were successfully discriminated.

Moreover, this approach coupled with molecular biology studies to describe genomic mutations and/or modifications in gene expression could bring a lot of information about resistance mechanisms.

---

## 2. *E. COLI* AND *K. PNEUMONIAE* CARRYING MCR-1

The sequential TK results suggest that both wild-type *E. coli* and *K. pneumoniae* were not able to adapt their resistance to polymyxins. They provided two stable heterogenous subpopulations (S) and (R) profiles as shown in article 1 and 3 results, except for wild-type *K. pneumoniae* during colistin selective pressure that shown a single susceptible population of bacteria as presented in article 2. In contrast, both MCR-1 transconjugants showed a progressive increase of resistance over colistin and polymyxin B after two consecutive TK. Only the adaptive resistance (AR) model was able to explain of these sequential TK results. The *mcr-1* gene harboring by MCR-1 plasmid expressed in *E. coli* resulting in the addition of phosphoethanolamine (PEtN) to lipid A (20). Accordingly, the stable regrowth in the 2<sup>nd</sup> TK is more expected instead of the second regrowth that suggesting a continuous adaptation with time. To investigate the mechanisms involved behind this adaptation, we started our observation from the LPS-modifying genes chromosomally-mediated polymyxin resistance. The activation of two-component regulatory systems (TCSs), PhoP/PhoQ and PmrA/PmrB, is known to contribute in polymyxin resistance by constitutive activation and subsequent overexpression of *arnT* gene (or *pmrF*, a L-Ara4N transferase) and *pmrC* gene (also known as *eptA*, a PEtN transferase) as illustrated in Fig. 9 (13, 16, 140, 141). Although the expression of PhoP/PhoQ are repressed by *mgrB* gene, the inactivation of this gene may cause the activation of PhoP/PhoQ thus causing LPS modification (143). However, no mutation was observed in *pmrA*, *pmrB*, *phoP*, *phoQ*, *mgrB*, *pmrC* and *arnT* for both MCR-1 transconjugants in this study which is contrary to the finding of *E. coli* study that shown a genome mutation in *pmrA* or *pmrB* during the presence of *mcr-1* (227).

Furthermore, RT-qPCR analysis was performed to observe these gene expression level change, and *pmrE*, *lpxM*, *cptA*, *lpxT* and *eptB* genes that involved in LPS modification were included since these genes activation are *pmrA/pmrB* and *phoP/PhoQ* dependent as described in table 4. For *E. coli* carrying MCR-1, our gene expression results (article 3)

linked with previous study that most of genes involved in glycerophospholipid metabolism were significantly up-regulated in *E. coli* carrying MCR-1 compare to *E. coli* without carrying MCR-1, but they protein expression were down-regulated in the presence of polymyxins by a proteomic analysis (22). Still, from a same study has also found the role of other mechanisms like overexpression of efflux pump during the presence of polymyxins (22).

In contrast with *K. pneumoniae*, this strain has not shown the changes of expression related to their LPS-modifying genes in the presence of *mcr-1* gene though the measured MICs are not markedly different compare with *E. coli*. However, its presence mediates selection of high-level polymyxin resistance in *K. pneumoniae* during colistin and polymyxin B pressure which is higher than *E. coli* carrying MCR-1 MICs. According to previous studies, they have demonstrated that *mcr-1* did not affect the mutation rates of *K. pneumoniae* (227), and the same level of colistin resistance as we obtained only could be reached by the inactivation of *mgrB* gene as a negative regulator for PhoP/PhoQ two-component systems (143, 174). In addition, other studies have shown that the amplified level of polymyxin resistance in the presence of *mcr-1* is associated with a significant biological fitness cost in *K. pneumoniae* (228). Compare to our study, we did not find any characterization assays of chromosomal genes involved in LPS modification over MCR-1-harboring *K. pneumoniae* strains to date. Even though we did not replicate the previously reported, our results suggest that the *mcr-1* presence can up-regulate the *arnT* gene that could lead to L-Arabinose addition (16). This modification may confer the level of polymyxins resistance in *K. pneumoniae* into high-level which is unexplained in the previous studies why the presence of *mcr-1* could increase the colistin MICs of *K. pneumoniae* up to 256-fold change compare with *E. coli* which is only up to 32-fold change (198).

The activation of two-component systems PmrA/PmrB and PhoP/PhoQ is very depending on the extracellular environmental conditions, such as high ferric ( $\text{Fe}^{3+}$ ) and aluminium ( $\text{Al}^{3+}$ ), low concentration of magnesium ( $\text{Mg}^{2+}$ ) and calcium ( $\text{Ca}^{2+}$ ), or low pH level condition

(13, 138–141). In this study, we used well defined media with fixed ion concentration and neutral pH. Thus, in future work, investigating their expression under variations of pH or ions concentration might prove important. Moreover, *in vitro* studies have one disadvantage that the situations for bacterial growth and killing are not similar between *in vitro* and *in vivo* studies, and therefore, the challenge of extrapolating the obtained *in vitro* results into *in vivo* model could be interesting to meet.

Indeed, we carried out the investigation of MCR-1 presence on the well-known genes modifying LPS structure to investigate this resistance mechanism, but our present data lead to the fact that no mutation have been found, particularly in the specific genes target. Thus, additional mutations on the other genes could be investigated for further studies, like next generation sequencing, since the mutations could be happened in the promotor of these genes target or probably in the other genes. In addition, deleting *arnT* gene in the MCR-1 *K. pneumoniae* could investigate the association between the presence of *mcr-1* gene and colistin-resistant caused by *arnT* overexpression.

Ideally, these findings should be confirmed with the structural changes of lipid A as the main component that contribute to polymyxin resistance. Thereby, the understanding of the relationship between modification of gene expression and LPS structural modification might be improved.

Overall, semi-mechanistic PK/PD modelling could help to find the optimal dosing regimen to adapt the treatment of these bacterial infections.

---

### 3. ACINETOBACTER BAUMANNII

The *mcr-1* gene has not been observed either in colistin-susceptible or colistin-resistant clinical isolates confirmed by sequencing analysis (data not shown) meaning that the clinical resistance was not caused by the presence of this gene. Our *in vitro* sequential TK results also confirmed the emergence of colistin-resistant *A. baumannii* clinical isolates in the patient with colistin-susceptible *A. baumannii* infection was associated with the suboptimal dosage of colistin treatment (229). The exposure of suboptimal dosage colistin may facilitate the selection of moderate-level colistin-resistant mutant and reduce the susceptibility to colistin (38, 132), which is not shown in polymyxin B based on our *in vitro* results. We confirmed the presence of two different phenotypes with a very large MICs difference in colistin-resistant isolates. During sequential TK observation, we noticed that continuing colistin treatment over colistin-resistant *A. baumannii* (colistin MICs 4-8 mg/L) isolates has the risk to facilitate the emergence of high-level colistin resistance mutants in *A. baumannii* (colistin MICs  $\geq 128$  mg/L after sequential TK), which explain why colistin-resistant *A. baumannii* with colistin MICs  $\geq 128$  mg/L was observed after patient received 8 days colistin treatment (229). Nevertheless, in line with our Enterobacteriaceae studies, no progressive continuous adaptation shown by both *A. baumannii* clinical isolates over polymyxin B during our sequential TK observation. Even though not linked, our results tie well with previous three clinical *A. baumannii* study that demonstrated the concentration-vs-time profiles of polymyxin B rapidly attained target concentration and greater-extensive bacterial killing than that seen with colistin dosage regimen (230).

It still remains unclear the role of *mcr* genes in the emergence of colistin-resistant *A. baumannii* clinical isolates for which resistance to colistin is still limited to chromosome-encoded resistance, such as *pmrCAB* operon and *lpxCAD* (231, 232). To date, only a study has been detected a *mcr-1* positive *A. baumannii* clinical isolate with no different MICs compared with a *mcr-1* negative clinical strains showing there is no clinical consequences

associated *mcr-1* gene presence over this strain (233). The presence of a novel plasmid-encoded *mcr-4.3* gene was lately identified in a colistin-resistant *A. baumannii* clinical strain and its presence was associated with colistin resistance (234). For that reason, we excluded the investigation of the relationship between *A. baumannii* and MCR-1 mediated polymyxin resistance in this study.

Within this thesis, we highlight three major findings:

- 1) Sequential TK constitute a simple approach to discriminate different PD model structures. Within this approach, a single bacterial population without adaptation, two stable heterogenous subpopulation (S/R) or unstable homogenous populations with adaptive resistance (AR) models could be characterized to describe the emergence of resistance.
- 2) Different genes expression profile was observed between two Enterobacteriaceae species, *E. coli* and *K. pneumoniae*, in the presence of MCR-1. To our knowledge, this is the first time that MCR-1 plasmid is described to induce different chromosomal LPS-modifying gene regulations depending on the bacterial species and is able to modify the LPS-modification pathway even in the absence of polymyxin.
- 3) Polymyxin B seems less potent to develop high resistant mutant than colistin. This is the first comparative study between colistin and polymyxin B regarding their potential issue in the emergence of polymyxin resistance over Gram-negative bacteria based on the best of our knowledge. Furthermore, this is the key component in future attempts to overcome the development of polymyxin resistance by considering the use of polymyxin B as alternative to colistin

## REFERENCES

1. World Health Organization. 2015. Global Action Plan on Antimicrobial Resistance. Geneva: WHO.
2. European Commission. 2017. A European One Health Action Plan against Antimicrobial Resistance (AMR). Brussels : EC.
3. European Centre for Disease Prevention and Control (ECDC). 2019. Surveillance of antimicrobial resistance in Europe – annual report of the European antimicrobial resistance surveillance network (EARS-net) 2018. ECDC, Stockholm.
4. Ruppé É, Woerther P-L, Barbier F. 2015. Mechanisms of antimicrobial resistance in Gram-negative bacilli. *Ann Intensive Care* 5:21.
5. Fraser G, Spiteri G. 2011. Annual epidemiological report reporting on 2009 surveillance data and 2010 epidemic intelligence data. European Centre for Disease Prevention and Control, Stockholm.
6. World Health Organization (WHO). 2017. Global Priority List of Antibiotic-Resistant Bacteria to Guide Research, Discovery, And Development Of New Antibiotics. World Health Organization.
7. Poirel L, Madec J-Y, Lupo A, Schink A-K, Kieffer N, Nordmann P, Schwarz S. 2018. Antimicrobial Resistance in *Escherichia coli*. *Microbiol Spectr* 6.
8. Ferreira RL, da Silva BCM, Rezende GS, Nakamura-Silva R, Pitondo-Silva A, Campanini EB, Brito MCA, da Silva EML, Freire CC de M, Cunha AF da, Pranchevicius M-C da S. 2019. High Prevalence of Multidrug-Resistant *Klebsiella pneumoniae* Harboring Several Virulence and  $\beta$ -Lactamase Encoding Genes in a Brazilian Intensive Care Unit. *Front Microbiol* 9:3198.
9. Almaghrabi MK, Joseph MRP, Assiry MM, Hamid ME. 2018. Multidrug-Resistant *Acinetobacter baumannii*: An Emerging Health Threat in Aseer Region, Kingdom of Saudi Arabia. *Can J Infect Dis Med Microbiol* 2018:9182747.
10. Xie R, Zhang XD, Zhao Q, Peng B, Zheng J. 2018. Analysis of global prevalence of antibiotic resistance in *Acinetobacter baumannii* infections disclosed a faster increase in OECD countries. *Emerg Microbes Infect* 7:1–10.
11. Arzanlou M, Chai WC, Venter H. 2017. Intrinsic, adaptive and acquired antimicrobial resistance in Gram-negative bacteria. *Essays Biochem* 61:49–59.
12. Li J, Nation RL, Kaye KS. 2019. Polymyxin Antibiotics: From Laboratory Bench to Bedside. Springer International Publishing, Cham.
13. Poirel L, Jayol A, Nordmann P. 2017. Polymyxins: Antibacterial Activity, Susceptibility Testing, and Resistance Mechanisms Encoded by Plasmids or Chromosomes. *Clin Microbiol Rev* 30:557–596.
14. Velkov T, Roberts KD, Nation RL, Thompson PE, Li J. 2013. Pharmacology of polymyxins: new insights into an “old” class of antibiotics. *Future Microbiol* 8:711–724.
15. Arduino SM, Quiroga MP, Ramírez MS, Merkier AK, Errecalde L, Di Martino A, Smayevsky J, Kaufman S, Centrón D. 2012. Transposons and integrons in colistin-resistant clones of *Klebsiella pneumoniae* and *Acinetobacter baumannii* with epidemic or sporadic behaviour. *J Med Microbiol* 61:1417–1420.

16. Olaitan AO, Morand S, Rolain J-M. 2014. Mechanisms of polymyxin resistance: acquired and intrinsic resistance in bacteria. *Front Microbiol* 5.
17. Baron S, Hadjadj L, Rolain J-M, Olaitan AO. 2016. Molecular mechanisms of polymyxin resistance: knowns and unknowns. *Int J Antimicrob Agents* 48:583–591.
18. Moffatt JH, Harper M, Harrison P, Hale JDF, Vinogradov E, Seemann T, Henry R, Crane B, St. Michael F, Cox AD, Adler B, Nation RL, Li J, Boyce JD. 2010. Colistin Resistance in *Acinetobacter baumannii* is Mediated by Complete Loss of Lipopolysaccharide Production. *Antimicrob Agents Chemother* 54:4971–4977.
19. Moffatt JH, Harper M, Adler B, Nation RL, Li J, Boyce JD. 2011. Insertion Sequence IS iAba11i Is Involved in Colistin Resistance and Loss of Lipopolysaccharide in *Acinetobacter baumannii*. *Antimicrob Agents Chemother* 55:3022–3024.
20. Liu Y-Y, Wang Y, Walsh TR, Yi L-X, Zhang R, Spencer J, Doi Y, Tian G, Dong B, Huang X, Yu L-F, Gu D, Ren H, Chen X, Lv L, He D, Zhou H, Liang Z, Liu J-H, Shen J. 2016. Emergence of plasmid-mediated colistin resistance mechanism MCR-1 in animals and human beings in China: a microbiological and molecular biological study. *Lancet Infect Dis* 16:161–168.
21. Quan J, Li X, Chen Y, Jiang Y, Zhou Z, Zhang H, Sun L, Ruan Z, Feng Y, Akova M, Yu Y. 2017. Prevalence of mcr-1 in *Escherichia coli* and *Klebsiella pneumoniae* recovered from bloodstream infections in China: a multicentre longitudinal study. *Lancet Infect Dis* 17:400–410.
22. Li H, Wang Y, Meng Q, Wang Y, Xia G, Xia X, Shen J. 2018. Comprehensive proteomic and metabolomic profiling of mcr-1 mediated colistin resistance in *Escherichia coli*. *bioRxiv* <https://doi.org/10.1101/434548>.
23. Landman D, Georgescu C, Martin DA, Quale J. 2008. Polymyxins Revisited. *Clin Microbiol Rev* 21:449–465.
24. Conly J, Johnston B. 2005. Where are all the new antibiotics? The new antibiotic paradox. *Can J Infect Dis Med Microbiol J Can Mal Infect Microbiol Med* 16:159–160.
25. World Health Organization. 2020. Lack of new antibiotics threatens global efforts to contain drug-resistant infections.[htm](#).
26. Nation RL, Li J, Cars O, Couet W, Dudley MN, Kaye KS, Mouton JW, Paterson DL, Tam VH, Theuretzbacher U, Tsuji BT, Turnidge JD. 2015. Framework for optimisation of the clinical use of colistin and polymyxin B: the Prato polymyxin consensus. *Lancet Infect Dis* 15:225–234.
27. Tsuji BT, Pogue JM, Zavascki AP, Paul M, Daikos GL, Forrest A, Giacobbe DR, Viscoli C, Giamarellou H, Karaikos I, Kaye D, Mouton JW, Tam VH, Thamlikitkul V, Wunderink RG, Li J, Nation RL, Kaye KS. 2019. International Consensus Guidelines for the Optimal Use of the Polymyxins: Endorsed by the American College of Clinical Pharmacy (ACCP), European Society of Clinical Microbiology and Infectious Diseases (ESCMID), Infectious Diseases Society of America (IDSA), International Society for Anti-infective Pharmacology (ISAP), Society of Critical Care Medicine (SCCM), and Society of Infectious Diseases Pharmacists (SIDP). *Pharmacother J Hum Pharmacol Drug Ther* 39:10–39.
28. Ainstworth GC, Brown AM, Brownlee G. 1947. Aerosporin, an antibiotic produced by *Bacillus aerosporus* Greer. *Nature* 159:263.
29. Benedict RG, Langlykke AF. 1947. Antibiotic activity of *Bacillus polymyxa*. *J Bacteriol* 54:24.



30. Stansly PG, Shepherd RG, White HJ. 1947. Polymyxin: a new chemotherapeutic agent. *Bull Johns Hopkins Hosp* 81:43–54.
31. Brownlee G, Bushby SRM. 1948. Chemotherapy and Pharmacology Of Aerosporin: A Selective Gram-Negative Antibiotic. *Orig Publ Vol 1 Issue 6491* 251:127–132.
32. Bell PH, Bone JF, English JP, Fellows CE, Howard KS, Rogers MM, Shepherd RG, Winterbottom R, Dornbush AC, Kushner S, SubbaRow Y. 1949. Chemical Studies on Polymyxin: Comparison With “Aerosporin.” *Ann N Y Acad Sci* 51:897–908.
33. White HJ, Alverson CM, Baker MJ, Jackson ER. 1949. Comparative Biological Studies of Polymyxin And “Aerosporin.” *Ann N Y Acad Sci* 51:879–890.
34. Stansly PG, Brownlee G. 1949. Nomenclature of polymyxin antibiotics. *Nature* 163:611.
35. Jones TSG. 1948. The chemical basis for the classification of the polymyxins. *Biochem J* 43:xxvi.
36. Brownlee G, Bushby SRM, Short EI. 1952. The chemotherapy and pharmacology of the polymyxins. *Br J Pharmacol Chemother* 7:170–188.
37. Yu Z, Qin W, Lin J, Fang S, Qiu J. 2015. Antibacterial Mechanisms of Polymyxin and Bacterial Resistance. *BioMed Res Int* 2015:679109.
38. Falagas ME, Rafailidis PI, Matthaïou DK. 2010. Resistance to polymyxins: Mechanisms, frequency and treatment options. *Drug Resist Updat* 13:132–138.
39. British Pharmacopoeia Commission. 2014. British pharmacopoeia.
40. European Pharmacopoeia Commission. 2014. European pharmacopoeia, 8th edn.
41. He J, Ledesma KR, Lam W-Y, Figueroa DA, Lim T-P, Chow DS-L, Tam VH. 2010. Variability of polymyxin B major components in commercial formulations. *Int J Antimicrob Agents* 35:308–310.
42. Koyama Y. 1950. A new antibiotic “colistin” produced by spore-forming soil bacteria. *J Antibiot* 3:457–458.
43. Suzuki T, Hayashi K, Fujikawa K, Tsukamoto K. 1965. The Chemical Structure of Polymyxin E: The Identities of Polymyxin E1 with Colistin A and of Polymyxin E2 with Colistin B\*. *J Biochem (Tokyo)* 57:226–227.
44. Orwa JA, Govaerts C, Busson R, Roets E, Van Schepdael A, Hoogmartens J. 2001. Isolation and structural characterization of colistin components. *J Antibiot (Tokyo)* 54:595–599.
45. Velkov T, Thompson PE, Nation RL, Li J. 2010. Structure–Activity Relationships of Polymyxin Antibiotics. *J Med Chem* 53:1898–1916.
46. Gallardo-Godoy A, Muldoon C, Becker B, Elliott AG, Lash LH, Huang JX, Butler MS, Pelingon R, Kavanagh AM, Ramu S, Phetsang W, Blaskovich MAT, Cooper MA. 2016. Activity and Predicted Nephrotoxicity of Synthetic Antibiotics Based on Polymyxin B. *J Med Chem* 59:1068–1077.
47. Khadka NK, Aryal CM, Pan J. 2018. Lipopolysaccharide-Dependent Membrane Permeation and Lipid Clustering Caused by Cyclic Lipopeptide Colistin. *ACS Omega*, 2018/12/19 ed. 3:17828–17834.
48. Ebbensgaard A, Mordhorst H, Aarestrup FM, Hansen EB. 2018. The Role of Outer Membrane Proteins and Lipopolysaccharides for the Sensitivity of *Escherichia coli* to Antimicrobial Peptides. *Front Microbiol* 9:2153.
49. Wang X, Quinn PJ. 2010. Lipopolysaccharide: Biosynthetic pathway and structure modification. *Prog Lipid Res* 49:97–107.

50. Sampath V. 2018. Bacterial endotoxin-lipopolysaccharide; structure, function and its role in immunity in vertebrates and invertebrates. *Agric Nat Resour* 52:115–120.
51. Steimle A, Autenrieth IB, Frick J-S. 2016. Structure and function: Lipid A modifications in commensals and pathogens. *Int J Med Microbiol* 306:290–301.
52. Dhariwal A, Tullu M. 2013. Colistin: Re-emergence of the “forgotten” antimicrobial agent. *J Postgrad Med* 59:208–215.
53. Falagas ME, Kasiakou SK, Saravolatz LD. 2005. Colistin: The Revival of Polymyxins for the Management of Multidrug-Resistant Gram-Negative Bacterial Infections. *Clin Infect Dis* 40:1333–1341.
54. Trimble MJ, Mlynářčík P, Kolář M, Hancock REW. 2016. Polymyxin: Alternative Mechanisms of Action and Resistance. *Cold Spring Harb Perspect Med* 6:a025288.
55. Deris ZZ, Akter J, Sivanesan S, Roberts KD, Thompson PE, Nation RL, Li J, Velkov T. 2014. A secondary mode of action of polymyxins against Gram-negative bacteria involves the inhibition of NADH-quinone oxidoreductase activity. *J Antibiot (Tokyo)* 67:147–151.
56. J. S. Teh, T. Yano, H. Rubin. 2007. Type II NADH: Menaquinone Oxidoreductase of *Mycobacterium tuberculosis*. *Former Curr Drug Targets - Infect Disord* 7:169–181.
57. Li Z, Velkov T. 2019. Polymyxins: Mode of Action. In: Li J., Nation R., Kaye K. (eds) *Polymyxin Antibiotics: From Laboratory Bench to Bedside.*, p. 37–54. *In Advances in experimental medicine and biology*. Springer, Cham, United States.
58. Kwa A, Kasiakou SK, Tam VH, Falagas ME. 2007. Polymyxin B: similarities to and differences from colistin (polymyxin E). *Expert Rev Anti Infect Ther* 5:811–821.
59. Rastogi N, Potar MC, David HL. 1986. Antimycobacterial spectrum of colistin (polymyxin E). *Ann Inst Pasteur Microbiol* 137A:45–53.
60. Chew KL, La M-V, Lin RTP, Teo JWP. 2017. Colistin and Polymyxin B Susceptibility Testing for Carbapenem-Resistant and Enterobacteriaceae: Comparison of Sensititre, MicroScan, Vitek 2, and Etest with Broth Microdilution. *J Clin Microbiol* 55:2609.
61. Gales AC, Reis AO, Jones RN. 2001. Contemporary Assessment of Antimicrobial Susceptibility Testing Methods for Polymyxin B and Colistin: Review of Available Interpretative Criteria and Quality Control Guidelines. *J Clin Microbiol* 39:183–190.
62. Jerke KH, Lee MJ, Humphries RM. 2016. Polymyxin Susceptibility Testing: a Cold Case Reopened. *Clin Microbiol Newsl* 38:69–77.
63. Tan TY. 2006. Comparison of three standardized disc susceptibility testing methods for colistin. *J Antimicrob Chemother* 58:864–867.
64. European Committee on Antimicrobial Susceptibility Testing. 2016. Recommendations for MIC determination of colistin (polymyxin E) As recommended by the joint CLSI - EUCAST Polymyxin Breakpoints Working Group.
65. Lee SY, Shin JH, Lee K, Joo MY, Park KH, Shin MG, Suh SP, Ryang DW, Kim SH. 2013. Comparison of the Vitek 2, MicroScan, and Etest Methods with the Agar Dilution Method in Assessing Colistin Susceptibility of Bloodstream Isolates of *Acinetobacter* Species from a Korean University Hospital. *J Clin Microbiol* 51:1924.
66. Lo-Ten-Foe JR, de Smet AMGA, Diederer BMW, Kluytmans JAJW, van Keulen PHJ. 2007. Comparative Evaluation of the VITEK 2, Disk Diffusion, Etest, Broth Microdilution, and Agar Dilution Susceptibility Testing Methods for Colistin in Clinical Isolates, Including Heteroresistant *Enterobacter cloacae* and *Acinetobacter baumannii* Strains. *Antimicrob Agents Chemother* 51:3726.

67. Maalej SM, Meziou MR, Rhimi FM, Hammami A. 2011. Comparison of disc diffusion, Etest and agar dilution for susceptibility testing of colistin against Enterobacteriaceae. *Lett Appl Microbiol* 53:546–551.
68. Ezadi F, Ardebili A, Mirnejad R. 2019. Antimicrobial Susceptibility Testing for Polymyxins: Challenges, Issues, and Recommendations. *J Clin Microbiol* 57:e01390-18.
69. Clinical and Laboratory Standards Institute. 2019. Performance Standards for Antimicrobial Susceptibility Testing; 29th Informational Supplement. CLSI Doc M100-S29 Clin Lab Stand Inst Wayne PA.
70. European Committee on Antimicrobial Susceptibility Testing. 2018. Breakpoint tables for interpretation of MICs and zone diameters. Version 81.
71. CA-SFM/ EUCAST. 2020. Comité de l'antibiogramme de la Société Française de Microbiologie: Recommandations 2020 V.1.1 Avril.
72. Koyama Y. 1957. [Colimycin]. *G Ital Chemioter* 4:279–287.
73. European Medicines Agency (EMA). 2014. European Medicines Agency completes review of polymyxin-based medicines. Recommendations issued for safe use in patients with serious infections resistant to standard antibiotics.
74. Li J, Milne RW, Nation RL, Turnidge JD, Smeaton TC, Coulthard K. 2004. Pharmacokinetics of colistin methanesulphonate and colistin in rats following an intravenous dose of colistin methanesulphonate. *J Antimicrob Chemother* 53:837–840.
75. Nation RL, Garonzik SM, Thamlikitkul V, Giamarellos-Bourboulis EJ, Forrest A, Paterson DL, Li J, Silveira FP. 2016. Dosing Guidance for Intravenous Colistin in Critically Ill Patients. *Clin Infect Dis* 64:565–571.
76. Clifford HE, Stewart GT. 1961. Intraventricular Administration of A New Derivative Of Polymyxin B in Meningitis Due To *Ps. Pyocyanea*. *Orig Publ Vol 2 Issue 7195* 278:177–180.
77. Zavascki AP, Goldani LZ, Li J, Nation RL. 2007. Polymyxin B for the treatment of multidrug-resistant pathogens: a critical review. *J Antimicrob Chemother* 60:1206–1215.
78. Zavascki AP, Nation RL. 2017. Nephrotoxicity of Polymyxins: Is There Any Difference between Colistimethate and Polymyxin B? *Antimicrob Agents Chemother* 61:e02319-16.
79. European Centre for Disease Prevention and Control. 2019. Antimicrobial Resistance Tackling the Burden in the European Union: OECD- ECDC Briefing Note.
80. Peleg AY, Hooper DC. 2010. Hospital-Acquired Infections Due to Gram-Negative Bacteria. *N Engl J Med* 362:1804–1813.
81. Taneja N, Sethi S, Kumar Tahlan A, Kumar Y. 2019. Introductory Chapter: Stepping into the Post-Antibiotic Era— Challenges and Solutions, p. . *In* Kumar, Y (ed.), *Antimicrobial Resistance - A Global Threat*. IntechOpen.
82. Clements A, Young JC, Constantinou N, Frankel G. 2012. Infection strategies of enteric pathogenic *Escherichia coli*. *Gut Microbes* 3:71–87.
83. 2011. *Bacterial pathogenesis: a molecular approach* 3rd ed. ASM Press, Washington, DC.

84. Tapader R, Basu S, Pal A. 2019. Secreted proteases: A new insight in the pathogenesis of extraintestinal pathogenic *Escherichia coli*. *Int J Med Microbiol* 309:159–168.
85. Kaper JB, Nataro JP, Mobley HLT. 2004. Pathogenic *Escherichia coli*. *Nat Rev Microbiol* 2:123–140.
86. Madappa T. 2019. *Escherichia coli* (*E coli*) Infections Background, Pathophysiology, Epidemiology.htm. Medscape.
87. Allocati N, Masulli M, Alexeyev MF, Di Ilio C. 2013. *Escherichia coli* in Europe: an overview. *Int J Environ Res Public Health* 10:6235–6254.
88. Gauthier L, Dortet L, Cotellon G, Creton E, Cuzon G, Ponties V, Bonnin RA, Naas T. 2018. Diversity of Carbapenemase-Producing *Escherichia coli* Isolates in France in 2012-2013. *Antimicrob Agents Chemother* 62:e00266-18.
89. Kang C-I, Kim J, Park DW, Kim B-N, Ha U-S, Lee S-J, Yeo JK, Min SK, Lee H, Wie S-H. 2018. Clinical Practice Guidelines for the Antibiotic Treatment of Community-Acquired Urinary Tract Infections. *Infect Chemother* 50:67–100.
90. Pitout JDD. 2012. Extraintestinal Pathogenic *Escherichia coli*: A Combination of Virulence with Antibiotic Resistance. *Front Microbiol* 3.
91. Martin RM, Bachman MA. 2018. Colonization, Infection, and the Accessory Genome of *Klebsiella pneumoniae*. *Front Cell Infect Microbiol* 8:4.
92. Li B, Zhao Y, Liu C, Chen Z, Zhou D. 2014. Molecular pathogenesis of *Klebsiella pneumoniae*. *Future Microbiol* 9:1071–1081.
93. Podschun R, Ullmann U. 1998. *Klebsiella spp.* as Nosocomial Pathogens: Epidemiology, Taxonomy, Typing Methods, and Pathogenicity Factors. *Clin Microbiol Rev* 11:589.
94. Mandell G, Dolin R, Bennett J. 2009. Mandell, Douglas, and Bennett's principles and practice of infectious diseases. Elsevier.
95. Gorrie CL, Mirčeta M, Wick RR, Edwards DJ, Thomson NR, Strugnell RA, Pratt NF, Garlick JS, Watson KM, Pilcher DV, McGloughlin SA, Spelman DW, Jenney AWJ, Holt KE. 2017. Gastrointestinal Carriage Is a Major Reservoir of *Klebsiella pneumoniae* Infection in Intensive Care Patients. *Clin Infect Dis* 65:208–215.
96. Martin RM, Cao J, Brisse S, Passet V, Wu W, Zhao L, Malani PN, Rao K, Bachman MA. 2016. Molecular Epidemiology of Colonizing and Infecting Isolates of *Klebsiella pneumoniae*. *mSphere* 1:e00261-16.
97. Happel KI, Nelson S. 2005. Alcohol, immunosuppression, and the lung. *Proc Am Thorac Soc* 2:428–432.
98. Tsai S-S, Huang J-C, Chen S-T, Sun J-H, Wang C-C, Lin S-F, Hsu BR-S, Lin J-D, Huang S-Y, Huang Y-Y. 2010. Characteristics of *Klebsiella pneumoniae* bacteremia in community-acquired and nosocomial infections in diabetic patients. *Chang Gung Med J* 33:532–539.
99. Tsay R-W, Siu LK, Fung C-P, Chang F-Y. 2002. Characteristics of Bacteremia Between Community-Acquired and Nosocomial *Klebsiella pneumoniae* Infection: Risk Factor for Mortality and the Impact of Capsular Serotypes as a Herald for Community-Acquired Infection. *Arch Intern Med* 162:1021–1027.
100. Follador R, Heinz E, Wyres KL, Ellington MJ, Kowarik M, Holt KE, Thomson NR. 2016. The diversity of *Klebsiella pneumoniae* surface polysaccharides. *Microb Genomics*. Microbiology Society.

101. Russo TA, Marr CM. 2019. Hypervirulent *Klebsiella pneumoniae*. Clin Microbiol Rev 32:42.
102. Magill SS, Edwards JR, Bamberg W, Beldavs ZG, Dumyati G, Kainer MA, Lynfield R, Maloney M, McAllister-Hollod L, Nadle J, Ray SM, Thompson DL, Wilson LE, Fridkin SK. 2014. Multistate Point-Prevalence Survey of Health Care–Associated Infections. N Engl J Med 370:1198–1208.
103. Lye WC, Chan RKT, Lee EJC, Kumarasinghe G. 1992. Urinary tract infections in patients with diabetes mellitus. J Infect 24:169–174.
104. Lin Y-T, Siu LK, Lin J-C, Chen T-L, Tseng C-P, Yeh K-M, Chang F-Y, Fung C-P. 2012. Seroepidemiology of *Klebsiella pneumoniae* colonizing the intestinal tract of healthy chinese and overseas chinese adults in Asian countries. BMC Microbiol 12:13.
105. Farida H, Severin JA, Gasem MH, Keuter M, van den Broek P, Hermans PWM, Wahyono H, Verbrugh HA. 2013. Nasopharyngeal Carriage of *Klebsiella pneumoniae* and Other Gram-Negative Bacilli in Pneumonia-Prone Age Groups in Semarang, Indonesia. J Clin Microbiol 51:1614.
106. Harada S, Doi Y. 2018. Hypervirulent *Klebsiella pneumoniae*: a Call for Consensus Definition and International Collaboration. J Clin Microbiol 56:e00959-18.
107. Russo TA, Marr CM. 2019. Hypervirulent *Klebsiella pneumoniae*. Clin Microbiol Rev 32:e00001-19.
108. Rafat C, Messika J, Barnaud G, Dufour N, Magdoud F, Billard-Pomarès T, Gaudry S, Dreyfuss D, Branger C, Decré D, Ricard J-D. 2018. Hypervirulent *Klebsiella pneumoniae*, a 5-year study in a French ICU. J Med Microbiol. Microbiology Society.
109. Rossi B, Gasperini ML, Leflon-Guibout V, Gioanni A, de Lastours V, Rossi G, Dokmak S, Ronot M, Roux O, Nicolas-Chanoine M-H, Fantin B, Lefort A. 2018. Hypervirulent *Klebsiella pneumoniae* in Cryptogenic Liver Abscesses, Paris, France. Emerg Infect Dis 24:221–229.
110. Gu D, Dong N, Zheng Z, Lin D, Huang M, Wang L, Chan EW-C, Shu L, Yu J, Zhang R, Chen S. 2018. A fatal outbreak of ST11 carbapenem-resistant hypervirulent *Klebsiella pneumoniae* in a Chinese hospital: a molecular epidemiological study. Lancet Infect Dis 18:37–46.
111. Antunes LCS, Visca P, Towner KJ. 2014. *Acinetobacter baumannii*: evolution of a global pathogen. Pathog Dis 71:292–301.
112. Lee C-R, Lee JH, Park M, Park KS, Bae IK, Kim YB, Cha C-J, Jeong BC, Lee SH. 2017. Biology of *Acinetobacter baumannii*: Pathogenesis, Antibiotic Resistance Mechanisms, and Prospective Treatment Options. Front Cell Infect Microbiol 7.
113. Fournier P-E, Vallenet D, Barbe V, Audic S, Ogata H, Poirel L, Riche H, Robert C, Mangenot S, Abergel C, Nordmann P, Weissenbach J, Raoult D, Claverie J-M. 2006. Comparative Genomics of Multidrug Resistance in *Acinetobacter baumannii*. PLOS Genet 2:e7.
114. Peleg AY, Seifert H, Paterson DL. 2008. *Acinetobacter baumannii*: Emergence of a Successful Pathogen. Clin Microbiol Rev 21:538–582.
115. Harding CM, Hennon SW, Feldman MF. 2018. Uncovering the mechanisms of *Acinetobacter baumannii* virulence. Nat Rev Microbiol 16:91–102.
116. Boral B, Unaldi Ö, Ergin A, Durmaz R, Eser ÖK, Zarakolu P, Ersöz G, Kaya A, Haciseyitoglu D, Ak Ö, Gencer S, Sarigüzel FM, Çelik İ, Uyanik MH, Özden K, Acikgöz ZC, Guner R, Akcali A, Sener A, Adiloglu A, Bulut C, Yalinay M, Dizbay M, Aydemir S, Sipahi OR, the Acinetobacter Study Group. 2019. A prospective

multicenter study on the evaluation of antimicrobial resistance and molecular epidemiology of multidrug-resistant *Acinetobacter baumannii* infections in intensive care units with clinical and environmental features. *Ann Clin Microbiol Antimicrob* 18:19.

117. Papadimitriou-Olivgeris M, Fligou F, Spiliopoulou A, Koutsileou K, Kolonitsiou F, Spyropoulou A, Zotou A, Marangos M, Anastassiou ED, Christofidou M, Spiliopoulou I. 2017. Risk factors and predictors of carbapenem-resistant *Pseudomonas aeruginosa* and *Acinetobacter baumannii* mortality in critically ill bacteraemic patients over a 6-year period (2010–15): antibiotics do matter. *J Med Microbiol. Microbiology Society*.
118. Russotto V, Cortegiani A, Graziano G, Saporito L, Raineri SM, Mammina C, Giarratano A. 2015. Bloodstream infections in intensive care unit patients: distribution and antibiotic resistance of bacteria. *Infect Drug Resist* 8:287–296.
119. Berlau J, Aucken H, Malnick H, Pitt T. 1999. Distribution of *Acinetobacter* species on skin of healthy humans. *Eur J Clin Microbiol Infect Dis* 18:179–183.
120. Ramette A, Kronenberg A, Burnens A, Cherkaoui A, Dubuis O, Egli A, Gaia V, Koch D, Kronenberg A, Leib SL, Nordmann P, Perreten V, Piffaretti J-C, Prod'Hom G, Schrenzel J, Widmer AF, Zanetti G, Zbinden R, and the Swiss Centre for Antibiotic Resistance (ANRESIS). 2018. Prevalence of carbapenem-resistant *Acinetobacter baumannii* from 2005 to 2016 in Switzerland. *BMC Infect Dis* 18:159.
121. Jeannot K, Diancourt L, Vaux S, Thouverez M, Ribeiro A, Coignard B, Courvalin P, Brisse S. 2014. Molecular Epidemiology of Carbapenem Non-Susceptible *Acinetobacter baumannii* in France. *PLOS ONE* 9:e115452.
122. Isler B, Doi Y, Bonomo RA, Paterson DL. 2019. New Treatment Options against Carbapenem-Resistant *Acinetobacter baumannii* Infections. *Antimicrob Agents Chemother* 63:e01110-18.
123. Kengkla K, Kongpakwattana K, Saokaew S, Apisarnthanarak A, Chaiyakunapruk N. 2017. Comparative efficacy and safety of treatment options for MDR and XDR *Acinetobacter baumannii* infections: a systematic review and network meta-analysis. *J Antimicrob Chemother* 73:22–32.
124. Paul M, Carmeli Y, Durante-Mangoni E, Mouton JW, Tacconelli E, Theuretzbacher U, Mussini C, Leibovici L. 2014. Combination therapy for carbapenem-resistant Gram-negative bacteria. *J Antimicrob Chemother* 69:2305–2309.
125. European Centre for Disease Prevention and Control. 2016. Rapid risk assessment. Carbapenem-resistant *Acinetobacter baumannii* in healthcare settings.
126. Meletis G, Skoura L. 2018. Polymyxin Resistance Mechanisms: From Intrinsic Resistance to *mcr* Genes. *Recent Patents Anti-Infect Drug Disc* 13:198–206.
127. Nation RL, Li J. 2009. Colistin in the 21st century: *Curr Opin Infect Dis* 22:535–543.
128. Kaye KS, Pogue JM, Tran TB, Nation RL, Li J. 2016. Agents of Last Resort: Polymyxin Resistance. *Antibiot Resist Chall Oppor* 30:391–414.
129. Bialvaei AZ, Samadi Kafil H. 2015. Colistin, mechanisms and prevalence of resistance. *Curr Med Res Opin* 31:707–721.
130. Gharaibeh MH, Shatnawi SQ. 2019. An overview of colistin resistance, mobilized colistin resistance genes dissemination, global responses, and the alternatives to colistin: A review. *Vet World* 12:1735–1746.
131. Wertheim H, Van Nguyen K, Hara GL, Gelband H, Laxminarayan R, Mouton J, Cars O. 2013. Global survey of polymyxin use: A call for international guidelines. *J Glob Antimicrob Resist* 1:131–134.

132. Couet W, Grégoire N, Marchand S, Mimoz O. 2012. Colistin pharmacokinetics: the fog is lifting. *Clin Microbiol Infect* 18:30–39.
133. Falagas ME, Kasiakou SK. 2006. Toxicity of polymyxins: a systematic review of the evidence from old and recent studies. *Crit Care* 10:R27.
134. Zurfluh K, Kieffer N, Poirel L, Nordmann P, Stephan R. 2016. Features of the *mcr-1* Cassette Related to Colistin Resistance. *Antimicrob Agents Chemother* 60:6438–6439.
135. Jeannot K, Bolard A, Plésiat P. 2017. Resistance to polymyxins in Gram-negative organisms. *Int J Antimicrob Agents* 49:526–535.
136. Jayol A, Nordmann P, Brink A, Poirel L. 2015. Heteroresistance to Colistin in *Klebsiella pneumoniae* Associated with Alterations in the PhoPQ Regulatory System. *Antimicrob Agents Chemother* 59:2780–2784.
137. Pelletier MR, Casella LG, Jones JW, Adams MD, Zurawski DV, Hazlett KRO, Doi Y, Ernst RK. 2013. Unique Structural Modifications Are Present in the Lipopolysaccharide from Colistin-Resistant Strains of *Acinetobacter baumannii*. *Antimicrob Agents Chemother* 57:4831.
138. Kox LF, Wösten MM, Groisman EA. 2000. A small protein that mediates the activation of a two-component system by another two-component system. *EMBO J* 19:1861–1872.
139. Tierney AR, Rather PN. 2019. Roles of two-component regulatory systems in antibiotic resistance. *Future Microbiol* 14:533–552.
140. Gerson S, Lucaßen K, Wille J, Nodari CS, Stefanik D, Nowak J, Wille T, Betts JW, Roca I, Vila J, Cisneros JM, Seifert H, Higgins PG. 2019. Diversity of amino acid substitutions in PmrCAB associated with colistin resistance in clinical *Acinetobacter baumannii* isolates. *Int J Antimicrob Agents* 105862.
141. Miller AK, Brannon MK, Stevens L, Johansen HK, Selgrade SE, Miller SI, Høiby N, Moskowitz SM. 2011. PhoQ Mutations Promote Lipid A Modification and Polymyxin Resistance of *Pseudomonas aeruginosa* Found in Colistin-Treated Cystic Fibrosis Patients. *Antimicrob Agents Chemother* 55:5761.
142. Haeili M, Javani A, Moradi J, Jafari Z, Feizabadi MM, Babaei E. 2017. MgrB Alterations Mediate Colistin Resistance in *Klebsiella pneumoniae* Isolates from Iran. *Front Microbiol* 8.
143. Cannatelli A, Giani T, D’Andrea MM, Di Pilato V, Arena F, Conte V, Tryfinopoulou K, Vatopoulos A, Rossolini GM, COLGRIT Study Group. 2014. *mgrB* inactivation is a common mechanism of colistin resistance in KPC-producing *Klebsiella pneumoniae* of clinical origin. *Antimicrob Agents Chemother* 58:5696–5703.
144. Véscovi EG, Soncini FC, Groisman EA. 1996. Mg<sup>2+</sup> as an Extracellular Signal: Environmental Regulation of Salmonella Virulence. *Cell* 84:165–174.
145. Chen HD, Groisman EA. 2013. The Biology of the PmrA/PmrB Two-Component System: The Major Regulator of Lipopolysaccharide Modifications. *Annu Rev Microbiol* 67:83–112.
146. Bader MW, Sanowar S, Daley ME, Schneider AR, Cho U, Xu W, Klevit RE, Le Moual H, Miller SI. 2005. Recognition of Antimicrobial Peptides by a Bacterial Sensor Kinase. *Cell* 122:461–472.
147. Moskowitz SM, Ernst RK, Miller SI. 2004. PmrAB, a Two-Component Regulatory System of *Pseudomonas aeruginosa* That Modulates Resistance to Cationic Antimicrobial Peptides and Addition of Aminoarabinose to Lipid A. *J Bacteriol* 186:575.

148. Fernández L, Gooderham WJ, Bains M, McPhee JB, Wiegand I, Hancock REW. 2010. Adaptive Resistance to the “Last Hope” Antibiotics Polymyxin B and Colistin in *Pseudomonas aeruginosa* Is Mediated by the Novel Two-Component Regulatory System ParR-ParS. *Antimicrob Agents Chemother* 54:3372.
149. Lee J-Y, Chung ES, Na IY, Kim H, Shin D, Ko KS. 2014. Development of colistin resistance in pmrA-, phoP-, parR- and cprR-inactivated mutants of *Pseudomonas aeruginosa*. *J Antimicrob Chemother* 69:2966–2971.
150. Adams MD, Nickel GC, Bajaksouzian S, Lavender H, Murthy AR, Jacobs MR, Bonomo RA. 2009. Resistance to Colistin in *Acinetobacter baumannii* Associated with Mutations in the PmrAB Two-Component System. *Antimicrob Agents Chemother* 53:3628–3634.
151. McPhee JB, Lewenza S, Hancock REW. 2003. Cationic antimicrobial peptides activate a two-component regulatory system, PmrA-PmrB, that regulates resistance to polymyxin B and cationic antimicrobial peptides in *Pseudomonas aeruginosa*. *Mol Microbiol* 50:205–217.
152. Winfield MD, Groisman EA. 2004. Phenotypic differences between *Salmonella* and *Escherichia coli* resulting from the disparate regulation of homologous genes. *Proc Natl Acad Sci U S A* 101:17162.
153. Aguirre A, Lejona S, Vescovi EG, Soncini FC. 2000. Phosphorylated PmrA Interacts with the Promoter Region of *ugd* in *Salmonella enterica* Serovar Typhimurium. *J Bacteriol* 182:3874.
154. Dentovskaya SV, Anisimov AP, Kondakova AN, Lindner B, Bystrova OV, Svetoch TE, Shaikhutdinova RZ, Ivanov SA, Bakhteeva IV, Titareva GM, Knirel YuA. 2011. Functional characterization and biological significance of *Yersinia pestis* lipopolysaccharide biosynthesis genes. *Biochem Mosc* 76:808–822.
155. Tamayo R, Choudhury B, Septer A, Merighi M, Carlson R, Gunn JS. 2005. Identification of *cptA*, a PmrA-regulated locus required for phosphoethanolamine modification of the *Salmonella enterica* serovar typhimurium lipopolysaccharide core. *J Bacteriol* 187:3391–3399.
156. Lee H, Hsu F-F, Turk J, Groisman EA. 2004. The PmrA-Regulated *pmrC* Gene Mediates Phosphoethanolamine Modification of Lipid A and Polymyxin Resistance in *Salmonella enterica*. *J Bacteriol* 186:4124.
157. Arroyo LA, Herrera CM, Fernandez L, Hankins JV, Trent MS, Hancock REW. 2011. The *pmrCAB* Operon Mediates Polymyxin Resistance in *Acinetobacter baumannii* ATCC 17978 and Clinical Isolates through Phosphoethanolamine Modification of Lipid A. *Antimicrob Agents Chemother* 55:3743.
158. Beceiro A, Llobet E, Aranda J, Bengoechea JA, Doumith M, Hornsey M, Dhanji H, Chart H, Bou G, Livermore DM, Woodford N. 2011. Phosphoethanolamine Modification of Lipid A in Colistin-Resistant Variants of *Acinetobacter baumannii* Mediated by the *pmrAB* Two-Component Regulatory System. *Antimicrob Agents Chemother* 55:3370–3379.
159. Lesho E, Yoon E-J, McGann P, Snesrud E, Kwak Y, Milillo M, Onmus-Leone F, Preston L, St. Clair K, Nikolich M, Viscount H, Wortmann G, Zapor M, Grillot-Courvalin C, Courvalin P, Clifford R, Waterman PE. 2013. Emergence of Colistin-Resistance in Extremely Drug-Resistant *Acinetobacter baumannii* Containing a Novel *pmrCAB* Operon During Colistin Therapy of Wound Infections. *J Infect Dis* 208:1142–1151.
160. Beceiro A, Moreno A, Fernández N, Vallejo JA, Aranda J, Adler B, Harper M, Boyce JD, Bou G. 2014. Biological Cost of Different Mechanisms of Colistin Resistance and



- Their Impact on Virulence in *Acinetobacter baumannii*. *Antimicrob Agents Chemother* 58:518.
161. Chin C-Y, Gregg KA, Napier BA, Ernst RK, Weiss DS. 2015. A PmrB-Regulated Deacetylase Required for Lipid A Modification and Polymyxin Resistance in *Acinetobacter baumannii*. *Antimicrob Agents Chemother* 59:7911.
  162. Wang X, Ribeiro AA, Guan Z, Raetz CRH. 2009. Identification of Undecaprenyl Phosphate- $\beta$ -d-Galactosamine in *Francisella novicida* and Its Function in Lipid A Modification. *Biochemistry* 48:1162–1172.
  163. Dortet L, Bonnin R, Jousset A, Gauthier L, Naas T. 2016. Émergence de la résistance à la colistine chez les entérobactéries : une brèche dans le dernier rempart contre la pan-résistance ! *J Anti-Infect* 18:139–159.
  164. Wright MS, Suzuki Y, Jones MB, Marshall SH, Rudin SD, van Duin D, Kaye K, Jacobs MR, Bonomo RA, Adams MD. 2015. Genomic and Transcriptomic Analyses of Colistin-Resistant Clinical Isolates of *Klebsiella pneumoniae* Reveal Multiple Pathways of Resistance. *Antimicrob Agents Chemother* 59:536.
  165. Cheng Y-H, Lin T-L, Lin Y-T, Wang J-T. 2016. Amino Acid Substitutions of CrrB Responsible for Resistance to Colistin through CrrC in *Klebsiella pneumoniae*. *Antimicrob Agents Chemother* 60:3709–3716.
  166. Fernández L, Jenssen H, Bains M, Wiegand I, Gooderham WJ, Hancock REW. 2012. The Two-Component System CprRS Senses Cationic Peptides and Triggers Adaptive Resistance in *Pseudomonas aeruginosa* Independently of ParRS. *Antimicrob Agents Chemother* 56:6212.
  167. Nowicki EM, O'Brien JP, Brodbelt JS, Trent MS. 2015. Extracellular zinc induces phosphoethanolamine addition to *Pseudomonas aeruginosa* lipid A via the ColRS two-component system. *Mol Microbiol* 97:166–178.
  168. Hood MI, Becker KW, Roux CM, Dunman PM, Skaar EP. 2013. Genetic Determinants of Intrinsic Colistin Tolerance in *Acinetobacter baumannii*. *Infect Immun* 81:542.
  169. Lean S-S, Suhaili Z, Ismail S, Rahman NIA, Othman N, Abdullah FH, Jusoh Z, Yeo CC, Thong K-L. 2014. Prevalence and Genetic Characterization of Carbapenem- and Polymyxin-Resistant *Acinetobacter baumannii* Isolated from a Tertiary Hospital in Terengganu, Malaysia. *ISRN Microbiol* 2014:953417.
  170. Henry R, Vithanage N, Harrison P, Seemann T, Coutts S, Moffatt JH, Nation RL, Li J, Harper M, Adler B, Boyce JD. 2012. Colistin-Resistant, Lipopolysaccharide-Deficient *Acinetobacter baumannii* Responds to Lipopolysaccharide Loss through Increased Expression of Genes Involved in the Synthesis and Transport of Lipoproteins, Phospholipids, and Poly- $\beta$ -1,6-Acetylglucosamine. *Antimicrob Agents Chemother* 56:59.
  171. Froelich JM, Tran K, Wall D. 2006. A pmrA Constitutive Mutant Sensitizes *Escherichia coli* to Deoxycholic Acid. *J Bacteriol* 188:1180–1183.
  172. Gunn JS, Miller SI. 1996. PhoP-PhoQ activates transcription of pmrAB, encoding a two-component regulatory system involved in *Salmonella typhimurium* antimicrobial peptide resistance. *J Bacteriol* 178:6857.
  173. Quesada A, Porrero MC, Téllez S, Palomo G, García M, Domínguez L. 2015. Polymorphism of genes encoding PmrAB in colistin-resistant strains of *Escherichia coli* and *Salmonella enterica* isolated from poultry and swine. *J Antimicrob Chemother* 70:71–74.

174. Cannatelli A, D'Andrea MM, Giani T, Di Pilato V, Arena F, Ambretti S, Gaibani P, Rossolini GM. 2013. In Vivo Emergence of Colistin Resistance in *Klebsiella pneumoniae* Producing KPC-Type Carbapenemases Mediated by Insertional Inactivation of the PhoQ/PhoP mgrB Regulator. *Antimicrob Agents Chemother* 57:5521–5526.
175. Mitrophanov AY, Jewett MW, Hadley TJ, Groisman EA. 2008. Evolution and Dynamics of Regulatory Architectures Controlling Polymyxin B Resistance in Enteric Bacteria. *PLOS Genet* 4:e1000233.
176. Raetz CRH, Reynolds CM, Trent MS, Bishop RE. 2007. Lipid A Modification Systems in Gram-Negative Bacteria. *Annu Rev Biochem* 76:295–329.
177. Tamayo R, Prouty AM, Gunn JS. 2005. Identification and functional analysis of *Salmonella enterica* serovar Typhimurium PmrA-regulated genes. *FEMS Immunol Med Microbiol* 43:249–258.
178. Clements A, Tull D, Jenney AW, Farn JL, Kim S-H, Bishop RE, McPhee JB, Hancock REW, Hartland EL, Pearse MJ, Wijburg OLC, Jackson DC, McConville MJ, Strugnell RA. 2007. Secondary Acylation of *Klebsiella pneumoniae* Lipopolysaccharide Contributes to Sensitivity to Antibacterial Peptides. *J Biol Chem* 282:15569–15577.
179. Tran AX, Lester ME, Stead CM, Raetz CRH, Maskell DJ, McGrath SC, Cotter RJ, Trent MS. 2005. Resistance to the Antimicrobial Peptide Polymyxin Requires Myristoylation of *Escherichia coli* and *Salmonella typhimurium* Lipid A. *J Biol Chem* 280:28186–28194.
180. Herrera CM, Hankins JV, Trent MS. 2010. Activation of PmrA inhibits LpxT-dependent phosphorylation of lipid A promoting resistance to antimicrobial peptides. *Mol Microbiol* 76:1444–1460.
181. Reynolds CM, Kalb SR, Cotter RJ, Raetz CRH. 2005. A Phosphoethanolamine Transferase Specific for the Outer 3-Deoxy-D-manno-octulosonic Acid Residue of *Escherichia coli* Lipopolysaccharide: IDENTIFICATION OF THE eptB GENE AND Ca<sup>2+</sup> HYPERSENSITIVITY OF AN eptB DELETION MUTANT. *J Biol Chem* 280:21202–21211.
182. Campos MA, Vargas MA, Regueiro V, Llombart CM, Albertí S, Bengoechea JA. 2004. Capsule Polysaccharide Mediates Bacterial Resistance to Antimicrobial Peptides. *Infect Immun* 72:7107.
183. Llobet E, Tomás JM, Bengoechea JA. 2008. Capsule polysaccharide is a bacterial decoy for antimicrobial peptides. *Microbiology*. Microbiology Society.
184. Lacour S, Doublet P, Obadia B, Cozzone AJ, Grangeasse C. 2006. A novel role for protein-tyrosine kinase Etk from *Escherichia coli* K-12 related to polymyxin resistance. *Res Microbiol* 157:637–641.
185. Padilla E, Llobet E, Doménech-Sánchez A, Martínez-Martínez L, Bengoechea JA, Albertí S. 2010. *Klebsiella pneumoniae* AcrAB Efflux Pump Contributes to Antimicrobial Resistance and Virulence. *Antimicrob Agents Chemother* 54:177.
186. Srinivasan VB, Rajamohan G. 2013. KpnEF, a New Member of the *Klebsiella pneumoniae* Cell Envelope Stress Response Regulon, Is an SMR-Type Efflux Pump Involved in Broad-Spectrum Antimicrobial Resistance. *Antimicrob Agents Chemother* 57:4449–4462.
187. Macfarlane ELA, Kwasnicka A, Ochs MM, Hancock REW. 1999. PhoP–PhoQ homologues in *Pseudomonas aeruginosa* regulate expression of the outer-membrane protein OprH and polymyxin B resistance. *Mol Microbiol* 34:305–316.

188. Mathur J, Waldor MK. 2004. The *Vibrio cholerae* ToxR-Regulated Porin OmpU Confers Resistance to Antimicrobial Peptides. *Infect Immun* 72:3577.
189. Tzeng Y-L, Ambrose KD, Zughaier S, Zhou X, Miller YK, Shafer WM, Stephens DS. 2005. Cationic Antimicrobial Peptide Resistance in *Neisseria meningitidis*. *J Bacteriol* 187:5387.
190. Ito-Kagawa M, Koyama Y. 1980. Selective cleavage of a peptide antibiotic, colistin by colistinase. *J Antibiot (Tokyo)* 33:1551–1555.
191. Yin J, Wang G, Cheng D, Fu J, Qiu J, Yu Z. 2019. Inactivation of Polymyxin by Hydrolytic Mechanism. *Antimicrob Agents Chemother* 63:e02378-18.
192. Balaban NQ, Helaine S, Lewis K, Ackermann M, Aldridge B, Andersson DI, Brynildsen MP, Bumann D, Camilli A, Collins JJ, Dehio C, Fortune S, Ghigo J-M, Hardt W-D, Harms A, Heinemann M, Hung DT, Jenal U, Levin BR, Michiels J, Storz G, Tan M-W, Tenson T, Van Melderen L, Zinkernagel A. 2019. Definitions and guidelines for research on antibiotic persistence. *Nat Rev Microbiol* 17:441–448.
193. El-Halfawy OM, Valvano MA. 2015. Antimicrobial Heteroresistance: an Emerging Field in Need of Clarity. *Clin Microbiol Rev* 28:191–207.
194. Hawley JS, Murray CK, Jorgensen JH. 2008. Colistin Heteroresistance in *Acinetobacter* and Its Association with Previous Colistin Therapy. *Antimicrob Agents Chemother* 52:351.
195. Matthaiou DK, Michalopoulos A, Rafailidis PI, Karageorgopoulos DE, Papaioannou V, Ntani G, Samonis G, Falagas ME. 2008. Risk factors associated with the isolation of colistin-resistant Gram-negative bacteria: A matched case-control study. *Crit Care Med* 36.
196. Li J, Rayner CR, Nation RL, Owen RJ, Spelman D, Tan KE, Liolios L. 2006. Heteroresistance to Colistin in Multidrug-Resistant *Acinetobacter baumannii*. *Antimicrob Agents Chemother* 50:2946–2950.
197. Poirel L, Nordmann P. 2016. Emerging plasmid-encoded colistin resistance: the animal world as the culprit? *J Antimicrob Chemother* 71:2326–2327.
198. Liu Y-Y, Chandler CE, Leung LM, McElheny CL, Mettus RT, Shanks RMQ, Liu J-H, Goodlett DR, Ernst RK, Doi Y. 2017. Structural Modification of Lipopolysaccharide Conferred by in Gram-Negative ESKAPE Pathogens. *Antimicrob Agents Chemother* 61.
199. Carroll LM, Gaballa A, Guldimann C, Sullivan G, Henderson LO, Wiedmann M. 2019. Identification of Novel Mobilized Colistin Resistance Gene in a Multidrug-Resistant, Colistin-Susceptible *Salmonella enterica* Serotype Typhimurium Isolate. *mBio* 10:e00853-19.
200. Xavier BB, Lammens C, Ruhai R, Kumar-Singh S, Butaye P, Goossens H, Malhotra-Kumar S. 2016. Identification of a novel plasmid-mediated colistin-resistance gene, *mcr-2*, in *Escherichia coli*, Belgium, June 2016. *Eurosurveillance* 21.
201. Yin W, Li H, Shen Y, Liu Z, Wang S, Shen Z, Zhang R, Walsh TR, Shen J, Wang Y. 2017. Novel Plasmid-Mediated Colistin Resistance Gene *mcr-3* in *Escherichia coli*. *mBio* 8:e00543-17.
202. Borowiak M, Fischer J, Hammerl JA, Hendriksen RS, Szabo I, Malorny B. 2017. Identification of a novel transposon-associated phosphoethanolamine transferase gene, *mcr-5*, conferring colistin resistance in d-tartrate fermenting *Salmonella enterica* subsp. *enterica* serovar Paratyphi B. *J Antimicrob Chemother* 72:3317–3324.

203. Carattoli A, Villa L, Feudi C, Curcio L, Orsini S, Luppi A, Pezzotti G, Magistrali CF. 2017. Novel plasmid-mediated colistin resistance *mcr-4* gene in *Salmonella* and *Escherichia coli*, Italy 2013, Spain and Belgium, 2015 to 2016. *Eurosurveillance* 22.
204. AbuOun M, Stubberfield EJ, Duggett NA, Kirchner M, Dormer L, Nunez-Garcia J, Randall LP, Lemma F, Crook DW, Teale C, Smith RP, Anjum MF. 2017. *mcr-1* and *mcr-2* (*mcr-6.1*) variant genes identified in *Moraxella* species isolated from pigs in Great Britain from 2014 to 2015. *J Antimicrob Chemother* 72:2745–2749.
205. Yang Y-Q, Li Y-X, Lei C-W, Zhang A-Y, Wang H-N. 2018. Novel plasmid-mediated colistin resistance gene *mcr-7.1* in *Klebsiella pneumoniae*. *J Antimicrob Chemother* 73:1791–1795.
206. Wang X, Wang Y, Zhou Y, Li J, Yin W, Wang S, Zhang S, Shen J, Shen Z, Wang Y. 2018. Emergence of a novel mobile colistin resistance gene, *mcr-8*, in NDM-producing *Klebsiella pneumoniae*. *Emerg Microbes Infect* 7:1–9.
207. Khedher MB, Baron SA, Riziki T, Ruimy R, Raoult D, Diene SM, Rolain J-M. 2020. Massive analysis of 64,628 bacterial genomes to decipher water reservoir and origin of mobile colistin resistance genes: is there another role for these enzymes? *Sci Rep* 10:5970.
208. Caniaux I, van Belkum A, Zambardi G, Poirel L, Gros MF. 2017. MCR: modern colistin resistance. *Eur J Clin Microbiol Infect Dis* 36:415–420.
209. Elbediwi M, Li Y, Paudyal N, Pan H, Li X, Xie S, Rajkovic A, Feng Y, Fang W, C. Rankin S, Yue M. 2019. Global Burden of Colistin-Resistant Bacteria: Mobilized Colistin Resistance Genes Study (1980–2018). *Microorganisms* 7.
210. Liassine N, Assouvie L, Descombes M-C, Tendon VD, Kieffer N, Poirel L, Nordmann P. 2016. Very low prevalence of MCR-1/MCR-2 plasmid-mediated colistin resistance in urinary tract Enterobacteriaceae in Switzerland. *Int J Infect Dis* 51:4–5.
211. Nordmann P, Assouvie L, Prod'Hom G, Poirel L, Greub G. 2016. Screening of plasmid-mediated MCR-1 colistin-resistance from bacteremia. *Eur J Clin Microbiol Infect Dis* 35:1891–1892.
212. Irrgang A, Roschanski N, Tenhagen B-A, Grobbel M, Skladnikiewicz-Ziemer T, Thomas K, Roesler U, Käsbohrer A. 2016. Prevalence of *mcr-1* in *E. coli* from Livestock and Food in Germany, 2010–2015. *PLOS ONE* 11:e0159863.
213. Wang Y, Tian G-B, Zhang R, Shen Y, Tyrrell JM, Huang X, Zhou H, Lei L, Li H-Y, Doi Y, Fang Y, Ren H, Zhong L-L, Shen Z, Zeng K-J, Wang S, Liu J-H, Wu C, Walsh TR, Shen J. 2017. Prevalence, risk factors, outcomes, and molecular epidemiology of *mcr-1*-positive Enterobacteriaceae in patients and healthy adults from China: an epidemiological and clinical study. *Lancet Infect Dis* 17:390–399.
214. Poirel L, Kieffer N, Brink A, Coetze J, Jayol A, Nordmann P. 2016. Genetic Features of MCR-1-Producing Colistin-Resistant *Escherichia coli* Isolates in South Africa. *Antimicrob Agents Chemother* 60:4394–4397.
215. Jiang Y, Zhang Y, Lu J, Wang Q, Cui Y, Wang Y, Quan J, Zhao D, Du X, Liu H, Li X, Wu X, Hua X, Feng Y, Yu Y. 2020. Clinical relevance and plasmid dynamics of *mcr-1*-positive *Escherichia coli* in China: a multicentre case-control and molecular epidemiological study. *Lancet Microbe* 1:e24–e33.
216. Anyanwu MU, Jaja IF, Nwobi OC. 2020. Occurrence and Characteristics of Mobile Colistin Resistance (*mcr*) Gene-Containing Isolates from the Environment: A Review. *Int J Environ Res Public Health* 17:1028.
217. Nielsen EI, Friberg LE. 2013. Pharmacokinetic-Pharmacodynamic Modeling of Antibacterial Drugs. *Pharmacol Rev* 65:1053–1090.

218. Derendorf H, Meibohm B. 1999. Modeling of Pharmacokinetic/Pharmacodynamic (PK/PD) Relationship: Concepts and Perspectives. *Pharm Res* 16:176–185.
219. Drusano GL. 2004. Antimicrobial pharmacodynamics: critical interactions of “bug and drug.” *Nat Rev Microbiol* 2:289–300.
220. Sy SKB, Derendorf H. 2014. Pharmacometrics in Bacterial Infections, p. 229–258. *In* Schmidt, S, Derendorf, H (eds.), *Applied Pharmacometrics*. Springer New York, New York, NY.
221. Mueller M, de la Peña A, Derendorf H. 2004. Issues in Pharmacokinetics and Pharmacodynamics of Anti-Infective Agents: Kill Curves versus MIC. *Antimicrob Agents Chemother* 48:369.
222. Jacobs M, Grégoire N, Couet W, Bulitta JB. 2016. Distinguishing Antimicrobial Models with Different Resistance Mechanisms via Population Pharmacodynamic Modeling. *PLoS Comput Biol* 12:e1004782–e1004782.
223. Qureshi ZA, Hittle LE, O’Hara JA, Rivera JI, Syed A, Shields RK, Pasculle AW, Ernst RK, Doi Y. 2015. Colistin-Resistant *Acinetobacter baumannii*: Beyond Carbapenem Resistance. *Clin Infect Dis* 60:1295–1303.
224. Li J, Nation RL, Turnidge JD, Milne RW, Coulthard K, Rayner CR, Paterson DL. 2006. Colistin: the re-emerging antibiotic for multidrug-resistant Gram-negative bacterial infections. *Lancet Infect Dis* 6:589–601.
225. Nielsen EI, Friberg LE. 2013. Pharmacokinetic-Pharmacodynamic Modeling of Antibacterial Drugs. *Pharmacol Rev* 65:1053.
226. Chauzy A, Ih H, Jacobs M, Marchand S, Grégoire N, Couet W, Buyck JM. 2020. Sequential time-kill: a simple experimental trick to discriminate between PK/PD models with distinct heterogeneous sub-populations versus homogenous population with adaptive resistance. *Antimicrob Agents Chemother* AAC.00788-20.
227. Zhang H, Zhao D, Quan J, Hua X, Yu Y. 2018. mcr-1 facilitated selection of high-level colistin resistant mutants in *Escherichia Coli*. *Clin Microbiol Infect* <https://doi.org/10.1016/j.cmi.2018.12.014>.
228. Nang SC, Morris FC, McDonald MJ, Han M-L, Wang J, Strugnell RA, Velkov T, Li J. 2018. Fitness cost of mcr-1-mediated polymyxin resistance in *Klebsiella pneumoniae*. *J Antimicrob Chemother* 73:1604–1610.
229. Jaidane N, Naas T, Mansour W, Radhia BB, Jerbi S, Boujaafar N, Bouallegue O, Bonnin RA. 2018. Genomic analysis of in vivo acquired resistance to colistin and rifampicin in *Acinetobacter baumannii*. *Int J Antimicrob Agents* 51:266–269.
230. Cheah S-E, Li J, Tsuji BT, Forrest A, Bulitta JB, Nation RL. 2016. Colistin and Polymyxin B Dosage Regimens against *Acinetobacter baumannii*: Differences in Activity and the Emergence of Resistance. *Antimicrob Agents Chemother* 60:3921.
231. Henry R, Crane B, Powell D, Deveson Lucas D, Li Z, Aranda J, Harrison P, Nation RL, Adler B, Harper M, Boyce JD, Li J. 2015. The transcriptomic response of *Acinetobacter baumannii* to colistin and doripenem alone and in combination in an in vitro pharmacokinetics/pharmacodynamics model. *J Antimicrob Chemother* 70:1303–1313.
232. Lima WG, Alves MC, Cruz WS, Paiva MC. 2018. Chromosomally encoded and plasmid-mediated polymyxins resistance in *Acinetobacter baumannii*: a huge public health threat. *Eur J Clin Microbiol Infect Dis* 37:1009–1019.
233. Hameed F, Khan MA, Muhammad H, Sarwar T, Bilal H, Rehman TU. 2019. Plasmid-mediated mcr-1 gene in *Acinetobacter baumannii* and *Pseudomonas aeruginosa*: first report from Pakistan. *Rev Soc Bras Med Trop* 52.

234. Martins-Sorenson N, Snesrud E, Xavier DE, Cacci LC, Iavarone AT, McGann P, Riley LW, Moreira BM. 2019. A novel plasmid-encoded mcr-4.3 gene in a colistin-resistant *Acinetobacter baumannii* clinical strain. *J Antimicrob Chemother* 75:60–64.