



HAL
open science

Adaptations métaboliques en réponse à l'exercice excentrique dynamique : application au réentraînement.

Julianne Touron

► **To cite this version:**

Julianne Touron. Adaptations métaboliques en réponse à l'exercice excentrique dynamique : application au réentraînement.. Santé. Université Clermont Auvergne [2017-2020], 2020. Français. NNT : 2020CLFAC051 . tel-03177393

HAL Id: tel-03177393

<https://theses.hal.science/tel-03177393v1>

Submitted on 23 Mar 2021

HAL is a multi-disciplinary open access archive for the deposit and dissemination of scientific research documents, whether they are published or not. The documents may come from teaching and research institutions in France or abroad, or from public or private research centers.

L'archive ouverte pluridisciplinaire **HAL**, est destinée au dépôt et à la diffusion de documents scientifiques de niveau recherche, publiés ou non, émanant des établissements d'enseignement et de recherche français ou étrangers, des laboratoires publics ou privés.



Université - Clermont-Ferrand

École doctorale des Sciences de la Vie et de la Santé, Agronomie &
Environnement

UFR de Médecine & des Professions Paramédicales

UMR 1019 Unité de Nutrition Humaine – Equipe ASMS

Adaptations métaboliques en réponse à l'exercice excentrique dynamique : application au réentraînement

Julianne Tournon

Doctorat Génétique, Physiologie, Pathologies, Nutrition,
Microbiologie Santé, Innovation

Directeurs de thèse : **Pr. Ruddy Richard & Pr. Frédéric Costes**

Soutenue publiquement le 14 Décembre 2020

Membres du jury :

Pr. Claire Thomas , PU, Université Evry Paris Saclay	Rapporteur
Dr. Frédéric Daussin , MCU-HDR, Université de Lille	Rapporteur
Dr. Alexandra Malgoyre , MD-PhD, IRBA	Examineur
Dr. Marie-Christine Iliou , PH, Hôpital Corentin Celton	Examineur
Pr. Anne Tournadre , PU-PH, UCA et CHU Clermont-Ferrand	Examineur
Pr. Eric Fontaine , PU-PH, Université Grenoble Alpes et CHU Grenoble	Examineur

« Le succès vient de la curiosité, de la concentration, de la persévérance et de l'autocritique. »

Albert Einstein, 1879-1955

Remerciements

Réaliser une thèse, quel que soit son domaine d'application, est une entreprise longue et difficile. Ce travail n'aurait pu être réalisé par ma seule implication, et de nombreuses personnes ont participé de près ou de loin à sa concrétisation et à sa réussite. Peu habile des mots pour exprimer émotions et sentiments, je tenais quand même à vous dire à tous : merci du fond du cœur !

Pour commencer, je tenais à remercier les Professeurs Frédéric Costes et Ruddy Richard, mes directeurs de thèse, grâce à qui j'en suis ici aujourd'hui. Sans la confiance qu'ils m'ont accordé dès mon arrivée en stage de Master 2 et au cours de ces trois années, tout ce travail aurait été impossible. Merci de m'avoir guidé et accompagné le long de ce parcours, encore inachevé, mais qui je l'espère nous réservera de beaux résultats ces deux prochaines années.

Merci au Professeur Eric Fontaine et au Docteur Frédéric Daussin pour leurs conseils et leur implication lors de mes comités de thèse. Merci de m'avoir permis d'apprendre à vos côtés lors de nos rencontres et merci de me faire l'honneur d'être présents pour clore ce chapitre.

Merci au Professeur Claire Thomas et au Docteur Frédéric Daussin d'avoir accepté d'être rapporteur de ce travail. Je vous remercie pour le regard critique que vous porterez sur ce manuscrit et le temps que vous y consacrerez.

J'adresse mes sincères remerciements au Docteur Marie-Christine Iliou et au Professeur Anne Tournadre pour prendre également de leur temps afin de faire partie de ce jury de thèse et de me faire bénéficier de leur expertise respective.

Je remercie le Docteur Alexandra Malgoyre d'avoir accepté de prendre part à cette dernière étape de la thèse. Je sais que pour elle, comme pour moi, ce nouveau cap à un sens particulier. Merci à vous et au Professeur Nathalie Koulmann de m'avoir accueillie et encadrée pour mon stage de Master 1, de m'avoir soutenue et de m'avoir encouragée à poursuivre sur la voie de la recherche malgré une année académique remplie de doutes et d'incertitudes. Sans vous je ne serai certainement pas arrivée jusque-là.

J'adresse également tous mes remerciements à l'ensemble de mes collaborateurs sur les projets terminés, en cours et à venir. Merci bien entendu à tous les patients qui font don de leur temps et d'un petit bout d'eux même pour faire avancer la recherche. Merci au Docteur Guillaume Plaquevent et à tout le personnel de la clinique de Durtol, pour leur implication, leur gentillesse

et leur accueille lors de mes visites. J'espère que les inclusions seront encore nombreuses et que les résultats seront au rendez-vous. Merci au Docteur Bruno Pereira, pour sa réactivité, son professionnalisme et grâce à qui la compréhension des statistiques devient plus facile. Merci au Docteur Hélène Perrault, pour nos échanges toujours riches d'enseignements, pour ses relectures et son regard éclairé sur nos travaux communs.

Je souhaite ensuite remercier tout le personnel du CRNH Auvergne que j'ai pu côtoyer et avec qui j'ai pu collaborer au cours des différentes études cliniques. Merci notamment aux infirmières Dominique et Hélène et aux attachées de recherche clinique Adeline et Nathalie pour leur gentillesse et leur aide tout au long de ce travail. Un grand merci à Véronique, technicienne au grand cœur, avec qui j'ai plus particulièrement travaillé lors de ces trois années. Merci pour ta présence, ton soutien et ton aide, merci pour tes questions, tes interrogations, ta rigueur et ton sens détail : ne doutes jamais de toutes tes qualités et de ton travail.

Le temps est maintenant venu de dire merci à mon équipe d'accueil, l'équipe ASMS. Et quelle équipe ! Ces trois années sont passées à une vitesse grand V et je n'ai pas eu le temps de m'ennuyer. Cette thèse c'est également un petit bout de vous, de votre influence et de votre bienveillance. Que ce soit lors d'un repas partagé, autour d'un café ou pour travailler et échanger, vous avez su être présents dans la bonne humeur, dans l'humour souvent, dans la solidarité et l'entraide toujours. Je m'estime chanceuse de vous avoir tous rencontrés et d'avoir pu évoluer à vos côtés.

A mes collègues et ex-collègues du bureau des « thésou-loulous », anciennement « la pouponnière », un grand merci à vous ! Merci pour votre soutien, pour vos qualités humaines incroyables, pour avoir su être les oreilles attentives et les détenteurs de conseils avisés. Karima, Kassandra, Insaf, Mathilde, Caroline, Alexandre, Thibault : merci d'avoir partagé mes journées. J'espère avoir su vous rendre et vous renvoyer tout ce que vous m'avez apporté de positif dans cette expérience.

Un grand merci également à Laura, mon binôme de Master 2. Qui aurait dit, en nous voyant lors de nos premiers jours de stage, qu'aujourd'hui nous serions amies, car il faut l'avouer c'était plutôt mal parti ! Mais tu as su voir au-delà de ma carapace de stress et de timidité et à grand renfort de Shi Fu Mi tu as su me déridier. Mon stage et mon intégration dans l'équipe n'auraient vraiment pas été les mêmes sans toi.

Enfin, un énorme merci à ma famille de sang et de cœur pour votre soutien infaillible tout au long de ces années. Merci d'avoir cru en moi et de me l'avoir montré. Citer un à un vos noms

et l'impact que vous avez eu sur ma vie serait bien trop long. Ce sont des mots que je ne prononce pas souvent, mais sachez que je vous aime. S'il ne fallait vraiment en citer que quelques-uns mes premières pensées vont à :

- Hélène et Frédéric, mes parents, qui m'ont inculqué le sens des mots travail, rigueur, investissement et persévérance. Merci de m'avoir toujours poussé à donner le meilleur de moi-même d'abord sur un terrain, puis dans la vie et le travail.
- Ambre, ma sœur adorée, qui malgré notre cohabitation parfois mouvementée et quelques crêpages de chignon a été à mes côtés tout au long de ces années.
- Josette et Bernard, mes grands-parents, qui m'ont soutenu à leur manière avec notamment des petits plats tous prêts et des week-ends de chouchoutage.
- Augusta, ma grand-mère, qui je l'espère aurait été fière de la femme que je suis devenue.
- Elise, ma marraine de cœur, avec qui nous nous sommes embarquées en même temps dans cette folle aventure qu'est la thèse. Cela n'a pas été un long fleuve tranquille mais nous y sommes arrivées !
- Gisèle, René, Nicolas, Alexise, Marion et tous les autres.

Résumé

Les pathologies chroniques sont la toute première cause de décès dans le monde. En plus de diminuer considérablement les capacités fonctionnelles des patients et de dégrader leur qualité de vie, elles constituent un poste de dépenses majeures en termes de santé publique. Une partie de la prise en charge de ces pathologies passe par l'activité physique adaptée et la mise en place d'un réentraînement à l'effort. Celui-ci vise à améliorer les capacités des sujets, notamment les capacités d'endurance et de force musculaire, afin de gagner en autonomie et diminuer les risques de morbi-mortalité. Classiquement, les exercices d'endurance de pédalage ou de course sur tapis roulant sont réalisés à une intensité métabolique sous maximale (~60 %) et en mode de contraction musculaire concentrique. Ces conditions de réentraînement et les adaptations associées sont cependant limitées par la capacité des patients à atteindre ou à maintenir dans le temps de telles sollicitations. Il est donc nécessaire de mettre au point des stratégies d'entraînement alternatives prenant en considération la problématique de limitations cardiaque, respiratoire et/ou musculaire liées à la pathologie tout en permettant la mise en place de réponses adaptatives optimales. L'une des pistes est celle de l'entraînement excentrique dynamique au travers d'exercices de pédalage en résistance ou de course en descente. Comparativement à la modalité concentrique, l'excentrique a la capacité de générer des charges mécaniques importantes pour une sollicitation cardio-respiratoire moindre. Depuis plusieurs années, la faisabilité de ce type d'entraînement a été observée, y compris auprès de patients atteints de maladies chroniques. Son efficacité dans la prise de masse musculaire et le gain de force a aussi largement été démontrée. De récents travaux montrent également son intérêt dans la gestion du surpoids et de l'obésité grâce à ses effets sur la composition corporelle *via* de la réduction de masse grasse. Toutefois, les adaptations aérobies suite à un entraînement excentrique restent incomplètes aux regards des attentes initiales d'amélioration de la consommation d'oxygène et de la fonctionnalité mitochondriale, pour lesquelles l'intensité métabolique de l'exercice semble être le facteur déterminant. Ainsi, des approches mixtes peuvent être envisagées afin de développer les meilleures combinaisons qui permettront d'optimiser les résultats globaux de l'entraînement en améliorant à la fois la force musculaire et l'endurance.

Mots-clés : maladies chroniques, limitations fonctionnelles, entraînement excentrique, consommation d'oxygène, mitochondries

Abstract

Chronic pathologies are the world leading cause of death. In addition to reducing functional capacities and degrading patients' life quality, they constitute a major public health expenditure. Part of the management involves appropriate physical activity and exercise training. This aims to improve subjects' capacities, in particular endurance and muscle strength, in order to increase their autonomy and reduce the risk of morbidity and mortality. Classically, endurance cycling or treadmill running exercises are performed at a sub-maximal metabolic intensity (~60%) and in a classic concentric muscle contraction mode. These training conditions, and the associated adaptations, are however limited by the patients' ability to achieve or maintain such stresses over time. It is therefore necessary to develop alternative strategies that take into account cardiac, respiratory and/or muscular limitations linked to the pathology while allowing optimal adaptive responses. One approach is that of dynamic eccentric training through resistance pedaling or downhill running exercises. Compared to concentric mode, eccentric has the ability to generate significant mechanical loads for less cardio-respiratory stress. For several years, the feasibility of this type of training has been observed, including in patients with chronic diseases. Its effectiveness in increasing muscle mass and strength has also been widely demonstrated. Recent work also shows its interest in overweight and obesity management through its effects on body composition and fat reduction. However, aerobic adaptations following eccentric training remain incomplete with regard to initial expectations of improved oxygen uptake and mitochondrial function, for which exercise metabolic intensity appears to be the determining factor. Thus, mixed approaches can be considered in order to develop the best combination that will optimize the overall physical training outcomes by enhancing both muscle strength and endurance.

Keywords: chronic disease, functional limitations, eccentric training, oxygen consumption, mitochondria

Table des matières

Abréviations	1
Liste des Publications.....	4
Liste des Communications	6
Liste des Figures.....	7
Liste des Tableaux.....	8
Avant-propos	9
Revue de la Littérature	11
1.1. La physiologie de l’oxygène et les spécificités de l’entraînement.....	11
1.1.1. Un système intégré du transport de l’oxygène	11
1.1.1.1. Le système respiratoire.....	12
1.1.1.2. Le système cardiovasculaire.....	13
1.1.1.3. Le muscle	14
1.1.1.4. Les mitochondries	15
1.1.1.4.1. Leur morphologie	15
1.1.1.4.2. Leur fonction	17
1.1.2. La plasticité du système en réponse à l’entraînement	20
1.2. La défaillance du système et le réentraînement.....	21
1.2.1. Quelles limitations ?.....	21
1.2.2. Quelle prise en charge ?	24
1.2.3. Le développement de méthodes alternatives.....	25
1.3. L’exercice excentrique	26
1.3.1. Définition et caractéristiques.....	26
1.3.1.1. La contraction musculaire	26
1.3.1.2. Ses caractéristiques mécaniques.....	27
1.3.1.3. Ses caractéristiques métaboliques	29
1.3.1.4. Sa place dans la réadaptation.....	29

1.3.2. Le dommage musculaire et les effets aigus de l'excentrique.....	30
1.3.2.1. Le dommage musculaire	30
1.3.2.2. La réponse inflammatoire.....	31
1.3.2.3. Les altérations mitochondriales.....	32
1.3.2.3.1. La respiration.....	32
1.3.2.3.2. Le stress oxydant.....	33
1.3.2.3.3. Le calcium	34
1.3.2.4. La régénération musculaire	35
1.3.3. Le « <i>repeated bout effect</i> » et les réponses adaptatives à l'excentrique.....	36
1.3.3.1. Le « <i>repeated bout effect</i> »	36
1.3.3.2. La composition corporelle.....	37
1.3.3.2.1. La masse grasse	37
1.3.3.2.2. La masse maigre.....	38
1.3.3.3. La consommation d'oxygène	39
1.3.3.4. Le muscle	40
1.3.3.4.1. La force musculaire.....	40
1.3.3.4.1. Les fibres musculaires.....	40
1.3.3.5. Les mitochondries	41
1.3.3.5.1. La respiration.....	41
1.3.3.5.2. Le stress oxydant.....	43
1.3.3.5.3. Le calcium	44
1.3.3.5.4. L'expression d'ARN	44
Problématique, Objectifs & Stratégies.....	46
Protocoles & Méthodes	49
3.1. L'étude animale STARTREX	49
3.1.1. Les aspects éthiques et les animaux	49
3.1.2. Le protocole d'entraînement et le design de l'étude	49

3.1.3. Les mesures in vivo.....	51
3.1.3.1. La composition corporelle.....	51
3.1.3.2. La dépense énergétique.....	51
3.1.4. Le sacrifice et les prélèvements.....	52
3.2. L'étude clinique REX-HF.....	52
3.3. Les mesures d'oxygraphie.....	63
3.3.1. La préparation des fibres musculaires perméabilisées.....	63
3.3.2. L'activité des complexes et l'affinité pour l'ADP.....	63
3.3.3. La production d'espèces réactives de l'oxygène.....	65
Résultats.....	67
4.1. Publication n°1.....	67
4.2. Publication n°2.....	79
4.3. Les résultats préliminaires de l'étude REX-HF.....	110
4.3.1. Les participants.....	111
4.3.2. Le test de marche 6 minutes, critère principal.....	112
4.3.3. Le test <i>Timed up and go</i>	113
4.3.4. La force musculaire.....	114
4.3.5. L'épreuve d'effort cardio-respiratoire.....	114
4.3.6. Le test d'endurance.....	115
4.3.7. La qualité de vie.....	115
4.3.8. La composition corporelle.....	116
4.3.9. Les analyses mitochondriales.....	117
4.3.9.1. La respiration mitochondriale.....	117
4.3.9.2. La libération de peroxyde d'hydrogène.....	117
4.3.9.3. La fuite de radicaux libres.....	118
Discussion Générale.....	119
5.1. Les effets de l'excentrique sur la composition corporelle.....	120

5.2. Les effets de l'excentrique sur les paramètres fonctionnels.....	121
5.3. Les effets de l'excentrique sur les mitochondries	123
Conclusion & Perspectives	126
Références bibliographiques	128
Annexes.....	139
Annexe 1 – Revue n°1.....	139
Annexe 2 – Revue n°2.....	155
Annexe 3 – Article de protocole n°2	170

Abréviations

ADN	Acide désoxyribonucléique
ADP	Adénosine diphosphate
ANSM	Agence nationale de sécurité du médicament et des produits de santé
ANT	Translocateur de nucléotides à adénine ou <i>adenine nucleotide translocator</i>
ARN	Acide ribonucléique
ATP	Adénosine triphosphate
BPCO	Bronchopneumopathie chronique obstructive
Ca²⁺	Calcium
CaO₂	Contenu artériel en dioxygène
CCCP	Carbonylcyanure m-chlorophénylhydrazone
CK	Créatine kinase
CO₂	Dioxyde de carbone
CoQ	Coenzyme Q
CPP	Comité de protection des personnes
CS	Citrate synthase
Cv̄O₂	Contenu veineux mêlé en dioxygène
Cyt C	Cytochrome c
DavO₂	Différence artério-veineuse du contenu en dioxygène
DEXA	Absorptiométrie biphotonique à rayon X ou <i>dual x-ray absorptiometry</i>
DOMS	Douleurs musculaires d'apparition retardée ou <i>delayed onset muscle soreness</i>
e⁻	Electron
EIMD	Domage musculaire induit par l'exercice ou <i>exercise induced muscle damage</i>
ERO	Espèce réactive de l'oxygène
FC	Fréquence cardiaque
FR	Fréquence respiratoire
FRL	Fuite de radicaux libres ou <i>free radical leak</i>
H⁺	Proton
H₂O	Eau
H₂O₂	Peroxyde d'hydrogène

Hb	Hémoglobine
HRP	Horseradish peroxidase
IC	Insuffisance cardiaque
IL	Interleukine
IMC	Indice de masse corporelle
K_m	Constante d'affinité
LDH	Lactate déshydrogénase
MCC	Contenu mitochondrial en calcium ou <i>mitochondrial calcium content</i>
mPTP	Pore de transition de perméabilité mitochondrial ou <i>mitochondrial permeability transition pore</i>
NADH	Nicotinamide adénine dinucléotide
NYHA	<i>New York Heart Association</i>
O₂	Dioxygène
O₂⁻	Anion superoxyde
PAO₂	Pression partielle alvéolaire en dioxygène
PCR	Réaction de polymérisation en chaîne ou <i>polymerase chain reaction</i>
Pi	Phosphate inorganique
PvO₂	Pression partielle veineuse en dioxygène
Q_c	Débit cardiaque
Q̇CO₂	Production de dioxyde de carbone
Q̇O₂	Utilisation de dioxygène
QR	Quotient respiratoire
RCR	Ratio de contrôle respiratoire ou <i>respiratory control ratio</i>
RER	Ratio d'échanges respiratoires ou <i>respiratory exchange ratio</i>
SAC	<i>Stretch activated channels</i>
SaO₂	Saturation en dioxygène
SERCA	Pompe ATPase ou <i>sarco/endoplasmic reticulum Ca²⁺-ATPase</i>
SOD	Superoxyde dismutase
SV1	Premier seuil ventilatoire
TM6	Test de marche 6 minutes
TMPD	N,N,N',N'-tétraméthyl-1,4-phénylènediamine
ṪO₂	Transport du dioxygène

TUG	<i>Timed up and go</i>
UCP	Protéine découplante ou <i>uncoupling protein</i>
\dot{V}_0	Respiration mitochondriale basale
\dot{V}_E	Débit ventilatoire
VES	Volume d'éjection systolique
$\dot{V}CO_2$	Rejet de dioxyde de carbone
VDAC	Canal anionique voltage-dépendant ou <i>voltage dependant anion channel</i>
\dot{V}_{max}	Respiration mitochondriale maximale
$\dot{V}O_2$	Consommation de dioxygène
$\dot{V}O_{2max}$	Consommation maximale de dioxygène
$\dot{V}O_{2pic}$	Consommation de dioxygène au pic
V_T	Volume courant
ΔpH	Gradient de protons
$\Delta \psi$	Potentiel de membrane

Liste des Publications

V. Julian, D. Thivel, F. Costes, **J. Touron**, Y. Boirie, B. Pereira, H. Perrault, M. Duclos, R. Richard (2018). **Eccentric training improves body composition by inducing mechanical and metabolic adaptations: a promising approach for overweight and obese individuals.** *Frontiers in physiology*, 9, 1013. doi:10.3389/fphys.2018.01013 Pages 141-154

J. Touron, H. Perrault, V. Julian, L. Maisonnave, P. Deat, J. Auclair-Ronzaud, J. Salles, S. Walrand, J. Hermet, J.P. Rigaudière, P. Lebecque, C. Malpuech-Brugère, C. Montaurier, B. Pereira, V. Coxam, F. Costes, R. Richard (2019). **Impact of eccentric or concentric training on body composition and energy expenditure.** *Medicine and science in sports and exercise*, 51(9), 1944-1953. doi: 10.1249/MSS.0000000000001992 Pages 69-78

G. Plaquevent-Hostache, **J. Touron**, F. Costes, H. Perrault, G. Clerfond, C. Cuenin, A. Moisa, B. Pereira, M.C. Boiteux, R. Eschalier, R. Richard (2019). **Effectiveness of combined eccentric and concentric exercise over traditional cardiac exercise rehabilitation programme in patients with chronic heart failure: protocol for a randomised controlled study.** *BMJ open*, 9(9), e028749. doi: 10.1136/bmjopen-2018-028749 Pages 54-62

J. Touron, F. Costes, E. Coudeyre, H. Perrault, R. Richard (en cours de révision). **Aerobic metabolic adaptations in dynamic eccentric exercise and training: from whole body to mitochondria.** Pages 156-178

J. Touron, H. Perrault, L. Maisonnave, P. Véronique, S. Walrand, C. Malpuech-Brugère, B. Pereira, Y. Burelle, F. Costes, R. Richard (en cours de soumission). **Effects of exercise-induced metabolic and mechanical loading on skeletal muscle mitochondrial function in rats.** Pages 81-109

N. Coste, **J. Touron**, B. Pereira, A. Goldstein, L. Féasson, P. Ornetti, E. Chaléat-Valayer, R. Richard, D. Pérennou, F. Costes, E. Coudeyre (en cours de soumission). **Muscular rehabilitation by eccentric exercise after severe COVID-19: research protocol for a randomized controlled trial (CovExc)**. Pages 181-204

Liste des Communications

3^{èmes} Assises Régionales de Nutrition et Santé (Saint-Galmier, France) – 22/11/2017 – *Communication Orale*. **Exercice excentrique et fibres perméabilisées musculaires.** **J. Touron**, F. Costes, R. Richard.

Journées Francophones de Nutrition (Nantes, France) – 15/12/2017 – *Communication orale*. **Evolution de la composition corporelle et de la dépense énergétique en réponse à un entraînement excentrique chez le rat.** **J. Touron**, C. Montaurier, B. Pereira, V. Julian, Y. Boirie, F. Costes, C. Malpuech-Brugère, H. Pérrault, R. Richard.

Journées Francophones de Nutrition (Nantes, France) – 15/12/2017 – *Communication orale*. **Impact d'un programme d'entraînement en mode excentrique dynamique sur la composition corporelle de l'adolescent en surpoids et obèse.** V. Julian, D. Thivel, M. Miguet, B. Pereira, **J. Touron**, Y. Boirie, F. Costes, E. Coudeyre, M. Duclos, R. Richard.

Cell Symposia, Exercise Metabolism (Sitges, Espagne) – 05/05/2019 au 07/05/2019 – *Poster*. **Impact of downhill running on body composition and energy expenditure.** **J. Touron**, H. Perrault, B. Pereira, F. Costes, R. Richard.

Journées Francophones de l'Insuffisance Cardiaque-CAT (Rennes, France) – 19/09/2019 et 20/09/2019 – *Poster*. **Effet d'un programme mixte de réentraînement (pédalage excentrique et concentrique) sur les capacités fonctionnelles d'insuffisants cardiaques versus réentraînement conventionnel (REX-HF).** G. Plaquevent-Hostache, **J. Touron**, C. Cuenin, M.C. D'Agrosa Boiteux, G. Clerfond, R. Eschalié, R. Richard.

Journées Nationales du GERS-P (Tours, France) – 14/11/2019 – *Communication orale*. **Effet d'un programme mixte de réentraînement associant pédalage excentrique et concentrique chez l'insuffisant cardiaque : étude REX-HF.** G. Plaquevent-Hostache, **J. Touron**, C. Cuenin, M.C. D'Agrosa Boiteux, G. Clerfond, R. Eschalié, R. Richard.

Liste des Figures

- Figure 1** Poumons, cœur et muscle : un système intégré du transport de l'oxygène.
- Figure 2** Organisation structurale et morphologique d'une mitochondrie.
- Figure 3** La chaîne respiratoire mitochondriale
- Figure 4** Cinétique des effets de l'entraînement en endurance.
- Figure 5** Diagnostique différentiel d'une valeur de $\dot{V}O_{2pic}$.
- Figure 6** Principe de fonctionnement du pédalage excentrique.
- Figure 7** Modèle expérimental de l'étude STARTREX.
- Figure 8** Design expérimental de l'étude STARTREX.
- Figure 9** Courbes de mesure représentatives A) d'un protocole d'oxygraphie et B) d'un protocole d'oxygraphie-fluorimétrie.
- Figure 10** Diagramme d'inclusion de l'étude REX-HF.
- Figure 11** Distances (m) au test de marche 6 minutes dans l'étude REX-HF.
- Figure 12** Temps (s,ms) au test *Time up and go* dans l'étude REX-HF.
- Figure 13** Consommation d'oxygène au premier seuil ventilatoire ($\dot{V}O_2$ au SV1, $mL \cdot min^{-1} \cdot kg^{-1}$) dans l'étude REX-HF.
- Figure 14** Consommation d'oxygène au pic ($\dot{V}O_{2pic}$, $mL \cdot min^{-1} \cdot kg^{-1}$) dans l'étude REX-HF.
- Figure 15** Consommation mitochondriale d'oxygène (JO_2 , $pmol \cdot sec^{-1} \cdot mg^{-1}$) dans l'étude REX-HF.

Liste des Tableaux

- Tableau 1** Caractéristiques histologiques, enzymologiques et fonctionnelles des fibres musculaires.
- Tableau 2** Comparaison des classes de sévérité de l'insuffisance cardiaque.
- Tableau 3** Caractéristiques des patients de l'étude REX-HF.
- Tableau 4** Scores des dimensions du questionnaire de qualité de vie SF-36 dans l'étude REX-HF.
- Tableau 5** Libération de peroxyde d'hydrogène (H_2O_2 , $\text{pmol}\cdot\text{sec}^{-1}\cdot\text{mg}^{-1}$) dans l'étude REX-HF.
- Tableau 6** Fuite de radicaux libres (FRL, %) dans l'étude REX-HF.

Avant-propos

L'activité physique est caractérisée par « tout mouvement corporel produit par les muscles entraînant une dépense énergétique supérieure à celle de repos ». Nous connaissons tous les grands messages de santé publique tels que « bougez plus » ou « pratiquez au moins 30 minutes d'activités physiques dynamiques par jour ». Ces messages de lutte contre la sédentarité sont entrés dans notre quotidien depuis maintenant plusieurs années au travers des différents plans nationaux nutrition santé, bien qu'ils ne soient pas encore totalement ancrés dans la pratique courante. L'activité physique et l'entraînement sont aussi des concepts parfaitement intégrés dans des objectifs de performance, notamment sportive. Mais l'activité physique, c'est également l'activité physique adaptée et le réentraînement dans un contexte clinique de prise en charge des patients. En effet, ses effets bénéfiques sur la santé sont retrouvés tant sur le plan préventif que curatif, seule ou en association avec un traitement médicamenteux ou chirurgical, et la balance bénéfico-risque est largement favorable à sa pratique même chez des personnes atteintes de pathologies chroniques. Sous bien des aspects, l'activité physique constitue donc un enjeu majeur de santé publique.

Depuis 2016, la loi autorise les médecins à prescrire une activité physique adaptée aux patients atteints de maladie chronique en affection longue durée. Cette prescription nécessite des connaissances générales sur l'activité physique, sur la physiologie de l'exercice et ses facteurs limitants dans un contexte pathologique. Cela implique la compréhension de tous les tenants et aboutissants entre activité physique et pathologie. Il faut avoir conscience que le stimulus généré par la pratique de l'activité physique, qu'il soit d'origine mécanique ou métabolique, va entraîner une réponse adaptative en conséquence. Des stress différents vont être générés selon les modalités de la stimulation (exercice de force *versus* endurance ; contraction musculaire concentrique *versus* excentrique ; etc.). Dans un contexte clinique de réentraînement, l'un des objectifs est de trouver la meilleure prise en charge du patient. Elle doit répondre à plusieurs impératifs, notamment être réalisable, ne pas être trop contraignante et induire des adaptations favorables à l'amélioration des capacités fonctionnelles et de la qualité de vie, tout en tenant compte du patient, de sa pathologie et de ses limitations.

Ce travail de thèse s'intègre dans une démarche d'optimisation de la prise en charge du patient *via* le réentraînement grâce à la mise en œuvre de l'exercice excentrique. Il s'agit d'ouvrir une fenêtre sur cette nouvelle approche afin d'appréhender l'adaptation des processus aérobie, et permettre leur évaluation du corps entier à la respiration mitochondriale, sur biopsies musculaires, en réponse à des modalités d'entraînement excentrique. Afin d'introduire ce travail, et de mieux cerner les concepts d'adaptations, un premier chapitre est consacré au rôle de l'oxygène dans les processus physiologiques et leurs adaptations à l'entraînement. Le second chapitre fait état de la prise en charge actuelle par le réentraînement des patients présentant des limitations, tels que les insuffisants cardiaques, et des limites rencontrées. Enfin, le dernier chapitre permet de faire le point sur les connaissances disponibles sur une méthode d'entraînement alternative fondée sur le concept de la contraction musculaire excentrique et de ses caractéristiques mécaniques et métaboliques.

Revue de la Littérature

1.1. La physiologie de l'oxygène et les spécificités de l'entraînement

1.1.1. Un système intégré du transport de l'oxygène

Le dioxygène (O_2) est au cœur du processus de production d'énergie par l'organisme. Le corps doit être capable de le capter, de le transporter, de le laisser diffuser et de l'utiliser. Ces différentes fonctions sont assurées par trois grands systèmes imbriqués : le système respiratoire, le système cardio-circulatoire, et les tissus consommateurs tels que le muscle (**Figure 1**). L'ensemble forme un circuit d'échange de gaz (O_2 et dioxyde de carbone, CO_2) entre l'environnement externe, les cellules et *in fine* les mitochondries (Wasserman, 1999). Au repos, en état stable, la consommation d' O_2 par unité de temps ($\dot{V}O_2$) et le rejet de CO_2 ($\dot{V}CO_2$) mesurés à la bouche sont équivalents à l'utilisation d' O_2 ($\dot{Q}O_2$) et à la production de CO_2 ($\dot{Q}CO_2$) au niveau cellulaire. Dans ces conditions, la respiration externe équivaut à la respiration interne, et le ratio d'échanges respiratoires (RER, *respiratory exchange ratio*, $\dot{V}CO_2/\dot{V}O_2$) est égal au quotient respiratoire (QR, $\dot{Q}CO_2/\dot{Q}O_2$) reflet du métabolisme tissulaire. Le passage d'un état de repos à un état d'exercice implique la variation de ces paramètres qui constituent des indicateurs de la capacité aérobie. En effet, si l'effort est maintenu à une puissance sous-maximale constante, un nouvel état d'équilibre va s'installer. La $\dot{V}O_2$ va s'ajuster à la demande énergétique, et le RER va augmenter du fait d'une production proportionnellement plus importante de CO_2 en lien avec l'utilisation supérieure des substrats glucidiques par la mitochondrie.

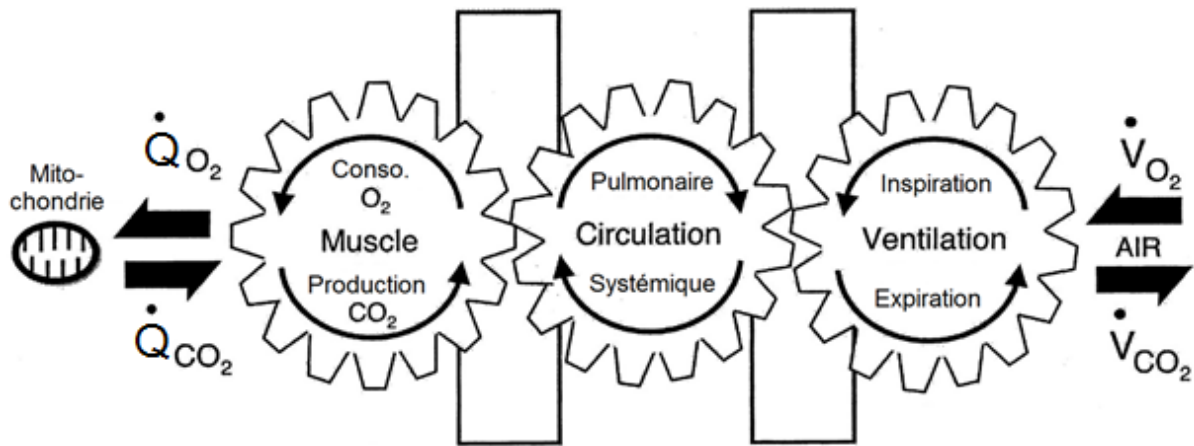

Figure 1 – Poumons, cœur et muscle : un système intégré du transport de l’oxygène. Les engrenages représentent l’interdépendance fonctionnelle des composants du système permettant le transport du dioxygène (O₂) et du dioxyde de carbone (CO₂) dans le sang. Sont distinguées la respiration pulmonaire (externe) et la respiration mitochondriale (interne), évalués par la consommation d’O₂ (\dot{V}_{O_2} et \dot{Q}_{O_2}) et la production de CO₂ (\dot{V}_{CO_2} et \dot{Q}_{CO_2}). Traduit de Milani et al. (2004), d’après Wasserman (1999).

La mesure de la consommation maximale d’O₂ ($\dot{V}_{O_{2max}}$) est l’une des principales mesures de la capacité fonctionnelle aérobie d’un sujet. La notion de $\dot{V}_{O_{2max}}$ reflète l’existence d’une limite d’utilisation de l’O₂ à l’exercice et donc d’une production maximale d’énergie au niveau mitochondrial. Ainsi, si au repos un individu en bonne santé a une \dot{V}_{O_2} comprise entre 3 et 4 mL·min⁻¹·kg⁻¹, sa $\dot{V}_{O_{2max}}$ mesurée à l’effort peut atteindre en moyenne 40 mL·min⁻¹·kg⁻¹, mais elle sera dépendante de l’âge, du sexe et du niveau d’entraînement. Cette valeur peut aussi être impactée par l’efficacité des systèmes respiratoire, cardio-circulatoire et musculaire-mitochondrial, dont les rôles et fonctionnements sont détaillés ci-après. Lorsque l’un de ces systèmes est limitant, comme par exemple dans la bronchopneumopathie chronique obstructive (BPCO, limitation respiratoire), l’insuffisance cardiaque (limitation cardio-circulatoire) ou la sarcopénie (limitation musculaire), le terme de $\dot{V}_{O_{2pic}}$ est utilisé pour décrire la capacité fonctionnelle maximale du sujet (cf. chapitre 1.2.1).

1.1.1.1. Le système respiratoire

Le système respiratoire est le premier système mis en jeu dans le processus de transport de l’O₂. La ventilation pulmonaire, ou débit ventilatoire (\dot{V}_E , L·min⁻¹), caractérise les échanges gazeux thoraciques qui ont lieu au moment des phases d’inspiration et d’expiration constitutives d’un cycle respiratoire. Ce paramètre est dépendant du volume courant (V_T), c’est-à-dire du volume d’air qui est inspiré puis expiré à chaque cycle respiratoire, et de la fréquence respiratoire (FR),

correspondant au nombre de cycles réalisés par unité de temps. Cet indicateur du renouvellement de l'air dans les poumons peut être calculé d'après l'équation :

$$\dot{V}_E = FR \times V_T$$

A l'effort, le \dot{V}_E augmente par modulation du V_T et de la FR, afin de répondre à la demande plus importante d'O₂ et la nécessité d'éliminer le CO₂.

Une fois l'O₂ présent dans les poumons, et plus précisément au niveau des sacs alvéolaires, il va devoir passer dans la circulation sanguine. Ce processus est appelé diffusion alvéolo-capillaire. Elle va se faire grâce à la différence de pression partielle de l'O₂ entre les alvéoles pulmonaires (PAO₂, 100 mmHg) et les capillaires sanguins (PvO₂, 40 mmHg). L'O₂ va alors passer de la zone à haute pression à la zone à pression plus basse.

1.1.1.2. Le système cardiovasculaire

Une fois dans le système circulatoire, l'O₂ est principalement pris en charge par l'hémoglobine (Hb) des érythrocytes qui va assurer son transport jusqu'aux organes. Chaque molécule d'Hb dispose de 4 sites de fixation. Leur saturation (SaO₂, %) et la concentration totale d'Hb ([Hb], g·100 mL de sang⁻¹) conditionnent le contenu artériel en O₂ (CaO₂, mL d'O₂·100 mL de sang⁻¹), de sorte que :

$$CaO_2 = (PaO_2 \times 0,003) + (1,34 \times [Hb] \times SaO_2 / 100)$$

avec PaO₂ la pression partielle artérielle en O₂, 0,003 % vol·mmHg⁻¹ le coefficient de solubilité de l'O₂ (une fraction limitée d'O₂ étant directement dissoute dans le sang), et 1,34 mL d'O₂·g d'Hb⁻¹ la quantité d'O₂ pouvant être fixée par l'Hb (pouvoir oxyphorique de l'Hb). La capacité de transport de l'O₂ ($\dot{T}O_2$, L d'O₂·min⁻¹) dans l'organisme est donc dépendante du CaO₂ mais aussi du débit cardiaque (\dot{Q}_C , L·min⁻¹), tel que :

$$\dot{T}O_2 = \dot{Q}_C \times CaO_2.$$

C'est le cœur qui, *via* sa fonction de pompe, va assurer le transport et la distribution de l'O₂ dans tout l'organisme. La mesure du \dot{Q}_C permet de connaître la quantité de sang pompée par le cœur. Il est dépendant de la fréquence cardiaque (FC, bpm) et du volume d'éjection systolique (VES, mL·bat⁻¹), de façon à ce que :

$$\dot{Q}_C = FC \times VES$$

L'équation de Fick, suivant le principe de conservation de la masse, exprime la relation étroite qui existe entre la $\dot{V}O_2$, le \dot{Q}_C , et la différence artérioveineuse du contenu en O_2 ($CaO_2 - C\bar{v}O_2$, le contenu veineux en O_2) :

$$\dot{V}O_2 = \dot{Q}_C * (CaO_2 - C\bar{v}O_2)$$

Ainsi, l'augmentation de la $\dot{V}O_2$ est dépendante d'une augmentation du \dot{Q}_C et/ou d'une extraction de l' O_2 plus importante au niveau tissulaire.

1.1.1.3. Le muscle

La bonne diffusion tissulaire de l' O_2 est essentielle à l'approvisionnement de son site d'utilisation. Au niveau musculaire, la typologie des fibres et leur capillarisation sont deux éléments déterminants corrélés aux besoins en O_2 des mitochondries, à leur nombre et à leur activité. Les fibres musculaires sont classées et nommées selon des critères histologiques, biochimiques et/ou fonctionnels, les principales étant les fibres de type I, IIA et IIB (**Tableau 1**). Chaque muscle a une composition spécifique en fibres et leurs proportions permettent de déterminer son caractère oxydatif ou glycolytique. Mais, quel que soit la typologie musculaire, le passage de l' O_2 du sang aux cellules musculaires se fait suivant le même principe de gradient de pression que pour la diffusion alvéolo-capillaire. À l'intérieur des myocytes, l' O_2 est pris en charge par la myoglobine dont la concentration est elle aussi différente selon le type de fibre (Nemeth and Lowry, 1984). Son rôle va être de transporter l' O_2 à travers le cytoplasme jusqu'à son lieu d'utilisation : les mitochondries.

Tableau 1 – Caractéristiques histologiques, enzymologiques et fonctionnelles des fibres musculaires.

Paramètre	Type I	Type IIA	Type IIB
Diamètre	Petite	Moyenne	Grande
Densité mitochondriale	+++	++	+
Densité capillaire	+++	++	+
[Myoglobine]	+++	++	+
[Glycogène]	+++	+++	+++
[Triglycérides]	+++	++	++
Métabolisme	Oxydatif	Mixte	Glycolytique

Activité ATPasique (myosine)	+	+++	+++
Vitesse de contraction	Lente	Rapide	Très rapide
Force de contraction	Faible	Modérée	Elevée
Résistance à la fatigue	Elevée	Modérée	Faible

+ : faible ++ : moyenne ; +++ : importante

1.1.1.4. Les mitochondries

1.1.1.4.1. Leur morphologie

Les mitochondries sont les accepteurs finaux de l'O₂. Il s'agit d'organites intracellulaires dont la densité dépend des besoins énergétiques de la cellule. L'une de leur principale caractéristique morphologique est leur double membrane lipidique (**Figure 2**).

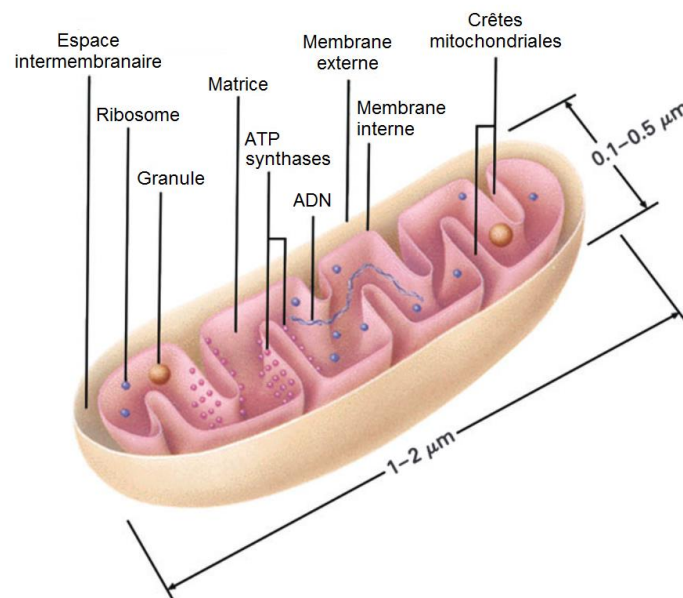

Figure 2 – Organisation structurale et morphologique d'une mitochondrie. Traduit de Logan (2006), d'après Lodish et al. (1995).

La membrane externe convexe constitue une importante surface d'échange avec le cytosol. Les canaux anioniques voltage-dépendants (VDAC, *voltage dépendant anion channel*) constituent la principale voie d'entrée et de sortie mitochondriale des ions (Ca²⁺, Na⁺, K⁺, Cl⁻, or OH⁻) et des métabolites solubles impliqués dans le processus de respiration tels que l'adénosine

diphosphate (ADP), l'adénosine triphosphate (ATP), le pyruvate, le succinate, ou le phosphate inorganique (Pi) (Noskov et al., 2016). Des molécules plus volumineuses sont transportées à l'intérieur grâce à des complexes d'importation de type TOM (*transporter outer membrane*) qui reconnaissent notamment la séquence d'adressage mitochondrial des protéines codées par le génome nucléaire (Endo and Yamano, 2010). La membrane externe permet également le transport des acides gras à chaîne longue via la carnitine palmitoyltransférase 1 (CPT1). L'eau et d'autres molécules tels que les acides gras à chaîne courte et moyenne diffusent passivement et n'ont donc pas besoin de système de pores ou de transport. Enfin cette membrane présente des points de contact avec d'autres organites intracellulaires comme le réticulum endoplasmique. Les jonctions favorisent les échanges entre les deux systèmes et participent par exemple aux transferts calciques pour le maintien de l'homéostasie (Rowland and Voeltz, 2012). Une fois la membrane externe franchie, les éléments se retrouvent dans l'espace intermembranaire, dont la composition est proche de celle du cytoplasme. Il joue un rôle majeur dans les mécanismes de respiration mitochondriale notamment par les échanges entre le cytoplasme et la matrice mitochondriale ou par sa fonction de régulation. Mais la membrane interne a la particularité de former une barrière entre l'espace intermembranaire et la matrice du fait de sa perméabilité réduite et sélective. Sa surface est supérieure à celle de la membrane externe en raison de nombreuses invaginations côté matriciel appelées crêtes mitochondriales. De nombreux transporteurs y sont présents et assurent les échanges entre les deux compartiments. Le translocateur ADP/ATP (ANT, *adenine nucleotide translocator*) est l'un d'entre eux. Il intervient dans les échanges d'ATP mitochondrial par de l'ADP cytosolique suivant un rapport 1:1. Les protéines découplantes (UCP, *uncoupling protein*) sont elles aussi enchâssées dans la membrane et permettent le passage de protons (H^+) de la matrice mitochondriale à l'espace intermembranaire sans passer par la chaîne respiratoire, et sont donc à l'origine d'un découplage entre les processus d'oxydation et de phosphorylation. C'est également au niveau de la membrane interne que sont localisés les complexes constitutifs de la chaîne respiratoire assurant ces fonctions. Pour finir, la matrice mitochondriale contient entre autres le génome mitochondrial, des ribosomes, des enzymes (cycle de Krebs, β -oxydation), des ions (Ca^{2+} , K^+ , Na^+). L'ADN mitochondrial circulaire compte 37 gènes codant pour 2 ARN ribosomiques, 22 ARN de transfert et 13 ARN messagers qui permettent la traduction finale de protéines constitutives de certaines sous-unités des complexes de la chaîne respiratoire. Les autres protéines mitochondriales sont encodées par l'ADN nucléaire et importées.

1.1.1.4.2. Leur fonction

Les mitochondries assurent différents rôles au sein de la cellule, les principaux étant la production d'énergie, l'homéostasie calcique, la production d'espèces réactives de l' O_2 (ERO) et le déclenchement de l'apoptose. Elles permettent également l'oxydation de substrats énergétiques par le cycle de Krebs ou la β -oxydation des lipides. Au sein des cellules, il existe peu de réserve d'énergie sous forme d'ATP, ce qui implique une production continue mais variable en fonction du tissu et de sa demande énergétique à l'instant « t ». La production se fait au niveau de la chaîne respiratoire qui se compose de 4 complexes protéiques : NADH déshydrogénase (complexe I), succinate déshydrogénase (complexe II), coenzyme Q cytochrome c réductase (complexe III), cytochrome c oxydase (complexe IV). L'ATP-synthase vient compléter le système d'oxydo-réduction et joue son rôle dans l'étape finale de phosphorylation (**Figure 3**).

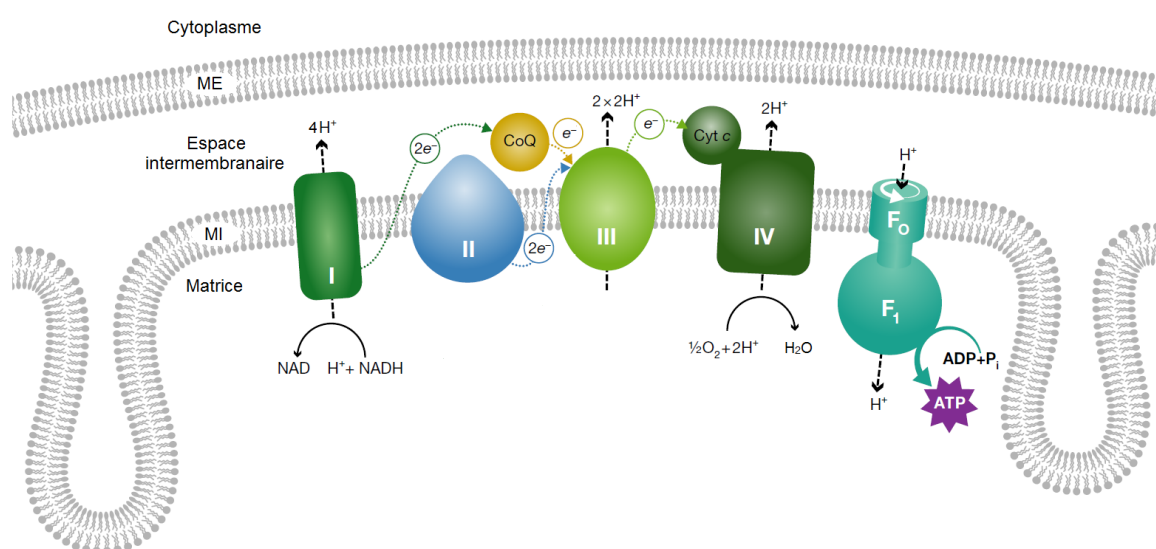
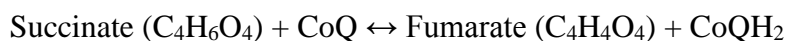

Figure 3 – La chaîne respiratoire mitochondriale. La chaîne d'oxydo-phosphorylation et de transport des électrons (e^-) est localisée au niveau de la membrane interne (MI) des mitochondries. Les complexes enzymatiques constitutifs de cette chaîne sont identifiés par leur numéro respectif (I à IV). Les e^- sont transférés entre les complexes (flèches en pointillés), favorisant le transport des protons (H^+) (flèches en tirets) de la matrice vers l'espace intermembranaire. Au niveau du complexe IV, le dioxygène (O_2) constitue l'accepteur final des e^- pour former de l'eau (H_2O). Le flux de H^+ à travers les sous-unités F_0 et F_1 de l'ATP synthase convertit l'adénosine diphosphate (ADP) et le phosphate inorganique (P_i) en adénosine triphosphate (ATP). CoQ, coenzyme Q ; Cyt c, cytochrome c ; ME, membrane externe ; NAD, nicotinamide adénine dinucléotide ; NADH, nicotinamide adénine dinucléotide réduit. Traduit et adapté de Dorn (2015).

L'ensemble de la chaîne *via* les transferts de H⁺ et le transport d'électrons (e⁻) va permettre de produire de l'énergie sous forme d'ATP. Pour cela il existe un gradient de H⁺ entre la matrice mitochondriale et l'espace intermembranaire à l'origine du ΔpH. Les H⁺ (charge positive) et les e⁻ (charge négative) sont également responsables d'un gradient électrique appelé potentiel de membrane ou Δψ. L'association des deux gradients reflète le gradient électrochimique régulateur de l'activité de l'ATP-synthase. Chaque complexe assure de son côté un rôle et une fonction bien spécifique dans la production d'énergie et le maintien de ces gradients. Le complexe I transforme le NADH+H⁺ en NAD⁺ avec le transfert de 2e⁻ jusqu'au coenzyme Q (CoQ) et le passage de 4H⁺ dans l'espace intermembranaire.



Le complexe II, commun à la chaîne respiratoire et au cycle de Krebs, catalyse l'oxydation du succinate en fumarate avec le transfert de 2e⁻ et l'utilisation de 2H⁺.



Le complexe III prend en charge les e⁻ transférés depuis les complexes I et II *via* le CoQ avec le passage de 4H⁺ dans l'espace intermembranaire.

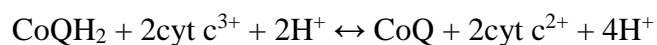

Les e⁻ sont ensuite transférés jusqu'au complexe IV grâce au cytochrome c (Cyt c). Le complexe IV catalyse l'oxydation du Cyt c par l'O₂ tout en expulsant 4H⁺ dans l'espace intermembranaire. Cette réaction consommatrice d'O₂ entraîne la formation de molécule d'eau (H₂O).

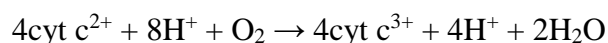

Pour finir, l'ATP-synthase transfère les H⁺ stockés dans l'espace intermembranaire vers la matrice mitochondriale grâce au gradient de H⁺ et à la force protomotrice. L'action mécanique induite par leur passage permet la formation d'ATP à partir d'ADP et de Pi.



L'ATP formé ressort de la matrice mitochondriale en passant par l'ANT. Tout comme l'ADP, il est transporté au sein de la cellule jusqu'à son site d'utilisation grâce à un système de navette réversible créatine-phosphocréatine faisant intervenir les enzymes créatine kinase (CK) (Walsh et al., 2001a).

Les méthodes d'analyse par oxygraphie permettent d'évaluer *in vitro* la consommation mitochondriale d'O₂ à partir de biopsies musculaires. Après préparation des mitochondries,

l'ajout de substrats ou d'inhibiteurs spécifiques de la chaîne respiratoire permet de mesurer des niveaux de respiration basale (\dot{V}_0) et maximale (\dot{V}_{\max}) complexe et substrat dépendants, et ainsi évaluer leur activité. À partir de ces données, le couplage entre l'oxydation et la phosphorylation (RCR, *respiratory control ratio*) peut être calculé. L'efficacité des mécanismes cellulaires de transfert d'énergie est également un indicateur majeur et peut être déterminée par la mesure de la constante d'affinité (K_m) pour l'ADP représentative de la sensibilité de la respiration mitochondriale à l'ADP.

Outre l' O_2 utilisé pour la production d'énergie, une partie peut être détournée et conduire à la production d'ERO que sont l'anion superoxyde ($O_2^{\cdot-}$), le radical hydroxyl (HO^{\cdot}), les radicaux peroxydes (ROO^{\cdot}), le radical perhydroxyl (HO_2^{\cdot}), le peroxyde d'hydrogène (H_2O_2) et l'acide hypochloreux HOCl (Apel et Hirt, 2004). Au niveau de la chaîne respiratoire une petite fraction d' e^- quitte la chaîne en amont du complexe IV et conduit à la réduction de l' O_2 en $O_2^{\cdot-}$ principalement au niveau des complexe I et III (Murphy, 2009).

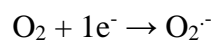

Au niveau du complexe II, lorsque celui génère une quantité d' e^- supérieure à ce que le Cyt c peut prendre en charge, un flux réverse d' e^- va être orienté en direction du complexe I, favorisant la production d'ERO. Par dismutation spontanée ou sous l'action de la superoxyde dismutase (SOD), l' $O_2^{\cdot-}$ va former de l' H_2O_2 .

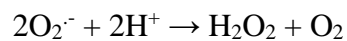

La mesure de la libération d' H_2O_2 par fluorimétrie est la technique de référence pour évaluer l'implication des mitochondries dans la production d'ERO. Celles-ci sont en moyenne responsables de 90 % de la production cellulaire d'ERO, le reste étant issue du réticulum endoplasmique, des peroxysomes, des NADPH oxydases et de la xanthine oxydase (Balaban et al., 2005). Les ERO ont un rôle physiologique dans la signalisation cellulaire, l'homéostasie et la réponse aux exercices physiques. Si de faibles concentrations régulées sont bénéfiques à la cellule, tout excès lui sera délétère, allant de la simple dysfonction à la mort cellulaire par apoptose.

1.1.2. La plasticité du système en réponse à l'entraînement

Les athlètes, notamment ceux entraînés en endurance, ont une valeur de $\dot{V}O_{2\max}$ supérieure à celle de sujets sédentaires, laissant supposer des adaptations et une plasticité importante du système de transport et d'utilisation de l' O_2 (Mettauer et al., 2001). Ces adaptations n'ont qu'un seul but, augmenter l'apport d' O_2 au niveau mitochondrial et améliorer son rendement d'utilisation dans un contexte de production d'énergie. L'entraînement en endurance induit ainsi des adaptations significatives au sein des systèmes du transport sanguin (hématologie), cardiovasculaire et musculo-squelettique, mais pas ou peu de changement au niveau du système respiratoire (McKenzie, 2012). Chez un sujet sain, les capacités pulmonaires sont démontrées comme étant suffisantes pour répondre aux besoins de ventilation et d'échanges gazeux. En d'autres termes, il n'existe pas de capacité intrinsèque d'adaptation maximale de ces paramètres. Du côté du système cardiovasculaire, l'entraînement a montré son efficacité pour améliorer les performances de la pompe cardiaque *via* notamment une augmentation du \dot{Q}_C et du VES (Blomqvist and Saltin, 1983). D'un point de vue hématologique, une plus grande quantité d'Hb permet une augmentation des capacités de transport de l' O_2 jusqu'aux tissus périphériques musculaires au niveau desquels une augmentation de la densité capillaire et une transition typologique en faveur des fibres oxydatives (type I et type IIA) sont observées (Hoppeler et al., 1985; Saltin et al., 1977). Les mitochondries sont elles-mêmes affectées par l'entraînement en endurance qui augmente leur nombre et leur fonctionnalité (Walsh et al., 2001b; Zoll et al., 2002, 2003). Ces adaptations se traduisent plus spécifiquement par une augmentation de la \dot{V}_{\max} , du RCR, du K_m et de l'activité citrate synthase (CS), faisant suite à des modifications traductionnelles (Coffey and Hawley, 2007). Il est important de noter que toutes ces adaptations sont progressives et fonction des charges et modalités d'entraînement appliquées (**Figure 4**). Toutefois, elles sont également très sensibles à l'arrêt de l'entraînement et au déconditionnement (Mujika and Padilla, 2001).

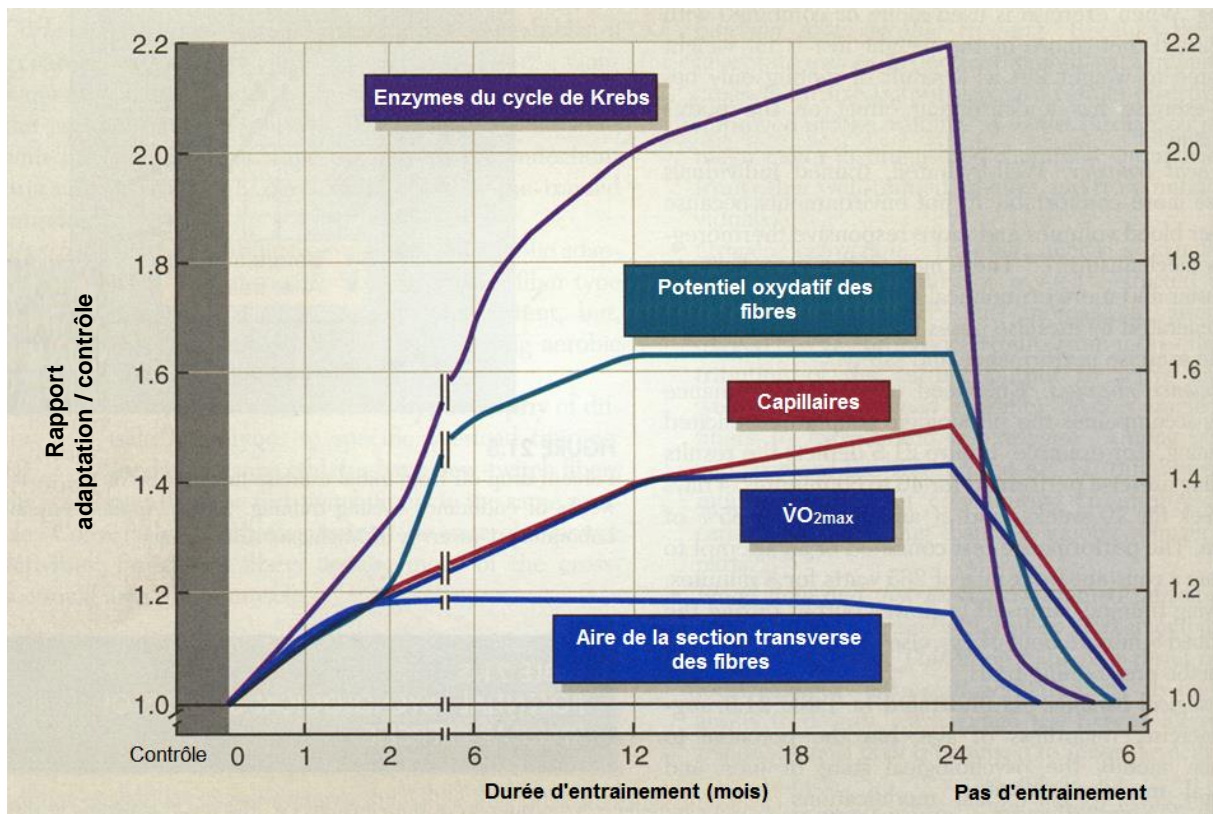

Figure 4 – Cinétique des effets de l'entraînement en endurance. Trois périodes peuvent être isolées : 1) les premiers mois où la reprise d'activité induit une augmentation de tous les paramètres ; 2) la période jusqu'à 24 mois où l'activité seule ne suffit plus à induire des adaptations et où il est nécessaire d'augmenter les charges d'entraînement pour continuer à observer des effets ; 3) l'arrêt de l'entraînement synonyme de déconditionnement. Traduit de Saltin et al. (1977).

1.2. La défaillance du système et le réentraînement

1.2.1. Quelles limitations ?

Le \dot{Q}_C , le VES, la diffusion dans les tissus ou bien encore l'utilisation mitochondriale de l' O_2 sont autant de facteurs pouvant limiter la réalisation d'un exercice aérobie et conduire à l'obtention de valeurs inférieures aux valeurs attendues (Milani et al., 2004). Cela se traduit par une incapacité pour les patients présentant une limitation respiratoire, cardiaque et/ou musculaire d'atteindre une $\dot{V}O_{2max}$, synonyme de stabilité de la $\dot{V}O_2$ et d'atteinte des capacités maximales. L'évaluation à l'effort lors d'un test d'effort incrémental maximal est donc arrêté prématurément en raison de symptômes limitants sa réalisation (douleurs musculaires, trouble

du rythme cardiaque, problème ventilatoire, etc.). On parle alors de $\dot{V}O_{2pic}$, et l'arrêt de l'exercice conditionne cette valeur. Des algorithmes décisionnels prenant en compte les paramètres cardiaques (FC, \dot{Q}_C , VES), ventilatoires (\dot{V}_E , V_T , FR) et musculaires (lactate, QR, $DavO_2$) en comparaison à des valeurs de références permettent d'établir un diagnostic quant à la cause de cette limitation à l'effort (**Figure 5**). Toutefois, puisque les systèmes respiratoire, cardio-vasculaire et musculaire-mitochondrial sont imbriqués les uns dans les autres, la défaillance de l'un d'eux aura irrémédiablement des répercussions sur l'intégralité de la chaîne de transport et d'utilisation de l' O_2 .

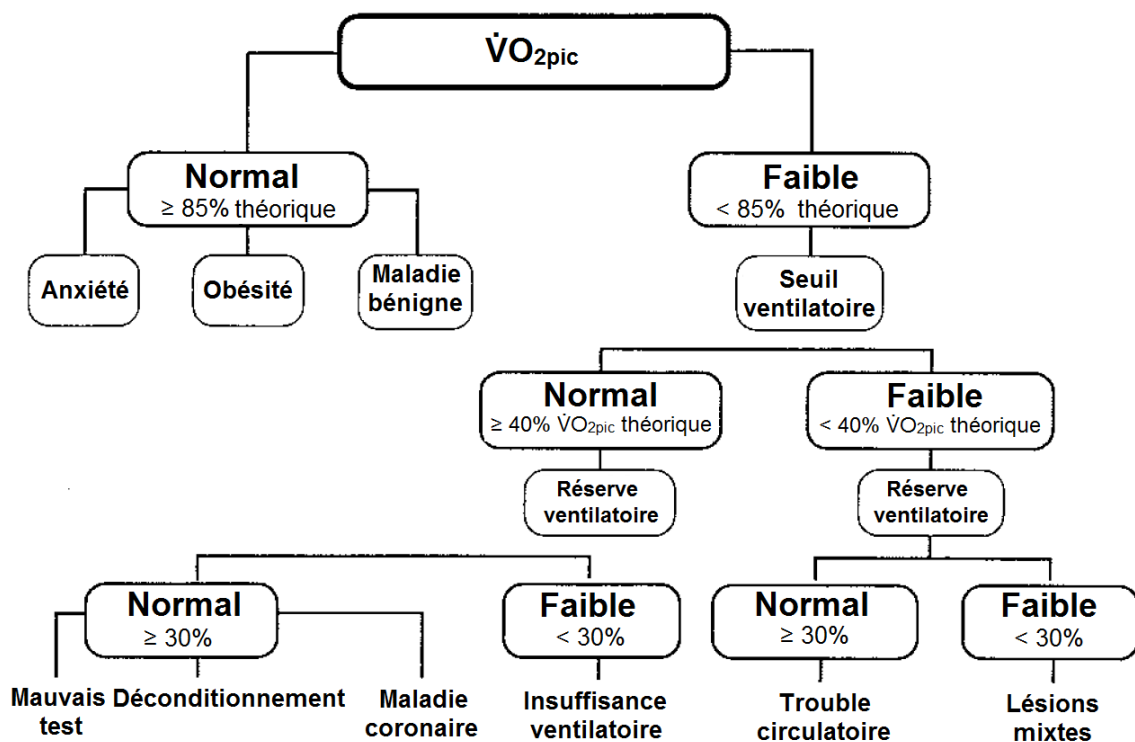





Figure 5 – Diagnostic différentiel d'une valeur de $\dot{V}O_{2pic}$. Une valeur de $\dot{V}O_{2pic}$ inférieure à 85 % de la valeur théorique (fonction de l'âge et du sexe du sujet) est considérée comme faible et nécessite des investigations plus poussées pour en déterminer la cause. Traduit de Milani et al. (2004), d'après Wasserman (1999).

L'insuffisance cardiaque (IC) est l'une des pathologies pour laquelle les patients présentent une limitation à l'effort et de plus faibles valeurs de $\dot{V}O_2$ (Mettauer et al., 2001). Elle se définit par une incapacité du cœur à assurer un \dot{Q}_C suffisant pour permettre la bonne perfusion en O_2 des tissus périphériques. Cette défaillance est la conséquence d'une anomalie de structure ou de fonction de la pompe cardiaque. Les IC sont classées selon leur étiologie et leurs conséquences

physiopathologiques à savoir les IC ischémiques et les IC non ischémiques. La dysfonction ventriculaire associée à l'IC peut quant à elle être stratifiée en trois classes selon l'atteinte de la fraction d'éjection (à savoir le pourcentage que représente le VES par rapport au volume télédiastolique) : les IC avec une fraction d'éjection réduite (< 40 %), les IC avec fraction d'éjection moyenne (40-49 %) et les IC avec fraction d'éjection préservée (≥ 50 %) (Ponikowski et al., 2016). Sur le plan clinique, plusieurs classifications en lien avec la diminution des capacités fonctionnelles existent et permettent d'évaluer le degré de sévérité de la maladie (**Tableau 2**).

Tableau 2 – Comparaison des classes de sévérité de l'insuffisance cardiaque.

	Classification NYHA	Classification de Weber
	Classe I : Aucun symptôme au repos. Pas de limitation à l'AP (absence de fatigue excessive, de palpitations, de dyspnée, de douleurs de poitrine)	Classe A, sévérité nulle à légère $\dot{V}O_{2pic} > 20 \text{ mL}\cdot\text{min}^{-1}\cdot\text{kg}^{-1}$
	Classe II : Aucun symptôme au repos. Légères limitations de l'AP (fatigue, palpitations, dyspnée ou douleurs de poitrine)	Classe B, sévérité légère à modérée $16 \text{ mL}\cdot\text{min}^{-1}\cdot\text{kg}^{-1} < \dot{V}O_{2pic} < 20 \text{ mL}\cdot\text{min}^{-1}\cdot\text{kg}^{-1}$
	Classe III : Aucun symptôme au repos. Limitations marquées de l'AP, un effort de faible intensité provoque fatigue, palpitations, dyspnées ou douleurs de poitrine.	Classe C, sévérité modérée à intense $10 \text{ mL}\cdot\text{min}^{-1}\cdot\text{kg}^{-1} < \dot{V}O_{2pic} < 16 \text{ mL}\cdot\text{min}^{-1}\cdot\text{kg}^{-1}$
	Classe IV : Présence de symptômes au repos. Incapacité à réaliser une AP	Classe D, sévérité intense $\dot{V}O_{2pic} < 10 \text{ mL}\cdot\text{min}^{-1}\cdot\text{kg}^{-1}$

AP, activité physique ; NYHA, *New York Heart Association* ; $\dot{V}O_{2pic}$, pic de consommation de dioxygène. D'après Bennett et al. (2002) et Weber et al. (1982).

Les classes de la *New York Heart Association* (NYHA) sont le reflet des capacités fonctionnelles du patient et de son aptitude à réaliser des tâches de la vie courante (Bennett et al., 2002). La classification de Weber est quant à elle établie sur les valeurs de $\dot{V}O_{2pic}$ (Weber et al., 1982). Les limitations fonctionnelles sont la conséquence directe de la diminution du $\dot{Q}c$. L'hypo-perfusion périphérique qu'elle entraîne est de son côté responsable d'une atteinte musculaire à dominante catabolique (Doehner et al., 2014), fréquemment accompagnée d'une diminution de la capillarisation (Drexler et al., 1992). Paradoxalement, les patients IC peuvent présenter une extraction musculaire d' O_2 accrue. Celle-ci s'explique par la diminution du débit périphérique qui conduit à un allongement du temps de transit de l' O_2 dans les capillaires et

donc à une possibilité d'extraction supérieure. Un phénomène semblable s'observe pour les échanges d'O₂ au niveau alvéolo-capillaire. L'augmentation de l'extraction périphérique en O₂ permet aux patients IC de compenser au moins en partie les conséquences de la réduction du \dot{Q}_C et d'assurer l'approvisionnement des mitochondries. Sur le plan histologique musculaire, l'IC se caractérise par une transition typologique avec l'augmentation du ratio fibres de type II/I, principalement portée par une diminution de la proportion des fibres oxydatives de type I, et par une réduction de leur diamètre (Lavine and Sierra, 2017). Sur le plan métabolique mitochondrial est observée l'altération des capacités oxydatives et des niveaux d'expression de plusieurs transcrits de gènes liés à la mitochondrie (Garnham et al., 2020; Liu and Marcinek, 2017).

1.2.2. Quelle prise en charge ?

Dans le contexte de l'IC, il est établi que l'exercice physique est bénéfique à un certain nombre de paramètres altérés par la pathologie et qu'il permet *in fine* l'amélioration du transport, de la distribution et de l'utilisation de l'O₂ (Hirai et al., 2015). Il fait ainsi l'objet de recommandations de grade IA dans un contexte de prise en charge pluridisciplinaire (Ponikowski et al., 2016; Yancy et al., 2013). L'amélioration du $\dot{V}O_{2pic}$ est un enjeu majeur de la prise en charge des patients car il constitue un facteur pronostic bien établi de morbi-mortalité (Cattadori et al., 2017). Classiquement, les programmes de réhabilitation cardiaque comprennent une prise en charge globale par une équipe pluridisciplinaire (médecin, infirmiers, kinésithérapeutes, personnel spécialisé en activité physique adaptée), et associent éducation thérapeutique, prises en charge sociales et diététiques, et activité physique. Le réentraînement des patients se fait au cours de séances d'exercice aérobie suivant une modalité d'exercice classique de pédalage ou de course à pieds. Les séances sont réparties sur une période de 5 semaines (18 séances à minima). Chaque séance dure en moyenne 30 minutes, et est réalisée à un pourcentage du $\dot{V}O_{2pic}$ correspondant au premier seuil ventilatoire (SV1, 50-60 % de la valeur de $\dot{V}O_{2pic}$). Cette prise en charge, malgré ses bénéfices (amélioration du $\dot{V}O_{2pic}$, de la force musculaire, du VES), est parfois difficile à réaliser pour les patients du fait de l'importance des limitations cardio-respiratoires.

1.2.3. Le développement de méthodes alternatives

Dans ce contexte, des méthodes alternatives doivent être envisagées afin de contourner ces limitations tout en étant bénéfiques à l'amélioration des composantes cardiaques, respiratoires et musculaires. Dans les années 90, Meyer et coll. ont ainsi étudié une modalité de réentraînement permettant de s'affranchir de la sollicitation aérobie des exercices en endurance : l'exercice intermittent (Meyer et al., 1997). La répétition d'exercices de courtes durées à très haute intensité (jusqu'à 150 % de la puissance maximale du sujet évaluée lors de l'épreuve d'effort), séparés par de courtes périodes de repos, permet en effet de solliciter majoritairement le métabolisme anaérobie. Pendant trois semaines, des patients souffrants d'IC ont réalisé des séances de 15 minutes d'exercice intermittent sur ergocycle (30 secondes de pédalage, 60 secondes de repos) cinq fois par semaine, et 10 minutes d'exercice intermittent sur tapis roulant (60 secondes de course, 60 secondes de repos) trois fois par semaine. Les résultats ont montré une amélioration des capacités aérobies (augmentation du $\dot{V}O_{2pic}$) et de la tolérance à l'effort (augmentation de la charge maximale de travail), malgré une moindre contrainte cardiaque liée à l'exercice.

Le champs d'application de cette modalité d'entraînement est vaste et les combinaisons d'intensités et de durées des phases d'exercice et de repos, actif ou passif, sont en réalité infinies (Buchheit and Laursen, 2013; Taylor et al., 2019). L'exercice intermittent peut ainsi être réalisé sur des programmes moins intenses que celui proposé par Meyer, généralement à ou en dessous du pic de puissance, avec une durée totale moyenne de 30 minutes (4 × 4 min ; 1 × 4 min ; 10 × 1 min ; etc.). C'est le cas dans l'étude REXOCHIR actuellement menée au centre Jean Perrin de lutte contre le cancer à Clermont-Ferrand (Laurent et al., 2017), Clinical Trial n° NCT03020251. L'objectif principal de cette étude est de mettre en évidence une réduction de la durée de séjour hospitalier après chirurgie d'exérèse d'un cancer pulmonaire opérable d'emblée, chez des patients BPCO ayant bénéficiés d'un programme préopératoire de réentraînement intermittent à l'effort à domicile. Les objectifs secondaires reposent sur l'évaluation des effets de ce réentraînement sur les capacités maximales d'exercice. L'objectif exploratoire ancillaire (pour lequel j'interviens) vise à étudier les effets sur les adaptations oxydatives musculaires mitochondriales du quadriceps et de l'intercostal. Les patients du bras interventionnel sont entraînés pendant trois semaines (15 séances) avant leur chirurgie selon un

programme intermittent de haute intensité. Les séances consistent en au moins 10 répétitions de 30 secondes à puissance maximale et 60 secondes à puissance équivalente au SV1. À ce jour, l'étude et les inclusions se poursuivent et les résultats, non détaillés dans ce manuscrit, feront l'objet de publications ultérieures. Des résultats préliminaires seront présentés en communication orale d'ici la fin de l'année dans le cadre des Journées de l'Ecole Doctorale 2020 et des 13èmes Journées Francophones Alvéole.

La modalité d'exercice intermittent a permis de montrer qu'il était possible de s'affranchir partiellement des limitations liées à des pathologies affectants les systèmes cardio-respiratoires. Mais dans la recherche de méthodes de substitutions, plusieurs équipes se sont également appuyées sur des travaux mettant en évidence les avantages de la modalité de contraction excentrique. Il a alors été émise l'hypothèse que ce type d'exercice pourrait présenter des effets bénéfiques et être transposable au champ de la réhabilitation cardio-respiratoire et musculaire.

1.3. L'exercice excentrique

1.3.1. Définition et caractéristiques

1.3.1.1. La contraction musculaire

Par définition, la contraction musculaire est le résultat du raccourcissement des sarcomères, unité fonctionnelle des myofibrilles, par le glissement des filaments d'actine et de myosine. Il est cependant important de distinguer les contractions isométriques, n'entraînant pas de modification de la longueur du muscle, et les contractions anisométriques impliquant une modification en raccourcissement ou en allongement du muscle selon qu'elles sont respectivement concentriques ou excentriques. Ainsi, au cours d'une contraction concentrique peut être observé un rapprochement des points d'insertions musculo-tendineux, et à l'inverse un éloignement lors d'une contraction excentrique. Ces deux modalités de contraction sont classiquement retrouvées dans la vie quotidienne notamment dans les mouvements locomoteurs. Les groupes musculaires impliqués sont plus précisément soumis à des cycles répétés d'étirement (pose du pied, amortissement) et de raccourcissement (propulsion) (Nicol et al., 2006). Lors d'un déplacement, l'inclinaison positive ou négative du terrain module la composante de contraction majoritaire du mouvement et des muscles sollicités : concentrique

au cours de la marche/course en monté et excentrique au cours de la marche/course en descente en ce qui concerne le quadriceps. D'autres modèles dynamiques de comparaison excentrique *versus* concentrique existent comme par exemple la montée et la descente d'escaliers (Theodorou et al., 2013), ou des modèles plus techniques de pédalage impliquant des ergocycles spécifiques (référence historique - (Abbott et al., 1952)).

1.3.1.2. Ses caractéristiques mécaniques

Qu'il s'agisse d'un mouvement excentrique segmentaire ou dynamique corps entier (marche/course à pieds ou pédalage), une contraction musculaire excentrique se caractérise par l'opposition d'une force extérieure supérieure à la force produite par le muscle. Cette particularité s'associe à sa capacité à générer une force plus importante et à moindre coût métabolique comparativement à la modalité de contraction concentrique (Nishikawa et al., 2018). En effet, lors d'une contraction isométrique, la force maximale excentrique peut atteindre 1,5 fois la force maximale concentrique. Pour cela, la modalité excentrique sollicite non seulement la composante contractile du muscle mais également les éléments « passifs » dotés de propriétés élastiques (protéines d'ancrages, membranes cellulaires, tissus aponévrotiques, etc.) qui vont jouer un rôle essentiel en réponse à la forte contrainte mécanique imposée. Lors de la phase d'allongement, les complexes actine-myosine vont générer une force de résistance à l'arrachement. À l'échelle du sarcomère un équilibre va se créer entre les complexes qui grâce à l'ATP vont d'une manière active réaliser un cycle de contraction classique et ceux majoritaires qui ne jouent qu'un rôle d'opposition à l'arrachement. À cette propriété intrinsèque du sarcomère, vient s'ajouter la contribution des éléments élastiques du muscle. La mise en tension de ces éléments va permettre d'absorber la force externe pour ensuite la restituer sous la forme d'énergie potentielle élastique ou la dissiper sous forme de chaleur. Ce mécanisme est notamment décrit pour la titine qui joue également un rôle dans l'alignement du sarcomère assurant une contraction musculaire efficace. En concentrique, c'est le glissement des filaments contractiles et les ponts d'accroche actine-myosine qui expliquent la production de force.

D'un point de vue biomécanique, lors d'un exercice sur ergocycle excentrique les contractions musculaires du quadriceps se font exclusivement en allongement et constituent un modèle « simple » (**Figure 6**). Le vélo excentrique est doté d'un moteur qui entraîne le pédalier en arrière du sens de pédalage conventionnel à une vitesse prédéfinie. Le sujet doit alors résister,

autrement dit ralentir le mouvement du pédalier, en appliquant une force opposée à celle générée par le moteur.

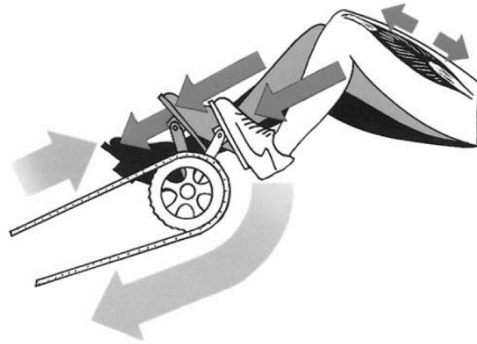

Figure 6 – Principe de fonctionnement du pédalage excentrique. Le moteur fait tourner les pédales à une vitesse définie dans le sens inverse (grandes flèches), le sujet tente de ralentir les pédales en appliquant une force (flèches intermédiaires). La force produite par le moteur étant supérieure à celle produite par le sujet, les muscles du quadriceps se contractent en allongement et donc en excentrique (petites flèches). D’après LaStayo et al. (2003).

Lors de la marche ou de la course à pied en descente, le modèle de contraction mis en jeu est plus complexe. Le muscle peut être modélisé sous la forme d’un ressort-amortisseur (modèle de Hill - (Bassett, 2002)) et se comporte comme tel à savoir que l’ensemble du système est capable de recevoir de l’énergie (énergie cinétique) et de la restituer (énergie potentielle élastique) grâce aux propriétés élastiques du muscle. La foulée se décompose en deux phases, celle de suspension et celle d’appui, l’une débutant quand l’autre s’arrête. Au cours de la phase de suspension, l’absence de point d’appui au sol est synonyme d’absence d’action motrice. Toutefois, la suspension est le résultat de la phase d’appui qui l’a précédé et correspond aux trois grandes étapes au cours desquelles le pied est en contact avec le sol. La première est l’étape d’amortissement. Elle fait appel à des contractions musculaires excentriques du quadriceps et à la mise en tension des éléments élastiques. Au moment de l’impact, les muscles s’activent pour absorber l’énergie issue de la force de réaction au sol et de l’action de la gravité pour maintenir l’équilibre du corps. L’étape suivante est celle de soutien et fait intervenir des contractions musculaires isométriques qui permettent notamment le maintien du centre de gravité. Enfin la dernière étape est la poussée ou propulsion qui implique des contractions concentriques. Elle implique le développement d’énergie musculaire et l’utilisation de celle précédemment emmagasinée au cours de l’amortissement. Avec une pente négative, les forces et tensions musculaires associées à l’amortissement et au freinage sont plus importantes et à l’inverse celles

associées à l'étape de poussée/propulsion moins importantes car une quantité plus conséquente d'énergie est stockée pendant la phase d'amortissement pour ensuite être libérée. L'inverse est valable avec une pente positive et donc avec un exercice majoritairement concentrique.

1.3.1.3. Ses caractéristiques métaboliques

Au cours de la contraction excentrique, la rupture mécanique d'une partie des ponts d'actine-myosine, générée par la force d'étirement extérieure, entraîne le détachement forcé de la tête de myosine et une rupture dans le cycle de formation des ponts, limitant l'hydrolyse d'ATP normalement associée à la contraction. Dans le même temps, l'enchaînement cyclique des contractions excentriques et concentriques dans les phases de déplacement implique un stockage transitoire de l'énergie cinétique rapidement restituée sous forme d'énergie potentielle élastique, réduisant considérablement le coût métabolique de la contraction. Ainsi, les exercices faisant majoritairement appel à des contractions musculaires de type excentriques sont réalisés à un coût énergétique global plus faible.

Les premières observations de ce phénomène remontent aux travaux d'Abbott dans les années 1950 qui portaient sur le coût physiologique du travail négatif (Abbott et al., 1952). Aujourd'hui, il est communément admis qu'un exercice à dominante excentrique, réalisé à même stimulation mécanique qu'un exercice à dominante concentrique, implique une $\dot{V}O_2$ deux à cinq fois moins importante. Chez l'Homme cette observation est valable à la fois pour des exercices réalisés sur ergocycles (Perrey et al., 2001), lors de la montée *versus* descente d'escaliers (Teh and Aziz, 2002), et au cours de la marche ou course en montée *versus* en descente (Minetti et al., 2002). Cette observation est aussi rapportée chez le rongeur entraîné sur tapis roulant (Chavanelle et al., 2014). À même puissance mécanique, l'exercice excentrique sollicite également une FC, un \dot{Q}_C et un \dot{V}_E significativement moins importants (Dufour et al., 2004; Lechauve et al., 2014).

1.3.1.4. Sa place dans la réadaptation

Les contractions musculaires excentriques, et l'exercice excentrique dynamique, se caractérisent par la possibilité d'appliquer d'importantes contraintes mécaniques et de développer une plus grande force musculaire, tout en limitant la sollicitation métabolique et les contraintes sur le système cardio-respiratoire. Ces particularités font que l'excentrique a suscité

et suscite encore aujourd'hui un intérêt de mise en œuvre auprès de populations souffrant de limitations cardiaques, pulmonaires et/ou musculaires. L'utilisation d'une modalité d'exercice avec une demande cardiorespiratoire plus faible représente une alternative de rééducation intéressante pour les personnes incapables d'atteindre ou de maintenir des intensités suffisamment élevées pour induire des gains significatifs. Plusieurs études ont aujourd'hui montré que l'ensemble de ces caractéristiques sont valables chez des patients atteints de pathologies cardiaques (Besson et al., 2013; Steiner et al., 2004) ou respiratoires chroniques (Rocha Vieira et al., 2011), mais aussi pour des personnes âgées (LaStayo et al., 2007) ou des sujets en surcharge pondérale ou souffrant d'obésité (Julian et al., 2018a). À l'heure actuelle, les modalités d'exercice excentrique dynamique ne font pas encore partie intégrante de la prise en charge des patients. Elles nécessitent l'acquisition de matériel spécifique et une expertise de mise en place par le praticien afin de déterminer le niveau d'intensité d'exercice adéquat permettant de minimiser les risques de dommages et de douleurs musculaires tout en conservant un niveau suffisant pour induire des adaptations.

1.3.2. Le dommage musculaire et les effets aigus de l'excentrique

1.3.2.1. Le dommage musculaire

Mécaniquement au cours d'une contraction excentrique, le muscle est étiré en réponse à la contrainte extérieure qui lui est appliquée et est soumis à une forte tension. De ce stress va apparaître du dommage musculaire qualifié d'induit par l'exercice (EIMD, *exercise induced muscle damage*) et défini par des microtraumatismes/microlésions au niveau des fibres. Il se traduit plus précisément par des perturbations de l'ultrastructure musculaire identifiées en histologie et en microscopie électronique par une dégradation de l'état général des fibres, des ruptures de sarcomères, ou bien encore le désalignement des disques Z (Armstrong et al., 1983; Liao et al., 2010). Cette désorganisation architecturale est associée à l'apparition de douleurs musculaires (DOMS, *delayed onset muscle soreness*), communément appelées courbatures. Elles apparaissent de manière différée par rapport à la constitution des lésions (24-48h) mais sont de résolution spontanée après quelques jours de repos (Gulick and Kimura, 1996). Les douleurs musculaires, avec la perte de force et la diminution de l'amplitude de mouvements, font partie des marqueurs cliniques et fonctionnels classiquement utilisés pour mettre en

évidence le dommage musculaire. Comme la douleur, la diminution de la force maximale est transitoire et revient à la normale dans les jours suivants (Lynch et al., 1997; Malm et al., 2004).

Outre les marqueurs histologiques et les marqueurs cliniques, plusieurs marqueurs biologiques indirects ont été identifiés et désignés comme illustrant la présence de dommage musculaire. Il s'agit des activités CK et lactate déshydrogénase (LDH), deux enzymes musculaires libérées dans la circulation sanguine en cas de lésions musculaires (Armstrong et al., 1983; Klossner et al., 2007). D'autres études rapportent également la libération de myoglobine (Balnave and Thompson, 1993; Rizo-Roca et al., 2017). Tous ces marqueurs sont significativement augmentés dans les heures qui suivent l'exercice excentrique et retournent progressivement à des valeurs basales dans les jours qui suivent.

Bien qu'étudiés et discutés depuis plusieurs décennies, les mécanismes associés au dommage musculaires et aux douleurs subséquentes ne sont pas encore complètement compris. Le dommage musculaire pourrait être dissocié en deux parties : 1) le dommage initial lié au stress mécanique de la contraction excentrique, 2) le dommage ultérieur lié aux événements secondaires d'origine métabolique, comme par exemple l'inflammation, la rupture de l'homéostasie calcique intracellulaire, le stress oxydatif.

1.3.2.2. La réponse inflammatoire

Système immunitaire et réponse inflammatoire jouent un rôle central dans les mécanismes mis en place en réponse au dommage mécanique induit par l'exercice excentrique (Peake et al., 2005). Le muscle endommagé libère les cytokines pro-inflammatoires interleukine (IL)-1 β et *tumor necrosis factor* (TNF)- α , initiant les processus de dégradation (Liao et al., 2010; Zuo et al., 2019). Ces molécules vont agir localement au niveau des cellules endothéliales qui vont alors exprimer des molécules d'adhésion à leur surface et libérer dans la circulation systémique des molécules chemo-attractrices et d'autres cytokines pro-inflammatoires (IL-6) (González-Bartholin et al., 2019; Toft et al., 2002; Tsuchiya et al., 2018). Ces médiateurs de l'inflammation ont pour objectif d'attirer les cellules phagocytaires, polynucléaires neutrophiles dans un premier temps et monocytes dans un second, vers les sites musculaires lésionnels (Frimpong et al., 2019; Malm et al., 2000). À ce niveau les cellules immunitaires participent à la dégradation et à l'élimination des tissus endommagés en phagocytant les débris cellulaires et en libérant protéases, cytokines, ERO et espèces réactives de l'azote (Close et al., 2005). Le nombre de ces

cellules atteint un pic entre 24 et 72h suivant la stimulation excentrique puis décline progressivement (Armstrong et al., 1983; Kato et al., 2016; Zuo et al., 2019).

1.3.2.3. Les altérations mitochondriales

De récentes images en microscopie électronique à transmission illustrent les répercussions mitochondriales suite à un stress mécanique excentrique et leurs évolutions au cours de la période de récupération (Shang et al., 2019). La comparaison d'échantillons musculaires de rats soumis à un exercice de course en descente par rapport à des animaux témoins révèle des altérations se traduisant par le gonflement et l'accumulation de mitochondries endommagées sous la membrane cellulaire. La présence de nombreux mitophagosomes vient confirmer les dommages causés et la nécessité d'éliminer les mitochondries rendues non fonctionnelles. Une autre preuve indirecte de la mise en place des processus de mitophagie est la diminution de la quantité d'enzyme CS, dont l'activité a également été retrouvée diminuée de façon différée à J+7 et J+14 (Rizo-Roca et al., 2017). En enzymologie, une diminution de l'activité des complexes II et IV de la chaîne respiratoire conforte l'effet délétère de l'exercice excentrique. Soixante-douze heures de repos complet permettent cependant un retour progressif à un aspect visuellement normal des mitochondries et à des niveaux fonctionnels comparables à ceux mesurés chez les rats témoins. Au regard des données mitochondriales disponibles dans la littérature en réponse à une stimulation excentrique aiguë, les effets observés ne semblent pas tous aussi contrastés, certaines études n'ayant rapporté aucun changement de respiration mitochondriale alors que d'autres indiquent une diminution et donc une altération de leur fonction. La production d'ERO et les flux de calcium (Ca^{2+}) sont également deux éléments au cœur des réponses mitochondriales à l'exercice excentrique.

1.3.2.3.1. La respiration

Walsh et coll. ont été les premiers à évaluer l'impact d'un exercice de pédalage excentrique sur les paramètres de respiration mitochondriale musculaire (Walsh et al., 2001c). Leurs résultats n'ont montré aucun effet significatif de l'excentrique sur les vitesses de respiration basale (\dot{V}_0), sous-maximale (\dot{V}_{submax}) ou maximale (\dot{V}_{max}) mesurées sur fibres musculaires perméabilisées, que ce soit immédiatement après l'effort, deux jours ou quatre jours post-exercice par rapport aux mesures initiales. Ils n'ont pas non plus observé de différence significative pour l'indice de sensibilité à l'ADP ($(\dot{V}_{submax} - \dot{V}_0)/(\dot{V}_{max} - \dot{V}_0)$) et pour le RCR. Molnar et coll. ont également étudié

la consommation mitochondriale d'O₂, bien que leur objectif principal ait été l'étude de la production de radicaux libres en réponse à un exercice excentrique chez le rat (Molnar et al., 2006). Comme l'étude précédente, ils n'ont trouvé aucun changement dans les paramètres de respiration (\dot{V}_0 , \dot{V}_{\max} et RCR) mesurés sur mitochondries isolées en présence de pyruvate-malate (complexe I) ou de succinate (complexe II) immédiatement après l'exercice de course en descente par rapport aux valeurs mesurées chez des animaux sédentaires. Mais quelques années plus tard, une nouvelle équipe s'est intéressée aux effets de l'exercice excentrique sur différents paramètres mitochondriaux (Rattray et al., 2011). Ils ont alors mis en évidence qu'un exercice excentrique altérait la respiration mitochondriale à l'état 3 (\dot{V}_{\max}) chez le rat immédiatement et 48h après la sollicitation, les amenant à suspecter une sensibilité accrue des complexes respiratoires mitochondriaux au stress oxydatif. Ils ont également observé une diminution significative du RCR 48h post-exercice. Les niveaux de respiration aux états 2 et 4 n'étant pas différents de ceux observés dans le groupe témoin, cette dépression est principalement liée à la réduction de la respiration à l'état 3. Une dysfonction respiratoire temporaire a également été observée chez la souris avec une diminution significative de la respiration à l'état 3 immédiatement après l'exercice excentrique, lorsque les mitochondries étaient énergisées avec les substrats liés au complexe I (Magalhães et al., 2013). Aucune différence n'a été relevée lorsque les mesures étaient réalisées avec le substrat du complexes II, et des résultats similaires ont été obtenus pour le RCR, sans différence de \dot{V}_0 et de rapport ADP/O.

1.3.2.3.2. Le stress oxydant

Malgré une absence de modification des paramètres de respiration mitochondriale, et initialement intéressés par la production de radicaux libres, Molnar et coll. ont constaté que la production basale d'H₂O₂ musculaire était réduite (Molnar et al., 2006). Des résultats similaires ont mis en avant une diminution transitoire de l'activité de l'aconitase, un marqueur indirect de la production d'O₂⁻, 6h post-exercice excentrique, mais ont à l'inverse montré une augmentation des concentrations d'H₂O₂ 24h post-exercice dans les deux muscles investigués (Liao et al., 2010). Molnar et coll. ont émis l'hypothèse que la faible production de radicaux libres post-exercice excentrique serait le résultat d'une diminution de l'activité du complexe I en tant que principal générateur de radicaux libres de la chaîne respiratoire mitochondriale, ou le résultat d'une diminution du contenu mitochondrial en SOD. Cependant, aucune de ces suggestions n'a pu être validée, ces deux paramètres n'étant pas significativement affectés dans

cette étude. Toujours chez le rat, une étude ultérieure a montré une augmentation de la production d' O_2^- et une augmentation de l'activité SOD 48h après une course en descente à vitesse moindre mais avec une pente plus prononcée (Silva et al., 2011). Un autre marqueur antioxydant indirect, l'activité glutathione peroxydase plasmatique, a été retrouvé augmenté immédiatement suite à un exercice de pédalage excentrique d'intensité modérée ou intense (González-Bartholin et al., 2019). Étant donné que la production de radicaux libres dépend également du $\Delta\psi$ et du ΔpH , et parce que les UCP peuvent affecter ces paramètres, ces dernières ont été quantifiées par Molnar et coll. Les auteurs n'ont rapporté aucune différence. Une précédente étude avait montré que 30 minutes de course en descente ne modifiaient pas l'expression des ARNm UCP3 dans le muscle plantaire du rat, mais que celle-ci était diminuée de 27,6 % dans le tibial antérieur par rapport au groupe témoin (Bryner et al., 2004).

1.3.2.3.3. Le calcium

Le troisième acteur du triangle mitochondrial est le Ca^{2+} (Brookes et al., 2004). Parallèlement à leurs mesures de respiration mitochondriale, Rattray et coll. ont rapporté une augmentation du contenu mitochondrial en Ca^{2+} (MCC, *mitochondrial calcium content*) à l'issue de la course en descente (Rattray et al., 2011). Ils ont par la suite établi une corrélation négative entre le MCC et la respiration à l'état 3 et le RCR. De façon concomitante à l'augmentation du MCC, les auteurs ont constaté que la sensibilité au Ca^{2+} du pore de transition de perméabilité mitochondriale (mPTP, *mitochondrial permeability transition pore*) était plus élevée suite au stress mécanique généré par l'exercice excentrique. Ces travaux interviennent plus d'une vingtaine d'années après la première publication identifiant un lien entre altération de l'homéostasie calcique et dommage musculaire (Duan et al., 1990). Duan et coll. ont été les premiers à montrer le rôle de l'altération de l'homéostasie calcique dans l'étiologie des dommages causés aux fibres musculaires et du dysfonctionnement mitochondrial. Dans une étude animale, les lésions musculaires résultant d'un exercice de marche en descente étaient fortement et positivement corrélées avec le MCC. La réduction de l'accumulation mitochondriale de Ca^{2+} en présence de chélateurs a également atténué les lésions causées aux fibres musculaires, confirmant le rôle central joué par le Ca^{2+} dans leur apparition (Duncan, 1978). Le réticulum sarcoplasmique étant le principal régulateur de la concentration intracellulaire de Ca^{2+} dans les muscles squelettiques, son absorption de Ca^{2+} et l'activité de l'enzyme SERCA (*sarco/endoplasmic reticulum Ca^{2+} -ATPase*) ont été mesurées dans le *Vastus Lateralis* humain après un exercice de pédalage excentrique (Enns et al., 1999). L'absorption

de Ca^{2+} par le réticulum sarcoplasmique était diminuée pendant la période de récupération et retardée après la fin de l'exercice. L'activité SERCA a quant à elle augmenté au cours des 2 premiers jours de récupération et est revenue au niveau initial 6 jours post-exercice. Les caractéristiques fonctionnelles du réticulum sarcoplasmique (c'est-à-dire l'absorption et la libération de Ca^{2+} , l'activité SERCA) ont également été significativement réduites dans la partie rouge du *Vastus Lateralis* chez le rat après une course en descente (Chen et al., 2007). Cependant, l'intégrité de la membrane du réticulum sarcoplasmique n'a pas été affectée. Les observations précédentes peuvent donc refléter un défaut au niveau du réticulum sarcoplasmique potentiellement lié à la gestion du Ca^{2+} . L'augmentation de la charge en Ca^{2+} peut cependant être attribuée à l'ouverture des canaux calciques activés par l'étirement au cours de la contraction musculaire excentrique (Allen et al., 2005). L'incubation des muscles avec des bloqueurs de SACs (*stretch activated channels*) après une contraction excentrique a significativement réduit l'accumulation de Ca^{2+} dans les myocytes, confirmant le rôle des SACs dans ce processus (Sonobe et al., 2008). Il est donc probable que les SACs contribuent au moins en partie à l'augmentation du Ca^{2+} intracellulaire et aux dommages des fibres musculaires observés après des contractions excentriques. Enfin, une étude chez la souris a par la suite confirmé la sensibilité accrue de l'ouverture du mPTP au Ca^{2+} et l'altération transitoire de la fonction mitochondriale du muscle squelettique (Magalhães et al., 2013).

Ainsi, les preuves expérimentales disponibles à ce jour suggèrent que la réalisation d'un exercice excentrique inhabituel est à l'origine d'une altération transitoire de la fonction mitochondriale probablement liée aux lésions musculaires induites par l'exercice lui-même, à la perte d'homéostasie calcique et aux réponses cellulaires associées. Comme pour le dommage et les douleurs musculaires, ces altérations sont de résolution spontanée avec la mise en place de processus de réparation, de régénération et de biogenèse.

1.3.2.4. La régénération musculaire

La régénération musculaire à la suite d'un dommage est l'un des principaux rôles des cellules satellites qui prennent part également aux processus de croissance et d'adaptation du tissu en réponse à l'entraînement. Il a été montré qu'un exercice excentrique maximal, responsable de dommages musculaires, induisait une augmentation de l'activation et du nombre de cellules satellites 24h post-exercice (Hyldahl et al., 2014). À l'état physiologique, les cellules satellites sont des cellules quiescentes localisées dans la matrice extracellulaire des fibres musculaires

squelettiques, au niveau de la lame basale (Mauro, 1961). En réponse à un stimulus suffisant, comme celui retrouvé avec l'exercice excentrique, elles s'activent, prolifèrent et migrent vers les zones endommagées et où elles fusionnent avec les fibres musculaires environnantes. Cette activation et cette différenciation passent notamment par l'expression augmentée de facteurs myogéniques (MyoD, MRF4) (Valladares-Ide et al., 2019). Une partie de la réponse inflammatoire, et notamment l'IL-6, régule la prolifération des myoblastes et leur différenciation *via* MyoD et la myogénine (Serrano et al., 2008).

1.3.3. Le « *repeated bout effect* » et les réponses adaptatives à l'excentrique

1.3.3.1. Le « *repeated bout effect* »

Il est consensuel de dire qu'un exercice excentrique aigu est responsable d'importants dommages musculaires. D'un autre côté, il est montré que sa répétition dans le temps au travers de plusieurs séances d'exercice est corrélée à une réduction graduelle du dommage et des effets délétères associés (McHugh et al., 1999). Ce phénomène d'habituation physiologique à l'excentrique s'appelle le "*repeated bout effect*". Son apparition dès la deuxième séance d'exercice excentrique inhabituel constitue l'un des principes clés de la physiologie de l'exercice et des mécanismes de protection à l'égard du dommage musculaire. Différentes théories neurales, structurelles tissulaires et cellulaires sont susceptibles d'expliquer tout ou partie de ce phénomène d'adaptation (Hyldahl et al., 2017). Plusieurs marqueurs biologiques et cliniques caractérisent sa mise en place comme l'absence d'augmentation des concentrations sériques de CK (Frimpong et al., 2019; Peñailillo et al., 2013), ou des DOMS post-exercice moins prononcées (Frimpong et al., 2019; Nosaka and Clarkson, 1995). En même temps que cet effet est protecteur pour le muscle, il peut constituer un frein à la mise en place des processus adaptatifs. Si à même intensité l'excentrique n'a plus d'effet et ne fait plus intervenir les processus de catabolisme et d'anabolisme musculaires mis en jeu au travers des mécanismes de lésion-réparation, l'amélioration et les bénéfices à plus ou moins long-terme ne sont pas évidents et pourraient être limités.

1.3.3.2. La composition corporelle

La modification de la composition corporelle peut être l'un des objectifs majeurs lors de la prise en charge de patients. Cette modification peut passer par une volonté de perte de masse grasse pour ceux souffrant de surpoids ou d'obésité, mais il peut également s'agir d'obtenir un gain de masse musculaire fonctionnelle chez des patients présentant une sarcopénie. Plusieurs méthodes de référence existent pour évaluer la composition corporelle, les principales étant l'absorptiométrie biphotonique à rayon X (DEXA), l'imagerie par résonance magnétique et la tomодensitométrie (Lemos and Gallagher, 2017). Julian et coll. ont ainsi porté au sein de l'équipe un travail de synthèse sur le sujet en se focalisant sur les mesures non invasives des paramètres de composition corporelle (Annexe n°1 - (Julian et al., 2018b)).

1.3.3.2.1. La masse grasse

Dans une thématique de lutte contre le surpoids et l'obésité, peu d'études se sont intéressées aux effets de l'entraînement excentrique sur l'indice de masse corporelle (IMC) et la masse grasse totale et/ou segmentaire, encore moins en tant que critère principal. Une première étude a été menée auprès de patients coronariens en surpoids (Steiner et al., 2004). Leurs résultats ne montrent aucune modification de l'IMC, ni du pourcentage de masse grasse dans le groupe excentrique, malgré une charge d'entraînement de 3×30 minutes par semaine à 60 % de $\dot{V}O_{2pic}$ sur 8 semaines. De leur côté, Drexel et coll. ont montré une diminution significative de -1,1 % de l'IMC de volontaires, initialement sédentaires et en bonne santé, après 8 semaines d'entraînement excentrique, et ceci malgré une plus faible dépense énergétique hebdomadaire en comparaison au groupe entraîné en concentrique (Drexel et al., 2008). Un autre essai randomisé a quant à lui quantifié les modifications de la masse grasse totale et des cuisses à la suite de 12 semaines de pédalage excentrique chez des patients âgés sarcopéniques (Mueller et al., 2009). Ces patients ont présenté une diminution significative de leur masse grasse corporelle totale (-5 %) et segmentaire (-6,9 %). Une étude menée chez des patients diabétiques de type 2 a de son côté comparé les effets d'un entraînement de 16 semaines combinant exercice excentrique sur stepper et exercice aérobie, à une prise en charge en endurance classique seule (Marcus et al., 2008). À l'issue de la période d'entraînement une réduction significative du tissu adipeux intramusculaire de la cuisse (-1,2 cm²) a été mesurée dans le groupe ayant été confronté à des séances d'entraînement en excentrique. Ces patients ont aussi affiché une diminution significative de leur IMC (-1,9 kg·m⁻²). La même équipe a mené une étude auprès de patientes

ménopausées en surpoids ou obèses et présentant une intolérance au glucose (Marcus et al., 2009). À cette occasion, ils ont montré qu'un programme d'entraînement sur ergocycle excentrique de 12 semaines entraînait une diminution non significative de la masse grasse abdominale par rapport au groupe contrôle non entraîné. Une autre étude ayant employé le même type d'appareil excentrique (stepper excentrique) que Marcus et coll. en 2008 a été réalisée chez des patients âgés présentant un risque important de chute, mais n'a pas montré de modification du tissu adipeux intramusculaire (Jacobs et al., 2014). Chez des patients BPCO, l'absence de modification de l'IMC n'a pas empêché l'observation d'une diminution du pourcentage de masse grasse totale (-1,3 %) et segmentaire de la cuisse (-2,1 %) suite à un entraînement en pédalage excentrique à haute intensité sur une période de 10 semaines (MacMillan et al., 2017). Les exercices de descente d'escaliers sont une alternative d'excentrique également efficace puisqu'une diminution de l'IMC et du pourcentage de masse grasse totale, chez des patientes âgées et obèses, a été montrée après 12 semaines d'entraînement (Chen et al., 2017). Enfin, une récente étude réalisée au sein du laboratoire a mis en évidence une réduction de l'IMC (-5,8 %), de la masse grasse totale (-10 %), du tronc (-13,8 %) et de la cuisse (-6,5 %) chez des adolescents obèses ayant suivi un programme d'entraînement excentrique sur ergocycle de 12 semaines (Julian et al., 2018a).

1.3.3.2.2. La masse maigre

Beaucoup d'études d'entraînement en excentrique segmentaire (exercices de presse sur les membres inférieurs) montrent une augmentation du volume et de la masse musculaire chez des sujets sains, mais aussi chez des patients atteints de maladie chronique (Franchi et al., 2017). L'augmentation de la masse musculaire, ou à minima sa conservation, est un élément crucial dans un contexte de vieillissement de la population générale et de sarcopénie. Comparativement moins de données sont disponibles pour des modèles d'étude dynamiques de type marche/course en descente, pédalage excentrique et stepper excentrique. Steiner et coll., malgré une absence de modification de la masse grasse, identifient une augmentation significative de la masse maigre de la jambe (+3,6 %) après 8 semaines de pédalage excentrique chez des patients présentant une pathologie coronarienne (Steiner et al., 2004). D'autres résultats obtenus à la suite d'entraînement sur ergocycle excentrique confortent cette observation auprès de jeunes skieurs alpins (+2,1 % jambe droite et +1,5 % jambe gauche après 6 semaines, (Gross et al., 2010)), d'adolescents obèses (+3 % après 12 semaines, (Julian et al., 2018a)), de patients en surpoids ou obèses (+5,6 % après 12 semaines, (Marcus et al., 2009)), de sujets âgés (+1,9 %

après 12 semaines, (Mueller et al., 2009)) et de patients BPCO (+2 % après 10 semaines, (MacMillan et al., 2017)). Les entraînements sur stepper excentrique se révèlent également efficaces puisqu'ils montrent une augmentation de la densité du tissu maigre de la cuisse que ce soit chez des patients diabétiques (Marcus et al., 2008), chez des sujets préalablement opérés pour une arthroscopie du genou (LaStayo et al., 2009), et chez des patients âgés à risque de chute (Jacobs et al., 2014; LaStayo et al., 2017). L'ensemble de ces études indique que l'entraînement excentrique dynamique est majoritairement plus efficace (Gross et al., 2010; Julian et al., 2018a; LaStayo et al., 2009; MacMillan et al., 2017; Marcus et al., 2008) ou au moins aussi efficace (Steiner et al., 2004) pour améliorer les paramètres relatifs à la masse maigre segmentaire que les autres modalités d'entraînement auxquelles il est comparé.

1.3.3.3. La consommation d'oxygène

Il a été largement démontré dans la littérature que des entraînements classiques en endurance, réalisés, chez des sujets sédentaires ou chez des patients, à une intensité équivalente à 60 % de la $\dot{V}O_{2max}$, conduisent à une amélioration progressive de ce paramètre. Toutefois, de tels résultats ne sont pas systématiquement observés à la suite d'un entraînement excentrique en endurance, que ce soit chez des sujets sains ou des patients présentant une limitation cardiaque, respiratoire et/ou musculaire.

Une caractéristique commune à plusieurs de ces études est la très faible intensité métabolique des séances d'entraînement excentrique, avec une $\dot{V}O_2$ d'exercice inférieure au SV1 synonyme de faible sollicitation cardiorespiratoire (Besson et al., 2013; Casillas et al., 2016; LaStayo et al., 2000; Lewis et al., 2018; Rooyackers et al., 2003; Toyomura et al., 2018). Leur conclusion générale est qu'aucune modification de $\dot{V}O_{2max}$, de $\dot{V}O_{2pic}$ et/ou de $\dot{V}O_2$ au SV1 n'est retrouvée, que ce soit chez des sujets sains (LaStayo et al., 2000; Lewis et al., 2018; Toyomura et al., 2018), ou chez des patients souffrant d'IC chronique (Besson et al., 2013; Casillas et al., 2016) ou de BPCO (Rooyackers et al., 2003). À l'inverse, d'autres études impliquant une intensité d'entraînement plus élevée, et donc une stimulation métabolique plus importante, ont montré une augmentation significative des valeurs de $\dot{V}O_{2pic}$ à la fois chez des adolescents en bonne santé mais obèses (+16,6 %, (Julian et al., 2018a)) et chez des patients atteints de coronaropathie (+13 %, (Meyer et al., 2003); +14,2 %, (Gremeaux et al., 2010)). C'est également le cas de l'unique étude réalisée dans des conditions équivalentes chez le rat sain (+24 %, (Hahn et al., 2007)).

Une augmentation de la charge de travail maximale lors du test à l'effort incrémental est cependant constatée à la fois à l'issue des entraînements à haute intensité avec augmentation concomitante de la $\dot{V}O_{2pic}$ (Gremeaux et al., 2010; Julian et al., 2018a; Meyer et al., 2003) et à l'issue des entraînements à plus faible intensité sans changement de $\dot{V}O_{2pic}/\dot{V}O_{2max}$ (Besson et al., 2013; Casillas et al., 2016; Lewis et al., 2018; Rooyackers et al., 2003; Toyomura et al., 2018). La dissociation qui semble exister entre la $\dot{V}O_{2pic}/\dot{V}O_{2max}$ et la charge de travail maximale peut suggérer une amélioration de l'efficacité bioénergétique grâce à l'entraînement excentrique, c'est-à-dire un meilleur rendement. Enfin, une $\dot{V}O_2$ inférieure pour effectuer un exercice à une puissance sous-maximale donnée a également été plusieurs fois observée sur un petit nombre de sujets à la suite d'une période d'entraînement de 5 semaines, confortant cette hypothèse (Bonde-Petersen et al., 1973; Klausen and Knuttgen, 1971; Knuttgen et al., 1982).

1.3.3.4. Le muscle

1.3.3.4.1. La force musculaire

Si les dommages musculaires induits par la réalisation d'un exercice excentrique inhabituel sont associés à une diminution transitoire de la force, l'entraînement permet quant à lui la mise en place d'adaptations et de modifications. Les caractéristiques mécaniques de la contraction excentrique font que de plus importantes forces sont développées et sont à l'origine de gains de force musculaire plus importants en réponse à des entraînements segmentaires en résistance (Roig et al., 2008). Malgré moins de données disponibles, les études réalisées en dynamique confortent cette observation et montrent des augmentations significatives de la force musculaire des membres inférieurs suite à des entraînements à composante excentrique majoritaire que ce soit chez le sujet sain (Lastayo et al., 1999; LaStayo et al., 2000; Lewis et al., 2018; Toyomura et al., 2018), le sujet âgé (Meyer et al., 2003; Mueller et al., 2009), dans un contexte d'obésité (Chen et al., 2017; Julian et al., 2018a), de maladie chronique cardiaque (Casillas et al., 2016; Gremeaux et al., 2010; Steiner et al., 2004) ou respiratoire (Bourbeau et al., 2020; MacMillan et al., 2017). Comme pour l'évolution de la masse maigre, et comparativement aux modalités d'entraînement concentrique, l'entraînement dynamique excentrique est à l'origine d'un gain fonctionnel musculaire plus important confirmant son intérêt pour la prise en charge des patients présentant une limitation périphérique.

1.3.3.4.1. Les fibres musculaires

Sur le plan histologique, les adaptations musculaires sont identifiées au travers de l'augmentation de la surface de section transverse des fibres (Hody et al., 2013; LaStayo et al., 2000; Lynch et al., 1997; Meyer et al., 2003), de la modification de leur typologie (Fridén et al., 1983; Mueller et al., 2009) et du nombre de sarcomères par fibre (Lynn and Morgan, 1994). Toutefois, quelques études ne montrent pas de modification de ces paramètres (MacMillan et al., 2017; Steiner et al., 2004).

1.3.3.5. Les mitochondries

1.3.3.5.1. La respiration

Ce n'est qu'au milieu des années 2000 que les chercheurs se sont intéressés aux effets chroniques de l'exercice excentrique sur la fonctionnalité mitochondriale mettant en lumière des effets contrastés de cette nouvelle modalité d'entraînement. En effet, certaines études n'ont rapporté aucun changement des marqueurs de respiration mitochondriale (Isner-Horobeti et al., 2014; MacMillan et al., 2017; Rattray et al., 2013) alors que d'autres ont montré une augmentation substrat-dépendante ou muscle-dépendante de ces paramètres (Molnar et al., 2006; Schlagowski et al., 2016).

En parallèle de leurs résultats mitochondriaux à l'issue d'un exercice excentrique aigu, Molnar et coll. se sont intéressés à l'effet d'un entraînement excentrique de 8 semaines sur les mitochondries du quadriceps de rats (Molnar et al., 2006). Ils ont alors constaté une \dot{V}_0 en présence de pyruvate-malate (complexe I) plus importante dans le groupe entraîné en excentrique par rapport au groupe sédentaire, mais pas en présence de succinate (complexe II). De son côté, la respiration à l'état 3 (ajout d'ADP) est restée inchangée quel que soit le substrat considéré. Ces résultats suggèrent une amélioration de la fonction respiratoire mitochondriale exclusivement portée par le complexe I. De la même façon Rattray et coll. se sont intéressés aux effets chroniques de l'excentrique, après de premiers résultats obtenus suite à un exercice excentrique aigu, en supposant que l'entraînement pouvait fournir un effet protecteur aux mitochondries (Rattray et al., 2011, 2013). Après plusieurs séances de course en descente, aucune différence significative au niveau des paramètres de respiration mitochondriale n'a pu être montrée entre le groupe entraîné en excentrique, le groupe non entraîné mais soumis à un exercice excentrique aigu, et le groupe à la fois entraîné et soumis à un exercice aigu, bien que la respiration à l'état 3 et le RCR ont eu tendance à être réduits dans le groupe exercice

excentrique aigu. Afin de tester si la réponse à l'entraînement est muscle-dépendante, Isner-Horobeti et son équipe ont comparé l'impact d'entraînements concentrique et excentrique réalisés à même puissance mécanique sur la respiration musculaire mitochondriale à l'état 3 du *Vastus Intermedius*, du *Soleus* et du *Gastrocnemius* de rats (Isner-Horobeti et al., 2014). Ces muscles ont été sélectionnés sur la base de leur recrutement différentiel lors de la course en montée et de la course en descente. La respiration mitochondriale en glutamate-malate (complexe I) mesurée sur fibres musculaires perméabilisées 12h après la dernière séance d'entraînement n'est pas différente entre les groupes, quel que soit le muscle étudié. De la même manière en présence de succinate (complexe II), aucune différence n'est observée entre les conditions d'entraînement pour le gastrocnémien et le soléaire, muscles préférentiellement recrutés en concentrique. À l'inverse, en comparaison au groupe témoin et au groupe entraîné en concentrique, les résultats montrent une respiration mitochondriale significativement moins importante au niveau du vaste interne dans le groupe entraîné en excentrique, muscle très sollicité lors de la course en descente. Dans une seconde étude chez le rat, la même équipe a de nouveau comparé les effets de l'entraînement concentrique et excentrique ou combiné concentrique-excentrique sur la consommation mitochondriale d'O₂ dans les trois mêmes muscles, mais cette fois-ci en conditions d'entraînement à même intensité métabolique (Schlagowski et al., 2016). Les auteurs rapportent une \dot{V}_{max} significativement plus importante après un entraînement concentrique par rapport au groupe contrôle, mais aucune différence après l'entraînement excentrique, ou l'entraînement combiné concentrique-excentrique, quel que soit le muscle étudié. De même, aucune modification du RCR post-entraînement n'est montrée. À l'issue de l'entraînement combiné, la \dot{V}_0 est significativement plus faible pour le *Gastrocnemius*, plus élevée pour le *Soleus* et inchangée pour le *Vastus Intermedius*. Dans le groupe d'entraînement excentrique seul, aucune différence n'a été identifiée par rapport au groupe contrôle, ceci dans les trois muscles d'intérêt. De leur côté, la respiration en présence d'amytal (inhibiteur du complexe I) et la respiration en présence de N,N,N'N'-tétraméthyl-1,4-phénylènediamine (TMPD) et d'ascorbate (complexe IV) ne sont pas différentes dans les deux conditions impliquant des contractions musculaires excentriques et dans les trois muscles. Enfin, les résultats d'une étude récente menée auprès de patients BPCO pour comparer les adaptations à l'entraînement concentrique et excentrique, entraînements réalisés à même intensité d'exercice basée sur une FC cible, n'ont montré aucun effet de l'entraînement excentrique sur les différents états respiratoires (MacMillan et al., 2017).

En conclusion, alors que les exercices excentriques aigus et non-habituels sont à l'origine d'une altération transitoire de la fonction mitochondriale, probablement liée à une production accrue de radicaux libres et d'importants flux de Ca^{2+} , l'entraînement excentrique permet d'atténuer, voire de faire disparaître, cette dysfonction. Dans le même temps, l'entraînement excentrique dynamique chronique n'est pas associé à des adaptations métaboliques mitochondriales supérieures à celles observées après un entraînement classique concentrique, lorsque celui-ci est réalisé à la même intensité métabolique.

1.3.3.5.2. Le stress oxydant

Malgré de plus en plus de recherches menées sur les adaptations à l'entraînement excentrique dynamique, seulement trois études ont évalué la production mitochondriale d'ERO. Molnar et coll. ont ainsi étudié si cette modalité d'entraînement influait sur la génération d'ERO mitochondriales dans des conditions associées à une atténuation des EIMD (Molnar et al., 2006). Suite à 8 semaines d'entraînement excentrique intermittent, un niveau inférieur d' H_2O_2 a été observé à l'état basal (-25 %), en présence de pyruvate-malate (complexe I) ou de succinate (complexe II), mais aucun changement après ajout d'ADP en comparaison au groupe d'animaux sédentaires. Il a alors été émise l'hypothèse que cette réduction était associée à une teneur accrue en protéines mitochondriales, en raison de l'augmentation de l'activité CS. De son côté, l'activité des SOD mitochondriale et cytosolique n'est pas significativement supérieure à celle des animaux contrôles. Comme observé pour la condition excentrique aiguë, ils n'ont détecté aucun changement dans la quantité de protéine UCP3. Cependant, cela n'exclut pas la possibilité que cette modalité d'entraînement puisse provoquer des changements intrinsèques dans la fonction mitochondriale, tels qu'un découplage léger, empêchant une production excessive d'ERO. À l'issue d'une période d'entraînement plus courte, et en conditions d'iso-puissance entre les modalités d'exercice, Isner-Horobeti et coll. n'ont observé aucune différence dans les niveaux basaux d' H_2O_2 en présence de glutamate-malate (complexe I), quel que soit le muscle étudié (Isner-Horobeti et al., 2014). Cependant, en présence d'ADP et de succinate, la libération d' H_2O_2 et la fuite de radicaux libres étaient significativement plus importantes dans le *Vastus Intermedius* après 20 séances de course en descente. Sur la base de ces résultats, les auteurs ont émise l'hypothèse d'une adaptation fonctionnelle de la chaîne de transport des e^- plutôt qu'un changement de densité mitochondriale. Enfin, une deuxième étude de la même équipe n'a rapporté aucune différence dans la production musculaire de ROS après

4 semaines d'exercice excentrique seul ou d'exercice combiné excentrique-concentrique (Schlagowski et al., 2016), confirmant partiellement les résultats de l'étude précédente.

Compte tenu des observations faites dans différents muscles des pattes arrières de rats et en utilisant différents protocoles d'entraînement, il semblerait que l'exercice excentrique ne soit pas associé à une production accrue d'ERO. Une amélioration du statut antioxydant n'est pour autant pas exclue, mais nécessite des études plus approfondies. Dans le même temps, l'absence de modifications majeures de la production de radicaux libres peut pour partie expliquer l'absence de toute réduction significative de la respiration mitochondriale après un entraînement excentrique.

1.3.3.5.3. Le calcium

Malgré le rôle central occupé par le Ca^{2+} dans les mécanismes de contraction musculaire et les preuves de son implication dans les processus de dommage, les études excentriques chroniques montrant l'évolution des paramètres calciques (sensibilité du mPTP, MCC, ...) sont rares. Rattray et coll. sont à première vue les seuls à s'être intéressés à cette problématique (Rattray et al., 2013). Ils montrent que l'élévation de la concentration matricielle mitochondriale en Ca^{2+} 48h après une stimulation excentrique est moins importante après une période d'entraînement. Ils observent également une augmentation de la tolérance du mPTP au Ca^{2+} qui se traduit par son ouverture retardée dans le temps. Des études plus approfondies sont nécessaires pour mieux caractériser ces phénomènes et déterminer s'ils sont préférentiellement liés à une adaptation mitochondriale ou à une diminution du dommage musculaire avec le phénomène de *repeated bout effect* et l'entraînement.

1.3.3.5.4. L'expression d'ARN

La première étude visant à étudier la réponse moléculaire à l'entraînement d'endurance excentrique a été menée chez des patients atteints de maladie coronarienne (Zoll et al., 2006). L'analyse des adaptations du *Vastus Lateralis* à l'état d'équilibre après un programme de 8 semaines a montré que les niveaux d'ARNm de TFAM et de COX-4 étaient réduits dans le groupe entraîné en excentrique à faible intensité en comparaison au groupe concentrique. Le niveau de transcrits de PGC1 α était lui inchangé. Chez la personne âgée, 12 semaines d'entraînement excentrique sont à l'origine d'une modification significative de l'expression de 29 gènes (Mueller et al., 2011). Un examen plus approfondi montre que les gènes codant pour

les enzymes impliqués dans le métabolisme énergétique et les protéines mitochondriales sont régulés à la baisse, tandis que les gènes codant pour les facteurs impliqués dans la réparation et le remodelage sont régulés à la hausse. Enfin, une étude menée auprès de patients BPCO ne montre aucun changement dans l'expression de PGC1 α après un programme excentrique de 10 semaines (MacMillan et al., 2017).

Problématique, Objectifs & Stratégies

A l'heure du 21^{ème} siècle, les problématiques liées au développement des maladies chroniques sont nombreuses : limitations à l'effort, dégradation de la qualité de vie, coûts de santé publique, impacts psychologique et social, perte d'autonomie, etc. Le paradigme qu'elles représentent pour les systèmes de santé nécessite la mise en place de dispositifs de prise en charge toujours plus performants. L'un des axes d'action majeure est l'activité physique, dont les bénéfices en termes de santé sont largement reconnus et validés par l'ensemble de la communauté scientifique. Sa principale limite fait écho aux propres limites des patients à savoir respiratoires, cardiaques et/ou musculaires qui les empêchent d'atteindre ou de maintenir des intensités d'effort ou des niveaux de sollicitation suffisamment élevés pour être à l'origine de processus adaptatifs significatifs. Par conséquent, il est nécessaire de mettre au point des stratégies alternatives d'exercice et d'entraînement permettant à la fois de contrecarrer les effets néfastes liés à la pathologie, tout en étant fiables et applicables auprès du plus grand nombre. Leur développement passe également par la connaissance et la compréhension des mécanismes d'action et d'adaptation en réponse à la stimulation, et la mise au point de nouveaux outils d'analyse pour mieux les cerner.

Dans cette optique, des stratégies fondées sur l'entraînement excentrique, et ses caractéristiques mécaniques et métaboliques, ont fait l'objet de plusieurs études au cours des dernières décennies. Pour une sollicitation musculaire mécanique identique comparativement à une modalité concentrique, l'excentrique se fait avec un coût métabolique moindre, confirmant son intérêt en pratique clinique chez des patients fortement limités. Les travaux déjà disponibles dans la littérature montrent des adaptations positives en termes de gains de masse maigre et de force musculaire, généralement supérieures à ceux observés suite à une prise en charge classique en concentrique. Les effets métaboliques, qu'ils soient corps entier avec la $\dot{V}O_{2pic}/\dot{V}O_{2max}$ ou cellulaires avec notamment la respiration mitochondriale, sont cependant moins étudiés et plus contrastés.

Dans le cadre de ce travail de thèse, un focus particulier a été fait sur les réponses et adaptations métaboliques, $\dot{V}O_2$ et mitochondriales, en réponses à des entraînements excentriques, sachant

que les modifications de ces paramètres suite à des exercices classiques de type concentrique sont bien connues et conduisent *in fine* à l'amélioration des capacités oxydatives, tant chez l'homme que chez l'animal. Un travail bibliographique a permis la rédaction d'une revue de la littérature intitulé « *Aerobic metabolic adaptations in dynamic eccentric exercise and training: from whole body to mitochondria* » actuellement en cours de révision auprès du journal *Frontiers in Physiology* (Annexe n°2). Le travail de recherche s'est quant à lui articulé autour de deux volets, l'un animal et l'autre clinique.

L'utilisation d'un modèle animal a l'avantage de permettre une exploration plus fondamentale et mécanistique des effets de l'entraînement excentrique. Dans ces conditions nous nous sommes appliqués à comparer les réponses adaptatives suite à des entraînements excentrique et concentrique de 8 semaines réalisés à même stimulation métabolique (iso- $\dot{V}O_2$) ou à même stimulation mécanique (iso-puissance). Lorsque la puissance est identique entre les deux modalités, la sollicitation métabolique excentrique est deux fois moins importante qu'en concentrique. La mise en avant d'effets bénéfiques conforterait d'avantage l'intérêt clinique de sa mise en place dans le champ de la réhabilitation. Cette étude a donné lieu à deux publications. La première intitulée « *Impact of eccentric or concentric training on body composition and energy expenditure* » a été publiée dans le journal *Medecine & Sciences in Sports & Exercise* (Touron et al., 2019). Elle rassemble l'intégralité des résultats obtenus corps entier, de la composition corporelle à la dépense énergétique. La deuxième publication intitulée « *Effects of exercise-induced metabolic and mechanical loading on skeletal muscle mitochondrial function in rats* » est actuellement en cours de soumission. Elle traite plus spécifiquement des adaptations mitochondriales, qu'elles soient fonctionnelles, enzymatiques ou transcriptionnelles.

L'insuffisance cardiaque (IC) constitue l'une des pathologies pour laquelle le réentraînement à l'effort des patients est essentiel et fait l'objet de recommandations par les sociétés de cardiologie. Les intensités d'entraînement classiques étant limitées par la capacité de leur système cardio-circulatoire, la mise en place de stratégies excentriques pourrait être bénéfique au regard des gains de masse maigre et de force déjà observés dans la littérature, mais moins évidente au regard des réponses adaptatives aérobies. Les études publiées à ce jour comparent généralement l'excentrique à la prise en charge conventionnelle concentrique. Cette dernière met en avant des adaptations plus modestes en termes de gain de masse et de force musculaire, mais des améliorations de la $\dot{V}O_2$ et mitochondriales significativement plus importantes. Il nous

a donc semblé intéressant de ne pas chercher à opposer les deux modalités d'exercice mais plutôt d'étudier leur combinaison en essayant de potentialiser les effets bénéfiques observés séparément. Le protocole de cette étude a fait l'objet d'une publication dans le *BMJ Open* intitulée « *Effectiveness of combined eccentric and concentric exercise over traditional cardiac exercise rehabilitation programme in patients with chronic heart failure: protocol for a randomised controlled study* » et d'un enregistrement sur le site ClinicalTrial.gov (NCT03716778) (Plaquet-Hostache et al., 2019). Les essais cliniques étant d'une réalisation et mise en œuvre plus complexes et longues, l'étude est toujours en cours. Les résultats préliminaires obtenus sur les premiers patients inclus seront présentés dans ce manuscrit. Les résultats feront par la suite l'objet d'une publication dans un journal avec évaluation par des experts, une fois les inclusions et le protocole entièrement complétés.

Protocoles & Méthodes

3.1. L'étude animale STARTREX

3.1.1. Les aspects éthiques et les animaux

Conformément à la réglementation française relative à l'expérimentation sur animaux vertébrés, les procédures de ce protocole expérimental ont reçu un avis favorable du comité d'éthique (C2EA-02, Auvergne, France).

Soixante rats Wistar mâles, âgés de neuf semaines et pesant entre 300 et 360 g à leur arrivée à l'animalerie de Theix (INRAE, France), ont été impliqués dans le cadre de cette étude (Janvier Labs, Le Genest-Saint-Isle, France). Chaque rat a été placé en cage individuelle dans un environnement thermo-régulé à $22 \pm 3^{\circ}\text{C}$ en cycle inversé jour/nuit de 12h. Tout au long du protocole, les animaux ont eu libre accès à de l'eau et à une alimentation standard non obésogène (A04 ; Safe, Augy, France). Une phase d'habituation d'une semaine a précédé le début de la période d'entraînement.

3.1.2. Le protocole d'entraînement et le design de l'étude

Les animaux ont été répartis par randomisation dans l'un des quatre groupes expérimentaux suivants (n = 15 par groupe) :

- groupe contrôle (CTRL), les rats n'ont subi aucune intervention particulière mais ont été manipulés et investigués à la même fréquence et de la même manière que les rats des groupes entraînés ;
- groupe concentrique (CON), les rats ont couru en monté sur un tapis incliné à une pente de +15 % ;
- groupe excentrique 15 (ECC15), les rats ont couru en descente sur un tapis incliné à une pente de -15 % ;

- groupe excentrique 30 (ECC30), les rats ont couru en descente sur un tapis incliné à une pente de -30 %.

Ces conditions ont été sélectionnées sur la base de résultats antérieurs montrant une puissance mécanique similaire lors d'une course en montée avec une pente de +15 % (CON) et en descente avec une pente de -15 % (ECC15) permettant ainsi des comparaisons à iso-puissance (Chavanelle et al., 2014; Isner-Horobeti et al., 2014). De son côté le coût métabolique de la course en montée (CON) étant similaire à celui de la course en descente avec une pente de -30 % (ECC30) des comparaisons à iso- $\dot{V}O_2$ sont rendues possibles (Chavanelle et al., 2014). Le coût métabolique dans le groupe ECC30 est alors le double de celui du groupe ECC15 (**Figure 7**).

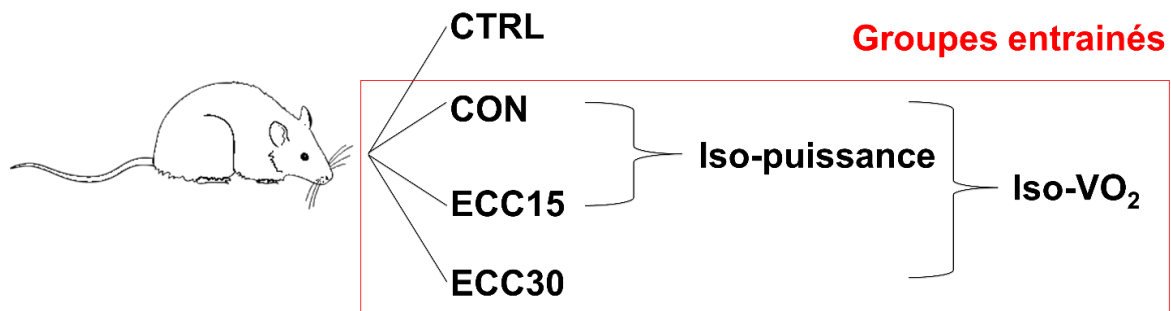

Figure 7 – Modèle expérimental de l'étude STARTREX. Un entraînement à la même puissance mécanique (iso-puissance) a été réalisé par les groupes concentrique (CON) et excentrique -15 % (ECC15) ; un entraînement au même niveau de $\dot{V}O_2$ (iso- $\dot{V}O_2$) a été réalisée par CON et excentrique -30 % (ECC30).

L'étude a été réalisée sur une période de huit semaines avec des mesures obtenues avant le début de la phase d'entraînement (T_0), après 20 séances (T_1) et à l'issue des 40 séances d'entraînement (T_2) (**Figure 8**). La durée des séances a été progressivement augmentée de 5 à 45 minutes au cours de la première semaine et maintenue à 45 minutes par séance sur les sept semaines suivantes. La fréquence des entraînements était de cinq jours consécutifs par semaine et deux jours de repos le week-end. Les animaux randomisés dans les groupes d'exercice ont tous couru sur un tapis roulant à une vitesse fixe de $15 \text{ m} \cdot \text{min}^{-1}$ (Quinton Instruments, Seattle, Washington, Etats-Unis).

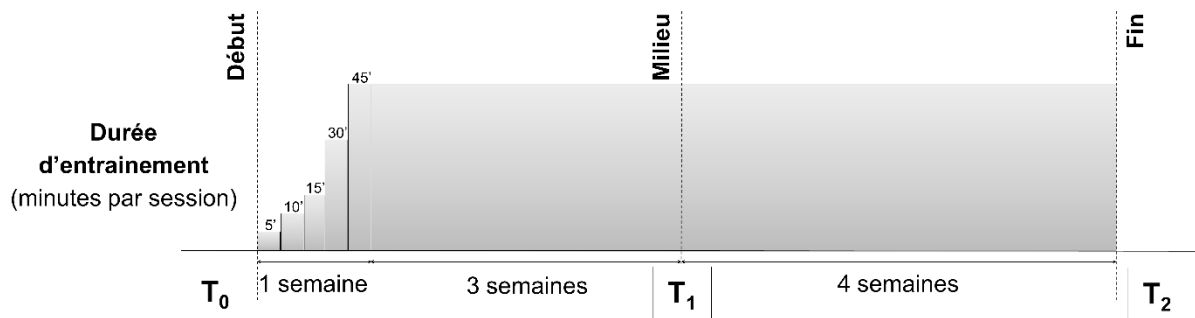

Figure 8 – Design expérimental de l'étude STARTREX. La durée des entraînements a été progressivement augmentée au cours des cinq premières séances d'exercice pour atteindre 45 min. Cette durée a ensuite été maintenue les semaines suivantes. Les valeurs basales ont été mesurées à T₀; T₁ reflète le point médian du protocole auquel le poids et la composition corporelle ont été réévalués; T₂ a été considéré comme la fin de la période de 8 semaines, après laquelle les animaux ont été sacrifiés et des échantillons de tissus ont été obtenus.

3.1.3. Les mesures in vivo

3.1.3.1. La composition corporelle

La masse et la composition corporelle ont été évaluées à T₀, T₁ et T₂. Les masses maigres et les masses grasses ont été déterminées par résonance magnétique quantitative (EchoMRI™, Echo Medical Systems, Houston, Texas, Etats-Unis). Les mesures d'une durée approximative de 90 secondes par passage n'ont pas nécessité de sédation ou d'anesthésie, et n'ont pas exposé les animaux à des radiations ou procédures invasives.

3.1.3.2. La dépense énergétique

À T₀ et à T₂ (24h après la dernière séance d'exercice et simultanément pour le groupe CTRL), les animaux ont été placés en cage calorimétrique individuelle (PhenoMaster/LabMaster, TSE Systems, Bad Homburg, Allemagne). Les conditions similaires de contrôle de la température, de cycle jour/nuit inverse, d'accès libre à l'eau et à la nourriture ont été maintenues pendant une période de 48h afin de déterminer le métabolisme de base et la dépense énergétique totale des animaux (kJ·jour⁻¹). La $\dot{V}O_2$ et la $\dot{V}CO_2$ mesurées ont permis le calcul du QR ($\dot{V}CO_2/\dot{V}O_2$). Les apports alimentaires (g·jour⁻¹) et en eau (ml·jour⁻¹) ont été obtenus à partir des variations de masse et de volume des rations mises à disposition. L'activité motrice spontanée (m·jour⁻¹) a été évaluée grâce à la détection des mouvements par des capteurs infrarouges.

3.1.4. Le sacrifice et les prélèvements

50 minutes avant leur sacrifice, les animaux à jeun ont reçu une injection sous-cutanée d'un isotope stable de valine à raison de 300 μM pour 100 g de poids corporel (L- [1- ^{13}C] valine, Eurisotop Saint-Aubin, France). La surcharge en valine du pool précurseur d'acides aminés permet d'étudier l'impact de l'entraînement physique sur la synthèse des protéines musculaires. À l'issue du temps d'incorporation, les rats ont été anesthésiés par inhalation d'isoflurane à 3 % à un débit d' O_2 de 1 $\text{L}\cdot\text{min}^{-1}$ dans une boîte d'induction. Ils ont ensuite été maintenus sous anesthésie à l'aide d'un masque facial (1,5 % d'isoflurane, 1 $\text{L}\cdot\text{min}^{-1}$ d' O_2) pendant que l'exsanguination au niveau de l'aorte abdominale été réalisée. Les muscles *Vastus Intermedius* des deux membres inférieurs ont été prélevés et coupés en fragments de 50 mg. Un fragment a été immédiatement placé dans une solution de conservation pour des mesures d'oxygraphie sur tissu frais. Les autres portions ont été immédiatement congelées à -80°C pour des analyses ultérieures d'activités enzymatiques et d'ARN. Les fémurs ont également été prélevés rapidement après l'arrêt cardiorespiratoire de l'animal, nettoyés des tissus adjacents et conservés à $+4^\circ\text{C}$ dans une solution saline standard (9 g de $\text{NaCl}\cdot\text{L}^{-1}$) jusqu'à leur analyse.

3.2. L'étude clinique REX-HF

Effectiveness of combined eccentric and concentric exercise over traditional cardiac exercise rehabilitation programme in patients with chronic heart failure: protocol for a randomized controlled study.

Il s'agit d'une étude prospective, ouverte, contrôlée et randomisée se déroulant à la Clinique de Cardio-Pneumologie de Durtol. Les procédures proposées ont été approuvées par un comité de protection des personnes (CPP Sud Méditerranée V) et par l'agence nationale de sécurité du médicament et des produits de santé (n° d'enregistrement ANSM : 2017-A00969-44). Cet essai clinique a également fait l'objet d'un enregistrement sur le site ClinicalTrial.gov (NCT03716778) et le protocole publié dans le journal BMJ Open (co-premier auteur, (Plaquevent-Hostache et al., 2019)).

L'objectif de l'étude est de comparer l'impact d'un programme d'entraînement mixte excentrique-concentrique à celui d'un réentraînement conventionnel concentrique chez des

patients souffrant d'IC chronique ($\dot{V}O_{2pic} < 15 \text{ mL}\cdot\text{kg}^{-1}\cdot\text{min}^{-1}$, fraction d'éjection $< 40 \%$). L'entraînement des sujets se fait à raison de cinq séances par semaine, ceux randomisés dans le groupe témoin effectuant les cinq séances en concentrique et ceux du groupe mixte trois des cinq séances en excentrique et les deux autres en concentrique. L'intensité des séances est la même dans les deux groupes et est fixée à la puissance associée au SV1. Un programme d'éducation thérapeutique, des séances de gymnastique et de renforcement musculaire sont également organisés dans les deux groupes, comme pour tout patient IC pris en charge dans la clinique. Le critère d'évaluation principal est le changement de distance parcourue pendant le test de marche de 6 minutes (TM6). Les critères d'évaluation secondaires incluent d'autres paramètres de mobilité physique, de capacité fonctionnelle à l'effort, de qualité de vie et de composition corporelle. Une biopsie musculaire du *Vastus Lateralis* est également réalisée afin d'évaluer des paramètres relatifs au muscle squelettique, notamment des paramètres de fonction mitochondriale.

BMJ Open Effectiveness of combined eccentric and concentric exercise over traditional cardiac exercise rehabilitation programme in patients with chronic heart failure: protocol for a randomised controlled study

Guillaume Plaquevent-Hostache,¹ Julianne Tournon,² Frédéric Costes,^{2,3} H el ene Perrault,⁴ Guillaume Clerfond,⁵ Christine Cuenin,¹ Andreea Moisa,¹ Bruno Pereira,⁶ Marie-Claire Boiteux,¹ Romain Eschalier,⁵ Ruddy Richard^{2,3}

To cite: Plaquevent-Hostache G, Tournon J, Costes F, et al. Effectiveness of combined eccentric and concentric exercise over traditional cardiac exercise rehabilitation programme in patients with chronic heart failure: protocol for a randomised controlled study. *BMJ Open* 2019;9:e028749. doi:10.1136/bmjopen-2018-028749

► Prepublication history for this paper is available online. To view these files, please visit the journal online (<http://dx.doi.org/10.1136/bmjopen-2018-028749>).

GP-H and JT contributed equally.

Received 21 December 2018

Revised 19 August 2019

Accepted 28 August 2019



  Author(s) (or their employer(s)) 2019. Re-use permitted under CC BY-NC. No commercial re-use. See rights and permissions. Published by BMJ.

For numbered affiliations see end of article.

Correspondence to Professor Ruddy Richard; ruddy.richard@uca.fr

ABSTRACT

Introduction Exercise-based rehabilitation is a standard feature of chronic heart failure management. The effectiveness of eccentric exercise could offer new opportunities for better tailoring rehabilitation programme to patients' limitations. The goal of the study is to contrast the impact of a mixed eccentric and concentric cycling training programme, to that of conventional concentric cycling rehabilitation in patients with chronic heart failure (peak oxygen consumption ($\text{VO}_{2\text{peak}}$) < 15 mL·kg⁻¹·min⁻¹, ejection fraction <40%).

Methods and analysis It is a prospective, open, controlled and randomised study (2×25 subjects) carried out in a single centre. Subjects will perform five exercise sessions per week per the randomisation outcome, with the intervention group performing eccentric in three of the five weekly sessions while the control group will perform the five sessions of concentric exercise. Cycling intensity will be the same in both groups and fixed to the power associated with the first ventilatory threshold. Self-management education programme, callisthenics sessions and muscle strength trainings will also be carried out as for any heart failure patient normally included in the rehabilitation programme. The primary outcome will be the change in distance covered during the 6 min walk test. Secondary outcomes will include other physical mobility parameters, functional exercise capacities, quality of life and body composition as well as skeletal muscle properties including mitochondrial function parameters.

Ethics and dissemination The study has been approved by the institutional ethics review board (17.079) and the French regulatory authority for research (2017-A00969-44). Adverse events that could occur during the protocol will be reported to the principal investigator. The results will be published in an international peer-reviewed journal.

Trial registration number NCT03716778.

Strengths and limitations of this study

- This is a monocentric randomised controlled trial.
- The trial will include 50 chronic heart failure patients with a reduced ejection fraction (<40%) referred for a 5 week cardiac rehabilitation programme.
- The trial will assess the relevance of a new combined training strategy (ie, concentric and eccentric cycling) for a more effective patient rehabilitation.
- Functionality, aerobic capacity and skeletal muscle parameters obtained through biopsy sample, will be assessed before and after the training period, which will allow between groups and individual comparisons.
- There is no assessor or patient blinding.

INTRODUCTION

Over the last decade, consensus has been reached by Heart Failure Associations Expert groups for a grade IA level recommendation regarding regular and structured physical conditioning in the management of chronic heart failure (CHF).^{1 2} The strong recommendation is based on a growing set of experimental evidence showing improved exercise capacity, quality of life and a potential reduction in mortality after exercise training. Yet despite many clinical trials carried out, the ideal exercise rehabilitation in the standard management of CHF still does not exist. The reduced ability of CHF patients to sustain the circulatory and metabolic requirements of the prescribed mechanical power outputs is well recognised and may be an important contributor to the potential suboptimal use and effectiveness of exercise rehabilitation.³ In these patients, the major functional



exercise limitation is of a central nature and relates to the extent of their cardio-circulatory impairment rather than to peripheral muscle capacity.⁴ It follows that the exercise-training enhancement capability will depend on the overall effectiveness of oxygen delivery to muscles and not on the ability of the latter to contract.

Over the past 10 years, there has also been a growing interest for the use of eccentric exercise as rehabilitation modality of interest for individuals suffering from chronic cardiorespiratory impairments on account of its lower metabolic, ventilatory and circulatory demands for any given external power output compared with conventional concentric exercise.^{5–7} Eccentric contraction is characterised by the ability to generate work during the lengthening of the muscle (contraction during the stretching phase) resulting in amplification of the biological adaptive stimulus owing to the additive influence of the mechanical loads being applied.^{8,9} So far, the eccentric exercise mode has been mainly applied to isolated segmental muscle strength trainings, but with the new availability on the market of eccentric cycle ergometers specifically designed for dynamic eccentric cycling, training protocols of ‘moderate load eccentric exercise’ are being increasingly used in populations with reduced physical capacities.¹⁰ This approach allows subjects to achieve a mechanical power overload three times that performed in concentric but for the same metabolic stimulation.^{11–13}

In most cases, studies are designed to assess the effects of dynamic eccentric exercise as compared with those of conventional concentric training programme.^{14–16} The subjects are randomised in comparative groups (eccentric vs concentric) and results of physical fitness and functional capacity are evaluated before and after performing exercise training sessions of the same duration, at a percentage of the peak oxygen consumption ($\text{VO}_{2\text{peak}}$) or maximal heart rate determined from an incremental concentric exercise test. At the end of the training programme, usually 6–8 weeks (three sessions of 30–45 min per week), the effects are compared with differences mainly related to the increase in muscle mass and strength in eccentric groups.^{14,17}

An alternative approach could be, not to contrast the impact of concentric and eccentric exercise training, but to enhance the effect through the addition of a concurrent eccentric exercise programme. Because higher cycling loads, or mechanical power output, can be sustained using the eccentric modality, one might anticipate that the combination of eccentric and concentric exercise training could serve to potentiate the beneficial effects of each modality performed separately. In other words, ‘the whole being greater than the sum of the parts’.

The goal of the study is thus to compare the impact of a mixed rehabilitation programme (ie, eccentric in addition to conventional concentric cycling, labelled ECC) to that of a conventional cycling rehabilitation programme alone (labelled CON) in CHF patients admitted to a clinical rehabilitation centre.

METHODS

The study is a prospective, open, controlled study in two parallel groups carried out in a single rehabilitation centre (ie, Medical Clinic of Cardio-Pneumology of Durtol, France) (table 1). The subjects, if they meet the inclusion criteria, will be randomised into two groups (ECC and CON). Stratification will be performed according to sex and pathology: ischaemic versus non-ischaemic CHF patients. The medical file of each patient addressed to the rehabilitation centre will be screened. Patients will be included in the study: (1) on referral to the cardiac rehabilitation centre to take part in the structured 5-week exercise training programme, (2) if they meet clinical inclusion criteria and (3) if they provide their signed consent.

Study population

Inclusion criteria

- ▶ CHF patient with reduced ejection fraction (EF <40%).
- ▶ Aged 45–75 years.
- ▶ Referred for participation in the regular 5-week structured rehabilitation programme.
- ▶ $\text{VO}_{2\text{peak}} < 15 \text{ mL}\cdot\text{kg}^{-1}\cdot\text{min}^{-1}$.
- ▶ At distance from an acute coronary syndrome or myocarditis (at least 3 months) and clinically stabilised.
- ▶ Beneficiary or affiliated with social security coverage.

Exclusion criteria

- ▶ Contraindications for cardiac exercise rehabilitation as per consensus guidelines and recommendations.
- ▶ Non-stabilised acute coronary syndrome.
- ▶ Current acute heart failure.
- ▶ NYHA (New York Heart Association) class IV.
- ▶ Patient having sustained a recent procedure that could act as a confounder to increase EF or performance on the 6 min walking distance (ie, coronary artery bypass graft surgery, percutaneous coronary intervention, cardiac resynchronisation therapy, valvular surgery or reparation).
- ▶ Severe, uncontrolled disturbances in ventricular rhythm.
- ▶ Intracardiac thrombus with high risk of embolism.
- ▶ Pericardial effusion of medium to high importance.
- ▶ Recent history of thrombophlebitis with or without pulmonary embolism.
- ▶ Obstacle to severe and/or symptomatic left ventricular ejection.
- ▶ Any progressive inflammatory and/or infectious condition.
- ▶ Severe and symptomatic pulmonary arterial hypertension.
- ▶ Inability to perform physical activity.
- ▶ Reversible heart disease.
- ▶ Patients undergoing circulatory assistance.
- ▶ Patients taking blood thinner medication.
- ▶ Patients with known allergy to Xylocaine.
- ▶ Pregnant or breastfeeding women.

Table 1 WHO trial registration data set summary

Data category	Information
Primary registry and trial identifying number	ClinicalTrials.gov NCT03716778
Date of registration in primary registry	23 October 2018
Secondary identifying numbers	2017-A00969-44 (ANSM)
Source(s) of monetary or material support	University Hospital of Clermont-Ferrand Medical Clinic of Cardio-Pneumology of Durtol
Primary sponsor	University Hospital of Clermont-Ferrand
Secondary sponsor(s)	Medical Clinic of Cardio-Pneumology of Durtol
Contact for public queries	Lise LACLAUTRE: drcli@chu-clermontferrand.fr
Contact for scientific queries	Pr. Ruddy RICHARD (MD, PhD): ruddy.richard@uca.fr
Public title	Rehabilitation by Eccentric eXercise in Heart Failure patients (REX-HF)
Scientific title	Effectiveness of combined eccentric and concentric exercise over traditional cardiac exercise rehabilitation programme in patients with chronic heart failure: a randomised controlled study
Countries of recruitment	France
Health condition(s) or problem(s) studied	Chronic heart failure
Intervention(s)	Control group: usual medical care according to the rehabilitation recommendations Experimental group: mixed programme combining eccentric pedalling sessions with the usual sessions
Key inclusion and exclusion criteria	Ages eligible for study: 18<age<75; Sexes eligible for study: both; Accepts healthy volunteers: no Inclusion criteria: Patient with systolic chronic heart failure, referred for participation in the 5-week rehabilitation programme, at a time distance from an acute coronary syndrome or myocarditis (less than 3 months old) and clinically stabilised, beneficiary or affiliated with social security coverage Exclusion criteria: all the usual criteria considered contra-indicated for cardiac exercise rehabilitation according to the consensus recommendations, non-stabilised acute coronary syndrome, decompensated heart insufficiency, stage IV NYHA, severe, uncontrolled disturbances in ventricular rhythm, presence of an intracardiac thrombus with high risk of embolism, presence of pericardial effusion of medium to high importance, recent history of thrombophlebitis with or without pulmonary embolism, obstacle to severe and/or symptomatic left ventricular ejection, any progressive inflammatory and/or infectious condition, severe and symptomatic pulmonary arterial hypertension, inability to perform physical activity, reversible heart disease, patients undergoing circulatory assistance, patients taking blood thinner medication, patients with known allergy to Xylocaine, pregnant or lactating women, women of childbearing age without contraception, patient under tutorship, curatorship or deprived of liberty
Study type	Interventional Allocation: randomised; Intervention model: parallel assignment; Masking: none Primary purpose: treatment Phase: not applicable
Date of first enrolment	November 2018
Target sample size	50
Recruitment status	Recruiting
Primary outcome(s)	6-min walk test
Key secondary outcomes	Time up and go test Quadiceps isometric muscular strength Peak VO ₂ Lean and fat body mass

NYHA, New York Heart Association.

- ▶ Childbearing age women without contraception.
- ▶ Patient under tutorship, curatorship or deprived of liberty.

Study design and patient management

Patients will be followed over the period of 5 weeks (ie, 20 exercise sessions) covering the duration of the standard structured cardiac rehabilitation programme in France and covered by the French healthcare insurance

programme (figure 1).¹⁸ They will undergo a standard evaluation as any CHF patient referred for rehabilitation including an initial 12-lead ECG, a trans-thoracic echocardiography, and a cardiopulmonary exercise test (CPET) with continuous gas exchange analysis and non-invasive measurement of cardiac output. A standard biological blood analysis will be performed for complete blood count, blood electrolytes, C-reactive protein, N-terminal

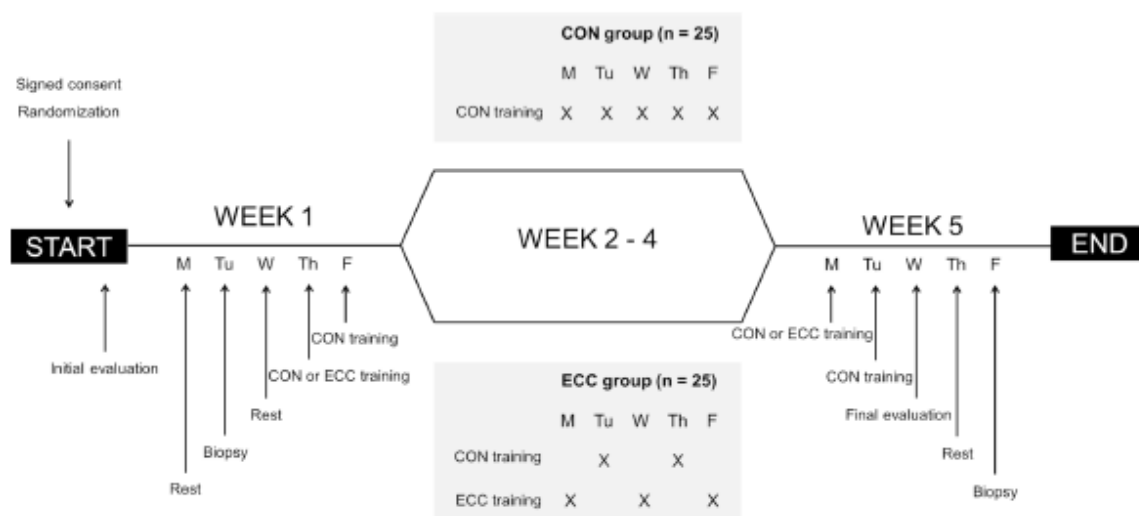

Figure 1 Study design of the 5-week rehabilitation programme. CON, concentric; ECC, eccentric; M, Monday; Tu, Tuesday; W, Wednesday; Th, Thursday; F, Friday.

prohormone of brain natriuretic peptide and nutritional status with albumin and prealbumin. Subjects will also perform a 6-min walk test (6MWT), a time up and go test (TUGT), an isometric muscular strength (IMS) measurement, a gait speed test and an endurance cycling test. Body composition will be measured and patients will be asked to complete short form health survey (SF36). Finally, a muscle biopsy of the *Vastus Lateralis* will be realised using the modified Bergström method. All initial tests and evaluations will be repeated at the end of the 5-week exercise rehabilitation programme, to compare the training-induced adaptations.

Exercise training approach

All subjects will perform five supervised cycle ergometer training sessions per week. Each 30-min session will be achieved at an intensity corresponding to the predetermined first ventilator threshold (VT_1) with a pedalling rate of 60 rotations per minute (RPM). As per randomisation outcome, the ECC group will perform three of the five weekly sessions in eccentric and the two others in concentric, while the CON group will perform all five weekly sessions using the concentric modality. The training programme is designed such that the total amount of work carried out on the ergometers will be equivalent (iso-energetic) for both groups ($Work = [Exercise\ Time\ (min) \times Oxygen\ Consumption\ (L \cdot min^{-1}) \times O_2\ energy\ equivalent\ coefficient\ (kJ \cdot LO_2^{-1})]$). The ECC group will be submitted to a habituation period of five sessions during which duration and intensity will be progressively increased. The same progression will be applied over the same period in the CON group. In all cases, the training sessions will be adjusted to the subjects' tolerance. Sessions will be performed under electrocardiographic control and blood pressure monitoring as per the usual practice.

Self-management education programme, callisthenics sessions and muscle strength training will also be carried out as included in the structured rehabilitation programme (ie, gymnastics every day and muscular reinforcement three times a week).

Eccentric exercise program

Eccentric cycling will be conducted at an intensity corresponding to VT_1 requirement using commercially available eccentric motor-driven ergometer (Cyclus2 Eccentric Recumbent, RBM Elektronik-automation, MSE Medical, Duttlenheim, France). This device works as follows: a motor drives the pedals in a backward rotation and subjects are asked to resist the rotary motion by applying force, resulting in eccentric muscle contractions of the extensor muscles.

Intensity and duration will be progressively increased during the first five sessions in order to minimise the extent of exercise-induced muscle soreness associated with unaccustomed eccentric exercise.^{5,12} Patients will be instructed to maintain a cycling rate of 60 RPM. The target duration after the habituation period will be 30 min. A typical eccentric habituation pattern is shown in table 2. During habituation period, session's duration and workload will not be increased if participants suffer

Table 2 Typical eccentric initiation pattern

Session of habituation	Eccentric power (W)	Concentric power equivalent (W)	Duration (min)
Session 1	50	16	10
Session 2	75	25	15
Session 3	100	33	20
Session 4	125	40	25
Session 5	150	50	30

from muscle soreness, as reported by a score above 3 on a visual analogic scale (0–10 scale) or when the rated perceived exertion exceeds 13 on the 6–20 Borg scale during the exercise session.

Primary end point

The primary end-point criterion will be the change in 6MWT distance covered, expressed as the percentage of change between the test performance at the end of the rehabilitation programme, and that of the initial test. Taking as reference point previous exercise rehabilitation studies in patients with chronic disease, the expected gain in walking distance would be at least of 5%.^{19–21} Our expectation is that a significant greater increase in 6MWT distance will be seen in the group having completed the mixed exercise protocol (ECC) as compared with CON group.

Secondary end points

The secondary study criteria are related to prerehabilitation and postrehabilitation parameters values as follows:

- ▶ Clinical evaluation of physical mobility:
 - TUGT.
 - Quadriceps IMS.
 - Gait speed test.
- ▶ CPET results:
 - VO_{2Peak} .
 - Peak power (P_{Peak}).
 - Peak cardiac output (Q_{Peak}).
 - Values of oxygen consumption (VO_2), power (P) and cardiac output (Q) at VT_1 (ie, VO_{2VT1} ; P_{VT1} ; Q_{VT1}).
 - Values of minute ventilation (VE) and carbon dioxide production (VCO_2) to calculate VE/VO_2 and VE/VCO_2 at VT_1 and at peak exercise.
- ▶ Time to exhaustion during the endurance cycling exercise test.
- ▶ NYHA functional score.
- ▶ SF36 scores.
- ▶ Biological parameters including albumin, prealbumin and BNP.
- ▶ Body composition (ie, lean and fat mass) evaluated by Dual-energy X-ray absorptiometry (DEXA).
- ▶ Muscle biopsy analysis.

Measurements

Six-minute walk test

Patients will be asked to cover the longest distance over a 30 m mark in a period of 6 min with or without stopping and with standardised encouragements according to standard recommendations, the first test being performed twice.²² Pulsed oxygen saturation and heart rate will be monitored continuously throughout the test using a digital oximeter.

Time up and go test

TUGT evaluates seated transfers, standing, walking and changes of direction.^{23 24} The subject sits on a chair with armrests facing a wall located at a 3-m distance. The

subject must stand up, walk to the wall, turn around without touching it, return to the chair, and sit down again. A score assessing assurance and movement stability on a scale from 1 to 5 will be determined by the evaluator such that:

1. No instability.
2. Very slightly abnormal (slow execution).
3. Moderately abnormal (hesitation, compensatory movements).
4. Abnormal (the patient stumbles).
5. Very abnormal (permanent risk of falling).

Quadriceps isometric muscular strength

Maximum muscle strength of the quadriceps, on the dominant limb, will be measured on a bench according to the instructions (MicroFET2, Hoggan Scientific, Salt Lake City, Utah, USA):

- ▶ Strength during isometric contraction (at 90° knee flexion).
- ▶ Standardised patient's position with the arms crossed on the chest, the absence of back support during the measurement and the maintenance of the hips and the contralateral leg to avoid any compensating movement.

Three reproducible measurements ($\pm 10\%$) will be carried out at 1-min intervals and the highest value will be retained.^{25 26}

Gait speed test

Evaluation of the gait speed over 4 m.²⁷ Participants will be instructed to walk from a standing start, at a normal and comfortable pace for them. Patient will walk through a 1 m 'acceleration' zone, a central 4 m 'testing' zone, and a 1 m 'deceleration' zone. A trained evaluator will start and stop timing respectively when the participant's foot will contact the floor at the beginning and at the end of the central testing zone. Gait speed will be calculated using distance in metres and time in seconds.

Cardiopulmonary exercise test

The patient will perform a symptom-limited incremental test on a traditional concentric cycling ergometer (VIAsprint 150P, Ergoline, Bitz, Germany) with continuous monitoring of ECG, pulsed oxygen saturation, cardiac output (Physioflow Enduro, Manatec Bio-medical, Macheren, France) and breath-by-breath expired gas analysis (MasterScreen CPX, Carefusion, Hoechberg, Germany) as per standard recommendation guidelines.²¹ The workload increments will be of 10 W·min⁻¹. The VT_1 will be determined using the V-slope method.²⁸ VO_{2Peak} , P_{Peak} and Q_{Peak} will be measured at the end of the last completed exercise level.

Endurance cycling exercise test

This test is performed using a conventional cycling ergometer (ER5/ES3000, MSE Medical, Duttlenheim, France) to assess the endurance capacity of patients.^{29 30} The subject will be asked to cycle as long as possible at a constant power output set at $[(P_{Peak} + P_{VT1})/2]$, with P_{Peak}

and P_{VTI} values predetermined from the incremental concentric cycling exercise test. Total cycling time will be measured without encouraging the subject. The 'time limit' is the time elapsed from the start of cycling to that time at which the subject can no longer maintain the requested pedalling of 50–60 RPM.

Body composition

Body composition will be assessed by DEXA (Hologic QDR-4500A, Bedford, Massachusetts, USA), since it is considered as a reference method allowing accurate measurement of body compartments.³¹ Measurements will focus on total body composition (more particularly total lean mass) but also segmental lean and fat mass (upper and lower limbs) and abdominal fat mass.

Disease severity and quality of life

Patients' functional status will be expressed using the NYHA classification frequently used as a reliable measure in CHF patients.³² Quality of life will be determined using the validated SF36 questionnaire.³³

Blood testing

Biological assessments will be performed as part of the usually prescribed patient care. In addition, albumin and prealbumin will be measured to characterise their nutritional status.

Muscle biopsy

Muscular adaptations will be studied on *Vastus Lateralis* samples taken during a muscular biopsy using the modified Bergström technique.³⁴ Some of the fresh tissue will be used to study mitochondrial functions on permeabilised muscle fibres by respirometry (Oxygraph-2k G series, Oroboros Instruments, Innsbruck, Austria) and fluorimetry (Oxygraph-2k-Fluo LED2-Module, Oroboros Instruments, Innsbruck, Austria). The rest of the biopsy will be sampled and frozen for further analysis (ie, histology, mRNA expression, biochemistry). There will be no data bank setup and the samples will only be conserved transiently for the duration of the analyses provided for in the study protocol. At the end of the study, if any samples remain, these will be destroyed. The micro-biopsy performed in the *Vastus Lateralis* muscle requires a 24 hours recovery and will have no impact on the exercise programme. Arm exercises will be performed to compensate during these 24 hours period in the two groups.

Ethics

All patients will receive verbal and written information on the aim of the study and the protocol. Written informed consent will be obtained prior to their inclusion in the study and before performing any specific procedure. During the study, patient will have the opportunity to ask all questions concerning the protocol to the cardiologist or investigator. They will be informed that they are free to stop the study at any time at their own discretion, in accordance with the Good Clinical Practice in current enforced under the French regulatory framework. Any

adverse event that could occur during the protocol will be reported to the principal investigator. Should there be any negative impact of participating in the study on the patient's health status, the participant will be entitled to compensation in accordance with the French regulations.

Pursuant to the provisions concerning the confidentiality of data that are available to persons responsible for quality control of biomedical research, persons with direct access will take all necessary precautions to ensure the confidentiality of information (identity and patients results). Data collected will be made anonymous.

Study status

The first inclusion was scheduled in November 2018. To date, seven patients were enrolled. The recruitment period spans over 2 years with the goal to include 25 patients per treatment arm, each patient completing evaluation before and after the 5-week exercise rehabilitation programme (figure 1).

Patient and public involvement

Patients were not involved in the development and the design of the study. The burden of the intervention will not be assessed by patients themselves. Patients will receive a written summary of tests and evaluation results they will have completed during their rehabilitation and will be written informed of global study results at its end.

Management of the study

The principal investigator and the trained clinical research team will collect data. Data will be recorded for each patient in a dedicated notebook at each assessment point, and any deviation from the protocol or adverse event will be noted. Study data will also be collected and managed using REDCap (Research Electronic Data Capture) electronic data capture tools hosted at the University Hospital of Clermont-Ferrand.³⁵ REDCap is a secure, web-based application designed to support data capture for research studies, providing:

- ▶ An intuitive interface for validated data entry.
- ▶ Audit trails for tracking data manipulation and export procedures.
- ▶ Automated export procedures for seamless data downloads to common statistical packages.
- ▶ Procedures for importing data from external sources.

A clinical research assistant will be commissioned to ensure the progress of the study, the data capture according to the Standard Operating Procedures implemented at the University Hospital of Clermont-Ferrand.

Statistical consideration and study size

Power of the study

Sample size estimation is based on previous reports from the scientific literature, describing a SD for exercise training induced changes in the 6MWT (primary outcome) ranging between 2% and 4%.¹⁹ For a two-sided type I error at 5% and a statistical power (1- β) greater 80%, sample size is calculated at 20 patients per arm in order to show a minimal absolute difference of 3% (more

precisely, $SD_{6MWT}=2.9$ and $1-\beta=90\%$). In order to account for patients dropping out of the study, the aim is to recruit 25 patients in each randomised group for a total of 50 patients.

Randomisation procedure

A permuted-block randomisation (ie, random block sizes) will be conducted using a computer-generated random allocation (Stata statistical software, V.13, StataCorp LP, College Station, Texas, United States of America), with a 1:1 ratio allocation, ensuring complete randomness of the assignment of a patient to each randomised group. Stratification will be performed according to sex and pathology (ischaemic vs no ischaemic heart failure). To ensure that there is no bias in their selection and allocation, patients will be randomised after it is clear that they meet the inclusion criteria, that they have provided written consent and that an anonymity number has been assigned to them.

Statistical analysis

All analyses will be conducted using Stata software (V.13). A two-sided *p* value less than 0.05 will be considered to indicate statistical significance. The continuous variables will be expressed as mean and SD or as medians and IQR, according to statistical distribution. The assumption of normality will be assessed using the Shapiro-Wilk test. The categorical parameters will be expressed as the number of patients and associated percentages. The patients will be described and compared at inclusion between randomised groups according to the following variables: compliance with the eligibility criteria, epidemiological, clinical and biological characteristics and treatments.

Student's *t*-test or Mann-Whitney *U* test, if *t*-test's assumptions are not met (normality studied using Shapiro-Wilk test and homoscedasticity verified by Fisher-Snedecor test), will be applied to compare the primary endpoint between randomised groups. The results will be described with effect-size and 95% CI. A multivariable analysis will then be performed using multiple linear regression to take into account adjustment on possible confounders/covariates selected according to clinical relevance and to univariate results. The normality of residuals will be studied using the Shapiro-Wilk test. If appropriate, a transformation of 6MWT change will be proposed to achieve Gaussian statistical distribution. Multivariable analysis results will be presented using regression coefficients and 95% CIs.

The other continuous variables will be compared similarly with the use of the unpaired *t*-test or the Mann-Whitney *U* test when appropriate and using the same adjustment variables described above for multivariable approach. For categorical endpoints, χ^2 or Fisher's exact tests will be used. The results will be described as absolute difference and 95% CIs. Furthermore, the relationships between quantitative variables will be explored with correlation coefficients (Pearson or Spearman, according to statistical distribution). At last, longitudinal

analyses of correlated repeated data will be performed using random-effects models. Patient will be considered as random-effect in order to take into account between and within patient variability, whereas the following fixed effects will be studied: randomisation group, time-points evaluation and their interaction.

Analysis of missing outcome data

The primary analysis will be conducted on an intention-to-treat basis, with a particular focus paid on loss to follow-up. An analysis of dropouts, considered as censored data, will be proposed using the Kaplan-Meier estimation in order to (1) study how much patients stop the study and (2) to take into account the time when they will be dropped out. The comparison between randomised groups will be conducted in univariate analysis by log-rank test and for multivariable analysis by the Cox proportional regression model. Then, a sensitivity analysis will be performed and the nature of missing data will be studied (missing at random or not). According to it, the most appropriate approach to the imputation of missing data will be proposed (last observation carried forward or multiple imputations). Then, a per-protocol analysis will be also considered to evaluate the efficacy of the experimental arm.

DISCUSSION

This is the first study to examine the potential benefits of adding an eccentric exercise-training component to a regular structured cardiac exercise rehabilitation programme in CHF patients.

The positive effects of exercise rehabilitation programme for patients with CHF and chronic lung diseases have now long been established.^{1,36} The current challenge is to ensure that the recommendation is implemented and to continue to make gains in the clinical management of these patients. Within this framework, moderate load dynamic eccentric exercise presents an interesting alternative on account of its efficiency in enhancing muscle strength even in patients with severe degrees of impairment.⁷

The functional limitation of CHF patients can be related to both central cardiorespiratory dysfunctions and peripheral musculoskeletal weakness resulting from deconditioning.^{4,37} Inasmuch as biological adaptations to exercise are proportional to the nature and to the extent of the stimulus, it is only logical to think that combining exercise modalities known to exert different but complementary effects could be of value in the design of more effective rehabilitation programme.

As a first approach, the present study examines the impact of adding a regimen of dynamic eccentric cycling to a structured rehabilitation programme of conventional cycling. The working hypothesis is that patients having completed the combined exercise programme should show greater functional gains resulting from a synergistic effect of these stimuli. Repercussions of deconditioning



and functional limitations of patients with chronic disease are far-reaching including enhanced comorbidity, decreased functional autonomy impacting the ability of patients to socialise as well as decreased self-efficacy and overall quality of life.³⁸ The effectiveness of eccentric type exercise to enhance functional strength even in more severely affected CHF patients could offer new opportunities for better tailoring programme to their limitations.

Author affiliations

¹Cardiology and Vascular Diseases, Medical Clinic of Cardio-Pneumology of Durtol, Durtol, France

²UMR1019 INRA-UCA, ASMS team, CRNH Auvergne, INRA Centre Auvergne Rhone Alpes, Clermont Ferrand, France

³Department of Sport Medicine and Functional Explorations, Centre Hospitalier Universitaire de Clermont-Ferrand, Clermont-Ferrand, France

⁴Faculty of Health Sciences, University of Ottawa, Ottawa, Ontario, Canada

⁵Department of Cardiology, Centre Hospitalier Universitaire de Clermont-Ferrand, Clermont-Ferrand, France

⁶Delegation to Clinical Research and Innovation, Centre Hospitalier Universitaire de Clermont-Ferrand, Clermont-Ferrand, France

Contributors The authors are solely responsible for the design and conduct of the study. They are also responsible for all the study analysis, the drafting and editing of manuscript and its final content. RR, GP-H, M-CB, RE, BP and JT conceived the study. RR, GP-H, M-CB, BP, JT and HP wrote the protocol and designed the study. JT and RR conceived the muscle biopsy analysis program. HP, JT and RR edited the English version of the manuscript. BP conceived the statistical analysis, and will perform randomisation and analysis. GP-H, M-CB, RR, RE, GC, CC, AM, FC will carry out the clinical study. RR and GP-H are the main investigators of the study, and will obtain informed consent.

Funding This work was supported by the University Hospital of Clermont-Ferrand (AOI Funding) and the Medical Clinic of Cardio-Pneumology of Durtol.

Competing interests None declared.

Patient consent for publication Not required.

Ethics approval According to the French regulation on clinical trials, the study has been submitted to the 'Comité de Protection des Personnes' (reference: 2017-A00969-44) and to the 'Agence Nationale de Sécurité du Médicament' (the French regulatory authority for research). Approval from the Ethics Review Board is dated from 7 April 2018. Any modification in the protocol or informed consent during the study will be presented to the reference authority.

Provenance and peer review Not commissioned; externally peer reviewed.

Open access This is an open access article distributed in accordance with the Creative Commons Attribution Non Commercial (CC BY-NC 4.0) license, which permits others to distribute, remix, adapt, build upon this work non-commercially, and license their derivative works on different terms, provided the original work is properly cited, appropriate credit is given, any changes made indicated, and the use is non-commercial. See: <http://creativecommons.org/licenses/by-nc/4.0/>.

REFERENCES

- Ponikowski P, Voors AA, Anker SD, et al. Esc guidelines for the diagnosis and treatment of acute and chronic heart failure: the task force for the diagnosis and treatment of acute and chronic heart failure of the European Society of cardiology (ESC), developed with the special contribution of the heart failure association (HFA) of the ESC. *Eur J Heart Fail* 2016;2016:891-975.
- Piepoli MF, Conraads V, Corrà U, et al. Exercise training in heart failure: from theory to practice. A consensus document of the heart failure association and the European association for cardiovascular prevention and rehabilitation. *Eur J Heart Fail* 2011;13:347-57.
- Hirai DM, Musch TI, Poole DC. Exercise training in chronic heart failure: improving skeletal muscle O₂ transport and utilization. *Am J Physiol Heart Circ Physiol* 2015;309:H1419-H1439.
- Doehner W, Frenneaux M, Anker SD. Metabolic impairment in heart failure: the myocardial and systemic perspective. *J Am Coll Cardiol* 2014;64:1388-400.
- Rocha Vieira DS, Baril J, Richard R, et al. Eccentric cycle exercise in severe COPD: feasibility of application. *COPD* 2011;8:270-4.
- Chasland LC, Green DJ, Maiorana AJ, et al. Eccentric cycling: a promising modality for patients with chronic heart failure. *Med Sci Sports Exerc* 2017;49:646-51.
- LaStayo P, Marcus R, Dibble L, et al. Eccentric exercise in rehabilitation: safety, feasibility, and application. *J Appl Physiol* 2014;116:1426-34.
- Roig M, O'Brien K, Kirk G, et al. The effects of eccentric versus concentric resistance training on muscle strength and mass in healthy adults: a systematic review with meta-analysis. *Br J Sports Med* 2009;43:556-68.
- Franchi MV, Reeves ND, Narici MV. Skeletal muscle remodeling in response to eccentric vs. concentric loading: morphological, molecular, and metabolic adaptations. *Front Physiol* 2017;8.
- Hoppeler H. Moderate load eccentric exercise; a distinct novel training modality. *Front Physiol* 2016;7.
- Perrey S, Betik A, Candau R, et al. Comparison of oxygen uptake kinetics during concentric and eccentric cycle exercise. *J Appl Physiol* 2001;91:2135-42.
- Dufour SP, Lampert E, Doutrelieu S, et al. Eccentric cycle exercise: training application of specific circulatory adjustments. *Med Sci Sports Exerc* 2004;36:1900-6.
- Julian V, Thivel D, Miguet M, et al. Eccentric cycling is more efficient in reducing fat mass than concentric cycling in adolescents with obesity. *Scand J Med Sci Sports* 2019;29:4-15.
- Steiner R, Meyer K, Lippuner K, et al. Eccentric endurance training in subjects with coronary artery disease: a novel exercise paradigm in cardiac rehabilitation? *Eur J Appl Physiol* 2004;91:572-8.
- Meyer K, Steiner R, Lastayo P, et al. Eccentric exercise in coronary patients: central hemodynamic and metabolic responses. *Med Sci Sports Exerc* 2003;35:1076-82.
- Gremaux V, Duclay J, Deley G, et al. Does eccentric endurance training improve walking capacity in patients with coronary artery disease? A randomized controlled pilot study. *Clin Rehabil* 2010;24:590-9.
- MacMillan NJ, Kapchinsky S, Konokhova Y, et al. Eccentric ergometer training promotes locomotor muscle strength but not mitochondrial adaptation in patients with severe chronic obstructive pulmonary disease. *Front Physiol* 2017;8.
- Pavy B, Iliou M, Vergès B, et al. Référentiel des bonnes pratiques de la réadaptation cardiaque de l'adulte en 2011 2011;84.
- Meyer K, Schwaibold M, Westbrook S, et al. Effects of exercise training and activity restriction on 6-minute walking test performance in patients with chronic heart failure. *Am Heart J* 1997;133:447-53.
- Puhan MA, Mador MJ, Held U, et al. Interpretation of treatment changes in 6-minute walk distance in patients with COPD. *European Respiratory Journal* 2008;32:637-43.
- Guazzi M, Dickstein K, Vicenzi M, et al. Six-minute walk test and cardiopulmonary exercise testing in patients with chronic heart failure: a comparative analysis on clinical and prognostic insights. *Circ Heart Fail* 2009;2:549-55.
- ATS Committee on Proficiency Standards for Clinical Pulmonary Function Laboratories. Ats statement: guidelines for the six-minute walk test. *Am J Respir Crit Care Med* 2002;166:111-7.
- Mathias S, Nayak US, Isaacs B. Balance in elderly patients: the "get-up and go" test. *Arch Phys Med Rehabil* 1986;67:387-9.
- Hwang R, Morris NR, Mandrusiak A, et al. Timed up and go test: a reliable and valid test in patients with chronic heart failure. *J Card Fail* 2016;22:648-50.
- Kamiya K, Mezzani A, Hotta K, et al. Quadriceps isometric strength as a predictor of exercise capacity in coronary artery disease patients. *Eur J Prev Cardiol* 2014;21:1285-91.
- Holsmann M, Quittan M, Berger R, et al. Muscle strength as a predictor of long-term survival in severe congestive heart failure. *Eur J Heart Fail* 2004;6:101-7.
- Studenski S, Perera S, Patel K, et al. Gait speed and survival in older adults. *JAMA* 2011;305:50-8.
- Beaver WL, Wasserman K, Whipp BJ. A new method for detecting anaerobic threshold by gas exchange. *J Appl Physiol* 1986;60:2020-7.
- Andrianopoulos V, Wagers SS, Groenen MTJ, et al. Characteristics and determinants of endurance cycle ergometry and six-minute walk distance in patients with COPD. *BMC Pulm Med* 2014;14:97.
- Larsen Aet al. Assessing the effect of exercise training in men with heart failure. Comparison of maximal, submaximal and endurance exercise protocols. *Eur Heart J* 2001;22:684-92.
- Uszko-Lencer NHMK, Bothmer F, van Pol PEJ, et al. Measuring body composition in chronic heart failure: a comparison of methods. *Eur J Heart Fail* 2006;8:208-14.

32. Bennett JA, Riegel B, Bittner V, et al. Validity and reliability of the NYHA classes for measuring research outcomes in patients with cardiac disease. *Heart Lung* 2002;31:262–70.
33. McHorney CA, Ware JE, Rachel Lu JF, et al. The mos 36-Item short-form health survey (SF-36): III. tests of data quality, scaling assumptions, and reliability across diverse patient groups. *Med Care* 1994;32:40–66.
34. Shanely RA, Zwetsloot KA, Triplett NT, et al. Human skeletal muscle biopsy procedures using the modified Bergström technique. *J Vis Exp* 2014;(91).
35. Harris PA, Taylor R, Thielke R, et al. Research electronic data capture (REDCap)—a metadata-driven methodology and workflow process for providing translational research informatics support. *J Biomed Inform* 2009;42:377–81.
36. McCarthy B, Casey D, Devane D, et al. Pulmonary rehabilitation for chronic obstructive pulmonary disease. *Cochrane Database Syst Rev* 2015:CD003793.
37. Drexler H, Riede U, Münzel T, et al. Alterations of skeletal muscle in chronic heart failure. *Circulation* 1992;85:1751–9.
38. Yancy CW, Jessup M, Bozkurt B, et al. ACCF/AHA guideline for the management of heart failure: a report of the American College of Cardiology Foundation/American heart association Task force on practice guidelines. *J Am Coll Cardiol* 2013;2013:e147–239.

3.3. Les mesures d'oxygraphie

3.3.1. La préparation des fibres musculaires perméabilisées

Immédiatement après prélèvement, la quantité de tissu musculaire nécessaire à la réalisation des protocoles d'oxygraphie est placée à +4°C dans une solution de conservation : le BIOPS (Fontana-Ayoub et al., 2016). L'ensemble des mesures mitochondriales sont effectuées *in situ* sur fibres musculaires perméabilisées dont la préparation se déroule en deux étapes, l'une mécanique et l'autre chimique (Kuznetsov et al., 2008). Dans un premier temps, les fibres sont séparées à l'aide de pinces de microdissection sous loupe binoculaire, dans du BIOPS et à +4°C. Les faisceaux de fibres sont ensuite perméabilisés pendant 30 minutes toujours à +4°C et sous agitation permanente dans une solution de BIOPS enrichie en saponine ($50 \mu\text{g}\cdot\text{mL}^{-1}$). Cette étape va permettre la création de pores au niveau de la membrane des fibres musculaires tout en conservant l'intégrité de la membrane mitochondriale et l'architecture intracellulaire. Une fois le temps écoulé, trois rinçages successifs de 5 minutes avec la solution de respiration, le MIR05, vont permettre d'éliminer la saponine et de laver les fibres de leur contenu en ADP et autres substrats présents dans le cytosol. Les fibres sont alors prêtes à être analysées.

3.3.2. L'activité des complexes et l'affinité pour l'ADP

Le principe de l'oxygraphie repose sur une mesure de la consommation d'O₂ par les mitochondries grâce à un capteur de type électrode de Clark (Strathkelvin Instruments, Glasgow, Écosse ou Oroboros Instruments, Innsbruck, Autriche) (Pesta and Gnaiger, 2012). L'évolution en temps réel de la concentration en O₂ dans le milieu constitue un indicateur du fonctionnement mitochondrial général et des complexes de la chaîne respiratoire selon les substrats, inhibiteurs et/ou découplants présents. Les mesures sont effectuées en continue entre 22 et 37°C, sous agitation permanente et avec une concentration initiale d'O₂ hyperoxique ($420 \mu\text{mol}\cdot\text{L}^{-1}$) ou normoxique. Les fibres perméabilisées sont placées dans les chambres

d'oxygraphie contenant 2 mL de milieu de respiration (2 à 5 mg de poids humide de fibres par cuve).

Le protocole mis en place vise à évaluer d'une part l'affinité de la mitochondrie pour l'ADP et d'autre part l'activité des différents complexes. Les injections commencent avec celles simultanées de glutamate (10 mM) et de malate (2 mM) permettant la mesure de la vitesse de respiration basale ($\dot{V}_{0, G+M}$). Vont suivre les injections de concentrations croissantes d'ADP (10 μ M à 20 mM), à saturation est effectuée la mesure de la vitesse maximale de respiration mitochondriale ($\dot{V}_{max, G+M}$). Un test au Cyt c (10 μ M) est ensuite réalisé afin de vérifier l'intégrité fonctionnelle de la membrane mitochondriale. Une lésion membranaire est soupçonnée lorsque la vitesse de respiration est augmentée de plus de 10 % par rapport au palier précédent. Les injections se poursuivent avec celles de succinate (10 mM), de carbonylcyanure m-chlorophénylhydrazone (CCCP, 0,5 μ M), de roténone (0,5 μ M), d'antimycine (2,5 μ M), d'ascorbate (2 mM) et de TMPD (0,5 mM) simultanément, et d'azide de sodium (200 mM) (**Figure 9-A**).

Les données de concentration en O_2 recueillies toutes les 2 secondes sont directement converties par le logiciel de mesure (DatLab 7, Oroboros Instruments, Innsbruck, Autriche) en vitesse de respiration exprimée en $pmol\ d'O_2 \cdot sec^{-1} \cdot mg^{-1}$ de poids humide de fibres. Pour chaque palier d'ajout de substrat, d'inhibiteur ou de découplant, est identifiée une période de stabilité de 30 secondes minimum sur laquelle les vitesses de respiration sont moyennées. Les valeurs correspondant aux paliers de concentrations croissantes d'ADP sont ensuite reportées graphiquement pour permettre la modélisation de la cinétique d'utilisation. L'objectif est de déterminer par itérations successives d'une régression non linéaire, suivant une équation de type Michaelis-Menten, la courbe la plus représentative des données expérimentales (Kemmer and Keller, 2010). Sont uniquement retenues les modélisations obtenues avec un coefficient de corrélation r^2 supérieur à 0,95. À partir de la courbe, il est possible d'obtenir le K_m de l'ADP comme étant la concentration de substrat pour laquelle une vitesse équivalente à la moitié de la \dot{V}_{max} est obtenue, et l'inverse du K_m représentera l'affinité pour le substrat.

3.3.3. La production d'espèces réactives de l'oxygène

Ce protocole a pour objectif d'évaluer, par l'intermédiaire de l' H_2O_2 , la quantité d'ERO produite par la chaîne respiratoire mitochondriale. L' H_2O_2 présent dans le milieu de respiration va, sous l'action de l'amplex red ($10 \mu\text{M}$) et de l'enzyme horseradish peroxidase (HRP, $1 \text{ U}\cdot\text{mL}^{-1}$), produire de la résorufine détectée par le module complémentaire de fluorescence (Oxygraph-2k-Fluo LED2-Module, Oroboros Instruments, Innsbruck, Autriche) (Makrecka-Kuka et al., 2015). De la SOD ($5 \text{ U}\cdot\text{mL}^{-1}$) est également ajoutée au milieu afin de s'affranchir de toute fuite potentielle d' O_2^- hors de la mitochondrie. Là encore, les mesures sont effectuées sur fibres musculaires perméabilisées (2-5 mg par cuve), dans 2 mL de MIR05 thermostatés à 37°C , sous agitation permanente et avec une concentration initiale d' O_2 de $420 \text{ pmol}\cdot\text{L}^{-1}$. La quantité d'ERO libérée par les complexes de la chaîne respiratoire sera évalué en présence de différents substrats et inhibiteurs ajoutés de manière séquentielle dans le milieu de respiration, à savoir : glutamate (10 mM) et malate (2 mM), succinate (10 mM), roténone ($0,5 \mu\text{M}$), ADP (5 mM), antimycine ($2,5 \mu\text{M}$) (**Figure 9-B**).

La mesure de fluorescence a lieu simultanément à celle de la concentration d' O_2 , rendant possible le calcul de la fuite de radicaux libres (FRL), c'est-à-dire la fraction d' e^- responsable de la réduction de l' O_2 en ERO, l'empêchant ainsi d'atteindre le complexe IV et d'être réduit en H_2O (Sanz et al., 2005). Deux e^- sont nécessaires pour réduire une mole d' O_2 en H_2O_2 , alors que quatre e^- sont transférés dans la réduction d'une mole d' O_2 en H_2O . Ainsi le pourcentage de FRL est calculé comme équivalent au taux de libération d' H_2O_2 divisé par deux fois le taux de consommation d' O_2 , le tout multiplié par 100.

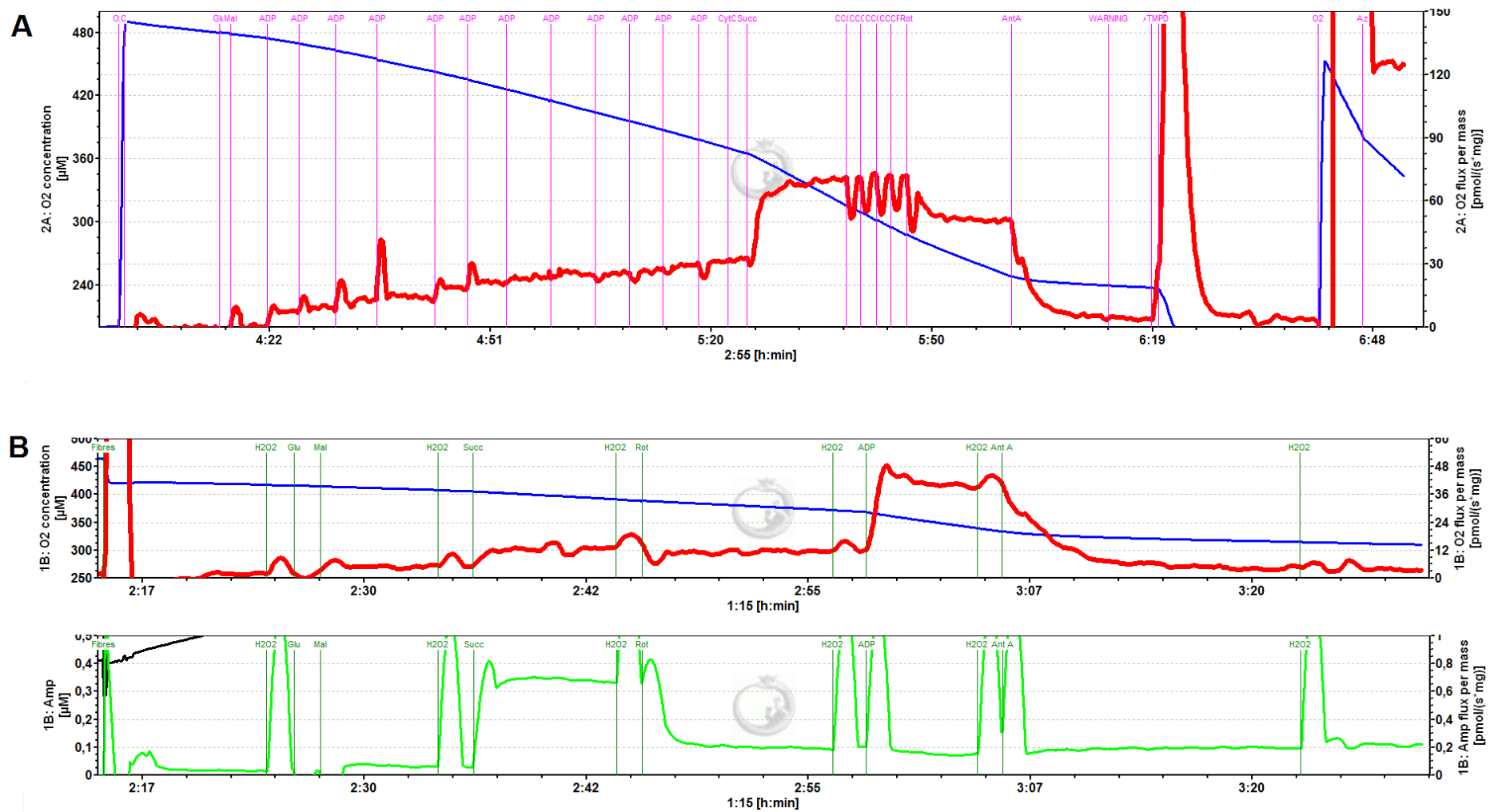

Figure 9 – Courbes de mesure représentatives A) d'un protocole d'oxygraphie et B) d'un protocole d'oxygraphie-fluorimétrie. Les mesures ont été réalisées à partir de fibres musculaires perméabilisées, en hyperoxie et à 37°C, dans les chambres de mesure Oroboros et exploitées sous DatLab. Les courbes bleues représentent la concentration en oxygène dans le milieu (μM), les courbes rouges la consommation d'oxygène (pmol d'O₂·sec⁻¹·mg⁻¹ de poids humide de fibres) et la courbe verte la libération de peroxyde d'hydrogène (pmol d'O₂·sec⁻¹·mg⁻¹ de poids humide de fibres). La durée des mesures est précisée en abscisse.

Résultats

4.1. Publication n°1

Impact of eccentric or concentric training on body composition and energy expenditure.

L'exercice excentrique dynamique est une méthode d'entraînement de plus en plus utilisée dans le cadre du handicap chronique chez des sujets limités sur le plan cardio-respiratoire et/ou musculaire. Cependant, très peu d'études se sont intéressées aux modifications de composition corporelle et de dépense énergétique en lien avec cette modalité. Notre hypothèse est que l'excentrique réalisé à même contrainte métabolique que le concentrique (iso- $\dot{V}O_2$) conduirait à des améliorations similaires, notamment au niveau de la masse corporelle totale et de la composition en masse grasse. Un entraînement excentrique sollicitant une moindre contrainte métabolique, mais une contrainte mécanique équivalente à celle d'un entraînement concentrique (iso-puissance), aurait de son côté un effet plus modéré sur les paramètres de composition corporelle mais un impact ostéogénique plus important.

60 rats Wistar mâles âgés de 9 semaines ont été répartis aléatoirement en 4 groupes : un groupe contrôle (CTRL) et trois groupes entraînés (CON ; ECC15 ; ECC30). L'entraînement a été réalisé sur tapis de course à une vitesse de 15 m·min⁻¹ pendant 45 minutes, avec un total de 40 séances réparties sur 8 semaines. La pente du tapis a été modulée entre les trois groupes entraînés afin d'obtenir des conditions d'iso-puissance (CON +15 % vs. ECC15 -15 %) ou d'iso- $\dot{V}O_2$ (CON +15 % vs. ECC30 -30 %). L'ensemble des paramètres ont été mesurés avant et après la période d'entraînement.

A l'issue des 8 semaines de protocole, tous les groupes ont présenté une augmentation de leur masse corporelle totale, mais de faibles variations de masse grasse ont uniquement été relevées pour les groupes entraînés (CON, $-4,8 \pm 6,18$ g ; ECC15, $0,6 \pm 3,32$ g ; ECC30, $2,6 \pm 6,01$ g). Un gain de masse maigre a principalement été observé pour les groupes ECC15 ($88,9 \pm 6,85$ g) et ECC30 ($101,6 \pm 11,07$ g). Il a également été constaté que l'entraînement excentrique a un effet positif sur la densité minérale osseuse. Enfin, une augmentation du métabolisme de base par rapport à la valeur initiale a été observée dans les groupes entraînés (CON, $13,9 \pm 4,13$ kJ·j

¹ ; ECC15, $11,6 \pm 5,10 \text{ kJ}\cdot\text{j}^{-1}$; ECC30, $18,3 \pm 4,33 \text{ kJ}\cdot\text{j}^{-1}$) mais pas dans le groupe CTRL. Cette différence disparaît lorsque les valeurs sont normalisées par la masse maigre.

Les résultats indiquent pour les entraînements à iso- $\dot{V}O_2$ que l'impact sur la masse maigre et sur la densité minérale osseuse est plus favorable avec l'excentrique (ECC30) par rapport au concentrique (CON). Pour l'entraînement à iso-puissance mais avec une $\dot{V}O_2$ inférieure en excentrique (ECC15), le stimulus reste suffisamment important pour être à l'origine d'adaptations via l'augmentation de masse maigre totale, l'absence de prise de masse grasse et l'augmentation de la densité osseuse. Les résultats de cette étude fournissent des éléments d'informations supplémentaires pour l'utilisation de l'excentrique dans les populations ayant des limitations à l'exercice d'ordre cardio-respiratoire et/ou musculaire.

Impact of Eccentric or Concentric Training on Body Composition and Energy Expenditure

JULIANNE TOURON¹, HÉLÈNE PERRAULT², VALÉRIE JULIAN^{1,3}, LAURA MAISONNAVE¹, PHILIPPE DEAT¹, JULIETTE AUCLAIR-RONZAUD¹, JÉRÔME SALLES¹, STÉPHANE WALRAND¹, JULIEN HERMET⁴, JEAN-PAUL RIGAUDIERE¹, PATRICE LEBECQUE¹, CORINNE MALPUECH-BRUGERE¹, CHRISTOPHE MONTAURIER¹, BRUNO PEREIRA³, VÉRONIQUE COXAM¹, FRÉDÉRIC COSTES^{1,3}, and RUDDY RICHARD^{1,3}

¹Human Nutrition Unit, ASMS Team, CRNH Auvergne, Clermont-Ferrand, FRANCE; ²Faculty of Health Sciences, University of Ottawa, Ottawa, ON, CANADA; ³Department of Sports Medicine and Functional Explorations, University Hospital of Clermont-Ferrand, Clermont-Ferrand, FRANCE; ⁴Human Nutrition Unit, IEN Team, Theix, FRANCE; and ⁵Delegation to Clinical Research and Innovation, University Hospital of Clermont-Ferrand, Clermont-Ferrand, FRANCE

ABSTRACT

TOURON, J., H. PERRAULT, V. JULIAN, L. MAISONNAVE, P. DEAT, J. AUCLAIR-RONZAUD, J. SALLES, S. WALRAND, J. HERMET, J.-P. RIGAUDIERE, P. LEBECQUE, C. MALPUECH-BRUGERE, C. MONTAURIER, B. PEREIRA, V. COXAM, F. COSTES, and R. RICHARD. Impact of Eccentric or Concentric Training on Body Composition and Energy Expenditure. *Med. Sci. Sports Exerc.*, Vol. 51, No. 9, pp. 1944–1953, 2019. **Purpose:** To compare the effects of 8-wk eccentric (ECC) versus concentric (CON) training using downhill and uphill running in rats on whole body composition, bone mineral density (BMD), and energy expenditure. **Methods:** Animals were randomly assigned to one of the following groups: 1) control (CTRL), 2) +1.5% uphill-running slope (CON), 3) -1.5% downhill-running slope (ECC15), and 4) -30% downhill-running slope (ECC30). Those programs enabled to achieve conditions of isopower output for CON and ECC15 and of iso-oxygen uptake ($\dot{V}O_2$) for CON and ECC30. Trained rats ran 45 min at 15 m·min⁻¹ five times per week. Total body mass, fat body mass, and lean body mass (LBM) measured through EchoMRITM, and 24-h energy expenditure including basal metabolic rate (BMR) assessed using PhenMaster/LabMasterTM cage system were obtained before and after training. At sacrifice, the right femur was collected for bone parameters analysis. **Results:** Although total body mass increased in all groups over the 8-wk period, almost no change occurred for fat body mass in exercised groups (CON, -4.8 ± 6.18 g; ECC15, 0.6 ± 3.32 g; ECC30, 2.6 ± 6.01 g). The gain in LBM was mainly seen for ECC15 (88.9 ± 6.85 g) and ECC30 (101.6 ± 11.07 g). ECC was also seen to positively affect BMD. An increase in BMR from baseline was seen in exercise groups (CON, 13.9 ± 4.13 kJ·d⁻¹; ECC15, 11.6 ± 5.10 kJ·d⁻¹; ECC30, 18.3 ± 4.33 kJ·d⁻¹) but not in CTRL one. This difference disappeared when BMR was normalized for LBM. **Conclusions:** Results indicate that for iso- $\dot{V}O_2$ training, the impact on LBM and BMD is enhanced with ECC as compared with CON, and that for isopower but lower $\dot{V}O_2$ ECC, an important stimulus for adaptation is still observed. This provides further insights for the use of ECC in populations with cardiorespiratory exercise limitations. **Key Words:** FAT MASS, LEAN MASS, DOWNHILL RUNNING, CALORIMETRIC CAGES, OSTEOGENIC RESPONSE

Eccentric (ECC) contraction is associated with active elongation as opposed to concentric (CON) contraction causing muscle fiber shortening. First studied by A. Fick, ECC exercise is receiving a renewed attention as a rehabilitation modality on account of its lower metabolic and cardiorespiratory demands for any given mechanical

power output (1,2). For an ECC exercise of downhill running results typically show oxygen uptake ($\dot{V}O_2$) to be a third to one half that of uphill running (CON) at the same power output (3,4).

The ECC exercise is particularly known for inducing greater muscle micro tears and overall musculoskeletal constraint and muscle tension than CON (5,6). It is also associated with distinctive inflammation patterns and repair processes that are particularly effective in promoting adaptations, such as skeletal muscle fiber hypertrophy (6), positive osteogenesis (7), glycemic control, (8) or mitochondrial H₂O₂ production (9). The extent to which muscle damage, muscle tension output, or metabolic factors constitute the triggering adaptive factors remain unclear. The ECC knee extension training has also been seen to result in greater effects on insulin sensitivity and lipid profiles in elderly men (10), whereas similar results, as well as improvements in bone mineral density (BMD), were found following descending as compared with ascending stair

Address for correspondence: Julianne Touron, Unité de Nutrition Humaine, Laboratoire de Nutrition Humaine, 58 rue Montalembert, B.P. 321, 63009 Clermont-Ferrand, France; E-mail: Julianne.TOURON@uca.fr.
Submitted for publication December 2018.
Accepted for publication March 2019.

0195-9131/19/5109-1944/0
MEDICINE & SCIENCE IN SPORTS & EXERCISE®
Copyright © 2019 by the American College of Sports Medicine
DOI: 10.1249/MSS.0000000000001992

walking in elderly obese women (11). Despite its lower energy and cardiorespiratory demands, Miles et al. (8) also found ECC exercise to be equally effective as CON in modulating glycemic control in a younger population.

The extrapolation of observed metabolic effects of dynamic ECC exercise to a more generalized effect on whole body remains poorly studied (12). Insights showing that, in addition to functional and structural muscle improvements, ECC training in elderly men and women also induced a significant loss of total body fat were first provided by Mueller et al. (13). The suggestion that dynamic ECC could more effectively impact whole body composition, substrate utilization or metabolism than CON is of particular interest for use in weight control management, because of its lower cardiorespiratory exercise demands. A caveat for exploring this issue remains the assurance that what is being compared is indeed comparable; namely that comparisons are made under conditions of both isopower outputs and iso- $\dot{V}O_2$, especially given the differences in oxygen cost per unit of power output (3).

In the present study, this was achieved using a rat model of downhill running previously developed in our laboratory, where variations in treadmill slope and speed are used to modulate exercise intensity and thus external power output (4). The study aimed at comparing the effects of ECC versus CON treadmill training on whole body composition including bone morphometry, bone mineral content (BMC) and BMD while also monitoring basal metabolic rate (BMR) and total energy expenditure (EE). In keeping with fundamental principles of bioenergetics, we hypothesized that after training at iso- $\dot{V}O_2$ changes in total body mass (TBM) and fat body mass (FBM) would be the same in ECC- and CON-trained animals. Conversely, downhill exercise training at the same mechanical power as uphill running (but half the $\dot{V}O_2$) would result in lesser changes in body composition but would have more of an osteogenic impact.

METHODS

Institutional Approvals

All procedures were approved by institutional and national regulating authorities for animal care and research ethics (Ethics Committee C2EA-02, Auvergne, France).

Experimental Protocol and Procedures

Animal population and testing conditions. Sixty 9-wk-old male Wistar rats (Janvier Labs, Le Genest-Saint-Isle, France) weighing between 300 and 360 g upon arrival were individually housed at $22^\circ\text{C} \pm 3^\circ\text{C}$ in a light-controlled room (reverse cycle, 12:12 light-dark). Animals were given free access to water and to a mixture of 20.2% proteins, 75.9% carbohydrates, and 3.9% lipids (A04; Safe Diets, Augy, France) corresponding to a food quotient (FQ) (14) of 0.93.

Randomization and experimental conditions. Animals were randomly assigned to one of four groups of equal size ($n = 15$): 1) control (CTRL), 2) uphill-run training (CON), 3) downhill-run training at a slope of -15% (ECC15), 4) downhill-run training at a slope of -30% (ECC30). The CTRL animals did not undergo any particular intervention but were manipulated and placed on the stopped treadmill at the same frequency as the exercise-trained animals and were investigated in a similar fashion.

The study was completed over an 8-wk period as illustrated in Figure 1 with measurements obtained at baseline (T_0), after completion of 20 exercise sessions (T_1) and after 40 sessions (T_2). Exercise training duration was progressively increased from 5 to 45 min during the first week and maintained at 45 min per session for the remaining 7 wk. Training frequency was five times per week, on five consecutive days with two consecutive days of rest per week.

Animals assigned to an exercise group ran on a 10-lane treadmill (Quinton Instruments, Seattle, WA) at a speed of

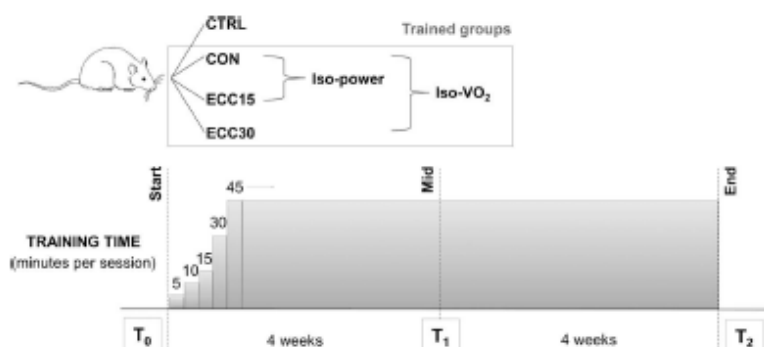

FIGURE 1—Study design and protocol. Training at the same mechanical power (isopower) was carried out by CON and ECC15; training at the same $\dot{V}O_2$ (iso- $\dot{V}O_2$) was carried out by CON and ECC30. Training duration was progressively increased over the five exercise sessions of the first week to reach 45 min by week 2. This duration was maintained throughout the rest of the experimental protocol. Baseline values were taken at T_0 ; T_1 reflects protocol midpoint at which time weight and body composition were reevaluated; T_2 was considered as the 8-wk completion time at which point animals were sacrificed and tissue samples were obtained.

15 m·min⁻¹. Rats in the CON group ran uphill at a treadmill slope of +15%, whereas those in the ECC15 and ECC30 groups ran at a downward slope of -15% and -30%, respectively. These treadmill settings were selected based on our prior results showing similar mechanical power output resulting from uphill running at +15% slope (CON) and downhill running at -15% slope (ECC15) thus enabling isopower comparisons (4,9). Briefly, external power output was determined by design, using mean initial animal body mass (kg) in each group × positive or negative slope and treadmill speed (m·s⁻¹) to obtain vertical displacement (m) × gravitational acceleration. Given that mean animal body mass was not different between groups, the computed external power for same treadmill settings of slope and speed resulted in similar external power outputs. Conversely, the oxygen cost of running uphill at +15% slope (CON) is similar to that of downhill running at -30% slope (ECC30) thus enabling iso- $\dot{V}O_2$ group comparisons. It also follows that the oxygen cost of ECC30 is twice that of ECC15.

Rats were sacrificed after completing a 48-h stay in the metabolic cage. To control for animal age at the time of sacrifice, rats were introduced into the experimental protocol in a progressive fashion. Following the baseline metabolic cage exposure, pairs of animals of the same age were included daily over a period of 6 wk to reach the desired numbers per group.

After completion of the 8-wk protocol, an isotope-based incorporation procedure was achieved after an overnight fast. Animals were then anesthetized by inhalation of 3% isoflurane and 1 L·min⁻¹ O₂ in an induction box, removed from the box and maintained under anesthesia using a face mask (1.5% isoflurane, 1 L·min⁻¹ O₂) while exsanguination at the abdominal aorta level was carried out. The right vastus intermedius muscles were collected and cut into 50-mg portions that were immediately frozen at -80°C. The right femurs were also collected promptly after the animal's cardiorespiratory arrest, cleaned of adjacent tissues, and stored at +4°C in a standard saline solution (9 g NaCl·L⁻¹) until analysis.

Analyses and Measurements

Body composition. Total body mass was recorded at T₀, T₁, and T₂. An EchoMRI™ device (Echo Medical Systems, Houston, TX) was used to assess body compartments at each time point. The quantitative magnetic resonance (QMR) body analysis, validated for use in rodents, enables measurements of fat and lean tissue masses, as well as total body water and free (unbound) water (15,16). The device is highly suited for repeated assessments of animals as it provides highly accurate measurements, is easy to use with scan times of less than 90 s, does not require sedation or anesthesia, and does not expose animals to radiation or invasive procedures (15,17).

EE and motor activity. At T₀ and at T₂, 24 h after the last exercise session for running groups and simultaneously for CTRL, animals were placed in a PhenoMaster/LabMaster home cages system (TSE Systems, Bad Homburg, Germany). A standard cage environment of 22°C temperature, 8:00 PM to 8:00 AM lights-on cycle, with free access to food and water,

was maintained for a period of 48 h for determination of BMR and total EE.

$\dot{V}O_2$ (mL·min⁻¹) and carbon dioxide production (VCO_2 mL·min⁻¹) were obtained for computation of the $VCO_2/\dot{V}O_2$ or respiratory quotient (RQ). Food (g) and water intakes (mL) were obtained from variations in weight and volume of rations, and spontaneous motor activity (m) through detection of movements by infrared sensors.

Muscle mass and protein turnover. To study the impact of the exercise training on muscle protein synthesis, the rate of incorporation of L-[1-¹³C] valine into muscle proteins was measured at T₂ using the flooding dose method (18). After an overnight fast, rats were injected subcutaneously with a large dose of a stable isotope, that is a labeled amino acid (L-[1-¹³C] valine, Eurisotop Saint-Aubin, France), to flood the precursor pool of protein synthesis (300 μM per 100 g body weight). Tracer incorporation time was 50 min in all groups.

Total protein isolation and hydrolysis were obtained from the vastus intermedius. Amino acids were derivatized in N-acetylpropyl for analysis using gas chromatography-combustion-isotope ratio mass spectrometry (Gas System; Fisons Instruments, VG Isotech, Middleswich, UK). L-[1-¹³C] valine enrichments in tissue fluid was assessed using gas chromatography-mass spectrometry (Hewlett-Packard 5971A; Hewlett-Packard Co., Palo Alto, California) and used as precursor pool enrichment to obtain fractional synthesis rate (FSR) and absolute synthesis rate (ASR).

Bone morphometry, absorptiometry, and biomechanical testing. Right femoral length and mean diaphyseal diameter were measured using a precision caliper (Mitutoyo, Shropshire, UK). Total femoral, epiphyseal and diaphyseal BMD were assessed through dual-energy x-ray absorptiometry using a Hologic QDR-4500 A x-ray bone densitometer (Hologic, Massy, France) with scans taken at the upper and lower quarters of the bone for proximal and distal trabecular assessments. Diaphyseal BMD was taken in the central portion of the femur (19). Bone stress and strain were assessed through standard approaches (20). Femoral failure load (N) was determined using a 3-point bending test (Instron 4501; Instron, Canton, MA), the two lower supports being separated by a 20-mm distance, and an upper crosshead roller being applied to the middle of the bone at a speed of 0.5 mm·min⁻¹ until failure. Femoral stiffness (N·mm⁻¹) was determined from the slope of the linear portion of the load-deformation curve.

Treatment of Data and Computations

Body composition, BMC, and femoral diameter. A QMR digital report of raw values was generated for each animal at each evaluation time and values of FBM, lean body mass (LBM), total body water, and free water (g) were recorded and served to determine groups' mean at T₀, T₁ and T₂. BMC (g) was estimated from the standard QMR algorithm (21). Mean femoral diameter diaphysis was taken as the mean of the greatest and the smallest femoral diaphysis diameters to account for its irregular shape.

Energy expenditure. Energy expenditure (kJ) was computed from gas exchange according to Weir (22), taking into account that 20.2% of diet energy was provided by proteins. For each animal, total EE was calculated as the sum of the two hundred eighty-eight 5-min sampling measurements over the 24-h period. Mean values for animals of a given group were calculated. Basal metabolic rate was computed from a series of the four lowest values of 5-min EE values over the 24-h monitored period. Minimal EE was taken as the average of these values and reported as kilojoules per day.

Vastus intermedius protein turnover. Fractional synthesis rate of proteins ($\% \cdot h^{-1}$) was calculated as: $FSR = 100E_i/E_{prec}$, where E_i was the enrichment as atom percent excess of L-[1- ^{13}C] valine derived from decarboxylation of valine from proteins at time t (minus basal enrichment), E_{prec} was the mean enrichment in the precursor pool (tissue fluid L-[1- ^{13}C]valine) and t was incorporation time in hours. Absolute synthesis rate of proteins ($mg \cdot h^{-1}$) was calculated as: $ASR = Q_{prot}FSR/100$, where Q_{prot} was the amount of protein per muscle.

Statistics

Sample size. The sample size estimation was determined based on: 1) the CONSORT 2010 statement (23), 2) the Cohen's-J recommendations (24), and 3) the preliminary results achieved by our team. The number of 15 animals per group was selected to highlight an effect size around 1.5 for a two-sided type I error at 0.008 (correction for multiple comparisons) and a statistical power at 90%.

Statistical Analyses

Statistical analyses were performed using Stata software (version 13; Stata Corp, College Station, TX). Values were expressed as mean \pm SEM. Statistical significance for two-sided comparisons was set for a type-I error of 0.05. Random-effects models for correlated data were performed for consideration of between- and within-animal variability due to repeated measurements on a same animal. Timepoint evaluations, groups and their interactions were considered as fixed effects whereas subject (animal) was random effect (slope and intercept). A Sidak's *post hoc* test for multiple comparisons was applied. The normality of residuals from these models was studied using the Shapiro-Wilk test. When appropriate, the data were log-transformed to achieve normality of the dependent endpoint. Concerning non-repeated-measures, quantitative variables were compared between groups by ANOVA or Kruskal-Wallis tests when assumptions required for the ANOVA were not met (normality and homoscedasticity analyzed using the Bartlett test). When appropriate (omnibus $P < 0.05$), a *post hoc* test to take into account multiple comparisons was performed: Tukey-Kramer *post-ANOVA* and Dunn after Kruskal-Wallis test.

RESULTS

Body Composition

TBM, FBM, and LBM. Figure 2 shows changes in TBM, FBM, and LBM at baseline, after 4 and 8 wk of intervention in

all groups. For those parameters, baseline values were not different between groups. As seen in panel A, no differences were seen between groups whatever the measurement time point, and a similar increase in TBM was seen in all groups from T_0 to T_2 . The table, inserted as Figure 2B, shows FBM and LBM expressed in grams, whereas panels C and D represent the relative contribution of FBM and LBM as percent of TBM. Results in CTRL indicate a significant increase in FBM from baseline when expressed in absolute (panel B) or in relative terms (panel C), with FBM at T_2 (in grams or percent) being significantly higher in CTRL compared with running groups. Consistent with a continuous growth model, significant increases in LBM (g) were seen at T_2 from T_0 in all groups (panel B). However, at T_2 results show significantly higher LBM in ECC15 and ECC30 compared with CTRL. This is also reflected by the significant decrease of LBM (%) in CTRL and its significant increase in all running groups from T_0 (panel D). Figures 2E and F show the absolute changes in FBM and LBM at T_2 from T_0 in all groups. A significant group difference from CTRL is seen at T_2 in exercise groups (panel E) and greater changes in LBM are seen for ECC15 and ECC30 (panel F).

Bone mineral content. Mean \pm SEM values of BMC (g), calculated from QMR, were not different between groups either at T_0 (CTRL, 32.95 ± 0.74 ; CON, 35.36 ± 1.04 ; ECC15, 34.69 ± 0.61 ; ECC30, 32.96 ± 1.63), T_1 (CTRL, 38.03 ± 1.34 ; CON, 41.23 ± 2.97 ; ECC15, 39.35 ± 1.06 ; ECC30, 38.50 ± 1.27) or at T_2 (CTRL, 41.84 ± 0.90 ; CON, 47.93 ± 5.64 ; ECC15, 41.95 ± 1.17 ; ECC30, 43.19 ± 1.54) but a significant increase from T_0 was found in all groups at T_2 .

BMD, Morphometry, and Biomechanical Properties

Results for BMD obtained at T_2 are shown in Figure 3A. As can be seen, the CON condition was associated with a significantly higher proximal BMD, as compared with the CTRL group. Regarding ECC15, the elicited effect is higher at both total and proximal level. Finally, all the BMD measurements were found to be significantly higher in ECC30 compared with CTRL, whether they were performed on cortical bone or on trabecular bone. Figures 3B and C, showing femoral length and diaphyseal diameter, reveal no significant differences between groups. Measured failure loads (N) were not significantly different between groups (CTRL, 152.44 ± 5.96 ; CON, 162.43 ± 5.97 ; ECC15, 154.23 ± 3.88 ; ECC30, 159.16 ± 4.23) nor were stiffness values ($N \cdot mm^{-1}$) (CTRL, 221.78 ± 12.24 ; CON, 244.73 ± 12.12 ; ECC15, 233.75 ± 10.29 ; ECC30, 255.51 ± 7.71).

Energy Balance

Food and water intake. Twenty-four-hour food and water intakes at T_0 and T_2 , are shown in Table 1. Results indicate a significant decrease in water intake at T_2 in CTRL. No other significant differences were seen in food or water intakes at T_2 compared with T_0 . There was no significant difference in food intake between groups either at T_0 or at T_2 . There was no

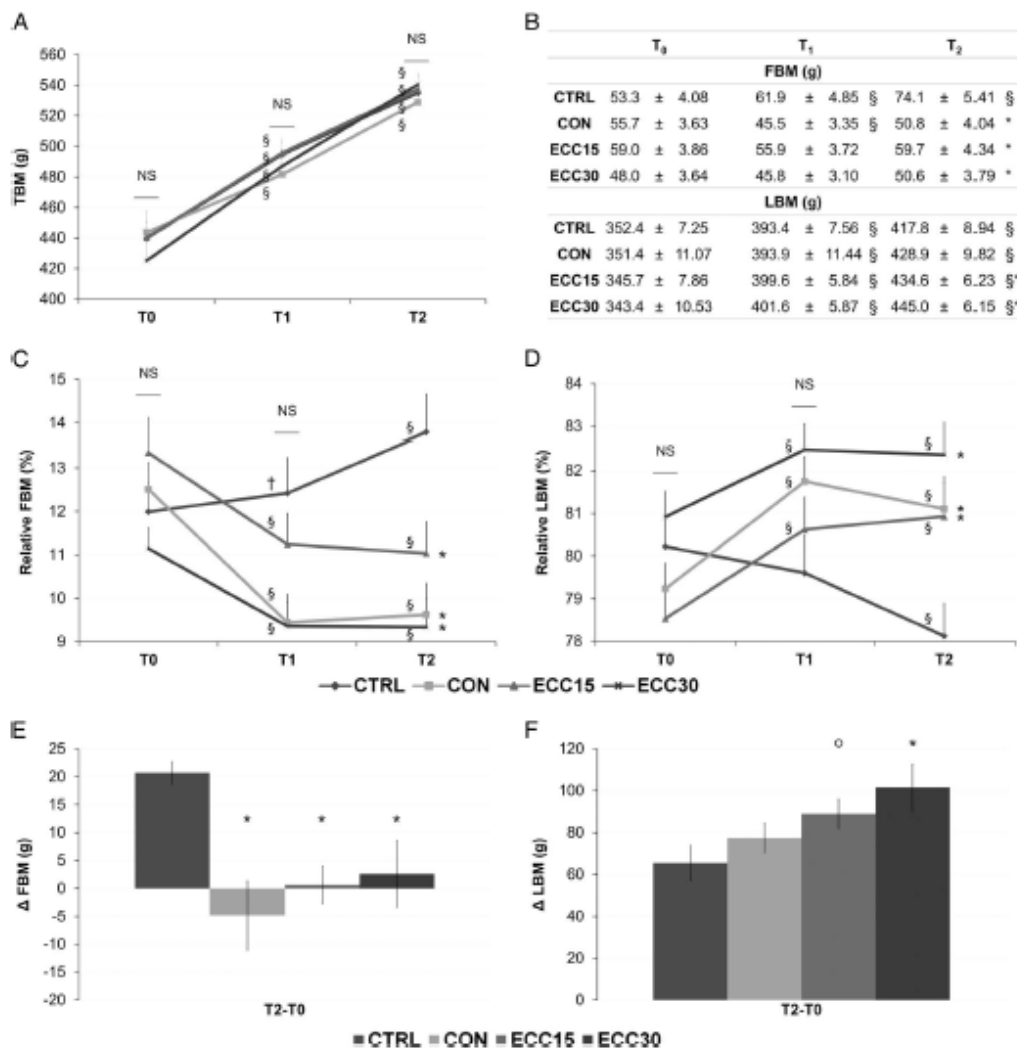

FIGURE 2—QMR data. (A) TBM (g). (B) Absolute FBM and LBM compartments (g). (C) FBM relative to TBM (%). (D) LBM relative to TBM (%). (E) Δ FBM (g). (F) Δ LBM (g). Values are mean \pm SEM (for sake of clarity only positive SEM are presented in panels A, B and C). § $P < 0.05$ from T₀; † $P < 0.10$ from T₀; * $P < 0.05$ from CTRL; ◊ $P < 0.10$ from CTRL; NS, non-significant difference between groups.

difference in water intake between groups at T₀, but exercised groups had higher values at T₂ compared to CTRL.

Energy expenditure. Total EE and BMR expressed in kilojoules per day at T₀ and T₂ are, respectively, shown in Figures 4A and B. Results indicate no significant difference in mean values between groups in either total EE or BMR at T₀. In ECC groups, total EE was found to be higher at T₂ compared to T₀. At T₂, BMR was statistically different from CTRL for all trained groups. Analysis of pretraining to posttraining BMR indicate significantly higher values at T₂ compared with T₀ in CON, ECC15, and ECC30 but not in CTRL. Figures 4C and D show changes in total EE and BMR at T₂ from T₀. Results provide evidence for an increase in total EE in all trained groups, but statistical

significance was only reached for ECC30. Similarly positive changes ($P < 0.05$: CON and ECC30, $P < 0.1$: ECC15) in BMR were seen in all exercised groups but not in CTRL. When corrected for LBM, results for total EE and BMR were lower at T₂ compared with both T₀ in all groups; however, there was no difference between groups at either measurement time (Figs. 4E and F).

Spontaneous activity. Mean \pm SEM values of activity ($m \cdot d^{-1}$) were not different between groups, either at T₀ (CTRL, 347.93 \pm 24.77; CON, 326.96 \pm 20.69; ECC15, 313.88 \pm 20.07; ECC30, 317.96 \pm 23.47) or at T₂ (CTRL, 270.60 \pm 14.89; CON, 267.94 \pm 14.95; ECC15, 255.88 \pm 9.86; ECC30, 247.61 \pm 18.17). The decrease found between T₂ and T₀ was significant in all groups.

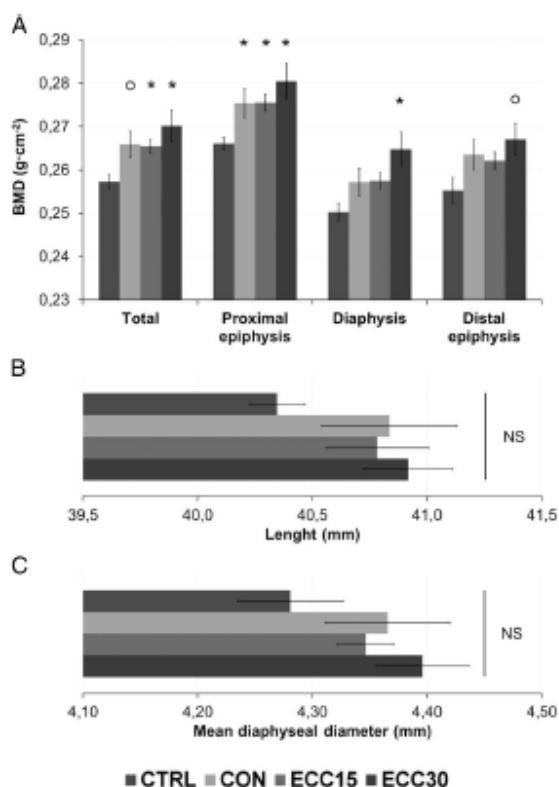

FIGURE 3—BMD and morphometry. (A) Total, proximal epiphysis, diaphysis and distal epiphysis femoral BMD (g·cm⁻²). (B) Femoral length (mm). (C) Mean diaphyseal diameter (mm). Values are mean ± SEM. **P* < 0.05 from CTRL; ◊*P* < 0.10 from CTRL; NS, nonsignificant difference between groups.

24-h RQ. Mean ± SEM values of 24-h RQ were not different between groups, either at T₀ (CTRL, 1.02 ± 0.01; CON, 1.01 ± 0.01; ECC15, 1.02 ± 0.01; ECC30, 1.00 ± 0.01) or at T₂ (CTRL, 0.99 ± 0.01; CON, 1.00 ± 0.01; ECC15, 1.01 ± 0.01; ECC30, 1.00 ± 0.01). A decrease from T₀ was found in CTRL, CON, and ECC15 (*P* < 0.05) at T₂ but not in ECC30. As can be seen, in all groups, RQ exceeds the FQ of 0.93 at both T₀ and T₂.

Muscle Mass and Protein Turnover

As shown in Table 2, there was no statistical difference in total vastus intermedius muscle mass measured at T₂ between CTRL and exercise-trained groups. Similarly, no significant differences between groups were found for measurements of FSR and ASR.

DISCUSSION

Main findings. General findings indicate an increase in TBM in all groups but compartment differentiation with exercise training serving to limit gains in FBM, irrespective of contraction modality. As per the working hypothesis, conditions

of iso- $\dot{V}O_2$ training (ECC30 and CON) resulted in effects of similar magnitudes on FBM as compared to the isopower lower $\dot{V}O_2$ condition (ECC15). Lean body mass and bone density increased in all exercise-trained animals compared to CTRL with greater effects in ECC30 but a positive effect seen even in the ECC15 group, with no changes in bone length or biomechanical characteristics. Basal metabolic rate and total EE increased after training, which can be explained by an increase in LBM in running groups.

General physiological response to dynamic ECC exercise training. Explanation of adaptations to ECC type exercise is beyond the scope of this article, and recent review articles report on the current understanding of findings from studies in humans and in animals (25–27). Briefly, findings show that ECC is effective for inducing muscle adaptations that may translate into enhanced strength and endurance functional abilities. There is, however, no clear evidence of an increase in aerobic parameters. This could be related to the difficulty of comparing training programs of similar metabolic overload using CON and ECC, because it would require imposing a CON power load in cycling or running two or three times that of ECC. The fact that the metabolic and cardiorespiratory requirements of dynamic ECC exercise are one third to one half those of CON is nonetheless of a particular interest for use in populations in whom the level of metabolic overload is limited by the cardiorespiratory exercise ability. It is, therefore, not surprising that much of the dynamic ECC exercise literature stems from studies conducted in patients with chronic heart, respiratory, metabolic or muscle disease or obesity (1,2,12). In animals, there are little data on the dynamic ECC versus CON repeated cardiorespiratory and metabolic exercise responses or their impact.

TBM and body mass compartments. To our knowledge, the present study is the first to report on the effects of dynamic CON and ECC exercise training on body composition compartments in rats. The study was conducted in rodents to enable comparisons of modalities for metabolic demands of similar magnitudes.

As expected from the continuous growth pattern of rodents, an increase in TBM was observed over the 8-wk period in all animals. The increase seen in CTRL is of a similar magnitude as the aging-related increase usually reported in Wistar rats of

TABLE 1. Food and water intakes at T₀ and at T₂.

	T ₀	T ₂
Food intake (g·d ⁻¹)		
CTRL	27.2 ± 1.19	26.3 ± 1.13
CON	26.5 ± 0.58	27.7 ± 1.42
ECC15	27.4 ± 0.82	27.7 ± 0.67
ECC30	26.4 ± 0.90	27.8 ± 0.94
Water intake (mL·d ⁻¹)		
CTRL	31.2 ± 2.97	26.0 ± 2.34*
CON	28.4 ± 1.45	26.8 ± 1.23**
ECC15	27.9 ± 1.48	27.4 ± 1.49***
ECC30	27.3 ± 1.72	31.2 ± 2.07***

Values are mean ± SEM.
**P* < 0.05 from T₀.
***P* < 0.10 from CTRL.
****P* < 0.05 from CTRL.

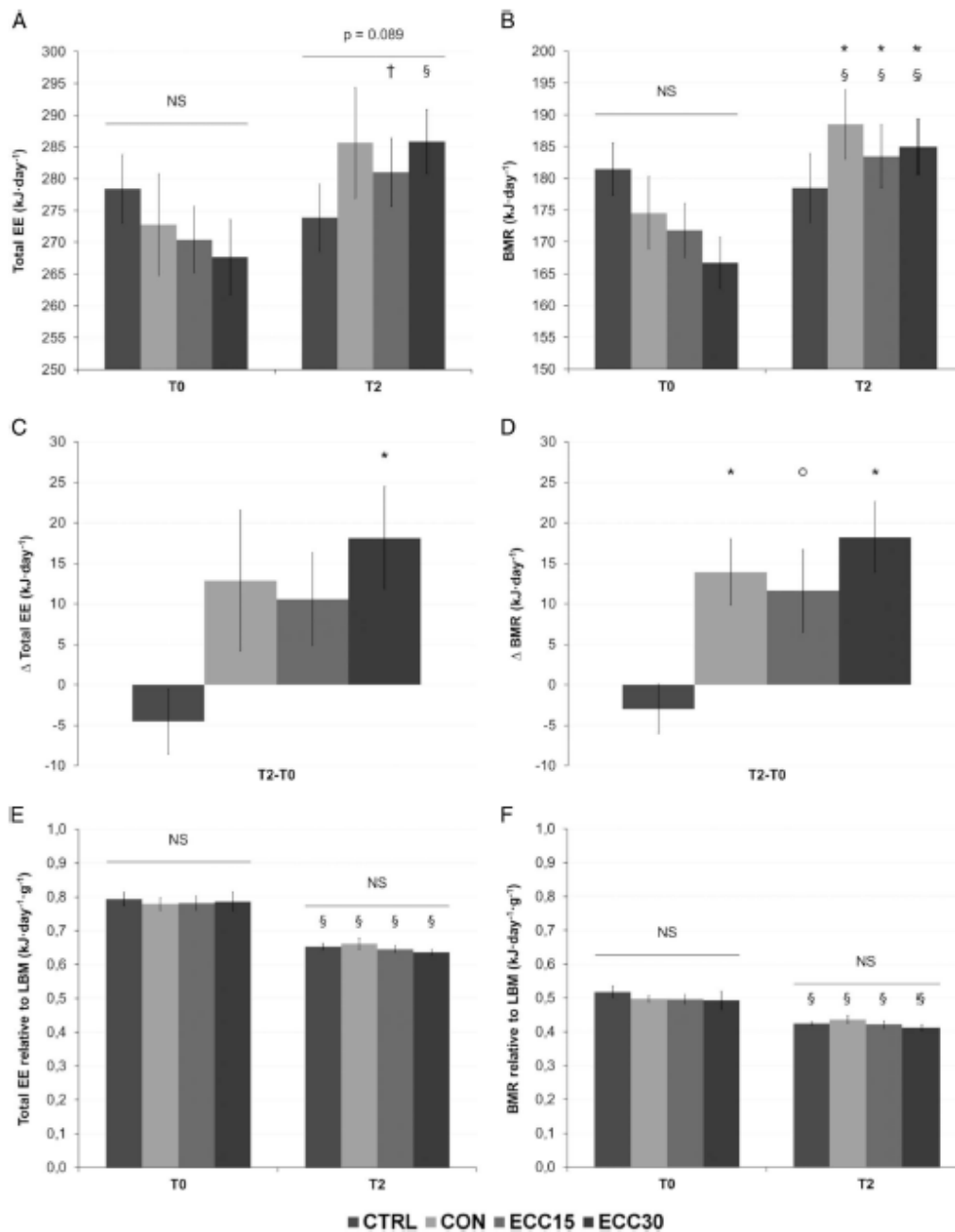

FIGURE 4—Total EE and BMR. (A) Total EE (kJ·d⁻¹). (B) BMR (kJ·d⁻¹). (C) Δ total EE (kJ·d⁻¹). (D) Δ BMR (kJ·d⁻¹). (E) Total EE (kJ·d⁻¹) relative to LBM. (F) BMR (kJ·d⁻¹) relative to LBM. Values are mean ± SEM. §*P* < 0.05 from T₀; †*P* < 0.10 from T₀; **P* < 0.05 from CTRL; ○*P* < 0.10 from CTRL; NS: nonsignificant difference between groups.

a similar age, over the same period (28) and the magnitude of increase in trained animals is in keeping with that after downhill running in rats (7). Our results, however, also show that the exercise-induced impact on whole body composition

may be training-overload dependent and specific to the exercise modality. In fact, measurements made at study mid-point show that exercise-induced changes in body compartments occur primarily over the first 4 wk of training.

TABLE 2. Muscle mass and protein turnover of vastus intermedius.

	Muscle Mass (g)	FSR (%·hr ⁻¹)	ASR (mg·hr ⁻¹)
CTRL	0.38 ± 0.058	0.36 ± 0.012	0.22 ± 0.010
CON	0.43 ± 0.051	0.35 ± 0.011	0.20 ± 0.014
ECC15	0.38 ± 0.037	0.35 ± 0.010	0.24 ± 0.032
ECC30	0.42 ± 0.107	0.36 ± 0.013	0.21 ± 0.052

Values are mean ± SEM.

As opposed to the average FBM increase of 20 g over the 8-wk period in the CTRL group, none of the three groups of exercise-trained animals exhibited a significant increase in FBM over the same period. Present results also show animals submitted to downhill running (ECC) to exhibit more important increases in LBM than those in the CON group. The magnitude of change is also consistent with the standard overload principles such that higher gains in LBM are seen with higher metabolic overload (ECC30 > ECC15). Thus, a significant increase in FBM (g) was seen in CTRL but not in exercised groups confirming the effect of exercise training to limit fat mass gain but also showing significant increases in lean mass which appeared enhanced with the ECC modality.

In a landmark study, Lynn and Morgan (29) used rats of similar age range as ours to examine at iso-power (16° incline and decline) the effects on vastus intermedius remodeling after 1 wk of consecutive days of treadmill running at a speed similar to the one used in the present study (14 m·min⁻¹ vs 15 m·min⁻¹). Results showed sedentary rats to have a similar sarcomere count as rats submitted to incline (CON) running. However, in decline (ECC) running rats, an average difference of +11% was seen in the number of sarcomeres compared to incline running animals. Such effects were further summarized in a recent review by Hedayatpour and Falla (25).

Aerobic exercise training using standard CON-type exercise has been widely used for body weight management (30,31). Results from these studies commonly show training-induced reductions in body fat and increases in LBM if the exercise-training stimulus was of sufficient intensity. Reports on segmental body composition evaluation using dual-energy x-ray absorptiometry scanning after dynamic ECC training have recently become available (13,32,33), showing an increase in lean tissue mass of trained muscle groups. A few studies also report decreases in whole-body total fat mass (13,33), which is of a particular interest considering that cardiorespiratory and metabolic demands of ECC are generally lower than those of CON type exercise (3).

Body composition and bone tissue. Exercise training-induced changes in bone tissue may also contribute to the observed variations in body composition. Compressive and tensile strains resulting from the muscle contractions of weight bearing exercise can induce an osteogenic and bone remodeling through mechanotransduction (34,35). To trigger the osteogenic cascade leading to morphological and mechanical adaptation of bony structures, stresses and strains must be of a sufficient impact, dynamic and variable (34,36,37). In humans, a remodeling cycle of bone resorption, formation, and mineralization is estimated to extend over a period of

up to 4 months (38). The timeframe in adult rats is significantly less with histomorphometric measurements establishing the cycle to be completed over 36 to 38 d for trabecular bone (39).

The particular osteogenic potential of flat or uphill running including high-intensity intermittent training has been well described and has been ascribed to the action of the repeated high impact ground reaction forces (40). The impact of downhill running or ECC on bony structures remains incompletely documented. In rats, the comparison of peak and rate of rise of ground reaction forces exerted on forelimbs and hindlimbs during uphill or downhill treadmill walking showed that even without additional body loading, downhill walking resulted in higher bone strain (41).

The present results show a significant increase in femoral BMD in ECC-trained groups as compared with CTRL, irrespective of slope, which was not the case in rats trained using uphill running. These findings are consistent with previous reports in rats showing increased in BMD after downhill but not uphill treadmill activity (7,41). Similar to the present observations, results from measurements of bone morphology or biomechanical characteristics do not show significant changes after ECC training despite significant impact on BMD.

Energy balance and changes in body composition.

Our results show no significant differences in food intake or spontaneous activity between groups whether before or after training, despite a decrease in activity from T₀ to T₂ seen in all groups probably as a result of aging and habituation to the metabolic cage environment. Rats were fed a mixture containing 20.2% protein, 75.9% carbohydrate and 3.9% lipids leading to an FQ calculated to be 0.93. The 24-h RQ values were higher than the FQ in all groups, both before and after the training period, consistent with the presence of *de novo* lipogenesis required to convert ingested carbohydrates to lipids (42). This lipogenesis may be seen as a natural phenomenon which contributes to the continuous age-related growth in rodents and the accumulated fat mass seen in CTRL animals.

This is not observed in exercise-trained animal groups suggesting a contribution of the added exercise-related EE because neither food intake nor spontaneous activity were different from CTRL. Using the average O₂ cost of +15% uphill running and -15% and -30% downhill running (4) and applying an oxygen energy equivalent of 5 kcal·L⁻¹, an additional EE of 3.4 kcal per running session for CON and ECC30 groups and of 1.7 kcal per session for the ECC15 group may be calculated. Totalling these extra oxygen costs over the entire 8-wk training volume results in an additional EE of 120 kcal for CON and ECC30 and of 60 kcal for the ECC15 group. Differences in FBM gains in exercised groups despite the presence of *de novo* lipogenesis could thus be explained by the increased EE to offset fat accumulation. The observed increase in EE is also reflected in BMR as shown in Figure 4. In turn, the observed posttraining increase in BMR may be explained by the concomitant increase in LBM given its predominant contribution to BMR and as may be seen by the disappearance of differences when BMR is expressed relative to LBM.

In humans, an increase in resting metabolic rate lasting up to 48 h after ECC exercise has been reported (43,44) with a suggested explanation of an increase in protein turnover, presumably resulting from the high rate of muscle microlesions associated with the ECC contraction modality.

In the present study, no differences in protein turnover between groups were observed. It is commonly accepted that exercise-induced physiological responses result from repair processes of muscle damage incurred in exercising muscles and that more extensive muscle micro tears and inflammation is seen after ECC type contractions, which also explains the more extensive muscle soreness reported in humans after ECC (5). For this reason, a period of progressive increase in ECC loading is commonly included in ECC training programs, as it was done in the present study for duration. However, because loading was not continuously increased over the 8-wk period, it is likely that the stimulus for an enhanced protein turnover was not maintained, resulting in no difference in ¹³C-labeled valine incorporation between trained groups and CTRL at the time of sacrifice. It is also possible that any exercise-induced increase in protein turnover could have been missed on account of the 24-h time lapse from the last exercise training bout.

Study limitation. In the present study, a progressive overload across the interventional period was not applied to reflect as much as possible the approach more commonly used in weight reduction exercise programs. This however may represent a limitation in the interpretation of findings. For example, it cannot be excluded that a significant effect of ECC over CON on protein turnover and incorporation or that a continued increase in LBM between T₁ and T₂ might have been seen if a progressive overload had been used.

CONCLUSIONS

The present study was specifically designed to allow comparisons of the impact of CON and ECC modalities at same power output (isopower) or same EE (iso- $\dot{V}O_2$) on body composition in rats. Results indicate regular exercise, irrespective

of modality, to favorably modulate body composition in a way to limit the increase in whole body fat mass and conversely to enhance lean mass. The latter observation is of a particular significance for the use of dynamic ECC exercise as an adjunct to the clinical management of individuals with limited functional capacities or suffering from chronic health conditions, knowing its characteristics of lower metabolic and cardiorespiratory demands. In practice, the feasibility of dynamic ECC exercise training in individuals with chronic disorders has been demonstrated in patients with chronic obstructive pulmonary disease and chronic heart failure (1,2). Recent results obtained in clinically obese individuals showing a greater FBM reduction with ECC-trained adolescent compared to CON also confirm its interest for weight control (33). It is well acknowledged that one of the factors acting to limit the benefits of exercise training in humans is the capacity for the individual to sustain sufficient metabolic overload.

The practical implication of present finding that effects of ECC training on body composition are seen even at lower intensity and constant overload training may open new avenues for designing weight reduction exercise programs. In particular, with the increase availability of ECC cycle ergometers on the market, overweight/obese individuals may benefit from gains in LBM through exercise that would not require extensive metabolic and cardiorespiratory requirements. The extent to which regular ECC cycling or descending treadmill walking can also be an adjunct for clinical management of osteoporosis remains to be clearly determined.

The authors thank the staff from the Experimental Animal Facility of the Human Nutrition Unit (INRA of Clermont-Ferrand) for their assistance throughout the animal protocol, and the staff from the metabolism exploration platform for their expertise in protein enrichment analysis. The authors also acknowledge the members of the ASMS team and the staff from the CRNH who participated closely into the success of this project.

The authors certify that the results of the study are presented clearly, honestly, and without fabrication, falsification, or inappropriate data manipulation. The results of the present study do not constitute endorsement by the American College of Sports Medicine.

The authors declare no conflict of interest.

REFERENCES

1. LaStayo P, Marcus R, Dibble L, Frujacomo F, Lindstedt S. Eccentric exercise in rehabilitation: safety, feasibility, and application. *J Appl Physiol*. 2013;116(11):1426–34.
2. Hoppeler H. Moderate load eccentric exercise; a distinct novel training modality. *Front Physiol*. 2016;7:483.
3. Minetti AE, Moia C, Roi GS, Susta D, Ferretti G. Energy cost of walking and running at extreme uphill and downhill slopes. *J Appl Physiol* (1985). 2002;93(3):1039–46.
4. Chavanelle V, Sirvent P, Ennequin G, et al. Comparison of oxygen consumption in rats during uphill (concentric) and downhill (eccentric) treadmill exercise tests. *J Sports Sci Med*. 2014;13(3):689–94.
5. Proske U, Morgan DL. Muscle damage from eccentric exercise: mechanism, mechanical signs, adaptation and clinical applications. *J Physiol*. 2001;537(Pt 2):333–45.
6. Roig M, O'Brien K, Kirk G, et al. The effects of eccentric versus concentric resistance training on muscle strength and mass in healthy adults: a systematic review with meta-analysis. *Br J Sports Med*. 2009;43(8):556–68.
7. Hamann N, Kohler T, Müller R, Bruggemann G-P, Niehoff A. The effect of level and downhill running on cortical and trabecular bone in growing rats. *Calcif Tissue Int*. 2012;90(5):429–37.
8. Miles MP, Horrigan LC, Jay SE, Brown KM, Porter JW, Steward AN. Concentric and eccentric exercise, glycemic responses to a post-exercise meal, and inflammation in women with high versus low waist circumference. *Appl Physiol Nutr Metab*. 2016;41(12):1262–70.
9. Isner-Horobeti M-E, Rasseneur L, Lonsdorfer-Wolfe, et al. Effect of eccentric versus concentric exercise training on mitochondrial function. *Muscle Nerve*. 2014;50(5):803–11.
10. Chen TC-C, Tseng W-C, Huang G-L, Chen H-L, Tseng K-W, Nosaka K. Superior effects of eccentric to concentric knee extensor resistance training on physical fitness, insulin sensitivity and lipid profiles of elderly men. *Front Physiol*. 2017;8:209.

11. Chen TC, Hsieh C-C, Tseng K-W, Ho C-C, Nosaka K. Effects of descending stair walking on health and fitness of elderly obese women. *Med Sci Sports Exerc.* 2017;49(8):1614–22.
12. Julian V, Thivel D, Costes F, et al. Eccentric training improves body composition by inducing mechanical and metabolic adaptations: a promising approach for overweight and obese individuals. *Front Physiol.* 2018;9:1013.
13. Mueller M, Breil FA, Vogt M, et al. Different response to eccentric and concentric training in older men and women. *Eur J Appl Physiol.* 2009;107(2):145–53.
14. Flatt JP. Body composition, respiratory quotient, and weight maintenance. *Am J Clin Nutr.* 1995;62(5):1107S–17.
15. Taicher GZ, Tinsley FC, Reideman A, Heiman ML. Quantitative magnetic resonance (QMR) method for bone and whole-body composition analysis. *Anal Bioanal Chem.* 2003;377(6):990–1002.
16. Nixon J, Zhang M, Wang C, et al. Evaluation of a quantitative magnetic resonance imaging system for whole body composition analysis in rodents. *Obesity (Silver Spring).* 2010;18(8):1652–9.
17. Kovner I, Taicher GZ, Mitchell AD. Calibration and validation of EchoMRI™ whole body composition analysis based on chemical analysis of piglets, in comparison with the same for DXA. *Int J Body Compos Res.* 2010;8(1):17–29.
18. Salles J, Chanet A, Berry A, et al. Fast digestive, leucine-rich, soluble milk proteins improve muscle protein anabolism, and mitochondrial function in undernourished old rats. *Mol Nutr Food Res.* 2017; 61(11).
19. Pastoreau P, Chomel A, Bonnet J. Specific evaluation of localized bone mass and bone loss in the rat using dual-energy X-ray absorptiometry subregional analysis. *Osteoporos Int.* 1995;5(3):143–9.
20. Turner CH, Burr DB. Basic biomechanical measurements of bone: a tutorial. *Bone.* 1993;14(4):595–608.
21. Questions & Answers about EchoMRI™ Body Composition Analysis [date unknown]; [cited 2018 Oct 18] Available from: http://www.echomri.com/Questions_and_Answers.aspx.
22. Weir JB. New methods for calculating metabolic rate with special reference to protein metabolism. *J Physiol.* 1949;109(1-2):1–9.
23. Eldridge SM, Chan CL, Campbell MJ, et al. CONSORT 2010 statement: extension to randomised pilot and feasibility trials. *Pilot Feasibility Stud.* 2016;2:64.
24. Cohen J. *Statistical Power Analysis for the Behavioral Sciences.* 2nd ed. Hillsdale (NJ): Lawrence Erlbaum Associates; 1988. 567 p.
25. Hodayatpour N, Falla D. Physiological and neural adaptations to eccentric exercise: mechanisms and considerations for training. *Biomed Res Int.* 2015;2015:193741.
26. Franchi MV, Reeves ND, Narici MV. Skeletal muscle remodeling in response to eccentric vs. concentric loading: morphological, molecular, and metabolic adaptations. *Front Physiol.* 2017;8:447.
27. Isner-Horobeti M-E, Dufour SP, Vautravers P, Geny B, Coudeyre E, Richard R. Eccentric exercise training: modalities, applications and perspectives. *Sports Med.* 2013;43(6):483–512.
28. Nistiar F, Racz O, Lukacimova A, et al. Age dependency on some physiological and biochemical parameters of male Wistar rats in controlled environment. *J Environ Sci Health Part A Tox Hazard Subst Environ Eng.* 2012;47(9):1224–33.
29. Lynn R, Morgan DL. Decline running produces more sarcomeres in rat vastus intermedius muscle fibers than does incline running. *J Appl Physiol Bethesda Md 1985.* 1994;77(3):1439–44.
30. LeMura LM, von Duvillard SP, Andreacci J, Klebez JM, Chelland SA, Russo J. Lipid and lipoprotein profiles, cardiovascular fitness, body composition, and diet during and after resistance, aerobic and combination training in young women. *Eur J Appl Physiol.* 2000; 82(5–6):451–8.
31. Nybo L, Sundstrup E, Jakobsen MD, et al. High-intensity training versus traditional exercise interventions for promoting health. *Med Sci Sports Exerc.* 2010;42(10):1951–8.
32. Marcus RL, Lastayo PC, Dibble LE, Hill L, McClain DA. Increased strength and physical performance with eccentric training in women with impaired glucose tolerance: a pilot study., increased strength and physical performance with eccentric training in women with impaired glucose tolerance: a pilot study. *J Womens Health (Larchmt).* 2009;18(2):253–60.
33. Julian V, Thivel D, Miguot M, et al. Eccentric cycling is more efficient in reducing fat mass than concentric cycling in adolescents with obesity. *Scand J Med Sci Sports.* 2019;29(1):4–15.
34. Goolsby MA, Boniquit N. Bone health in athletes. *Sports Health.* 2017;9(2):108–17.
35. Pellikaan P, Giarmatzis G, Vander Sloten J, Verschueren S, Jonkers I. Ranking of osteogenic potential of physical exercises in postmenopausal women based on femoral neck strains. *PLoS One.* 2018; 13(4):e0195463.
36. Kohrt WM, Barry DW, Schwartz RS. Muscle forces or gravity: what predominates mechanical loading on bone? *Med Sci Sports Exerc.* 2009;41(11):2050–5.
37. Tagliaferri C, Wittrant Y, Davicco M-J, Walrand S, Coxam V. Muscle and bone, two interconnected tissues. *Ageing Res Rev.* 2015;21:55–70.
38. Kohrt WM, Bloomfield SA, Little KD, Nelson ME, Yingling VR. American College of Sports Medicine. American College of Sports Medicine position stand: physical activity and bone health. *Med Sci Sports Exerc.* 2004;36(11):1985–96.
39. Baron R, Tross R, Vignery A. Evidence of sequential remodeling in rat trabecular bone: morphology, dynamic histomorphometry, and changes during skeletal maturation. *Anat Rec.* 1984;208(1):137–45.
40. Ravriholt T, Tybirk J, Jørgensen NR, Bangsbo J. High-intensity intermittent “5-10-15” running reduces body fat, and increases lean body mass, bone mineral density, and performance in untrained subjects. *Eur J Appl Physiol.* 2018;118(6):1221–30.
41. Bravenboer N, van Rens BTTM, van Essen HW, van Dieën JH, Lips P. Ground reaction forces during walking with different load and slope combinations in rats. *J Exp Orthop.* 2017;4(1):28.
42. Elia M, Livesey G. Theory and validity of indirect calorimetry during net lipid synthesis. *Am J Clin Nutr.* 1988;47(4):591–607.
43. Paschalis V, Nikolaidis MG, Giakas G, et al. Beneficial changes in energy expenditure and lipid profile after eccentric exercise in overweight and lean women. *Scand J Med Sci Sports.* 2010;20(1):e103–11.
44. Burt DG, Lamb K, Nicholas C, Twist C. Effects of exercise-induced muscle damage on resting metabolic rate, sub-maximal running and post-exercise oxygen consumption. *Eur J Sport Sci.* 2014;14(4): 337–44.

4.2. Publication n°2

Effects of exercise-induced metabolic and mechanical loading on skeletal muscle mitochondrial function in rats.

Il est aujourd'hui largement démontré que l'exercice physique est à l'origine de l'activation de voies de signalisation permettant d'améliorer les niveaux de transcription génique et la synthèse protéique influant sur les modifications morphologiques, histologiques et métaboliques en lien avec l'entraînement. La complexité du modèle d'exercice excentrique dynamique fait qu'il permet de forts stimuli mécaniques, qui à haute intensité impliquent une importante sollicitation métabolique, dont les effets sur la fonction mitochondriale restent à identifier. Notre objectif a donc été de comparer les résultats obtenus à la suite d'un entraînement excentrique et concentrique réalisés à même contrainte mécanique ou métabolique sur la biogenèse et la fonction mitochondriale du muscle squelettique. Il s'agit plus précisément de la suite des résultats de la publication n°1 avec les analyses réalisées sur tissus musculaires frais et sur tissus musculaires congelés.

Soixante rats adultes ont été randomisés dans un groupe contrôle (CTRL) ou l'un des trois groupes d'entraînement dans lesquels la pente du tapis de course a été modulée pour permettre des équivalences de puissance mécanique ou métabolique. Le groupe concentrique (CON, + 15 % en montée) et le groupe excentrique 30 (ECC30, -30 % en descente) permettaient des comparaisons iso-métaboliques, tandis que le groupe CON et le groupe excentrique 15 (ECC15, -15 % en descente) permettaient une comparaison iso-mécanique. Les animaux entraînés ont couru en continu pendant 45 min à 15 m·min⁻¹ cinq jours consécutifs par semaine pendant 8 semaines. La respiration mitochondriale a été évaluée sur fibres musculaires perméabilisées de *Vastus Intermedius*. Les activités enzymatiques mitochondriales ont été obtenues par spectrophotométrie tandis que la PCR quantitative en temps réel a été utilisée pour les transcrits d'ARN messager (ARNm).

Dans l'ensemble, les niveaux de respiration mitochondriale maximale étaient 18 % plus élevés ($p \leq 0,10$) dans les groupes CON et ECC30 par rapport au groupe CTRL, avec un K_m apparent pour l'ADP significativement plus élevé. Les valeurs des activités du complexe I et de la CS étaient de 1,6 (ECC15) à 1,8 (ECC30 et CON) fois les valeurs du groupe CTRL, tandis que l'activité du complexe IV était significativement plus élevée pour le groupe CON (129 %) et le

groupe ECC30 (86 %) comparativement à celle des animaux CTRL. Une discontinuité entre les modifications des marqueurs de la fonction mitochondriale et les transcrits d'ARNm a été observée en conditions excentriques, cette modalité exerçant des différences significatives sur les éléments régulateurs mitochondriaux mais pas sur ceux impliqués dans la biogenèse.

Les résultats confirment qu'indépendamment de la modalité d'exercice, la surcharge métabolique régit les adaptations de la fonction mitochondriale en réponse à l'entraînement en endurance. Toutefois, nos observations suggèrent également que l'activation ou l'inhibition de voies de signalisation cellulaires dans un contexte de contractions excentriques s'opère dans une fenêtre différente selon l'intensité de la stimulation mécanique et le dommage musculaire et les réparations qu'elle implique, préalablement à la mise en place d'une réponse adaptative à l'entraînement.

21 **ABSTRACT**

22 **Purpose:** To contrast outcomes of eccentric and concentric exercise training at iso-metabolic
23 and iso-mechanical power output on skeletal muscle mitochondrial function and biogenesis
24 adaptations.

25 **Methods:** Sixty adult rats were randomly assigned a control (CTRL) and three training groups
26 with the uphill or downhill treadmill slope being modulated to enable two-by-two mechanical
27 or metabolic power output equivalences. The concentric (CON, +15% uphill running) and the
28 ECC30 (-30% eccentric downhill running) provided for iso-metabolic comparisons while
29 contrasting CON with an ECC15 (-15% downhill running) group enabled iso-mechanical power
30 output comparison. Animals assigned to training groups ran continuously for 45min at
31 $15\text{m}\cdot\text{min}^{-1}$ on five consecutive days weekly for 8 weeks. Mitochondrial respiration was
32 assessed using permeabilized fibers of *Vastus Intermedius*. Mitochondrial enzymatic activities
33 were obtained through spectrophotometry while real-time qPCR was used for mRNA
34 transcripts.

35 **Results:** Overall, maximal rates of mitochondrial respiration were 18% higher ($p \leq 0.10$) in the
36 CON and ECC30 groups compared to CTRL and ECC15 with apparent K_m also significantly
37 higher than CTRL. Values for Complex I and citrate synthase activities were 1.6 (ECC15) to
38 1.8 (ECC30 and CON) times values of CTRL whereas complex IV activity was only
39 significantly higher than CTRL for CON (129%) and ECC30 (86%). A disconnect between
40 changes in markers of mitochondrial function and mRNA transcripts was seen with eccentric
41 training exerting significant differences in mitochondrial regulatory elements but not
42 biogenesis.

43 **Conclusions:** Results confirm that irrespective of exercise modality, metabolic overload
44 governs mitochondrial function adaptations to endurance training but our observations also

45 suggest that cytoskeleton mechanical signaling resulting from eccentric contractions operate
46 within a different damage-repair/adaptive response window.
47 **KEY WORDS:** Aerobic training; Eccentric exercise; Mitochondrial respiration; Mitochondrial
48 enzymatic activities; Gene expression.

49 **INTRODUCTION**

50 Exercise-induced adaptations involve specific signaling mechanisms enabling enhanced levels
51 of gene transcription to support the synthesis of proteins expressed in wide range of
52 morphological, histological and metabolic changes (1, 2). Mitochondria appears as major actors
53 of these adaptive responses to training on account of their essential role in ATP production.
54 Mitochondrial biogenesis, improved oxidative capacities, and changes in mitochondrial protein
55 content are predominant and consistent expressions of muscle biological adaptability to
56 conventional using large muscle mass dynamic concentric endurance exercise training (2-4).
57 The extent to which these adaptations occur and translate to an improvement in peak aerobic
58 capacity are highly intensity-dependent, limiting the potential impact for populations with
59 physical limitations.

60 Dynamic eccentric exercise provides an interesting alternative as cardiorespiratory and
61 metabolic requirements for a given mechanical load are one half to one third that of
62 conventional concentric exercise while it serves effectively to preserve muscle mass and
63 enhance strength (5-9). However, because mechanical strain on the muscle cytoskeletal
64 structures generated through an eccentric contraction is higher than that during concentric force
65 generation, it also results in greater lesions and micro-tears (10,11). Whereas repeated eccentric
66 exercise is known to stimulate myogenic growth, how it impacts and drives signaling pathways
67 for mitochondrial adaptation is not well established.

68 To date only a few studies have examined the impact of eccentric contractions on skeletal
69 muscle mitochondrial function. Two of these used an animal model of treadmill running to
70 contrast the impact of uphill (concentric) and downhill (eccentric) running on skeletal muscle
71 oxidative capacity, mitochondrial respiration and regulatory control mechanisms (12,13). A
72 third compared locomotor adaptations in patients with chronic obstructive pulmonary disease

73 after conventional and eccentric cycle ergometry training (14). Results from the latter study
74 showed the 10-week eccentric regimen but not the concentric to significantly enhance thigh
75 muscle mass and isometric peak strength but no impact on mitochondrial biogenesis, content
76 or respiration was seen after either program. The two animal studies originating from the same
77 laboratory provided evidence for the role of muscle specificity and the interplay of muscle
78 oxidative responses and mitochondrial reactive oxygen species in the adaptive response to
79 concentric and eccentric exercise training (12, 13). Results showed that despite having
80 completed the similar amount of mechanical work after 20 days of training, a significant
81 increase in oxidative capacity markers was only seen in the muscles used for concentric
82 exercise. Conversely, a significant increase in mitochondrial H₂O₂ production, a potential signal
83 for mitochondrial adaptation, was only seen in the *Vastus Intermedius* muscle, and only after
84 eccentric exercise (12).

85 The interpretation of these findings is however complicated by differences and inequalities in
86 the nature and magnitude of skeletal muscle metabolic and mechanical overloads imposed by
87 the two training modalities. In the present study, the downhill (eccentric) and uphill treadmill
88 running model, previously used to create conditions of iso-metabolic and iso-mechanical power
89 (6), was used to lessen interference from these confounding factors. This model has also
90 recently been effectively used in our laboratory to contrast the impact of eccentric and
91 concentric exercise training on rat body composition and energy expenditure (15).

92 Using experimental conditions of cross-modalities equivalencies for both exercise oxygen
93 demand (iso-VO₂) and mechanical power output (iso-power), we compared effects of
94 concentric and eccentric training on muscle mitochondria respiration, enzymes activities and
95 intracellular signaling as reflected by selected gene expression. In keeping with fundamentals

96 principals of bioenergetics, we hypothesized that exercise training at iso-VO₂ would have the
97 same impact on mitochondrial function irrespective of modality.

98 **METHODS**

99 Experimental Protocol and Procedures

100 *Institutional Approvals, Animals and Housing*

101 All procedures were approved by institutional and national regulating authorities for animal
102 care and research ethics (Ethics Committee C2EA-02, Auvergne, France). Sixty male Wistar
103 rats (Janvier Labs, Le Genest-Saint-Isle, France), aged 9 weeks and weighing 300-360g upon
104 arrival, were individually housed in a temperature and light controlled room maintained at
105 22±3°C on a reverse 12:12 light-dark cycle. Rats were fed ad libitum with a commercial rat
106 chow (A04, Safe Diets, Augy, France) and had free access to water.

107 *Randomization and Experimental Conditions*

108 As described elsewhere, the study was completed over an 8-week period (15). Briefly, animals
109 were randomly assigned to one of the four following groups (n = 15 per group): 1) control
110 (CTRL), 2) uphill-running at a slope of +15% (CON), 3) downhill-running at a slope of -15%
111 (ECC15), 4) downhill-running at a slope of -30% (ECC30).

112 Animals assigned to an exercise group ran on a 10-lane treadmill (Quinton Instruments, Seattle,
113 WA) at a speed of 15 m·min⁻¹. Exercise training duration was progressively increased from 5
114 to 45 min during the first week and maintained at 45 min per session for the remaining 7 weeks
115 (**Figure 1**). Training frequency was five times per week, on five consecutive days with two
116 consecutive days of rest per week. The CTRL animals did not undergo any particular
117 intervention but were manipulated and investigated in a similar fashion as the exercise-trained
118 animals.

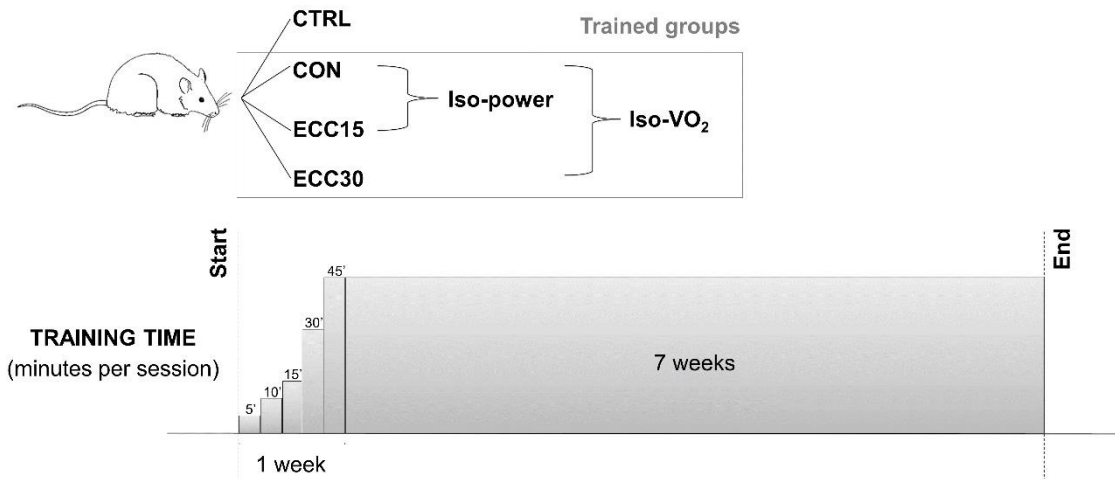

119 **FIGURE 1 - Study design and protocol.** CTRL: control group, no exercise intervention; CON: uphill-
 120 run training at a slope of +15%; ECC15: downhill-run training at a slope of -15%; ECC30: downhill-
 121 run training at a slope of -30%. Training at the same mechanical power (iso-power) was carried out by
 122 CON and ECC15; training at the same VO_2 (iso- VO_2) was carried out by CON and ECC30. Training
 123 duration was progressively increased over the five exercise sessions of the first week to reach 45 minutes
 124 by week 2. This duration was maintained throughout the rest of the experimental protocol.

126 At the end of the 8-week period, and 48h after the last training session, animals were
 127 anesthetized by inhalation of 3% isoflurane and $1 \text{ L} \cdot \text{min}^{-1} \text{ O}_2$ in an induction box and
 128 exsanguinated. The *Vastus Intermedius* muscles were collected and cut into 50mg portions
 129 immediately frozen at -80°C for subsequent enzymology and RNA analyzes. In a subset of six
 130 animals per group, a few milligrams of muscles were placed in a preservation solution for
 131 further preparation and mitochondrial respiration analyzes on fresh tissue.

132 Analyses and Measurements

133 *Body characteristics*

134 Animal total mass and lean body mass were recorded at baseline and after completion of the 8-
 135 week training program (EchoMRITM, Echo Medical Systems, Houston, TX).

136 *Mitochondrial Analyses*

137 *Mitochondrial respiration*

138 Mitochondrial function was examined using a water-jacketed oximeter equipped with a Clark-
139 type electrode (Strathkelvin Instruments). Muscle fibers were mechanically separated on ice
140 using dissecting microforceps (16). Bundles fiber were permeabilized for 30 minutes at +4°C
141 with 50 $\mu\text{g}\cdot\text{mL}^{-1}$ of saponin added to solution S (2.77mM of CaK₂EGTA, 7.23mM of K₂EGTA,
142 6.56mM of MgCl₂, 20mM of taurine, 0.5mM of dithiothreitol, 50mM of potassium
143 methanesulfonate, 20mM of imidazole, 5.7mM of Na₂ ATP and 15 mM of creatine phosphate).
144 Skinned muscle fibers were washed in solution R (2.77mM of CaK₂EGTA, 7.23mM of
145 K₂EGTA, 6.56mM of MgCl₂, 20mM of taurine, 0.5mM of dithiothreitol, 50mM of potassium
146 methanesulfonate, 20mM of imidazole, 5mM of glutamate, 2mM of malate, 3mM of phosphate,
147 and 2 mg $\cdot\text{mL}^{-1}$ of fatty acid-free bovine serum) and transferred in a 22°C oxygraphic chamber
148 containing room air saturated oxygen concentration solution.

149 After determination of basal O₂ consumption ($V_{0\text{GM}}$) using glutamate (5mM) and malate (2mM)
150 as substrates, mitochondrial respiration was measured at increasing concentrations of ADP
151 (from 2.5 μM to 1.5mM). Maximal O₂ consumption (V_{maxGM}) was assessed with a saturating
152 ADP concentration (2 mM). Respiration rates were expressed in $\mu\text{mol O}_2\cdot\text{min}^{-1}\cdot\text{g}^{-1}$ dry weight.
153 At the end of each experiment, cytochrome c was added to confirm the outer mitochondrial
154 membrane integrity. In addition, the acceptor control ratio (ACR) reflecting coupling between
155 oxidation and phosphorylation with complex I substrates was computed from the respiration
156 rates as V_{max}/V_0 . The apparent Km of mitochondria for ADP was determined using nonlinear
157 regression of the individual relationships between ADP concentration and corresponding O₂
158 consumption level, using a Lineweaver–Burk plot (17).

159 *Mitochondrial Enzymatic Assays*

160 Proteins were extracted from 10mg of pulverized frozen muscle and 500 μ L of the extraction
161 buffer (120mM of KCl, 20mM of HEPES, 2mM of MgCl₂, 1mM of EGTA, 5mg·mL⁻¹ of BSA,
162 pH 7.4). After homogenization on a bead mill, 500 μ L of hypotonic media (25mM potassium
163 phosphate) were added. Homogenates were submitted to three rounds of freeze-thaw in liquid
164 nitrogen before being centrifuged at 600g and 4°C for 10min. The supernatant was recover in
165 clean tubes for assays and the total protein dosage made with the Micro BCA Protein Assay Kit
166 according to manufacturer's recommendations (ref. 23235, Thermo Scientific). All
167 spectrophotometric measurements were performed using a 96-well plate reader (POLARstar
168 Omega, BMG Labtech) and enzymes assays expressed in mU·mg⁻¹ of proteins.

169 Complex I Activity

170 Complex I assays were performed using 8 μ g of proteins and 200 μ L of reagent mix (per mL:
171 500 μ L of Tris buffer at pH 8.0, 20 μ L of BSA, 5 μ L of decylubiquinone, 12,5 μ L of KCN, 2 μ L
172 of antimycin A, 2 μ L of NADH, 500 μ L of water). Before each use, the reagent mix was heated
173 to 30°C in water bath. The kinetic of decrease in absorbance was recorded at 340nm and 30°C.
174 At the end of reading, 4 μ L of rotenone were added and the plate reading ran again to measure
175 slope after complex I inhibition. Complex I activity is obtained by subtracting the slope after to
176 the slope before rotenone add. All samples were run in triplicate.

177 Complex IV Activity

178 Complex IV assays were performed using 2 μ g of proteins and 200 μ L of reagent mix (per mL:
179 500 μ L of 100mM potassium phosphate buffer at pH 7.0, 1 μ L of cytochrome C, 10 μ L of
180 dodecylmaltoside 10%, 500 μ L of water). Before each use, the reagent mix was heated to 30°C
181 in water bath. The kinetic of decrease in absorbance was recorded at 550nm and 30°C. Complex
182 IV activity is obtained by measuring the slope. All samples were run in triplicate.

183 Citrate Synthase Activity

184 Citrate synthase assays were performed using 1µg of proteins, 7µL of oxaloacetic acid and
185 200µL of reagent mix (per mL: 500µL of 200mM Tris buffer at pH 7.4, 20µL of acetyl-CoA,
186 20µL of DTNB, 10µL of triton X-100 10%, 500µL of water). Before each use, the reagent mix
187 was heated to 30°C in water bath. The kinetic of increase in absorbance was recorded at 412nm
188 and 30°C. Citrate synthase activity is obtained by measuring the slope. All samples were run in
189 triplicate.

190 *RNA Isolation, Reverse Transcription and Gene Expression*

191 Ribonucleic acids (RNA) were extracted from 50mg of *Vastus Intermedius* muscle using 1mL
192 of TRI Reagent (ref. 15596, Invitrogen). 0.2mL of chloroform was added to the homogenate
193 and samples were mixed and centrifuged for 15min at 14000rpm at 4°C. The aqueous phase
194 containing RNA was collected, mixed with 0.5mL of isopropanol, incubated at least 30min at
195 room temperature and centrifuged (14000rpm, 4°C, 15min). After centrifugation, the
196 supernatant has been removed and the pellet washed with 1mL of ethanol 75%, dried and
197 resuspended in 30µL of sterile autoclaved water.

198 RNA concentration and purity were assessed by spectrophotometry using optical densities (OD)
199 at 260 and 280nm (NanoDrop Lite, Thermo Scientific). Quality was judged good if the results
200 of OD_{260} / OD_{280} ratios were between 1.8 and 2. On the other hand, extraction quality and RNA
201 integrity was confirmed after 2µg sample migration on an 1.5% agarose gel. Gel images were
202 observed and the absence of RNA degradation (well-defined RNA bands), and of contaminating
203 DNA has been checked (GelDoc2000, Bio-Rad).

204 Diluted RNAs (5µg/12µL of sterile autoclaved water) were used for reverse transcription (RT).
205 Samples, to which 1µL of dNTP (ref. 18427, Invitrogen), 0.5µL of oligo dT (ref. 18418,

206 Invitrogen) and 0.5 μ L of random primers (ref. 48190, Invitrogen) were added, were heated to
 207 65°C for 5min (SimpliAmp Thermal Cycler, Applied Biosystem). First strand buffer 5x (4 μ L)
 208 and DTT (1 μ L) were then distributed. After 2min at room temperature, 1 μ L of Superscript III
 209 Reverse Transcriptase (ref. 18080, Invitrogen) was added. The tubes stripes were again placed
 210 in the thermocycler, this time for 1h at 50°C followed by 15min at 70°C. The RT products were
 211 diluted (1/60), aliquoted and used for real-time quantitative polymerase chain reaction (RT-
 212 qPCR).

213 PCRs were prepared and distributed on rotor-disc 100 by QIAgility robot (Qiagen), using
 214 specific primers purchased from Sigma-Aldrich and Rotor-Gene SYBR Green PCR Kit (ref.
 215 204076, Qiagen), and the disc sealed before moving to next step (Rotor-Disk Heat Sealer,
 216 Qiagen). All gene primer pairs are summarized in **Table 1**. Cycling were achieved with Rotor-
 217 Gene Q (Qiagen) and conditions set as follow: 95°C for 5min and 40 cycles of 95°C for 6s,
 218 60°C for 10s, and finally a ramp from 65 to 99°C. At the end of each run, the reaction specificity
 219 has been checked using the dissociation curves provided by the computer program (Rotor-Gene
 220 Q Series Software 2.3.1).

221 **TABLE 1 - Primer and probe sequences used in comparative real-time RT–quantitative PCR.**

Gene	GenBank ID	Forward	Reverse
Rplp0	NM_022402.2	CTGGCTTTGTCTGTGGAGACT	CGACTCTTCCTTTGCTTCGAC
Ppargc1a	NM_031347.1	AGAGTCACCAAATGACCCCAAG	GGCTTTATGAGGAGGAGTCGTG
Tfam	NM_031326.1	TTCCAGGGGGCTAAGGATGA	CACACTGCGACGGATGAGAT
Cs	NM_130755	CAAGGAAAGGCTAAGAACCCT	CGACACTCCGAACAGGACT
Ndufs1	NM_001005550.1	GCCTTATGCCTTTACTGCCC	TACCTCTCCAGTTCTTGTGCT
SdhA	NM_130428.1	CACTCGGGCTGGTTTACCTT	TGGCAACAGGGGCATATCTC
Cyc1	NM_001277194.1	TCCTCCCATCTACACAGAAGTC	CAGCAGCAAGCCCATCATCAA

Cox4i1	NM_017202.1	TTCCAGGGATGAGAAAGTCCAA	TCAAAGGTATGAGGGATGGGGC
Atp5f1a	NM_023093.1	CTTGGGGTCATCTTTTGTGGT	AGAATGGAGGACATCTCGGCA
Slc25a4	NM_053515.1	TGCCAGACCCCAAGAATGTG	CAGTCAACTGTCCCCGTGTA
Ckm	NM_012530.2	AGCAAGCACCCCAAGTTTGA	TTTACGCCATCCACCACCAG
Ckmt2	NM_001127652.1	AACCTCGGAACTGGATTGCG	GGAAATGTCGTACACGTCGG
Sod2	NM_017051.2	TGAACAATCTGAACGTCACCG	CCTTAGGGCTCAGGTTTGTC
Mcu	NM_001106398.1	CTCCACGGGGATAGACCTCC	GACCAGCGTCTTCACATCGT
Ppid	NM_001004279	CAGAATGGGACAGGTGGAGA	TGAGGAGTTGGAAGTGTGTG

222 Atp5f1a: Adenosine triphosphate synthase F1 subunit alpha, Ckm: creatine kinase M-type, Ckmt2: creatine kinase
223 mitochondrial 2, Cs: citrate synthase, Cox4i1: cytochrome c oxidase subunit 4i1, Cyc1: cytochrome c-1, Mcu: mitochondrial
224 calcium uniporter, Ndufs1: NADH:ubiquinone oxidoreductase core subunit S1, Ppargc1a: peroxisome proliferator-activated
225 receptor gamma coactivator 1 alpha, Ppid: peptidylprolyl isomerase D, Rplp0: ribosomal protein lateral stalk subunit P0
226 (reference gene), Sdha: succinate dehydrogenase complex flavoprotein subunit A, Slc25a4: solute carrier family 25 member 4,
227 Sod2: superoxide dismutase 2, Tfam: transcription factor A, mitochondrial.

228 Rn18s, Hprt and Rplp0 were all tested as reference genes, but Rplp0 was chosen for its
229 intergroup stability. RNA expression data were processed using the $2^{-\Delta\Delta C_T}$ method (18) as
230 follow:

- 231 1) for each studied gene, the threshold has been set and the corresponding cycle threshold
232 (C_T) values exported to a spreadsheet;
- 233 2) for each sample, C_T was normalized to the reference gene as $\Delta C_T, \text{ sample} = C_T, \text{ sample}$
234 $- C_T, \text{ reference gene}$;
- 235 3) then, each sample was expressed relative to a calibrator (*i.e.* an untreated control) as
236 $\Delta\Delta C_T, \text{ sample} = \Delta C_T, \text{ sample} - \Delta C_T, \text{ calibrator}$;
- 237 4) finally relative quantification (RQ) was calculated as $RQ = 2^{-\Delta\Delta C_T}$.

238 Statistics

239 *Sample size*

240 The sample size was determined based on the CONSORT 2010 statement (19), the Cohen's-J
241 recommendations (20), and the preliminary results achieved by our team. The number of 15
242 animals per group was selected to highlight an effect size around 1.5 for a two-sided type I error
243 at 0.008 (correction for multiple comparisons) and a statistical power at 90% for our primary
244 endpoint.

245 *Statistical analyses*

246 Statistical analyses were performed using Stata software (version 13, Stats Corp, College
247 Station, Texas, United States of America). Values were expressed as mean \pm SEM. Statistical
248 significance was set for a type-I error of 0.05. Variables were compared between groups by
249 ANOVA or Kruskal-Wallis tests when assumptions required for the ANOVA were not met
250 (normality and homoscedasticity analyzed using the Bartlett test). When appropriate (omnibus
251 p-value $<$ 0.05), a post-hoc test to take into account multiple comparisons was performed:
252 Tukey-Kramer post ANOVA and Dunn after Kruskal-Wallis test.

253 **RESULTS**

254 Pre- and post-training animal characteristics

255 Total body mass and lean body mass values measured at baseline and after 8 weeks of
256 intervention are shown in **Table 2**. As can be seen, baseline values were not different between
257 groups. After completion of the training program, a significant increase from baseline values is
258 seen for total and lean body mass in all groups, which is consistent with the continuous rodent
259 growth model. At the end of the training period, results indicate no difference between control
260 and trained groups for total body mass. However, lean body mass was higher in ECC15 and
261 ECC30, not in the CON-trained group, when compared to CTRL. There was no significant
262 difference in lean mass between CON and ECC trained groups.

263 **TABLE 2 – Animal body characteristics.**

	Total body mass		Lean body mass	
	Baseline	After training	Baseline	After training
CTRL	439.8 ± 10.81	535.0 ± 10.78 §	352.4 ± 7.25	417.8 ± 8.94 §
CON	443.7 ± 15.41	528.9 ± 12.39 §	351.4 ± 12.13	428.9 ± 10.75 §
ECC15	440.4 ± 9.67	537.4 ± 8.16 §	345.7 ± 7.86	434.6 ± 6.23 §*
ECC30	425.2 ± 15.32	540.4 ± 7.54 §	343.4 ± 10.53	445.0 ± 6.15 §*

264 Values are mean ± SEM. *P < 0.05 from CTRL; §P<0.05 from the start.

265 Mitochondrial function

266 Mitochondrial basal (V_{0GM}) and maximal (V_{maxGM}) rates of respiration using glutamate and
 267 malate as substrates expressed in $\mu\text{mol O}_2 \cdot \text{min}^{-1} \cdot \text{g}^{-1}$ dry weight and measured at the end of the
 268 8-week training program are shown in **Figures 2A** and **B**. As can be seen, there was no
 269 statistical difference in V_{0GM} between CTRL and exercise-trained groups. For V_{maxGM} (ADP
 270 stimulated state), overall one-way ANOVA results showed a P=0.10 value for the higher values
 271 seen in the CON and ECC30. Results for apparent K_m are represented in **Figure 2C**. Higher
 272 values were seen in all exercise-trained groups compared to CTRL but statistical significance
 273 was only reached for CON and ECC30. Computation of the ACR (V_{max}/V_0) expressed as mean
 274 ± SEM revealed no difference between groups (CTRL: 3.65 ± 0.22 ; CON: 3.62 ± 0.13 ; ECC15:
 275 3.31 ± 0.16 ; ECC30: 3.70 ± 0.09).

276

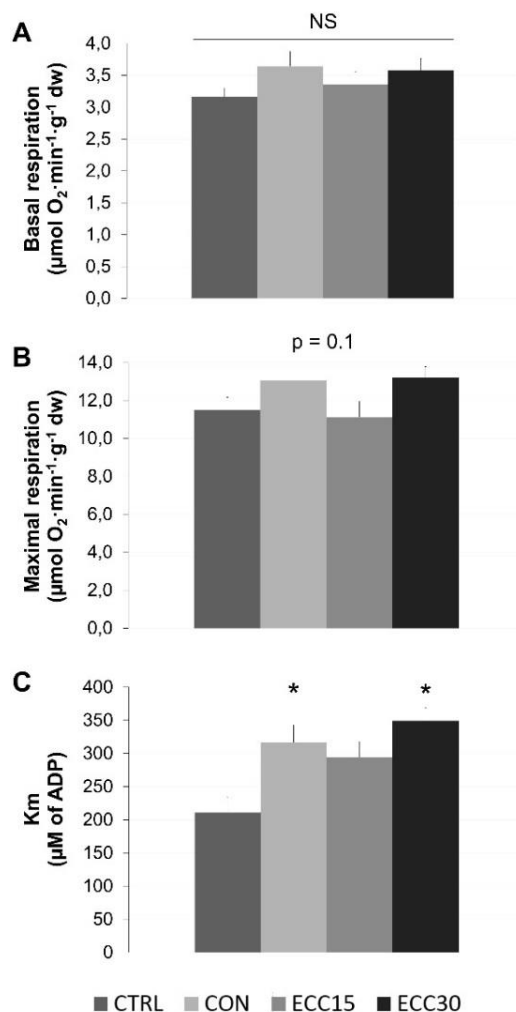

277

278 **FIGURE 2 – Mitochondrial respiration parameters.** (A) Basal mitochondrial respiration measured
 279 with glutamate and malate as substrates (V_{0GM} , $\mu\text{mol O}_2 \cdot \text{min}^{-1} \cdot \text{g}^{-1}$ dry weight). (B) Maximal
 280 mitochondrial respiration measured after the addition of ADP (V_{maxGM} , $\mu\text{mol O}_2 \cdot \text{min}^{-1} \cdot \text{g}^{-1}$ dry weight).
 281 (C) Apparent K_m of the mitochondria for ADP (μM). Values are mean \pm SEM. * $P < 0.05$ from CTRL;
 282 NS: non-significant difference between groups.

283 Mitochondrial Enzymes Activities

284 Mitochondrial respiratory chain enzymes activities measured after the training period are
 285 presented in **Table 3**. Complex I and citrate synthase activities were statistically different from
 286 CTRL for all exercise trained groups while statistical significance for a higher Complex IV
 287 activity groups compared to CTRL was reached only for CON and ECC30 but not ECC15.

288 **TABLE 3 – Mitochondrial enzymes activities.**

	Complex I ($\mu\text{U}\cdot\text{mg}^{-1}$ of proteins)	Complex IV ($\mu\text{U}\cdot\text{mg}^{-1}$ of proteins)	Citrate synthase ($\mu\text{U}\cdot\text{mg}^{-1}$ of proteins)
CTRL	0.5 \pm 0.06	2.1 \pm 0.25	2.1 \pm 0.22
CON	0.9 \pm 0.12 *	4.8 \pm 0.53 *	3.7 \pm 0.45 *
ECC15	0.8 \pm 0.08 *	3.1 \pm 0.45	3.8 \pm 0.33 *
ECC30	0.9 \pm 0.08 *	3.9 \pm 0.35 *	3.4 \pm 0.36 *

289 Values are mean \pm SEM. *P < 0.05 from CTRL.

290 Mitochondrial Related Genes Expression

291 The relative quantification of several mitochondrial-related mRNAs is shown in **Figure 3 A-**
 292 **D. Panel A** represent values for transcription coactivator peroxisome proliferator-activated
 293 receptor gamma (PPAR γ), coactivator 1-alpha also known as PGC- α and mitochondrial
 294 transcription factor A (Tfam) that are major regulators of mitochondrial biogenesis and
 295 transcription in skeletal muscle. Results show significantly lower PGC1- α mRNA content in
 296 both CON and ECC15 groups compared to CTRL with no difference between concentric and
 297 eccentric trained groups be it ECC15 or ECC30. Levels of Tfam mRNA were not significantly
 298 different from CTRL but the mean value for ECC30 was higher than that of CON.

299 **Panel B** shows mRNA quantification for selected indicators of oxidative phosphorylation
 300 respiratory chain complexes correspond to one key subunit of each respiratory chain complex
 301 implicated in oxidative phosphorylation. Results generally show no significant differences
 302 between groups for any of these indicators, except for expression of Complex II succinate
 303 dehydrogenase complex flavoprotein subunit A (SDHa) which was found to be significantly
 304 higher in ECC30 group compared to CON.

305 Results of quantitative PCR associated with inner mitochondrial membrane ADP/ATP
306 translocation and network transport are shown in **panel C**. Solute carrier family 25-member 4
307 gene coding for adenine nucleotide translocase-type 1 (ANT1) was significantly higher in
308 ECC30 than in CTRL group. Relative quantification of muscle creatine kinase (CKm) mRNA
309 was not significantly different between groups, whereas mitochondrial creatine kinase (CKmt2)
310 was higher in ECC30 compared to both CTRL and the CON groups and in ECC15 significantly
311 higher compared to CTRL.

312 Finally, mRNA encoding for citrate synthase (CS), superoxide dismutase 2 (SOD2),
313 mitochondrial calcium uniporter (MCU) and Cyclophilin D or peptidylprolyl isomerase D
314 (PPID) proteins are illustrated in **panel D**. No significant difference between groups is seen for
315 CS while the expression of SOD2, a marker of antioxidant capacity, is found to be higher in the
316 ECC30 group compared to CTRL although the magnitude of difference remained above
317 $P < 0.05$. MCU complex mRNA was not seen to be significantly higher from CTRL in any of
318 the exercise-trained groups but statistical significance was found for the lower value observed
319 in the CON-trained group compared to the ECC15 group. Expression of PPID was significantly
320 higher in the ECC30-trained group compared to CTRL but also when compared to the CON
321 and ECC15 trained groups.

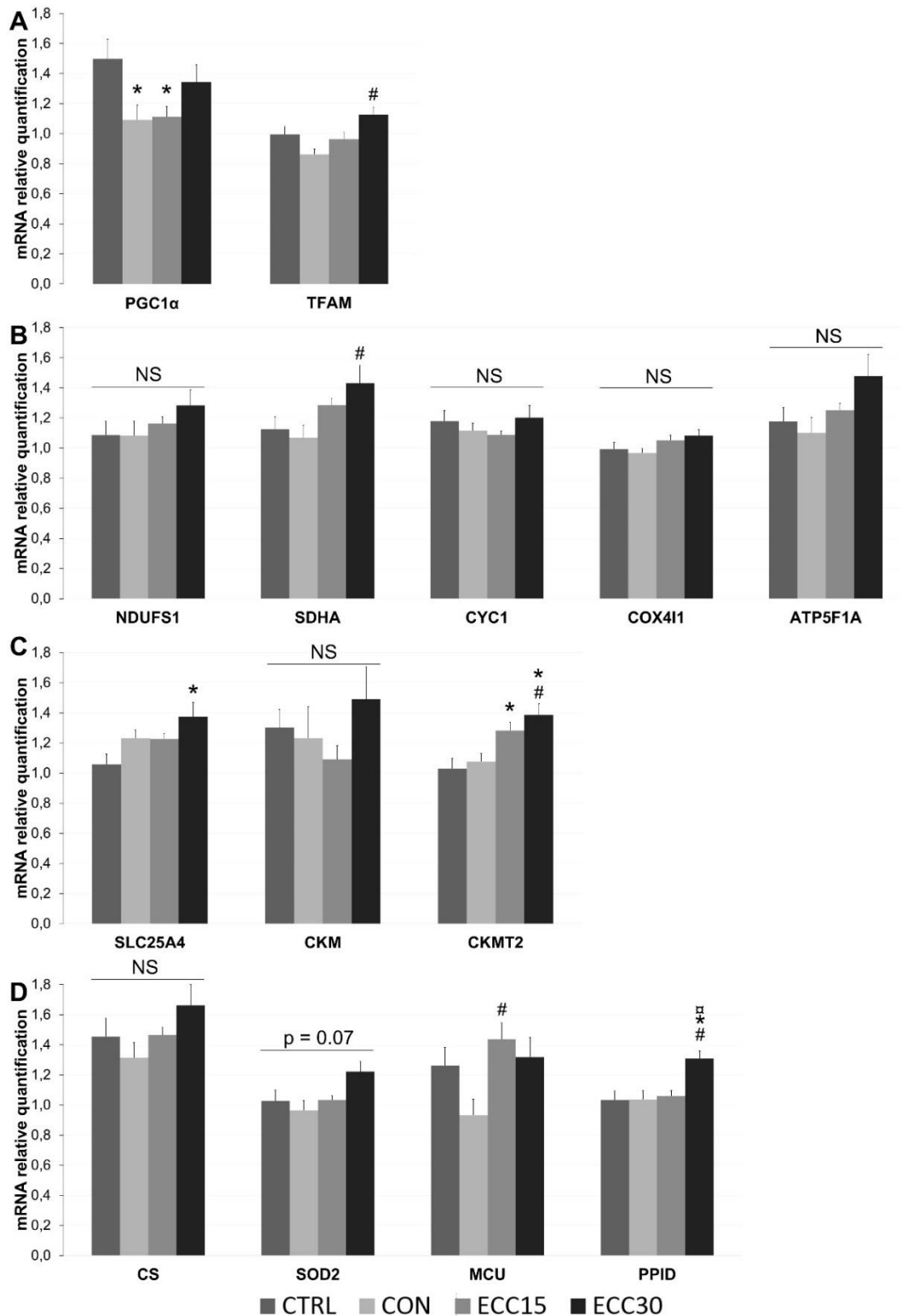

322

323 **FIGURE 3 – mRNA expression.** (A) Mitochondrial biogenesis. (B) Mitochondrial respiratory chain.
 324 (C) Mitochondrial and cellular energy transport. (D) Mitochondrial regulatory control elements. Values
 325 are mean \pm SEM. *P<0.05 from CTRL; #P<0.05 from CON; ⊠P<0.05 from ECC15; NS, non-significant
 326 difference between groups.

327 **DISCUSSION**

328 Main Findings

329 In support of the working hypothesis, the present findings establish that skeletal muscle
330 metabolic overload is the primary factor governing the extent of exercise training-induced
331 skeletal muscle mitochondrial respiration adaptive responses. Results however show a
332 disconnect between changes in markers of mitochondrial function and post-translational
333 mitochondrial gene expression transcripts. Our findings suggest that the greater mechanical
334 cytoskeletal disruption caused by eccentric contraction may interfere with the repair/damage
335 adaptive sequence such as to counter stimulus induction and translation.

336 Exercise training effectiveness

337 At the end of training, animals from both downhill running groups but not the uphill running
338 group showed significantly higher lean body mass compared to CTRL animals. Because a
339 significant difference in total body mass was not seen between groups, a lower fat mass
340 concomitant with the observed higher lean body mass can be inferred. These results are in
341 keeping with previous findings of higher lean body mass and bone density from our laboratory
342 using the same exercise-training model (15). Eccentric contractions have been shown to be
343 particularly effective for skeletal muscle growth and hypertrophy (2) not only through resistive
344 training but also using low-moderate endurance type training (21). Thus, although the metabolic
345 demands of the ECC15 training group was lower, the greater mechanical constraints of
346 eccentric contraction stimulate myogenic and osteogenic activities leading to body
347 compartment remodeling (15). Similarly, the present results for eccentric show that, even if of
348 a lower intensity than that of CON, this training modality resulted in markedly higher values

349 for K_m and mitochondrial enzyme activities compared to CTRL indicating its overall
350 effectiveness.

351 Impact of training modality on markers of mitochondrial function

352 To our knowledge, the present study is the first to compare the impact of concentric and
353 eccentric training designed for cross-modality equivalence in metabolic and mechanical power,
354 on skeletal muscle mitochondrial function adaptations.

355 Direct skeletal muscle remodeling and global function improvements including cellular and
356 mitochondrion functions are well-known exercise training outcomes resulting from an
357 integrated regulation of protein content and enzymatic activities in response to the repeated
358 intracellular environment perturbations (3, 22).

359 The working hypothesis from the present study is anchored in the notion that irrespective of the
360 modality of contraction, intracellular bioenergetic perturbations should be the same for
361 equivalent level of metabolic demands and should therefore induce a similar adaptive response.

362 The mitochondrion is particularly sensitive to perturbations such that discrete changes in
363 myocellular energy status induces a signaling cascade leading to mitochondrial biogenesis (3).

364 Among the many parameters reflective of mitochondrial function, the most common are basal
365 (V_0 or state 4), and maximal (V_{max} or state 3) ADP-stimulated rates of respiration and its related
366 apparent K_m , as well as the ACR reflecting the degree of coupling between oxidation and
367 phosphorylation with complex I substrates and computed as V_{max}/V_0 (23).

368 Results from this study show higher CS and complex I activities in all groups of trained
369 compared to untrained animals while a significant increase in complex IV activity was seen
370 only in the ECC30 and CON trained groups. Similarly, differences in apparent K_m for ADP
371 only reached significance in the CON and the ECC30 groups indicating markers of

372 mitochondrial function to be impacted to the same extent by the iso-VO₂ higher metabolic
373 demands training regimen. A similar pattern is also observed for maximal rate of respiration
374 although difference comparisons did not reach statistical significance.

375 Although markedly higher than that of CTRL, mitochondrial respiratory parameters values did
376 not reach statistical significance when compared to CTRL perhaps suggesting an insufficient
377 stimulation. Using a similar model of eccentric and concentric treadmill running at -15 or +15
378 grades results from Isner-Horobeti et al. (2014) showed that *Vastus Lateralis* V_{GM-ADP} was not
379 impacted after either 5 or 20 days of either concentric or eccentric running (12). In addition to
380 the shorter overall training duration, the exercising metabolic demand incurred by animals in
381 their study was lower compared to that in the present study on account of the lower running
382 speed. Using a similar approach, Daussin et al. (2012) contrasted three groups of animals
383 trained concentrically using daily 30-minute sessions of uphill treadmill running (+15% grade;
384 26 m.min⁻¹) for 1, 5 and 10 days to provide insight into the time course of mitochondrial
385 adaptations (24). In contrast to findings from Isner-Horobeti study after 20 days of concentric
386 training, their results showed higher respiration rates with complex I and complex II substrates
387 after 10 days of uphill running. The difference in findings may be explained by the higher
388 running speed used in the latter study, amounting to a higher metabolic demand for each
389 exercise bout. Similar to the present observations for the CON trained group, results from
390 Daussin et al. also showed significantly higher citrate synthase activity after both 5 and 10 days
391 of training.

392 In a study following-up from Isner Horobeti et al. investigators examined the impact of 20 days
393 of concentric, eccentric and combined concentric-eccentric exercise training performed under
394 conditions aiming for 80% peak modality specific measured running VO₂ in all groups (13).
395 Considering the lower oxygen cost of eccentric contraction, the mechanical load required to

396 match the VO_2 was substantially higher, as seen by the nearly doubled treadmill speed for
397 animals running downhill as compared to uphill. Results showed maximal rate of mitochondrial
398 respiration to be significantly impacted only in the group of animals running uphill or
399 concentrically-trained despite the similar relative training intensity. Using high intensity
400 interval eccentric training, Molnar et al (2006) examined the impact of both acute and chronic
401 (8 weeks) high speed downhill running on mitochondrial function of rat quadriceps muscles
402 (25). Their results showed that state 3 mitochondrial respiration rate was not different from
403 CTRL animals after either the acute bout of eccentric exercise or the chronic exercise program.
404 In the latter study, although the speed was higher, the negative treadmill slope of 7° was half
405 that of the study by the Isner-Horobeti et al. group and four times lower than that used in our
406 ECC30 group.

407 Taken together these observations may be found to support the working hypothesis that
408 metabolic intensity acts as the predominant trigger for mitochondrial adaptations. Thus,
409 irrespective of contraction mode, the absolute exercise stimulus intensity and its related
410 metabolic consequences on intra-cellular energy status and/or oxidative stress dictate the
411 mitochondrial respiration adaptive response. Over recent years, evidence has been
412 accumulating that mitohormesis, the ability of the mitochondria to trigger significant adaptive
413 response signaling pathways to restore and improve function may operate to govern adaptations
414 to aerobic training (26). Mitohormesis is however highly dependent on respecting an
415 appropriate balance between adaptative and disruptive activation factors. The extent to which
416 the mitohormetic effects of aerobic exercise are expressed and translated effectively across
417 exercise training modalities remains incompletely documented.

418 Cellular and molecular mechanism of mitochondrial adaptation

419 At a molecular level, intense prolonged exercise is known to increase the rates of oxygen and
420 nitrogen reactive species production activating a large number of antioxidant and other
421 cytoprotective enzyme systems as well as those responsible for enhancing mitochondrial
422 biogenesis and function (3, 22, 27). A detailed description of mechanisms by which acute and
423 chronic aerobic exercise promote skeletal muscle fiber hypertrophy and mitohormetic
424 adaptations may be found in several recent publications (4, 28).

425 In the present study, significant differences from CTRL are seen for some but not all markers
426 of mitochondrial biogenesis and function. The disconnect between mitochondrial biological
427 and biogenetic responses is in keeping with numerous current reports showing widely variable
428 mRNA transcript responses. Using a multi-array approach Mueller et al. (2011) examined gene
429 expression profiles of a large number of markers of interest in the *Vastus Lateralis* before and
430 after 12 weeks of eccentric ergometry or conventional resistance training in 80-year-old adults
431 (29). Results showed 60 of the 178 analyzed muscle-specific mRNA transcripts to be
432 significantly changed with training and 29 to be impacted exclusively by eccentric training and
433 four affected by resistance training. This is also illustrated by contrary reports of either no
434 change, increases and decreases following endurance training in both rodents and humans for
435 several markers of mitochondrial protein synthesis such as PGC-1 α ,TFAM (14, 24, 30, 31),
436 CS mRNA (32), SOD (33) or CKm (34). The heterogeneity of response could be due to
437 differences in timing of mitochondrial mRNA transcript response curves as transient changes
438 in transcriptomes have also been described after a single bout of both eccentric and concentric
439 cycling showing a significant depression of a large number of metabolic gene transcripts such
440 as complex IV subunit (COX5b) over a 24-hour period (35). It could also be related to inter-
441 related factors affecting the degree and the damage-repair modulation sequence induced by the
442 training stimulus. Examining the time course of endurance training-induec mitochondrial

443 respiration and respiratory chain electron flux modulations through observations at days 1, 5 or
444 10 (24).

445 Taking into account such confounders, common practice is to consider patterns of responses
446 rather than to target a single master regulator or to examine single isolated mRNA transcripts
447 markers (3, 36). General profiles have been described and pathways defined, for “resistance”
448 or “strength” as compared to “aerobic” or “endurance” training, which signals may act
449 concurrently to up-or down-regulate protein synthesis (22, 28, 29). For aerobic exercise
450 training, increased expression of mitochondrial and nuclear genes encoding for mitochondrial
451 biogenesis proteins occur through the AMPK-p38 MAPK-PGC1- α pathway triggered by
452 mitochondrial and cytoplasmic redox-sensitive regulatory signals (37).

453 In the present study, examining the global pattern of changes in mRNA transcripts indicate a
454 mitochondrial protein synthesis signature expressed through higher levels of TFAM, SDHA,
455 SLC25A4, CKMT2 and PPID in the ECC30 group when compared to CTRL. The fact that
456 similar results are not seen in CON group despite similarities in the degree of metabolic
457 perturbation may reflect persistence of a signalling factor related to the eccentric contraction
458 per se. The greater tensile forces exerted on the skeletal muscle cytoskeleton during eccentric
459 as compared to concentric contraction are known to produce greater muscle microlesions (38)
460 and presumably greater local inflammation. Increases in mRNA expression of inflammatory
461 markers measured in the *Vastus Lateralis* of recreationally trained men have been reported three
462 and 24-hours after a single 45-minute bout of strenuous treadmill downhill running (39). The
463 extent to which the degree of cytoskeletal mechanical stress and timing of the damage and repair
464 cycle modulate the adaptive responses is not clear.

465 In their wide-span study of gene expression profiles, Mueller et al. (2011) report a specific
466 response pattern for endurance and resistance-type training (29). Similarly, Zoll et al. (2006)

467 examining the impact of exercise training in heart patients found transcripts coding for
468 mitochondrial proteins to be downregulated after eccentric training while others coding for
469 repair and remodeling were enhanced (30). Under such a scenario, one might expect mRNA
470 expression levels to be blunted in eccentrically-trained animals on account of damage-related
471 downregulatory influences as compared to that seen in the concentric -trained group. Present
472 results do not support “opposite” concentric vs eccentric training mRNA transcript responses
473 since mitochondrial protein biomarkers remained undifferentiated in the CON trained group
474 when compared to CTRL. However, findings of higher MCU and PPID in ECC30 compared to
475 CON and equally in ECC15 compared to CTRL may be taken to suggest an enhanced signaling
476 influence related to the mechanical stimulus. This factor would also appear to be of particular
477 significance for the induction of mitochondrial regulatory elements such as translocation for
478 calcium channel regulation.

479 Study limitations

480 Muscle selection, stimulus intensity and timing of analysis are three factors that may limit or
481 confound the present interpretation of findings. In the present study the choice was made to
482 examine the *Vastus Intermedius* muscle because it had been shown to be involved in both
483 concentric and eccentric type contractions (40, 41). Given differences in skeletal muscle
484 phenotypes that adaptive responses could be different for the soleus or gastrocnemius muscles
485 cannot be excluded. Because running speed and grade were kept constant over the 7 of the 8
486 weeks of training, it is also possible that the intensity of the stimulus was insufficient to drive
487 a continued adaptive responses over the entire training duration and thus, a greater induction
488 impact might have been seen at an earlier time period. Nonetheless, because the same protocol
489 was used across both eccentric and concentric type training, results contrasting impact across
490 modalities remain valid, albeit with the caveat of similarity in response time. Finally, while

491 providing insight into the kinetics of mitochondrial biogenesis was not the aim of this study, it
492 is important to recognize that the time span between the last exercise bout and sacrifice may
493 influence mRNA transcript results.

494 Conclusion

495 The present results demonstrate that the intensity of the metabolic perturbation, as reflected by
496 oxygen demand, is a primary factor governing skeletal muscle mitochondrial function adaptive
497 responses. Our observations also indicate low intensity eccentric exercise modality to be an
498 effective trigger for mitochondrial function adaptations proportional to the level of aerobic
499 demands. Our findings also suggest that cytoskeleton mechanical signaling may serve as a
500 prime factor governing the modulation of mitochondrial function coupling through activation
501 of the permeability transition pore and mitochondrial calcium uniporter.

502 **ACKNOWLEDGMENT**

503 The authors thank the staff from the Experimental Animal Facility of the Human Nutrition Unit
504 (INRAE of Clermont-Ferrand) for their assistance throughout the animal protocol. The authors
505 also acknowledge the members of the ASMS team and the staff from the CRNH who
506 participated closely into the success of this project.

507 **COMPLIANCE WITH ETHICAL STANDARDS**

508 The authors certify that the results of the study are presented clearly, honestly, and without
509 fabrication, falsification, or inappropriate data manipulation. The results of the present study
510 do not constitute endorsement by the American College of Sports Medicine.

511 The authors declare no conflict of interest.

512 **REFERENCES**

- 513 1. Coffey VG, Hawley JA. The molecular bases of training adaptation. *Sports Med.*
514 2007;37(9):737–63.
- 515 2. Flann KL, LaStayo PC, McClain DA, Hazel M, Lindstedt SL. Muscle damage and muscle
516 remodeling: no pain, no gain? *J Exp Biol.* 2011;214(Pt 4):674–9.
- 517 3. Calbet JAL, Martín-Rodríguez S, Martín-Rincon M, Morales-Alamo D. An integrative
518 approach to the regulation of mitochondrial respiration during exercise: Focus on high-
519 intensity exercise. *Redox Biol.* 2020;35:101478.
- 520 4. Gan Z, Fu T, Kelly DP, Vega RB. Skeletal muscle mitochondrial remodeling in exercise
521 and diseases. *Cell Res.* 2018;28(10):969–80.
- 522 5. Minetti AE, Moia C, Roi GS, Susta D, Ferretti G. Energy cost of walking and running at
523 extreme uphill and downhill slopes. *J Appl Physiol.* 2002;93(3):1039–46.
- 524 6. Chavanelle V, Sirvent P, Ennequin G, et al. Comparison of oxygen consumption in rats
525 during uphill (concentric) and downhill (eccentric) treadmill exercise tests. *J Sports Sci*
526 *Med.* 2014;13(3):689–94.
- 527 7. Dufour SP, Lampert E, Doutreleau S, et al. Eccentric cycle exercise: training application
528 of specific circulatory adjustments. *Med Sci Sports Exerc.* 2004;36(11):1900–6.
- 529 8. Perrey S, Betik A, Candau R, Rouillon JD, Hughson RL. Comparison of oxygen uptake
530 kinetics during concentric and eccentric cycle exercise. *Journal of Applied Physiology.*
531 2001;91(5):2135–42.
- 532 9. Roig M, O’Brien K, Kirk G, et al. The effects of eccentric versus concentric resistance
533 training on muscle strength and mass in healthy adults: a systematic review with meta-
534 analysis. *British Journal of Sports Medicine.* 2009;43(8):556–68.
- 535 10. Ebbeling CB, Clarkson PM. Muscle adaptation prior to recovery following eccentric
536 exercise. *Eur J Appl Physiol Occup Physiol.* 1990;60(1):26–31.
- 537 11. Lieber RL. Biomechanical response of skeletal muscle to eccentric contractions. *J Sport*
538 *Health Sci.* 2018;7(3):294–309.
- 539 12. Isner-Horobeti M-E, Rasseneur L, Lonsdorfer-Wolf E, et al. Effect of eccentric versus
540 concentric exercise training on mitochondrial function. *Muscle Nerve.* 2014;50(5):803–
541 11.
- 542 13. Schlagowski A-I, Isner-Horobeti M-E, Dufour SP, et al. Mitochondrial function
543 following downhill and/or uphill exercise training in rats. *Muscle Nerve.* 2016;54(5):925–
544 35.
- 545 14. MacMillan NJ, Kapchinsky S, Konokhova Y, et al. Eccentric Ergometer Training
546 Promotes Locomotor Muscle Strength but Not Mitochondrial Adaptation in Patients with
547 Severe Chronic Obstructive Pulmonary Disease. *Front Physiol* [Internet]. 2017 [cited
548 2017 May 29];8 Available from:
549 <http://www.ncbi.nlm.nih.gov/pmc/articles/PMC5334343/>. doi:10.3389/fphys.2017.00114.

- 550 15. Tournon J, Perrault H, Julian V, et al. Impact of Eccentric or Concentric Training on Body
551 Composition and Energy Expenditure. *Med Sci Sports Exerc.* 2019;51(9):1944–53.
- 552 16. Kuznetsov AV, Veksler V, Gellerich FN, Saks V, Margreiter R, Kunz WS. Analysis of
553 mitochondrial function in situ in permeabilized muscle fibers, tissues and cells. *Nat*
554 *Protoc.* 2008;3(6):965–76.
- 555 17. N’Guessan B, Zoll J, Ribera F, et al. Evaluation of quantitative and qualitative aspects of
556 mitochondrial function in human skeletal and cardiac muscles. *Mol Cell Biochem.*
557 2004;256–257(1–2):267–80.
- 558 18. Livak KJ, Schmittgen TD. Analysis of relative gene expression data using real-time
559 quantitative PCR and the 2(-Delta Delta C(T)) Method. *Methods.* 2001;25(4):402–8.
- 560 19. Eldridge SM, Chan CL, Campbell MJ, et al. CONSORT 2010 statement: extension to
561 randomised pilot and feasibility trials. *Pilot Feasibility Stud* [Internet]. 2016 [cited 2018
562 Nov 21];2 Available from: <https://www.ncbi.nlm.nih.gov/pmc/articles/PMC5154046/>.
563 doi:10.1186/s40814-016-0105-8.
- 564 20. Cohen J. *Statistical Power Analysis for the Behavioral Sciences*. 2nd ed. Hillsdale (NJ):
565 Lawrence Erlbaum Associates; 1988. 567 p.
- 566 21. Julian V, Thivel D, Costes F, et al. Eccentric Training Improves Body Composition by
567 Inducing Mechanical and Metabolic Adaptations: A Promising Approach for Overweight
568 and Obese Individuals. *Front Physiol.* 2018;9:1013.
- 569 22. Webb R, Hughes MG, Thomas AW, Morris K. The Ability of Exercise-Associated
570 Oxidative Stress to Trigger Redox-Sensitive Signalling Responses. *Antioxidants (Basel)*
571 [Internet]. 2017 [cited 2020 Sep 2];6(3) Available from:
572 <https://www.ncbi.nlm.nih.gov/pmc/articles/PMC5618091/>. doi:10.3390/antiox6030063.
- 573 23. Zoll J, Koulmann N, Bahi L, Ventura-Clapier R, Bigard A-X. Quantitative and
574 qualitative adaptation of skeletal muscle mitochondria to increased physical activity. *J*
575 *Cell Physiol.* 2003;194(2):186–93.
- 576 24. Daussin FN, Rasseneur L, Bouitbir J, et al. Different timing of changes in mitochondrial
577 functions following endurance training. *Med Sci Sports Exerc.* 2012;44(2):217–24.
- 578 25. Molnar AM, Servais S, Guichardant M, et al. Mitochondrial H₂O₂ production is reduced
579 with acute and chronic eccentric exercise in rat skeletal muscle. *Antioxid Redox Signal.*
580 2006;8(3–4):548–58.
- 581 26. Merry TL, Ristow M. Mitohormesis in exercise training. *Free Radic Biol Med.*
582 2016;98:123–30.
- 583 27. Musci RV, Hamilton KL, Linden MA. Exercise-Induced Mitohormesis for the
584 Maintenance of Skeletal Muscle and Healthspan Extension. *Sports (Basel)* [Internet].
585 2019 [cited 2020 Aug 20];7(7) Available from:
586 <https://www.ncbi.nlm.nih.gov/pmc/articles/PMC6681340/>. doi:10.3390/sports7070170.

- 587 28. Flück M. Functional, structural and molecular plasticity of mammalian skeletal muscle in
588 response to exercise stimuli. *J Exp Biol.* 2006;209(Pt 12):2239–48.
- 589 29. Mueller M, Breil FA, Lurman G, et al. Different molecular and structural adaptations
590 with eccentric and conventional strength training in elderly men and women.
591 *Gerontology.* 2011;57(6):528–38.
- 592 30. Zoll J, Steiner R, Meyer K, Vogt M, Hoppeler H, Flück M. Gene expression in skeletal
593 muscle of coronary artery disease patients after concentric and eccentric endurance
594 training. *Eur J Appl Physiol.* 2006;96(4):413–22.
- 595 31. Dehghani M, Kargarfard M, Rabiee F, Nasr-Esfahani MH, Ghaedi K. A comparative
596 study on the effects of acute and chronic downhill running vs uphill running exercise on
597 the RNA levels of the skeletal muscles PGC1- α , FNDC5 and the adipose UCP1 in
598 BALB/c mice. *Gene.* 2018;679:369–76.
- 599 32. Siu PM, Donley DA, Bryner RW, Alway SE. Citrate synthase expression and enzyme
600 activity after endurance training in cardiac and skeletal muscles. *J Appl Physiol.*
601 2003;94(2):555–60.
- 602 33. Hollander J, Fiebig R, Gore M, et al. Superoxide dismutase gene expression in skeletal
603 muscle: fiber-specific adaptation to endurance training. *Am J Physiol.* 1999;277(3):R856-
604 862.
- 605 34. Apple FS, Billadello JJ. Expression of creatine kinase M and B mRNAs in treadmill
606 trained rat skeletal muscle. *Life Sci.* 1994;55(8):585–92.
- 607 35. Klossner S, Däpp C, Schmutz S, Vogt M, Hoppeler H, Flück M. Muscle transcriptome
608 adaptations with mild eccentric ergometer exercise. *Pflugers Arch.* 2007;455(3):555–62.
- 609 36. Islam H, Edgett BA, Gurd BJ. Coordination of mitochondrial biogenesis by PGC-1 α in
610 human skeletal muscle: A re-evaluation. *Metab Clin Exp.* 2018;79:42–51.
- 611 37. Hoppeler H, Baum O, Lurman G, Mueller M. Molecular mechanisms of muscle plasticity
612 with exercise. *Compr Physiol.* 2011;1(3):1383–412.
- 613 38. LaStayo PC, Woolf JM, Lewek MD, Snyder-Mackler L, Reich T, Lindstedt SL. Eccentric
614 muscle contractions: their contribution to injury, prevention, rehabilitation, and sport. *J*
615 *Orthop Sports Phys Ther.* 2003;33(10):557–71.
- 616 39. Buford TW, Cooke MB, Shelmadine BD, Hudson GM, Redd L, Willoughby DS. Effects
617 of eccentric treadmill exercise on inflammatory gene expression in human skeletal
618 muscle. *Appl Physiol Nutr Metab.* 2009;34(4):745–53.
- 619 40. Armstrong RB, Ogilvie RW, Schwane JA. Eccentric exercise-induced injury to rat
620 skeletal muscle. *J Appl Physiol Respir Environ Exerc Physiol.* 1983;54(1):80–93.
- 621 41. Armstrong RB, Laughlin MH, Rome L, Taylor CR. Metabolism of rats running up and
622 down an incline. *J Appl Physiol Respir Environ Exerc Physiol.* 1983;55(2):518–21.

4.3. Les résultats préliminaires de l'étude REX-HF

Aujourd'hui, le réentraînement à l'effort est une composante majeure de la prise en charge clinique des patients souffrant d'IC chronique, notamment ceux présentant une fraction d'éjection réduite. Chez ces patients, la limitation fonctionnelle est d'origine centrale mais se répercute également par de plus faibles capacités musculaires périphériques. Or, l'efficacité des programmes de réadaptation est limitée par la capacité des sujets à atteindre et à maintenir des intensités d'exercice suffisantes pour induire des adaptations significatives.

Au cours des 10 dernières années, un intérêt croissant est apparu pour l'utilisation de modalités d'exercice excentrique dans le champ du réentraînement. Celui-ci est fondé sur ses caractéristiques mécaniques et métaboliques de fortes contraintes musculaires pour de plus faibles $\dot{V}O_2$ et sollicitation cardio-respiratoire. Les études disponibles dans la littérature ont été conçues de façon à évaluer les effets de l'excentrique dynamique par rapport aux effets d'un programme d'entraînement conventionnel concentrique. Leurs résultats s'accordent sur une augmentation de la masse musculaire et de la force en réponse à l'entraînement excentrique mais peu ou pas d'adaptation en termes de $\dot{V}O_{2pic}$.

Il semble donc nécessaire de mettre au point une prise en charge permettant d'optimiser les résultats globaux de l'entraînement, à savoir l'amélioration de la force, de l'endurance et de la capacité aérobie. L'intégration des deux modalités d'exercice concentrique et excentrique au sein d'un même programme d'entraînement peut être une approche alternative visant à potentialiser ces adaptations observées séparément. L'objectif de l'étude REX-HF est donc de comparer l'impact fonctionnel d'un programme de réentraînement mixte, alternant des séances de pédalage excentrique et des séances de pédalage concentrique, à celui d'un programme conventionnel, recommandé usuellement par la Société Française de Cardiologie, chez des patients IC chroniques admis en centre de réadaptation.

4.3.1. Les participants

L'ensemble des dossiers médicaux des patients orientés à la Clinique Médicale Cardio-Pneumologie de Durtol pour un réentraînement dans le cadre d'une pathologie cardiaque ont été attentivement examinés afin de vérifier leur potentielle adéquation aux critères de l'étude (Figure 10).

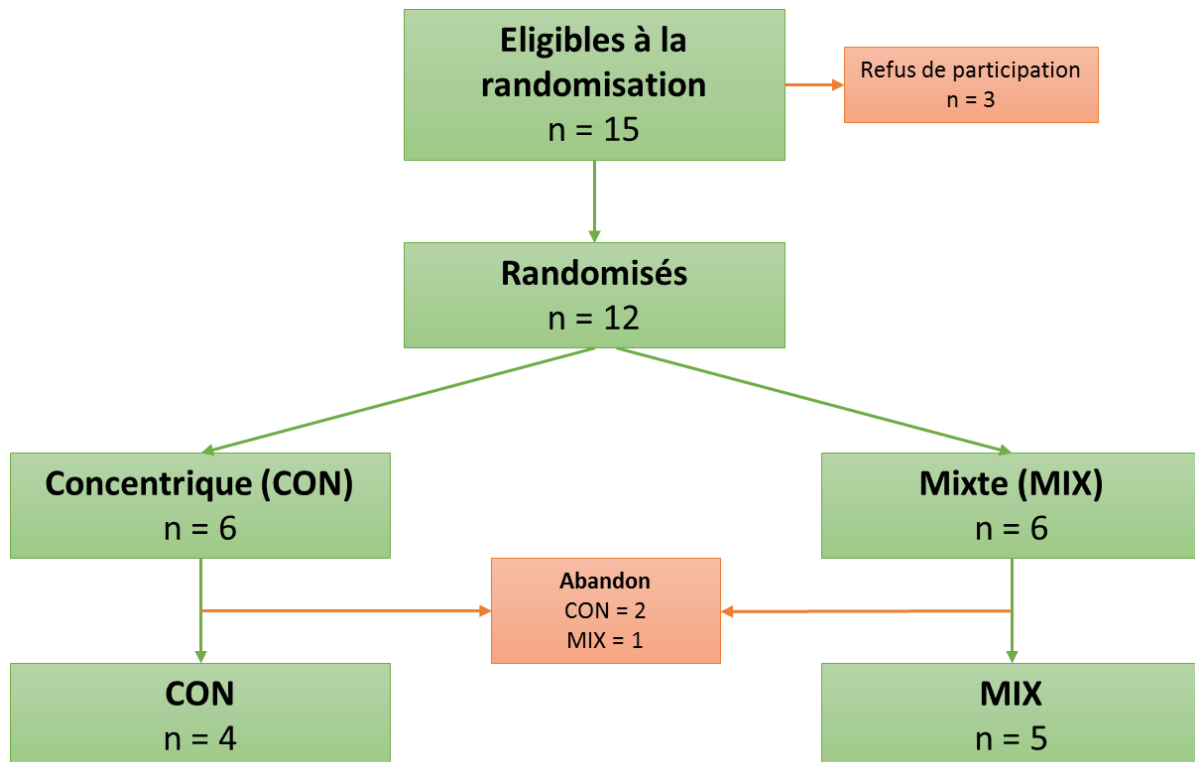

Figure 10 – Diagramme d'inclusion de l'étude REX-HF. Les patients éligibles sur la base des critères d'inclusion/exclusion se sont vu proposer l'étude. Ceux ayant signé le consentement ont été randomisés dans l'un des deux bras du protocole : entraînement concentrique (CON) ou entraînement mixte (MIX).

Parmi les patients éligibles sur la base des critères d'inclusion et d'exclusion, 12 sujets ont été randomisés dans les groupes réentraînement concentrique ou réentraînement mixte (n = 6 par groupe). Sur cet effectif de départ, trois patients n'ont pas terminé l'intégralité du protocole pour des raisons sans lien avec l'étude (une hospitalisation en urgence, deux confinements dus à la pandémie à Covid-19). Les autres patients inclus ont réalisé tous les tests d'entrée et de sortie ainsi que l'ensemble des séances d'exercice, confirmant la faisabilité de ce protocole quel que soit le groupe. Les caractéristiques de ces neuf patients à leur entrée sont résumées dans le

Tableau 3. Au moment de la rédaction de ce manuscrit, le recrutement est toujours en cours et les inclusions se poursuivront ainsi jusqu'en Juillet 2022.

Tableau 3 – Caractéristiques des patients de l'étude REX-HF.

	Groupe CON	Groupe MIX
Sexe (H/F)	3/1	5/0
Age (ans)	61,5 ± 5,0	67,4 ± 1,6
Poids (kg)	80,0 ± 10,8	88,1 ± 5,9
Taille (m)	1,71 ± 0,06	1,76 ± 0,04
IMC (kg·m⁻²)	27,1 ± 3,9	28,3 ± 3,0
VO_{2pic} (mL·min⁻¹·kg⁻¹)	13,5 ± 2,0	14,3 ± 0,4
Stade NYHA (II/III)	2/2	1/4

Patients inclus à date et ayant réalisé le protocole dans son intégralité. Les valeurs sont exprimées sous la forme de moyenne ± erreur-type. CON, concentrique ; IMC, indice de masse corporelle ; MIX, mixte ; NYHA, New York heart association ; VO_{2pic}, pic de consommation d'oxygène.

4.3.2. Le test de marche 6 minutes, critère principal

Les distances parcourues par les patients au TM6 à l'entrée et à l'issue des 20 séances de réentraînement sont présentées dans la **Figure 11**. Comme indiqué sur le graphique, aucune différence n'est observée dans la cinétique de réponse, l'entraînement conduisant à une augmentation de ce paramètre dans le groupe CON (+26,8 ± 15,7 m) et dans le groupe MIX (+57,1 ± 23,9 m). Quel que soit leur groupe d'appartenance et l'entraînement réalisé, les patients ont amélioré de façon significative leur résultat à ce test confirmant l'effet positif attendu de la prise en charge (p = 0,02).

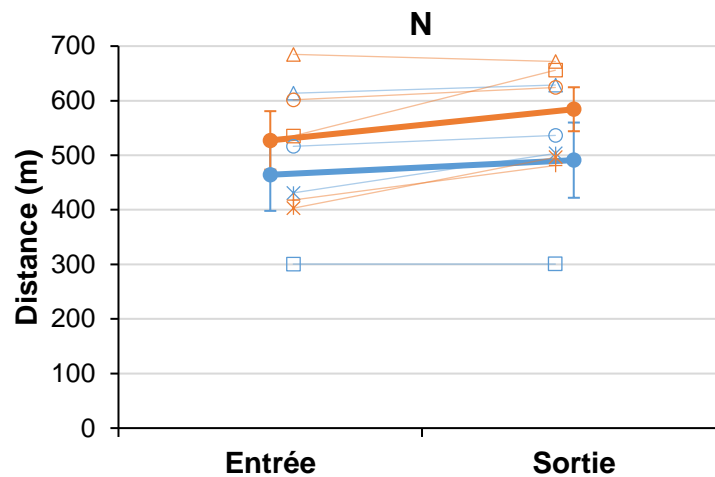

Figure 11 – Distances (m) au test de marche 6 minutes dans l'étude REX-HF. Les mesures ont été réalisées en entrée et en sortie du programme de réentraînement dans les groupes concentrique (●) et mixte (●). Les valeurs sont exprimées sous la forme de moyenne \pm erreur-type (traits épais). Les symboles vides reliés par des traits fins représentent les évolutions individuelles de chaque patient. NS, non-significatif (interaction temps \times groupe).

4.3.3. Le test *Timed up and go*

Les temps réalisés par les patients des groupes CON et MIX lors du test Timed up and go (TUG) en entrée et en sortie de protocole sont représentés dans la **Figure 12**. La réponse à l'entraînement MIX ($-1,60 \pm 0,91$ sec), incluant des séances en concentrique et en excentrique, est statistiquement différente de celle observée dans le groupe CON ($+0,05 \pm 0,74$ sec).

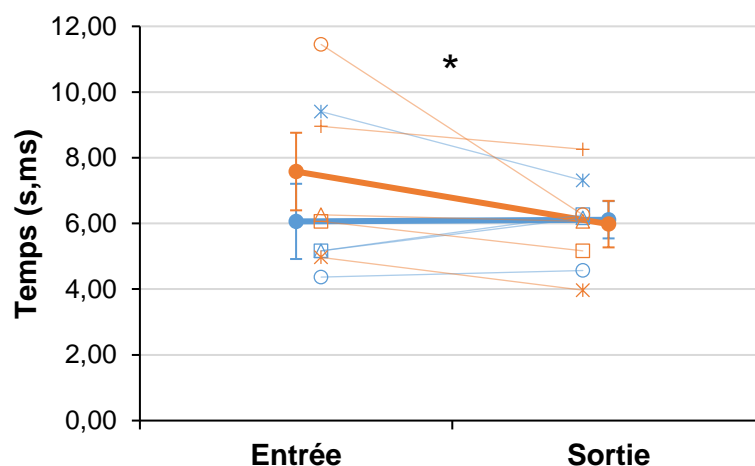

Figure 12 – Temps (s,ms) au test *Time up and go* dans l'étude REX-HF. Les mesures ont été réalisées en entrée et en sortie du programme de réentraînement dans les groupes concentrique (●) et mixte (●). Les valeurs sont exprimées sous la forme de moyenne \pm erreur-type (traits épais). Les symboles vides reliés par des traits fins représentent les évolutions individuelles de chaque patient. * : $p < 0,05$ (interaction temps \times groupe).

4.3.4. La force musculaire

L'évolution de la charge utilisée pour réaliser le test de répétition maximale, représentative de la force musculaire des deux jambes, ne montre aucune différence significative pour l'interaction temps \times groupe (CON_{entrée} : $56,5 \pm 15,3$ kg ; CON_{sortie} : $58,5 \pm 12,7$ kg ; MIX_{entrée} : $78,6 \pm 9,9$ kg ; MIX_{sortie} : $83,6 \pm 7,1$ kg).

4.3.5. L'épreuve d'effort cardio-respiratoire

Les données relatives à la $\dot{V}O_2$ au SV1 mesurée lors des tests d'effort sont représentées dans la **Figure 13**. L'entraînement CON permet une augmentation statistiquement plus importante en comparaison de celle de l'entraînement MIX ($+2,8 \pm 0,7$ versus $+1,6 \pm 0,2$ mL \cdot min $^{-1}\cdot$ kg $^{-1}$). Concernant la puissance mesurée au SV1, une différence significative pour l'interaction temps \times groupe est observée en faveur d'une augmentation plus importante dans le groupe CON ($+23 \pm 7$ W) comparativement au groupe MIX ($+8 \pm 2$ W). Toutes modalités confondues, la prise en charge des patients a permis d'améliorer de façon significative ce paramètre ($p = 0,02$).

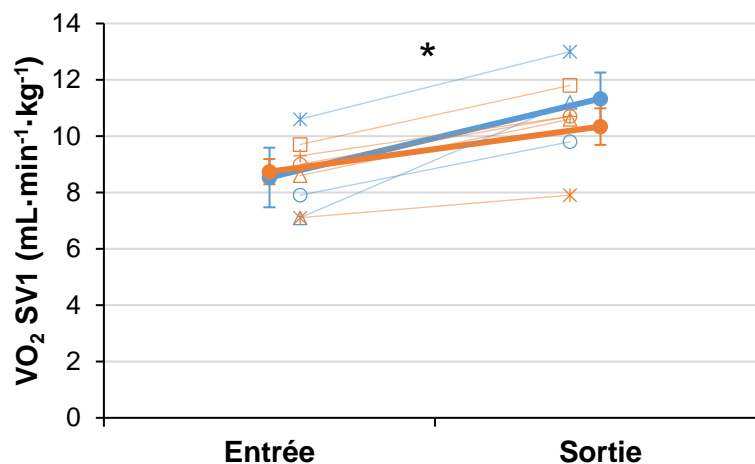

Figure 13 – Consommation d'oxygène au premier seuil ventilatoire ($\dot{V}O_2$ au SV1, mL \cdot min $^{-1}\cdot$ kg $^{-1}$) dans l'étude REX-HF. Les mesures ont été réalisées en entrée et en sortie du programme de réentraînement dans les groupes concentrique (●) et mixte (●). Les valeurs sont exprimées sous la forme de moyenne \pm erreur-type (traits épais). Les symboles vides reliés par des traits fins représentent les évolutions individuelles de chaque patient. * : $p < 0,05$ (interaction temps \times groupe).

À leur entrée dans l'étude, les patients présentaient une $\dot{V}O_{2pic}$ inférieure à 15 mL \cdot min $^{-1}\cdot$ kg $^{-1}$ (**Figure 14**). Les deux groupes montrent une amélioration similaire de ce paramètre après 20 séances de réentraînement (CON : $+1,4 \pm 1,4$ mL \cdot min $^{-1}\cdot$ kg $^{-1}$; MIX : $+1,4 \pm 0,9$ mL \cdot min $^{-1}\cdot$ kg $^{-1}$).

¹). Quel que soit la modalité, une tendance à l'amélioration de la puissance pic est observée chez les patients ($p = 0,06$; entrée : 83 ± 5 W ; sortie : 95 ± 10 W).

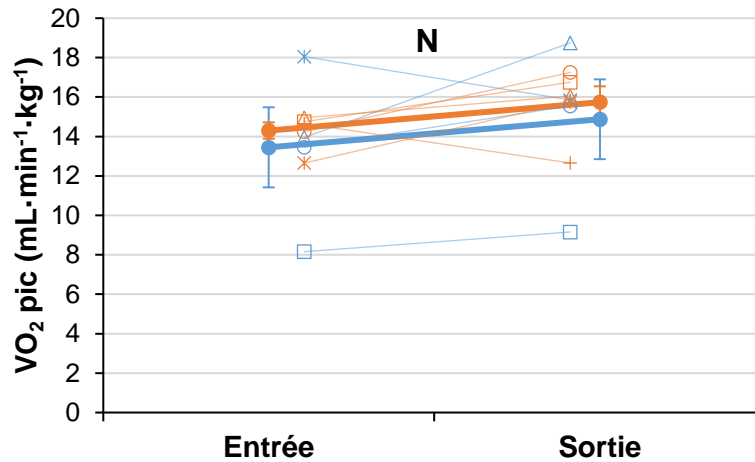

Figure 14 – Consommation d'oxygène au pic ($\dot{V}O_{2pic}$, $mL \cdot min^{-1} \cdot kg^{-1}$) dans l'étude REX-HF. Les mesures ont été réalisées en entrée et en sortie du programme de réentraînement dans les groupes concentrique (●) et mixte (●). Les valeurs sont exprimées sous la forme de moyenne \pm erreur-type (traits épais). Les symboles vides reliés par des traits fins représentent les évolutions individuelles de chaque patient. * : $p < 0,05$ (interaction temps \times groupe).

4.3.6. Le test d'endurance

L'évolution du temps de maintien à puissance constante, reflet de la capacité d'endurance, ne met en avant aucune différence d'interaction temps \times groupe suite à la prise en charge CON (entrée : $7min15 \pm 1min45$; sortie : $12min36 \pm 5min57$) ou MIX (entrée : $10min42 \pm 3min26$; sortie : $16min28 \pm 4min05$). Quel que soit l'entraînement réalisé, les patients ont amélioré de façon significative leur résultat à ce test confirmant l'effet positif attendu de la prise en charge ($p = 0,03$).

4.3.7. La qualité de vie

Les scores obtenus aux dimensions du questionnaire court de qualité de vie (SF-36), avant et après les 20 séances d'entraînement concentrique ou mixte, sont répertoriés dans le **Tableau 4**. La réponse à la prise en charge tend à être différente entre les groupes CON et MIX pour la dimension « activité physique » ($p < 0,1$). De son côté l'interaction temps \times groupe est statistiquement différente pour la dimension « état psychique ». Les autres dimensions du SF-36 n'ont mis en évidence aucune autre différence de réponse suite à la période de réentraînement.

Tableau 4 – Scores des dimensions du questionnaire de qualité de vie SF-36 dans l'étude REX-HF.

	Groupe CON			Groupe MIX	
	Entrée	Sortie		Entrée	Sortie
Activité physique (%)	71,6 ± 4,7	73,8 ± 6,6	○	54,0 ± 13,6	75,0 ± 10,5
Etat physique (%)	31,6 ± 15,8	37,5 ± 23,9	NS	35,0 ± 17,0	70,0 ± 20,0
Douleurs physiques (%)	49,3 ± 11,3	77,5 ± 9,0	NS	50,2 ± 9,8	76,6 ± 14,3
Santé générale (%)	36,3 ± 9,4	32,3 ± 4,3	NS	39,8 ± 7,2	50,2 ± 10,6
Vitalité (%)	37,5 ± 10,1	37,5 ± 9,7	NS	45,0 ± 6,3	54,0 ± 9,5
Activité sociale (%)	43,8 ± 23,1	68,8 ± 8,1	NS	60,0 ± 13,4	80,0 ± 12,9
Etat psychique (%)	83,3 ± 16,7	50,0 ± 21,5	*	46,7 ± 22,6	100,0 ± 0,0
Santé psychique (%)	61,0 ± 8,4	78,0 ± 6,8	NS	60,8 ± 9,6	78,4 ± 8,0
Evolution de la santé (%)	31,3 ± 12,0	37,5 ± 21,7	NS	50,0 ± 11,2	70,0 ± 9,4

Le questionnaire a été auto-administré en entrée et en sortie du programme de prise en charge dans les deux groupes, concentrique (CON) et mixte (MIX). Les valeurs sont exprimées sous la forme de moyenne ± erreur-type. ○ : $0,05 < p < 0,1$ (interaction temps × groupe) ; * : $p < 0,05$ (interaction temps × groupe) ; NS, non-significatif (interaction temps × groupe).

4.3.8. La composition corporelle

La période d'entraînement n'a pas eu d'effet sur la masse totale des patients des groupes CON (sortie : $80,0 \pm 10,3$ kg) et MIX (sortie : $87,7 \pm 6,0$ kg) par rapport aux valeurs d'entrée (**Tableau 3**), mais les patients entraînés en CON ont eu tendance à diminuer leur quantité de masse grasse totale par rapport à ceux entraînés suivant la modalité MIX ($-1,0 \pm 0,8$ kg *versus* $0,5 \pm 0,4$ kg). Au niveau des membres inférieurs, le même schéma de réponse s'applique avec une réduction plus importante de la quantité de masse grasse dans le groupe CON (entrée : $3,1 \pm 0,2$ kg·jambe⁻¹ ; sortie : $2,9 \pm 0,2$ kg·jambe⁻¹) comparativement au groupe MIX (entrée : $3,0 \pm 0,3$ kg·jambe⁻¹ ; sortie : $3,0 \pm 0,4$ kg·jambe⁻¹). L'étude de la masse maigre des membres inférieurs n'a pas permis de mettre en évidence d'évolution significativement différente entre la prise en charge CON (entrée : $8,7 \pm 0,8$ kg·jambe⁻¹ ; sortie : $8,9 \pm 0,8$ kg·jambe⁻¹) ou MIX (entrée : $10,1 \pm 0,4$ kg·jambe⁻¹ ; sortie : $10,3 \pm 0,4$ kg·jambe⁻¹).

4.3.9. Les analyses mitochondriales

4.3.9.1. La respiration mitochondriale

Les différents niveaux de respiration mitochondriale mesurés sur fibres musculaires perméabilisées, et exprimés en $\text{pmol O}_2 \cdot \text{sec}^{-1} \cdot \text{mg}^{-1}$ de poids humide avant et après les 20 séances d'entraînement dans les groupes CON et MIX, sont représentés dans la **Figure 15**. Ainsi, il n'y a de différence statistique pour aucun des états respiratoires au regard des interactions temps \times groupe. Les moyennes de RCR ne présentent pas de différence de réponse entre le groupe CON (entrée : $7,7 \pm 1,6$; sortie : $6,0 \pm 1,2$) et le groupe MIX (entrée : $7,1 \pm 0,7$; sortie : $6,2 \pm 1,0$).

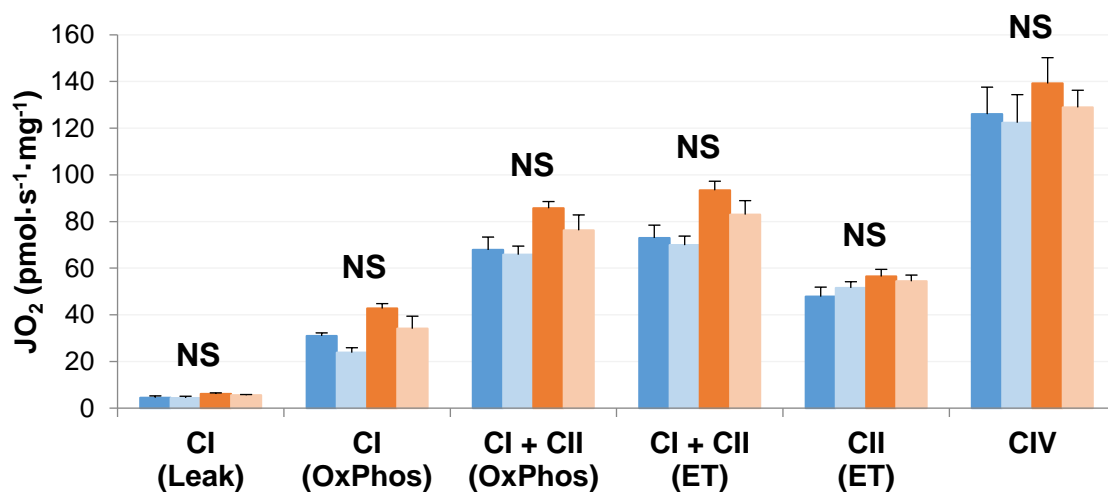

Figure 15 – Consommation mitochondriale d'oxygène (JO_2 , $\text{pmol} \cdot \text{sec}^{-1} \cdot \text{mg}^{-1}$) dans l'étude REX-HF. Les mesures ont été réalisées sur fibres musculaires perméabilisées de *Vastus Lateralis* dans les groupes concentrique (●/●) et mixte (●/●) en entrée (●/●) et en sortie (●/●) du programme de réentraînement. Les valeurs sont exprimées sous la forme de moyenne \pm erreur-type. CI, complexe I ; CII, complexe II ; CIV, complexe IV ; ET, *electron transfer*. NS, non-significatif (interaction temps \times groupe).

4.3.9.2. La libération de peroxyde d'hydrogène

Les niveaux de libération d' H_2O_2 mitochondrial en fonction de l'état respiratoire sont répertoriés dans le **Tableau 5**. À l'état basal, en présence de glutamate et de malate (CI *Leak*), la libération d' H_2O_2 est significativement augmentée en réponse à l'entraînement MIX, ce qui n'est plus le cas après ajout de succinate (CI + CII *Leak*). L'ajout de roténone (CII *Leak*) entraîne une réponse significativement opposée entre les deux groupes en termes d'interaction

temps × groupe. La présence d'ADP (CII *OxPhos*) en concentration saturante ne met en avant aucune différence de réponse à l'entraînement entre les deux modalités.

Tableau 5 – Libération de peroxyde d'hydrogène (JH_2O_2 , $\text{pmol}\cdot\text{sec}^{-1}\cdot\text{mg}^{-1}$) dans l'étude REX-HF.

	Groupe CON			Groupe MIX	
	Entrée	Sortie		Entrée	Sortie
CI (Leak)	0,056 ± 0,007	0,057 ± 0,005	*	0,027 ± 0,004	0,051 ± 0,005
CI + CII (Leak)	0,715 ± 0,094	0,490 ± 0,012	NS	0,841 ± 0,117	0,774 ± 0,113
CII (Leak)	0,206 ± 0,019	0,173 ± 0,007	*	0,214 ± 0,028	0,260 ± 0,026
CII (OxPhos)	0,124 ± 0,026	0,123 ± 0,014	NS	0,127 ± 0,025	0,119 ± 0,011

Les mesures ont été réalisées sur fibres musculaires perméabilisées de *Vastus Lateralis* dans les groupes concentrique et mixte en entrée et en sortie du programme de réentraînement. Les valeurs sont exprimées sous la forme de moyenne ± erreur-type. CI, complexe I ; CII, complexe II. * : $p < 0,05$ (interaction temps × groupe) ; NS, non-significatif (interaction temps × groupe).

4.3.9.3. La fuite de radicaux libres

Les estimations de FRL selon les états respiratoires mitochondriaux sont résumées dans le **Tableau 6**. L'entraînement CON a eu tendance ($p < 0,1$) à diminuer plus fortement les FRL mesurés en présence de glutamate, malate et succinate (CI + CII Leak) et après ajout de roténone (CII Leak). Les calculs de FRL aux autres états respiratoires n'ont pas montré de différence de réponse à l'entraînement.

Tableau 6 – Fuite de radicaux libres (FRL, %) dans l'étude REX-HF.

	Groupe CON			Groupe MIX	
	Entrée	Sortie		Entrée	Sortie
CI (Leak)	0,767 ± 0,076	0,994 ± 0,199	NS	0,245 ± 0,033	0,641 ± 0,103
CI + CII (Leak)	2,593 ± 0,421	1,639 ± 0,261	○	2,204 ± 0,170	1,999 ± 0,252
CII (Leak)	0,850 ± 0,113	0,643 ± 0,104	○	0,648 ± 0,065	0,740 ± 0,076
CII (OxPhos)	0,140 ± 0,027	0,135 ± 0,025	NS	0,107 ± 0,016	0,096 ± 0,011

Les calculs ont été réalisés à partir des données de respiration mitochondriale et de libération de peroxyde d'hydrogène mesurées sur fibres musculaires perméabilisées de *Vastus Lateralis* dans les groupes concentrique et mixte en entrée et en sortie du programme de réentraînement. Les valeurs sont exprimées sous la forme de moyenne ± erreur-type. CI, complexe I ; CII, complexe II. ○ : $0,05 < p < 0,1$ (interaction temps × groupe) ; NS, non-significatif (interaction temps × groupe).

Discussion Générale

L'activité physique est un acteur majeur pour la santé et a pour objectif l'amélioration des capacités fonctionnelles des patients dans un contexte clinique où les limites physiologiques de l'organisme correspondent en réalité aux limites imposées par la pathologie. Elles nécessitent alors la mise en place de stratégies alternatives à celles utilisées classiquement dans le champ de l'entraînement et de la performance. Que les limitations soient respiratoires, cardiaques et/ou musculaires, elles empêchent les patients d'atteindre ou de maintenir dans le temps des intensités d'exercice suffisamment importantes pour permettre la mise en place d'adaptations significatives. Parmi les différentes modalités d'entraînement explorées au cours des dernières années, l'exercice excentrique se révèle être une modalité tout particulièrement intéressante de par ses caractéristiques mécaniques et métaboliques.

L'utilisation d'un modèle de course en descente sur rongeur a mis en évidence l'efficacité de cette modalité dans le cadre de la régulation de la composition corporelle. *A minima* identiques aux effets induits par une modalité classique concentrique, l'excentrique a permis de limiter le gain de masse grasse et de majorer la prise de masse maigre corps entier, tout en ayant un impact positif sur la densité minérale osseuse. Ces réponses, observées dans le groupe soumis aux contraintes mécaniques et métaboliques les plus importantes (ECC30), ont également été retrouvées dans le groupe entraîné à plus faible $\dot{V}O_2$ (ECC15). Toutefois, au regard des adaptations mitochondriales du muscle squelettique, il semble que le niveau d'intensité métabolique de l'exercice soit le principal facteur régulateur des réponses aérobies.

Ces résultats obtenus chez le rat rejoignent les éléments déjà retrouvés dans la littérature et en faveur d'un effet plus marqué de l'excentrique sur la masse et la force musculaire et d'un effet plus modulé sur la composante aérobie corps entier et mitochondriale. Ces éléments confortent et justifient la stratégie adoptée dans l'étude clinique à savoir de rechercher une complémentarité des deux modalités d'exercice, concentrique et excentrique, afin de majorer les adaptations cardio-respiratoires et musculaires chez des patients IC chroniques. Les premiers résultats montrent que l'alternance de séances en concentrique et en excentrique n'est pas délétère puisque des adaptations au moins équivalentes sont obtenues pour la distance au TM6, le temps au TUG et la $\dot{V}O_2$. La poursuite des inclusions devrait permettre de confirmer ces observations.

5.1. Les effets de l'excentrique sur la composition corporelle

À notre connaissance, l'étude STARTREX est la première à s'être intéressée aux effets sur les paramètres de composition corporelle de l'entraînement dynamique excentrique, réalisé à même contrainte mécanique ou métabolique qu'un entraînement concentrique ((Touron et al., 2019) - **Publication n°1**). Les résultats montrent qu'aucun des groupes entraînés pendant 8 semaines n'a augmenté sa masse grasse par rapport au groupe contrôle, mais qu'à l'inverse ils ont majoré leur prise de masse maigre, et ceci plus particulièrement dans les deux groupes excentriques (ECC15 et ECC30). Il est à noter que ces adaptations ont principalement eu lieu au cours des 4 premières semaines du protocole, suggérant à la fois une spécificité de la modalité d'exercice et un effet dépendant de la charge d'entraînement. Dans cette configuration, sur la seconde partie du protocole, les animaux se sont retrouvés dans une phase d'entretien des adaptations initialement induites par l'exercice et qui laisse supposer qu'un ajustement et une modulation de l'intensité est nécessaire pour continuer à observer des modifications de ces paramètres dans le temps. Une augmentation de la dépense énergétique des animaux entraînés en lien avec leur prise de masse maigre a également été observée, sans modification de leur prise alimentaire ou de leur activité spontanée. Parallèlement à la tenue de cette étude animale, une étude clinique chez des adolescents obèses a été menée dans le laboratoire (Julian et al., 2018a). Les résultats obtenus dans le cadre d'un entraînement sur ergocycle excentrique de 12 semaines à intensité modérée (50-70 % de $\dot{V}O_{2max}$) ont montré une diminution significative de la masse grasse totale (-10 %) et de celle des membres inférieurs (-6,5 %). De la même manière, une augmentation significativement plus importante de la masse maigre totale a été observée dans le groupe entraîné en excentrique (+3,8 %). Une étude de 12 semaines d'exercice en pédalage excentrique chez la personne âgée rapporte également des résultats similaires (Mueller et al., 2009). Ainsi, les bénéfices en termes de composition corporelle obtenus à l'échelle animale semblent transposables à l'Homme dans une situation de surcharge pondérale et, associées à la bonne tolérance métabolique et cardio-respiratoire de l'exercice excentrique, mettent en lumière l'intérêt de cette modalité d'entraînement dans les stratégies de prise en charge de patients. Dans l'étude clinique REX-HF, le réentraînement n'a pas pour objectif la régulation de la composition corporelle des patients, d'autant que le protocole est réalisé sur

une très courte période (20 séances réparties sur 4 semaines). Cependant nous avons souhaité vérifier si ce temps était suffisant pour induire un gain de masse maigre au niveau des membres inférieurs sollicités par les exercices de pédalage. Par le passé, un protocole de pédalage excentrique seul chez des patients coronariens a montré une augmentation significative de la masse musculaire des jambes (191 ± 37 g) après 24 séances d'entraînement réparties sur 8 semaines (Steiner et al., 2004). Dans notre étude, les patients du groupe MIX ont d'avantage augmenté leur masse maigre segmentaire par rapport aux patients du groupe CON (117 ± 104 g *versus* 78 ± 60 g), mais les importantes variations individuelles et les faibles effectifs ne permettent pas d'atteindre la significativité. L'alternance des séances excentrique et concentrique permettrait malgré tout de conserver la spécificité de réponse de la modalité excentrique.

5.2. Les effets de l'excentrique sur les paramètres fonctionnels

L'excentrique est également connu pour améliorer de manière significative la force des groupes musculaires. Dans l'étude STARTREX, la force des animaux ou leur résistance à la fatigue musculaire n'ont pas été évaluées. Parmi toutes les études animales ayant réalisé des entraînements de course en descente une seule a rapporté des résultats sur cette thématique (Hahn et al., 2007). Ainsi, 6 semaines de course excentrique ont permis aux muscles de rats entraînés de produire une force supérieure (+70 %), traduisant une résistance à la fatigue supérieure après 15 minutes de contractions par rapport aux animaux sédentaires, sans différence de tension initiale. Chez les premiers patients inclus dans l'étude clinique REX-HF, la modification de la charge lors du test de répétition maximale réalisé sur deux jambes n'est pas significative (groupe CON, +3,5 % ; groupe MIX, +6,4 %). Encore une fois, les actuels faibles effectifs et les variations individuelles sont à considérer dans l'interprétation de cette absence de significativité. Dans la littérature, deux études réalisées auprès de patients coronariens ont respectivement montré que 15 et 24 séances d'entraînement excentrique seul permettaient une augmentation significative de 7 et 11 % de la force isométrique des muscles extenseurs du genou (Gremeaux et al., 2010; Steiner et al., 2004). Chez des patients IC chroniques, un entraînement similaire de 20 séances n'a pas réussi à montrer un résultat significatif malgré une augmentation de 6 % (Casillas et al., 2016). Parallèlement à cette

augmentation de force isométrique, une augmentation de la puissance maximale lors des tests à l'effort incrémental est également rapportée par plusieurs études (Casillas et al., 2016; Gremeaux et al., 2010; Meyer et al., 2003). Dans l'étude REX-HF, cette observation est également applicable aux patients IC chroniques réentraînés mais avec une augmentation de la puissance au SV1 plus importante dans le groupe CON (+23 W *versus* +8 W) et non différente entre les groupes pour la puissance maximale (CON +15 W *versus* MIX +9 W) après 20 séances d'exercice. Chez des populations de patients IC, l'augmentation de la masse et de la force musculaire se révèle particulièrement intéressante dans le cadre de la prévention ou de la prise en charge de la sarcopénie secondaire induite par la pathologie.

La littérature rapporte des effets plus mitigés concernant la réponse adaptative des capacités fonctionnelles aérobies. Le faible nombre d'études disponibles ne permet pas encore de tirer de conclusions définitives, d'autant qu'il existe une grande variabilité dans les procédures appliquées (durée, fréquence, intensité), mais il semblerait que les adaptations tendent à être intensité en excentrique et sollicitation métabolique dépendantes. Trois études rapportent des résultats de $\dot{V}O_{2pic}$ suite à un entraînement excentrique seul, comparativement à un entraînement concentrique classique, chez des patients présentant une pathologie cardiaque. Les protocoles de durée et de fréquence similaires (30 minutes, 3 fois par semaine) ont été réalisés sur une durée de 5 (Gremeaux et al., 2010), 7 (Casillas et al., 2016) et 8 semaines (Meyer et al., 2003). D'un côté les intensités ont été ajustées pour atteindre, à faible fréquence de pédalage (15-20 RPM), une FC cible équivalente à celle mesurée au SV1 du test d'effort initial concentrique (Casillas et al., 2016; Gremeaux et al., 2010), et de l'autre l'intensité a été ajustée pour sollicité 60 % de la $\dot{V}O_{2pic}$ mesurée au test d'effort initial concentrique à une fréquence de pédalage de 60 RPM (Meyer et al., 2003). Si les trois études ont noté une augmentation des valeurs de $\dot{V}O_{2pic}$ à l'issue de la période d'entraînement, seules celle de Gremeaux (+14,2 % (Gremeaux et al., 2010)) et de Meyer (+10,4 % (Meyer et al., 2003)) ont montré que cette hausse était significative sans pour autant trouver de différence par rapport à la modalité concentrique. Dans l'étude REX-HF, un total de 20 séances d'entraînement de 30 minutes sont réalisées à raison de 5 par semaine (Plaquet-Hostache et al., 2019). Leur intensité est fixée de sorte qu'une comparaison iso-énergétique soit possible entre les modalités. Les premiers résultats montrent une augmentation similaire de $\dot{V}O_{2pic}$ dans les groupes CON (+10,6 %) et MIX (+11,2 %). Toutefois, ils mettent en avant une différence de réponse concernant la $\dot{V}O_2$ au SV1, significativement plus augmentée dans le groupe CON (+32,8 %) comparativement au groupe

MIX (+16,5 %). Chez les patients IC chroniques l'amélioration des paramètres aérobie tels que $\dot{V}O_2$ au SV1 et $\dot{V}O_{2pic}$ est primordiale car ces facteurs sont corrélés à un mauvais pronostic et à un risque accru de morbi-mortalité (Szlachcic et al., 1985). Le fait que l'alternance des séances excentrique et concentrique permettent une amélioration de ces paramètres est un point essentiel pour une future application de ce type de protocole en routine.

Bien que la mesure de la $\dot{V}O_2$ au cours d'un test d'effort cardiorespiratoire soit la référence pour déterminer la capacité fonctionnelle et évaluer les bénéfices de l'entraînement chez les patients en réhabilitation cardiaque, le TM6 est également couramment pratiqué. Les résultats d'une méta-analyse montrent ainsi une augmentation moyenne de +66,3 m chez des sujets ayant suivie un réentraînement à l'effort conventionnel (Bellet et al., 2012). Dans le cadre de l'étude REX-HF, le groupe MIX a amélioré sa distance parcourue au TM6 de +57,1 m tandis que le groupe CON l'a amélioré de +26,8 m, sans qu'il n'y ait de différence significative de réponse entre les deux groupes. Des augmentations du même ordre de grandeur sont retrouvés dans les études ayant comparé des modalités de prise en charge concentrique et excentrique auprès de patients présentant une pathologie cardiaque (Besson et al., 2013; Casillas et al., 2016; Gremeaux et al., 2010). L'ensemble des résultats évoqués jusqu'à présent, à savoir l'augmentation de la masse et de la force musculaire, l'amélioration des $\dot{V}O_2$ au SV1 et $\dot{V}O_{2pic}$, l'augmentation de la distance parcourue au TM6, mais aussi la diminution du temps au test TUG et l'augmentation du temps de maintien à puissance constante au test d'endurance, sont autant d'indicateurs laissant supposer que le couplage des modalités d'entraînement concentrique et excentrique est au moins aussi bénéfique que la prise en charge classique chez des patients IC chroniques.

5.3. Les effets de l'excentrique sur les mitochondries

L'étude STARTREX est la première à comparer l'impact des entraînements concentrique et excentrique, conçus pour être équivalents en termes de sollicitation mécanique (CON *versus* ECC15) ou métabolique (CON *versus* ECC30), sur les adaptations mitochondriales du muscle squelettique (**Publication n°2**). Les résultats montrent que l'affinité des mitochondries pour l'ADP est statistiquement modifiée pour les groupes CON et ECC30 entraînés aux plus hautes

intensités métaboliques comparativement aux animaux contrôles. Une réponse similaire est observée pour les niveaux de respiration maximale mesurées en condition d'oxydation phosphorylante, alors qu'aucune différence n'est relevée en condition basale, quelle que soit la condition d'entraînement. Ces résultats sont appuyés par une augmentation significative de l'activité CS et des complexes I et IV de la chaîne respiratoire. Bien que dans l'absolu supérieures aux valeurs mesurées chez les animaux CTRL, les valeurs du groupe ECC15 ne sont pas significativement différentes excepté pour les activités enzymatiques CS et du complexe I. Ceci laisse suggérer un niveau de stimulation insuffisant pour induire des adaptations plus marquées de la fonctionnalité mitochondriale. Un modèle similaire d'entraînement (CON *versus* ECC15 à une vitesse de 20 m·min⁻¹) a par le passé montré que la \dot{V}_{\max} du *Vastus Intermedius* en présence de glutamate, malate et d'ADP n'était pas modifiée après 5 ou 20 jours d'entraînement (Isner-Horobeti et al., 2014). Avec une période d'entraînement similaire (4 semaines), des pentes de course identiques (+15 *versus* -15) mais une vitesse moins importante en concentrique qu'en excentrique (23-30 m·min⁻¹ *versus* 36-48 m·min⁻¹), les résultats de respiration mitochondriale n'ont pas montré de différence significative par rapport au groupe sédentaire (Schlagowski et al., 2016). Dans ces deux études, comparativement à l'étude STARTREX, la période d'entraînement était plus courte, de même que la durée des séances, mais la vitesse de course plus élevée. La stimulation métabolique globale pourrait expliquer les résultats statistiquement plus importants des groupes CON et ECC30 obtenus après 8 semaines d'entraînement. Une dernière étude ayant mis en place un entraînement intermittent excentrique sur une durée de 8 semaines n'a pas montré d'augmentation significative de la \dot{V}_{\max} (Molnar et al., 2006). Dans ce protocole, bien que la vitesse ait été plus élevée, la durée de travail effectif (15-20 min) et la pente de course (-7°) étaient inférieurs à celles du groupe ECC30.

Chez les patients IC, il n'existe à l'heure actuelle aucune publication ayant analysé les réponses mitochondriales suite à un entraînement excentrique. Cependant il est connue que chez ces patients la \dot{V}_{\max} et l'expression d'un certain nombre de gènes mitochondriaux soient significativement impactées par la pathologie, que ce soit au niveau du muscle cardiaque ou des muscles squelettiques périphériques (Garnham et al., 2020; Garnier et al., 2003). Les analyses sur tissus congelés n'ont pas encore été effectuées pour l'étude clinique REX-HF car nous souhaitons que tous les échantillons soient traités simultanément afin de limiter les biais expérimentaux. Toutefois, à la vue des résultats obtenus au cours de l'étude animale et les

quelques résultats disponibles dans la littérature pour d'autres pathologies, nous espérons observer une amélioration des paramètres mitochondriaux à l'issue de la période d'entraînement.

Conclusion & Perspectives

Les résultats et les études présentés dans le cadre de cette thèse mettent en avant l'intérêt de l'exercice excentrique, d'un côté dans le champ du contrôle pondéral et de la composition corporelle, et de l'autre dans celui de la réadaptation clinique comme avec la prise en charge de l'IC chronique. Dans ces deux contextes, la modalité d'entraînement excentrique présente l'avantage de pouvoir être réalisée à une sollicitation métabolique moindre, facilitant l'adhésion des sujets au protocole, tout en permettant la mise en place d'adaptations notamment au niveau de la masse musculaire. Les adaptations aérobies n'étant pas clairement démontrées, le couplage de séances d'entraînement classique et d'entraînement excentrique devrait permettre une prise en charge globale des patients au moins aussi efficace et mieux tolérée. En effet, les exercices d'endurance concentrique sont connus pour permettre une augmentation des capacités aérobies tandis que les exercices excentriques permettent préférentiellement un gain de masse et de force musculaire. La poursuite des inclusions dans le protocole REX-HF devrait permettre de clarifier ce point.

Outre une application chez les patients IC, l'exercice excentrique peut présenter un intérêt dans d'autres contextes cliniques, comme celui de la pandémie à coronavirus de 2019. Les infections symptomatiques à COVID-19 entraînent principalement une atteinte de la sphère cardio-pulmonaire pouvant conduire à une hospitalisation en unité de réanimation. Il est connu que de tels séjours sont à l'origine d'amyotrophie et de dysfonction musculaire dont les conséquences peuvent perdurer jusqu'à plusieurs mois après la sortie de l'hôpital. Ce déconditionnement implique la mise en place d'interventions rééducatives dès que l'état de santé le permet afin de gagner en autonomie, en qualité de vie et de réduire les coûts de santé. Classiquement, les patients sont pris en charge selon un réentraînement en endurance sur ergocycle concentrique. Cependant les limitations des sujets sont parfois trop lourdes et les empêchent de réaliser les exercices proposés. Dans ces conditions, la mise en place d'une stratégie d'entraînement excentrique prend tout son sens du fait de ses caractéristiques mécaniques et métaboliques. Actuellement, un protocole de prise en charge de patients post-COVID-19 a été mis en place par le service de Médecine Physique et de Réadaptation du Centre Hospitalier Universitaire de Clermont-Ferrand, et d'autres établissements de santé partenaires. L'objectif de cette étude multicentrique, contrôlée et randomisée, est de comparer l'efficacité de deux programmes de

réentraînement iso-énergétique, l'un en mode classique concentrique et l'autre en mode excentrique, sur l'augmentation de la distance parcourue au TM6 chez des patients post-infection sévère à COVID-19. En parallèle, l'un des objectifs secondaires est de comparer la fonctionnalité mitochondriale et les réponses musculaires à partir des biopsies du *Vastus Lateralis* (étude ancillaire optionnelle). L'étude CovExc a reçu l'avis favorable d'un CPP (Ile-de-France 1) le 29 Mai 2020 (numéro d'enregistrement ANSM : 2020-A01201-38), et est actuellement en cours de recrutement (**Annexe n°3**).

Enfin, l'analyse de la littérature a permis d'identifier le rôle central que semble jouer le Ca^{2+} dans les mécanismes de dommage musculaire et d'altération des fonctionnalités mitochondriales en réponse à une stimulation excentrique. Ces observations suite à un exercice excentrique aigu et leur absence à l'issue d'une période d'entraînement excentrique amènent à se demander si des adaptations en lien avec la sensibilité de la mitochondrie pour le Ca^{2+} existent. Aujourd'hui deux techniques majeures sont retrouvées dans la littérature à savoir l'analyse de l'ouverture du mPTP par fluorimétrie sur mitochondries isolées ou sur fibres musculaires perméabilisées fantomisées (sans myosine). Couteuses en termes de quantité de tissu nécessaire ou en réactifs et matériel, nous avons souhaité mettre au point une alternative permettant de limiter la quantité de matériel biologique nécessaire à l'analyse, de conserver les mitochondries dans un environnement architectural cellulaire proche des conditions physiologiques et de s'affranchir de la nécessité de faire appel à des techniques de fluorimétrie. L'étude COMMEF que nous avons mis en place vise donc une preuve de concept afin d'évaluer le contrôle de l'ouverture du mPTP par mesures oxygraphiques *ex vivo* sur fibres musculaires perméabilisées non fantomisées. Les objectifs de cette étude portent sur la faisabilité de cette nouvelle méthode et sur sa reproductibilité. Il s'agit dans un premier temps de réaliser un certain nombre de mesures sur des échantillons de muscle sain récupérés au bloc opératoire lors de ligamentoplastie du genou. La validation de cette technique de mesure devrait permettre par la suite de la mettre œuvre la technique de mesure au cours de protocole clinique de réentraînement, notamment excentrique, afin d'évaluer de potentielles adaptations en lien avec la prise en charge mitochondriale du Ca^{2+} et la sensibilité du mPTP. Cette étude a reçu l'avis favorable d'un CPP (Sud-Est VI) le 1er Août 2019 (enregistrement Clinical Trial : NCT04209413), et est actuellement en cours de recrutement.

Références bibliographiques

- Abbott, B.C., Bigland, B., and Ritchie, J.M. (1952). The physiological cost of negative work. *J Physiol* 117, 380–390.
- Allen, D., Whitehead, N., and Yeung, E. (2005). Mechanisms of stretch-induced muscle damage in normal and dystrophic muscle: role of ionic changes. *J Physiol* 567, 723–735.
- Armstrong, R.B., Ogilvie, R.W., and Schwane, J.A. (1983). Eccentric exercise-induced injury to rat skeletal muscle. *J Appl Physiol Respir Environ Exerc Physiol* 54, 80–93.
- Balaban, R.S., Nemoto, S., and Finkel, T. (2005). Mitochondria, oxidants, and aging. *Cell* 120, 483–495.
- Balnave, C.D., and Thompson, M.W. (1993). Effect of training on eccentric exercise-induced muscle damage. *Journal of Applied Physiology* (Bethesda, Md.: 1985) 75, 1545–1551.
- Bassett, D.R. (2002). Scientific contributions of A. V. Hill: exercise physiology pioneer. *Journal of Applied Physiology* (Bethesda, Md.: 1985) 93, 1567–1582.
- Bellet, R.N., Adams, L., and Morris, N.R. (2012). The 6-minute walk test in outpatient cardiac rehabilitation: validity, reliability and responsiveness--a systematic review. *Physiotherapy* 98, 277–286.
- Bennett, J.A., Riegel, B., Bittner, V., and Nichols, J. (2002). Validity and reliability of the NYHA classes for measuring research outcomes in patients with cardiac disease. *Heart Lung* 31, 262–270.
- Besson, D., Joussain, C., Gremeaux, V., Morisset, C., Laurent, Y., Casillas, J.-M., and Laroche, D. (2013). Eccentric training in chronic heart failure: feasibility and functional effects. Results of a comparative study. *Ann Phys Rehabil Med* 56, 30–40.
- Blomqvist, C.G., and Saltin, B. (1983). Cardiovascular adaptations to physical training. *Annual Review of Physiology* 45, 169–189.
- Bonde-Petersen, F., Henriksson, J., and Knuttgen, H.G. (1973). Effect of training with eccentric muscle contractions on skeletal muscle metabolites. *Acta Physiologica Scandinavica* 88, 564–570.
- Bourbeau, J., De Sousa Sena, R., Taivassalo, T., Richard, R., Jensen, D., Baril, J., Rocha Vieira, D.S., and Perrault, H. (2020). Eccentric versus conventional cycle training to improve muscle strength in advanced COPD: A randomized clinical trial. *Respiratory Physiology & Neurobiology* 276, 103414.
- Brookes, P.S., Yoon, Y., Robotham, J.L., Anders, M.W., and Sheu, S.-S. (2004). Calcium, ATP, and ROS: a mitochondrial love-hate triangle. *Am. J. Physiol., Cell Physiol.* 287, C817-833.
- Bryner, R.W., Donley, D.A., Cutlip, R.G., Wirth, O., and Alway, S.E. (2004). Effects of downhill treadmill running on uncoupling protein 3 mRNA expression. *Int J Sports Med* 25, 433–437.

- Buchheit, M., and Laursen, P.B. (2013). High-intensity interval training, solutions to the programming puzzle. Part II: anaerobic energy, neuromuscular load and practical applications. *Sports Medicine (Auckland, N.Z.)* 43, 927–954.
- Casillas, J.M., Besson, D., Hannequin, A., Gremeaux, V., Morisset, C., Tordi, N., Laurent, Y., and Laroche, D. (2016). Effects of an eccentric training personalized by a low rate of perceived exertion on the maximal capacities in chronic heart failure: a randomized controlled trial. *Eur J Phys Rehabil Med* 52, 159–168.
- Cattadori, G., Segurini, C., Picozzi, A., Padeletti, L., and Anzà, C. (2017). Exercise and heart failure: an update. *ESC Heart Fail* 5, 222–232.
- Chavanelle, V., Sirvent, P., Ennequin, G., Caillaud, K., Montaurier, C., Morio, B., Boisseau, N., and Richard, R. (2014). Comparison of oxygen consumption in rats during uphill (concentric) and downhill (eccentric) treadmill exercise tests. *J Sports Sci Med* 13, 689–694.
- Chen, T.C., Hsieh, C.-C., Tseng, K.-W., Ho, C.-C., and Nosaka, K. (2017). Effects of Descending Stair Walking on Health and Fitness of Elderly Obese Women. *Med Sci Sports Exerc* 49, 1614–1622.
- Chen, W., Ruell, P.A., Ghodduzi, M., Kee, A., Hardeman, E.C., Hoffman, K.M., and Thompson, M.W. (2007). Ultrastructural changes and sarcoplasmic reticulum Ca²⁺ regulation in red vastus muscle following eccentric exercise in the rat. *Exp. Physiol.* 92, 437–447.
- Close, G.L., Ashton, T., McArdle, A., and Maclaren, D.P.M. (2005). The emerging role of free radicals in delayed onset muscle soreness and contraction-induced muscle injury. *Comparative Biochemistry and Physiology. Part A, Molecular & Integrative Physiology* 142, 257–266.
- Coffey, V.G., and Hawley, J.A. (2007). The molecular bases of training adaptation. *Sports Med* 37, 737–763.
- Doehner, W., Frenneaux, M., and Anker, S.D. (2014). Metabolic impairment in heart failure: the myocardial and systemic perspective. *J. Am. Coll. Cardiol.* 64, 1388–1400.
- Drexel, H., Saely, C.H., Langer, P., Loruenser, G., Marte, T., Risch, L., Hoefle, G., and Aczel, S. (2008). Metabolic and anti-inflammatory benefits of eccentric endurance exercise – a pilot study. *European Journal of Clinical Investigation* 38, 218–226.
- Drexler, H., Riede, U., Münzel, T., König, H., Funke, E., and Just, H. (1992). Alterations of skeletal muscle in chronic heart failure. *Circulation* 85, 1751–1759.
- Duan, C., Delp, M.D., Hayes, D.A., Delp, P.D., and Armstrong, R.B. (1990). Rat skeletal muscle mitochondrial [Ca²⁺] and injury from downhill walking. *Journal of Applied Physiology* 68, 1241–1251.
- Dufour, S.P., Lampert, E., Doutreleau, S., Lonsdorfer-Wolf, E., Billat, V.L., Piquard, F., and Richard, R. (2004). Eccentric cycle exercise: training application of specific circulatory adjustments. *Med Sci Sports Exerc* 36, 1900–1906.
- Duncan, C.J. (1978). Role of intracellular calcium in promoting muscle damage: a strategy for controlling the dystrophic condition. *Experientia* 34, 1531–1535.

- Endo, T., and Yamano, K. (2010). Transport of proteins across or into the mitochondrial outer membrane. *Biochimica Et Biophysica Acta* 1803, 706–714.
- Enns, D., Green, H., Tupling, R., Burnett, M., Grant, S., and Ranney, D. (1999). Alterations in sarcoplasmic reticulum function in female vastus lateralis with eccentric exercise. *Mol. Cell. Biochem.* 202, 19–30.
- Fontana-Ayoub, M., Fasching, M., and Gnaiger, E. (2016). Selected media and chemicals for respirometry with mitochondrial preparations.
- Franchi, M.V., Reeves, N.D., and Narici, M.V. (2017). Skeletal Muscle Remodeling in Response to Eccentric vs. Concentric Loading: Morphological, Molecular, and Metabolic Adaptations. *Front Physiol* 8.
- Fridén, J., Seger, J., Sjöström, M., and Ekblom, B. (1983). Adaptive response in human skeletal muscle subjected to prolonged eccentric training. *International Journal of Sports Medicine* 4, 177–183.
- Frimpong, E., Ofori, E.K., Kaoje, Y.S., Ababio, E., and Dzudzor, B. (2019). Muscle Damage and Repeated Bout Effect from High Intensity Non-Eccentric Exercises. *Journal of Exercise Physiology Online* 22, 126–140.
- Garnham, J.O., Roberts, L.D., Caspi, T., Al-Owais, M.M., Bullock, M., Swoboda, P.P., Koshy, A., Gierula, J., Paton, M.F., Cubbon, R.M., et al. (2020). Divergent skeletal muscle mitochondrial phenotype between male and female patients with chronic heart failure. *J Cachexia Sarcopenia Muscle* 11, 79–88.
- Garnier, A., Fortin, D., Deloménie, C., Momken, I., Veksler, V., and Ventura-Clapier, R. (2003). Depressed mitochondrial transcription factors and oxidative capacity in rat failing cardiac and skeletal muscles. *J Physiol* 551, 491–501.
- González-Bartholin, R., Mackay, K., Valladares, D., Zbinden-Foncea, H., Nosaka, K., and Peñailillo, L. (2019). Changes in oxidative stress, inflammation and muscle damage markers following eccentric versus concentric cycling in older adults. *European Journal of Applied Physiology* 119, 2301–2312.
- Gremeaux, V., Duclay, J., Deley, G., Philipp, J.L., Laroche, D., Pousson, M., and Casillas, J.M. (2010). Does eccentric endurance training improve walking capacity in patients with coronary artery disease? A randomized controlled pilot study. *Clin Rehabil* 24, 590–599.
- Gross, M., Lüthy, F., Kroell, J., Müller, E., Hoppeler, H., and Vogt, M. (2010). Effects of eccentric cycle ergometry in alpine skiers. *International Journal of Sports Medicine* 31, 572–576.
- Gulick, D.T., and Kimura, I.F. (1996). Delayed Onset Muscle Soreness: What Is It and How Do We Treat It? *Journal of Sport Rehabilitation* 5, 234–243.
- Hahn, S.A., Ferreira, L.F., Williams, J.B., Jansson, K.P., Behnke, B.J., Musch, T.I., and Poole, D.C. (2007). Downhill treadmill running trains the rat spinotrapezius muscle. *Journal of Applied Physiology* 102, 412–416.

- Hirai, D.M., Musch, T.I., and Poole, D.C. (2015). Exercise training in chronic heart failure: improving skeletal muscle O₂ transport and utilization. *Am. J. Physiol. Heart Circ. Physiol.* *309*, H1419-1439.
- Hody, S., Lacrosse, Z., Leprince, P., Collodoro, M., Croisier, J.-L., and Rogister, B. (2013). Effects of eccentrically and concentrically biased training on mouse muscle phenotype. *Medicine and Science in Sports and Exercise* *45*, 1460–1468.
- Hoppeler, H., Howald, H., Conley, K., Lindstedt, S.L., Claassen, H., Vock, P., and Weibel, E.R. (1985). Endurance training in humans: aerobic capacity and structure of skeletal muscle. *J Appl Physiol* (1985) *59*, 320–327.
- Hyldahl, R.D., Olson, T., Welling, T., Groskost, L., and Parcell, A.C. (2014). Satellite cell activity is differentially affected by contraction mode in human muscle following a work-matched bout of exercise. *Front Physiol* *5*.
- Hyldahl, R.D., Chen, T.C., and Nosaka, K. (2017). Mechanisms and Mediators of the Skeletal Muscle Repeated Bout Effect. *Exercise and Sport Sciences Reviews* *45*, 24–33.
- Isner-Horobeti, M.-E., Rasseneur, L., Lonsdorfer-Wolf, E., Dufour, S.P., Doutreleau, S., Bouitbir, J., Zoll, J., Kapchinsky, S., Geny, B., Daussin, F.N., et al. (2014). Effect of eccentric versus concentric exercise training on mitochondrial function. *Muscle Nerve* *50*, 803–811.
- Jacobs, J.L., Marcus, R.L., Morrell, G., and LaStayo, P. (2014). Resistance Exercise with Older Fallers: Its Impact on Intermuscular Adipose Tissue. *Biomed Res Int* *2014*.
- Julian, V., Thivel, D., Miguet, M., Pereira, B., Costes, F., Coudeyre, E., Duclos, M., and Richard, R. (2018a). Eccentric cycling is more efficient in reducing fat mass than concentric cycling in adolescents with obesity. *Scand J Med Sci Sports*.
- Julian, V., Thivel, D., Costes, F., Touron, J., Boirie, Y., Pereira, B., Perrault, H., Duclos, M., and Richard, R. (2018b). Eccentric Training Improves Body Composition by Inducing Mechanical and Metabolic Adaptations: A Promising Approach for Overweight and Obese Individuals. *Front Physiol* *9*, 1013.
- Kato, H., Miura, K., Nakano, S., Suzuki, K., Bannai, M., and Inoue, Y. (2016). Leucine-enriched essential amino acids attenuate inflammation in rat muscle and enhance muscle repair after eccentric contraction. *Amino Acids* *48*, 2145–2155.
- Kemmer, G., and Keller, S. (2010). Nonlinear least-squares data fitting in Excel spreadsheets. *Nat Protoc* *5*, 267–281.
- Klausen, K., and Knuttgen, H.G. (1971). Effect of training on oxygen consumption in negative muscular work. *Acta Physiologica Scandinavica* *83*, 319–323.
- Klossner, S., Däpp, C., Schmutz, S., Vogt, M., Hoppeler, H., and Flück, M. (2007). Muscle transcriptome adaptations with mild eccentric ergometer exercise. *Pflugers Arch.* *455*, 555–562.

- Knuttgen, H.G., Nadel, E.R., Pandolf, K.B., and Patton, J.F. (1982). Effects of training with eccentric muscle contractions on exercise performance, energy expenditure, and body temperature. *Int J Sports Med* 3, 13–17.
- Kuznetsov, A.V., Veksler, V., Gellerich, F.N., Saks, V., Margreiter, R., and Kunz, W.S. (2008). Analysis of mitochondrial function in situ in permeabilized muscle fibers, tissues and cells. *Nat Protoc* 3, 965–976.
- LaStayo, P., McDonagh, P., Lipovic, D., Napoles, P., Bartholomew, A., Esser, K., and Lindstedt, S. (2007). Elderly patients and high force resistance exercise—a descriptive report: can an anabolic, muscle growth response occur without muscle damage or inflammation? *J Geriatr Phys Ther* 30, 128–134.
- LaStayo, P., Marcus, R., Dibble, L., Wong, B., and Pepper, G. (2017). Eccentric versus traditional resistance exercise for older adult fallers in the community: a randomized trial within a multi-component fall reduction program. *BMC Geriatr* 17.
- Lastayo, P.C., Reich, T.E., Urquhart, M., Hoppeler, H., and Lindstedt, S.L. (1999). Chronic eccentric exercise: improvements in muscle strength can occur with little demand for oxygen. *The American Journal of Physiology* 276, R611-615.
- LaStayo, P.C., Pierotti, D.J., Pifer, J., Hoppeler, H., and Lindstedt, S.L. (2000). Eccentric ergometry: increases in locomotor muscle size and strength at low training intensities. *Am. J. Physiol. Regul. Integr. Comp. Physiol.* 278, R1282-1288.
- LaStayo, P.C., Meier, W., Marcus, R.L., Mizner, R., Dibble, L., and Peters, C. (2009). Reversing Muscle and Mobility Deficits 1 to 4 Years after TKA: A Pilot Study. *Clin Orthop Relat Res* 467, 1493–1500.
- Laurent, H., Galvaing, G., Thivat, E., Coudeyre, E., Aubretton, S., Richard, R., Kwiatkowski, F., Costes, F., and Filaire, M. (2017). Effect of an intensive 3-week preoperative home rehabilitation programme in patients with chronic obstructive pulmonary disease eligible for lung cancer surgery: a multicentre randomised controlled trial. *BMJ Open* 7.
- Lavine, K.J., and Sierra, O.L. (2017). Skeletal Muscle Inflammation and Atrophy in Heart Failure. *Heart Fail Rev* 22, 179–189.
- Lechavue, J.B., Perrault, H., Aguilaniu, B., Isner-Horobeti, M.E., Martin, V., Coudeyre, E., and Richard, R. (2014). Breathing patterns during eccentric exercise. *Respiratory Physiology & Neurobiology* 202, 53–58.
- Lemos, T., and Gallagher, D. (2017). Current body composition measurement techniques. *Curr Opin Endocrinol Diabetes Obes* 24, 310–314.
- Lewis, M.C., Peoples, G.E., Groeller, H., and Brown, M.A. (2018). Eccentric cycling emphasising a low cardiopulmonary demand increases leg strength equivalent to workload matched concentric cycling in middle age sedentary males. *J Sci Med Sport* 21, 1238–1243.
- Liao, P., Zhou, J., Ji, L.L., and Zhang, Y. (2010). Eccentric contraction induces inflammatory responses in rat skeletal muscle: role of tumor necrosis factor-alpha. *American Journal of Physiology. Regulatory, Integrative and Comparative Physiology* 298, R599-607.

- Liu, S.Z., and Marcinek, D.J. (2017). Skeletal Muscle Bioenergetics in Aging and Heart Failure. *Heart Fail Rev* 22, 167–178.
- Lynch, G.S., Fary, C.J., and Williams, D.A. (1997). Quantitative measurement of resting skeletal muscle [Ca²⁺]_i following acute and long-term downhill running exercise in mice. *Cell Calcium* 22, 373–383.
- Lynn, R., and Morgan, D.L. (1994). Decline running produces more sarcomeres in rat vastus intermedius muscle fibers than does incline running. *J. Appl. Physiol.* 77, 1439–1444.
- MacMillan, N.J., Kapchinsky, S., Konokhova, Y., Gouspillou, G., de Sousa Sena, R., Jagoe, R.T., Baril, J., Carver, T.E., Andersen, R.E., Richard, R., et al. (2017). Eccentric Ergometer Training Promotes Locomotor Muscle Strength but Not Mitochondrial Adaptation in Patients with Severe Chronic Obstructive Pulmonary Disease. *Front Physiol* 8.
- Magalhães, J., Fraga, M., Lumini-Oliveira, J., Gonçalves, I., Costa, M., Ferreira, R., Oliveira, P.J., and Ascensão, A. (2013). Eccentric exercise transiently affects mice skeletal muscle mitochondrial function. *Appl Physiol Nutr Metab* 38, 401–409.
- Makrecka-Kuka, M., Krumschnabel, G., and Gnaiger, E. (2015). High-Resolution Respirometry for Simultaneous Measurement of Oxygen and Hydrogen Peroxide Fluxes in Permeabilized Cells, Tissue Homogenate and Isolated Mitochondria. *Biomolecules* 5, 1319–1338.
- Malm, C., Nyberg, P., Engström, M., Sjödin, B., Lenkei, R., Ekblom, B., and Lundberg, I. (2000). Immunological changes in human skeletal muscle and blood after eccentric exercise and multiple biopsies. *J Physiol* 529, 243–262.
- Malm, C., Sjödin, B., Sjöberg, B., Lenkei, R., Renström, P., Lundberg, I.E., and Ekblom, B. (2004). Leukocytes, cytokines, growth factors and hormones in human skeletal muscle and blood after uphill or downhill running. *J Physiol* 556, 983–1000.
- Marcus, R.L., Smith, S., Morrell, G., Addison, O., Dibble, L.E., Wahoff-Stice, D., and LaStayo, P.C. (2008). Comparison of Combined Aerobic and High-Force Eccentric Resistance Exercise With Aerobic Exercise Only for People With Type 2 Diabetes Mellitus. *Phys Ther* 88, 1345–1354.
- Marcus, R.L., Lastayo, P.C., Dibble, L.E., Hill, L., and McClain, D.A. (2009). Increased strength and physical performance with eccentric training in women with impaired glucose tolerance: a pilot study., Increased Strength and Physical Performance with Eccentric Training in Women with Impaired Glucose Tolerance: A Pilot Study. *J Womens Health (Larchmt)* 18, 18, 253, 253–260.
- Mauro, A. (1961). Satellite cell of skeletal muscle fibers. *J Biophys Biochem Cytol* 9, 493–495.
- McHugh, M.P., Connolly, D.A., Eston, R.G., and Gleim, G.W. (1999). Exercise-induced muscle damage and potential mechanisms for the repeated bout effect. *Sports Medicine (Auckland, N.Z.)* 27, 157–170.
- McKenzie, D.C. (2012). Respiratory physiology: adaptations to high-level exercise. *British Journal of Sports Medicine* 46, 381–384.

- Mettauer, B., Zoll, J., Sanchez, H., Lampert, E., Ribera, F., Veksler, V., Bigard, X., Mateo, P., Epailly, E., Lonsdorfer, J., et al. (2001). Oxidative capacity of skeletal muscle in heart failure patients versus sedentary or active control subjects. *J. Am. Coll. Cardiol.* *38*, 947–954.
- Meyer, K., Schwaibold, M., Westbrook, S., Beneke, R., Hajric, R., Lehmann, M., and Roskamm, H. (1997). Effects of exercise training and activity restriction on 6-minute walking test performance in patients with chronic heart failure. *Am. Heart J.* *133*, 447–453.
- Meyer, K., Steiner, R., Lastayo, P., Lippuner, K., Allemann, Y., Eberli, F., Schmid, J., Saner, H., and Hoppeler, H. (2003). Eccentric Exercise in Coronary Patients: Central Hemodynamic and Metabolic Responses. *Medicine & Science in Sports & Exercise* *35*, 1076–1082.
- Milani, R.V., Lavie, C.J., and Mehra, M.R. (2004). Cardiopulmonary exercise testing: how do we differentiate the cause of dyspnea? *Circulation* *110*, e27-31.
- Minetti, A.E., Moia, C., Roi, G.S., Susta, D., and Ferretti, G. (2002). Energy cost of walking and running at extreme uphill and downhill slopes. *J. Appl. Physiol.* *93*, 1039–1046.
- Molnar, A.M., Servais, S., Guichardant, M., Lagarde, M., Macedo, D.V., Pereira-Da-Silva, L., Sibille, B., and Favier, R. (2006). Mitochondrial H₂O₂ production is reduced with acute and chronic eccentric exercise in rat skeletal muscle. *Antioxid Redox Signal* *8*, 548–558.
- Mueller, M., Breil, F.A., Vogt, M., Steiner, R., Lippuner, K., Popp, A., Klossner, S., Hoppeler, H., and Däpp, C. (2009). Different response to eccentric and concentric training in older men and women. *Eur. J. Appl. Physiol.* *107*, 145–153.
- Mueller, M., Breil, F.A., Lurman, G., Klossner, S., Flück, M., Billeter, R., Däpp, C., and Hoppeler, H. (2011). Different molecular and structural adaptations with eccentric and conventional strength training in elderly men and women. *Gerontology* *57*, 528–538.
- Mujika, I., and Padilla, S. (2001). Muscular characteristics of detraining in humans. *Med Sci Sports Exerc* *33*, 1297–1303.
- Nemeth, P.M., and Lowry, O.H. (1984). Myoglobin levels in individual human skeletal muscle fibers of different types. *The Journal of Histochemistry and Cytochemistry: Official Journal of the Histochemistry Society* *32*, 1211–1216.
- Nicol, C., Avela, J., and Komi, P.V. (2006). The stretch-shortening cycle : a model to study naturally occurring neuromuscular fatigue. *Sports Medicine (Auckland, N.Z.)* *36*, 977–999.
- Nishikawa, K.C., Lindstedt, S.L., and LaStayo, P.C. (2018). Basic science and clinical use of eccentric contractions: History and uncertainties. *J Sport Health Sci* *7*, 265–274.
- Nosaka, K., and Clarkson, P.M. (1995). Muscle damage following repeated bouts of high force eccentric exercise. *Med Sci Sports Exerc* *27*, 1263–1269.
- Noskov, S.Yu., Rostovtseva, T.K., Chamberlin, A.C., Teijido, O., Jiang, W., and Bezrukov, S.M. (2016). Current State of Theoretical and Experimental Studies of the Voltage-Dependent Anion Channel (VDAC). *Biochim Biophys Acta* *1858*, 1778–1790.

- Peake, J., Nosaka, K., and Suzuki, K. (2005). Characterization of inflammatory responses to eccentric exercise in humans. *Exercise Immunology Review* 11, 64–85.
- Peñailillo, L., Blazevich, A., Numazawa, H., and Nosaka, K. (2013). Metabolic and muscle damage profiles of concentric versus repeated eccentric cycling. *Medicine and Science in Sports and Exercise* 45, 1773–1781.
- Perrey, S., Betik, A., Candau, R., Rouillon, J.D., and Hughson, R.L. (2001). Comparison of oxygen uptake kinetics during concentric and eccentric cycle exercise. *Journal of Applied Physiology* 91, 2135–2142.
- Pesta, D., and Gnaiger, E. (2012). High-resolution respirometry: OXPHOS protocols for human cells and permeabilized fibers from small biopsies of human muscle. *Methods Mol. Biol.* 810, 25–58.
- Plaquet-Hostache, G., Touron, J., Costes, F., Perrault, H., Clerfond, G., Cuenin, C., Moisa, A., Pereira, B., Boiteux, M.-C., Eschalier, R., et al. (2019). Effectiveness of combined eccentric and concentric exercise over traditional cardiac exercise rehabilitation programme in patients with chronic heart failure: protocol for a randomised controlled study. *BMJ Open* 9.
- Ponikowski, P., Voors, A.A., Anker, S.D., Bueno, H., Cleland, J.G.F., Coats, A.J.S., Falk, V., González-Juanatey, J.R., Harjola, V.-P., Jankowska, E.A., et al. (2016). 2016 ESC Guidelines for the diagnosis and treatment of acute and chronic heart failure: The Task Force for the diagnosis and treatment of acute and chronic heart failure of the European Society of Cardiology (ESC). Developed with the special contribution of the Heart Failure Association (HFA) of the ESC. *Eur. J. Heart Fail.* 18, 891–975.
- Rattray, B., Caillaud, C., Ruell, P.A., and Thompson, M.W. (2011). Heat exposure does not alter eccentric exercise-induced increases in mitochondrial calcium and respiratory dysfunction. *Eur J Appl Physiol* 111, 2813–2821.
- Rattray, B., Thompson, M., Ruell, P., and Caillaud, C. (2013). Specific training improves skeletal muscle mitochondrial calcium homeostasis after eccentric exercise. *Eur J Appl Physiol* 113, 427–436.
- Rizo-Roca, D., Ríos-Kristjánsson, J.G., Núñez-Espinosa, C., Santos-Alves, E., Magalhães, J., Ascensão, A., Pagès, T., Viscor, G., and Torrella, J.R. (2017). Modulation of mitochondrial biomarkers by intermittent hypobaric hypoxia and aerobic exercise after eccentric exercise in trained rats. *Applied Physiology, Nutrition, and Metabolism = Physiologie Appliquee, Nutrition Et Metabolisme* 42, 683–693.
- Rocha Vieira, D.S., Baril, J., Richard, R., Perrault, H., Bourbeau, J., and Taivassalo, T. (2011). Eccentric cycle exercise in severe COPD: feasibility of application. *COPD* 8, 270–274.
- Roig, M., Shadgan, B., and Reid, W.D. (2008). Eccentric Exercise in Patients with Chronic Health Conditions: A Systematic Review. *Physiother Can* 60, 146–160.
- Rooyackers, J.M., Berkeljon, D.A., and Folgering, H.T.M. (2003). Eccentric exercise training in patients with chronic obstructive pulmonary disease. *Int J Rehabil Res* 26, 47–49.
- Rowland, A.A., and Voeltz, G.K. (2012). Endoplasmic reticulum–mitochondria contacts: function of the junction. *Nat Rev Mol Cell Biol* 13, 607–625.

- Saltin, B., Henriksson, J., Nygaard, E., Andersen, P., and Jansson, E. (1977). Fiber types and metabolic potentials of skeletal muscles in sedentary man and endurance runners. *Ann. N. Y. Acad. Sci.* *301*, 3–29.
- Sanz, A., Caro, P., Ibañez, J., Gómez, J., Gredilla, R., and Barja, G. (2005). Dietary restriction at old age lowers mitochondrial oxygen radical production and leak at complex I and oxidative DNA damage in rat brain. *Journal of Bioenergetics and Biomembranes* *37*, 83–90.
- Schlagowski, A.-I., Isner-Horobeti, M.-E., Dufour, S.P., Rasseneur, L., Enache, I., Lonsdorfer-Wolf, E., Doutreleau, S., Charloux, A., Goupilleau, F., Bentz, I., et al. (2016). Mitochondrial function following downhill and/or uphill exercise training in rats. *Muscle Nerve* *54*, 925–935.
- Serrano, A.L., Baeza-Raja, B., Perdiguero, E., Jardí, M., and Muñoz-Cánoves, P. (2008). Interleukin-6 is an essential regulator of satellite cell-mediated skeletal muscle hypertrophy. *Cell Metabolism* *7*, 33–44.
- Shang, H., Xia, Z., Bai, S., Zhang, H.E., Gu, B., and Wang, R. (2019). Downhill Running Acutely Elicits Mitophagy in Rat Soleus Muscle. *Medicine and Science in Sports and Exercise* *51*, 1396–1403.
- Silva, L.A., Silveira, P.C.L., Ronsani, M.M., Souza, P.S., Scheffer, D., Vieira, L.C., Benetti, M., De Souza, C.T., and Pinho, R.A. (2011). Taurine supplementation decreases oxidative stress in skeletal muscle after eccentric exercise. *Cell Biochemistry and Function* *29*, 43–49.
- Sonobe, T., Inagaki, T., Poole, D.C., and Kano, Y. (2008). Intracellular calcium accumulation following eccentric contractions in rat skeletal muscle in vivo: role of stretch-activated channels. *American Journal of Physiology-Regulatory, Integrative and Comparative Physiology* *294*, R1329–R1337.
- Steiner, R., Meyer, K., Lippuner, K., Schmid, J.-P., Saner, H., and Hoppeler, H. (2004). Eccentric endurance training in subjects with coronary artery disease: a novel exercise paradigm in cardiac rehabilitation? *Eur. J. Appl. Physiol.* *91*, 572–578.
- Szlachcic, J., Massie, B.M., Kramer, B.L., Topic, N., and Tubau, J. (1985). Correlates and prognostic implication of exercise capacity in chronic congestive heart failure. *The American Journal of Cardiology* *55*, 1037–1042.
- Taylor, J.L., Holland, D.J., Spathis, J.G., Beetham, K.S., Wisløff, U., Keating, S.E., and Coombes, J.S. (2019). Guidelines for the delivery and monitoring of high intensity interval training in clinical populations. *Progress in Cardiovascular Diseases* *62*, 140–146.
- Teh, K.C., and Aziz, A.R. (2002). Heart rate, oxygen uptake, and energy cost of ascending and descending the stairs. *Medicine and Science in Sports and Exercise* *34*, 695–699.
- Theodorou, A.A., Panayiotou, G., Paschalis, V., Nikolaidis, M.G., Kyparos, A., Mademli, L., Grivas, G.V., and Vrabas, I.S. (2013). Stair descending exercise increases muscle strength in elderly males with chronic heart failure. *BMC Res Notes* *6*, 87.
- Toft, A.D., Jensen, L.B., Bruunsgaard, H., Ibfelt, T., Halkjaer-Kristensen, J., Febbraio, M., and Pedersen, B.K. (2002). Cytokine response to eccentric exercise in young and elderly humans. *American Journal of Physiology. Cell Physiology* *283*, C289–295.

- Touron, J., Perrault, H., Julian, V., Maisonnave, L., Deat, P., Auclair-Ronzaud, J., Salles, J., Walrand, S., Hermet, J., Rigaudiere, J.-P., et al. (2019). Impact of Eccentric or Concentric Training on Body Composition and Energy Expenditure. *Med Sci Sports Exerc* 51, 1944–1953.
- Toyomura, J., Mori, H., Tayashiki, K., Yamamoto, M., Kanehisa, H., and Maeo, S. (2018). Efficacy of downhill running training for improving muscular and aerobic performances. *Appl Physiol Nutr Metab* 43, 403–410.
- Tsuchiya, Y., Mizuno, S., and Goto, K. (2018). Irisin response to downhill running exercise in humans. *J Exerc Nutrition Biochem* 22, 12–17.
- Valladares-Ide, D., Peñailillo, L., Collao, N., Marambio, H., Deldicque, L., and Zbinden-Foncea, H. (2019). Activation of protein synthesis, regeneration, and MAPK signaling pathways following repeated bouts of eccentric cycling. *American Journal of Physiology. Endocrinology and Metabolism* 317, E1131–E1139.
- Walsh, B., Tonkonogi, M., Söderlund, K., Hultman, E., Saks, V., and Sahlin, K. (2001a). The role of phosphorylcreatine and creatine in the regulation of mitochondrial respiration in human skeletal muscle. *J Physiol* 537, 971–978.
- Walsh, B., Tonkonogi, M., and Sahlin, K. (2001b). Effect of endurance training on oxidative and antioxidative function in human permeabilized muscle fibres. *Pflugers Arch* 442, 420–425.
- Walsh, B., Tonkonogi, M., Malm, C., Ekblom, B., and Sahlin, K. (2001c). Effect of eccentric exercise on muscle oxidative metabolism in humans. *Med Sci Sports Exerc* 33, 436–441.
- Wasserman, K. (1999). *Principles of Exercise Testing & Interpretation: Including Pathophysiology and Clinical Applications* (Lippincott Williams & Wilkins).
- Weber, K.T., Kinasewitz, G.T., Janicki, J.S., and Fishman, A.P. (1982). Oxygen utilization and ventilation during exercise in patients with chronic cardiac failure. *Circulation* 65, 1213–1223.
- Yancy, C.W., Jessup, M., Bozkurt, B., Butler, J., Casey, D.E., Drazner, M.H., Fonarow, G.C., Geraci, S.A., Horwich, T., Januzzi, J.L., et al. (2013). 2013 ACCF/AHA guideline for the management of heart failure: a report of the American College of Cardiology Foundation/American Heart Association Task Force on Practice Guidelines. *J. Am. Coll. Cardiol.* 62, e147-239.
- Zoll, J., Sanchez, H., N'Guessan, B., Ribera, F., Lampert, E., Bigard, X., Serrurier, B., Fortin, D., Geny, B., Veksler, V., et al. (2002). Physical activity changes the regulation of mitochondrial respiration in human skeletal muscle. *J Physiol* 543, 191–200.
- Zoll, J., Koulmann, N., Bahi, L., Ventura-Clapier, R., and Bigard, A.-X. (2003). Quantitative and qualitative adaptation of skeletal muscle mitochondria to increased physical activity. *J. Cell. Physiol.* 194, 186–193.
- Zoll, J., Steiner, R., Meyer, K., Vogt, M., Hoppeler, H., and Flück, M. (2006). Gene expression in skeletal muscle of coronary artery disease patients after concentric and eccentric endurance training. *Eur. J. Appl. Physiol.* 96, 413–422.

Zuo, Q., Qu, F., Li, N., Wang, S., Liu, J., Xu, C., and Yu, X. (2019). Eccentric exercise results in a prolonged increase in interleukin-6 and tumor necrosis factor- α levels in rat skeletal muscle. *Journal of Muscle Research and Cell Motility* 40, 379–387.

Annexes

Annexe 1 – Revue n°1

Eccentric training improves body composition by inducing mechanical and metabolic adaptations: a promising approach for overweight and obese individuals.

Depuis les 40 dernières années, une accélération de la recherche impliquant la modalité de contraction excentrique s'est opérée entraînant la publication de multiples articles. Des études *in vitro* sur muscles isolés aux études *in vivo* chez l'animal et chez l'Homme, faisant appel à des exercices segmentaires ou dynamiques, ont généré tout autant de données dans des champs expérimentaux variés, de la recherche fondamentale à l'application clinique. L'ensemble de ces travaux offrent l'opportunité de faire un bilan des connaissances acquises tout au long de ces années et de tirer des conclusions quant à l'orientation des recherches futures. Plusieurs revues de la littérature sont déjà disponibles concernant le dommage musculaire, le remodelage, les réponses biomécaniques et physiologiques, mais aucune n'avait fait le point sur un potentiel effet de l'entraînement excentrique sur les paramètres de composition corporelle et son intérêt dans la prise en charge du surpoids et de l'obésité. L'objectif premier a donc été de passer en revue les arguments relatifs aux effets de cette modalité d'entraînement sur les adaptations corps entier en termes de masse maigre et grasse, mais également segmentaire, tout en les comparant aux effets de l'entraînement classique concentrique. Le deuxième objectif était de fournir des informations sur les principales adaptations mécaniques, physiologiques et métaboliques à l'entraînement excentrique pouvant contribuer aux effets observés. Enfin, le dernier objectif était de déterminer les effets bénéfiques de l'exercice excentrique sur les paramètres liés à la santé chez les patients en surpoids et obèses.

Il en résulte que l'excentrique est une modalité au moins aussi efficace que la modalité concentrique pour augmenter la masse maigre. Quelques études indiquent également qu'elle peut être favorable à la perte de masse grasse par l'augmentation de la dépense énergétique au repos, par la modification des substrats métaboliques préférentiels et par l'amélioration du profil lipidique sanguin et de la résistance à l'insuline. L'entraînement excentrique présente donc de multiples intérêts pour la prise en charge du surpoids et de l'obésité. Des investigations

supplémentaires sur la composition corporelle corps entier et segmentaire, mettant en pratique des conditions expérimentales standardisées, sont cependant nécessaires afin de mieux cerner les réponses différentielles entre les modalités d'entraînement excentrique et concentrique.



Eccentric Training Improves Body Composition by Inducing Mechanical and Metabolic Adaptations: A Promising Approach for Overweight and Obese Individuals

Valérie Julian^{1*}, David Thivel², Frédéric Costes¹, Julianne Touron³, Yves Boirie⁴, Bruno Pereira⁵, Hélène Perrault⁶, Martine Duclos¹ and Ruddy Richard¹

OPEN ACCESS

Edited by:

Vincent Plaboux,
Claude Bernard University Lyon 1,
France

Reviewed by:

Michalis G. Nikolaidis,
Aristotle University of Thessaloniki,
Greece
Michael Harris-Love,
Washington DC VA Medical Center,
United States

*Correspondence:

Valérie Julian
vjulian@chu-clermontferrand.fr

Specialty section:

This article was submitted to
Exercise Physiology,
a section of the journal
Frontiers in Physiology

Received: 19 January 2018

Accepted: 09 July 2018

Published: 07 August 2018

Citation:

Julian V, Thivel D, Costes F, Touron J,
Boirie Y, Pereira B, Perrault H,
Duclos M and Richard R (2018)
Eccentric Training Improves Body
Composition by Inducing Mechanical
and Metabolic Adaptations: A
Promising Approach for Overweight
and Obese Individuals.
Front. Physiol. 9:1013.
doi: 10.3389/fphys.2018.01013

¹ Service de Médecine du Sport et Explorations Fonctionnelles, CHU Clermont-Ferrand, INRA, CRNH, Université Clermont Auvergne, Clermont-Ferrand, France, ² Laboratoire AME2P, Université Clermont Auvergne, Clermont-Ferrand, France, ³ INRA, CRNH, Université Clermont Auvergne, Clermont-Ferrand, France, ⁴ Service de Nutrition Clinique, CHU Clermont-Ferrand, INRA, CRNH, Université Clermont Auvergne, Clermont-Ferrand, France, ⁵ Service de Biostatistique, CHU Clermont-Ferrand, Université Clermont Auvergne, Clermont-Ferrand, France, ⁶ Faculté des Sciences de la Santé, Université d'Ottawa, Ottawa, ON, Canada

Skeletal muscle generates force by either shortening (concentrically) or lengthening (eccentrically). Eccentric (ECC) exercise is characterized by a lower metabolic demand and requires less muscle activity than concentric (CON) exercise at the same level of exerted force. However, the specific effect of ECC training vs. CON training on lean and fat mass remains underexplored. The first aim of this paper was to review the available evidence regarding the effects of ECC training on whole body and segmental lean and fat mass and, when possible, compare these with the effects of CON training. The second aim was to provide some insights into the main mechanical, physiological, and metabolic adaptations of ECC training that contribute to its effects on body composition. The third aim was to determine the beneficial effects of ECC exercise on health-related parameters in overweight and obese patients. ECC training is an effective modality to improve lean mass, but when matched for load or work, the difference between ECC and CON trainings seems unclear. A few studies reported that ECC training is also efficient at reducing fat mass. By increasing post-exercise resting energy expenditure, modifying metabolic substrate, and improving both blood lipid profile and insulin resistance, ECC training is a potential exercise modality for individuals with chronic conditions such as those who are overweight and obese. Further investigations using standardized experimental conditions, examining not only segmental but also whole body composition, are required to compare ECC and CON trainings.

Keywords: eccentric exercise, concentric exercise, fat mass, lean mass, obesity, metabolism, training effects

INTRODUCTION

Daily life activities are performed with a combination of concentric (CON) and eccentric (ECC) muscle contractions. CON contractions serve to generate motor actions, whereas ECC contractions are involved in the braking movements of externally loaded muscles. ECC training involves isoinertial or isokinetic segmental contractions (Coratella et al., 2015). Recently, training alternative modalities, such as downhill walking or running, or cycling with special motorized eccentric cycle-ergometers (Rakobowchuk et al., 2018), have been conceived and characterized as “continuous moderate load eccentric exercise” (Hoppeler, 2016). Hoppeler (2016) characterized three types of ECC training into plyometric exercises (such as drop jumps, with contractions lasting milliseconds and producing thousands of watts of negative power), classical ECC resistance exercises (protocols consisting of near maximal ECC contractions lasting few seconds, used to lift and lower weights), and “continuous moderate load ECC exercises” [also as denoted (RENEW) Resistance Exercise via Negative Eccentric Work by LaStayo et al. (2017)]. For the same mechanical power, oxygen consumption ($\dot{V}O_2$) during downhill running is approximately half compared with that during uphill running and is three to four times lower during ECC cycling than that during CON cycling (Perrey et al., 2001; Dufour et al., 2004). Continuous moderate load ECC exercise is characterized by lower metabolic and cardiorespiratory demands than CON exercise when performed at the same power output (Perrey et al., 2001; Minetti et al., 2002; Dufour et al., 2004; Chavanelle et al., 2014). Thus, an increasing interest has emerged with its use in patients with chronic diseases (Isner-Horobeti et al., 2013; Hoppeler, 2016) that are accompanied by cardiac, respiratory, or muscular impairments. This ECC modality has been increasingly prescribed and is proposed to patients with cardiac problems (Hortobágyi and DeVita, 2000; Meyer et al., 2003; Steiner et al., 2004; Zoll et al., 2006; Theodorou et al., 2013), respiratory disabilities (Meyer et al., 2003; Steiner et al., 2004; Rocha Vieira et al., 2011), sarcopenia (LaStayo et al., 2003), or neurological and musculoskeletal diseases (Engardt et al., 1995; Hawkins et al., 1999; Gür et al., 2002).

As improving body composition is a major target of training programs, identification of the exact effects of CON and ECC modalities on both lean and fat mass is necessary. However, the specific effects of ECC training on lean and fat mass remain underexplored compared with CON training. Several methodological barriers make it difficult to compare CON and ECC trainings, including (i) the difficulty of isolating ECC and CON actions during usual movements of daily life, and (ii) the lack of simple comparisons of ECC and CON exercises in standardized experimental conditions of similar power output (i.e., at the same mechanical power), similar oxygen consumption (i.e., at the same metabolic rate), and similar intensity and work volume.

This narrative review aimed to summarize the available evidence about the effects of ECC training on whole body lean and fat mass, and on segmental body composition (i.e., of the trained part), and compare this with the effects of CON

training or, when not possible, with traditional training (which are mainly executed in practice). We reviewed studies carried out over the last two decades in which ECC was used as a training modality using ECC exercises mobilizing “segmental” or “large muscle mass.” For greater consistency, we prioritized, whenever possible, continuous moderate load ECC training over classical ECC resistance training and focused our research on whole body and lower limb composition. The second aim was to provide some insights into the main mechanical, physiological, and metabolic adaptations of ECC training that contribute to its potential effects on body composition. Finally, we determined whether ECC training is an innovative and promising approach for the management of overweight and obesity. This review is aimed at exercise scientists, health professionals, and trainers in the field of chronic disease and rehabilitation.

EFFECTS OF ECCENTRIC TRAINING ON BODY COMPOSITION

Evaluation of body composition depends on the assessment model used to access both lean and fat mass. Advanced technologies, such as dual-energy X-ray absorptiometry (DXA), computed tomography (CT), and magnetic resonance imaging (MRI), are used by researchers to precisely quantify both whole body and segmental body composition at specific sites. Systematic differences have been reported between DXA and CT or MRI measures of lean mass. DXA overestimates the measure of lean mass, which is attributed to the significant non-fat component of adipose tissue (Levine et al., 2000). DXA is generally preferred when tissue mass is needed as a denominator for metabolic measurements, and CT or MRI are more appropriate when appendicular tissue composition is needed for relating it to muscle strength. Thus, if appendicular composition is measured for the purpose of relating it to muscle strength, CT is the most satisfactory method, whereas if tissue mass is needed as a denominator for metabolic measurements, DXA is preferred (Levine et al., 2000). Ultrasonography is also currently used to assess lean body mass (muscle thickness and muscle volume; Abe et al., 2015) and body fat (Wagner, 2013; Váczi et al., 2014). Several other measurement techniques are available but we focused on the aforementioned reference methods, which are the most sensitive, safe, and relevant in clinical practice (Lemos and Gallagher, 2017).

Eccentric Training and Lean Mass

Direct measurements of segmental body composition performed before and after ECC training generally show an improvement in lean mass and volume in healthy subjects of a wide age range (including elderly subjects), as well as in patients with chronic pathologies. These lean mass improvements are summarized in **Table 1** and compared either to CON or traditional training.

Several studies revealed significantly “greater effectiveness” of ECC in comparison with CON or traditional training. Raj et al. (2012) demonstrated that a 16-week ECC resistance training in older adults is superior to a conventional resistance training matched for the same relative volume. In older and moderate

TABLE 1 | Studies analyzing the effects of eccentric training on lean mass.

Studies	Population	Technique for body composition measurements	Training Intervention	Training duration	Effects
Biazevich et al., 2007	Active young adults Mean age: 22.5 years CON $n = 12$; ECC $n = 12$ (17 F; 16 M)	MRI (Whole quadriceps volume)	ECC: 4–6 sets of 6 reps (knee extension on an isokinetic dynamometer), 50–90%MVC. Volume (sets \times reps \times load): 1,200 to 3,240 CON: 4–6 sets of 6 reps (knee extension on an isokinetic dynamometer), 50–90%MVC. Volume (sets \times reps \times load): 1,200 to 3,240	10 weeks (3 x/week)	+10% $p < 0.001$ NS between groups
Marcus et al., 2008	Adults with type 2 diabetes mellitus Mean age: 50.7 years AE $n = 8$; AE/RE $n = 7$ (7 F; 8 M)	MRI (Thigh lean tissue CSA)	AE: aerobic exercise (treadmill, recumbent stepper, stationary bicycle, rowing machine). Intensity: 60–85% of age-predicted heart rate. Duration: 50 min. Workload not available AE/RE: recumbent eccentric stepper. Intensity: RPE from “very very light” to “somewhat hard”. Duration: 20 min + aerobic training to complete 50 min. Workload not available	16 weeks (3 x/week)	AE: -4% $p < 0.05$ AE/RE: +10.5% $p < 0.05$
Marcus et al., 2009	Post-menopausal women Mean age: 56.1 years CT $n = 6$; ECC $n = 10$	DXA (Leg lean mass)	ECC: eccentric ergometer. Intensity: RPE from “very very light” to “somewhat hard”. Duration 30 min. Work increased from 20.3–229.7 kJ. CT: control group with no supervised program	12 weeks (3 x/week)	ECC: +6% $p < 0.05$ CT: -0.03% NS
Mueller et al., 2009	Older adults Mean age: 80.6 years CT $n = 14$; RET $n = 21$; EET $n = 19$ (38 F; 26 M)	DXA (Thigh muscle mass)	EET: eccentric ergometer. Intensity: initially set at 30 W for women and 50 W for men, gradually ramped up according to RPE and DOMS. Duration 20 min. Workload not available RET: 3 sets of 8–10 reps (leg press, knee extension, leg curl, hip extension) with a progressive load based on RPE and DOMS. Duration 20 min. Load was increased if subject was able to do 10 reps. Intensity not described. Workload not available CT: computer-guided cognitive training without physical training	12 weeks (2 x/week)	EET: +2.5% $p < 0.05$ RET: +2% $p < 0.05$ CT: +0.4% NS
LaSlayo et al., 2009	Older and obese adults Mean age: 67.5 years ECC $n = 9$; TRAD $n = 8$ (13 F; 4 M)	MRI (Whole quadriceps volume)	ECC: eccentric stepper. Intensity ramped according to RPE from “fairly light” to “somewhat hard”. Duration 30 min. Mean work increased from 44 003 to 86 480 kJ TRAD: 3 sets of 10–12 reps (leg press, leg curl, leg extension, calf raise). Intensity 70% 1 RM. Relative volume 2,100–2,520	12 weeks (3 x/week)	ECC: +11.5% $p < 0.001$ TRAD: +3% NS
Reeves et al., 2009	Older adults Mean age: 70 years ECC $n = 10$; CONV $n = 9$ (10 F; 9 M)	Ultrasonography (Vastus lateralis thickness)	ECC: 2 sets of 10 reps (knee extension, leg press), Intensity 80% 5 RM. Absolute volume (sets \times reps \times load) 157,525 \pm 47,790 CONV: 2 sets of 10 reps (knee extension, leg press), Intensity 80% 5 RM. Absolute volume (sets \times reps \times load) 197,722 \pm 77,461	14 weeks (3 x/week)	ECC: +11% $p < 0.05$ CONV: +11% $p < 0.05$
Raj et al., 2012	Older adults Mean age: 68 years EB $n = 13$; CONV $n = 12$ CT $n = 13$ (11 F; 17 M)	Ultrasonography (Vastus lateralis thickness)	EB: 3 sets of 10 reps (leg press, toe press, pull-down, bench press), Intensity 50% 1 RM. Relative volume (sets \times reps \times load) 1,500 CONV: 2 sets of 10 reps (leg press, toe press, pull-down, bench press), Intensity 75% 1 RM. Relative volume (sets \times reps \times load) 1,500 CT: no exercise	16 weeks (3 x/week)	EB: +5% $p < 0.05$ CONV: +0% NS CT: -6% $p < 0.05$
English et al., 2014	40 healthy males Mean age: 34.9 years CON $n = 8$; ECC 33 $n = 8$; ECC 66 $n = 8$; ECC 100 $n = 8$; ECC 138 $n = 8$	DXA (Whole body lean mass and leg lean mass)	CON: 2–5 sets of 2–8 reps (supine leg press and supine calf press). Intensity modified each session from 55–96% 1 RM ECC 33: program based on CON + ECC training (leg press) at 33% of the CON load ECC 66: program based on CON + ECC training (leg press) at 66% of the CON load ECC 100: program based on CON + ECC training (leg press) at 100% of the CON load ECC 138: program based on CON + ECC training (leg press) at 138% of the CON load	8 weeks (3 x/week)	Whole body lean mass NS in any group Leg lean mass ECC 138: +2.4% $p < 0.05$ NS in other groups

(Continued)

TABLE 1 | Continued

Studies	Population	Technique for body composition measurements	Training Intervention	Training duration	Effects
Váczl et al., 2014	Active older males Mean age: 65 years ECC $n = 38$; SOC $n = 9$ (57 F; 20 M)	MRI (Quadriceps CSA)	ECC (knee extension on an isokinetic dynamometer): 4 sets of 8 to 14 reps. Intensity based on %MVC. SOC: Stretch load/contractions from 86 ± 24 J to 120 ± 10 J. Total work matched in the 2 groups.	10 weeks (3 x/week)	ECC: +3% $p < 0.05$ SOC: +2% $p < 0.05$
Franchi et al., 2015	Young males Mean age: 23 ± 4 $n = 10$ 1 leg CON; 1 leg ECC	Ultrasonography (Quadriceps thickness) DXA (Thigh lean mass)	80% of CON or ECC 1 RM CON: 4 sets of 8–10 reps (leg press). Intensity 80% 1 RM CON. ECC: 4 sets of 8–10 reps (leg press). Intensity 80% 1 RM ECC. Relative loads matched.	4 weeks (3 x/week)	Muscle thickness ECC: +7.5% $p < 0.001$; CON: +8.4% $p < 0.001$ Thigh lean mass ECC: +2.3% $p < 0.01$; CON: +3% $p < 0.01$ NS between groups
LaStayo et al., 2017	Older adults fallers Mean age: 76.1 $n = 134$ (87 F; 47 M)	MRI (Thigh lean tissue CSA)	TRAD: circuit training, static tasks, aerobic exercise (cycle ergometer), flexibility exercises, upper extremity resistance exercise (free weights), 3 sets of 15 reps (leg press, standing multidirectional straight leg). Intensity 60–70% 1 RM. Duration 1 h. Workload not available. RENEW: circuit training + eccentric stepper. Intensity ramped according to RPE from "very very light" to "somewhat hard." Duration 15 min. Total training duration 1 h. Workload not available	12 weeks (3 x/week)	Pre-post difference $p < 0.05$ in each group but NS between groups

AE, aerobic exercise; AE/RE, aerobic exercise/resistance exercise; CON, concentric; CONV, conventional resistance training; CSA, cross-sectional area; CT, control group; DOMS, delayed onset muscular soreness; DXA, dual-X-ray absorptiometry; EB, Eccentrically biased resistance training; ECC, eccentric; EET, eccentric ergometer training; MRI, magnetic resonance imaging; MVC, maximal voluntary contraction; NS, non-significant; RET, conventional resistance training; RM, repetition maximum; RPE, rating of perceived exertion; SSC, stretch-shortening cycle; TRAD, traditional resistance training program; RENEW, resistance exercise via negative eccentric work.

obese adults, another study showed that a 12-week moderate load ECC training (with ECC cycle-ergometers) exhibits a greater increase in quadriceps muscle size than a conventional resistance training (LaStayo et al., 2009). Similar results were obtained by Marcus et al. (2008) in a high-metabolic risk population of patients with type 2 diabetes: a 16-week program combining moderate load ECC exercises (with ECC cycle-ergometers) and aerobic exercises induces a superior increase in the thigh lean tissue cross-sectional area (CSA), compared with a program based on aerobic exercises only.

Other studies indicated similar results with regard to gain in lean mass after both forms of training. In elderly subjects with sarcopenia, Mueller et al. (2009) compared a 12-week moderate load ECC training group (with ECC cycle-ergometers) with a conventional resistance training group. They observed that both trainings induce a significant gain in thigh lean mass, without any significant difference between the groups. In older adult fallers, LaStayo et al. (2017) compared a moderate load ECC training group (the RENEW group, training with ECC cycle-ergometers) with a traditional resistance training group. Similarly, they found no significant difference in the increase in the CSA of thigh lean tissue after 12 weeks of training. In healthy active men and women, a 10-week ECC or CON resistance training

matched for relative volume shows similar improvements in whole quadriceps volume (Blazevich et al., 2007). In young males, Franchi et al. (2015) also compared an ECC training with a CON resistance training matched for relative loads and found that quadriceps thickness and thigh lean mass increase with similar proportions after 4 weeks. In older adults, Reeves et al. (2009) also demonstrated similar improvements in *vastus lateralis* thickness after 14 weeks of resistance training (however, the volume of the ECC program was lower than that of the conventional program). Interestingly, English et al. (2014) demonstrated that an 8-week resistance ECC training in healthy males produces a superior increase in leg lean mass compared with CON training, provided that ECC loads were superior to CON.

Thus, both forms of exercise are effective to induce gains in lean mass. The studies reported above indicate that ECC training is more effective (LaStayo et al., 2009; Marcus et al., 2009; Raj et al., 2012; English et al., 2014) or at least as effective as other exercise modalities (Blazevich et al., 2007; Mueller et al., 2009; Reeves et al., 2009; Franchi et al., 2015) in improving segmental lean mass. Nevertheless, the greater effectiveness of ECC training in improving lean mass is not clearly elucidated in recent reviews. Franchi et al. (2017) discussed the contribution of ECC and CON resistance trainings to muscular hypertrophy. They grouped

studies in different categories depending on the index used to assess hypertrophy (and thus on the model of assessment) and concluded that the changes between ECC and CON trainings are similar when matched for load or work. Furthermore, Schoenfeld et al. (2017) conducted a systematic review comparing low- and high-load resistance training protocols and found similar hypertrophy between conditions.

The increase in muscle fiber volume induced by ECC training is also microscopically confirmed by measuring the CSA of the muscle fiber. LaStayo et al. (2000) compared 8-week trainings based on either ECC or CON cycling matched for metabolic rate (quantified as a percentage of the patients' peak heart rate) in healthy males. The ECC program show an increase of more than 50% in the CSA of the muscle fibers measured using biopsy from the middle part of the vastus lateralis, whereas CON training exhibited no changes (LaStayo et al., 2000). However, measurement of the CSA of the whole muscle was not performed. This increase in the CSA of the muscle fiber after ECC training has been validated by several studies (Hortobágyi et al., 1996; LaStayo et al., 2003; Vikne et al., 2006). Other studies showed similar positive changes in the size of the muscle fibers after ECC training compared with CON training (Jones et al., 1989; Meyer et al., 2003). Only few studies failed to detect any significant change after ECC training (Colliander and Tesch, 1990; Fisher et al., 2016).

Moreover, muscle strength measurement, muscle CSA measurement, and DXA evaluation of thigh lean mass are closely correlated (Levine et al., 2000). Hence, muscle strength measurement is considered as a reliable indirect measure of lean mass, and has been extensively studied. The findings have revealed that ECC training induces a significantly greater increase in appendicular total strength (i.e., the sum of CON, isometric and ECC peak torque) and ECC strength, whereas the difference in isometric and CON measures seems less significant (Roig et al., 2009). Thus, the increase in ECC strength after ECC training is greater than the gain in CON strength after CON training (Higbie et al., 1996; Vikne et al., 2006).

In summary, ECC training is effective at inducing gains in lean mass. Comparison between ECC and CON training programs in terms of mechanical power, metabolic rate, intensity, or volume remains methodologically difficult. Although ECC training was previously associated with greater muscle hypertrophy, the findings were extremely varied to clearly affirm its superiority over CON or traditional training. However, considering the lower metabolic demand of ECC exercise, it would be more efficient than CON training given the ratio of energy expenditure to net force or work production. Investigations comparing not only segmental but also whole body lean mass after ECC and CON trainings are necessary.

Eccentric Training and Fat Mass

The effects of ECC training on body fat mass remain underexplored. The available clinical evidences are detailed and summarized in **Table 2**. As no study has considered the variations of whole body or segmental fat mass in comparing ECC and CON training, we presented here indirect comparisons between ECC and traditional trainings. We noted a 12-week randomized

controlled trial among elderly patients with sarcopenia that measured both thighs and whole body fat mass in three groups of patients: (i) the moderate load ECC training group (training with motorized eccentric ergometer with a power output based on the patients' perceived exertion); (ii) the conventional resistance training group; and (iii) the cognitive training group. Although the trainings were not matched for load, only the ECC ergometer training group showed a significant reduction in thigh fat content and whole body fat mass (Mueller et al., 2009). In a high-metabolic risk population of patients with type 2 diabetes mellitus, a 16-week intervention combining moderate load ECC exercises (on motorized cycle-ergometers) and aerobic exercises was compared against a program with aerobic exercises only. The two groups experienced a decrease in thigh intramuscular fat area, without any significant difference between the groups concerning intramuscular fat. Interestingly, a greater reduction in body mass index was observed in the ECC group (Marcus et al., 2008). Another study showed that after 12 weeks of multimodal exercise intervention in elderly patients with comorbidities and a history of falling, no significant difference in intermuscular adipose tissue was found after either the ECC program (paired with moderate load ECC exercises on motorized stepper ergometers) or the traditional training program (paired with traditional resistance training; Jacobs et al., 2014). However, in these studies, the total training loads were not available. Another study that enrolled post-menopausal women with impaired glucose tolerance evaluated the effect of a 12-week moderate load ECC training program (with motorized eccentric ergometers) and measured a significant increase in leg lean mass combined with a decrease in abdominal fat mass (total body fat was not reported). Although the study also enrolled a control group (a computer-guided cognitive training group), it lacked a CON group for comparison (Marcus et al., 2009).

In summary, ECC training is effective at reducing fat mass. Studies comparing ECC vs. CON training have not been conducted. Nevertheless, referring to the previous studies that compared ECC training and traditional trainings, ECC training is more (Mueller et al., 2009) or at least as effective as traditional training (Marcus et al., 2008; Jacobs et al., 2014) in reducing fat mass. ECC training may simultaneously increase lean mass and decrease fat mass, which would contribute to preventing sarcopenia and a number of other age-related metabolic impairments (Marcus et al., 2008, 2009; Mueller et al., 2009). Nevertheless, studies on the effects of ECC training on fat mass are scarce and further investigations are required. In particular, studies that evaluate both segmental and whole body composition and that employ the same mechanical power, the same metabolic intensity, or the same total training load or volume when calibrating training interventions are necessary.

PHYSIOLOGIC AND METABOLIC EFFECTS OF ECCENTRIC EXERCISE

Figure 1 schematically illustrates the physiological and metabolic effects of ECC training, and their relationship to changes in lean and fat mass.

TABLE 2 | Studies analyzing the effects of eccentric training on fat mass.

Study, year	Population	Technique for body composition measurements	Training Intervention	Training duration	Effects
Marcus et al., 2008	Adults with type 2 diabetes mellitus Mean age: 50.7 years AE $n = 8$; AE/RE $n = 7$ (7 F; 8 M)	MRI (Thigh intramuscular fat CSA)	AE: aerobic exercise (treadmill, recumbent stepper, stationary bicycle, rowing machine). Intensity: 60%–85% of age-predicted heart rate. Duration: 50 min. Workload not available AE/RE: recumbent eccentric stepper. Intensity: RPE from "very very light" to "somewhat hard". Duration: 20 min + aerobic training to complete 50 min. Workload not available	16 weeks (3 x/week)	Thigh intramuscular fat CSA AE: -2.2 cm^2 $p < 0.05$ AE/RE: -1.2 cm^2 $p < 0.05$ NS between groups
Marcus et al., 2009	Post-menopausal women Mean age: 56.1 years CT $n = 6$; ECC $n = 10$	DXA (Abdominal fat mass)	ECC: eccentric ergometer. Intensity: RPE from "very very light" to "somewhat hard". Duration: 30 min. Work increased from 20.3 to 229.7 kJ	12 weeks (3 x/week)	Abdominal fat mass CT: $+2.5\%$ NS; ECC: -3.7% NS
Mueller et al., 2009	Older adults Mean age: 80.6 years CT $n = 14$; RET $n = 21$; EET $n = 19$ (36 F; 26 M)	DXA (Total body and thigh fat mass)	RET: 3 sets of 10 reps (leg press, knee extension, leg curl, hip extension) with a progressive load based on RPE and DOMS. Duration 20 min. Volume not available. EET: eccentric ergometer. Intensity: initially set at 30W for women and 50W for men, gradually ramped up according to RPE and DOMS. Duration: 20 min. Workload not available CT: computer-guided cognitive training without physical training	12 weeks (2 x/week)	Whole body fat mass RET: -0.6% NS EET: -5.0% $p < 0.01$; CT: $+1.4\%$ NS Thigh fat mass RET: -2.7% NS; EET: -6.9% $p < 0.01$; CT: $+0.6\%$ NS
Jacobs et al., 2014	Older adults Mean age: 75.5 years TRAD $n = 38$; ECC $n = 9$ (57 F; 20 M)	MRI (Thigh intermuscular adipose tissue)	TRAD: 3 sets of 15 reps (bilateral leg press), 3 sets of 15 reps (standing multidirectional straight leg exercise). Intensity 60–70% 1 RM + aerobic exercise. Duration: 60 min. Volume (sets \times reps \times load) 2 700–3 150 ECC: eccentric ergometer. Intensity: RPE from "very very light" to "somewhat hard." Duration: 15 min + aerobic exercise to complete 60 min. Workload not available	12 weeks (3 x/week)	Thigh intermuscular adipose tissue TRAD: -0.1% NS; ECC: -0.1% NS

AE, aerobic exercise; AE/RE, aerobic exercise/resistance exercise; CSA, cross-sectional area; CT, control group; DXA, dual-X-ray absorptiometry; DOMS, delayed onset muscular soreness; ECC, eccentric; EET, eccentric ergometer training; MRI, magnetic resonance imaging; NS, non-significant; RET, conventional resistance training; RM, repetition maximum; RPE, rating of perceived exertion; TRAD, traditional resistance training program.

Eccentric Training and Resting Energy Expenditure

Resting energy expenditure (REE), which represents 60 to 75% of the total daily energy expenditure in humans, can remain elevated up to 48 h after a single bout of exercise (Melby et al., 1993; Gillette et al., 1994). Several studies have recently shown that ECC exercise may increase and prolong this rise in post-exercise REE more than CON exercise. A study conducted among healthy young women using oxygen calorimetry recorded a significant increase of 12% in REE 48 h after an acute segmental ECC exercise (five sets of 15 maximal voluntary contraction knee extensions), but not after a CON exercise set at the same power output (Paschalis et al., 2011). Some authors have even emphasized that acute ECC exercise can prolong the increase in post-exercise REE to at least 72 h (Hackney et al., 2008). This higher REE observed after an acute bout of ECC exercise may be caused by enhanced muscle protein turnover (i.e., an increase in both muscle protein degradation, which activates proteases and hydrolases, and muscle protein synthesis). The elevated turnover arises because of inflammatory processes to repair muscular myofibrillar damage and support muscle hypertrophy (Chesley

et al., 1992; Burleson et al., 1998; Tidball, 2011). Although every exercise modality can lead to exercise-induced muscle damage (EIMD), ECC exercise has more damaging effects due to the higher force developed and the mechanical disruption of the actin-myosin bonds (Eliasson et al., 2006). EIMD is the result of both "mechanical" and "metabolic" stresses on the muscle fibers (Proske and Morgan, 2001; Allen et al., 2005; Tee et al., 2007), which cause temporary lesions of the cytoskeleton and disruption of the sarcomeres and Z-lines in response to overstretching (Proske and Morgan, 2001; Morgan et al., 2004; Tee et al., 2007). The unregulated influx of extracellular ions into the injured muscle induces elevation in cytosolic calcium concentration. This elevation leads to the activation of calcium-dependent proteases within the muscle cytosol (calpains), the activation of phospholipases and the elevation of free radical production, contributing to muscle damages (Tidball, 2011). These damages can be specific to a few macromolecules of muscular tissue or can involve large tears of sarcolemma, basal lamina and connective tissue (Vierck et al., 2000), with more damages to type II fibers (Douglas et al., 2017a). The increase in REE after acute ECC exercise is higher in untrained subjects

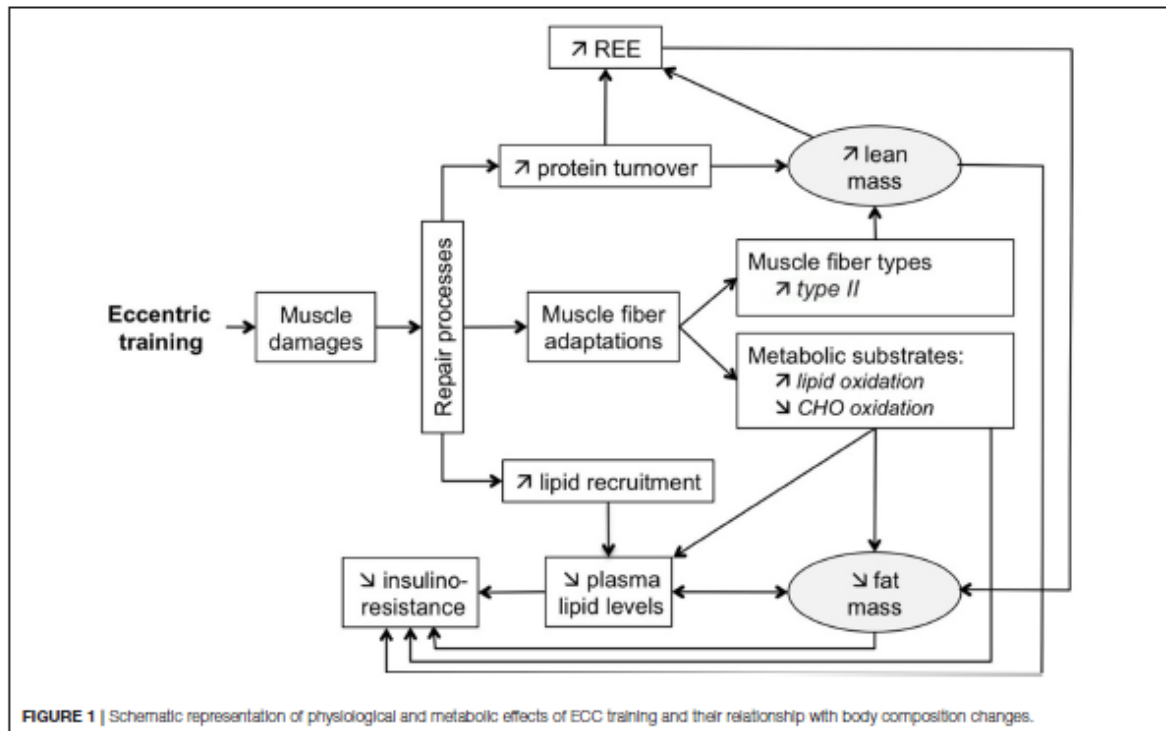

than in trained subjects, suggesting that the degree of muscle damage is a strong determinant and that the repeated bout effect is increased in untrained subjects (Hackney et al., 2008). The inflammatory adaptations, the repair process mechanisms and the protein synthesis following ECC exercise are speculated to be limited after subsequent ECC bouts (McHugh, 2003; Lehti et al., 2007). It has been described that a bout of ECC exercise protects against muscle damages from subsequent ECC bouts (McHugh, 2003; Gault and Willems, 2013). Several mechanisms interact in this protective adaptation called the repeated bout effect, including neural adaptations with change in motor unit synchronization, alterations to muscle mechanical properties, structural remodeling of the extracellular matrix and inflammatory response (Hyldahl et al., 2017). The severity of EIMD increases with the intensity and duration of exercise (Lieber and Friden, 2002; Cheung et al., 2003), the untrained status of the subjects, aging, and chronic disease status (Tee et al., 2007; Tidball, 2011; Schoenfeld, 2012; Gault and Willems, 2013; Baumert et al., 2016). Other factors, such as the muscle involved (Jamurtas et al., 2005), muscle length (Paschalis et al., 2005), and angular velocity (Chapman et al., 2008) at which the exercise is performed, affect the extent and the duration of the EIMD.

A significant increase in REE is also observed in healthy young women after chronic ECC exercise compared with chronic CON exercise performed at the same power output (Paschalis et al., 2011). This increase may be attributed to the continuous adaptation of skeletal muscles to repair and regenerate after bouts of exercise and the larger increase in lean mass (described

above) after ECC training. The inflammatory response to ECC exercise leads to increased content, recruitment and migration of satellite cells, thereby inducing muscle hypertrophy (Tidball, 2011; Peake et al., 2016). Once activated by the ECC mechanical stimulus, satellite cells generate myoblasts that proliferate and fuse to existing cells, increasing the number of myonuclei per cell (Tidball, 2011; Schoenfeld, 2012). Muscle repair is associated with novel transcriptional programs involving gene regulation, growth, and membrane synthesis (Schoenfeld, 2012). Moreover, mRNA production in the new myonuclear domains provides new muscle tissue (Petrella et al., 2008; Schoenfeld, 2012). *In fine*, the increase in the CSA of existing muscle fibers in response to ECC exercise may be associated with this expansion in myofibrillar content as a result of the activation of satellite cells, stimulation of anabolic signaling pathways, up-regulation of genes involved in anabolic mechanisms, and increase in protein translation and synthesis (Douglas et al., 2017b). As EIMD repair and regeneration processes decrease with training, the increase in post-exercise REE after chronic ECC exercises may occur due to both the increase in muscle protein turnover and gain in lean mass.

Eccentric Training, Muscle Fibers, and Metabolic Changes

Paschalis et al. (2011) showed that acute ECC exercise in untrained subjects can significantly modify metabolic substrate use, increasing post-exercise fat oxidation by 13% and reducing

glucose oxidation. However, they observed no significant modification in metabolic substrates after exercise in the CON group at the same power output. This modification of substrate oxidation rates in response to ECC exercise might be due to a specific effect of ECC exercise on muscle metabolism. Considering muscle type fiber composition, greater increase in type II compared with type I muscle fibers has been extensively described in human subjects after ECC training (Hortobágyi and DeVita, 2000; Paddon-Jones et al., 2001; Friedmann-Bette et al., 2010; Douglas et al., 2017a), with a shift from IIx to IIa. According to Hody et al. (2013), the proportion of type I and IIa fibers significantly increases compared with type IIx or IIb fibers. By using a proteomic analysis approach without any pre-established hypothesis on humans trained with five sessions of ECC exercises, they observed a decrease in several glycolytic enzymes coupled with a lower expression of the fast isoforms of some contractile and structural proteins, suggesting that ECC training could result in a switch to more oxidative metabolism (Hody et al., 2011). A similar proteomic approach, completed with histological analyses of whole quadriceps muscles, was conducted in mice, comparing two groups submitted to five sessions of either uphill or downhill running (exercises performed at the same power output; Hody et al., 2013). The proteomic profiling confirmed the results previously observed in humans, showing that the ECC group had a lower abundance of the myosin heavy chain isoforms specific to fast-twitch glycolytic fibers compared with the CON group. When they combined the quantification of muscle fiber types and the calculation of the CSA of each muscle fiber type (i.e., the number of type I, IIa, and IIb fibers per square millimeter multiplied by the mean area), both the ECC and CON groups had a significantly higher relative surface area for slow oxidative fibers and a significantly lower surface area for fast glycolytic fibers than the untrained control group (Hody et al., 2013), and the ECC group had a significantly higher surface area for type I and IIa fibers than the CON group (Hody et al., 2013). The hypothesis of a higher oxidative muscle phenotype is also supported by blood profile analyses. In untrained subjects, both acute and chronic ECC exercises favor decreased triglyceride (TG), LDL cholesterol, and total cholesterol levels, along with improved HDL cholesterol levels (which were not significantly modified after similar CON exercises; Paschalis et al., 2011). This improvement in blood lipid profile may be associated with the increased demand of the working muscles for fatty acid substrates (coming from blood TGs and LDL cholesterol) to regenerate injured muscles and particularly to synthesize new cell membranes after ECC exercises (Drexel et al., 2008). Fatty acids are necessary for the replenishment of muscle phospholipids and TG stores for the regeneration of damaged muscle fibers (Nikolaidis et al., 2008). The observed increase in HDL cholesterol may be due to the heightened activity of the lipoprotein lipase after ECC exercise, which causes lipoprotein particles to shrink and transfer to HDL cholesterol (Frayn, 2003). TG plasma concentrations are also reduced by this rise in lipoprotein lipase, which acts on lipoprotein particles passing through the capillaries and releases free fatty acids. These may be taken up by muscles and then esterified in phospholipids and intramuscular TGs, or

oxidized in the mitochondria (Nikolaidis et al., 2008). Thus, the improvement in lipid and lipoprotein profiles may be aided by the increase in lipid oxidation rate previously described after acute and chronic ECC exercise (Paschalis et al., 2011). The improvement in lipid profiles after ECC training may be attenuated in trained patients, partially because of a lower muscle repair activity owing to diminished EIMD (Nikolaidis et al., 2008).

With regard to insulin resistance, several studies have reported that an acute ECC exercise increases glycemia, insulin levels, and homeostasis model assessment of insulin resistance (Tee et al., 2007; Paschalis et al., 2011). This transitory increase in insulin resistance may be caused by EIMD, which may impair insulin signal transduction via inflammatory processes and decrease glucose transporter proteins (Tee et al., 2007). Nevertheless, most studies (Drexel et al., 2008; LaStayo et al., 2008; Paschalis et al., 2011; Zeppetzauer et al., 2013), but not all (Marcus et al., 2009; Philippe et al., 2016), demonstrated that the adverse effects of acute ECC exercise subside after chronic ECC exercise and that ECC training would decrease insulin resistance. An 8-week ECC training program proved sufficient to increase insulin sensitivity and improve lipid profile (Paschalis et al., 2011). The improvement in insulin sensitivity after ECC exercise may result from improved mitochondrial function and increased fat oxidation, which prevent the accumulation of fatty acid-derived metabolites in skeletal muscle (such as long chain acyl-CoA, diacylglycerol, and ceramides, which can in turn impair insulin signal transduction) (Rigalleau et al., 1998; Christ-Roberts et al., 2004; Houmard, 2007). The associated decrease in plasma TG may also be involved in the decrease in insulin resistance, as it can impair insulin action through over-activity of the glucose-fatty acid cycle (Randle et al., 1963). Moreover, these improvements in blood lipid profile and insulin resistance are combined with a decrease in low-grade inflammation, as proved by Drexel et al. (2008) in a chronic downhill hiking model of ECC training and confirmed by other studies (LaStayo et al., 2008; Zeppetzauer et al., 2013). Low-grade inflammation contributes to impaired insulin signal transduction, and reduction of such inflammation contributes to improving insulin sensitivity (Barrett and Eringa, 2012). Moreover, both lowering fat mass and increasing fat free mass are determinant factors that strongly influence insulin resistance (Macor et al., 1997; Kelly, 2000; Fernández-Real et al., 2003; Srikanthan and Karlamangla, 2011; Alemán-Mateo et al., 2014).

ECCENTRIC TRAINING FOR OVERWEIGHT AND OBESE PATIENTS

Obesity is a major public health challenge. It is defined as an excessive fat accumulation due to an imbalance between energy intake and energy expenditure (Ebbeling et al., 2002). Obesity is associated with numerous comorbidities, such as type 2 diabetes, dyslipidemia, high blood pressure, cardiovascular disease, respiratory disease, and joint disease (Daniels et al., 2005). Educational strategies, in particular the combination of nutritional and physical interventions, are required to

counteract the progressive metabolic disorders and functional impairments associated with obesity (Machado et al., 2016). Physical activity is effective for both preventing and controlling obesity, hypertension, type 2 diabetes, metabolic syndrome and cardiovascular diseases, because it contributes to better blood glucose control, reduced weight and waist circumference, and improved body composition, with benefits to the cardiovascular system (Machado et al., 2016). Nevertheless, patients with overweight and obesity present muscular, respiratory, or cardiac limitations with regard to their exercise capacities (Suastika, 2006; Look AHEAD Research Group and Wing, 2010). These limitations frequently reduce the intensity and duration of training exercises. Multidisciplinary programs are often used and are mainly based on CON activities, mostly due to limited access to ECC ergometers (because of the bespoke design and financial constraints). ECC exercise produces less cardiovascular and respiratory stress (Meyer et al., 2003) and less fatigue (Horstmann et al., 2001) than CON exercise, and requires lower metabolic demand than equal CON exercise (Perrey et al., 2001; Minetti et al., 2002; Dufour et al., 2004; Chavanelle et al., 2014). Although the energy expenditure during ECC exercise is lower than that during CON exercise when power output is matched, ECC exercise should be considered more efficient compared with CON exercise in increasing post-exercise REE (Paschalis et al., 2013) and thus in improving energy balance and weight management over time. Moreover, moderate load ECC training could be a strategy to maximize compliance, as it induces effective stimulations that not exceed the cardiorespiratory capacity of a patient (Mitchell et al., 2017). Moderate load ECC training is well-tolerated in multiple chronic conditions and critically ill patients (LaStayo et al., 2014; Mitchell et al., 2017).

The modality of muscle actions has not been completely studied in all aspects of energy balance, particularly in food intake. In the study by Paschalis et al. (2011) conducted in healthy subjects, daily energy and macronutrient intakes do not significantly change after ECC and CON training. Brain-derived neurotrophic factor (BDNF), which increases its production after muscle contraction in rodent and humans, is a growth factor that induces neurogenesis, protects against neurodegeneration, positively influences neural plasticity (learning and memory), plays a central role in fuel metabolism (fat oxidation), and is a strong central regulator of energy intake (Hu and Russek, 2008; Matthews et al., 2009; Yarrow et al., 2010). Several investigations in humans and rodents have supported the role of BDNF in regulating energy balance. In mice, global BDNF haploinsufficiency or brain-specific BDNF depletion results in excessive feeding and body weight gain accompanied by other features of the associated metabolic syndrome, including hyperleptinemia, hyperglycemia, and hyperinsulinemia (Rios et al., 2001; Beckers et al., 2008; Skledar et al., 2012). The BDNF levels in mice increase BDNF significantly (more than double) after ECC running compared with CON running (Aguilar et al., 2008). Moreover, BDNF increases in both the hippocampus and striatum after ECC running, but it increases in the hippocampus only after CON running (ECC and CON exercises were performed at the same mechanical power). This finding indicates that BDNF levels are most responsive after

ECC exercise than CON exercise (Aguilar et al., 2008). In human subjects, Yarrow et al. (2010) demonstrated that an eccentric-enhanced progressive resistance training intervention enhances the transient post-exercise elevation of circulating BDNF. Conclusive research may be necessary to compare food intakes and biological regulators of appetite after acute and chronic ECC compared with CON exercise.

Overweight and obese patients are more sedentary than lean subjects, which in turn keep them in positive energy balance. They are also less active with regard to ECC exercise (Pacy et al., 1986). Biopsies obtained from vastus lateralis in patients with obesity show a higher proportion of type IIb muscle fibers (Kriketos et al., 1997), which are preferentially recruited and damaged during and after ECC exercise (Nardone and Schieppati, 1988). Since these patients are untrained, they exhibit higher EIMD and display more significant and more prolonged muscle alterations after ECC exercise than lean patients (Paschalis et al., 2013). Concerning post-exercise REE, Paschalis et al. (2011) demonstrated that patients with overweight and obesity exhibit significantly larger (+25% in overweight and obese subjects vs. +9% in lean subjects) and more prolonged (up to 72 h) increases in REE after acute ECC exercises, even in relation to their fat free mass. Additionally, their results showed that acute ECC exercise induces a significantly greater increase in lipid oxidation in overweight and obese patients than in lean subjects (Paschalis et al., 2011). This is particularly relevant because of the following three reasons. First, patients with obesity usually exhibit a lower rate of lipolysis (Blaak et al., 1994). Second, body fat content significantly positively correlates with type IIx fibers (Blaak et al., 1994). Third, oxidative enzyme activities negatively correlate with insulin resistance (Kriketos et al., 1996). This greater increase in lipid oxidation may arise from the increase in the hydrolysis of fatty acid phospholipids of the damaged muscle membranes and the alteration of the glucose transport system and insulin resistance following ECC exercise (King et al., 1993; Asp and Richter, 1996). Furthermore, the magnitude of the response of circulating lipids in patients with obesity after an acute ECC exercise is likewise significantly higher than that in non-obese patients. This result confirms that the extent of muscle damage is a strong determinant of the improvements in post-exercise blood profile (Paschalis et al., 2010). Nikolaidis et al. (2008) examined the effect of a repeated muscle damage exercise on the time-course changes in blood lipids and lipoprotein profiles. They showed that the effect of a repeated session of ECC exercise induces a relatively less improvement compared with the first exercise. Nevertheless, the beneficial effects of chronic ECC training on healthy subjects suggest that the decrease in circulating lipids may continue after bouts of ECC exercises (Paschalis et al., 2011). With regard to glucose metabolism and insulin resistance, ECC training similarly offers benefits to patients with metabolic risk factors (Drexel et al., 2008; Marcus et al., 2008; Miles et al., 2016). Thus, decreased insulin resistance, intra-myocellular lipid pool changes, and decreases in glucose oxidation after ECC exercises support the growing interest for the ECC modality for the management of metabolic diseases (Hughes et al., 2010; Beaven et al., 2014; Gavin

et al., 2015). Notably, ECC exercise may protect against low-grade inflammation usually observed in patients with obesity (Nascimento et al., 2016).

LIMITATIONS OF ECCENTRIC EXERCISE

For chronic patients, which exhibit severe muscle wasting (in relation to general deconditioning, nutrition, systemic inflammation and/or medication), dyspnea is often experienced during classical CON exercises. Moreover, skeletal muscle dysfunction limits patient tolerance to classical ECC exercises at relatively high load (close to maximal), which would make an evident choice for moderate load ECC exercises (Hoppeler, 2016). To date, a wide range of techniques and equipment, such as upper and lower limb ergometers (Isner-Horobeti et al., 2013; LaStayo et al., 2017), treadmills for walking downhill, and ergometers offering stair descending (Theodorou et al., 2013), facilitate ECC exercises. To reach a moderate training load, the supervision must be strict and require a specific experience. However, these moderate loads could be achieved without undue delayed onset muscular soreness (DOMS) provided that the initial 2- or 3-week progressive ramping protocol is followed (LaStayo et al., 2017). Nevertheless, the equipment is often bespoke and sophisticated, with financial constraints, which may also limit their expansion. These factors may contribute to the lack of studies comparing moderate load ECC training and other modalities of training. For specific cases of obese individuals, who display significant and prolonged muscle alterations after ECC exercise (Paschalis et al., 2013), the training may require an additional caution from the supervisor to adapt the progressive initial ramped phase to limit DOMS and to maximize exercise tolerance and training compliance. Nevertheless, the beneficial effect of ECC training on body composition and other health-related parameters make it a promising tool for this population.

CONCLUSION

ECC training results in multi-target beneficial effects on lean and fat mass. Further investigations employing similar mechanical power, metabolic rate, intensity, and work volume when calibrating the ECC and CON exercises are required to provide a conclusive comparison of the two modalities. Our review focused on the effect of ECC training on lean and fat mass and particularly on whole body measurements, but more studies

with better power and design are warranted. The heterogeneity of the available studies (in terms of populations, measurement techniques, etc.) makes it premature to draw any definitive conclusions (and explains why a meta-analysis was not possible here). EIMD after ECC exercise leads to local inflammation and regeneration, which enhance protein degradation and synthesis via activation of well-known intracellular hypertrophy signaling pathways. Both acute and chronic ECC exercises induce larger increases in post-exercise REE than acute and chronic CON exercises performed at the same power output, partially because of the increase in muscle protein turnover and gain in lean mass. Both acute and chronic ECC exercises can also modify metabolic substrate use by increasing post-exercise fat oxidation and reducing glucose oxidation, leading to a switch to a more oxidative metabolism. In line with the increased demand of the working muscle for fatty acid substrates to regenerate injured muscles, both acute and chronic ECC exercises improve blood lipid profile to a greater extent than CON exercises. Although a transient increase in insulin resistance occurs after acute ECC exercise because of EIMD, chronic ECC exercise also decreases insulin resistance.

ECC training, particularly continuous moderate load ECC training, is a potential exercise modality for overweight and obese patients because most metabolic and biological effects induced by ECC exercise are heightened in these subjects in comparison with lean subjects. Moreover, ECC exercise requires lower metabolic demands than CON exercises when performed at the same mechanical power and induces a greater increase in post-exercise REE. Further investigations using standardized experimental conditions in the ECC and CON training groups are necessary to define the specific metabolic effects of ECC training, to determine the effectiveness and long-term effect of this exercise modality in overweight and obese patients and to guide future physical activity prescriptions, particularly in terms of exercise modality, intensity and duration. Finally, the combination of ECC and nutritional anabolic compounds as an appropriate source of dietary proteins could be examined in future multimodal approaches for chronic diseases that limit mobility.

AUTHOR CONTRIBUTIONS

VJ wrote the manuscript with the help of DT, HP, and RR. RR and MD supervised the project. All authors contributed to manuscript revision, read and approved the submitted version.

REFERENCES

- Abe, T., Thiebaut, R. S., Loenneke, J. P., and Young, K. C. (2015). Prediction and validation of DXA-derived appendicular lean soft tissue mass by ultrasound in older adults. *Age* 37:114. doi: 10.1007/s11357-015-9853-2
- Aguiar, A. S., Speck, A. E., Prediger, R. D., Kapczinski, F., and Pinho, R. A. (2008). Downhill training upregulates mice hippocampal and striatal brain-derived neurotrophic factor levels. *J. Neural Transm.* 115, 1251–1255. doi: 10.1007/s00702-008-0071-2
- Alemán-Mateo, H., López Teros, M. T., Ramírez, F. A., and Astiazarán-García, H. (2014). Association between insulin resistance and low relative appendicular skeletal muscle mass: evidence from a cohort study in community-dwelling older men and women participants. *J. Gerontol. A. Biol. Sci. Med. Sci.* 69, 871–877. doi: 10.1093/gerona/glt193
- Allen, D. G., Whitehead, N. P., and Yeung, E. W. (2005). Mechanisms of stretch-induced muscle damage in normal and dystrophic muscle: role of ionic changes. *J. Physiol.* 567, 723–735. doi: 10.1113/jphysiol.2005.091694
- Asp, S., and Richter, E. A. (1996). Decreased insulin action on muscle glucose transport after eccentric contractions in rats. *J. Appl. Physiol.* 81, 1924–1928.

- Barrett, E. J., and Eringa, E. C. (2012). The vascular contribution to insulin resistance: promise, proof, and pitfalls. *Diabetes* 61, 3063–3065. doi: 10.2337/db12-0948
- Baumert, P., Lake, M. J., Stewart, C. E., Drust, B., and Erskine, R. M. (2016). Genetic variation and exercise-induced muscle damage: implications for athletic performance, injury and ageing. *Eur. J. Appl. Physiol.* 116, 1595–1625. doi: 10.1007/s00421-016-3411-1
- Beaven, C. M., Willis, S. J., Cook, C. J., and Holmberg, H.-C. (2014). Physiological comparison of concentric and eccentric arm cycling in males and females. *PLoS ONE* 9:e112079. doi: 10.1371/journal.pone.0112079
- Beckers, S., Peeters, A., Zegers, D., Mertens, L., Van Gaal, L., and Van Hul, W. (2008). Association of the BDNF Val66Met variation with obesity in women. *Mol. Genet. Metab.* 95, 110–112. doi: 10.1016/j.ymgme.2008.06.008
- Blaak, E. E., Van Baak, M. A., Kemmerink, G. J., Pakbiers, M. T., Heidendal, G. A., and Saris, W. H. (1994). Beta-adrenergic stimulation of energy expenditure and forearm skeletal muscle metabolism in lean and obese men. *Am. J. Physiol.* 267, E306–E315.
- Blazevich, A. J., Cannavan, D., Coleman, D. R., and Horne, S. (2007). Influence of concentric and eccentric resistance training on architectural adaptation in human quadriceps muscles. *J. Appl. Physiol.* 103, 1565–1575. doi: 10.1152/jappphysiol.00578.2007
- Burleson, M. A., O'Bryen, H. S., Stone, M. H., Collins, M. A., and Triplett-McBride, T. (1998). Effect of weight training exercise and treadmill exercise on post-exercise oxygen consumption. *Med. Sci. Sports Exerc.* 30, 518–522.
- Chapman, D. W., Newton, M., McGuigan, M. R., and Nosaka, K. (2008). Comparison between old and young men for responses to fast velocity maximal lengthening contractions of the elbow flexors. *Eur. J. Appl. Physiol.* 104, 531–539. doi: 10.1007/s00421-008-0806-7
- Chavanelle, V., Sirvent, P., Ennequin, G., Caillaud, K., Montaurier, C., Morio, B., et al. (2014). Comparison of oxygen consumption in rats during uphill (concentric) and downhill (eccentric) treadmill exercise tests. *J. Sports Sci. Med.* 13, 689–694.
- Chesley, A., MacDougall, J. D., Tarnopolsky, M. A., Atkinson, S. A., and Smith, K. (1992). Changes in human muscle protein synthesis after resistance exercise. *J. Appl. Physiol.* 73, 1383–1388.
- Cheung, K., Hume, P., and Maxwell, L. (2003). Delayed onset muscle soreness: treatment strategies and performance factors. *Sports Med.* 33, 145–164. doi: 10.2165/00007256-200333020-00005
- Christ-Roberts, C. Y., Pratiapanawati, T., Pratiapanawati, W., Berria, R., Belfort, R., Kashyap, S., et al. (2004). Exercise training increases glycogen synthase activity and GLUT4 expression but not insulin signaling in overweight nondiabetic and type 2 diabetic subjects. *Metabolism* 53, 1233–1242. doi: 10.1016/j.metabol.2004.03.022
- Colliander, E. B., and Tesch, P. A. (1990). Effects of eccentric and concentric muscle actions in resistance training. *Acta Physiol. Scand.* 140, 31–39. doi: 10.1111/j.1748-1716.1990.tb08973.x
- Coratella, G., Milanese, C., and Schena, F. (2015). Unilateral eccentric resistance training: a direct comparison between isokinetic and dynamic constant external resistance modalities. *Eur. J. Sport Sci.* 15, 720–726. doi: 10.1080/17461391.2015.1060264
- Daniels, S. R., Arnett, D. K., Eckel, R. H., Gidding, S. S., Hayman, L. L., Kumanyika, S., et al. (2005). Overweight in children and adolescents: pathophysiology, consequences, prevention, and treatment. *Circulation* 111, 1999–2012. doi: 10.1161/01.CIR.0000161369.71722.10
- Douglas, J., Pearson, S., Ross, A., and McGuigan, M. (2017a). Chronic adaptations to eccentric training: a systematic review. *Sports Med.* 47, 917–941. doi: 10.1007/s40279-016-0628-4
- Douglas, J., Pearson, S., Ross, A., and McGuigan, M. (2017b). Eccentric exercise: physiological characteristics and acute responses. *Sports Med.* 47, 663–675. doi: 10.1007/s40279-016-0624-8
- Drexel, H., Saely, C. H., Langer, P., Loruenser, G., Marte, T., Risch, L., et al. (2008). Metabolic and anti-inflammatory benefits of eccentric endurance exercise – a pilot study. *Eur. J. Clin. Invest.* 38, 218–226. doi: 10.1111/j.1365-2362.2008.01937.x
- Dufour, S. P., Lampert, E., Doutreleau, S., Lonsdorfer-Wolf, E., Billat, V. L., Piquard, F., et al. (2004). Eccentric cycle exercise: training application of specific circulatory adjustments. *Med. Sci. Sports Exerc.* 36, 1900–1906. doi: 10.1249/01.MSS.0000145441.80209.66
- Ebbeling, C. B., Pawlak, D. B., and Ludwig, D. S. (2002). Childhood obesity: public-health crisis, common sense cure. *Lancet* 360, 473–482. doi: 10.1016/S0140-6736(02)09678-2
- Eliasson, J., Elfegoun, T., Nilsson, J., Köhnke, R., Ekblom, B., and Blomstrand, E. (2006). Maximal lengthening contractions increase p70 S6 kinase phosphorylation in human skeletal muscle in the absence of nutritional supply. *Am. J. Physiol. Endocrinol. Metab.* 291, E1197–E1205. doi: 10.1152/ajpendo.00141.2006
- Engardt, M., Knutsson, E., Jonsson, M., and Sternhag, M. (1995). Dynamic muscle strength training in stroke patients: effects on knee extension torque, electromyographic activity, and motor function. *Arch. Phys. Med. Rehabil.* 76, 419–425.
- English, K. L., Loefer, J. A., Lee, S. M. C., and Smith, S. M. (2014). Early-phase musculoskeletal adaptations to different levels of eccentric resistance after 8 weeks of lower body training. *Eur. J. Appl. Physiol.* 114, 2263–2280. doi: 10.1007/s00421-014-2951-5
- Fernández-Real, J.-M., Broch, M., Vendrell, J., and Ricart, W. (2003). Insulin resistance, inflammation, and serum fatty acid composition. *Diabetes Care* 26, 1362–1368. doi: 10.2337/diacare.26.5.1362
- Fisher, J. P., Carlson, L., and Steele, J. (2016). The effects of muscle action, repetition duration, and loading strategies of a whole-body, progressive resistance training programme on muscular performance and body composition in trained males and females. *Appl. Physiol. Nutr. Metab.* 41, 1064–1070. doi: 10.1139/apnm-2016-0180
- Franchi, M. V., Reeves, N. D., and Narici, M. V. (2017). Skeletal muscle remodeling in response to eccentric vs. concentric loading: morphological, molecular, and metabolic adaptations. *Front. Physiol.* 8:447. doi: 10.3389/fphys.2017.00447
- Franchi, M. V., Wilkinson, D. J., Quinlan, J. I., Mitchell, W. K., Lund, J. N., Williams, J. P., et al. (2015). Early structural remodeling and deuterium oxide-derived protein metabolic responses to eccentric and concentric loading in human skeletal muscle. *Physiol. Rep.* 3:e12593. doi: 10.14814/phy2.12593
- Frayn, K. N. (2003). The glucose-fatty acid cycle: a physiological perspective. *Biochem. Soc. Trans.* 31, 1115–1119. doi: 10.1042/bst0311115
- Friedmann-Bette, B., Bauer, T., Kinscherf, R., Vorwald, S., Klute, K., Bischoff, D., et al. (2010). Effects of strength training with eccentric overload on muscle adaptation in male athletes. *Eur. J. Appl. Physiol.* 108, 821–836. doi: 10.1007/s00421-009-1292-2
- Gault, M. L., and Willems, M. E. (2013). Aging, functional capacity and eccentric exercise training. *Aging Dis.* 4, 351–363. doi: 10.14336/AD.2013.0400351
- Gavin, J. P., Myers, S., and Willems, M. E. (2015). The accumulative effect of concentric-biased and eccentric-biased exercise on cardiorespiratory and metabolic responses to subsequent low-intensity exercise: a preliminary study. *J. Hum. Kinet.* 49, 131–140. doi: 10.1515/hukin-2015-0115
- Gillette, C. A., Bullough, R. C., and Melby, C. L. (1994). Postexercise energy expenditure in response to acute aerobic or resistive exercise. *Int. J. Sport Nutr.* 4, 347–360.
- Gür, H., Cakin, N., Akova, B., Okay, E., and Kutçukoglu, S. (2002). Concentric versus combined concentric-eccentric isokinetic training: effects on functional capacity and symptoms in patients with osteoarthritis of the knee. *Arch. Phys. Med. Rehabil.* 83, 308–316. doi: 10.1053/apmr.2002.30620
- Hackney, K. J., Engels, H.-J., and Gretebeck, R. J. (2008). Resting energy expenditure and delayed-onset muscle soreness after full-body resistance training with an eccentric concentration. *J. Strength Cond. Res.* 22, 1602–1609. doi: 10.1519/JSC.0b013e31818222c5
- Hawkins, S. A., Schroeder, E. T., Wiswell, R. A., Jaque, S. V., Marcell, T. J., and Costa, K. (1999). Eccentric muscle action increases site-specific osteogenic response. *Med. Sci. Sports Exerc.* 31, 1287–1292.
- Higbie, E. J., Cureton, K. J., Warren, G. L., and Prior, B. M. (1996). Effects of concentric and eccentric training on muscle strength, cross-sectional area, and neural activation. *J. Appl. Physiol.* 81, 2173–2181.
- Hody, S., Lacrosse, Z., Leprince, P., Colodro, M., Croisier, J.-L., and Rogister, B. (2013). Effects of eccentrically and concentrically biased training on mouse muscle phenotype. *Med. Sci. Sports Exerc.* 45, 1460–1468. doi: 10.1249/MSS.0b013e3182894a33
- Hody, S., Leprince, P., Sergeant, K., Renaud, J., Croisier, J.-L., Wang, F., et al. (2011). Human muscle proteome modifications after acute or repeated eccentric exercises. *Med. Sci. Sports Exerc.* 43, 2281–2296. doi: 10.1249/MSS.0b013e318222edf3

- Hoppeler, H. (2016). Moderate load eccentric exercise; a distinct novel training modality. *Front. Physiol.* 7:483. doi: 10.3389/fphys.2016.00483
- Horstmann, T., Mayer, F., Maschmann, J., Niess, A., Roecker, K., and Dickhuth, H. H. (2001). Metabolic reaction after concentric and eccentric endurance-exercise of the knee and ankle. *Med. Sci. Sports Exerc.* 33, 791–795. doi: 10.1097/00005768-200105000-00018
- Hortobágyi, T., and DeVita, P. (2000). Favorable neuromuscular and cardiovascular responses to 7 days of exercise with an eccentric overload in elderly women. *J. Gerontol. A Biol. Sci. Med. Sci.* 55, B401–B410. doi: 10.1093/gerona/55.8.B401
- Hortobágyi, T., Hill, J. P., Houmard, J. A., Fraser, D. D., Lambert, N. J., and Israel, R. G. (1996). Adaptive responses to muscle lengthening and shortening in humans. *J. Appl. Physiol.* 80, 765–772
- Houmard, J. A. (2007). Do the mitochondria of obese individuals respond to exercise training? *J. Appl. Physiol.* 103, 6–7. doi: 10.1152/jappphysiol.00368.2007
- Hu, Y., and Russek, S. J. (2008). BDNF and the diseased nervous system: a delicate balance between adaptive and pathological processes of gene regulation. *J. Neurochem.* 105, 1–17. doi: 10.1111/j.1471-4159.2008.05237.x
- Hughes, J. D., Johnson, N. A., Brown, S. J., Sachinwalla, T., Walton, D. W., and Stannard, S. R. (2010). Effects of eccentric exercise-induced muscle damage on intramyocellular lipid concentration and high energy phosphates. *Eur. J. Appl. Physiol.* 110, 1135–1141. doi: 10.1007/s00421-010-1605-5
- Hylidahl, R. D., Chen, T. C., and Nosaka, K. (2017). Mechanisms and mediators of the skeletal muscle repeated bout effect. *Exerc. Sport Sci. Rev.* 45, 24–33. doi: 10.1249/JES.0000000000000095
- Iner-Horobeti, M.-E., Dufour, S. P., Vautraviers, P., Geny, B., Coudeyre, E., and Richard, R. (2013). Eccentric exercise training: modalities, applications and perspectives. *Sports Med.* 43, 483–512. doi: 10.1007/s40279-013-0052-y
- Jacobs, J. L., Marcus, R. L., Morrell, G., and LaStayo, P. (2014). Resistance exercise with older fallers: its impact on intermuscular adipose tissue. *BioMed. Res. Int.* 2014:398960. doi: 10.1155/2014/398960
- Jamurtas, A. Z., Theocharis, V., Tofas, T., Tsiokanos, A., Yfanti, C., Paschalis, V., et al. (2005). Comparison between leg and arm eccentric exercises of the same relative intensity on indices of muscle damage. *Eur. J. Appl. Physiol.* 95, 179–185. doi: 10.1007/s00421-005-1345-0
- Jones, N. L., Summers, E., and Killian, K. J. (1989). Influence of age and stature on exercise capacity during incremental cycle ergometry in men and women. *Am. Rev. Respir. Dis.* 140, 1373–1380. doi: 10.1164/ajrccm/140.5.1373
- Kelly, G. S. (2000). Insulin resistance: lifestyle and nutritional interventions. *Altern. Med. Rev. J. Clin. Ther.* 5, 109–132. doi: 10.2337/diacare.25.3.445
- King, D. S., Feltmeyer, T. L., Baldus, P. J., Sharp, R. L., and Nespor, J. (1993). Effects of eccentric exercise on insulin secretion and action in humans. *J. Appl. Physiol.* 75, 2151–2156.
- Kriketos, A. D., Baur, L. A., O'Connor, J., Carey, D., King, S., Caterson, I. D., et al. (1997). Muscle fibre type composition in infant and adult populations and relationships with obesity. *Int. J. Obes. Relat. Metab. Disord.* 21, 796–801.
- Kriketos, A. D., Pan, D. A., Lillioja, S., Cooney, G. J., Baur, L. A., Milner, M. R., et al. (1996). Interrelationships between muscle morphology, insulin action, and adiposity. *Am. J. Physiol.* 270, R1332–R1339.
- LaStayo, P. C., Meier, W., Marcus, R. L., Mizner, R., Dibble, L., and Peters, C. (2009). Reversing muscle and mobility deficits 1 to 4 years after TKA: a pilot study. *Clin. Orthop.* 467, 1493–1500. doi: 10.1007/s11999-009-0801-2
- LaStayo, P. C., Pierotti, D. J., Pifer, J., Hoppeler, H., and Lindstedt, S. L. (2000). Eccentric ergometry: increases in locomotor muscle size and strength at low training intensities. *Am. J. Physiol. Regul. Integr. Comp. Physiol.* 278, R1282–R1288. doi: 10.1152/ajpregu.2000.278.5.R1282
- LaStayo, P. C., Woolf, J. M., Lewek, M. D., Snyder-Mackler, L., Reich, T., and Lindstedt, S. L. (2003). Eccentric muscle contractions: their contribution to injury, prevention, rehabilitation, and sport. *J. Orthop. Sports Phys. Ther.* 33, 557–571. doi: 10.2519/jospt.2003.33.10.557
- LaStayo, P., Marcus, R., Dibble, L., Frajacomo, F., and Lindstedt, S. (2014). Eccentric exercise in rehabilitation: safety, feasibility, and application. *J. Appl. Physiol.* 116, 1426–1434. doi: 10.1152/jappphysiol.00008.2013
- LaStayo, P., Marcus, R., Dibble, L., Wong, B., and Pepper, G. (2017). Eccentric versus traditional resistance exercise for older adult fallers in the community: a randomized trial within a multi-component fall reduction program. *BMC Geriatr.* 17:149. doi: 10.1186/s12877-017-0539-8
- LaStayo, P., Pifer, J., Pierotti, D., and Lindstedt, S. (2008). Electromyographic adaptations elicited by submaximal exercise in those naive to and in those adapted to eccentric exercise: a descriptive report. *J. Strength Cond. Res.* 22, 833–838. doi: 10.1519/JSC.0b013e31816a5825
- Lehti, T. M., Kalliokoski, R., and Komulainen, J. (2007). Repeated bout effect on the cytoskeletal proteins titin, desmin, and dystrophin in rat skeletal muscle. *J. Muscle Res. Cell Motil.* 28, 39–47. doi: 10.1007/s10974-007-9102-0
- Lemos, T., and Gallagher, D. (2017). Current body composition measurement techniques. *Curr. Opin. Endocrinol. Diabetes Obes.* 24, 310–314. doi: 10.1097/MED.0000000000000360
- Levine, J. A., Abboud, L., Barry, M., Reed, J. E., Sheedy, P. F., and Jensen, M. D. (2000). Measuring leg muscle and fat mass in humans: comparison of CT and dual-energy X-ray absorptiometry. *J. Appl. Physiol.* 88, 452–456. doi: 10.1152/jappphysiol.2000.88.2.452
- Lieber, R. L., and Friden, J. (2002). Morphologic and mechanical basis of delayed-onset muscle soreness. *J. Am. Acad. Orthop. Surg.* 10, 67–73. doi: 10.5435/00124635-200201000-00009
- Look AHEAD Research Group and Wing, R. R. (2010). Long-term effects of a lifestyle intervention on weight and cardiovascular risk factors in individuals with type 2 diabetes mellitus: four-year results of the Look AHEAD trial. *Arch. Intern. Med.* 170, 1566–1575. doi: 10.1001/archinternmed.2010.334
- Machado, A. P., Lima, B. M., Laureano, M. G., Silva, P. H., Tardin, G. P., Reis, P. S., et al. (2016). Educational strategies for the prevention of diabetes, hypertension, and obesity. *Rev. Assoc. Med. Bras.* 62, 800–808. doi: 10.1590/1806-9282.62.08.800
- Macor, C., Ruggeri, A., Mazzonetto, P., Federspil, G., Cobelli, C., and Vettor, R. (1997). Visceral adipose tissue impairs insulin secretion and insulin sensitivity but not energy expenditure in obesity. *Metabolism* 46, 123–129.
- Marcus, R. L., Lastayo, P. C., Dibble, L. E., Hill, L., and McClain, D. A. (2009). Increased strength and physical performance with eccentric training in women with impaired glucose tolerance: a pilot study. *J. Womens Health* 18, 253–260. doi: 10.1089/jwh.2007.0669
- Marcus, R. L., Smith, S., Morrell, G., Addison, O., Dibble, L. E., Wahoff-Stice, D., et al. (2008). Comparison of combined aerobic and high-force eccentric resistance exercise with aerobic exercise only for people with type 2 diabetes mellitus. *Phys. Ther.* 88, 1345–1354. doi: 10.2522/ptj.2008.0124
- Matthews, V. B., Aström, M.-B., Chan, M. H. S., Bruce, C. R., Krabbe, K. S., Prelovsek, O., et al. (2009). Brain-derived neurotrophic factor is produced by skeletal muscle cells in response to contraction and enhances fat oxidation via activation of AMP-activated protein kinase. *Diabetologia* 52, 1409–1418. doi: 10.1007/s00125-009-1364-1
- McHugh, M. P. (2003). Recent advances in the understanding of the repeated bout effect: the protective effect against muscle damage from a single bout of eccentric exercise. *Scand. J. Med. Sci. Sports* 13, 88–97. doi: 10.1034/j.1600-0838.2003.02477.x
- Melby, C., Scholl, C., Edwards, G., and Ballough, R. (1993). Effect of acute resistance exercise on postexercise energy expenditure and resting metabolic rate. *J. Appl. Physiol.* 75, 1847–1853.
- Meyer, K., Steiner, R., Lastayo, P., Lippuner, K., Allemann, Y., Eberli, F., et al. (2003). Eccentric exercise in coronary patients: central hemodynamic and metabolic responses. *Med. Sci. Sports Exerc.* 35, 1076–1082. doi: 10.1249/01.MSS.0000074580.79648.9D
- Miles, M. P., Horrigan, L. C., Jay, S. E., Brown, K. M., Porter, J. W., and Steward, A. N. (2016). Concentric and eccentric exercise, glycemic responses to a postexercise meal, and inflammation in women with high versus low waist circumference. *Appl. Physiol. Nutr. Metab.* 41, 1262–1270. doi: 10.1139/apnm-2016-0281
- Minetti, A. E., Moia, C., Roi, G. S., Susta, D., and Ferretti, G. (2002). Energy cost of walking and running at extreme uphill and downhill slopes. *J. Appl. Physiol.* 93, 1039–1046. doi: 10.1152/jappphysiol.01177.2001

- Mitchell, W. K., Taivassalo, T., Narici, M. V., and Franchi, M. V. (2017). Eccentric exercise and the critically ill patient. *Front. Physiol.* 8:120. doi: 10.3389/fphys.2017.00120
- Morgan, D. L., Gregory, J. E., and Proske, U. (2004). The influence of fatigue on damage from eccentric contractions in the gastrocnemius muscle of the cat. *J. Physiol.* 561, 841–850. doi: 10.1111/jphysiol.2004.069948
- Mueller, M., Breil, F. A., Vogt, M., Steiner, R., Lippuner, K., Popp, A., et al. (2009). Different response to eccentric and concentric training in older men and women. *Eur. J. Appl. Physiol.* 107, 145–153. doi: 10.1007/s00421-009-1108-4
- Nardone, A., and Schieppati, M. (1988). Shift of activity from slow to fast muscle during voluntary lengthening contractions of the triceps surae muscles in humans. *J. Physiol.* 395, 363–381.
- Nascimento, D., da, C., Navalta, J. W., Durigan, J. L., Marqueti, R. de, C., Tibana, R. A., Luit Franco, O., et al. (2016). Acute eccentric resistance exercise decreases matrix metalloproteinase activity in obese elderly women. *Clin. Physiol. Funct. Imaging* 36, 139–145. doi: 10.1111/cpf.12207
- Nikolaïdis, M. G., Paschalis, V., Giakas, G., Fatouros, I. G., Sakellariou, G. K., Theodorou, A. A., et al. (2008). Favorable and prolonged changes in blood lipid profile after muscle-damaging exercise. *Med. Sci. Sports Exerc.* 40, 1483–1489. doi: 10.1249/MSS.0b013e31817356f2
- Pacy, P. J., Webster, J., and Garrow, J. S. (1986). Exercise and obesity. *Sports Med.* 3, 89–113.
- Paddon-Jones, D., Leveritt, M., Lonergan, A., and Abernethy, P. (2001). Adaptation to chronic eccentric exercise in humans: the influence of contraction velocity. *Eur. J. Appl. Physiol.* 85, 466–471. doi: 10.1007/s004210100467
- Paschalis, V., Koutedakis, Y., Jamurtas, A. Z., Mougios, V., and Baltzopoulos, V. (2005). Equal volumes of high and low intensity of eccentric exercise in relation to muscle damage and performance. *J. Strength Cond. Res.* 19, 184–188. doi: 10.1519/R-14763.1
- Paschalis, V., Nikolaïdis, M. G., Giakas, G., Theodorou, A. A., Sakellariou, G. K., Fatouros, I. G., et al. (2010). Beneficial changes in energy expenditure and lipid profile after eccentric exercise in overweight and lean women. *Scand. J. Med. Sci. Sports* 20, e103–e111. doi: 10.1111/j.1600-0838.2009.00920.x
- Paschalis, V., Nikolaïdis, M. G., Theodorou, A. A., Deli, C. K., Raso, V., Jamurtas, A. Z., et al. (2013). The effects of eccentric exercise on muscle function and proprioception of individuals being overweight and underweight. *J. Strength Cond. Res.* 27, 2542–2551. doi: 10.1519/JSC.0b013e31827f9a6
- Paschalis, V., Nikolaïdis, M. G., Theodorou, A. A., Panayiotou, G., Fatouros, I. G., Koutedakis, Y., et al. (2011). A weekly bout of eccentric exercise is sufficient to induce health-promoting effects. *Med. Sci. Sports Exerc.* 43, 64–73. doi: 10.1249/MSS.0b013e3181e91d90
- Peake, J. M., Neubauer, O., Della Gatta, P. A., and Nosaka, K. (2016). Muscle damage and inflammation during recovery from exercise. *J. Appl. Physiol.* 122, 559–570. doi: 10.1152/jappphysiol.00971.2016
- Perrey, S., Betik, A., Candau, R., Rouillon, J. D., and Hughson, R. L. (2001). Comparison of oxygen uptake kinetics during concentric and eccentric cycle exercise. *J. Appl. Physiol.* 91, 2135–2142. doi: 10.1152/jappphysiol.2001.91.5.2135
- Petrella, J. K., Kim, J.-S., Mayhew, D. L., Cross, J. M., and Bamman, M. M. (2008). Potent myofiber hypertrophy during resistance training in humans is associated with satellite cell-mediated myonuclear addition: a cluster analysis. *J. Appl. Physiol.* 104, 1736–1742. doi: 10.1152/jappphysiol.01215.2007
- Philippe, M., Junker, G., Gatterer, H., Melmer, A., and Burtscher, M. (2016). Acute effects of concentric and eccentric exercise matched for energy expenditure on glucose metabolism in healthy females: a randomized crossover trial. *SpringerPlus* 5:1455. doi: 10.1186/s40064-016-3062-z
- Proske, U., and Morgan, D. L. (2001). Muscle damage from eccentric exercise: mechanism, mechanical signs, adaptation and clinical applications. *J. Physiol.* 537, 333–345. doi: 10.1111/j.1469-7793.2001.00333.x
- Raj, I. S., Bird, S. R., Westfold, B. A., and Shield, A. J. (2012). Effects of eccentrically biased versus conventional weight training in older adults. *Med. Sci. Sports Exerc.* 44, 1167–1176. doi: 10.1249/MSS.0b013e3182442ecd
- Rakobowchuk, M., Isacco, L., Ritter, O., Represas, A. G., Bouhaddi, M., Degano, B., et al. (2018). Muscle oxygenation responses to low-intensity steady rate concentric and eccentric cycling. *Int. J. Sports Med.* 39, 173–180. doi: 10.1055/s-0043-121272
- Randle, P. J., Garland, P. B., Hales, C. N., and Newsholme, E. A. (1963). The glucose fatty-acid cycle. Its role in insulin sensitivity and the metabolic disturbances of diabetes mellitus. *Lancet Lond. Engl.* 1, 785–789.
- Reeves, N. D., Maganaris, C. N., Longo, S., and Narici, M. V. (2009). Differential adaptations to eccentric versus conventional resistance training in older humans. *Exp. Physiol.* 94, 825–833. doi: 10.1113/expphysiol.2009.046599
- Rigalleau, V., Beylot, M., Pachiaudi, C., Guillot, C., Deleris, G., and Gin, H. (1998). Mechanisms of glucose intolerance during triglyceride infusion. *Am. J. Physiol.* 275, E641–E648.
- Rios, M., Fan, G., Fekete, C., Kelly, J., Bates, B., Kuehn, R., et al. (2001). Conditional deletion of brain-derived neurotrophic factor in the postnatal brain leads to obesity and hyperactivity. *Mol. Endocrinol.* 15, 1748–1757. doi: 10.1210/mend.15.10.0706
- Rocha Vieira, D. S., Baril, J., Richard, R., Perrault, H., Bourbeau, J., and Taivassalo, T. (2011). Eccentric cycle exercise in severe COPD: feasibility of application. *COPD* 8, 270–274. doi: 10.3109/15412555.2011.579926
- Roig, M., O'Brien, K., Kirk, G., Murray, R., McKinnon, P., Shadgan, B., et al. (2009). The effects of eccentric versus concentric resistance training on muscle strength and mass in healthy adults: a systematic review with meta-analysis. *Br. J. Sports Med.* 43, 556–568. doi: 10.1136/bjsm.2008.051417
- Schoenfeld, B. J. (2012). Does exercise-induced muscle damage play a role in skeletal muscle hypertrophy? *J. Strength Cond. Res.* 26, 1441–1453. doi: 10.1519/JSC.0b013e31824f207e
- Schoenfeld, B. J., Grgic, J., Ogborn, D., and Krieger, J. W. (2017). Strength and hypertrophy adaptations between low- vs. high-load resistance training: a systematic review and meta-analysis. *J. Strength Cond. Res.* 31, 3508–3523. doi: 10.1519/JSC.0000000000002200
- Skledar, M., Nikolac, M., Dodig-Curkovic, K., Curkovic, M., Borovecki, F., and Pivac, N. (2012). Association between brain-derived neurotrophic factor Val66Met and obesity in children and adolescents. *Prog. Neuropsychopharmacol. Biol. Psychiatry* 36, 136–140. doi: 10.1016/j.pnpb.2011.08.003
- Srikanthan, P., and Karlamangla, A. S. (2011). Relative muscle mass is inversely associated with insulin resistance and prediabetes. Findings from the third national health and nutrition examination survey. *J. Clin. Endocrinol. Metab.* 96, 2898–2903. doi: 10.1210/jc.2011-0435
- Steiner, R., Meyer, K., Lippuner, K., Schmid, J.-P., Saner, H., and Hoepfeler, H. (2004). Eccentric endurance training in subjects with coronary artery disease: a novel exercise paradigm in cardiac rehabilitation? *Eur. J. Appl. Physiol.* 91, 572–578. doi: 10.1007/s00421-003-1000-6
- Suastika, K. (2006). Update in the management of obesity. *Acta Med. Indones.* 38, 231–237.
- Tee, J. C., Bosch, A. N., and Lambert, M. I. (2007). Metabolic consequences of exercise-induced muscle damage. *Sports Med.* 37, 827–836. doi: 10.2165/00007256-200737100-00001
- Theodorou, A. A., Panayiotou, G., Paschalis, V., Nikolaïdis, M. G., Kyrtaros, A., Mademli, L., et al. (2013). Stair descending exercise increases muscle strength in elderly males with chronic heart failure. *BMC Res. Notes* 6:87. doi: 10.1186/1756-0500-6-87
- Tidball, J. G. (2011). Mechanisms of muscle injury, repair, and regeneration. *Compr. Physiol.* 1, 2029–2062. doi: 10.1002/cphy.c100092
- Vácz, M., Nagy, S. A., Kostegi, T., Ambrus, M., Bogner, P., Perlaki, G., et al. (2014). Mechanical, hormonal, and hypertrophic adaptations to 10 weeks of eccentric and stretch-shortening cycle exercise training in old males. *Exp. Gerontol.* 58, 69–77. doi: 10.1016/j.exger.2014.07.013
- Vierck, J., O'Reilly, B., Hossner, K., Antonio, J., Byrne, K., Bucci, L., et al. (2000). Satellite cell regulation following myotrauma caused by resistance exercise. *Cell Biol. Int.* 24, 263–272. doi: 10.1006/cbir.2000.0499
- Vikne, H., Refsnes, P. E., Ekmark, M., Medbø, J. I., Gundersen, V., and Gundersen, K. (2006). Muscular performance after concentric and eccentric exercise in trained men. *Med. Sci. Sports Exerc.* 38, 1770–1781. doi: 10.1249/01.mss.0000229568.17284.ab
- Wagner, D. R. (2013). Ultrasound as a tool to assess body fat. *J. Obes.* 2013:280713. doi: 10.1155/2013/280713

- Yarrow, J. F., White, L. J., McCoy, S. C., and Borst, S. E. (2010). Training augments resistance exercise induced elevation of circulating brain derived neurotrophic factor (BDNF). *Neurosci. Lett.* 479, 161–165. doi: 10.1016/j.neulet.2010.05.058
- Zeppetzauer, M., Drexel, H., Vonbank, A., Rein, P., Actel, S., and Saely, C. H. (2013). Eccentric endurance exercise economically improves metabolic and inflammatory risk factors. *Eur. J. Prev. Cardiol.* 20, 577–584. doi: 10.1177/2047487312444236
- Zoll, J., Steiner, R., Meyer, K., Vogt, M., Hoppeler, H., and Flück, M. (2006). Gene expression in skeletal muscle of coronary artery disease patients after concentric and eccentric endurance training. *Eur. J. Appl. Physiol.* 96, 413–422. doi: 10.1007/s00421-005-0082-8

Conflict of Interest Statement: The authors declare that the research was conducted in the absence of any commercial or financial relationships that could be construed as a potential conflict of interest.

Copyright © 2018 Julian, Thivel, Costes, Touron, Boirie, Pereira, Perrault, Duclos and Richard. This is an open-access article distributed under the terms of the Creative Commons Attribution License (CC BY). The use, distribution or reproduction in other forums is permitted, provided the original author(s) and the copyright owner(s) are credited and that the original publication in this journal is cited, in accordance with accepted academic practice. No use, distribution or reproduction is permitted which does not comply with these terms.

Annexe 2 – Revue n°2

Aerobic metabolic adaptations in dynamic eccentric exercise and training: from whole body to mitochondria.

Les caractéristiques métaboliques de l'exercice excentrique dynamique le rendent particulièrement intéressant à appliquer auprès de patients présentant une limitation cardiorespiratoire. Il a largement été démontré que la plus forte charge mécanique pouvant être appliquée comparativement à un exercice concentrique permettait des gains considérables en termes de masse et de force musculaire. Cependant, la dissociation entre les sollicitations du système de transport de l'O₂ et la surcharge des muscles squelettiques soulève des interrogations quant à la prescription de ce type d'entraînement. Cet article vise à décrire les effets aérobie de l'exercice excentrique dynamique à travers l'adaptation de la $\dot{V}O_2$ corps entier et de la respiration mitochondriale. Dans les études examinées, les contractions physiologiques excentriques ont été obtenues à l'aide d'un ergocycle spécifique ou grâce à la course en descente. Au niveau corps entier, le principal facteur modulant les adaptations de la capacité aérobie semble être l'intensité de l'entraînement, souvent trop faible pour générer une augmentation de la $\dot{V}O_{2pic}/\dot{V}O_{2max}$. Cependant, augmenter l'intensité d'entraînement signifierait appliquer des contraintes musculaires plus élevées, ce qui pourrait ne pas être supportable pour les patients. Au niveau de la respiration mitochondriale, l'exercice excentrique aigu stimulerait le stress oxydatif et le flux de Ca²⁺, ce qui pourrait nuire à l'intégrité mitochondriale. Des séances répétées d'exercices excentriques semblent contrecarrer ces effets, bien qu'une augmentation significative des paramètres de respiration mitochondriale ou de biogenèse mitochondriale ne soient pas observés après ce type d'entraînement. Du point de vue de la réadaptation, l'entraînement sur ergocycle excentrique tel qu'il est actuellement pratiqué est efficace pour augmenter la masse et la force musculaire, mais pas la capacité maximale aérobie. Une approche combinant séquentiellement entraînements concentrique et excentrique pourrait être une piste plus efficace à explorer.



Aerobic Metabolic Adaptations in Endurance Eccentric Exercise and Training: From Whole Body to Mitochondria

Julianne Tournon^{1*}, Frédéric Costes^{1,2}, Emmanuel Coudeyre^{1,3}, Hélène Perrault⁴ and Ruddy Richard^{1,2,5}

¹UCA-INRAE, Human Nutrition Unit, ASMS Team, University Clermont Auvergne, Clermont-Ferrand, France, ²Service de Médecine du Sport et des Explorations Fonctionnelles, CHU Gabriel Montpied, Clermont-Ferrand, France, ³Service de Médecine Physique et de Réadaptation, CHU Gabriel Montpied/CHU Louise Michel, Clermont-Ferrand, France, ⁴Respiratory Division, McGill University Health Center, Montreal, QC, Canada, ⁵Unité d'Exploration en Nutrition (UEN), CRNH Auvergne, Clermont-Ferrand, France

OPEN ACCESS

Edited by:

Trevor Chung-Ching Chen,
National Taiwan Normal University,
Taiwan

Reviewed by:

Martino V. Franchi,
University of Padua, Italy
Stéphane P. Dufour,
Université de Strasbourg, France
Luis E. Penailillo,
Universidad Finis Terrae, Chile

*Correspondence:

Julianne Tournon
Julianne.TOURNON@uca.fr;
julianne.tournon@gmail.com

Specialty section:

This article was submitted to
Exercise Physiology,
a section of the journal
Frontiers in Physiology

Received: 19 August 2020

Accepted: 16 December 2020

Published: 27 January 2021

Citation:

Tournon J, Costes F, Coudeyre E,
Perrault H and Richard R (2021)
Aerobic Metabolic Adaptations
in Endurance Eccentric Exercise
and Training: From Whole Body to
Mitochondria.
Front. Physiol. 11:596351.
doi: 10.3389/fphys.2020.596351

A characteristic feature of eccentric as compared with concentric exercise is the ability to generate greater mechanical loads for lower cardiopulmonary demands. Current evidence concurs to show that eccentric training translates into considerable gains in muscle mass and strength. Less is known, however, regarding its impact on oxygen transport and on factors to be considered for optimizing its prescription and monitoring. This article reviews the existing evidence for endurance eccentric exercise effects on the components of the oxygen transport system from systemic to mitochondria in both humans and animals. In the studies reviewed, specially designed cycle-ergometers or downhill treadmill running were used to generate eccentric contractions. Observations to date indicate that overall, the aerobic demand associated with the eccentric training load was too low to significantly increase peak maximal oxygen consumption. By extension, it can be inferred that the very high eccentric power output that would have been required to solicit a metabolic demand sufficient to enhance peak aerobic power could not be tolerated or sustained by participants. The impact of endurance eccentric training on peripheral flow distribution remains largely undocumented. Given the high damage susceptibility of eccentric exercise, the extent to which skeletal muscle oxygen utilization adaptations would be seen depends on the balance of adverse and positive signals on mitochondrial integrity. The article examines the protection provided by repeated bouts of acute eccentric exercise and reports on the impact of eccentric cycling and downhill running training programs on markers of mitochondrial function and of mitochondrial biogenesis using mostly from animal studies. The summary of findings does not reveal an impact of training on skeletal muscle mitochondrial respiration nor on selected mitochondrial messenger RNA transcripts. The implications of observations to date are discussed within future perspectives for advancing research on endurance eccentric exercise physiological impacts and using a combined eccentric and concentric exercise approach to optimize functional capacity.

Keywords: oxygen consumption, free radicals, calcium, eccentric training, mitochondria

INTRODUCTION

Since its first description at the end of the 19th century (Fick, 1881), eccentric exercise has sparked much interest on account of distinctive features enabling high external mechanical power at reduced cost and its potential for positive rehabilitation and training outcomes (Hoppeler, 2016).

In regular daily movement, concentric and eccentric muscle contractions are combined, for example, when using the stairs or when braking a fall or lowering a heavy object. An activity that involves predominantly eccentric contractions can be described as an eccentric exercise, such as downhill running/walking or eccentric cycling, using a specifically designed ergometer (LaStayo et al., 2003). Endurance eccentric exercise is characterized by lower cardiorespiratory demands (Perrey et al., 2001; Minetti et al., 2002; Dufour et al., 2004; Chavanelle et al., 2014), which makes it particularly attractive for use in patients with chronic heart and lung diseases or with muscle impairments (Roig et al., 2008). Indeed, in individuals with a limited capacity to reach and sustain exercise intensities high enough for significant functional gains to be seen using traditional physical conditioning, the use of an eccentric modality with lower cardiorespiratory demand represents a valuable alternative. Moreover, a bonus outcome of eccentric training would be a non-negligible increase in muscle mass and strength, which is particularly interesting for individuals in whom skeletal muscle mass is compromised due to chronic disease, sarcopenia, and/or aging (Ellis et al., 2015; Cruz-Jentoft et al., 2019).

The impact of eccentric training on skeletal muscle mass and strength has been well-reviewed (Roig et al., 2009; Franchi et al., 2017; Julian et al., 2018a). However, the extent to which the framework for adaptations of the oxygen transport system remains the same as that for concentric exercise training stays unclear. To our knowledge, there has not been a comparative analysis of modality-specific elements that could potentially impact the training adaptation responses or serve as confounders in the interpretation of the data. This article aims to summarize and integrate findings relating to systemic adjustments to endurance eccentric exercise training with a particular emphasis on the central role of mitochondria for energy production and regulation of oxygen consumption (VO_2). First, we review the specifics of endurance eccentric exercise and report on changes in maximal or peak oxygen consumption ($\text{VO}_{2\text{max}}$ or $\text{VO}_{2\text{peak}}$) observed after eccentric exercise training. Second, we consider findings related to factors contributing to oxygen distribution and utilization in the context of acute and chronic eccentric exercise. Considering the dominant role of mitochondria for aerobic adaptations, we examine how eccentric exercise impacts global markers of skeletal muscle mitochondrial respiration and function modulators and regulators. Finally, we provide a perspective for current knowledge, gaps, and opportunities to devise and apply novel physical training and rehabilitation-based approaches.

DISTINCTIVE FEATURES OF ENDURANCE ECCENTRIC EXERCISE

For the purpose of this review, we did not include studies that used repeated segmental resistance eccentric contractions but focused on studies in which dynamic eccentric exercise was carried out using adapted cycle ergometry or downhill walking/running with the view to enable whenever possible comparisons across modality with concentric work.

In humans, depending on the exercise modality, the metabolic cost of eccentric exercise has been reported as being half to one third that of a concentric exercise of equivalent mechanical power output (Perrey et al., 2001; Minetti et al., 2002). Conversely, the power output generated using an eccentric exercise modality can be more than twice that of concentric exercise for the same VO_2 . A similar observation has been reported in rats, using uphill or downhill treadmill running at given speeds and grades, showing the oxygen uptake during eccentric downhill running to be halved compared with concentric work (Chavanelle et al., 2014; Schlagowski et al., 2016). Although the lower oxygen cost of eccentric exercise has been shown repeatedly in both humans and animals, the kinetics of the cardiorespiratory responses through an incremental eccentric exercise protocol have not been as widely examined. In humans, only a few studies have compared concentric and eccentric physiological adaptations with volitional exhaustion probably because of the requirement to safely generate very high mechanical power output during the eccentric exercise protocol (Dufour et al., 2004; Lechauve et al., 2014; Lipski et al., 2018; Lemire et al., 2020). In previous studies of healthy, active young men, data were reported on eccentric vs. concentric heart rates (HR's) and cardiac output across a wide range of mechanical power outputs as well as for incrementally increasing oxygen uptakes. Consistent with the lower oxygen cost per watt of eccentric mechanical power, cardiac output was significantly reduced on account of a lesser chronotropic effect (Dufour et al., 2004). Differences in respiratory adaptations were seen primarily with respect to ventilatory mode with an undifferentiated VO_2 -ventilation relationship being observed between concentric and eccentric exercise tests but with the latter characterized by a lower tidal volume and hyperpnea (Lechauve et al., 2014). In a more recent study, Lipski et al. (2018) have extended the range of comparison by monitored cardiopulmonary responses during incremental tests with exhaustion during both concentric and eccentric cycling. Similarly, results showed a down and rightward shift of the HR-power output response. However, the extension to task failure relationship enabled to establish that peak HR was not different between modalities but that peak power was 50% higher under concentric modality. Peak minute ventilation was also seen to be significantly lower during eccentric cycling, explained by a lower tidal volume, as peak breathing frequency was not different between modalities. A similar observation was made during uphill and downhill running where subjects reached the same maximal HR but failed to reach concentric $\text{VO}_{2\text{max}}$ value under eccentric exercise modality (Lemire et al., 2020). These results are of significance, as they provide a quantifiable

comparison of cardiorespiratory demands that can serve to guide exercise rehabilitation recommendations. The extent to which physiological exercise adaptations translate to an improvement in peak aerobic capacity is however, highly intensity-dependent, which may be limiting on account of the greater skeletal muscle lesions induced by eccentric type contractions.

Compared with concentric muscle contractions, the lengthening effect of eccentric contraction results in a greater mechanical tensile force production leading to enhance exercise-induced muscle damage. Muscle damage can be classified according to the sequence of occurrence, with a first set, more immediate relating to the mechanical stress of exercise and another appearing subsequently as skeletal muscle cells react to the physical insult, such as cellular inflammation, intracellular calcium imbalance, or oxidative stress disruptions (Pereira Panza et al., 2015). In addition to reported symptoms of discomfort or pain, several histological and biological markers have been used to qualify and quantify the eccentric exercise impact. With respect to the impact of the mechanical constraints on the skeletal muscle structure, several studies have described morphological abnormalities such as disruptions of myofibrils and cytoskeleton and widespread Z-line streaming appearing gradually after eccentric exercise (Armstrong et al., 1983; Fridén and Lieber, 2001). Sarcomere disorganization could also be associated with extracellular matrix disruption, mitochondrial swelling, oxidative stress, and inflammation (Pereira Panza et al., 2015). The skeletal muscle disruptions impact performance with transient decrements in maximal force seen immediately after eccentric exercise and lasting several days to a week (Balnave and Thompson, 1993; Howell et al., 1993; Malm et al., 2004; Peñaillillo et al., 2013; Hyldahl et al., 2017). In addition to histological alterations, symptoms of muscle soreness associated with increased intramuscular compartment pressure appear within 24 h of exercise and extend over several days. Exercise-induced damage confirmation showing maximal swelling occurring between 4 and 7 days post-exercise has been provided in both humans and animal muscles using ultrasound elastography, magnetic resonance imaging, and quantitative analysis approaches (McHugh, 2003; Lacourpaille et al., 2014; Fu et al., 2020). An elevation in blood creatine kinase activity 24–48 h post-exercise reflecting myofiber membrane disruption is also a consistent finding after eccentric exercise, the magnitude of increase being related to the exercise intensity (Balnave and Thompson, 1993; Malm et al., 2004; Klossner et al., 2007; Frimpong et al., 2019). Increases in messenger RNA (mRNA) expression of inflammatory markers have also been reported 3 and 24 h after a single 45-min bout of strenuous treadmill downhill running in recreationally trained men (Buford et al., 2009). The extent to which the degree of cytoskeletal mechanical stress and timing of the damage and repair cycle modulate the adaptive responses is not clear. This point is indeed illustrated by the report of transient alterations after one session of unaccustomed/acute eccentric exercise, which resolve spontaneously with rest, as well as evidence that after a few bouts, a repeated effect is seen such that post-exercise markers of damage are no longer seen (McHugh, 2003; Hyldahl et al., 2017).

In a recent review paper, Hyldahl et al. (2017) propose an integrated perspective on the time course of various sarcomere and membrane damage markers and remodeling after eccentric exercise. The schematics show functional and extracellular matrix disruption damage responses over an initial 3-day period, with structural remodeling responses extending to several weeks afterward. The diagram also illustrates the “repeated bout effect” defined by a lesser muscle fiber disruption and related symptoms upon a repeated bout of same intensity eccentric exercise (Nosaka and Clarkson, 1995; McHugh, 2003; Hyldahl et al., 2017). Although of progressively declining magnitude, the repeated bout protective effect appears to last over several weeks, the degree of protection being proportional to the intensity and to the degree of muscle damage resulting from the initial eccentric exercise bout (Hyldahl et al., 2017; Bontemps et al., 2020). It is of interest, however, that a repeated bout effect is seen even after a preconditioning exercise bout as short as 12 min (Pierrynowski et al., 1987) or exercise intensities as low as 40% VO_2max [see table in Bontemps et al. (2020)]. The concept is also put to practice when designing the 1–2-week “familiarization or habituation” phase that is generally integrated within endurance eccentric exercise training studies. In such protocols, animal or human participants are submitted to successive bouts of eccentric exercise of progressively increasing intensity and/or duration, each bout generally being separated by a 24–48 h rest period, such as is the case in studies appearing in **Table 1**. The extent to which the “repeated bout effect” contributes to the adaptation occurring during the familiarization period of an eccentric training program is difficult to establish clearly. Results from a study in rats using a combined magnetic resonance imaging and skeletal muscle histopathological analysis to explore the kinetics of eccentric exercise-induced injury showed maximal disruption to be seen at day 2 post-exercise with gradual muscle repair continuing until at least day 7 (Fu et al., 2020). In contrast to most investigations of repeated bouts effects in which there is a long period separating an initial and a second exercise, familiarization is characterized by successive exercise bouts separated by short rest periods.

To our knowledge, how the sequence and timing of neural, structural, and inflammatory responses are integrated to facilitate adaptations during such a period has not been fully described. Nonetheless, when monitoring post-exercise symptoms and subsequent exercising ability, participants report limited delayed muscle soreness and are capable of increasing force production (Pageaux et al., 2020). The fact that by the end of the familiarization period subjects are capable of achieving at least twice the volume of exercise performed in the initial week may be taken as evidence that if there is repeated skeletal muscle disruption, it is not sufficient to impair function.

EFFECTS OF ECCENTRIC TRAINING ON PEAK OXYGEN CONSUMPTION

Repeated large muscle mass dynamic exercise of sufficient intensity induces systemic adaptations that lead to an increase in $\text{VO}_{2\text{peak/max}}$, which is a strong indicator of the aerobic,

TABLE 1 | Effects of endurance concentric or eccentric training on peak aerobic power.

References	Population Number per group and status Age per group (mean ± SD)	Concentric training protocol (bout duration (min) × frequency (x/week) × training period (weeks) @ Intensity Indicator) Eccentric training protocol (bout duration (min) × frequency (x/week) × training period (weeks) @ Intensity Indicator)	VO _{2peak} or VO _{2max} Pre-post training (%)			
			CON	Stats. Sign.	ECC	Stats. Sign.
Human studies						
Rooyackers et al., 2003	12 COPD patients CON: 59 ± 13 years ECC: 59 ± 10 years	CON: C Intermittent; 20 min × 5x/week × 10 weeks @ SaO ₂ > 90% ECC: C mixed (intermittent CON: 20 min × 5x/week × 10 weeks @ SaO ₂ > 90% + ECC: 15 min × 5x/week × 10 weeks @ CON W _{peak})	0	NS	0	NS
Meyer et al., 2003	6–7 CAD patients CON: 56 ± 9 years ECC: 53 ± 8 years	CON: C; 30 min × 3x/week × 8 weeks @ ~60% VO _{2peak} and/or 85% HR _{peak} (74–82 rpm) ECC: C; 30 min × 3x/week × 8 weeks @ ~60% CON VO _{2peak} and/or 85% CON HR _{peak} (51–60 rpm)	+7.1	NS	+10.4	*
Gremeaux et al., 2010	7 CAD patients CON: 45 ± 5 years ECC: 53 ± 1 years	CON: C; 30 min × 3x/week × 5 weeks @ target HR of VT ₁ (50 rpm) ECC: C; 30 min × 3x/week × 5 weeks @ target HR of CON VT ₁ (20 rpm)	+4.6	**	+14.2	**
Casillas et al., 2016	21 CHF patients CON: 62 ± 9 years ECC: 64 ± 10 years	CON: C; 32 min × 3x/week × 7 weeks @ target HR of VT ₁ (60 rpm) ECC: C; 32 min × 3x/week × 7 weeks @ target HR of CON VT ₁ (15 rpm)	+11.6	**	+11.4	NS
Toyomura et al., 2018	8–10 healthy CON and ECC: 23 ± 2 years	CON: R (+10% grade); 20 min × 3x/week × 5 weeks @ target HR of CON lactate threshold ECC: R (-10% grade); 20 min × 3x/week × 5 weeks @ target HR of CON lactate threshold	+5	**	+2	NS
Lewis et al., 2018	8–9 healthy CON: 46 ± 8 years ECC: 40 ± 8 years	CON: C; 30 min × 2x/week × 8 weeks @ 60% W _{peak} ECC: C; 30 min × 2x/week × 8 weeks @ 60% CON W _{peak}	+9.5	*	+0.3	NS
Julian et al., 2018b	11–12 obese adolescents CON: 13 ± 1 years ECC: 14 ± 1 years	CON: C; 45 min × 3x/week × 12 weeks @ 70% VO _{2peak} (55–65 rpm) ECC: C; 45 min × 3x/week × 12 weeks @ 70% CON VO _{2peak} (55–65 rpm)	+10.9	*	+16.6	*

Relative change in selected performance variable calculated from mean data provided or values taken from publication figures as: (post-value – pre-value/pre-value × 100). C, cycling; CAD, coronary artery disease; CHF, chronic heart failure; CON, concentric; COPD, chronic obstructive pulmonary disease; ECC, eccentric; HR, heart rate; NS, not significant; R, running; SaO₂, arterial oxygen saturation; VO₂, oxygen consumption; VT₁, first ventilator threshold; W, workload. *p < 0.05; **p < 0.01.

muscle, and functional cardiorespiratory capacities (Bassett and Howley, 2000). Its improvement after regular aerobic exercise of moderate–high intensity ($\geq 60\%$ of the initial VO_{2max/peak}) is well documented in many different populations (Diaz-Canestro and Montero, 2019). Interestingly, such adaptations have not been consistently observed after eccentric training of large muscle masses, performed in healthy subjects and also in patients. Despite the growing interest in eccentric training, data on the systemic metabolic and cardiorespiratory adaptations to such training remain scarce. **Table 1** summarizes an updated set of studies examining the impact of eccentric exercise training in most cases using cycling ergometry to contrast effects with those of traditional concentric cycling.

Three of the seven studies were conducted on healthy participants, whereas the four others included patients with chronic heart or lung disease and completed the exercise protocol extending between 5 and 10 weeks within the context of an

exercise rehabilitation program. Findings from **Table 1** reveal a significant increase in the selected functional performance marker (VO_{2peak/max}) ranging between 5 and 10% in five of the studies after concentric training, whereas significant positive changes between 10 and 15% were seen in three of the studies after eccentric training (Meyer et al., 2003; Gremeaux et al., 2010; Julian et al., 2018b). When comparing the relative impact of eccentric with concentric, Meyer et al. (2003) found eccentric but not concentric training to result in an enhanced peak aerobic power in their sample of coronary artery disease patients. Similarly, although significant improvements were seen after rehabilitation using both modalities, a greater improvement was in the eccentric-trained group (Gremeaux et al., 2010). In contrast, in patients with chronic heart failure, Casillas et al. (2016) reported no significant improvement after eccentric training but a significant improvement in the concentric-trained group. When considering results from samples of healthy

participants, statistically significant increases were seen in all three studies after concentric exercise training (Lewis et al., 2018; Toyomura et al., 2018) and only in one study after eccentric training (Julian et al., 2018b). Interestingly, an increase in peak power ranging from 10.3 to 23.0% is a common observation after all eccentric training programs summarized in **Table 1**. Other indications of physiological adaptive changes have also been reported. At the end of the 7-week pulmonary rehabilitation program, Rooyackers et al. (2003) observed an improvement in the alveolar–arterial O₂ gradient at peak exercise, potentially reflecting some level of systemic adaptation. Similarly, a lower VO₂ requirement (-0.55 L min^{-1}) for given submaximal eccentric power output was seen in a small sample of healthy subjects ($n = 6$) after five training weeks (Knuttgén et al., 1982). A clear mechanistic explanation for this observation suggestive of enhanced bioenergetic efficiency has not been provided. Although a full review of biomechanical repercussions of eccentric exercise is beyond the scope of this article, it cannot be excluded that changes in the biomechanical properties of soft tissues and skeletal muscles consecutive to the repeated eccentric exercise bouts could impact the oxygen cost of the contraction (Peñailillo et al., 2015). Other predominant impacts of eccentric relative to concentric exercise training relate to impacts on muscle strength, mass, and body composition. Significant increases in strength-related parameters have been reported as a result of the low-intensity training protocols in several studies from **Table 1** (Gremeaux et al., 2010; Casillas et al., 2016; Julian et al., 2018b; Lewis et al., 2018; Toyomura et al., 2018). Eccentric exercise training has also been seen to reduce body mass in the study of obese adolescents, which could contribute to the reported outcome on VO₂max when expressed relative to total body mass (Julian et al., 2018b). Thus, an increase in peak VO₂ is not a consistent finding after endurance eccentric training; experimental evidence support that it can induce skeletal muscle physiological adaptive responses and that the repeated increase in metabolic demand can have a systemic impact (Drexel et al., 2008; Nikolaidis et al., 2008; Paschalis et al., 2011).

A common feature of studies presented in **Table 1** is the relatively low exercise training intensity, established on the basis of a pre-training concentric incremental exercise with a training intensity set above 70% peak HR or peak VO₂ in only three studies (Meyer et al., 2003; Gremeaux et al., 2010; Julian et al., 2018b). In the case of studies on patients with chronic heart or pulmonary disease, eccentric exercise training intensity was set from prior incremental concentric tests for a target training HR corresponding to that below the first ventilatory threshold or approximately 60% of peak VO₂ or 85% symptom-limited peak HR or above 90% SaO₂. As discussed previously, this translates to a significantly lower cardiorespiratory demand compared with concentric training (Dufour et al., 2004; Lipski et al., 2018). It is, therefore, likely that given equivalent metabolic training overload, similar improvements would be seen across modalities. Indeed, when considering the three studies from **Table 1** in which the highest target training intensities were used, a significant impact of eccentric training is seen (Meyer et al., 2003; Gremeaux et al., 2010; Julian et al., 2018b). The potential for endurance

eccentric training to equally enhance peak oxygen uptake is also confirmed in animals. In a recent report, VO₂max measured in rats submitted to a regular program of downhill running at -14° grade, $35 \text{ m}\cdot\text{min}^{-1}$, five times weekly for 6 weeks was found to be 24% higher than that of sedentary animals (Hahn et al., 2007). If converting this speed of running to gauge training intensity, $35 \text{ m}\cdot\text{min}^{-1}$ may be seen to be near-maximal if one refers to the maximal uphill and downhill treadmill running speeds sustained by rats at a grade of $+15$ and -15° , previously reported to be $70 \text{ cm}\cdot\text{s}^{-1}$ or $42 \text{ m}\cdot\text{min}^{-1}$ (Schlagowski et al., 2016). Thus, similar to that for concentric exercise training, inasmuch as the training protocol induces an adequate overload of the oxygen transport system, a training-induced effect to enhance its peak function could be expected. Clear comparative data to definitely establish that similarity of response is, however, lacking.

To date, only a few studies have examined the central and/or peripheral circulatory adaptations during endurance eccentric exercise (Meyer et al., 2003; Dufour et al., 2004), and none to our knowledge have explored the repercussions of eccentric vs. concentric exercise training of similar intensities to compare differences in training-induced adaptations. With respect to peripheral circulatory adaptations, only a few studies have assessed skeletal muscle capillarization and angiogenesis after eccentric exercise training and in two cases in the context of post-disuse rehabilitation in rats. Using a hind limb suspension and flat or downhill training remobilization model, Cornachione et al. (2011) found an increase in capillary density with both remobilization protocols. Similarly, after hind limb immobilization, 21 days of downhill treadmill running (-16° ; $17 \text{ m}\cdot\text{min}^{-1}$) were seen to induce significant angiogenesis in excess of that resulting from passive limb stretch of similar duration (Benedini-Elias et al., 2014). Eccentric cycling has also been shown to be responsible for a 47% increase in capillary-to-fiber ratio after eight training weeks, whereas no change was reported after concentric (LaStayo et al., 2000).

Taken together, these observations may be taken to suggest that irrespective of the eccentric or concentric nature of the skeletal muscle contraction, chronic regular, sustained large muscle mass endurance exercise sufficient to produce the same magnitude of overload to the oxygen transport and utilization requirements would induce similar skeletal muscle adaptations. Consequently, similar to that seen after large muscle mass training using concentric exercise, adaptations in skeletal muscle mitochondrial density and activity would also be expected to follow from chronic eccentric training.

MITOCHONDRIAL RESPONSES AND ADAPTATIONS TO ECCENTRIC TRAINING

Over recent years, evidence has been accumulating that mitohormesis, the ability of the mitochondria to trigger significant adaptive response signaling pathways to restore and improve function, may operate to govern adaptations to aerobic training (Merry and Ristow, 2016). The extent to which the mitohormetic effects of aerobic exercise are

expressed and translated across exercise training modalities remains incompletely documented, as is the interplay of effects on signaling factors and regulators modulating mitochondrial function (Walsh et al., 2001; Zoll et al., 2002; Mueller et al., 2011; MacMillan et al., 2017). Like any other cellular organelle, mitochondria can be studied in terms of protein content, RNA expression, or isolated enzymatic activities and integrated functionality. Mitochondrial function can be analyzed in isolated mitochondria (Frezza et al., 2007) and permeabilized fibers (Kuznetsov et al., 2008) from fresh muscle biopsy samples. The differences between these techniques are mainly based on 1) the amount of tissue and 2) the use of *in vitro* or *in situ* (intracellular architecture conservation) mitochondria. Both methods allow assessing several mitochondrial parameters, including respiratory function through O₂ consumption, reactive oxygen species production (ROS), and calcium (Ca²⁺) uptake. For the sake of simplicity, in this review, the different parameters will be discussed separately, although they are interconnected (Brookes et al., 2004). In this section, we present data related to mitochondrial respiration in eccentrically trained skeletal muscles in both animal and human studies and examine how the chronic exercise intervention directly or indirectly impacts mitochondrial function through monitoring of modulating signals and regulators.

Impact on Mitochondrial Respiration: Acute vs. Chronic Responses

The precise functioning of the mitochondrial respiratory chain has been extensively described (Brown et al., 2010), with reports on mitochondrial respiration properties generally considering a set of three common indicators: V₀ or "state 4" for basal respiration, V_{max} or "state 3" for maximal adenosine diphosphate (ADP)-stimulated respiration, and the ratio of V_{max}/V₀ referring to the respiratory control ratio (RCR). It was only at the beginning of the 21st century that researchers became interested in the effects of eccentric exercise on mitochondrial energy metabolism showing contrasting effects of eccentric exercise on mitochondrial respiration. As can be seen from Tables 2, 3, a limited number of studies have examined the impact of endurance eccentric exercise or training in humans, which may be related, at least in part, to the need to perform skeletal muscle biopsies for muscle samples to be obtained.

Mitochondrial respiration is a dynamic phenomenon, but because of technical limitations, its quantification is not provided in "real-time," which complicates the interpretation of intervention impact. In the study of exercise training effects, the difficulty remains to dissociate immediate post-acute from post-chronic exercise effects. Several studies conducted, most of them using an animal model, have examined the impact of an acute bout of eccentric exercise on mitochondrial respiration. Walsh et al. (2001) were the first to assess the immediate and delayed impact of a single cycling eccentric exercise bout on mitochondrial respiration parameters in healthy young men. Results showed no significant effect on V₀; submaximal ADP stimulated respiration (V_{submax}) and V_{max} immediately after exercise and at days 2 and 4 of recovery. There was

also no significant difference in the ADP sensitivity index [(V_{submax} - V₀)/(V_{max} - V₀)] and RCR. As can be seen in Table 2, in the other studies completed in rodents, pyruvate-malate ADP-stimulated mitochondrial respiration was measured in hind limb muscle immediately and up to 48 h post-downhill running at a negative treadmill incline of -7 to -14° and speeds ranging between 20 and 40 m·min⁻¹ (Molnar et al., 2006; Rattray et al., 2011, 2013; Magalhães et al., 2013). Compilation of results shows no significant changes being reported for V₀. Data on V_{max} do not reveal a consistent pattern of impact. In the immediate post-exercise period, significant decreases of magnitude -16 and -27% are seen only in two of the experimental conditions across studies (Rattray et al., 2011; Magalhães et al., 2013). Of the four studies examining the post-48-h window, a significant decrease (-45.9%) was reported by only one group on two different occasions (Rattray et al., 2011, 2013). In both of these studies, the exercise protocol parameters were not at the extreme range or intensity and duration and therefore could not be responsible for inducing more severe muscle damage. It is therefore difficult to conclude from these results that the delayed muscle damage present 2 days post-exercise negatively affects the mitochondrial respiration capacity. This observation may serve as a basis to rule out the confounding effect that acute muscle damage impacts the results from exercise training studies.

In the study by MacMillan et al. (2017) patients with chronic obstructive pulmonary disease (COPD) were randomly assigned to either a concentric or an eccentric exercise training protocol to contrast the effects of a rehabilitation program consisting of three weekly 30-min sessions for 10 weeks at an intensity defined by the target HR corresponding to 60–80% of peak power output established from a concentric incremental test. For the eccentric training group, the target work rate was computed as four times the power output corresponding the 60–80% of measured concentric peak power. The first 2 weeks served as a familiarization period, with the eccentric intensity being set at 20–40% of concentric peak power sustained for 20 min in week 1 and for 30 min in week 2 (Table 3). The mechanical power performed during eccentric exercise bouts was threefold the concentric power output. Patients showed significant increases in leg muscle strength after eccentric but not after concentric training, whereas no differences in the various respiration states were observed (MacMillan et al., 2017). In contrast, significant changes in electron transport chain complexes were seen in the group trained through concentric cycling (MacMillan et al., 2017). In addition, Table 3 shows the small set of four studies having measured mitochondrial respiration in skeletal muscles of animals submitted to eccentric exercise training using downhill running on a motor-driven treadmill (Molnar et al., 2006; Rattray et al., 2013; Isner-Horobeti et al., 2014; Schlagowski et al., 2016). As can be seen, training duration including the familiarization period ranged between 5 and 8 weeks, for running speeds between 20 m·min⁻¹ up to maximal (previously measured at approximately 40 m·min⁻¹), at a 5-day per week frequency and with a negative treadmill grade between -7 and 15°. As can be seen, a significant change in V₀ is not a consistent observation after either 24 or 48 h, whereas, for maximal mitochondrial respiration rates, a significant impact is

TABLE 2 | Effects of acute endurance eccentric exercise on mitochondrial respiration parameters.

References	Population Number per group	Eccentric training protocol (bout duration (min) @ Intensity Indicator)	Experimental methods (muscles/technique)	Mitochondrial respiration markers relative to substrates and measurement time post-exercise (%Δ from baseline or from sedentary group)					
				V_0	Sign.	V_{max}	Sign.	RCR	Sign.
Human study									
Walsh et al., 2001	6 healthy volunteers	C: 30 min @ CON W_{max} (with rapid W ↑)	Vastus lateralis/skinned fibers	$P+M$		$P+M$		$P+M$	
				Imm.: -17.4	NS	Imm.: -2.5	NS	Imm.: +14.3	NS
				48 h: +4.3	NS	48 h: +6.6	NS	48 h: 0.0	NS
				96 h: -4.3	NS	96 h: -2.5	NS	96 h: -3.6	NS
Animal studies									
Molnar et al., 2006	8 Wistar rats	R (-7°): initial speed @ 8 m·min ⁻¹ , ↑ every 5 min up to 30 m·min ⁻¹ ; then 4 min @ 30 m·min ⁻¹ and 1 min @ 40 m·min ⁻¹ until exhaustion Deep portion of quadriceps muscle/isolated mitochondria		$P+M$		$P+M$		$P+M$	
				Imm.: -0.3	NS	Imm.: +6.9	NS	Imm.: +6.5	NS
				S		S		S	
				Imm.: +7.9	NS	Imm.: +3.2	NS	Imm.: -2.7	NS
Ratray et al., 2011	8 Sprague-Dawley rats	R (-14°): 90 min (5 min run + 2 min rest) @ 20-30 m·min ⁻¹ Vastus muscle group (vastus intermedius, vastus medialis, and vastus lateralis)/isolated mitochondria		$P+M$		$P+M$		$P+M$	
				Imm.: -17.9	NS	Imm.: -16.2	*	Imm.: -1.5	NS
				2 h: -16.2	NS	2 h: -2.7	NS	2 h: +11.8	NS
				48 h: -28.0	NS	48 h: -45.9	*	48 h: -29.4	*
Ratray et al., 2013	8-9 Sprague-Dawley rats	R (-14°): 90 min (5 min run + 2 min rest) @ 20 m·min ⁻¹ Red muscles (vastus intermedius, vastus medialis, and vastus lateralis)/isolated mitochondria		$P+M$		$P+M$		$P+M$	
				48 h: -12.7	NS	48 h: -25.8	+	48 h: -12.2	+
Magalhães et al., 2013	10 CD-1 mice	R (-16°): total = 120 min (15 min gradual speed ↑; 75 min @ 25 m·min ⁻¹ ; 30 min @ 30 m·min ⁻¹) Hindlimb muscles (soleus, gastrocnemius, and quadriceps) + spinotrapezius/isolated mitochondria		$P+M$		$P+M$		$P+M$	
				Imm.: +7.0	NS	Imm.: -27.1	*	Imm.: -33.1	*
				48 h: -11.6	NS	48 h: -10.5	NS	48 h: -0.1	NS
				S		S		S	
				Imm.: +7.3	NS	Imm.: +6.0	NS	Imm.: -9.1	NS
				48 h: -8.0	NS	48 h: -4.0	NS	48 h: -10.3	NS

Relative change in mitochondrial respiration markers calculated from mean data provided or values taken from publication figures as: (post-value - pre-value/pre-value × 100). C, cycling; M, malate; NS, not significant; P, pyruvate; R, running; RCR, respiratory control ratio; S, succinate; V_0 , basal mitochondrial respiration (state 4); V_{max} , maximal mitochondrial respiration (state 3, adenosine diphosphate stimulated state); W, workload. * $p < 0.05$, + $p < 0.10$.

not reported in any of the studies irrespective of the post-exercise timing of muscle sampling.

Reactive Oxygen Species Production

It is well known that several factors, such as oxidative stress and calcium fluxes, act as regulators of mitochondrial respiration rates. ROS are mainly by-products of mitochondrial O_2 respiration and electron transport, in particular at the level of complexes I and III (Inoue et al., 2003). Other major endogenous sources of ROS in skeletal muscle include nicotinamide adenine dinucleotide phosphate hydrogen oxidase and xanthine oxidase (He et al., 2016). In some non-physiological conditions, which may result in membrane potential ($\Delta\psi$) or Ca^{2+} uptake changes, ROS homeostasis can be altered due to an imbalance between production and detoxification/antioxidant mechanisms (Jezeck and Hlavatá, 2005). Excessive mitochondrial ROS production may lead to the opening of the mitochondrial permeability transition pores (mPTP) and to the alteration of the respiratory chain complex activity (Choksi et al., 2004). ROS have therefore

been long thought to serve only as by-products of respiration that caused oxidative damage and contributed to aging, mitochondrial disorders, and cell death. However, recent evidence indicates that ROS produced in mitochondria are involved in various cell signaling processes (Brookes et al., 2004). ROS also play an important role in response to dynamic exercise, which is influenced by exercise type, intensity, duration, and training (He et al., 2016).

Although there is growing evidence that ROS may be involved in exercise-induced muscle damage (Close et al., 2004; Nikolaidis et al., 2008; González-Bartholin et al., 2019), there are only a few investigations that have assessed mitochondrial ROS production rate in relation to eccentric exercise, mostly after an acute bout. In the mid-2000s, Molnar et al. (2006) were the first to examine whether eccentric exercise promoted mitochondrial ROS generation. They found that in response to acute eccentric exercise in rats (one exhaustive downhill running bout), muscle hydrogen peroxide (H_2O_2) production and back electron flow were reduced in state 4 measurements, and most of the ROS

TABLE 3 | Effects of endurance chronic eccentric exercise on mitochondrial respiration parameters.

References	Population Number per group	Eccentric training protocol (bout duration (min) × frequency (x/week) × training period (weeks) @ Intensity Indicator)	Experimental methods (muscles/technique)	Mitochondrial respiration markers relative to substrates and measurement time after last training session (%Δ from pre-training or from sedentary group)									
				V ₀	Sign.	V _{max}	Sign.	RCR	Sign.				
Human study													
MacMillan et al., 2017	4 COPD patients	C: 30 min × 3x/week × 10 weeks @ 4 × 60–80% CON W _{peak} (60 rpm) Vastus lateralis/skinned fibers		No data		<u>G + M</u> 96 h: -3.6 <u>G + M + S</u> 96 h: +10.9		No data		NS		NS	
Animal studies													
Molnar et al., 2006	8 Wistar rats	R (-7°): week 1, 4 × 5 min (2 min rest); weeks 2–8, 6 × 2.5 min (1 min rest) × 5x/week × 8 weeks @ 20–35 m·min ⁻¹ Deep portion of quadriceps muscle/isolated mitochondria		<u>P + M</u> 48 h: +14.1 <u>S</u> 48 h: +3.1	*	<u>P + M</u> 48 h: +4.1 <u>S</u> 48 h: -2.3		<u>P + M</u> 48 h: -8.7 <u>S</u> 48 h: -4.9		NS		NS	
Ratray et al., 2013	8–9 Sprague-Dawley rats	R (-14°): 30 min (5 min run + 2 min rest) × 5x/week × 1 week @ 20 m·min ⁻¹ Red muscles (vastus Intermedius, vastus medialis, and vastus lateralis)/isolated mitochondria		<u>P + M</u> 48 h: -4.7	NS	<u>P + M</u> 48 h: -8.2		<u>P + M</u> 48 h: -1.4		NS		NS	
Isner-Horobelt et al., 2014	8–10 Wistar rats	R (-15°): 20–40 min × 5x/week × 1 or 4 weeks @ 20 m·min ⁻¹ Vastus Intermedius/Skinned fibers		No data		<u>G + M</u> 12 h: -13.2 (1 week) 12 h: -12.4 (4 weeks) <u>S</u> 12 h: -11.8 (1 week) 12 h: -21.0 (4 weeks)		No data		NS		NS	
Schlagowski et al., 2016	8 Wistar rats	R (-15°): 20–30 min × 5x/week × 4 weeks @ 60–80% of maximal speed Vastus Intermedius/Skinned fibers		<u>G + M + S</u> 24 h: 0.0	NS	<u>G + M + S</u> 24 h: -2.2		<u>G + M + S</u> 24 h: -4.0		NS		NS	

Relative change in mitochondrial respiration markers calculated from mean data provided or values taken from publication figures as: (post-value - pre-value/pre-value × 100). C, cycling; COPD, chronic obstructive pulmonary disease; G, glutamate; M, malate; NS, not significant; P, pyruvate; R, running; RCR, respiratory control ratio; S, succinate; V₀, basal mitochondrial respiration (state 4); V_{max}, maximal mitochondrial respiration (state 3, adenosine diphosphate stimulated state); W, workload. *p < 0.05.

came from reverse electron transport through complex I. No modification was observed in state 3 measurements. Authors speculated that the low ROS production post-eccentric exercise could be explained either by a decrease in complex I activity as the main ROS generator within the electron transport chain or by a decrease in mitochondrial matrix superoxide dismutase content. However, none of these suggestions could be validated because both of these parameters were unaffected by acute eccentric exercise. Because ROS production is also greatly dependent on Δψ and electrochemical gradient and because uncoupling proteins (U) can affect these parameters, levels of UCP3 protein were also quantified. Unfortunately, the authors reported no change in this protein level. Another study showed that 30 min of continuous downhill running did not change UCP3 mRNA expression in the rat *plantaris* muscle, whereas its expression was decreased by 27.6% in *tibialis anterior* compared with the control

group (no exercise) (Bryner et al., 2004). Molnar et al. (2006) also measured H₂O₂ generation in rats after 8 weeks of intermittent downhill training to determine whether the attenuation of muscle damage with eccentric training was related to a reduction in mitochondrial ROS generation or an adaptation of antioxidant enzymes. In the chronic eccentric exercise group, they observed lower H₂O₂ level in state 4 measurements with pyruvate-malate or succinate but no change in state 3 measurements. They hypothesized that this reduction was associated with increased mitochondrial protein content because they also found that citrate synthase activity was increased. As observed for the acute eccentric condition, they did not detect any change in UCP3 protein level in response to chronic eccentric training. However, this does not exclude the possibility that eccentric exercise might cause intrinsic changes in mitochondrial function, such as mild uncoupling, and prevent excess ROS production.

When ROS production after concentric and eccentric training performed at similar mechanical power was compared, basal mitochondrial H_2O_2 production rates were not different between groups after 5 and 20 days of training, regardless of the studied muscle (Isner-Horobeti et al., 2014). However, in *vastus intermedius*, 20 days of eccentric training significantly increased mitochondrial H_2O_2 production and free radical leak. Based on these results, the authors suggested a functional adaptation to the mitochondrial electron transport chain rather than a change in mitochondrial density because H_2O_2 production increased in state 3 but was unchanged in state 4 measurements. Finally, a third study found no difference in muscle ROS production after 4 weeks of eccentric exercise alone and of combined eccentric and concentric exercise (Schlagowski et al., 2016), partially confirming the results of the previous study. In view of the observations mentioned earlier in multiple leg muscles and using different training protocols, it seems that eccentric exercise is not associated with increased ROS production. An improvement in antioxidant status cannot be totally excluded but will need to be further examined. The absence of major ROS production modifications may be taken to explain, at least in part, the absence of any significant reduction in mitochondrial respiration after eccentric training.

Calcium-Related Outcomes

Disruptions in cellular structural integrity promote extracellular calcium fluxes that, in turn, may alter function. Considering the higher mechanical constraints exerted by eccentric exercise on skeletal muscle structures, the issue of calcium balance and the impact of eccentric exercise-induced muscle damage is of prime importance. The key role of Ca^{2+} as a regulator for many cellular processes, including contraction, protein synthesis, and degradation, is well known. Muscle cytosolic concentration is finely regulated by Ca^{2+} transport across the sarcolemma membrane, sarcoplasmic reticulum (SR), and mitochondria. Ca^{2+} homeostasis is also essential for proper mitochondrial functioning, as much evidence indicates that mitochondrial Ca^{2+} plays a role in mitochondrial oxidative phosphorylation regulation, ATP production, mitochondrial permeability transition, and cell death (Gunter et al., 2004; Giorgi et al., 2018). Whereas a low increase in mitochondrial Ca^{2+} concentrations enhances respiration and ATP production, higher matrix Ca^{2+} accumulation can induce mPTP opening, electrochemical proton gradient dissipation, respiratory chain dysfunction, and ultimately mitochondrial swelling, membrane disruption, and release of pro-apoptotic factors (Halestrap, 2009).

Duan et al. (1990) were the first to show the potential role of Ca^{2+} homeostasis alteration in the etiology of muscle fiber damage and mitochondrial dysfunction. In an animal study, muscle injury resulting from acute downhill walking was strongly and positively correlated with mitochondrial Ca^{2+} content (MCC). The reduction of mitochondrial Ca^{2+} accumulation with chelators attenuated muscle fiber injury, confirming the central role played by Ca^{2+} in promoting muscle damage (Duncan, 1978). As SR primarily regulates skeletal muscle intracellular Ca^{2+} concentration, SR Ca^{2+} uptake and SR Ca^{2+} ATPase (SERCA) activity were measured in human *vastus lateralis* after

a cycling exercise (Enns et al., 1999). SR Ca^{2+} uptake was depressed during the recovery period and delayed after the exercise end. SERCA activity was increased during the first 2 days of recovery and returned to the pre-exercise level at day 6 post-exercise. SR functional characteristics (i.e., Ca^{2+} uptake and release, SERCA activity) were also significantly reduced in the red part of the *vastus lateralis* in rats after 90 min of downhill running (-16°) at $15\text{ m}\cdot\text{min}^{-1}$ (Chen et al., 2007). However, the SR membrane integrity was not affected. The previous observations may be taken to reflect an SR defect possibly related to Ca^{2+} management. The rise in Ca^{2+} can, however, also be ascribed to stretch-activated Ca^{2+} channels (SACs) opening with eccentric muscle contraction (Allen et al., 2005). Incubation of muscles with SAC blockers after eccentric contraction abolished or significantly reduced myocyte Ca^{2+} accumulation, indicating the role of SACs in this process (Sonobe et al., 2008). It is, therefore, likely that SACs contribute, at least partly, to the rise in intracellular Ca^{2+} and muscle fiber damage seen after eccentric contractions. More than 20 years after the first publication on the link between Ca^{2+} homeostasis alteration and muscle fiber damage, Rattray et al. (2011) reported an increase in MCC after acute downhill running in rats. Concomitant with the elevated MCC, the authors also found that the mPTP sensitivity to Ca^{2+} was higher at the same time point after the stress event. Moreover, the elevation in skeletal muscle MCC at 48-h post-exercise was lower after an acute bout of eccentric exercise compared with the untrained condition (Rattray et al., 2013). The authors suggested a correlation between MCC and RCR because high Ca^{2+} level was associated with lower mitochondrial respiratory function. Finally, they confirmed the increased sensitivity of mPTP opening to Ca^{2+} after acute eccentric exercise while showing that training increased mPTP tolerance to Ca^{2+} . A study in mice confirmed the increased susceptibility of mPTP opening to Ca^{2+} and the transient impairment of skeletal muscle mitochondrial function after downhill running (Magalhães et al., 2013).

These first insights into the links between Ca^{2+} homeostasis and eccentric muscle contractions indicate that unaccustomed muscle solicitation causes a transient and local Ca^{2+} elevation and increases mPTP sensitivity. The absence of calcium-related issue after several weeks of training seems to suggest muscle and/or mitochondrial adaptation (Rattray et al., 2013). Although it is still difficult to clearly identify the targets of this adaptive response, the transient alteration in mitochondrial O_2 consumption may be explained by the transient elevation of and sensitivity to Ca^{2+} .

Messenger RNA Expression of Mitochondrial Proteins

Over the last decades, several studies have examined the expression of mRNA after eccentric exercise to understand better molecular mechanisms underlying structural and functional changes induced by this training modality (Zoll et al., 2006; Klossner et al., 2007; Hody et al., 2011; Mueller et al., 2011; Valladares-Ide et al., 2019). Evidence from the literature indicates that "strength" exercises and "endurance" exercises do not activate the same gene networks and signaling pathways

(Coffey and Hawley, 2007; Egan and Zierath, 2013). As reviewed, the PI3K-AKT-mTOR pathway is the main integrator of mechanical stress for hypertrophy and muscle mass gain, whereas endurance-type training induces the AMPK-p38 MAPK-PGC1 α pathway, leading to mitochondrial biogenesis. As eccentric exercise and training are carried out in endurance mode, they would concomitantly involve significant mechanical stress and metabolic stimulation. However, to date, there are only scarce data on gene expression of mitochondrial function modulators and regulators after such stimulus.

The first study investigating the molecular response to eccentric endurance training was conducted in patients with coronary artery disease (Zoll et al., 2006). Analysis of steady-state adaptations of *vastus lateralis* after an 8-week training program of 30 min three times per week up to 60% of concentric VO_2 peak showed that the mRNA levels of mitochondrial transcription factor A and of cytochrome c oxidase subunit 4 were reduced after low-intensity eccentric training compared with concentric training. Conversely, PGC1 α , a transcriptional coactivator central to mitochondrial biogenesis, was unchanged. Consistent with these findings, a study on the effects of a single bout of unaccustomed eccentric exercise (15 min at 50% of individual concentric maximal power output) later reported that the expression of 80 genes was significantly changed, mainly downregulated immediately after the bout and/or during the recovery time (Klossner et al., 2007). The authors concluded that the eccentric stimulus was insufficient to induce carbohydrate or lipid metabolism upregulation or to positively affect energy generation and mitochondrial biogenesis. Similarly, in older adults, after 12 weeks of eccentric training, only 29 transcripts were significantly changed (Mueller et al., 2011). Further examination showed genes encoding for metabolic enzymes and mitochondrial proteins were downregulated, whereas genes encoding factors involved in repair and remodeling were upregulated. Finally, a study on patients with COPD did not find any change in PGC1 α expression and also in the electron transport chain complex content after a 10-week eccentric program (MacMillan et al., 2017).

Thus, the few studies currently available suggest that mitochondrial biogenesis is not stimulated in response to either acute or chronic eccentric exercise, at least when performed at intensities as used in studies summarized in **Tables 1–3**, which is consistent with the absence of changes in mitochondrial respiration parameters.

DISCUSSION

Main Findings

Metabolic adaptations to eccentric training remain incompletely understood, but the currently available data indicate that eccentric exercise training as currently done does not induce adaptations in peak aerobic power and mitochondrial function. Spontaneous acute eccentric exercise may cause transient alterations in mitochondrial O_2 consumption, Ca^{2+} matrix content, and sensitivity to Ca^{2+} , with evidence for repeated exercise to provide some protective effect from these outcomes.

The observed lack of adaptive responses may be explained by the relatively low exercise training metabolic stimulus. This results in a dominance of the mechanical vs. metabolic overload induced by the eccentric exercise protocols and, in turn, in an uncoupling of the mechanical load and systemic metabolic demands on exercised muscles leading to a suboptimal metabolic stimulus (Meyer et al., 2003; MacMillan et al., 2017). This is supported by the absence of upregulation of mitochondrial and metabolism-related genes, although a significant increase in muscle mass and strength are reported after the eccentric exercise training, presumably the outcome of the activation of these specific signaling pathways attesting to the capacity of response.

Perspectives for Functional Capacity Recovery and Rehabilitation

Because of the high mechanical power output to low cardiorespiratory demand advantages conferred by the eccentric-type contractions, its use for restoring muscle function after an acute injury or enhancing mobility and exercise capacity in individuals with chronic heart or lung disorders is increasingly recognized. This modality is safe and effective for patients with chronic diseases (LaStayo et al., 2007; Rocha Vieira et al., 2011; Besson et al., 2013; Pageaux et al., 2020). However, in addition to the practical difficulties of defining and monitoring training parameters to minimize muscle damage and soreness, the use of eccentric exercise for rehabilitation remains a challenge for several reasons. First, mechanical loads required to overload the oxygen transport system in a way sufficient to induce desired improvements may be too high to be sustained by patients. Second, because of this disproportional coupling of mechanical and metabolic loading, it is difficult to design an eccentric exercise training protocol that can adequately address the overall functional improvement. Except in cases where muscle strengthening is the predominant goal and in which cases, targeted segmental eccentric exercise might offer advantages over traditional resistance training, the use of endurance eccentric exercise needs to be considered in combination with other approaches.

Various technological advances are being made to allow for more selectivity in nature and in the sequence of loading across movement cycles (Flück et al., 2017; Franchi and Maffioletti, 2019; Doyle et al., 2020). As more technological advances are being made, so are opportunities for a more “individualized” approach to exercise rehabilitation. This requires an understanding of not only the targeted physiological and/or functional adaptive responses expected from the “designer” program but also an appreciation of the selection and the combination of “building blocks” that will best serve the identified purposes. In theory, the best combination should be one to optimize the overall physical training outcomes, enhancing muscle strength, and endurance and aerobic capacity. In practice, this will require more advanced knowledge of the impact of varying eccentric exercise modalities on skeletal muscle structures and ultra-structures to understand the fine balance between disruptive and adaptive responses to exercise. A wide range of possible combinations should be integrated to

include blocks of segmental isokinetic and/or isoweight eccentric strength training, large muscle mass eccentric/concentric exercise aerobic training, allowing for blocks of different duration, sequencing, and stacking. Similarly, within each block, consideration can be given to use continuous and discontinuous approaches, with loading strategies to include periodization and various combinations of constant load or intermittent exercise in alternating sequences (Flück et al., 2017; Harris-Love et al., 2017; Franchi and Maffiuletti, 2019; Plaquevent-Hostache et al., 2019).

As expressed in the previous sections, exercise-induced muscle damage may be seen as a necessary evil to trigger skeletal muscle adaptations. In the same manner, as "mitohormesis" is used to define the delicate balance of negative and positive influences of ROS on mitochondria, a concept of "eccentric hormesis" could be introduced to capture the duality of deleterious and beneficial effects particularly associated with this exercise modality. Although there is growing evidence that muscle growth can be triggered by alternative pathways (Fukada et al., 2020), muscle destabilization as induced by eccentric contraction allows adaptations, whether or not it is accompanied by symptoms of muscle damage. In applying this concept, building blocks can be selected with the view to modulate the exercise prescription such that the exercise-induced muscle damage is of nature and magnitude just enough to trigger a beneficial adaptation but not to the extent that it has a deleterious effect that prevents adaptive activation or impairs performance. From the current review, it would appear that in aligning building blocks, a predominance of moderate–high intensity dynamic concentric components would be needed to impact skeletal muscle mitochondrial function. A combination of traditional aerobic type training and segmental eccentric strength could enable optimization of overall rehabilitation impact. The higher the proportion of eccentric contractions, the higher the signals for muscle mass and strength building but presumably at the expense of mitochondrial adaptations and peak aerobic function effects. On the other hand, if the proportion of eccentric exercise-induced damage is too low to activate the signaling pathways, the result could be a loss of impact on skeletal muscle and body composition without impact on oxygen transport or utilization.

Although experimental evidence is still needed to validate many aspects of the eccentric-hormesis approach, an example focusing on exercise prescription from the rehabilitation setting

is presented here for illustration purposes. Among patients with chronic heart or lung disease whose progression is such that there is very pronounced and significant muscle atrophy, the prescribed balance would favor the eccentric exercise component to stimulate muscle mass and strength gains, even if at the expense of mitochondrial function adaptations. In such patients, endurance eccentric exercise carried out at a low% $\dot{V}O_2$ peak would remain well within limits imposed by factors of chronotropic insufficiency, low cardiac-output, or ventilatory restrictions. After some 4 or 5 weeks, as previously seen in COPD or coronary artery disease (Meyer et al., 2003; MacMillan et al., 2017), the eccentric load maintained by patients would start approaching levels of metabolic demands susceptible to trigger aerobic-related effects. Resetting exercise prescription recommendations would then focus on gradually reaching exercise levels equivalent to or higher than 60% $\dot{V}O_2$ peak with the view to maintaining strength gains while minimizing exercise-induced muscle soreness. These goals could be implemented through different combinations of alternating, sequential, or stacked blocks of continuous or intermittent concentric training, eccentric segmental strength maintenance exercises with gradual re-shifting toward higher eccentric loading as dictated by the patient's limits and progression.

The importance of regular exercise for the maintenance and rehabilitation of individuals with physical limitations is no longer a debate. Several research teams are contributing conceptual, theoretical, and technological bases for approaches to enhance the impact and effectiveness of exercise prescription. New tools and technologies continue to be developed and need to be tested, promoted, and better integrated into non-research or institutional settings. Approaches to gauge symptoms of soreness and overall patient well-being also need to be refined to understand better how the information is best integrated to center around the willingness, the ability, and the enthusiasm of the patient to sustain the exercise prescription.

AUTHOR CONTRIBUTIONS

JT, FC, EC, HP, and RR edited the English version of the manuscript. All authors contributed to the article and approved the submitted version.

REFERENCES

- Allen, D., Whitehead, N., and Yeung, E. (2005). Mechanisms of stretch-induced muscle damage in normal and dystrophic muscle: role of ionic changes. *J. Physiol.* 567, 723–735. doi: 10.1113/jphysiol.2005.091694
- Armstrong, R. B., Ogilvie, R. W., and Schwane, J. A. (1983). Eccentric exercise-induced injury to rat skeletal muscle. *J. Appl. Physiol. Respir. Environ. Exerc. Physiol.* 54, 80–93. doi: 10.1152/jappl.1983.54.1.80
- Balnavae, C. D., and Thompson, M. W. (1993). Effect of training on eccentric exercise-induced muscle damage. *J. Appl. Physiol.* 75, 1545–1551. doi: 10.1152/jappl.1993.75.4.1545
- Bassett, D. R., and Howley, E. T. (2000). Limiting factors for maximum oxygen uptake and determinants of endurance performance. *Med. Sci. Sports Exerc.* 32, 70–84. doi: 10.1097/00005768-200001000-00012
- Benedini-Elias, P. C. O., Morgan, M. C., Cornachione, A. S., Martinez, E. Z., and Mattiello-Sverzut, A. C. (2014). Post-immobilization eccentric training promotes greater hypertrophic and angiogenic responses than passive stretching in muscles of weanling rats. *Acta Histochem.* 116, 503–513. doi: 10.1016/j.acthis.2013.10.008
- Besson, D., Jousain, C., Gremeaux, V., Morisset, C., Laurent, Y., Casillas, J.-M., et al. (2013). Eccentric training in chronic heart failure: feasibility and functional effects. results of a comparative study. *Ann. Phys. Rehabil. Med.* 56, 30–40. doi: 10.1016/j.rehab.2013.01.003
- Bontemps, B., Vercruyssen, F., Gruet, M., and Louis, J. (2020). Downhill running: what are the effects and how can we adapt? a narrative review. *Sports Med.* 50, 2083–2110. doi: 10.1007/s40279-020-01355-z
- Brookes, P. S., Yoon, Y., Robotham, J. L., Anders, M. W., and Sheu, S.-S. (2004). Calcium, ATP, and ROS: a mitochondrial love-hate triangle. *Am. J. Physiol. Cell Physiol.* 287, C817–C833. doi: 10.1152/ajpcell.00139.2004

- Brown, G. C., Murphy, M. P., Rich, P. R., and Maréchal, A. (2010). The mitochondrial respiratory chain. *Essays Biochem.* 47, 1–23. doi: 10.1042/bse0470001
- Bryner, R. W., Donley, D. A., Cutlip, R. G., Wirth, O., and Alway, S. E. (2004). Effects of downhill treadmill running on uncoupling protein 3 mRNA expression. *Int. J. Sports Med.* 25, 433–437. doi: 10.1055/s-2004-820934
- Burford, T. W., Cooke, M. B., Shelmadine, B. D., Hudson, G. M., Redd, L., and Willoughby, D. S. (2009). Effects of eccentric treadmill exercise on inflammatory gene expression in human skeletal muscle. *Appl. Physiol. Nutr. Metab.* 34, 745–753. doi: 10.1139/H09-067
- Casillas, J. M., Besson, D., Hannequin, A., Gremeaux, V., Morisset, C., Tordi, N., et al. (2016). Effects of an eccentric training personalized by a low rate of perceived exertion on the maximal capacities in chronic heart failure: a randomized controlled trial. *Eur. J. Phys. Rehabil. Med.* 52, 159–168.
- Chavanelle, V., Sirvent, P., Ennequin, G., Caillaud, K., Montaurier, C., Morio, B., et al. (2014). Comparison of oxygen consumption in rats during uphill (concentric) and downhill (eccentric) treadmill exercise tests. *J. Sports Sci. Med.* 13, 689–694.
- Chen, W., Ruell, P. A., Ghodassi, M., Kee, A., Hardeman, E. C., Hoffman, K. M., et al. (2007). Ultrastructural changes and sarcoplasmic reticulum Ca²⁺ regulation in red vastus muscle following eccentric exercise in the rat. *Exp. Physiol.* 92, 437–447. doi: 10.1113/expphysiol.2006.036442
- Choksi, K. B., Boylston, W. H., Rabek, J. P., Widger, W. R., and Papaconstantinou, J. (2004). Oxidatively damaged proteins of heart mitochondrial electron transport complexes. *Biochim. Biophys. Acta* 1688, 95–101. doi: 10.1016/j.bbdis.2003.11.007
- Close, G. L., Ashton, T., Cable, T., Doran, D., and MacLaren, D. P. M. (2004). Eccentric exercise, isokinetic muscle torque and delayed onset muscle soreness: the role of reactive oxygen species. *Eur. J. Appl. Physiol.* 91, 615–621. doi: 10.1007/s00421-003-1012-1012
- Coffey, V. G., and Hawley, J. A. (2007). The molecular bases of training adaptation. *Sports Med.* 37, 737–763. doi: 10.2165/00007256-200737090-00001
- Cornachione, A., Caçõo-Benedini, L. O., Martinez, E. Z., Nader, L., and Cláudia Mattiello-Sverzut, A. (2011). Effects of eccentric and concentric training on capillarization and myosin heavy chain contents in rat skeletal muscles after hindlimb suspension. *Acta Histochem.* 113, 277–282. doi: 10.1016/j.acthis.2009.10.009
- Cruz-Jentoft, A. J., Bahat, G., Bauer, J., Boirie, Y., Bruyère, O., Cederholm, T., et al. (2019). Sarcopenia: revised European consensus on definition and diagnosis. *Age Ageing* 48, 16–31. doi: 10.1093/ageing/afy169
- Diaz-Canestro, C., and Montero, D. (2019). Sex dimorphism of VO₂max trainability: a systematic review and meta-analysis. *Sports Med.* 49, 1949–1956. doi: 10.1007/s40279-019-01180-x
- Doyle, M., Brown, M., Kemp, L., McLennan, P., and Peoples, G. (2020). Eccentric cycling ergometer to address skeletal muscle dysfunction in hospitalised patients: ergometer design, construction and demonstration. *BMJ Innov.* 7, 185–191. doi: 10.1136/bmjinnov-2019-2403
- Drexel, H., Saely, C. H., Langer, P., Loruenser, G., Marte, T., Risch, L., et al. (2008). Metabolic and anti-inflammatory benefits of eccentric endurance exercise – a pilot study. *Eur. J. Clin. Invest.* 38, 218–226. doi: 10.1111/j.1365-2362.2008.01937.x
- Duan, C., Delp, M. D., Hayes, D. A., Delp, P. D., and Armstrong, R. B. (1990). Rat skeletal muscle mitochondrial [Ca²⁺] and injury from downhill walking. *J. Appl. Physiol.* 68, 1241–1251. doi: 10.1152/jappl.1990.68.3.1241
- Dufour, S. P., Lampert, E., Doutreleau, S., Lonsdorfer-Wolf, E., Billat, V. L., Piquard, F., et al. (2004). Eccentric cycle exercise: training application of specific circulatory adjustments. *Med. Sci. Sports Exerc.* 36, 1900–1906. doi: 10.1249/01.mss.0000145441.80209.66
- Duncan, C. J. (1978). Role of intracellular calcium in promoting muscle damage: a strategy for controlling the dystrophic condition. *Experientia* 34, 1531–1535. doi: 10.1007/bf02034655
- Egan, B., and Zierath, J. R. (2013). Exercise metabolism and the molecular regulation of skeletal muscle adaptation. *Cell Metab.* 17, 162–184. doi: 10.1016/j.cmet.2012.12.012
- Ellis, R., Shields, N., Lim, K., and Dodd, K. J. (2015). Eccentric exercise in adults with cardiorespiratory disease: a systematic review. *Clin. Rehabil.* 29, 1178–1197. doi: 10.1177/0269215515574783
- Enns, D., Green, H., Tupling, R., Burnett, M., Grant, S., and Ranney, D. (1999). Alterations in sarcoplasmic reticulum function in female vastus lateralis with eccentric exercise. *Mol. Cell. Biochem.* 202, 19–30. doi: 10.1023/a:1007039302381
- Fick, A. (1881). The development of heat by muscular activity. *Science* 2, 618–621. doi: 10.1126/science.os-2.80.618
- Flück, M., Bosshard, R., and Lungarella, M. (2017). Cardiovascular and muscular consequences of work-matched interval-type of concentric and eccentric pedaling exercise on a soft robot. *Front. Physiol.* 8:640. doi: 10.3389/fphys.2017.00640
- Franchi, M. V., and Maffiuletti, N. A. (2019). Distinct modalities of eccentric exercise: different recipes, not the same dish. *J. Appl. Physiol.* 127, 881–883. doi: 10.1152/jappphysiol.00093.2019
- Franchi, M. V., Reeves, N. D., and Narici, M. V. (2017). Skeletal muscle remodeling in response to eccentric vs. concentric loading: morphological, molecular, and metabolic adaptations. *Front. Physiol.* 8:447. doi: 10.3389/fphys.2017.00447
- Frezza, C., Cipolat, S., and Scorrano, L. (2007). Organelle isolation: functional mitochondria from mouse liver, muscle and cultured fibroblasts. *Nat. Protoc.* 2, 287–295. doi: 10.1038/nprot.2006.478
- Fridén, J., and Lieber, R. L. (2001). Eccentric exercise-induced injuries to contractile and cytoskeletal muscle fibre components. *Acta Physiol. Scand.* 171, 321–326. doi: 10.1046/j.1365-201x.2001.00834.x
- Frimpong, E., Ofori, E. K., Kooje, Y. S., Abahio, E., and Dzudzor, B. (2019). Muscle damage and repeated bout effect from high intensity non-eccentric exercises. *J. Exerc. Physiol. Online* 22, 126–140.
- Fu, C., Xia, Y., Meng, F., Li, F., Liu, Q., Zhao, H., et al. (2020). MRI quantitative analysis of eccentric exercise-induced skeletal muscle injury in rats. *Aoed. Radiol.* 27, e72–e79. doi: 10.1016/j.acra.2019.05.011
- Fukada, S., Akimoto, T., and Sotiropoulos, A. (2020). Role of damage and management in muscle hypertrophy: different behaviors of muscle stem cells in regeneration and hypertrophy. *Biochimica et Biophysica Acta Mol. Cell Res.* 1867:118742. doi: 10.1016/j.bbamcr.2020.118742
- Giorgi, C., Marchi, S., and Pinton, P. (2018). The machineries, regulation and cellular functions of mitochondrial calcium. *Nat. Rev. Mol. Cell Biol.* 19, 713–730. doi: 10.1038/s41580-018-0052-58
- González-Bartholin, R., Mackay, K., Valladares, D., Zbinden-Foncea, H., Nosaka, K., and Peailillo, L. (2019). Changes in oxidative stress, inflammation and muscle damage markers following eccentric versus concentric cycling in older adults. *Eur. J. Appl. Physiol.* 119, 2301–2312. doi: 10.1007/s00421-019-04213-4217
- Gremeaux, V., Duclay, J., Deley, G., Philipp, J. L., Laroche, D., Pousson, M., et al. (2010). Does eccentric endurance training improve walking capacity in patients with coronary artery disease? a randomized controlled pilot study. *Clin. Rehabil.* 24, 590–599. doi: 10.1177/0269215510362322
- Gunter, T. E., Yule, D. L., Gunter, K. K., Eliseev, R. A., and Salter, J. D. (2004). Calcium and mitochondria. *FEBS Lett.* 567, 96–102. doi: 10.1016/j.febslet.2004.03.071
- Hahn, S. A., Ferreira, I. F., Williams, J. B., Jansson, K. P., Behnke, B. J., Musch, T. I., et al. (2007). Downhill treadmill running trains the rat spinotrapezius muscle. *J. Appl. Physiol.* 102, 412–416. doi: 10.1152/jappphysiol.00581.2006
- Halestrap, A. P. (2009). What is the mitochondrial permeability transition pore? *J. Mol. Cell. Cardiol.* 46, 821–831. doi: 10.1016/j.yjmcc.2009.02.021
- Harris-Love, M. O., Seamon, B. A., Gonzales, T. I., Hernandez, H. J., Pennington, D., and Hoover, B. M. (2017). Eccentric exercise program design: a periodization model for rehabilitation applications. *Front. Physiol.* 8:112. doi: 10.3389/fphys.2017.00112
- He, F., Li, J., Liu, Z., Chuang, C.-C., Yang, W., and Zuo, L. (2016). Redox mechanism of reactive oxygen species in exercise. *Front. Physiol.* 7:486. doi: 10.3389/fphys.2016.00486
- Hody, S., LePrince, P., Sergeant, K., Renaut, J., Croisier, J.-L., Wang, F., et al. (2011). Human muscle proteome modifications after acute or repeated eccentric exercises. *Med. Sci. Sports Exerc.* 43, 2281–2296. doi: 10.1249/MSS.0b013e318222edf3
- Hoppeler, H. (2016). Moderate load eccentric exercise; a distinct novel training modality. *Front. Physiol.* 7:483. doi: 10.3389/fphys.2016.00483
- Howell, J. N., Chleboun, G., and Conatser, R. (1993). Muscle stiffness, strength loss, swelling and soreness following exercise-induced injury in humans. *J. Physiol.* 464, 183–196. doi: 10.1113/jphysiol.1993.sp019629
- Hyldahl, R. D., Chen, T. C., and Nosaka, K. (2017). Mechanisms and mediators of the skeletal muscle repeated bout effect. *Exerc. Sport Sci. Rev.* 45, 24–33. doi: 10.1249/JES.0000000000000095

- Inoue, M., Sato, E. F., Nishikawa, M., Park, A.-M., Kira, Y., Imada, I., et al. (2003). Mitochondrial generation of reactive oxygen species and its role in aerobic life. *Curr. Med. Chem.* 10, 2495–2505. doi: 10.2174/0929867033456477
- Iser-Horobeti, M.-E., Rasseneur, L., Lonsdorfer-Wolf, E., Dufour, S. P., Doutreleau, S., Bouitbir, J., et al. (2014). Effect of eccentric versus concentric exercise training on mitochondrial function. *Muscle Nerve* 50, 803–811. doi: 10.1002/mus.24215
- Jezek, P., and Hlavatá, L. (2005). Mitochondria in homeostasis of reactive oxygen species in cell, tissues, and organism. *Int. J. Biochem. Cell Biol.* 37, 2478–2503. doi: 10.1016/j.biocel.2005.05.013
- Julian, V., Thivel, D., Costes, F., Touron, J., Boirie, Y., Pereira, B., et al. (2018a). Eccentric training improves body composition by inducing mechanical and metabolic adaptations: a promising approach for overweight and obese individuals. *Front. Physiol.* 9:1013. doi: 10.3389/fphys.2018.01013
- Julian, V., Thivel, D., Miguët, M., Pereira, B., Costes, F., Coudeyre, E., et al. (2018b). Eccentric cycling is more efficient in reducing fat mass than concentric cycling in adolescents with obesity. *Scand. J. Med. Sci. Sports* 29, 4–15. doi: 10.1111/sms.13301
- Klossner, S., Däpp, C., Schmutz, S., Vogt, M., Hoppeler, H., and Flück, M. (2007). Muscle transcriptome adaptations with mild eccentric ergometer exercise. *Pflugers Arch* 455, 555–562. doi: 10.1007/s00424-007-0303-306
- Knuttgen, H. G., Nadel, E. R., Pandolf, K. B., and Patton, J. P. (1982). Effects of training with eccentric muscle contractions on exercise performance, energy expenditure, and body temperature. *Int. J. Sports Med.* 3, 13–17. doi: 10.1055/s-2008-1026054
- Kuznetsov, A. V., Veksler, V., Gellerich, F. N., Saks, V., Margreiter, R., and Kunz, W. S. (2008). Analysis of mitochondrial function in situ in permeabilized muscle fibers, tissues and cells. *Nat. Protoc.* 3, 965–976. doi: 10.1038/nprot.2008.61
- Lacourpaille, L., Nordex, A., Hug, F., Couturier, A., Dibie, C., and Guilhem, G. (2014). Time-course effect of exercise-induced muscle damage on localized muscle mechanical properties assessed using elastography. *Acta Physiol.* 211, 135–146. doi: 10.1111/apha.12272
- LaStayo, P. C., Pierotti, D. J., Pifer, J., Hoppeler, H., and Lindstedt, S. L. (2000). Eccentric ergometry: increases in locomotor muscle size and strength at low training intensities. *Am. J. Physiol. Regul. Integr. Comp. Physiol.* 278, R1282–R1288.
- LaStayo, P. C., Woolf, J. M., Lewek, M. D., Snyder-Mackler, L., Reich, T., and Lindstedt, S. L. (2003). Eccentric muscle contractions: their contribution to injury, prevention, rehabilitation, and sport. *J. Orthop. Sports Phys. Ther.* 33, 557–571. doi: 10.2519/jospt.2003.33.10.557
- LaStayo, P., McDonagh, P., Lipovic, D., Naples, P., Bartholomew, A., Esser, K., et al. (2007). Elderly patients and high force resistance exercise—a descriptive report: can an anabolic, muscle growth response occur without muscle damage or inflammation? *J. Geriatr. Phys. Ther.* 30, 128–134. doi: 10.1519/00139143-200712000-00008
- Lechavue, J. B., Perrault, H., Aguilaniu, B., Iser-Horobeti, M. E., Martin, V., Coudeyre, E., et al. (2014). Breathing patterns during eccentric exercise. *Respir. Physiol. Neurobiol.* 202, 53–58. doi: 10.1016/j.resp.2014.07.007
- Lemire, M., Hureau, T. J., Remetter, R., Geny, B., Kouassi, B. Y. L., Lonsdorfer, E., et al. (2020). Trail runners cannot reach vo₂max during a maximal incremental downhill test. *Med. Sci. Sports Exerc.* 52, 1135–1143. doi: 10.1249/mss.0000000000002240
- Lewis, M. C., Peoples, G. E., Groeller, H., and Brown, M. A. (2018). Eccentric cycling emphasizing a low cardiopulmonary demand increases leg strength equivalent to workload matched concentric cycling in middle age sedentary males. *J. Sci. Med. Sport* 21, 1238–1243. doi: 10.1016/j.jsams.2018.05.009
- Lipski, M., Abbiss, C. R., and Nosaka, K. (2018). Cardio-pulmonary responses to incremental eccentric and concentric cycling tests to task failure. *Eur. J. Appl. Physiol.* 118, 947–957. doi: 10.1007/s00421-018-3826-y
- MacMillan, N. J., Kapchinsky, S., Konokhova, Y., Gouspillou, G., de Sousa Sena, R., Jagoe, R. T., et al. (2017). Eccentric ergometer training promotes locomotor muscle strength but not mitochondrial adaptation in patients with severe chronic obstructive pulmonary disease. *Front. Physiol.* 8:114. doi: 10.3389/fphys.2017.00114
- Magalhães, J., Fraga, M., Lumini-Oliveira, J., Gonçalves, L., Costa, M., Ferreira, R., et al. (2013). Eccentric exercise transiently affects mice skeletal muscle mitochondrial function. *Appl. Physiol. Nutr. Metab.* 38, 401–409. doi: 10.1139/apnm-2012-2226
- Malm, C., Sjödin, B., Sjöberg, B., Lenkei, R., Renström, P., Lundberg, I. E., et al. (2004). Leukocytes, cytokines, growth factors and hormones in human skeletal muscle and blood after uphill or downhill running. *J. Physiol.* 556, 983–1000. doi: 10.1113/jphysiol.2003.056598
- McHugh, M. P. (2003). Recent advances in the understanding of the repeated bout effect: the protective effect against muscle damage from a single bout of eccentric exercise. *Scand. J. Med. Sci. Sports* 13, 88–97. doi: 10.1034/j.1600-0838.2003.02477.x
- Merry, T. L., and Ristow, M. (2016). Mitohormesis in exercise training. *Free Radic. Biol. Med.* 98, 123–130. doi: 10.1016/j.freeradbiomed.2015.11.032
- Meyer, K., Steiner, R., Lastayo, P., Lippuner, K., Allemann, Y., Eberli, F., et al. (2003). Eccentric exercise in coronary patients: central hemodynamic and metabolic responses. *Med. Sci. Sports Exerc.* 35, 1076–1082. doi: 10.1249/01.mss.0000074580.79648.9d
- Minetti, A. E., Moia, C., Roi, G. S., Susta, D., and Ferretti, G. (2002). Energy cost of walking and running at extreme uphill and downhill slopes. *J. Appl. Physiol.* 93, 1039–1046. doi: 10.1152/jappphysiol.01177.2001
- Molnar, A. M., Servais, S., Guichardant, M., Lagarde, M., Macedo, D. V., Pereira-Da-Silva, L., et al. (2006). Mitochondrial H₂O₂ production is reduced with acute and chronic eccentric exercise in rat skeletal muscle. *Antioxid. Redox Signal.* 8, 548–558. doi: 10.1089/ars.2006.8.548
- Mueller, M., Breil, F. A., Lurman, G., Klossner, S., Flück, M., Billeter, R., et al. (2011). Different molecular and structural adaptations with eccentric and conventional strength training in elderly men and women. *Gerontology* 57, 528–538. doi: 10.1159/000323267
- Nikolaidis, M. G., Jamurtas, A. Z., Paschalis, V., Fatouros, I. G., Koutedakis, Y., and Kouretas, D. (2008). The effect of muscle-damaging exercise on blood and skeletal muscle oxidative stress: magnitude and time-course considerations. *Sports Med.* 38, 579–606. doi: 10.2165/00007256-200838070-00005
- Nosaka, K., and Clarkson, P. M. (1995). Muscle damage following repeated bouts of high force eccentric exercise. *Med. Sci. Sports Exerc.* 27, 1263–1269.
- Pageaux, B., Besson, D., Casillas, J.-M., Lepers, R., Gremeaux, V., Ornetti, P., et al. (2020). Progressively increasing the intensity of eccentric cycling over four training sessions: a feasibility study in coronary heart disease patients. *Ann. Phys. Rehabil. Med.* 63, 241–244. doi: 10.1016/j.rehab.2019.09.007
- Paschalis, V., Nikolaidis, M. G., Theodorou, A. A., Panayiotou, G., Fatouros, I. G., Koutedakis, Y., et al. (2011). A weekly bout of eccentric exercise is sufficient to induce health-promoting effects. *Med. Sci. Sports Exerc.* 43, 64–73. doi: 10.1249/mss.0b013e318e91d90
- Peñailillo, L., Blazevich, A. J., and Nosaka, K. (2015). Muscle fascicle behavior during eccentric cycling and its relation to muscle soreness. *Med. Sci. Sports Exerc.* 47, 708–717. doi: 10.1249/mss.0000000000000473
- Peñailillo, L., Blazevich, A., Numatazawa, H., and Nosaka, K. (2013). Metabolic and muscle damage profiles of concentric versus repeated eccentric cycling. *Med. Sci. Sports Exerc.* 45, 1773–1781. doi: 10.1249/mss.0b013e31828f8a73
- Pereira Panza, V. S., Diefenthaler, F., and da Silva, E. L. (2015). Benefits of dietary phytochemical supplementation on eccentric exercise-induced muscle damage: is including antioxidants enough? *Nutrition* 31, 1072–1082. doi: 10.1016/j.nut.2015.02.014
- Perrey, S., Betik, A., Candau, R., Rouillon, J. D., and Hughson, R. L. (2001). Comparison of oxygen uptake kinetics during concentric and eccentric cycle exercise. *J. Appl. Physiol.* 91, 2135–2142. doi: 10.1152/jappl.2001.91.5.2135
- Pierrynowski, M. R., Tüds, P. M., and Phlyle, M. J. (1987). Effects of downhill or uphill training prior to a downhill run. *Eur. J. Appl. Physiol. Occup. Physiol.* 56, 668–672. doi: 10.1007/BF00424808
- Plaquet-Hostache, G., Touron, J., Costes, F., Perrault, H., Clerfond, G., Guenin, C., et al. (2019). Effectiveness of combined eccentric and concentric exercise over traditional cardiac exercise rehabilitation programme in patients with chronic heart failure: protocol for a randomised controlled study. *BMJ Open* 9:e028749. doi: 10.1136/bmjopen-2018-028749
- Rattray, B., Caillaud, C., Ruell, P. A., and Thompson, M. W. (2011). Heat exposure does not alter eccentric exercise-induced increases in mitochondrial calcium and respiratory dysfunction. *Eur. J. Appl. Physiol.* 111, 2813–2821. doi: 10.1007/s00421-011-1913-1914
- Rattray, B., Thompson, M., Ruell, P., and Caillaud, C. (2013). Specific training improves skeletal muscle mitochondrial calcium homeostasis after eccentric

- exercise. *Eur. J. Appl. Physiol.* 113, 427–436. doi: 10.1007/s00421-012-2446-2441
- Rocha Vieira, D. S., Baril, J., Richard, R., Perrault, H., Bourbeau, J., and Taivassalo, T. (2011). Eccentric cycle exercise in severe COPD: feasibility of application. *COPD* 8, 270–274. doi: 10.3109/15412555.2011.579926
- Roig, M., O'Brien, K., Kirk, G., Murray, R., McKinnon, P., Shadgan, B., et al. (2009). The effects of eccentric versus concentric resistance training on muscle strength and mass in healthy adults: a systematic review with meta-analysis. *Br. J. Sports Med.* 43, 556–568. doi: 10.1136/bjsm.2008.051417
- Roig, M., Shadgan, B., and Reid, W. D. (2008). Eccentric exercise in patients with chronic health conditions: a systematic review. *Physiother. Can.* 60, 146–160. doi: 10.3138/physio.60.2.146
- Rooyackers, J. M., Berkeljon, D. A., and Folgering, H. T. M. (2003). Eccentric exercise training in patients with chronic obstructive pulmonary disease. *Int. J. Rehabil. Res.* 26, 47–49. doi: 10.1097/01.mrr.0000054807.81886.9e
- Schlagowski, A.-I., Isner-Horobeti, M.-E., Dufour, S. P., Rasseneur, L., Enache, I., Lonsdorfer-Wolf, E., et al. (2016). Mitochondrial function following downhill and/or uphill exercise training in rats. *Muscle Nerve* 54, 925–935. doi: 10.1002/mus.25144
- Sonobe, T., Inagaki, T., Poole, D. C., and Kano, Y. (2008). Intracellular calcium accumulation following eccentric contractions in rat skeletal muscle in vivo: role of stretch-activated channels. *Am. J. Physiol. Regul. Integr. Comp. Physiol.* 294, R1329–R1337. doi: 10.1152/ajpregu.00815.2007
- Toyomura, J., Mori, H., Tayashiki, K., Yamamoto, M., Kanehisa, H., and Maeo, S. (2018). Efficacy of downhill running training for improving muscular and aerobic performances. *Appl. Physiol. Nutr. Metab.* 43, 403–410. doi: 10.1139/apnm-2017-2538
- Valladares-Ide, D., Peñailillo, L., Collao, N., Marambio, H., Deldicque, L., and Zbinden-Poncea, H. (2019). Activation of protein synthesis, regeneration, and MAPK signaling pathways following repeated bouts of eccentric cycling. *Am. J. Physiol. Endocrinol. Metab.* 317, E1131–E1139. doi: 10.1152/ajpendo.00216.2019
- Walsh, B., Tonkonogi, M., Malm, C., Ekblom, B., and Sahlin, K. (2001). Effect of eccentric exercise on muscle oxidative metabolism in humans. *Med. Sci. Sports Exerc.* 33, 436–441. doi: 10.1097/00005768-200103000-00016
- Zoll, J., Sanchez, H., N'Guessan, B., Ribera, F., Lampert, E., Bigard, X., et al. (2002). Physical activity changes the regulation of mitochondrial respiration in human skeletal muscle. *J. Physiol.* 543, 191–200. doi: 10.1113/jphysiol.2002.019661
- Zoll, J., Steiner, R., Meyer, K., Vogt, M., Hoppeler, H., and Flück, M. (2006). Gene expression in skeletal muscle of coronary artery disease patients after concentric and eccentric endurance training. *Eur. J. Appl. Physiol.* 96, 413–422. doi: 10.1007/s00421-005-0082-88

Conflict of Interest: The authors declare that the research was conducted in the absence of any commercial or financial relationships that could be construed as a potential conflict of interest.

Copyright © 2021 Touron, Costes, Coudeyre, Perrault and Richard. This is an open-access article distributed under the terms of the Creative Commons Attribution License (CC BY). The use, distribution or reproduction in other forums is permitted, provided the original author(s) and the copyright owner(s) are credited and that the original publication in this journal is cited, in accordance with accepted academic practice. No use, distribution or reproduction is permitted which does not comply with these terms.

Annexe 3 – Article de protocole n°2

Muscular rehabilitation by eccentric exercise after severe COVID-19: research protocol for a randomized controlled trial (CovExc).

Il a largement été rapporté dans la littérature qu'une hospitalisation dans une unité de soins intensifs pour infection sévère était à l'origine d'une atrophie musculaire et un dysfonctionnement associé pouvant persister jusqu'à plusieurs mois après la sortie. Avec la pandémie actuelle de COVID-19, il a été constaté une augmentation du nombre de patients nécessitant un réentraînement à l'effort suite à l'infection, ce qui pourrait à terme saturer les capacités de réadaptation des centres dédiés. Or, les modalités classiques de réentraînement concentrique peuvent être difficiles à réaliser pour les patients présentant de graves déficits. Les caractéristiques mécaniques et métaboliques des exercices excentriques font d'eux une alternative particulièrement intéressante dans le cadre de la prise en charge de ces patients. De nombreuses études rapportent les effets positifs de cette modalité sur l'hypertrophie musculaire, le gain de force et de puissance. L'objectif de cette étude est donc de comparer la récupération fonctionnelle musculaire à la suite d'un programme de 2 mois d'entraînement en mode excentrique ou concentrique chez des sujets ayant présenté une forme sévère de la COVID-19. Il s'agit d'une étude prospective, ouverte, contrôlée, randomisée et multicentrique (Clermont-Ferrand, Saint-Etienne, Lyon, Dijon). Les participants effectueront 24 séances d'exercice sur cycloergomètre à raison de 3 séances par semaine pendant 8 semaines. Le groupe expérimental (excentrique, n = 60) effectuera 5 séances d'habituation au pédalage excentrique. La puissance initiale sera fixée à 10 W puis augmentée de 10 % à chaque séance en fonction de la tolérance musculaire. Une puissance excentrique cible équivalente à 3 fois celle du groupe témoin permettra une stimulation métabolique similaire entre les groupes. Le groupe témoin (concentrique, n = 60) effectuera un réentraînement à l'effort à une intensité faisant appel à 60 % de la FC de réserve déterminée lors d'un test cardio-respiratoire initial. Le critère principal sera le changement de distance parcourue au TM6. Les critères secondaires comprendront l'étude de la sarcopénie, la force musculaire, la fatigue générale et musculaire, la qualité de vie, les données de métabolomique sanguine, et des marqueurs *in vitro* de fonctionnalité mitochondriale et d'histobiochimie sur biopsies musculaires de *Vastus Lateralis*. Il s'agit du premier essai contrôlé randomisé explorant la capacité de marche fonctionnelle après un

programme d'entraînement excentrique chez des patients atteints d'une infection sévère par le SRAS-CoV-2. Les exercices excentriques pourraient optimiser la rééducation par rapport aux exercices concentriques.

**Muscular rehabilitation by eccentric exercise after severe COVID-19: research protocol
for a randomized controlled trial (CovExc)**

Nicolas Coste, MD, MSc¹; Juliane Touron, MSc¹; Bruno Pereira, PhD², Anna Goldstein, MD, MSc¹; Léonard Féasson, MD, PhD³; Paul Ornetti, MD, PhD⁴; Emmanuelle Chaléat-Valayer, MD, PhD⁵; Ruddy Richard¹; Dominic Pérennou, MD, PhD⁶; Frédéric Costes, MD, PhD¹; Emmanuel Coudeyre, MD, PhD¹

1 CHU Clermont-Ferrand, Université Clermont Auvergne, INRAE, UNH, F-63000 Clermont-Ferrand, France

2 Direction de la Recherche Clinique et de l'Innovation, Unité de Biostatistiques CHU Clermont-Ferrand, Clermont-Ferrand, France

3 Univ Lyon, UJM Saint-Etienne, Laboratoire Interuniversitaire de Biologie de la Motricité, EA 7424, Unité de myologie, CHU Saint-Etienne, Saint-Etienne F-42023, France

4 Service de rhumatologie, Chu de Dijon, Plateforme d'investigation technologique, Inserm CAPS 1093, Université de Bourgogne, 21000 Dijon, France

5 Service de Médecine Physique et de Réadaptation, CMCR des Massues, F-69 000 Lyon, France

6 Département de Médecine Physique et de Réadaptation, CHU Laboratoire des neurosciences cognitives, CNRS UMR5105, Université Grenoble Alpes, F-38040 Grenoble, France

Corresponding author

Dr Nicolas Coste

Service de Médecine Physique et de Réadaptation, CHU Clermont-Ferrand, CHU Louise Michel

61 Rue de Chateaugay, 63118 Cébazat, France

Phone: +33 4 73 750 900; ncoste@chu-clermontferrand.fr

Total word count: 2973

References: 25

Table: 1

Figures: 1

E-components: 2

Highlights

Highlights

- The trial will assess the relevance of eccentric versus concentric cycling for effective patient rehabilitation after severe COVID-19.
- This is a multicentric randomized controlled trial.
- Effective rehabilitation could help reduce costs and duration of care.

Abstract

Background. Hospitalization for severe infection can induce muscular atrophy and muscular dysfunction that persists for several months. With the COVID-19 pandemic, we have seen an increase in patients needing retraining, and rehabilitation capacities may be exceeded. Concentric exercises can be difficult to perform with severe deficits in muscle strength and endurance, but exercises in eccentric mode could be performed, inducing greater muscular hypertrophy, muscle strength, power and speed.

Objective. The goal of this study was to compare functional recovery at 2 months after a training program in eccentric and concentric mode in individuals after severe COVID-19.

Methods. This is a prospective, open, controlled randomized study (2 x 60 individuals) performed in 5 centers. Participants will perform 24 exercise sessions on cycloergometer (3 sessions/week, 8 weeks). The experimental group (eccentric) will perform 5 habituation sessions: the initial power of the exercise will be set to 10 Watts and then increased by 10% each session, depending on the muscle tolerance. The training power must correspond to 3 times that of the control group to obtain a similar metabolic stimulation. The control group (concentric) will perform exercise training at an intensity of 60% of the reserve heart rate determined during an initial cardiorespiratory test. The primary outcome will be the change in distance covered during the 6-min walk test between the initial assessment and month 2. Secondary outcomes will include study of sarcopenia, muscle strength, general and muscular fatigue, quality of life, blood metabolomic data, ex vitro data for mitochondrial and histo-biochemical functionality from muscle biopsies of the Vastus Lateralis.

Discussion. This is the first randomized controlled trial exploring functional walking ability after an eccentric training program in patients with severe SARS-CoV-2 infection. Eccentric exercises could optimize rehabilitation as compared with concentric exercises.

1
2
3
4
5
6
7
8
9
10
11
12
13
14
15
16
17
18
19
20
21
22
23
24
25
26
27
28
29
30
31
32
33
34
35
36
37
38
39
40
41
42
43
44
45
46
47
48
49
50
51
52
53
54
55
56
57
58
59
60
61
62
63
64
65

Ethics and dissemination: The study was submitted to the institutional ethics review board CPP Ile de France I (May , 2020) and the French regulatory authority for research (ID-RCB 2020-A01201-38). Adverse events that could occur during the protocol will be reported to the principal investigator. The results will be published in an international peer-reviewed journal.

Trial registration: In process (ClinicalTrials.gov).

Keywords: Exercise training; COVID-19; eccentric; deconditioning; muscular dysfunction.

•

Background

1
2 Hospitalization in an intensive care unit can induce muscular atrophy and muscular dysfunction,
3
4 which persist for several months (1). Decreased physical capacity and quality of life can persist
5
6 for up to 5 years after hospitalization for acute respiratory distress syndrome (2), with
7
8 musculoskeletal, post-traumatic stress, depression and chronic fatigue sequelae persisting up to
9
10
11
12 4 years. Prospective cohort studies of the SARS epidemic in 2003 revealed that survivors of
13
14 severe forms had long-term pulmonary dysfunction sequelae for up to 15 years later (3,4). Other
15
16 disorders are linked to the occurrence of intensive care unit-acquired neuromyopathy and to
17
18 usual bedridden complications (sarcopenia, bedsores, muscle deconditioning (5), muscle-
19
20 tendon retractions and joint limitations (6), cognitive and psychiatric disorders such as post-
21
22 traumatic stress as well as severe multifactorial undernutrition)(7).

23
24
25
26 In the context of severe coronavirus disease 2019 (COVID-19), the impairment preferably
27
28 concerns the cardiopulmonary sphere (interstitial pneumonia, myocarditis type and
29
30 thromboembolic lesions), but other disorders have also been described, in particular
31
32 neurological damage (8,9), participating in exercise deconditioning.

33
34
35
36
37
38
39
40
41
42
43
44
45
46
47
48
49
50
51
52
53
54
55
56
57
58
59
60
61
62
63
64
65
66
67
68
69
70
71
72
73
74
75
76
77
78
79
80
81
82
83
84
85
86
87
88
89
90
91
92
93
94
95
96
97
98
99
100
101
102
103
104
105
106
107
108
109
110
111
112
113
114
115
116
117
118
119
120
121
122
123
124
125
126
127
128
129
130
131
132
133
134
135
136
137
138
139
140
141
142
143
144
145
146
147
148
149
150
151
152
153
154
155
156
157
158
159
160
161
162
163
164
165
166
167
168
169
170
171
172
173
174
175
176
177
178
179
180
181
182
183
184
185
186
187
188
189
190
191
192
193
194
195
196
197
198
199
200
201
202
203
204
205
206
207
208
209
210
211
212
213
214
215
216
217
218
219
220
221
222
223
224
225
226
227
228
229
230
231
232
233
234
235
236
237
238
239
240
241
242
243
244
245
246
247
248
249
250
251
252
253
254
255
256
257
258
259
260
261
262
263
264
265
266
267
268
269
270
271
272
273
274
275
276
277
278
279
280
281
282
283
284
285
286
287
288
289
290
291
292
293
294
295
296
297
298
299
300
301
302
303
304
305
306
307
308
309
310
311
312
313
314
315
316
317
318
319
320
321
322
323
324
325
326
327
328
329
330
331
332
333
334
335
336
337
338
339
340
341
342
343
344
345
346
347
348
349
350
351
352
353
354
355
356
357
358
359
360
361
362
363
364
365
366
367
368
369
370
371
372
373
374
375
376
377
378
379
380
381
382
383
384
385
386
387
388
389
390
391
392
393
394
395
396
397
398
399
400
401
402
403
404
405
406
407
408
409
410
411
412
413
414
415
416
417
418
419
420
421
422
423
424
425
426
427
428
429
430
431
432
433
434
435
436
437
438
439
440
441
442
443
444
445
446
447
448
449
450
451
452
453
454
455
456
457
458
459
460
461
462
463
464
465
466
467
468
469
470
471
472
473
474
475
476
477
478
479
480
481
482
483
484
485
486
487
488
489
490
491
492
493
494
495
496
497
498
499
500
501
502
503
504
505
506
507
508
509
510
511
512
513
514
515
516
517
518
519
520
521
522
523
524
525
526
527
528
529
530
531
532
533
534
535
536
537
538
539
540
541
542
543
544
545
546
547
548
549
550
551
552
553
554
555
556
557
558
559
560
561
562
563
564
565
566
567
568
569
570
571
572
573
574
575
576
577
578
579
580
581
582
583
584
585
586
587
588
589
590
591
592
593
594
595
596
597
598
599
600
601
602
603
604
605
606
607
608
609
610
611
612
613
614
615
616
617
618
619
620
621
622
623
624
625
626
627
628
629
630
631
632
633
634
635
636
637
638
639
640
641
642
643
644
645
646
647
648
649
650
651
652
653
654
655
656
657
658
659
660
661
662
663
664
665
666
667
668
669
670
671
672
673
674
675
676
677
678
679
680
681
682
683
684
685
686
687
688
689
690
691
692
693
694
695
696
697
698
699
700
701
702
703
704
705
706
707
708
709
710
711
712
713
714
715
716
717
718
719
720
721
722
723
724
725
726
727
728
729
730
731
732
733
734
735
736
737
738
739
740
741
742
743
744
745
746
747
748
749
750
751
752
753
754
755
756
757
758
759
760
761
762
763
764
765
766
767
768
769
770
771
772
773
774
775
776
777
778
779
780
781
782
783
784
785
786
787
788
789
790
791
792
793
794
795
796
797
798
799
800
801
802
803
804
805
806
807
808
809
810
811
812
813
814
815
816
817
818
819
820
821
822
823
824
825
826
827
828
829
830
831
832
833
834
835
836
837
838
839
840
841
842
843
844
845
846
847
848
849
850
851
852
853
854
855
856
857
858
859
860
861
862
863
864
865
866
867
868
869
870
871
872
873
874
875
876
877
878
879
880
881
882
883
884
885
886
887
888
889
890
891
892
893
894
895
896
897
898
899
900
901
902
903
904
905
906
907
908
909
910
911
912
913
914
915
916
917
918
919
920
921
922
923
924
925
926
927
928
929
930
931
932
933
934
935
936
937
938
939
940
941
942
943
944
945
946
947
948
949
950
951
952
953
954
955
956
957
958
959
960
961
962
963
964
965
966
967
968
969
970
971
972
973
974
975
976
977
978
979
980
981
982
983
984
985
986
987
988
989
990
991
992
993
994
995
996
997
998
999
1000

1
2
3
4
5
6
7
8
9
10
11
12
13
14
15
16
17
18
19
20
21
22
23
24
25
26
27
28
29
30
31
32
33
34
35
36
37
38
39
40
41
42
43
44
45
46
47
48
49
50
51
52
53
54
55
56
57
58
59
60
61
62
63
64
65

metabolic stimulation (VO₂) (14). Training in eccentric mode also seems superior to concentric mode in terms of muscle strength, power and speed (15). However, eccentric training can induce muscle soreness, which can be prevented by a gradual increase in intensity (16).

With the COVID-19 pandemic, a large number of patients will need to be trained, but usual capacities for early rehabilitation may be exceeded. Patients are expected to maintain decreased muscular and functional capacities long after hospitalization, which requires long and costly treatments.

We aim to conduct a multicentric, prospective, randomized controlled trial to compare functional recovery, measured by a 6-min walk test (6MWT), with a training program on a cycloergometer in eccentric and concentric modes.

Methods

Aim

The main objective of this study is to compare the effect of 2 iso-energetic training programs (eccentric vs concentric mode) on functional walking capacity (assessed with a 6MWT) after severe COVID-19 infection.

Secondary objectives are to compare the effect of these 2 programs on sarcopenia (Short Physical Performance Battery [SPPB] score), muscle strength (handgrip strength and Quadriceps Isometric Muscular Strength [QIMS] tests), general and muscular fatigue (Quadriceps Intermittent Fatigue [QIF] test and Modified Fatigue Impact Scale [MFIS]), quality of life (EQ-5D), blood metabolomic data, and ex vitro data for mitochondrial and histo-biochemical functionality from muscle biopsies of the vastus lateralis.

Study design

This is a 10-month multicenter, prospective, open, comparative and randomized trial. After the initial assessments, participants will be randomized (1:1) with stratification by center and with random sized blocks to 2 arms: experimental group (eccentric exercises) and control group (concentric exercises). Evaluations will be carried out with blinding by investigators different from those involved in the exercise training sessions. Patients will be blinded to the training mode hypothesis (Table 1).

The design and conduct of this trial will adhere to the requirements of the Standard Protocol Items: Recommendations for Interventional Trials (SPIRIT) (17) (Appendix 1). The results will be reported in accordance with the CONSORT Statement for non-pharmacologic trials (18).

Study population

Participants and recruitment

We will recruit 120 participants, male and female, 18 to 80 years old, hospitalized for SARS-CoV-2 infection (COVID-19) requiring a muscle rehabilitation program in 5 French hospital centers. All patients will receive an information leaflet with study information and eligibility criteria. Patients will be identified by intensive care and infectious disease registers or by checking post-hospital rehabilitation prescriptions.

For patients who meet the inclusion criteria, the research coordinator will perform the information and consent process and the physician will verify the inclusion criteria.

Inclusion criteria

- Male or female, 18 to 80 years old

1
2
3
4
5
6
7
8
9
10
11
12
13
14
15
16
17
18
19
20
21
22
23
24
25
26
27
28
29
30
31
32
33
34
35
36
37
38
39
40
41
42
43
44
45
46
47
48
49
50
51
52
53
54
55
56
57
58
59
60
61
62
63
64
65

- HDiagnosed for SARS-CoV-2 infection (COVID-19) requiring a rehabilitation program at least 1 month after the hospitalization
- Autonomy in daily life activities 1 month after diagnosis
- Able to walk for 6 min (discontinuous walking possible)
- Giving informed written consent to participate in the study
- Health insurance coverage

Non-inclusion criteria

- Cardiovascular or respiratory contraindication to the rehabilitation program
- Difficulty to perform an eccentric exercise on a seated ergometer
- Pregnant or breastfeeding
- Under guardianship, curatorship or deprived of liberty
- Taking antivitamin K anticoagulation (muscle biopsy)
- Refusal to participate

Ethics

All patients will receive verbal and written information about the aim of the study and the protocol. Written informed consent will be obtained before inclusion in the study and before performing any specific procedure (Appendix 2). During the study, patients will have an opportunity to ask the investigator questions about the protocol.

Patients will be informed that they are free to stop the study at any time at their own discretion, in accordance with Good Clinical Practices currently enforced under the French regulatory framework. Any adverse event that could occur during the protocol will be reported to the principal investigator. In case of any negative impact of participating in the study on the patient's health status, the participant will be entitled to compensation in accordance with French regulations. Pursuant to the provisions concerning the confidentiality of data that are

1 available to individuals responsible for quality control of biomedical research, individuals with
2 direct access will take all necessary precautions to ensure the confidentiality of information
3
4 (identity and patient results). Data collected will be anonymized.
5
6
7

8 9 **Interventions and measures**

10 All eligible patients will initially consult with a trained physician for a clinical examination.
11
12 They will undergo exercise electrocardiography on a conventional cycling ergometer (15 min)
13
14 to exclude a cardiovascular contraindication to carrying out intense exercises. In the absence of
15
16 contraindications, the physician will perform the initial tests: 6MWT, SPPB, QIMS and QIF
17
18 tests, hand grip strength test, MFIS questionnaire, EQ-5D questionnaire, blood sample and
19
20 muscle biopsy. At the end of this consultation, the practitioner will check the inclusion criteria
21
22 and randomise the patients (1:1) to the experimental group (eccentric exercises) or control
23
24 group (concentric exercises). Both groups will perform 3 training sessions per week for 8
25
26 weeks, each session lasting 30 min (Fig. 1).
27
28
29
30
31
32

33 34 35 **Interventions**

36 The experimental group (eccentric exercises) will perform an eccentric exercise training
37
38 program. The first 5 sessions will be habituation sessions to avoid the onset of invalidating
39
40 muscle soreness observed at the beginning of the training program. Each session will be spaced
41
42 by at least 48 hr. Before each new session, we will ensure the absence of residual pain by using
43
44 a 10 cm visual analog scale (score < 3 to perform a new session). The initial power of the
45
46 exercise will be set at 10 Watts and then increased by 10% each session depending on the
47
48 muscle tolerance. The training power must correspond to 3 times that of the control group to
49
50 obtain a similar metabolic stimulation and will be adapted according to the pain felt at the end
51
52 of the session.
53
54
55
56
57
58
59
60
61
62
63
64
65

1
2
3
4
5
6
7
8
9
10
11
12
13
14
15
16
17
18
19
20
21
22
23
24
25
26
27
28
29
30
31
32
33
34
35
36
37
38
39
40
41
42
43
44
45
46
47
48
49
50
51
52
53
54
55
56
57
58
59
60
61
62
63
64
65

The control group (concentric exercises) will perform an exercise training in concentric mode at 60% intensity of the reserve heart rate (RHR, FCmax-FCrest) determined during the initial cardiorespiratory test. The power will be adjusted weekly to stay within the target heart rate range.

All evaluations will be repeated after the 24 training sessions (month 2 assessment). These assessments will be performed by investigators different from those performing the exercise training sessions. A follow-up evaluation will be performed at 6 months (month 6 assessment) and will include 6MWT, SSPB, and MFIS and EQ-5D questionnaires.

Primary endpoint

The primary endpoint will be the change in 6MWT distance, expressed as the percentage change between the initial assessment and month 2. Our hypothesis is a significantly larger increase in 6MWT distance after the eccentric than concentric training program.

Secondary endpoints

The secondary outcomes are related to pre- versus post-rehabilitation changes in the following:

- sarcopenia: SPPB score
- muscle strength: handgrip strength test and QIMS test
- general and muscular fatigue: QIF and MFIS
- quality of life: EQ-5D
- blood metabolomic data
- ex vitro data for mitochondrial and histo-biochemical functionality from muscle biopsies of the vastus lateralis.

Measurements

1
2
3
4
5
6
7
8
9
10
11
12
13
14
15
16
17
18
19
20
21
22
23
24
25
26
27
28
29
30
31
32
33
34
35
36
37
38
39
40
41
42
43
44
45
46
47
48
49
50
51
52
53
54
55
56
57
58
59
60
61
62
63
64
65

6MWT: patients will be asked to cover the longest distance over a 30-m distance in 6 min with or without stopping and with standardized verbal encouragements according to standard recommendations; to take into account a learning effect, the test will be performed twice, with the longer distance retained (19). Pulsed oxygen saturation and heart rate will be monitored continuously throughout the test by using a digital oximeter.

SPPB: this test consists of assessing balance in a standing position, lifting from a chair (5 stand-to-sit repetitions) and measuring 4-m walking speed (20). The patient walks 4 m at a normal and comfortable speed. The “test zone” (4 m) is preceded by an “acceleration zone” (1 m) and is followed by a “deceleration zone” (1 m). The assessor starts and stops the timing when the subject’s foot meets the ground when entering and leaving the “test area”, respectively.

QIMS test: maximum muscle strength of the quadriceps, on the dominant limb, will be measured on a bench:

- Strength during isometric contraction (at 90° knee flexion)
- Standardized position with the arms crossed on the chest, the absence of back support during the measurement and the maintenance of the hips and the contralateral leg to avoid any compensating movement

Three reproducible measurements ($\pm 10\%$) will be taken at 1-min intervals, with the highest value retained (21).

QIF test: this test consists of performing 10 knee extensions at 10% QIMS, then gradually increasing the load (10% by 10%) until exhaustion (cannot perform the movement 2 consecutive times). The value retained is the last level (% QIMS) performed (22).

MFIS: this scale explores cognitive, physical and psychosocial fatigue (23).

1
2
3
4
5
6
7
8
9
10
11
12
13
14
15
16
17
18
19
20
21
22
23
24
25
26
27
28
29
30
31
32
33
34
35
36
37
38
39
40
41
42
43
44
45
46
47
48
49
50
51
52
53
54
55
56
57
58
59
60
61
62
63
64
65

EQ-5D questionnaire: this questionnaire explores 5 dimensions: mobility, self-care, usual activities, pain/discomfort and anxiety/depression (24).

Handgrip strength test: measurement is in 90° elbow flexion, wrist in neutral position. Three reproducible measurements ($\pm 10\%$) will be taken at 1-min intervals, with the highest value retained.

Blood sample: a 3-mL blood sample will be collected for studying specific biomarkers responding to training (metabolomic study).

Muscle biopsy: muscular adaptations will be studied on vastus lateralis samples taken during a muscle biopsy by using the modified Bergström technique. The biopsy will be taken in the morning, after at least 24 hr without intense physical activity, in the Clermont-Ferrand and Saint-Etienne centers, which have the experience and logistics to carry out and condition the samples. Biopsies will be taken under local anesthesia in a medical environment. After local anesthesia, a 5- to 10-mm incision of the skin and fascia will allow for introducing the needle and then collecting a muscle sample of 100 to 200 mg. Some of the fresh tissue will be used to study mitochondrial functions on permeabilized muscle fibres by respirometry (Oxygraph-2k G series, Oroboros Instruments, Innsbruck, Austria) and fluorimetry (Oxygraph-2k-Fluo LED2-Module, Oroboros Instruments, Innsbruck, Austria). The rest of the biopsy will be sampled and frozen for further analysis (i.e., histology, mRNA expression, biochemistry).

Statistical considerations

Randomisation procedure

A permuted-block randomization (i.e., random block sizes) will involve a computer-generated random allocation (Stata v15, StataCorp, College Station, TX, USA) with a 1:1 allocation, ensuring complete randomness of the assignment of a patient to each group. The randomization will be stratified by center.

Sample size estimation

According to the work of Herridge et al. (25), 50 participants per randomized group will be needed to highlight a clinically relevant difference of 6MWT = 30 m with two-sided type I error 5%, statistical power 85%, and standard deviation of 50 m for the 6MWT. We propose to include 60 participants per group to consider lost to follow-up and a non-Gaussian distribution of the 6MWT primary endpoint. Because of the difficulty in estimating the number of individuals to include, depending on the flow of the COVID-19 pandemic, an exploratory intermediate analysis will be carried out after the inclusion of 20 participants per group to measure effect size and estimate the statistical power.

Statistical analysis

Statistical analyses will be conducted with Stata v15 (StataCorp, College Station, TX, USA). Two-sided $p < 0.05$ will be considered statistically significant. Participants will be described at baseline and compared between randomized groups in terms of compliance with eligibility criteria, demographic characteristics, clinical characteristics, and treatments. The comparability of the 2 groups at baseline will be assessed on the main participant characteristics and potential factors associated with the primary outcome. A possible difference between groups in any of these characteristics will be determined by both clinical and statistical considerations. The number of patients included and the inclusion curve will be presented by group.

The primary endpoint will be compared between groups by Student *t* test or non-parametric Mann-Whitney test as appropriate. Normality will be studied with the Shapiro-Wilk test. Homoscedasticity will be analyzed with the Fisher-Snedecor test. The results will be expressed as effect size and 95% confidence intervals (CIs). Intention-to-treat analysis will be considered for the primary analysis. To prevent attrition bias, imputation of missing data is planned. The statistical analysis plan also provides for an additional per-protocol analysis.

1
2
3
4
5
6
7
8
9
10
11
12
13
14
15
16
17
18
19
20
21
22
23
24
25
26
27
28
29
30
31
32
33
34
35
36
37
38
39
40
41
42
43
44
45
46
47
48
49
50
51
52
53
54
55
56
57
58
59
60
61
62
63
64
65

The analysis of the primary outcome will be completed by multivariable analysis using a linear mixed model to compare 6MWT between groups taking into account 1) covariates determined according to univariate results and clinical relevance (gender, age, number of complete sessions performed, and baseline 6MWT) and 2) center as a random effect (to measure between- and within-center variability). The normality of the residuals from linear regression will be studied. If necessary, a logarithmic transformation of the dependent variable will be proposed.

The groups will be compared 1) for continuous secondary endpoints as mentioned previously and 2) by using the chi-square or Fisher exact test for categorical variables. For non-Gaussian data, results will be presented with median differences and 95% CIs estimated with a quantile regression model. For categorical variables, results will be expressed with absolute differences and 95% CIs. The multivariable analysis associated with dichotomous endpoints will be a generalized linear mixed model, with a logit link function, and center as a random effect. Because secondary endpoints will be exploratory, no type I error correction will be applied, but the results will be expressed with odds ratios and 95% CIs. The analysis of blood biomarkers will involve more specific statistical approaches suitable for metabolomics data, such as factorial analyses. Longitudinal data will be analyzed with random-effects regression, modeling between- and within-participant effects, as a random effect in addition to a center effect. The following fixed effects will be studied: randomization group, time-point evaluation and their interaction. According to clinical relevance and European Medicines Agency and Consolidated Standards of Reporting Trials recommendations, planned subgroup analyses of gender and age subgroups, for example, will be proposed after study of the *subgroup × randomisation group* interaction in regression models.

Particular attention will be paid to study of the adherence of participants to the intervention. A sensitivity analysis will be performed to study the statistical nature of missing

1
2
3
4
5
6
7
8
9
10
11
12
13
14
15
16
17
18
19
20
21
22
23
24
25
26
27
28
29
30
31
32
33
34
35
36
37
38
39
40
41
42
43
44
45
46
47
48
49
50
51
52
53
54
55
56
57
58
59
60
61
62
63
64
65

data and to determine the most appropriate approach for imputing missing data: maximum bias (e.g., last observation carried forward, baseline observation carried forward) or estimation proposed by Verbeke and Molenberghs for repeated data. A study of non-adherence will be proposed, considering this variable as censored data and using the Kaplan-Meier method for estimation and log-rank analysis for comparing groups.

Discussion

To our knowledge, this study will be the first randomized controlled trial exploring the effects of an eccentric training program for individuals with severe COVID-19 on functional walking ability.

With the COVID-19 pandemic, many patients have significant fatigability associated with loss of muscular endurance after discharge and need rehabilitation. However, rehabilitation facilities and capacities remain limited and affect wait time.

The eccentric mode training allows for 3 to 4 times greater mechanical stimulation at the same level of metabolic stimulation as concentric mode training. This type of eccentric program could optimize rehabilitation after COVID-19 and avoid saturation of rehabilitation units (shorter stays, less equipment used, less staff mobilized). The limitation of this type of program is that patients sometimes have difficulty performing eccentric exercise. Complications such as delayed pain can be avoided with progressive habituation sessions.

The typology of patients is not yet established, so we will need to identify the individuals for whom this type of rehabilitation would be beneficial versus out-patient rehabilitation or self-rehabilitation.

The main limitation of our study is the lack of double blinds. This bias may be limited by 3 measures: 1) participants being unaware of the hypotheses, 2) the initial and final

1
2
3
4
5
6
7
8
9
10
11
12
13
14
15
16
17
18
19
20
21
22
23
24
25
26
27
28
29
30
31
32
33
34
35
36
37
38
39
40
41
42
43
44
45
46
47
48
49
50
51
52
53
54
55
56
57
58
59
60
61
62
63
64
65

evaluations carried out by a different investigator, and 3) the investigators blinded to participant group.

Author contributions

Conception and design of the study. NC, EC, BP, AG, RR, FC

Drafting of the original protocol. NC, EC, BP, AG, RR, FC

Coordination of the study. NC, EC, AG, FC

Acquisition of data. NC, EC, BP, AG, LF, PO, JT, ECV, RR, DP, FC

Design of the statistical analysis plan. NC, EC, BP, RR, FC

Drafting of the present manuscript. NC, EC, BP, AG, RR, FC

Obtaining funding. NC, EC, RR, FC

Final approval. NC, EC, BP, AG, LF, PO, JT, ECV, RR, DP, FC

Data sharing statement. CHU Clermont-Ferrand is the owner of the data, which cannot be used or disclosed to a third party without prior approval from CHU Clermont-Ferrand. Statistical codes will be available by contacting the biostatistician of the study (bpereira@chu-clermontferrand.fr). The full original protocol in French and the full dataset will be available by contacting the coordinating investigator (ncoste@chu-clermontferrand.fr). Patients will be informed and will consent that their data can be shared and that they could be re-contacted for research purposes.

1
2
3
4
5
6
7
8
9
10
11
12
13
14
15
16
17
18
19
20
21
22
23
24
25
26
27
28
29
30
31
32
33
34
35
36
37
38
39
40
41
42
43
44
45
46
47
48
49
50
51
52
53
54
55
56
57
58
59
60
61
62
63
64
65

Ethical consideration and funding statement. The study protocol was submitted to the Comité de Protection des Personnes (May 11, 2020). The ClinicalTrials.gov registration is in progress.

Funding. The study is funded by the DGOS (Direction Générale de l'Offre de Soins) for the PHCR-I 2020 COVID-19 (Projet Hospitalier de recherche Clinique Inter-régional) (register no. 2020-A01201-38). The funders will not be involved in the study design or collection, management, analysis, or interpretation of data.

Protocol version. Version 1 (April 10, 2020)

Conflict of interest. None to declare.

Acknowledgements. The authors thank Caroline Cartier dit Moulin, Katia Bouton and the Clermont-Ferrand University hospital DRCI team for their help to build up this study protocole in a very short time period

References

1. Puthuchery ZA, Rawal J, McPhail M, Connolly B, Ratnayake G, Chan P, et al. Acute skeletal muscle wasting in critical illness. *JAMA*. 16 oct 2013;310(15):1591 - 600.
2. Herridge MS, Tansey CM, Matté A, Tomlinson G, Diaz-Granados N, Cooper A, et al. Functional disability 5 years after acute respiratory distress syndrome. *N Engl J Med*. 7 avr 2011;364(14):1293 - 304.

1
2
3
4
5
6
7
8
9
10
11
12
13
14
15
16
17
18
19
20
21
22
23
24
25
26
27
28
29
30
31
32
33
34
35
36
37
38
39
40
41
42
43
44
45
46
47
48
49
50
51
52
53
54
55
56
57
58
59
60
61
62
63
64
65

3. Xiang YT, Yu X, Ungvari GS, Correll CU, Chiu HF. Outcomes of SARS survivors in China: not only physical and psychiatric co-morbidities. *East Asian Arch Psychiatry Off J Hong Kong Coll Psychiatr Dong Ya Jing Shen Ke Xue Zhi Xianggang Jing Shen Ke Yi Xue Yuan Qi Kan.* mars 2014;24(1):37- 8.
4. Zhang P, Li J, Liu H, Han N, Ju J, Kou Y, et al. Long-term bone and lung consequences associated with hospital-acquired severe acute respiratory syndrome: a 15-year follow-up from a prospective cohort study. *Bone Res.* 2020;8:8.
5. Connolly B, Salisbury L, O’Neill B, Geneen L, Douiri A, Grocott MPW, et al. Exercise rehabilitation following intensive care unit discharge for recovery from critical illness: executive summary of a Cochrane Collaboration systematic review. *J Cachexia Sarcopenia Muscle.* 2016;7(5):520- 6.
6. Clavet H, Doucette S, Trudel G. Joint contractures in the intensive care unit: quality of life and function 3.3 years after hospital discharge. *Disabil Rehabil.* 2015;37(3):207- 13.
7. van Zanten ARH, De Waele E, Wischmeyer PE. Nutrition therapy and critical illness: practical guidance for the ICU, post-ICU, and long-term convalescence phases. *Crit Care Lond Engl.* 21 2019;23(1):368.
8. Mao L, Jin H, Wang M, Hu Y, Chen S, He Q, et al. Neurologic Manifestations of Hospitalized Patients With Coronavirus Disease 2019 in Wuhan, China. *JAMA Neurol.* 10 avr 2020;
9. Wu Y, Xu X, Chen Z, Duan J, Hashimoto K, Yang L, et al. Nervous system involvement after infection with COVID-19 and other coronaviruses. *Brain Behav Immun.* 30 mars 2020;
10. Bailey P, Thomsen GE, Spuhler VJ, Blair R, Jewkes J, Bezdjian L, et al. Early activity is feasible and safe in respiratory failure patients. *Crit Care Med.* janv 2007;35(1):139- 45.

1
2
3
4
5
6
7
8
9
10
11
12
13
14
15
16
17
18
19
20
21
22
23
24
25
26
27
28
29
30
31
32
33
34
35
36
37
38
39
40
41
42
43
44
45
46
47
48
49
50
51
52
53
54
55
56
57
58
59
60
61
62
63
64
65

11. Morris PE, Goad A, Thompson C, Taylor K, Harry B, Passmore L, et al. Early intensive care unit mobility therapy in the treatment of acute respiratory failure. *Crit Care Med.* août 2008;36(8):2238- 43.
12. Burtin C, Clerckx B, Robbeets C, Ferdinande P, Langer D, Troosters T, et al. Early exercise in critically ill patients enhances short-term functional recovery. *Crit Care Med.* sept 2009;37(9):2499- 505.
13. Needham DM. Mobilizing patients in the intensive care unit: improving neuromuscular weakness and physical function. *JAMA.* 8 oct 2008;300(14):1685- 90.
14. Isner-Horobeti M-E, Dufour SP, Vautravers P, Geny B, Coudeyre E, Richard R. Eccentric exercise training: modalities, applications and perspectives. *Sports Med Auckl NZ.* juin 2013;43(6):483- 512.
15. Douglas J, Pearson S, Ross A, McGuigan M. Chronic Adaptations to Eccentric Training: A Systematic Review. *Sports Med Auckl NZ.* mai 2017;47(5):917- 41.
16. Hody S, Croisier J-L, Bury T, Rogister B, Leprince P. Eccentric Muscle Contractions: Risks and Benefits. *Front Physiol.* 2019;10:536.
17. Chan A-W, Tetzlaff JM, Altman DG, Laupacis A, Gotzsche PC, Krlje A-Jerić K, et al. SPIRIT 2013 Statement: defining standard protocol items for clinical trials. *Rev Panam Salud Publica Pan Am J Public Health.* déc 2015;38(6):506- 14.
18. Boutron I, Altman DG, Moher D, Schulz KF, Ravaud P, CONSORT NPT Group. CONSORT Statement for Randomized Trials of Nonpharmacologic Treatments: A 2017 Update and a CONSORT Extension for Nonpharmacologic Trial Abstracts. *Ann Intern Med.* 4 juill 2017;167(1):40- 7.
19. Brooks D, Solway S, Gibbons WJ. ATS statement on six-minute walk test. *Am J Respir Crit Care Med.* 1 mai 2003;167(9):1287.

1
2
3
4
5
6
7
8
9
10
11
12
13
14
15
16
17
18
19
20
21
22
23
24
25
26
27
28
29
30
31
32
33
34
35
36
37
38
39
40
41
42
43
44
45
46
47
48
49
50
51
52
53
54
55
56
57
58
59
60
61
62
63
64
65

20. Treacy D, Hassett L. The Short Physical Performance Battery. *J Physiother.* 2018;64(1):61.

21. Kamiya K, Mezzani A, Hotta K, Shimizu R, Kamekawa D, Noda C, et al. Quadriceps isometric strength as a predictor of exercise capacity in coronary artery disease patients. *Eur J Prev Cardiol.* oct 2014;21(10):1285- 91.

22. Machado Rodrigues F, Demeyer H, Hornikx M, Camillo CA, Calik-Kutukcu E, Burtin C, et al. Validity and reliability of strain gauge measurement of volitional quadriceps force in patients with COPD. *Chron Respir Dis.* août 2017;14(3):289- 97.

23. Debouverie M, Pittion-Vouyovitch S, Louis S, Guillemin F. Validity of a French version of the fatigue impact scale in multiple sclerosis. *Mult Scler Houndmills Basingstoke Engl.* sept 2007;13(8):1026- 32.

24. Beaudart C, Reginster J-Y, Petermans J, Bruyère O. [Quality of life of sarcopenic patients: contribution of the SarcoPhAge study]. *Geriatr Psychol Neuropsychiatr Vieil.* déc 2015;13(4):391- 5.

25. Enright PL, Sherrill DL. Reference equations for the six-minute walk in healthy adults. *Am J Respir Crit Care Med.* nov 1998;158(5 Pt 1):1384- 7.

Figure

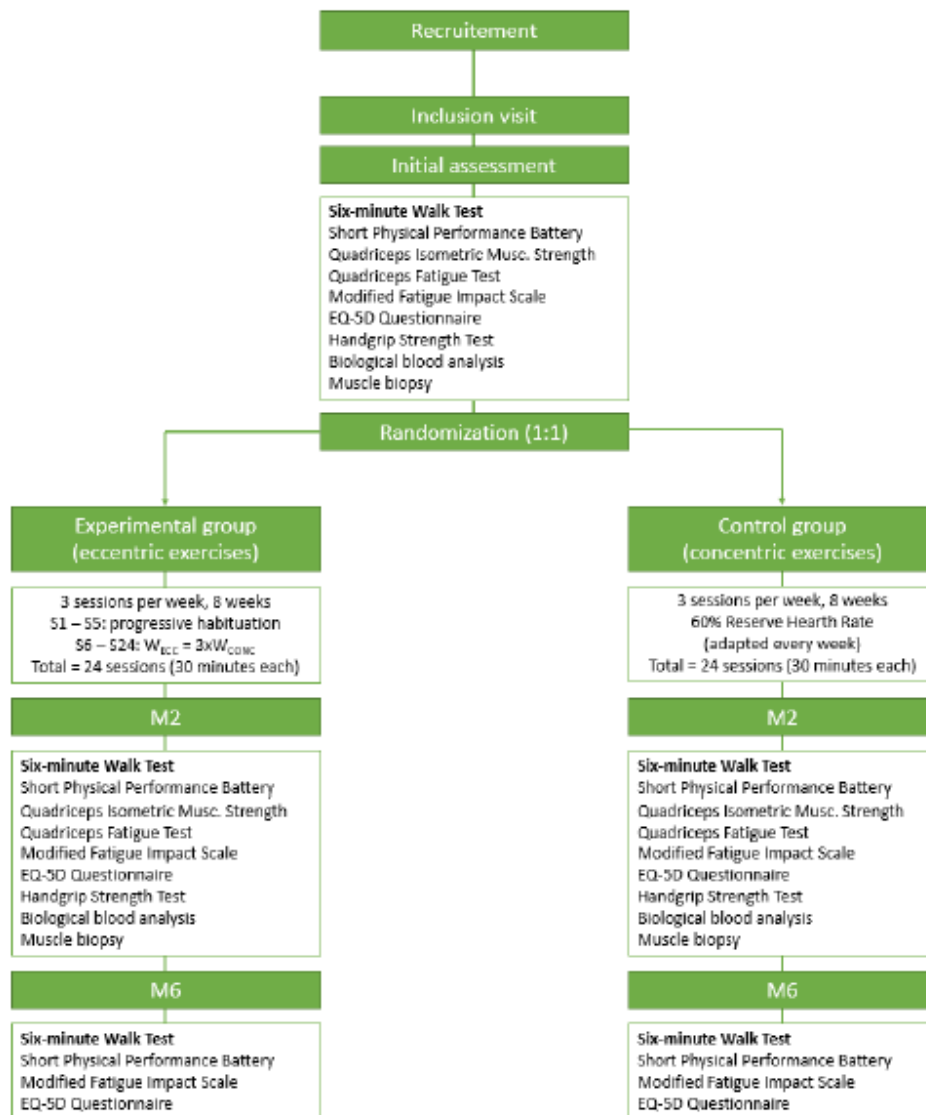

Fig 1- Flow chart

Table 1 – WHO trial registration data set summary

Data category	Information
Primary registry and trial identifying number	ClinicalTrials.gov NCT submission in progress
Date of registration in primary registry	May 2020
Secondary identifying number	2020-A01201-38 (ANSM)
Source(s) of monetary or material support	University Hospital of Clermont-Ferrand
Primary sponsor	University Hospital of Clermont-Ferrand
Contact for public queries	Lise LACLAUTRE: drci@chu-clermontferrand.fr
Contact for scientific queries	Dr. Nicolas COSTE (MD, MSc): ncoste@chu-clermontferrand.fr
Public title	Muscular rehabilitation by eccentric exercise after severe COVID-19 infection: research protocol for a randomized controlled trial (CovExc)
Scientific title	Assessment of the effect of two iso-energetic training programs (eccentric versus concentric mode) on functional walking capacity after a severe COVID-19 infection: a randomized controlled study.
Countries of recruitment	France
Health condition(s) or problem(s) studied	COVID-19, sarcopenia, muscular dysfunction
Intervention	The experimental group (eccentric) will perform an eccentric exercise training. The control group (concentric) will perform an exercise training in concentric mode. Both groups perform 24 sessions (3 sessions per week, for 8 weeks).
Key inclusion and exclusion criteria	Inclusion criteria: patient male or female, 18 to 80 years old, patient hospitalized for SARS-CoV-2 pneumonia (COVID-19 pandemic) requiring a muscle rehabilitation program following hospitalization one month after the hospitalization, independent in daily life one month after hospitalization, patient able to walk for 6 minutes (discontinuous walking possible), giving informed written consent to participate in the study, covered under a health insurance. Non-inclusion criteria: cardiovascular or respiratory contraindication to the rehabilitation program, difficulty to perform an eccentric exercise on a seated ergometer, pregnant or breastfeeding woman, patient under guardianship, curatorship or deprived of liberty, patients with antivitamin K anticoagulation, refusal to participate.

Study type	Interventional Allocation: randomized; Intervention model: parallel assignment; Masking: non. Primary purpose: treatment. Phase: not applicable.
Date of the first enrolment	May 2020
Target sample size	120
Recruitment status	Not yet recruiting
Primary outcome(s)	6-min walk test
Key secondary outcomes	SPPB score, Handgrip Strength Test, QIMS test, QIF, MFIS, EQ-5D, blood metabolomic data, ex vitro data of mitochondrial and histo-biochemical functionality from muscle biopsies of the Vastus Lateralis.