



**HAL**  
open science

# A History of Gravitational Waves between Discoveries & Nature of Science Teaching: hypotheses and Perspectives

Philippe Vincent

► **To cite this version:**

Philippe Vincent. A History of Gravitational Waves between Discoveries & Nature of Science Teaching: hypotheses and Perspectives. History, Philosophy and Sociology of Sciences. Université de Lille, 2020. English. NNT : 2020LILUH027 . tel-03216952

**HAL Id: tel-03216952**

**<https://theses.hal.science/tel-03216952>**

Submitted on 4 May 2021

**HAL** is a multi-disciplinary open access archive for the deposit and dissemination of scientific research documents, whether they are published or not. The documents may come from teaching and research institutions in France or abroad, or from public or private research centers.

L'archive ouverte pluridisciplinaire **HAL**, est destinée au dépôt et à la diffusion de documents scientifiques de niveau recherche, publiés ou non, émanant des établissements d'enseignement et de recherche français ou étrangers, des laboratoires publics ou privés.

## Doctor of **Philosophy** Diploma

### **Ph.D. School**

École Doctorale des Sciences de l'Homme et de la Société, Université  
de Lille, France

### **Area**

History of Physics, Epistemology—History of Science and Techniques,  
Nature of Science Teaching [CNU 72, 70]

**Philippe VINCENT**

## **A History of Gravitational Waves between Discoveries & Nature of Science Teaching: *Hypotheses and Perspectives***

To be Presented & Discussed for Ph.D Defence in a Public Exam, 2020, 27<sup>th</sup>  
November

<b>Mr. Prof. dr. Stavros KATSANEVAS</b> European Gravitational Observatory & Paris Diderot University, Italy/France	Rapporteur
<b>Mme Prof. dr. Patricia RADELET-DE GRAVE</b> IRMP, Catholic Louvain la Neuve University, Belgium	Rapporteur
<b>Mr. Prof. dr. Fabrizio CLERI</b> IEMN, CNRS–Lille University, France	Examineur
<b>Mme Prof. dr. Ana DIAS-CHIARUTTINI</b> LINE, ESPE-Université Côte d'Azur, France	Examineur
<b>Mme Prof. dr. Flavia MARCACCI</b> IRAFS, Pontifical Lateran University, Vatican State	Examineur
<b>Mme A/Prof. dr. Mateja PLOJ–VIRTIC</b> Technical Education Department, Maribor University, Slovenia	Examineur
<b>Mr. A/Prof. dr. Serge QUILIO</b> LINE, ESPE-Université Côte d'Azur, France	Examineur
<b>Mr. Prof. dr. Raffaele PISANO</b> IEMN, CNRS–Lille University, France	Supervisor





## ACKNOWLEDGEMENTS

I am deeply indebted to my thesis supervisor, Prof. Dr. Raffaele Pisano, who took great care of me and taught me a great deal during these last years.

I express my deepest appreciation to Dr. Julie Robarts (Australian National University, Canberra) who proofread the thesis and dealt with my many mistakes.

I am also very grateful to Vincenzo Cioci and Andrea Durlò who helped with the Physics proofreading.

I would like to take this opportunity to warmly thank Prof. Stavros Katsanevas, Director of the *European Gravitational Observatory* (EGO), to whom I owe my visit of the Virgo site and whom I regret having missed by a few days; and the scientists that I met there, particularly Gabriel Pillant, Dr. Julia Casanueva, Dr. Nicolas Arnaud and Dr. Valerio Boschi.

I would sincerely thank Prof. Gregory Good, Director of the *American Institute of Physics History Center*, to whom I owe my visit at the *Niels Bohr Library*, for such a productive and wonderful time spent during my doctoral research, including the professional and friendly collaboration of the archivists, who kindly sent me the following beautiful card: Allison, Audrey, Samantha, Sarah, Corinne and Chip.

I address my deep acknowledgements, as well, to Prof. Daniel Kennefick (University of Arkansas, USA) for our interesting discussions on history of science held at the 39<sup>th</sup> *Congress of the Italian Society for the History of Physics and Astronomy* (Pisa/VIRGO 2019, 9<sup>th</sup>-12<sup>th</sup> September).

I would also like to extend my gratitude to the members of my International Scholarly Committee: Prof. Jorge L. Cervantes-Cota and Prof. Salvador Galindo-Uribarri from the *National Institute of Nuclear Research*, Mexico, Mexico, Associated Prof. Joseph Kouneiher from the University of Nice-Sophia Antipolis, Professors Shahid Rahman, Catherine Maignant and Nathalie Lebrun from the Lille University, France.

I also would like to acknowledge Grant Sanderson (3Blue1Brown) as such a great Science–Mathematics Mediator who gave me the special permission to use his contents.

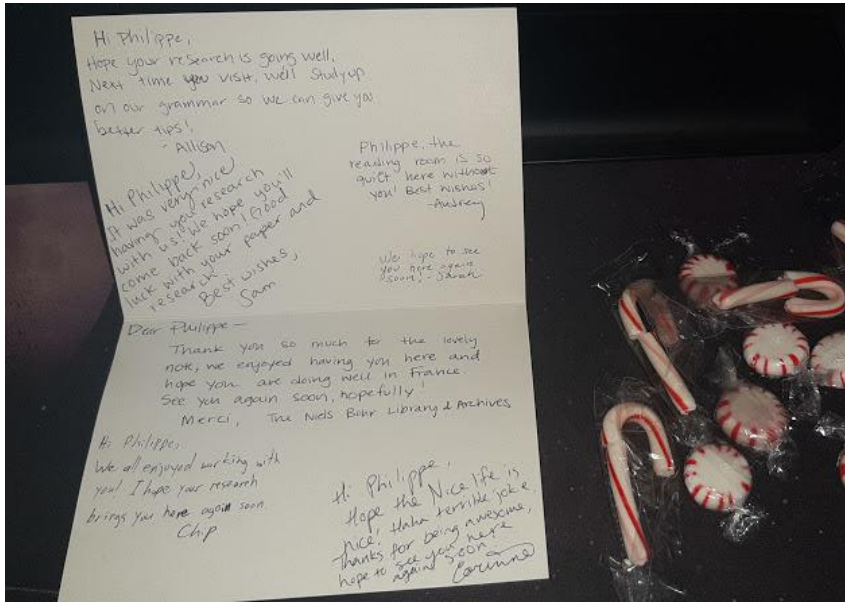
I deeply thank Prof. Alain Brillet (ARTEMIS CNRS-Université Côte d'Azur, France) for his help and discussions.

I also address my thanks to Prof. Adele La Rana (University of Rome) for her expertise.

I thank Dr. Carl Rod Nave (Georgia State University, USA) for his courteous permission to use his contents.

I gratefully acknowledge the help of Etienne Bonnet, who used his Photoshop skills to render certain images used in my thesis.

And of course, I am deeply grateful to my parents who educated me, always helped me, and supported me during all my life.



New Year Greeting Card  
Source: Photo taken by Philippe Vincent







## REMARKS FOR READERS

This document contains a description of my doctoral thesis, its aim & methodology, including general—and—specific objectives, state-of-the-art, literature review and *ad hoc* recaps of my two international grants motilities: 1) EGO–Virgo (Italy, 2019, June 9<sup>th</sup>–15<sup>th</sup>) where I had the crucial opportunity to discuss and participate in state-of-the-art data and science, a real-time job, with specialist researchers on gravitational waves and an interferometer, and 2) the *Niels Bohr Library* (NBL) of the *American Institute of Physics* (U.S.A, 2019, October 29<sup>th</sup>–November 15<sup>th</sup>) where I produced important historical advancement for my doctoral research thanks to a grant-in-aid from the *Friends of the Center for History of Physics*, AIP. Therefore, readers can find never seen before results found from Virgo and the NBL. I studied and archived copies of the original documents in the field to be used in my thesis. Finally, the reader will find expected results—and—an overview of the thesis curricula project, as well.

For each chapter the readers are provided with a short outline at the beginning, but also final remarks preceding the list of references used. Exceptions being made for the first chapter which is a technical chapter on the Physics of Waves and chapters closing each Part of the thesis where the readers can instead find an epilogue concluding the respective parts —Part I, The Physics of Waves; Part II, A History of Waves and the Case of Gravitation; Part III, History of Physics & Nature of Science Teaching (NOS) – and with the exception of Part IV, Concluding Remarks.

The readers should note that Part I –The Physics of Waves– is essentially there for non-physicist readers to familiarize themselves with the thesis subject.

The readers will also find an appendix at the end of the thesis containing administrative documents related to this thesis, the two mobility grants, the *Introductory module* and curricula and the first pages of my articles. The reader can find a complete list of all references used for the thesis, including the ones at the end of each chapter at the end of this document.

The referencing style follows the *Springer Basic Style* both as recall in the running text and in the dedicated section at the end of this document. This section is composed of: *Primary*—and—*Secondary*, *General*—and—*Specific* references, including *Original sources*. In addition, the sources of the figures and tables can be found both in their respective *legenda* and in the final Index which is divided in three parts – analytical, images and scientists' names. The readers will notice that a number of source attributions are written as PV or PV Handmade which stand for the initials of the author (Philippe VINCENT).

Furthermore, the readers are provided with an Index subdivided into two sections:

- The first one is an Index of all the images presented in this thesis, complete with the location in the thesis, the source of the image, the purpose and the copyright status.
- The second one is where the readers are provided with an analytical index chapter by chapter for names and subjects.

The table below displays the most frequent sources I used.

<b>References</b>	- Primary and Secondary Sources
<b>Sources</b>	- Online Resources:
	✓ Academia
	✓ AAPT
	✓ AIP publishing
	✓ APS
	✓ American Scientist
	✓ Archive.org
	✓ arXiv.org
	✓ Cairn
	✓ DESY
	✓ DOAJ
	✓ EGO/Virgo
	✓ Elsevier
	✓ Emis.de
	✓ Gallica (BNF)
	✓ GravitySpy
	✓ HAL
	✓ HathiThrust
	✓ Journals.openedition.org
	✓ Library of Congress
	✓ LIGO
	✓ MPI
	✓ NASA
	✓ Nature
	✓ NewScientist
	✓ PlosOne
	✓ Science magazine
	✓ Science Publishing Group
	✓ Springer
	✓ Researchgate
	✓ Wiley online Library
	✓ Various Press Universities (Caltech, Cambridge, MIT, ...)
	- <i>Interviews with researchers</i> : Virgo Interferometer, European Gravitational Observatory, Cascina, Italy;
	- <i>Manuscripts, letters, in situ</i> : Niels Bohr Library, American Institute of Physics, College Park, USA.

Additionally, I have asked for and obtained the permission to use copyrighted materials from their respective authors (Cfr. Copyright Authorizations in the Appendix).

In order to have an almost complete overview in the field, the reader will also find other references (that I did not consult) such as those cited by the authors that I studied. Therefore, this large References section represents a source book of value within my doctoral thesis, as well; typically for History of science and Historiography research.

When encountering non-English historical texts in the document a translation in English is always provided in the running text while the original text will be found in the footnotes; using preferentially trusted English translations when possible, or the note “Translation by PV (Philippe Vincent)” otherwise.

Finally, as a native English speaker (English mother tongue), Dr. Julie Robarts (Australian National University, Canberra) proofread this thesis.



# INTRODUCTION

## General Introduction on Gravitational Waves Topic

Since October, 3<sup>rd</sup> 2017, on the official website of the Nobel Prize, it can be read that “The Royal Swedish Academy of Sciences has decided to award the Nobel Prize in Physics 2017 to Rainer Weiss, Barry C. Barsih and Kip S. Thorne for decisive contributions to the LIGO detector and the observation of gravitational waves”.<sup>1</sup>

Gravitational waves are a very particular concept that belongs to Physics, Astronomy and Cosmology. They are very peculiar objects that had been merely theoretical for almost a century when the first successful detection event happened. Naively, gravitational waves combine two concepts: the concept of gravitation and the concept of waves. If, by taking each of these concepts separately, they are somewhat well understood by everyone, the same thing cannot be said in the case of their combination, which is at first sight anything but intuitive. Indeed, while gravity or gravitation is generally accepted as being a force keeping us to the ground and the Earth in orbit; and waves are generally associated as the phenomena occurring at the surface of a body of water, the two might seem to be completely unrelated or assimilated to be two separate things in a causal relationship in which gravity causes waves; i.e. *gravity waves* and *tides*. However *gravitational waves* are their own entity encompassing both aspects. Therefore, in order to understand what gravitational waves are, we ought to understand how these concepts interact with each other; and thus, it seems only natural that we first have to understand each of these two concepts separately.

On one hand, the most ubiquitous definition of a wave would probably be, simply put, that waves are perturbations of some kind propagating in a certain way in something. This raises questions such as: *What kind of perturbations? How are they propagated? What do they propagate in?* and *How are they generated?* which will be answered in Part I.

On the other hand, defining gravitation can be a bit trickier depending on the audience. Indeed, in order to give a sensible definition of gravitational waves, not all descriptions of gravitation are equal, i.e. the Newtonian description of gravitation as a force is not going to be enough; in fact we need its generalization: the Theory of General Relativity which was developed by Albert Einstein (1879-1955). First of all, General Relativity is the theory from which the prediction of the existence of gravitational waves and their description originate (Einstein 1918). Second of all, the Theory of General Relativity is our best current description of astronomical phenomena

---

<sup>1</sup> Cfr. <https://www.nobelprize.org/prizes/physics/2017/press-release/>

which are the actual sources of the gravitational waves we are able to detect. Third of all, stepping up to General Relativity is essential because we need the concept of spacetime curvature which provides us with an understanding of gravitation as an emergent property of the curvature of the fabric of space. Consequently, gravitational waves can then be defined as perturbations of spacetime propagating in spacetime.

The very first question we should ask ourselves is why is this discovery so important? Especially when, all things considered, discoveries in Science are made on a daily basis and Nobel Prizes are awarded every year. Actually, the first element of answer to that question resides in the history of Astronomy.

The Mesopotamian civilization, one of the first civilizations, is well known for the invention of writing, but less known for the great interest for astronomy it had for millennia (Chadwick 1984). Until the work of Johann Strassmaier (1846-1920) who was an assyriologist and Joseph Epping (1835-1894) who was also a mathematics professor during the early 1880s that lead to the recovery of ancient tablets from Babylon and Uruk, the Greco-Roman texts were the only documents available to have a peek at the “celestial science” of Mesopotamia (Rochberg 2017). The Mesopotamians believed that the Earth was flat and enclosed in a superior hemisphere that contained all the celestial bodies. The astronomers of that time observed the night sky with great interest and with quite a good precision over centuries. They left behind a number of very detailed astronomic tables and were allegedly the first to use mathematics to calculate astronomical ephemerids. They were also able to predict the positions of the Sun, moon and planets; although the first signs of science were already present at that time, one last heirloom from them that still subsists today are the famous zodiacal signs and the field of astrology, not to be confused with astronomy. The Egyptian civilization is also one of the oldest civilizations famous for their interest in astronomy, even if astronomy was of a lesser importance for their daily life outside religion; to them, astronomy was particularly useful for agriculture as they needed to predict diverse phenomena such as Nile floods and the seasons. The Ancient Egyptians had such a good understanding of the seasons that 5 000 years ago they used a solar calendar with a year lasting 365 days and, later noticing a drift in the season’s cycle, adopted a year of 365 days and a quarter.

Before classical antiquity, religions had mythical representations of Earth and the Universe. As an example, for Hesiod, the origins of the world and of the gods began with Chaos, Gaia, Erebus, Tartarus, Eros and Nyx; although all religions might have had their own mythical version of the origin of the Earth, the Universe and the rest. We had to wait until Thales of Miletus and the Milesian school to get at least two great advances. The first one being the separation of the supernatural from the natural, by looking for natural causes for natural phenomena; without completely getting rid of the divine. The second one concerns the method proposed to be used for research, based on observation, discussion and rationality.

Around the same time period, Pythagoras attracting numerous philosophers and mathematicians founded the Pythagoreanism movement.

To them, anything regarding the celestial movements had to be “perfect”, and thus spherical or perfect circles. Parmenides and Empedocles seem to have known about the idea of a spherical Earth although it is not completely clear where this idea first came from. Empedocles brought the concept that all things were made out of fire, air, water and earth; later called “elements” by Plato. Aristotle stated that it was obvious to him that the surface of the Earth is curved, since there are visible stars in the Egypt’s sky that aren’t visible from Greece. Furthermore, according to him, the universe is ruled by 3 fundamental principles: (i) The Earth is at the centre of the universe, (ii) there is an absolute separation between the changing and imperfect terrestrial world and the perfect everlasting celestial world –the limit being at the Moon’s orbit– and (iii) the only celestial movements possible are uniform circular motions. From these principles, he managed to create a model for the apparent movement of the “wandering stars” –planets–.

The first known model placing the Sun at the centre of the universe with the Earth revolving around it is attributed to Aristarchus of Samos (Africa 1961, p. 406). Nicolaus Copernicus (1473-1543), a polish canon (clergyman) and an astronomer published “*De revolutionibus orbium coelestium*” in 1543 (On the Revolutions of the Celestial Spheres, Copernicus 1966) in which he makes several statements based on observations such as that the planets and the Earth are revolving around the Sun, that the retrograde movement of planets can be explain by the fact that they are further from the Sun than Earth, and that the revolution of a planet is function of its distance to the Sun.

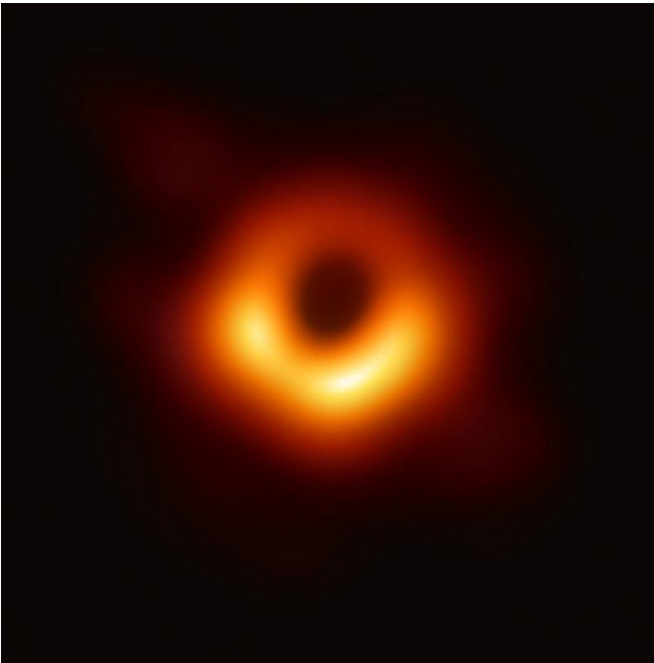
Then arrived the time of a first technology-driven revolution in astronomy with telescopes. Thanks to this new instrument, Galileo Galilei (1564-1642) who studied the science of weights and astronomy (Gal 2010) and Johannes Kepler (1571-1630) who figured out the mathematical relationship between the movements of planets on their orbits, which laid an exploitable basis for Isaac Newton’s Theory of Gravitation, made numerous amazing observations.

However, I would like to argue that the greatest achievement of this period was in fact practical rather than theoretical as since then, the refinement of telescopes, lenses and mirrors have been improved again and again up to almost unconceivable precisions. The point being that the observations that followed were in fact providing the means to confirm or refute theories based on actual precise measurements of the celestial bodies. For instance, Newton’s Theory of Gravitation was unable to explain the observed precession of Mercury’s perihelion which thus had to be fixed by adding extensions to the theory (Valluri 2005) until a better theory was found in General Relativity.

In the same way, we are now at the dawn of a new era for both Astronomy and Cosmology. While the telescopes of the 17<sup>th</sup> century improved human vision, up to the point of nowadays being able to see all the electromagnetic spectrum; we are now able to study the Universe in a completely different way. The main issue with Physics in general, and with Astronomy and Cosmology in particular is our inability to perform all the experiments we would like to do. As Richard Feynman (1918-1988) put it:

There exists, however, one serious difficulty, and that is the lack of experiments. Furthermore, we are not going to get any experiments, so we have to take a viewpoint of how to deal with problems where no experiments are available. There are two choices. The first choice is that of mathematical rigor. People who work in gravitational theory believe that the equations are more difficult than in any other field, and from my viewpoint this is false. If you then ask me to solve the equations I must say I can't solve them in the other fields either. However, one can do an enormous amount by various approximations which are non-rigorous and unproved mathematically, perhaps for the first few years. Historically, the rigorous analysis of whether what one says is true or not comes many years later after the discovery of what is true. And, the discovery of what is true is helped by experiments. The attempt at mathematical rigorous solutions without guiding experiments is exactly the reason the subject is difficult, not the equations. The second choice of action is to "play games" by intuition and drive on. (Renn 2011, p. 283)

Indeed, in Astronomy or Cosmology, –with a few exceptions– the actual objects studied are too far away to experiment on. Up until now, all we could do was “see” the objects with our artificial eye extensions. Fortunately, we managed to achieve great results through this optical astronomy; one of the latest major ones being the obtaining by the Event Horizon Collaboration of the first image of the supermassive black hole of the supergiant elliptical galaxy Messier 87 (Cfr. figure below).



**Fig.1.** The supermassive black hole at the core of supergiant elliptical galaxy Messier 87 in the first image released by the Event Horizon Telescope (10 April 2019) | CC BY 4.0 | Source: EHT Collaboration: <https://www.eso.org/public/images/eso1907a/>

Just as a revolution in Astronomy happened thanks to the development of this new instrument that was the telescope, by having successfully developed



a new tool completely different in nature –since it is not preoccupied by the emission of light– it seems only natural to expect a number of discoveries; especially so around a particular type of objects which are invisible to telescope, i.e. black holes.

Indeed, black holes are famously known for being these amazing celestial objects so dense and massive that not even light can escape their gravitational pull if it approaches too close and crosses the event horizon – which is the point of no-return– of the black hole; hence their name, i.e. black, for the absence of light. Therefore, up until now in order to determine that the imagery system of a telescope was pointed at a region of space where a black hole was residing, there were only a few indirect ways to proceed; such as seeing the accretion disk formed by matter infalling the black hole (Cfr. Fig. 1 above) or tracing the trajectories of stars orbiting a massive invisible object.

However, gravitational waves astronomy is not concerned with electromagnetic waves (light), instead it is concerned with gravitational waves which are often referred to as *ripples in spacetime*. An analogy that is often heard is that if telescopes were akin to our sense of sight, gravitational wave detectors are akin to our sense of hearing. Another – perhaps less striking– comparison could be made using a lacustrine analogy: in order to measure the behaviour of objects adrift on the lake that is spacetime we could only observe them with our artificial eyesight, but we now have buoys able to detect the ripples they produce.

To continue with this analogy, the height of the waves produced by objects on this hypothetical lake correspond to the amplitude of the gravitational waves and are produced by the movements of the objects. Moreover, every massive object can produce gravitational waves, but just like one would expect, the more massive the object, the bigger the amplitude. Additionally, just like the waves on the surface of the lake lose height the further they propagate, so too do gravitational waves diminish in amplitude the further they travel. Indeed, despite being catastrophic events involving extremely massive celestial objects, because of their distance to us, by the time they reach us, the gravitational waves are minuscule. These last facts which are the reasons for the expected tininess of the gravitational waves that are measured by the gravitational observatories are also the reasons why their detection was such a challenge.

However, contrary to our common knowledge of the production of ripples on the surface of a body of water, gravitational waves are generated in a slightly different way. In fact, in order to radiate gravitational waves an object needs to be non-spherical and in rotation in order to produce a perturbation or to undergo an accelerated motion, i.e. a variation of the velocity vector –either by varying its speed (like with common notions of acceleration or deceleration) or by varying its direction (like being in orbit). These results come from solving the Einstein Field Equations:

$$R_{\mu\nu} - \frac{1}{2}Rg_{\mu\nu} + \Lambda g_{\mu\nu} = \frac{8\pi G}{c^4} T_{\mu\nu}$$

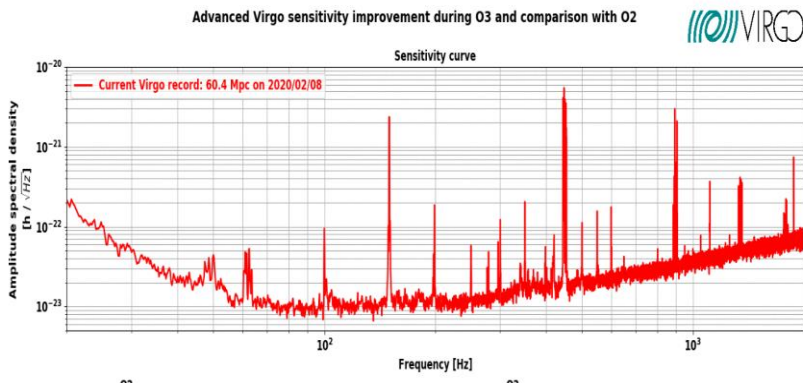
Where  $R_{\mu\nu}$  is the Ricci curvature tensor,  $R$  is the scalar curvature,  $g_{\mu\nu}$  is the metric tensor,  $\Lambda$  is the cosmological constant,  $G$  is Newton’s gravitational constant,  $c$  the speed of light and  $T_{\mu\nu}$  is the stress-energy tensor which basically describes the density of energy and momentum in spacetime.

This relation represents another point where our analogy breaks down as it describes that “Space tells matter how to move” and “Matter tells space how to curve” (Misner 1973, p.5) and therefore the anti-substantialism ontological belief that space(time) and matter are inextricably coupled (Cfr. Slowik 2005); contrary to objects at the surface of the lake which can still exist independently from it.

In fact, the study of gravitational waves is not only a new window for both Astronomy and Cosmology with deep meaning for Physics, its ontology and further confirmations of the validity of two of our best descriptions of reality; it is a whole new frontier of physics.

While gravitational waves were the last prediction of General Relativity to be confirmed, somewhat ironically their detection also relied on Quantum Mechanics which is another field of Physics famously said to be incompatible with General Relativity. The detectors themselves are nothing but technological prowesses and feats of ingenuity able to measure variations of distances of the order of  $10^{-21}$  m –for comparison, the radius of a proton is approximately  $10^{-15}$  m– produced by signals originating from inconceivably far away. e.g. the record sensibility for Binary Neutron Star mergers of the Virgo detector corresponded to a sphere of 60.4 Mpc on February, 8<sup>th</sup> 2020 (Cfr. Fig. 2, below); which is approximately equivalent to 196’998’452 light years. Furthermore, it is not uncommon for the gravitational wave detectors to have a sensibility range up to 10 times better for Binary Black Hole mergers as they involve much stronger signals (Cfr. Section 4.6).

The physics, principles and characteristics behind the gravitational wave detectors will be developed respectively in Chapter 1 and 4.



**Fig. 2** Screenshot of the Virgo sensitivity Binary Neutron Star system Range | Credit: EGO/Virgo Collaboration| Source: <https://www.virgo-gw.eu/status.html>

Furthermore, thanks to the success of the collaboration, the number of gravitational wave observatories will increase in the near future. Indeed, the

next logical steps are to multiply the number of detectors both to increase the sensibility of the network and to cover the whole spectrum of gravitational radiation, to increase their performance with new upgrades and to push the development of novel technologies forward.

The first observing runs have already yielded interesting and surprising results. For instance, some of them recently found out, anticipated or discussed:

- GW190412 – A coalescence of two Black Holes with a significant difference in masses (LIGO Scientific Collaboration, Virgo Collaboration 2020)
- GW190814 – A coalescence of a Black Hole of 23 Solar masses and a compact object of a mass of 2.6 Solar masses at the theoretical mass limit between Neutron Star and Black Hole (Abott 2020)
- The problem of the Hubble Tension – which is a problem regarding significant discrepancies in the values of the Hubble constant<sup>2</sup> depending on independent methods for measuring it. (Jeong 2020)
- The possibility of studying the composition of neutron stars (Chatziioannou 2020)
- Research on Primordial gravitational waves – gravitational waves from the early Universe (Giarè 2020)
- The time difference between lensed gravitational waves and light from a source emitting them simultaneously (Suyama 2020)

While most of them are attached to the fields of Astronomy and Cosmology, there were also advances in Quantum Mechanics, e.g. (Yu 2020); the scope of the topic of gravitational waves being in fact very wide both in terms of fields of study and, as a natural consequence of this, in terms of potential discoveries. For instance, now that measuring gravitational waves has been made possible, besides an increased number of detections for the next runs and a higher degree of precision in regards of the sky localization of the sources thanks to the addition of more gravitational wave observatories to the gravitational waves detector network, it is hoped that measuring primordial gravitational waves will eventually become possible thanks to future gravitational wave detectors sensible to other frequencies (Campeti 2020).

Indeed, the hope is to be able to measure gravitational waves emitted right after the Big Bang in order to study the first instants of the Universe. This is particularly important for Cosmology as we are currently restricted in our optical observations of the early stages of the Universe at around 370 000 years after the Big Bang occurred. This correspond to observations of the Cosmic Microwave Background (CMB), often presented as the afterglow of

---

<sup>2</sup> The Hubble constant is the constant measured in km/s/Mpc corresponding to the rate of expansion of the Universe.

the Big Bang, since it is estimated that during that time all the matter in the Universe was in a dense plasma state in which light could not travel very far freely until the Universe itself had expanded enough to become transparent and let light travel freely. Hence, making any optical observation of the Universe prior to this epoch impossible since the farthest back in time we can see is the CMB.

However, unlike electromagnetic waves which can be stopped by matter, gravitational waves are spacetime perturbations and can propagate through matter without any trouble. Observing these primordial gravitational waves which are thought to have been travelling through the Universe since as early as  $10^{-24}$  seconds after the Big Bang, is expected to yield results putting further constraints on theories and models preoccupied with the first moments of the Universe and therefore confirming and/or infirming some of them and their predictions.

Furthermore, it is thought that gravitational waves produced then could have been traveling ever since, generating a “Stochastic Background of Gravitational Waves” still observable today and therefore making it possible to go beyond the limit drawn by the CMB and study the Universe before it became transparent to light (Easter 2007).

Moreover, an ever greater number of discoveries are expected to happen in the future thanks to multimessenger astronomy which consists of coordinated observations of different types of signals. For instance, in the case of Binary system mergers, gravitational wave signals are emitted perpetually until the coalescence. However, the signals only become strong enough in the very last instants of the events when the two objects are very close and orbiting extremely fast around each other. Nevertheless, ideally, a gravitational wave signal and its source’s sky localization could be identified fast enough to send an alert to astronomers so that they could position their telescopes adequately and observe the event.

## **A Specific Introduction to My PhD Thesis**

My PhD research concerns a) history of the discovery of gravitational waves<sup>3</sup> and b) how the results of this discovery influenced physics—and—mathematics curricula teaching (especially at University). This research is based on an interdisciplinary framework composed of Physics, History of Science, Historical Epistemology of Science (Agassi 1965; Barbin 2013) and Nature of Science Teaching (hereafter NoS).

The problematic revolves around history of physics in the field & the difficulties around the teaching of physical concepts, which are complex from different point of views: theoretical, historical, physical and of course epistemological practical obstacles; the case study of the history of the discovery of gravitational waves and their physics (Misner 1973) being an example. This doctoral research is an attempt to open the road and to discuss

---

<sup>3</sup> A list of selected authors on the subject: Renn 2011; Cervantes-Cota 2016, 2018; DeWitt 2016; Kennefick 2019; Weisberg 2004.

how and when we can teach the physics of gravitational waves (Einstein 1918; Bondi 1957) and how the framework of the Nature of Science Teaching (Galili 2001, 2008; McComas 2002, 1998) is adequate for this task.

## 1. The Purposes

I intended to complete multiple objectives. First of all, I analysed and developed a historical—and—contemporary account on the historical subject in the field of modern physics; collecting scientific and historical data and constructing a synthesis of the principal facts & events which allowed the scientific knowledge (Bachelard 1934, 1940; Duhem 1906; Mach 1898, 1911) to grow from the roots of the concepts to the actual measurements.

From a foundational standpoint, I examined in order the role played by the development of non-Euclidean geometry (Riemann 1868; Clifford 1870, 1873, 1873b, 1976, 1901) and the geometrization of physics from physical–epistemological and historical points of view (Kouneiher 2005, 2018).

To do so, I have been, a) examining the role played by mathematics (Yildiz 2013) and physics in the methodological physical aspects/measurements within the history of gravitational wave discovery, b) examining the role played by the relationship between physics–mathematics (Lakatos 1971, 1980) along their modelling within new results in gravitational waves inquiring, c) examining the scientific and science/society role played by various scientists (Radelet-de Grave 2010) in the physics of waves and gravitation and d) examining the role played by the design and the technical studies (Radelet-de Grave 2012) by those scientists and the engineers that led to the discovery of gravitational waves.

Secondly, I developed a nature of science teaching account/curricula (Cfr. Braund 2006) by applying historical, physical and foundations of the Nature of Science results for teachings through an *ad hoc* curricula. Mainly about e) being able to evaluate how we can teach the physics of gravitational waves within a NoS perspective, f) to rethink the historical accounts concerning the development of the concepts at the roots of the discovery and the less-known scientists' views on those concepts, both from physical and epistemological points of view, g) to explore the role played by various scientists on the subject and to design Physics & History of Physics Teachings, and h) to help raise awareness on the matter and disseminate the results both for teaching purposes and as part as our cultural duty of remembrance; to examine the role played by mathematics/physical aspects/measurements within gravitational waves.

## 1.1 General Objectives

I examined the needs for teaching a particular concept, gravitational waves, a) to justify why this particular concept is relevant at university and even at a high school level, b) to propose *ad hoc* NoS Teaching curricula and c) to study the effectiveness of these curricula.

Nature of Science Teaching promotes learning by providing solid foundations rooted in reality through the use of concrete examples which can be used for didactic (Chevallard 1985) and pedagogical purposes. In particular, it is a question of having an analytical approach to the history of the genesis of modern physics from the pedagogical and didactic points of view of a specific theme with a rigorous and historical approach to the disciplines of scientific education (physics, mathematics, epistemology; Cfr. DiSessa 2011). Recent studies have shown (Radford 1997; Yildiz 2013) that the establishment of a historical perspective in science teaching is also a source of motivation for the learners and the teachers and that the historical content should focus on the learning process with an epistemological point of view; ontology and evolution of notions and theories, and conditions regarding the construction of knowledge. Thus I produced an *ad hoc* NoS Teaching curriculum on the history of the discovery of gravitational waves.

In the case study of the history of the discovery of gravitational waves and the roots of the concepts involved, the key is to identify the different steps of the cognitive development and identifying the Epistemological obstacles relevant to the theoretical framework considered<sup>4</sup>. In general, the choice should be guided by the determination of the epistemological obstacles on which the didactical transposition depends without, of course, neglecting the usual variables (culture, social background, institutional background, cognitive and emotional aspects, etc. (Radford 1997; Bage 1999; Reif 2008). Thus, I explored the common misconceptions and main epistemological obstacles in the field in order to design the curricula.

## 1.2 Specific Objectives

The specific objective of this thesis was to evaluate how and how soon gravitational waves physics can be taught. But also to study why teaching the physics of gravitational waves is important and more and more relevant; and how to effectively achieve an introductory teaching for audiences of different levels according to the scientific studies and literature in diverse fields<sup>5</sup>.

The object of this research, gravitational waves, is clearly not an easy concept to master, or even just grasp (Carmichael 1990; Caramazza 1981).

---

<sup>4</sup> A list of selected of authors: Piaget 1927, 1970; Daw 2008; Gallistel 2011; Goldman 1986; Goswami 2008.

<sup>5</sup> A list of selected of authors: Katsanevas 1986, 1993, 1995, 1998; Goswami 2008; Lampin 2013; Landuzzi 2020; Karam 2015; Kaur 2017

As their name suggests, gravitational waves can be understood as a physical object that encompasses both waves and gravitation, but also Relativity, which are topics already taught in High School (Cfr. curricula sources), therefore, a study of gravitational waves could very well be used as some kind of synthesis of the three.

However, even if this duality gravitation-waves is palpable, in order to properly comprehend the subject, one has to understand that gravitational waves are not actually waves of gravitation, but rather the propagation of deformations or perturbations of *spacetime*. In fact, the main difficulty resides here, in the conceptual jumps (Carey 1985, 1986) one has to do (epistemological obstacles) when considering *spacetime* (Cfr. Friedmann 1922); a concept at the core of both Special (Arlego 2017; Logunov 2005) and General Relativity. However, while delving directly into considerations such as *spacetime*, the warping of the fabric of the Universe, might seem attractive or even a fun experience in perspective to some, the subject remains one of the most advanced and complex theoretical description of reality on astronomical scales.

In part one, instead of beginning with the Theory of Relativity, it seemed more appropriate to begin with a simpler object of study. Hence, and because gravitational waves are waves, a good starting point is the study of waves. In this first part of the thesis, I will examine the main physical properties and theories related to waves and their study in order to have a stepping stone on which we will then be able to build. This section is essentially there for non-physicists readers and non-specialists.

In part two, I will explore broad outlines of the history of waves and the case of gravitation. In order to understand the history of the discovery of gravitational waves, firstly I worked on the theory, how the concepts developed, how new advancements were made and how paradigms shifted (cfr. Kuhn 1962; Nersessian 2003 | Brownlee 2003; Dykstra 1992; Liston 1996). As I scratched the surface of what gravitational waves are and represent for the future of physics in chapter one, we need to have a respectably deep comprehension of two fundamental concepts: waves, through the Physics of Waves; and spacetime, through the relativities and the theory of gravitation. These fundamental concepts, themselves rely on other concepts that originate more or less further in time. As the earliest science itself appeared<sup>6</sup>, the first explanations of nature came along.

On one hand, gravitation find its roots in the study of falling bodies by Galileo Galilei (1564-1642; 1890, 2005; Cfr. Radelet-de Grave 1999; Marcacci 2009, 2015) and his principle of relativity and then with Isaac Newton (Newton [1713],1729; [1726; 1739-1742], 1687, 1833, 1999); while the first traceable attempts at explanation date as far back as the pre-Socratic with natural philosophy and the theory of elements and their natural place (Cfr. Cohen 1994). In order to understand the concept of spacetime, we first need to have a better understanding of geometry. Initially, starting with

---

<sup>6</sup> A list of selected of authors: Aristotle 1979; Marcacci 2005, 2005, 2008; and for Aristotelian Physics, Cfr. DiSessa 1982, Crapanzano 2018; McLaren 2013; McGrath 2010, 2012.

Euclidean geometry which was developed during Antiquity; it is the first type of geometry developed (for “flat” spaces), to get a better grasp of more advanced ideas such as curved spaces or non-Euclidean geometries.

In particular with Bernhard Riemann (1826-1866; Cfr. Monastyrsky 2008) and William Kingdon Clifford (1845-1879; 1870, 1873, 1873b, 1875, 1879, 1882, 1901, 1976; Atiyah 1964); then with a *geometrization of Physics* with Albert Einstein<sup>7</sup> (Einstein 1916, 1918, 1920, 1937)’s theory and finally with the development of the ideas<sup>8</sup> that lead to the gravitational waves observatories, the Nobel Prize in Physics 2017, and the recent discoveries they brought (Abbott 2016a, 2016d, 2016f, 2016o; Hellings 1983).

On the other hand, the history of the physics of waves is quite peculiar because of the notion of waves itself. The notion of waves remained unclear for the longest of times as its abstract comprehension and the formalization of a framework to study them was very obscure. In fact, the notion of waves rely upon other notions such as periodicity or vibrations and oscillations the latter two of which were (sort of) thrown into the “violent motion” category of the theory of elements and basically ignored as scholars turned a blind eye to it. The most basic example of waves encountered in everyday life were the waves at the surface of the ocean: the explanation for this phenomenon was simply the action of wind on water and needed no further explanation. Furthermore, the undulatory nature of seismic waves and soundwaves remained unclear even though they were also a source of questioning at that time: seismic events were perceived as originating from underground phenomena; and sound was mainly studied through musicology.

Finally, in part three, I will examine the framework of NoS Teaching comparatively with disciplinary didactics and how it can be used for the case study of gravitational waves and in part four, I will evaluate the effectiveness of the developed *ad hoc* curricula. First with comparative didactics, which seek to study the interplay of disciplinary didactics. The idea being to compare disciplinary didactics in order to identify the common and specific parts which depend both on the teaching and learning objects and on the interactions between the elements of the studied system (content, teacher, learners)<sup>9</sup> and perspectives (Ploj Vrtič 2009b, 2014, 2016). Then by selecting the right approach for the NoS teaching of gravitational waves; and finally by analysing the results yielded by the pre-tests and post-tests realized respectively before and after the Introductory lecture to gravitational waves physics and discovery.

Each disciplinary didactics has its own history; which is explained on the one hand by the institutional environment with a separation of the different subjects of study (e.g., Languages, Civic Education, Science, Physical Education, Plastic Arts) themselves subdivided into different subjects (e.g., French, English, Spanish, Mathematics, Physics, Biology); and on the other

---

<sup>7</sup> A list of selected authors on Albert Einstein: Bracco 2006, 2015, 2017, 2018; Clark 2011; Kenefick 2007, 2019.

<sup>8</sup> Cfr. Weber 1960, 1969, 1970; Schutz 1989; Saulson 1994; Bartusiak 1998; Trimble 2017.

<sup>9</sup> Cfr. Maurines 2003; Sensevy 2002, 2013, 2018; Morellato 2012; Brun 2017; Ligozat 2017; Romero 2017; Guisasaola 2005.



hand by their different epistemological foundations (Sarremejane 2001; Sensevy 2013).

At present, the different disciplinary didactics are differentiated precisely by their object: the discipline they study, which has the consequence of greatly restricting the global vision, or the number of facets in which an object or content can be perceived and studied (for example, think of the different nuances that exist for mathematicians and physicists when asked to consider derivatives). However, the theoretical framework of NoS is a naturally interdisciplinary framework (conceived and designed as such).

The idea here is therefore to identify the specificities of the different disciplinary didactics conveyed by the NoS framework and to combine them as best as possible with each other and with related disciplines; therefore it will be a question of taking a point of view focusing on content and its teaching–learning (Crapanzano 2018), rather than a more restricted point of view taking into account educational institutions and learning environments, in order to widen the horizon linked to the objects, concepts and knowledge taught in order to best study the epistemological perspectives offered by the prism of NoS within the framework of educational sciences. In other words, it is a matter of trying as best as possible to have a global vision and of avoiding some sort of disciplinary isolation while delimiting the field of research so as to achieve a certain balance between the different fields studied and their interactions; it is not a question of trying to study or develop a kind of universal didactics, but rather to do research within the framework of the nature of science more on the substance than the form.

This subject of gravitational waves and the history of their discovery alone calls upon a certain number of disciplines (e.g., physics, mathematics, history, epistemology) and its teaching invokes even more of them (e.g., psychology, neurosciences, philosophy)<sup>10</sup>.

The comparison will therefore be made on the disciplinary teachings and learnings as they are described by the didactics, by comparing in particular concepts common to several disciplines (Sensevy 2002, Ligozat 2017), their differences in use (Dias-Chiaruttini 2017e) and their foundations: e.g., epistemological obstacles, didactic transposition; joint action theory (Brun 2017).

It will also include describing different possibilities of interactions between content and learners in the theoretical framework of NoS and describing how the specifics of disciplinary content, which are at the basis of each didactic discipline, interact or merge in this teaching–learning framework (Sensevy 2018).

Finally, it will be a question of explaining the choice of the conceptual system applied to this theoretical framework trying to combine the specificities of different didactics, which is *a priori* justified by the epistemological foundations and the multidisciplinary nature of NoS.

---

<sup>10</sup>A list of selected of authors: Matthews 1992; Carew 2010; Willis 2010; Marcacci 2015a ; Buonomano 2017; Condé 2017.

## 2. On the Gravitational Waves: The State-of-the-Art

The first direct measurement of gravitational waves was on September 14, 2015 at 09:50:45 UTC by the LIGO–Virgo Scientific collaboration. This detection was achieved thanks to the advancement of cutting edge technology and technical prowess as well as the development of the theoretical frameworks involved. Since this detection, the methods and data for the measurement of gravitational waves continue to evolve with each improvement and upgrade of the detectors and new projects.

Selected for a Viewpoint in *Physics*  
 PHYSICAL REVIEW LETTERS  
 week ending  
 12 FEBRUARY 2016

### Observation of Gravitational Waves from a Binary Black Hole Merger

B. P. Abbott et al.  
 (LIGO Scientific Collaboration and Virgo Collaboration)  
 (Received 21 January 2016; published 11 February 2016)

On September 14, 2015 at 09:50:45 UTC the detectors of the Laser Interferometer Gravitational-Wave Observatory simultaneously observed a transient gravitational-wave signal. The signal shows signals in frequency from 35 to 250 Hz with peak gravitational-wave strain of  $1.0 \times 10^{-21}$  in multiple waveforms predicted by general relativity for the inspiral and merger of a pair of black holes and the ringdown of the resulting single black hole. The signal was observed with a matched filter signal-to-noise ratio of 24 and a false alarm rate estimated to be less than 1 event per 200 000 years, equivalent to a significance greater than 5.1 $\sigma$ . The source has a luminosity distance of  $410^{+120}_{-180}$  Mpc corresponding to a redshift  $z = 0.09^{+0.01}_{-0.02}$ . In the source frame, the initial black hole masses are  $56^{+8}_{-9} M_{\odot}$  and  $36^{+5}_{-4} M_{\odot}$ , and the final black hole mass is  $62^{+9}_{-8} M_{\odot}$ , with  $1.9^{+0.3}_{-0.4} M_{\odot}$  radiated in gravitational waves. All uncertainties define 90% credible intervals. These observations demonstrate the existence of binary stellar-mass black hole systems. This is the first direct detection of gravitational waves and the first observation of a binary black hole merger.

DOI: 10.1103/PhysRevLett.116.061102

#### 1. INTRODUCTION

In 1916, the year after the final formulation of the field equations of general relativity, Albert Einstein predicted the existence of gravitational waves. He found that the linearized weak field equations had wave solutions: transverse waves of spatial strain that travel at the speed of light, generated by time variations of the mass quadrupole moment of the source [1, 2]. Einstein understood that gravitational wave amplitudes would be remarkably small; moreover, until the Chapel Hill conference in 1957 there was significant debate about the physical reality of gravitational waves [3].

Also in 1916, Schwarzschild published a solution for the field equations [4] that was later understood to describe a black hole [5, 6], and in 1963 Kerr generalized the solution to rotating black holes [7]. Starting in the 1970s theoretical work led to the understanding of black hole quasinormal modes [8–10], and in the 1980s higher-order post-Newtonian calculations [11] preceded extensive analytical studies of relativistic two-body dynamics [12, 13]. These advances, together with numerical relativity breakthroughs in the past decade [14–16], have enabled modeling of binary black hole mergers and accurate predictions of their gravitational waveforms. While numerical black hole calculations have now been identified through astronomical observations [17–19], black hole mergers have not previously been observed.

The discovery of the binary pulsar system PSR B1513–16 by Hulse and Taylor [20] and subsequent observations of its energy loss by Taylor and Weisberg [21] demonstrated the existence of gravitational waves. This discovery, along with emerging astrophysical understanding [22], led to the recognition that observations of the amplitude and phase of gravitational waves would enable studies of additional relativistic systems and provide new tests of general relativity, especially in the dynamic strong-field regime.

Experiments to detect gravitational waves began with Weber and his resonant mass detectors in the 1960s [23], followed by an international network of cryogenic resonant detectors [24]. Interferometric detectors were first suggested in the early 1960s [25] and the 1970s [26]. A study of the noise and performance of such detectors [27], and further concepts to improve them [28], led to proposals for long-baseline broadband laser interferometers with the potential for significantly increased sensitivity [29–32]. By the early 2000s, a set of initial detectors was completed, including LISA, VIRGO in Italy, GEO600 in Germany, the Laser Interferometer Gravitational-Wave Observatory (LIGO) in the United States, and Virgo in Italy. Construction of these detectors made joint observations from 2002 through 2011, setting upper limits on a variety of gravitational-wave sources while evolving into a global network. In 2015, Advanced LIGO became the first of a significantly more sensitive network of advanced detectors to begin observations [33–36].

A century after the fundamental predictions of Einstein and Schwarzschild, we report the first direct observation of a binary black hole system merging to form a single black hole. Our observations provide unique access to the

Full text link given at the end of the article.  
 Published by the American Physical Society under the terms of the Creative Commons Attribution 3.0 license (<https://creativecommons.org/licenses/by/3.0/>). Images of the work must maintain attribution to the author(s) and the published article's title, journal citation, and DOI.

0031-9007/16/116(6):061102(6)

061102-1 Published by the American Physical Society

PHYSICAL REVIEW LETTERS  
 week ending  
 12 FEBRUARY 2016

properties of space time in the strong field, high-velocity regime and confirm predictions of general relativity for the nonlinear dynamics of highly distorted black holes.

#### II. OBSERVATION

On September 14, 2015 at 09:50:45 UTC, the LIGO Hanford, WA, and Livingston, LA, observatories detected

the gravitational signal GW150914 shown in Fig. 1. The initial detection was made by low-latency searches for generic gravitational-wave transients [41] and was repeated within three minutes of data acquisition [43]. Subsequently, matched-filter analyses that use relativistic models of compact binary waveforms [44] recovered GW150914 as the most significant event from each detector for the observation period seen. Occurring within the 10-min. interval

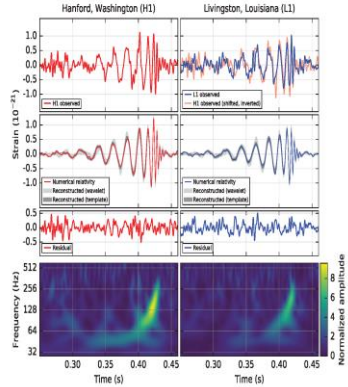


FIG. 3. The gravitational-wave event GW150914 observed by the LIGO Hanford (H1, left column panels) and Livingston (L1, right column panels) detectors. Time was shown relative to September 14, 2015 at 09:50:45 UTC. For visualization, all time series are filtered with a 35–250 Hz bandpass filter to suppress large fluctuations outside the detectors’ most sensitive frequency band, and bandpass filters to remove the strong instrument spectral lines seen in Fig. 3 spectra. Top row, left–H1 strain; Top row, right–L1 strain; GW150914 strain from L1 and L2 (red) and H1, for a visual comparison; the H1 data are also shown, shifted in time by the amount and inverted to account for the detectors’ relative orientations. Second row–Gravitational-wave strain projected onto each detector in the 35–250 Hz band. Solid lines show numerical relativity waveforms for a system with parameters consistent with those recovered from GW150914 [37, 38], constructed to 99.9% by an independent calculation based on [15]. Shaded areas show 90% credible regions for two independent waveform reconstructions. Our (black gray) models the signal using binary black hole template waveforms [19]. The other (right gray) lines are not an astrophysical model, but instead calculate the strain signal as a linear combination of zero-Gaussian waveforms [41]. These reconstructions have a 94% overlap, as shown in [35]. Third row–Residuals after subtracting the filtered numerical relativity waveforms from the filtered detector time series. Bottom row–A time-frequency representation [42] of the strain data, showing the signal frequency increasing over time.

**Fig. 3** B. P. Abbott et Collaborations (LIGO Scientific Collaboration and Virgo Collaboration)

Physical Review Letters 116, 061102, pp. 1-2. | Creative Commons Attribution 3.0 |

Source: <https://doi.org/10.1103/PhysRevLett.116.061102>

This new field represents a new tool for astronomy and cosmology and it has already contributed to further our knowledge and comprehension of the universe thanks to the study of the properties of the binary black hole mergers, the astrophysical implications of binary black hole mergers, further testing of General Relativity and much more (Abbott 2016a, 2016d, 2016f, 2016g). Although gravitational waves have been predicted a long time ago to be a consequence of General Relativity (Einstein 1918), the concept of gravitational wave itself is even older and a huge part of the theoretical research on the subject has been made prior the actual discovery of 2015. This new ability to measure gravitational waves and thus observe the universe in a new way represents an opportunity to do research in a field in

rapid expansion; furthermore, with the growth of the field will undoubtedly come the need to have more researchers working on the matter. Thus, this thesis represents an attempt to elaborate a curricula as accessible as possible using the framework of the Nature of Science dedicated to this issue. The readers will find an extensive part on the subject in section 4.6.

## 2.1 Methods & Data

On a fundamental level, the concept of gravitational waves relies on two general concepts: waves and gravitation. Both the Physics of Waves and Gravitation represent huge fields of study in Physics which have been studied since the very beginning of Science<sup>11</sup>.

The physics of Waves is a very wide-ranging subject, that has mainly been developed somewhat indirectly through the study of other disciplines which it encompasses such as, i.e., musicology (Von Helmholtz 2010), the study of light, e.g. by Huygens (1629-1695; 1912), Hooke (1635-1703; 1665), Euler (1707-1783; 1746), Fourier (1768-1830; 1824), Young (1773-1829; 1800) and Fresnel (1788-1827; 1866-1870), while Gravitation was studied through the science of weights with notably Galileo (Tartaglia 1845-1846; Galilei 1890; 2005; and Abattouy 2006; 2018; Koyré 1996; Pisano and Capecchi 2013, 2015; Pisano 2011, 2012, 2013, 2013a, 2014, 2014a, 2014b, 2015b, 2016; Pisano, Capecchi and Lukešová 2013), and then as a type of force with Kepler (1571-1630; 1596, 1906; 1937, 1929) and Newton (1642-1727; [1713], 1729, [1726; 1739-1742], 1687, 1833, 1999) until Einstein's theories (Einstein 1916, 1918, 1920, 1937).

Based on the international secondary literatures (Cfr. Bibliography sections) and my aims, I made the methodological—and—content choice of inquiring:

- a) The history of the concepts at the core of our modern understanding of gravitational waves,
- b) The lesser known aspects of the History of the Physics of Waves and Gravitation that lead to the concepts involved in the discovery of gravitational waves, since covering the whole history that led to the discovery is probably more than one could accomplish in a lifetime.
- c) Nature of Science Teaching

The change of environment in the field of physics provide a new, fresh and fertile terrain with great educational potential. Indeed, thanks to the fact that much ink has been spilled over the history of modern science, it contains many concrete examples. Moreover, gravitational waves and their history are now trending. With topics yet to be explored in the light of the new results

---

<sup>11</sup> A list of selected of authors: Aristotle 1979; Kepler 1596, 1906, 1929, 1937; Newton [1713], 1729; [1726; 1739-1742], 1687, 1833, 1999; Einstein 1918; De Broglie 1924; Bondi 1957; and Cohen 1994; Russo 2004; Barker 2007; Elders 2013.

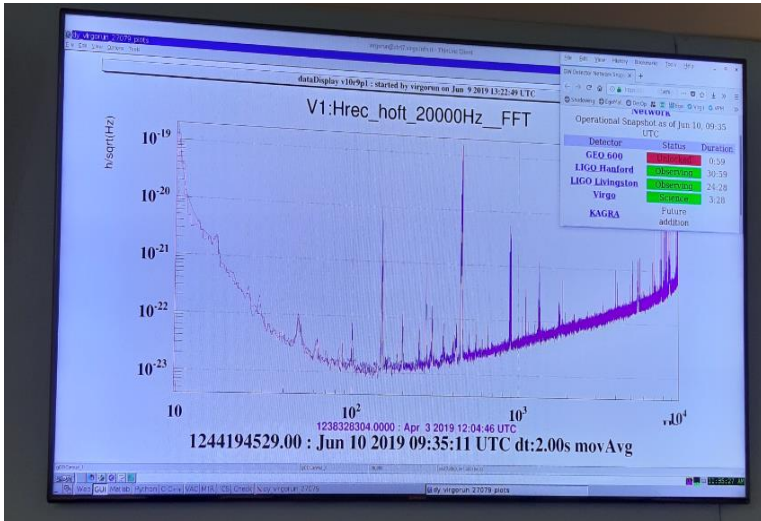
brought by the detection of gravitational waves and what they imply for our understanding of the universe as a whole comes the opening of a new field of research in cosmology. Indeed, since GW150914 (Detection, 2015, September 14; hereafter GW150914) the subject of gravitational waves has been the object of a several of historical studies in-and-around the field (Cfr. Galindo-Uribarri, Cervantes-Cota and Smoot 2016; Trimble 2017; Kennefick 2019) showing that the story of gravitational waves is very rich and very intricate. Thus my approach is part of an attempt to help untangle and clarify both the physics and the context of this history, but also to shed light on insights scientists had. In my opinion, doing so will serve many objectives, which are discussed further. In order to complete this task, I did both physics and historical research *in situ*. On one hand, at the Virgo detector in Cascina, near Pisa, where I was invited in June 2019, I had the opportunity to visit the facilities and talk with the very friendly (and incredibly kind) scientists there.

Below I present photos (Figs. 4-9) that I was granted permission to take of the facilities and interferometer. The Fig 4 is a photo of the control room. The Fig. 5 is a photo of a monitor displaying the real time sensitivity plot of the detector. The Fig. 6 is a photo taken from the clean room of the Injection System (IS). The Fig. 7 is a photo of myself wearing the protective equipment. The Fig. 8 is a photo of the Towers containing the superattenuators and mirrors. The Fig. 9 is a photo of a superattenuator on display in the main building.



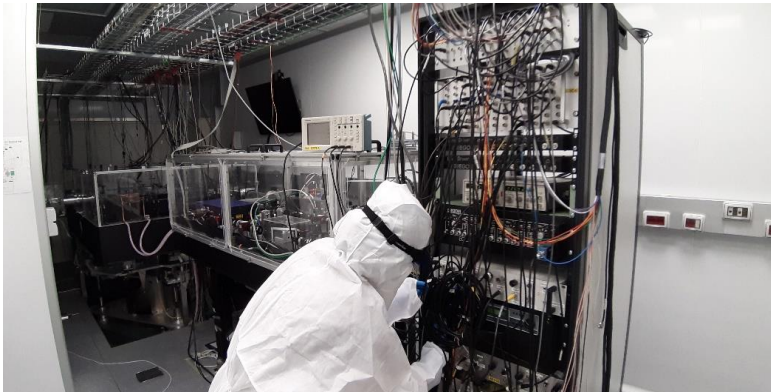
**Fig. 4** Photo of the Control Room of the detector with the duty team (left) and Julia Casanueva (my local guide).

Source: Photo taken by Philippe Vincent



**Fig. 5** Photo of the Virgo Sensitivity plot as of June 10, 2019. The sensitivity of the Advanced Virgo detector, as a function of the frequency (in the horizontal axis)  
Source: Photo taken by Philippe Vincent

The sensitivity of the Advanced Virgo detector, as a function of the frequency (in the horizontal axis). The sensitivity of the gravitational wave interferometer is of direct influence to the range at which the detector can perceive signals. The peaks are intrinsic to the design of the detector (for instance, due to the violin modes of the suspension system or to other physical effects such as quantum effects of light, Brownian motion in the mirrors, etc.).



**Fig. 6** Photo of Gabriel Pillant working in the clean room where the laser is located. The infrared laser (1064 nm) of the interferometer is inside the box on the left. The whole setup is located in a clean room to control the environment and avoid dust.  
Source: Photo taken by Philippe Vincent



**Fig. 7** Philippe Vincent self-portrait. This equipment’s function is to prevent dust from entering the clean room. The goggles are designed to protect the eyes of the wearer from being damaged by the laser (the laser is very powerful and despite being invisible to the naked eye, possible reflexions from the bench table can damage the eyes).  
Source: Photo taken by Philippe Vincent



**Fig. 8** Towers containing the superattenuators and the mirrors. The 5 towers are under vacuum and each contain a superattenuator from which the mirrors are suspended and controlled by the marionetta. The towers from left to right contain the: Power Recycling Mirror, (West) Input Mirror, Beam Splitter, (North) Input Mirror, Signal Recycling Mirror.  
Source: Photo taken by Philippe Vincent



**Fig. 9** A superattenuator on display in the Main building to show what is inside the towers. The superattenuators structures can be subdivided into three principal parts: the inverted pendulum (referred to as IP); the chain of seismic filters starting at filter0 to filter7 (the steering filter); and the payload (the marionette, the reference mass, and the mirror) The “marionette” is holding a mirror suspended by monolithic silica fibers.

Source: Photo taken by Philippe Vincent

I did important historical research at the Niels Bohr Library. I spent 3 weeks at the Niels Bohr Library of the *American Institute of Physics* located 1, Physics Ellipse road in College Park, MD. I studied and discovered documents relevant to the subject on gravitational waves. Indeed, this place is linked to a number of historical figures and events. For instance, the first gravitational wave detectors were bars (aluminum cylinders) built by Joseph Weber (1919-2000) who was a pioneer in the search for gravitational waves. These bars are displayed at the University of Maryland where a memorial was built in 2018 to honour Joseph Weber (cf. Photo below). This work was supported thanks to a grant-in-aid from the Friends of the Center for History of Physics, American Institute of Physics. More details on my consulting job at the two centres are below.



**Fig. 10** Joseph Weber Memorial Garden at the University of Maryland

Source: Photo taken by Philippe Vincent

## 2.2 An Early History

From an historical–epistemological standpoint a root of early and applied study in gravitational waves dates as far back as Bernard Riemann (1826–1866) and William Kingdon Clifford (1845–1879) including the no less important at that time concepts of non-Euclidean geometry and curved spaces (i.e. Riemann 1868; Clifford 1873, 1873b, 1875, 1879). Most research on the latter two scientists has focused on the mathematical standpoint only (Cfr. Cartan 1926; Atiyah 1964; Karoubi 1968; Tits 1968; Ghys 1999; Lounesto 2001). Others worked on the influences of Riemann’s work on physics (cfr. Monastyrsky 2008; Schumayer 2011). While very few dealt with physical space or the relationship between his mathematical findings and their implications for physics (Grünbaum 1973; Torretti 1978; Richards 1988; Pesic 2007); and even fewer have referred to Clifford’s conceptions (Yu Cao 1997; Cervantes-Cota 2016; 2018).

Riemann and Clifford’s research can be considered an early fundamental framework with respect to Einstein’s Relativities. The latter were still brewing at the turn of the century; the debate on the Relativity priority dispute (Logunov 2005; Pais 1982) is not our concern since tensor calculus was not yet developed in this period. Nevertheless, the first known mention of gravitational waves *per se* is attributed to Henri Poincaré (1854–1912) in his paper “*Sur la dynamique de l’électron*” of 1905 (Poincaré 1905, p. 1507). Below I present the page mentioning the term “gravitational wave” that Poincaré coined (Fig. 11) and an account of Poincaré’s idea by Émile Picard’s “*L’œuvre de Poincaré*” (Fig. 12).



SÉANCE DU 5 JUIN 1905.

1507

ces conditions, la compensation est complète, si l'on suppose que l'inertie est un phénomène exclusivement électromagnétique, comme on l'admet généralement depuis l'expérience de Kaufmann, et qu'à part la pression constante dont je viens de parler et qui agit sur l'électron, toutes les forces sont d'origine électromagnétique. On a ainsi l'explication de l'impossibilité de montrer le mouvement absolu et de la contraction de tous les corps dans le sens du mouvement terrestre.

Mais ce n'est pas tout : Lorentz, dans l'Ouvrage cité, a jugé nécessaire de compléter son hypothèse en supposant que toutes les forces, quelle qu'en soit l'origine, soient affectées, par une translation, de la même manière que les forces électromagnétiques, et que, par conséquent, l'effet produit sur leurs composantes par la transformation de Lorentz est encore défini par les équations (4).

Il importait d'examiner cette hypothèse de plus près et en particulier de rechercher quelles modifications elle nous obligerait à apporter aux lois de la gravitation. C'est ce que j'ai cherché à déterminer; j'ai été d'abord conduit à supposer que la propagation de la gravitation n'est pas instantanée, mais se fait avec la vitesse de la lumière. Cela semble en contradiction avec un résultat obtenu par Laplace qui annonce que cette propagation est, sinon instantanée, du moins beaucoup plus rapide que celle de la lumière. Mais, en réalité, la question que s'était posée Laplace diffère considérablement de celle dont nous nous occupons ici. Pour Laplace, l'introduction d'une vitesse finie de propagation était la *seule* modification qu'il apportait à la loi de Newton. Ici, au contraire, cette modification est accompagnée de plusieurs autres; il est donc possible, et il arrive en effet, qu'il se produise entre elles une compensation partielle.

Quand nous parlerons donc de la position ou de la vitesse du corps attirant, il s'agira de cette position ou de cette vitesse à l'instant où l'onde gravifique est partie de ce corps; quand nous parlerons de la position ou de la vitesse du corps attiré, il s'agira de cette position ou de cette vitesse à l'instant où ce corps attiré a été atteint par l'onde gravifique émanée de l'autre corps; il est clair que le premier instant est antérieur au second.

Si donc  $x, y, z$  sont les projections sur les trois axes du vecteur qui joint les deux positions, si la vitesse du corps attiré est  $\xi, \eta, \zeta$ , et celle du corps attirant  $\xi_1, \eta_1, \zeta_1$ , les trois composantes de l'attraction (que je pourrai encore appeler  $X, Y, Z$ ) seront des fonctions de  $x, y, z, \xi, \eta, \zeta, \xi_1, \eta_1, \zeta_1$ . Je me suis demandé s'il était possible de déterminer ces fonctions de telle

Thus when we will talk about the position or the speed of the attracting body, it will be this position or this speed at the moment where the *gravitational wave* left this body; when we will talk about the position or speed of the attracted body, it will be this position or this speed at the moment where the attracted body has been reached by the gravitational wave emitted by the other body; it is clear that the first instant is preceding the second.<sup>12</sup>

(Author's Translation)

**Fig. 11** Sur la dynamique de l'électron. Note de H. Poincaré.

Public domain:

[https://www.academiesciences.fr/pdf/dossiers/Poincare/Poincare\\_pdf/Poincare\\_CR19\\_05.pdf](https://www.academiesciences.fr/pdf/dossiers/Poincare/Poincare_pdf/Poincare_CR19_05.pdf)

Therefore, considering the historical importance of Clifford and Poincaré's works in regard to the fundamentals of the conception of gravitational waves, and for the first time a historical comparative analysis between them is presented.

<sup>12</sup> "Quand nous parlerons donc de la position ou de la vitesse du corps attirant, il s'agira de cette position ou de cette vitesse à l'instant où l'onde gravifique est partie de ce corps; quand nous parlerons de la position ou de la vitesse du corps attiré, il s'agira de cette position ou de cette vitesse à l'instant où ce corps attiré a été atteint par l'onde gravifique émanée de l'autre corps; il est clair que le premier instant est antérieur au second." (Poincaré 1905, p. 1507).

L'ŒUVRE DE HENRI POINCARÉ. 17

cet esprit hypercritique, si j'ose le dire, dans certains écrits philosophiques de Poincaré.

Poincaré, sans cesse curieux de nouvelles théories et de nouveaux problèmes, ne pouvait manquer d'être attiré par l'Électromagnétisme qui tient une si grande place dans la Science de notre époque. On ne saurait trop admirer avec quelle sûreté et quelle maîtrise il repense les diverses théories, les faisant ainsi siennes. Il leur donne parfois une forme saisissante, comme quand, dans l'exposition de la théorie de Lorentz, il distingue entre les observateurs ayant les sens subtils et les observateurs ayant les sens grossiers. La considération, bien personnelle à Poincaré, de ce qu'il appelle « la quantité de mouvement électromagnétique », la localisation de celle-ci dans l'éther et sa propagation avec une perturbation électromagnétique sont venues rétablir d'importantes analogies. Le Mémoire sur la dynamique de l'électron, écrit en 1905, restera dans l'histoire du principe de la relativité; le groupe des transformations de Lorentz, qui n'altèrent pas les équations d'un milieu électro magnétique, y apparaît comme la clef de voûte dans la discussion des conditions auxquelles doivent satisfaire les forces dans la nouvelle dynamique. La nécessité de l'introduction dans l'électron de forces supplémentaires, en dehors des forces de liaison est établie, ces forces supplémentaires pouvant être assimilées à une pression qui régnerait à l'extérieur de l'électron. Poincaré montre encore quelles hypothèses on peut faire sur la gravitation pour que le champ gravifique soit affecté par une transformation de Lorentz de la même manière que le champ électromagnétique.

On sait l'importance qu'a prise aujourd'hui le principe de la relativité, dont le point de départ est l'impossibilité, proclamée sur la foi de quelques expériences négatives, de mettre en évidence le mouvement de translation uniforme d'un système au moyen d'expériences d'optique ou d'électricité faites à l'intérieur de ce système. En admettant, d'autre part, que les idées de Lorentz et ses équations électromagnétiques sont inattaquables, on a été conduit à regarder comme nécessaire le changement de nos idées sur l'espace et sur le temps; espace et temps ( $x, y, z$  et  $t$ ) n'ont plus leurs transformations séparées et entrent simultanément dans le groupe de Lorentz. La simultanéité de deux phénomènes devient une notion toute relative; un phénomène

The Memoir on the Dynamics of the Electron, written in 1905, will remain in the history of the principle of relativity; the Lorentz group of transformations, which are not altered by the equations of an electromagnetic medium, appears to be the keystone in the discussion of the conditions which forces must satisfy in the new dynamics. [...] Poincaré also shows what hypotheses can be made about gravitation so that the gravitational field is affected by a Lorentz transformation in the same way as the electromagnetic field.<sup>13</sup>

(Author's Translation)

**Fig. 12** *L'œuvre de Henri Poincaré, par Émile Picard* (Picard 1913a).

Source: *Niels Bohr Library*, Courtesy of the American Institute of Physics, USA.

Einstein's work and life (Pais 1982; Kennefick 2005, 2007, 2019; Isaacson 2008; Clark 2011; Bracco 2015, 2017, 2018; Pisano and Casolaro 2011, 2012) has been and still is very well investigated by countless studies. Nevertheless, in regards to the subject—and—objects of this thesis, recent scientific data in the field revolves around the existence of gravitational waves and the possibility of detecting (experimentally—modelling) them. Indeed, since their prediction as a potential consequence of General Relativity (hereafter GR), there have been some debates about their existence, even within Einstein's work and publications (Einstein 1937; Kennefick 2005). After that, the scientific community worldwide published less on General Relativity (Cfr. Eisenstaedt 1986a, 1986b, 1992); indeed, according to Jean Eisenstaedt and Anne Kox:

He [Eisenstaedt] found a peak [of publications on general relativity] after 1922, a rapid decline from 1925-1926 to 1930, and a not very pronounced second high in the beginning of the 1930s. Eisenstaedt's survey covers all countries. (Eisenstaedt 1992, p. 21)

<sup>13</sup> "Le Mémoire sur la dynamique de l'électron, écrit en 1905, restera dans l'histoire du principe de la relativité; le groupe des transformations de Lorentz, que n'altèrent pas les équations d'un milieu électro magnétique, y apparaît comme la clef de voûte dans la discussion des conditions auxquelles doivent satisfaire les forces dans la nouvelle dynamique. [...] Poincaré montre encore quelles hypothèses on peut faire sur la gravitation pour que le champ gravifique soit affecté par une transformation de Lorentz de la même manière que le champ électromagnétique." (Picard 1913a, p. 17).

and: “But beyond this long period of isolation, silence, after the death of Einstein in 1955, little by little general relativity will experience a renewed interest [...]”<sup>14</sup> (Author’s translation; Eisenstaedt 1986b, p. 117). Until the time that Joseph Weber started to study how to detect gravitational waves. In 1956 – during his sabbatical period – he studied General Relativity, discussed the problematic of the detection with Freeman Dyson (1923–2020) (Bartusiak 1998) and presented the subject at the Chapel Hill Conference of 1957 (Collins 2004; Renn 2011; Trimble 2017). This renewed the interest in the field and led Weber, inspired by the works of Walter Baade (1893-1960) and Fritz Zwicky (1898-1974) on supernovae, to develop his bars. I remark that despite his claims (Weber 1960, 1969, 1970), Joe Weber never actually detected gravitational waves. Below I present (Fig. 13) in which Weber presented a series of experiments involving his gravitational wave detectors.

VOLUME 20, NUMBER 23      PHYSICAL REVIEW LETTERS      3 JUNE 1968

GRAVITATIONAL-WAVE-DETECTOR EVENTS\*

J. Weber

Department of Physics and Astronomy, University of Maryland, College Park, Maryland  
(Received 4 April 1968)

A new series of experiments is described, involving two gravitational wave detectors spaced about 2 km. A number of coincident events have been observed, with extremely small probability that they are statistical. It is clear that on rare occasions these instruments respond to a common external excitation which may be gravitational radiation.

Two aluminum cylinders have been instrumented to record the Fourier transform of the Riemann tensor<sup>1,2,3</sup> in the vicinity of the angular frequency  $\omega = 10^4$  rad sec<sup>-1</sup>. One detector has a diameter of 2 ft, the other has a diameter of 8 in. Both are about 5 ft long. The larger cylinder employs cryogenic electronics and has been employed with a relatively fixed bandwidth  $\Delta\omega \approx 0.1$  rad sec<sup>-1</sup>. The smaller cylinder does not ordinarily employ cryogenics. Its electronics differ from that of the larger instrument in many respects, resulting in electronically adjustable bandwidth over a wide range, and adjustable center frequency.

These detectors are spaced about 2 km. An earlier<sup>4</sup> paper reported observation of coincident events. During the remainder of 1967 roughly one coincidence a month was noted. The relaxation time of these detectors is about 30 sec. Pen-and-ink recorders preceded by circuits averaging over more than the relaxation time were employed. The time resolution was about 1 min.

A gravitational wave detector is a harmonic oscillator driven by the Riemann curvature tensor. The response to a sudden increase in the driving force is a fast rise with decay governed by the relaxation time. It is therefore feasible to re-

solve signals from the two detectors with precision determined by our ability to resolve the leading edges of the response envelopes.

A two-channel coincidence detector was developed. An average of the envelope is taken over a short interval  $\tau$  in one channel. If a given threshold is crossed in the positive direction a pulse is generated. Similar functions are performed in the second channel. If the pulses overlap in time an output pulse is generated. Measurements indicated that only pairs of events with leading edges spaced closer than about 0.20 sec generated event-marker pulses. Experiments established that the large detector (with longest relaxation time) required ordinarily less than 0.20 sec between excitation and receiver output. A telephone line joins the small detector to the coincidence apparatus at the large detector site.

**Observation of events.**—During the past 3 months of operation, events were observed coincident at least to within 0.20 sec. For each coincidence I have listed in Table I the probability and frequency of a random coincidence with the same power. The probability of random coincidences was measured for the last two events listed in the following ways. A chart recorder gives

Table I. Observed coincidences January-March 1968.

Event	(Large-detector power)/mean	No. of large-detector events per day exceeding given power	(Small-detector power)/mean	No. of small-detector events per day exceeding given power	Probability of a random coincidence	Frequency of random coincidence	Date and Greenwich mean time
A	18	Too infrequent to determine by experiment	2.2	43	$7.7 \times 10^{-12}$	Once in 8090 yr	7 February 2101
B	11	Too infrequent to determine by experiment	2.2	43	$1.5 \times 10^{-12}$	Once in 40 yr	13 March 1150
C	6	40	2.3	39	$8 \times 10^{-7}$	Once in 300 d	29 March 0732
D	5	80	2.3	39	$1.6 \times 10^{-6}$	Once in 150 d	29 March 6358

1307

**Fig. 13** Gravitational-wave-detector events. Physical Review Letters, 20(23):1307.

Source: *Niels Bohr Library*, Courtesy of the American Institute of Physics, USA.

<sup>14</sup> “Mais au-delà de cette longue période d’isolement, de silence, après la mort d’Einstein en 1955, petit à petit la relativité générale va connaître un regain d’intérêt [...]” (Eisenstaedt 1986b, p. 117)

In fact, the first hint confirming their existence came in 1974 with the discovery of PSR B1913+16 (Hulse 1975) a pulsar (the Hulse-Taylor binary), which lead to the Nobel Prize in Physics 1993 "[...] for the discovery of a new type of pulsar, a discovery that has opened up new possibilities for the study of gravitation." awarded to Russel A. Hulse and Joseph H. Taylor Jr<sup>15</sup>. Indeed, after three decades of observation, the results (Weisberg 2004; Rasio 2005) showed that the orbital decay of the system – due to loss of potential energy of the orbiting bodies – was consistent with the corresponding amount of energy that was evaluated to be lost from the emission of gravitational radiation according to General Relativity laws:

*Relativistic Binary Pulsar B1913+16* 3

measured orbital parameter,  $\dot{P}_b$ , overdetermines the system dynamically and thus provides a test of gravitation theory.

### 3.1. Emission of Gravitational Radiation

According to general relativity, a binary star system should emit energy in the form of gravitational waves. The loss of orbital energy results in shrinkage of the orbit, which is most easily observed as a decrease in orbital period. Peters & Matthews (1963) showed that in general relativity the rate of period decrease is given by

$$\dot{P}_{b,GR} = -\frac{192\pi G^{5/3}}{5c^5} \left(\frac{P_b}{2\pi}\right)^{-5/3} (1-e^2)^{-7/2} \times \left(1 + \frac{73}{24}e^2 + \frac{37}{96}e^4\right) m_p m_c (m_p + m_c)^{-1/3}. \quad (1)$$

Note that except for Newton's constant  $G$  and the speed of light  $c$ , all quantities on the right hand side of Eq. (1) have measured values listed in Table 1, or, in the case of the component masses, are derivable from those quantities. The predicted orbital period derivative due to gravitational radiation computed from Eq. (1) is  $\dot{P}_{b,GR} = -(2.40242 \pm 0.00002) \times 10^{-12}$  s/s.

Comparison of the measured  $\dot{P}_b$  with the theoretical value requires a small correction,  $\dot{P}_{b,Gal}$ , for relative acceleration between the solar system and binary pulsar system, projected onto the line of sight (Damour & Taylor 1991). This correction is applied to the measured  $\dot{P}_b$  to form a "corrected" value  $\dot{P}_{b,corrected} = \dot{P}_b - \dot{P}_{b,Gal}$ . The correction term depends on several rather poorly known quantities, including the distance and proper motion of the pulsar and the radius of the Sun's galactic orbit. The best currently available values yield  $\dot{P}_{b,Gal} = -(0.0128 \pm 0.0050) \times 10^{-12}$  s/s, so that  $\dot{P}_{b,corrected} = (2.4056 \pm 0.0051) \times 10^{-12}$  s/s. Hence

$$\frac{\dot{P}_{b,corrected}}{\dot{P}_{b,GR}} = 1.0013 \pm 0.0021, \quad (2)$$

and we conclude that the measured orbital decay is consistent at the  $(0.13 \pm 0.21)\%$  level with the general relativistic prediction for the emission of gravitational radiation. The observed and theoretical orbital decays are compared graphically in Figure 1.

Accuracy of the test for gravitational radiation damping is now dominated by the uncertainty in the galactic acceleration term. Work now underway should lead to improved accuracy of the pulsar proper motion, and the Sun's galactocentric distance may be better known in the future. However, we see little prospect for a significant improvement in knowledge of the pulsar distance. Consequently, it seems unlikely that this test of relativistic gravity will be improved significantly in the foreseeable future.

### 4. Geodetic Precession: Mapping the Emission Beam

Relativistic spin-orbit coupling causes the pulsar's spin axis to precess (Damour & Rufini 1974; Barker & O'Connell 1975a,b). In the PSR B1913+16 system

Abstract. We describe results derived from thirty years of observations of PSR B1913+16. Together with the Keplerian orbital parameters, measurements of the relativistic periastron advance and a combination of gravitational redshift and time dilation yield the stellar masses with high accuracy. The measured rate of change of orbital period agrees with that expected from the emission of gravitational radiation, according to general relativity, to within about 0.2 percent.

[...]

[...] and we conclude that the measured orbital decay is consistent at the  $(0.13 \pm 0.21)\%$  level with the general relativistic prediction for the emission of gravitational radiation. (Weisberg 2004, p. 3)

**Fig. 14** Weisberg JM, Taylor JH (2004) Relativistic Binary Pulsar B1913+16: Thirty Years of Observations and Analysis. In: ASP Conference Series, Rasio FA & Stairs IH (eds.), Vol. TBD, 2004.

Sources: <https://arxiv.org/abs/astro-ph/0407149v1>  
<http://arxiv.org/licenses/nonexclusive-distrib/1.0/>

The idea of using an interferometer to detect the effects of a gravitational wave passing can be attributed to Felix Pirani and Philip Chapman (Weiss 1972). This ultimately led to several projects in different countries to build laser interferometers able to detect gravitational waves, e.g., GEO600 in Germany, LIGO in the USA, Virgo in Italy, KAGRA in Japan, and even more to come in the future with IndIGO in India, eLISA and LISA pathfinder, the Big Bang

<sup>15</sup> The Nobel Prize in Physics 1993. Press release. The Royal Swedish Academy of Sciences. NobelPrize.org. <https://www.nobelprize.org/prizes/physics/1993/press-release>

Observer (BBO) and using the pulsar timing arrays (Hellings 1983). It should be noted that the Nobel Prize in Physics 2017 “[...] for decisive contributions to the LIGO detector and the observation of gravitational waves” was awarded to Rainer Weiss, Barry C. Barish and Kip S. Thorne (cfr. [nobelprize.org](https://www.nobelprize.org)<sup>16</sup>). Of course, in parallel to this, an account on the History of Cosmology will be explored from the beginning of Observational Cosmology to Nowadays.

This part of the History of Science is extremely rich and the implications are far reaching; especially in light of the recent discovery of gravitational waves, and gravitational wave astronomy in general. Indeed, the beginning of our current understanding of the Universe is still new. For instance, the simple fact that we live in a galaxy among 100 billion galaxies is a rather new idea. Indeed, from the first ideas that some nebulae in the night sky were actually outside of our own “island universe” to the “Great Debate” also known as the “Shapley-Curtis Debate” which took place on April 26, 1920 (Hetherington 1967; Trimble 1995) that discussed this very issue, centuries had passed.

Therefore, the mere idea that galaxies exist is almost exactly one century old. Similarly, the ideas that the Universe is not eternal, nor static and that it is in fact expanding; and moreover, expanding increasingly faster are also very young.

Furthermore, it is interesting to explore how a number of discoveries and theories explaining physical phenomena of seemingly various natures finally came along to contribute to a greater understanding; e.g. the discovery of spectroscopy and Fraunhofer line –with William Hyde Wollaston (1766-1828) and Joseph von Fraunhofer (1787-1826)– found its explanation in the Photoelectric effect and Quantum Mechanics before finally being used to measure the distance of celestial objects via the redshift/blueshift of their light; which in turn allowed notably to confirm:

- a) the existence of galaxies,
- b) that the universe was expanding, and finding the rate of its expansion,
- c) which subsequently allowed to determine the age of the Universe,
- d) the implications for the Universe to have a beginning lead to determine that as it was not eternal, it certainly had a future –however remote–
- e) and that this future was in fact function of the rate of expansion (the Hubble parameter), the energy density of its content, and its overall curvature.

In the end, having painted the global picture of the History of the discovery of gravitational waves and discussing the prior cosmological explanatory context allows to better understand the various implications of gravitational astronomy for this new era of Cosmology.

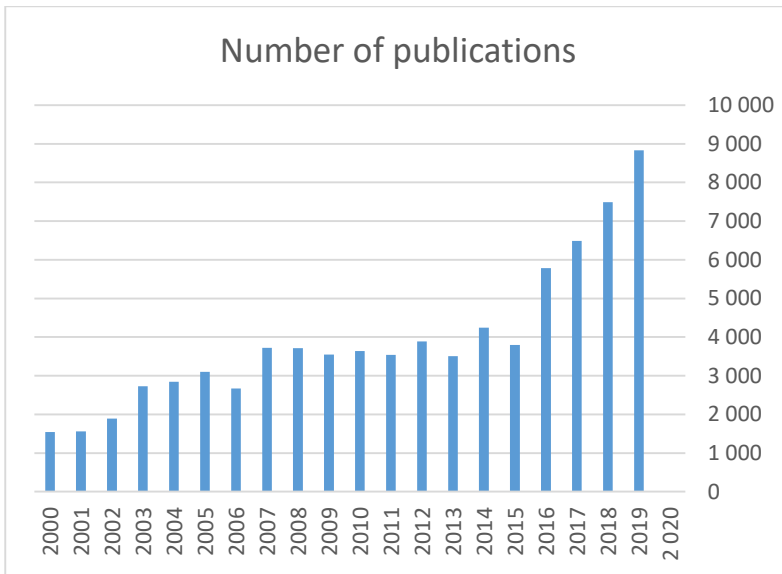
Below I present (Tab. 1 and Fig. 15) as an incomplete inquiring of mine on the number of publications that – by using the keywords “gravitational waves” on Google Scholar returns the following.

---

<sup>16</sup> Press release: The Nobel Prize in Physics 2017. NobelPrize.org. Nobel Media AB 2020. <<https://www.nobelprize.org/prizes/physics/2017/press-release/>>

**Table. 1** Number of Return Results of Articles Containing the Keywords “gravitational waves” from Google Scholar Queries:

Year	# of publications	Year	# of publications
2020	2 200-		
2019	8 830	2009	3 550
2018	7 490	2008	3 710
2017	6 490	2007	3 720
2016	5 780	2006	2 670
2015	3 800	2005	3 100
2014	4 240	2004	2 840
2013	3 510	2003	2 730
2012	3 890	2002	1 890
2011	3 540	2001	1 560
2010	3 640	2000	1 540



**Fig. 15** Plot of Table. 1. Source: Philippe Vincent.

Unsurprisingly, the table and graph clearly show that the number of articles containing the keywords “gravitational waves” followed the development of the Virgo and LIGO detectors. Indeed, on the official LIGO website, one can read: “LIGO’s original instrument, a largely ‘proof of concept’ model dubbed “Initial LIGO”, engaged in “science observations” from 2002 to 2010. No detections were made in that time, but enormous strides in detector engineering were achieved as a result of what was learned during that initial run.”<sup>17</sup>, while on the Virgo side, the project, which was approved by the CNRS and the INFN respectively in 1993 and 1994, and “initial” Virgo’s

<sup>17</sup> Cfr. <https://www.ligo.caltech.edu/page/about>

construction was finished in 2003. Of course, this is visible on the plot as an increase in the number of publications. These initial detectors observed the sky between 2007 and 2011, but no detection was made. However, the efforts for the search of gravitational waves continued, the detectors underwent upgrades to boost their sensitivity and a first series of signals were detected, starting with GW150914; soon followed by GW170814 for the first binary black hole merger signal detected by all three detectors. This last part of the story matching with a great increase of the number of publications as visible on the graph.

### **3. On the *Nature of Science Teaching* (NoS)**

The Nature of Science, including for my aims, teaching (NoS) is an interdisciplinary product of inquiring science and its foundations, whether historical, epistemological or scientific, curricula & modelling. In particular, it incorporates in its investigations the notions of limits, modelling, methods and methodologies in scientific practices. The study of gravitational waves is a new window for Astronomy and Cosmology with deep meaning for Physics. Furthermore, by bringing new ontological elements it furthers the confirmations of the validity of two of our best descriptions of reality.

The inclusion of the History of Science for Teaching Science and Science Education has been well inquired. Indeed, the subject along with HPS and NoS, have spilled a lot of ink, i.e Mach (1838-1916; 1898) Duhem (1861-1916; 1906), Bachelard (1884-1962; 1934, 1940), Piaget (1896-1980; 1927, 1970), Kuhn (1922-1996; 1962, 2005), and still is.<sup>18</sup>

#### **3.1 History of Gravitational Waves & NoS**

The history of gravitational waves and the history of the birth of modern science (physics and mathematics for my aims) is a historical period very well documented (Cfr. Agassi 1965; Kouneiher 2005, 2018; Pisano 2011, 2013, 2015). Thus, interesting elements for scientific teaching purposes are in abundance; including images (historical icons) and the different changes of perspective. For example, one can see a logical scientific progression into different paradigms from Gallileo to Newton, Riemann, Clifford, Poincaré and Einstein, prior to their official GW discovery in 2014. Thus ad hoc curricula can be modelled within an interdisciplinary teaching proposal, typically – and for my inquiring – at high school and university; either, Newton's writings on his theory of gravitation (Newton [1713], 1729, [1726; 1739-1742], 1687, 1833, 1999), Clifford's "On the space-theory of matter"

---

<sup>18</sup> Taking into account my doctoral thesis aims, an incomplete but selected list of authors is: Aubin 2004, Condé 2017, Dhombres 1978, Gatto 1994, Lévy-Leblond 1996, Navarro 2012, Oliveira 2014, Pisano 2011, 2012, 2013, 2019, 2020, Duit 1991, Galili 2001, 2008, Maurines 2003, Barbin 2013.

(Clifford 1870) or Poincaré’s “On the dynamics of the electron” (Poincaré 1905) in order to model a contextual approach (i.e, a curriculum) in the field. In my thesis I show – by means of NoS modelling of a GW curriculum – multiple benefits for the teaching of physics, and science education in general.<sup>19</sup>

In particular, it incorporates in its investigations the notions of limits, modelling, methods and methodologies in scientific practices. It is not just the addition of History and Philosophy of Science as another item on top of the science curricula, but the incorporation of approaches and HPS elements to teaching science based on the assumption that using adjacent and surrounding fields contribute to a greater understanding of science items, content, etc. and therefore to a better understanding of science. The study, and by extension the teaching of the Nature of Science should be considered as essential as it is a complex subject encompassing many elements that are key both to our cultural heritage and to teaching science in order to produce scientists. These elements include discussions on scientific method and objectivity, how to differentiate science from pseudo-science, how evidence is obtained in its historical and philosophical context, how the gathering of evidence impacts theories, etc. This framework studies the relevance and added value of philosophical and historical knowledge for the development of teaching courses. The addition of a historical perspective in science teaching aims to use history as a framework in which the problematization of the objects or concepts of the science lecture emerges naturally rather than a framework describing the then problematization. This addition is therefore more a pedagogical tool usable to help the students understand the taught concepts rather than a teaching of history of science (Cfr. Matthews 1992).

Another, perhaps more practical, advantage is that teachers sometimes struggle to find appropriate problems to motivate students and/or confront them with the concepts from other angles. Fortunately, the history of science contains a great number of historical problems which can enrich the teachers’ lessons and the students’ apprehension of mathematics while keeping them engaged in the object of the lecture (Cfr. Duhem 1906; Mach 1911; McComas 2002; Galili 2008; Yildiz 2013).

### 3.2 Teaching Physics

The teaching of physics and the associated mathematical, description—and–interpretations as tools, are each highly categorized and often perceived by students as completely different fields of study: theoretical sciences on one side and experimental sciences on the other.

Sometimes a distorted perception of theoretical sciences so far from everyday life activities amplifies the difficulties of teaching complex sciences such as physics and mathematics. Recent research has shown that

---

<sup>19</sup> Taking into account my doctoral thesis’ aims, an incomplete but selected list of authors is: Chevillard 1985, McComas 1998, 2002, Pisano 2019, 2020, Ploj-Virtic 2009b, 2014, Recami 2011, Rocha 2009, Kouneihier 2005, 2018, Freire 2016, Viennot 1979, 2007.



scientific knowledge –prior to a proper formal science education– seems to be constructed on some kind of naïve theories, intuitions, common sense that would be similar to the ones developed by natural philosophers (Caramazza 1981; Vosniadou 1992) or frailly structured understanding and poorly organized knowledge (McDermott 1984; Di Sessa 2011; McLaren 2013). For example teaching from school to university being done in a rather abstract way and with too little historical context to understand and follow their evolution, instead of learning the methods of scientific research. It is rather to browse the content of textbooks than to follow the results of NoS research (Guisasola 2005; Abd-El-Khalick 2017).

A correlated problem is the relationship (and its dynamics) between teaching and learning theoretical–experimental sciences like physics. Such teaching methods like chaining exercises and problems from the textbooks might be fine for young students still developing their understanding of the world and learning its basic rules.

However, starting with high school, if not a bit earlier, one can notice a growing divide in the results of the students as well as a general disinterest for the subject; often the reason being something along the lines of “I liked maths when I was little, but now it’s too complicated” (Di Martino 2010) and other similar attitudes on the subject. Therefore, I analyse certain pedagogical–teaching issues for physics teaching related to history of physics and teaching physics, based on different approaches to the transmission of knowledge, including interdisciplinarity as a crucial component of the teaching—learning process.

Moreover, with regard to the renewal of teaching, it can be approached with theoretical hypotheses, such as those related to the importance of Nature of Science in Education Science, the evaluation of hypotheses and *critical thinking*. In fact, the reference to the history of physics serves as a guide and confers a rich context for a critical analysis of different and varied hypotheses (Warren 2020). For example the question of whether the gravitational waves transmit energy with Feynman, or on their speed of propagation and their existence with Poincaré. Students’ formal and informal learning, personal experience, social interactions and the resulting common knowledge give them a basic framework on which to rely to interpret everyday life phenomena which shape their common sense.

This social aspect is mainly separated from a scientific guidance and leads to common views that can ultimately lead to misconceptions and difficulties. A lot of research has been done on this epistemological break of abstraction from everyday life (Carey 1985; Carmichael 1990) which maybe is best illustrated by the many studies that have been done about informal and formal reasoning (Wason 1971); especially in mechanics where a common misconception is that a constant force is required to keep an object in constant motion (Clement 1982; Viennot 1979; Crapanzano 2018).

Unfortunately, this can have dire consequences for teaching students. Indeed, considering that students’ common sense precedes scientific reasoning, added to the fact that there is some kind of mistrust in science due to the problem of idealization, it is common for them to encounter difficulties. Those difficulties mostly arise from clashes with common sense

formed by their pre-established conceptions and common knowledge or even beliefs, whether religious or otherwise. It should be noted that not only the students are victims of their common sense, but teachers and even scientists are subject to this problem; although to different degrees. A good example of this could be counterintuitive results, which are counterintuitive on the basis that these kind of intuitions are guided by common sense; such as those encountered in Quantum Mechanics, or just concepts like non-locality, etc. In those cases, common sense logic is inadequate for understanding, let alone problem solving.

The history of physics in the classroom also helps stimulate students' reflections on the fundamentals of science and enable them to follow the reasoning of scientists and their insights while motivating them through comparisons and analogies (Sherry 1996). Furthermore, nowadays it is possible to teach a scientific discipline by NoS using various technological tools available such as smartphones, computers and applications that they can use (Oliveira 2019), capturing students' interest and trying to motivate them, so also can the historical difficulties of the development of the scientific method and paradigm.

With all this in mind, and coming back to GW, I worked and still am working to show the need to make teaching methods evolve especially at high school and the University as well as the need to fight the disenchantment of students towards scientific matters (in particular Physics and Mathematics) through the postulate that the History of the discovery of gravitational waves provides an excellent didactic terrain for teaching Physics. At University, and maybe as early as in high school, I believe that the students can get a sound first understanding of many fundamental concepts in Physics such as *spacetime*, and *special relativity* within the NoS Teaching framework. Moreover, the core ideas and concepts of *special relativity* are in principle accessible to anyone who understands some geometry and basic algebra. Yet, despite of all this, *special relativity* is one of the subjects in physics that confuses the most people and in many cases turns them away from Physics altogether.

For instance, while a special attention has always been put on students' misconceptions, science education and physics education in general are treating the problems associated with the nature of students ideas and how they are confronted by the scientific understanding of phenomena; in particular, for the case study of the teaching-learning of special relativity, different models and their effectiveness have been evaluated e.g. misconceptions and pieces models. However, for this specific example, it turns out that the results from the students confronted with one model or the other agree with both models, thus suggesting that these models are either both valid to a certain extent or at the very least accommodating enough (Scherr 2007).

Another case study about learning in special relativity explored the impact of using a relativistic virtual environment in order to introduce concepts of special relativity. The authors identified the main issues to be related to the difficulty that “modifying everyday concepts of motion, time and space to develop accurate constructs of the theory of special relativity is extremely

difficult” (McGrath 2010, p. 862). Their conclusion was that the exploration of their virtual reality helped the students to improve their understanding and see the topic as less abstract, as a small but measurable improvement was observed. Moreover, their analysis showed that “[...] completing the experiment sometimes aided in answering an exam question on relativity based on the lecture component of the course.” (Ivi. p. 867). Thus showing that despite the fact that special relativity is very confusing, there are leads to help students overcome their difficulties with the matter.

### 3.3 The Originality

The originality of this thesis comes from the study of the historical roots of the concept of gravitational waves which predates Einstein’s paper “Über Gravitationswellen” (Einstein 1918) from NoS perspectives as well as providing the students with a curricula designed to use, at the same time, multidisciplinary approaches and tools that have shown to improve students’ understanding of difficult physics topics. Indeed, using results of nature of science teaching–learning and many different adjacent fields (including but not limited to cognitive psychology, neurobiology, logics, epistemology), the resulting *ad hoc* curricula is very complete. Moreover, the logical sequence of the teaching is expected to provide the students with a sound understanding of the physics of gravitational waves that can then be relied upon for actual advanced physics classes on the subject. Indeed, despite the limitations of each individual approach the completeness and variety of the different examples and methods employed is expected to be complementary with each other, thus allowing the students to identify which framework or tool to use for each case they encounter. My motivation comes from:

a) The fact that lesser–known scientists’ contributions are at the very best equally or less-known, such as the original ideas of Clifford (Clifford 1870, 1876, 1882). Indeed, Clifford’s conceptions about our physical space are extremely interesting and they could even represent a precursor sign that the conception of our physical space was about to shift like it did with Einstein’s theories. Although it should be noted that Clifford was still very far from the same conceptions of Einstein. This is even more obvious when considering that when Clifford was working on his theories, tensor calculus was not yet invented. It may very well be this deficiency that lead Clifford to develop his own mathematical tools (Clifford 1882) in his *Preliminary Sketch of Biquaternions* (Clifford 1873b) in order to tackle this very problem that he was yet unaware of. Clifford’s idea behind biquaternions was to model motion in a higher dimensional space which he used extensively in 1875 in *On the Free Motion Under No Forces of a Rigid System in an n-fold Homaloid*. Here his idea was to find an equivalence between ordinary three-dimensional space and the motion on a surface of a sphere in order to study the rotation of an object:

In general, the problem of free motion in elliptic space of  $n$  dimensions is identical with that of free motion, or motion about a fixed point, in parabolic space of  $n+1$  dimensions. (Clifford 1875, p. 67).

Moreover, in “The Postulates of the Science of Space” (Clifford 1901), Clifford explicitly explained his beliefs and intuitions about our physical space (as well as his understanding of our place in time to a lesser extent) and concluded by stating:

If you were to start in any direction whatever, and move in that direction in a perfect straight line [...], after a most prodigious distance to which the parallactic unit—200.000 times the diameter of the earth’s orbit— would be only a few steps, you would arrive at—this place. Only, if you had started upwards, you would appear from below. [...] In fact, I do not mind confessing that I personally have often found relief from the dreary infinities of homaloidal space in the consoling hope that, after all, this other may be the true state of things. (*Ivi.* p. 387)

b) The teachings specifically about gravitational waves have been largely skimmed over despite the fact that the physics behind gravitational waves started being investigated, decades ago, as gravitational waves were predicted consequences of Einstein’s General Relativity a century ago. Probably one of the first official gravitational waves teachings happened in the 1970s when Rainer Weiss attempted to teach his students Joseph Weber’s work on gravitational waves: “Weiss, frustrated by the difficulty of teaching Weber’s work to his undergraduates at the Massachusetts Institute of Technology.”<sup>20</sup> (Cfr. Weiss 2000); while “*Gravitation*” (Misner 1973) co-authored by Kip Thorne, Charles Misner and John Wheeler (1911-2008), presented a dedicated part (Part VII) about the study of gravitational waves (Misner 1973, pp. 941-1044).

Nowadays the physics of gravitational waves appears, *anecdotally*, to be almost barely taught, despite the fact that this discovery is a major one. Thus, opening a new field of physics and a new window to the Universe seems to be necessary. Furthermore, the gravitational waves teachings are included in Astrophysics Master’s degrees curriculum (only) despite the fact that a lot of progress has been done in rendering the subject more accessible (Kaur 2017). Therefore, my opinion is that my Ph.D thesis could represent an intellectual opportunity – among History of physics, applied sciences and technology & NoS curricula – for starting to -consider implementing *ad hoc* curricula on the subject; and to esteem teaching–learning, its extension into quality (concepts, measures, modelling and calculations). Indeed, students’ difficulties understanding SR and GR have been studied (Sherr 2001, 2002, 2007, Belloni 2004, McGrath 2010, 2012, Arlego 2017), but none has been done on gravitational waves. When I began this doctoral thesis, I also had in mind to show that GW physics could be taught at least in concepts to high

---

<sup>20</sup> Weiss May 10, 2000; sound recording. Retrieved via: <https://www.newyorker.com/tech/annals-of-technology/gravitational-waves-exist-heres-how-scientists-finally-found-them> and <https://collections.archives.caltech.edu/repositories/2/accessions/8240>

school students, but it turned out that high schoolers of the *Aragon d'Héricourt Lyceum* won the first place of the *Olympiades de physique 2019* with their project “Advanced Arago” which simulated a gravitational wave detector using an ultrasound beam instead of a laser, thus demonstrating that it was possible (Fig. 16).



**Fig. 16** Abstract of the “Advanced Arago” project, 1<sup>st</sup> place winner of the *Olympiades de physique 2019* contest.  
Source: Courtesy of Antoine Tondou.

The American LIGO and European VIRGO detectors recently made it possible to detect gravitational waves resulting from the fusion of black holes and neutron stars. Since 2017, the school's scientific club has set out to discover these waves and their detection.

On the principle of the LIGO and VIRGO interferometers, we simulate a gravitational wave detector using an ultrasound beam rather than a laser beam.

The space-time oscillations induced by the passage of the gravitational wave are generated using the movement of the membranes of two speakers.

This “space-time distortion” is then detected and analyzed in order to determine the parameters of the responsible event: mass of the merging objects and distance to Earth. To stick to reality, the signals produced are becoming weaker and this will require the use of analysis techniques similar to those actually used. Like LIGO and VIRGO, our ARAGO interferometer has undergone several improvements, hence its name Advanced ARAGO. (Author's translation).

Moreover, as recent studies reveal (Kaur 2017, Ryston 2019), the views that these types of physics concepts are too hard to understand without strong educations in physics and mathematics are starting to be challenged. Hence, the problem is not if students can understand those concepts; but rather *How to teach them effectively?* In order to study a possible reply to this question,

I have endeavoured to build an introductory course to the physics of gravitational waves that could be part of an *ad hoc* curricula consisting of a modular programme relying on NoS teaching–learning. An example of module is given below.

### **Science Teaching-Learning: History and Epistemology of Gravitational Waves—Nos**

#### **- *The conceptualisation of waves – Late Period Einstein's two theories of relativity***

1. Physics and mathematics of the twentieth century.
2. The role of Galileo's heritage for mechanics
3. The role of Newton's heritage for mechanics
4. The founding text of relativity: 1905, “Sur la dynamique de l'électron” - Poincaré
5. The problem of Aether
6. The Michelson-Morley experiment
7. The electromagnetic theory of Maxwell
8. The Lorentz transformations
9. The birth of Special Relativity
  - a. On the measurement of the speed of light and the principle of relative motion
  - b. On the addition of a description of gravitation
10. The development of General Relativity
11. General Relativity predictions

#### *Teaching - Albert Einstein. Biography and Works*

- a. 1905. The three fundamental articles on the theory of special relativity
- b. 1907. On mass and energy equivalence
- c. 1916. On the theory of general relativity
- d. 1921 (-2). *Nobel prize*
- e. 1937. On gravitational waves

#### *On Teaching - Theory of Special Relativity*

12. Galilean relativity and the principle of inertia
13. A heuristic point of view: the quantum of light
14. The concepts of space and time of Einstein's relativity
15. The postulates of special relativity
16. The experimental confirmations of the new theory
17. Relativity and simultaneity

#### *On Teaching - Physical Space-Time and Geometry and in the Theory of Special Relativity*

18. Physical space-time in Minkowski's theory
19. The transformation of Lorentz without the second postulate
20. Non-Euclidean Geometry and Time Coordinates. The case of hyperbolic geometry
21. The dilation of time and the twins paradox
22. The train in tunnel paradox
23. The problem of hard bodies and the Ehrenfest paradox
24. 1911-1912. Acceptance of special relativity

*On Teaching - Theory of General Relativity*

25. The problem of the laws of physics for the non-inertial system
26. Gravitation and acceleration
27. *Weighting mass and mass of inertia*
28. The role of Ricci Curvatures and Levi-Civita's results in relativity
29. The laws of the new theory

*On Teaching - Geometry of the Theory of General Relativity*

30. Riemannian Geometry: curved spaces
31. Geometry and gravitation
32. The gravitational field
33. The sources of gravitation
34. Einstein's equations
35. A short story about astrophysical implications: gravitational waves, black holes, cosmology

*On Teaching Epistemology - Epistemological Reflections on the Foundations of Einstein's Relativity*

36. Small historical reflections on controversies about the theory of special relativity
37. The logical organization of Einstein's theories of relativity

*Teaching-Learning Bibliography*

- Astolfi JP, Peterfalvi B (1993) Obstacles et construction de situations didactiques en sciences expérimentales. In: Aster, éditions INRP, n°16, pp.100-110.
- Ballini P, Robardet G, Rolando JM (1997) L'intuition, obstacle à l'acquisition de concepts scientifiques: propositions pour l'enseignement du concept d'énergie en première S. In: Aster, éditions INRP, n°24, pp.81-112.
- Benseghir A (1989) Transition électrostatique-électrocinétique ; point de vue historique et analyse des difficultés des élèves. Thèse, Université Paris 7.
- Fawaz A, Viennot L (1986) Image optique et vision. In: B.U.P., n°686, pp.1125-1146.
- Galili I (1996) Students' conceptual change in geometrical optics. *Int.J.Sci.Educ*, vol.18, n°7, pp. 847-868.
- Guilbert L, Méloche D (1993) L'idée de science chez les enseignants en formation : un lien entre l'histoire des sciences et l'hétérogénéité des visions ? In *Didaskalia*, éditions DeBoeck, n°2, pp.23-46.
- Martinand JL (1993) Histoire et didactique de la physique et de la chimie : quelles relations ? In: *Didaskalia*, éditions de Boeck, n°2, pp.89-99.
- Maurines L (2001) Le raisonnement géométrique en terme d'objet dans la physique des ondes. Mémoire d'habilitation à diriger des recherches, Université Paris 11.
- Mialaret G (2011) Le nouvel esprit scientifique et les sciences de l'éducation, PUF, Paris.

- Mialaret G (2017) *Les sciences de l'éducation*. Presses Universitaires de France, « Que sais-je ? », Paris.
- Piaget J, Garcia R (1983) *Psychogénèse et histoire des sciences*, éditions Flammarion.
- Toussaint J, Gréa J (1996) *Construire des concepts et mettre en œuvre des raisonnements, ce que peut apporter un regard sur l'histoire des sciences*. In: *Didactique appliquée de la physique chimie*, éditions Nathan, pp.86-118.
- Viennot L (1996) *Raisonner en physique*, éditions De Boeck.

*History and Historiographies: Reading Texts*

- Poincaré's thought and contribution to modern science
- Einstein-Podolsky-Rosen's thought and contribution on the physical description of reality
- Einstein's thought and contribution to the world
- Darrigol's thought and contribution to the mystery of the Einstein-Poincaré connection

*Primary Sources: Reading Texts*

- Balibar F (1993) (ed) *Albert Einstein, œuvres choisies*. Vol. 1. Quanta. Seuil-CNRS, Paris.
- Balibar F (ed) (1993) (ed) *Albert Einstein, œuvres choisies, volume 2 : Relativités*. Seuil-CNRS, Paris, Paris.
- Bracco C, Provost JP (2006) *The quanta in Einstein's 1905 relativity theory*. In: *AIP Conference Proceedings, American Institute of Physics*, 861/1:1076-1080.
- Bracco C (2015) *L'environnement scientifique du jeune Albert Einstein: La période milanaise (1899-1901)*. *Revue d'histoire des sciences*, 68/1:109-144.
- Bracco C (2017) *Quand Albert devient Einstein*. CNRS.
- Bracco C, Provost JP (2018) *Les années italiennes du jeune Einstein- La thèse oubliée sur les forces moléculaires*. *Reflets de la physique*, (56):31-34.
- Einstein A (1925) *Sur l'électrodynamique des corps en mouvement*. Gauthier-Villars, Paris [réimprimé aux Éditions Jacques Gabay, Paris en 2005]
- Einstein A (1991) *Œuvres choisies*. Éditions du Seuil, Paris.
- Einstein A ([1934] 1983) *Comment je vois le monde*. Flammarion-Champs, Paris.
- Einstein A, Infeld L (1993) *L'évolution des idées en physique*. Flammarion-Champs, Paris.
- Isaacson W (2008) *Einstein: His life and universe*. Simon and Schuster.
- Kennefick D (2005) *Einstein Versus the Physical Review*. *Physics Today* 58/9:43. Retrieved: <https://doi.org/10.1063/1.2117822>
- Kennefick D (2007) *Traveling at the Speed of Thought: Einstein and the Quest for Gravitational Waves*. Princeton University Press, Princeton.
- Kennefick D (2019) *No shadow of a doubt: the 1919 eclipse that confirmed Einstein's theory of relativity*. Princeton University Press.
- Pais A (1982) *Subtle is the Lord: The Science and the Life of Albert Einstein*, Oxford University Press, New York.



Pais A (2005) *Albert Einstein – Sa vie, son œuvre, Interéditions*. Dunod, Paris.

*A First Specific Bibliography on the Module*

Adair R (1987) *The Great Design: Particles, Fields and Creation*. The Oxford University Press, NY.

Bachelard G (1951) *L'activité rationaliste de la physique contemporaine*. Presses Universitaires de France, Paris.

Borel É (1913), *La théorie de la relativité et la cinématique*. Comptes Rendus des séances de l'Académie des Sciences 156: 215–218.

Borel É (1914) *Introduction géométrique à quelques théories physiques*. Gauthier–Villars, Paris.

Bouzid A, Zaoui H, Luca Palla P, Ori G, Boero M, Massobrio C, Cleri F, Lampin E (2017) Thermal conductivity of glassy GeTe<sub>4</sub> by first-principles molecular dynamics. *Physical Chemistry Chemical Physics*, 19(15):9729–9732. doi:10.1039/c7cp01063j

Brun S J-L, Morellato M, Sensevy G, Quilio S (2017) Cooperative engineering as a joint action. *European Educational Research Journal* 17:187–208. <https://doi.org/10.1177/1474904117690006>

Cleri F, Rosato V (1993) Tight-binding potentials for transition metals and alloys. *Physical Review B*, 48(1):22–33. doi:10.1103/physrevb.48.22

Cohen-Azria C, Dias-Chiaruttini A (2014) Analyser les contenus en jeu dans la visite scolaire au Musée : questions méthodologiques. In: Daunay B., Fluckiger C. et Hassan R. (dir.) *Les Contenus d'enseignement et d'apprentissage. Approches didactiques*, Bordeaux, Presses Universitaires de Bordeaux, p. 109-119.

Damour T, Darrigol O, Duplantier B, Rivasseau V (2006) (eds) *Einstein, 1905–2005. Poincaré Seminar 2005*, Birkhäuser Verlag, Basel.

Darrigol O (2000) *Electrodynamics from Ampère to Einstein*. The Oxford University Press, Oxford.

Darrigol O (2004) *The Mystery of the Einstein–Poincaré Connection*. *Isis* 95/4:614–626.

Darrigol O (2006) *The Genesis of the theory of relativity* En : Damour T, Darrigol O, Duplantier B, Rivasseau V (eds) 2006, *Séminaire Poincaré* 1:1–22, op. cit.

Dias-Chiaruttini A (2010a) *Dysfonctionnements et évaluations dans des débats interprétatifs : la place particulière de l'EI (erreur interprétative)*. *Les Cahiers Théodile* 9:111–137.

Dias-Chiaruttini A (2010b) *Comment les performances-apprentissages en lecture sont analysés en didactique du français ? Recherches en Didactiques*: *Les Cahiers Théodile* 10:9–30.

Dias-Chiaruttini A (2011a) *Former les enseignants au débat interprétatif : places et enjeux des styles enseignants*. *Repères*, pp. 117–134. <https://doi.org/10.4000/reperes.182>

Dias-Chiaruttini A (2012b) *Le discours des enseignants sur les œuvres lues en classe*. In: Isabelle et Ferrier Béatrice (dir.) *Enseigner les “ classiques ” aujourd'hui*, Bruxelles, Peter Lang, Collection *Théocrit* 5:275-288.

- Dias-Chiaruttini A (2014a) *Actualités de la recherche en didactiques, Recherches en didactiques*, n17, Villeneuve d'Ascq, Presses Universitaires du Septentrion.
- Dias-Chiaruttini A (2017c) Introduction de la conférence de Jean-Paul Bronckart : Apports et limites de la quête d'identité disciplinaire. In: *Colloque Invention des espaces de travail : entre chemins individuels et pistes collectives*, Villeneuve d'Ascq, France.
- Dias-Chiaruttini A (2017e) Le débat : enjeux didactiques, épistémologiques et disciplinaires. In: Fisher C., Gagnon R., de Pietro J.-F. (dir.) *L'oral aujourd'hui : perspectives didactiques*, Namur, Presses Universitaires de Namur, collection Recherche en didactique du français 9:67-85.
- Dias-Chiaruttini A (2017g) La forme scolaire des visites scolaires muséales : la scolarisation des médiations muséales. In: *Journée d'études PROSCITEC - Renouveler l'attractivité de la médiation scientifique, technique et industrielle auprès des jeunes publics*, Arras, France.
- Dias-Chiaruttini A (2019h) Place du numérique et des médias sociaux dans l'expérience du visiteur scolaire au musée. *Revue de recherches en littératie médiatique multimodale*. <https://doi.org/https://doi.org/10.7202/1062030ar>
- Dias-Chiaruttini A, Cohen-Azria C, Souplet C (2016g) La visite scolaire au musée éclairée par des didactiques contrastées. In: *4ème colloque international de l'ARCD, Analyses didactiques des pratiques d'enseignement et de formation : quelles perspectives ?* Toulouse, France.
- Dirac PAM (1978) *Direction in Physics*. Wiley, NY.
- Einstein A ([1921] 2005) *Quatre conférences sur la théorie de la relativité*. [Texte de quatre conférences prononcées à l'université de Princeton en 1921] Dunod, Paris.
- Einstein A (1927). *Newtons Mechanik und ihr Einfluss auf die Gestaltung der theoretischen Physik*, *Naturwissenschaften* 15:273–276. Trad. fr. par le Cnel Cros. *La mécanique de Newton et son influence sur l'évolution de la physique théorique*. In : Einstein A [1934]1983, pp. 180–193, op. cit.
- Einstein A (1956) *La théorie de la relativité restreinte et générale*. Gauthier–Villars, Paris.
- Einstein A, Freud S ([1933] 2005) *Pourquoi la guerre ?* Rivages, Paris.
- Feynman R (1985) *QED: The Strange Theory of Light and Matter*. Princeton University, Princeton, NJ.
- Gillispie CC (ed) (1970–1980) *Dictionary of Scientific Biography*. Charles Scribner's Sons, New York.
- Hawking SW, Israel W (1980) (eds) *General relativity. An Einstein centenary survey*. The Cambridge University Press, Cambridge.
- Holton G (1988) *Thematic Origins of Scientific Thought: Kepler to Einstein*. The Harvard University Press, Cambridge–MA.
- Katsanevas S (1986) *Results on neutrino oscillations from an appearance experiment in BEBC*.
- Katsanevas S (1993) *Prospects for supersymmetry at LEP200*. Report DELPHI-93-109 PHYS 336, 7.

- Katsanevas S (1995) Long baseline neutrino oscillation beams and experiments. 30th Rencontres de Moriond: Electroweak Interactions and Unified Theories, pp. 481-489.
- Katsanevas S (1998) Supersymmetry at LEP, experimental review. *Journal of Physics G: Nuclear and Particle Physics*, 24(2):337-352. doi:10.1088/0954-3899/24/2/008
- Keswani G H, Kilmister CW (1983) *Intimations Of Relativity: Relativity Before Einstein*. The British Journal of Philosophy of Science 34/4:343-354.
- Kragh H, Marage P, Vanapaemel G (2002) (eds) *The history of Modern Physics*. Brepols, Liège.
- Lampin E, Palla PL, Francioso P-A, Cleri F (2013) Thermal conductivity from approach-to-equilibrium molecular dynamics. *Journal of Applied Physics*, 114(3):033525. doi:10.1063/1.4815945
- Landuzzi F, Viader-Godoy X, Cleri F, Pastor I, Ritort F (2020) Detection of single DNA mismatches by force spectroscopy in short DNA hairpins. *The Journal of Chemical Physics*, 152(7):074204. doi:10.1063/1.5139284
- Lecat M (1924) *Bibliographie de la relativité*. Lamertin, Bruxelles.
- Ligozat F, Orange C, Dufays J-L, Doussot S, Quilio S, Loquet M, Tiberghien A, Martine J, Mercier A (2017) La modélisation des savoirs dans les analyses didactiques des situations d'enseignement et apprentissage. *Recherches en Education*, 29.
- Lorentz HA, Einstein A, Minkowski M, Weyl H (1923) *The principle of relativity. A collection of original memoirs on the special and general theory of relativity*. Dover, NY.
- Manca F, Giordano S, Palla PL, Cleri F (2014) On the equivalence of thermodynamics ensembles for flexible polymer chains. *Physica A: Statistical Mechanics and Its Applications*, 395:154-170. doi:10.1016/j.physa.2013.10.042
- Marcacci F (2005) L'induzione e la conoscenza scientifica in Aristotele: un'analisi di An. Pr. II 23.
- Marcacci F (2005) Sul ruolo dell'induzione nell'epistemologia di Aristotele. *AQUINAS-ROME-*, 48 (1/2):33.
- Marcacci F (2008) *Alle origini dell'assiomatica: gli Eleati, Aristotele, Euclide*. Roma: Aracne.
- Marcacci F (2009) *Bibliografia tematica galileiana*. In: Galileo Galilei, *Sidereus Nuncius*, traduzione e commento di P. A. Giustini, a cura di Flavia Marcacci. Lateran University Press, Roma, pp. 221-328.
- Marcacci F (2009) From the sky to maps: observation and theory of the heavens between the 16th and the 18th century (con versione italiana Dal cielo alle carte: osservazione e teoria del cielo tra XVI e XVIII secolo). In: *Magna longaque ad mirabilia. Astronomia e cosmologia nel fondo antico della Biblioteca Beato Pio IX*, a cura di F. Marcacci, F. C. Panini e Lateran University Press, Modena - Città del Vaticano, 24-52.

- Marcacci F (Ed.) (2009) *Magna longeuque admirabilia: astronomia e cosmologia nel fondo antico della Biblioteca Beato Pio IX*;[29 novembre-11 dicembre 2009], Panini.
- Marcacci F (2010) *Metaphors of Galileo between cosmography and astronomy: some brief reflections*. In: Altamore A, Antonini G (eds.), *Galileo and the renaissance scientific discourse*. Edizioni Nuova Cultura, pp. 103-110.
- Marcacci F (2014) *Illusions, Ghosts and Movies in the history of scientific instruments*. Gino Tarozzi *Philosopher of Physics*. *Studies in the philosophy of entanglement on his 60th birthday: Studies in the philosophy of entanglement on his 60th birthday*, pp. 148-158.
- Marcacci F (2015) *Galileo Galilei: una storia da osservare*. Lateran University Press.
- Marcacci F (2015) *History of Science, Epistemology, and Ontology*. In *Science Between Truth and Ethical Responsibility*. Springer, pp. 231-241.
- Marcacci F (2015) *The World-System of Giovanni Battista Riccioli and the Phases of Venus and Mercury*. *Advances in Historical Studies*, 4(2):106-117. doi: 10.4236/ahs.2015.42011.
- Marcacci F (2018) *Creazione e cosmologia scientifica: Problemi epistemologici e opportunità speculative*. *Aquinas*, 61(1/2):147-164.
- Martin E, Palla PL, Cleri F, Bouzid A, Ori G, Le Roux S, Boero M, Massobrio C (2018). *On the occurrence of size effects in the calculation of thermal conductivity by first-principles molecular dynamics: The case of glassy GeTe 4*. *Journal of Non-Crystalline Solids*, 498:190–193. doi:10.1016/j.jnoncrysol.2018.05.014
- Max Born M ([1923] 2003) *La théorie de la relativité d'Einstein et ses bases physiques*. Gabay, Paris.
- Nagel E (1961) *The Structure of Science: Problems in the Logic of Scientific Explanation*. Harcourt–Brace & World Inc, New York.
- Neil Ashby N (2002) *Relativity and the Global Positioning System*. *Physics Today* 55/5:41–47.
- Pais A (2005) *Albert Einstein – Sa vie, son œuvre*, Interéditions. Dunod, Paris.
- Palla PL, Patera G, Cleri F, Giordano S (2020) *A stochastic force model for the ballistic-diffusive transition of heat conduction*. *Physica Scripta*. doi:10.1088/1402-4896/ab8d56
- Palla PL, Zampa S, Martin E, Cleri F (2019). *Interface thermal behavior in nanomaterials by thermal grating relaxation*. *International Journal of Heat and Mass Transfer*, 131:932–943. doi:10.1016/j.ijheatmasstransfer.2018.11.064
- Paty M (2004) *Albert Einstein, ou la création scientifique du monde*, Belles Lettres, Paris.
- Paty M (1979) *Sur le réalisme d'Albert Einstein*. *La Pensée* 204:18–37.
- Paty M (1999) *La création scientifique selon Poincaré et Einstein*. En : Serfati M (ed) *La recherche de la vérité : Coll. « L'Écriture des Mathématiques »*, ACL–Éditions du Kangourou, Paris, pp 241–280.

- Paty M (2003) *La physique du XXe siècle*. EDP Sciences, Les Ulis.
- Penrose R (2004) *The Road to Reality. A complete guide to laws of the universe*. Knopf, NY.
- Pisano R, Sozzo S (2020) *A Unified Theory of Human Judgements and Decision-making under Uncertainty*. Submitted to *Entropy Special Issue. Quantum Models of Cognition and Decision-Making*. Andrei Khrennikov A, Bagarello F (eds).
- Pisano R, Vincent P (2018) *Methods and Cognitive Modelling in the History and Philosophy of Science—&—Education Special Issue Transversal Historiography of Science* 5:3-9.
- Pisano R, Anakkar A (2017) *Reading Science, Technology and Education: A Tradition Dating back to Science into the History and Historiography*. *Transversal Historiography of Science* 3:77-97.
- Pisano R, Bussotti P (2017) *The Fiction of the Infinitesimals in Newton's Works: A note on the Metaphoric use of Infinitesimals in Newton*. *Special Issue Isonomia* 9:141-160.
- Pisano R, Bussotti P (2016) *A Newtonian Tale Details on Notes and Proofs in Geneva Edition of Newton's Principia (avec Paolo Bussotti)*. *Bulletin—Journal of the British Society for the History of Mathematics* 31/3: 160-178.
- Pisano R, Bussotti P (2015) *Historical and Philosophical Reflections on the Culture of Machines around the Renaissance: Machines, Machineries and Perpetual Motion*. *Acta Baltica Historiae et Philosophiae Scientiarum* 3/1:69–87.
- Pisano R, Bussotti P (2015) *Exploring Changes in How the Histories of the Exact Sciences Have Been Written: Interpreting the Dynamics of Change in These Sciences and Interrelations amongst Them—Past Problems, Future Cures?* *Advances in Historical Studies Special Issue* 4/2:65–67.
- Pisano R, Bussotti P (2015) *Newton's Philosophiae Naturalis Principia Mathematica « Jesuit » Edition: The Tenor of a Huge Work*. *Atti Accademia Nazionale Lincei Rendiconti Lincei Matematica e Applicazioni* 25:413–444.
- Pisano R (2014) (ed.) *Isaac Newton and his Scientific Heritage: New Studies in the History and Historical Epistemology of Science*. *Special Issue. Advances in Historical Studies* 3/3.
- Pisano R, Bussotti P (2014) *Notes on mechanics and mathematics in Torricelli as physics mathematics relationships in the history of science*. *Problems of Education In: The 21st Century International Journal. Special Issue* 61/61:88–97.
- Pisano R, Capecchi D, Lukešová A (eds.) (2013) *Physics, Astronomy and Engineering. Critical Problems in the History of Science*. *International 32nd Congress for the SISFA—Italian Society of Historians of Physics and Astronomy*. The Scientia Socialis UAB & Scientific Methodical Centre Scientia Educologica Press, Šiauliai University, Lithuania.
- Pisano R, Bussotti P (2013) *On Popularization of Scientific Education In Italy Between 12th And 16th Centuries*. *Problems of Education in the 21st Century* 57:90–101.

- Pisano R, Bussotti P (2013) Open problems in mathematical modelling and physical experiments: exploring exponential function. *Problems of education in the 21st century* 50/50:56–69.
- Pisano R, Mellone M (2012) Learning Mathematics In Physics Phenomenology and Historical Conceptual Streams. *Problems of Education in The 21st Century* 46:93–100.
- Pisano R, Casolaro F (2012) An Historical Inquiry On Geometry In Relativity. Reflections on Late Relationship Geometry–Physics (Part II). *HR 2/1:56–64*.
- Pisano R, Casolaro F (2012) An Historical Inquiry On Geometry In Relativity. Reflections on Early Relationship Geometry–Physics (Part I). *HR 1/1:47-60*.
- Pisano R (2011) Physics-mathematics relationship. Historical and Epistemological notes. In: Barbin E, Kronfellner M, Tzanakis C. (eds), *ESU–6 European Summer University on The History And Epistemology In Mathematics*, The University of Vienna Press, pp. 457-472.
- Pisano R (2010) On Principles In: Sadi Carnot’s Thermodynamics (1824). *Epistemological Reflections. Almages International Interdisciplinary Journal* 2/2010:128–179.
- Ploj Vrtič M (2009a) Model of ICT Implementation in the Technical Education. *Problems of Education in the 21st Century*, 14:144-158.
- Ploj Vrtič M (2009b) The Computer as a Modern Form of Communication in the Educational Process From the Teachers` Point of View. *Informatologia* 42(1):10-17.
- Ploj Vrtič M (2009c) Enhancement of Educational Process Using Experience Based Tutoring Approaches. *Problems of Education in the 21st Century*, 14:7-22.
- Ploj Vrtič M (2012) The role of internet in education. *Proceedings of DIVAI 2012-9th International Scientific Conference on Distance Learning in Applied Informatics*, Štúrovo, Slovakia, pp. 243-249.
- Ploj Vrtič M (2014) Gamification of learning : an effective teaching method of a modern school or a fashion fad? *Conference: 9th IOSTE Symposium for Central and Eastern Europe*.
- Ploj Vrtič M, Pšunder M (2010a) Future Teachers’ Opinions on the Digital Competencies Obtained During Their Studies. *Problems of Education in the 21st Century*, 24:95-105. Retrieved: [https://www.researchgate.net/profile/Mateja\\_Vrtic/publication/283345140\\_Future\\_teachers'\\_opinions\\_on\\_the\\_digital\\_competencies\\_obtained\\_during\\_their\\_studies/links/565d7af208aeafc2aac7b3fa/Future-teachers-opinions-on-the-digital-competencies-obtained-during-their-studies.pdf](https://www.researchgate.net/profile/Mateja_Vrtic/publication/283345140_Future_teachers'_opinions_on_the_digital_competencies_obtained_during_their_studies/links/565d7af208aeafc2aac7b3fa/Future-teachers-opinions-on-the-digital-competencies-obtained-during-their-studies.pdf)
- Ploj Vrtič M, Pšunder M (2010b) The Influence of the Field of Study on the Use of Modern Information and Communication Technologies Among Student and Teachers. *Informatologia*, 43(4):269-279.

- Ploj Virtič M, Pšunder M (2014a) Innovative pedagogy: Developing of pupils' competencies through the use of modern technologies in the classroom. In 10th International Scientific Conference on Distance Learning in Applied Informatics, Štúrovo, pp. 5-7.
- Ploj Virtič M, Šorgo A (2016) Can we expect to recruit future engineers among students who have never repaired a toy? *Eurasia Journal of Mathematics, Science & Technology Education*, 12(2):249-266.
- Ploj Virtič M, Župerl U, Javornik Krečič M (2013) Pedagogy 1: 1 In Higher Education: A Case Study. *Problems of Education in the 21st Century*, 57:102-110.
- Poincaré HJ (1889) *Théorie mathématique de la lumière*. Carré & Naud, Paris.
- Poincaré HJ (1900a) Les relations entre la physique expérimentale et la physique mathématique. *Revue générale des sciences pures et appliquées* 11:1163–1175.
- Poincaré HJ (1900b) La théorie de Lorentz et le principe de réaction, *Archives néerlandaises des sciences exactes et naturelles* 5:252–278.
- Poincaré HJ (1913) *Dernières pensée*. Flammarion, Paris.
- Prasher RS, Hu XJ, Chalopin Y, Mingo N, Lofgreen K, Volz S, Cleri F, Keblinski P (2009) Turning Carbon Nanotubes from Exceptional Heat Conductors into Insulators. *Physical Review Letters*, 102(10). doi:10.1103/physrevlett.102.105901
- Quilio S (2012) Une forme caractéristique de condition de l'étude dans la réalisation d'une ingénierie didactique en mathématiques à l'école primaire. *Éducation et didactique* 6:9–26. <https://doi.org/10.4000/educationdidactique.1470>
- Quilio S, Forest D (2011) Comment initier en mathématiques la production d'une notation et ses usages à partir de l'activité des élèves ? Un exemple d'entrelacement de phénomènes langagiers et non-langagiers dans la construction conjointe d'un milieu pour l'étude à l'école primaire.
- Radelet-de Grave P (1999) Relativité galiléenne et lois de conservation. In: *Revue des Questions Scientifiques*, 170(3):209-260.
- Radelet-de Grave P (2009) L'analogie comme outil de découverte, in *Revue des Questions Scientifiques*, 180(1):1-32.
- Radelet-de Grave P (2009a) Guarini et la structure de l'Univers. *Nexus Network Journal* 11/3:393–414.
- Radelet-de Grave P (2010) Publishing Complete Works of the Great Scientists, An International Undertaking . In: *Crossroads : History of Science, History of Art, Essays* by David Speiser, Birkhäuser, Bâle, pp. 127-147.
- Radelet-de Grave P (2012) Des montres pour calculer des vitesses: ou comment Kepler explique sa découverte des deux premières lois. In: *Philosophica*, 41-42(I-II):13-79.

- Romero M, Brunel M, Santini J, Quilio S, Calistri C, De Smet C, Douek N (2017) De l'innovation éducative aux usages créatifs des TIC: présentation du Laboratoire d'Innovation et Numérique pour l'Éducation (LINE).
- Sensevy G, Forest D, Quilio S, Morales G (2013) Cooperative engineering as a specific design-based research. *ZDM - Mathematics Education* 45:1–13. <https://doi.org/10.1007/s11858-013-0532-4>
- Whittaker ET (1953) The relativity theory of Poincaré and Lorentz. En: *A History of the theories of aether and electricity. Vol 2: The modern theories 1900–1926*. Nelson, London, pp. 27–77.
- Wolfgang R (2001) *Relativity: special, general and cosmological*. The Oxford University Press, Oxford.
- Zahar E (1987) Les fondements des mathématiques d'après Poincaré et Russell. *Fundamenta Scientiae VIII* 1987:31–56.
- Zahar E (1989) *Einstein's Revolution: A Study in Heuristic*. The Open Court Publishing Company, Chicago.
- Zaoui H, Palla PL, Cleri F, Lampin E (2017) Fourier-like conduction and finite one-dimensional thermal conductivity in long silicon nanowires by approach-to-equilibrium molecular dynamics. *Physical Review B*, 95(10). doi:10.1103/physrevb.95.104309
- Zaoui H, Palla PL, Giordano S, Cleri F, Verdier M, Lacroix D, Robillard JF, Termentzidis K, Martin E (2018) Thermal conductivity of deca-nanometric patterned Si membranes by multiscale simulations. *International Journal of Heat and Mass Transfer*, 126:830–835. doi:10.1016/j.ijheatmasstransfer.2018.06.004

#### 4. The Methodology & Work in Situ

Under the supervision of my PhD Supervisor, Prof. Raffaele Pisano, I learned the guidelines of scientific and historical research: observation, data, modelling and theory, primary to secondary literature in Physics/History and Epistemology of Science, NoS, NoS Teaching, Science Education, Cognitive psychology, Neurosciences<sup>21</sup>. Particularly, experience and

---

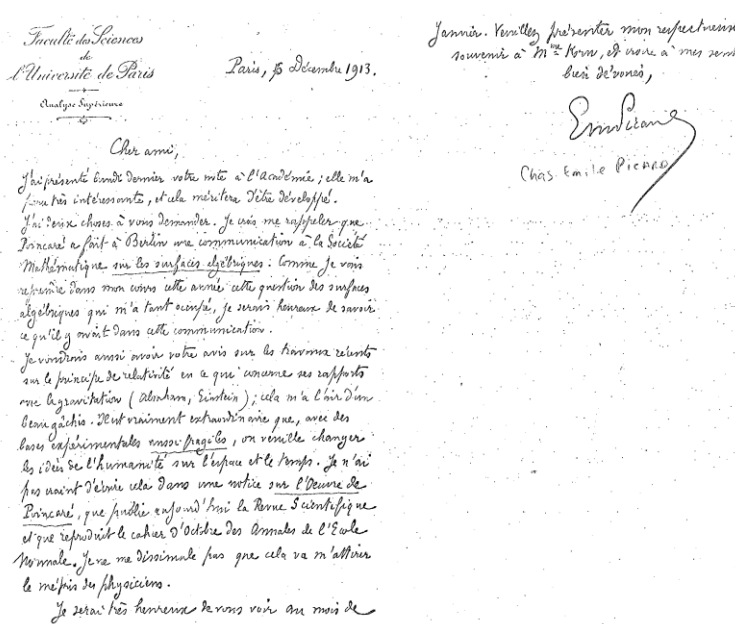
<sup>21</sup> Taking into account my doctoral thesis aims, an incomplete but selected list of authors is: Physics: Friedmann 1922; Misner 1973; Schutz 1989; Saulson 1994; Van Heuvelen 2001; Kokkotas 2002; Longair 2004; Buonanno 2007; Fairhurst 2009; Sathyaprakash 2009; Zacharia 2011, Pisano and Sozzo 2020. History of Science: Pisano's works (Cfr. references below); Lakatos 1971; Gabel 1993; Bage 1999; Schleppegrell 2003; Braund 2006; Radelet-de Grave 1999, 2009, 2009a, 2010, 2012; Ramadas 2009; Kim 2010; Kelly 2012; Hodson 2014; Bracco 2006, 2015, 2017, 2018, Kouneihier 2005, 2018. Epistemology of science: Lakatos 1980; Livingstone 1981; Goldman 1986; Kuhn 2002; Schommer-Aikins 2002; Brownlee 2003; Steup 2005; Rahman 2018; Crapanzano 2018. Teaching/Science Education: Dykstra 1992; Niedderer 1992; Gautreau 1997; Boxtel 2000; Hammer 2003; Adams 2006; Perkins 2006; Chang 2008; Sahin 2009, 2010; Teixeira 2012, Burko 2017. Cognitive Psychology: DiSessa 1982; Carey 1986; Glaser 1988; Prosser 1989; Niedderer 1992; Nersessian 2003; Chater 2008; Reif 2008; Tytler 2010; Gallistel 2011, Neurosciences: Kosslyn 1995; Liston 1996; Kéri 2003; Fanselow



research *in situ*: American Institute of Physics, VIRGO. On one hand, my stay at the Niels Bohr Library was supported thanks to a grant-in-aid from the Friends of the Center for History of Physics, American Institute of Physics. During this time I had the chance of discussing with distinguished AIP scholars during the *Lyne Starling Trimble Science Public Lecture* of November 2019 which consisted of a gathering of historians and historians of science on the theme of “The impact of World War I on the Sciences”. I also took the chance to visit and consult the Library of Congress and the Smithsonian National Museum of American History on weekends. I managed to gather and collect new materials for my PhD project. I tried to consult as many archived documents of the Niels Bohr Library related to gravitational waves as possible, especially correspondence, manuscripts, lecture notes, but also documents related to Institutional Histories and I even had the opportunity to consult reels and operate the reel machine. Thus working *in situ* was extremely meaningful to me, as it provided a very rich unmatched experience. Specifically, I consulted:

- ✓ The History of the Search for Gravitational Waves [sound recordings] of January 30th, 2017, and a number of other audio archived documents.
- ✓ The common sense of the exact sciences / by the late William Kingdon Clifford, with one hundred figures.
- ✓ The common sense of the exact sciences, by William Kingdon Clifford; edited, and with a preface, by Karl Pearson; newly edited and with an introduction by James R. Newman; preface by Bertrand Russell.
- ✓ Elements of dynamic: an introduction to the study of motion and rest in solid and fluid bodies / by W.K. Clifford; part I. Kinematic.
- ✓ Mathematical papers. Edited by Robert Tucker. With an introd. by H. J. Stephen Smith.
- ✓ Letters and manuscripts from Émile Picard (Cfr. figure below)
- ✓ Fabry’s Les applications des interferences des ondes lumineuses, oral histories and documents related to the Chapel Hill Conference of 1957 (Renn 2011; DeWitt 2016).

Below I present (Fig. 17) which is a letter from Émile Picard to Arthur Korn that I found in the NBL archives which illustrates how the new works on the principle of relativity in regards to gravitation were perceived in 1913:



**Fig. 17** Letter from Émile Picard to Arthur Korn – dated Paris, 6 Décembre 1913.<sup>22</sup>  
Source: Niels Bohr Library, courtesy of the American Institute of Physics, USA.

On the other hand, I was invited to come to the site at EGO from June 9<sup>th</sup> to 15<sup>th</sup> 2019 and had the opportunity to discuss the principle of the detection of gravitational waves with laser interferometers and the functioning of the detectors, its design and characteristics; especially with Gabriel Pillant, Julia Casanueva, Valerio Boschi and Nicolas Arnaud; who were kind enough to provide me with some resources for my research and answer all my questions.

<sup>22</sup> Dear friend,

I presented last month your note to the Academy; it appeared very interesting to me, and it deserves to be developed.

I have two things to ask you. If I recall correctly Poincaré did a communication in Berlin to the Mathematical Society on algebraic surfaces. As I am going to include this question that kept me so busy in my lectures of this year, I would be glad to know what the content of this communication was.

I would also like to have your opinion on the recent works on the principle of relativity with regard to its relations with gravitation (Abraham, Einstein); this seems like a nice mess. It is extraordinary, with such fragile experimental bases, to be willing to change humanity's ideas on space and time. I did not fear to write this in a notice on l'Oeuvre de Poincaré, the Revue Scientifique is publishing today and that the Annales de l'Ecole Normale reproduces. I will not hide that this will bring spite from physicists<sup>22</sup> (Author's translation)

## In detail:

- ✓ I established a preliminary table of contents that was updated regularly and used as a guide.
- ✓ I decided to use a multidisciplinary theoretical framework built from different fields for this research based on common principles. For example:
  1. The real world exists (Philosophy of Science) and each individual generates their own internal interpretation of it (Cognitive Sciences) from their sensory inputs (Neurosciences) and consciousness –the phaneron– (Philosophy-Epistemology);
  2. Each student is an individual with complex mental structures, responses, genetic, cultural and environmental backgrounds...(Social Sciences and Humanities, Science Education);
  3. New knowledge is built on existing knowledge by establishing new links through associations and analogies and suppressing old ones; etc.

## Below I summarise the main steps:

- ✓ I selected-resumed fundamental concepts of Physics in the scientific literature and textbooks for the first part of the thesis.
- ✓ I selected–summarised fundamental concepts using a historical approach and using key texts belonging to the history of the root concepts at the basis of the history of the discovery of gravitational waves.
- ✓ I built the case study of NoS Teachings for introductory lectures on gravitational waves.
- ✓ I selected case–studies interesting for my aims.
- ✓ I designed pedagogical introductory lectures and curricula for different audience levels using historical texts and modern tools such as simulation software available to the general public, simple scientific equipment available in Physics classes and other experiments doable with everyday life objects.
- ✓ I worked on NoS teaching with Universe Sandbox to simulate effects of moving mass on astronomical scales, a spandex sheet grid with weights to help them grasp the effects of spacetime curvature, and different kinds of balls with strings to illustrate gravitational decay through analogies.
- ✓ I preferred a mixed NoS teaching exploring approach: selected hypotheses–observables and modelling in order to identify the different steps of the development of the concept of a gravitational wave, then identifying the historical–epistemological items of the learners to verify–explore the hypothesis.
- ✓ I visited the *Olympiades de physique 2019* that took place at Lilliad, during which students of the *Arago d’Héricourt Lyceum* won first place with their project “Advanced Arago”. It presented the development of physics behind the LIGO/Virgo observatories. Unfortunately, I was working during the day, but I managed to

leave my stand at Xperium and got the opportunity to talk with them and their Physics teacher. However, because of this I was forced to conduct an informal interview.

Acting as if I did not know anything on the subject, I asked them many questions during their presentation in order to evaluate how much they understood the subjects of gravitational waves and how to detect them. With this event/result for my thesis, I concluded that their understanding –although not perfect– was quite advanced.

- ✓ I also discussed with various Professors (specialists of the different fields) and did dissertations of partial results and developments in conferences, workshops, etc.
- ✓ I studied different lectures on the subject of Special and General Relativity.
- ✓ I researched the existence of lectures on gravitational waves in different curricula (anecdotal presence; non-existent outside of Astrophysics Masters Degree).

## 5. Expected Impact

The expected impact of my thesis concerns its contribution to historians of physics and I hope scientists in the field, in particular on the history of the discovery of gravitational waves and the concepts at the roots of this discovery. Very interesting will be the possible influence to the history of the mathematical–physical interplay (Cfr. Pisano 2011, 2013a, 2014, 2015b; Pisano & Capocchi 2013 ; Karam 2015) with the views of Sir William Kingdon Clifford about physical space and his insights and ideas; Clifford considered geometry to be a physical science (Cervantes-Cota 2016; 2018). I expect my thesis to contribute to raising the awareness that Clifford was not just Riemann’s follower, but had his own ideas. Another expected impact is related to Nature of Science Teaching and research: a) a revised synthetic history in which it is easy to uncover multiple useful examples for teaching Physics, History, Epistemology and NoS and Epistemology of science disciplines–topics (i.e., for the later they are falsification and repeatability, constructivism, critical thinking and confirmation bias, paradigm shifts, b) a historical–epistemological perspective including a model of inquiring modern physics, both for research and teaching; c) the identification of a NoS method for teaching gravitational waves physics based on historical foundations of science; d) the possibility of viewing the usual associated epistemological obstacles of the concepts evoked by the physics of gravitational waves (belonging to the Physics of Waves, Gravitation and the Relativities) in a new light and at different audience levels, e) evaluating if the physics of gravitational waves can be taught as soon as High School through the use of Nature of Science Teachings, f) building a coherent multidisciplinary framework for NoS teaching-learning, and g) Publications.

## 6. A Short Overview of the Thesis Project

<b>Ph.D Candidate</b>	Mr. Philippe VINCENT CIREL, Lille University, France
<b>Ph.D Thesis Title</b> a.y. 2017-2020	<i>A History of Gravitational Waves between Discoveries &amp; Nature of Science Teaching: Hypotheses and Perspectives</i>
<b>Ph.D Advisor</b>	Prof. Dr. Raffaele PISANO, HDR Physicist, Professor of History of Physics, History of science & Education IEMN, CNRS–Lille University, France
<b>Follow-up PhD Committee</b> <sup>23</sup> [Comité de suivi]	<ol style="list-style-type: none"> <li>1. Prof. Salvador Galindo-Uribarri, Instituto Nacional de Investigaciones Nucleares (<b>Mexico</b>) [Nuclear Physics &amp; Gravitation]</li> <li>2. Prof. Jorge L. Cervantes-Cota, Instituto Nacional de Investigaciones Nucleares (<b>Mexico</b>) [Nuclear Physics &amp; Gravitation]</li> <li>3. Prof. Joseph Kouneiher, Université de Nice-Sophia Antipolis (<b>France</b>) [Mathematical Physics &amp; History of Science]</li> <li>4. Prof. Shahid Rahman, Université de Lille (<b>France</b>) [Epistemology of Science, Foundations of Science &amp; Logic]</li> <li>5. Prof. Catherine Maignant, Université de Lille (<b>France</b>) [History &amp; Civilization]</li> <li>6. A/Prof. Nathalie Lebrun, Université de Lille (<b>France</b>) [Didactic of Science &amp; Physics]</li> </ol>
<b>Ph.D School</b>	École Doctorale des Sciences de l'Homme et de la Société, Lille University, France

---

<sup>23</sup> The Follow-up PhD Committee is an advisory body whose role is to monitor the progress of the doctoral student's thesis work, including related activities and to detect any scholarly problems or difficulties. In accordance with current French rules and regulations, this committee does not inquire on the content and methodology of the thesis and cannot be part of the final PhD defence jury.

<b>Area of Research</b>	History of Physics, Foundations and epistemology of science (Physics and Mathematics), Nature of science Teaching, Physics, Mathematics, Geometry
<b>Subject</b>	History of Gravitational Waves
<b>The Structure</b>	<ol style="list-style-type: none"> <li>1. The first part, the Physics of Waves is mainly there to introduce the scientific topic to the readers, both for scientific-physicist and for non-physicists</li> <li>2. The second – dominant – part concerns the history of gravitational waves and is related to their discovery; particularly the case of Gravitation</li> <li>3. The last two parts are about the analysis of Teaching-Learning both as <i>NoS</i> inquiring and Didactics and Epistemological inquiring for this case study</li> </ol>
<b>Outline of the Problem</b>	The study of the history of the discovery of gravitational waves in Physics and the roots of the concepts. <i>The proposal consists of an historical and epistemological analysis as well as a Nature of Science Physics Inquiring and Teaching proposal.</i>
<b>General Objectives</b>	The overall objective of this work is to study the history of the discovery of gravitational waves, history of science and nature of science teaching (NoS) from an interdisciplinary point of view (Physics, History of Science, Epistemology and Nature of Science Teaching) and to make a teaching proposal within the NoS Teaching framework.
<b>Specific Objectives</b>	<ul style="list-style-type: none"> <li>- To evaluate how soon gravitational waves physics can be taught.</li> <li>- To develop an historical and contemporary account on the gravitational waves discovery, collecting data and constructing a synthesis of the history of the subject to elaborate a teaching proposal within the NoS Teaching framework.</li> <li>- To design introductory teachings on gravitational waves.</li> </ul>
<b>Methodology of Research</b>	<ul style="list-style-type: none"> <li>- Research and study based on primary sources, <i>in situ</i> when possible (e.g., American Institute of Physics Sources, Gallica, Archive.org, etc.).</li> <li>- Online Research, peer-reviewed papers, etc.</li> <li>- Using established scientific research and social sciences research methodology guidelines.</li> </ul>

**Expected  
Results**

- Showing that gravitational waves can be taught at the University to non-specialists and to High School students (at least in concepts).
- Recognition of the role played by different scientists in the discovery of gravitational waves and its history.
- Designing a logical, intuitive and easy to understand course for the teaching of gravitational waves and its framework (i.e., physics of waves, relativities).
- Recognition of the impact of less-known scientists.
- Influence on the teaching of the related subjects at high school and university as well as a stepping stone for disenchanted students towards a renewal of interest.
- A theoretical model to make science (and its scientific objects) an interdisciplinary and multipurpose tool for science of education.
- Raising awareness of the importance of the discovery of gravitational waves for astronomy and as a great tool for science didactics.
- Identifying epistemological obstacles from another perspective.

**Perspectives**

- Building a synthesis of the development of the history and the roots of the concepts, breakthroughs and insights that lead to the discovery of gravitational waves.
- Identifying theoretical, historical, epistemological, physical and practical obstacles in the history of the discovery of gravitational waves.
- Influence of non-classical logic (and language) in the history of scientific thought.
- Influence of the history of the discovery of the gravitational waves as a drive for an advancement on various technological aspects.
- Teaching based on different approaches to the transmission of knowledge for teaching and learning.
- To examine interdisciplinarity which is at the heart of many discoveries and plays an extremely important role in research and science education.
- With regard to the renewal of teaching, it can be approached with theoretical hypotheses, such as those related to the importance of Nature of Science in Education Science. In fact, the references to the history of physics can serve as a guide and can confer a rich context for a critical analysis of different and varied hypotheses (for example for the foundations of quantum mechanics, the question of whether the gravitational waves transmit energy with Feynman).
- To show that the history of physics in the classroom also helps stimulate students' reflections on the fundamentals of science and enables them to follow the reasoning of scientists and their insights while motivating them through comparisons and analogies.
- The identification and production of a method for science teaching based on the history of science, following the reasoning and insights of scientists using modern simpler and more intuitive tools.
- Publications



- References**
- Primaries and Secondaries
  - Sources**
    - Online Resources:
      - ✓ Academia
      - ✓ AAPT
      - ✓ AIP publishing
      - ✓ APS
      - ✓ American Scientist
      - ✓ Archive.org
      - ✓ arXiv.org
      - ✓ Cairn
      - ✓ DESY
      - ✓ DOAJ
      - ✓ EGO/Virgo
      - ✓ Elsevier
      - ✓ Emis.de
      - ✓ Gallica (BNF)
      - ✓ GravitySpy
      - ✓ HAL
      - ✓ HathiThrust
      - ✓ Journals.openedition.org
      - ✓ Library of Congress
      - ✓ LIGO
      - ✓ MPI
      - ✓ NASA
      - ✓ Nature
      - ✓ NewScientist
      - ✓ PlosOne
      - ✓ Science magazine
      - ✓ Science Publishing Group
      - ✓ Springer
      - ✓ Researchgate
      - ✓ Wiley online Library
      - ✓ Various Press Universities (Caltech, Cambridge, MIT, ...)
    - *Interviews with researchers*: Virgo Interferometer, European Gravitational Observatory, Cascina, Italy;
    - *Manuscripts, letters, in situ*: Niels Bohr Library, American Institute of Physics, College Park, USA.

## REFERENCES

### Locations for the Manuscripts/Documents in situ

Virgo Interferometer, European Gravitational Observatory, Cascina, Italy.  
 Niels Bohr Library, 1 Physics Ellipse Dr, College Park, MD 20740, USA.  
 Dibner Library, 12th & Conston Ave NW #1041, Washington, DC 20560, USA.  
 Library of Congress, 101 Independence Ave SE, Washington, DC 20540, USA.

### Primary Sources

- Aristotle (1979) *Physics Books I and II*. Translated with introduction, commentary, note on recent work and revised bibliography by William Charlton, Clarendon Press.
- Bachelard G (1934) *La formation de l'esprit scientifique*. Vrin, Paris.
- Bachelard G (1940) *La Philosophie du Non : Essai d'une philosophie du nouvel esprit scientifique*. Quatrième Édition, Presses Universitaires de France, Paris.
- Clifford WK (1870) Lecture delivered to the Cambridge Philosophical Society February 1870, Abstract Reprint In: *Mathematical Papers W.K. Clifford*. Ed. Robert Tucker (ed). London Macmillan & Co, 1882. Reproduced in P. Pesic *Beyond Geometry* (2007) p. 73, Dover N.Y.
- Clifford WK (1873) On the Hypothesis which lie at the Bases of Geometry, *Nature*, vol 8(183,184), pp.14-17, pp.36-37.
- Clifford WK (1873b) Preliminary Sketch of Biquaternions. *Proceedings of the London Mathematical Society* s1-4:381–395. <https://doi.org/10.1112/plms/s1-4.1.381>
- Clifford WK (1875) On the Free Motion under no Forces of a Rigid System in an n-fold Homaloid. *Proceedings of the London Mathematical Society* s1-7:67–70. <https://doi.org/10.1112/plms/s1-7.1.67>
- Clifford WK (1879) *Lectures and Essays by William Kingdon Clifford*. Macmillan
- Clifford WK (1976) On the Space-Theory of Matter. In: Čapek M. (ed) *The Concepts of Space and Time*. Boston Studies in the Philosophy of Science. 22. Springer, Dordrecht, pp. 157–158.
- Clifford WK (1882) *Mathematical Papers*. In: Macmillan, Robert Tucker (ed.), London.
- Clifford WK (1901) The Postulates of the Science of Space. In: Stephen L, Pollock F (eds.), *Lectures and essays by the late William Kingdon Clifford*, MacMillan and Co., Limited, New-York, Vol. 1, pp. 352-388.
- Copernicus N (1966) *De revolutionibus orbium cœlestium: libri VI*. Norimbergae, I. Petreium, 1543. Culture et Civilisation.
- De Broglie L (1924) *Recherches sur la théorie des Quanta*. Theses, Migration - université en cours d'affectation.
- Dewey J (1986) Experience and Education. *The Educational Forum* 50:241–252. <https://doi.org/10.1080/00131728609335764>
- Duhem P (1906) *La théorie physique*. Vrin, Paris.
- Einstein A (1916) Näherungsweise Integration der Feldgleichungen der Gravitation. *Sitzungsberichte der Königlich Preussischen Akademie der Wissenschaften Berlin*, part 1: 688–696.

- Einstein A (1918) Über Gravitationswellen. Sitzungsberichte der Königlich Preussischen Akademie der Wissenschaften Berlin, part 1:154–167.
- Einstein A (1920) Relativity The Special and General Theory, translated by Robert W. Lawson, University of Sheffield, Henry Holt and Company, New York, pp. 135-137, 148-159.
- Einstein A, Rosen N (1937) On gravitational waves. Journal of the Franklin Institute, 223/1:43–54.  
Doi:10.1016/S0016-0032(37)90583-0.
- Euler L (1746) Nova theoria lucis et colorum. Opuscula varii argumenti, 169-244.
- Fourier J (1824) Résumé théorique des Propriétés de la chaleur rayonnante. Annales de chimie et de physique, 27:236-281. Retrieved: <https://gallica.bnf.fr/ark:/12148/bpt6k65708960/f242.image>
- Fresnel A (1866-1870) Oeuvres complètes d'Augustin Fresnel. Tomes 1 & 2. Retrieved: <https://gallica.bnf.fr/ark:/12148/bpt6k1512245j/f11.image>
- Friedmann A (1922) 125. On the curvature of space. Zeitschrift für Physik, 10:377-386.
- Galilei G (1890) Le operazioni del compasso geometrico e militare. In: Favaro, A. (ed.) Opere di Galileo Galilei, Edizione Nazionale, vol. II. Barbera Editore, Firenze.
- Galilei G (2005) Opere, vol. I, Brunetti F (ed.), pp. 189–261. U.T.E.T., Padova.
- Hooke R (1665) Micrographia or Some physiological descriptions of minutes bodies made by magnifying glasses: with observations and inquiries thereupon. Printed by Jo. Martyn and Ja. Allestry, London. Retrieved: <https://gallica.bnf.fr/ark:/12148/bpt6k98770v/f99.item>
- Huygens C (1912) Treatise on Light: In Which Are Explained the Causes of That Which Occurs in Reflexion, & in Refraction. And Particularly in the Strange Refraction of Iceland Crystal. MacMillan and Company, limited.
- Kepler, J. (1596). *Mysterium Cosmographicum*. Georgius Gruppenbachius, Tübingen.
- Kepler J (1906) *Astronomia nova ... seu physica coelestis, tradita commentariis de motibus stellae martis*, Heidelberg, Vögelin. Retrieved: <http://www.rarebookroom.org/Control/kepast/index.html>
- Kepler, J (1937) *Gesammelte Werke*. Von Dyck W, Caspar M, Hammer F and List M (eds.), 14:278–278.
- Kepler J, Caspar M (1929) *Neue astronomie*. R. Oldenbourg, Munchen-Berlin.
- Kuhn T (1962) *La structure des révolutions scientifiques*. Champs-Flammarion, Paris.
- Kuhn, L. Reiser, B. (2005). Students constructing and defending evidence-based scientific explanations. A paper presented at the annual meeting of the National Association for Research in Science Teaching, Dallas, Texas.
- Mach E (1898) *The science of mechanics; a critical and historical account of its development*. Translated by Thomas J. McCormack, Open Court Publishing Co., 1960, Chicago, London.  
Retrieved: <https://archive.org/details/sciencemechanic01machgoog/page/n8/mod/e/2up>
- Mach E (1911) *History and Root of the Principle of the Conservation of Energy*, trans. PE Jourdain. Open Court, Illinois (1st German edn 1871), p. 83.
- Newton I ([1713], 1729) *The Mathematical principles of natural philosophy*. Translated by Motte Andrew. Motte B, London.
- Newton I ([1726; 1739–1742], 1822) *Philosophiae Naturalis Mathematica Principia*, auctore Isaaco Newtono, Eq. Aurato, perpetuis commentariis illustrata, communi studio Pp. Thomae Le Seur et Francisci Jacquier ex Gallicana minimorum familia, matheseos professorum. Editio nova (in three volumes). Duncan, Glasgow.

- Newton I (1687) *Philosophiae Naturalis Principia Mathematica*. Imprimatur S. Pepys, Reg. Soc. Preses. Julii 5. 1686. Londini, Jussi Societatus Regiae ac Typis Josephi Streater. Prostat apud plures Bibliopolas. Anno MDCLXXXVII.
- Newton I (1833) *Philosophiae naturalis principia mathematica*. G. Brookman.
- Newton I (1999) *The Principia: mathematical principles of natural philosophy*. Univ of California Press.
- Piaget J (1927) *La causalité physique chez l'enfant*. Librairie Félix Alcan, Paris.
- Piaget J, Duckworth E (1970) Genetic epistemology. *American Behavioral Scientist*, 13(3):459-480.
- Poincaré H (1905) *Sur la dynamique de l'électron* (The dynamics of the electron by Henri Poincaré) pour l'académie des sciences. C.R. T.140 (1905) 1504-1508.  
Retrieved: [https://www.academie-sciences.fr/pdf/dossiers/Poincare/Poincare\\_pdf/Poincare\\_CR1905.pdf](https://www.academie-sciences.fr/pdf/dossiers/Poincare/Poincare_pdf/Poincare_CR1905.pdf)
- Picard CE (1913) Letter from Émile Picard to Arthur Korn – dated Paris, 6 Décembre 1913. Source: Niels Bohr Library, courtesy of the American Institute of Physics, USA.
- Picard CE (1913a) *L'Oeuvre de Henri Poincaré, par Émile Picard, membre de l'institut et du bureau des longitudes*. Gauthier-Villars, Imprimeur-Libraire du bureau des longitudes de l'École Polytechnique, Quai des Grands-Augustins, 55, Paris.
- Riemann B (1868) *Ueber die Hypothesen, welche der Geometrie zu Grunde liegen, Abhandlungen der Königlichen Gesellschaft der Wissenschaften zu Göttingen*, 13:133-150. Retrieved: [http://www.deutschestextarchiv.de/riemann\\_hypothesen\\_1867/7](http://www.deutschestextarchiv.de/riemann_hypothesen_1867/7)
- Tartaglia N (1845-1846) *La balistique de Nicolas Tartaglia : ouvrage publié pour la 1re fois en 1537 sous le titre de "La Science nouvelle", et continué en 1546 dans les deux 1ers livres du recueil du même auteur intitulé : Questions et inventions diverses / traduit de l'italien... par Rieffel*.  
Retrieved: <https://gallica.bnf.fr/ark:/12148/bpt6k9760464g?rk=21459:2>
- Young T (1800) VII. *Outlines of experiments and inquiries respecting sound and light*. By Thomas Young, MDRS In a letter to Edward Whittaker Gray, MD Sec. R. S. *Philosophical Transactions of the Royal Society of London*, (90):106-150.
- Weber J (1960) *Detection and Generation of Gravitational Waves*. *Phys. Rev.* 117/1:306-313. Retrieved: <https://doi.org/10.1103/PhysRev.117.306>
- Weber J (1969) *Evidence for Discovery of Gravitational Radiation*. *Phys. Rev. Lett.* 22/24:1320-1324. Retrieved: <https://doi.org/10.1103/PhysRevLett.22.1320>
- Weber J (1970) *Anisotropy and Polarization in the Gravitational-Radiation Experiments*. *Phys. Rev. Lett.* 25/3:180-184. Retrieved: <https://doi.org/10.1103/PhysRevLett.25.180>

## Secondary Sources

- Abattouy M (2006) *The Arabic transformation of mechanics: the birth of science of weights*. *Foundation for Science Technology and Civilisation*, 615:1-25.
- Abattouy M (2018) *Seminars Abattouy at Lille University* (May 2018). Retrieved: [https://www.researchgate.net/publication/326440942\\_Seminars\\_Abattouy\\_at\\_Lille\\_University\\_May\\_2018](https://www.researchgate.net/publication/326440942_Seminars_Abattouy_at_Lille_University_May_2018)
- Abbott BP, Abbott R, Abbott TD, et al (2016o) *Tests of General Relativity with GW150914*. *Physical Review Letters* 116:221101. Retrieved: <https://doi.org/10.1103/physrevlett.116.221101>

- Abbott BP, Abbott R, Abbott T, et al (2016a) GW150914: First results from the search for binary black hole coalescence with Advanced LIGO. *Physical Review D* 93:122003.
- Abbott BP, Abbott R, Abbott T, et al (2016d) Properties of the binary black hole merger GW150914. *Physical review letters* 116:241102.
- Abbott BP, Abbott R, Abbott TD, et al (2016f) ASTROPHYSICAL IMPLICATIONS OF THE BINARY BLACK HOLE MERGER GW150914. *The Astrophysical Journal* 818:L22. <https://doi.org/10.3847/2041-8205/818/2/L22>
- Abbott R, Abbott TD, Abraham S, Acernese F, Ackley K, Adams C, ... Agatsuma K (2020) GW190814: Gravitational waves from the coalescence of a 23 solar mass black hole with a 2.6 solar mass compact object. *The Astrophysical Journal Letters*, 896(2):L44.
- Abd-El-Khalick F, Myers JY, Summers R, Brunner J, Waight N, Wahbeh N, Zeineddin AA, Belarmino J (2017) A longitudinal analysis of the extent and manner of representations of nature of science in U.S. high school biology and physics textbooks. *Journal of Research in Science Teaching*, 54:82-120. doi:10.1002/tea.21339
- Adams WK, Perkins KK, Podolefsky NS, Dubson M, Finkelstein ND, Wieman CE (2006) New instrument for measuring student beliefs about physics and learning physics: The Colorado Learning Attitudes about Science Survey. *Physical review special topics-physics education research*, 2(1):010101.
- Africa TW (1961) Copernicus' relation to Aristarchus and Pythagoras. *Isis*, 52(3):403-409.
- Agassi J (1965) Towards an historiography of science.
- Atiyah MF, Bott R, Shapiro A (1964) Clifford modules. *Topology*, 3:3-38.
- Arlego MJ, Otero MR (2017) Teaching basic special relativity in high school: the role of classical kinematics. *International Journal of Physics & Chemistry Education*, 9(1):9-12.
- Aubin D (2004) Quelques tendances actuelles en histoire des mathématiques. A propos de trois livres récents. *Gazette des mathématiciens*, 102:91-100.
- Bage G (1999) *Narrative matters: teaching and learning history through story*. Psychology Press.
- Barbin E, Pisano R (2013) Historical Reflections on Physics Mathematics Relationship In: *Electromagnetic Theory In: Barbin E, Pisano R, (eds). The dialectic relation between physics and mathematics in the XIXth Century*. Springer, Dordrecht, pp. 31–57.
- Barker A (2007) *The Science of Harmonics in Classical Greece*. Cambridge University Press, Cambridge.
- Bartusiak M (1998) Interview with Joseph Weber, University of Maryland, May 6, 1998. Recordings/transcripts available at Niels Bohr Library Archives, 1 Ellipse Road, College Park, Maryland.
- Belloni M, Christian W, Dancy MH (2004) Teaching special relativity using Physlets®. *The Physics Teacher*, 42(5):284-290.
- Bondi H (1957) Plane gravitational waves in general relativity. *Nature* 179:1072-1073. <https://doi.org/10.1038/1791072a0>
- Boxtel CV, van der Linden J, Kanselaar G (2000) The use of textbooks as a tool during collaborative physics learning. *The Journal of Experimental Education*, 69(1):57-76.
- Bracco C, Provost JP (2006) The quanta in Einstein's 1905 relativity theory. In: *AIP Conference Proceedings*, American Institute of Physics, 861/1:1076-1080.
- Bracco C (2015) L'environnement scientifique du jeune Albert Einstein: La période milanaise (1899-1901). *Revue d'histoire des sciences*, 68/1:109-144.
- Bracco C (2017) *Quand Albert devient Einstein*. CNRS.

- Bracco C, Provost JP (2018) Les années italiennes du jeune Einstein-La thèse oubliée sur les forces moléculaires. *Reflète de la physique* 56:31-34.
- Braund M, Reiss M (2006) Towards a more authentic science curriculum: The contribution of out-of-school learning. *International journal of science education*, 28(12):1373-1388.
- Brownlee JM (2003) Paradigm shifts in preservice teacher education students: A case study of changes in epistemological beliefs for two teacher education students. *Australian Journal Educational and Developmental Psychology* 3:1-6.
- Brun S J-L, Morellato M, Sensevy G, Quilio S (2017) Cooperative engineering as a joint action. *European Educational Research Journal* 17:187–208. <https://doi.org/10.1177/1474904117690006>
- Buonanno A (2007) Gravitational Waves. *Les Houches*, 3–52. doi:10.1016/s0924-8099(07)80027-8
- Buonomano D (2017) Your brain is a time machine: The neuroscience and physics of time. WW Norton & Company.
- Burko LM (2017) Gravitational Wave Detection in the Introductory Lab, *The Physics Teacher*, 55:288-292.
- Campeti P, Komatsu E, Poletti D, Baccigalupi C (2020) Measuring the spectrum of primordial gravitational waves with CMB, PTA and Laser Interferometers. arXiv preprint arXiv:2007.04241.
- Carey S (1985) *Conceptual change in childhood*. MIT Press, Cambridge, USA.
- Carey S (1986) Cognitive science and science education. *American psychologist*, 41(10):1123.
- Carmichael P, Driver R, Holding B, Phillips I, Twigger D, Watts M (1990) Research on students' conceptions in science: A bibliography. Children's Learning in Science Research Group, Centre for Studies in Science and Mathematics Education, University of Leeds, UK.
- Caramazza A, McCloskey M, Green B (1981) Naive beliefs in "sophisticated" subjects: misconceptions about trajectories of objects. *Cognition*, 9(2):117-123. Retrieved: [https://doi.org/10.1016/0010-0277\(81\)90007-X](https://doi.org/10.1016/0010-0277(81)90007-X)
- Cartan É (1926) Sur une classe remarquable d'espaces de Riemann. *Bul de la Société Mathématique de France*, 54:214-264.
- Carew TJ, Magsamen SH (2010) Neuroscience and education: An ideal partnership for producing evidence-based solutions to guide 21st century learning. *Neuron*, 67(5):685-688.
- Cervantes-Cota J, Galindo-Uribarri S, Smoot G (2016) A Brief History of Gravitational Waves, *Universe review*, 2/3:22.
- Cervantes-Cota J, Galindo-Uribarri S (2018) Clifford's attempt to test his gravitation hypothesis. *Revista Mexicana de Física E* 64:162–168.
- Chadwick R (1984) The origins of astronomy and astrology in Mesopotamia. *Archaeoastronomy*, 7:89.
- Chang KE, Chen YL, Lin HY, Sung YT (2008) Effects of learning support in simulation-based physics learning. *Computers & Education*, 51(4):1486-1498.
- Chater N, Oaksford M (Eds.) (2008) *The probabilistic mind: Prospects for Bayesian cognitive science*. OUP Oxford.
- Chatziioannou K, Han S (2020) Studying strong phase transitions in neutron stars with gravitational waves. *Physical Review D*, 101(4). doi:10.1103/physrevd.101.044019
- Chevallard Y, Johsua MA (1985) La transposition didactique: du savoir savant au savoir enseigné. *La Pensée sauvage*.
- Clark R (2011) *Einstein: The life and times*. A&C Black.
- Clement J (1982) Students preconceptions in introductory mechanics. *American Journal of Physics* 50(1):66-71. Retrieved: <https://doi.org/10.1119/1.12989>.
- Cohen F (1994) *The Scientific Revolution: A Historiographical Inquiry*. The University of Chicago Press, Chicago.

- Collins H (2004) *Gravity's Shadow: The Search for Gravitational Waves*. The University of Chicago Press, Chicago.
- Condé M, Salomon M (2017) *Historiography of Science: The Link between History and Philosophy in Understanding Science*. *Transversal: International Journal for the Historiography of Science*, 2:1-2. Retrieved: <http://dx.doi.org/10.24117/2526-2270.2017.i2.01>
- Crapanzano F (2018) "Strange Trajectories": Naive Physics, Epistemology and History of Science. *Transversal: International Journal for the Historiography of Science*, (5):49-65 ISSN 2526-2270. DOI: <http://dx.doi.org/10.24117/2526-2270.2018.i5.06>
- Daw ND, Shohamy D (2008) The cognitive neuroscience of motivation and learning. *Social Cognition*, 26(5):593-620.
- de de Jong T, Van Gog T, Jenks K, Manlove S, Van Hell J, Jolles J, ... Boschloo A (2009) Explorations in learning and the brain: On the potential of cognitive neuroscience for educational science. Springer Science & Business Media.
- DeWitt CM, Rickles D et al. (2016) An Expanded Version of the Remarks by R.P. Feynman on the Reality of Gravitational Waves. In: *The Role of Gravitation in Physics, Report from the 1957 Chapel Hill Conference*. Retrieved <http://www.edition-open-sources.org/sources/5/34/index.html>
- Dhombres, JG (1978) *Nombre, mesure et continu: épistémologie et histoire*. Cedic.
- Di Martino P, Zan R (2010) 'Me and maths': towards a definition of attitude grounded on students' narratives. *J Math Teacher Educ* 13/1:27–48. Retrieved: <https://doi.org/10.1007/s10857-009-9134-z>
- DiSessa AA (1982) Unlearning Aristotelian physics: A study of knowledge-based learning. *Cognitive science*, 6(1):37-75.
- Di Sessa AA (2011) Toward an Epistemology of Physics. *Cognition and Instruction* 10/2-3:105-225.
- Duit R (1991) On the role of analogies and metaphors in learning science. *Science education*, 75(6): 649-672.
- Dykstra Jr DI, Boyle CF, Monarch IA (1992) Studying conceptual change in learning physics. *Science Education*, 76(6):615-652.
- Easterher R, Giblin JT, Lim EA (2007) Gravitational Wave Production at the End of Inflation. *Physical Review Letters*, 99(22). doi:10.1103/physrevlett.99.221301
- Eisenstaedt J (1986a) The Low Water Mark of General Relativity, 1925-1955. In: *Einstein and the History of General Relativity*, Howard D and Stachel J (eds), Birkhäuser, Boston, pp. 277-292.
- Eisenstaedt J (1986b) La relativité générale à l'étiage: 1925—1955. *Archive for History of Exact Sciences*, pp. 115-185.
- Eisenstaedt J, Kox AJ (Eds.) (1992) *Studies in the history of general Relativity* (Vol. 3). Springer Science & Business Media.
- Elders L (2013) ST. THOMAS AQUINAS'S COMMENTARY ON ARISTOTLE'S "PHYSICS". *The Review of Metaphysics*, 66(4), 713–748. Retrieved: [www.jstor.org/stable/23597906](http://www.jstor.org/stable/23597906)
- Fairhurst S (2009) Triangulation of gravitational wave sources with a network of detectors. *New Journal of Physics*, 11(12), 123006. doi:10.1088/1367-2630/11/12/123006
- Fanselow MS, Poulos AM (2005) The neuroscience of mammalian associative learning. *Annu. Rev. Psychol.*, 56:207-234.
- Freire O (2016) Contemporary Science and the History and Philosophy of Science. Retrieved: <https://www.mprl-series.mpg.de/proceedings/8/8/>
- Gabel DL (1993) *Handbook of Research on Science Teaching and Learning Project*. Macmillan Publishing Company, Division of Macmillan, Inc., 866 Third Avenue, New York, NY 10022.

- Gal O, Chen-Morris R (2010) Empiricism without the senses: How the instrument replaced the eye. In: *The body as object and instrument of knowledge*, pp. 121-147. Springer, Dordrecht.
- Galili I (2001) Weight versus gravitational force: Historical and educational perspectives. *International Journal of Science Education*, 23(10):1073-1093.
- Galili I (2008) The history of physics as a tool of teaching. In: Vicentini M, Sassi E (eds.), *Connecting research in physics education with teachers education*, pp. 1-11. International Commission on Physics Education.
- Gallistel CR, King AP (2011) *Memory and the computational brain: Why cognitive science will transform neuroscience*, Vol. 6. John Wiley & Sons.
- Gatto R (1994) *Tra scienza e immaginazione: le matematiche presso il collegio gesuitico napoletano (1552-1670 ca.)*. LS Olschki.
- Gautreau R, Novemsky L (1997) Concepts first—A small group approach to physics learning. *American Journal of Physics*, 65(5):418-428.
- Ghys É (1999) Laminations par surfaces de Riemann. *Dynamique et géométrie complexes*, 8:49-95.
- Giarè W, Melchiorri A (2020) Probing the inflationary background of gravitational waves from large to small scales. arXiv preprint arXiv:2003.04783.
- Glaser R (1988) *Cognitive Science and Education*. *International Social Science Journal*, 40(1):21-44.
- Goldman AI (1986) *Epistemology and cognition*. Harvard University Press.
- Goswami U (2008) Principles of learning, implications for teaching: A cognitive neuroscience perspective. *Journal of Philosophy of Education*, 42(3-4):381-399.
- Grünbaum A (1973) *Philosophical Problems of Space and Time Second, enlarged edition*. Boston Studies in the Philosophy of Science, vol. XII, D. Reidel Publishing Company, Dordrecht, Boston.
- Grünbaum yer D, Hutchinson DA (2011) Colloquium: Physics of the Riemann hypothesis. *Reviews of Modern Physics*, 83/2:307.
- Guisasola J, Almudi JM, Furió C (2005) The Nature of Science and Its Implications for Physics Textbooks: The Case of Classical Magnetic Field Theory. *Science & Education* 14:321-328.
- Hammer D, Elby A (2003) Tapping epistemological resources for learning physics. *The Journal of the Learning Sciences*, 12(1):53-90.
- Hellings RW, Downs GS (1983) Upper limits on the isotopic gravitational radiation background from pulsar timing analysis. *Astrophysical Journal*, Vol. 265, p. L39-L42.
- Hetherington NS (1967) The Shapley-Curtis Debate. *Astronomical Society of the Pacific Leaflets*, 10(490):313-320. Retrieved: <http://adsabs.harvard.edu/full/1970aspl...10..313h>
- Hodson D (2014) Learning science, learning about science, doing science: Different goals demand different learning methods. *International Journal of Science Education*, 36(15):2534-2553.
- Hulse RA, Taylor JH (1975) Discovery of a pulsar in a binary system. *Astrophysical Journal* 195:L51–L53. <https://doi.org/10.1086/181708>
- Isaacson W (2008) *Einstein: His life and universe*. Simon and Schuster.
- Jeong D, Kamionkowski M (2020) Gravitational Waves, CMB Polarization, and the Hubble Tension. *Physical Review Letters*, 124(4). doi:10.1103/physrevlett.124.041301
- Johnson S, Taylor K (eds.) (2011) *The Neuroscience of Adult Learning: New Directions for Adult and Continuing Education*, 81(110). John Wiley & Sons.
- Katsanevas S (1986) Results on neutrino oscillations from an appearance experiment in BEBC.
- Katsanevas S (1993) Prospects for supersymmetry at LEP200. Report DELPHI-93-109 PHYS 336, 7.



- Katsanevas S (1995) Long baseline neutrino oscillation beams and experiments. 30th Rencontres de Moriond: Electroweak Interactions and Unified Theories, pp. 481-489.
- Katsanevas S (1998) Supersymmetry at LEP, experimental review. *Journal of Physics G: Nuclear and Particle Physics*, 24(2):337-352. doi:10.1088/0954-3899/24/2/008
- Karam R (2015) Introduction of the Thematic Issue on the Interplay of Physics and Mathematics. *Science & Education*, 24(5-6):487-494. doi:10.1007/s11191-015-9763-9
- Karoubi M (1968) Algèbres de Clifford et  $K$ -théorie. In: *Annales scientifiques de l'École Normale Supérieure* 1/2:161-270.
- Kaur T, Blair D, Moschilla J, Stannard W, Zadnik M (2017) Teaching Einsteinian physics at schools: part 3, review of research outcomes. *Physics Education*, 52(6):065014.
- Kelly GJ, McDonald S, Wickman PO (2012) Science learning and epistemology. In: *Second international handbook of science education*. Springer, Dordrecht, pp. 281-291.
- Kennefick D (2005) Einstein Versus the Physical Review. *Physics Today* 58/9:43. Retrieved: <https://doi.org/10.1063/1.2117822>
- Kennefick D (2007) *Traveling at the Speed of Thought: Einstein and the Quest for Gravitational Waves*. Princeton University Press, Princeton.
- Kennefick D (2019) *No shadow of a doubt: the 1919 eclipse that confirmed Einstein's theory of relativity*. Princeton University Press.
- Kéri S (2003) The cognitive neuroscience of category learning. *Brain Research Reviews*, 43(1):85-109.
- Kim SY, Irving KE (2010) History of science as an instructional context: Student learning in genetics and nature of science. *Science & Education*, 19(2):187-215.
- Kokkotas KD (2002) Gravitational wave physics. *Encyclopedia of Physical Science and Technology*, 7(3):67-85.
- Kosslyn SM, Behrmann M, Jeannerod M (1995) The cognitive neuroscience of mental imagery. *Neuropsychologia*.
- Kouneihier J (2005) *Géométrie au XXe siècle, 1930-2000: histoire et horizons*. Presses internationales Polytechnique.
- Kouneihier J (Ed.) (2018) *Foundations of Mathematics and Physics One Century After Hilbert: New Perspectives*. Springer.
- Koyré A (1996) *Etudes Galiléennes*. Hermann, Paris.
- Kuhn D, Weinstock M (2002) *What is epistemological thinking and why does it matter?*. Lawrence Erlbaum Associates Publishers.
- Lakatos I (1971) History of science and its rational reconstructions. In: *PSA 1970*. Springer, Dordrecht, pp. 91-136.
- Lakatos I (1980) *Mathematics, Science and Epistemology: Volume 2, Philosophical Papers*. Cambridge University Press.
- Lévy-Leblond JM (1996) *Aux Contraires l'Exercice de la Pensée Et la Pratique de la Science*.
- LIGO Scientific Collaboration, Virgo Collaboration (2020) GW190412: Observation of a Binary-Black-Hole Coalescence with Asymmetric Masses. arXiv preprint arXiv:2004.08342.
- Ligozat F, Orange C, Dufays J-L, Doussot S, Quilio S, Loquet M, Tiberghien A, Martine J, Mercier A (2017) La modélisation des savoirs dans les analyses didactiques des situations d'enseignement et apprentissage. [Numéro thématique REE 29]
- Liston DD (1996) Changing Our Minds: The Struggle To Generate a Humanistic Neuroscience Language through Metaphors from Quantum Physics.
- Livingstone DN, Harrison RT (1981) Meaning through metaphor: analogy as epistemology. *Annals of the Association of American Geographers*, 71(1):95-107.
- Longair MS (2004) A brief history of cosmology. *Measuring and modeling the universe*, 2, 1-18.

- Logunov AA (2005) Henri Poincaré and Relativity Theory, Translated by Pontecorvo G and Soloviev VO, Petrov VA (ed), Nauka, Russia.
- Lounesto P (2001) Clifford algebras and spinors (Vol. 286). Cambridge university press.
- Matthews MR (1992) History, philosophy, and science teaching: The present rapprochement. *Science & Education* 1:11-47.
- Maurines L, Mayrargue A (2003) Regard croisés de l'histoire des sciences et de la didactique de la physique sur le concept d'onde. La pluridisciplinarité dans les enseignements scientifiques, 1.
- McComas WF (2002) The Nature of Science in Science Education, Rationales and Strategies. McComas (ed), Kluwer Academic Publishers, New York, Boston, Dordrecht, London, Moscow.
- McComas WF, Almazroa H, Clough MP (1998) The Nature of Science in Science Education: An Introduction. *Science & Education*, 7:511. Doi:10.1023/A:1008642510402
- McDermott LC (1984) Research on conceptual understanding in mechanics. *Physics Today* 37, 7, 24.
- McLaren IPL, Wood K, McLaren R (2013) Naïve Physics – the wrong theory? *Cognitive Science*, 35.
- McGrath D, Savage C, Williamson M, Wegener M, McIntyre T (2012) Teaching special relativity using virtual reality. In: Proceedings of The Australian Conference on Science and Mathematics Education (formerly UniServe Science Conference).
- McGrath D, Wegener M, McIntyre TJ, Savage C, Williamson M (2010) Student experiences of virtual reality: A case study in learning special relativity. *American Journal of Physics*, 78(8):862-868.
- Misner CW, Thorne KS, Wheeler JA (1973) GRAVITATION. W. H. Freeman and Company, San Francisco
- Monastyrsky MI (2008) Riemann, topology, and physics. Springer Science & Business Media.
- Morellato M, Quilio S (2012) Obstacles à l'usage du nombre et à l'enquête sur ses propriétés dans l'implantation d'une ingénierie sur la soustraction
- Navarro J (2012) A History of the Electron: JJ and GP Thomson. Cambridge University Press.
- Nersessian NJ (2003) Kuhn, conceptual change, and cognitive science. Thomas Kuhn, pp. 178-211.
- Niedderer H, Goldberg F, Duit R (1992) Towards learning process studies: A review of the workshop on research in physics learning. *Research in physics learning: Theoretical issues and empirical studies*, pp. 10-28.
- Niedderer H, Schecker H (1992a) Towards an explicit description of cognitive systems for research in physics learning. *Research in physics learning: Theoretical issues and empirical studies*, pp.74-98.
- Oliveira ARE (2014) A history of the work concept. Springer, Dordrecht.
- Oliveira A (2019) Emerging technologies as pedagogical tools for teaching and learning science: A literature review. *Human Behaviour and Emerging Technologies*, 1/2:149-160.
- Perkins K, Adams W, Dubson M, Finkelstein N, Reid S, Wieman C, LeMaster R (2006) PhET: Interactive simulations for teaching and learning physics. *The physics teacher*, 44(1):18-23.
- Pais A (1982) *Subtle is the Lord: The Science and the Life of Albert Einstein*, Oxford University Press, New York.
- Pesic P (2007) *Beyond Geometry: Classic Papers from Riemann to Einstein*. Dover, New York.
- Pisano R (2013a) History Reflections on Physics Mathematics Relationship in Electromagnetic Theory. In: Barbin and Pisano 2013, pp. 31–58.
- Pisano R (2014) (ed.) *Isaac Newton and his Scientific Heritage: New Studies in the History and Historical Epistemology of Science*. Special Issue. *Advances in Historical Studies* 3/3.

- Pisano R, Bussotti P (2014a) Galileo in Padua: architecture, fortifications, mathematics and “practical” science. *Lettera Matematica Pristem International* 2/4:209–221.
- Pisano R, Bussotti P (2014b) Historical and Philosophical Reflections on the Culture of Machines around the Renaissance. How Science and Technique Work? *Acta Baltica Historiae et Philosophiae Scientiarum* 2/2:20–42.
- Pisano R, Bussotti P (2015b) Introduction to Exploring Changes in How the Histories of the Exact Sciences from the 18th to through the 20th Century Have Been Written: Interpreting the Dynamics of Change in these Sciences and Interrelations Amongst Them—Past Problems, Future Cures? *Advances in Historical Studies Special Issue* 4/2:65–67.
- Pisano R, Bussotti P (2016) A Newtonian Tale Details on Notes and Proofs in Geneva Edition of Newton’s *Principia*. *Bulletin—British Society for the History of Mathematics* 32:1–19.
- Pisano R, Capecchi D, Lukešová A (2013) (eds.) *Physics, Astronomy and Engineering. Critical Problems in the History of Science. International 32nd Congress for the SISFA—Italian Society of Historians of Physics and Astronomy. The Scientia Socialis UAB & Scientific Methodical Centre Scientia Educologica Press, Šiauliai University, Lithuania.*
- Pisano R, Casolaro F (2011) An Historical Inquiry On Geometry In Relativity. Reflections on Early Relationship Geometry–Physics (Part I). *History Research* 1/1:47–60
- Pisano R, Casolaro F (2012) An Historical Inquiry On Geometry In Relativity. Reflections on Late Relationship Geometry–Physics (Part II). *HR* 2/1:56–64.
- Pisano R, Paulo M, Vincent P (2020) Introduction. In: IDTC Joule’s Bicentenary Special Issue. *Foundations of Science* (Springer).
- Pisano R, Sozzo S (2020) A Unified Theory of Human Judgements and Decision-making under Uncertainty. Submitted to *Entropy Special Issue. Quantum Models of Cognition and Decision-Making*. Andrei Khrennikov A, Bagarello F (eds).
- Pisano R, Vincent P (2019) Introduction. In: IDTC Dossier Methods and Cognitive Modelling in the History and Philosophy of Science–&–Education, *Transversal International Journal for the Historiography of Science* 5:3–9.
- Pisano R, Vincent P, Dolenc K, Ploj-Vrtič M (2020) Historical Foundations of Physics & Applied Technology as Dynamic Frameworks in Pre-Service STEM, *Foundations of Science* (Springer) <https://link.springer.com/article/10.1007%2Fs10699-020-09662-4>
- Pisano R, Vincent P (2020) Reading the Discoveries of Gravitational Waves as New History of Physics Frontier Research Programme Part two, *SISFA Proceedings 2019*. Pavia University Press, pp. 359–366.
- Pisano R, Vincent P (2020) Notes on Discoveries of Gravitational Waves as New History of Physics Frontier Research Programme, *SISFA Proceedings 2018*. Pavia University Press, pp. 279–283.
- Ploj Vrtič M (2009b) The Computer as a Modern Form of Communication in the Educational Process From the Teachers’ Point of View. *Informatologia* 42(1):10–17.
- Ploj Vrtič M (2014) Gamification of learning : an effective teaching method of a modern school or a fashion fad? Conference: 9th IOSTE Symposium for Central and Eastern Europe.
- Prosser M, Millar R (1989) The “how” and “what” of learning physics. *European Journal of Psychology of Education*, 4(4):513.
- Quilio S (2012) Une forme caractéristique de condition de l’étude dans la réalisation d’une ingénierie didactique en mathématiques à l’école primaire. *Éducation et didactique* 6:9–26. <https://doi.org/10.4000/educationdidactique.1470>

- Quilio S, Forest D (2011) Comment initier en mathématiques la production d'une notation et ses usages à partir de l'activité des élèves ? Un exemple d'entrelacement de phénomènes langagiers et non-langagiers dans la construction conjointe d'un milieu pour l'étude à l'école primaire.
- Radelet-de Grave P (1999) Relativité galiléenne et lois de conservation. In: *Revue des Questions Scientifiques*, 170(3):209-260.
- Radelet-de Grave P (2009) L'analogie comme outil de découverte, in *Revue des Questions Scientifiques*, 180(1):1-32.
- Radelet-de Grave P (2009a) Guarini et la structure de l'Univers. *Nexus Network Journal* 11/3:393-414.
- Radelet-de Grave P (2010) Publishing Complete Works of the Great Scientists, An International Undertaking . In: *Crossroads : History of Science, History of Art, Essays by David Speiser*, Birkhäuser, Bâle, pp. 127-147.
- Radelet-de Grave P (2012) Des montres pour calculer des vitesses: ou comment Kepler explique sa découverte des deux premières lois. In: *Philosophica*, 41-42(I-II):13-79.
- Ramadas J (2009) Visual and spatial modes in science learning. *International Journal of Science Education*, 31(3):301-318.
- Rasio FA, Stairs IH (Eds.) (2005) Binary Radio Pulsars. *Astronomical Society of the Pacific Conference Series*; *Astronomical Society of the Pacific*, 328:25-31.
- Rahman S, Iqbal M (2018) UNFOLDING PARALLEL REASONING IN ISLAMIC JURISPRUDENCE: Epistemic and Dialectical Meaning in Abū Ishāq al-Shīrāzī's System of Co-Relational Inferences of the Occasioning Factor. *Arabic Sciences and Philosophy*, 28(1):67-132.
- Recami E (2011). Einstein: le mie idee sull'Educazione. pp. 69-100.
- Reif F (2008) *Applying cognitive science to education: thinking and learning in scientific and other complex domains*. MIT press.
- Renn J, Blum A, Damerow P (2011) The Role of Gravitation in Physics Report from the 1957 Chapel Hill Conference Communicated by Jürgen Renn, Alexander Blum and Peter Damerow. DeWitt CM, Rickles D (eds.), *Sources 5*, Edition Open Access, Oranienstraße 183, 10999 Berlin.
- Richards J (1988) *Mathematical Visions: The Pursuit of Geometry in Victorian England*. Academic Press Boston, New York.
- Rocha GR (2009) CONTROVÉRSIAS CIENTÍFICAS: O caso do modelo padrão da cosmologia. *Caderno de física da UEFS*, 7(01):65-85.
- Rochberg F (2017) These Bones Live! *KNOW: A Journal on the Formation of Knowledge*, 1(1):67-83.
- Romero M, Brunel M, Santini J, Quilio S, Calistri C, De Smet C, Douek N (2017) De l'innovation éducative aux usages créatifs des TIC: présentation du Laboratoire d'Innovation et Numérique pour l'Éducation (LINE).
- Russo L (2004) *The Forgotten Revolution How Science Was Born in 300 BC and Why It Had to Be Reborn*. First published as *La rivoluzione dimenticata*, Giangiacomo Frtrinelli Editore, Milano, 1996. Springer, Berlin.
- Ryston M (2019) Interactive animations as a tool in teaching general relativity to upper secondary school students. In: *Journal of Physics: Conference Series*, IOP Publishing, 1286(1):012049.
- Sahin M (2009) Exploring University Students' Expectations and Beliefs about Physics and Physics Learning in a Problem-Based Learning Context. *Eurasia Journal of Mathematics, Science & Technology Education*, 5(4).
- Sahin M (2010) Effects of problem-based learning on university students' epistemological beliefs about physics and physics learning and conceptual understanding of Newtonian mechanics. *Journal of Science Education and Technology*, 19(3):266-275.
- Sarremejane P (2001) *Histoire des didactiques disciplinaires, 1960-1995*. Editions L'Harmattan.

- Sathyaprakash BS, Schutz BF (2009) Physics, astrophysics and cosmology with gravitational waves. *Living reviews in relativity*, 12(1):2.
- Saulson PR (1994) Fundamentals of interferometric gravitational wave detectors.
- Scherr RE (2007) Modeling student thinking: An example from special relativity. *American Journal of Physics*, 75(3):272–280. doi:10.1119/1.2410013
- Scherr RE, Shaffer PS, Vokos S. (2001) Student understanding of time in special relativity: Simultaneity and reference frames. *American Journal of Physics* 69(7):S24-S35.
- Scherr RE, Shaffer PS, Vokos S. (2002) The challenge of changing deeply held student beliefs about the relativity of simultaneity. *American Journal of Physics* 70(12):1238-1248.
- Schleppegrell M, Achugar M (2003) Learning language and learning history: A functional linguistics approach. *Tesol Journal*, 12(2):21-27.
- Schommer-Aikins M, Hutter R (2002) Epistemological beliefs and thinking about everyday controversial issues. *The Journal of Psychology*, 136(1):5-20.
- Sherry L, Trigg M (1996) Epistemic Forms and Epistemic Games. *Educational Technology*, 36/3:38-44. Retrieved: [www.jstor.org/stable/44428338](http://www.jstor.org/stable/44428338)
- Schutz BF (1989) Gravitational wave sources and their detectability. *Classical and Quantum Gravity*, 6(12):1761–1780. doi:10.1088/0264-9381/6/12/006
- Sensevy G, Quilio S (2002) Les discours du professeur. Vers une pragmatique didactique. *Revue française de pédagogie*. <https://doi.org/10.3406/rfp.2002.2914>
- Sensevy G, Quilio S (2002) Teacher's discourse: Towards pragmatist didactics. 141:47–56
- Sensevy G, Forest D, Quilio S, Morales G (2013) Cooperative engineering as a specific design-based research. *ZDM - Mathematics Education* 45:1–13. <https://doi.org/10.1007/s11858-013-0532-4>
- Sensevy G, Santini J, Cariou D, Quilio S (2018) Preuves fondées sur la pratique, pratiques fondées sur la preuve: Distinction et mise en synergie. *Education et Didactique* 12:111–125.
- Slowik E (2005) Spacetime, Ontology, and Structural Realism. *International Studies in the Philosophy of Science*, 19(2):147–166. doi:10.1080/02698590500249456
- Steup M, Neta R (2005) Epistemology.
- Suyama T (2020) On Arrival Time Difference Between Lensed Gravitational Waves and Light. *The Astrophysical Journal*, 896(1):46. doi:10.3847/1538-4357/ab8d3f
- Teixeira ES, Greca IM (2012). The history and philosophy of science in physics teaching: a research synthesis of didactic interventions. *Science & Education*, 21(6), 771-796.
- Tits J (1968) Formes quadratiques, groupes orthogonaux et algèbres de Clifford. *Inventiones mathematicae*, 5/1:19-41.
- Torretti R (1978) *Philosophy of Geometry from Riemann to Poincaré*. Springer, Dordrecht.
- Trimble V (1995) The 1920 Shapley-Curtis Discussion: Background, Issues, and Aftermath. *Publications of the Astronomical Society of the Pacific*, 107:1133-1144. Retrieved: <https://iopscience.iop.org/article/10.1086/133671/pdf>
- Trimble V (2017) Wired by Weber: The story of the first searcher and searches for gravitational waves. *Eur. Phys. J. H* 42:261–291. Retrieved: <https://doi.org/10.1140/epjh/e2016-70060-5>
- Tytler R, Prain V (2010) A framework for re-thinking learning in science from recent cognitive science perspectives. *International Journal of Science Education*, 32(15):2055-2078.
- Valluri SR, Yu P, Smith GE, Wiegert PA (2005) An extension of Newton's apsidal precession theorem. *Monthly Notices of the Royal Astronomical Society*, 358(4):1273-1284.

- Van Heuvelen A (2001) Millikan lecture 1999: The workplace, student minds, and physics learning systems. *American Journal of Physics*, 69(11):1139-1146.
- Viennot L (1979) Spontaneous Reasoning in Elementary Dynamics. *European Journal of Science Education*, 1(2):205-221. DOI: 10.1080/0140528790010209
- Viennot L, Bradamante F (2007) Mapping Gravitational and Magnetic Fields with Children 9–11: Relevance, difficulties and prospects. *International Journal of Science Education* 29:349–372. <https://doi.org/10.1080/09500690600718245>
- Vilette B, Fischer J-P, Sander E, Sensevy G, Quilio S, Richard J-F (2017) Peut-on améliorer l'enseignement et l'apprentissage de l'arithmétique au CP ? Le dispositif ACECan we improve the teaching and learning of arithmetic during first grade? The ACE program. *Revue française de pédagogie* 105–120. <https://doi.org/10.4000/rfp.7296>
- Von Helmholtz H (2010) *On the Sensations of Tone as a Physiological Basis for the Theory of Music*. Translated by Alexander John Ellis. Nabu Press.
- Vosniadou S, Brewer WF (1992) Mental models of the earth: A study of conceptual change in childhood. *Cognitive Psychology*, 24/4:535-585. Retrieved: [https://doi.org/10.1016/0010-0285\(92\)90018-W](https://doi.org/10.1016/0010-0285(92)90018-W)
- Warren A (2020) Bayesian updating activities on student epistemologies. *Phys. Rev. Phys. Educ. Res.* 16/1:010101. Retrieved: <https://doi.org/10.1103/PhysRevPhysEducRes.16.010101>
- Wason PC, Shapiro D (1971) Natural and Contrived Experience in a Reasoning Problem. *Quarterly Journal of Experimental Psychology* 23(1):63-71. DOI: 10.1080/00335557143000068.
- Weisberg JM, Taylor JH (2004) Relativistic Binary Pulsar B1913+16: Thirty Years of Observations and Analysis. Retrieved: <https://arxiv.org/abs/astro-ph/0407149>
- Weiss R (1972) Electronically Coupled Broadband Gravitational Antenna. Quaterly Progress Report, Research Laboratory of Electronics (MIT), N° 105, p. 54. Retrieved: [http://www.hep.vanderbilt.edu/BTeV/test-DocDB/0009/000949/001/Weiss\\_1972.pdf](http://www.hep.vanderbilt.edu/BTeV/test-DocDB/0009/000949/001/Weiss_1972.pdf)
- Weiss R (2000) Caltech Oral History Sound Recording. Retrieved: <https://collections.archives.caltech.edu/repositories/2/accessions/8240>
- Willis J (2010) The current impact of neuroscience on teaching and learning. *Mind, brain and education: Neuroscience implications for the classroom*, pp. 45-68.
- Yildiz C (2013) Historical Problems in the History of Mathematics: Examples for the Classroom. Retrieved: [https://www.researchgate.net/publication/280248513\\_Historical\\_Problems\\_in\\_the\\_History\\_of\\_Mathematics\\_Examples\\_for\\_the\\_Classroom](https://www.researchgate.net/publication/280248513_Historical_Problems_in_the_History_of_Mathematics_Examples_for_the_Classroom)
- Yu H, McCuller L, Tse M, Barsotti L, Mavalvala N, Betzwieser J, ... & Fernandez-Galiana A (2020) Quantum correlations between the light and kilogram-mass mirrors of LIGO. arXiv preprint arXiv:2002.01519.
- Yu Cao T (1997) *Conceptual Developments of 20th Century Field Theories*. Cambridge University Press, Cambridge.
- Yves M, Gueudet G, Krysinska M, Rogalski M, Trouche L, Winsløw C, Quilio S, Sierra T (2016) Enjeux et débats en didactique des mathématiques : XVIIIe école d'été de didactique des mathématiques.
- Zacharia ZC, Olympiou G (2011) Physical versus virtual manipulative experimentation in physics learning. *Learning and instruction*, 21(3):317-331.



# CONTENTS

## **A History of Gravitational Waves between Discoveries & Nature of Science Teaching: *Hypotheses and Perspectives***

Acknowledgements  
Remarks for Readers

**Introduction** i

### **PART I – PHYSICS THE PHYSICS OF WAVES**

An Outline	1
Prologue I	3
1. What is a Wave?	2
1.1. Definition of a Wave	4
1.2. Physical and Mathematical Characteristics	5
1.3. Different Types of Waves	11
1.3.1. Longitudinal Waves	12
1.3.2. Transverse Waves	13
1.3.3. Polarization	13
1.3.4. Standing Waves	15
1.4. Media Characteristics	18
1.4.1. Dispersion	18
1.5. Types of Media	18
1.5.1. Media Made of Matter	18
1.5.2. The Special Case of Vacuum	19
1.6. Waves Interactions with Matter	21
1.6.1. Reflection	21
1.6.2. Refraction	23
1.6.3. Diffraction	26
1.7. Waves Interactions with Waves	27
1.7.1. Interference, Adding Waves	27
1.7.2. Constructive Interference	29
1.7.3. Destructive Interference	29
1.7.4. Interference Patterns	30
1.7.5. Waveforms and Pitch	31
1.8. Waves Sources Study	32
1.8.1. Doppler Effect	32



1.9. Gravitational Waves	34
1.9.1. Definition	36
1.9.2. Properties of Gravitational Waves	38
1.9.3. Properties of the Signal	43
1.9.4. Sources	44
1.9.4.1. Black Hole-Black Hole Merger	45
1.9.4.2. Neutron Star-Neutron Star Merger	45
1.9.4.3. Gravity Waves & Tidal Force	46
Epilogue I	49
References	50

**PART II – HISTORY OF PHYSICS  
A HISTORY OF WAVES  
AND THE CASE OF GRAVITATION**

An Outline	62
Prologue II	64
2. Researching and Inquiring Waves into the History	63
2.1. Antiquity	65
2.2. Galileo Galilei (1564-1642)	67
2.3. Isaac Newton (1643-1727)	69
2.4. Bernhard Riemann (1826-1866)	76
2.5. William Kingdon Clifford (1845-1879)	78
2.6. Oliver Heaviside (1850-1925)	84
2.7. Henri Poincaré (1854-1912)	88
2.8. Historical Comparative Analysis Between Clifford and Poincaré	96
2.9. The Ultraviolet Catastrophe	109
2.10. Charles Fabry (1867-1945) & Alfred Perot (1863-1925)	116
2.11. Louis-Victor Pierre Raymond de Broglie (1892–1987)	124
Final Remarks	130
References	131
3. Gravitational Waves: Theoretical Methods & Data	139
An Outline	139
3.1. Albert Einstein (1879–1955)	140
3.2. The Relativities	141
3.2.1. Special Relativity	143
3.2.1.1. Special Relativity Consequences	149
3.2.2. General Relativity	162
3.2.2.1. General Relativity Predictions	167
3.2.2.2. The Precession of Mercury’s Perihelion	168
3.2.2.3. Bending of Light and Gravitational Lensing	169
3.2.2.4. The Geodetic and Frame-dragging Effects	172
3.3. 1905. <i>Comptes Rendus of the French Academy of Sciences</i>	174
3.4. On the Existence of Gravitational Waves: The 1937 Incident	176
Final Remarks	179
References	180

4.	Gravitational waves: Experimental Observations & Data	187
	An Outline	187
4.1.	How do we detect a gravitational wave?	188
4.2.	1949. Joseph Weber (1919-2000) and the <i>Gravity Research Foundation &amp; Institute of Field Physics</i>	189
4.3.	1957. The <i>Chapel Hill</i> Congress, Debates and Heritages	192
4.4.	The Effects of a Gravitational Wave	198
4.5.	The Interferometer Method	198
4.6.	The Gravitational Waves Observatories	200
	4.6.1. <i>LIGO &amp; VIRGO</i>	200
4.7.	The <i>Mirabilis Data</i>	215
	4.7.1. Analyses of Some Signals	219
	4.7.1.1. <i>GW150914</i>	219
	4.7.1.2. <i>GW151226</i>	220
	4.7.1.3. <i>GW170608</i>	221
	4.7.1.4. <i>GW170817 – The First Triple Detection</i>	221
	4.7.1.5. <i>GW170817 – The First Neutron Star Merger</i>	222
4.8.	2017. The <i>Nobel Prize</i> in Physics	224
	Final Remarks	225
	References	226
5.	Gravitational Waves: A History of Science & Technology in Society	235
	An Outline	235
5.1.	Science & Technologies: New Devices to Detect	236
5.2.	The Research: New Collaborative Inquiring Approaches	240
5.3.	The Universe in Society: a Revolutionary Change of View	242
5.4.	Towards a New History of Cosmology	259
	Epilogue II	264
	References	267

### **PART III – HISTORY OF PHYSICS & NATURE OF SCIENCE TEACHING (NOS)**

	An Outline	280
	Prologue III	281
6.	On the Nature of Science Teaching	284
6.1.	Interdisciplinary Comparative Teaching	286
6.2.	History of Mathematics and Mathematics Teaching	288
6.3.	History of Physics and Physics Teaching	291
6.4.	The Relationship Physics–Mathematics	296
6.5.	Teaching the Interplay Physics–Mathematics Languages	298
6.6.	History of Science, Epistemology and Philosophy	300
6.7.	Common Knowledge vs. Scientific knowledge	303
6.8.	Students’ Difficulties and Misconceptions	307
6.9.	Critical Mind Training	313
	Final Remarks	316
	References	317

7.	Teaching Gravitational Waves	325
	An Outline	325
	7.1. Representations, Parallel Reasoning and Epistemology	326
	7.2. Conceptual Maps	329
	7.3. Modelling	330
	7.4. Thought Experiments	332
	7.5. Experiments	335
	7.6. Lecturing the Gravitational Waves & Additional Frameworks	340
	7.6.1. Prerequisites & Typology of Class	341
	7.6.2. Cognitive Objectives	343
	7.6.3. Operative Objectives	345
	7.6.4. Methodology	346
	7.7. Expected Results	347
	7.7.1. Selected Readings: Documents, Handbooks and Historical Resources	348
	7.7.1.1. Primary Sources: Reading Texts	348
	7.7.1.2. A First Specific Bibliography on the Module	349
	7.8. Assessment	353
	7.8.1. Learning	360
	7.8.2. Outcomes	366
	Final Remarks	368
	References	369
8.	A Didactic Inquiring: Which Teaching Approach for the Gravitational Waves?	375
	An Outline	375
	8.1. Didactics, Methods and Methodologies	376
	8.2. Frameworks from Selected Current Literatures	378
	8.3. Structuring the main Physical Principles: A Proposal	380
	8.3.1. Observations and Hypotheses	381
	8.3.2. Testing the Hypotheses	382
	8.4. An Early Modelling of Curricula	383
	8.5. Designing an Experiment	476
	8.6. An <i>ad hoc</i> Modelling, A proposition	479
	8.7. Discussion & Generalization	482
	8.8. An Epistemological Inquiring: Methods and Falsifiability?	483
	8.9. What about Falsifiability in Didactics of Physics–Mathematics	490
	8.10. Teaching: Formal, Informal and Non-Formal	493
	8.11. Scientific, Didactic and Epistemological Debate on the Results	496
	8.12. Qualitative and Quantitative Choices	498
	8.13. Structuring an Epistemological Framework: Modular Program	500
	Epilogue III	501
	References	502

**PART IV  
CONCLUSION**

9. Concluding Remarks	514
9.1. General Conclusion	515
9.2. Specific Conclusion	517

**Appendix**

1. Documents from Virgo	526
1.1. Invitation Letter	526
1.2. Some Resources	527
2. Documents from the Niels Bohr Library	561
2.1. Invitation Letter	561
2.2. Some Resources	563
3. Articles Previews	573
4. Administrative Documents	578
5. Copyright Permissions	589
6. Research Annex to my Teaching at a Distance Course	595
7. Table of Acronyms	615
8. Pre/Post Tests Data	617

<b>References</b>	663
-------------------	-----

<b>Index</b>	727
1. Names Index	727
2. Subjects Index	733
3. Images Index	753





# PART I

## The Waves

*An outline.* This chapter is dedicated to the Physics of Waves in order for non-specialists readers to have the opportunity to familiarize themselves with the subject of Waves in general before being exposed to the Physics of Gravitational Waves. Therefore, we will notably see how to define a wave, but also explore the differences between the various kinds of waves, their properties and physical phenomena involving them.

# **CHAPTER I**

## **What is a Wave?**



## Prologue I

The object of this research, gravitational waves, is clearly not an easy concept to master, or even just grasp. As their name suggests, gravitational waves can be understood as a physical object that encompasses both waves and gravitation. However, even if this duality gravitation-waves is palpable, in order to properly comprehend the subject, one has to understand that gravitational waves are not actually waves of gravitation, but rather the propagation of deformations or perturbations of *spacetime*.

In fact, the main difficulty resides here, in the conceptual jump one has to do when considering *spacetime*; a concept at the core of both Special and General Relativity. However, while delving directly into considerations such as *spacetime*, the warping of the fabric of the Universe, might seem attractive or even a fun experience in the perspective of some, the subject remains one of the most advanced and complex theoretical description of reality on astronomical scales. This section is essentially here for non-physicists readers and non-specialists.

Therefore, instead of beginning with the Theory of Relativity, it seems more appropriate to begin with a simpler object of study. Hence, and because gravitational waves are waves, a good starting point is the study of waves. In this first part of the thesis, we will examine the main physical properties and theories related to waves and their study in order to have a stepping stone on which we will then be able to build.

Although different from the general idea that springs to mind when thinking about waves (namely waves on the ocean or a lake, soundwaves, etc.), gravitational waves are just waves of another kind.

## 1.1 Definition of a Wave

Although the literal definition of a wave may vary a bit from one source to another, the general scientific consensus is that the term “wave” refers to the transmission of a disturbance from one location to another. All waves are disturbances that propagate. Some waves travel through a media and others do not. These disturbances carry energy without carrying matter (or with little matter transport). Specific cases vary depending the wave (Cfr. Walker, Halliday and Resnick 2011, p. 413):

Waves can be of different types:

- *Mechanical waves*  
This type of wave is the one that immediately jumps in mind. Mechanical waves are transmitted through media made of matter. They can be produced if, and only if, there is matter for them to propagate into. Some examples of mechanical waves: soundwaves, seismic waves, water waves, slinky waves, etc.
- *Electromagnetic waves*  
This type of waves is a little less known. Electromagnetic waves consist of the wave representation of electromagnetic radiations. In other words, all types of lights (from gamma rays, to X-rays, to ultraviolet light, to visible light, to infrared, to microwaves, to radar waves, to radio waves).
- *Matter waves*  
This type of waves is used when considering fundamental particle such as electrons and protons, and sometimes atoms and molecules.
- *Gravitational waves*  
This type of waves are disturbances of *spacetime* propagating and will be further developed in section (1.9).

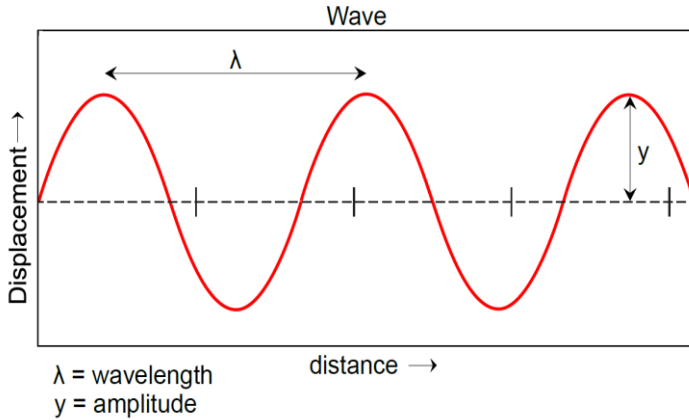
In the following, I present a typical wave modelling.<sup>24</sup>

---

<sup>24</sup> A more intuitive and less abstract manner of thinking about them, is to think about waves propagating as vibrations/oscillations of a physical medium (1) or field (2) around determined points of a location.

(1) A physical medium is anything made out of matter (a fluid, a solid...).

(2) A “field” is any physical quantity which takes on different values at different points in space. (Feynman 1970)



**Fig. 1.1.** Representation of a one-dimensional sine wave (or harmonic wave) propagating to the right.

Source: Etienne Bonnet | Public Domain.

## 1.2 Physical and Mathematical Characteristics of Waves

In order to fully describe a wave, before defining the physical and mathematical characteristics of a wave, we will be starting with one of the simplest cases (*Ivi.* p.414), a wave on a string.

To describe our wave, we will need a function of the following type to be used:

$$y = h(x, t) \quad (1.1)$$

Where  $y$  is the transverse displacement of any oscillating point of the string as a function  $h$  of the time  $t$  and the position  $x$  of the element along the string (*Ibidem*).

If the considered wave is of a sinusoidal form and travelling in the positive direction of an  $x$  axis, then the displacement of any element oscillating parallel to the  $y$  axis at point  $x$  at time  $t$  is given by:

$$y(x, t) = y_m \sin(kx - \omega t) \quad (1.2)$$

Where

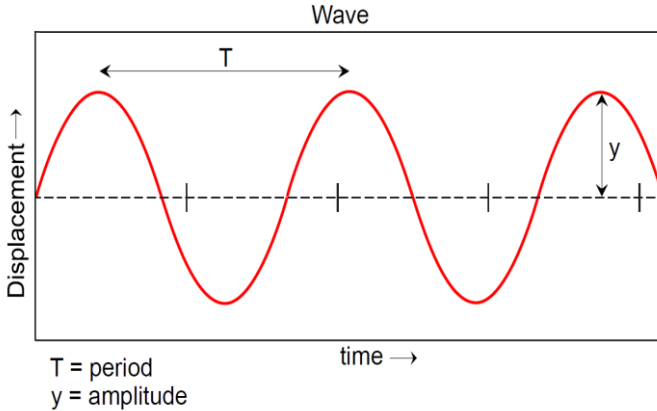
$y(x, t)$  is the displacement,

$y_m$  the amplitude,

$\sin(kx - \omega t)$  the oscillating term,

$(kx - \omega t)$  the phase,  $k$  the wavenumber and  $\omega$  the angular frequency (*Ibidem*).

Starting from this simple case, the Physics of Waves has defined variables corresponding to physical properties possessed by waves which will be enunciated in this section<sup>25</sup>.



**Fig. 1.2.a.** Representation of a one-dimensional wave (oscillation) at an arbitrary location. Adapted from Fig. 1. | Public Domain.

The physical and mathematical characteristics of waves are the following:

#### 1. Amplitude:

- The *amplitude* of a wave at a given point is the measure of the displacement of said point enduring the effects of the wave passing through it from its resting location or equilibrium position.
- The *peak-to-peak amplitude* is the measure of the displacement of a point between the highest amplitude value (the peak *per se*, or crest) and the lowest amplitude value (the trough) during one change of period.
- The *peak amplitude* is the maximum absolute value of the magnitude of the displacement of the elements from their equilibrium positions.
- Amplitude is represented by the letter *A*.

---

<sup>25</sup> As a wave is a physical object – in the sense of an object of Physics, a representation, and not as in a physical, tangible object – it possesses Physical and Mathematical characteristics and properties that have been attached to it. Since waves are the propagation of a disturbance or oscillations, they can be represented in function of space and time; in other words, we can study waves through the displacement that occurs when passing by in function of space or time. In mathematics waves are signals (Blackstock 2000). Another way to obtain the shape of a wave, is to consider the displacements of a single point that is oscillating over time (French 1971). The graphical representation obtained is equivalent to that of the wave passing through it, as these displacements are induced by the wave travelling through that point. The graphic of those oscillations is thus a graphic representing a spatiotemporal wave in essence.

## 2. Wavelength:

The wavelength of a wave can be defined as the distance between two consecutive locations in same phase. It is also the repeat distance between oscillations.<sup>26</sup>

Wavelength is inversely proportional to frequency of the wave; in other words, the higher the frequency of a wave, the shorter its wavelength, and reciprocally, the lower the frequency of a wave, the longer its wavelength. The wavelength is represented by the letter  $\lambda$  and its S.I. unit is meters (m).

## 3. Period and Frequency:

When considering a displacement as a function of time, the period, is the duration of one cycle of a repeating event, for waves, it is the duration between oscillations in a wave; for example, the time needed for a crest to reach the point of the next crest.

The period is represented by the letter  $T$  and its S.I. unit is the second (s).

Reciprocally, the frequency, is the number of oscillations that occur in a unit of time, which is to say, usually for convenience, the number of crests (or points of the wave in phase) that pass a point (position in the medium where the wave passes through) in one second.

The frequency is represented by the letter  $f$  and its S.I. unit is the hertz (Hz).

Therefore, from this we can define:

$$T = \frac{1}{f} \quad (1.3)$$

Hence, when considering a displacement as a function of space, if  $f$  is the number of waves which pass a fixed point per second, then the time it takes for each succeeding chosen point in phase, crest or trough to reach this point is  $\frac{1}{f}$ .

## 4. Velocity:

Waves propagate with a finite speed. The velocity of a wave is measured by the change in position of the wave over time in a direction.

By definition, speed is the distance divided by the time taken to travel that distance. Therefore, it is the distance travelled by a wave over a given period of time.

---

<sup>26</sup> For convenience, the points usually used to measure a wavelength are the two points between crests, troughs or the two zero crossing points (in the same phase).

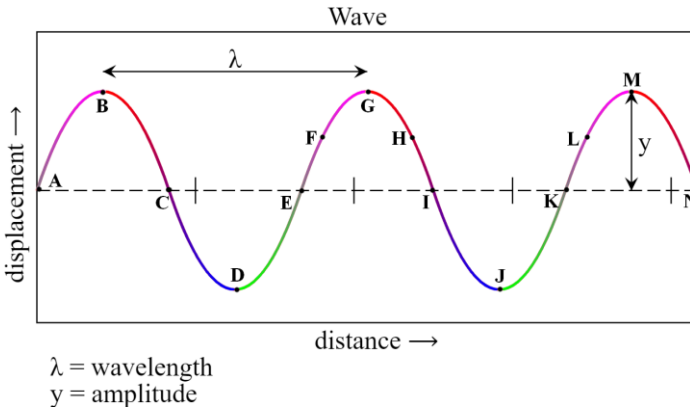
Hence, the speed of a wave,  $v$ , is defined by its wavelength over its period:

$$v = \frac{\lambda}{T} = \lambda f \quad (1.4)$$

The speed of a wave depends on the medium, in other words, what it is in, but it also depends on the composition of the medium and its state.

### 5. Phase:

The phase is used to describe a specific location within a given cycle of a periodic wave. By considering a whole period of the wave as being 360 degrees or  $2\pi$  if we are using radians, we can measure the distance between two points and know how far out of phase they are and express the result as a fraction of wavelength. For sinusoidal waves, the phase is the argument  $kx - \omega t$  of the sine.



**Fig. 1.2.b.** Representation of a one-dimensional wave. In this figure, the points of the same colour are in the same phase. Adapted from Fig. 1. | Public Domain.

### 6. Angular number (wavenumber):

The angular number of a wave is defined as the spatial frequency of the measured radians per unit distance or cycles per units of distance; which is to say that the wavenumber is the number of wavelengths per units of distance, and its S.I. unit is  $\text{m}^{-1}$  (reciprocal metre).

Because a sine function repeats itself when its angle is increased by  $2\pi$  radians, we have:

$$k = \frac{2\pi}{\lambda} = \frac{2\pi\nu}{v_p} = \frac{\omega}{v_p} \quad (1.5)$$

Where  $\nu$  is the frequency of the wave,  $v_p$  the phase velocity and  $\omega$  the angular frequency of a wave.

### 7. Angular frequency:

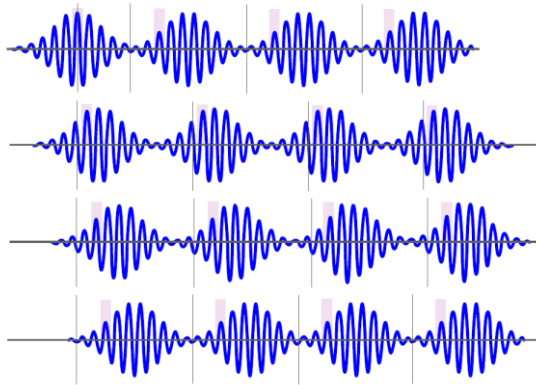
The angular frequency of a wave is defined as the measure of the rotation rate of a wave; it is the rate of change of the phase of a wave and is measured in S.I. units in radians per second. As such, taking into account that a revolution is equal to  $2\pi$ , we have:

$$\omega = \frac{2\pi}{T} = 2\pi f \quad (1.6)$$

### 8. Phase velocity and Group velocity:

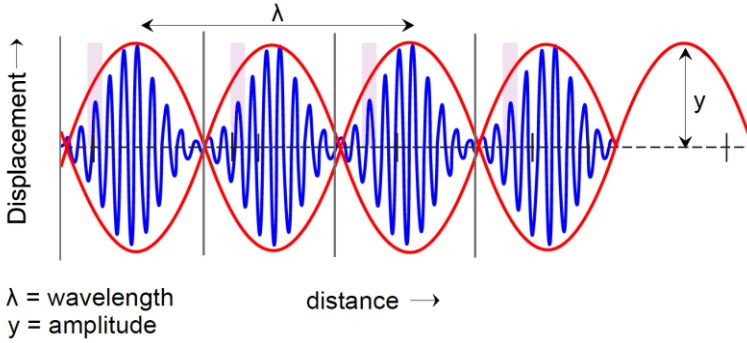
The phase velocity of a wave is the rate at which any component of the frequency of a wave travels. It is the velocity of the wave's phase propagation in space.

$$v = \frac{\lambda}{T} = \lambda f = \frac{\omega}{k} \quad (1.7)$$



**Fig. 1.2.c.** Representations of wave packets (wave trains) with a direction of propagation to the right. Adaptation from a Mathematica plot. Source: Etienne Bonnet.

The group velocity of a wave is the velocity at which the envelope, or global profile (shape) of the wave travels through space. A single wave packet is also known as a pulse.

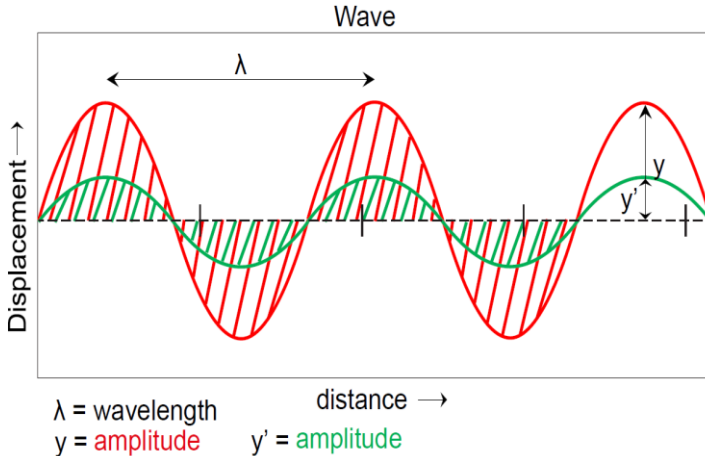


**Fig. 1.2.d.** Representations of wave packets (wave trains) with a direction of propagation to the right. In this figure, the wave envelope is represented in red. Adapted from Fig. 1.2.c.  
 Source: Etienne Bonnet

9. Intensity:

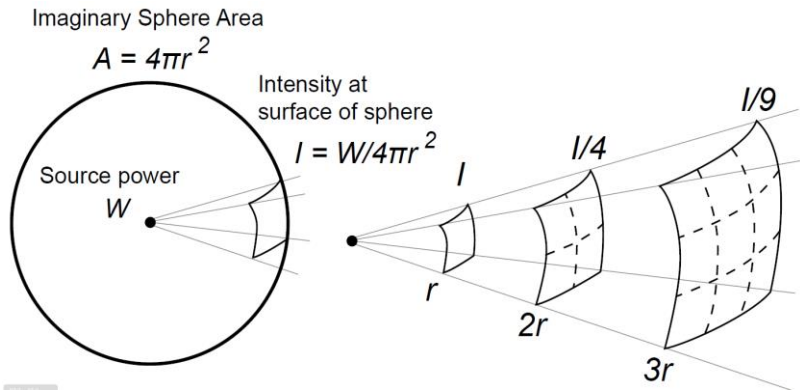
Intensity is the average rate per unit area at which energy is transferred by the wave. The intensity of a wave (the brightness of light or the loudness of sound for example) is the rate of flow of energy. The bigger the amplitude, the greater the energy. The intensity of a wave is proportional to the square of the amplitude.

$$I \propto A^2 \tag{1.8}$$



**Fig. 1.2.e.** Representation of two one-dimensional waves with the same wavelength and different amplitudes. In this figure, since intensity is equal to power over the cross-sectional area, we can see that, for a same wavelength, the area underneath the waves is proportional to the amplitude squared. Adapted from Fig. 1.





**Fig. 1.2.f.** Representation of the change of Intensity **I**, the average rate (average power) per unit area at which energy is transferred by the wave following an inverse square law, from a source of power **W** in function of distance **r**. Source: Etienne Bonnet.

From this, we have:

$$I \propto \frac{1}{r^2} \quad (1.9)$$

Finally, the momentum of the wave is given by Plank's constant divided by the wavelength:

$$\rho = \frac{h}{\lambda} = \frac{h}{2\pi} k = \hbar k \quad (1.10)$$

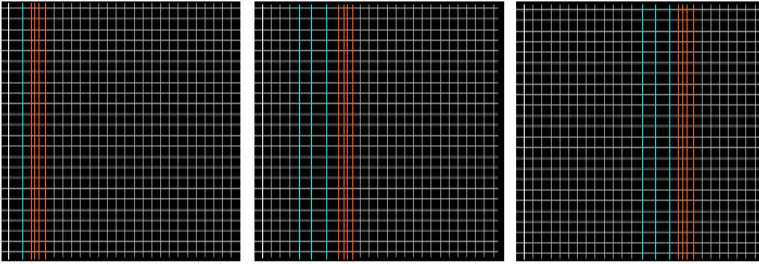
where  $\hbar$  is the reduced version of Plank's constant.

### 1.3 Different Types of Waves

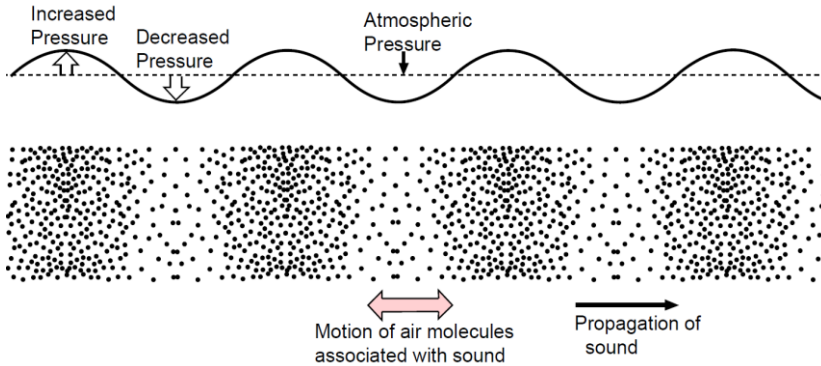
Waves are the propagation of oscillations or disturbances. Different waves travel in different manners, just like different oscillations can oscillate in a different way. Indeed, the oscillations of a wave can happen in any direction of our 3 spatial dimensions. Therefore, we can define two main types of waves depending on the manner these oscillations behave relative to the direction of the propagation of the wave they belong to.

### 1.3.1 Longitudinal Waves

Longitudinal waves are a type of waves in which the oscillations are in the same direction or parallel to the propagation of the movement of the wave itself. They consist of an alternating pattern of compressions and rarefactions.

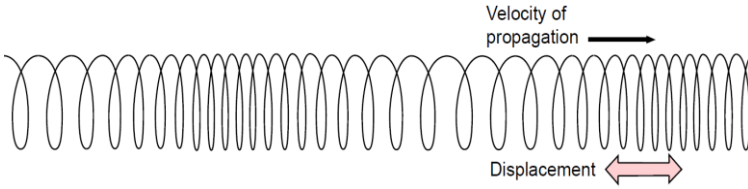


**Fig. 1.3.1.a.** Representation of a longitudinal wave propagating from left to right. The compressions are represented in red, the rarefactions in blue. Adapted from Source: [https://kids.kiddle.co/Image:Onde\\_compression\\_impulsion\\_1d\\_30\\_petit.gif](https://kids.kiddle.co/Image:Onde_compression_impulsion_1d_30_petit.gif) | (CC-BY-SA-3.0) | Credit: Christophe Dang Ngoc Chan.



**Fig. 1.3.1.b.** Representation of longitudinal waves propagating from left to right in air. The compressions and rarefactions respectively corresponding to regions where the air pressure is increased and regions where the air pressure is decreased are shown relatively to the atmospheric pressure.

Source: <http://hyperphysics.phy-astr.gsu.edu/hbase/Sound/imgsou/lwav2.gif> | Dr. Rod Nave | Permission granted.



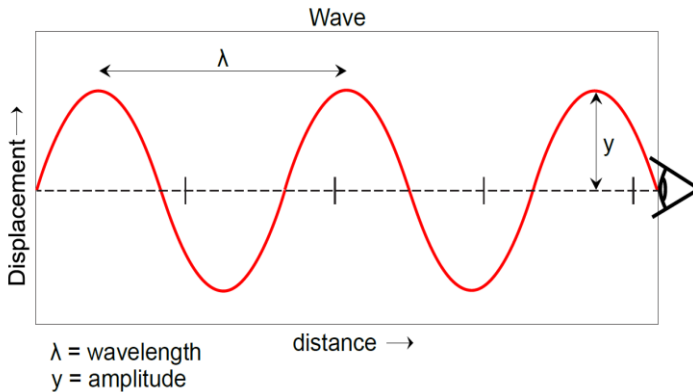
**Fig. 1.3.1.c.** Representation of compressions and expansions in a spring due to longitudinal waves propagating from left to right.  
Source: <http://hyperphysics.phy-astr.gsu.edu/> | Dr. Rod Nave | Permission granted.

### 1.3.2 Transverse Waves

Transverse waves are a type of waves in which the oscillations are perpendicular to the propagation of the movement of the wave itself. In other words, the motion of every oscillating element when the wave passes through them is perpendicular to the direction of travel of the wave. Additionally, this property of transverse waves implies that transverse waves can be polarized.<sup>27</sup>

### 1.3.3 Polarization

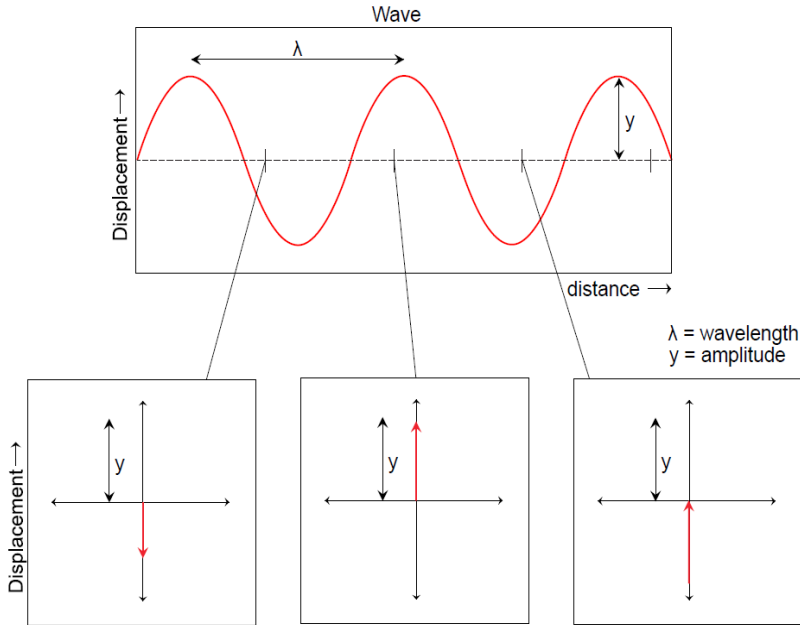
For transverse waves, the geometrical orientation of the oscillations, which are perpendicular to the direction of motion of the waves, is defined by a property named Polarization.



**Fig. 1.3.2.a.** Representation of a one-dimensional wave reaching an observer (detector, eye, etc.). Adapted from Fig. 1.

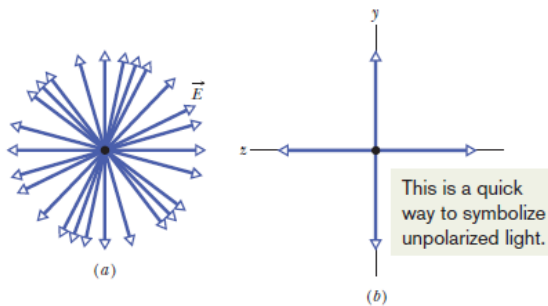
<sup>27</sup> At this point, it is important to note that electromagnetic waves can only be formed in transverse waves. (Wang WC 2009)

In this example, by imagining placing ourselves in front of the direction of the motion of a wave in such a way that we are looking straight at a wave, we are able to understand that the oscillations of this particular waves happen in the vertical plane, like represented in the figure below (Fig.1.3.b)



**Fig. 1.3.2.b.** Representation of what an observer (detector, eye, etc.) would see placed at different distances along a one-dimensional transverse wave’s direction of motion (polarized vertically). Adapted from Fig. 1.

This geometrical orientation of transverse waves can be vertical (as we have just seen), horizontal or anything in between.



**Fig. 1.3.2.c.** Representation of what an observer (detector, eye, etc.) would see along the direction of motion of unpolarised light (a) and a simple way to symbolize unpolarised light.

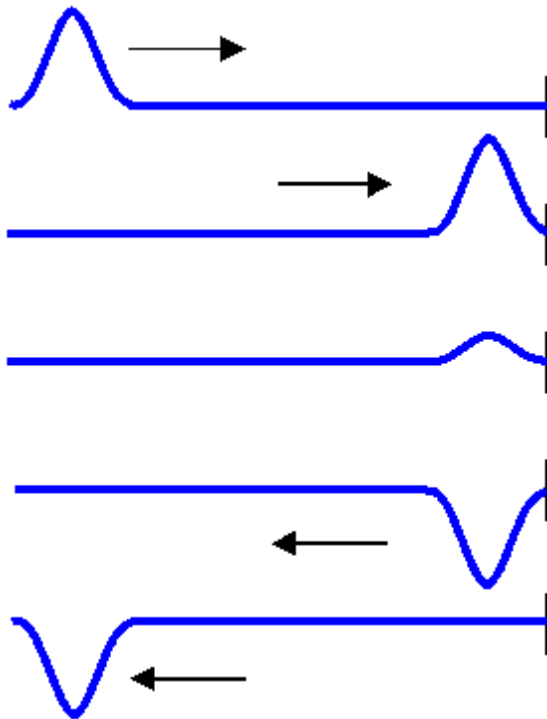
**N.B.** for convenience, only the oscillating electric field is being represented. Source: Walker, Halliday and Resnick 2011, p. 901.

### 1.3.4 Standing Waves

Standing or Stationary waves are waves that oscillate in time and whose peak amplitude position remains the same along the medium. In the case of a stretched rope fixed at both ends, standing waves can be seen when two sinusoidal waves of the same amplitude and wavelength travel in opposite directions and interfere.

When sending a continuous sinusoidal wave, the waves propagate until reaching a fixed point at which moment it will be reflected.

Let us consider a stretched rope attached on a wall at a fixed point. By swinging the rope up and down we can send a pulse that will pass through the rope and then be reflected back to us as shown in the picture below:



**Fig. 1.3.3.a** Representation of a pulse sent along an idealised stretched rope fixed to a wall being reflected back. Source: <http://labman.phys.utk.edu/phys136core/modules/m9/Thin%20films.htm> , Physics 136, Introduction to Physics II, The University of Tennessee, Department of Physics and Astronomy | Public domain.

With a certain wavelength, this back and forth, the overlapping of the waves being reflected left and right, can lead to one of the situations as shown in the figure below depending on the frequency.

For those frequencies, the resulting interference pattern is a stationary wave and is called an oscillation mode. In this case, the wave is in resonance, and the frequencies leading to those patterns are called resonant frequencies.

Standing waves also have noticeable features such as nodes and antinodes which are points on the medium remaining at the same location. On one hand, nodes refer to the points that appear to be standing still on the standing wave pattern along the medium, and on the other hand, like their name suggest, antinodes refer to the points undergoing the maximum displacements along the medium. In fact, it is this alternating pattern of nodes and antinodes that make up stationary waves.

Nodes' existence is due to the fact that a destructive interference occurs at a certain location in such a way that the resulting interference over time does not produce any displacement of the point at that location; however, antinodes' existence results from a constructive interference where a crest meets a crest and when a trough meets a trough at a specific location.

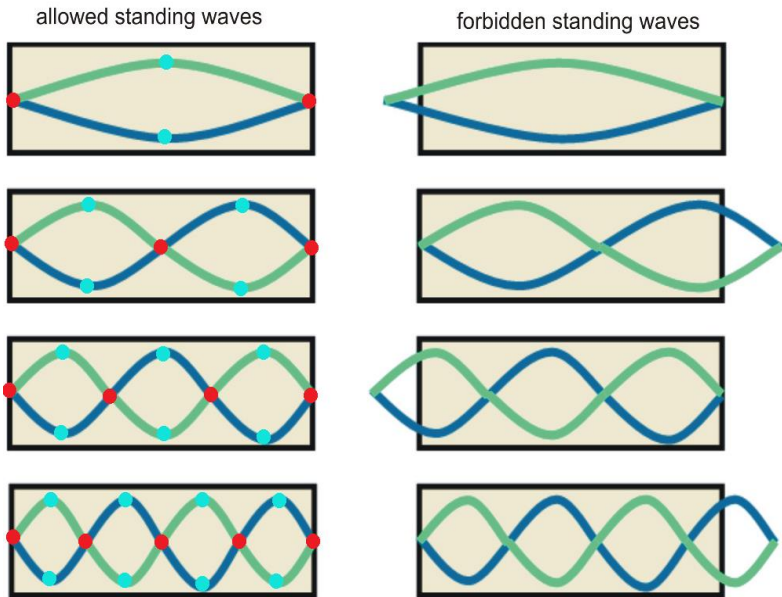
Just like normal waves, standing waves follow the equation:

$$y = A \sin(kx - \omega t) \quad (1.11)$$

However, if it were  $(kx + \omega t)$ , it would mean that the wave is travelling to the left; even though standing waves do not appear to be moving.

This phenomenon is the same at play in all waves. One could think of wiggling a piece of rope and notice that once the pulses or waves have passed, all the pieces of the rope are at their resting position, i.e. there was no matter transfer. In the same way, for electromagnetic waves, the electric and the magnetic fields are not moving, it is their oscillations that gives the impression of a wave travelling.

In order to have a standing wave, nodes must coincide with the fixed points, like shown in the picture below; and each of the frequencies related to the production of a standing wave pattern is referred to as a harmonic.



**Fig. 1.3.3.b.** Representation of standing waves travelling through strings at extreme displacements (both respectively in green and blue) at different oscillation modes or harmonics (left), and waves wrongly set up (right). The nodes and antinodes are represented (respectively in red and light blue). Source: <http://resources.ck12.org/22f797d4e55e2ede4c65ad1a6583eec7.pdf> (CC BY-SA 3.0), Credit: CK-12 Foundation.

All harmonics are associated with a number of nodes and antinodes and follow the following table:

Harmonic	Number of Nodes	Number of Antinodes
1st	2	1
2nd	3	2
3rd	4	3
4th	5	4
5th	6	5
...	...	...
<i>n</i> th	$n+1$	$n$

## 1.4 Media Characteristics

A media is a material substance that allows the propagation of waves. When a wave passes through a medium, it causes the oscillations of the particles the medium is made out of. This implies that the particles of the medium are affected by changes of kinetic energy and potential energy (hence their oscillating movements). Therefore, the elasticity and the mass of the medium determine the speed at which a wave is able to travel.

However, electromagnetic waves, which can propagate through a medium like water or a gas, can also propagate in the absence of a material substance (vacuum). The reason behind this special ability of this kind of wave is given by their fundamentally different nature due to the fact that they are oscillations of electric and magnetic fields.

### 1.4.1 *Dispersion*

The speed of a wave is defined by its wavelength over its period and the velocity of a wave is determined by the medium. This means that for a given medium, increasing the frequency of a wave decreases its wavelength. A medium is called *dispersive* when the celerity of a wave depends on its frequency (Wahlén 2011).

## 1.5 Types of Media

Up to this point, we have been referring to material media as material substances that allow the propagation of waves. In fact, depending on their nature, waves have different limitations in regards to the media they are travelling through.

### 1.5.1 *Media Made of Matter*

Concerning the media made out of matter, by nature they consist of a collection of –physical– particles transmitting a perturbation or disturbance gradually from one another.

As long as a (non-dispersive) media has matter to work with (Graff 2012), and its particles are able to oscillate and interact with one another (e.g., through collisions), the wave carries on undisturbed in the same direction until the wave reaches a boundary. This also implies that waves can propagate through a composite medium or from one medium to another. This kind of waves travelling thanks to gradually disturbing and making particles oscillate are mechanical waves, therefore their movement is limited by the



material's limits. As an example, a wave propagation through an ideal tensed string of a guitar will produce sound because the vibrations of the string will in turn produced vibrations in the air and slowly stop vibrating as energy gets dissipated in the air, but the same string put in a vacuum won't ever stop vibrating because the energy cannot dissipate without air.

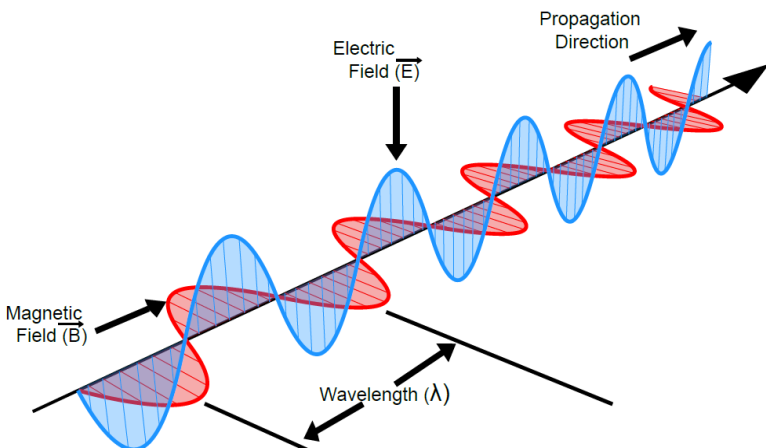
As a consequence mechanical waves can only propagate in a medium which also has elasticity and mass.

### 1.5.2 The Special Case of Vacuum

Electromagnetic waves, like their name suggests, have two components: an electric component and a magnetic component. In fact, those two components of the electromagnetic wave are oscillations of the electric field and the magnetic field that take place in phase. Electromagnetic radiation do not need a medium to travel.

This can be easily understood by considering that since an electric current generates a magnetic field (and vice-versa), the variations of the electric field produced by the electric component of the wave generate the variations of the magnetic field which in turn will generate variations of the electric field and so on. Therefore, electromagnetic radiation can travel in a vacuum and they also all travel at celerity  $c = 299\,792\,458$  m/s (in vacuum), usually rounded to  $3 \cdot 10^8$  m/s for easier calculations when precision is not needed.

## Electromagnetic Wave



**Fig. 1.5.2.a.** Representation of an electromagnetic wave and its two components. The electric component is represented in blue and the magnetic component is represented in red. Source: Etienne Bonniec.

It was James Clark Maxwell (Maxwell 1865) who showed that the speed of light is equal to:

$$c = \frac{1}{\sqrt{\mu_0 \epsilon_0}} \tag{1.12}$$

(Cfr. Wang 2009)

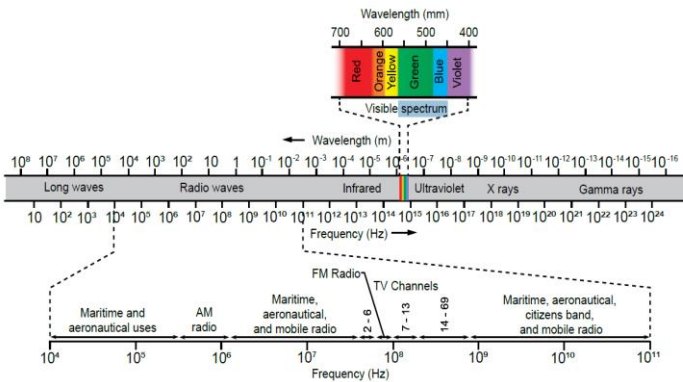
where  $\mu_0$  is the permeability of free space and  $\epsilon_0$  is the permittivity of free space.

Since all electromagnetic radiations travel at the speed of light, this means that we have:

$$c = \lambda f \tag{1.13}$$

Therefore this means that  $c$  has to remain constant, which implies that if the frequency goes up, the wavelength must go down to compensate. Reciprocally, if the wavelength increases, the frequency must decrease.

For electromagnetic waves, the wavelength (and also the frequency because of the previous relation) determines the energy of the electromagnetic waves, hence, where it belongs in the electromagnetic spectrum. For visible light, the wavelength or frequency also determines the colour of light. Usually speaking, the shortest wavelengths or the more energetic electromagnetic waves are on the “blue side” of the spectrum (with higher frequencies) and the longest wavelengths or the less energetic electromagnetic waves (with lower frequencies) are on the “red side” of the spectrum.



**Fig. 1.5.2.b.** Representation of the electromagnetic spectrum with the associated wavelengths and frequencies of different electromagnetic classification of waves. Source: Etienne Bonnet.

e.g., visible light, electromagnetic radiations with wavelengths within the 400-700 nm, are on the red side of the spectrum compared to X-rays and are therefore less energetic.

It is Albert Einstein (1879-1955) who showed that a photon (a particle of electromagnetic radiation) there is a relation between its energy  $E$ , its frequency  $\nu$  and the Planck's constant  $h$ :

$$E = h\nu \quad (1.14)$$

(Einstein 1905)

From this relation and the previous figure, we can see that the higher the frequency of a photon, the higher energy it has. Reciprocally, since all electromagnetic radiations travel at the speed of light, the shorter the wavelength, the higher the energy.

Additionally, for electromagnetic waves in vacuum, we have:

$$k = \frac{E}{\hbar c} \quad (1.15)$$

## 1.6 Waves' Interactions with Matter

When encountering matter, waves can adopt different types of behaviours depending on several variables that will be explored in this section. These behaviours can be discriminated in three main types, namely Reflection, Refraction and Diffraction (Chartier 2005; Pedrotti 2017). However, it is important to keep in mind that these types of behaviours are not mutually exclusive. For instance, a wave can be partially reflected.

### 1.6.1 Reflection

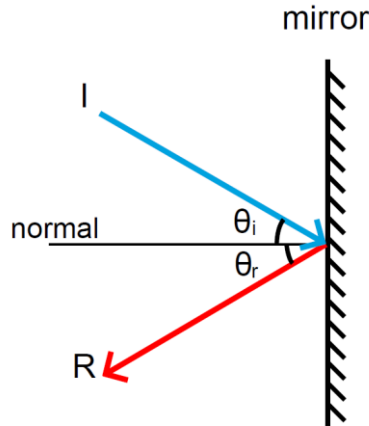
Reflection is a phenomenon that takes place when a boundary between one medium and another medium is reached by a wave and after arriving at this boundary, the wavefront returns into the medium from which it came. Based on the dissimilarities of the two media, parts of the wave undergoes reflection and the remaining parts of the wave undergoes absorption or transmission across the boundary depending on factors such as the nature of the wave and the nature of the medium. The boundary between two or more media is called an *interface*.

Waves are governed by Newton's laws and behave accordingly in a very predictable manner:

In optics, this phenomenon is ruled by *the laws of reflection*.

- The reflected ray has an angle of reflection equal to the angle of incidence relative to the normal of the point belonging to the surface of reflection

- The incident ray, the normal and the reflected ray are situated in the same plane of incidence.
- The incident ray and the reflected ray are on opposite sides of the normal.



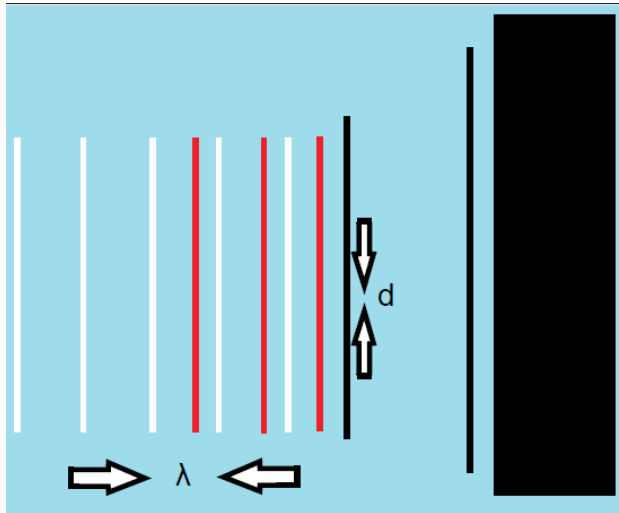
**Fig. 1.6.1.a.** Representation of an incident ray **I** (in blue) with an incident angle  $\theta_i$  reflected **R** (in red) by a mirror at an angle  $\theta_r$ . Source: Etienne Bonnet.

In this figure, the normal is drawn from the point of the mirror hit by the incident ray. The ray of light (in blue) incoming on the mirror is called the *incident ray* and strikes the mirror at an angle  $\theta_i$  with respect to the normal line. The ray of light (in red) leaving the mirror at an angle  $\theta_r$  with the normal line is the *reflected ray*. From the laws of reflection, we know that the two angle  $\theta_i$  and  $\theta_r$  are equal.

In acoustics, for soundwaves which are longitudinal waves, when the wavefront collides with a flat surface, the sound is reflected in a coherent manner provided that the dimension of the surface reflecting it is larger than the wavelength of the incident soundwave.

It is thanks to this phenomenon that one can hear echoes in altitude, when the soundwaves are reflected by the flanks of mountains in the surroundings, or in cathedrals, when the sound is reflected by the stone walls. Because of this, places like theatres, where a minimal sound reflection is wished, need to be constructed with architectural acoustics in mind.

Reflection can also occur when longitudinal waves of a given wavelength are unable to pass through a slit of a comparably smaller width. Because of the size of the slit, the waves are behaving as if the obstacle was not porous.



**Fig. 1.6.1.b.** Representation of the result seen on a screen from longitudinal waves of a wavelength of  $\lambda$  unable to pass through a slit of a width  $d$  of a smaller order of magnitude. In this figure, the waves are propagating from left to right (in white) but because the slit is too narrow, the waves are **reflected** (in red). Source: Etienne Bonniec.

In seismology, the study of seismic waves which can also be reflected lead to the discovery of the layered structure of the Earth.

## 1.6.2 Refraction

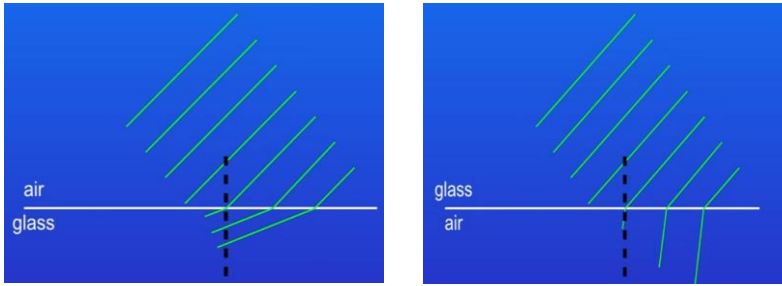
Refraction<sup>28</sup> is a phenomenon that takes place when a wave propagates along a series of changes in the medium or from one medium to another and experiences a change in direction. The angle of refraction, the amount of change in direction, is determined by the change of speed and the incident angle of the wave.

*Refractive index.* The velocity of a wave depends on the medium it is propagating through. Therefore we can easily explain this phenomenon in a quite intuitive way: when a number of waves passes from one medium to another in which their velocity is decreased i.e. the waves slow down, this causes the direction of the waves to change towards the normal.

Reciprocally, when the waves pass through a medium in which their velocity is heightened, this causes their direction to bend away from the normal.

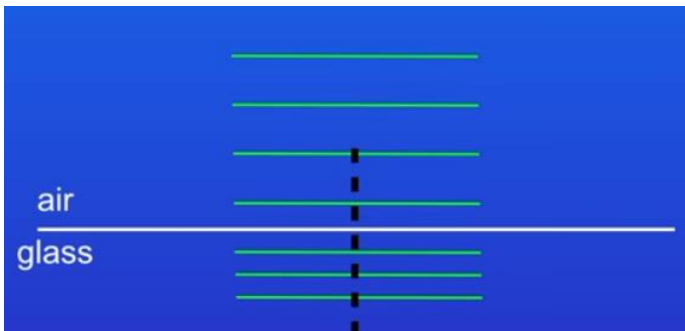
---

<sup>28</sup> Refraction is a phenomenon that has been well understood since Descartes (Malet 1990; Busotti 2013) and that we encounter on a daily basis, in optics, refraction is at the origins of some of the most well-known phenomenon for phantasmagorical reasons: rainbows and mirages.

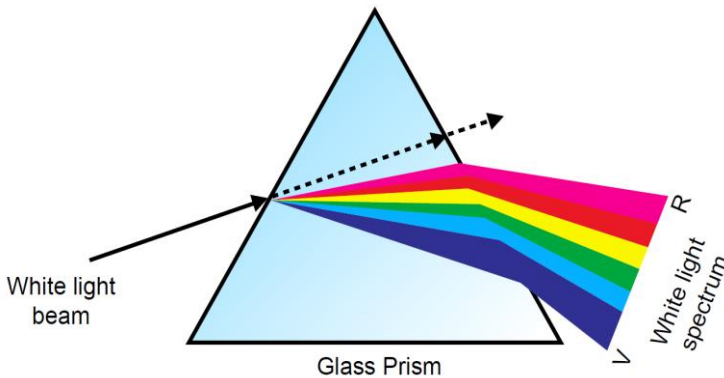


**Fig. 1.6.2.a.** Illustration of an incident electromagnetic wave (in green) refracted because of a change in velocity at the interface of two medium. Source: Freesciencelessons YouTube video screenshots.

On the other hand, if the waves cross the interface or leave it at right angles, then they do not experience a change in direction.



**Fig. 1.6.2.b.** Illustration of an incident electromagnetic wave (in green) not being refracted because of its perpendicular angle of incidence. Source: Freesciencelessons YouTube video screenshots.



**Fig. 1.6.2.c.** Illustration of an incident ray of white light being refracted and decomposed by a prism. Source: <https://schools.aglasem.com/34154> | Permission Granted.

White light is actually composed of a uniform superposition of electromagnetic waves of different wavelengths (correspondingly, of different colours). Whenever it hits the prism and enters glass at an angle, some colours are slowed more than others. This is by this same phenomenon that rainbows can be produced.

In order to understand what happens, let us consider one colour in the white light at a time. When the wavefronts of red light reach the glass at an angle, a part of the wavefront gets in the glass first and gets slowed before the rest of it, which changes the angle of the whole red light waves towards the normal. Light on the other end of the spectrum, blue light for example, gets slowed down even more so its waves bends more. This happens with all colours, in function of their wavelength. So the colours are separated when they first pass in the medium and they spread out even more as they leave the prism at an angle and as their celerity increases.

One way to look at why different wavelengths are slowed down by different amounts is to consider that short wavelengths of light interact more with the electrons of the molecules that make up the glass than longer wavelengths. As those interactions take time, the longer the wavelength, the lesser the frequency and the less interactions are made.

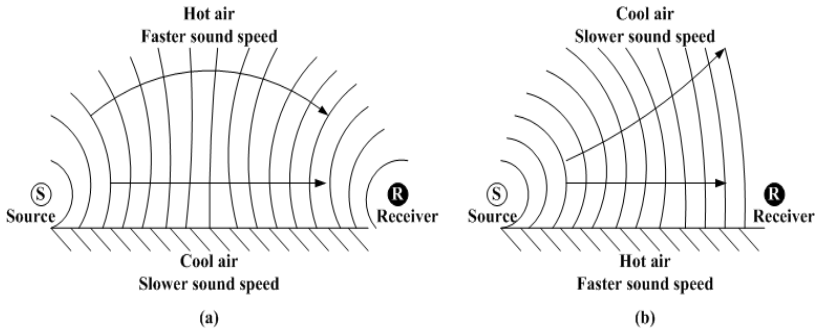
For mirages, the refraction that happens is due to the fact that even if the waves propagating though air do not change medium, the properties of this medium are gradually varying because of the temperature difference, i.e. the index of refraction is varying (Owens 1967).



**Fig. 1.6.2.d.** Photographs of mirages due to the bending of light because of a difference in temperature (and density) of the air from the ground up.  
 Source (left): Flickr.com (CC-BY 2.5), Photographer: Michael Gwyther-Jones;  
 Source (right): <https://www.panoramio.com/photo/38088792> (CC-BY 3), Photographer: Aleksandrs Timofejev.

In acoustics, refraction also allows us to understand why sound is so clear and travels so far on a boat on calm waters: just like with the mirage phenomenon, the difference in temperature just above water and the rest of the air is often enough to bend the soundwaves such that the wavefront, instead of propagating as a section of a sphere which centre is the source of the soundwaves, will be bent in another way. Actually, since the temperature of the air increases significantly enough as we go up, there is a gradient in temperature above the surface of the water. Hence, with cooler temperatures,

cooler air closer to water, the soundwaves are less delayed from top to bottom, giving the wavefront a downward bend towards water (Ross 2000).

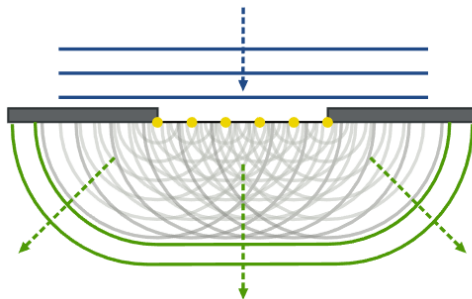


**Fig. 1.6.2.e.** Illustration of the bending of soundwaves happening due to a gradient in temperature in the air. Source: Etienne Bonnec.

### 1.6.3 Diffraction

Diffraction is the name given to the phenomenon that happens when waves come upon an obstacle or a slit with comparable dimensions or lower than their wavelength and change direction or bend around sharp edges. Depending on the nature of the waves, these obstacles can be of many sorts. For example, rocks in a pond could diffract ripples, mountains could diffract radio waves, etc.

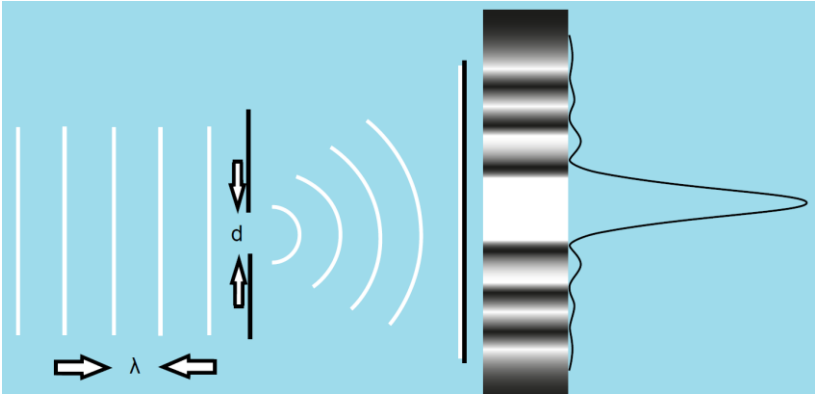
The principle of Huygens-Fresnel (Born 2013) states that when light passes through a slit, each point of the wavefront passing the slit produces an effect equivalent to them being sources of spherical waves. Thus, the resulting wavefront leaving the slit is made out of the sum of the interferences of all these point-like sources.



**Fig. 1.6.3.a.** Representation of the interference phenomenon happening according to the Huygens-Fresnel principle. Source: [https://www.nhn.ou.edu/~jeffery/astro/ial/ial\\_006.shtml](https://www.nhn.ou.edu/~jeffery/astro/ial/ial_006.shtml) | (CC BY-SA 3.0), Credit: Arne Nordmann.



This diffraction can be visualized on a screen by making waves pass through a narrow slit which size is similar to the wavelength (Vokos 2000).



**Fig. 1.6.3.b.** Representation of the interference pattern on a screen emerging from longitudinal waves of a wavelength of  $\lambda$  passing through a single slit of a width  $d$  of the same order of magnitude. Adapted from <http://physicsopenlab.org/2016/03/07/light-as-a-wave-slit-diffraction/>, Permission granted.

## 1.7 Waves' Interactions with Waves

When two or more waves of the same type cross paths, they *interfere* with one another, they pass through one another without altering the state of one another. However, when they do actually meet, they enter a state of superposition and what we actually see is the resulting formation of a new wave pattern: the resultant wave or net wave. This phenomenon is called the *Principle of Superposition of Waves*.<sup>29</sup>

### 1.7.1 Interference, Adding Waves

When two or more waves occupy the same region of space, the resulting net effect of their interaction is the sum of the individual effects of each wave. For the interference phenomenon, the relevant variable is the amplitude which will be the same as the vector sum of the amplitudes of all the interacting waves at a given region of space.

Let us go back a bit to better understand what is happening and analyse a case. In this example, we will imagine a stretched rope fixed at both ends in which two pulses are sent with a short delay in order to have two travelling waves. At one point after the first wave has been reflected, the two waves are travelling in opposite directions and then cross paths and superimpose.

<sup>29</sup> Not to be confused with the Superposition of states of Quantum Mechanics.

Because we set the waves to travel in opposite directions, our two waves, from (eq.11) can be described by:

$$y_1 = A \sin(kx - \omega t) \quad (1.16)$$

For the first wave

$$y_2 = A \sin(kx + \omega t) \quad (11.7)$$

For the second wave.

Adding the waves, we get:

$$y_1 + y_2 = A \sin(kx - \omega t) + A \sin(kx + \omega t) \quad (1.18)$$

Let  $a = kx$  and  $b = \omega t$

$$y_1 + y_2 = A \sin(a - b) + A \sin(a + b) \quad (11.9)$$

Using trigonometry,

$$\sin(a - b) = \sin a \cos b - \sin b \cos a \quad (1.20)$$

$$\sin(a + b) = \sin a \cos b + \sin b \cos a \quad (1.21)$$

We get:

$$y_1 + y_2 = A (\sin a \cos b - \sin b \cos a + \sin a \cos b + \sin b \cos a) \quad (1.22)$$

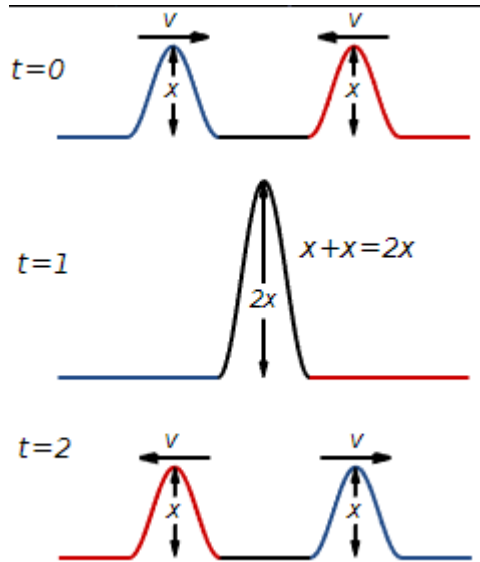
Simplifying, and replacing  $a$  and  $b$ , we end up with:

$$y = y_1 + y_2 = 2 A \sin kx \cos \omega t \quad (1.23)$$

Finally, in this example we can see that the phase argument  $kx \pm \omega t$  is no longer present under its usual form, thus not giving us a direction and therefore describing a standing wave.

### 1.7.2 Constructive Interference

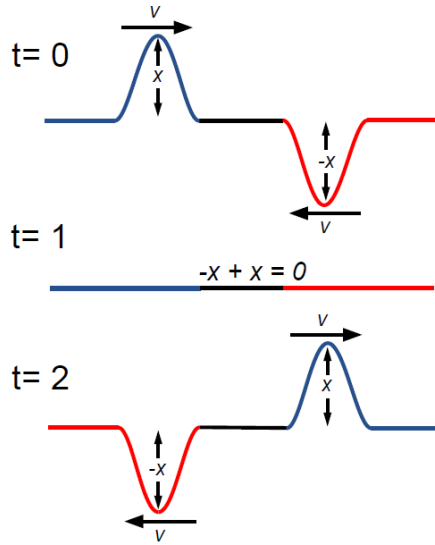
When the amplitude of the resulting wave is increased, whether two crests meet at the same point, the interference will be labelled as a constructive interaction.



**Fig. 1.7.2.** Representation of two one-dimensional pulses of amplitude  $x$  travelling in opposite directions ( $t=0$ ), interfering constructively with one another and producing a resulting wave of an amplitude of  $2x$  ( $t=1$ ), and continuing on their way without being disturbed or altered by their encounter ( $t=2$ ). Source: Public domain, Credit: “Inductiveload”.

### 1.7.3 Destructive Interference

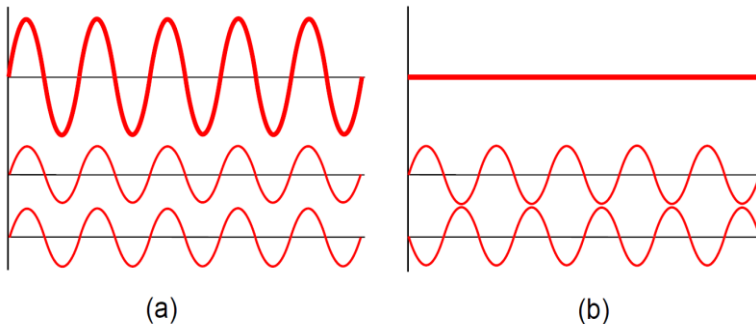
This phenomenon happens when two waves cross paths and the amplitude of the resulting wave is decreased, this decrease of amplitude being due to the fact that a crest and a trough are meeting at the same point. The interference will be labelled as a destructive interaction.



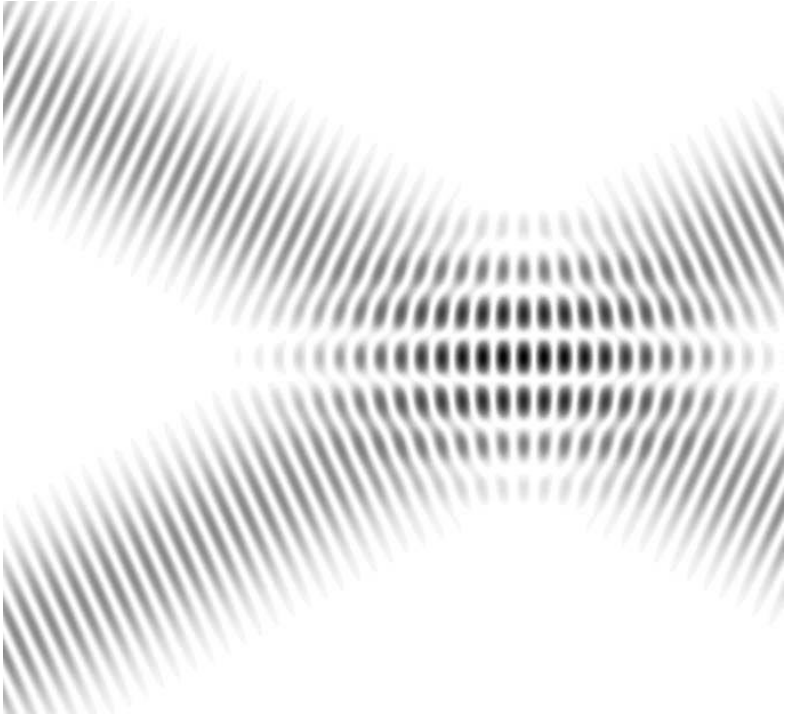
**Fig. 1.7.3** Representation of two one-dimensional pulses of amplitude  $x$  and  $-x$  travelling in opposite directions ( $t=0$ ), interfering destructively with one another and producing a resulting wave of an amplitude of 0 ( $t=1$ ), and continuing on their way without being disturbed or altered by their encounter ( $t=2$ ). Source: Public domain, Credit: “Inductiveload”.

#### 1.7.4 Interference Patterns

In order to get an interference pattern, the waves do not need to be propagating in opposite directions. For instance, multiple waves can be in or out of phase and interfere with one another.



**Fig. 1.7.4.a.** Representation of two one-dimensional waves in phase, interfering constructively (a), and two identical waves out of phase, interfering destructively (b). Source: <http://galleryhip.com/sound-interference.html> | (CC BY-SA 3.0), Credit: Haade.



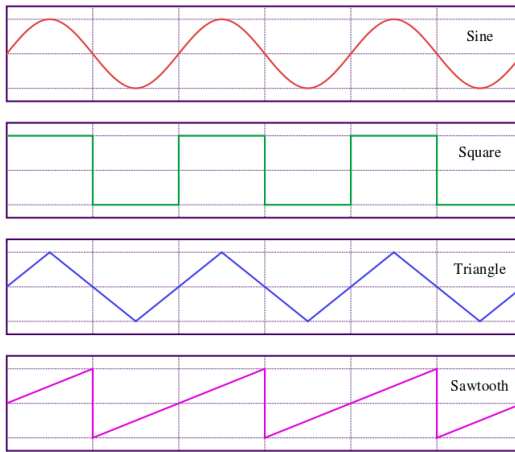
**Fig. 1.7.4.b.** Representation of two plane waves with different incident angles interfering and producing interference fringes. Public domain, Credit: “Ffred”.

### ***1.7.5 Waveforms and Pitch***

A waveform is what is possible to observe on the screen of an oscilloscope plotting an incoming or outgoing signal as a function of time.

As we have seen previously, waves can interfere with one another. However, no matter the form of the wave, or its apparent shape, all waveforms, whether square, triangle, sawtooth, wavetrain, or any imaginable form for that matter, can be constructed from sine waves. Sine waves are the building blocks of waves, just like elementary particles are the building blocks of atoms, etc. Those elementary waves are called harmonics.

Vibrations or soundwaves can be turned into an electric signal (with a microphone for example) which in turn can be displayed on an oscilloscope.



**Fig. 1.7.5.** Example of different waveforms. Source: (CC BY-SA 3.0), Credit: “Omegatron”.

The waveform of a soundwave is the variable that determines the pitch of a sound. When using musical instruments, the soundwaves produced have different waveforms depending on the instrument played. This is how one can differentiate two identical notes played by two different instruments, e.g., a A440, which is the musical note A of frequency 400 Hz, will sound different if played on a piano or a guitar or violin.

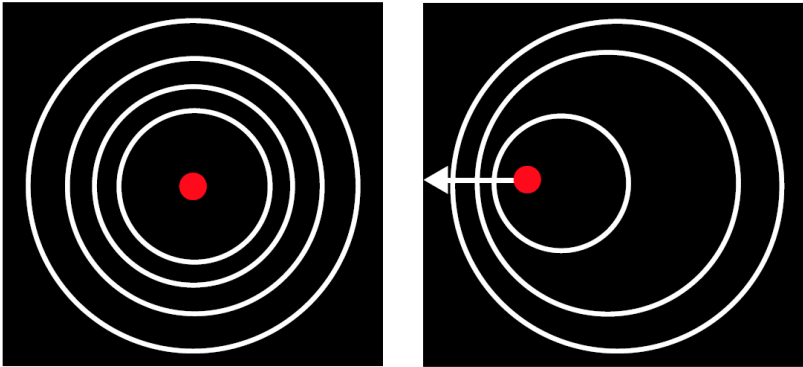
The shape of the waveform can be very complicated, the reason behind this being that multiple signals could be responsible in producing the waveform. Indeed, several signals could be mixed together and the sum of their constructive and destructive interactions would produce a resulting wave with a peculiarly unusual waveshape. However, since every signal can be represented as a sum of sines.

## 1.8 Waves Sources Study

### 1.8.1 *Doppler Effect*

The Doppler Effect is the name we give the phenomenon that takes place when a source emitting waves and an observer perceiving them have a motion relative to each other, i.e. the relative motion of the source and/or the relative motion of the observer has a component towards or away from one another (Ballard 2010).

As a source is emitting waves at a fixed frequency and is moving towards an immobile observer, the wavefronts of the waves emitted by the source see the distance between them being reduced in the direction of the source and lengthened in the opposite direction.



**Fig. 1.8.1.** Illustration of the effects on the frequency of a moving source relative to the direction of its motion. Source: Flickr.com (CC BY 2.0), Credit: Zappys Technology Solutions.

The resulting effect relative to the observer is an increase in the observed frequency. Because the distance between consecutive emitted wavefronts is shorter, the observer measures a shorter wavelength or a shorter time interval between consecutive wavefronts, and therefore a higher frequency. The same effect happens when an observer's motion relative to an immobile source is directed towards the source. As the observer is continuously moving closer to the source, the relative measurement of the distance between consecutive wavefronts gets shorter, and therefore the perceived frequency is higher. From this, it is easy to understand that the greater the velocity of a source towards an observer or the greater the velocity of an observer towards a source, the greater the measured frequency.

Reciprocally, the resulting effect relative to an immobile observer from which the source is moving away is a decrease in the observed frequency. Because the distance or the time interval between consecutive emitted wavefronts is longer, the observer measures a longer wavelength and a lower frequency. The same effect happens when an observer's motion relative to an immobile source is directed away from the source. As the observer is continuously getting further from the source, the relative measurement of the distance or time interval between consecutive wavefronts gets longer, and therefore the perceived frequency is lower. From this, it is straightforward to understand that the greater the velocity of a source moving away from an observer or the greater the velocity of an observer moving away from a source, the lower the measured frequency.

For sound, the Doppler Effect results in a higher pitch when the relative motion of a source and an observer is directed towards one another, and in a lower pitch when the relative motion of a source and an observer is directed away from one another.

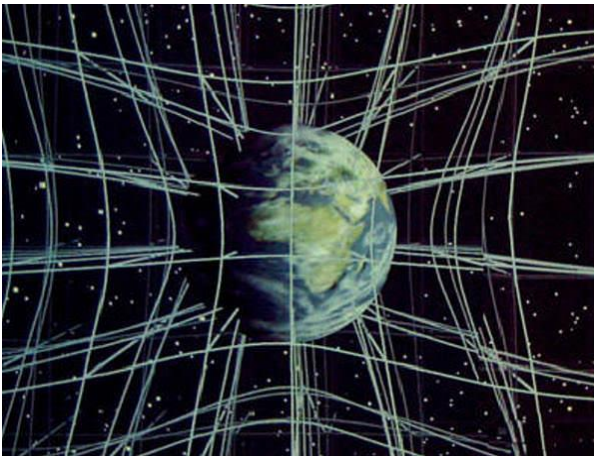
For electromagnetic waves, since the Doppler Effect results in a change in frequency depending on the relative motion of the source and observer, the perceived effect is a displacement of the electromagnetic wave in the electromagnetic spectrum depending on the direction of this relative motion.

For instance, when the observer and source are moving towards another, the increase in the observed frequency corresponds to a displacement to the blue side of the electromagnetic spectrum. This displacement towards higher frequencies is called a “blueshift”. Reciprocally, if the relative movement of the observer and the source is directed away from one another, the measured frequency appears to be lower and this displacement towards lower frequencies, to the red side of the electromagnetic spectrum is called a “redshift”.

In Astronomy, the displacement of the spectral line resulting from the emission or absorption of light of the constituents of distant galaxies is used to determine the motion and velocity of these galaxies relative to us. A blueshift of spectral lines in the electromagnetic spectrum of a galaxy (or rather its stars) meaning that its relative motion is directed towards us, when a redshift means that its relative motion is directed away from us (Adams 1925).

## 1.9 Gravitational Waves

It is a well-known fact that Gravitational Waves are a consequence of General Relativity as their existence was predicted by Albert Einstein’s theory as early as 1916. In General Relativity, the theory presents a new model for physics where the force of gravity is some kind of illusion produced by the curvature of a 4-dimensional object called “spacetime” in which time and the three space dimensions are but one entity. From this, the general idea is that matter (and energy) tell spacetime how to curve and spacetime curvature tells matter how to move.

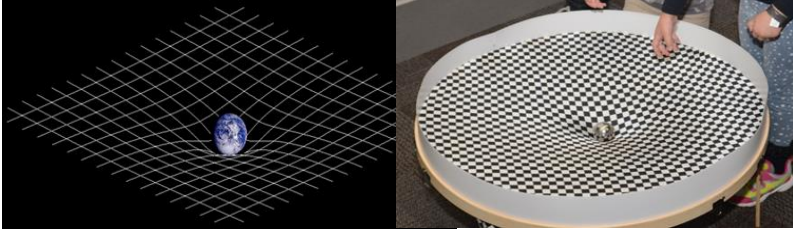


**Fig. 1.9.a.** Illustration of the curvature of a grid representing the 3 spatial dimensions of spacetime due to the presence of the Earth.

Source: [https://www.ligo.caltech.edu/system/media\\_files/binaries/303/original/ligo-educators-guide.pdf?1455165573](https://www.ligo.caltech.edu/system/media_files/binaries/303/original/ligo-educators-guide.pdf?1455165573) | Courtesy Caltech/MIT/LIGO Laboratory.



The idea of gravity not as a force, but as warped spacetime is often depicted in analogy as a flexible sheet being deformed by a heavy ball in which the sheet is representing a simplified spacetime with only 2 spatial dimensions instead of 3 and with a ball representing a massive celestial object.



**Fig. 1.9.b.** Illustration of the curvature of a grid representing a simplified spacetime of 2 spatial dimensions by the Earth compared to the curvature of a spandex sheet produced by a ball.

Source: [https://www.ligo.caltech.edu/system/media\\_files/binaries/303/original/ligo-educators-guide.pdf?1455165573](https://www.ligo.caltech.edu/system/media_files/binaries/303/original/ligo-educators-guide.pdf?1455165573) | Courtesy Caltech/MIT/LIGO Laboratory.

As such, Gravitational Waves are important in the sense that their discovery furthers the confirmation that General Relativity is correct; but also because they open up a new path, an entire field of Physics. This represents one of the next frontiers of physics as well as a new window on the universe and a new opportunity to study it in completely new ways, leading us towards a new era of cosmology.

Until now, and for millennia, mankind has been studying the universe by turning to the stars, and has tried to understand celestial mechanics by looking at them. Undeniably, the –almost– only tools at our disposition were light based in the sense that whether it was by observing the stars with the naked eye or thanks to the assistance provided by artificial eyes such as telescopes, we have been using all the electromagnetic spectrum in order to comprehend our world.

However, this era has come to an end thanks to the discovery of Gravitational Waves. I think that it would be fair to say that up until this point we were studying the silent film of the universe, as Gravitational Waves are of an analogous nature to soundwaves (Bernard 1984). Having now an entirely new way of detecting what is happening out in the universe is as exciting for astronomers as the innovation that lead to sound film; we now have a new sense to perceive the universe and pursue our research.

Recently, on September 14th 2015, the first detection of Gravitational Waves was made by the Advanced LIGO detectors, which are part of the LIGO-Virgo collaboration. The event that generated the Gravitational Waves detected was the collision of two black holes, and took place about 400 megaparsecs or 1.3 billion light-years from Earth which equivalent to say that this incredible event took place 1.3 billion years ago. This binary black hole merger involved a pair of black holes of around 36 and 29 solar masses.

### 1.9.1 Definition

Gravitational Waves are oscillations of the gravitational field that are propagating. Simply put, if waves are the propagation of a disturbance, Gravitational Waves are a propagation of a disturbance of spacetime. Gravitational Waves are local distortions of spacetime that propagate out. In order to produce them, there needs to be accelerating masses, which is to say a change in the quadrupole moment of a mass distribution; in other words, that means any change that is not spherically or cylindrically symmetric such as a two objects orbiting each other (LIGO Scientific Collaboration 2005).

When matter, or energy, passes through some region of spacetime, it distorts the spacetime<sup>30</sup>. As a consequence, the presence of matter causes perturbations travelling through spacetime at the vacuum speed of light. These perturbations propagating are the contraction and expansion of spacetime itself. Therefore, Gravitational Waves are ripples of spacetime, propagating spherically outwards from the source and continually being passed on from one region of spacetime to another after the manner of a wave.

Gravitational waveform can be computed using numerical solutions to Einstein's field Equations:

$$R_{\mu\nu} - \frac{1}{2}Rg_{\mu\nu} + \Lambda g_{\mu\nu} = \frac{8\pi G}{c^4} T_{\mu\nu} \quad (1.24)$$

Where  $R_{\mu\nu}$  is the Ricci curvature tensor,  $R$  is the scalar curvature,  $g_{\mu\nu}$  is the metric tensor,  $\Lambda$  is the cosmological constant,  $G$  is Newton's gravitational constant and  $T_{\mu\nu}$  is the stress-energy tensor which describes the density of energy and momentum in spacetime.

In fact, General Relativity describes the gravitational field and the gravitational radiations by their effects on free test masses. However, since gravitational waves interact very weakly with matter, and fall off rapidly, the scale of their effects is minuscule unless produced by very massive and very close objects. That is the reason why gravitational astronomy is looking for cataclysmic events in the observable universe such as binary black holes mergers.

In General Relativity, the solutions to Einstein's field equations are often impossible to solve exactly; even with the help of modern technology and very effective supercomputers. Therefore, in order to make progress, one has to do some approximations. Gravitational waves are easier to describe in flat spacetime and cause very little variations in spacetime curvature far from their source; in this weak field limit, gravitational waves described using those approximations are named *linearized* gravitational waves.

---

<sup>30</sup> An analogy for this phenomenon would be that just like an object moving through water would distort it and generate waves, matter and energy distort spacetime and generate waves which are a propagation of spacetime itself.

The metric –a type of function that measures distances– used to describe the geometry in these conditions –a flat spacetime– is defined as:

$$g_{\mu\nu}(x) = \eta_{\mu\nu} + h_{\mu\nu}(x) \quad (1.25)$$

Where  $\eta_{\mu\nu}$  is the flat Minkowski metric:

$$\eta_{\mu\nu} = \begin{matrix} & t & x & y & z \\ \begin{matrix} t \\ x \\ y \\ z \end{matrix} & \begin{pmatrix} -1 & 0 & 0 & 0 \\ 0 & 1 & 0 & 0 \\ 0 & 0 & 1 & 0 \\ 0 & 0 & 0 & 1 \end{pmatrix} \end{matrix} \quad (1.26)$$

and  $h_{\mu\nu}(x)$  is a minor perturbation.

A linearized gravitational wave propagating along the z-axis has a perturbation:

$$h_{\mu\nu}(t, z) = \begin{matrix} & t & x & y & z \\ \begin{matrix} t \\ x \\ y \\ z \end{matrix} & \begin{pmatrix} 0 & 0 & 0 & 0 \\ 0 & 1 & 0 & 0 \\ 0 & 0 & -1 & 0 \\ 0 & 0 & 0 & 0 \end{pmatrix} \end{matrix} f(t - z) \quad (1.27)$$

where  $f(t - z)$  is expressing the amplitude of the transverse components and  $|f(t - z)| \ll 1$ . This polarization is the “plus” polarization.

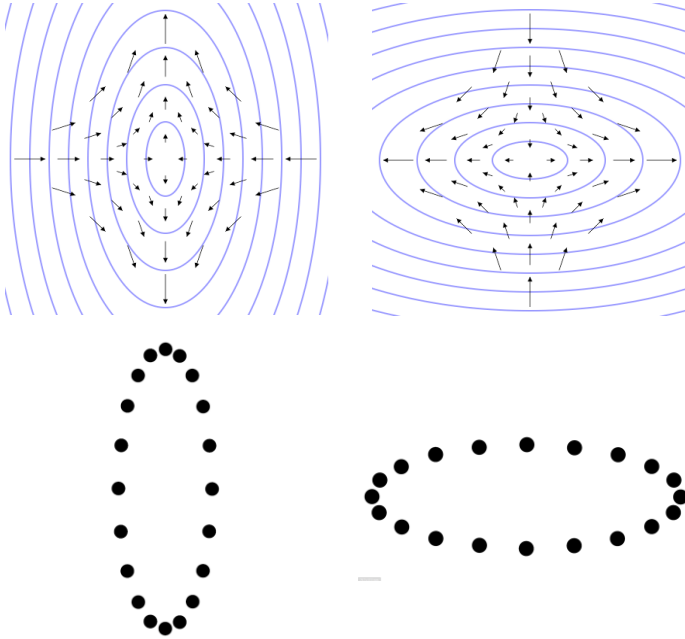
The other independent polarization is called the “cross” polarization and is the same rotated by an angle of  $45^\circ$  (Misner 1973; Rubenzahl 2017):

$$h_{\mu\nu}(t, z) = \begin{matrix} & t & x & y & z \\ \begin{matrix} t \\ x \\ y \\ z \end{matrix} & \begin{pmatrix} 0 & 0 & 0 & 0 \\ 0 & 0 & 1 & 0 \\ 0 & 1 & 0 & 0 \\ 0 & 0 & 0 & 0 \end{pmatrix} \end{matrix} f(t - z) \quad (1.28)$$

### 1.9.2 Properties of Gravitational Waves

In order to improve our understanding of what Gravitational Waves are, we need to take into consideration what their physical and mathematical properties are.

First of all, the distortions of Gravitational Waves are transverse to the direction of propagation, so if they are propagating along the  $z$  axis, they stretch space in the  $x$  axis and squeeze space in the  $y$  axis; and as they are waves, they oscillate and the stretching and squeezing alternate.



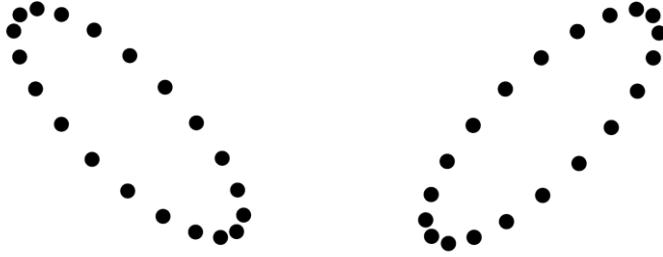
**Fig. 1.9.2.a.** Representation of the effects of  $h_+$  polarization on spacetime (top panels) and free test masses (bottom panels) in extreme positions in the  $xy$ -plane. Source: Etienne Bonnet.

Additionally, Gravitational Waves just like electromagnetic waves, can be polarized. When we describing the polarization of electromagnetic waves, we considered vertical and horizontal polarizations, however, visually one can notice that those kinds of polarizations do not work for Gravitational Waves as they would be the same. In fact, for Gravitational Waves, the polarizations are not at a  $90^\circ$  angle, but at a  $45^\circ$  angle.

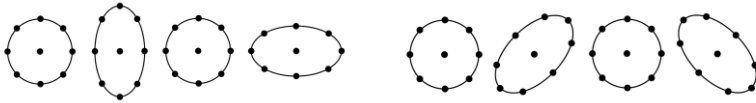
An interferometric detector is sensitive to a particular linear combination of these two polarizations; this is described by  $F_+$  and  $F_\times$ , two response functions. Hence, we consider the two polarizations:  $h_+$  and  $h_\times$ :

$$h(t) = F_+ F_+(t) + F_\times h_\times(t) \quad (1.29)$$

(Cfr. LIGO Scientific Collaboration 2005a)



**Fig. 1.9.2.b.** Representation of the effects of  $h_x$  polarization on free test masses in the extreme positions in the  $xy$ -plane. Source: Etienne Bonnac.



**Fig. 1.9.2.c.** Representation of the alternating pattern of free test masses made by passing  $h_+$  polarized gravitational waves (left panel) and  $h_x$  polarized gravitational waves (right panel). Source: Etienne Bonnac.

Gravitational Waves are quadrupole waves. Unlike electromagnetic waves which are dipole transverse waves, varying simultaneously in two perpendicular directions and with an equal amplitude for the electric and magnetic fields at any given point, Gravitational Waves contract and expand in two perpendicular directions at the same time. The letter  $h$  is used to represent the metric tensor of the Gravitational waves, in other words, the distortions affecting a flat space with a Euclidean metric  $g$ .

Just like more classical waves do, Gravitational Waves carry energy, and have a frequency, and thus a wavelength. They come in all kinds of frequencies, depending on the period of the considered system.

In the case of a self-gravitating body, the frequency is defined by the following equations:

$$\omega_0 = \sqrt{\pi G \bar{\rho}} \text{ or } f_0 = \frac{\omega_0}{2\pi} = \sqrt{G \bar{\rho} / 4\pi} \tag{1.30}$$

(Cfr. Sathyaprakash 2009)

where  $\bar{\rho}$  is the mean density of the mass-energy in the source.

The number of contractions and expansions per second of the Gravitational Waves is proportional to the rate at which the objects are orbiting.

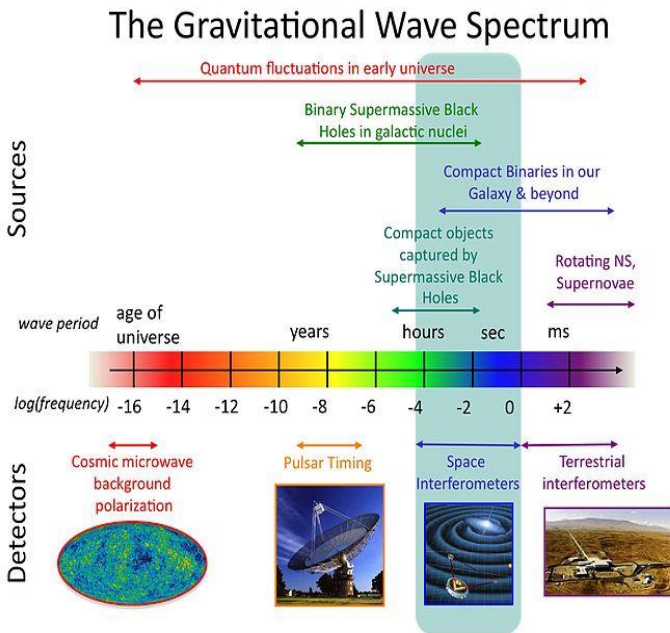
The angular frequency  $\omega$  of two orbiting masses  $M_1$  and  $M_2$ , is given by Kepler’s third law of planetary motion (Barker 2001):

$$\omega = \left(\frac{2\pi}{P}\right)^2 = \frac{G (M_1 + M_2)}{a^3} \tag{1.31}$$

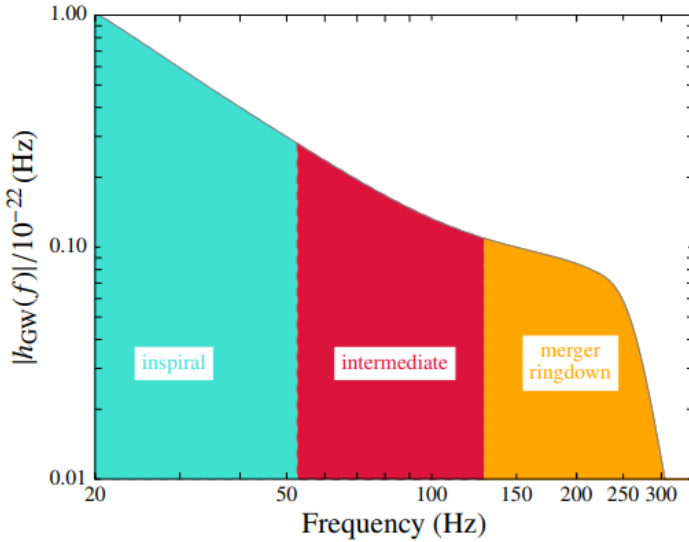
(Cfr. Pettini 2013)

Where  $P$  is the period,  $G$  the Gravitational constant and  $a$  the semi-major axis.

In fact, to be accurate, the wave frequency is equal to twice the orbital frequency (for approximately circular orbits).



**Fig. 1.9.2.d.** Infographics of the Gravitational Wave Spectrum. Source: NASA – <https://science.gsfc.nasa.gov/663/research/> | Public Domain.



**Fig. 1.9.2.e.** Frequency regions of the parameterized waveform of a model (Cfr. Khan 2016). The plot shows the absolute value of the frequency-domain amplitude of the most-probable waveform from GW150914 [3]. The inspiral region (cyan) from 20 Hz to ~55 Hz corresponds to the early and late inspiral regimes. The intermediate region (red) goes from ~ 55 Hz to ~ 130 Hz. Finally, the merger–ringdown region (orange) goes from ~ 130 Hz to the end of the waveform. (Cfr. LIGO Scientific Collaboration and Virgo Collaboration 2016b). Source: <https://arxiv.org/abs/1602.03841> | <http://arxiv.org/licenses/nonexclusive-distrib/1.0/>

The gravitational luminosity:

Gravitational Waves are propagating spherically outwards from the source, in a context where two point masses of  $M_1$  and  $M_2$  with a mass  $M$  for the total mass of the binary system in a circular orbit with a semi-major axis of length  $a$ , the radiating energy from the system can be calculated using the following relation:

$$P = \frac{dE}{dt} = - \left( \frac{32}{5} \right) \frac{G^4 (M_1 M_2)^2 M}{c^5 a^5} \quad (1.32)$$

(Cfr. Postnow, Yungelson 2014)

where  $P$  is the power,  $dE$  the difference of binding energy over a time difference  $dt$ .

According to the works of Newton and Kepler, binding energy is a negative quantity:

$$E = - G \frac{M_1 M_2}{2a} \quad (1.33)$$

(Cfr. Mapelli 2012)

Since the only Lorentz invariant velocity is  $c$  and since it is the speed of causality and Gravitational Waves have no mass, the velocity of Gravitational Waves must also be  $c$ , the speed of light.

Because all the different forms of matter and energy have the same gravitational effect, namely a positive attraction, there is no dipole radiation (like in electromagnetism with positive and negative charges, different signed charges attracting each other and same signed charges repelling each other), there can only be quadrupole and higher orders.

Gravitational Waves are extremely weak. The most cataclysmic gravitational phenomena such as neutron star-neutron star or black hole-black hole inspiralling just before their mergers, supernovae explosions or collisions of extremely massive objects produce Gravitational Waves that lengthen or contract space on Earth by a factor of  $10^{-21}$  or less (Shoemaker 2016). Obviously, this power depends on several different variables such as the distance from the source of the Gravitational Waves, i.e. how far from the event we are.

Because coalescing black holes or neutron star mergers are not common events, astronomers are listening outside of our galaxy, to the Virgo supercluster, within a 55 million light year radius. This range is the reason why the amplitude of the Gravitational Waves is dropping so low. Fortunately for us, these kinds of events producing Gravitational Waves have been far enough away not to be ripped by them.

When objects are close enough to produce Gravitational waves, their orbits will lose energy and decay, causing them to spiral in towards each other. This effect, which has been observed in a binary system of neutron stars orbiting each other matched the predictions of the theory and lead to a Nobel Prize in Physics. Indeed, the Nobel Prize in Physics 1993 was awarded jointly to Russell A. Hulse and Joseph H. Taylor Jr., both of Princeton University, New Jersey, USA, "for the discovery of a new type of pulsar, a discovery that has opened up new possibilities for the study of gravitation."

The observations of the Hulse-Taylor pulsar and the study of its behaviour lead to the deduction that it was made out of two neutron stars (Penrose 2013) approximately of the same masses revolving at a distance equivalent to a few times the distance of the Moon from the Earth. Along with the Gravitational Waves equations, they managed to estimate that the loss of gravitational energy through gravitational radiation corresponded to the rate at which the orbit was decaying. Finally, the study and measurements of this system for over 40 years lead to witness that the observations the predictions of the theory, which consisted in the first indirect detection of Gravitational Waves.

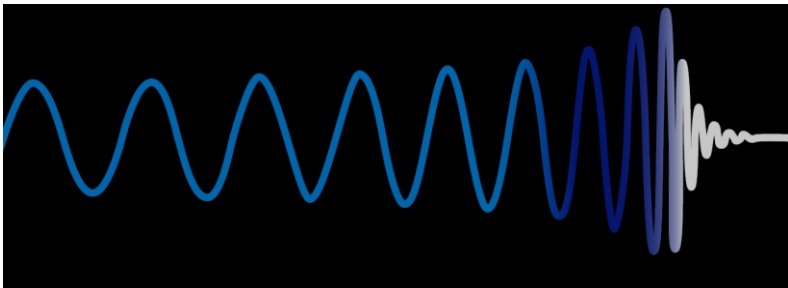
A physical system is emitting gravitational radiation if it possesses some extra energy that it prefers to release as gravitational waves, and if the system is not exactly spherically or cylindrically symmetric (LIGO Scientific Collaboration 2005). As an example, the system consisting of the Earth and the Sun is emitting gravitational waves as a result of the Earth revolving around the Sun. However, even if this has the consequence of making the Earth's orbit to decay with gravitational radiation by carrying energy away, this effect is so minuscule that it is impossible to detect.



### 1.9.3 *Properties of the Signal*

In essence, the main sources that produce Gravitational Waves are very massive objects accelerating. A pair of some kind of those objects in orbit qualify for this, as orbiting around one another in a circular or elliptical motion means accelerating, because non accelerating objects carry on in a straight line. As the two objects get closer and closer, faster and faster, they undergo an acceleration that increases at a more and more rapid rate so that the amount of gravitational radiation goes up and up until the collision or merger of the objects. The underlying reason being that as the objects spiralling around one another lose potential energy, they get closer and closer. In fact, the potential energy of the system is being converted into gravitational radiation.

Therefore, this means that the classical shape of the signal has to look like a “chirp” signal, by analogy with the associated sound if the signal is considered as coming from soundwaves, in which the frequency follows a *crescendo* and abruptly ends.



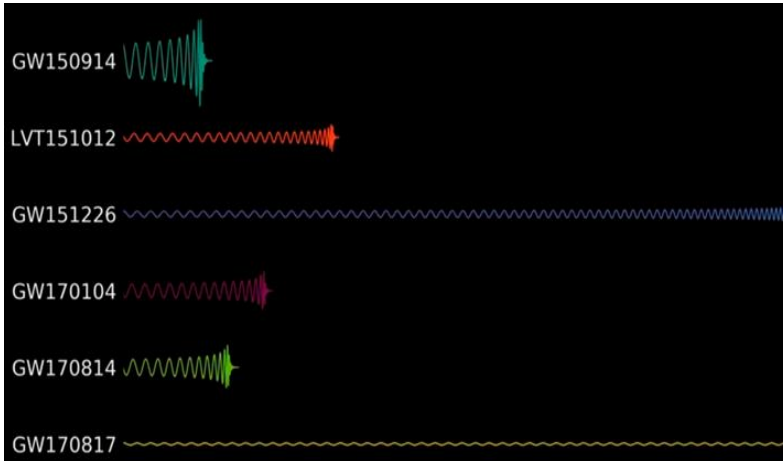
**Fig. 1.9.3.a.** Illustration of the “chirp” signal given by a binary black hole merger.  
Source: Etienne Bonnec.

From the measured signals, we can then infer how big the gravitational waves are once they reached us, and by extension how luminous the event was in terms of gravitational radiation as well as how big the gravitational waves were to start with. Finally, the combination of these properties of the signal allows us to deduce how far away the event took place. Moreover, since there are multiple detectors, this allows for a triangulation of the signal. Indeed, depending on the order of reception of the same signal by different detectors, and as we know that gravitational waves, just like electromagnetic waves, travel at the speed of light, we can dedetermine the origin of the signal by measuring the delay between those receptions.

Considering the signals, because we have standard sirens (Holz 2005) – by opposition to standard candles– we know that the larger the black hole masses, the higher the intrinsic amplitude, and thus by knowing their gravitational luminosity, in other words, one could say their loudness, we can deduce how far they are. Moreover, the more massive the objects are, the more rapidly they lose their energy and the faster they inspiral thus producing a signal passing faster from lower to higher frequencies. In the

same manner, lower mass systems have lower amplitude and pass from lower to higher frequencies less rapidly. This combination of effects and characteristics in the observed signal is what allows researchers to identify the type of systems that produced the signal.

Additionally, in order to help with the identification of the origin of a signal, astronomers can use conventional telescopes to look in the designated region of space determined by the data from the interferometers, the actual gravitational wave detection, for potential events corresponding to the detected signal. This is what happened on 17 August 2017 for a neutron star – neutron star merger.



**Fig. 1.9.3.b.** Illustration of the comparison of different detected signals with different properties (Cfr. LIGO Scientific Collaboration 2005b, page 10).

Source: <https://arxiv.org/abs/gr-qc/0509129> | <http://arxiv.org/licenses/nonexclusive-distrib/1.0/>

### 1.9.4 Sources

In this section, we will discuss what kind of sources we expect are capable of producing Gravitational Waves that are strong enough to provide us a detectable gravitational signal with our current sensitivity.

### ***1.9.4.1 Black Hole-Black Hole Merger***

For GW150914, the first detected signal of Gravitational Waves, the event at the origin was a black hole–black hole merger. This event distorted the spacetime enough that the generated Gravitational Waves could be detected down on Earth.<sup>31</sup>

On GW150914, the amount by which space was expanding over many kilometres of the arms of the detectors was less than the diameter of the nucleus of an atom. This is also the reason why we do not notice them going past us, since if they were big enough to have macroscopic effects, we would be able to directly observe space behaving in all kinds of abnormal manners.

This binary system of two black holes have been plausibly orbiting each other for millions of years and getting closer and closer, and faster and faster until they merged. In the final instants just before the actual merger (about 0.2 seconds before the collision), as the 30 solar mass black holes get closer, they revolve around one another so rapidly that they approach the speed of light (around 60%) and start merging together at a distance of around 350 kilometres. With such massive objects spinning at such incredible velocity, the local region of spacetime where this event is occurring is highly distorted and fluctuating between contractions and expansions so fast that Gravitational Waves with higher and higher amplitude are produced as the merger progresses and propagate out as ripples in spacetime.

Finally, by looking at the received signal, the estimated mass of the resulting black hole was not around 65 solar masses as one could think when adding the two masses of the black holes involved, but around 62 solar masses. This difference comes from the conversion of a part of the masses involved into Gravitational Waves.

### ***1.9.4.2 Neutron Star-Neutron Star Merger***

Neutron stars are the densest stars known and are produced when massive stars explode in supernovae but are not massive enough to collapse into a black hole. A neutron star-neutron star merger is called a *killonova*. Because neutron stars are very massive objects with an incredibly high density, this kind of merger is thought to almost always produce a black hole as a result. As we now know, the frequency of Gravitational Waves depends on the period of a rotating system, and since neutron stars are very compact objects, this implies that the two celestial objects can orbit around one another very close, thus allowing a neutron star-neutron star merger to be detected because the orbital frequency will be high enough. GW170817, the first

---

<sup>31</sup> In fact, even if the Moon and the Earth are themselves distorting and producing Gravitational Waves, these ones are so minuscule that they can't be detected. Indeed, in order for us to detect Gravitational Waves, they have to have been produced by extremely massive objects.

neutron star-neutron star merger signal was detected on 17 August 2017 by the LIGO-Virgo collaboration. The signal was created in the very last moments of the two neutron stars' inspiral and was detected just two seconds before a gamma-ray burst was observed by NASA's Fermi gamma-ray Space Telescope (Science 2017).

These kinds of events, besides being very interesting in itself, are very important for research. Indeed, because neutron stars are a type of stars, they emit electromagnetic radiation, contrary to black holes. Because of this, an early detection by the LIGO-Virgo collaboration and the study of the signal can provide the approximated origin of the event through a time triangulation –the deduction of the direction to the source provided by an analysis of the different times of arrival of the signal at each detector– and thus would allow astronomers to point their telescopes to the area of the estimated source. This in turn leading to a direct observation of the phenomenon.

After the detection of GW170817, numerous telescopes started to scrutinize the region of space where the origin of the signal was estimated to come from and observed a new source of light in the surroundings of the NGC 4993 galaxy.

Moreover, since Gravitational Waves are emitted before the actual coalescence, during the last moments of the inspiral they become detectable, and start arriving to us before the collision of the two objects. Therefore, one can hope that in the future, with better detecting apparatus and a greater number of them, we will be able to pinpoint the location of such events with great accuracy and sufficiently early in their process to give astronomers time to orient their telescopes and obtain a direct observation of the phenomenon.<sup>32</sup>

### *1.9.4.3 Gravity Waves & Tidal Force*

Tides do not exist because of the propagation of Gravitational Waves. In fact, because the Earth is orbiting the Sun and the Moon is orbiting the Earth, and because they are very massive objects, there is a net attraction due to their mass. (Penrose 1997) As these massive celestial bodies are orbiting each other, the water on the Earth gets distorted by the changing gravitational field. According to Newton's Law, this force follows the relation:

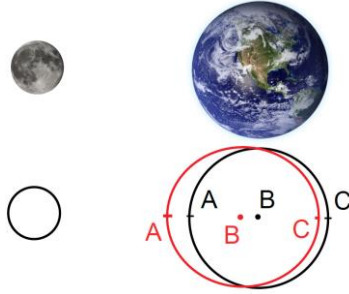
$$F = G \frac{m_a m_b}{r^2} \quad (1.34)$$

---

<sup>32</sup> At this point, it is essential to note and understand that Gravitational Waves are completely different from gravity waves which are associated with tides and tidal forces.

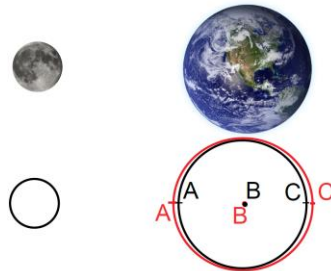
Tides explained:

For simplicity, we will us just consider the Earth-Moon system and draw a simple sketch.



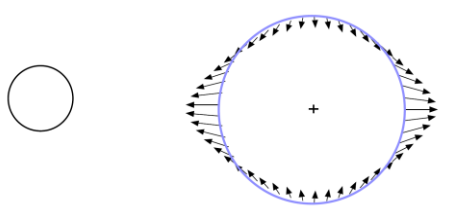
**Fig. 1.9.4.3.a.** Illustration of the Earth-Moon system and the sketch of the positions of the Earth and the Moon. The red circle represents the greatly exaggerated effects of gravity we could expect because of the gravitational gradient. Source: Etienne Bonniec.

From a referential in space, we know that the gravitational attraction on points A, B and C is different. Point A is more attracted to the Moon than point B and point B is more attracted than point C. However, this is not what is actually observed from the Earth:



**Fig. 1.9.4.3.b.** Illustration of the Earth-Moon system and the sketch of the positions of the Earth and the Moon. In red, the actual effects of gravity observed. Source: Etienne Bonniec.

From this perspective, points A and C act as if they were distancing themselves from point B under the action of a force; the tidal force. On the surface of the Earth, the gravitational differential exerted by the Moon is called the Generating Force. These combined effects of gravity and inertia lead to the production of a second bulge of water.



**Fig. 1.9.4.3.c.** Sketch of the Earth-Moon system double bulge of water due to the combined effects of gravity and inertia. Source: Etienne Bonniec.

On the other hand, Gravity waves is the name given in fluid dynamics to the waves generated at the interface of two media or at the surface of a fluid under the influence of gravity. For instance, waves and swell at the surface of oceans as well as winds are types of gravity waves.

## Epilogue I

Recently, the discovery of gravitational waves has led to a renewal, a second wind for Astronomy, Cosmology and Physics. By not just simply participating in the everlasting endeavour that is Science, but by giving us –almost literally– a new sense to work with, to test our theories and model, to experiment, we are currently at the edge of a number of discoveries that will teach us a lot. Since the likes of Aristotle (Aristotle 1999), Galileo Galilei (1564-1642), etc. our knowledge has been growing again and again, sometimes constantly, but often by leaps and bounds and as our understanding of the universe and its mechanics unveils with paradigm shifts (Khun 1962).

Men –and women– of science have been observing the sky and its stars for millennia, whether with their eyes or with artificial extensions of them, searching for answers, developing hypothesis and designing ways to test them and the predictions of the theories they suggested, with more or less success and with more or less ease or freedom –think of Copernicus (Koyré 1934)–. These scientists also depended on the Historical context of their time and sometimes suffering from the ruthlessness of their contemporary era’s mainstream. Nevertheless, progress has been made, theories have risen and fallen, the Physics of Waves has been developed along with mathematical tools (Katz 2014), and as we kept advancing, we have been given direct evidence of the existence of Gravitational Waves. In order to understand the role played by the history of this discovery and its importance in Science and Sciences of Education/Didactics, and since the basics of the Physics of Waves have now been laid, we are now set to continue our journey. However, until now we have only seen one side of the coin, with the Gravitational aspect of the Gravitational Waves through Historical, Epistemological and Science of Education/Nature of Science points of view.

# REFERENCES

## Primary Sources

- Adams WS (1925) The relativity displacement of the spectral lines in the companion of Sirius. *The Observatory*, UK. 48:337-342. Retrieved: <http://adsabs.harvard.edu/full/1925Obs....48..337A>
- Einstein A (1905) Ueber einen die Erzeugung und Verwandlung des Lichtes betreffenden heuristischen Gesichtspunkt, *Annalen der Physik*, ser. 4, XVII, 1905, 132-148. (CP, 2, p. 150-166). Trad. fr., *Un point de vue heuristique concernant la production et la transformation de la lumière*, O.C., 1, p. 39-53.
- Koyré A (1934) *Nicolas Copernic, Des révolutions des orbés céleste*. Alcan, Paris.
- Kuhn TS (1962) *The Structure of Scientific Revolutions*. The Chicago University Press, Chicago.
- Maxwell JC (1865) *A Dynamical Theory of the Electromagnetic Field*. *Philosophical Transactions of the Royal Society*, London, UK. 155, Part VI:497-501. Retrieved: <http://www.bem.fi/library/1865-001.pdf>
- Whitehead AN (1922) *The Principle of Relativity with applications to Physical Science*. Cambridge University Press, UK. Retrieved: <https://archive.org/details/cu31924004208165>
- Whitehead AN (1989) *On the Geodesic Geometry of Surfaces in non-Euclidean Space*. *Proceedings of the London Mathematical Society*, s1-29: 275-324. doi:10.1112/plms/s1-29.1.275

## Secondary Sources

- Aiton E J (1978) Kepler's Path to the Construction and Rejection of his First Oval Orbit for Mars. *Annals of Science* 35/2:173-190.
- Alvarez C, Dhombres J (2011) *Une histoire de l'Imaginaire mathématique*. Hermann, Paris.
- Ballard MS (2010) Doppler Effect. *The Journal of the Acoustical Society of America* 127/3, 1912, Published Online. Retrieved: <https://doi.org/10.1121/1.3384841>
- Barker P, Goldstein BR (2001) *Theological Foundations of Kepler's Astronomy*. *Osiris* 16:88-113.
- Bernard C, De Rújula A, Lautrup B (1984) Sonic search for monopoles, gravitational waves and newtorites. *Nuclear Physics B*, 242/1: 93-144. Retrieved: [https://doi.org/10.1016/0550-3213\(84\)90136-6](https://doi.org/10.1016/0550-3213(84)90136-6).
- Bieri L, Garfinkle D, Yunes N (2017) *Gravitational Waves and Their Mathematics*. *AMS Notices*, 64/07:685-707. Retrieved: <http://arxiv.org/abs/1710.03272>
- Blackstock DT (2000) *Fundamentals of physical acoustics*. John Wiley & Sons, Inc, USA. Retrieved: [https://books.google.fr/books?id=e\\_8sPIEd36YC&](https://books.google.fr/books?id=e_8sPIEd36YC&)
- Blanchet L, Damour T, Iyer BR, Clifford MW, Wiseman AG (1995) Gravitational-Radiation Damping of Compact Binary Systems to Second Post-Newtonian Order. *Phys. Rev. Lett.* 74, 3515. Retrieved: <https://journals.aps.org/prl/abstract/10.1103/PhysRevLett.74.3515>
- Born M, Wolf E (2013) *Principles of Optics, Electromagnetic Theory of Propagation Interference and diffraction of Ligth*, Sixth (corrected) Edition. Pergamon Press, Oxford, UK. Chap.8.2, pp. 370-375. Retrieved: <https://books.google.fr/books?id=HY-GDAAAQBAJ&>
- Bussotti, P. & Pisano, R. (2013). On the Conceptual and Civilization Frames in René Descartes' Physical Works. *Advances in Historical Studies*, 2, 106-125. doi: 10.4236/ahs.2013.23015.
- Chartier G (2005) *Introduction to Optics*. Springer Science & Business Media, NY, USA. Retrieved: <https://books.google.fr/books?hl=fr&lr=&id=qLoU7Aihl9QC&oi>



- Cho A (2017) Merging neutron stars generate gravitational waves and a celestial light show. *Sciencemag News*. Retrieved: <https://www.sciencemag.org/news/2017/10/merging-neutron-stars-generate-gravitational-waves-and-celestial-light-show>
- Damour T, Iyer BR, Sathyaprakash BS (2001) Comparison of search templates for gravitational waves from binary inspiral. *Physical Review D* 63, 044023. Erratum *Phys. Rev. D* 72, 029902 (2005). Retrieved: <https://journals.aps.org/prd/abstract/10.1103/PhysRevD.63.044023>
- French AP (1971) *Vibrations and Waves*. CRC Press, London, UK. Retrieved: <https://www.taylorfrancis.com/books/9781482289350>
- Graff KF (2012) *Wave Motion in Elastic Solids*. Courier Corporation, Chelmsford, MA, USA. Retrieved: <https://books.google.fr/books?id=jorRagAAQBAJ&dq>
- Holz DE, Hughes SA (2005) Using Gravitational-Wave Standard Sirens. *The Astrophysical Journal*, USA. 629:15–22. Retrieved: <http://iopscience.iop.org/article/10.1086/431341/pdf>
- Katz VJ, Parshall KH (2014) *Taming the unknown. History of algebra from antiquity to the early twentieth century*. The Princeton University Press. Princeton–New Jersey.
- Khan S, Husa S, Hannam M, Ohme F, Pürrer M, Forteza XJ, Bohé A (2016) Frequency-domain gravitational waves from non-precessing black-hole binaries. II. A phenomenological model for the advanced detector era. *Phys. Rev. D* 93, 044007. Retrieved: <https://arxiv.org/abs/1508.07253>
- Kokkotas KD (2002) *Gravitational Wave Physics*. In: *Encyclopedia of Physical Science and Technology*, 3<sup>rd</sup> Edition, Vol.7. Academic Press. Retrieved: [http://www.tat.physik.uni-tuebingen.de/~kokkotas/Teaching/NS.BH.GW\\_files/GW\\_Physics.pdf](http://www.tat.physik.uni-tuebingen.de/~kokkotas/Teaching/NS.BH.GW_files/GW_Physics.pdf)
- LIGO Scientific Collaboration, Abbott B, et al. (2005) First all-sky upper limits from LIGO on the strength of periodic gravitational waves using the Hough transform. *Physical Review D*, 72/102004. DOI: 10.1103/PhysRevD.72.102004. Retrieved: [arXiv:gr-qc/0508065](https://arxiv.org/abs/gr-qc/0508065)
- LIGO Scientific Collaboration, Abbott B, et al. (2005a) Search for gravitational waves from galactic and extra-galactic binary neutron stars. *Physical Review D*, 72/082001. Retrieved: <https://arxiv.org/abs/gr-qc/0505041>
- LIGO Scientific Collaboration, Abbott B, et al. (2005b) Search for gravitational waves from binary black hole inspirals in LIGO data. *Physical Review D*, 73/062001:10. Retrieved: <https://arxiv.org/abs/gr-qc/0509129>
- LIGO Scientific Collaboration and Virgo Collaboration, Abbott BP, et al. (2016) Observation of Gravitational Waves from Binary Black Hole Merger. *Physical Review Letters*. 116, 061102. Retrieved: <https://journals.aps.org/prl/pdf/10.1103/PhysRevLett.116.061102>
- LIGO Scientific Collaboration and Virgo Collaboration, Abbott BP, et al. (2016b) Tests of General Relativity with GW150914. *Phys. Rev. Lett.* 116, 221101. P.8. Retrieved: <https://arxiv.org/abs/1602.03841>
- LIGO Scientific Collaboration and Virgo Collaboration, Abbott BP, Abbott R, Abbott TD, Acernese F, Ackley K, Adams C, et al. (2017) GW170817: Observation of Gravitational Waves from a Binary Neutron Star Inspiral. *Physical Review Letters* 119/16:161101. <https://doi.org/10.1103/PhysRevLett.119.161101>.
- Main IG (1993) *Vibrations and Waves in Physics*. Cambridge University Press, UK. Retrieved: [https://books.google.fr/books/about/Vibrations\\_and\\_Waves\\_in\\_Physics.html?id=4Z719sLSgbIC&redir\\_esc=y](https://books.google.fr/books/about/Vibrations_and_Waves_in_Physics.html?id=4Z719sLSgbIC&redir_esc=y)
- Malet A (1990) Gregoire, Descartes, Kepler and the law of refraction. *Archives Internationales d’Histoire des Sciences* 40:278–304.
- Mapelli M (2012) *Lectures on Collisional Dynamics*. Lecture 3: Binaries and 3-Body Encounters. Osservatorio Astronomico di Padova, Padova, Italy. Retrieved: <http://web.pd.astro.it/mapelli/collodyn3.pdf>
- Misner CW, Thorne KS, Wheeler JA (1973) *GRAVITATION*. W. H. Freeman and Company, San Francisco, USA.

- Mohon L (2018) GRB 150101B: A Distant Cousin to GW170817. NASA. [http://www.nasa.gov/mission\\_pages/chandra/images/grb-150101b-a-distant-cousin-to-gw170817.html](http://www.nasa.gov/mission_pages/chandra/images/grb-150101b-a-distant-cousin-to-gw170817.html).
- Nørgaard MW (2017) Gravitational Waves in Special and General Relativity. Bachelor Project, Aarhus University, Denmark.
- Owens JC (1967) Optical Refractive Index of Air: Dependence on Pressure, Temperature, and Composition, *Applied Optics*, Washington DC, USA, 6/1:51–58. Retrieved: <https://pdfs.semanticscholar.org/ee25/a6fee957533194bb2f06b3832cf418dfd5f6.pdf>
- Pedrotti FL, Pedrotti LM, Pedrotti LS (2017) *Introduction to Optics*. Cambridge University Press, UK. Retrieved: <https://books.google.fr/books?hl=fr&lr=&id=WHhTDwAAQBAJ&oi>
- Pettini M (2013) Binary stars and Type Ia Supernovae. Lecture, Cambridge University, UK. Retrieved: <https://www.ast.cam.ac.uk/~pettini/STARS/Lecture18.pdf>
- Penrose R (1997) *The Large, the Small and the Human Mind*. Cambridge University Press.
- Penrose R (2013) *Les Cycles du temps: Une nouvelle vision de l'Univers*. Translated in French, Odile Jacob, Paris. ISBN 978273129147.
- Postnov KA, Yungelson LR (2014) The Evolution of Compact Binary Star Systems. Springer International Publishing. *Living Rev. Relativ.* 17:3. Retrieved: <https://doi.org/10.12942/lrr-2014-3>
- Ross CD (2000) Blending History with Physics: Acoustic Refraction. Chemistry and Physics Faculty Publications, Longwood College, Farmville, VA, USA. Paper 26. Retrieved: [https://digitalcommons.longwood.edu/cgi/viewcontent.cgi?article=1028&context=chemphys\\_facpubs](https://digitalcommons.longwood.edu/cgi/viewcontent.cgi?article=1028&context=chemphys_facpubs)
- Ross DA (1995) *Introduction to Oceanography*. New York, NY: HarperCollins. pp. 236-242.
- Rubenzahl R (2017) Gravitational Wave Radiation by Binary Black Holes. PHY 413 Final Paper. Retrieved: [http://www.pas.rochester.edu/~rrubenza/projects/RR\\_PHY413\\_GW\\_Paper.pdf](http://www.pas.rochester.edu/~rrubenza/projects/RR_PHY413_GW_Paper.pdf)
- Sathyaprakash BS, Schutz BF (2009) Physics, Astrophysics and Cosmology with Gravitational Waves. *Living Reviews in Relativity*, 12/1 ISSN 1433-8351. <https://doi.org/10.12942/lrr-2009-2>.
- Shoemaker DH, Nary Man C, Vinet J-Y (2016) Detecting Gravitational Waves: Theory, Experiments and Results. In: *Ondes Gravitationnelles, Séminaire Poincaré XXII* (2016) 5.1/53 – 80.
- Smoot GF (2003) P139 - Relativity Problem Set 12: GRAVITATIONAL WAVES. University of California, Berkeley, USA. Retrieved: <http://aether.lbl.gov/www/classes/p139/homework/hw12.pdf>
- Sormani C (2017) A Two-Part Feature: The Mathematics of Gravitational Waves. *Notices of the American Mathematical Society* 64/07:684-85. Retrieved: <https://doi.org/10.1090/noti1551>.
- Tanvir NR, Levan AJ, Fruchter AS, Hjorth J, Hounsell RA, Wiersema K, Tunnicliffe RL (2013) A “killonova” associated with the short-duration  $\gamma$ -ray burst GRB130603B. *Nature* 500, 7464:547-549. Retrieved: <https://arxiv.org/abs/1306.4971>
- Troja E, Ryan G, Piro L, Van Eerten H, Cenko SB, Yoon Y, Lee S-K, et al. (2018) A Luminous Blue Kilonova and an Off-Axis Jet from a Compact Binary Merger at  $z = 0.1341$ . *Nature Communications* 9/1:4089. Retrieved: <https://doi.org/10.1038/s41467-018-06558-7>
- Vokos S, Shaffer PS, Ambrose BS, McDermott LC (2000) Student understanding of the wave nature of matter: Diffraction and interference of particles. *American Journal of Physics* 68(7). DOI: 10.1119/1.19519 Retrieved: <https://pdfs.semanticscholar.org/e426/8af256d8dd5ec7633175907fd319f666194.pdf>
- Wahlén E (2011) *An Introduction to Nonlinear Waves*. Lecture Notes, Lund University. Retrieved: [http://www.maths.lth.se/media/MATM24/2011MATM24\\_ht11/manuscript.pdf](http://www.maths.lth.se/media/MATM24/2011MATM24_ht11/manuscript.pdf)

- Walker J, Halliday D, Resnick R (2011) Fundamentals of physics. Hoboken, NJ, Wiley. Retrieved:  
<https://archive.org/details/FundamentalsOfPhysicsHallidayResnickWalker/page/n3>.
- Wang WC (2009) Electromagnetic Wave Theory. Course, Departement of Mechanical Engineering, University of Washington. Retrieved:  
<http://depts.washington.edu/mictech/optics/me557/week2.pdf>
- Wildon Carr H, Nunn TP, Whitehead AN, Wrinch D (1921-1922) Discussion: The Idealistic Interpretation of Einstein's Theory. Proceedings of the Aristotelian Society. Oxford University Press, UK. 22:123-138. Retrieved:  
<https://www.jstor.org/stable/4544017>

## Web References

- « All in the Family: Kin of Gravitational Wave Source Discovered ». EurekAlert! Retrieved December 15, 2018. [https://www.eurekalert.org/pub\\_releases/2018-10/uom-ait101518.php](https://www.eurekalert.org/pub_releases/2018-10/uom-ait101518.php)
- [https://www.ligo.caltech.edu/system/media\\_files/binaries/301/original/detection-science-summary.pdf?1455157973](https://www.ligo.caltech.edu/system/media_files/binaries/301/original/detection-science-summary.pdf?1455157973)
- information@eso.org – « Hubble Observes Source of Gravitational Waves for the First Time ». www.spacetelescope.org. Retrieved: December 15, 2018. <https://www.spacetelescope.org/news/heic1717/>
- Press release. NobelPrize.org. Nobel Media AB 2018. Fri. 21 Dec 2018. <<https://www.nobelprize.org/prizes/physics/1993/press-release/>> « The Nobel Prize in Physics 1993 ». Retrieved: December 15, 2018

## Selected Additional References on the Subjects – Non-Cited in the Above Running Text

- Aiton E J (1977) Kepler and the “Mysterium Cosmographicum”. *Sudhoffs Archive* 61/2:73–194.
- Aristotle (1801) *The metaphysics of Aristotle*, Translated from the Greek; with Copious Notes in which the Pythagoric and Platonic dogmas respecting numbers and ideas are unfolded from ancient sources. Thomas Taylor (ed.). Davis–Wilks–Taylor, Chancery–Lane, London.
- Aristotle (1999) *Physics*. Translation by Waterfield R. The Oxford University Press, Oxford.
- Baigre BB (1990) The justification of Kepler’s ellipse. *Studies in History and Philosophy of Science* 21/4:633–664.
- Barbin E, Pisano R 2013 (eds.) *The Dialectic Relation between Physics and Mathematics in the XIXth Century*. Springer, Dordrecht.
- Barker P, Goldstein BR (1994) Distances and velocity in Kepler’s astronomy. *Annals of Science* 51:59–73.
- Barker P, Goldstein BR (2001) *Theological Foundations of Kepler’s Astronomy*. *Osiris* 16:88–113.
- Beer A, Beer P (1975) (eds.) *Kepler. Four Hundred Years, Vistas in Astronomy 18*. The Pergamon Press, Oxford.
- Bialas V (2003) *Keplers Vorarbeiten zu seiner Weltharmonik*. In Pichler 2003, pp. 1–14.
- Blum J, Helmchen W (1987) Von Kepler zu Newton. Von den Planetenbahnen zum Gravitationsgesetz. *Praxis Mathematica* 29/4:193–199.
- Boner P (2006) Kepler’s Living Cosmology. Bridging the Celestial and Terrestrial Realms. *Centaurus* 48/1:32–39.
- Boner P (2008) Life in the Liquid Fields. Kepler, Tycho and Gilbert on the Nature of Heavens and Earth. *History of Science* 46/3:275–297.
- Boner P (2009) A Tenuous Tandem: Patrizi and Kepler on the Origins of Stars. *Journal for the History of Astronomy* 40/4:381–391.
- Boner P (2011) Kepler’s Imprecise Astrology. In Mehl 2011, pp. 115–132.
- Boner P (2013) *Kepler’s Cosmological Synthesis: Astrology, Mechanism and the Soul*. Brill, Boston.
- Bruhn S (2005) *The musical Order of the World: Kepler, Hesse, Hindemith*. Hillsdale, New York.
- Buridan J (1509) *Acutissimi philosophi reverendi magistri Johannis Buridani subtilissime questiones super octo phisicorum libros Aristotelis diligenter recognite & revise a magistro Johanne Dullaert de Gandavo antea nusquam impresse*.
- Bussotti P (2011) The circulation of Kepler’s cosmological ideas in Italy during Kepler’s lifetime. In Mehl 2011, pp. 197–217.
- Bussotti P (2015) *The Complex Itinerary of Leibniz’s Planetary Theory*. Springer-Birkhäuser, Basel.
- Bussotti P, Pisano R (2013a) On the Conceptual Frames in René Descartes’ Physical Works. *Advances in Historical Studies* 2/3:106–125.
- Bussotti P, Pisano R (2014a) Newton’s *Philosophiae Naturalis Principia Mathematica* “Jesuit” Edition: The Tenor of a Huge Work. *Accademia Nazionale Lincei-Rendiconti Matematica e Applicazioni* 25/4:413–444.
- Bussotti P, Pisano R (2014b) On the Jesuit Edition of Newton’s *Principia*. *Science and Advanced Researches in the Western Civilization*. In Pisano 2014 3/1:33–55.
- Carnot L (1786) *Essai sur les machines en général*. Defay, Dijon.
- Caspar M ([1948] 1962) *Kepler*. Collier, New York.
- Cohen FH (1994) *The Scientific Revolution: A Historiographical Inquiry*. The University of Chicago Press, Chicago.
- Cohen FH (2011) *How Modern Science Came into the World: Four Civilizations, One Seventeenth-Century Breakthrough*. The University of Amsterdam Press, Amsterdam.

- Crombie AC (1963) (ed.) *Scientific change: historical studies in the intellectual, social and technical conditions for scientific discovery and technical invention, from antiquity to the present*—Symposium on the history of science, University of Oxford, 9–15 July 1961. Heinemann education books, London.
- Davis AEL (1981) *A Mathematical Elucidation of the Bases of Kepler’s Laws*. The University Microfilms International, Ann Arbor—Mi.
- Davis AEL (1992a) Kepler’s Resolution of Individual Planetary Motion. *Centaurus* 35/2:97–102.
- Davis AEL (1992b) Kepler’s “Distance Law”—Myth, not Reality. *Centaurus* 35/2:103–120.
- Davis AEL (1992c) Grading the Egg (Kepler’s Sizing—Procedure for the Planetary Orbit). *Centaurus* 35/2:121–142.
- Davis AEL (1992d) Kepler’s Road to Damascus. *Centaurus* 35/2:143–164.
- Davis AEL (1992e) Kepler’s Physical Framework for Planetary Motion. *Centaurus* 35/2:165–191.
- Davis AEL (2003) The Mathematics of the Area Law: Kepler’s successful proof in *Epitome Astronomiae Copernicanae* (1621). *Archive for History of Exact Sciences* 57/5:355–393.
- Davis AEL (2007) Some plane geometry from a cone: the focal distance of an ellipse at a glance. *The Mathematical Gazette* 91/521:235–245, 520–522.
- De Gandt F (1995) *Force and geometry in Newton’s principia*. The Princeton University Press, Princeton—New Jersey.
- Delambre JB ([1817], 1965) *Histoire de l’astronomie ancienne*. Johnson Reprint Corporation, New York and London.
- Delambre JB ([1819], 1965) *Histoire de l’astronomie du Moyen Âge*. Johnson Reprint Corporation, New York and London.
- Delambre JB ([1821], 1969) *Histoire de l’astronomie moderne*. Johnson Reprint Corporation, New York and London.
- Dhombres J (1978) *Nombre, mesure et continu : épistémologie et histoire*. Cedic—Nathan, Paris.
- Dhombres J (2013) *Pierre—Simon de Laplace (1749–1827). Le parcours d’un savant*. Hermann, Paris.
- Dijksterhuis EJ ([1950], 1961) *The Mechanization of the World Picture*. The Oxford University Press, Oxford.
- Donahue WH (1981) *The dissolution of celestial spheres 1595–1650*. Arno Press, New York.
- Donahue WH (1993) Kepler’s first thoughts on oval orbits: text, translation and commentary. *Journal for the History of Astronomy* 24/1–2:71–100.
- Donahue WH (1994) Kepler’s invention of the second planetary law. *British Journal for the History of Science* 27/92–1:89–102.
- Donahue WH (1996) Kepler’s approach to the oval of 1602, from the Mars notebook. *Journal for the History of Astronomy* 27/4:281–295.
- Dreyer JLE ([1906], 1953) *History of planetary systems from Tales to Kepler*. Dover, New York.
- Elena A (1983) On the different kinds of attractive forces in Kepler. *Archive Internationales d’Histoire des Sciences* 33:22–29.
- Escobar JM (2008) Kepler’s Theory of the Soul: A Study on Epistemology. *Studies in History and Philosophy of Science* 39:15–41.
- Fabbi N (2009) *Cosmologia e armonia in Kepler e Mersenne. Contrappunto a due voci sul tema dell’Harmonice Mundi*. Olschki, Firenze.
- Feynman R (1970) *The Feynman Lectures on Physics Vol II: Mainly electromagnetism and matter*, Addison-Wesley, Boston, USA, Chapter 1-2. Available online: [http://www.feynmanlectures.caltech.edu/II\\_toc.html](http://www.feynmanlectures.caltech.edu/II_toc.html)
- Field J (1979) Kepler’s rejection of solid celestial spheres. *Vistas in Astronomy* 23/3:207–211.
- Field J (1988) *Kepler’s geometrical cosmology*. The Chicago University Press, Chicago.

- Field J (2009) Kepler's Harmony of the World. In Kremer R, Włodarczyk J (eds.), Johannes Kepler. From Tübingen to Zagan. Institute for the History of Science–The Polish Academy of Sciences–The Copernicus Centre for the Interdisciplinary Studies. Instytut Historii Nauki PAN, Warszawa, pp. 11-28.
- Gaukroger S, Schuster J, Sutton J (2000) (eds.) Descartes' natural philosophy. Routledge, London and New York.
- Gilbert G (1600) De magnete, magneticisque corporibus, et de magno magnete tellure Physiologia nova, plurimis et argumentis et experimentis demonstrata. Petrus Shout, London.
- Gillispie CC, Pisano R (2014) Lazare and Sadi Carnot. A Scientific and Filial Relationship. 2<sup>nd</sup> ed. Springer, Dordrecht.
- Gingerich O (1975) Kepler's place in astronomy. In Beer and Beer 1975, pp. 261–275.
- Gingerich O (2011) Kepler's Trinitarian cosmology. *Science and Theology* 9/1:45-51.
- Goldbeck E (1896) Keplers Lehre von der Gravitation. Olms, Hildesheim–New York.
- Granada MA (2009) Novelties in the Heavens between 1572 and 1604 and Kepler's Unified View of Nature. *Journal for the History of Astronomy* 40/4:393-402.
- Granada MA (2010) "A quo moventur planetae?". Kepler et la question de l'agent du mouvement planétaire après la disparition des orbres solides. *Galilaeana VII*:111–141.
- Grössing H (2003) Astrologie bei Johannes Kepler, Georg von Feuerbach und Johannes Regiomontanus. In Pichler 2003, pp. 63-68.
- Grössing H (2005) Gedanken zu Keplers Astrologie. In Boockmann F, Di Liscia D, Kothmann H (eds.), *Miscellanea Kepleriana. Festschrift für Volker Bialas zum 65. Geburtstag*. Rauner, Augsburg, pp. 175-182.
- Guerlac H (1963) Some historical assumptions of the history of science. In Crombie 1963, pp. 797–817.
- Guidi Itokazu A (2006) A Força que Move os Planetas: Da Noção de Species Immateriata na Astronomia de Johannes Kepler. *CHPC* 3/16/2:211-231. Retrieved: <http://www.cle.unicamp.br/cadernos/pdf/AnastasiaGuidiItokazu.pdf>.
- Guidi Itokazu A (2007) Da Potência Motriz Solar Kepleriana como Emissão Imaterial. *CHPC* 3/17/2:303-324. Retrieved: <http://www.cle.unicamp.br/cadernos/pdf/%288%29Anastasia%20Guidi.pdf>.
- Haase R (1998) Johannes Keplers Weltharmonik. Der Mensch im Geflecht von Musik, Mathematik und Astronomie. Eugen Diederichs, München.
- Heinzmann G (2009) Some Coloured Remarks on the foundations of Mathematics in the 20th Century. In Rahman, Symons, Gabbay and van Bendegem 2009, pp. 41–50.
- Holton G (1956) Johannes Kepler's universe: its physics and metaphysics. *The American Journal of Physics* 24/5:340–351.
- Hoyer U (1979) Kepler's celestial mechanics. *Vistas in Astronomy* 23/1:69–74.
- Ihmig KN (1990) Trägheit und Massebegriff bei Johannes Kepler. *Philosophia Naturalis* 27/2:156–205.
- Jaballah HD (1999) La formation du concept de force dans la physique moderne. Vol. II. Contribution à une épistémologie historique. Alpha Edition, Tunis.
- Jahnke HN (ed) (2003) A history of analysis. Proceedings of the American Mathematical Society and The London Mathematical Society, London.
- Jammer M (1957) Concept of Force: a Study in the Foundations of Dynamics. The Harvard University Press, Cambridge–Ma.
- Jardine N (1984) The birth of history and philosophy of science: Kepler's A Defense of Tycho against Ursus, with essays on its provenance and significance. The Cambridge University Press, Cambridge.
- Jardine N (2000) Koyré's Kepler/Kepler's Koyré. *History of Science* 38/4:363-376.
- Juste D (2010) Musical Theory and Astrological Foundations. In Wuidar L (ed.), *Kepler: The Making of the New Aspects. Music and Esotericism*. Brill, Leiden, pp. 177-195.
- Kepler J ([1606] 1859) De stella nova in pede Serpentarii [Prague, Ex Officina calcographica Pauli Sessii]. *Opera Omnia*. Vol. II, Frankofurti et Erlangae [see also: KGW, I, pp. 147-292].
- Kepler J (1596) Prodomus dissertationum cosmographicarum seu mysterium cosmographicum. In KGW, I.

- Kepler J (1609) *Astronomia Nova AITIOΛOΓETOS seu phisica coelestis tradita de commentariis de motibus stellae Martis ex observationibus G. V. Tychonis Brahe*. In KGW, III.
- Kepler J (1618–1621) *Epitome astronomiae copernicanae*. In KGW, VII.
- Kepler J (1621) *Mysterium Cosmographicum (editio altera)*. In KGW, VIII.
- Kepler J (1624) *Chilias logarithmorum ad totidem numeros rotundus, praemissa demonstratione legitima ortus logarithmorum eorumque usus*. In KGW, IX, pp. 275–352.
- Kepler J (1625) *Supplementum chiliadis logarithmorum, continens praecepta de eorum usu*. In KGW, IX, pp. 353–426.
- Kepler J (1981) *Mysterium Cosmographicum (The Secret of the Universe)*. Abaris Book, New York.
- Kepler J (1992) *New Astronomy*. Translation of *Astronomia Nova* by William H. Donahue. The Cambridge University Press, Cambridge.
- Kepler J (1993) *Le Secret du monde*. Gallimard, Paris.
- Kepler J (2010) *Kurze Darstellung der kopernikanischen Astronomie*. Nachwort von Eberhard Knobloch. Deutsche, Übersetzung von Eberhard Knobloch und Otto und Eva Schönberger. Königshausen & Neumann. Würzburg.
- KGW Kepler J (1937–2012) *Johannes Kepler, Gesammelte Werke*. Van Dyck W, Caspar M. et al. (eds.). Revised April 2013. 10 Vols. Deutsche Forschungsgemeinschaft und Bayerische Akademie der Wissenschaften. Beck'sche Verlagsbuchhandlung, München.
- Knobloch E (1997) *Die gesamte Philosophie ist eine Neuerung in alter Unkenntnis. Johannes Keplers Neuorientierung der Astronomie um 1600*. *Berichte zur Wissenschaftsgeschichte* 20/2–3:135–146.
- Knobloch E (2012) *La rivoluzione scientifica. I protagonisti: Johannes Kepler*. Enciclopedia Treccani. Istituto della Enciclopedia Italiana, Roma, Capitolo XXVII.
- Koyré A (1957) *From the Closed World to the Infinite Universe*. The Johns Hopkins University Press, Baltimore.
- Koyré A (1961a) *Du monde de « à-peu-près » à l'univers de la précision*. M Leclerc et Cie–Armand Colin Librairie, Paris (*Id.*, *Les philosophes et la machine. Du monde de l'« à-peu-près » à l'univers de la précision. Études d'histoire de la pensée philosophique*).
- Koyré A (1961b) *Message d'Alexandre Koyré à l'occasion du centenaire de la naissance d'Émile Meyerson*. *Bulletin de la Société française de philosophie* 53:115–s.
- Koyré A (1961c) *La révolution astronomique: Copernic, Kepler, Borelli*. Hermann, Paris.
- Koyré A (1963) *Scientific Change*. In Crombie 1963, pp. 847–857.
- Koyré A (1966) *Études galiléennes*. Hermann, Paris.
- Koyré A (1971) *Études d'Histoire de la pensée philosophique*. Gallimard, Paris.
- Koyré A (1973) *Études d'histoire de la pensée scientifique*. Gallimard, Paris.
- Koyré A (1986) *De la mystique à la science. Cours, conférences et documents 1922–1962*. In Redondi P (ed.). *Cours, conférences et documents 1922–1962*. EHESS Éditions, Paris.
- Koyré A (1965) *Newtonian Studies*. The Harvard University Press, Cambridge–MA.
- Krafft F (1975) *Nicolaus Copernicus and Johannes Kepler: New Astronomy from old Astronomy*. In Beer and Beer 1975, pp. 287–306.
- Krafft F (1991) *The New Celestial Physics of Johannes Kepler*. In Unguru 1991, pp. 185–227.
- Kragh H (1991) *Cosmonumerology and empiricism*. *Astronomy Quarterly* 8:109–126.
- Kragh H (2008) *The Moon that Wasn't*. Birkhäuser Verlag, Basel.
- Lindberg DC (1986) *The Genesis of Kepler's Theory of Light: Light Metaphysics from Plotinus to Kepler*. *Osiris* 2<sup>nd</sup> ser.:25–42.
- Malet A (1990) *Gregoire, Descartes, Kepler and the law of refraction*. *Archives Internationales d'Histoire des Sciences* 40:278–304.
- Martens R (2000) *Kepler's Philosophy and the New Astronomy*. The Princeton University Press, Princeton–New Jersey.
- Mehl E (2011) (ed) *Kepler. La Physique celeste. Autour de l'Astronomia Nova*. Les Belles Lettres, Paris.

- Menschl E (2003) Die Faszination der Harmonie - Pythagoras und Kepler. In Pichler 2003 (ed.), pp. 127-139.
- Mittelstrass J (1972) Methodological Elements of Keplerian Astronomy. *Studies in History and Philosophy of Science* 3:203–232.
- Musgrave A (1999) *Essays on Realism and Rationalism*. Rodopi, Amsterdam–Atlanta.
- Nagel E (1961) *The Structure of Science: Problems in the Logic of Scientific Explanation*. Harcourt–Brace & World Inc., New York.
- Naylor RH (1976) Galileo: the Search for the Parabolic Trajectory. *Annals of Science* 33:153–172.
- Newton I ([1713], 1729) *The Mathematical principles of natural philosophy*. Translated by Motte Andrew. Motte B, London.
- Newton I ([1726; 1739–1742], 1822), *Philosophiae Naturalis Mathematica Principia*, auctore Isaaco Newtono, Eq. Aurato, perpetuis commentariis illustrata, communi studio Pp. Thomae Le Seur et Francisci Jacquier ex Gallicana minimorum familia, matheseos professorum. Editio nova (in three volumes). Duncan, Glasgow.
- Newton I (1687) *Philosophiae Naturalis Principia Mathematica*. Imprimatur S. Pepys, Reg. Soc. Preses. Julii 5. 1686. Londini, Jussi Societatus Regiae ac Typis Josephi Streater. Prostat apud plures Bibliopolas. Anno MDCLXXXVII.
- Petroni AM (1989) I modelli, l'invenzione e la conferma. Franco Angeli, Milano.
- Peurbach G (1473) *Theoricæ novæ planetarum, id est septem errantium siderum nec non octavi seu firmamenti*. Nürnberg.
- Pichler F (2003) (ed.). *Der Harmoniegedanke Gestern und Heute*. Peurbach Symposium 2002. Trauner, Linz.
- Pisano R (2008) A history of chemistry à la Koyré? Introduction and setting of an epistemological problem. *Khimiya* 2/17:143–161.
- Pisano R (2009) On method in Galileo Galilei' mechanics. In Hunger H (ed.), *Proceedings of 3<sup>rd</sup> Congress of the European Society for the History of Science*. The Austrian Academy of Science, Vienna, pp. 174–186.
- Pisano R (2011) Physics–Mathematics Relationship. Historical and Epistemological notes. In Barbin E, Kronfellner M and Tzanakis C (eds.), *Proceedings of the ESU 6 European Summer University History And Epistemology in Mathematics*. Verlag Holzhausen GmbH–Holzhausen Publishing Ltd., Vienna, pp. 457–472.
- Pisano R (2013a) History Reflections on Physics Mathematics Relationship in Electromagnetic Theory. In Barbin and Pisano 2013, pp. 31–58.
- Pisano R (2014) (ed.) *Isaac Newton and his Scientific Heritage: New Studies in the History and Historical Epistemology of Science*. Special Issue. *Advances in Historical Studies* 3/3.
- Pisano R (2016a) What kind of Mathematics in Leonardo da Vinci and Luca Pacioli? *Bulletin–British Society for the History of Mathematics* 31:104-111.
- Pisano R (2016b) A Development of the Principle of Virtual Laws and its Framework in Lazare Carnot's Mechanics as Manifest Relationship between Physics and Mathematics. *Transversal–International Journal for Historiography of Science*, 2:166-203.
- Pisano R, Bussotti P (2012) Galileo and Kepler: On Theoremata Circa Centrum Gravitatis Solidorum and Mysterium Cosmographicum. *History Research* 2/2:110–145.
- Pisano R, Bussotti P (2013) Notes on the Concept of Force in Kepler. In Pisano, Capecchi and Lukešová 2013, pp. 337–344.
- Pisano R, Bussotti P (2014a) Galileo in Padua: architecture, fortifications, mathematics and “practical” science. *Lettera Matematica Pristem International* 2/4:209–221.
- Pisano R, Bussotti P (2014b). Historical and Philosophical Reflections on the Culture of Machines around the Renaissance. How Science and Technique Work? *Acta Baltica Historiae et Philosophiae Scientiarum* 2/2:20–42.
- Pisano R, Bussotti P (2015a) Historical and Philosophical Reflections on the Culture of Machines around the Renaissance: Machines, Machineries and Perpetual Motion. *Acta Baltica Historiae et Philosophiae Scientiarum* 3/1:69-87.



- Pisano R, Bussotti P (2015b) Introduction to Exploring Changes in How the Histories of the Exact Sciences from the 18th to through the 20th Century Have Been Written: Interpreting the Dynamics of Change in these Sciences and Interrelations Amongst Them—Past Problems, Future Cures? *Advances in Historical Studies Special Issue* 4/2:65-67.
- Pisano R, Bussotti P (2016) A Newtonian Tale Details on Notes and Proofs in Geneva Edition of Newton's *Principia*. *Bulletin—British Society for the History of Mathematics* 32:1–19.
- Pisano R, Capecchi D (2013) Conceptual and Mathematical Structures of Mechanical Science in the Western Civilization around 18th Century. *Almagest* 4/2:86–121.
- Pisano R, Capecchi D (2015) Tartaglia's science weights. *Mechanics in sixteenth century. Selection from Quesiti et invention diverse: Books VII–VIII*. Dordrecht, Springer.
- Pisano R, Capecchi D, Lukešová A (eds.) (2013) *Physics, Astronomy and Engineering. Critical Problems in the History of Science*. International 32nd Congress for The SISFA—Italian Society of Historians of Physics and Astronomy. The Scientia Socialis UAB & Scientific Methodical Centre Scientia Educologica Press, Šiauliai University, Lithuania.
- Pisano R, Fichant M, Bussotti P, Oliveira ARE (2017) (eds.) *Leibniz and the Dialogue between Sciences, Philosophy and Engineering, 1646-2016*. New Historical and Epistemological Insights. The College Publications, London.
- Pisano R, Gaudiello I (2009a) Continuity and discontinuity. An epistemological inquiry based on the use of categories in history of science. *Organon* 41:245–265.
- Pisano R, Gaudiello I (2009b) On categories and scientific approach in historical discourse. In Hunger H (ed.) *Proceedings of ESHS 3rd conference*. The Austrian Academy of Science, Vienna, pp. 187–197.
- Pulte H, Mandelbrote S (2011) (eds.) *The Reception of Isaac Newton in Europe*. Continuum—Publishing Corporation, London.
- Rabin SJ (1997) Kepler's Attitude toward Pico and the Anti-astrology Polemic. *Renaissance Quarterly* 50/3:750-770.
- Rabin SJ (2005) Was Kepler's species immateriaata substantial? *Journal for the History of Astronomy* 36:49-56.
- Radelet-de Grave P (1996) Entries: Stevin, Kepler, Leibniz, Huygens. *Dictionnaire du patrimoine littéraire européen, Patrimoine Littéraire Européen*. Vol. 8, *Avènement de l'Équilibre européen 1616–1720*. De Boeck Supérieur Bruxelles, p. 18, pp. 745–755, pp. 1020–1027.
- Radelet-de Grave P (2007) Kepler (1571–1630) et Cavalieri (1598–1647) astrologues, ou le logarithme au secours de l'astrologie. In Daelemans F, Elkhadem H (eds.), *Mélanges offerts à Hossam Elkhadem par ses amis et ses élèves*. Archives et Bibliothèques de Belgique, Bruxelles, pp. 297–315k.
- Radelet-de Grave P (2009) Guarini et la structure de l'Univers. *Nexus Network Journal* 11(3):393–414.
- Rahman S, Symons J, Gabbay DM, van Bendegem JP (2009) (eds.) *Logic, Epistemology, and the Unity of Science*. Springer, Dordrecht.
- Scaliger JC (1577) *Julii Caesaris Scaligeri exotericarum exercitationum liber XV de Subtilitate, ad Hieronymum Cardanum. Claudium Marnium et haeredes Ioannis Aubrii, Frankfurt*.
- Schuster JA (2000) Descartes opticien: the construction of the law of refraction and the manufacture of its physical rationales, 1618–1629. In Gaukroger, Schuster and Sutton 2000, pp. 258–312.
- Schuster JA (2013) *Descartes—Agonistes. Physico-mathematics, Method and Corpuscular—Mechanism 1618–1633*. Springer, Dordrecht.
- Schwaetzer H (1997) "Si nulla esset in terra anima". Johannes Keplers Seelenlehre als Grundlage seines Wissenschaftsverständnisses. Ein Beitrag zum vierten Buch der *Harmonice Mundi*. *Studien und Materialien zur Geschichte der Philosophie* 44. Hildesheim, Zürich—New York.
- Shank JB (2008) *The Newton Wars and the Beginning of French Enlightenment*. The University of Chicago Press, Chicago.

- Small R (1804) *An account of the astronomical discoveries of Kepler*. Mawman, London.
- Stephenson B ([1987], 1994) *Kepler's Physical Astronomy*. The Princeton University Press, Princeton–New Jersey.
- Stephenson B (1994) *The Music of the Heavens. Kepler's Harmonic Astronomy*. The Princeton University Press, Princeton–New Jersey.
- Tartaglia N (1537) *La noua scientia de Nicolo Tartaglia: con una gionta al terzo libro, per Stephano Da Sabio, Venetia*.
- Tartaglia N (1554) *La nuova edizione dell'opera Quesiti et inventioni diverse de Nicolo Tartaglia brisciano, Riproduzione in facsimile dell'edizione del 1554 (1959)*. Masotti A (ed.). *Commentari dell'Ateneo di Brescia, Tipografia La Nuova cartografica, Brescia*.
- Treder HJ (1975) *Kepler and the Theory of Gravitation*. In Beer and Beer 1975, pp. 617–619.
- Unguru S (1991) (ed.) *Physics, Cosmology and Astronomy, 1300–1700: Tension and Accommodation. The Boston Studies in the Philosophy of Science. Vol. 126*. Kluwer Academic Publishers, Dordrecht–Boston–London, pp. 101–127.
- Voelkel JR (1999) *Johannes Kepler and the New Astronomy*. The Oxford University Press, Oxford.
- Voltmer U (1998) *Rhythmische Astrologie. Johannes Keplers Prognose-Methode aus neuer Sicht*. Urenia, Neuhausen am Rheinfall.
- Westfall RS (1971) *The Construction of Modern Science. Mechanism and Mechanic*. Wiley & Sons Inc., New York.
- Westman R (2001) *Kepler's Early Physical-astrological Problematic*. *Journal for the History of Astronomy* 32:227-236.



## **PART II**

### **HISTORY OF PHYSICS A HISTORY OF WAVES AND THE CASE OF GRAVITATION**

#### **Early, Late and Current Scientific Accounts**

*An outline.* In this part, I will explore broad outlines of the history of waves and the case of gravitation. In order to understand the history of the discovery of gravitational waves, one must first understand the basis of the theory and how the concepts have developed and evolved over time with each new advancement in the theories or technologies which resulted in paradigms shifts. In particular, I did a historical comparative analysis between Clifford and Poincaré's most remarkable work in regard to the concept of gravitational waves.

I will also make a short account of the History of Cosmology in order to understand how gravitational astronomy opens the way towards a new era in Cosmology, and of course, I will discuss the future of the research of gravitational waves.

## **CHAPTER II**

### **Researching and Inquiring Waves into History**

## Prologue II

As we have now scratched the surface of what gravitational waves are and represent for the future of physics, we know that in order to understand what they actually are, we need to have a respectably deep comprehension of two fundamental concepts: Waves, through the Physics of Waves, and spacetime, through the relativities and the theory of gravitation. These fundamental concepts themselves rely on other concepts that originate more or less further in time. As ancient science itself appeared, the first explanations of nature came along.

Gravitation finds its roots in the study of falling bodies by Galileo Galilei, while the first traceable attempts at explanation date as far back as the pre-Socratic with natural philosophy and the theory of elements and their natural place. In order to understand the concept of spacetime, we first need to have a better understanding of geometry, and especially Euclidean geometry which was developed during Antiquity, as it is the first type of geometry developed (for “flat” spaces), to get a better grasp of more advanced ideas such as curved spaces or non-Euclidean geometries.

Finally, the history of the physics of waves is quite peculiar because of the notion of waves itself. The notion of waves remained unclear for the longest of times as its abstract comprehension and the formalization of a framework to study them was very obscure. In fact, the notion of waves rely upon other notions such as periodicity or vibrations and oscillations the latter two of which were (sort of) thrown into the “violent motion” category of the theory of elements and basically ignored as scholars turned a blind eye to it. The most basic example of waves encountered in everyday life were the waves at the surface of the ocean, the explanation for this phenomenon was simply the action of wind on water and needed no further explanation. Furthermore, the undulatory nature of seismic waves and soundwaves remained unclear even though were also a source of questioning at that time: seismic events were perceived as originating from underground phenomena (Bousquet 2005); and sound was mainly studied through musicology (Baskevitch 2008).

## 2.1 Antiquity

During Antiquity, science was present in a different form. The knowledge was most commonly obtained via everyday observations but also from experiments. As an example, in Aristotle's *Physics* (Aristotle 1999), in order to prove that air is different from a void, one just has to look at clepsydras<sup>33</sup> (Barnes 2002, p. 313). The ancient Greek beliefs and knowledge of the inner workings of Nature and the World revolved around a certain type of pre-Socratic philosophy involving the classical four elements (Plato 1925): Air, Fire, Water and Earth. In this philosophy originating from Empedocles (Wallace 1911, pp. 344-345), everything that exists is composed of these four components. In this context, the diversity of things arises from different proportions of those elements constituting the different objects (*Ibidem*).

In Aristotle's works "*On Generation and Corruption*" and "*On the Heavens*", Aristotle attributed scholastic qualities (Pasnau 2011, pp. 41-61) to each of the four elements (Gerson 1968, pp. 166-169): Air was hot and wet, Fire was hot and dry, Water was cold and wet, and Earth was cold and dry. About this, Pasnau wrote:

The standard Scholastic view was that these qualities are accidents of the elements, and that the elements have some further substantial form, unknown to us, that gives rise to these qualities. Still, the four qualities are explanatorily basic, for it is in virtue of them that the elements function as they do. And since these elements are the building blocks of the natural world—as Thomas Aquinas puts it, they are “the cause of generation and corruption and alteration in all other bodies” (In De gen. et cor. proem., n. 2)—the primary qualities get pride of place in an account of the natural world. (Pasnau 2011, p. 42)

In this belief system, each of these four elements constituted everything that exists and for this reason, everything belonged to natural places in the universe, determined by these elements; and thus possessed an intrinsic predisposition to move towards the natural places of those constituting elements (Brown 2018). Therefore, for example, the explanation of why a rock falls to the ground was given by the assumption that because it was mainly constituted of the Earth element, it *wanted* to move to its natural place, i.e.: the earth. The same kind of logic applied to the other elements, rivers are made of water and thus *wanted* to re-join the sea; air bubbles in water *wanted* to re-join the ambient air above water, in the sky; and fire rose unless prevented as its natural place was celestial. By opposition to these natural motions, all other types of motion were possible but were described as “violent” as it was thought that they required some kind of force. Thus, oscillations and waves fell under the “violent motion” category. (Gerson 1999, pp. 67-71)

---

<sup>33</sup> “Those who attempt to prove that it [sc. the void] does not exist do not refute what men mean by void but only what they erroneously say; e.g., Anaxagoras and those who refute it in that fashion. For they show that the air is something, by twisting wineskins and proving that the air is strong, and by capturing it in clepsydras (290; *Phys* 213a22-7=59 A 68).” (Author's bold and brackets – Barnes 2002, p. 313)

During the third century BC, a treatise regrouping the previous developments of mathematics, “Elements” was published by Euclid (Euclid 300 BC). This work represents the first milestone on which physics and mathematics were based. This geometry was developed empirically, from observations of daily life, experiments, and the study of nature; rigorously formalized with definitions, postulates, common notions and propositions. The fundamental bases laid at that time arose with the Pythagorean Theorem which in modern mathematical language gives a definition for a formula of the distance from the origin in Cartesian coordinates  $x, y, z$  (cfr. Logunov 2005, pp. 5-6):

$$l^2 = x^2 + y^2 + z^2 \quad (2.1)$$

and for infinitesimally close points, the distance in differential form (*Ibidem*):

$$(dl)^2 = (dx)^2 + (dy)^2 + (dz)^2 \quad (2.2)$$

where  $dx, dy, dz$  are the differentials of the Cartesian coordinates.

It is important to note that the square distance  $l^2$  is invariant to transformations of coordinates from a Cartesian coordinate system to another Cartesian system  $(x', y', z')$ :

$$l^2 = x^2 + y^2 + z^2 = x'^2 + y'^2 + z'^2 \quad (2.3)$$

About the invariance of the square distance, Anatoly Alekseyevich Logunov commented:

[...] the square distance  $l^2$  is an invariant, while its projections onto the coordinate axes are not. We especially note this obvious circumstance, since it will further be seen that such a situation also takes place in four-dimensional space-time, so, consequently, depending on the choice of reference system in spacetime the projections onto spatial and time axes will be relative. (*Ibidem*)

Aristotelian physics was the dominant theory of natural philosophy for nearly two millennia, until the likes of Copernicus (1473-1543) and Galileo Galilei (1564-1642) completely refuted it.



## 2.2 Galileo Galilei (1564-1642)

Galileo Galilei was an Italian mathematician, astronomer and natural philosopher –natural philosophy being the study of nature and the Universe before modern science ended up renaming the discipline as physics. Galileo is well-known for being linked to the development of the telescope and its usage for astronomy, but also for his scientific discoveries related to the science of weights, allegedly having dropped masses from the leaning tower of Pisa in order to study the fall of bodies, and his beliefs –and especially his attitude– that ultimately led him to be tried and found guilty of heresy by the Inquisition<sup>34</sup>.

Galileo has been the object of much research (Koyré 1943; Crombie 1961; Drake 1999; Yaglom 2012; Pisano 2009, 2012, 2014a, 2017; Drago 2017) as he represents one of the major figures of Science. However, a comprehensive analysis on Galileo’s work is largely beyond the scope of this thesis; therefore I will just have a look at the major advances relevant to the object of our study.

First of all, the birth of modern science is for the major part due to the birth of the experimental method which allowed Galileo to set “hard experimental facts against the idealistic philosophical tenets of Aristotelian philosophers” (Drago 2017, p. 37), thus allowing us to free ourselves from the erroneous notions it maintained for so long; but in particular giving concrete examples of how to obtain scientific results –in the sense that following a protocol allowed for repeatability and reproducibility of the results.

Secondly, Galileo recognized that there existed a relationship between the real world, experimental results, and mathematics:

Philosophy [read: science] is written in that great book which ever lies before our eyes—I mean the universe—but we cannot understand it if we do not first learn the language and grasp the symbols, in which it is written. This book is written in the mathematical language, and the symbols are triangles, circles and other geometrical figures, without whose help it is impossible to comprehend a single word of it; without which one wanders in vain through a dark labyrinth. [Galilei 1890, vi, 232]<sup>35</sup> (Ivi. p. 41)

From this realisation also came his understanding of the addition of speeds and the apparent non-distinguishability between the perceptions of someone at rest and someone travelling at constant velocity (in uniform constant motion) which he discussed in an example in a dialogical way in his *Dialogue Concerning the Two Chief World Systems* (Cfr. Galileo 1632; 2001); what is now called the *Principle of Galilean relativity* which states that all laws of nature should look the same in all inertial (non-accelerating) reference frames. In fact, this principle represents the –Galilean– view of the invariance of the equations of motions under linear transformations (Fuschchych 1985); namely, the interpretation that the combinations of speeds follow simple additions. i.e.: that for an observer at rest on a beach, a man walking at speed  $v_1$  to the bow of a ship travelling at

<sup>34</sup> Cfr. <https://www.britannica.com/biography/Galileo-Galilei>

<sup>35</sup> Galilei G (1890) *Il Saggiatore* [Galilei 1890-1909, VI, 197-372].

speed  $v_2$  and in the same direction will appear to the observer as if he were travelling at speed  $v_3 = v_1 + v_2$ . While this is apparently true in regards to our everyday experience, we will see in the next chapter (Chapter 3) that this is in fact simply an approximation which is only usable for speeds greatly inferior to the celerity of light.



Source gallica.bnf.fr / Bibliothèque nationale de France

**Fig. 2.2.** Frontispiece. Dialogo di Galileo Galilei linceo matematico sopra i due massimi sistemi del mondo, tolemaico, e copernicano ([Reprod. en fac-sim.]) | Source: <https://gallica.bnf.fr/ark:/12148/bpt6k3353m/f3.image>

Additionally, this simple observation led to the Galilean principle of inertia (Drago 2017, p. 43) which unfortunately was not stated explicitly by Galileo (Drake 1964) but nevertheless later permitted Galileo and his followers to develop the science of dynamics and build upon it; with for example Newton's first law of motion.

## 2.3 Isaac Newton (1643-1727)

Sir Isaac Newton was an English physicist and mathematician and certainly the greatest figure of the 17th century. This extraordinary man made extremely important contributions to many diverse fields e.g. he greatly helped develop infinitesimal calculus with his notion of *fluxion* (Arthur 1995); but is mainly known for his contributions to Physics.

On one hand, he helped to advance the understanding of the physics of waves by showing that white light could be decomposed in the different colours of the rainbow, but also recomposed from them; thus emphasising the wavelike nature of light.

And on the other hand, he formulated the three laws of motion from which he managed to derive the law of universal gravitation.

*On Newton's laws of motion.* In an English translation of Newton's *Principia Mathematica* (cfr. Newton [1729] 1846<sup>36</sup>), which was written in Latin originally, one can read his three laws of motion:

- LAW I. Every body perseveres in its state of rest, or of uniform motion in a right line, unless it is compelled to change that state by forces impressed thereon.
- LAW II. The alteration of motion is ever proportional to the motive force impressed; and is made in the direction of the right line in which that force is impressed.
- LAW III. To every action there is always opposed an equal reaction: or, the mutual actions of two bodies upon each other are always equal and directed to contrary parts (cfr. Newton [1729] 1846, p. 83).

A more modern explanation of the laws of motion can be found on the website of NASA:

Newton's first law states that every object will remain at rest or in uniform motion in a straight line unless compelled to change its state by the action of an external force. This is normally taken as the definition of inertia. The key point here is that if there is no net force acting on an object (if all the external forces cancel each other out) then the object will maintain a constant velocity. If that velocity is zero, then the object remains at rest.

---

<sup>36</sup> Cfr. (Newton [1713] 1729) and Newton ([1726; 1739–1742] 1822).

If an external force is applied, the velocity will change because of the force.

The second law explains how the velocity of an object changes when it is subjected to an external force. The law defines a force to be equal to change in momentum (mass times velocity) per change in time. Newton also developed the calculus of mathematics, and the "changes" expressed in the second law are most accurately defined in differential forms. (Calculus can also be used to determine the velocity and location variations experienced by an object subjected to an external force.) For an object with a constant mass  $m$ , the second law states that the force  $F$  is the product of an object's mass and its acceleration  $a$ :

$$F = m * a$$

For an external applied force, the change in velocity depends on the mass of the object. A force will cause a change in velocity; and likewise, a change in velocity will generate a force. The equation works both ways.

The third law states that for every action (force) in nature there is an equal and opposite reaction. In other words, if object A exerts a force on object B, then object B also exerts an equal force on object A. Notice that the forces are exerted on different objects. The third law can be used to explain the generation of lift by a wing and the production of thrust by a jet engine.<sup>37</sup>

---

<sup>37</sup> Cfr. <https://www.grc.nasa.gov/www/k-12/airplane/newton.html>

## AXIOMS, OR LAWS OF MOTION.

### LAW I.

*Every body perseveres in its state of rest, or of uniform motion in a right line, unless it is compelled to change that state by forces impressed thereon.*

PROJECTILES persevere in their motions, so far as they are not retarded by the resistance of the air, or impelled downwards by the force of gravity. A top, whose parts by their cohesion are perpetually drawn aside from rectilinear motions, does not cease its rotation, otherwise than as it is retarded by the air. The greater bodies of the planets and comets, meeting with less resistance in more free spaces, preserve their motions both progressive and circular for a much longer time.

### LAW II.

*The alteration of motion is ever proportional to the motive force impressed; and is made in the direction of the right line in which that force is impressed.*

If any force generates a motion, a double force will generate double the motion, a triple force triple the motion, whether that force be impressed altogether and at once, or gradually and successively. And this motion (being always directed the same way with the generating force), if the body moved before, is added to or subducted from the former motion, according as they directly conspire with or are directly contrary to each other; or obliquely joined, when they are oblique, so as to produce a new motion compounded from the determination of both.

### LAW III.

*To every action there is always opposed an equal reaction: or the mutual actions of two bodies upon each other are always equal, and directed to contrary parts.*

Whatever draws or presses another is as much drawn or pressed by that other. If you press a stone with your finger, the finger is also pressed by the stone. If a horse draws a stone tied to a rope, the horse (if I may so say) will be equally drawn back towards the stone: for the distended rope, by the same endeavour to relax or unbend itself, will draw the horse as much towards the stone, as it does the stone towards the horse, and will obstruct the progress of the one as much as it advances that of the other.

**Fig. 2.3.** Formulation of Newton's Three Laws of Motions | Source: MATHEMATICAL PRINCIPLES OF NATURAL PHILOSOPHY, BY SIR ISAAC NEWTON; TRANSLATED INTO ENGLISH BY ANDREW MOTTE. TO WHICH IS ADDED NEWTON'S SYSTEM OF THE WORLD; With a Portrait taken from the Bust in the Royal Observatory at Greenwich. FIRST AMERICAN EDITION, CAREFULLY REVISED AND CORRECTED, WITH A LIFE OF THE AUTHOR, BY N. W. CHITTENDEN, M. A., &c. NEW-YORK PUBLISHED BY DANIEL ADEE, 45 LIBERTY STREET. (Author's Capital letters)

Newton's law of Universal gravitation in its modern form:

$$F = F_{A/B} = F_{B/A} = G \frac{m_a m_b}{r^2} \quad (2.4)$$

states that  $F$ , the force of gravity between two objects is the same for each of them; namely that the force exerted by an object  $A$  of mass  $m_a$  on an object  $B$  of mass  $m_b$  is the same as the force exerted by  $B$  on  $A$ :  $F_{A/B} = F_{B/A}$ ; and that this force is proportional to their respective masses, but also to  $G$ , the gravitational constant; and is inversely proportional by the square of the distance  $r$  separating them.

This interpretation of gravity as a force was first published in 1687 and held true for more than two centuries thanks to both its apparent simplicity and precision. Unfortunately for Newton, it turns out that his theory was fundamentally flawed as it relied on incorrect assumptions; namely the existence of an absolute time and space –and therefore of place and motion too.

For instance, Newton attempted to clarify his thoughts on the matter:

#### SCHOLIUM.

Hitherto I have laid down the definitions of such words as are less known, and explained the sense in which I would have them to be understood in the following discourse. I do not define time, space, place and motion, as being well known to all. Only I must observe, that the vulgar conceive those quantities under no other notions but from the relation they bear to sensible objects. And thence arise certain prejudices, for the removing of which, it will be convenient to distinguish them into absolute and relative, true and apparent, mathematical and common. I. Absolute, true, and mathematical time, of itself, and from its own nature flows equably without regard to anything external, and by another name is called duration: relative, apparent, and common time, is some sensible and external (whether accurate or unequal) measure of duration by the means of motion, which is commonly used instead of true time ; such as an hour, a day, a month, a year.

II. Absolute space, in its own nature, without regard to anything external, remains always similar and immovable. Relative space is some movable dimension or measure of the absolute spaces; which our senses determine by its position to bodies; and which is vulgarly taken for immovable space; such is the dimension of a subterraneous, an æreal, or celestial space, determined by its position in respect of the earth. Absolute and relative space, are the same in figure and magnitude; but they do not remain always numerically the same. For if the earth, for instance, moves, a space of our air, which relatively and in respect of the earth remains always the same, will at one time be one part of the absolute space into which the air passes ; at another time it will be another part of the same, and so, absolutely understood, it will be perpetually mutable. (Newton [1729] 1846, pp. 77-78)

Therefore, with this passage, we can clearly see that for Newton the notions of *time* and *space* are independent of the objects or observers and really do possess an external quality.

He then further explained the difference between the common notion of time and his ontological view that there exists a *true mathematical time* the progress of which is exactly the same from one moment to the next:

Absolute time, in astronomy, is distinguished from relative, by the equation or correction of the vulgar time. For the natural days are truly unequal, though they are commonly considered as equal, and used for a measure of time ; astronomers correct this inequality for their more accurate deducing of the celestial motions. It may be, that there is no such thing as an equable motion, whereby time may be accurately measured. All motions may be accelerated and retarded; but the true, or equable, progress of absolute time is liable to no change. The duration or perseverance of the existence of things remains the same, whether the motions are swift or slow, or none at all : and therefore it ought to be distinguished from what are only sensible measures thereof ; and out of which we collect it, by means of the astronomical equation. (Newton [1729] 1846, p. 78-79)

At the beginning of Book III, Newton formulated what he called “Rules of Reasoning in Philosophy” in which Rule 1 is closely related to a formulation of Occam’s razor, while Rules 2 and 3 are concerned with inference and generalization:

#### RULES OF REASONING IN PHILOSOPHY.

---

##### RULE I.

*We are to admit no more causes of natural things than such as are both true and sufficient to explain their appearances.*

To this purpose the philosophers say that Nature does nothing in vain, and more is in vain when less will serve ; for Nature is pleased with simplicity, and affects not the pomp of superfluous causes.

##### RULE II.

*Therefore to the same natural effects we must, as far as possible, assign the same causes.*

As to respiration in a man and in a beast; the descent of stones in *Europe* and in *America* ; the light of our culinary fire and of the sun ; the reflection of light in the earth, and in the planets.

##### RULE III.

*The qualities of bodies, which admit neither intension nor remission of degrees, and which are found to belong to all bodies within the reach of our experiments, are to be esteemed the universal qualities of all bodies whatsoever.*

For since the qualities of bodies are only known to us by experiments, we are to hold for universal all such as universally agree with experiments ; and such as are not liable to diminution can never be quite taken away. (Ivi. p. 384)

Before using his theory for explanatory purpose, Newton reflected on the empirical evidence at our disposal allowing us to infer characteristics and rules from our perceptions; discussing the justifiability of generalizing the properties of bodies on an universal scale:

That all bodies are impenetrable, we gather not from reason, but from sensation. The bodies which we handle we find impenetrable, and thence conclude impenetrability to be an universal property of all bodies whatsoever. That all bodies are moveable, and endowed with certain powers (which we call the *vires inertias*) of persevering in their

motion, or in their rest, we only infer from the like properties observed in the bodies which we have seen. The extension, hardness, impenetrability, mobility, and *vis inertia* of the whole, result from the extension, hardness, impenetrability, mobility, and *vires inertia* of the parts; and thence we conclude the least particles of all bodies to be also all extended, and hard and impenetrable, and moveable, and endowed with their proper *vires inertia*. And this is the foundation of all philosophy. (Newton [1729] 1846, p. 384-385)

Newton somewhat puts forward what we gather from “sensation” as facts; while we would expect some kind of superiority of *reason* over *sensation*; especially when considering Newton’s ideas about the absoluteness of time for example. However, Newton concludes that in the absence of a contradiction, we must accept the universal nature of the observations; especially when considering that we could not have the reach to proceed to actual experiments in the sky:

Lastly, if it universally appears, by experiments and astronomical observations, that all bodies about the earth gravitate towards the earth, and that in proportion to the quantity of matter which they severally contain ; that the moon likewise, according to the quantity of its matter, gravitates towards the earth; that, on the other hand, our sea gravitates towards the moon ; and all the planets mutually one towards another ; and the comets in like manner towards the sun ; we must, in consequence of this rule, universally allow that all bodies whatsoever are endowed with a principle of mutual gravitation. For the argument from the appearances concludes with more force for the universal gravitation of all bodies than for their impenetrability ; of which, among those in the celestial regions, we have no experiments, nor any manner of observation. (Newton [1729] 1846, p. 385)

It results that by following these rules of reasoning and using his observations and considerations, Newton determined:

PROPOSITION VI. THEOREM VI.

*That all bodies gravitate towards every planet ; and that the weights of bodies towards any the same planet, at equal distances from the centre of the planet, are proportional to the quantities of matter which they severally contain. (Ivi. p. 394)*

and:

PROPOSITION VII. THEOREM VII.

That there is a power of gravity tending to all bodies, proportional to the several quantities of matter which they contain. (Ivi. p. 397)

Newton further explained the mutual attraction between celestial bodies as a result of the universal attraction between all of the matter constituting them:

PROPOSITION VII. THEOREM VII.

That there is a power of gravity tending to all bodies, proportional to the several quantities of matter which they contain. That all the planets mutually gravitate one towards another, we have proved before ; as well as that the force of gravity towards every one of them, considered apart, is reciprocally as the square of the distance of places from the centre of the planet. And thence (by Prop. LXIX, Book I, and its



Corollaries<sup>38</sup>) it follows, that the gravity tending towards all the planets is proportional to the matter which they contain. Moreover, since all the parts of any planet A gravitate towards any other planet B ; and the gravity of every part is to the gravity of the whole as the matter of the part to the matter of the whole ; and (by Law III) to every action corresponds an equal re-action ; therefore the planet B will, on the other hand, gravitate towards all the parts of the planet A ; and its gravity towards any one part will be to the gravity towards the whole as the matter of the part to the matter of the whole. Q.E.D.

COR. 1. Therefore the force of gravity towards any whole planet arises from, and is compounded of, the forces of gravity towards all its parts. (Newton [1729] 1846, p. 397)

but also stated how, therefore, this attractive force changed according to the distance between the centres –of gravity– of the bodies considered:

#### PROPOSITION VIII. THEOREM VIII.

In two spheres mutually gravitating each towards the other, if the matter in places on all sides round about and equi-distant from the centres is similar, the weight of either sphere towards the other will be reciprocally as the square of the distance between their centres. .p. 398)

Despite its success, Newton's theory was also criticized by some of his contemporaries, especially about his conceptions of space and time (Janiak 2019), but also later notably by Ernst Mach (1838-1916) whose participation inspired Albert Einstein's development of his own theory of gravitation rather than, somewhat ironically, the geometrical ideas developed by Bernard Riemann (1826-1866; cfr. Strauss 1968).

---

<sup>38</sup> "Cfr. pp. 216-218."

## 2.4 Bernhard Riemann (1826-1866)

Georg Friedrich Bernhard Riemann was a German mathematician. This great figure of the field of mathematics is very famous in the scientific community for his famous hypothesis, nowadays known as the “Riemann Hypothesis” which, to this day, remains unproven; and for his achievements and works in many different mathematical fields, especially complex analysis, number theory and, probably more relevantly for our matter, differential geometry.

In 1867, after Riemann’s death, Richard Dedekind (1831-1916) published “*Ueber die Hypothesen, welche der Geometrie zu Grunde liegen*” in *Abhandlungen der Königlichen Gesellschaft der Wissenschaften zu Göttingen*, vol. 13 which was translated from German to English by Sir William Kingdon Clifford as “*On the Hypotheses which lie at the Bases of Geometry*” (Clifford 1867, Wilkins 1998). In order to better understand this production, a few keywords might be helpful to clarify:

- *Magnitude* refers to the measurable extent of something such as size, i.e. *dimension*, therefore a “*triplly extended magnitude*” refers to a 3-dimensional space of any sort.
- *Measure-relationship* refers to the relation between mathematical objects, i.e. the mathematical notion of *distance* between points, *angles* between lines or segments, *volumes*, etc.

In this work Riemann started by describing how he built general  $n$ -dimensional spaces from scratch through notions he redefined and stated how this reasoning lead him to the conclusion that physical space is in essence only a particular case of –mathematical 3-dimensional– spaces. For instance, Clifford translated Riemann’s process:

I have in the first place, therefore, set myself the task of constructing the notion of a multiply extended magnitude out of general notions of magnitude. It will follow from this that a multiply extended magnitude is capable of different measure-relations, and consequently that *space is only a particular case of a triply extended magnitude*. (Clifford 1867, p. 14 – emphasis is ours).

Riemann then elaborates on his idea that (physical) space being a particular case, the axioms of geometry laid by Euclid are just hypotheses and not true for all 3-dimensional spaces. In fact, it is up to us to determine with which kind of 3-dimensional space we are working on and if these “traditional” axioms are usable, namely if we are in the particular case of a flat space. Indeed, in Clifford’s translation Riemann stated:

But hence flows as a necessary consequence that *the propositions of geometry cannot be derived from general notions of magnitude*, but that the properties which distinguish space from other conceivable triply extended magnitudes are **only to be deduced by experience**. Thus arises the problem, to discover the simplest matters of fact from which the measure-relations of space may be determined; [...] the most important system for our present purpose being that which Euclid has laid down as

foundation. These matters of fact are – like all matters of fact – not necessary, but only of empirical certainty; *they are hypotheses*. (*Ibidem*)

In a later section of Riemann’s dissertation titled “*On the infinitely great*”, Riemann discussed the different possibilities related to the different kinds of “*space-constructions*” that one can consider and properties – the relevance of this passage will later become obvious to the reader (in the analysis of Clifford’s conceptions for space). Indeed, Riemann stated:

In the extension of space-construction to the infinitely great, we must distinguish between unboundedness and infinite extent [...] That space is an unbounded three-fold manifoldness, is an assumption which is developed by every conception of the outer world; [...] The unboundedness of space possesses in this way a greater empirical certainty than any external experience. But its infinite extent by no means follows from this; on the other hand if we assume independence of bodies from position, and therefore ascribe to space constant curvature, it must necessarily be finite provided this curvature has ever so small a positive value. If we prolong all the geodesics starting in a given surface-element, we should obtain an unbounded surface of constant curvature, i.e., a surface which in a flat manifoldness of three dimensions would take the form of a sphere, and consequently be finite. (*Ivi*, p. 16)

However, these considerations though interesting from an Epistemological point of view (cfr. Rahman 2009) were of a limited interest to Riemann who dismisses them quickly after barely evoking an unlikely impact to keep in mind on practical phenomena if it helps explaining them:

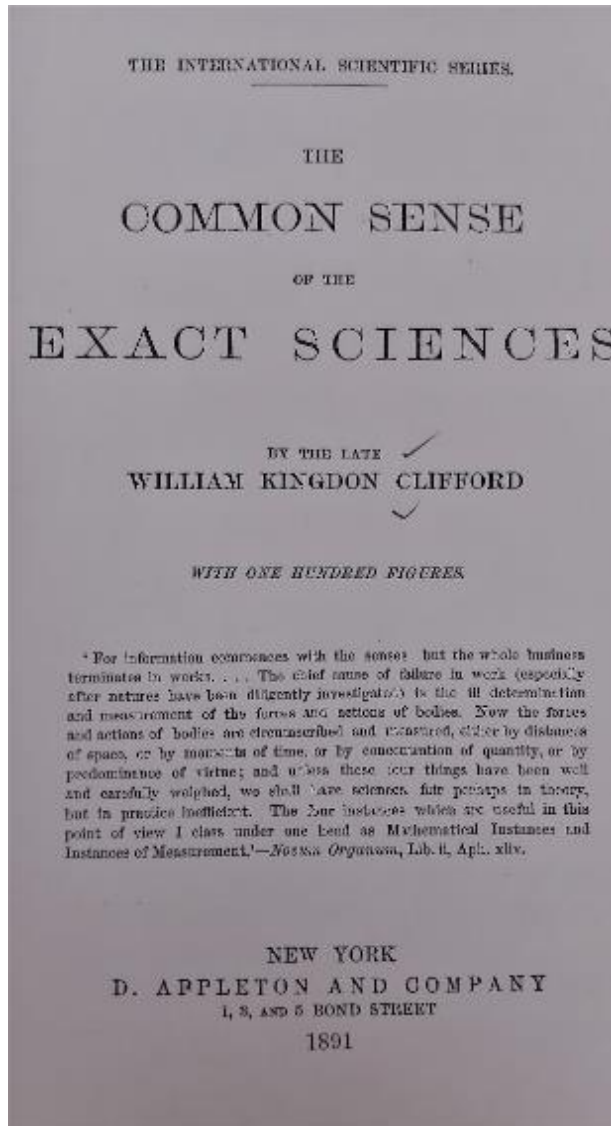
The questions about the infinitely great are for the interpretation of nature useless questions. But this is not the case with the questions about the infinitely small. [...] the infinitely small do not conform to the hypotheses of geometry; and we ought in fact to suppose it, if we can thereby obtain a simpler explanation of phenomena. This leads us into the domain of another science, of physic, into which the object of this work does not allow us to go to-day. (*Ivi*, p. 17)

During this era, it was commonplace for *natural philosophers* and mathematicians alike to consider Geometry as a physical science, and not necessarily purely mathematical (Cfr. Clifford 1901b). Besides the obvious contributions to the field of Geometry and the birth of Differential Geometry, the main interesting idea that we can extract from this work is of an ontological nature. Following from Riemann’s work, Riemann himself explained that according to him space was only a particular case of a triply extended magnitude. This idea of our Physical space being, in a more modern way of putting it, a 3 dimensional space is what inspired and prompted William Kingdon Clifford (1845-1879) to try to develop his later theories.

## 2.5 William Kingdon Clifford (1845-1879)

William Kingdon Clifford was a British mathematician who worked with Bernhard Riemann and was his follower (Cervantes–Cota 2018, p.163). He was born in Starcross near Exeter, Devon, England and died in Madeira, Portugal (*Ivi. p.162*; Encyclopaedia Britannica; Clifford 2007). Clifford was educated at Mr. Templeton's school in Exeter where he won several prizes (Clifford 2007, p. xv). In 1860, being only fifteen years old, he obtained a Mathematical and Classical Scholarship to the Department of General Literature and Science at King's College, London. He then moved to Trinity College, Cambridge where he graduated Second Wrangler (the second highest scoring student in mathematics). After being elected a Fellow of his College in 1868, he participated in the English eclipse expedition of December 1870 that sailed to Sicily and gained the position of Professor of Applied Mathematics and Mechanics in University College, London which he kept until he passed away.

Sir William Kingdon Clifford is well-known for his Mathematical works (Clifford's algebra in Clifford 1873; Oziewicz 1992), his Philosophical and Epistemological contributions with his *The Ethics of Belief* of 1876 (Clifford 1901a) and *The Common Sense of the Exact Sciences* of 1885 (Clifford 1891) but less known for his research in Physics.



**Fig. 2.5.a.** Clifford W.K. (1891) *The Common Sense of the Exact Sciences* by the late William Kingdon Clifford with one hundred figures. The International Scientific Series Volume L., D. Appleton and Company, New York, 1, 3 and 5 Bond Street. Source: Niels Bohr Library, Courtesy of the American Institute of Physics, USA.

Clifford was a geometer and according to him and his conceptions, Geometry was a physical science (Clifford 1901b). Influenced by the work of Riemann (Clifford 1867; Cervantes–Cota 2018, p.163) and Lobachevski<sup>39</sup>

<sup>39</sup> Clifford said: "It is quite simple, merely Euclid without the vicious assumption, but the way things come out of one another is quite lovely.", "What Vesalius was to Galen,

(Lobachevski 1891), Clifford was interested in Riemann’s mathematical-geometrical work and ideas about his theories regarding curved spaces. He translated some of Riemann’s works from German to English, namely “*Ueber die Hypothesen, welche der Geometrie zu Grunde liegen*” (Cfr. Cervantes–Cota and Galindo–Uribarri 2018), as “*On the Hypotheses which lie at the Bases of Geometry*”, which was published posthumously in “*Abhandlungen der Königlichen Gesellschaft der Wissenschaften zu Göttingen*” (Riemann 1854; Clifford 1867).

Roughly three years after the publication of his translation of Riemann’s work, on February 21st, 1870, Clifford made a few interesting points in his lecture titled *On the Space-Theory of Matter* (Fig. 2.5) in which he developed a proposal in which he argued that the intrinsic nature of (physical) space is non-Euclidean and that gravitation could be formally represented by this underlying geometry.

157

On dividing this expression by  $x^s + p_1x + p_2$ , we obtain the ordinary algebraic rules a remainder of the form  $M_{2s-1}x + N$  where  $M_{2s-1}$  and  $N$  are functions of  $p_1$  and  $p_2$ , whose weights  $s(2s-1)$  and  $2s$  respectively, and which may accordingly be written in the forms

$$M_{2s-1} = b_{2s-1} + p_1b_{2s-2} + \dots + p_1^{s-1}b_1,$$

$$N = c_s + p_1c_{s-1} + \dots + p_1^s,$$

where the  $b, c$  are of an order in  $p_1$  indicated by their suffix. On writing down (by Professor Sylvester’s Dialectic method) the result of eliminating  $p_1$  between these equations, it is at once apparent that this resultant is of the order  $s(2s-1)$ . Thus the determination of a quadratic factor of an expression of degree  $s$  is reduced to the solution of an equation of order  $s(2s-1)$ . But this number is one degree more odd than the original number  $s$ ; that is to say, if the number  $2s$  is  $2^r$  multiplied by an odd number, then  $s(2s-1)$  is  $2^{r-1}$  multiplied by an odd number. Hence by a repetition of this process we shall ultimately arrive at an equation of odd order, which, as is well known, must have a real root. By then retracing our steps the existence of a quadratic factor of the original expression is demonstrated.

(3) *On the Space-Theory of Matter.* By W. K. CLIFFORD, B.A., Trinity College.

[Abstract.]

RIEMANN has shewn that as there are different kinds of lines and surfaces, so there are different kinds of space of three dimensions; and that we can only find out by experience which of these kinds the space in which we live belongs. In particular, the axioms of plane geometry are true within the limits of experiment on the surface of a sheet of paper, as yet we know that the sheet is really covered with a number

158

of small ridges and furrows, upon which (the total curvature not being zero) these axioms are not true. Similarly, he says although the axioms of solid geometry are true within the limits of experiment for finite portions of our space, yet we have no reason to conclude that they are true for very small portions; and if any help can be got thereby for the explanation of physical phenomena, we may have reason to conclude that they are not true for very small portions of space.

I wish here to indicate a manner in which these speculations may be applied to the investigation of physical phenomena. I hold in fact

- (1) That small portions of space are in fact of a nature analogous to little hills on a surface which is on the average flat; namely, that the ordinary laws of geometry are not valid in them.
  - (2) That this property of being curved or distorted is continually being passed on from one portion of space to another after the manner of a wave.
  - (3) That this variation of the curvature of space is what really happens in that phenomenon which we call the motion of matter, whether ponderable or ethereal.
  - (4) That in the physical world nothing else takes place but this variation, subject (possibly) to the law of continuity.
- I am endeavouring in a general way to explain the law of double refraction on this hypothesis, but have not yet arrived at any results sufficiently decisive to be communicated.

March 7, 1870.

The President (Professor CAYLEY) in the Chair.

New Fellows elected:

- W. G. ADAMS, M.A., St John’s College.
- A. T. CHAPMAN, M.A., Emmanuel College.

Fig. 2.5.b. Proceedings of the Cambridge Philosophical Society, On the Space-Theory of Matter. By W. K. Clifford, B.A., Trinity College [Abstract]. Source: 1876, University Press | Public domain, Retrieved via: <https://archive.org/details/proceedingscamb06sociogoo/page/n175>

what Copernicus was to Ptolemy, that was Lobachevski to Euclid." (Halsted’s preface of Lobachevski N, 1891)

In this lecture he started by referencing Riemann's work on curved spaces and adding that we ought to find out by experience to which type of 3-dimensional space we live in, it seems quite obvious that Clifford, if not influenced by Riemann, at least shared these ideas with him. Referring to Riemann's research, Clifford said the following:

Riemann has shewn that as there are different kinds of lines and surfaces, so there are different kinds of space of three dimensions; and that we can only find out by experience to which of these kinds the space in which we live belongs. (Clifford 1870, pp. 157-158).

His focus in this lecture was on the results of the relations between physical space and the geometric axioms of three-dimensional spaces of constant curvature and presented some of the ideas he developed (*Ibidem*). For instance, he postulated (*Ibidem*) that as the intrinsic nature of physical space would have been non-Euclidean and therefore that the axioms of Euclidean geometry were not valid in them. He then proceeded to explain that their supposed validity was originating from a deceptive flatness arising from an apparent average of the geometry due to the scale considered. To illustrate this and by using a sheet of paper as an example, Clifford wrote:

In particular, the axioms of plane geometry are true within the limits of experiment on the surface of a sheet of paper, and yet we know that the sheet is really covered with a number of small ridges and furrows, upon which (the total curvature not being zero) these axioms are not true. Similarly, he [Riemann] says, although the axioms of solid geometry are true within the limits of experiment for finite portions of our space, yet we have no reason to conclude that they are true for very small portions; and if any help can be got thereby for the explanation of physical phenomena, we may have reason to conclude that they are not true for very small portions of space. (*Ibidem*).

Particularly important in above example is what conclusions an observer would draw depending on the chosen scale. When looking at the sheet of paper, one could see it as flat and representing a Euclidean two-dimensional space –not counting its thickness– in which “the ordinary laws of geometry” are true. However, when changing scale and looking closer at the constituents of the paper, one would observe a completely different kind of space. Still ignoring the thickness of the sheet of paper, the observer, if looking close enough, would notice that this space is clearly not flat, but a collection of intertwined fibres. Clifford continues by also stating that “the motion of matter” –Gravitation– could be formally represented by this underlying geometry:

I hold in fact (1) That small portions of space *are* in fact of a nature analogous to little hills on a surface which is on the average flat; namely, that the ordinary laws of geometry are not valid in them. (2) That this property of being curved or distorted is continually being passed on from one portion of space to another after the manner of a wave. (3) That this variation of the curvature of space is what really happens in that phenomenon which we call the *motion of matter*, whether ponderable or

etherial. (4) That in the physical world nothing else takes place but this variation, subject (possibly) to the law of continuity [...]. (*Ibidem*).

Regarding these statements, and in particular his points “(2)” and “(3)”, Clifford was on to something when talking about the property of space to be curved or distorted after the manner of a wave and that this variation is influencing the *motion of matter*. The idea behind the propagation of curvature done “after the manner of a wave” was some sort of precursor concept similar to the actual effects that gravitational waves have along their path, as suggested by more recent research. Thus laying the basis for the next generations of scientists and physicists, namely Henri Poincaré and Albert Einstein and foreshadowing a discovery that would happen more than a century later. As Prof. Cervantes-Cota and Prof. Galindo-Urribarri conclude in their article *Clifford’s attempt to test his gravitation hypothesis*, “Nowadays Clifford is better known for his mathematical works: Clifford numbers, Clifford algebras, Clifford-Klein surfaces but is less known in physics, at most he is known by very few for having anticipated Einstein’s curved space paradigm of general relativity.” (Cervantes-Cota and Galindo-Urribarri 2018, p. 11)

Another interesting element of this lecture is the statement of Clifford’s intentions to demonstrate the validity of his speculations to explain “the laws of double refraction”. In fact, Clifford did try to corroborate his assumptions by joining an expedition to observe an eclipse in December of the same year. Clifford’s expectations were that the passing of the Moon in front of the Sun might produce a measurable change in the skylight polarisation thereby showing that space surrounding the Moon might be curved by its presence (*Ivi.* p. 10); which in retrospect to our current understanding resembles a lot the common notion that mass distorts spacetime.

At this point, it seems necessary to clarify that Einstein’s Theory of Relativity and the concept of spacetime were still a few decades away and that the previous statement is not an analogue of a psychological projection but merely pointing at similarities in Clifford’s conceptions; whether they were the result of chance, a fluke, a contingency or something else is left aside since tensor calculus was not yet developed. Incidentally, it may well be this deficiency that lead Clifford to develop his own mathematical tools (Clifford 1882) in his *Preliminary Sketch of Biquaternions* (Clifford 1873) in order to develop his theories further. Clifford’s idea behind biquaternions was to model motion in a higher dimensional space which he used extensively in 1875 in *On the Free Motion Under No Forces of a Rigid System in an n-fold Homaloid* (Clifford 1875) in which his idea was to find an equivalence between ordinary three-dimensional space and the motion on a surface of a sphere in order to study the rotation of an object:

In general, the problem of free motion in elliptic space of  $n$  dimensions is identical with that of free motion, or motion about a fixed point, in parabolic space of  $n+1$  dimensions. (*Ivi.* p. 67)



Over the course of the years his natural desire to do scientific mediation along with peer pressure lead him to reveal his particular conception of space at that time in a lecture titled *The Postulates of the Science of Space* he delivered at the Royal Institution in March 1873.

After Epistemological and Philosophical considerations in the introduction about what “the geometer of to-day knows” and our position in space “Here with the consciousness of a There beyond it” and time “Now, with the consciousness of a Then before it” (Clifford 1901b, pp. 357-359), and some clarifications he deemed necessary for a broad audience about boundaries of solids in space, lines, surfaces and points (*Ivi*, pp. 360-368), Clifford shared his views and the postulates attached to this conception.

His first postulate was space continuity, the second elementary flatness, corresponding to the idea that the more one magnifies something the flatter it looks, the third superposition i.e. a body can be moved about in space without altering its size or shape and all parts of space are exactly alike (similar to our current understanding of space isotropy and homogeneity), the fourth and last one being similarity with which any figure may be magnified or diminished in any degree without altering its shape (*Ivi*, pp. 368-374).

After he commented on these postulates, Clifford decided to conclude by exploring the assumption that if the property of elementary flatness exists on the average and despite the apparent flatness of the very great, if “the deviations from it being, as we have supposed, too small to be perceived” and if we suppose the “curvature of all space to be [is] nearly uniform and positive” then:

If you were to start in any direction whatever, and move in that direction in a perfect straight line [...], after a most prodigious distance to which the parallactic unit—200.000 times the diameter of the earth’s orbit— would be only a few steps, you would arrive at—this place. Only, if you had started upwards, you would appear from below. (*Ivi*, p. 387)

Finally, Clifford concluded with his own personal opinion on the matter:

In fact, I do not mind confessing that I personally have often found relief from the dreary infinities of homaloidal space in the consoling hope that, after all, this other may be the true state of things. (*Ibidem*)

In addition, he added a note saying that “even the finite extent does not follow necessarily from uniform positive curvature: as Riemann seems to have supposed.” (*ibidem*)

While Clifford is often described as Riemann’s follower, it should be noted that Clifford was his own man, not just Riemann’s disciple. However, Clifford agreed with Riemann’s ideas and was clearly greatly influenced by them. Even if Clifford did not write his Space-Theory of matter *per se*, taking the abundance of information and hints he left in his

works post 1870 about his conception of space added to the considerations about his areas of interest and study, it is obvious that either Clifford was preparing himself to produce his theory or preparing his audience for the ideas that he would have developed if he did not pass away at such a young age. Moreover, it should be noted that Clifford’s ideas about the relationship between mass and space (i.e. the reason for joining the expedition of December 1870) are a tell-tale sign that our modern understanding of the fabric of space was already brewing.

## 2.6 Oliver Heaviside (1850-1925)

Oliver Heaviside was an English physicist, mathematician who made important contributions to the field of electrical engineering. Indeed, he notably reformulated Maxwell’s equations and developed “the Heaviside operational calculus” which represents an alternative to the Laplace transform (Nahin 2002) which is “a powerful tool for solving ordinary and partial differential equations, linear difference equations and linear convolution equations” (Berberan-Santos 2005, p. 165) but also indispensable for changing perspectives when drawing spacetime diagrams (Cfr. Section 3.2.) which came later with Einstein’s Special Relativity.

Though, besides these considerations, the brilliant mind that was Heaviside made a noteworthy analysis of an analogy between electromagnetism and gravity. Indeed, one can notice that gravity is not the only force capable of attraction: just like gravity can attract masses, magnets can attract magnetic objects; although a repulsive gravitational force or anti-gravity is merely an hypothetical phenomenon.

Moreover, when comparing Coulomb’s law with Newton’s formulation of the force of gravity, it is rather hard not to see the similarities:

$$F = F_{A/B} = F_{B/A} = G \frac{m_a m_b}{r^2} \quad |F_1| = |F_2| = k_e \frac{|q_1 q_2|}{r^2}$$

(2.5) (2.6)

where the absolute values of the forces  $F_1$  and  $F_2$  are equal to Coulomb’s constant  $k_e$ , times the magnitudes of the charges  $q_1$  and  $q_2$ , divided by their distance  $r$  squared.

However, Heaviside’s approach for an analogy between the theory of gravitation and the theory of electromagnetism was taken from a slightly different angle: he was examining the question of the “flux of gravitational energy” (Heaviside 1893, p.455; Heaviside 1893a).

and the current amplitude, according to (21), becomes

$$(C) = \frac{\rho^3 \epsilon^{-Pz} e}{(\rho^2 + \lambda^2 n^2)(R^2 + L^2 n^2)^{3/2}} \dots (29)$$

in which, of course,  $\rho$  and  $\lambda n$  are not independent, having a relation fixed between them by the vanishing of  $S$  in (25). By giving a suitable value to  $\sigma$ , for instance,  $\frac{1}{4}$  microfarad per kilometre (which is a suitable unit of length to employ), and also fixing the frequency, we may readily apply the formulæ to estimate the attenuation with different values of the insulation resistance or its equivalent.

---

## APPENDIX B.

### A GRAVITATIONAL AND ELECTROMAGNETIC ANALOGY.

#### Part I.

To form any notion at all of the flux of gravitational energy, we must first localise the energy. In this respect it resembles the legendary hare in the cookery book. Whether the notion will turn out to be a useful one is a matter for subsequent discovery. For this, also, there is a well-known gastronomical analogy.

Now, bearing in mind the successful manner in which Maxwell's localisation of electric and magnetic energy in his ether lends itself to theoretical reasoning, the suggestion is very natural that we should attempt to localise gravitational energy in a similar manner, its density to depend upon the square of the intensity of the force, especially because the law of the inverse squares is involved throughout.

Certain portions of space are supposed to be occupied by matter, and its amount is supposed to be invariable. Furthermore, it is assumed to have personal identity, so that the position and motion of a definite particle of matter are definite, at any rate relative to an assumed fixed space. Matter is recog-

Fig. 2.6. A Gravitational and Electromagnetic Analogy in Electromagnetic theory, p. 455.  
Source: <https://archive.org/details/electromagnetic01heavrich/page/454/mode/2up>

In fact, his idea was to simply take the same reasoning that was used for electromagnetism and to apply it to gravitation from the notion of a flux of gravitational energy in order to examine the then obtained results:

Now, bearing in mind the successful manner in which Maxwell's localization of electric and magnetic energy in his ether lends itself to theoretical reasoning, the suggestion is very natural that we should attempt to localize gravitational energy in a similar manner, its density to depend upon the square of the intensity of the force, especially because the law of the inverse squares<sup>40</sup> is involved throughout (Heaviside 1893, p. 455).

Furthermore, there are multiple interesting points throughout the development of his analogy. Indeed, for instance, Heaviside wrote:

The electromagnetic analogy may be pushed further. It is as incredible now as it was in Newton's time<sup>41</sup> that gravitative influence can be exerted without a medium; and, granting a medium, we may as well consider that it propagates in time, although immensely fast. (Ivi. p. 459)

Therefore considering the speed of gravity to be finite, and not instantaneous through the Universe, from this point on. Continuing his analysis of this analogy, Heaviside notes that by inferring this finite speed to be that of the speed of light, the results are sensibly the same as with an instantaneous action:

This [if we introduce the hypothesis of propagation at finite speed], of course, might be inferred from the electromagnetic case. [...]

Thus results will be sensibly as in the common theory of instantaneous action, although expressed in terms of wave-propagation. Results showing signs of wave-propagation would require an inordinately large velocity of matter through the ether. It may be worth while to point out that the lines of gravitational force connected with a particle of matter will no longer converge to it uniformly from all directions when the velocity  $v$  is finite, but will show a tendency to lateral concentration, though only to a sensible extent when the velocity of the matter is not an insensible fraction of  $v$ . (Ivi. p. 460)

It is remarkable to see at this point that Heaviside wrote that “the results would be similar but expressed in terms of wave-propagation” but missed the opportunity to discuss gravitational waves, thus showing that the concept of gravitational waves was still further down the road.

However, with this analogy, Heaviside's goal was mostly an attempt to examine gravity in a new light while making the point that there was no need for gravity to be instantaneous:

But the above analogy, though interesting in its way, and serving to emphasise the non-necessity of the assumption of instantaneous or direct action of matter upon matter, does not enlighten us in the least about the ultimate nature of

---

<sup>40</sup> Cfr. equations (2.5) and (2.6).

<sup>41</sup> “\* To Newton himself, as shown in his often quoted letter to Bentley.”

gravitational energy. It serves, in fact, to further illustrate the mystery. (Ivi. p. 461)

Furthermore, in order to respond to remarks about “gravitational aberration” Heaviside pushed the analogy even further by applying this new hypothesis that the speed of gravity could be finite –and in fact be the speed of light– and some of his previous work from his “theory of convective currents of electrification” to the Sun and Earth system:

The remarks of the Editor<sup>42</sup> and of Prof. Lodge<sup>43</sup> on gravitational aberration, lead me to point out now some of the consequences of the modified law which arises when we assume that the ether is the working agent in gravitational effects, and that it propagates disturbances at speed  $v$  in the manner supposed in my former article. There is, so far as I can see at present, no aberrational effect, but only a slight alteration in the intensity of force in different directions round a moving body considered as an attractor.

Thus, take the case of a big Sun and a small Earth, of masses  $S$  and  $E$ , at distance  $r$  apart. Let  $f$  be the unmodified force of  $S$  on  $E$ , thus

$$f = \frac{S E}{4\pi r^2 c} \quad (2.7)$$

(Ivi. p. 463)

According to him, the absence of aberration is replaced by a “slight alteration in different directions in the intensity of force” because of his modified force expression that takes into account the speed  $u$  of the Sun through the ether:

$$F = f \times \frac{1 - s}{(1 - s \sin^2 \theta)^{3/2}} \quad (2.8)$$

(*Ibidem*)

with

$$s = \frac{u^2}{v^2} \quad (2.9)$$

where  $u$  is the speed of the Sun through the ether,  $v$  is the speed of light, and  $\theta$  the angle between  $r$  and the line of motion (*Ibidem*).

After noting in a footnote that “[...] Prof. Lodge tells me that our own particular Sun is considered to move only 10-9 miles per second. This is stupendously slow.” (*Ibidem*), Heaviside estimated that this smallness was thus making  $s$  very small and that it would therefore produce “perturbing forces [...] of the order of only one-millionth of the full force” (*Ibidem*).

---

<sup>42</sup> “*The Electrician*, July 14, p. 277 and July 28, p. 340.”

<sup>43</sup> “*The Electrician*, July 28, p. 347.”

Finally, after having completed his analysis, Heaviside concluded with a possible way to verify his results:

All we need expect, then, so far as I can see from the above considerations, are small perturbations due to the variation of the force of gravity in different directions, and to the auxiliary force. Of course, there will be numerous minor perturbations

**If variations of the force of the size considered above are too small to lead to observable perturbations of motion, then the striking conclusion is that the speed of gravity may even be the same as that of light.** If they are observable, then, if existent, they should turn up, but if non-existent then the speed of gravity should be greater. Furthermore, it is to be observed that **there may be other ways of expressing the propagation of gravity.**

But I am mindful of the good old adage about the shoemaker and his last, and am, therefore, reluctant to make any more remarks about perturbations. The question of the ether in its gravitational aspect must be faced, however, and solved sooner or later, if it be possible. Perhaps, therefore, my suggestions may not be wholly useless. (Emphasis is mine – Ivi. p. 466)

Unfortunately for Heaviside, Henri Poincaré (1854-1912) also ended up being interested in the question of the propagation of gravity through yet another result just over a decade later in 1905.

## 2.7 Henri Poincaré (1854-1912)

As good as the intuition of Clifford was, and despite using the keyword “wave” when saying “after the manner of a wave” (Clifford 1870, pp. 158) to describe the propagation of a variation in the geometry of space almost a decade before Einstein was even born and almost three decades before Einstein’s theories (cfr Einstein 1916, 1920, 1937, 2005); and despite Heaviside’s analogy, the first mention of gravitational waves *per se* has to be attributed to Henri Poincaré (cfr. Chapter 3, Section 3).

Henri Poincaré was a French mathematician, physicist, philosopher and engineer. He was born in 1854 in Nancy, France and died in 1912 in Paris, France. Besides his important works and contributions to diverse mathematical fields, he is also considered a major precursor of Special Relativity (Logunov 2005).

During my research at the Niels Bohr Library, I uncovered a letter from Charles Émile Picard (1856-1941), a French mathematician, to Arthur Korn (1870-1945) who was a German physicist; about this (Picard 1913):

Faculté des Sciences  
de  
l'Université de Paris

Paris, 6 Décembre 1913.

Analyse Supérieure

Cher ami,

J'ai présenté lundi dernier votre note à l'Académie; elle m'a paru très intéressante, et cela méritera d'être développée.

J'ai deux choses à vous demander. Je vois me rappeler que Poincaré a fait à Berlin une communication à la Société Mathématique sur les surfaces algébriques: comme je vois reprise dans mon cours cette année cette question des surfaces algébriques qui m'a tant occupé, je serais heureux de savoir ce qu'il y avait dans cette communication.

Je voudrais aussi avoir votre avis sur les travaux relatifs sur le principe de relativité en ce qui concerne ses rapports avec la gravitation (Abraham, Einstein); cela m'a l'air d'un beau gâchis. Il est vraiment extraordinaire que, avec des bases expérimentales assez fragiles, on veuille changer les idées de l'humanité sur l'espace et le temps. Je n'ai pas vu tout d'abord cela dans une notice sur l'œuvre de Poincaré, que j'ai publiée en fond' Ami la Revue Scientifique et que reproduit le cahier d'octobre des Annales de l'École Normale. J'en me dissimule pas que cela va m'attirer le mépris des physiciens.

Je serais très heureux de vous voir au mois de

Janvier. Veuillez présenter mon respectueux souvenir à M<sup>me</sup> Korn, et vous à mes sentiments  
très dévoués,

Emile Picard

Chas. Emile Picard

Fig. 2.7.a. Letter from Émile Picard to Arthur Korn – dated Paris, 6 Décembre 1913. Source: Niels Bohr Library, courtesy of the American Institute of Physics, USA.

In this letter, after telling Arthur Korn that he presented “his note to the academy”, Picard asked Korn two questions. The first one about a communication Poincaré gave in Berlin on algebraic surfaces and the second one about Korn’s opinion on the implications of the principle of relativity for gravitation:

I have two things to ask you. If I recall correctly Poincaré did a communication in Berlin to the Mathematical Society on algebraic surfaces. As I am going to include this question that kept me so busy in my lectures of this year, I would be glad to know what the content of this communication was.

I would also like to have your opinion on the recent works on the principle of relativity with regard to its relations with gravitation (Abraham, Einstein); this seems like a nice mess. It is extraordinary, with such fragile experimental bases, to be willing to change humanity’s ideas on space and time. I did not fear to write this in a notice on *l’Oeuvre de Poincaré*, the *Revue Scientifique* is publishing today and that the *Annales de l’Ecole Normale* reproduces. I will not hide that this will bring spite from physicists. (Translated from Fig. 2.6.a. by Philippe Vincent)

This last passage is quite amusing in retrospect as Picard will be the author of one of the very first textbooks on Einstein’s Special and General Relativities (cfr. figure below).





**Fig. 2.7.b.** Frontispiece of *La Théorie de la Relativité et ses applications à l'Astronomie* par M. Émile PICARD (1922) |

Source: <https://archive.org/details/lathoriedelare00picauoft/page/n7/mode/2up>

However, before arriving at this point, in *L'Œuvre de Henri Poincaré* (Picard 1913a) which Picard published after Poincaré's passing as a celebration of his works and accomplishments, he acknowledged that

Poincaré's paper of 1905 played a key role in the history of the relativity principle, as well as how Poincaré's work utterly marked the understanding of this principle with regard to its implications for simultaneity and a new way to consider both space and time:

The memoire on the dynamics of the electron, written in 1905, will stay in the history of the relativity principle; the Lorentz transformations group, that do not change the equations of the electromagnetic medium, appears in it as the keystone of the discussion about the conditions which must satisfy the forces in the new dynamic. The necessity of the introduction in the electron of additional forces, putting aside the bonding forces, is established, these additional forces being putatively equivalent to an ambient pressure outside of the electron. Poincaré shows also which hypotheses one can make about gravitation in order for the gravitational field to be affected by the Lorentz transform in the same manner as the electromagnetic field.

We are aware of the importance that the principle of relativity has acquired nowadays, the origin of which is the impossibility, claimed by faith in a few negative experiments, to show the proof of a uniform translation of a system using optics or electrical experiments done within this system. Admitting, besides, that Lorentz's ideas and his electromagnetic equations are irrefutable, we have been lead to a necessary change of our ideas on *space* and on *time*; space and time ( $x$ ,  $y$ ,  $z$ , and  $t$ ) do not undergo their own transformations separately but simultaneously in the Lorentz group. The simultaneity of two phenomena becoming a relative notion; a phenomenon can be anterior to another one for a first observer, while it would be posterior for a second one.<sup>44</sup> (Translation by Philippe Vincent – *Ivi*. p. 17-18)

Picard then continued, pondering the conceptions of space and time and as a result how the principle of relativity influenced and then upset the scientific community of the time:

The mathematicians, interested in a group of transformations that transforms itself the quadratic form  $x^2+y^2+z^2-c^2t^2$  ( $c$  = speed of light) engaged in elegant

---

<sup>44</sup> Le Mémoire sur la dynamique de l'électron, écrit en 1905, restera dans l'histoire du principe de la relativité; le groupe des transformations de Lorentz, qui n'altèrent pas les équations d'un milieu électro magnétique, y apparaît comme la clef de voûte dans la discussion des conditions auxquelles doivent satisfaire les forces dans la nouvelle dynamique. La nécessité de l'introduction dans l'électron de forces supplémentaires, en dehors des forces de liaison est établie, ces forces supplémentaires pouvant être assimilées à une pression qui régnerait à l'extérieur de l'électron. Poincaré montre encore quelles hypothèses on peut faire sur la gravitation pour que le champ gravifique soit affecté par une transformation de Lorentz de la même manière que le champ électromagnétique.

On sait l'importance qu'a prise aujourd'hui le principe de la relativité, dont le point de départ est l'impossibilité, proclamée sur la foi de quelques expériences négatives, de mettre en évidence le mouvement de translation uniforme d'un système au moyen d'expériences d'optique ou d'électricité faites à l'intérieur de ce système. En admettant, d'autre part, que les idées de Lorentz et ses équations électromagnétiques sont inattaquables, on a été conduit à regarder comme nécessaire le changement de nos idées sur l'*espace* et sur le *temps*; espace et temps ( $x$ ,  $y$ ,  $z$  et  $t$ ) n'ont plus leurs transformations séparées et entrent simultanément dans le groupe de Lorentz. La simultanéité de deux phénomènes devient une notion toute relative ; un phénomène peut être antérieur à un autre pour un premier observateur, tandis qu'il lui est postérieur pour un second.

dissertations on the subject and without doubt contributed to the popularity of the principle of relativity. At other times, we might have, before rejecting humanity's traditional ideas on space and time, to sift through extremely harsh critics the conceptions on ether and the formation of electromagnetic equations; but the desire for novelty does not know any bounds today. The objections are nonetheless not lacking, and illustrious physicists, such as Lord Kelvin and Ritz, without mentioning the still living ones, have stated very motivated doubts. Science assuredly knows no dogma, and it may very well be that precise positive experiments force us one day to modify certain ideas which had become common sense; but has that moment already come?<sup>45</sup> (Translation by Philippe Vincent – *Ivi.* p. 18)

In the next paragraph, Picard expressed his doubts a little more in depth:

Poincaré saw the danger in these infatuations, and, in a conference on the new dynamics, he besought the professors not to bring discredit upon the old Mechanics which proved itself. [...] In all this relativism, an absolute remains, namely the speed of light in a vacuum, independent of the state of rest or motion of its source. This absolute is probably going to disappear, the Lorentz equations only being a first approximation. The greatest difficulties come from gravitation, to the point that certain Physics theoreticians believe that the only way to get rid of them is to attribute inertia and a weight to energy, hence in particular the weight of light.<sup>46</sup> (Translation by Philippe Vincent – *Ibidem*)

According to Picard, Poincaré's point of view about the ontology of geometrical properties was that they only were an illusion. From a more philosophical-epistemological reference frame, according to this statement, Poincaré probably would have sided with the mathematicians thinking that mathematics were invented rather than discovered. Indeed, Picard wrote:

The geometrical properties do not correspond, for Poincaré, to any reality; they form a set of *conventions* that experience might have suggested to the mind, but

---

<sup>45</sup> Les mathématiciens, intéressés par un groupe de transformations qui transforment en elle-même la forme quadratique  $x^2+y^2+z^2-c^2t^2$  ( $c$  = vitesse de la lumière) se sont livrés à d'élégantes dissertations sur ce sujet et ont sans doute contribué à la popularité du principe de relativité. A d'autres époques, on eût peut-être, avant de rejeter les idées traditionnelles de l'humanité sur l'espace et le temps, passé au crible d'une critique extrêmement sévère les conceptions sur l'éther et la formation des équations de l'électromagnétisme; mais le désir du nouveau ne connaît pas de bornes aujourd'hui. Les objections ne manquent pas cependant, et d'illustres physiciens, comme Lord Kelvin et Ritz, sans parler des vivants, ont émis des doutes très motivés. La Science assurément ne connaît point de dogmes, et il se peut que des expériences positives précises nous forcent un jour à modifier certaines idées devenues notions de sens commun; mais le moment en est-il déjà venu?

<sup>46</sup> Poincaré voyait le danger de ces engouements, et, dans une conférence sur la dynamique nouvelle, il adjurait les professeurs de ne pas jeter le discrédit sur la vieille Mécanique qui a fait ses preuves. [...] Dans tout ce relativisme, il reste un absolu, à savoir la vitesse de la lumière dans le vide, indépendante de l'état de repos ou de mouvement de la source lumineuse. Cet absolu va probablement disparaître, les équations de Lorentz ne représentant plus qu'une première approximation. Les plus grandes difficultés viennent de la gravitation, au point que certains théoriciens de la Physique croient ne pouvoir les lever qu'en attribuant de l'inertie et un poids à l'énergie, d'où en particulier la pesanteur de la lumière.

did not impose. The evolutionist whom I was talking of up above sees there great difficulties, not only for the mundane reason that this duality between mind and exterior medium is contrary to his doctrine, but because, looking to retrace the genesis of the origins of Geometry in the human species, it seems impossible to them to separate the acquisition of geometrical notions and the simplest physical notions, Geometry being in ancient times part of Physics.<sup>47</sup> (Translation by Philippe Vincent – *Ivi*. p. 21)

Picard finally ended this chapter by talking about Poincaré’s take on Max Planck’s (1858-1947) *quanta*:

One of Poincaré’s last works was an in depth discussion on the *quanta* theory, erected by Planck, according to which the energy of luminous radiators would be varying in a discrete manner. From this point of view “physical phenomena, said Poincaré, would cease to obey laws expressed with differential equations, and this would without a doubt be the greatest revolution and the deepest that natural philosophy would have seen since Newton”.<sup>48</sup> (Translation by Philippe Vincent – *Ivi*. pp. 17-18)

For clarity, this point was also republished in *Dernières pensées* (Poincaré 1920, p. 166):

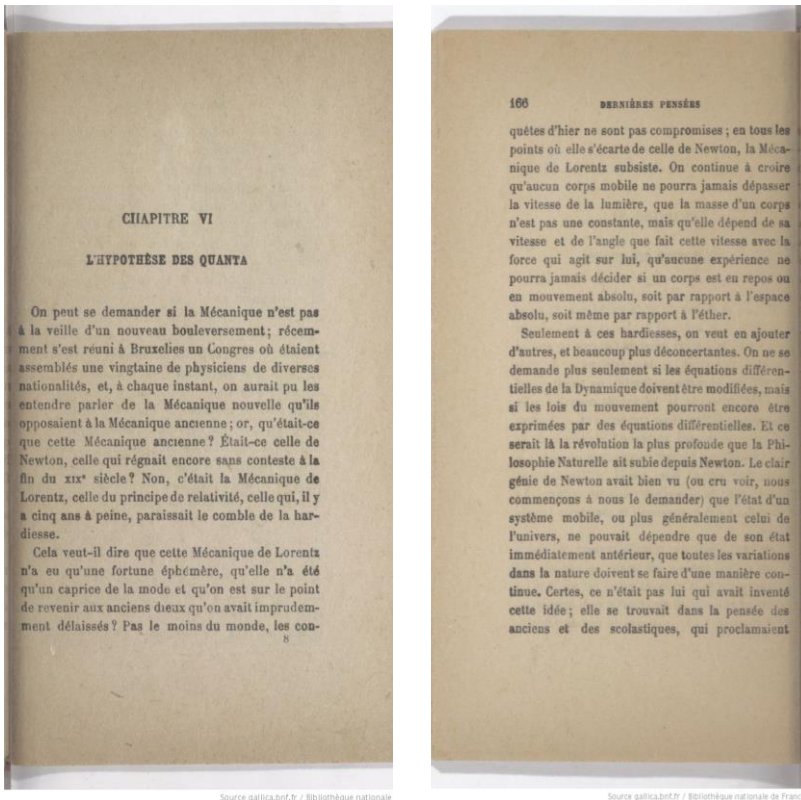
One no longer just wonders if the differential equations of Dynamics must be modified, but if the laws of motion will still be expressed with differential equations. And this would hereby be the deepest revolution that Natural Philosophy would have been subject to since Newton.<sup>49</sup> (Translation by Philippe Vincent – *Ibidem*)

---

<sup>47</sup> Les propriétés géométriques ne correspondent, pour Poincaré, à aucune réalité ; elles forment un ensemble de conventions que l’expérience a pu suggérer à l’esprit, mais qu’elle ne lui a pas imposées. L’évolutionniste dont je parlais plus haut voit là de grandes difficultés, non pas seulement pour la raison banale que la dualité ainsi posée entre l’esprit et le milieu extérieur est contraire à sa doctrine, mais parce que, cherchant à retracer la genèse des origines de la Géométrie dans l’espèce humaine, il lui paraît impossible de séparer l’acquisition des notions géométriques et celles des notions physiques les plus simples, la Géométrie ayant dans des temps très anciens fait partie de la Physique.

<sup>48</sup> Un des derniers travaux de Poincaré a été une discussion approfondie de la théorie des *quanta*, édifiée par Planck, d’après laquelle l’énergie des radiateurs lumineux varierait d’une manière discontinue. De ce point de vue « les phénomènes physiques, dit Poincaré, cesseraient d’obéir à des lois exprimables par des équations différentielles, et ce serait là sans aucun doute la plus grande révolution et la plus profonde que la philosophie naturelle ait subie depuis Newton ».

<sup>49</sup> On ne se demande plus seulement si les équations différentielles de la Dynamique doivent être modifiées, mais si les lois du mouvement pourront encore être exprimées par des équations différentielles. Et ce serait là la révolution la plus profonde que la Philosophie Naturelle ait subie depuis Newton.



**Fig. 2.7. c.** Poincaré H (1920) *Dernières pensées*. Ernest Flammarion, éditeur. 26, Rue Racine, Paris, p. 165 (left), p. 166 (right).

Source: gallica.bnf.fr / BnF  
<https://gallica.bnf.fr/ark:/12148/bpt6k96240944/f183.image>  
<https://gallica.bnf.fr/ark:/12148/bpt6k96240944/f184.image>

In this next section of the sixth chapter “hypothesis on quanta” (*Ivi*. p. 165) of *Dernières pensées*, Poincaré explained to the reader what led this then-called *hypothesis* to be formulated from the principle of Sadi Carnot’s (1796-1832) to the “law of the *blackbodies*”.

Carnot’s principle, or the second principle of Thermodynamics, teaches us that the world tends to a final state from which it will not be able to escape; it thus teaches us that statistical equilibrium is possible; [...] (Translation by Philippe Vincent – *Ivi*. p. 169)<sup>50</sup>

Poincaré then explained his thoughts on the matter:

By what singular coincidence are the conditions of this equilibrium always the same, whatever the bodies brought into contact? the previous considerations make

<sup>50</sup> Le principe de Carnot, ou second principe de la Thermodynamique, nous apprend que le monde tend vers un état final dont il ne pourra plus s’écarter ; il nous apprend donc que l’équilibre statistique est possible ; [...]

us understand this, it is because the general laws of Dynamics, expressed by Hamilton's differential equations, apply to all bodies.<sup>51</sup> (Translation by Philippe Vincent – *Ivi*. p. 170)

and finally dedicates a subsection of the chapter to the law of radiation (“La Loi du Rayonnement”, *Ivi*. p. 171). This whole ordeal is in fact none other than the very well-known scientific crisis later called the *Ultraviolet Catastrophe* (see section 2.9).

## 2.8 Historical Comparative Analysis Between Clifford and Poincaré

Before continuing with the great historical role played by the *Ultraviolet Catastrophe* in the great scheme of things and in particular in regards to the development of the tools needed for gravitational wave detection, i.e. the birth of Quantum Mechanics and the development of optical tools, it seems appropriate to do a short comparative historical analysis between Clifford's and Poincaré's key ideas relevant to the history of the discovery of gravitational waves.

Both Clifford and Poincaré were mathematicians and well-versed in the field of Geometry. Moreover, both Clifford and Poincaré were unquestionably well aware of the works of Bernhard Riemann.

Indeed, according to Paul Appell (1855-1930) who was a French mathematician of the *Académie des Sciences* and among their contemporaries, Poincaré worked on *Analysis situs* which corresponds to Algebraic topology:

I would also like to point out the fine work of H. Poincaré, also cited by Rados, relating to the *Analysis situs* or geometry of situations, a kind of geometry in which we deal with the relative positions of geometric entities, but not with their shapes nor their sizes. The necessity of creating this part of geometry had already been perceived by one of the men to whom the sciences owe the most discoveries, and above all the most original and fruitful views; Leibniz was convinced that the analysis of geometers could not be applied to all questions of natural philosophy.<sup>52</sup> (Translation by Philippe Vincent – Appell 1925, pp. 66-67)

---

<sup>51</sup> Par quelle singulière coïncidence les conditions de cet équilibre sont-elles toujours les mêmes, quels que soient les corps mis en présence ? les considérations qui précèdent nous le font comprendre, c'est parce que les lois générales de la Dynamique, exprimées par les équations différentielles de Hamilton, s'appliquent à tous les corps.

<sup>52</sup> Je tiens aussi à signaler les beaux travaux d'H. Poincaré, cités également par Rados, relatifs à l'*Analysis situs* ou géométrie de situations, sorte de géométrie dans laquelle on s'occupe des positions relatives des êtres géométriques, mais non de leur formes ne de leurs grandeurs. La nécessité de la création de cette partie de la géométrie avait déjà été aperçue par un des hommes à qui les sciences doivent le plus de découvertes, et surtout le plus de vues originales et fécondes ; Leibniz était persuadé que l'analyse des géomètres ne pouvait s'appliquer à toutes les questions de la philosophie naturelle.

And

The German mathematician Riemann introduced in *Analysis situs* the idea of connection of a continuous space: let us take, to fix ideas, the interior volume of a room without furniture, all the doors of which are closed. If there is no column in the room, it is limited only by the walls, ceiling and floor. A closed line, like a thread whose two ends are knotted, can, by continuous deformation in the volume and without meeting the walls, be reduced to a point and this whatever its initial arrangement. The volume is then said to be simply connected. But if there is in the room a column joining the floor to the ceiling, the volume will be limited by walls comprising the walls, the ceiling, the floor and the outer surface of the column. We can then imagine in this volume two kinds of closed curves, some not surrounding the column, the others surrounding it; the former can, by continuous deformation, be reduced to points without encountering any portion of the walls; the second, on the contrary, cannot be reduced to points; the volume is then said to be *doubly connected*. If there are two columns, there will be three kinds of closed curves in free space; those which do not contain any columns; those which contain one of the two columns; those that contain the other. The curves which contain the two columns can always by continuous deformation be reduced to two curves each of which contains only one column. The volume is then *triply connected*. And so on. We see that in this concept the shape and dimensions of the walls play no role.

The problems of *Analysis situs* are, in general, very difficult, because they present the highest degree of abstraction possible. H. Poincaré made a lot of progress in this part of science.<sup>53</sup> (Translation by Philippe Vincent – Appell 1925, pp. 68-69)

Furthermore, in *La valeur de la science* (Poincaré S.D. b) and in his *Science et méthode* (Poincaré S.D. a), Poincaré discussed both *Analysis situs* and non-Euclidean Geometry with simple yet explicit examples; thus giving us a great opportunity to compare his explanations with Clifford's.

---

<sup>53</sup> Le mathématicien allemand Riemann a introduit en *Analysis situs* l'idée de connexion d'un espace continu : prenons, pour fixer les idées, le volume intérieur d'une salle sans meubles dont toutes les portes sont fermées. S'il n'y a aucune colonne dans la salle, celle-ci est limitée uniquement par les murs, le plafond et le plancher. Une ligne fermée, comme un fil dont les deux extrémités sont nouées, peut, par déformation continue dans le volume et sans rencontrer les parois, être réduite à un point et cela quelle que soit sa disposition initiale. Le volume est dit alors simplement connexe. Mais s'il y a dans la pièce une colonne réunissant le plancher au plafond, le volume sera limité par des parois comprenant les murs, le plafond, le plancher et la surface extérieure de la colonne. On peut alors imaginer dans ce volume deux sortes de courbes fermées, les unes n'entourant pas la colonne, les autres l'entourant ; les premières peuvent, par déformation continue, être réduites à des points sans rencontrer une portion quelconque des parois ; les deuxièmes au contraire ne pourront pas se réduire à des points ; le volume est dit alors *doublement connexe*. S'il y a deux colonnes, il existera trois espèces de courbes fermées dans l'espace libre ; celles qui ne renferment aucune colonne ; celles qui renferment l'une des deux colonnes ; celles qui renferment l'autre. Les courbes qui renferment les deux colonnes peuvent toujours par déformation continue être ramenées à deux courbes dont chacune renferme seulement une colonne. Le volume est alors *triplement connexe*. Et ainsi de suite. On voit que dans cette notion la forme et les dimensions des parois ne jouent aucun rôle.

Les problèmes d'*Analysis situs* sont, en général, fort difficiles, parce qu'ils présentent le plus haut degré d'abstraction possible. H. Poincaré a fait beaucoup avancer cette partie de la science.

First of all, it is essential to note that both of them had similar and yet subtly different approaches in regard to the relativity of position and considerations about sizes. For instance, in Poincaré's *Science et méthode*, he wrote:

Earlier, we saw that when I say: I will be here tomorrow, that did not mean: I will be tomorrow at the point in space where I am today, but: I will be tomorrow at the same distance of the Pantheon than today. And now this statement is no longer sufficient and I must say: Tomorrow and today, my distance from the Pantheon will be equal to the same number of times the length of my body.<sup>54</sup> (Poincaré S.D. a, p. 102)

Thereby implicitly implying two types of relative positions: the relative position of a body compared to another, and the relative position for an outside observer. The first one being exemplified by the fact that we could state that Poincaré was from one day to the next at the same position compared to the Panthéon, while at the same time, this position is not the same as the day before that relatively to space since the Earth is moving.

Furthermore, Poincaré's explanation also presents the feature of declaring a specific unit, the length of his body, which he implicitly assumed to be invariant in this example. This last observation is important when comparing a similar explanation given by Clifford.

While Poincaré's started by his position in space and then moved to the measurement of his distance to the Panthéon in units of his own height, in Clifford's *The Common Sense of the Exact Sciences* (Clifford 1891), Clifford wrote in details how this procedure of measurement is essential:

Let us now consider what is meant by the first of our observations about space, viz., that a thing can be moved about from one place to another without altering its size or shape.

First as to the matter of size. We measure the size of a thing by measuring the distances of various points on it. For example, we should measure the size of a table by measuring the distance from end to end, or the distance across it, or the distance from the top to the bottom. The measurement of a distance is only possible when we have something, say a yard measure or a piece of tape, which we can carry about and which does not alter its length while it is carried about. The measurement is then affected by holding this thing in the place of the distance to be measured, and observing what part of it coincides with this distance. (Clifford 1891, p. 52)

However, Clifford notes that the process of measurement has an important fundamental ontological implication, i.e. we assume the following:

---

<sup>54</sup> Tout à l'heure, nous avons vu que quand je dis : Je serai ici demain, cela ne voulait pas dire : Je serai demain au point de l'espace où je suis aujourd'hui, mais : Je serai demain à la même distance du Panthéon qu'aujourd'hui. Et voici que cet énoncé n'est plus suffisant et que je dois dire : Demain et aujourd'hui, ma distance du Panthéon sera égale à un même nombre de fois la longueur de mon corps.



Thus we should say that two tables are equally broad, if we marked the breadth of one of them on a piece of tape, and then carried the tape over to the other table and found that its breadth came up to just the same mark. [...] Or we may say generally that two lengths or distances of any kind are equal, when, one of them being brought up close to the other, they can be made to fit without alteration. But the tape is a thing far more easily carried about than the table, and so in practice we should test the equality of the two breadths by measuring both against the same piece of tape. We find that each of them is equal to the same length of tape; and we assume that two lengths which are equal to the same length are equal to each other. This is equivalent to saying that if our piece of tape be carried round any closed curve and brought back to its original position, it will not have altered in length. (Clifford 1891, p. 52)

Before concluding:

The reader will probably have observed that we have defined length or distance by means of a measure which can be carried about without changing its length. But how then is this property of the measure to be tested? We may carry about a yard measure in the form of a stick, to test our tape with; but all we can prove in that way is that the two things are always of the same length when they are in the same place; not that this length is unaltered. (Clifford 1891, p. 53)

At this point it is interesting to note that a similar reasoning could be applied to a change in orientation – which is essentially the principle at the core of the Riemann tensor (see section 3.2.2) –.

Clifford goes on:

The fact is that everything would go on quite as well if we supposed that things did change in length by mere travelling from place to place, provided that (1) different things changed equally, and (2) anything which was carried about and brought back to its original position filled the same space<sup>55</sup>. All that is wanted is that two things which fit in one place should also fit in another place, although brought there by different paths; unless, of course, there are other reasons to the contrary. (Clifford 1891, p. 54)

This is what Clifford referred to as the principle of superposition in his *The Postulates of the Science of Space*:

Now in the particular case where a space of three dimensions has the property of superposition, or is all over alike, these geodesic surfaces are *planes*. That is to say, since the space is all over alike, these surfaces are also of the same shape all over and on both sides; which is Leibnitz's definition of a plane. (Clifford 1901b, p. 564).

On the other hand, in Poincaré's *La valeur de la science*, one can read and understand that one would be driven to the same conclusion if, instead of the bodies, space itself was uniformly varying in size:

---

<sup>55</sup> “These remarks refer to the geometrical, and not necessarily to all the physical properties of bodies.–K.P.” This footnote was an addition made by the editor, Karl Pearson (1857-1936).

It has often been observed that if all the bodies of the Universe were to expand simultaneously and in the same proportion, we would have no means of noticing this, since all our measuring instruments would grow at the same time as the very objects which they are used to measure. The world, after this expansion, would continue on its course without anything warning us of such a huge event.<sup>56</sup> (Translation by Philippe Vincent – Poincaré S.D. b, p. 69)

However, we must recognize a subtle difference between the two cases. Indeed, in Clifford's case, he did not assume that space was homogeneous; which case is addressed by Clifford:

Is it possible, however, that lengths do really change by mere moving about, without our knowing it?

Whoever likes to meditate seriously upon this question will find that it is wholly devoid of meaning. But the time employed in arriving at that conclusion will not have been altogether thrown away. (Clifford 1891, p. 55)

On one hand, to Clifford, Geometry was a physical science. This is especially obvious when considering his writings in *The postulates of the Science of Space* (Clifford 1901b), in *The Common Sense of the Exact Sciences* (Clifford 1891) and in *Seeing and Thinking* (Clifford 1879). Indeed, in these works, he explained in details basic geometrical concepts in order to discuss the notion of boundaries in an almost identical way.

Moreover, the fact that he dedicated a whole section to boundaries starting essentially from scratch, asking the reader to forget all they have been taught before, in which he gave a very detailed description in layman's terms of these notions (Clifford 1879, pp. 127-156) exemplifies how important this was to him:

Before I begin to talk to you about the sizes and shapes of things, I am going to make a request that may seem somewhat strange. I am going to ask you to forget that you have ever lived until this moment. It is not that I am going to tell you anything new, that you did not know before; for I am merely going to remind you of a lot of things that you have known familiarly for years. Only I want you to observe them all quite freshly over again, as if you had not seen them before. I want you not to believe a word I say, unless you can see quite plainly at the moment that it is true; and I shall try only to say such things as you can quite easily verify at once while you sit there. That is what I mean by asking you to forget that you have ever lived until this moment: for geometry, you know, is the gate of science, and the gate is so low and small that one can only enter it as a little child. (Clifford 1879, p. 127)

---

<sup>56</sup> On a souvent observé que si tous les corps de l'Univers venaient à se dilater simultanément et dans la même proportion, nous n'aurions aucun moyen de nous en apercevoir, puisque tous nos instruments de mesure grandiraient en même temps que les objets mêmes qu'ils servent à mesurer. Le monde, après cette dilatation, continuerait son train sans que rien vienne nous avertir d'un événement aussi considérable.

On the other hand, Poincaré had a different perception of geometry:

Another framework that we impose on the world is space. Where did the first principles of geometry come from? Are they imposed on us by logic? Lowachevsky has shown that not by creating non-Euclidean geometries. Is space revealed to us by our senses? Not yet, because that which our senses could show us is absolutely different from that of the geometer. Does geometry derive from experience? An in-depth discussion will show us not. We will therefore conclude that these principles are only conventions; but these conventions are not arbitrary, and transported to another world (which I call the non-Euclidean world and which I try to imagine), we would have been led to adopt others.<sup>57</sup> (Translation by Philippe Vincent – Poincaré 1902, p. 5)

Additionally, at this point, it should be noted that Poincaré's views on the subject are quite different. Indeed, to him *Analysis situs* experiments can only be approached but are however enough to obtain rigorous theorems, since *Analysis situs* has the advantage of being qualitative rather than quantitative:

Note also that here the empiricists are freed from one of the most serious objections that can be raised against them, that which makes absolutely vain in advance all their efforts to apply their thesis to the truths of Euclidean geometry. These truths are rigorous and all experience can only be approximated. In *Analysis Situs* the approximate experiments may be sufficient to give a rigorous theorem and, for example, if we see that space can have neither two or less than two dimensions, nor four or more than four, we are certain that he has exactly 3, because he cannot have 2 and a half or 3 and a half.<sup>58</sup> (Translation by Philippe Vincent – Poincaré S.D. b, p. 74)

Actually, Poincaré had a different philosophy of science:

Poincaré's philosophy is primarily that of a scientist originating in his own daily practice of science and in the scientific debates of his time. As such, it is strongly influenced by the reflections of Ernst Mach, James Maxwell and Hermann von Helmholtz. However, his thinking is also strongly influenced by the philosophical

---

<sup>57</sup> Un autre cadre que nous imposons au monde, c'est l'espace. D'où viennent les premiers principes de la géométrie ? Nous sont-ils imposés par la logique ? Lowatchevski a montré que non en créant les géométries non euclidiennes. L'espace nous est-il révélé par nos sens ? Non encore, car celui que nos sens pourrait nous montrer diffère absolument de celui du géomètre. La géométrie dérive-t-elle de l'expérience ? Une discussion approfondie nous montrera que non. Nous concluons donc que ces principes ne sont que des conventions ; mais ces conventions ne sont pas arbitraires, et transportés dans un autre monde (que j'appelle le monde non euclidien et que je cherche à imaginer), nous aurions été amenés à en adopter d'autres.

<sup>58</sup> Remarquons également qu'ici les empiristes sont débarrassés de l'une des objections les plus graves qu'on peut diriger contre eux, de celle qui rend absolument vains d'avance tous leurs efforts pour appliquer leur thèse aux vérités de la géométrie euclidienne. Ces vérités sont rigoureuses et toute expérience ne peut être qu'approchée. En *Analysis Situs* les expériences approchées peuvent suffire pour donner un théorème rigoureux et, par exemple, si l'on voit que l'espace ne peut avoir ni deux ou moins de deux dimensions, ni quatre ou plus de quatre, on est certain qu'il en a exactement 3, car il ne saurait en avoir 2 et demi ou 3 et demi.

doctrines of his time (those of Emile Boutroux, who was his brother-in-law, but also of Jules Lachelier, William James, etc.), and is imbued with the neokantism that was very much in vogue. Nevertheless, one must not assume that Poincaré’s “Kantian” vocabulary is exactly that of the German philosopher, given that Poincaré often radically changes the meaning of Kant’s terms. (Heinzmann 2017, via URL: <https://plato.stanford.edu/archives/win2017/entries/poincare/>)

Beyond the fact that, as mathematicians and geometers, they were both trained in these fields and even made significant contributions on the matter, we have to note that their births happened within a time interval just shy of a decade. Therefore, they ought to have had access to the same mathematical tools and contemporary theories in principle.

However, even though the two men shared different cultures and nationalities, and therefore different educations, opinions and views, it is nevertheless noteworthy to remark that they used two radically different approaches. Nonetheless, they managed to reach insights on the physical nature of space which in retrospect share deep ontological similarities and which foreshadowed the intellectual development that would ultimately lead to our modern understanding of gravitational waves.

On one hand, Clifford, by exposing and sharing his reasoning and conceptions in rather popular writings, which we would certainly qualify nowadays as scientific mediation, proceeds by following an inductive approach.

Similarly, he [Riemann] says, although the axioms of solid geometry are true within the limits of experiment for finite portions of our space, yet we have no reason to conclude that they are true for very small portions; and if any help can be got thereby for the explanation of physical phenomena, we may have reason to conclude that they are not true for very small portions of space.

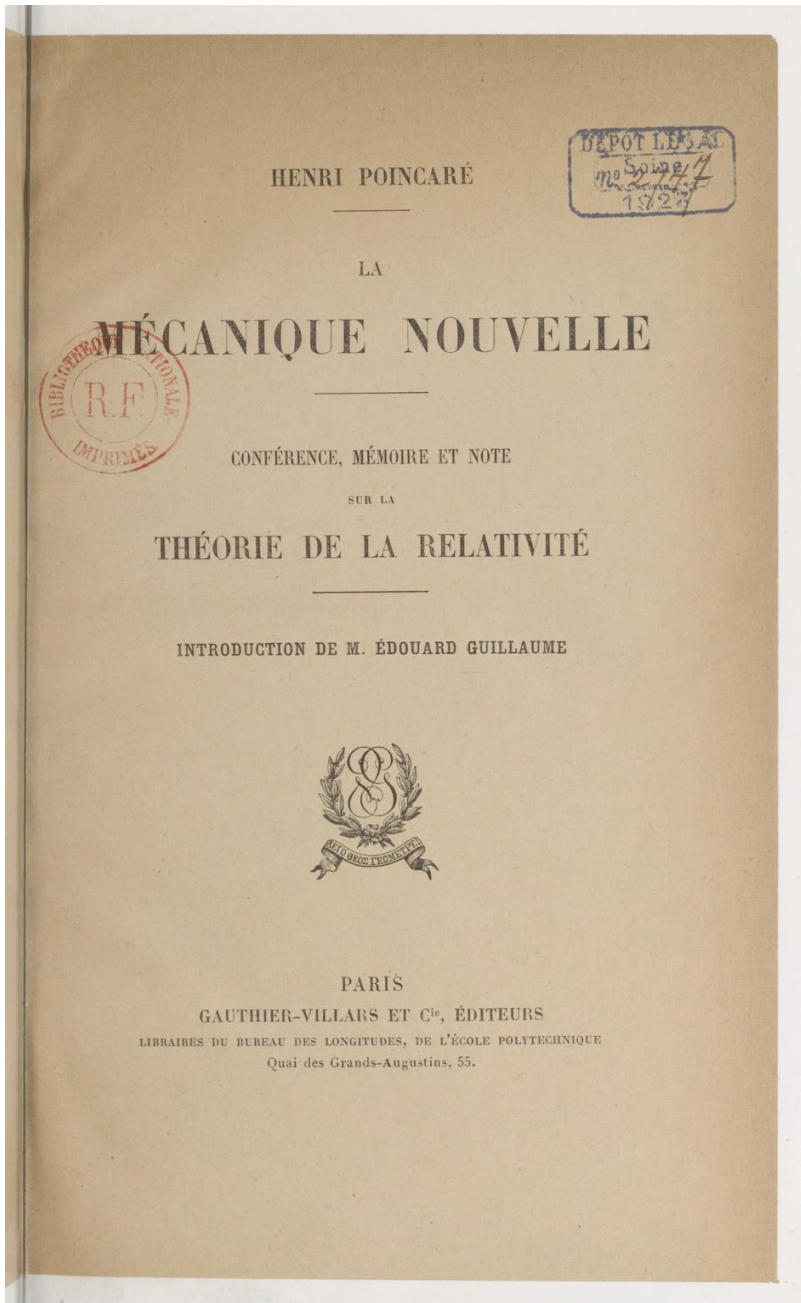
I wish here to indicate a manner in which these speculations may be applied to the investigation of physical phenomena. I hold in fact (1) That small portions of space *are* in fact of a nature analogous to little hills on a surface which is on the average flat; namely, that the ordinary laws of geometry are not valid in them. (2) That this property of being curved or distorted is continually being passed on from one portion of space to another after the manner of a wave. (3) That this variation of the curvature of space is what really happens in that phenomenon which we call the *motion of matter*, whether ponderable or etherial. (4) That in the physical world nothing else takes place but this variation, subject (possibly) to the law of continuity [...]. (Clifford 1870, pp. 157-158)

Thus, using the analogy of the sheet of paper representing a 2-dimensional space perceived as flat despite the fact that the cellulose fibers of the paper are intertwined in such a way that they become clearly apparent once the right scale has been chosen, Clifford transposed and generalized this observation to physical space. And thus, was able to formulate his “speculations”; in particular that this possible capacity of space of being curved and distorted would be “continually being passed on from one portion of space to another after the manner of a wave”. Therefore, arriving at a conceptual precursor version of gravitational waves closer to the General

Relativity Theory in essence due to the statement regarding the ability of space of being curved or distorted.

On the other hand, Poincaré's approach was more abstract, analytical, and thus more deductive in nature. Indeed, in a note to the *Académie des Sciences*, instead of starting from speculative ideas or insights obtained through his understanding of space, Poincaré's starting point is the Michelson-Morley experiment's result and the exploration of Lorentz's hypothesis of the contraction of bodies which would happen in the same direction as the movement of the Earth (see also section 3.3).

In the end, Poincaré reported his analysis, which he had expanded, and which was finally published later in his *La mécanique nouvelle* of 1923 (see Fig. 2.8.a. below).



Source gallica.bnf.fr / Bibliothèque nationale de France

**Fig. 2.8.a.** La mécanique nouvelle : conférence, mémoire et note sur la théorie de la relativité / Henri Poincaré ; introduction de M. Édouard Guillaume, Frontispice.

Source: Public Domain, <https://gallica.bnf.fr/ark:/12148/bpt6k9801836f>

In 1905, Poincaré explained:

[...] Lorentz sought to complete and modify his hypothesis so as to bring it into line with the postulate of the complete impossibility of determining absolute motion. This is what he managed to do in his article entitled *Electromagnetic phenomena in a system moving with any velocity smaller than that of light* (*Proceedings of the Amsterdam Academy*, May 27, 1904).

The importance of the question determined me to take it up again; my results agree on all important points with those of Lorentz; I was only led to modify them and supplement them in a few details.<sup>59</sup> (Poincaré 1905, p. 1505)

However, after this preliminary analysis, Poincaré turned his attention to a complement of Lorentz's hypothesis stating that in fact all forces, no matter their nature were in fact subject to this.

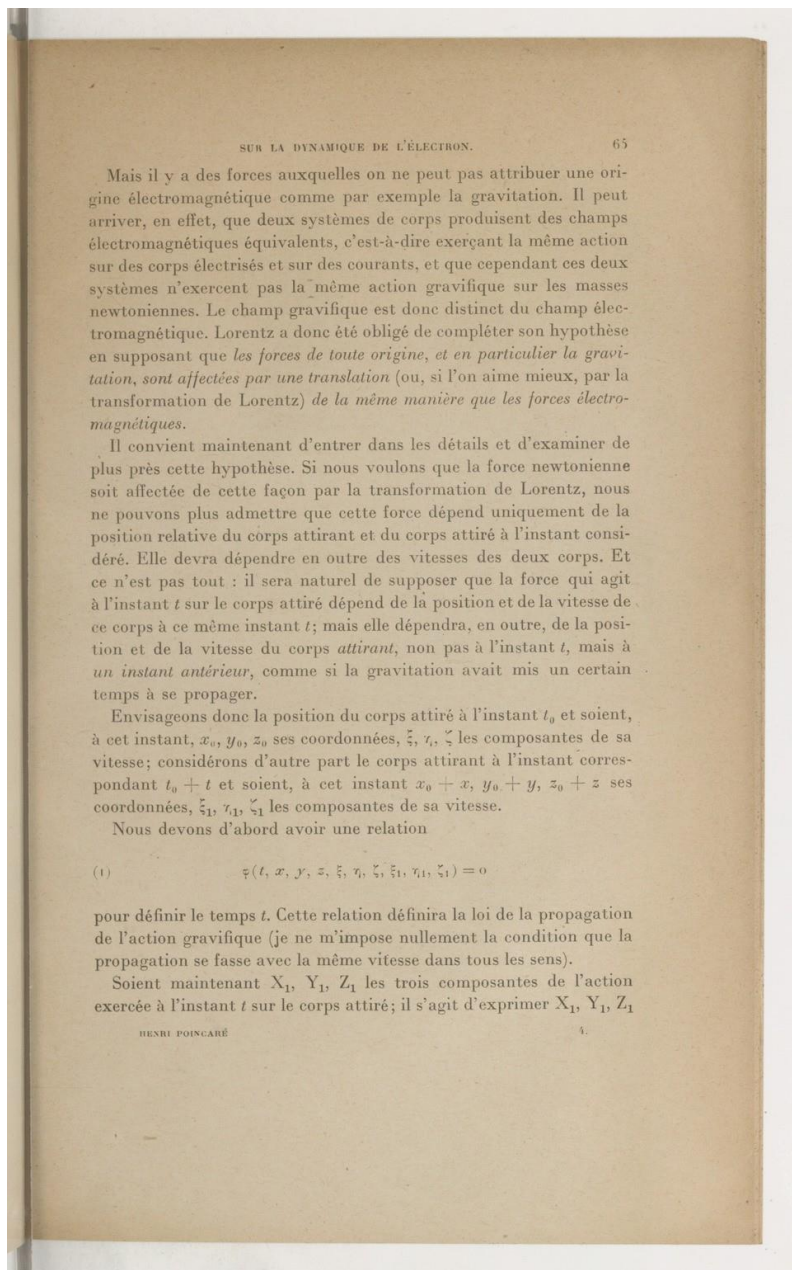
Consequently, Poincaré sought to explore this hypothesis further and in particular its consequences in regard to the modifications it implied for the laws of gravitation. In particular, and as Poincaré explained later in *La mécanique nouvelle*, if Lorentz's contraction is admitted, and most notably by considering two distances as being equal if the time taken by light to travel through them is equal, then the consequence would be that if the speed of gravity was the same as the speed of light, then it would be a consequence of a function of the ether (Poincaré 1923, p. 21).

Furthermore, Poincaré noted that in order for gravity to be affected by the Lorentz transform, then it would no longer be only affected by the respective position of the bodies, but also by their speed “as if gravitation had taken some time to propagate” (Ivi. p. 65 – see Fig. 2.8.b. below) and thus prompting Poincaré to use the concept of gravitational wave in a framework much closer to Special Relativity already in 1905.

---

<sup>59</sup> [...] Lorentz a cherché à compléter et à modifier son hypothèse de façon à la mettre en concordance avec le postulat de l'impossibilité *complète* de la détermination du mouvement absolu. C'est ce qu'il a réussi à faire dans son article intitulé *Electromagnetic phenomena in a system moving with any velocity smaller than that of light* (*Proceedings de l'Académie d'Amsterdam*, 27 mai 1904).

L'importance de la question m'a déterminé à la reprendre ; les résultats que j'ai obtenus sont d'accord sur tous les points importants avec ceux de Lorentz ; j'ai été seulement conduit à les modifier et à les compléter dans quelques points de détails.



Source gallica.bnf.fr / Bibliothèque nationale de France

**Fig. 2.8.b.** La mécanique nouvelle : conférence, mémoire et note sur la théorie de la relativité / Henri Poincaré ; introduction de M. Édouard Guillaume, p. 65. Source: Public Domain, <https://gallica.bnf.fr/ark:/12148/bpt6k9801836f/r91.image>

Particularly in this section I have highlighted the two different ways in which Clifford and Poincaré have reached their conclusions. The differences



between, the speculative aspect of Clifford’s *On the Space-Theory of Matter* and Poincaré’s note *Sur la dynamique de l’électron* are both related to the methodological aspects and the content. Below, I present a comparative analysis on this issue:

**Table. 2.8.** Historical Comparative Analysis between Clifford and Poincaré.

Clifford (1845-1879) 1870. <i>On the Space-Theory of Matter</i>	Poincaré (1854-1912) 1905. <i>Sur la dynamique de l’électron</i>
<b>General Fundamental Conceptions</b>	
. Topology of space	. Motion with respect of the Ether
. Space is non-Euclidean “for very small portions of space” ( <i>Ivi.</i> p. 158)	. “Absolute movement of the Earth” ( <i>Ivi.</i> p. 1504)
. Space curvature	. Distortion of bodies in the direction of motion
	. gravitation
	. The speed of light is finite
	. Lorentz’s transformations can be applied to the laws of gravitation
	. Gravity propagates “at the speed of light” ( <i>Ivi.</i> p. 1507)
	. The delayed effects of gravity due to the finite speed of gravity imply relativity and the emission of “gravitational waves” ( <i>Ibidem</i> )
<b>Interplay Theory-Experience</b>	
. Inductive Theoretical speculation	. Deductive Theoretical analysis only
. Space is analogous to a sheet of paper	Poincaré did not treat the subject
. Can help for “the explanation of physical phenomena” ( <i>Ibidem</i> )	
. Space curvature propagation “after the manner of a wave” ( <i>Ibidem</i> )	
. The variation of space curvature is responsible for “the motion of matter” ( <i>Ibidem</i> )	

Interplay Theory-Experiment	
. “Axioms of geometry are true within the limits of experiments” ( <i>Ivi</i> , p. 158)	. “The Michelson-Morley experiment seems to indicate that the determination of the absolute movement of the Earth is a fact of nature” ( <i>Ivi</i> , p. 1504)
. Astronomical observations are not precise enough	. Astronomical observations are not precise enough
. Might explain “the law of double refraction” ( <i>Ibidem</i> )	
. The presence of the Moon should distort space which distortion might be measurable during an eclipse through its effects on the law of double refraction	
Problems Connected to the Cultural Environment	
. Focus on space curvature	. Focus on Ether
. Possible: Eclipse Expedition	. Experiments are conceived easier than done

When comparing the items present in the table above which summarize the essential points made by Clifford and Poincaré, it seems retrospectively clear from the respective similarity of the used concepts that the development of both Special and General Relativity was imminent.

Also, it is interesting to note that there is a 35 years difference between the two publications and that conceptually they appeared in reverse order compared to the development of Special and General Relativity; i.e. Clifford’s paper which is conceptually closer to General Relativity came first.

Furthermore, the extended version of Poincaré’s *Sur la dynamique de l’électron* that was published in his *La mécanique nouvelle* explicitly included the mention of the “*Postulat de Relativité*” (Poincaré 1923, p. 18).

## 2.9 The *Ultraviolet Catastrophe*

The *Ultraviolet Catastrophe*, also known as the *Rayleigh-Jeans catastrophe* is the name given to the crisis in physics that arose from the study of blackbody radiation measurements. The name was coined by Paul Ehrenfest (1880-1933), an Austrian physicist in 1911.

The concept of a blackbody takes its origins from Gustave Robert Kirchhoff (1824-1887) who was a German physicist (Kirchhoff 1901, p. 76). Kirchhoff worked on thermal radiation as part of his studies on the solar spectrum and the spectra of the chemical elements (Kirchhoff 1862); during his research in the 1850s and early 1860s he managed to make several interesting observations and findings about the temperature of objects and how the radiations emitted depended on it:

[...] it may happen that the spectrum appears to be totally changed, when the mass of the vapour is altered. Change of temperature appears to produce an effect similar to this alteration in the mass of the incandescent vapour. If the temperature be raised, no deviation of the maxima of light is observed, but the intensities of the lines increase so differently that those which are most plainly seen at a high temperature are not the most visible at a low temperature. This influence of the mass, and of the temperature of the incandescent gas, explains perfectly why in the spectra of many metals those lines which are the most prominent [...] are not the most distinct when the spectrum of the induction-spark from the metal is examined. (*Ivi.* p. 12)

And:

We learn how far this supposition is correct, by help of a theorem which I have enunciated, and believe to be of great importance. The theorem considers rays of heat in general; not merely those rays of heat which produce an impression on the eye, and which we therefore call rays of light. It affirms that for each sort of ray the relation between the power of emission and the power of absorption is, at the same temperature, constant for all bodies<sup>60</sup>. In this theorem, however, I suppose that the bodies only emit rays in consequence of the temperature to which they are heated, and that all the rays which are absorbed are transformed into heat [...](*Ivi.* p. 17)

Which ultimately led the Kirchhoff law of Thermodynamics to bear his name.

With this law, an ideal black body is an object in thermal equilibrium absorbing all light (no matter the frequency or wavelength), hence the *black* in black body, and thus emitting light solely depending on its temperature; since all light is absorbed and nothing is reflected.

A more visual representation of this kind of object, given by John William Strutt, Lord Rayleigh (1842-1919) in 1900 (Kuhn 1978, p. 144) can be understood as a cavity or some kind of box with a small opening through

---

<sup>60</sup> For the more precise definition of the terms occurring in this theorem, for its proof, and the conclusions which may be drawn therefrom, see *Philosophical Magazine*, Vol. xx. p. I, and Pogendorff's *Annalen*, Bd. 109, p. 275.

which light is shone, while the cavity or box itself is placed in a dark room (with no light) or inside some kind of dark oven. The light which is shone into the object is thus fully absorbed according to its ideal ability to perfectly absorb all light, and thus the temperature of this ideal object rises until reaching thermal equilibrium, at which point its temperature can be measured by the light it emits through thermal radiation.

From this point on, as thermal radiation was more and more researched, a relation between temperature and thermal radiation based on empirical data was found in 1879 by Josef Stefan (1835-1893) (Stefan 1879) and a bit later derived by Ludwig Boltzmann (1844-1906):

The rate  $P_{\text{rad}}$  at which an object emits energy via electromagnetic radiation depends on the object's surface area  $A$  and the temperature  $T$  of that area in kelvins and is given by:

$$P_{\text{rad}} = \sigma \epsilon A T^4 \quad (18-38)$$

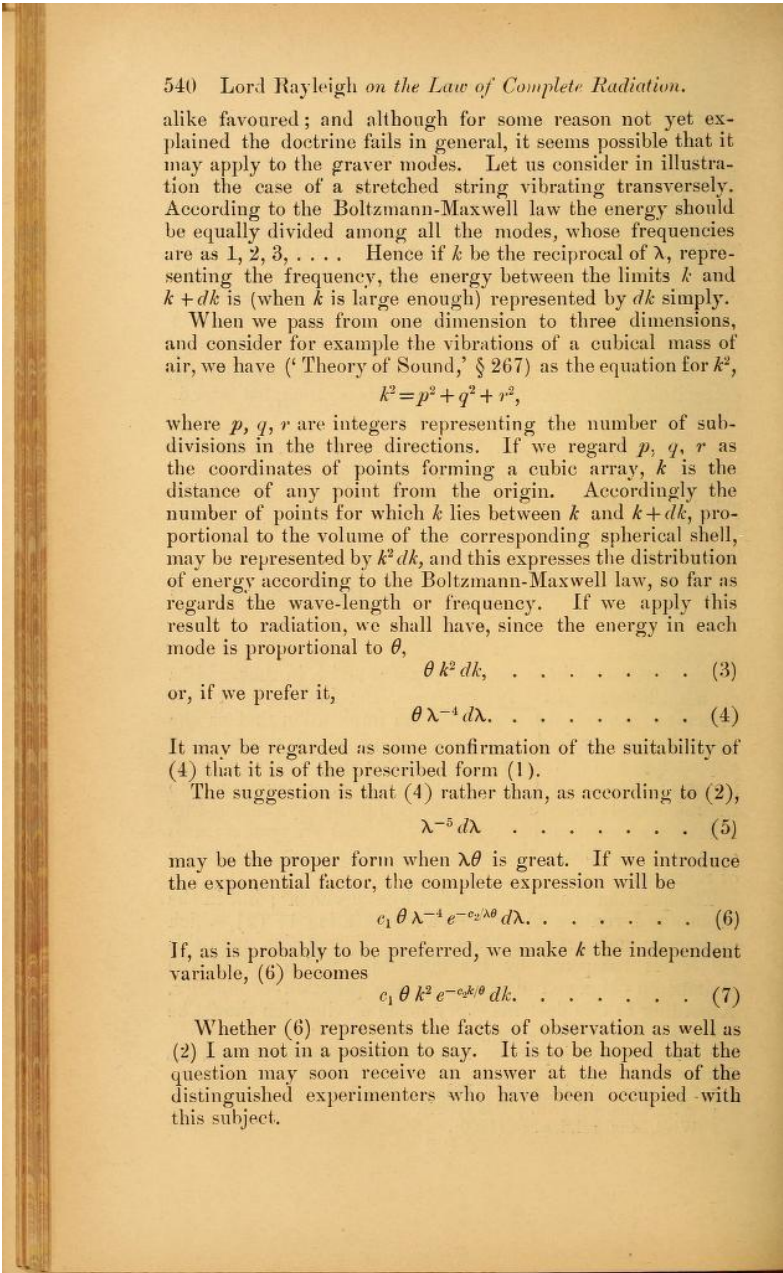
Here  $s = 5.6704 \times 10^{-8} \text{ W/m}^2 \cdot \text{K}^4$  is called the *Stefan-Boltzmann constant* after Josef Stefan (who discovered Eq. 18-38 experimentally in 1879) and Ludwig Boltzmann (who derived it theoretically soon after). The symbol  $\epsilon$  represents the *emissivity* of the object's surface, which has a value between 0 and 1, depending on the composition of the surface. A surface with the maximum emissivity of 1.0 is said to be a *blackbody radiator*, but such a surface is an ideal limit and does not occur in nature. Note again that the temperature in Eq. 18-38 must be in kelvins so that a temperature of absolute zero corresponds to no radiation. (Walker 2011, p. 496)

More than a decade later, in 1893 Wilhelm Wien (1864-1928) enunciated his displacement law to which his name was given: Wien's displacement law. This law was an attempt to describe at what wavelength the peak intensity of thermal radiation was situated at a certain temperature but ultimately failed to match empirical data for large wavelengths.<sup>61</sup>

In June 1900 in *Remarks upon the Law of Complete Radiation* (Rayleigh 1900), using classical reasoning, Lord Rayleigh derived that the distribution of energy increases with regards to the frequency as a square (cfr. Figure below).

---

<sup>61</sup> Cfr. <https://www.nobelprize.org/prizes/physics/1911/wien/facts/>



540 Lord Rayleigh on the Law of Complete Radiation.

alike favoured; and although for some reason not yet explained the doctrine fails in general, it seems possible that it may apply to the graver modes. Let us consider in illustration the case of a stretched string vibrating transversely. According to the Boltzmann-Maxwell law the energy should be equally divided among all the modes, whose frequencies are as 1, 2, 3, . . . . Hence if  $k$  be the reciprocal of  $\lambda$ , representing the frequency, the energy between the limits  $k$  and  $k + dk$  is (when  $k$  is large enough) represented by  $dk$  simply.

When we pass from one dimension to three dimensions, and consider for example the vibrations of a cubical mass of air, we have ('Theory of Sound,' § 267) as the equation for  $k^2$ ,

$$k^2 = p^2 + q^2 + r^2,$$

where  $p, q, r$  are integers representing the number of subdivisions in the three directions. If we regard  $p, q, r$  as the coordinates of points forming a cubic array,  $k$  is the distance of any point from the origin. Accordingly the number of points for which  $k$  lies between  $k$  and  $k + dk$ , proportional to the volume of the corresponding spherical shell, may be represented by  $k^2 dk$ , and this expresses the distribution of energy according to the Boltzmann-Maxwell law, so far as regards the wave-length or frequency. If we apply this result to radiation, we shall have, since the energy in each mode is proportional to  $\theta$ ,

$$\theta k^2 dk, \dots \dots \dots (3)$$

or, if we prefer it,

$$\theta \lambda^{-4} d\lambda. \dots \dots \dots (4)$$

It may be regarded as some confirmation of the suitability of (4) that it is of the prescribed form (1).

The suggestion is that (4) rather than, as according to (2),

$$\lambda^{-5} d\lambda \dots \dots \dots (5)$$

may be the proper form when  $\lambda\theta$  is great. If we introduce the exponential factor, the complete expression will be

$$c_1 \theta \lambda^{-4} e^{-c_2/\lambda\theta} d\lambda. \dots \dots \dots (6)$$

If, as is probably to be preferred, we make  $k$  the independent variable, (6) becomes

$$c_1 \theta k^2 e^{-c_2 k/\theta} dk. \dots \dots \dots (7)$$

Whether (6) represents the facts of observation as well as (2) I am not in a position to say. It is to be hoped that the question may soon receive an answer at the hands of the distinguished experimenters who have been occupied with this subject.

**Figure 2.8.a:** The London, Edinburgh and Dublin philosophical magazine and journal of science, 5<sup>th</sup> ser. v. 49 Jan-June 1900, p. 540. Source: Public Domain | Archive.org | <https://archive.org/details/londonedinburgh549190lond/page/540/mode/2up>

However, classical interpretations of Physics at that time could not explain the empirical data. On this Kuhn wrote:

To discover the dependence of energy density on temperature, he appealed next to a very different set of considerations, which led to what he called “the Maxwell-Boltzmann doctrine of the partition of energy”. Subsequently better known as the equipartition theorem, it specifies that in any mechanical system each degree of freedom will on the average possess the same kinetic energy. (Kuhn 1978, p. 146)

In more modern terms, an object with thermal energy will see its constituting particles vibrate, rotate and move in every way possible; or in other words, at equilibrium, energy is evenly spread between all possible energy states. From these assumptions of particles’ thermal motions and the frequencies of all the thermal radiations Planck deduced from his research (*Ibidem*; Boya 2004, p. 7):

$$u_{\lambda} d\lambda = \frac{8\pi kT}{\lambda^4} d\lambda \left( = \frac{8\pi v^2}{c^3} kT dv \right)$$

That equation, usually in its wavelength form, is what came after 1905 to be known as the Rayleigh-Jeans law, but it is not the law proposed in 1900 by Rayleigh. (*Ibidem*)

The Rayleigh-Jeans law described the blackbody spectrum very well for low frequency infrared light but for higher frequencies like visible or ultraviolet light, the predicted values for brightness were unreasonably too high as it predicted that brightness should have approached infinity as frequency increased. This resulted in calling this inconsistency in the theory of the time the *Ultraviolet Catastrophe*.

This *Catastrophe* implied that something was fundamentally wrong with the theories used to deduce the relation. On this matter, Louis de Broglie (1892-1987) even wrote in his thesis:

Lord Kelvin, in 1900, announced that there were two threatening dark clouds on the horizon of Physics. One of these clouds represented the difficulties raised by the famous Michelson and Morley experiment which seemed incompatible with the preexistent ideas. The second cloud represented the failure of the methods of Statistical Mechanics in the domain of blackbody radiation; the equipartition theorem of energy, rigorous consequence of Statistical Mechanics, leading effectively to a well-defined repartition of energy between the diverse frequencies of the radiation of thermal equilibrium; however, this law, the Rayleigh-Jeans law, is in gross contradiction with experience and is itself almost absurd as it predicts an infinite value for the total energy density, which obviously does not make any physical sense.<sup>62</sup> (Translation by Philippe Vincent – De Broglie 1925, p. 26)

---

<sup>62</sup> Lord Kelvin, en 1900, annonçait que deux nuages noirs apparaissaient menaçants à l’horizon de la Physique. L’un de ces nuages représentait les difficultés soulevées par la fameuse expérience de Michelson et Morley qui paraissait incompatible avec les idées alors reçues. Le second nuage représentait l’échec des méthodes de la Mécanique statistique dans le domaine du rayonnement noir ; le théorème de l’équipartition de l’énergie, conséquence rigoureuse de la Mécanique statistique, conduit en effet à une

In the end, this crisis came to a resolution most notably thanks to the works of Planck, Einstein and Paul Ehrenfest (1880-1933) and the realization that the problem laid in the interpretation that in classical physics everything can be divided infinitely. For instance, the equipartition theorem allowed particles' motion to take all and any value, no matter how infinitesimally small. Searching for a new mathematical approach to derive the blackbody spectrum, in his famous “act of desperation” (Giulini 2000; Boya 2004, p. 8), Planck was led to suppose that constraints existed on these motions, and thus that there was a finite number of possible motions (or at least a denumerable one), thus resulting that a blackbody could only absorb or emit energy in specific amounts, or packets. Finally, on December 14<sup>th</sup>, 1900, Planck presented the relation perfectly describing the shape of the blackbody spectrum he found in *Zur Theorie des Gesetzes der Energieverteilung im Normalspektrum* (Planck 1900), or in English, *On the Theory of the Law of Energy Distribution in Normal Spectrum* (Planck 1901) which is now called Planck's law:

$$B_\nu = \frac{2h\nu^3}{c^2} \frac{1}{e^{h\nu/k_bT} - 1} \quad (2.10)$$

where  $B_\nu$ , the brightness at a frequency  $\nu$  is a function of a constant  $h$  (the now called Planck's constant),  $c$ , is the speed of light,  $k_b$  is the Boltzmann constant and  $T$  the temperature. Kuhn wrote:

To achieve Planck's result, conservation of energy and of the number of vibrators or vibration modes would have to be supplemented by some additional constraint, foreign to classical theory. One such constraint, Ehrenfest pointed out in closing, would be to restrict the energy of each vibration mode to integral multiples of the energy element  $h\nu$ . (Kuhn 1978, p. 143)

In this same communication, Planck estimated this “universal constant” (Planck 1901, p. 6) to have a value of  $h = 6.55 \times 10^{-27}$  erg.sec (*Ibidem*) from measurements of other scientists, namely F. Kurlbaum (1857-1927), Otto Lummer (1860-1925) and Ernst Pringsheim (1859-1917): “Die mitgeteilten Zahlenwerte von  $h$  und  $k$  habe ich aus dieser Formel nach den Messungen von Ferdinand Kurlbaum und von O. Lummer und E. Pringsheim” (Planck 1900, p. 242).

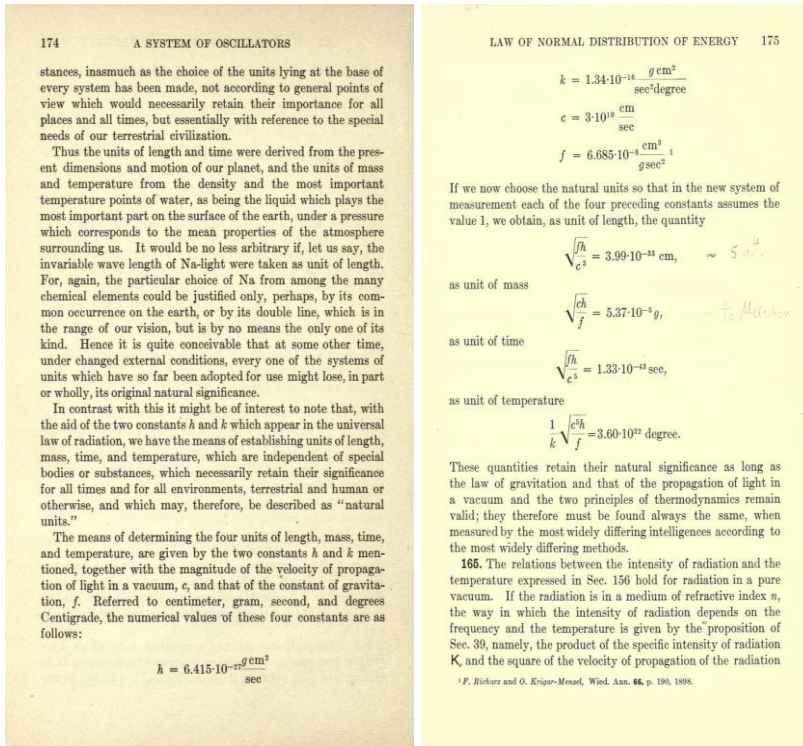
In the end Planck called those packets *quanta*, won the 1918 Nobel Prize “in recognition of the services he rendered to the advancement of Physics by his discovery of energy quanta”<sup>63</sup> and by doing so paved the way to Quantum Mechanics.

---

répartition bien définie de l'énergie entre les diverses fréquences dans le rayonnement d'équilibre thermodynamique ; or, cette loi, la loi de Rayleigh-Jeans, est en contradiction grossière avec l'expérience et elle est même presque absurde car elle prévoit une valeur infinie pour la densité totale de l'énergie, ce qui évidemment n'a aucun sens physique

<sup>63</sup> Cfr. <https://www.nobelprize.org/prizes/physics/1918/planck/facts/>

In 1914, important results of Planck’s investigations were published. Among those, one can find the establishment that the constant  $h$  can be mathematically linked to other quantities and by doing so, setting new units for them. By taking into account the other constants and manipulating their units, he obtained the minimum theoretical units of length, mass, time and temperature (Cfr. figures below):



**Fig. 2.8.b.** Planck M (1914) The theory of heat radiation, by Dr. Max Planck authorized translation by Morton Masius, M. A. Ph. D. (Leipzig), P. Blakiston’s Son & Co. 1012 Walnut Street, Philadelphia. Source : Public Domain | Archive.org | <https://archive.org/details/theoryofheatradi00planrich/page/142/mode/2up>

These are the smallest theoretical physical quantities beyond which the very notions of the quantities they define lose their physical meaning. In other words, taking the example of length, using this relation gives us the value of a *Planck’s length* which is the smallest distance to which physical meaning can be assigned. By extension, this also can be understood as the smallest length on which gravity could have an effect; this is also the scale at which space-time is theorized to become quantized in Loop Quantum Gravity theory and the scale and size of the *strings* in String Theory (Mead 2001).

However, it should be noted that although Planck managed to figure out this law, he did not realize how fundamental the result of having quantified energies was (Giulini 2000). Moreover, to add to that fact, even Planck



himself clarified this point, that to carry his analysis in such a way it was an obligation to use a discrete quantity:

It is now a matter of finding the probability  $W$  so that the  $N$  resonators together possess the vibrational energy  $U_N$ . Moreover, it is necessary to interpret  $U_N$  not as a continuous, infinitely divisible quantity, but as a discrete quantity composed of an integral number of finite equal parts. (Planck 1901, p. 2)

This passage clearly indicating that this discrete treatment of the problem has nothing to do with an insight about the fundamental physical phenomena, but rather a side effect of an insight of how to treat the problem. Moreover, Thomas Kuhn argued that Planck's theory was still classical in essence at that time and that the more familiar interpretation of what is actually happening arrived quite some time later:

[Talking about Planck's first quantum papers] They were not, I now saw, a fresh start, an attempt to supply an entire new theory. Rather they aimed to fill a previously recognized gap in the derivation of Planck's older theory [...] In particular, the arguments in Planck's first quantum papers did not, as I now read them, seem to place any restrictions on the energy of the hypothetical resonators that their author had introduced to equilibrate the distribution of energy in the black-body radiation field. Planck's resonators, I concluded, absorbed and emitted energy continuously at a rate governed precisely by Maxwell's equations. His theory was still classical. [...] Even in the middle of 1906, neither restrictions on classically permissible energy nor discontinuities in the processes of emission or absorption were to be found in Planck's work. Those are, however, the central conceptual novelties we have come to associate with the quantum, and they have invariably been attributed to Planck and located in his work at the end of 1900. (Kuhn 1978, p. viii)

Indeed, it is in fact Einstein who realized that it was actually light itself that had to be quantized with his 1905 theory of light quanta and who found the explanation to Planck's quantized vibration modes which were in fact quantized because they could only emit or absorb light in *packets* of a specific energy, *indivisible quanta* of light. Einstein got this realization during his study of the photoelectric effect, a physical phenomenon in which electrons are stripped from matter by electromagnetic radiation.

Although counterintuitive, the results of the experiments showed that the energy of the ripped electrons depended on the frequency of the electromagnetic radiation but did not depend on the intensity of the radiation. The explanation of this phenomenon given by Einstein led him to earn the Nobel Prize of 1921 "for his services to Theoretical Physics, and especially for his discovery of the law of the photoelectric effect"<sup>64</sup>. The name of photons, part waves, part particles, was given to these quanta of light which carry a quantum energy equal to the frequency of the wave times the Planck's constant:

$$E = h\nu \quad (2.11)$$

---

<sup>64</sup> Cfr. <https://www.nobelprize.org/prizes/physics/1921/summary/>

It is also interesting to read what the thoughts were of Louis De Broglie on this very matter; he wrote:

The study of the photoelectric effect uncovered a new enigma. The expulsion by matter of electrons in motion under the influence of radiation is called the photoelectric effect. The experience shows, paradoxically, that the energy of the expelled electrons depends on the frequency of the excitatory radiation and not on its intensity. Mr. Einstein, in 1905, has given an account of this strange phenomenon by admitting that the radiation can be absorbed only by quanta consequently, if the electron absorbs the energy  $h\nu$  and if to leave the matter it must spend a work  $w$  its final kinetic energy will be  $h\nu - w$ . This law was found to be well verified. With his deep intuition, Mr. Einstein felt that there was some reason to return in some way to the corpuscular concept of light and hypothesized that all radiation of frequency  $\nu$  is divided into atoms of energy of value  $h\nu$ . This assumption of quanta of light (licht quanten) in opposition to all the facts of Wave Optics was considered too simplistic and rejected by most physicists. While MM. Lorentz, Jeans, and others objected to him fiercely. Mr. Einstein retaliated by showing how the study of fluctuations in black radiation also led to the concept of discontinuity of radiant energy.<sup>65</sup> (Translation by Philippe Vincent – De Broglie 1925, p. 29)

Thus giving us a direct testimony about the historical context and the state the scientific community was in at that time, as well as some stances taken by some of the greatest names of Physics regarding this *quantization* of energy.

## 2.10 Charles Fabry (1867-1945) & Alfred Perot (1863-1925)

Regarding the history of the physics of waves and in particular the study of electromagnetic waves and their applications, it seems quite necessary to discuss the interferometer of Charles Fabry and Alfred Perot; especially so,

---

<sup>65</sup> L'étude de l'effet photoélectrique souleva une nouvelle énigme. On nomme effet photoélectrique l'expulsion par la matière d'électrons en mouvement sous l'influence d'un rayonnement. L'expérience montre, fait paradoxal, que l'énergie des électrons expulsés dépend de la fréquence du rayonnement excitateur et non de son intensité. M. Einstein, en 1905, a rendu compte de cet étrange phénomène en admettant que la radiation peut être absorbée uniquement par quanta dès lors, si l'électron absorbe l'énergie  $h\nu$  et s'il doit pour sortir de la matière dépenser un travail  $w$  son énergie cinétique finale sera  $h\nu - w$ . Cette loi s'est trouvée bien vérifiée. Avec sa profonde intuition, M. Einstein sentit qu'il y avait lieu de revenir en quelque manière à la conception corpusculaire de la lumière et émit l'hypothèse que toute radiation de fréquence  $\nu$  est divisée en atomes d'énergie de valeur  $h\nu$ . Cette hypothèse des quanta de lumière (licht quanten) en opposition avec tous les faits de l'Optique ondulatoire fut jugée trop simpliste et repoussée par la plupart des physiciens. Tandis que MM. Lorentz, Jeans et d'autres lui faisaient de redoutables objections. M. Einstein ripostait en montrant comment l'étude des fluctuations dans le rayonnement noir conduisait aussi à la conception d'une discontinuité de l'énergie radiante

when considering the fact that one of their devices is used in the gravitational waves observatories (cfr. Chapter 4).

Alfred Perot and Charles Fabry were French physicists who both studied at the *École polytechnique*. In 1887, two years after joining the *École polytechnique*, Fabry decided to dedicate himself to teaching. He taught at high school level until 1894 when he became *Maître de conférence* and then Physics Professor at Marseille's university of Industry and Sciences. In 1921, he took the direction of the Institute of Optics at *la Sorbonne*. Meanwhile, Perot had been working at Meudon's observatory as a physicist and astronomer from 1908 after which he became professor of physics at the *École polytechnique* from 1909 to 1925 when he passed away. Fabry inherited his position the next year in 1926, was elected member of the *Académie des sciences* in 1927, and had to leave the *École polytechnique* in 1937 after founding the *Société de recherches et études en optique et sciences connexes*<sup>66</sup>.

One of the most important writings for our subject matter may very well be Fabry's "Les applications des interferences lumineuses" of 1923 (Fabry 1923) that I obtained from the Niels Bohr Library, and which is interesting both from the physical and historical points of views. Indeed, in 1923 the scientific community was still baffled and debating on the nature of light. While there was absolutely no doubt about its electromagnetic nature, the chasm dividing scientists originated from the dichotomy of interpretations of light as waves and light as made out of particles. These two visions seemed completely irreconcilable and the debates were spilling much ink because of the results of various experiments that were supporting evidence for each interpretation –e.g. Young's double slit experiment; the photoelectric effect (cfr. Sections 2.5 & 2.7)–.

The first interesting point about this work is that Fabry did not concern himself much with this debate or even allude to it, however it could be inferred from the very first sentence of this work that he probably would have sided with the *light as waves camp*:

**1. Theories about light.** – The direct study of luminous phenomena, independently from any hypothesis, leads to the following conclusion:

Light consists of a periodical perturbation that propagates.<sup>67</sup> (Author's bold, translation by Philippe Vincent – *Ivi*. p. 1)

And this is further confirmed in the next paragraph:

About the very nature of this perturbation, diverse interpretations can come to mind. Having shown in an irrefutable way that light is caused by the propagation of a periodical phenomenon, FRESNEL, and the physicists of the beginning of the 19<sup>th</sup> century admitted that this phenomenon was nothing but the deformation of an

---

<sup>66</sup> Cfr. <https://www.safran-reosc.com/company#2>

<sup>67</sup> **1. Théories de la lumière.** – L'étude directe des phénomènes lumineux, indépendamment de toute hypothèse, conduit à la conclusion suivante:  
La lumière consiste en une perturbation périodique qui se propage.

elastic medium, which brought the propagation of light back to a *vibratory motion*.<sup>68</sup> (Translation by Philippe Vincent – *Ibidem*)

However, Fabry then described how the influence of the works of Faraday and Maxwell finally led to treating the problem from another angle:

Later, after FARADAY had accustomed physicists to the consideration of the electric field and the magnetic field as defining particular states of space, even void of matter, MAXWELL showed that light waves are electromagnetic and founded the electromagnetic theory of light [...]. It begins to take as its starting point the properties, discovered by experience, of electric and magnetic fields, and to show that light is produced by such fields, periodically and rapidly varying at each point.<sup>69</sup> (Translation by Philippe Vincent – *Ibidem*)

And finished by stating that the explanations found in this book did not concern themselves with ontological questions raised by a theory or another:

To put it better, we will only have to call upon the experimental fact recalled at the beginning, and which statement is independent of any hypothesis; there will be no need to refer to either theory. [...] Nothing is changed in the results or their mathematical expression.<sup>70</sup> (Translation by Philippe Vincent – *Ivi*. p. 2)

Fabry then continued by defining the very first notions indispensable for a physical description of the phenomena –speed, time period, wavelength... (*Ibidem*)– later discussed. It is at this point that an interesting remark can be made about Fabry's conceptions about electromagnetic waves. Indeed, he wrote:

The *speed V* is, in a vacuum, the same for all the radiations and even for all the electromagnetic disturbances, fast or slow, which one can produce. According to the best measurements, it is 299,900 kilometers per second. This number expresses one of the fundamental constants of empty space devoid of matter.<sup>71</sup> (Translation by Philippe Vincent – *Ivi*. p. 3)

---

<sup>68</sup> Quant à la nature même de cette perturbation, diverses interprétations peuvent venir à l'esprit. Ayant montré d'une manière irréfutable que la lumière a pour cause la propagation d'un phénomène périodique, FRESNEL, et les physiciens du commencement du XIX<sup>e</sup> siècle admettaient que ce phénomène périodique n'était autre que la déformation d'un milieu élastique, ce qui ramenait la propagation de la lumière à celle d'un *mouvement vibratoire*

<sup>69</sup> Plus tard, après que FARADAY eût habitué les physiciens à la considération du champ électrique et du champ magnétique comme définissant des états particuliers de l'espace, même vide de matière, MAXWELL montra que les ondes lumineuses sont des ondes électromagnétiques et fonda ainsi la théorie électro-magnétique de la lumière [...]. Elle se borne à prendre comme point de départ les propriétés, découvertes par l'expérience, des champs électriques et magnétiques, et à montrer que la lumière est produite par de tels champs, périodiquement et rapidement variables en chaque point.

<sup>70</sup> Pour mieux dire, nous n'aurons à faire appel qu'au fait expérimental rappelé au début, et dont l'énoncé est indépendant de toute hypothèse; il sera inutile de se référer à l'une ou à l'autre théorie. [...] Rien n'est changé aux résultats ni à leur expression mathématique.

<sup>71</sup> La *vitesse V* est, dans le vide, la même pour toutes les radiations et même pour toutes les perturbations électromagnétiques, rapides ou lentes, que l'on peut produire. Elle est, d'après les meilleures mesures, de 299 900 kilomètres par seconde. Ce nombre exprime

Here, it should be noted that Fabry's work is based on –the correct assumption– that all electromagnetic radiation travels in vacuum at the velocity  $c$  which he recognized as a fundamental constant of nature; which in contrast is a point of view that was probably not shared by Louis de Broglie (cfr. Section 2.7). Despite using this strong assumption, it certainly seems that with this book Fabry wanted to deploy a series of physical description while distancing himself from theoretical interpretations. This willingness to focus on what is actually observable is clearly empirical and, dare we say, almost feels like an anti-realism approach. However, this point of view is not surprising considering the title of this book and its purpose since it was clearly written as a manual or textbook laying the general theoretical bases but mainly focusing on guiding the (scientific) reader on which experiment to choose from and on how to setup his optical experiments. To illustrate this point, which is especially relevant for the development of the Fabry-Perot cavities used in the gravitational waves observatories as the finesse plays a crucial role in the interferometers (cfr. Section 4.5.1); we just have to take a look at how Fabry described the differences between theoretical modelling and the actual reality of the measurements:

**6. Conditions of sharpness of the fringes.** - We have implicitly assumed that two conditions have been met on which we have to expand.

1 ° The light source has been reduced to a point S. However a point source is only a conception of the mind: any light source has finite dimensions. [...]

2. It has been supposed that the source emits a rigorously monochromatic radiation. This requires some explanation. Simple radiations are in infinite number: they form a continuous series, like the points contained in a line segment. Rigorously monochromatic radiation is, like the point in geometry, purely an abstraction: it would correspond to a rigorously sinusoidal displacement extending indefinitely, without any disturbance: no light source can achieve such perfection. [...] All radiation is therefore a more or less extended portion of the continuous spectrum, and achieves monochromatic radiation all the better as the extent of this spectrum is narrower. A spectral line emitted by a gas is represented by an energy curve such as that of Figure 2, in which the quantity  $A B$ , difference of the extreme wavelengths, can be called the width of the line. The smaller this quantity, the finer the line.<sup>72</sup>(Author's bold, translation by Philippe Vincent – *Ivi*. p. 9)

---

l'une des constantes fondamentales de l'espace vide de matière.

<sup>72</sup> **6. Conditions de netteté des franges.** – On a implicitement supposé réalisées deux conditions sur lesquelles il faut revenir.

1° La source de lumière a été réduite à un point S. Or une source ponctuelle n'est qu'une conception de l'esprit : toute source de lumière a des dimensions finies. [...]

2° On a supposé que la source émettait une radiation rigoureusement monochromatique. Ceci exige quelques explications. Les radiations simples sont en nombre infini : elles forment une série continue, comme les points contenus sur un segment de droite. La radiation rigoureusement monochromatique est, comme le point en géométrie, une pure abstraction : elle correspondrait à un déplacement rigoureusement sinusoidal se prolongeant indéfiniment, sans aucune perturbation : aucune source de lumière ne peut réaliser une telle perfection. [...] Toute radiation est donc une portion plus ou moins étendue de spectre continu, et réalise la radiation monochromatique d'autant

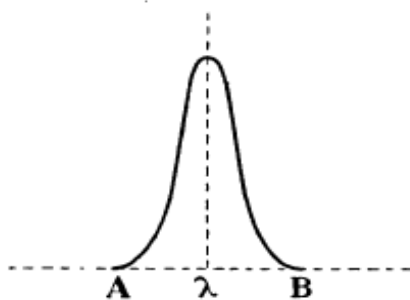


Fig. 2.

**Fig. 2.9.a.** Fabry's Fig. 2 describing the finesse  $\lambda$  of a monochromatic radiation emitted by a source of light (*Ibidem*).

Source : Public Domain | <http://hdl.handle.net/2027/mdp.39015039610848>

*On the Fabry-Perot Interferometer.* In the 14<sup>th</sup> section, Fabry described the case of the "Interférences à ondes multiples" (Multiple waves interferences; *Ivi.* p. 27) which is at the basis of principle behind the Fabry-Perot interferometer. The object considered is a transparent plate with two surfaces labelled P and P' which are slightly silvered (cfr. Fig. 2.8.b; *Ivi.* p. 27-28).

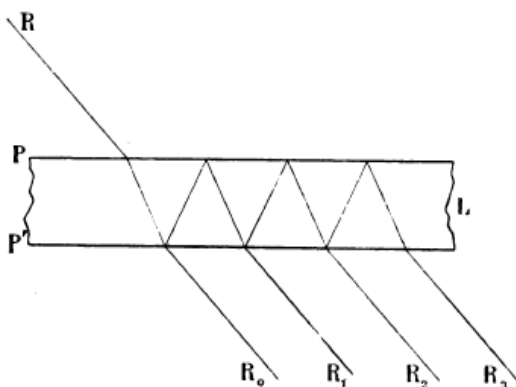


Fig. 16.

**Fig. 2.9.b.** Fabry's Fig. 16 showing the silvered transparent plate of width L reflecting an incident ray R of light multiple times ( $R_0, R_1, R_2, R_3$ ).

Source : Public Domain | <http://hdl.handle.net/2027/mdp.39015039610848>

mieux que l'étendue de ce spectre est plus étroite. Une ligne spectrale émise par un gaz est représentée par une courbe d'énergie telle que celle de la figure 2, dans laquelle la quantité A B, différence des longueurs d'onde extrêmes, peut être appelée la largeur de la raie. Plus cette quantité est petite, plus la raie est *fine*.

Fabry explained that the silvered transparent plate is shone at with an incident ray of light R which is then in part transmitted through the plate and in part reflected by the silver layer P'. The reflected part is then reflected again, this time by the silvered P surface before reaching the P' surface again where the same process repeats itself; thus establishing the above pattern that could potentially repeat itself *ad infinitum*. Obviously, Fabry explained, the intensity of each subsequent ray quickly decreases following an arithmetic progression (*Ibidem*).

The apparatus itself (Cfr. Fig. 2.8.c below) is described in the 17<sup>th</sup> section as “simply consisting of two slightly silvered surfaces, plane and exactly parallel” (*Ivi*.p. 35).

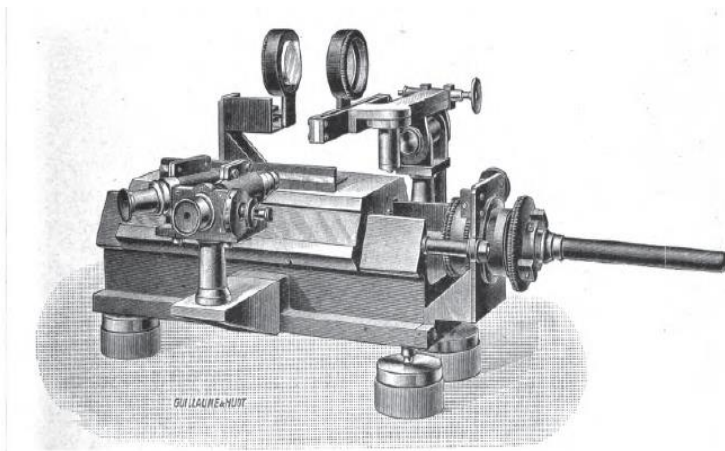


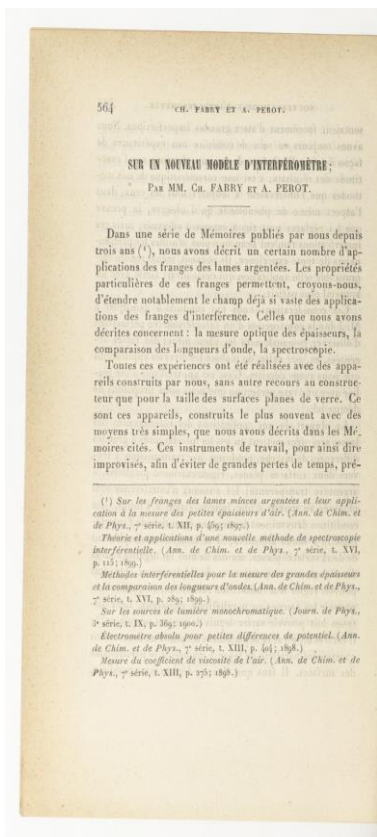
Fig. 20.

**Fig. 2.9.c.** Fabry's Fig. 20 representing the apparatus (the later so-called Fabry-Perot interferometer).

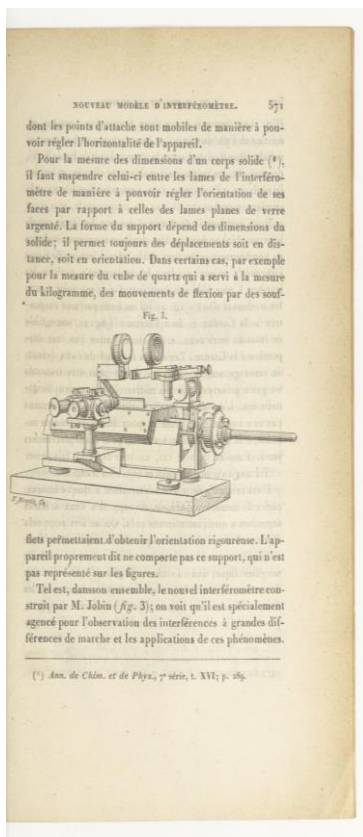
Source : Public Domain | <http://hdl.handle.net/2027/mdp.39015039610848>

At this point, it should be noted that this was not the first time this device had been described. Indeed, in 1901 in the “Annales de chimie et de physique” (Fabry 1901, pp. 564-574), Fabry and Perot co-authored a publication titled “Sur un nouveau modèle d'interféromètre” (On a new model of interferometer) in which they discuss this device and credit “Mr. Jobin”<sup>73</sup> (Cfr. Fig. 2.8.e below) for its construction:

<sup>73</sup> Amédée Louis Jobin (1861-1945)



Source gallica.bnf.fr / Bibliothèque de Météo



Source gallica.bnf.fr / Bibliothèque de Météo-France

**Fig. 2.9.d.** Fabry C (1901) Sur un nouveau modèle d'interféromètre. *Annales de chimie et de physique*, Paris, Masson et Cie, éditeurs, Libraires de l'académie de médecine, Boulevard Saint—Germain, 120, Gauthier-Villars, Quai des Grands-Augustins, 55, Paris, septième série – tome XXII (series 7, Vol. 22), p. 564 (left), 571 (right).

Source : gallica.bnf.fr / BnF |

<https://gallica.bnf.fr/ark:/12148/bpt6k9605118v/f570>

<https://gallica.bnf.fr/ark:/12148/bpt6k9605118v/f577>

Similarly to what is represented in Fig. 2.8.b., the incident ray of light goes through the first mirror and then reaches the second one where it is in part transmitted and in part reflected back to the first mirror, at which point it is reflected again to the second mirror where the process repeats itself. With each back and forth, one more subsequent ray is produced and since they are produced by the same source of light, they can easily interfere with themselves and produce an interference pattern which properties can be studied (Fabry 1923, p. 5).

Fabry then discussed in great detail how to setup the apparatus correctly both in principle, by examining how a small deviation from a perfect



parallelism of the two plates can greatly influence the calibration of the device (*Ivi.* p. 35); but also in a more down to earth way, even giving – amusingly – tips to the reader on what to buy:

In many cases, interference standards can be built up from inexpensive coins that are commercially available. The steel balls used for bicycle bearings, which can be found at a small price and with a very varied range of diameters, are cut with remarkable precision. If we randomly take three of these balls in the same batch, it is not uncommon for their diameters to be identical within 1 micron [...] <sup>74</sup> (*Ivi.* p. 37)

The rest of the book is about the different possible applications of those interferences and spectroscopy. The second chapter, is subdivided into two parts, “Application des interferences à la mesure de petits déplacements ou de petites déformations” (Application of interferences to measurements of small displacements or small deformations) and “Applications métrologiques” (Metrological Applications) which are about the study of displacements and lengths, or as Fabry put it:

These applications are already extremely numerous and varied. [...]

Although the principles are always the same, we can, from a practical point of view, divide these applications into two groups:

1 ° The ones in which the lengths to be measured are very small [...]

2 ° The applications in which the lengths to be measured are much longer and amount to thousands or even millions of wavelengths. [...] <sup>75</sup> (Translation by Philippe Vincent – *Ivi.* p. 51)

The third chapter, “Application à la mesure des petits angles” (Application to the measurement of small angles; *Ivi.* p. 99) focuses on the measure of small angles, and the fourth and final chapter “Applications à la spectroscopie” (Applications to spectroscopy; *Ivi.* p. 103) treats the subject of the applications to spectroscopy in general and its applications for astrophysics.

---

<sup>74</sup> Dans bien des cas, on peut constituer les étalons interférentiels au moyen de pièces de peu de valeur, existant dans le commerce. Les billes d’acier employées pour les roulements de bicyclettes, que l’on trouve à un prix infime et avec une série très variée de diamètres, sont taillées avec une remarquable précision. Si l’on prend au hasard trois de ces billes dans un même lot, il n’est pas rare que leurs diamètres soient identiques à moins de 1 micron près

<sup>75</sup> Ces applications sont déjà extrêmement nombreuses et variées. [...]

Bien que les principes soient toujours les mêmes on peut, en se plaçant au point de vue pratique, diviser ces applications en deux groupes :

1° Celles dans lesquelles les longueurs à mesurer sont très petites [...]

2° Les applications dans lesquelles les longueurs à mesurer sont beaucoup plus grandes et se chiffrent par milliers ou même par millions de longueurs d’onde. [...]

## 2.11 Louis-Victor Pierre Raymond De Broglie (1892-1987)

One of the great difficulties laid down by Quantum Mechanics is related to all the possible interpretations regarding both the outcomes of the theory and of its applications. However, no matter how counterintuitive or mindboggling those results are, some of their aspects are very well worth evoking if not investigating as such concepts played an immensely important role for obvious reasons both in the discovery and in the measurement of gravitational waves with gravitational wave interferometers. One of these, belonging to the history of waves in Physics, has to do with the wave-particle duality and De Broglie's associated wavelength.

Louis de Broglie, was a French physicist and mathematician. He is considered to be one of the founders of Quantum Mechanics and especially known for having been awarded the Nobel Prize in Physics of 1929 “for his discovery of the wave nature of electrons”<sup>76</sup>. In fact, in conjunction with Erwin Schrödinger (1887-1961), De Broglie is one of the great figures involved in the development of Wave Mechanics. Aside from his work that earned him the Nobel Prize, De Broglie made several other contributions especially relevant for our matter. For instance, one of De Broglie's most well-known contributions can be found in his thesis, *Recherches sur la théorie des Quanta* (Research on the theory of Quanta), published in 1924 (De Broglie 1925).

At the very beginning of the document, in the summary of his thesis, after a brief recapitulation of the two approaches of light (dynamical or wave conceptions) for optical theories, De Broglie explained how and what idea guided his investigations and finally led him to his discoveries. He wrote:

The history of optical theories shows that the scientific thinking has hesitated for a long time between a dynamical conception and a wave conception of light; these two representations are thus without a doubt less in opposition than previously supposed and the development of the Theory of Quanta seems to confirm this conclusion.

Guided by the idea of a general relation between the notions of frequency and energy, in this work we admit the existence of a periodical phenomenon which nature has yet to be determined that would be linked to any isolated piece of energy and that would depend on its proper mass via the Planck-Einstein equation. The theory of relativity leads therefore to associate to uniform motion of any material point the propagation of a certain wave which phase is moving through space faster than light.<sup>77</sup> (Translation by Philippe Vincent – DeBroglie 1925, p. 3)

---

<sup>76</sup> Cfr. <https://www.nobelprize.org/prizes/physics/1929/summary/>

<sup>77</sup> L'histoire des théories optiques montre que la pensée scientifique a longtemps hésité entre une conception dynamique et une conception ondulatoire de la lumière ; ces deux représentations sont donc sans doute moins en opposition qu'on ne l'avait supposé et le développement de la théorie des quanta semble confirmer cette conclusion.

Guidé par l'idée d'une relation générale entre les notions de fréquence et d'énergie, nous admettons dans le présent travail l'existence d'un phénomène périodique d'une nature encore à préciser qui serait lié à tout morceau isolé d'énergie et qui dépendrait de sa masse propre par l'équation de Planck-Einstein. La théorie de relativité conduit alors à

De Broglie's thesis' introduction is divided into two parts, it is a historical introduction about the main fields of physics and the state they were in from the 16<sup>th</sup> to the 20<sup>th</sup> century. In the first part, he started by evoking Newton, his work and the development of Mechanics:

Through its intervention in Acoustics, Hydrodynamics, Optics, Capillarity, Mechanics seemed to reign in all areas for an instant.<sup>78</sup> Translation by Philippe Vincent – (*Ivi.* p. 4)

And continued with major figures and their work such as Maupertuis, Hamilton, Clausius, Boltzmann, Maxwell, etc. up to 1900.

The second part is titled “Le XX<sup>e</sup> siècle: la Relativité et les Quanta” and relates how the *two dark clouds* of Lord Kelvin led to the development of the Theory of Relativity and the Theory of Quanta:

During the first years of the 20<sup>th</sup> century, Lord Kelvin's two clouds have, if I may say, condensed one into the Theory of Relativity, and the other one into the Theory of Quanta.<sup>79</sup> (Translation by Philippe Vincent – *Ivi.* p. 7)

and ends with De Broglie describing his thesis as a contribution to the attempt to unify the two seemingly exclusive interpretations on the nature of light, as waves or as particles:

In short, it seems that it was time to make an attempt to unify both the corpuscular and wave points of view and to deepen the true signification of quanta. This is what we have done recently and this thesis has for main objective to present a more complete exposition of the new ideas we have proposed, the successes to which we were led and also the numerous lacks they contain.<sup>80</sup> (Translation by Philippe Vincent – *Ivi.* p. 11)

Following this thread, it seems only natural to start from the very beginning, the foundations on which De Broglie's hypotheses rely: the new conceptions brought by Relativity. Thus, De Broglie explained that since Einstein's new theories, the relationship between mass and energy represented by the most famous formula in physics,  $E = mc^2$ , has to be understood within this paradigm. Hence: “energy has to be considered as having mass and all mass represents some energy”<sup>81</sup> (*Ivi.* p. 12); De Broglie even adds “Since there's

associer au mouvement uniforme de tout point matériel la propagation d'une certaine onde dont la phase se déplace dans l'espace plus vite que la lumière.

*N.B.:* The explanation of this last sentence can be found a bit later (*Ivi.* p. 16-18)

<sup>78</sup> Par son intervention en Acoustique, en Hydrodynamique, en Optique, en Capillarité, la Mécanique parut un instant régner sur tous les domaines.

<sup>79</sup> Dans les premières années du XX<sup>e</sup> siècle, les deux nuages de lord Kelvin se sont, si je puis dire, condensés l'un en la théorie de Relativité, l'autre en la théorie des Quanta

<sup>80</sup> Bref, le moment semblait venu de tenter un effort dans le but d'unifier les points de vue corpusculaire et ondulatoire et d'approfondir un peu le sens véritable des quanta. C'est ce que nous avons fait récemment et la présente thèse a pour principal objet de présenter un exposé plus complet des idées nouvelles que nous avons proposées, des succès auxquels elles nous ont conduit et aussi des très nombreuses lacunes qu'elles contiennent.

<sup>81</sup> l'énergie doit être considérée comme ayant de la masse et toute masse représente de

always proportionality between mass and energy, we must consider matter and energy as two synonyms designating the same physical reality”<sup>82</sup>.

He then went on by describing the results from relativity, defining proper mass from a mass in uniform motion as seen by an observer attached to it and the same mass seen by an observer at rest compared to the same object.

At this point, it might be interesting to note that De Broglie did not employ the terms “reference frame” or “frame of reference” yet (cfr. Section 2.7); and from proper mass, De Broglie gets to proper energy. From this point, De Broglie assumed that the fundamental idea behind the theory of quanta was that a definite quantity of energy could not be considered without linking it with a frequency:

It seems to us that the fundamental idea of the theory of quanta is the impossibility to consider an isolated quantity of energy without associating it with a certain frequency. This relationship is expressed by what I would call the quantum relation:

$$\text{energy} = h \times \text{frequency}$$

$h$  Planck’s constant.<sup>83</sup> (Translation by Philippe Vincent – *Ivi*. p. 13-14)

From this, De Broglie combined those two ideas into one which became the fundamental hypothesis at the basis of his work:

It can thus be conceived that because of a great law of Nature, each piece of proper energy of mass  $m_0$  is linked to a periodical phenomenon of frequency  $\nu_0$  such that we have:

$$h\nu_0 = m_0c^2$$

$\nu_0$  being measured, of course, in the system of the piece of energy. This hypothesis is the basis of our system: it is worth, like all hypotheses, as much as the consequences that can be deduced from it.<sup>84</sup> (Translation by Philippe Vincent – *Ibidem*)

l’énergie.

<sup>82</sup> Puisqu’il y a toujours proportionnalité contre la masse et l’énergie, on doit considérer matière et énergie comme deux termes synonymes désignant la même réalité physique.

<sup>83</sup> Il nous semble que l’idée fondamentale de la théorie des quanta soit l’impossibilité d’envisager une quantité isolée d’énergie sans y associer une certaine fréquence. Cette liaison s’exprime par ce que j’appellerai la relation du quantum :

$$\text{énergie} = h \times \text{fréquence}$$

$h$  constante de Planck.

<sup>84</sup> On peut donc concevoir que par suite d’une grande loi de la Nature, à chaque morceau d’énergie de masse propre  $m_0$  soit lié un phénomène périodique de fréquence  $\nu_0$  telle que l’on ait :

$$h\nu_0 = m_0c^2$$

$\nu_0$  étant mesurée, bien entendu, dans le système lié au morceau d’énergie. Cette hypothèse est la base de notre système : elle vaut, comme toutes les hypothèses, ce que valent les conséquences qu’on en peut déduire.

Using this idea, and the framework of Relativity and Minkowski's spacetime (*Ivi.* p. 125-106), De Broglie managed to show that this could lead to finding Planck's results through the introduction of “*a new hypothesis*” (*Ivi.* p. 116-97):

“If two or several atoms have phasewaves superposing exactly such that we can say that they are being transported by the same wave, then their motions cannot be considered as entirely independent and these atoms will not be treatable as distinct units for the calculations of probabilities.” The motion of these atoms “as a wave” thus would have some sort of coherence because of interactions impossible to specify [...].<sup>85</sup> (Translation by Philippe Vincent – *Ibidem*)

However, although De Broglie's results are impressive, his reasoning was impaired by the uncertainties still present at the time concerning what a photon (or “atom of light”) was. As he put it in his conclusion: “Il faut avouer que la structure réelle de l'énergie lumineuse reste encore très mystérieuse.” (“It must be admitted that the real structure of light energy is still very mysterious”, *Ivi.* p. 125). Indeed, through all his thesis, De Broglie considered that light quanta did possess a mass. For instance, he wrote:

[...] we must, because of the principle of inertia of energy, attribute a proper mass to it [an atom of light] :

$$m_0 = \frac{\varepsilon_0}{c^2}$$

This definition is entirely analogous to the one that can be given to the electron.<sup>86</sup> (Translation by Philippe Vincent – *Ivi.* p. 77)

It is an experimental fact that luminous energy travels at an indiscernible speed from the limit value of  $c$ . The speed  $c$  being a speed that energy can never reach because of the same law of variation of mass with speed, we are naturally led to suppose that radiations are formed of atoms of light traveling at speeds neighboring very close to  $c$ , but slightly inferior.<sup>87</sup> (Translation by Philippe Vincent – *Ivi.* p.78)

Indeed, based on experimental data, he even estimated that light quanta had a proper mass of  $10^{-44}$  grams (*Ivi.* p. 79).

<sup>85</sup> « Si deux ou plusieurs atomes ont des ondes de phase qui se superposent exactement dont on peut dire par suite qu'ils sont transportés par la même onde, leurs mouvements ne pourront plus être considérés comme entièrement indépendants et ces atomes ne pourront plus être traités comme des unités distinctes dans les calculs de probabilité ». Le mouvement de ces atomes « en onde » présenterait donc une sorte de cohérence par suite d'interactions impossibles à préciser [...].

<sup>86</sup> [...] il faut, d'après le principe de l'inertie de l'énergie, lui [l'atome de lumière] attribuer une masse propre :

$$m_0 = \frac{\varepsilon_0}{c^2}$$

Cette définition est entièrement analogue à celle qu'on peut donner de l'électron. [...]

<sup>87</sup> C'est un fait expérimental que l'énergie lumineuse se déplace avec une vitesse indiscernable de la valeur limite  $c$ . La vitesse  $c$  étant une vitesse que l'énergie de peut jamais atteindre en raison même de la loi de variation de la masse avec la vitesse, nous sommes tout naturellement amenés à supposer que les radiations sont formées d'atomes de lumière se mouvant avec des vitesses très voisines de  $c$ , mais légèrement inférieures.

Alternatively, in his paper *A Tentative Theory of Light Quanta* (De Broglie 2006), De Broglie arrived at a slightly different estimation:

We shall assume that the “mass at rest” of every light quantum has a given value  $m_0$  : since the atoms of light have velocities very nearly equal to the Einstein’s limiting velocity  $c$ , they must have an extremely small mass (not infinitely small in a mathematical sense) ; [...] The light quanta would have velocities of slightly different values, but such that they cannot be discriminated from  $c$  by any experimental means. It then seems that  $m_0$  should be at most of the order of  $10^{-50}$  gr. (*Ivi.* p. 447)

However, this difference is quite negligible for De Broglie’s reasoning. De Broglie’s idea is to ascribe wavelike features to bodies through the use of their energy and this led him to formulate “a theorem”:

Let us consider a moving body whose “mass at rest” is  $m_0$  ; it moves with regard to a given observer with velocity  $v = \beta c$  ( $\beta < 1$ ). In consequence of the principle of energy inertia, it must contain an internal energy equal to  $m_0 c^2$ . Moreover, the quantum relation suggests the ascription of this internal energy to a periodical phenomenon whose frequency is  $\nu_0 = \frac{1}{h} m_0 c^2$ . [...]

Let us suppose that, at time 0, the moving body coincides in space with a wave whose frequency  $\nu$  has the value given above and which spreads with velocity  $\frac{c}{\beta} = \frac{c^2}{v}$ . [...]

Our theorem is the following: –“If, at the beginning, the internal phenomenon of the moving body is in phase with the wave, this harmony of phase will always persist.” (*Ivi.* p. 449)

From which he inferred: “We are then inclined to admit that any moving body may be accompanied by a wave and that it is impossible to disjoin motion of body and propagation of wave.” (*Ivi.* p. 450)

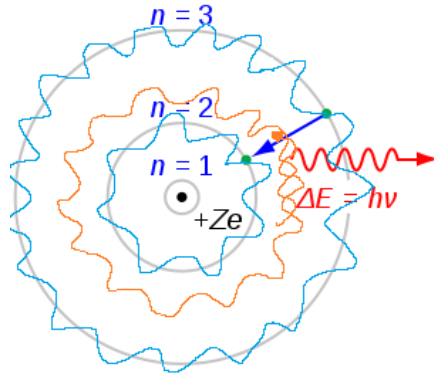
In the next part of his paper, continuing to follow those ideas and results and using Fermat’s principle and the principle of least action (*Ibidem*), De Broglie managed to give a reasonable explanation of Bohr’s stability conditions:

The present theory suggests an interesting explanation of Bohr’s stability conditions. At time 0 the electron is in a point A of its trajectory. The phase wave starting at this instant from A will describe all the path and meet again the electron in A’. It seems quite necessary that the phase wave shall find the electron in phase with itself. This is to say: “The motion can only be stable if the phase wave is tuned with the length of the path.” (*Ibidem*).

This point is particularly interesting from an Epistemological point of view, as with this statement De Broglie gave in fact a geometric interpretation and justification to the question regarding the stability of the electrons orbiting an atom. Indeed, Bohr’s atomic model of 1913 is analogous to the solar system in that it presents smaller bodies orbiting a bigger one, i.e. just like the planets are orbiting the Sun, the electrons of an atom are orbiting the core

of the atom. This atomic model (despite being incorrect) can easily be used as a simple tool for visualization to illustrate De Broglie's idea.

This idea that “The motion can only be stable if the phase wave is tuned with the length of the path” is equivalent to a geometric interpretation of the wavelike behavior of the electrons and can easily be visualized with the figure below:



**Fig 2.10.** Visualization of a geometric interpretation of De Broglie's idea. The stable electronic orbitals of the atom are the ones where tuning of the phase wave of an electron with the length of the orbital matches (in blue). An electron orbiting a hypothetical orbital (in orange) would arrive out of phase at its starting point after a whole revolution (unstable orbital) and thus would lose energy and decay to a lower orbital. Source: Philippe Vincent.

However, it should be noted that the figure above only serves as a modern illustration of what De Broglie might have considered, since it is obvious from his conclusion that this might be still quite far from what he might have actually imagined. Indeed, he wrote:

Many other questions remain open: What is the mechanism of Bragg's absorption? **What occurs when an atom passes from a stable state to another, and how does it eject a single quantum?** How may we introduce the granular structure of energy into our conceptions of elastic waves and into Debye's theory of specific heats? (Emphasis is mine - *Ivi.* p. 457)

Indeed, considering this question, it seems likely that if De Broglie actually had this exact geometric visualization in mind he would have been able to find a justification for this very question. Whatever the case may be, the most important point De Broglie made about the close relationship between motion of a body and propagation of a wave can be found in the last part of his paper:

In the present paper it is assumed that light is essentially made up of light quanta, all having the same extraordinary small mass. It is shown mathematically that the Lorentz-Einstein transformation joined with the quantum relation leads us necessarily to associate motion of body and propagation of wave, and that this idea gives a physical interpretation of Bohr's analytical stability conditions. (*Ibidem*)

## Final Remarks

In this chapter, from the ancient Aristotelian ideas of motion with elements trying to return to their natural places to the development of modern science with Galileo and Newton's Theory of Gravitation I have explored the historical foundations of the concept of gravity. Then with Riemann and Clifford to Heaviside and Poincaré, I have examined the actual physical understanding of natural philosophers regarding the ontological nature of space and gravity propagation and their considerations about the nature of the transmission of gravity as well as the speed of gravity itself, from infinite to finite and finally to the conclusion that the propagation of gravity was certainly done at the speed of light. Furthermore, I did a historical comparative analysis between Clifford and Poincaré's most remarkable work in regard to the concept of gravitational waves. Through these considerations, I accounted for the intuition of the existence of wave-like features and possible nature of the propagation of gravity, especially with Clifford through his insights about space, Heaviside through his analysis of the analogy between electromagnetism and the Newtonian theory of gravitation. Finally, I discussed the historical foundations that laid the basis for the development of the Relativity theories and Quantum Mechanics as well as the development of Physics of Waves applications necessary to have a good understanding of the principles at play in the detection of gravitational waves.



## REFERENCES

### Primary Sources

- Appell P (1925) Henri Poincaré par Paul Appell de l'Académie des Sciences. Librairies Plan, Paris.
- Aristotle (1999) *Physics*. Translation by Waterfield R. The Oxford University Press, Oxford.
- Clifford WK (1870) Lecture delivered to the Cambridge Philosophical Society February 1870, Abstract Reprint In: *Mathematical Papers W.K. Clifford*. Ed. Robert Tucker (ed). London Macmillan & Co, 1882. Reproduced in P. Pesic *Beyond Geometry* (2007) p. 73, Dover N.Y.
- Clifford WK (1867) On the Hypothesis which lie at the Bases of Geometry, *Nature*, vol 8, pp.14-17, pp. 36-37.
- Clifford WK (1873) Preliminary Sketch of Biquaternions, in *Proceedings of the London Mathematical Society* (Read June 12th 1873). Vol s1-4 (1), pp. 381-395. doi:10.1112/plms/s1-4.1.381
- Clifford WK (1875) On the Free Motion under no Forces of a Rigid System in an n-fold Homaloid, in *Proceedings of the London Mathematical Society* (Read January 13th 1876). Vol s1-7(1):67-70. doi:10.1112/plms/s1-7.1.67
- Clifford WK (1882) *Mathematical Papers*. In: Macmillan, Robert Tucker (ed.), London, reprinted on 1/p. 71.
- Clifford WK (1891) *The Common Sense of the Exact Sciences by the late William Kingdon Clifford with one hundred figures*. The International Scientific Series Volume L., D. Appleton and Company, New York, 1, 3 and 5 Bond Street.
- Clifford WK (1901a) *The Ethics of Belief*, in F.R.S. Stephen L., Pollock F. (eds.), *Lectures and essays by the late William Kingdon Clifford*, MacMillan and Co., Limited, New-York, 1901, pp. 163-205.
- Clifford WK (1901b) *The Postulates of the Science of Space*, in F.R.S. Stephen L., Pollock F. (eds.), *Lectures and essays by the late William Kingdon Clifford*, MacMillan and Co., Limited, New-York, 1901, Vol. 1, pp. 352-388.
- Clifford WK (2007) *Mathematical Papers*, American Mathematical Society, Providence, Rhode Island.
- De Broglie L (1925) *Recherches sur la théorie des Quanta*. Reproduction photographique de l'édition originale de sa thèse, parue en 1924. Retrieved: <https://tel.archives-ouvertes.fr/tel-00006807>
- De Broglie L (2006) XXXV. A Tentative Theory of Light Quanta. *Philosophical Magazine Letters*, Vol. 86, issue 7, pp. 411-423. Retrieved: <https://www.tandfonline.com/doi/full/10.1080/09500830600914721>
- Einstein A (1916) Näherungsweise Integration der Feldgleichungen der Gravitation. *Sitzungsber. Preuss. Akad. Wiss. Berlin (Math.Phys.)*, 22:688–696.
- Einstein A (1920) *Relativity The Special and General Theory*, translated by Lawson R. W., University of Sheffield, New York, Henry Holt and Company, pp. 135-137, 148-159.
- Einstein A, Rosen N (1937) On gravitational waves. *Journal of the Franklin Institute*. 223(1):43–54. Bibcode:1937FrInJ.223 | 43E. Retrieved: 2016–05–13 [see also “Näherungsweise Integration”, June 1916 and “Über Gravitationswellen”, 1918].
- Einstein A (2005) *The Born–Einstein Letters: Friendship, Politics, and Physics in Uncertain Times*, MacMillan, New York, p. 122.
- Euclid (300 BC) *Elements*
- Fabry C (1901) Sur un nouveau modèle d'interféromètre. *Annales de chimie et de physique*, Paris, Masson et Cie, éditeurs, Libraires de l'académie de médecine, Boulevard Saint—Germain, 120, Gauthier-Villars, Quai des Grands-Augustins, 55, Paris, septième série – tome XXII (series 7, Vol. 22), pp. 564-574. Retrieved : <https://gallica.bnf.fr/ark:/12148/bpt6k9605118v/f570>

- Fabry C (1923) Les applications des interferences lumineuses. Éditions de la Revue d'Optique théorique et instrumentale, 140, Boulevard du Montparnasse, Paris (XIV<sup>e</sup>).
- Galilei G (1632) Dialogo di Galileo Galilei linceo matematico sopraordinario.... : massimi sistemi del mondo tolemaico, e Copernicano ([Reprod. en fac-sim.])
- Galilei G (1890) Il Saggiatore [Galilei 1890-1909, VI, 197-372].
- Galilei G (2001) Dialogue concerning the two chief world systems, Ptolemaic and Copernican. Modern Library Classics.
- Heaviside O (1893) A Gravitational and Electromagnetic analogy. In: Electromagnetic Theory by Oliver Heaviside Vol. 1. "The Electrician" Printing and Publishing Company Limited, London, pp. 455-466.
- Heaviside O (1893a) A gravitational and electromagnetic analogy. The Electrician, 31(Part I):281-282.
- Heinzmann G, Stump D (2017) Henri Poincaré. The Stanford Encyclopedia of Philosophy, Metaphysics Research Lab, Stanford University, USA. Retrieved: <https://plato.stanford.edu/archives/win2017/entries/poincare/>
- Kirchhoff GR (1862) Solar Spectrum and the Spectra of the Chemical Elements. Translated with the author's sanction from the transactions of the Berlin Academy for 1861 by Henry E. Roscoe, B.A. MacMillan and Co., London.
- Kirchhoff GR (1901) On the Relation Between the Emissive and the Absorptive Power of Bodies for Heat and Light. In: The laws of radiation and absorption; memoirs by Prévost, Stewart, Kirchhoff, and Kirchhoff and Bunsen. American Book Company, New York, Cincinnati.
- Retrieved: <https://archive.org/details/lawsoradiationa00bracrigh/page/76/mode/2up/search/black+body>
- Kuhn TS (1978) Black-Body Theory and the Quantum Discontinuity 1894-1912. The University of Chicago Press, Chicago.
- Lobachevski N (1891) Geometrical Researches on the Theory of Parallels by Nicholas Lobachevsky translated by Dr. George Bruce Halsted, University of Texas, Austin, USA.
- Newton I ([1713] 1729) The Mathematical principles of natural philosophy. Translated by Motte Andrew. Motte B, London.
- Newton I ([1726; 1739-1742] 1822) Philosophiae Naturalis Mathematica Principia, auctore Isaaco Newtono, Eq. Aurato, perpetuis commentariis illustrata, communi studio Pp. Thomae Le Seur et Francisci Jacquier ex Gallicana minimorum familia, matheoseo professorum. Editio nova (in three volumes). Duncan, Glasgow.
- Newton I ([1729] 1846) Mathematical Principles of Natural Philosophy, by Sir Isaac Newton; Translated into English by Andrew Motte. To Which is Added Newton's System of the World ; With a portrait taken from the bust in the royal observatory at Greenwich. First American Edition, Carefully Revised and Corrected, With a Life of the Author, by N. W. Chittenden, M. A., &c. New-York Published by Daniel Adee, 45 liberty street.
- Picard CE (1913) Letter from Émile Picard to Arthur Korn – dated Paris, 6 Décembre 1913. Source: Niels Bohr Library, courtesy of the American Institute of Physics, USA.
- Picard CE (1913a) L'Oeuvre de Henri Poincaré, par Émile Picard, membre de l'institut et du bureau des longitudes. Gauthier-Villars, Imprimeur-Libraire du bureau des longitudes de l'École Polytechnique, Quai des Grands-Augustins, 55, Paris.
- Planck M (1900) Zur Theorie des Gesetzes der Energieverteilung im Normalspektrum; von M. Planck. Vorgetragen in der Sitzung vom 14. December 1900. Vgl. oben S. 235. pp. 237-245. Retrieved: <http://www.fisicafundamental.net/relicario/doc/planck1.pdf>
- Planck M (1901) On the Law of Distribution of Energy in the Normal Spectrum. Annalen der Physik, vol. 4, p. 553 ff. Retrieved: <http://strangepaths.com/files/planck1901.pdf>

- Planck M (1914) The theory of heat radiation, by Dr. Max Planck authorized translation by Morton Masius, M. A. Ph. D. (Leipzig), P. Blakiston's Son & Co. 1012 Walnut Street, Philadelphia.
- Poincaré H (S.D. a) Œuvres philosophiques (Édition définitive), Flammarion, Paris. Retrieved: <https://gallica.bnf.fr/ark:/12148/bpt6k9691658b/f11>
- Poincaré H (S.D. b) La valeur de la science : œuvres philosophiques de Henri Poincaré. Flammarion, Paris. Retrieved : <https://gallica.bnf.fr/ark:/12148/bpt6k2071994/f72.image.r=Poincar%C3%A9,%20Henri>
- Poincaré H (1920) Dernières pensées. Ernest Flammarion, éditeur. 26, Rue Racine, Paris.
- Poincaré H (1923) La mécanique nouvelle: conférence, mémoire et note sur la théorie de la relativité; introduction de M. Édouard Guillaume. Retrieved: <https://gallica.bnf.fr/ark:/12148/bpt6k9801836f>
- Plato (1925) Plato in Twelve Volumes, translated by W.R.M. Lamb. Cambridge, MA, Harvard University Press; London, William Heinemann Ltd, Vol. 9, 48b. Retrieved: <http://www.perseus.tufts.edu/hopper/text?doc=Perseus%3Atext%3A1999.01.0180%3Atext%3DTim.%3Asection%3D48b>
- Rayleigh JWS (1900) On the Law of Complete Radiation. The London, Edinburgh and Dublin philosophical magazine and journal of science, 5<sup>th</sup> ser. v. 49 Jan-June 1900, p. 540. Retrieved: <https://archive.org/details/londonedinburgh549190lond/page/540/mode/2up>
- Riemann B (1854) Ueber die Hypothesen, welche der Geometrie zu Grunde liegen. (Habilitationsschrift, 1854, Abhandlungen der Königlichen Gesellschaft der Wissenschaften zu Göttingen, 13).
- Stefan J (1879) Über die Beziehung zwischen der Wärmestrahlung und der Temperatur. Sitzungs-berichte der Akademie der Wissenschaften zu Wien, 79:391-428.

## Secondary Sources

- Barnes J (2002) The Presocratic Philosophers, Routledge, New York, p. 313.
- Baskevitch F (2008) Les représentations de la propagation du son d'Aristote à l'Encyclopédie, thesis, Université de Nantes. <tel-00423362>
- Berberan-Santos, M. N. (2005). Analytical inversion of the Laplace transform without contour integration: application to luminescence decay laws and other relaxation functions. *Journal of Mathematical Chemistry*, 38(2), 165–173. doi:10.1007/s10910-005-4961-3
- Bousquet B (2005) Les séismes de l'Antiquité, entre nature et société, actes du 16ème colloque de la Villa Kérylos à Beaulieu-sur-Mer, Académie des inscriptions et Belle-Lettres, 2006, pp. 33-59.
- Boya LJ (2004) The thermal Radiation Formula of Planck (1900). *Rev. Academia de Ciencias, Zaragoza*. 58 (2003) 91-114. Retrieved: <https://arxiv.org/abs/physics/0402064v1>
- Brown K (2018) Reflections on Relativity, lulu.com, Chap.3.2. Retrieved: <https://www.mathpages.com/rr/s3-02/3-02.htm>
- Castelvecchi D., Witze A. (2016). "Einstein's gravitational waves found at last" [online]. URL: <https://www.nature.com/news/einstein-s-gravitational-waves-found-at-last-1.19361> [Retrieved 2016-02-11]. doi:10.1038/nature.2016.19361.
- Cervantes-Cota, J, Galindo-Uribarri S, Smoot G (2016) A Brief History of Gravitational Waves. *Universe review* 2/22:1–30.
- Cervantes-Cota, J, Galindo-Uribarri S (2018) Clifford's attempt to test his gravitation hypothesis. *Revista Mexicana de Física E* 64:162–168
- Crombie AC (1961) Augustine to Galileo, Vol. 1. Harvard University Press, Cambridge, MA.

- Drago A (2017) What Was the Role of Galileo in the Century-Long Birth of Modern Science? *Philosophia Scientiae*, 21(1):35-54. Retrieved: <https://doi.org/10.4000/philosophiascientiae.1238>
- Gerson LP (1968), *Aristotle: The Growth and Structure of His Thought*, Cambridge University Press, Cambridge, pp. 166–169.
- Gerson LP (1999) *Aristotle: Logic and metaphysics*, Routledge, *Aristotle: Critical Assessments Vol.1*, pp. 67-71.
- Giulini D, Strautmman N (2000) "... I didn't reflect much on what I was doing.." How Planck discovered his radiation formula. Retrieved: <https://arxiv.org/abs/quant-ph/0010008>
- Janiak A (2019) Newton's Philosophy. In: (ed)Zalta E N *The Stanford Encyclopedia of Philosophy*, Winter 2019. Metaphysics Research Lab, Stanford University
- Kragh H (2000) Max Planck: the reluctant revolutionary *Phys. World* 13 (12) 31. Doi: <https://doi.org/10.1088/2058-7058/13/12/34>
- Logunov AA (2005) *Henri Poincaré and Relativity Theory*, Translated by G. Pontecorvo and V.O. Soloviev, Petrov VA (ed), Nauka, Russia.
- Mead CA (2001) Walking the Planck length through history. *Physics Today*, Vol. 54, issue 11, p. 15. DOI: 10.1063/1.1428424. Retrieved: [https://www.researchgate.net/publication/241511932\\_Walking\\_the\\_Planck\\_length\\_through\\_history](https://www.researchgate.net/publication/241511932_Walking_the_Planck_length_through_history)
- Nahin PJ (2002) *Oliver Heaviside: the life, work, and times of an electrical genius of the Victorian age*. JHU Press.
- Oziewicz Z, Sitarczyk C (1992) Parallel treatment of Riemannian and Symplectic Clifford algebras, in Micali A., Boudet R., Helmstetter J. (eds.), *Clifford Algebras and their Applications in Mathematical Physics. Fundamental Theories of Physics*, Springer, Dordrecht, Vol 47, pp. 83-95.
- Pasnau R (2011) Scholastic Qualities, Primary and Secondary. In: Lawrence Nolan (ed.), *Primary and Secondary Qualities: The historical and Ongoing Debate*. Oxford University Press, pp. 41-61.
- Rahman S., Symons J., Gabbay D.M., van Bendegem J.P. (eds.) (2009). *Logic, Epistemology, and the Unity of Science*. Springer, Dordrecht.
- Strauss M (1968) Einstein's Theories and the Critics of Newton: An Essay in Logico-Historical Analysis. *Synthese*, 18(2/3):251-284. Retrieved: [www.jstor.org/stable/20114606](http://www.jstor.org/stable/20114606)
- Walker J, Halliday D, Resnick R (2011) *Fundamentals of physics*. Hoboken, NJ, Wiley. Retrieved: <https://archive.org/details/FundamentalsOfPhysicsHallidayResnickWalker/page/n3>.
- Wallace W (1911) Empedocles. In: Chisholm, Hugh. *Encyclopædia Britannica*. 9 (11th ed.). Cambridge University Press. pp. 344–345.
- Wilkins DR (1998) On the Hypotheses which lie at the Bases of Geometry. Bernhard Riemann Translated by William Kingdon Clifford. *Nature*, 8(183-184):14-17, 36-37.

## Web References

- Encyclopaedia Britannica  
<https://www.britannica.com/biography/Galileo-Galilei>
- Press release. NobelPrize.org  
<https://www.nobelprize.org/prizes/physics/1911/wien/facts/>  
<https://www.nobelprize.org/prizes/physics/1918/planck/facts/>  
<https://www.nobelprize.org/prizes/physics/1921/summary/>  
<https://www.nobelprize.org/prizes/physics/1929/summary/>
- NASA.gov  
<https://www.grc.nasa.gov/www/k-12/airplane/newton.html>
- Safran Reosc website:  
<https://www.safran-reosc.com/company#2>

## Selected Additional References on the Subjects – Non-Cited in the Above Running Text

- Aristotle (1801) *The metaphysics of Aristotle*, Translated from the Greek; with Copious Notes in which the Pythagoric and Platonic dogmas respecting numbers and ideas are unfolded from ancient sources. Thomas Taylor (ed.). Davis–Wilks–Taylor, Chancery–Lane, London.
- Clifford WK (1976) On the Space-Theory of Matter. In: Čapek M. (ed) *The Concepts of Space and Time*. Boston Studies in the Philosophy of Science. 22. Springer, Dordrecht, pp. 157–158.
- Connes A (2000) *Triangle de pensée*, Paris, Odile Jacob.
- De Broglie L (1922) Rayonnement noir et quanta de lumière. *J. Phys. Radium*, Vol. 3, issue 11, pp.422-428. Retrieved: <https://hal.archives-ouvertes.fr/jpa-00204370/document>
- Hanle PA (1977) Erwin Schrödinger's Reaction to Louis de Broglie's Thesis on the Quantum Theory. *ISIS* 68, no. 4, pp. 606-609.
- Kepler J ([1606] 1859) *De stella nova in pede Serpentarii* [Prague, Ex Officina calcographica Pauli Sessii]. *Opera Omnia*. Vol. II, Frankfurtur et Erlangae [see also: KGW, I, pp. 147-292].
- Kepler J (1596) *Prodromus dissertationum cosmographicarum seu mysterium cosmographicum*. In KGW, I.
- Kepler J (1609) *Astronomia Nova AITIOΛΟΓΕΤΟΣ seu phisica coelestis tradita de commentariis de motibus stellae Martis ex observationibus G. V. Tychoonis Brahe*. In KGW, III.
- Kepler J (1618–1621) *Epitome astronomiae copernicanae*. In KGW, VII.
- Kepler J (1621) *Mysterium Cosmographicum (editio altera)*. In KGW, VIII.
- Kepler J (1624) *Chilias logarithmorum ad totidem numeros rotundus, praemissa demonstratione legitima ortus logarithmorum eorumque usus*. In KGW, IX, pp. 275–352.
- Kepler J (1625) *Supplementum chiliadis logarithmorum, continens praecepta de eorum usu*. In KGW, IX, pp. 353–426.
- Kepler J (1981) *Mysterium Cosmographicum (The Secret of the Universe)*. Abaris Book, New York.
- Kepler J (1992) *New Astronomy*. Translation of *Astronomia Nova* by William H. Donahue. The Cambridge University Press, Cambridge.
- Kepler J (1993) *Le Secret du monde*. Gallimard, Paris.

- Kepler J (2010) Kurze Darstellung der kopernikanischen Astronomie. Nachwort von Eberhard Knobloch. Deutsche, Übersetzung von Eberhard Knobloch und Otto und Eva Schönberger. Königshausen & Neumann. Würzburg.
- KGW Kepler J (1937–2012) Johannes Kepler, Gesammelte Werke. Van Dyck W, Caspar M. et al. (eds.). Revised April 2013. 10 Vols. Deutsche Forschungsgemeinschaft und Bayerische Akademie der Wissenschaften. Beck'sche Verlagsbuchhandlung, München.
- LIGO Scientific Collaboration (2016). "Tests of General Relativity with GW150914", Phys. Rev. Lett. 116, 221101. Retrieved: <https://arxiv.org/abs/1602.03841>
- Moskowitz C. (2014). "Gravity Waves from Big Bang Detected" [online], Scientific American. <https://www.scientificamerican.com/article/gravity-waves-cmb-b-mode-polarization/> [Retrieved 24/11/2019]
- Newton I ([1713], 1729) The Mathematical principles of natural philosophy. Translated by Motte Andrew. Motte B, London.
- Newton I ([1726; 1739–1742], 1822), Philosophiae Naturalis Mathematica Principia, auctore Isaaco Newtono, Eq. Aurato, perpetuis commentariis illustrata, communi studio Pp. Thomae Le Seur et Francisci Jacquier ex Gallicana minimorum familia, matheseos professorum. Editio nova (in three volumes). Duncan, Glasgow.
- Newton I (1687) Philosophiae Naturalis Principia Mathematica. Imprimatur S. Pepys, Reg. Soc. Preses. Julii 5. 1686. Londini, Jussi Societatus Regiae ac Typis Josephi Streater. Prostat apud plures Bibliopolas. Anno MDCLXXXVII.
- Pignard O (2014) Omnium, au-delà de la matière. Théorie des créatons, des vortex et des ondes quantifiées. Société des écrivains, 14, rue des Volontaires, Paris.
- Pisano R (2008) A history of chemistry à la Koyré? Introduction and setting of an epistemological problem. Khimiya 2(17):143–161.
- Pisano R (2009) On method in Galileo Galilei' mechanics. In Hunger H (ed.), Proceedings of 3<sup>rd</sup> Congress of the European Society for the History of Science. The Austrian Academy of Science, Vienna, pp. 174–186.
- Pisano R (2011) Physics–Mathematics Relationship. Historical and Epistemological notes. In Barbin E, Kronfellner M and Tzanakis C (eds.), Proceedings of the ESU 6 European Summer University History And Epistemology in Mathematics. Verlag Holzhausen GmbH–Holzhausen Publishing Ltd., Vienna, pp. 457–472.
- Pisano R (2013a) History Reflections on Physics Mathematics Relationship in Electromagnetic Theory. In: Barbin and Pisano 2013, pp. 31–58.
- Pisano R (2014) (ed.) Isaac Newton and his Scientific Heritage: New Studies in the History and Historical Epistemology of Science. Special Issue. Advances in Historical Studies 3/3.
- Pisano R (2016a) What kind of Mathematics in Leonardo da Vinci and Luca Pacioli? Bulletin–British Society for the History of Mathematics 31:104–111.
- Pisano R (2016b) A Development of the Principle of Virtual Laws and its Framework in Lazare Carnot's Mechanics as Manifest Relationship between Physics and Mathematics. Transversal–International Journal for Historiography of Science, 2:166–203.
- Pisano R, Bussotti P (2012) Galileo and Kepler: On Theoremata Circa Centrum Gravitatis Solidorum and Mysterium Cosmographicum. History Research 2(2):110–145.
- Pisano R, Bussotti P (2013) Notes on the Concept of Force in Kepler. In Pisano, Capecchi and Lukešová 2013, pp. 337–344.
- Pisano R., Bussotti P. (2014). "Newton's Philosophiae Naturalis Principia Mathematica "Jesuit" Edition: The Tenor of a Huge Work". Accademia Nazionale Lincei–Rendiconti Matematica e Applicazioni 25 (4):413–444.
- Pisano R, Bussotti P (2014a) Galileo in Padua: architecture, fortifications, mathematics and "practical" science. Lettera Matematica Pristem International 2(4):209–221.
- Pisano R, Bussotti P (2014b). Historical and Philosophical Reflections on the Culture of Machines around the Renaissance. How Science and Technique Work? Acta Baltica Historiae et Philosophiae Scientiarum 2(2):20–42.

- Pisano R, Bussotti P (2015a) Historical and Philosophical Reflections on the Culture of Machines around the Renaissance: Machines, Machineries and Perpetual Motion. *Acta Baltica Historiae et Philosophiae Scientiarum* 3(1):69-87.
- Pisano R, Bussotti P (2015b) Introduction to Exploring Changes in How the Histories of the Exact Sciences from the 18th to through the 20th Century Have Been Written: Interpreting the Dynamics of Change in these Sciences and Interrelations Amongst Them—Past Problems, Future Cures? *Advances in Historical Studies Special Issue* 4(2):65-67.
- Pisano R., Bussotti P. (2016). “A Newtonian Tale Details on Notes and Proofs in Geneva Edition of Newton’s Principia”. *Bulletin–Journal of the British Society for the History of Mathematics*, 31 (3):160-178.
- Pisano R., Bussotti P. (2017). On the Conceptualization of Force in Johannes Kepler’s Corpus: an Interplay between Physics/Mathematics and Metaphysics, in Pisano R., Agassi J. and Drozdova D. (eds.), *Hypothesis and Perspective in History and Philosophy of Science. Homage to Alexandre Koyré 1892-1964*. Springer, Dordrecht, pp. 295-346
- Pisano R, Capecchi D (2013) Conceptual and Mathematical Structures of Mechanical Science in the Western Civilization around 18th Century. *Almagest* 4(2):86–121.
- Pisano R, Capecchi D (2015) Tartaglia’s science weights. *Mechanics in sixteenth century. Selection from Quesiti et invention diverse: Books VII–VIII*. Dordrecht, Springer.
- Pisano R, Capecchi D, Lukešová A (eds.) (2013) *Physics, Astronomy and Engineering. Critical Problems in the History of Science. International 32nd Congress for The SISFA–Italian Society of Historians of Physics and Astronomy. The Scientia Socialis UAB & Scientific Methodical Centre Scientia Educologica Press, Šiauliai University, Lithuania.*
- Pisano R, Fichant M, Bussotti P, Oliveira ARE (2017) (eds.) *Leibniz and the Dialogue between Sciences, Philosophy and Engineering, 1646-2016. New Historical and Epistemological Insights*. The College Publications, London.
- Pisano R, Gaudiello I (2009a) Continuity and discontinuity. An epistemological inquiry based on the use of categories in history of science. *Organon* 41:245–265.
- Weinberger P (2006) Revisiting Louis de Broglie’s famous 1924 paper in the Philosophical Magazine. *Philosophical Magazine Letters*, Taylor & Francis, 86(7):405-410. Retrieved: <https://doi.org/10.1080/09500830600876565>





# CHAPTER III

## Gravitational Waves: Theoretical Methods & Data

*An outline.* In this part, I focussed on the historical foundations of our contemporary concept of gravitational waves. Therefore, we will explore the history and principles behind the development of Albert Einstein's Special and General Relativities and the first appearance of the exact term "gravitational wave" through Poincaré's *Sur la dynamique de l'électron* (On the Dynamics of the Electron) of 1905 (Poincaré 1905). In particular, I will illustrate the ideas and principles behind the Relativities and give examples of the principles and predictions of the theory. This last point is particularly important as it also illustrates the link between gravitational waves and the Relativities (see section 3.4 below).

### 3.1 Albert Einstein (1879-1955)

Albert Einstein was born on 14 March 1879 in Ulm, Germany. After his family moved, he went to school in Munich. In 1894, his family moved again, to Italy this time. Later, in 1896, he worked at the Swiss Institute of Technology of Zurich before starting his work as a clerk at Bern's Patent Office in 1902. It was at that moment, in his spare time, that he began to develop his theories.

Einstein's contributions are related to many fields of physics: thermodynamics, kinetics, statistical mechanics, etc. Even though other famous scientists such as Maxwell, Lorentz or Henri Poincaré issued papers on relativity before 1900, it was Einstein in 1905 that formulated what we nowadays call special relativity.

In the context of the theory of Special Relativity, Einstein's position was quite different from other contemporaries of his such as Poincaré; the latter thought of concepts such as the "principle of relativity" as the consequences of an underlying dynamic belonging to Mechanics rather than –the postulate at– the basis of the theory (Damour 2005, p.6). This appears clearly in the discussion on Relativity between Einstein and Poincaré reported by Maurice de Broglie (*Ibidem*) that happened in 1911 at the first Solvay council in Brussels. It has to be noted that the –classical– concept of relativity in itself dates as far back as Galileo, centuries before. Indeed, Galileo famously considered the case of a boat moving at a constant speed on which an experimenter on the boat's crow's nest would let an object drop to find that independently of the speed of the boat, the object would land at the same point. However, in the case of Einstein's interpretation of the principle of relativity, all laws of nature must be exactly the same for all observers in their respective inertial frames of reference. For instance, this principle applied to Maxwell's theory of electromagnetism points toward the reasons why the speed of light in a vacuum is a universal constant and the same for all observers independently of their motion. It was in his paper of September 27, received by the *Annalen der Physik* (Einstein 1905b), that Einstein showed that mass and energy were equivalent, and it was at that moment that the formula  $E=mc^2$  would become the most famous formula of physics (Pais 2005, p. 522).

Later, after continuing his research and the development of his theory, Einstein realized that his theory of Special Relativity was incompatible with Newton's theory. Indeed, contrary to Newton's theory, absolute time cannot exist in the framework of Special Relativity as events are relative, just like simultaneity. This realization also pushed him to find a way to add a description of gravitation to his theory. In 1907, he finally got the insight that led to the breakthrough of general relativity. Known nowadays as "Einstein's happiest thought", he then realized that gravitation and acceleration are linked. On November 25, 1915, he announced his discovery to the Prussian Academy, presenting General Relativity.

### 3.2 The Relativities

In Physics, broadly speaking, Relativity, the Theory of relativity or Relativities are the name given to Special Relativity and General Relativity. The two theories developed by Albert Einstein. Basically, the Theory of Relativity is based on a few assumptions such as the Principle of Equivalence, that the speed of light in vacuum is always constant for all observers in inertial frames of reference regardless of their motion relative to the source of the light (Taylor 1992) and that space and time are inseparable as they are different aspects of the same object, a continuum called *spacetime*.

*A note on the mass-energy equivalence.* The mass-energy equivalence comes from –what is probably the most famous physics formula– the relation between mass and energy:

$$E = mc^2 \quad (3.1)$$

where  $E$  represents the energy,  $m$  the mass and  $c$  the celerity of light in a vacuum.

However, Einstein actually used this relation in another form in another of his papers “*Ist die Trägheit eines Körpers von seinem Energieinhalt abhängig?*” (Does the Inertia of a Body Depend Upon Its Energy Content?) of 1905 (cfr. Figure below). Indeed, he wrote: “Gibt ein Körper die Energie  $L$  in Form von Strahlung ab, so verkleinert sich seine Masse um  $L/V^2$ .” which translates as “If a body releases the energy  $L$  in the form of radiation, its mass decreases by  $L/V^2$ ” (Cfr. Stachel 1989). Thus, the equivalent of:

$$\text{Masse} = L/V^2 \quad (3.2)$$

where these quantities are identified in our contemporary form as

$$m = E/c^2. \quad (3.3)$$

Furthermore, Einstein added: “The mass of a body is a measure of its energy content” (*Ibidem*). However, contrary to popular belief, Einstein was not the first to discover this relation as it was already known and used by others (Bizouard 1999).

Today, this equivalence between mass and energy is often used in another form, sometimes more convenient, in which the mass  $m$  is invariant to a change in referential:

$$m^2 = \frac{(E^2 - p^2 c^2)}{c^4} \quad (3.4)$$

where  $E$  represents the energy,  $m$  the mass,  $p$  the impulsion and  $c$  the celerity of light in a vacuum.

*Trägheit eines Körpers von seinem Energieinhalt abhängig?* 641

tiven Konstanten der Energien  $H$  und  $E$  abhängt. Wir können also setzen:

$$H_0 - E_0 = K_0 + C,$$

$$H_1 - E_1 = K_1 + C,$$

da  $C$  sich während der Lichtaussendung nicht ändert. Wir erhalten also:

$$K_0 - K_1 = L \left\{ \frac{1}{\sqrt{1 - \left(\frac{v}{V}\right)^2}} - 1 \right\}.$$

Die kinetische Energie des Körpers in bezug auf  $(\xi, \eta, \zeta)$  nimmt infolge der Lichtaussendung ab, und zwar um einen von den Qualitäten des Körpers unabhängigen Betrag. Die Differenz  $K_0 - K_1$  hängt ferner von der Geschwindigkeit ebenso ab wie die kinetische Energie des Elektrons (l. c. § 10).

Unter Vernachlässigung von Größen vierter und höherer Ordnung können wir setzen:

$$K_0 - K_1 = \frac{L}{V^2} \frac{v^2}{2}.$$

Aus dieser Gleichung folgt unmittelbar:

Gibt ein Körper die Energie  $L$  in Form von Strahlung ab, so verkleinert sich seine Masse um  $L/V^2$ . Hierbei ist es offenbar unwesentlich, daß die dem Körper entzogene Energie gerade in Energie der Strahlung übergeht, so daß wir zu der allgemeineren Folgerung geführt werden:

Die Masse eines Körpers ist ein Maß für dessen Energieinhalt; ändert sich die Energie um  $L$ , so ändert sich die Masse in demselben Sinne um  $L/9 \cdot 10^{20}$ , wenn die Energie in Erg und die Masse in Grammen gemessen wird.

Es ist nicht ausgeschlossen, daß bei Körpern, deren Energieinhalt in hohem Maße veränderlich ist (z. B. bei den Radiumsalzen), eine Prüfung der Theorie gelingen wird.

Wenn die Theorie den Tatsachen entspricht, so überträgt die Strahlung Trägheit zwischen den emittierenden und absorbierenden Körpern.

Bern, September 1905.

(Eingegangen 27. September 1905.)

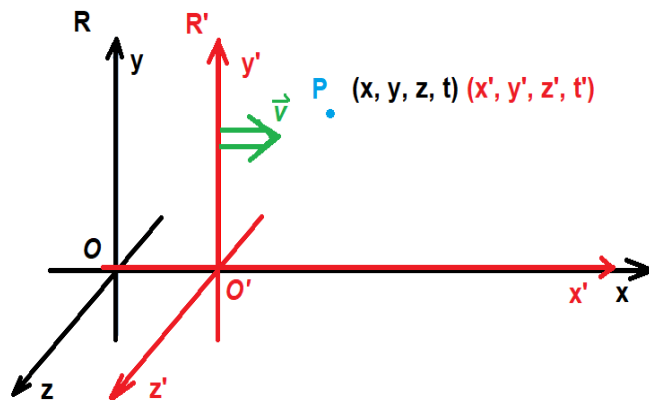
Fig. 3.2. Annalen der Physik, 323(13), p. 641.

Source: <https://gallica.bnf.fr/ark:/12148/bpt6k15325j/f649.image>

### 3.2.1 Special Relativity

Einstein's Special Relativity theory was published in a paper titled "On the Electrodynamics of Moving Bodies" on the 26th September 1905 (Einstein 1905). The Special Relativity theory postulates that viewing space and time as separated entities is erroneous as space and time are intrinsically linked on a fundamental level as they consist of one and the same entity: *spacetime*. It is most often used when considering weak gravitational fields (*flat spacetimes*) as it does not take gravity into account in its description. It is based on two postulates:

- The first postulate states that the laws of physics are invariant in all inertial systems. In other words, the laws of physics are identical everywhere and at all times in non-accelerating frames of reference. (Cfr. Section 2.2 and Figure below)



**Fig. 3.2.1.a.** A point  $P$  (in blue) and the associated coordinates in two different inertial reference frames,  $R$  (in black) and  $R'$  (in red).  $R'$  being translated at constant velocity  $v$  (in green).

Source: Philippe Vincent (hereafter PV); made with MS Paint.

- The second postulate states that the speed of light in vacuum is invariant for all observers, i.e. always the same for all observers, regardless of their motion or the motion of the source emitting the light. This being a direct result evidenced by the Michelson-Morley experiment of 1887 (Michelson 1887, 1887a; Shankland 1964).

These two strong assumptions, while certainly not very intuitive, have since been verified on countless occasions and lead to many very interesting developments in mathematics, physics, engineering, etc. In order to better

appreciate the physical meaning of these statements, let us use some examples.

*On the Invariance of the Speed of Light: The Michael-Morley Experiment.* The Michael-Morley experiment (Michelson 1887, 1887a) is a crucial milestone in the History of Physics as its surprising –at the time– result led to the development of Special Relativity. The experiment took place in Cleveland in 1887 (Shankland 1964) and aimed to measure the relative speed of the luminiferous ether which was thought to be the medium responsible for the propagation of light, as light had this particularity of being able to travel in a vacuum. Indeed, at that time, it was thought that all waves needed a medium through which to propagate; e.g. just like soundwaves need matter to propagate and thus cannot propagate into a vacuum.

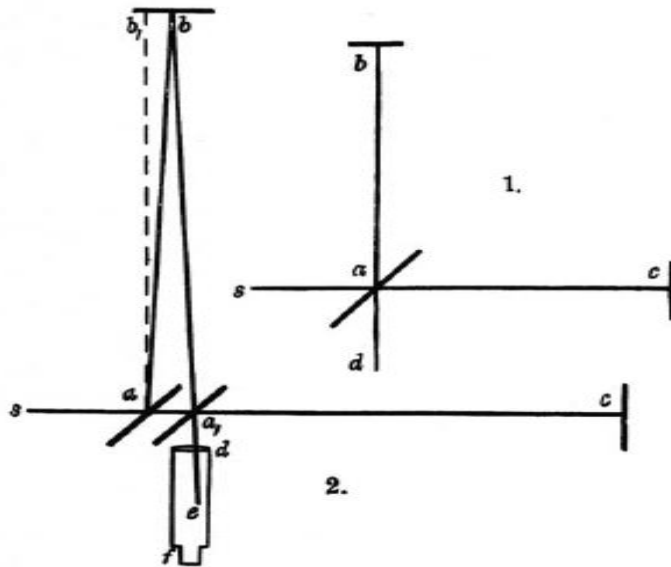
Therefore, the hypothesis was that the Universe was filled with an imperceptible medium through which light and other electromagnetic waves could propagate. Furthermore, since this medium filled the Universe, it was postulated that the relative motion of the Earth and by extension, the relative motion of the solar system travelling through the ether could be determined. Indeed, the idea was that the Earth orbiting the Sun and travelling through the ether could produce an effect on the speed of light –making it vary depending on the direction of propagation of light.

This idea was in fact relying on the Galilean relativity principle, i.e. that if light was opposing the motion of the ether, it should travel slower as it would have to travel upstream; and vice-versa.

Thus, an experiment was set up in order to verify in which direction this effect preferably occurred –if it occurred at all– and how much it impacted the speed of light in this or that direction. Notably, the experiment had also the potential of unveiling some clues about if the ether was static –e.g. with a preferential direction depending on the combination of the motion of the Earth and the solar system– or dynamical –with preferential directions changing independently of this combined motion.

The experimental setup of the interferometer was described as follows:

Let  $sa$  fig. 1, be a ray of light which is partly reflected in  $ab$ , and partly transmitted in  $ac$ , being returned by the mirrors  $b$  and  $c$ , along  $ba$  and  $ca$ .  $ba$  is partly transmitted along  $ad$ , and  $ca$  is partly reflected along  $ad$ . Suppose now, the ether being at rest, that the whole apparatus moves in the direction  $sc$ , with the velocity of the earth in its orbit, the directions and distances traversed by the rays will be altered thus: – The ray  $sa$  is reflected along  $ab$ , fig. 2; the angle  $bab$ , being equal to the aberration  $=a$ , is returned along  $ba$ , ( $aba = 2a$ ), and goes to the focus of the telescope, whose direction is unaltered. The transmitted ray goes along  $ac$ , is returned along  $ca$ , and is reflected at  $a$ , making  $ca,e$  equal  $90-a$ , and therefore still coinciding with the first ray. (Michelson 1887, p. 335-336)



**Fig. 3.2.1.b.** Michelson–Morley interferometer figures 1 & 2. (From Michelson 1887, p. 335)

Source: Niels Bohr Library, Courtesy of the American Institute of Physics, USA.

Therefore, from this angle variation due to the motion of the ether, a variation of the displacement of the interference fringes would have been observed. In the publication of the results in the *American Journal of Science* (Michelson 1887; Cfr. Figures 3.2.1.c. and d.), the authors explained that the first experiment encountered difficulties, especially in regard to distortions, to the “extreme sensitiveness to vibration” of the apparatus, and to the smallness of the displacement of the fringes: “a displacement of something less than a twentieth of the distance between the interference fringes may have been too small to be detected when masked by experimental errors.” (Ivi. p. 336).

No. 203. VOL. XXXIV.

NOVEMBER, 1887.

Established by **BENJAMIN SILLIMAN** in 1818.

---

THE

**AMERICAN**

**JOURNAL OF SCIENCE.**

EDITORS

**JAMES D. AND EDWARD S. DANA.**

ASSOCIATE EDITORS

**PROFESSORS ASA GRAY, JOSIAH P. COOKE, AND  
JOHN TROWBRIDGE, OF CAMBRIDGE,**

**PROFESSORS H. A. NEWTON AND A. E. VERRILL, OF  
NEW HAVEN,**

**PROFESSOR GEORGE F. BARKER, OF PHILADELPHIA.**

---

**THIRD SERIES.**

**VOL. XXXIV.—[WHOLE NUMBER, CXXXIV.]**

WITH PLATES II TO IX.

**No. 203—NOVEMBER, 1887.**

**NEW HAVEN, CONN.: J. D. & E. S. DANA.**

**1887.**

---

**TUTTLE, MOREHOUSE & TAYLOR, PRINTERS, 871 STATE STREET.**

Six dollars per year (postage prepaid). \$8.40 to foreign subscribers of countries in the Postal Union. Remittances should be made either by money orders, registered letters, or bank checks.

Fig. 3.2.1.c. Frontispiece of The American Journal of Science, Third Series Vol. 34. Source: *Niels Bohr Library*, courtesy of the *American Institute of Physics*, USA.



THE  
AMERICAN JOURNAL OF SCIENCE.

[THIRD SERIES.]

ART. XXXVI.—*On the Relative Motion of the Earth and the Luminiferous Ether*; by ALBERT A. MICHELSON and EDWARD W. MORLEY.\*

THE discovery of the aberration of light was soon followed by an explanation according to the emission theory. The effect was attributed to a simple composition of the velocity of light with the velocity of the earth in its orbit. The difficulties in this apparently sufficient explanation were overlooked until after an explanation on the undulatory theory of light was proposed. This new explanation was at first almost as simple as the former. But it failed to account for the fact proved by experiment that the aberration was unchanged when observations were made with a telescope filled with water. For if the tangent of the angle of aberration is the ratio of the velocity of the earth to the velocity of light, then, since the latter velocity in water is three-fourths its velocity in a vacuum, the aberration observed with a water telescope should be four-thirds of its true value.†

\* This research was carried out with the aid of the Bache Fund.

† It may be noticed that most writers admit the sufficiency of the explanation according to the emission theory of light; while in fact the difficulty is even greater than according to the undulatory theory. For on the emission theory the velocity of light must be greater in the water telescope, and therefore the angle of aberration should be less; hence, in order to reduce it to its true value, we must make the absurd hypothesis that the motion of the water in the telescope carries the ray of light in the opposite direction!

AM. JOUR. SCI.—THIRD SERIES, VOL. XXXIV, No. 203.—Nov., 1887.

22

Fig. 3.2.1.d. Frontispiece of the Michelson–Morley article of 1887 (Michelson 1887). Source: *Niels Bohr Library*, courtesy of the *American Institute of Physics*, USA.

In order to surpass these difficulties, they mounted “the apparatus on a massive stone floating on mercury” and increased the displacement of the interference fringes by making the light travel a greater distance: increasing

–“by repeated reflection, the path of the light to about ten times its former value” (Ivi. p. 337)–.

However, despite the ameliorations the experiment yielded results that lead them to write the following:

The actual displacement was certainly less than the twentieth part of this, and probably less than the fortieth part. But since the displacement is proportional to the square of the velocity, the relative velocity of the earth and the ether is probably less than one sixth the earth’s orbital velocity, and certainly less than one fourth.

In what precedes, only the orbital motion of the earth is considered. If this is combined with the motion of the solar system, concerning which but little is known with certainty, the result would have to be modified; and it is just possible that the resultant velocity at time of the observations was small though the chances are much against it. The experiment will therefore be repeated at intervals of three months, and thus all uncertainty will be avoided.

It appears, from all that precedes, reasonably certain that if there be any relative motion between the earth and the luminiferous ether, it must be small; quite small enough entirely to refute Fresnel’s explanation of aberration. Stokes has given a theory of aberration which assumes the ether at the earth’s surface to be at rest with regard to the latter, and only requires in addition that the relative velocity have a potential; but Lorentz shows that these conditions are incompatible. Lorentz then proposes a modification which combines some ideas of Stokes and Fresnel, and assumes the existence of a potential, together with Fresnel’s coefficient. If now it were legitimate to conclude from the present work that the ether is at rest with regard to the earth’s surface, according to Lorentz there could not be a velocity potential, and his own theory also fails. (Michelson 1887, p. 341)

In the end, this null result of the experience led to the disproof of the existence of the ether, the confirmation of the invariance of the speed of light and ultimately to Special Relativity (Handschy 1982).

*On frames of reference.* One of the most used example –usually seen in all sorts of scientific mediation material because of its simplicity– to describe inertial and non-inertial frames of references is that of an elevator. It is interesting to note that this example which is often referred to as “Einstein’s elevator thought experiment” possesses a wide array of alleged origins about how Einstein got the idea when in fact, on December 14, 1922, in a speech given in Kyoto, Japan, Albert Einstein explained that he was sitting on a chair in his patent office in Bern when the thought that a man falling freely would not feel his own weight (Schucking 2007, p.2).

Let us consider an elevator at rest at the bottom of a building. Since the elevator is idle in a resting state, standing still at the bottom of the building’s elevator shaft, the elevator’s speed is constant and equals 0. Thus, since the speed of the elevator is constant, the elevator is not accelerating and represents an inertial frame of reference.

However, if someone pushes the button to call the elevator to a different floor, the elevator will start moving. Since our elevator was at the bottom of

the shaft, it will start to move up; therefore changing its speed and, by definition, accelerating.

At this moment, since the elevator is experiencing an acceleration, it is representing a non-inertial system because of a change of speed. The elevator then reaches its travel speed and becomes an inertial frame of reference again.

The elevator, then slows down approaching the selected floor, and ceases to be an inertial frame of reference as its speed is changing again: it is slowing down (decelerating). Finally, reaching the selected floor, the elevator stops and becomes an inertial frame of reference again.

Since the definition of an acceleration is a change in velocity, and velocity is in fact composed both of speed and direction, an object moving in a circular motion is accelerating even if moving at constant speed because of the changing direction of the speed vector (just like what would happen if you think of a merry-go-round spinning reasonably fast that someone would ride on the edge).

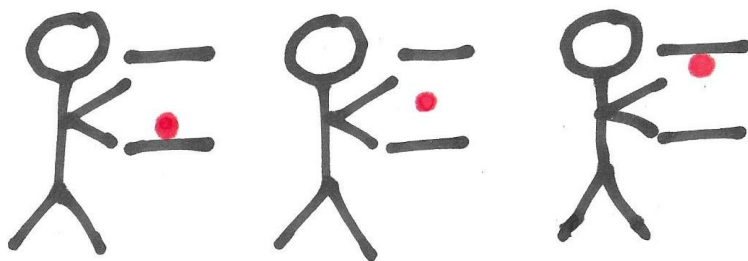
In actuality, in this example, the person would feel a –fictitious– force: the centrifugal force; as at any given instant, the direction of their velocity would be tangent to the circle describing their circular motion. According to Newton’s first law, the person would travel in a straight line tangent to the circle if they let go their hold.

However, maintaining their position on the merry-go-round, the person would be accelerating as they would be experiencing a constant change in velocity (in the direction of its speed) and thus representing a non-inertial frame of reference since the direction of its motion is varying along the trajectory of the object.

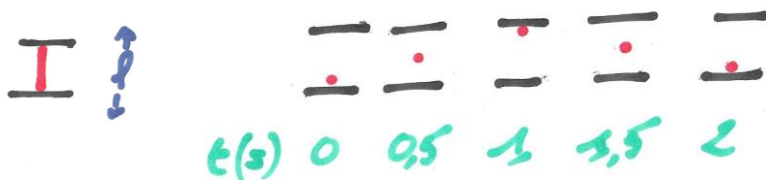
### ***3.2.1.1 Special Relativity Consequences***

During and after the development of Special Relativity, a number of consequences of the theory have been studied theoretically and through numerous experiences. These consequences include effects such as mass-energy equivalence, relativistic effects, a universal speed limit –the speed of light in vacuum, which is also the absolute limit of the transmission of information thus also known as “the speed of causality”–, the relativity of simultaneity, as well as after effects from this speed limit such as the contraction of lengths and time dilation.

*Time dilation.* Let us imagine holding an apparatus consisting of a pair of ideal mirrors reflecting a trapped photon back and forth. The mirrors are separated by a distance  $l$  equal to 1 light-second. This implies that the photon takes exactly 1 second to get from bottom to top, and 1 other second to go from top to bottom and reach its initial position. While our apparatus is at rest, i.e. not moving, we obtain the following:



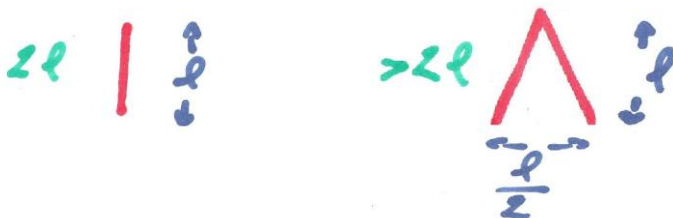
**Fig. 3.2.1.1.a.** Drawing of someone with extremely long arms holding the apparatus. In this illustration, the photon is represented in red. From left to right, the photon is located at the bottom of the apparatus and is going up (*left*); the photon travelled half the distance in exactly 0,5 seconds (*middle*); the photon reached the top of the apparatus in exactly 1 second total (*right*). Source: PV, handmade.



**Fig. 3.2.1.1.b.** In this drawing, the path of our photon is represented in red (*left*) and the position of our photon is represented in function of time (*right*). It takes exactly 2 seconds for our photon to reach its starting position. Source: PV, handmade.

From this point, let us imagine that our experimenter is travelling at a constant velocity to the right at half the speed of light instead of being immobile.

To our experimenter (in their frame of reference), nothing changed. However, an observer at rest relative to our experimenter would see something completely different:



**Fig. 3.2.1.1.c.** In this drawing, the path of our photon, in red, as seen by the experimenter (*left*) and as seen by our observer (*right*). Source: PV, handmade.

Since both our experimenter and our observer are in inertial frames (the experimenter travels at a constant velocity; our observer is at rest relative to the experimenter), the speed of light is invariant. Thus, in this context, the observed speed of our photon is the same for both. However, as we can see in the above figure (Fig. 3.2.1.1.c), the distance travelled by our photon seems to be different; which seems to be contradictory at first glance. In fact, the observer would state that the photon took longer than 2 seconds to do a whole back and forth, while it took exactly 2 seconds according to the experimenter. The explanation lies in that the faster an object moves relative to an observer in a different inertial frame, the slower its proper time appears to tick according to said observer; when in fact each referential can be independently considered at rest or in movement relative to the other.

This well-known phenomena is taken into account for a technology that we use on a daily basis: the GPS system. The knowledge of this induced delay coming from time dilation is essential for the GPS system as the satellites involved use atomic clocks which have to be extremely precise for the calculation of the position of the vehicles. Because satellites in orbit are moving at high speeds, the atomic clocks embarked on the satellites tick at a different rate compared to atomic clocks on Earth; that is the reason why they have to be resynchronized every day.

*Speed of causality and Spacetime Diagrams.* Spacetime diagrams are a very useful type of representation that allow us to solve visually many paradoxes that arise in the theory when considering different referential systems. In this type of graph, the spatial coordinates are on the x-axis and the time coordinates are on the y-axis. One of the great features of this type of graph is that the y-axis holds “ct” a quantity that is *time* multiplied by the *celerity of light in a vacuum*; thus also associated with a distance.

In this representation, points are called “events” –whether they are actual events in the common sense or not (i.e. a point in spacetime where nothing happens)– as they represent a point somewhere in space (on the x-axis) at a certain time (on the y-axis).

When considering them and their evolution, these “events” have a past, a future and draw a “worldline” on the graph. By convention, the worldline of a photon, which is massless and travelling at the speed of light in a vacuum, is represented as lines with an inclination of  $45^\circ$  for reference and are thus drawing light trajectories.

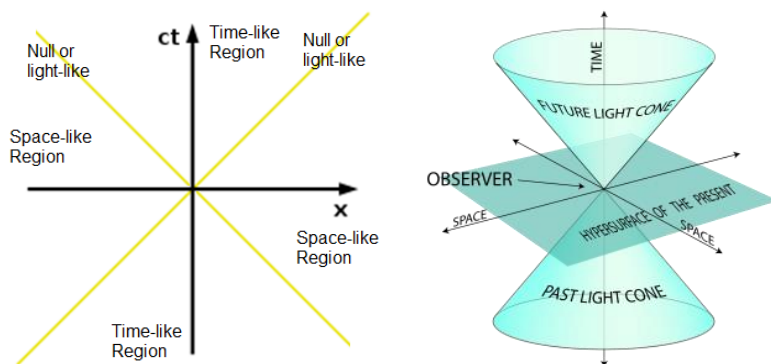
All objects at rest in regards to the reference frame chosen draw vertical lines since their position is not changing and they only travel through time.

As Einstein’s theory states that only massless particles can travel at the speed of light, this implies that the speed of anything with mass has to be slower, i.e. the worldline of an object, the collection of all the events belonging to its history, has to be contained in the inside part of a light cone –called the time-like region– defined by extending the light-like (or null) spacetime intervals –the  $45^\circ$  angle lines (cfr. figure below).

Because nothing can travel faster than light, not even information, the causal range of an event is represented by a “light cone” delimited by the null trajectories drawn from the event.

Thanks to this representation, all causal links can be visualized by looking at both the past and the future parts of the light cone of any event.

Indeed, it follows from this that all the elements inside the past part of the light cone of an event either could have potentially influenced or have influenced this event; and all the elements inside the future part of the light cone of an event will potentially be influenced by the event.



**Fig. 3.2.1.1.d.** Different Light cone Representations (All Spatial coordinates are contained in the  $x$ -axis – *left*; All Spatial coordinates are represented in a 2-dimensional plane, the hypersurface of the present - *right*).

Sources: <http://abuledu.org/full/minkowski-le-trajet-d-un-photon-50ad7bd4.svg> | (CC BY-SA 2.0 FR), adaptation, Credit: DR; <http://www.physicscentral.com/explore/action/memory-and-time.cfm> | (Attribution-ShareAlike 3.0 Unported), Credit: K. Aainsqatsi

Therefore, with this representation it is easy to determine visually if two events could have potentially been produced as the result of a third – anterior– event: i.e. it is a question of identifying if the anterior event is located in the common intersection of the two events’ past light cones.

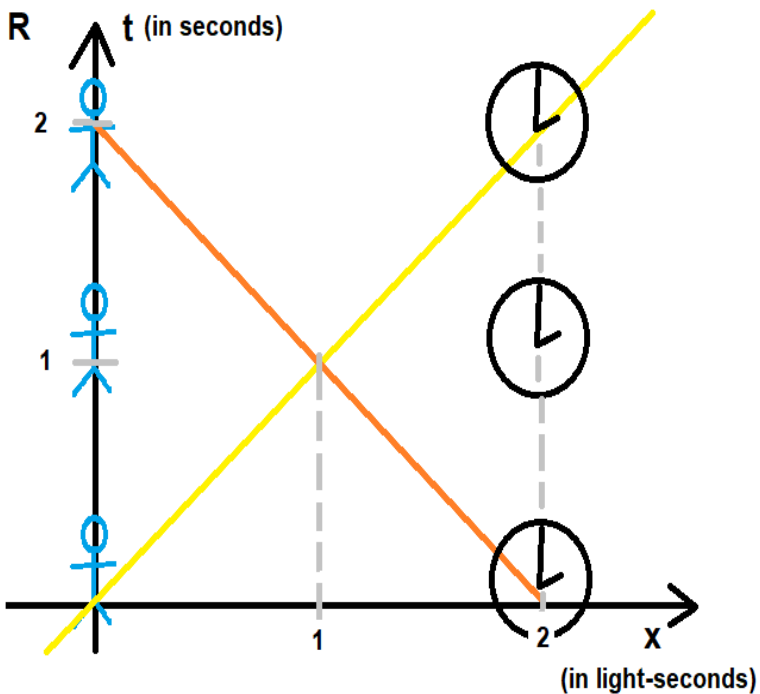
Furthermore, it is important to recognize that light cones are not just useful objects belonging to a rather clear style of representation. Indeed, they possess the amazing property of having the speed of light built-into them which as a consequence makes them a very powerful tool for visualizing the *structure of spacetime*.

*Some examples of simple cases.*

Example 1:

An observer at rest in an inertial reference frame  $R$  observes a clock located 2 light-seconds away. The clock is also at rest in  $R$ .

From this choice of units for the axes, light travels at a  $45^\circ$  angle; and the light emitted by the observer takes 2 seconds to reach the clock since it is located at 2 light-seconds away from them. Similarly, the light coming from the clock takes 2 seconds to reach the observer. Therefore, at  $t = 2$  seconds, the observer sees the light coming from the clock as it was emitted at  $t = 0$ . Thus, the observer reads a time delayed by 2 seconds.

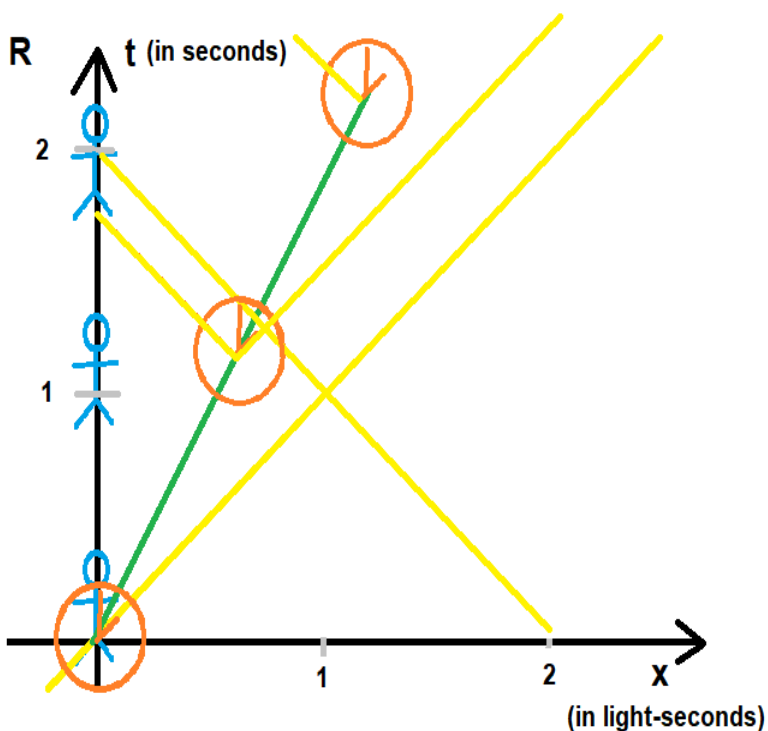


**Fig. 3.2.1.1.e.** Drawing of the situation. The observer (in blue) and the clock (in black) are at rest. Light emitted by the observer (in yellow) travels to the right, towards the clock; similarly, light from the clock (in orange) travels to the left, towards the observer.

Source: PV, made with MS Paint.

Example 2:

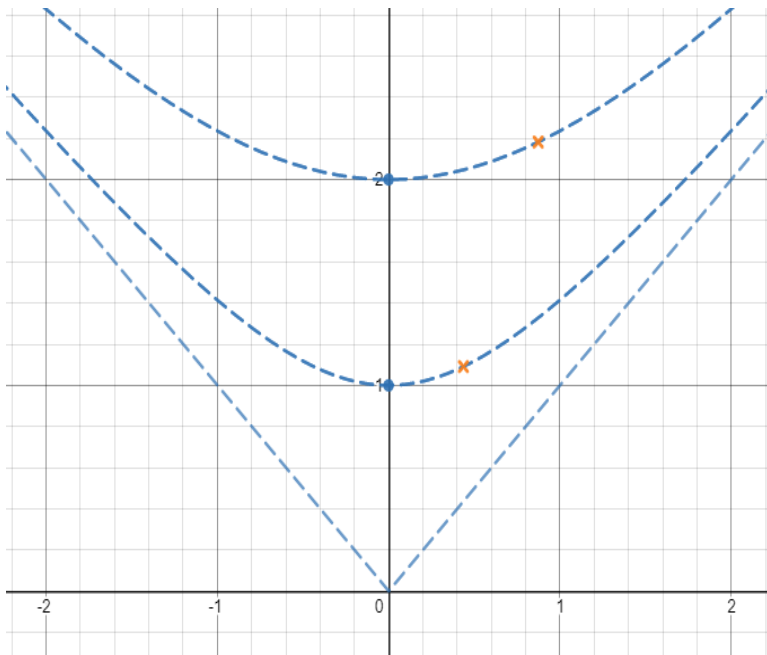
In this next situation, the observer is at rest and the clock is travelling at constant velocity. At  $t = 0$ , the clock passes exactly in front of the observer (they are at the same exact location). Therefore, starting at  $t = 0$  seconds, and choosing the rest frame of the observer for reference, we can draw the following diagram:



**Fig. 3.2.1.1.f.** Drawing of the situation. The observer (in blue) is at rest and the clock (in orange) travelling at constant velocity is at the same location at  $t = 0$ . Source: PV, made with MS Paint.

However, in order to better understand what is represented, we can also draw the lines of constant time as seen by our observer (cfr. figure below).

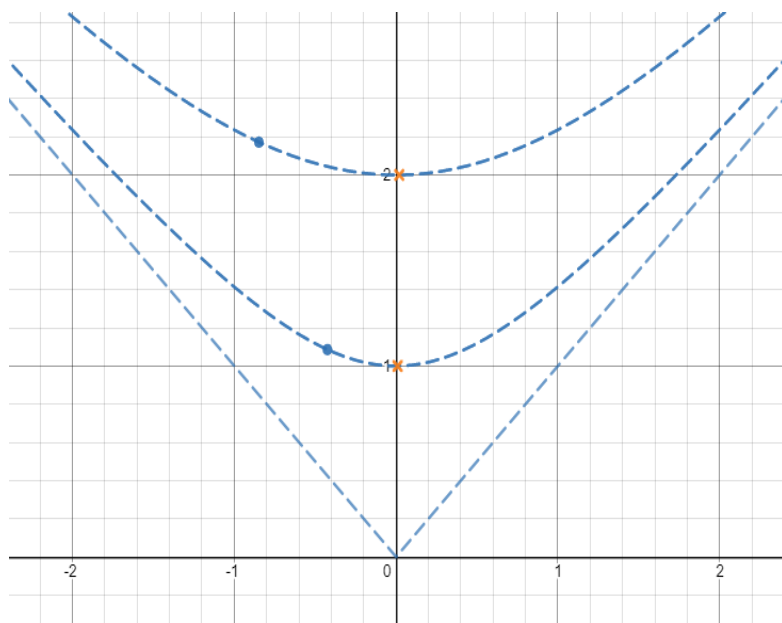




**Fig. 3.2.1.1.g.** Screenshot from a *spacetime globe* of the situation. The observer is represented by the blue points, the clock by the orange crosses. The dotted rectilinear light blue lines from the origin represent null trajectories; the dotted curved blue lines represent same time intervals as perceived by the observer. In this diagram, the clock is travelling at  $0.4 c$ .

Source: Simulated from <https://www.desmos.com/calculator/pc7azsxtch?lang=fr>

These representations are very useful as they allow us to visualize graphically results from Special Relativity that would otherwise be difficult to imagine. Moreover, they also allow to easily do coordinate changes and jump from one reference frame to another:



**Fig. 3.2.1.1.h.** Screenshot from a *spacetime globe* of the same situation as seen from the reference frame of the clock. In this diagram, the observer appears to be travelling at  $0.4 c$  away from the clock.

Source: Simulated from <https://www.desmos.com/calculator/pc7azsxteh?lang=fr>

This result is not surprising as it is the symmetrical equivalent of the previous diagram. Indeed, since in Special Relativity there is no absolute space, nor absolute time or motion, there are no external universal reference frames; all motions are relative and all observers are at rest in their own reference frame. Therefore, the propositions: “The observer is moving away from the clock at  $0.4 c$ ” and “The clock is moving away from the observer at  $0.4 c$ ” are exactly equivalent.

### Example 3:

When passing from a reference frame to another, and because the speed of light is invariant for all observers, we ought to find relationships between coordinate systems which leave the speed of light invariant; and therefore which preserve the  $45^\circ$  angle in the spacetime diagrams. The problem being that the usual Galilean transformations are inadequate for this task; in particular when considering speeds which are not negligible in front of the speed of light, i.e. relativistic speeds.

The solution to this problem was in fact found much earlier by Lorentz in 1892 (Cfr. Lorentz 1892) when he tried to explain the results of the Michelson-Morley experiment and developed the mathematical tool, now known as *Lorentz Transformations*, which leave the Maxwell equations invariant. (Faraoni 2013).

Indeed, in the case of our spacetime diagrams, the idea is to find transformations such that the path taken by the clock –or any other object (cfr. figure below)– ends up coinciding with the time axis. Therefore, the transformation needs to be *more powerful* than a simple translation –a basic linear transformation– because it also needs to shift the angle of the line drawn by the objects while at the same time conserving the angles between the respective lines (just like with the previous two figures, Fig. 3.2.1.1.g. and 3.2.1.1.h.) and finally keep the 45° angle of the lines representing the light-like paths.

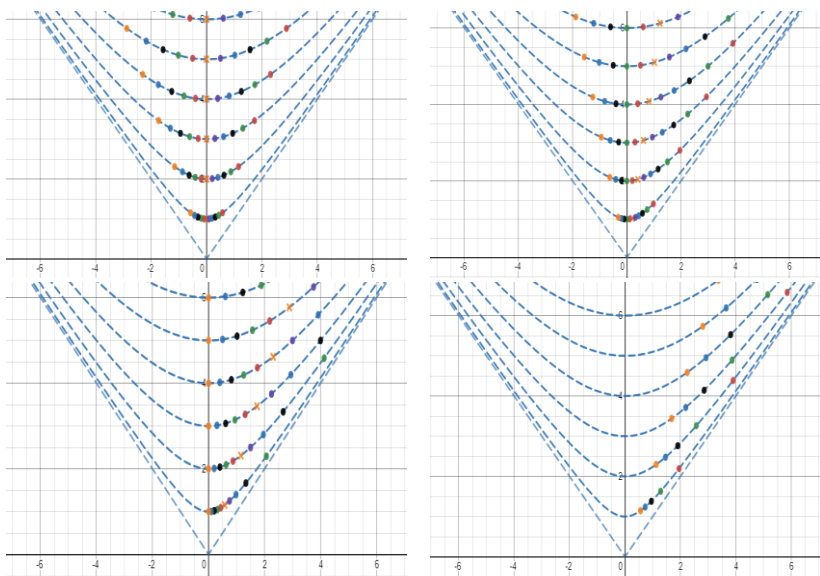
Lorentz Transformations (also called Lorentz boosts) are of the form:

$$t' = \gamma \left( t - \frac{v}{c^2} x \right) \tag{3.5}$$

$$x' = \gamma (x - vt) \tag{3.6}$$

$$\gamma = \frac{1}{\sqrt{1 - \frac{v^2}{c^2}}} \tag{3.7}$$

(Cfr. Faraoni 2013, p. 30)

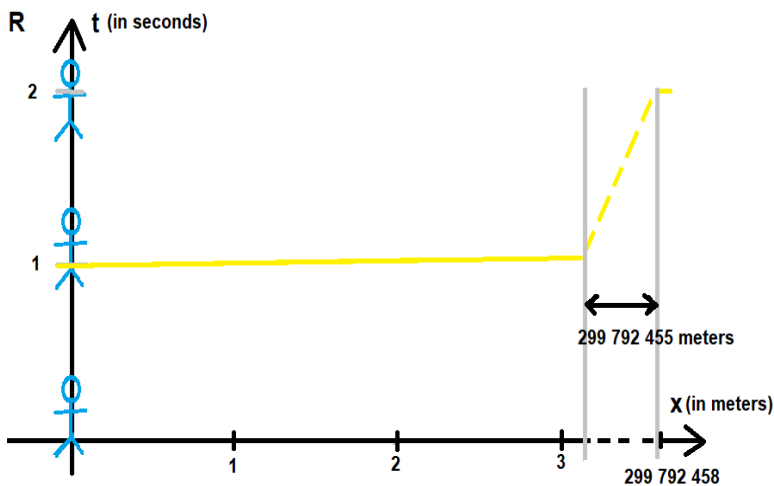


**Fig. 3.2.1.1.i.** Screenshots from *spacetime globe* of the same situation as seen from the reference frame of different observers travelling respectively at 0, 0.2, 0.5 and 0.99 *c*. Source: Simulated from <https://www.desmos.com/calculator/pc7azsxtex?lang=fr>

*Remark on the absence of relativistic effects in everyday life.*

The question one could ask is: *If this is true, how come we do not notice such effects in our daily life?*

The justification for this stems from the units of distance we are used to: during our daily activities, we are confronted with extremely small distances compared to light seconds; therefore we perceive light-like paths as being basically horizontal (Cfr. figure below), which is akin to saying that on our scale we perceive light to be travelling so fast that it feels as if it were instantaneous phenomena.



**Fig. 3.2.1.1.j.** Screenshot from a *spacetime globe* of the same situation as seen from the reference frame of the clock. In this diagram, the observer appears to be travelling at  $0.4 c$  away from the clock.

Source: Simulated from <https://www.desmos.com/calculator/pc7azsxteh?lang=fr>

*A synthesis - The (relativistic) Train in tunnel problem.* Let us consider a train traveling at a velocity  $v$  close to the speed of light approaching a tunnel which has the exact same proper length as the train (proper length signifying the length measured in a reference frame at rest with respect to the measured object). In this context, using Special Relativity, we obtain that an observer at rest with respect to the tunnel would see the train –or more precisely its length– contracted by a factor  $\gamma$  (Treschman KJ, 2015):

$$\gamma = \frac{1}{\sqrt{1 - \frac{v^2}{c^2}}} \tag{3.7}$$

where  $v$  is the speed of the object considered and  $c$  the speed of light in a vacuum.

However, the situation from the reference frame of the train is different. In this reference frame, it is the tunnel that would appear to be shorter to passengers, as from their perspective they are at rest with respect to the train and it is the tunnel that is approaching them. Thus, as the tunnel seems to be shorter than the train, it obviously cannot hold the whole train in it at once (with both ends in the tunnel at the same time).

In order to better understand this phenomenon, let us do a short numerical analysis. Let us set:

- $v$ , the speed of the train to  $v = \frac{c}{2}$ ,
- $L_{train}$ , the length of the train to 100 metres, and
- $L_{tunnel}$ , the length of the tunnel, to be 90 metres.

Now, let us add a system of guillotine doors at both ends of the tunnel with the special property of being instantaneously shut or opened as soon as the train arrives and set the entrance door to [open] and the exit door to [close].

Let us call the entrance of the tunnel E, the exit of the tunnel X, the front of the train F and the back of the train B.

The aim of this setup is to determine if it is possible to have a situation in which both doors would be [closed] at the same time and thus conclude that the whole train is actually inside the tunnel.

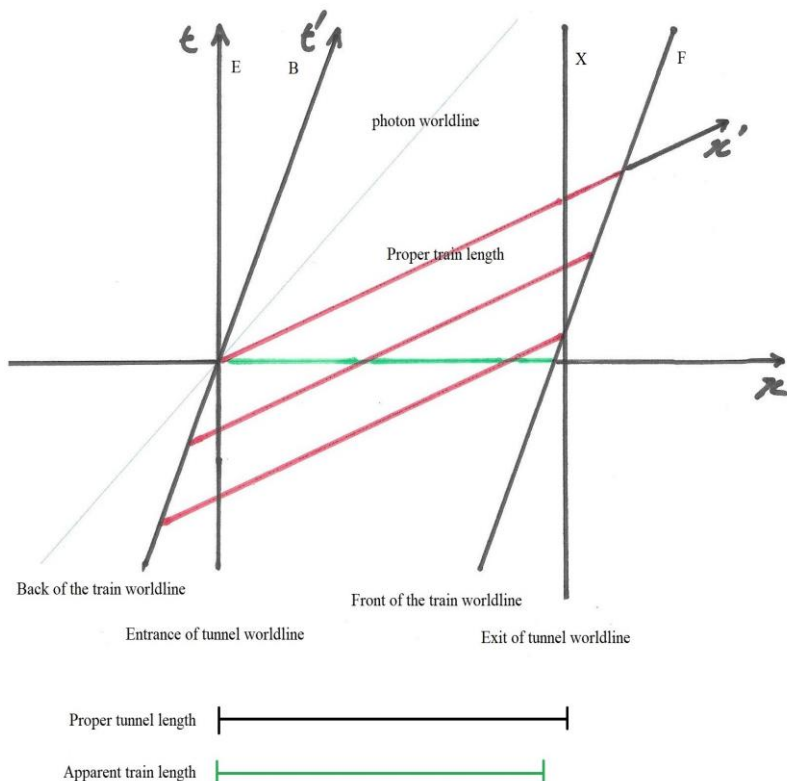
Let us call respectively R and R' the frames of reference of the tunnel and of the train. From R, the apparent length of the train is:

$$L_{train-apparent} = \frac{L_{train}}{\gamma}$$

or approximately 87 metres.

By the same procedure, from R', the apparent length of the tunnel is 78 metres.

Let us draw the spacetime diagram of this situation with coordinates  $(t,x)$  for R and  $(t',x')$  for R' :



**Fig. 3.2.1.1.k.** Spacetime diagram of the train in tunnel problem. Source: PV, handmade.

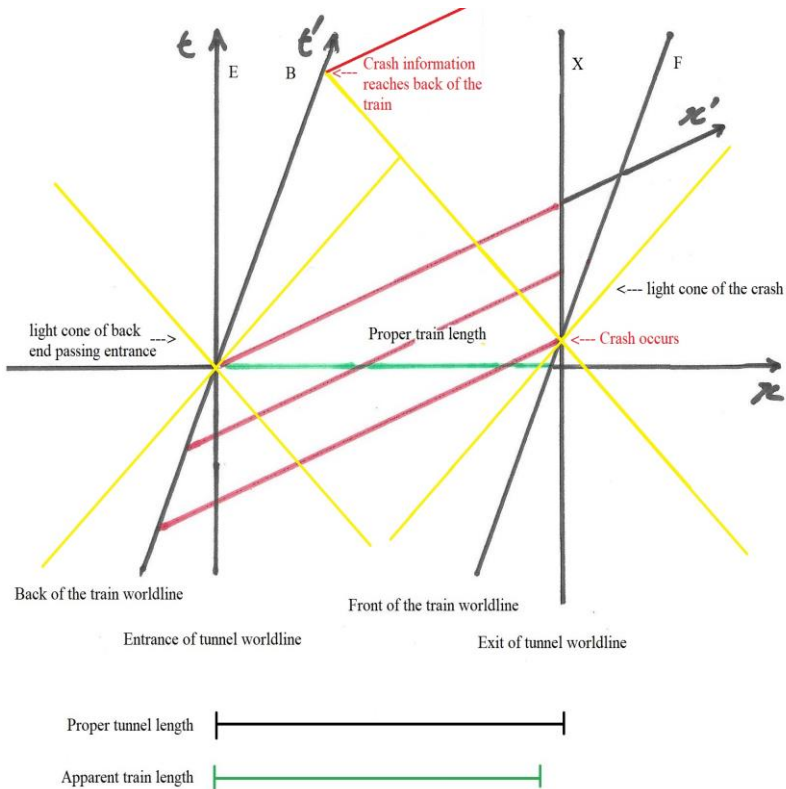
We now have a –geometrical-physical– representation that seems to show two different results when considering one referential frame at a time. As both the entrance and exit of the tunnel are fixed points, their position does not change. Therefore, their trajectory in this spacetime diagram is represented as a vertical line in the referential of the tunnel, i.e. they only advance in time. The worldline of a photon is represented by a line (in cyan) and tilted at a 45° angle. Finally, as the train has a constant velocity of half the speed of light, the worldlines of the extremities of the train are represented by lines tilted at a value of half a 45° angle.

Hence, in the first referential (R), the referential of the tunnel, it seems that the train would in fact be contained inside the tunnel. Indeed, this is shown in the drawing by the green segment representing the train (or rather its apparent length as seen by an observer in R). This green segment being shorter than the proper tunnel length and contained in between lines E and X. On the contrary, in the second referential (R'), it looks like the exit door

has to open before that of the entrance closes; meaning that the whole train never was entirely inside the tunnel at once; as shown by the red lines, which do not fit in between lines E and X.

To solve this seemingly paradoxical situation, let us imagine that the exit door at the end of the tunnel is closed at all times. On one hand, in the (R) referential, this does not pose any problem (except for the passengers of the train) and implies that the train is completely contained in the tunnel. On the other hand, in the (R') referential, this implies that upon reaching the door, the front of the train cannot keep going and crashes into the door.

However, as information cannot travel faster than light because of the speed limit of causality, this implies that the back of the train goes on into the tunnel until the information of the crash, travelling in the opposing direction, catches up.



**Fig. 3.2.1.1.1.** Spacetime diagram of the train in tunnel problem. The light cones of two events have been added in yellow: the back end of the train passing the entrance and of the crash. Source: PV, handmade.

In order to visualize this, the light cones of two events (the back of the train passing the entrance and the crash) are drawn in yellow. Hence, as shown on the figure above, we can see that one the light cone of the crash intersects with line (B); this intersection representing the event corresponding to the rear of the train receiving the information of the crash. Moreover, we can see that the back of the train has already travelled well past the –now shut–entrance door. Therefore, we can conclude that the train is completely contained inside the tunnel (as a wreck). This also illustrates the notion that rigid bodies do not exist (in such circumstances) according to the theory of relativity because the transmission of information is not instantaneous; and the notion that simultaneity can be considered an illusion or a particular case, as seemingly simultaneous events can be perceived as happening at different times depending on the choice of the referential.

### 3.2.2 *General Relativity*

General relativity is a relativistic theory of gravitation. It is a geometrical theory based on the notion that physical space is coupled and inseparable from time, forming a 4-dimensional object: *spacetime*, and that its geometry is deformed by the presence of matter and energy.

In fact, this theory describes the influence of matter–energy density on the motion of celestial objects through *spacetime* curvature. It is often stated in various media that General Relativity is the generalization of Special Relativity; but General Relativity is a *Theory* and as such should rather be considered a generalization of Newton’s Theory of Gravitation first and not simply as an extension of Special Relativity that includes gravity.

In Einstein’s own words from a letter sent to Karl Schwarzschild (1873-1916) dated January, 9, 1916:

The Earth’s surface is irregular as long as I envisage very small sections of it. But it approaches the flat basic form when I envisage larger sections of it, whose dimensions are still small against the length of the meridian. This basic form becomes a curved surface when I envisage even larger sections. Likewise for the gravitational field. On a small scale the individual masses produce gravitational fields that even with the most simplifying choice of reference system [sic] reflect the character of a quite irregular small-scale distribution of matter. If I regard larger regions, as those [sic] available to us in astronomy, the Galilean reference system provides me with the analogue to the flat basic form of the Earth’s surface in the previous comparison. But if I consider even larger regions, a continuation of the Galilean system providing the description of the universe in the same dimensions as on a smaller scale probably does not exist, that is, where throughout, a mass-point sufficiently removed from other masses moves uniformly in a straight line. Ultimately, according to my theory, inertia is simply an interaction between masses, not an effect in which “space” of itself were involved, separate from the observed mass. The essence of my theory is precisely that no independent properties are attributed to space on its own. It can be put jokingly this way. If I allow all things to vanish from the world, then following Newton, the Galilean



inertial space remains; following my interpretation, however, nothing remains.  
(Einstein 1998, p. 204)

A famous quote attributed to John Archibald Wheeler (1911-2008) describes the fundamental principle behind General Relativity: “Space tells matter how to move and matter tells space how to curve” (Misner 1973, p.5).

In fact, Einstein’s Field Equation (cfr. Section 1.9.1):

$$R_{\mu\nu} - \frac{1}{2}Rg_{\mu\nu} + \Lambda g_{\mu\nu} = \frac{8\pi G}{c^4} T_{\mu\nu} \quad (1.24)$$

is actually encompassing these two statements. Indeed, the left part is in fact describing the curvature of a region of spacetime while the right part is encoding the mass–energy density in that same region.

Furthermore, the geometrical curvature of spacetime taken into consideration in General Relativity is responsible for a number of effects; some of which will be explored in the next section. Therefore, in order to better understand General Relativity, we need to examine this *curvature*.

Taking the example of Special Relativity in “flat” Minkowski spacetime, where there is no curvature, when comparing two physical vectors such as the velocities of two objects is fairly straightforward; however, in General Relativity, because of the curvature of spacetime, this comparison needs to take place at the same point.

The reason for this is that the curvature at a point affects the vector at that point. Therefore, in order to compare two vectors in General Relativity, we first need to parallel transport one of them to the other.

This notion of parallel transport is essential to understand General Relativity as it is a fundamental notion required to understand what the Riemann curvature tensor<sup>88</sup> is –from which are built the two tensors of the left hand side of equation (1.24).

*On Parallel transport & Riemann Curvature Tensor (conceptually).* At a fundamental level, the notion of parallel transport revolves around the notions of vectors and spaces.

Definition: The notion of parallel transport on a manifold  $M$  [a topological space that is locally Euclidean] makes precise the idea of translating a vector  $V$  along a curve to attain a new vector  $V'$  which is parallel to  $V$ .<sup>89</sup>

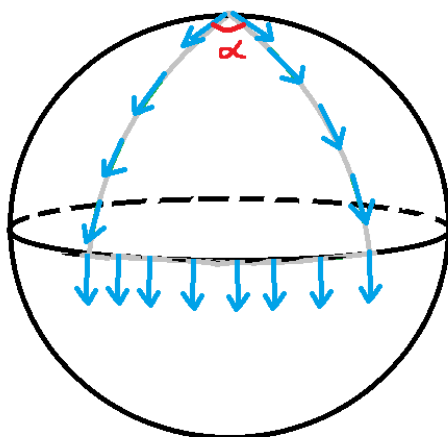
---

<sup>88</sup> Broadly speaking, tensors are generalizations of scalars (numbers; no index), vectors (that have exactly one index), and matrices (that have exactly two indices) to an arbitrary number of indices.

<sup>89</sup> Adapted from <https://mathworld.wolfram.com>

In other words, it is a question of continuously translating a vector associated with a point embedded in a particular space from one location to another by making sure that it always remains parallel to itself along the way.

Some examples are given below.



**Fig. 3.2.2.a.** (Top): Parallel transport of a vector along a line.

**Fig. 3.2.2.b.** (Left): Starting from the pole of the sphere (2-sphere) which is equipped with a vector aligned with a longitude and parallel transporting it along the grey path to the equator, then to another longitude and back to the pole, the direction of the vector ends up making an angle  $\alpha$  compared to its original orientation. This is a consequence of parallel transport on a curved manifold.

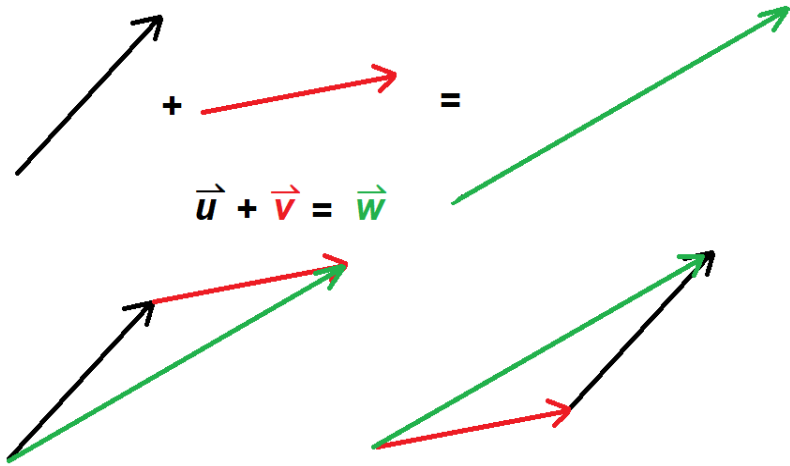
**Table 3.2.2.** Examples of parallel transport of vectors.

Source: PV, made with MSPaint.

From this last observation that when a vector is parallel transported along a closed path on a manifold, it is affected by a change and is not parallel to itself anymore is very valuable. Indeed, it tells us that this procedure acted as some kind of probe able to detect the curvature of the space. In fact, it is from this idea that a visualisation of the meaning of the Riemann Curvature Tensor can be done: by looking at how vectors change as a measure of curvature.

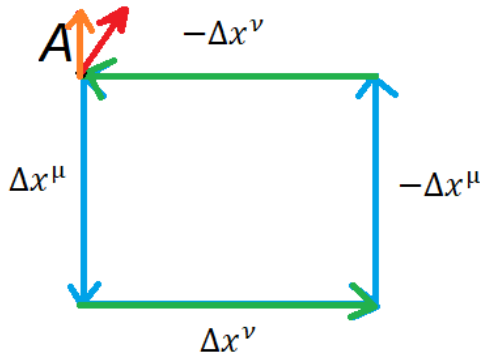
During school, pupils are taught Euclidean Geometry and one of the key concepts that we will need to build a visualization of the Riemann Curvature Tensor is the Chasles Relation –which is essentially the relation used for vector addition (cfr. figure below).

In Geometry, the Chasles Relation is the rule stating the procedure to follow in order to build the vector corresponding to the addition of any two vectors.



**Fig. 3.2.2.c.** Illustration of the Chasles Relation. In order to build the vector  $\vec{w} = \vec{u} + \vec{v}$ , we have to parallel transport the two free vectors  $\vec{u}$  and  $\vec{v}$  so that the tip of one of them is aligned to the end of the other, thus allowing to draw the vector  $\vec{w}$  by tracing a line segment from the end of the first vector to the tip of the other.  
 Source: PV, made with MSPaint.

From this we will consider a simple case, i.e. a simple closed path from one point to which we assign a vector:

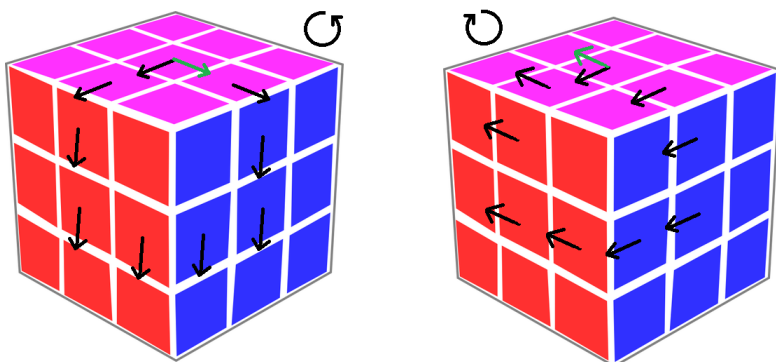


**Fig. 3.2.2.d.** Illustration of parallel transport of a vector (orange) associated to a point (A) along a closed path. The new (red) vector results from the parallel transport.  
 Source: PV, made with MSPaint.

Therefore, by parallel transporting the orange vector along coordinate changes  $\Delta x^\mu$ , then  $\Delta x^\nu$ , then  $-\Delta x^\mu$  and finally  $-\Delta x^\nu$ , and subtracting the new vector (the red vector in the above figure) obtained from this, we can measure the change of the vector—following this procedure, if the result were 0 (no change), the curvature of the space at point A would then correspond to a “flat” space; i.e. the space would have no curvature at point A.

At that point, it is important to recognize that this shift in the vector not only depends on the curvature of the space, but also on the path taken. In

Fig. 3.2.2.b., if we chose to parallel transport the vector round the sphere from the same starting point (the pole) along a closed path defined by a longitude, we would end up with the exact same vector and would be inclined to reach the conclusion that the space had no curvature at that point. Furthermore, we would have gotten yet again a different result in Fig. 3.2.2.d. by parallel transporting the orange vector along coordinate changes  $-\Delta x^\nu$ , then  $-\Delta x^\mu$ , then  $\Delta x^\nu$  and finally  $-\Delta x^\mu$ . This last point is obvious when considering the figure below:

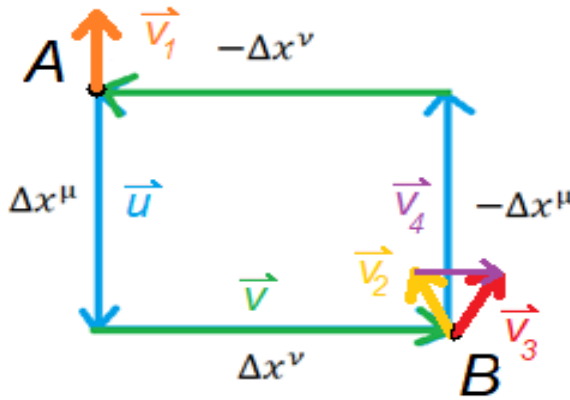


**Fig. 3.2.2.e.** Illustration of the non-commutativity of a closed path along a Rubik cube. The parallel transport of a (black) vector results in different (green) vectors depending on the direction in which it undergoes along the same closed path.

Source: Adapted from <https://publicdomainvectors.org/fr/gratuitement-des-vecteurs/Cube-Rubik-en-clair/45879.html> | (Public domain) |

The solution to remedy this problem is actually beautifully simple to understand graphically by adapting fig 3.2.2.d. (cfr. figure below):

- Let us take a vector  $\vec{v}_1$  at some point  $A$ .
- Then, let us take another point,  $B$  infinitesimally close to  $A$ .  
i.e.  $B$  is chosen to be infinitesimally close to  $A$  in order to get infinitesimally small coordinate changes and make the total path tend to 0 so as to measure the curvature at that unique point and not the influence of the curvature of the region of space on the vector along the path.
- Draw a closed path from  $A$  passing through  $B$  using the same procedure as before.
- Because  $B$  is infinitesimally close to  $A$ , we can approximate the closed path to a parallelogram of sides  $\Delta x^\mu$ ,  $\Delta x^\nu$ ,  $-\Delta x^\mu$  and  $-\Delta x^\nu$  by considering the limit where  $\Delta x^\mu$ ,  $\Delta x^\nu \rightarrow 0$
- Now, let us parallel transport  $\vec{v}_1$  to point  $B$  by taking the path identified by  $\Delta x^\mu$ ,  $\Delta x^\nu$  and call the resulting vector  $\vec{v}_2$ .
- We can do the same procedure using the other path in order to construct  $\vec{v}_3$ .
- Finally, we can construct  $\vec{v}_4$  by using  $\vec{v}_2$  and  $\vec{v}_3$  (with the Chasles relation;  $\vec{v}_4 = -\vec{v}_3 + \vec{v}_2$ )



**Fig. 3.2.2.f.** Illustration of parallel transport of a vector (orange) from a point (A) to another (B) via two different paths. The resulting vectors are in yellow and red; and a fourth vector, in purple, is measuring the shift between them.  
 Source: PV, made with MSPaint.

The limit

$$\lim_{\Delta x^\mu, \Delta x^\nu \rightarrow 0} \frac{v_4}{u \ v} = \lim_{\Delta x^\mu, \Delta x^\nu \rightarrow 0} \frac{v_2 - v_3}{u \ v} = R(u, v)v_1 \tag{3.8}$$

is well defined, and it measures the curvature of spacetime at point A. In local coordinates, we can write it as:

$$R(u, v)v_1 = R^\alpha_{\beta\gamma\delta} u^\beta v^\gamma v_1^\delta \tag{3.9}$$

where the quantity  $R^\alpha_{\beta\gamma\delta}$  is the Riemann Curvature Tensor.

Finally, this tensor can be used “to compute the relative acceleration of nearby particles in free fall if they are initially at rest relative to one another” (cfr. Baez 2006, pp. 15-16).

### 3.2.2.1 General Relativity Predictions

General Relativity is the best current description of the Universe we have when considering celestial objects.

Through the last century, the development of General Relativity lead to new explanations and its study made several predictions such as the precession of Mercury’s perihelion, the phenomenon of gravitational lensing or the bending of light, gravitational redshifting, geodesics and frame-dragging effects, B1913+16, time dilation in gravitational fields, and so on.

### 3.2.2.2 *The precession of Mercury's Perihelion*

The perihelion is the point in the orbit of an object that is the closest to the sun, by opposition to the aphelion, which is the farthest point from the sun. The precession of the perihelion is the name given to the phenomenon which makes the trajectory of an object orbiting the sun slowly rotate in the ecliptic plane; thus making the perihelion rotate in this plane.

In 1915, Einstein published a paper titled “Erklärung der Perihelbewegung des Merkur aus der allgemeinen Relativitätstheorie” which English translation is available as “Explanation of the Perihelion Motion of Mercury from General Relativity Theory” (Vankov 2011). In this paper, after acknowledging the works of Urbain Le Verrier (1811-1877) on Mercury and his discoveries (Le Verrier 1843):

In this work, I found an important confirmation of this radical Relativity theory; it exhibits itself namely in the secular turning of Mercury in the course of its orbital motion, as was discovered by Le Verrier. (Vankov A, 2011, p.4)

Einstein used his theory to analyse the issue and concluded by comparing his results to the ones given using Newton's theory of gravitation:

“This calculation leads to the planet Mercury to move its perihelion forward by 43 " per century, while the astronomers give 45 "±5", an exceptional difference between observation and Newtonian theory. This has great significance as full agreement.” (Ivi. p.11)

According to Anatoli Vankov this paper is probably the only one of Einstein's publications discussing this problem through General Relativity:

“Einstein's paper devoted to the GR prediction of Mercury's perihelion advance<sup>90</sup>, is the only one among his publications that contains the explanation of the GR effect. [...] Since then, to our knowledge, he never returned to the methodology of the GR perihelion advance problem.” (Ivi. p.15)

However, even if Einstein did not preoccupy himself much with this problem, numerous works have been published since then. It is also important to note that Einstein also alludes to the bending of light predicted by his theory:

“Furthermore, it shows that this theory has a stronger (doubly strong) light bending effect in consequence through the gravitational field than it amounted to in my earlier investigation.” (Ivi. p.4)

---

<sup>90</sup> Cfr. Volume 6 of The Collected Papers of Albert Einstein (further ColPap for short); Volume 6 (1996), Doc.24.

### 3.2.2.3 Bending of Light and Gravitational Lensing

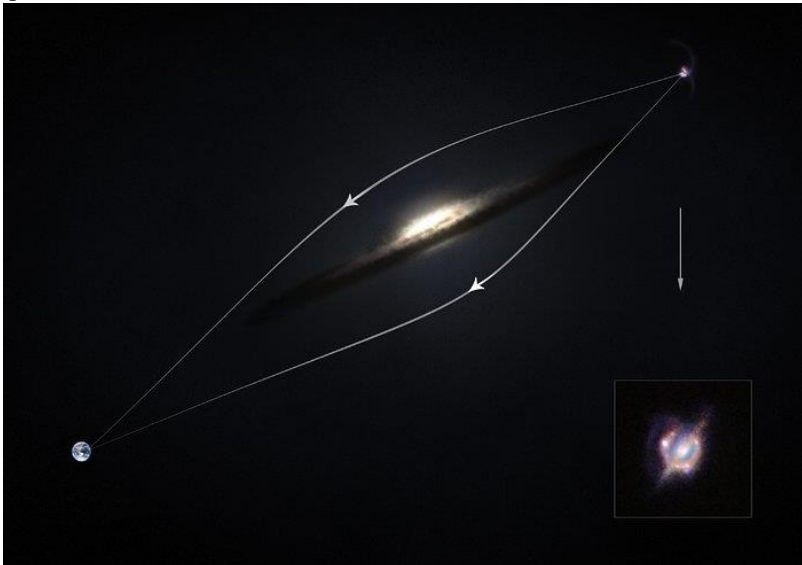
In General Relativity, the curvature of a region of *spacetime* depends on the amount of mass and energy present and how it is distributed; the mass-energy density.

Light is made of photons which are massless particles and travels in straight lines, as empirically confirmed by various experiences and our everyday experience of life. However, this is not entirely correct; in fact, light follows straight paths *in spacetime* and not just space. The result is that the paths taken by objects in spacetime actually follow *geodesics* which correspond to the generalization of the notion of straight lines. In particular, *geodesics* are curves which extremize the distance between points.

In order to understand how the trajectory of such rays can be influenced, one must first consider the effects of space curvature on an object whose trajectory is inscribed into said space.

Consider a sufficiently high density of mass-energy bending a region of spacetime; as light then travels in a straight line on this bent region of spacetime, thus following a geodesic trajectory in spacetime, the result would be that its trajectory has changed (cfr. figure below).

Here, one could also understand this phenomenon through an analogy done with the mirage phenomena. In mirages, the bending of light is caused by a change in the index of refraction because of a gradient in temperature in the medium (air); whereas the trajectory of light in space is changed because of the presence of a gravitational field, a gravitational gradient on spacetime.



**Fig. 3.2.2.3.a.** Illustration of the Gravitational bending of light by a galaxy.

Source: <https://www.eso.org/public/images/eso1426b/> | (CC BY 4.0 International License), Credit: ESO/M. | Kommesser.

*Gravitational lensing.* In some circumstances, especially those involving very massive celestial objects, this phenomenon of the bending of light can result in what is called “Gravitational lensing”. The term Gravitational lensing applies to the phenomenon by which an image of a background object is visible to an observer thanks to the bending of light despite there being another object between them that should block line of sight.

In this phenomenon, the amount of mass-energy density of a celestial body is such that light emitting objects situated behind said celestial objects can be visible. In fact, the deformations in the curvature of spacetime in the vicinity of the celestial object is such that it acts as if instead of the object, there was some kind of glass lense. These gravitational lenses, just like glass lenses deform the images coming from the region of space of their background which can culminate in several optical effects, i.e. mirages, mirror images, Einstein’s crosses, etc.



**Fig. 3.2.2.3.b.** Picture of gravitational lensing, galaxy cluster Abell 2218. Source: NASA | <https://apod.nasa.gov/apod/ap080210.html> | Credit: Andrew Fruchter (STScI) *et al.*



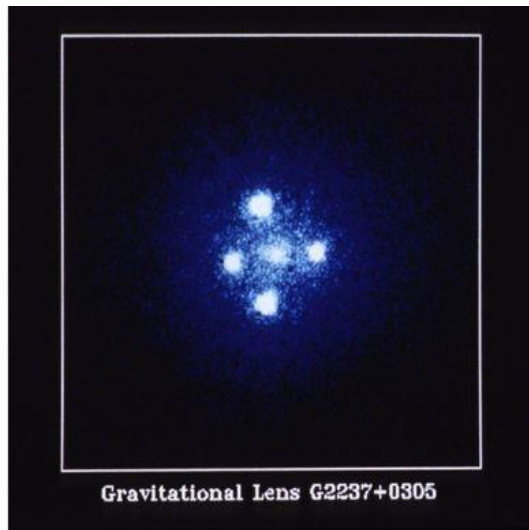


Fig. 3.2.2.3.c. Image of an “Einstein’s cross”.

Source: NASA, ESA, and STScI | [http://hubblesite.org/image/22/news\\_release/1990-20](http://hubblesite.org/image/22/news_release/1990-20)

The first experimental test of the theory of relativity was done during Eddington’s expedition to measure the bending of light happening during a total solar eclipse in 1919 (Eddington 1919, pp. 119-122). After having developed his theory of General Relativity, Einstein noticed that he had made a mistake a few years earlier about the problem of the bending of light and proceeded to correct his findings.

The latest formula he obtained was:

$$\alpha = \frac{4 GM}{c^2 r}$$

where  $\alpha$  is the angle of deviation,  $G$  the gravitational constant,  $M$  the mass of the Sun,  $c$  the celerity of light and  $r$  the distance from the centre of the Sun; and where half that value comes from space curvature and the other from time (Einstein 1916b; Coles 2001).

This –double– expedition to Brazil with Andrew Claude de la Cherois Crommelin and to Principe with Arthur Stanley Eddington revealed that light was indeed deflected by the presence of the Sun. In 1922, another expedition to Wallal in Australia with William Wallace Campbell and from the Lick Observatory confirmed that starlight was deflected by the Sun (Campbell 1928).

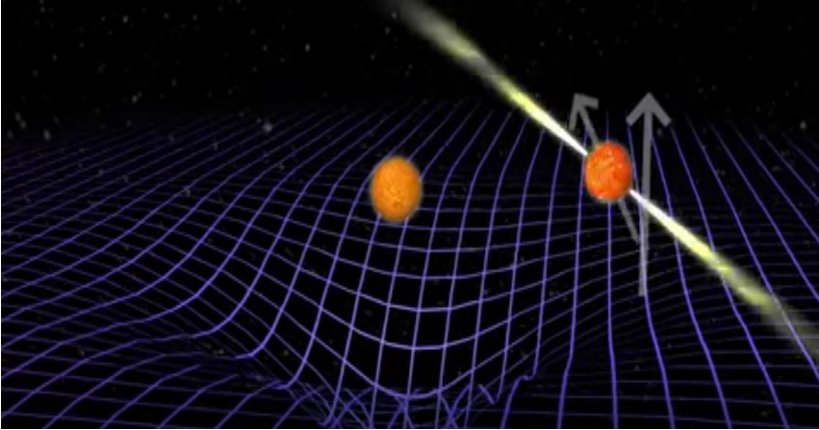
*Light propagation in gravitational fields.* Another way gravitational fields can influence light is by exerting a shift in the observed frequency of a photon in a similar way to the Doppler Effect (discussed in Chapter 1). Due to a gravitational gradient, light undergoes a blueshift when observed from

a region where the gravitational field is stronger and, vice-versa, it experiences a redshift when observed from a region where the gravitational field is weaker. As showed by the Pound-Rebka experiment, the underlying principle in action affecting how light is perceived from gravitational fields of different intensities is that of time dilation or length contraction (of the wavelengths). In this experiment, a gravitational blueshift was measured in gamma rays sent from the top of a tower to the bottom. The measured gamma rays acquired energy on their way to the bottom of the tower while travelling through the gravitational gradient corresponding to the difference of altitude of the height of the tower and its ground level.

### *3.2.2.4 The Geodetic and Frame-dragging Effects*

In order to fully describe the motion of a celestial object in the framework of General Relativity, it is often necessary to take into consideration the change in the orientation of the rotational axis of the rotating object. To do so, one has to study the total precession of the object which is the combination of two effects: the De Sitter Effect and the Lense-Thirring Effect (Lämmerzahl 2001).

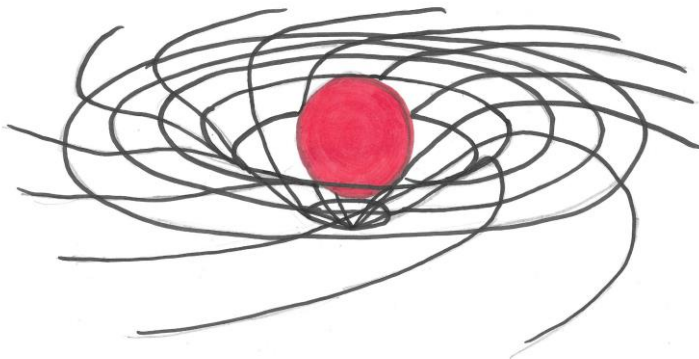
On one hand, the De Sitter Effect, also called the geodetic effect, is the name given to a phenomenon that affects objects around a celestial body due to the fact that the presence of said body produces distortions of spacetime around the celestial object. To be more specific, this precession comes from the curvature of spacetime produced by the celestial body. An intuitive way to think about this effect is with an analogy using our usual sheet deformed by an object such as a bowling ball to represent a two dimensional spacetime deformed by a celestial body and a spinning top/whirligig representing an object in the vicinity of the celestial body such as a satellite. In this configuration, the toy spins around the bowling ball (the satellite is in orbit) and as it is following the curvature of the sheet (the curvature of spacetime), its rotating axis undergoes a precession as it follows the curvature around the ball. In the figure below, two neutron stars orbit one another, the rotational axis of the star with the beams is represented; the vertical arrow represents the rotational axis of the star if it were on a flat region of spacetime.



**Fig. 3.2.2.4.a.** Screenshot of an Animation of the effect of geodetic precession in the observer pulsar. Two neutron stars orbit one another. The star visible as a pulsar shows rotating beams.

Source: <https://www.astron.nl/dailyimage/main.php?date=20150123> | CC-BY-AS | Credit: Joeri van Leeuwen/ASTRON.

On the other hand, the Lense-Thirring Effect, also called the frame-dragging effect, is the name given to a phenomenon that comes from the distortions of spacetime around a rotating celestial object. Predicted by Josef Lense (1890-1985) and Hans Thirring (1888-1976), this effect, like its name suggests, describes the phenomenon by which the –fast– rotation of the celestial body drags spacetime along its motion.



**Fig. 3.2.2.4.b.** Drawing of the frame dragging effect on spacetime of a massive celestial object spinning (*in red*). Source: PV handmade.

To test both effects, a satellite was launched on April 20, 2004, Gravity Probe B, and NASA announced that Gravity Probe B successfully managed to measure both the geodetic and frame-dragging effects on the satellite's gyroscope (Will 2015).

### 3.3 1905. *Comptes Rendus of the French Academy of Sciences*

On the 5<sup>th</sup> of June 1905, Poincaré reported his latest work and reflections at the French Academy of Science. In his paper “*Sur la dynamique de l'électron*” (On Electron Dynamics; Poincaré 1905).

He began by discussing the problem of the aberration of light –i.e. “the aberration of light and related optical and electrical phenomena” (Ivi. p. 1504), and about using these phenomena in order to determine “the absolute motion of the Earth” (*Ibidem*) with respect to the ether, as opposed to its motion with respect to other celestial bodies. Unbeknownst to Poincaré, this problem actually came from the bending of light due to gravitational lensing, and Michelson's experiment had actually shown that this impossibility of determining an absolute motion was in fact a law of nature.

Poincaré then discussed Lorentz's idea: the hypothesis that a contraction of all bodies in the direction of the motion of the Earth was happening as an explanation for Michelson's experiment results:

[...] But Michelson, who conceived an experiment sensitive to terms depending on the square of the aberration, failed in turn. It appears that this impossibility to detect the absolute motion of the Earth by experiment may be a general law of nature [...]. An explanation was proposed by Lorentz, who introduced the hypothesis of a contraction of all bodies in the direction of the Earth's motion. (Cfr. Walter 2020)

91

From this postulate and, according to Poincaré, as Lorentz judged necessary to extend his hypothesis for all forces and not just electromagnetic forces, Poincaré reflected on what modifications could be applied to the laws of gravitation in order for them to follow Lorentz postulate.

In order to do so, Poincaré thus used Lorentz's transformations (Cfr. Section 3.2.1.1.) and added the assumption that the transmission of gravity was done at the speed of light even though “Laplace demonstrated that this cannot be the case”:

---

<sup>91</sup> Mais Michelson, ayant imaginé une expérience où l'on pouvait mettre en évidence les termes dépendant du carré de l'aberration, ne fut pas plus heureux. Il semble que cette impossibilité de démontrer le mouvement absolu soit une loi générale de la nature. Une explication a été proposée par Lorentz, qui a introduit l'hypothèse d'une contraction de tous les corps dans le sens du mouvement terrestre. (Poincaré 1905, p.1504)

It was important to examine this hypothesis closely, and in particular to ascertain the modifications we would have to apply to the laws of gravitation. We find first of all that it requires us to assume that gravitational propagation is not instantaneous, but occurs with the speed of light. (*Ibidem*)<sup>92</sup>

Poincaré then continues his reflection stating that one of Lorentz' results was that his transformations were applicable to all forces (Poincaré 1905, p. 1507) and thus, Poincaré extended it to the transmission of gravity.

At that point, he explained that he was compelled to suppose that the propagation of gravity between different bodies was not an instantaneous process, but had in fact to be done at the speed of light.

However, Poincaré explained that this was at first concerning to him because of the fact that it was in contradiction with a result obtained by Pierre-Simon de Laplace (1749-1827). Nevertheless, Poincaré noted that Laplace's question was considerably different to these since it was the one and only modification he attempted; contrary to the present case where multiple modifications were used; in particular, Lorentz transformations, thus allowing the possibility for compensations to happen between the modifications.

Finally, reaching his conclusion, Poincaré coined the term "gravitational wave":

Remember that when we speak of the position or velocity of the attracting body, this refers to its position or velocity at the instant the gravitational wave [*onde gravifique*] takes off; for the attracted body, on the contrary, this refers to the position or velocity at the instant the gravitational wave arrives [...] (Cfr. Walter 2020).<sup>93</sup>

Unfortunately, Poincaré refrained from continuing his analysis further and concluded his paper with a few remarks regarding the appreciation of the deviation with the ordinary law of gravitation when choosing the speed of the propagation of gravity as being the same as the speed the speed of light; ultimately closing his intervention by explaining that it would not be unimaginable that this was in fact the case, as the precision required for such astronomical observations was such that it would have been almost undetectable.

---

<sup>92</sup> Il importait d'examiner cette hypothèse de plus près et en particulier de rechercher quelles modifications elle nous obligerait à apporter aux lois de la gravitation. C'est ce que j'ai cherché à déterminer ; j'ai été d'abord conduit à supposer que la propagation de la gravitation n'est pas instantanée, mais se fait avec la vitesse de la lumière. (Poincaré 1905, pp. 1507)

<sup>93</sup> Quand nous parlerons donc de la position ou de la vitesse du corps attirant, il s'agira de cette position ou de cette vitesse à l'instant où l'*onde gravifique* est partie de ce corps ; quand nous parlerons de la position ou de la vitesse du corps attiré, il s'agira de cette position ou de cette vitesse à l'instant où ce corps attiré a été atteint par l'onde gravifique émanée de l'autre corps [...]. (Poincaré 1905, pp. 1507)

### 3.4 On The Existence of Gravitational Waves: The 1937 Incident

After its amazing successes at both explaining gravity from a geometrical point of view and at describing and predicting results, Albert Einstein's General Relativity Theory continued to be researched and developed until this very day. However some of the predictions of the theory from its early days had yet to be examined, let alone tested, and gravitational waves are part of those.

Soon after having finished his theory, Einstein wrote a letter dated 19 February, 1916 to Karl Schwarzschild in which he explained that there was no gravitational wave analogous to electromagnetic waves for electromagnetism because unlike in electromagnetism where charge can be either positive or negative, the same was not true for mass:

Since then, I have handled Newton's case differently, of course, according to the final theory. Thus there are no gravitational waves analogous to light waves. This probably is also related to the one-sidedness of the sign of scalar T, incidentally. (Nonexistence of the "dipole".) (Einstein 1998, p. 224)

Nevertheless, according to Prof. Daniel Kennefick, Einstein studied the possibility of their existence thanks to a suggestion made by Willem de Sitter (Kennefick 2016) and ended up discussing them in his 1916 paper (Einstein 1916, 1916a). Unfortunately, he made a mistake and finally published a dedicated article: "*Über Gravitationswellen*" (On Gravitational Waves) in 1918 (Einstein 1918).

However, according to Prof. Kennefick –which certainly gave him the idea for his 2007 book title (cfr. Kennefick 2007):

Even in his 1918 paper Einstein made some errors. He at first thought he had discovered three different types of gravitational waves. Two of these types are spurious. Einstein quickly realized this and Eddington later showed these spurious waves travel at arbitrary speeds depending on the choice of coordinates. As he put it, they travel not at the speed of light, but at "the speed of thought." (Kennefick 2016, p. 12)

It was not until 1936 that Einstein started to have second thoughts about the existence of gravitational waves as attests a letter (Einstein 2005) from Einstein to Max Born (1882-1970):

"Next term we are going to have your temporary collaborator Infeld here in Princeton, and I am looking forward to discussions with him. Together with a young collaborator, I arrived at the interesting result that gravitational waves do not exist, though they had been assumed a certainty to the first approximation. This shows that the non linear general relativistic field equations can tell us more or, rather, limit us more than we had believed up to now." -Albert Einstein to Max Born, written in mid 1936. (Kennefick 2016, p. 18)

Thus, second guessing himself, Einstein sent a paper with Nathan Rosen (1909-1995) to *The Physical Review* for publication. However, the paper met resistance from the journal as the referee judged that it needed revision (cfr. Figure 3.4.a.).

THE PHYSICAL REVIEW  
REVIEWS OF MODERN PHYSICS  
PHYSICS

Conducted by  
THE AMERICAN PHYSICAL SOCIETY  
JOHN T. TATE, *Managing Editor*

*University of Minnesota, Minneapolis, Minn., U. S. A.*

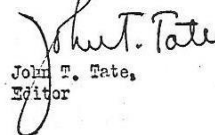
July 23, 1936

Professor A. Einstein  
Saranac Lake, New York

Dear Professor Einstein:

I am taking the liberty of returning to you the paper by yourself and Dr. Rosen on gravitational waves together with some comments by the referee. Before publishing your paper I would be glad to have your reaction to the various comments and criticisms the referee has made.

Sincerely yours,

  
John T. Tate,  
Editor

JTT:B  
Enc.

**Fig. 3.4.a.** Letter from John T. Tate to Einstein, dated July 23, 1936. Source: Courtesy of Prof. Daniel Kennefick.

Unfamiliar with this procedure (Kennefick 2016, p. 22), Einstein sent a reply stating that he did not authorize the journal to show his paper to a specialist; he sent it for it to be printed; and for this reason, he was going to publish the paper somewhere else (cfr. Figure below).

Herrn John T. Tate  
 Editor The Physical Review  
 University of Minnesota  
 Minneapolis, Minn.

Sehr geehrter Herr:

Wir (Herr Rosen und ich) hatten Ihnen unser Manuskript zur Publikation gesandt und Sie nicht autorisiert, dasselbe Fachleuten zu zeigen, bevor es gedruckt ist. Auf die - übrigens irrtümlichen - Ausführungen Ihres anonymen Gewährsmannes einzugehen sehe ich keine Veranlassung. Auf Grund des Vorkommnisses ziehe ich es vor, die Arbeit anderweitig zu publizieren.

Mit vorzüglicher Hochachtung

P.S. Herr Rosen, der nach Sowjet-Russland abgereist ist, hat mich autorisiert, ihn in dieser Sache zu vertreten.

Fig. 3.4.b. Einstein's reply (in German) to John T. Tate.  
 Source: Courtesy of Prof. Daniel Kennefick.

Prof. Kennefick remarked that “In Germany, it was considered an insult to reject a paper by an established physicist”; hence Einstein's first reaction (*Ibidem*) and probably also why he never published in *The Physical Review* after that.

In the end, and with support from Leopold Infeld (1898-1968) and Howard Percy Robertson (1903-1961), Einstein realized that he indeed made a mistake and was finally convinced again of the existence of gravitational waves (Ivi. p.28) and the paper titled “On Gravitational Waves” was published in the Journal of the Franklin Institute with Rosen in 1937 (Einstein 1937).



## **Final Remarks**

In this part, I have explored the historical foundations of gravitational waves by revisiting some of the most impactful historical events and discoveries that led to the formulation of both Einstein's Special and General Relativities.

By doing so I also grabbed the opportunity to discuss the bases of the principles and physical phenomena attached to them, and first and foremost how they were developed and their geometrical and physical interpretations. This was necessary as they are required in order to have a deeper understanding of both the theories and gravitational waves.

I also explored some consequences of the theories through examples, both theoretical and practical; and revisited the historical context surrounding the development of the concept of gravitational waves and its evolution and revisited the role played by various scientists.

# REFERENCES

## Primary Sources

- De Broglie M (1956) Poincaré et la philosophie. In: *Le livre du centenaire de la naissance de Henri Poincaré, 1854-1954*, in *Œuvres de Poincaré*, Gauthier-Villars, Paris XI, pp. 71-77.
- Eddington AS (1919) The total eclipse of 1919 May 29 and the influence of gravitation on light. *Observatory* 42:119-122.
- Einstein A (1905a) Zur Elektrodynamik bewegter Körper, *Annalen der Physik* 17:891
- Einstein A (1905b) Ist die Trägheit eines Körpers von seinem Energieinhalt abhängig? *Annalen der Physik* (ser. 4), 18:639–641.  
Retrieved: <https://onlinelibrary.wiley.com/doi/epdf/10.1002/andp.19053231314>
- Einstein A (1915) Erklärung der Perihelbewegung des Merkur aus der allgemeinen Relativitätstheorie Von A. Einstein above theoretical premises. Retrieved: [http://articles.adsabs.harvard.edu/cgi-bin/get\\_file?pdfs/SPAW/1915/1915SPAW.....831E.pdf](http://articles.adsabs.harvard.edu/cgi-bin/get_file?pdfs/SPAW/1915/1915SPAW.....831E.pdf)
- Einstein A (1916) Näherungsweise Integration der Feldgleichungen der Gravitation. *Sitzungsberichte der Königlich Preussischen Akademie der Wissenschaften Berlin*, part 1: 688–696.
- Einstein A (1916a) Approximative integration of the field equations of gravitation. *Sitzungsber. Preuss. Akad. Wiss. Berlin (Math. Phys.)*, 1916(688-696):1.
- Einstein A (1916b) Die Grundlage der allgemeinen Relativitätstheorie (The Foundations of the General Theory of Relativity). *Annalen der Physik*. 49:769-822. Retrieved: <https://onlinelibrary.wiley.com/doi/abs/10.1002/andp.200590044>
- Einstein A (1918) Über Gravitationswellen. *Sitzungsberichte der Königlich Preussischen Akademie der Wissenschaften Berlin*, part 1:154–167.
- Einstein A, Rosen N (1937) On gravitational waves. *Journal of the Franklin Institute*, 223/1:43–54. Doi:10.1016/S0016-0032(37)90583-0.
- Einstein A (1998) The Collected Papers of Albert Einstein, Volume 8: The Berlin Years: Correspondence, 1914-1918. p. 203, p. 224. Retrieved: <https://einsteinpapers.press.princeton.edu/vol8-trans/224>  
<https://einsteinpapers.press.princeton.edu/vol8-trans/203>
- Einstein A, Born M, Born H (2005) The Born-Einstein letters: friendship, politics, and physics in uncertain times. Correspondence between Albert Einstein and Max and Hedwig Born from 1916 to 1955 with commentaries by Max Born. Macmillan.
- Lense J, Thirring H (1918) Über den Einfluss der Eigenrotation der Zentralkörper auf die Bewegung der Planeten und Monde nach der Einsteinschen Gravitationstheorie. *Physikalische Zeitschrift* 19:156-63.
- Le Verrier U (1843) Recherches sur l'orbite de Mercure et sur ses perturbations. Détermination de la masse de Vénus et du diamètre du Soleil; par U.-J. Le Verrier. In: *Journal de mathématiques pures et appliquées : ou recueil mensuel de mémoires sur les diverses parties des mathématiques / publié par Joseph Liouville*, p. 277. Retrieved: <https://gallica.bnf.fr/ark:/12148/bpt6k16387b/f281.item>
- Lorentz HA (1892) The relative motion of the earth and the ether. *Zittingsverlag Akad. V. Wet.*, 1:74-79.
- Michelson AA, Morley EW (1887) On the relative motion of the earth and the luminiferous ether. *Amer. J. Sci*, 34:333.
- Michelson AA, Morley EW (1887a) LVIII. On the relative motion of the earth and the luminiferous Æther. *The London, Edinburgh, and Dublin Philosophical Magazine and Journal of Science*, 24(151):449-463.

- Plato (1925) *Plato in Twelve Volumes*, translated by W.R.M. Lamb. Cambridge, MA, Harvard University Press; London, William Heinemann Ltd, Vol. 9, 48b. Retrieved: <http://www.perseus.tufts.edu/hopper/text?doc=Perseus%3Atext%3A1999.01.0180%3Atext%3DTim.%3Asection%3D48b>
- Poincaré H (1905) Sur la dynamique de l'électron (The dynamics of the electron by Henri Poincaré) pour l'académie des sciences. C.R. T.140 (1905) 1504-1508. Retrieved: [https://www.academie-sciences.fr/pdf/dossiers/Poincare/Poincare\\_pdf/Poincare\\_CR1905.pdf](https://www.academie-sciences.fr/pdf/dossiers/Poincare/Poincare_pdf/Poincare_CR1905.pdf)
- Poincaré HJ (1913) *Dernières pensée*. Flammarion, Paris
- Poincaré HJ (1906) On the dynamics of the electron, translated by Scott Walter from *Rendiconti del Circolo Matematico di Palermo* 21, 1906, 129–176.
- Schwarzschild B (1915) Schwarzschild's letter to Einstein Letter from K Schwarzschild to A Einstein dated 22 December 1915 (ColP ap, vol. 8a, Doc.169, posted on Internet).
- Thirring H (1918) Über die Wirkung rotierender ferner Massen in der Einsteinschen Gravitationstheorie. *Physikalische Zeitschrift* 19:33.

## Secondary Sources

- Baez JC, Bunn EF (2006) The Meaning of Einstein Equation. Retrieved: <http://math.ucr.edu/home/baez/einstein/einstein.pdf>
- Bizouard C (1999)  $E=mc^2$ . L'équation de Poincaré, Einstein et Planck. In: *Colloquium Lecture*, Observatoire de Paris, Vol. 4.
- Brown K (2018) Reflections on Relativity, lulu.com, Chap.3.2. Retrived: <https://www.mathpages.com/rr/s3-02/3-02.htm>
- Campbell WW, Trumpler R (1928) Observations made with a pair of five-foot cameras on the light-deflections in the Sun's gravitational field at the total solar eclipse of September 21, 1922. *Lick Observatory Bulletin* 397(13):130-160.
- Coles P (2001) Einstein, Eddington and the 1919 Eclipse. In: *Historical Development of Modern Cosmology*; Martínez VJ, Trimble V, Pons-Bordería MJ (eds), *Astronomical Society of the Pacific*: San Francisco, CA, USA, 2001; 252:1-25.
- Damour T (2005) Einstein 1905-1955 : son approche de la physique. Séminaire Poincaré, Institut Henri Poincaré, Paris, pp. 1-25. Retrieved : <http://www.bourbaphy.fr/damour3.pdf>
- Faraoni V (2013) The Lorentz Transformation. Undergraduate Lecture Notes in Physics, 29–57. doi:10.1007/978-3-319-01107-3\_2
- Gerson LP (1968) *Aristotle: The Growth and Structure of His Thought*, Cambridge University Press, Cambridge, pp. 166–169.
- Gerson LP (1999) *Aristotle: Logic and metaphysics*, Routledge, Aristotle: Critical Assessments Vol.1, pp. 67-71.
- Handschy MA (1982) Re-examination of the 1887 Michelson–Morley experiment. *American Journal of Physics*, 50(11):987–990. doi:10.1119/1.12938
- Kennefick D (2005) Einstein Versus the Physical Review. *Physics Today* 58/9:43. Retrieved: <https://doi.org/10.1063/1.2117822>
- Kennefick D (2007) *Traveling at the Speed of Thought: Einstein and the Quest for Gravitational Waves*. Princeton University Press, Princeton.
- Kennefick D (2016) History of Gravitational Wave Emission. Einstein Papers Project, 6<sup>th</sup> Francis Bacon Conference, 2016.
- Lämmerzahl C, Neugebauer G (2001) The Lense-Thirring Effect: From the Basic Notions to the Observed Effects. *Lecture Notes in Physics book series Vol. 562*.
- Misner CW, Thorne KS, Wheeler JA (1973) *GRAVITATION*. W. H. Freeman and Company, San Francisco

- Pais A (2005) *Subtle is the Lord, The science and the life of Albert Einstein with a new foreword by Sir Roger Penrose*. Oxford University Press, New York, USA.
- Pasnau R (2011) *Scholastic Qualities, Primary and Secondary*. In: Lawrence Nolan (ed.), *Primary and Secondary Qualities: The historical and Ongoing Debate*. Oxford University Press, pp. 41–61.
- Renn J (2007) *The Summit Almost Scaled: Max Abraham as a Pioneer of a Relativistic Theory of Gravitation*. In: Janssen M, Norton JD, Renn J, Sauer T, Stachel J (eds), *The Genesis of General Relativity*. Boston Studies in the Philosophy of Science, Vol. 250. Springer, Dordrecht. Retrieved: [https://doi.org/10.1007/978-1-4020-4000-9\\_22](https://doi.org/10.1007/978-1-4020-4000-9_22)
- Schucking EL, Surowitz EJ (2007) *Einstein's Apple: His First Principle of Equivalence*. Retrieved: <https://arxiv.org/pdf/gr-qc/0703149v2.pdf>
- Shankland RS (1964) Michelson-Morley Experiment. *American Journal of Physics*, 32(1):16–35. doi:10.1119/1.1970063
- Stachel J, Cassidy DC, Renn J, Schulmann R (1989) *The Collected Papers of Albert Einstein*. Volume 2. *The Swiss Years: Writings, 1900-1909*, p. 174.
- Taylor EF, Wheeler JA (1992) *Spacetime Physics: Introduction to Special Relativity*. W. H. Freeman.
- Treschman KJ (2015) Recent astronomical tests of general relativity. *International journal of physical sciences*, 10(2):90-105. DOI: 10.5897/IJPS2014.4236
- Vankov A (2011) *Einstein's Paper: "Explanation of the Perihelion Motion of Mercury from General Relativity Theory"*
- Wallace W (1911) Empedocles. In: Chisholm, Hugh. *Encyclopædia Britannica*. 9 (11th ed.). Cambridge University Press. pp. 344–345.
- Walter S (ed)(2020) *Henri Poincaré Papers*. Retrieved: <http://henripoincarepapers.univ-nantes.fr/chp/text/hp2007gg.html>
- Will CM (2015) Focus issue: Gravity Probe B. *Classical and Quantum*. IOP. 32 (22): 220301

## **Selected Additional References on the Subjects – Non-Cited in the Above Running Text**

- Adair R (1987) *The Great Design: Particles, Fields and Creation*. The Oxford University Press, NY
- Bachelard G (1951) *L'activité rationaliste de la physique contemporaine*. Presses Universitaires de France, Paris
- Balibar F (1993) (ed) *Albert Einstein, œuvres choisies, volume 1 : Quanta*. Éditions du Seuil / Éditions du CNRS, Paris
- Balibar F (ed) (1993) (ed) *Albert Einstein, œuvres choisies, volume 2 : Relativités*. Éditions du Seuil / Éditions du CNRS, Paris
- Borel É (1913) *La théorie de la relativité et la cinématique*. *Comptes Rendus des séances de l'Académie des Sciences* 156:215–218
- Borel É (1914) *Introduction géométrique à quelques théories physiques*. Gauthier–Villars, Paris
- Born M ([1923] 2003) *La théorie de la relativité d'Einstein et ses bases physiques*. Gabay, Paris.
- Damour T, Darrigol O, Duplantier B, Rivasseau V (2006) (eds) *Einstein, 1905–2005. Poincaré Seminar 2005*, Birkhäuser Verlag, Basel
- Darrigol O (2000) *Electrodynamics from Ampère to Einstein*. The Oxford University Press, Oxford
- Darrigol O (2004) *The Mystery of the Einstein–Poincaré Connection*. *Isis* 95/4:614–626
- Darrigol O (2006) *The Genesis of the theory of relativity*. In : Damour T, Darrigol O, Duplantier B, Rivasseau V (eds) 2006, *Séminaire Poincaré* 1:1–22, op. cit.
- Dirac PAM (1978) *Direction in Physics*. Wiley, NY

- Einstein A ([1921] 2005) *Quatre conférences sur la théorie de la relativité*. [Texte de quatre conférences prononcées à l'université de Princeton en 1921] Dunod, Paris
- Einstein A (1925) *Sur l'électrodynamique des corps en mouvement*. Gauthier–Villars, Paris [réimprimé aux Éditions Jacques Gabay, Paris en 2005]
- Einstein A ([1934] 1983) *Comment je vois le monde*. Flammarion–Champs, Paris
- Einstein A, Infeld L (1993) *L'évolution des idées en physique*. Flammarion–Champs, Paris
- Einstein A (1927) *Newtons Mechanik und ihr Einfluss auf die Gestaltung der theoretischen Physik*, *Naturwissenschaften* 15:273–276. Trad. fr. par le Cnel Cros. La mécanique de Newton et son influence sur l'évolution de la physique théorique. En : Einstein A [1934]1983, pp. 180–193, op. cit.
- Einstein A (1956) *La théorie de la relativité restreinte et générale*. Gauthier–Villars, Paris
- Einstein A (1991) *Œuvres choisies*. Éditions du Seuil, Paris
- Feynman R (1985) *QED: The Strange Theory of Light and Matter*. Princeton University, Princeton, NJ
- Gillispie CC (ed) (1970–1980) *Dictionary of Scientific Biography*. Charles Scribner's Sons, New York
- Hawking SW, Israel W (1980) (eds) *General relativity. An Einstein centenary survey*. The Cambridge University Press, Cambridge
- Holton G (1988) *Thematic Origins of Scientific Thought: Kepler to Einstein*. The Harvard University Press, Cambridge–MA
- Keswani G H, Kilmister CW (1983) *Intimations Of Relativity: Relativity Before Einstein*. *The British Journal of Philosophy of Science* 34/4:343–354
- Kragh H, Marage P, Vanapaemel G (2002) (eds) *The history of Modern Physics*. Brepols, Liège
- Lecat M (1924) *Bibliographie de la relativité*. Lamertin, Bruxelles
- Lorentz HA, Einstein A, Minkowski M, Weyl H (1923) *The principle of relativity*. A collection of original memoirs on the special and general theory of relativity. Dover, NY
- Nagel E (1961) *The Structure of Science: Problems in the Logic of Scientific Explanation*. Harcourt–Brace & World Inc, New York
- Newton I ([1713], 1729) *The Mathematical principles of natural philosophy*. Translated by Motte Andrew. Motte B, London.
- Newton I ([1726; 1739–1742], 1822), *Philosophiae Naturalis Mathematica Principia*, auctore Isaaco Newtono, Eq. Aurato, perpetuis commentariis illustrata, communi studio Pp. Thomae Le Seur et Francisci Jacquier ex Gallicana minimorum familia, matheseos professorum. Editio nova (in three volumes). Duncan, Glasgow.
- Newton I (1687) *Philosophiae Naturalis Principia Mathematica*. Imprimatur S. Pepys, Reg. Soc. Preses. Julii 5. 1686. Londini, Jussi Societatus Regiae ac Typis Josephi Streater. Prostat apud plures Bibliopolas. Anno MDCLXXXVII.
- Pais A (2005) *Albert Einstein – Sa vie, son œuvre*, Interéditions. Dunod, Paris
- Paty M (2004) *Albert Einstein, ou la création scientifique du monde*, Belles Lettres, Paris
- Paty M (1999) *La création scientifique selon Poincaré et Einstein*. En : Serfati M (ed) *La recherche de la vérité : Coll. « L'Écriture des Mathématiques »*, ACL–Éditions du Kangourou, Paris, pp 241–280
- Paty M (2003) *La physique du XXe siècle*. EDP Siences, Les Ulis
- Penrose R (2004) *The Road to Reality. A complete guide to laws of the universe*. Knopf, NY
- Pisano R (2008) *A history of chemistry à la Koyré? Introduction and setting of an epistemological problem*. *Khimiya* 2/17:143–161.
- Pisano R (2009) *On method in Galileo Galilei' mechanics*. In Hunger H (ed.), *Proceedings of 3<sup>rd</sup> Congress of the European Society for the History of Science*. The Austrian Academy of Science, Vienna, pp. 174–186.
- Pisano R (2011) *Physics–Mathematics Relationship. Historical and Epistemological notes*. In Barbin E, Kronfellner M and Tzanakis C (eds.), *Proceedings of the ESU 6 European Summer University History And Epistemology in Mathematics*. Verlag Holzhausen GmbH–Holzhausen Publishing Ltd., Vienna, pp. 457–472.

- Pisano R (2013a) History Reflections on Physics Mathematics Relationship in Electromagnetic Theory. In Barbin and Pisano 2013, pp. 31–58.
- Pisano R (2014) (ed.) Isaac Newton and his Scientific Heritage: New Studies in the History and Historical Epistemology of Science. Special Issue. *Advances in Historical Studies* 3/3.
- Pisano R (2016a) What kind of Mathematics in Leonardo da Vinci and Luca Pacioli? *Bulletin–British Society for the History of Mathematics* 31:104–111.
- Pisano R (2016b) A Development of the Principle of Virtual Laws and its Framework in Lazare Carnot’s Mechanics as Manifest Relationship between Physics and Mathematics. *Transversal–International Journal for Historiography of Science*, 2:166–203.
- Pisano R, Bussotti P (2012) Galileo and Kepler: On Theoremata Circa Centrum Gravitatis Solidorum and Mysterium Cosmographicum. *History Research* 2/2:110–145.
- Pisano R, Bussotti P (2013) Notes on the Concept of Force in Kepler. In Pisano, Capecchi and Lukešová 2013, pp. 337–344.
- Pisano R, Bussotti P (2014a) Galileo in Padua: architecture, fortifications, mathematics and “practical” science. *Lettera Matematica Pristem International* 2/4:209–221.
- Pisano R, Bussotti P (2014b). Historical and Philosophical Reflections on the Culture of Machines around the Renaissance. How Science and Technique Work? *Acta Baltica Historiae et Philosophiae Scientiarum* 2/2:20–42.
- Pisano R, Bussotti P (2015a) Historical and Philosophical Reflections on the Culture of Machines around the Renaissance: Machines, Machineries and Perpetual Motion. *Acta Baltica Historiae et Philosophiae Scientiarum* 3/1:69–87.
- Pisano R, Bussotti P (2015b) Introduction to Exploring Changes in How the Histories of the Exact Sciences from the 18th to through the 20th Century Have Been Written: Interpreting the Dynamics of Change in these Sciences and Interrelations Amongst Them—Past Problems, Future Cures? *Advances in Historical Studies Special Issue* 4/2:65–67.
- Pisano R, Bussotti P (2016) A Newtonian Tale Details on Notes and Proofs in Geneva Edition of Newton’s *Principia*. *Bulletin–British Society for the History of Mathematics* 32:1–19.
- Pisano R, Capecchi D (2013) Conceptual and Mathematical Structures of Mechanical Science in the Western Civilization around 18th Century. *Almagest* 4/2:86–121.
- Pisano R, Capecchi D (2015) Tartaglia’s science weights. *Mechanics in sixteenth century. Selection from Quesiti et invention diverse: Books VII–VIII*. Dordrecht, Springer.
- Pisano R, Capecchi D, Lukešová A (eds.) (2013) *Physics, Astronomy and Engineering. Critical Problems in the History of Science*. International 32nd Congress for The SISFA–Italian Society of Historians of Physics and Astronomy. The Scientia Socialis UAB & Scientific Methodical Centre Scientia Educologica Press, Šiauliai University, Lithuania.
- Pisano R, Fichant M, Bussotti P, Oliveira ARE (2017) (eds.) *Leibniz and the Dialogue between Sciences, Philosophy and Engineering, 1646–2016*. New Historical and Epistemological Insights. The College Publications, London.
- Pisano R, Gaudiello I (2009a) Continuity and discontinuity. An epistemological inquiry based on the use of categories in history of science. *Organon* 41:245–265.
- Pisano R, Gaudiello I (2009b) On categories and scientific approach in historical discourse. In Hunger H (ed.) *Proceedings of ESHS 3rd conference*. The Austrian Academy of Science, Vienna, pp. 187–197.
- Pisano R, Casolaro F (2011–soumis) *Historical Inquiring On Geometry In Relativity. A Geometry Model (Part II)* [CFV Cahiers]
- Poincaré HJ (1889) *Théorie mathématique de la lumière*. Carré & Naud, Paris
- Poincaré HJ (1900a) Les relations entre la physique expérimentale et la physique mathématique. *Revue générale des sciences pures et appliquées* 11:1163–1175
- Poincaré HJ (1900b) La théorie de Lorentz et le principe de réaction, *Archives néerlandaises des sciences exactes et naturelles* 5:252–278

- Poincaré HJ (1905a) Sur la dynamique de l'électron (The Dynamics of the electron by Henri Poincaré). In: Henri Poincaré, *La mécanique nouvelle*, conférence, mémoire et note sur la théorie de la relativité, introduction de M. Édouard Guillaume. 1924, Gauthier-Villars et Cie, pp. 18-76, 77-81.
- Whittaker ET (1953) The relativity theory of Poincaré and Lorentz. En: *A History of the theories of aether and electricity*. Vol 2: The modern theories 1900-1926. Nelson, London, pp 27-77
- Wolfgang R (2001) *Relativity: special, general and cosmological*. The Oxford University Press, Oxford
- Zahar E (1987) Les fondements des mathématiques d'après Poincaré et Russell. *Fundamenta Scientiae* VIII 1987:31-56
- Zahar E (1989) *Einstein's Revolution: A Study in Heuristic*. The Open Court Publishing Company, Chicago





## CHAPTER IV

### **Gravitational Waves: Experimental Observations & Data**

*An Outline.* This part of the thesis explores the principles and the development of the detection of Gravitational Waves through its historical context and physical meaning starting from a description of the necessity of measuring with light. The very important role played by Joseph Weber, a true scientific pioneer in the search for gravitational waves and other scientist as well as the role played by the Chapel Hill Conference in 1957 will also be described. Our contemporary understanding of gravitational wave astronomy, the associated phenomena and their astrophysical implications will be exposed in the following sections.

The objective of this chapter is to depict how the challenges involved in gravitational waves detection have been dealt with as well as to provide a more in depth understanding of how the gravitational waves observatories function.

## 4.1 How Do We Detect a Gravitational Wave?

However trivial this question might look like at first, it is actually a challenge that had to be undertaken and which took decades to solve. As we now know, gravitational waves are disturbances in spacetime travelling through spacetime. A simple visualizing trick is to imagine flat spacetime as a 3-dimensional grid progressing with time. Using this representation in order to gain an insight about gravitational waves, we can visualize a gravitational wave passing through this grid and squeezing and stretching it perpendicularly to its axis of travel. Within this framework, if we now imagine a classic ruler which is placed in this representation, since it is made of matter, it will undergo the same distortions, hence cannot be used to measure any variations since the ruler size would change too. Therefore, the problem becomes something else; because measuring a change in length with something that also changes at the same rate is impossible. Thus, in order to measure those distortions, one must find some kind of “special ruler” that is somehow independent or free from such considerations. That’s the reason why to detect gravitational waves, the ruler being used is light – or more precisely, the change in the quantity of light detected, i.e. the measured power reaching the photodetector in an interferometer.

Indeed, one of the essential properties of light is that its speed, the celerity of light, is always constant, no matter the reference frame. Thanks to this property, we can determine how long something is by sending light along its length and thus determining its length by measuring the time it took light to travel. With light serving the purpose of our special ruler, a change in time of arrival corresponds to a change in length since the speed of light is always constant. To see this, let us consider that we send light to measure some distance  $d$  in vacuum. It takes exactly 10 seconds for light to travel distance  $d$ . Therefore,  $d = 10$  light-seconds. However, if we were to repeat this experience continually and measure different arriving times, since the speed of light is always the same, if the time light takes to travel distance  $d$  is varying, that implies that either the distance  $d$  is varying or that the rate of time passing along  $d$  is varying according to the Theory of Relativity. Gravitational wave detectors are relying on this principle by continually measuring differences in lengths in order to measure the effects of a passing gravitational wave and determining its characteristics.

Detecting gravitational waves is an absurdly difficult prowess of science and engineering. Indeed, one of the main problems is that gravitational waves are minuscule. Therefore, the perturbations produced by them are also extremely small. In fact, the changes in length gravitational waves are responsible for are of a scale of about 1 part in  $10^{21}$ . In turn, that is the reason why the scale of the detectors is so great. Because of this littleness, the longer the distances we can observe, the greater the change. Thus, having a detector with kilometres long arms is a necessity.

However, 3 or 4 kilometre arms are still too short to measure such small changes in length. Thankfully this issue is resolved by having a system

involving multiple mirrors at each extremity of the arms that allow to artificially lengthen this distance. This mirror arrangement actually make the laser beams do a series of comings and goings, effectively drastically increasing the distance travelled by light which in turn facilitates the measurements. However, even if this has a significant impact, the gravitational waves make the lengths of the arms vary by at most  $10^{-18}$  meters (about 1/10.000 the length of a proton). Probably –if not the most– precise measurement ever done.

#### ***4.2 1949–. Joseph Weber and the Gravity Research Foundation & Institute of Field Physics***

Created by Roger W. Babson (1875-1967) in 1949, the GRF is a foundation which aims to bolster the research on Gravity. The GRF is mainly known because it organizes a yearly competition in which participants are asked to submit short essays –of 1500 words– “for stimulating thought and encouraging work on the phenomenon of gravitation”.

The history behind the creation of the GRF starts with Roger Babson who stated that he was marked by the loss of his older sister in a drowning accident. In fact, he related “She was unable to fight gravity, which came up and seized her like a dragon and brought her to the bottom” in an essay titled “Gravity – Our Enemy No. 1”. Later in his life while he was studying at the Massachusetts Institute of Technology his interest for gravity was strengthened thanks to one of his Professors, Prof. Swain, who used to illustrate Newton’s Laws “particularly of action and reaction” with stock market charts. Consequently, after analysing the stock market, as he thought “What goes up will come down”, he concluded that the market would crash and successfully anticipated the 1929 crisis which ultimately lead him to acquire his fortune.

Despite years going by, his interest in gravity and research about gravity did not fade and his opinion was that since research in this area of Physics seemed to be left behind, it needed a renewal of interest. That is the reason why he consulted his associate George M. Rideout on how to proceed to inspire this renewal. George Rideout suggested that he create a foundation which would be reward the best ideas with cash prizes. After the meeting organizing the foundation on January 19<sup>th</sup>, 1949, the first awards for the best essays were given on December 1<sup>st</sup>, 1949.

The guidelines for the first wave of essays were to find practical applications and that awards would be given to “suggestions for anti-gravity devices, for partial insulators, reflectors, or absorbers of gravity, or for some substance that can be rearranged by gravity to throw off heat”. However, because of this, the scientific community was not thrilled by this competition and George Rideout understood that the reason was the poor choice of words for the guidelines. He then managed to persuade Robert Babson to change

the phrasing to “essays on the subject of gravitation, its theory, application or effects”.

*On Joseph Weber (1919-2000)*. At the time, gravitational waves had yet to be detected and the debate on whether they existed was still dividing the scientific community. (c.f. section the 1937 incident)

However, in 1958 and 1959, the GRF received two essays from an American physicist, Joseph Weber, and rewarded him with respectively third and first awards for his ideas about “the possibility of observing gravity waves and describing a method of detecting them”. Nowadays, Joseph Weber is well-known for being a pioneer in the search for gravitational waves and for his dedication to the detection of gravitational waves, his involvement with the GRF and for his “Weber bars”.

Joseph Weber was a Navy veteran and Professor at the University of Maryland in College Park. In 1956, he used his sabbatical year to study Relativity at the Institute for Advanced Studies after being invited by Freeman Dyson (1923-2020) – well-known for his works in Quantum Electrodynamics and by the general public for his works in Science-Fiction, in particular Dyson Spheres. Weber even met John Archibald Wheeler. During this period Dyson convinced Weber that sources powerful enough that their gravitational waves could be detected on Earth might very well exist.

Since Weber was an engineer by formation, he started developing ideas about how to potentially detect gravitational waves. One of his ideas was to use interferometers with a laser as a source of light but this appeared to him as unrealizable for technical reasons. In fact, he built a prototype of a laser interferometer with Robert Forward which was online in the 70s but with its 2 meter long arms, it was not (nearly) sensitive enough.

However Weber, who was very versatile, had a simpler idea: since passing gravitational waves lengthen and contract distances they should have a measurable effect of elongation and compression on objects. Considering this, he decided to use aluminium cylinders with piezoelectric sensors that would be extremely sensitive and able to detect variations in the cylinders’ length of  $10^{-15}$  cm and later  $10^{-17}$  cm with better crystals cooled at  $4^{\circ}\text{K}$  (DJ Gretz 2018, p. 6). His train of thought was that since different sources of gravitational waves emit gravitational waves of different frequencies he first had to choose the sensitivity of his detector accordingly. This lead him to choose supernovae which since the works of Walter Baade (1893-1960) and Fritz Zwicky (1898-1974) were estimated to be events lasting 1 millisecond or about 1 000 Hertz. Therefore, Weber chose aluminium cylinders and his calculation lead him to build those cylinders of a length of 1.5 metres and a diameter of 60 centimetres for a weight of 1.5 tons to obtain a frequency of 1660 Hertz<sup>94</sup>. This setup, he thought, would allow gravitational waves to

---

<sup>94</sup> The wavelength of a soundwave is given by the following relation:

make the cylinder vibrate by their passage just like one ringing tuning fork makes another one ring in sympathy; the gravitational waves would have therefore induced a strain in the metal bar which in turn would be detected by the piezoelectric sensors.

The next problem was to isolate the detector from sources of noise which could influence the bar itself and therefore the results. To do so, Weber built several detectors thus hoping to be able to identify false positives due to seismic noises since the vibrations of a seismic event could trigger them. By doing so, Weber thought that in the event of a detection of an event in multiple bars, due to the fact that gravitational waves travel at the speed of light, unlike earthquakes, a signal detected by those bars would need to have detection delays between them consistent with this travel speed.

*On Weber's interview.* In an interview with Marcia Bartusiak (Bartusiak 1998), for her book *Einstein's Unfinished Symphony* (Bartusiak M 2000, 2017), Weber recalled that it was around 1984 that he started have new ideas on gravitational waves detected by the bars. He claimed that his 1984 paper described the effects a nearby supernova would produce and that it was exactly what happened with SN1987A and feared that nowadays the NSF was focusing too much on LIGO and neglecting other approaches for the search for gravitational waves. Despite the general consensus in the scientific community that Weber did not detect gravitational waves, until his last breath Weber claimed the opposite and that his results were backed up by the ones obtained in the University of Rome. The reason Weber gave for the problem with the repeatability of the results by the other groups was that according to him they were using different equipment. Bartusiak wrote in her notes:

Except for the occasional upgrades or maintenance, his room-temperature detectors have been steadily operating since the late 1960s. But his NSF funding came to a halt, right after his claim that the detectors registered a pulse when SN1987A was spotted, at the very same time as the neutrino detectors. An Italian group backed him up. Led by the late E. Amaldi at the University of Rome. Weber points to the fact that they used the exact same instrumentation, which to Weber is the key to his seeing gravity waves while no one else does. There were groups in Rochester and Munich that also duplicated his detector design and saw nothing. Weber blames their lack of proper temperature controls to keep their bars at an absolutely stable temperature.

She also described Weber as “a man who gets down to business. No casual sweater and sneakers. He dresses in grey suit, white shirt, and solid red tie. Maintains his military haircut, no sideburns. Initial chit-chat at a minimum.” According to her notes:

---


$$\lambda = \frac{V_s}{f} \tag{4.0}$$

where  $\lambda$  is the wavelength,  $V_s$  the speed of sound and  $f$  the frequency.

Weber also claims that he first had the idea for a laser interferometer around 1958, although he didn't publish it. However, he did convince his student Robert Forward to pursue it. Forward acknowledges the debt in his published papers.

If you can have antennas for picking up electromagnetic waves, why not antennas for gravity?

My Philosophy is to act like Galileo: build something, make it work, and see if you find anything.

### 4.3 1957. The *Chapel Hill Congress, Debates and Heritage*

The Chapel Hill Conference is a scientific event that took place at Chapel Hill in the University of North Carolina in 1957 and lasted for 6 days. The Conference on the Role of Gravitation in Physics was in fact the inaugural event of the Institute of Field Physics (IOFP) with Bryce and Cécile DeWitt at the head. This conference played a very important role in the History of the Discovery of Gravitational Waves as it initiated a renewed interest in Gravitation in general.

At that time, Einstein's Relativities had been studied for almost 4 decades but had been somewhat neglected in favour of other fields of Physics as attested by the drop in the number of publications on the subject that lasted from 1925 to 1957 (Eisenstaedt 1986, pp. 277-292). On this matter, Prof. Eisenstaedt who called this period "the low water mark of general relativity" wrote:

We can see the spectacular growth of the theory after its birth followed by its peak in 1920 (the verification of the second test takes place in 1919). The fact that the theory becomes fashionable at the beginning of the 1920s is reflected in the increased number of publications. And then a sharp decline starting in 1922-23, a situation that would last until the end of the 1950s. (Eisenstaedt 2015, p. 12)

This disinterest had a multifactorial origin: a large portion of scientists preferred to spend their time and efforts on other disciplines such as Quantum Mechanics, High Energy Particle Physics or Nuclear Physics because of the historical context of that time. The Second World War was still present in the mind of everyone and the Cold War raised tensions in such a way that the scientific fields with more direct applications were favoured. Despite the fact that the US Air Force was keen to finance research in General Relativity, more fundamental research waited until the beginning of the 70s as they kept in mind the decisive role that scientists played during the war (Deruelle 2018, p. 90). It is also important to point out that at that time, the concept of gravitational fields so strong that they could produce a black hole –a term coined by Wheeler in 1967– was generally rejected. On another note, Whitehead wrote: "It is not going too far to say that the announcement that physicists would have in future to study the theory of tensors created a veritable panic among them when the verification of

Einstein’s predictions was first announced.” (Whitehead 1920, p. 182)

On the other hand, the mythos surrounding Gravitation in the mind of the general public with the beginning of UFO sightings –and secret programs such as project Mogul– deterred interest in the field and certainly did not contribute in a positive way to the scientific progress. Babson’s GRF first competition “for the best two thousand word essays on the possibilities of discovering some partial insulator, reflector or absorber of gravity waves” (Babson 1950, p. 344) could also be cited as an example of misunderstanding and phantasms about the matter to illustrate this. Bryce DeWitt even said “I won the Gravity Research Foundation first prize by writing something, essentially giving them hell for such a stupid-the way it had been phrased in those early years.”<sup>95</sup>

Those unfortunate matters of fact pertaining to the perception of General Relativity in the scientific community went as far as making Einstein say “In Princeton they regard me as an old fool” as Leopold Infeld (1898-1968) reported and certainly discouraged many physicists to get involved in General Relativity research (Eisenstaedt 2015). This can somewhat be easy to put in evidence:

Chandra particularly mentions that Niels Bohr discouraged him from making a move into relativity. [...] Kip Thorne reports that he received similarly negative advice when he was contemplating doing graduate work in relativity in the early 1960s. [...] when I moved into gravitational wave detection, many astronomers told me I was throwing away my career. (Schutz 2012, p. 260).

Putting apart the fact that this conference’s official objective was inaugural, it managed to serve a different purpose by bolstering the interest for Gravitational research despite being a “closed event” organized by Bryce DeWitt. Indeed, in the Foreword to Feynman Lectures on Gravitation, John Preskill and Kip S. Thorne relayed a comment by DeWitt:

Although he felt that some of the discussion at the Chapel Hill conference was nonsensical (as did I), I think he had a reasonably good time there. I remember him being very interested when I showed that his path integral for a curved configuration space leads to a Schrödinger equation with a Ricci scalar term in it. The people at that conference (such as Bondi, Hoyle, Sciama, Møller, Rosenfeld, Wheeler) were not stupid and talked with him intelligently. (I had chosen the participants myself—it was a closed conference.) (Preskill 1995, p. 19)

The conference consisted of 9 sessions (Renn 2011):

- Session I: Unquantized General Relativity, *Chairman: B.S. DeWitt*
  - The Present Position of Classical Relativity Theory and Some of its Problems, *John Wheeler*

---

<sup>95</sup> Interview of Bryce DeWitt and Cecile DeWitt-Morette by Kenneth W. Ford on 1995 February 28, Niels Bohr Library & Archives, American Institute of Physics, College Park, MD USA, [www.aip.org/history-programs/niels-bohr-library/oral-histories/23199](http://www.aip.org/history-programs/niels-bohr-library/oral-histories/23199)

- The Experimental Basis of Einstein's Theory, *R. H. Dicke*
- Session II: Unquantized General Relativity, Continued, *Chairman: P. G. Bergmann*
  - On the Integration of the Einstein Equations, *André Lichnerowicz*
  - Remarks on Global Solutions, *C. W. Misner*
  - Solving The Initial Value Problem Using Cartan Calculus, *Y. Fourès*
  - Some Remarks on Cosmological Models, *R. W. Bass and L. Witten*
- Session III: Unquantized General Relativity, Continued, *Chairman: H. Bondi*
  - Gravitational Waves, *L. Marder, Presented by H. Bondi*
  - Gravitational Field of an Axially Symmetric System, *N. Rosen and H. Shamir, Presented by F. Pirani*
  - The Dynamics of a Lattice Universe, *R. W. Lindquist*
- Session IV: Invited Reports on Cosmology, *Chairman: F. J. Belinfante*
  - Measurable Quantities that May Enable Questions of Cosmology to be Answered, *T. Gold*
  - Radio Astronomical Measurements of Interest to Cosmology, *A. E. Lilley*
- Session V: Unquantized General Relativity, Concluded, *Chairman: A. Lichnerowicz*
  - Measurement of Classical Gravitation Fields, *F. Pirani*
  - Correspondence in the General Theory of Gravitation, *Behram Kursunoglu*
  - Presentation of Work by T. Taniuchi, *Ryoyu Utiyama*
  - Negative Mass in General Relativity, *Hermann Bondi*
- Session VI: Quantized General Relativity, *Chairman: J. A. Wheeler*
  - The Problems of Quantizing the Gravitational Field, *P. G. Bergmann*
  - Conceptual Clock Models, *H. Salecker*
  - The Three-Field Problem, *F. J. Belinfante*
- Session VII: Quantized General Relativity, Continued, *Chairman: A. Schild*
  - Quantum Gravidynamics, *B. DeWitt*
- Session VIII: Quantized General Relativity, Concluded, *Chairman: V. Bargmann*
  - The Possibility of Gravitational Quantization
  - The Necessity of Gravitational Quantization
- Closing Session, *Chairman: B. S. DeWitt*
  - Divergences in Quantized General Relativity, *S. Deser*



During the different sessions, the questions of cosmological models and the reality of gravitational waves were addressed and fuelled new insights, in particular the now called “Feynman’s sticky bead arguments”, and ideas for research projects still in progress nowadays. A number of these then discussed interrogations are still unanswered, especially the ones about Quantum Gravity (Renn 2011; pp. 3-4).

Feynman’s perceptions on “gravitational theory” was that the lack of experiments was probably the major difficulty. Since the ability to conduct experiments in order to test hypotheses and the like was so limited, the only option left for them was to do as best as they could with what they had, which to Feynman was their imagination. To do so, Feynman advocated for an exploratory approach in which a scientist would “play games” and explore make believe situations in which an experiment was done. Thus, instead of lamenting the challenging difficulty of doing impossible experiments and obtaining their results, they should undertake this –often– much less meticulous approach, not shying away from approximations, attempting new things, and following the loose threads they entangled until their encounter with an inconsistency:

[However] one can do an enormous amount by various approximations which are non-rigorous and unproved mathematically, perhaps for the first few years. [...] The attempts at mathematical rigorous solutions without guiding experiments is exactly the reason the subject is difficult, not the equations. The second choice of action is to ‘play games’ by intuition and drive on. (*Ivi.* pp. 271-272)

Unsurprisingly for someone like Feynman and according to his character (cf. Surely You’re Joking Mr. Feynman) he advised the following:

I think the best viewpoint is to pretend that there are experiments and calculate. In this field since we are not pushed by experiments we must be pulled by imagination. (*Ivi.* p. 272)

Obviously, this kind of approach –imagination, thought experiments and the likes– was nothing new and has been used in a multitude of different fields an even greater multitude of times. However, with this statement, it is clear that Feynman recognized that there was potential in the field and that efforts should have been devoted sooner to this study despite the lack of actual practical experiments and possible observations.

About this issue, Peter G. Bergmann (1915-2002) also had something to say:

A call for more experiments at the present time is not likely to produce more experiments, but more experiments that have been suggested at this conference fall in two classes. First, do all old experiments over again with more accuracy and increased care. And as Dicke has pointed out, if an experiment reported an accuracy great enough to check on the energy of interaction of weak interactions it might give a result different, in principle from those done up to now. The other type of experiments which are going on, and ought to be going on, are those intended to shed light on cosmological problems at all levels. Actually, there exists a third type of experiment which is apparently not feasible, and is not going to be feasible for a long time. This type considers the detection of gravitational waves. (*Ivi.* p. 277)

[...] The most important of these [special] questions [where things having physical or model significance] which must be settled is, are there gravitational waves? At the present there is no general agreement. (*Ivi.* pp. 277-278)

*On Feynman’s Sticky Bead Argument.* Feynman was absent during some sessions about gravitational waves, nevertheless, when the question of whether gravitational waves could carry energy arose, Feynman gave his view on the matter by sharing his thought experiment.

According to him, it was easy to see that gravitational waves could carry energy and do work if they were indeed a real phenomenon:

I think it is easy to see that if gravitational waves can be created they can carry energy and can do work. Suppose we have a transverse-transverse wave generated by impinging on two masses close together. Let one mass *A* carry a stick which runs past touching the other *B*. I think I can show that the second in accelerating up and down will rub the stick, and therefore by friction make heat. I use coordinates physically natural to *A*, that is so at *A* there is flat space and no field (what are they called, “natural coordinates”?). Then Pirani at an earlier section gave an equation for the notion of a nearby particle, vector distance  $\eta$  from origin *A*, it went like, to 1<sup>st</sup> order in  $\eta$

$$\ddot{\eta}^a + R^a_{0b0} \eta^b = 0 \quad (a, b = 1, 2, 3)$$

*R* is the curvature tensor calculated at *A*. Now we can figure *R* directly, it is not reasonable by coordinate transformation for it is the real curvature. It does not vanish for the transverse-transverse gravity wave but oscillates as the wave goes by. So,  $\eta$  on the RHS is sensibly constant, so the equation says the particle vibrates up and down a little (with amplitude proportional to how far it is from *A* on the average, and to the wave amplitude.) Hence it rubs the stick, and generates heat.

Feynman then commented on the argument that there might not be a relative motion between the particle and the stick because of the way the gravitational field might force the stick to distend and contract:

[...] this cannot be. Since the amplitude of *B*’s motion is proportional to the distance from *A*, to compensate it the stick would have to stretch and shorten by certain ratios of its own length. Yet at the center it does no such thing, for it is in natural metric - and that means that the lengths determined by size of atoms etc. are correct and unchanging at the origin. In fact that is the definition of our coordinate system. Gravity does produce strains in the rod, but these are zero at the center for *g* and its gradients are zero there.

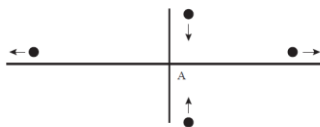


Figure 27.1:

Thus a quadrupole moment is generated by the wave.

Now the question is whether such a wave can be generated in the first place. First since it is a solution of the equations (approx.) it can probably be made. Second, when I tried to analyze from the field equations just what happens if we drive 4 masses in a quadrupole motion of masses like the figure above would do - even including the stress-energy tensor of the machinery which drives the weights, it was very hard to see how one could avoid having a quadrupole source and generate waves. Third my instinct is that a device which could draw energy out of a wave acting on it, must if driven in the corresponding motion be able to create waves of the same kind. The reason for this is the following: If a wave impinges on our “absorber” and generates energy - another “absorber” placed in the wave behind the first must absorb less because of the presence of the first, (otherwise by using enough absorbers we could draw unlimited energy from the waves). That is, if energy is absorbed the wave must get weaker. How is this accomplished? Ordinarily through interference. To absorb, the absorber parts must move, and in moving generate a wave which interferes with the original wave in the so-called forward scattering direction, thus reducing the intensity for a subsequent absorber. In view therefore of the detailed analysis showing that gravity waves can generate heat (and therefore carry energy proportional to  $R^2$  with a coefficient which can be determined from the forward scattering argument). I conclude also that these waves can be generated and are in every respect real.

I hesitated to say all this because I don't know if this was all known as I wasn't here at the session on gravity waves. (Renn 2011, pp. 279-280)

Feynman never published about this idea, but there is a letter<sup>96</sup> in which this work is described:

[...] the letter describes Feynman's gravitational wave detector: It is simply two beads sliding freely (but with a small amount of friction) on a rigid rod. As the wave passes over the rod, atomic forces hold the length of the rod fixed, but the proper distance between the two beads oscillates. Thus, the beads rub against the rod, dissipating heat. (Preskill 1995, p. 17)

*A more contemporary formulation of Feynman's idea.* Feynman's gravitational wave detector is simply a rod with two sliding beads. When a gravitational wave passes through the rod and beads, the beads are follow the expansion and contraction of space while the rod resists the change because of the atomic forces between its atoms. This implies that as the beads move along the rod, these beads should generate friction and thus heat thus showing that gravitational wave can transmit some of their energy into matter.

---

<sup>96</sup> Unpublished letter to Victor F. Weisskopf, January 4–February 11, 1961; in Box 3, File 8 of The Papers of Richard P. Feynman, the Archives, California Institute of Technology. (Feynman RP 1961)

## 4.4 The Effects of a Gravitational Wave

As we have already seen, gravitational waves produce a number of effects when passing, namely lengths contraction and dilatation. Keeping in mind that these effects are extremely small coupled to the fact that their sources are at great distances, the detectors must therefore be extremely precise. Considering a simple example using the framework of flat spacetime, the passing of a gravitational wave through along an axis perpendicular to the plane in which a ring of test particles is at rest, one would observe the properties discussed in Chapter 1. These effects have a direct impact on the measurements made by the gravitational detectors, since the variations in the lengths of the arms induce variations in the light arriving on the photodetector.

The signals follow the Einstein quadrupole radiation formula<sup>97</sup>:

$$h = \frac{\Delta L}{L} = \frac{GM}{c^2 R} \frac{v^2}{c^2} \quad (4.1)$$

where  $M$  is the mass scale of the source,  $v$  its velocity,  $R$  the distance of the source to the detector,  $\Delta L$  the strain on the free masses of the detector and  $L$  the distance between them. For example, the required strain sensitivity for the LIGO detectors is  $h < 3 \cdot 10^{-24} \text{ Hz}^{-1/2}$ .

## 4.5 The Interferometers Method

In order to understand how to actually detect gravitational waves, one of the first steps is to understand what an interferometer is and how it functions. Also called a Michelson Interferometer or sometimes a “Michelson’s”, this device invented by Albert Abraham Michelson consists of an optical configuration using a light source, a beam splitter, mirrors and a photodetector.

The light produced by the source (usually a laser) is split by the beam splitter (oriented at a  $45^\circ$  angle), then the two light beams are reflected back to the beam splitter which recombines them in the photodetector and the superposition of the amplitude is then measured. This setup can be arranged in a variety of ways, with different lengths of arms or with an additional optical apparatus; for example, it allows observation of the result of the interference pattern or can be set up in such a way that the result of the interferences is calibrated on dark fringe interference which corresponds to destructive interferences. In this last example of an interferometer calibrated on dark fringes, the photodetector

---

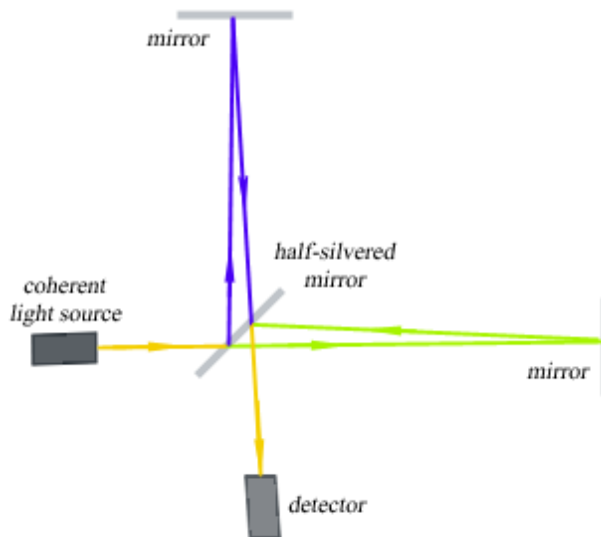
<sup>97</sup> LIGO-India proposal for an interferometric gravitational-wave observatory: [https://dcc.ligo.org/public/0075/M1100296/002/LIGO-India\\_lw-v2.pdf](https://dcc.ligo.org/public/0075/M1100296/002/LIGO-India_lw-v2.pdf).

would measure the luminosity of the recombined beams thus indicating changes along the paths of the beams<sup>98</sup>.

The Michelson interferometer is very well-known for its use in the Michelson-Morley experiment of 1887 in which its configuration was set up to detect the absolute motion of the Earth through a hypothetical luminiferous aether. As referenced in Poincaré's *Sur la Dynamique de l'électron* of 1905, discussed in Chapter 3, the experiment's results refuted the belief of many scientists of that time in the hypothesis that this luminiferous aether was the medium through which light was propagating.

According to Rainer Weiss, the idea of using an interferometer to detect the effects of a gravitational wave passing can be attributed to Felix Pirani (1928-2015) and Philip Chapman who thought of it independently and published in 1956:

The principal idea of the antenna is to place free masses at several locations and measure their separations interferometrically. The notion is not new; it has appeared as a gedanken experiment in F. A. E. Pirani's studies of the measurable properties of the Riemann tensor<sup>99</sup>. However, the realization that with the advent of lasers it is feasible to detect gravitational waves by using this technique grew out of an undergraduate seminar that I ran at M. I. T. several years ago, and has been independently discovered by Dr. Philip Chapman of the National Aeronautics and Space Administration, Houston. (Weiss 1972, p. 58)



**Fig. 4.5.** Schema of a Michelson interferometer. Source: “Maksim” | (CC BY-SA 3.0)

<sup>98</sup> These variations in the paths of the beams can be caused of a wide variety of reasons depending on the experiment design (change in the refraction index, change of length, etc.).

<sup>99</sup> Cfr. (Pirani 2009)

## 4.6 The Gravitational Waves Observatories

### 4.6.1 *LIGO & VIRGO*

The LIGO and Virgo gravitational wave detectors are giant Michelson Interferometers in essence. However, with their kilometric long arms, their state of the art mirrors suspended in vacuum and the superattenuators, they are far from being simple interferometers. They are the culminating point of technological marvels and research in many different fields of Physics and scientists working together towards the same goal. The twin detectors of LIGO and Virgo, their sibling, are very similar both in design and technology –for instance, their mirrors are produced by the same group.

When a gravitational wave passes through the arms of the detector, it produces a change on the quantity of light detected –power (commonly noted  $\delta P_{det}$ ) by the photodetector. The detectors are set up in a dark fringe configuration such that when both arms of the detectors have the same length, and since the beams have been set up to have opposed phases they cancel each other and there is no light reaching the photodetector. However, when the lengths of the arms are varying, the sum of both beams is also varying and is differing from zero because the beams are no longer cancelling each other out. In this case, some light reaches the photodetector.

The aim of their setup is to bring the interferometer to its working point – dark fringe and Fabry-Pérot cavities on resonance–, to maximise the detected signal  $\delta P_{det}$  and at the same time to filter out and eliminate as much as possible any unwanted noise or other things in order to only detect the effects of actual gravitational waves passing through the detectors. Indeed, as the goal is to measure a length difference of the order of  $10^{-18}$  m, almost any noise source becomes limiting. For instance, we can establish some raw approximations, e.g.:

- Fluctuations of the laser: a stable laser beam is needed (frequency, alignment, power...)
- Mirror quality: low roughness ( $10^{-10}$ m RMS), right curvature...
- Seismic noise: the movement of the earth would be dominant at low frequencies without superattenuators ( $10^{12}$  of attenuation from 10 Hz)
- Pressure fluctuations: it is necessary to work under vacuum ( $P=10^{-9}$  mbar)

I was invited to visit the Virgo site from the 9<sup>th</sup> to the 15<sup>th</sup> of June 2019, and took pictures of the actual facilities and devices. Below, the readers will find the same images as in the Introduction with expanded content.

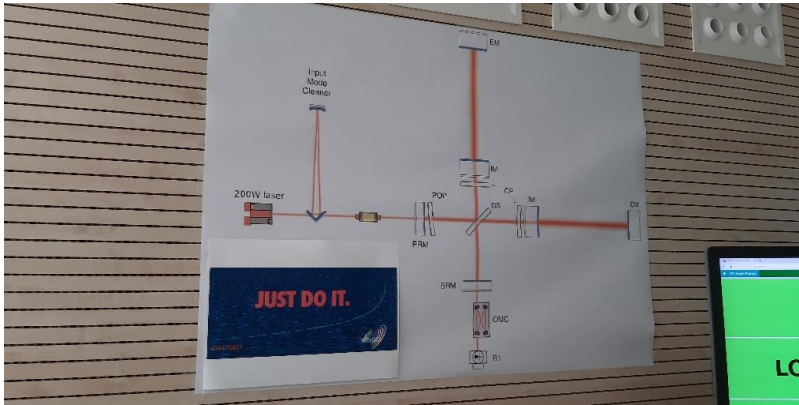


**Fig. 4.6.1.a.** Photo of the Control Room building. Source: Philippe Vincent



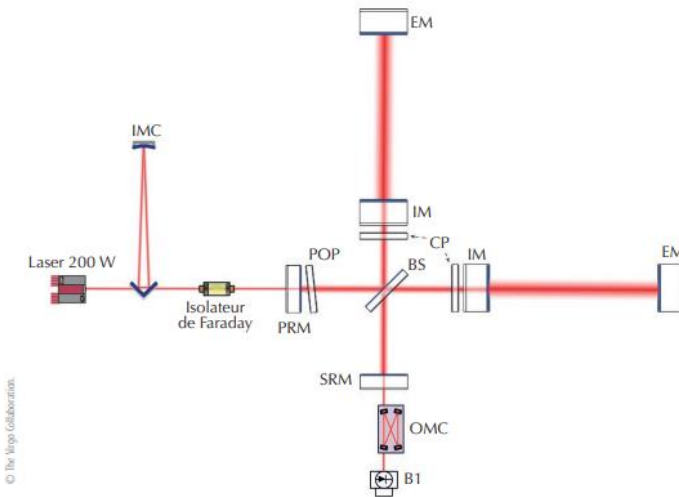
**Fig. 4.6.1.b.** Control Room. Source: Philippe Vincent

Because the observing runs for months, there are scientists in the control room at all times. In this picture, the three top screens (from left to right) are displaying: the status of the all the sensors of the interferometer in real time, those inform on different variables such as local noises from the environment (seismic activity, weather, etc.); the raw signal measurement, the sensitivity, status of the interferometer (science, locking, in lock, etc.). In addition to that, the four bottom screens display the live feed of cameras placed at different strategic places in the Michelson in order to have information about the beam. In the room, there is also a simplified schema of the Virgo interferometer which is in the photograph below:



**Fig. 4.6.1.c.** Schema of the Interferometer. Source: Philippe Vincent

A similar version of the schema is shown below with a detailed description of the system.

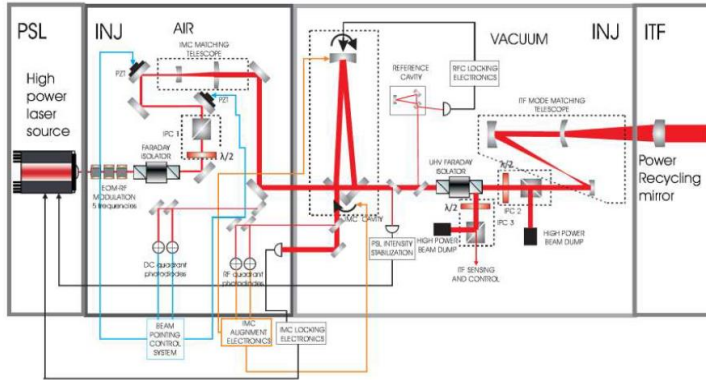


**Fig. 4.6.1.d.** Final Optical Configuration of Advanced Virgo.  
Source: The Virgo Collaboration | Commons License Attribution - Non-commercial - Share Alike 4.0 International. | Courtesy of Nicolas Arnaud

In this illustration (Fig. 4.6.1.d), the laser source produces a continuous emission (beam) of photons of 1064 nm (infrared) which enters the (IMC) Input Mode Cleaner. It is a triangular cavity 144 meters long which role is to “clean” the laser beam from wavelengths different from the fundamental mode of the laser, this provides a source of a constant and very stable wavelength. In fact the laser beam does multiple back and forth in this triangular arrangement in such a way that only one wavelength exactly can proceed on its way, the other



wavelengths being scattered. This stability is critical for the system in order to lock the interferometer and reach the sensitivity goal.



Requirements from the Technical report

**Fig.4.6.1.e.** Diagram of the Laser Injection System at Virgo. | Courtesy of Gabriel Pillant



MC payload in MC tower

**Fig.4.6.1.f.** Photo of the Input Mode Cleaner (IMC). | Courtesy of Gabriel Pillant

The beam then enters a Faraday Isolator (in yellow in Fig. 4.6.1.d.) the function of which is to guarantee that the light cannot go backwards in the system (towards the IMC). These components make up the Injection system of the Virgo Interferometer.

The laser then passes through the Power Recycling Mirror (PRM) the function of which is to reflect the portion of light on its way back that is not reflected by the beam splitter to the photodetector and reinvest it in the system.

It then passes the Pick-Off-Plate (POP) the role of which is to inform on the configuration of the laser by analysing a small sample of light.

The next step is the separation of the beam in two by the Beam Splitter (BS) which is essentially a semi mirror that has the property of allowing 50% of the photons to pass through it and forces the other 50% to be reflected.

Each laser beam then passes through the Compensating Plates. The Compensating Plates are there to correct the deformations produced by the thermal energy on the mirror as they receive a lot of radiation from the laser, which naturally causes them to deform. These devices compensate the change in the nominal curvature of the mirrors because of the variation of temperature. Following this, the laser beams enter the Fabry-Pérot cavities.

The Fabry-Pérot cavities are –located in– the actual arms of the detector and are delimited by the IM and EM mirrors. The Fabry-Pérot cavities are used to store photons making them bounce a great number of times between the IM and EM mirrors. This artificially increases the lengths of the arms and thus allows light to have a greater time interval for an interaction with a gravitational wave and therefore increases the sensitivity at low frequencies.

Next, the beams hit the BM and are redirected and pass through the SRM (Signal Recycling Mirror) and enter the OMC (Output Mode Cleaner).

The purpose of the OMC is to spatially clean the signal. This means that this device is used to remove aberrations in the beam due to imperfections, dust, dirt or damaged optics. One example would be the use of a focusing lens to compensate for the diffraction of the beam over a large distance<sup>100</sup>. Then the beam finally reaches B1 (the Detection Bench).

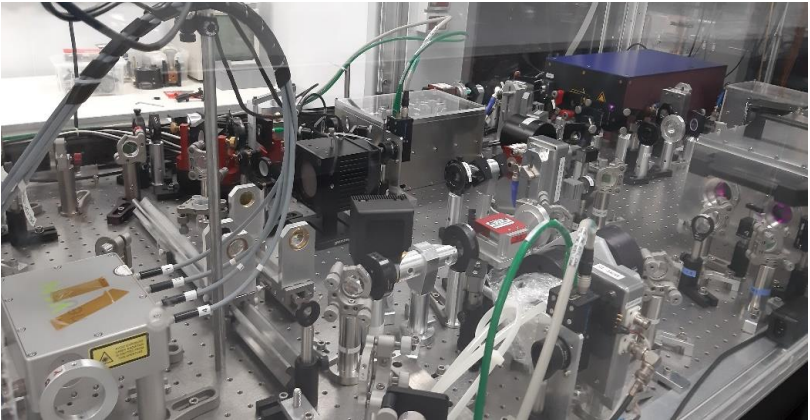
The laser is produced in a white room in which eye protective gear is required to prevent eye damage due to reflections of the (invisible) laser on surfaces as well as a full body suit to prevent dust and other particles from entering the system.

---

<sup>100</sup> This is similar to what would happen to a laser beam on Earth that was aimed at the Moon. Even if over short distances, the laser beam appears to only shine a point on a wall, after reaching the Moon it would not be as thin as that, but rather a spot with a diameter of several meters.



**Fig. 4.6.1.g.** A scientist working in the white room. Source: Philippe Vincent



**Fig. 4.6.1.h.** The laser source. Source: Philippe Vincent

The laser beam then enters the Mode Cleaner the purpose of which is to stabilize the wavelength of the beam as much as possible so that only one wavelength can go through.



**Fig. 4.6.1.i.** Injection. Source: Philippe Vincent

Then, the laser beam enters the building where all the towers containing the mirrors, beam splitter and suspension systems are.



**Fig. 4.6.1.j.** Towers containing the superattenuators and the mirrors. Source: Philippe Vincent



**Fig. 4.6.1.k.** Human PhD Student for scale (1,75 m). Source: Gabriel Pillant

The suspension system of the mirrors (superattenuators) in each of these towers is under vacuum (just like everything else) and an example of both is on display in the hall of the main building.



**Fig. 4.6.1.l.** A superattenuator on display in the Main building to show what is inside the towers. Source: Philippe Vincent



**Fig. 4.6.1.m.** The “marionetta” holding a mirror suspended by the monolithic silica fibers on display in the Main building. Source: Philippe Vincent

After being split, the laser beam then travels along the 3 kilometre arms which are isolated from the exterior, on suspensions and permanently cooled.



**Fig. 4.6.1.n.** The North gallery hosting the North 3 kilometers-long arm of the interferometer. Source: Philippe Vincent

The mirrors (c.f. Photo 10) are incredibly smooth and very slightly curved – to compensate for the scattering of the light that happens over its travel in the arms– and have a coating size (thickness) of just a few layers of atoms. This coating is made out of  $Ta_2O_5$ . In my interview with Prof. Alain Brillet, he explained the principle behind the coating technique. In fact, the mirrors are produced in pairs in order to maximize their identicalness and are coated in pairs too. For the coating, they are put in a chamber under vacuum in which a laser blasts a target made out of the coating material. The setup is made such that both mirrors are coated at the same time by the particles ejected by the target when it is blasted by the laser. The characteristics of the mirrors were given to me by Julia Casanueva at Virgo and are as follows: 35 centimetres of diameter, 20 centimetres of width, and 42 kilograms of fused silica for a reflectivity factor of 0,9998 (for the mirrors at the extremity of the arms).

The control of the mirrors and their quality is of paramount importance. On one hand the mechanical losses in the coating determine the quality factor of the mirrors as the laser exerts pressure on them because even if photons are massless, they still carry momentum. Therefore, when the laser is turned on, the mirrors are experiencing this as a pressure which pushes them back by reaction. Although this effect is negligible in usual circumstances for other experiments, this is far from being negligible here. Indeed, due to the levels of precision required and the scales at which LIGO and Virgo operate, this effect is pretty significant and needs to be taken into account. Moreover, the displacement of the mirror surface due to its thermal vibration has also to be taken into account and corrected. On the other hand the optical losses in the coatings due to the absorption of some of the photons determine the amount of power which is lost in the Fabry-Pérot cavities and consequently they also determine the power that is stored in the recycling cavity. These effects determine the amount of quantum noise which is expected to limit the sensitivity at the higher frequencies –the “shot noise” which is a direct consequence of the quantum nature of light which is responsible for the statistical fluctuations on the number of photons detected. This shot noise from photons of wavelength  $\lambda$  limits the determination of the shift of a fringe in an interferometer and is at best  $\lambda (N)^{-1/2}$  where N is the number of photons (LIGO-India proposal).

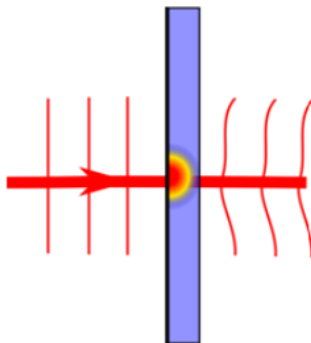
Titanium doped  $Ta_2O_5$  coatings recently developed at LMA are –if not the best– among the best solutions known so far. In fact, this type of coating offers one of the best reflectivities that we can currently achieve and is the reason why the wavelength of the laser was chosen to be in infrared, as it is in the optimal range of wavelengths to be reflected and provides minimal absorption.

There are new types of fused silica with smaller absorption that are available today (smaller than 1ppm) that are considered for later upgrades. The bulk absorption for this material being 3 times less significant than the one used for Virgo, while the other specifications (quality factor, index homogeneity, residual strain, birefringence) are still the same. Reducing the absorption in the substrates is clearly of great interest as the power absorbed causes thermal lensing in all transmissive optics. However, the thermal effects generated by the coating absorption are the dominant effects.

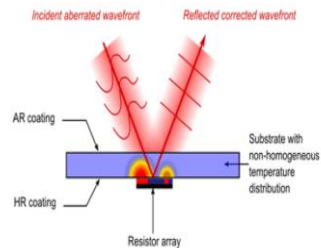
In general, the polishing quality of the mirrors is characterized by two different parameters: their flatness and their micro-roughness. The first parameter is expressed as the root mean square (RMS) of the difference between the perfect surface and the actual surface as measured by phase map interferometer; in other words, the RMS between the microscopic peaks and valleys in the surface of the mirror. The second parameter gives a measurement of the mirror surface roughness at small scale lengths. The distinction between these two different length scales originates in the fact that different instruments are used to measure them: both effects contribute to scatter the light from the fundamental mode to higher order modes and generate losses and additional noise. These polishing losses play an even more important role in Advanced Virgo due to the higher finesse –which quantifies the amplification of the light inside– of the cavities. Moreover, depending on the difference in the losses between the two cavities they are sources of finesse asymmetry and contrast defects.

The mirrors are equipped with a Thermal Compensation system to counteract the thermal lensing effect due to their heating by the laser, as this effect can deform the mirrors and thus scatter the beam. The Thermal Compensation system consists mainly of two actuators: a Ring Heater (cf. Fig. 4.6.1.r.) which induces a divergent lensing by heating the external parts of the mirrors and a Double Axicon System (cf. Fig. 4.6.1.q.) which induces a convergent lensing.

This system is necessary because the thermal energy the mirrors are subject to influences their index of refraction. Moreover, as the heat they receive is not uniformly distributed this creates local differences in the index of refraction of the mirrors, which in turn generates an effect similar to the “Mirage” discussed in Chapter I, in that it alters the coherence of the beam (the wavefronts of the beam are modified and scatter more if the substrate is not perfectly homogeneous, i.e. if its thermal energy is not uniformly distributed). This is illustrated in the figures below:

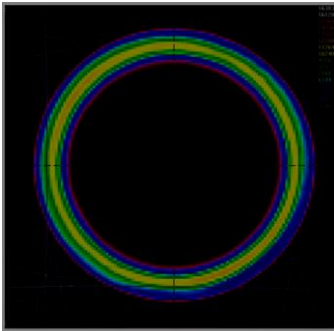
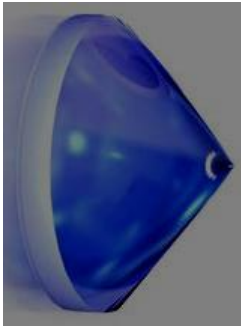


**Fig. 4.6.1.o.** Illustration of the altering effects of thermal energy on the beam. Source: Etienne Bonnec.

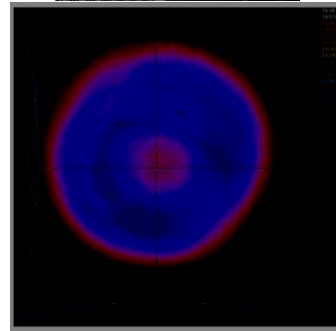


**Fig. 4.6.1.p.** Illustration of the correction of the beam by a Thermal Compensation system. Source: Etienne Bonnec.

The Thermal Compensation system facilitates adaptive optics that can greatly reduce the otherwise unavoidable aberrations, loss of Gaussian properties and other critical features of the beam.



**Fig. 4.6.1.q.** Axicon and its effects



**Fig. 4.6.1.r.** Ring Heater and its effects

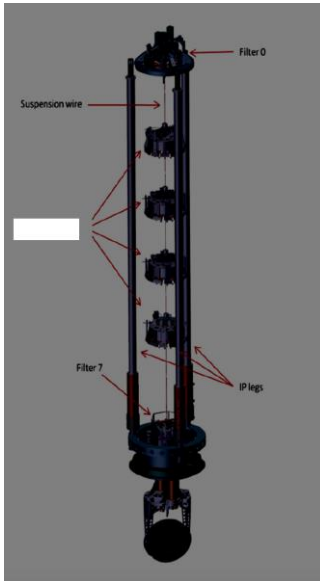
Source: The Virgo Collaboration | Courtesy of Julia Casanueva

These mirrors weigh 42 kg. They are –obviously– under vacuum and are suspended in their towers by monolithic fibres of silica only 400  $\mu\text{m}$  thin –for comparison, the thickness of a human hair ranges between 50 and 100  $\mu\text{m}$ . These super thin fibres link the mirrors with the superattenuators.

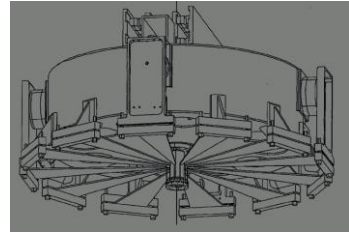
In order to reach nominal detection sensitivity at low frequencies, the mirrors of the interferometric gravitational wave detectors must be isolated from seismic noise. These vibration isolators are the devices referred to as superattenuators.

The superattenuators are around 9 meters high. They can be divided in two parts: the top stage which is made of six mechanical filters plus the inverted pendulum, and the bottom part which incorporates the “Marionetta” and the mirror. These components of this system is controlled using coil-magnet pairs. The whole system is set up such that all the optical cavities are suspended and coupled. Moreover, to attain resonance in order to maximize the power resonating inside each cavity, it is possible to tune the cavities lengths on a microscopic scale.





**Fig. 4.6.1.s.** The superattenuators mechanical structures



**Fig. 4.6.1.t.** The “marionette” suspending the mirrors at the bottom of the superattenuators

Source: The Virgo Collaboration | Courtesy of Julia Casanueva

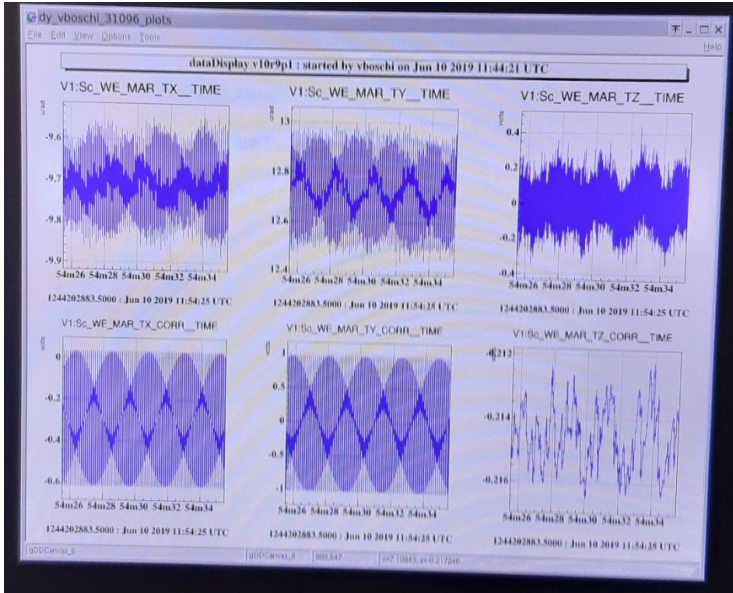
The seismic noise attenuation is crucial for the detection of gravitational waves in ground (Earth) based interferometers. When I talked with Valerio Boschi he explained that the displacement of the test masses of the Virgo Interferometer had to be decreased to around  $10^{-18}\text{m}/\sqrt{\text{Hz}}$  in the 10 Hz – 10 kHz detection band and that to achieve such a strong attenuation, the superattenuators were designed in a very specific way. For instance, there are two main types of approach that one can use for attenuation devices or other systems: active or passive. On one hand for the active approach, as its name suggests, there is a control system that commands the actuators the role of which is to counterbalance whichever effect one wants to reduce. On the other hand, for the passive approach, the idea is to use the fundamental properties of a particular setup to remove as much as possible the unwanted motions. Of course, both approaches can be used at the same time for maximum efficiency. The superattenuators in the Virgo installations were built in order to be able to reduce the seismic noises by more than 10 orders of magnitude for a seismic isolation in all six degrees of freedom above a few Hz.

The superattenuator structures (Fig.4.6.1.s) can be subdivided into three principal parts: the inverted pendulum (referred to as IP); the chain of seismic filters starting at filter0 to filter7 (the steering filter); and the payload (the marionette, the reference mass, and the mirror).

The inverted pendulum is itself subdivided into three 6 meter long hollow legs supporting the top ring which is an interconnecting structure from which the seismic filters are suspended. The filters are suspended one after another in the chain and are each equipped with a set of sensors and actuators set up in a

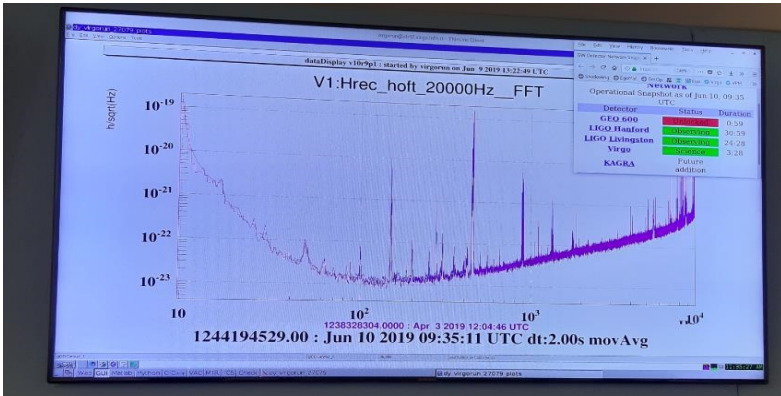
“pinwheel” configuration. This allows the active damping of the inverted pendulum resonance modes.

Additionally, these passive filters in the chain, which consist of an 8 m-long set of five cylindrical passive filters, are able to diminish the seismic noise by 40dB each for the payload which is suspended from the last seismic filter of the chain in both the horizontal and the vertical directions.

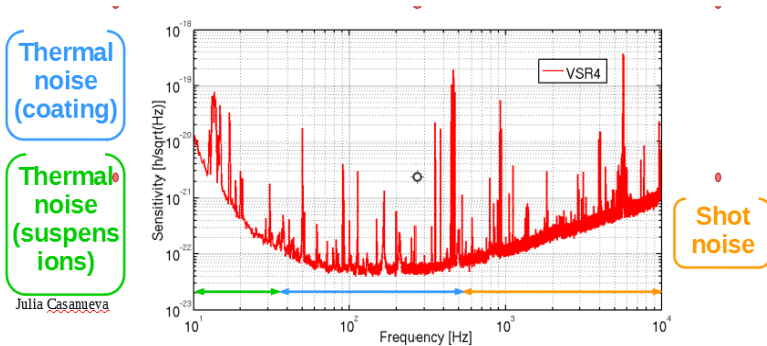


**Fig. 4.6.1.u.** Virgo Inertial Damping data display on June 10, 2019 11:44:21 UTC  
Source: The Virgo Collaboration | Photo taken by Philippe Vincent | Courtesy of Valerio Boschi

*On Sensitivity plots.* The sensitivity of the Virgo interferometer is subject to changes and has to be evaluated in real time. However, as you can observe in the figures below, some of the peaks of the curve (which actually represent weak spots of the sensitivity) are always there. In fact, these permanent features are intrinsic to the design of the detector (for instance, the violin modes of the suspension system) or due to other physical effects (such as quantum effects of light, Brownian motion in the mirrors, etc.).



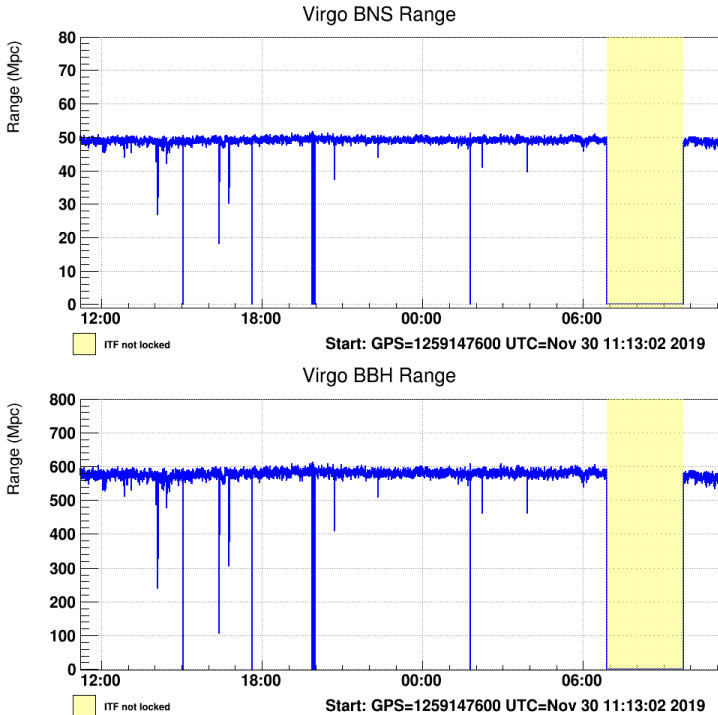
**Fig. 4.6.1.v.** Photo of the Virgo Sensitivity plot as of June 10, 2019. The sensitivity of the Advanced Virgo detector, as a function of the frequency (in the horizontal axis).



**Fig. 4.6.1.w.** Virgo sensitivity plot showing the different domains of intrinsic noise. Source: The Virgo Collaboration | Courtesy of Julia Casanueva

The sensitivity of the gravitational wave interferometer is of direct influence to the range at which the detector can perceive signals.

From the Virgo Status webpage<sup>101</sup>:



**Fig. 4.6.1.x.** and **Fig. 4.6.1.y.** The distance at which Advanced Virgo can observe the merger of binary neutron star (BNS) and binary black hole (BBH) systems as functions of time.

Source: <http://www.virgo-gw.eu/status.html> | Attribution 4.0 International (CC BY 4.0)

“The plotted quantity, called ‘BNS range’, is the distance at which the merger of a BNS system gives a matched filter signal-to-noise ratio (SNR) of 8 in Advanced Virgo with the current sensitivity; the distance is averaged over all the possible sky localisations and binary orientations. Each neutron star in the binary is assumed to have mass equal to 1.4 solar masses. The BNS range is given in units of megaparsecs (Mpc): a parsec is equal to 3.26 light-years. The stability of the range with respect to time reflects the stationarity of the detector; when Advanced Virgo is not locked then the range drops to zero (yellow shaded area).

The plotted quantity, called ‘BBH range’, is the distance at which the merger of a BBH system gives a matched filter signal-to-noise ratio (SNR) of 8 in Advanced Virgo with the current sensitivity; the distance is averaged over all the possible sky localisations and binary orientations. Each black hole in the binary is assumed to have mass equal to 30 solar masses. The BBH range is given in units of megaparsecs (Mpc): a parsec is equal to 3.26 light-years. The stability of the range with respect to time reflects the stationarity of the detector; when Advanced Virgo is not locked then the range drops to zero (yellow shaded area).”

<sup>101</sup> <http://www.virgo-gw.eu/status.html>

## 4.7 The *Mirabilis* Data

The first observing run of the Advanced LIGO gravitational wave observatories, referred to as *O1*, lasted from September 12, 2015 to January 19, 2016. During this period, the twin detectors collected 51,5 days of coincident observations. The second observing run *O2* of the Advanced LIGO gravitational observatories began on November 30, 2016 and ended on August 25, 2017. The Advanced Virgo gravitational observatory joined *O2* on August 1, 2017. Thus allowing the first observations of gravitational waves with three detectors and greatly increasing the sky localization of the gravitational wave signals (LIGO Scientific Collaboration and Virgo Collaboration 2016; 2019).

The gravitational waves from compact binaries carry information about the physical properties of the sources. These can be inferred from their waveforms and extracted through the use of models which are themselves built via post-Newtonian calculations, Bayesian inference and numerical relativity. For instance, for binary black holes, these describe the evolution of the binary –inspiral, merger and ringdown– which gives information on the characteristics of the system such as its masses, spins (LIGO Scientific Collaboration and Virgo Collaboration 2016, p. 6; 2019, p. 2).

*On the raw signal.* The raw signal is in fact a measurement of the strain amplitude in the detector. This strain corresponds to the noise in the detector when no gravitational wave is passing through it, and a superposition of noise plus the gravitational wave signal when a gravitational wave passes. Thus we have:

$$s(t) = n(t) + h(t) \quad (4.2)$$

where  $s(t)$  is the strain,  $n(t)$  the noise and  $h(t)$  the gravitational wave signal. (Cutler C, Flanagan EE 1994, p. 5)

The signal-to-noise ratio (SNR) for a given detector being (Wang 1996, p. 3):

$$\rho(z) = 8 \Theta \frac{r_0}{d_L(z)} \left( \frac{\mathcal{M}(z)}{1.2 M_\odot} \right)^{5/6} \zeta(fmax) \quad (4.3)$$

where  $d_L$  is the luminosity distance to the source,  $r_0$  and  $\zeta(fmax)$  are depending on the detector's noise power spectrum,  $\Theta$  is the angular orientation function (Finn 1993) and the expected SNR of a signal  $h(t)$  can be expressed as:

$$\rho^2 = \int_0^\infty \frac{(2|\tilde{h}(f)|\sqrt{f})^2}{S_n(f)} d \ln(f) \quad (4.4)$$

where  $\tilde{h}(f)$  is the Fourier transform of the signal,  $\sqrt{S_n(f)}$  the amplitude spectral density of the total strain noise of both detectors calibrated in units of strain per  $\text{Hz}^{1/2}$  (LIGO Scientific Collaboration 2016a, p. 8).

*On signal analysis.* Fortunately, because the gravitational wave signals are so characteristic, it is possible to use a match filtering technique. Once the different relevant regions of the raw signals have been identified and cleared of external nuisances, they undergo a series of treatments such as noise reduction and are compared between one another in order to identify potential gravitational wave candidates.

First of all, the frequencies at which the detectors have the largest noises are suppressed. Moreover, when a significant noise source is identified, polluted data are removed from the final analysis data set (*Ibidem*), then each template there is an analysis of the signal to noise ratio in order to be able to quantify how much the potential gravitational wave signal stands out compared to the noise. This step is important because unless the signal is strong enough to bypass a certain threshold, it would be unrecognizable from a random noise fluctuation. This process is as automated as possible and consists in scanning the signals together for common features within timeframes consistent with Relativity theory, i.e. since gravitational waves travel at the speed of light, the signals are examined such that the time difference between the signals received by two detectors do not exceed the maximum time light would need to travel from one detector to the other and vice-versa.

*On signal templates.* In order to identify these common patterns effectively, one needs of course to know what to look for, common features are not enough. That is the reason why the scientific teams in charge are constantly adding new templates to their database. These templates are designed according to the theory and are in essence a direct result of its application to simulated events involving different binary systems of different characteristics (such as different masses, distances, source's location, orientation, etc.). Additionally, the combination of broad-band frequency and sensitivity of the detectors allow a very good matching selectivity between signal and template, and thus making a false positive very unlikely. Obviously, these are not the only characteristics relevant in a coalescing binary, however even if a certain number of other parameters or effects take place (such as orbital eccentricity), they are very small in comparison. These signals are often called “chirp signals” because of their waveform. Indeed, the sound these kinds of signals make when translated in soundwaves resembles a bird's chirp. At this point, it is important to note that this implies that since we are looking for matches between the developed templates and the actual detected signal, it is (so far) only possible to observe phenomena that we understand and for which we have templates. In other

words, we could well be detecting unknown phenomena producing gravitational waves that we are still unaware of.

*On the obtainable information.* The analyses of the signals inform us on a number of characteristics of the systems involved. Indeed, these chirp signals actually contain a lot of information. At the end of its life, a binary system undergoes 3 main phases: the inspiral during which the two masses' orbits have diminished so much that the masses are about to collide, the merger or coalescence of the masses, and the ringdown which is the final release of gravitational radiation, carrying notably the information about the final mass of the resulting object. Each of these phases can be observed in the signal and each phase informs us on the system.

The overall obtainable information is listed below:

- Total mass:  $M = m_1 + m_2$
- Primary black hole mass:  $m_1$
- Secondary black hole mass:  $m_2$
- Mass ratio
- Final black hole mass:  $M_f$
- Final black hole spin:  $a_f$
- Effective inspiral spin parameter:  $\chi_{eff}$
- Luminosity distance  $D_L$
- Peak Luminosity  $l_{peak}$
- Radiated energy  $E_{rad}$ :
- Source redshift  $z$
- The Chirp mass: The combination  $\mathcal{M} \equiv \frac{(M_1 M_2)^{3/5}}{(M_1 + M_2)^{1/5}}$  of the masses of the two bodies (Cutler 1994, p.1; Wang 1996 ; Blanchet 1996, p. 11)

Remark: by convention,  $m_1 > m_2$ .

The measured mass of a star in the binary is its true mass times  $1 + z$  (Schutz 1999, p. 1777):

$$\mathcal{M} \equiv \mathcal{M}_0(1 + z) \quad (4.5)$$

where

$$\mathcal{M} \equiv \mu^{3/5} \mathcal{M}^{-1/5} \quad (4.6)$$

where  $\mu$  is the reduced mass and  $\mathcal{M}$  is the total mass of the system. This combination is referred to as the “chirp mass.”(Cutler 1994, p.1, 42; Blanchet 1996, p. 11).

The effective inspiral spin parameter  $\chi_{eff}$  can be defined as<sup>102</sup>:

---

<sup>102</sup> Cfr. Hotokezaka 2017, p. 2.

$$\chi_{eff} = \frac{m_1 a_1 \cos(\theta_{LS_1}) + m_2 a_2 \cos(\theta_{LS_2})}{M} \quad (4.7)$$

where  $\theta_{LS_i} = \cos^{-1}(\hat{L} \cdot \hat{S}_i)$  is the tilt angle between the spin  $S_i$  and the orbital momentum  $L$  (LIGO Scientific Collaboration and Virgo Collaboration 2018, p. 4)<sup>103</sup>.

From the works of Cutler and Flanagan we also have:

*The gravitational wave signal in the Newtonian approximation*

Inspiring compact binaries can be described, to lowest order, as two Newtonian point particles whose orbital parameters evolve secularly due to gravitational radiation, where the gravitational waves and corresponding energy loss rate are given by the Newtonian quadrupole formula. That is, the orbital frequency  $\Omega$  at any instant is given by:

$$\Omega = \frac{M^{1/2}}{r^{3/2}}$$

where  $M \equiv M_1 + M_2$  is the total mass of the system and  $r$  is the orbital separation.

The inspiral rate, for circular orbits, is given by:

$$\frac{dr}{dt} = - \frac{r}{E} \frac{dE}{dt} = - \frac{64}{5} \frac{\mu M^2}{r^3}$$

where  $\mu \equiv M_1 M_2 / M$  is the reduced mass. Integrating this equation we obtain:

$$r = \left( \frac{256}{5} \mu M^2 \right)^{1/4} (t_c - t)^{1/4}$$

where  $t_c$  is the ‘‘collision time’’ at which (formally)  $r \rightarrow 0$ . Since the emitted gravitational waves are quadrupolar, their frequency  $f$  (cycles/sec) is equal to  $\Omega/\pi$  (Cutler 1994, p. 15).

The radiated energy is estimated from the difference between the total mass of the system and the final mass as this difference directly gives the amount of mass converted in gravitational radiation (LIGO Scientific Collaboration and Virgo Collaboration 2018, p. 8):

$$E_{rad} = M^{source} - M_f^{source} (M_\odot) c^2 \quad (4.8)$$

---

<sup>103</sup> A simple mass weighted linear combination for a one dimensional parameterization of the dominant spin effect found in the literature can also be used (LIGO Scientific Collaboration and Virgo Collaboration 2016b, p. 4):

$$\chi_{eff} = \frac{c}{GM} \left( \frac{S_1}{m_1} + \frac{S_2}{m_2} \right) \cdot \frac{L}{|L|}$$



The luminosity distance is given by:

$$d_L(z) = (1 + z)^2 d_A(z) \quad (4.9)$$

where  $d_A(z)$  is the angular diameter distance (Wang 1996, p. 3).

For the final spin of a black hole of mass  $m$ , “the spin can be at most  $\frac{Gm^2}{c}$ ; hence, it is conventional to note the dimensionless spin magnitude  $a = \frac{c|S|}{(Gm^2)} \leq 1$ .” (LIGO Scientific Collaboration and Virgo Collaboration 2016b, p. 1)

### 4.7.1 Analyses of Some Signals (2015-2017)

In this section I will explore some of the most interesting signals of the two first observing runs, (*O1*) and (*O2*), and their astrophysical implications.

#### 4.7.1.1 GW150914

GW150914 was the first gravitational wave signal detected. The existence of gravitational waves was first established with radio observations of the orbital decay of PSR B1913+16, the first binary pulsar (Hulse 1975; Taylor 1982; c.f. Chapter 1). It was identified as a binary black hole merger and as such it provided the first observational evidence of the existence of binary black hole systems (LIGO Scientific Collaboration and Virgo Collaboration 2016c). Along with that, GW150914 also lead to the confirmation that “heavy” black holes exist<sup>104</sup>, that binary black holes also exist, and that binary black holes merge “within the age of the universe at a detectable rate” (*Ivi.* p. 5).

Moreover, the inspirals and mergers of binaries, whether with black holes or neutron stars, have been confirmed as sources of gravitational waves by ground-based gravitational interferometers (Thorne 1987, p. 330; Schutz 1989) with GW150914, GW170817 and the very recent gravitational wave candidate S190814bv<sup>105</sup>.

The luminosity distance of GW150914 was estimated to be “in the range of 230–570 Mpc (at 90% credible level) which corresponds to a redshift of 0.05–0.12 and an age of the universe of ;12.2–13.1 Gyr at the time of the merger” (LIGO Scientific Collaboration and Virgo Collaboration 2016c, p. 9).

The signal-to-noise ratio of the detection was very strong, estimated to be 24 (Yunes 2016). Since its detection, the signal has been very thoroughly studied, analysed and the latest values for the masses involved are t masses

<sup>104</sup> c.f. (Belczynski 2010; Fryer 2000, in particular part 4, p.8)

<sup>105</sup>c.f. <https://gracedb.ligo.org/superevents/S190814bv/>

of  $35^{+5}_-3 M_\odot$  and  $30^{+3}_-4 M_\odot$  where the errors correspond to credible levels of 90% (LIGO Scientific Collaboration and Virgo Collaboration 2016d).

Black holes are fully described by 3 physical properties: their mass, spin (angular momentum) and charge. The charge is usually considered to be neutral as a positively charged black hole would naturally tend to attract negatively charged particles, repel positively charged ones, and reciprocally, a negatively charged black hole would attract positively charged particles and repel negatively charged ones. Therefore, to describe the resulting black hole from the GW150914 event, we only need the final mass and spin which are estimated to be overall respectively  $62.2^{+3.7}_-3.4 M_\odot$  and  $0.68^{+0.05}_-0.06$ . (*Ivi.* p. 5)

Finally, even if this newer analysis managed to put a “tighter limit on the spin magnitude [...] the recovery of the spin parameters (magnitude and tilt angles) is too broad to hint at whether the black hole binary was formed via stellar binary interactions or dynamical capture”. (*Ivi.* p. 10)

In other words, we are still uncertain if the binary black hole system at the origin of GW150914 was created by the black holes capturing each other or if they are the result of the death of a binary star system.

#### 4.7.1.2 GW151226

This signal was the second confirmed gravitational wave signal of a binary black hole merger. Although, it should be noted that GW151226 is not the second gravitational wave event candidate, this position being occupied by the so called LVT151012 as it was called at that time but which unfortunately had a relatively low significance (LIGO Scientific Collaboration and Virgo Collaboration 2016e ,p. 3).

Unlike GW150914, the estimation of the masses of the two black holes are consistent with the usual observations found in x-ray binaries<sup>106</sup> (*Ivi.* p. 6):

“The initial binary was composed of two stellar-mass black holes with a source-frame primary mass  $m_1 = 14.2^{+8.3}_-3.7 M_\odot$ , secondary mass  $m_2 = 7.5^{+2.3}_-2.3 M_\odot$ , and a total mass of  $21.8^{+5.9}_-1.7 M_\odot$ . The binary merged into a black hole of mass  $20.8^{+6.1}_-1.7 M_\odot$ , radiating  $1.0^{+0.1}_-0.2 M_\odot c^2$  in gravitational waves with a peak luminosity of  $3.3^{+0.8}_-1.6 \times 10^{56}$  erg/s” (*Ivi.* p. 4).

The signal-to-noise ratio for GW151226 was of 13 with a  $\sigma > 5$ , therefore even if it was weaker than GW150914, there is no doubt that it was indeed caused by a gravitational wave. Moreover, since it involved black holes of lesser mass, the signal lasted longer, i.e. “there were many more cycles in band compared to GW150914” (Yunes 2016).

---

<sup>106</sup> Cfr. (Kreidberg 2012; Miller 2014).

*On the effective spin:*

[...] the precessing and nonprecessing spin waveform models indicate that  $\chi_{eff}$  is positive at greater than the 99% credible level; therefore, at least one of the black holes has nonzero spin. We find that at least one black hole has a spin magnitude greater than 0.2 at the 99% credible level. (LIGO Scientific Collaboration and Virgo Collaboration 2016e, p. 5)

GW170104's source is a heavy binary black hole system, with a total mass of  $\sim 50 M_{\odot}$ , suggesting formation in a sub-solar metallicity environment. Measurements of the black hole spins show a preference away from being (positively) aligned with the orbital angular momentum, but do not exclude zero spins. This is distinct from the case for GW151226, which had a strong preference for spins with positive projections along the orbital angular momentum. (LIGO Scientific Collaboration and Virgo Collaboration 2018)

According to Kenta Hotokezaka and Tsvi Piran, the implications of the measured spins –of GW150914, GW151226 and LVT151012– were consistent with either Wolf-Rayet or Population III star progenitors (Hotokezaka 2017).

**4.7.1.3 GW170608**

As its name suggests, GW170608 is a gravitational wave signal that was detected on June 8, 2017. The gravitational waves producing this signal have been identified as originating from a black hole binary. GW170608 was measured at 02:01:16.49 UTC.

The most notable feature of this signal is that at the time of its publication, the masses involved in this black hole-black hole merger were estimated to have been  $12^{+7}_{-2} M_{\odot}$  and  $7^{+2}_{-2} M_{\odot}$  with a 90% certainty and a luminosity distance of  $340^{+140}_{-140}$  Mpc with a corresponding redshift of  $0.07^{+0.03}_{-0.03}$ , which made this binary system the lightest observed. (LIGO Scientific Collaboration and Virgo Collaboration 2017)

**4.7.1.4 GW170814–The First Triple Detection**

GW170814 was detected on August 14, 2017 at 10:30:43 UTC and corresponds to a black hole binary merger. This was the first time a detection was observed with three gravitational wave detectors: Virgo and the twin detectors of LIGO. Moreover, the signal-to-noise ratio was relatively strong with a value of 18 and with the addition of a detector, the false alarm rate dropped by an order of magnitude.

Prior to the coalescence, the black holes were estimated to have been  $30.5^{+5.7}_{-3} M_{\odot}$  and  $25.3^{+2.8}_{-4.2} M_{\odot}$ , with a 90% certainty and a luminosity

distance of  $540_{-210}^{+130}$  Mpc, which corresponds to a redshift of  $0.11_{-0.04}^{+0.03}$ . (LIGO Scientific Collaboration and Virgo Collaboration 2017a)

As for the first time three gravitational wave observatory were in observation and the three of them actually detected the same event, it was possible to drastically narrow the sky region from which the signal came (c.f. section 4.8). Moreover, it also allowed to examine the “gravitational wave’s polarizations geometrically by projecting the wave’s amplitude onto the three detectors” (*Ivi.* pp. 1-2) which, added to the fact that the gravitational waveform consists of only two polarization, further constrains sky localization.

#### 4.7.1.5 *GW170817–The First Neutron Stars Merger*

When a massive star ends its life in a supernova explosion it leaves behind an ultra-dense core. This supernova remnant is called a Neutron Star. GW170817 was the first Kilonova, a Neutron star-Neutron star merger, which was detected by the gravitational waves observatories. Neutron stars should be much more common than black holes as black holes are usually made from the death of the most massive stars. This implies that neutron star binaries should be much more common than black hole binaries, however, the detections of black hole binaries are much more frequent (Mapelli 2018; McKernan 2018). The reason for this resides in the fact that neutron stars are much less massive celestial objects. The constraints for existing neutron stars are such that they need to fit in a certain range of mass–estimated to be between  $0,8 M_{\odot}$  and  $2,5 M_{\odot}$  for a radius of between 8 and 17 km (Miller 2014; Steiner 2013)– but this also means that the gravitational waves they can emit are much less powerful. This in turn implies that a neutron star merger needs to happen much closer to us for a detection to happen. In fact, if neutron star mergers need to happen approximately 10 times closer, by extension, it means that they need to happen in a volume around us  $10^3$  smaller; which translates to having to wait longer to make a neutron star- neutron star merger detection compared to a black hole-black hole merger.

However, this type of merger has an advantage compared to binary black hole mergers: because binary neutron stars are less massive, they take a longer time to inspiral and merge. This has the effect that the gravitational waves they emit produce a detectable signal that lasts longer.

Finally, another advantage provided by this type of merger is that they have an optical counterpart: this type of merger emits electromagnetic waves across all the electromagnetic spectrum– especially gamma rays–, unlike binary black hole mergers which are dark. Fortunately, the Fermi satellite detected a gamma ray burst coincident with the detection of GW170817 in a galaxy 130 million years away. Actually, the gravitational signal arrives before the electromagnetic signal as the gravitational waves are getting stronger and stronger the more the neutron stars get closer during the inspiral

(Nakar 2007, p. 55). In GW170817, the burst of gamma radiation arrived approximately<sup>107</sup> 1,7 seconds after the gravitational waves<sup>108</sup>.

This coincident detection provided information on the distance actually travelled by the gravitational waves thus giving the opportunity to discuss certain hypotheses.

For example, GW170817 allowed for the testing of a potential leakage of gravitational radiation in other dimensions (Pardo 2018). We usually think of space as tri-dimensional plus one dimension of time in order to have a 4D-spacetime (or rather a 3+1 spacetime), but there are a lot of theories (i.e. string theory) in which more dimensions are considered to explain certain phenomena and observations (i.e. the nature of dark energy,...). In General Relativity, the gravitational waves amplitude decreases inversely with luminosity distance:

$$h_{GR} \propto \frac{1}{d_L} \quad (4.10)$$

where  $d_L$  is the luminosity distance of the gravitational waves' source (*Ivi.* p. 2). However, in theories considering higher numbers of dimensions in which gravitational leakage may occur<sup>109</sup>, the relation becomes:

$$h \propto \frac{1}{d_L^\gamma} \quad (4.11)$$

where  $\gamma$  depends on  $D$ , the number of dimensions (*Ibidem*):

$$\gamma = \frac{D - 2}{2} \quad (4.12)$$

Thanks to the independent measurements of on one hand the gravitational observatories and on the other hand the Fermi Gamma-ray Space Telescope, the distance the wave travelled was determined and the authors concluded that the results were “completely consistent with GR” (*Ivi.* p. 7). Thus excluding some theories.

GW170817 was detected on August 17, 2017 at 12:41:04 UTC. This was the first time that the detection of a kilonova was observed with three gravitational wave detectors: Virgo and the twin detectors of LIGO. The – combined– signal-to-noise ratio value was 32,4. The masses of the binary have been estimated to be  $0.86 M_\odot$  and  $2.26 M_\odot$ , for a total mass of

<sup>107</sup> Also considering effects such as dispersion measure in the interstellar medium (Cfr. Dorimer 2007).

<sup>108</sup> Cfr. Multi-messenger Observations of a Binary Neutron Star Merger, *The Astrophysical Journal Letters*, 848:L12.

Retrieved: <https://dcc.ligo.org/public/0145/P1700294/007/ApJL-MMAP-171017.pdf>

<sup>109</sup> c.f. Pardo 2018, p. 5: “We stress that our results do not hold for extradimensional theories with compact extra dimensions (e.g. string theory or the ADD model)”

$2.74^{+0.04}_{-0.01} M_{\odot}$  and a luminosity distance of  $40^{+8}_{-14}$  Mpc, which corresponds to a redshift of  $0.008^{+0.002}_{-0.003}$  (LIGO Scientific Collaboration and Virgo Collaboration 2017b).

## 4.8 2017. The *Nobel Prize* in Physics

On October 3, 2017, The Royal Swedish Academy of Sciences decided to award the Nobel Prize in Physics 2017 to three scientists from the LIGO/VIRGO Collaboration with one half to Rainer Weiss, professor at the Massachusetts Institute of Technology and the other half jointly to Barry C. Barish and Kip S. Thorne, from California Institute of Technology “for decisive contributions to the LIGO detector and the observation of gravitational waves”.<sup>110</sup> The Royal Swedish Academy rather appropriately called it “a discovery that shook the world”.

Unfortunately, Ronald Drever who was expected to also receive the honours passed away in March 2017 and thus, according to the terms of the Nobel Foundation, was not granted the distinction, as Nobel Prizes cannot be awarded posthumously.

---

<sup>110</sup> The Nobel Prize in Physics 2017, NobelPrize.org. Nobel Media AB 2019. Wed. 16 Oct 2019. <<https://www.nobelprize.org/prizes/physics/2017/summary/>>

## **Final Remarks**

In this part I have explored the role played by the pioneers of the search for gravitational waves, in particular the role played by Joseph Weber; and the major impact that the Chapel Hill Conference of 1957 had, in particular on the theory behind the physics of gravitational waves, but also on the bolstering effect it had on the actual search.

I have also showed the principles and methods for the detection of gravitational waves, through the study of the Virgo interferometer; as well as our contemporary understanding of gravitational wave astronomy, and associated phenomena. Furthermore, I have explored some of the astrophysical implications of some of the most noteworthy signals.

# REFERENCES

## Primary Sources

- Babson RW (1950) *Actions and Reactions: An Autobiography of Roger W. Babson*. 2<sup>nd</sup> revised edition, Harper & Brothers Publishers, New York.
- Feynman RP, Morinigo FB, Wagner WG, Hatfield B (1995) *Feynman Lectures on Gravitation*. Advanced book program, Addison-Wesley, University of Michigan. ISBN:9780201627343
- Hulse RA, Taylor JH (1975) Discovery of a pulsar in a binary system. *Astrophysical Journal*, The American Astronomical Society, 195/2:L51-L53
- Whitehead AN (1920) *The Concept of NATURE*. The Turner Lectures Delivered in Trinity College, November 1919, Imperial College of Science and Technology. Project Gutenberg, retrieved: <http://www.gutenberg.org/files/18835/18835-h/18835-h.htm>

## Secondary Sources

- Abbott BP and Abbott R and Abbott TD and Acernese F and Ackley K and Adams C and Adams T and Addesso P and Adhikari RX and Adya VB and et al. (2017) Multimessenger Observations of a Binary Neutron Star Merger. *The Astrophysical Journal Letters*, 848(2):L12. DOI: 10.3847/2041-8213/aa91c9
- Armano M *et al* (2016) Sub-Femto-g Free Fall for Space-Based Gravitational Wave Observatories: LISA Pathfinder Results. *Phys. Rev. Lett.* 116:23/1101. DOI: 10.1103/PhysRevLett.116.231101  
Retrieved: <https://journals.aps.org/prl/pdf/10.1103/PhysRevLett.116.231101>
- Aso Y, Michimura Y, Somiya K, Ando M, Miyakawa O, Sekiguchi T, Tatsumi D, Yamamoto H (2013) Interferometer design of the KAGRA gravitational wave detector. *Phys. Rev. D* 88, 043007. Retrieved: <https://doi.org/10.1103/PhysRevD.88.043007>
- Bartusiak M (1998) Interview with Joseph Weber, University of Maryland, May 6, 1998. Recordings/transcripts available at Niels Bohr Library Archives, 1 Ellipse Road, College Park, Maryland.
- Bartusiak M (2000) *Einstein's Unfinished Symphony: Listening to the Sounds of Space-Time*. Joseph Henry Press; 1st edition (December 15, 2000)
- Bartusiak M (2017) *Einstein's Unfinished Symphony: The Story of a Gamble, Two Black Holes, and a New Age of Astronomy*. Yale University Press; Reprint edition.
- Belczynski K, Bulik T, Fryer CL, Ruiter A, Valsecchi F, Vink JS, Hurley JR (2010) On the Maximum Mass of Stellar Black Holes. *The Astrophysical Journal*, The American Astronomical Society, 714:1217–1226. DOI:10.1088/0004-637X/714/2/1217
- Blanchet L, Iyer BR, Clifford WM, Wiseman AG (1996) Gravitational waveforms from inspiralling compact binaries to second-post-Newtonian order. *Class.Quant.Grav.* 13 (1996), pp. 575-584. DOI: 10.1088/0264-9381/13/4/002
- Broadhurst T, Diego JM, Smoot G (2018) Reinterpreting Low Frequency LIGO/Virgo Events as Magnified Stellar-Mass Black Holes at Cosmological Distances. arXiv. Retrieved: <https://arxiv.org/abs/1802.05273v3>
- Cutler C, Flanagan EE (1994) Gravitational waves from merging compact binaries: How accurately can one extract the binary's parameters from the inspiral waveform? *Physical Review D*, 49(6):2658-2697.
- Cutler C, Harms J (2006) Big Bang Observer and the neutron-star-binary subtraction problem. *Phys. Rev. D* 73, 042001. DOI:<https://doi.org/10.1103/PhysRevD.73.042001>.



- Danzmann (2017) LISA Laser Interferometer Space Antenna, A proposal in response to the ESA call for L3 mission concepts.  
Retrieved: [https://www.elisascience.org/files/publications/LISA\\_L3\\_20170120.pdf](https://www.elisascience.org/files/publications/LISA_L3_20170120.pdf)
- Deruelle N, Lasota JP (2018) Les Ondes gravitationnelles. Odile Jacob, 15 rue soufflot, Paris. ISBN: 978-2-7381-4334-1
- Dorimer DR, Bailes M, McLaughlin MA, Narkevic DJ, Crawford F (2007) A bright millisecond radio burst of extragalactic origin. DOI:10.1126/science.1147532. Retrieved: <https://arxiv.org/abs/0709.4301v1>
- Eisenstaedt J (1986) The Low Water Mark of General Relativity, 1925-1955. In: Einstein and the History of General Relativity, Howard D and Stachel J (eds), Birkhäuser, Boston, pp. 277-292
- Eisenstaedt J (2015) General Relativity, a Theory Ahead of its Time, Presentation given at the Observatoire de Paris. Retrieved: <https://www.mpiwg-berlin.mpg.de/sites/default/files/migrated/Jean%20Eisenstaedt%20-%20The%20Low-water%20Mark%20of%20General%20Relativity%2C%20a%20Theory%20Ahead%20of%20its%20Time.pdf>
- Finn LS, Chernoff DF (2008) Observing binary inspiral in gravitational radiation: One interferometer. Phys.Rev. D47 (1993) 2198-2219. Retrieved: <https://arxiv.org/abs/gr-qc/9301003v1>
- Fryer CL, Woosley SE, Heger A (2000) Pair-Instability Supernovae, Gravity Waves, and Gamma-Ray Transients. Astrophys.J. 550:372-382,2001. DOI: 10.1086/319719 Retrieved: <https://arxiv.org/abs/astro-ph/0007176v1>
- Gawiser E, Silk J (2000) The Cosmic Microwave Background Radiation. Physics Report 333-334:245-267. DOI: 10.1016/s0370-1573(00)00025-9
- Gretz DJ (2018) Early History of Gravitational Wave Astronomy: The Weber Bar Antenna Development. History of Physics Newsletter, 8/6:1,5-17
- Hotokezaka K, Piran T (2017) Implications of the Low Binary Black Hole Aligned Spins Observed by LIGO. The Astrophysical Journal, 842:111. Retrieved: <https://doi.org/10.3847/1538-4357/aa6f61>
- Kreidberg L, Bailyn CD, Farr WM, Kalogera V (2012) Mass Measurements of Black Holes in X-Ray Transients: Is There a Mass Gap? The Astrophysical Journal, 757:36. DOI:10.1088/0004-637X/757/1/36. Retrieved: <https://iopscience.iop.org/article/10.1088/0004-637X/757/1/36>
- LIGO Scientific Collaboration and Virgo Collaboration, Abbott BP, *et al.* (2016a) Binary Black Hole Mergers in the First Advanced LIGO Observing Run. Physical Review X 6, 041015, American Physical Society. DOI: 10.1103/physrevx.6.041015. Retrieved: <https://arxiv.org/abs/1606.04856>
- LIGO Scientific Collaboration and Virgo Collaboration Abbott BP, *et al.* (2016b) Properties of the Binary Black Hole Merger GW150914. Phys. Rev. Lett. 116, 241102, American Physical Society. DOI: 10.1103/PhysRevLett.116.241102 Retrieved: <https://journals.aps.org/prl/pdf/10.1103/PhysRevLett.116.241102>
- LIGO Scientific Collaboration and Virgo Collaboration Abbott BP, *et al.* (2016c) Astrophysical Implications of the Binary Black Hole Merger GW150914. The Astrophysical Journal Letters, The American Astronomical Society, 818/2:L22. Retrieved: <https://doi.org/10.3847/2041-8205/818/2/L22>
- LIGO Scientific Collaboration and Virgo Collaboration, Abbott BP, *et al.* (2016d) Improved Analysis of GW150914 Using a Fully Spin-Precessing Waveform Model. Phys. Rev. X 6, 041014. DOI: 10.1103/PhysRevX.6.041014. Retrieved: <https://journals.aps.org/prx/pdf/10.1103/PhysRevX.6.041014>

- LIGO Scientific Collaboration and Virgo Collaboration, Abbott BP, *et al.* (2016e) GW151226: Observation of Gravitational Waves from a 22-Solar-Mass Binary Black Hole Coalescence. *Phys. Rev. Lett.* 116, 241103. DOI: 10.1103/PhysRevLett.116.241103. Retrieved: <https://arxiv.org/ftp/arxiv/papers/1606/1606.04855.pdf>
- LIGO Scientific Collaboration and Virgo Collaboration, Abbott BP, *et al.* (2017) Observation of a 19-Solar-Mass Binary Black Hole Coalescence. *The Astrophysical Journal Letters*, 851:L35. DOI: <https://doi.org/10.3847/2041-8213/aa9f0c>
- LIGO Scientific Collaboration and Virgo Collaboration, Abbott BP, *et al.* (2017a) GW170814: A Three-Detector Observation of Gravitational Waves from a Binary Black Hole Coalescence. *Phys. Rev. Lett.* 119, 141101, American Physical Society. DOI:<https://doi.org/10.1103/PhysRevLett.119.141101>
- LIGO Scientific Collaboration and Virgo Collaboration, Abbott BP, *et al.* (2017b) GW170817: Observation of Gravitational Waves from a Binary Neutron Star Inspiral. *Phys. Rev. Lett.* 119, 161101. DOI: 10.1103/PhysRevLett.119.161101
- LIGO Scientific Collaboration and Virgo Collaboration, Abbott BP, *et al.* (2018) Observation of a 50-Solar-Mass Binary Black Hole Coalescence at Redshift 0.2. *Phys. Rev. Lett.* 118, 221101 (2017), Erratum *Phys. Rev. Lett.* 121, 129901 (2018), American Physics Society. Retrieved: <https://arxiv.org/pdf/1706.01812.pdf>
- LIGO Scientific Collaboration and Virgo Collaboration, Abbott BP, *et al.* (2019) GWTC-1: A Gravitational-Wave Transient Catalog of Compact Binary Mergers Observed by LIGO and Virgo during the First and Second Observing Runs. *Phys. Rev. X* 9, 031040, American Physical Society DOI: 10.1103/PhysRevX.9.031040. Retrieved: <https://journals.aps.org/prx/pdf/10.1103/PhysRevX.9.031040>
- LIGO Scientific Collaboration and Virgo Collaboration, Abbott BP, *et al.* (2019a) Binary Black Hole Population Properties Inferred from the First and Second Observing Runs of Advanced LIGO and Advanced Virgo. *Astrophys. J. Lett.* 882, L24. DOI:10.3847/2041-8213/ab3800. Retrieved: <https://arxiv.org/abs/1811.12940>
- Mapelli M, Giacobbo N (2018) The cosmic merger rate of neutron stars and black holes. *Monthly Notices of the Royal Astronomical Society*, Oxford University Press, Oxford, 479/4:4391-4398. DOI: 10.1093/mnras/sty1613. Retrieved: <https://arxiv.org/abs/1806.04866>
- McKernan B, Ford KES, Bellovary J, Leigh NWC, Haiman Z, Kocsis B, Lyra W, Mac Low MM, Metzger B, O'Dowd M, Endlich S, Rosen DJ (2018) Constraining Stellar Mass Black Hole Mergers In Agn Disks Detectable With Ligo. Retrieved: <https://arxiv.org/pdf/1702.07818.pdf>
- Miller MC, Miller JM (2014) The Masses and Spins of Neutron Stars and Stellar-Mass Black Holes. *Physics Reports*, Elsevier, Volume 548, pp. 1-34. DOI:10.1016/j.physrep.2014.09.003. Retrieved: <https://arxiv.org/abs/1408.4145>
- Misner CW, Thorne KS, Wheeler JA (1973) *Gravitation*. W. H. Freeman and Company, USA. ISBN 0-7167-0334-3.
- Nakar E (2007) Short-Hard Gamma-Ray Bursts. *Phys.Rept.*442:166-236, Elsevier. DOI:10.1016/j.physrep.2007.02.005. Retrieved: <https://arxiv.org/abs/astro-ph/0701748>
- Pardo K, Fishbach M, Holz DE, Spergel DN (2018) Limits on the number of spacetime dimensions from GW170817. *Journal of Cosmology and Astroparticle Physics*, IOP Publishing. DOI:10.1088/1475-7516/2018/07/048. Retrieved: <https://arxiv.org/abs/1801.08160>

- Pirani FAE (2009) Republication of: On the physical significance of the Riemann tensor. *Gen. Relativ. Gravit.* 41:1215-1232. DOI: 10.1007/s10714-009-0787-9. *Original paper*: Pirani FAE (1956) On the physical significance of the Riemann tensor. *Acta Physica Polonica* 15, 389-405. Reprinted with the kind permission of the Editors of *Acta Physica Polonica* and of Felix Pirani.
- Preskill J, Thorne KS (1995) Foreword to Feynman Lectures on Gravitation. In: Feynman Lectures on Gravitation, Addison-Wesley, University of Michigan.
- Rampp M, Müller E, Ruffert M (1997) Simulations of non-axisymmetric rotational core collapse. Retrieved: [arXiv:astro-ph/9711122](https://arxiv.org/abs/astro-ph/9711122)
- Renn J, Blum A, Damerow P (2011) The Role of Gravitation in Physics Report from the 1957 Chapel Hill Conference Communicated by Jürgen Renn, Alexander Blum and Peter Damerow. DeWitt CM, Rickles D (eds.), *Sources* 5, Edition Open Access, Oranienstraße 183, 10999 Berlin. ISBN 978-3-86931-963-6
- Schutz BF (1999) Gravitational wave sources and their detectability. *Class. Quantum Grav.* 6(12):1761-1780. DOI: 10.1088/0264-9381/6/12/006
- Schutz BF (2012) Thoughts About a Conceptual Framework for Relativistic Gravity. In: Lehner *et al.* (eds), *Einstein and the Changing Worldviews of Physics*, *Einstein Studies* 12, The Center for Einstein Studies, pp. 259-269.
- Taylor JH, Weisberg (1982) A new test of general relativity - Gravitational radiation and the binary pulsar PSR 1913+16. *Astrophysical Journal*, The American Astronomical Society, 253/1:908-920.
- Thorne KS (1987) Three Hundred Years of Gravitation. Hawking SW, Israel W (eds), Cambridge: Cambridge Univ. Press, p. 330.
- Wang Y, Stebbins A, Turner EL (1996) Gravitational lensing of gravitational waves from merging neutron star binaries. *Physical Review Letters*, American Physical Society, 77/14:2875-2878. DOI:10.1103/physrevlett.77.2875. Retrieved: <https://arxiv.org/abs/astro-ph/9605140>
- Weiss Rainer (1972) Electronically Coupled Broadband Gravitational Antenna. *Quarterly Progress Report*, Research Laboratory of Electronics (MIT), N° 105, p. 54. Retrieved: [http://www.hep.vanderbilt.edu/BTeV/test-DocDB/0009/000949/001/Weiss\\_1972.pdf](http://www.hep.vanderbilt.edu/BTeV/test-DocDB/0009/000949/001/Weiss_1972.pdf)
- Yunes N, Yagi K, Pretorius F (2016) Theoretical Physics Implications of the Binary Black-Hole Mergers GW150914 and GW151226. DOI: 10.1103/PhysRevD.94.084002
- Zwergner T, Müller E (1997) Dynamics and gravitational wave signature of axisymmetric rotational core collapse. *Astronomy and Astrophysics*, 320:209-227. Retrieved: <http://adsabs.harvard.edu/full/1997A%26A...320..209Z>

## Web References

- Interview of Bryce DeWitt and Cecile DeWitt-Morette by Kenneth W. Ford on 1995 February 28, Niels Bohr Library & Archives, American Institute of Physics, College Park, MD USA. Retrieved: [www.aip.org/history-programs/niels-bohr-library/oral-histories/23199](http://www.aip.org/history-programs/niels-bohr-library/oral-histories/23199)
- LIGO-India proposal: [https://dcc.ligo.org/public/0075/M1100296/002/LIGO-India\\_lw-v2.pdf](https://dcc.ligo.org/public/0075/M1100296/002/LIGO-India_lw-v2.pdf)
- LISA (2019) official website: <https://www.lisamission.org/articles/lisa-mission/lisa-mission-gravitational-universe>
- The Nobel Prize in Physics 2017, NobelPrize.org. Nobel Media AB 2019. Wed. 16 Oct 2019. <https://www.nobelprize.org/prizes/physics/2017/summary/>

## Selected Additional References on the Subjects – Non-Cited in the Above Running Text

- Adair R (1987) *The Great Design: Particles, Fields and Creation*. The Oxford University Press, NY.
- Balibar F (1993) (ed) Albert Einstein, *œuvres choisies*, volume 1 : Quanta. Éditions du Seuil / Éditions du CNRS, Paris.
- Balibar F (ed) (1993) (ed) Albert Einstein, *œuvres choisies*, volume 2 : Relativités. Éditions du Seuil / Éditions du CNRS, Paris.
- Borel É (1914) *Introduction géométrique à quelques théories physiques*. Gauthier–Villars, Paris.
- Brown K (2018) *Reflections on Relativity*, lulu.com, Chap.3.2. Retrieved: <https://www.mathpages.com/rr/s3-02/3-02.htm>
- Campbell WW, Trumpler R (1928). Observations made with a pair of five-foot cameras on the light-deflections in the Sun's gravitational field at the total solar eclipse of September 21, 1922. *Lick Observatory Bulletin* 397(13):130-160.
- Damour T, Darrigol O, Duplantier B, Rivasseau V (2006) (eds) Einstein, 1905–2005. Poincaré Seminar 2005, Birkhäuser Verlag, Basel.
- Darrigol O (2006) *The Genesis of the theory of relativity* En : Damour T, Darrigol O, Duplantier B, Rivasseau V (eds) 2006, Séminaire Poincaré 1:1–22, op. cit.
- Dirac PAM (1978) *Direction in Physics*. Wiley, NY.
- Einstein A (1905a) Zur Elektrodynamik bewegter Körper, *Annalen der Physik* 17: 891
- Einstein A (1905b) Ist die Trägheit eines Körpers von seinem Energieinhalt abhängig? *Annalen der Physik* (ser. 4), 18, 639–641.  
Retrieved: <https://onlinelibrary.wiley.com/doi/epdf/10.1002/andp.19053231314>
- Einstein A (1915) Erklärung der Perihelbewegung des Merkur aus der allgemeinen Relativitätstheorie Von A. Einstein above theoretical premises. Retrieved: [http://articles.adsabs.harvard.edu/cgi-bin/get\\_file?pdfs/SPAW./1915/1915SPAW.....831E.pdf](http://articles.adsabs.harvard.edu/cgi-bin/get_file?pdfs/SPAW./1915/1915SPAW.....831E.pdf)
- Einstein A (1916) *Die Grundlage der allgemeinen Relativitätstheorie* (The Foundations of the General Theory of Relativity). *Annalen der Physik*. 49:769-822. Retrieved: <https://onlinelibrary.wiley.com/doi/abs/10.1002/andp.200590044>
- Einstein A ([1921] 2005) *Quatre conférences sur la théorie de la relativité*. [Texte de quatre conférences prononcées à l'université de Princeton en 1921] Dunod, Paris.
- Einstein A ([1934] 1983) *Comment je vois le monde*. Flammarion–Champs, Paris.
- Einstein A, Infeld L (1993) *L'évolution des idées en physique*. Flammarion–Champs, Paris.
- Einstein A (1927). Newtons Mechanik und ihr Einfluss auf die Gestaltung der theoretischen Physik, *Naturwissenschaften* 15:273–276. Trad. fr. par le Cnel Cros. La mécanique de Newton et son influence sur l'évolution de la physique théorique. En : Einstein A [1934]1983, pp. 180–193, op. cit.
- Einstein A (1956) *La théorie de la relativité restreinte et générale*. Gauthier–Villars, Paris
- Einstein A (1991) *Œuvres choisies*. Éditions du Seuil, Paris.
- Feynman R (1985) *QED: The Strange Theory of Light and Matter*. Princeton University, Princeton, NJ.
- Hawking SW, Israel W (1980) (eds) *General relativity. An Einstein centenary survey*. The Cambridge University Press, Cambridge.
- Holton G (1988) *Thematic Origins of Scientific Thought: Kepler to Einstein*. The Harvard University Press, Cambridge–MA.
- Kepler J ([1606] 1859) *De stella nova in pede Serpentarii* [Prague, Ex Officina calcographica Pauli Sessii]. *Opera Omnia*. Vol. II, Frankofurti et Erlangae [see also: KGW, I, pp. 147-292].
- Kepler J (1596) *Prodromus dissertationum cosmographicarum seu mysterium cosmographicum*. In KGW, I.

- Kepler J (1609) *Astronomia Nova ΑΙΤΙΟΛΟΓΕΤΟΣ seu phisica coelestis tradita de commentariis de motibus stellae Martis ex observationibus G. V. Tychonis Brahe*. In KGW, III.
- Kepler J (1618–1621) *Epitome astronomiae copernicanae*. In KGW, VII.
- Kepler J (1621) *Mysterium Cosmographicum (editio altera)*. In KGW, VIII.
- Kepler J (1624) *Chilias logarithmorum ad totidem numeros rotundus, praemissa demonstratione legitima ortus logarithmorum eorumque usus*. In KGW, IX, pp. 275–352.
- Kepler J (1625) *Supplementum chiliadis logarithmorum, continens praecepta de eorum usu*. In KGW, IX, pp. 353–426.
- Kepler J (1981) *Mysterium Cosmographicum (The Secret of the Universe)*. Abaris Book, New York.
- Kepler J (1992) *New Astronomy*. Translation of *Astronomia Nova* by William H. Donahue. The Cambridge University Press, Cambridge.
- Kepler J (1993) *Le Secret du monde*. Gallimard, Paris.
- Kepler J (2010) *Kurze Darstellung der kopernikanischen Astronomie*. Nachwort von Eberhard Knobloch. Deutsche, Übersetzung von Eberhard Knobloch und Otto und Eva Schönberger. Königshausen & Neumann. Würzburg.
- Kepler J (1937–2012) *Johannes Kepler, Gesammelte Werke*. Van Dyck W, Caspar M. et al. (eds.). Revised April 2013. 10 Vols. Deutsche Forschungsgemeinschaft und Bayerische Akademie der Wissenschaften. Beck'sche Verlagsbuchhandlung, München.
- Kragh H, Marage P, Vanapaemel G (2002) (eds) *The history of Modern Physics*. Brepols, Liège.
- Lämmerzahl C, Neugebauer G (2001) *The Lense-Thirring Effect: From the Basic Notions to the Observed Effects*. Lecture Notes in Physics book series Vol. 562.
- Lecat M (1924) *Bibliographie de la relativité*. Lamertin, Bruxelles.
- Lense J, Thirring H (1918) *Über den Einfluss der Eigenrotation der Zentralkörper auf die Bewegung der Planeten und Monde nach der Einsteinschen Gravitationstheorie*. *Physikalische Zeitschrift* 19/156-63.
- Lorentz HA, Einstein A, Minkowski M, Weyl H (1923) *The principle of relativity*. A collection of original memoirs on the special and general theory of relativity. Dover, NY.
- Max Born M ([1923] 2003) *La théorie de la relativité d'Einstein et ses bases physiques*. Gabay, Paris.
- Nagel E (1961) *The Structure of Science: Problems in the Logic of Scientific Explanation*. Harcourt–Brace & World Inc, New York.
- Neil Ashby N (2002) *Relativity and the Global Positioning System*. *Physics Today* 55/5:41–47.
- Newton I ([1713], 1729) *The Mathematical principles of natural philosophy*. Translated by Motte Andrew. Motte B, London.
- Newton I ([1726; 1739–1742], 1822), *Philosophiae Naturalis Mathematica Principia, auctore Isaaco Newtono, Eq. Aurato, perpetuis commentariis illustrata, communi studio Pp. Thomae Le Seur et Francisci Jacquier ex Gallicana minimorum familia, matheseos professorum*. Editio nova (in three volumes). Duncan, Glasgow.
- Newton I (1687) *Philosophiae Naturalis Principia Mathematica*. Imprimatur S. Pepys, Reg. Soc. Preses. Julii 5. 1686. Londini, Jussi Societatus Regiae ac Typis Josephi Streater. Prostat apud plures Bibliopolas. Anno MDCLXXXVII.
- Pais A (2005) *Albert Einstein – Sa vie, son œuvre*, Interéditions. Dunod, Paris.
- Paty M (2004) *Albert Einstein, ou la création scientifique du monde*, Belles Lettres, Paris.
- Paty M (1979) *Sur le réalisme d'Albert Einstein*. *La Pensée* 204:18–37.
- Paty M (1999) *La création scientifique selon Poincaré et Einstein*. En : Serfati M (ed) *La recherche de la vérité* : Coll. « L'Écriture des Mathématiques », ACL–Éditions du Kangourou, Paris, pp 241–280.
- Paty M (2003) *La physique du XXe siècle*. EDP Siences, Les Ulis.
- Penrose R (2004) *The Road to Reality. A complete guide to laws of the universe*. Knopf, NY.

- Pisano R (2008) A history of the chemistry à la Koyré? Introduction and setting of an epistemological problem. *Khimiya* 2/17:143–161.
- Pisano R (2009) On method in Galileo Galilei's mechanics. In Hunger H (ed.), *Proceedings of 3<sup>rd</sup> Congress of the European Society for the History of Science*. The Austrian Academy of Science, Vienna, pp. 174–186.
- Pisano R (2011) Physics–Mathematics Relationship. Historical and Epistemological notes. In Barbin E, Kronfellner M and Tzanakis C (eds.), *Proceedings of the ESU 6 European Summer University History And Epistemology in Mathematics*. Verlag Holzhausen GmbH–Holzhausen Publishing Ltd., Vienna, pp. 457–472.
- Pisano R (2013a) History Reflections on Physics Mathematics Relationship in Electromagnetic Theory. In Barbin and Pisano 2013, pp. 31–58.
- Pisano R (2014) (ed.) *Isaac Newton and his Scientific Heritage: New Studies in the History and Historical Epistemology of Science*. Special Issue. *Advances in Historical Studies* 3/3.
- Pisano R (2016a) What kind of Mathematics in Leonardo da Vinci and Luca Pacioli? *Bulletin–British Society for the History of Mathematics* 31:104–111.
- Pisano R (2016b) A Development of the Principle of Virtual Laws and its Framework in Lazare Carnot's Mechanics as Manifest Relationship between Physics and Mathematics. *Transversal–International Journal for Historiography of Science*, 2:166–203.
- Pisano R, Bussotti P (2012) Galileo and Kepler: On Theoremata Circa Centrum Gravitatis Solidorum and Mysterium Cosmographicum. *History Research* 2/2:110–145.
- Pisano R, Bussotti P (2013) Notes on the Concept of Force in Kepler. In Pisano, Capecchi and Lukešová 2013, pp. 337–344.
- Pisano R, Bussotti P (2014a) Galileo in Padua: architecture, fortifications, mathematics and “practical” science. *Lettera Matematica Pristem International* 2/4:209–221.
- Pisano R, Bussotti P (2014b). Historical and Philosophical Reflections on the Culture of Machines around the Renaissance. How Science and Technique Work? *Acta Baltica Historiae et Philosophiae Scientiarum* 2/2:20–42.
- Pisano R, Bussotti P (2015a) Historical and Philosophical Reflections on the Culture of Machines around the Renaissance: Machines, Machineries and Perpetual Motion. *Acta Baltica Historiae et Philosophiae Scientiarum* 3/1:69–87.
- Pisano R, Bussotti P (2015b) Introduction to Exploring Changes in How the Histories of the Exact Sciences from the 18th to through the 20th Century Have Been Written: Interpreting the Dynamics of Change in these Sciences and Interrelations Amongst Them—Past Problems, Future Cures? *Advances in Historical Studies Special Issue* 4/2:65–67.
- Pisano R, Bussotti P (2016) A Newtonian Tale Details on Notes and Proofs in Geneva Edition of Newton's *Principia*. *Bulletin–British Society for the History of Mathematics* 32:1–19.
- Pisano R, Capecchi D (2013) Conceptual and Mathematical Structures of Mechanical Science in the Western Civilization around 18th Century. *Almagest* 4/2:86–121.
- Pisano R, Capecchi D (2015) Tartaglia's science weights. *Mechanics in sixteenth century*. Selection from *Quesiti et invention diverse: Books VII–VIII*. Dordrecht, Springer.
- Pisano R, Capecchi D, Lukešová A (eds.) (2013) *Physics, Astronomy and Engineering. Critical Problems in the History of Science*. International 32nd Congress for The SISFA–Italian Society of Historians of Physics and Astronomy. The Scientia Socialis UAB & Scientific Methodical Centre Scientia Educologica Press, Šiauliai University, Lithuania.
- Pisano R, Fichant M, Bussotti P, Oliveira ARE (2017) (eds.) *Leibniz and the Dialogue between Sciences, Philosophy and Engineering, 1646–2016*. New Historical and Epistemological Insights. The College Publications, London.
- Pisano R, Gaudiello I (2009a) Continuity and discontinuity. An epistemological inquiry based on the use of categories in history of science. *Organon* 41:245–265.
- Pisano R, Gaudiello I (2009b) On categories and scientific approach in historical discourse. In Hunger H (ed.) *Proceedings of ESHS 3rd conference*. The Austrian Academy of Science, Vienna, pp. 187–197.

- Pisano R, Casolaro F (2011–soumis) Historical Inquiring On Geometry In Relativity. A Geometry Model (Part II) [CFV Cahiers]
- Poincaré HJ (1900a) Les relations entre la physique expérimentale et la physique mathématique. *Revue générale des sciences pures et appliquées* 11:1163–1175.
- Poincaré HJ (1900b) La théorie de Lorentz et le principe de réaction, *Archives néerlandaises des sciences exactes et naturelles* 5:252–278.
- Taylor EF, Wheeler JA (1992). *Spacetime Physics: Introduction to Special Relativity*. W. H. Freeman. ISBN 978-0-7167-2327-1.
- Thirring H (1918) Über die Wirkung rotierender ferner Massen in der Einsteinschen Gravitationstheorie. *Physikalische Zeitschrift* 19, 33.
- Treschman KJ (2015) Recent astronomical tests of general relativity. *International journal of physical sciences*, Vol. 10(2), pp. 90-105. DOI: 10.5897/IJPS2014.4236
- Virgo Collaboration, Acernese *et al.* (2019) Increasing the Astrophysical Reach of the Advanced Virgo Detector via the Application of Squeezed Vacuum States of Light. *Phys. Rev. Lett.* 123, 231108. DOI:<https://doi.org/10.1103/PhysRevLett.123.231108>
- Whittaker ET (1953) The relativity theory of Poincaré and Lorentz. En: *A History of the theories of aether and electricity*. Vol 2: The modern theories 1900–1926. Nelson, London, pp. 27–77.
- Will CM (2015) Focus issue: Gravity Probe B. *Classical and Quantum*. IOP. 32 (22):220301.
- Wolfgang R (2001) *Relativity: special, general and cosmological*. The Oxford University Press, Oxford.
- Zahar E (1987) Les fondements des mathématiques d'après Poincaré et Russell. *Fundamenta Scientiae* VIII 1987:31–56.
- Zahar E (1989) *Einstein's Revolution: A Study in Heuristic*. The Open Court Publishing Company, Chicago.





## CHAPTER V

### **Gravitational Waves: A History of Science & Technology in Society**

*An Outline.* This part of the thesis I discuss the innovation in new collaborative approaches to doing science, but also the principles and the development of recent technological advances, and I explore the history of cosmology's main ideas and results and its impact on the notions and conceptions of the universe.

Finally, the future of gravitational wave astronomy as a new era of cosmology through the establishment of a network of detectors able to detect gravitational waves of the major parts of the gravitational wave spectrum will be discussed.

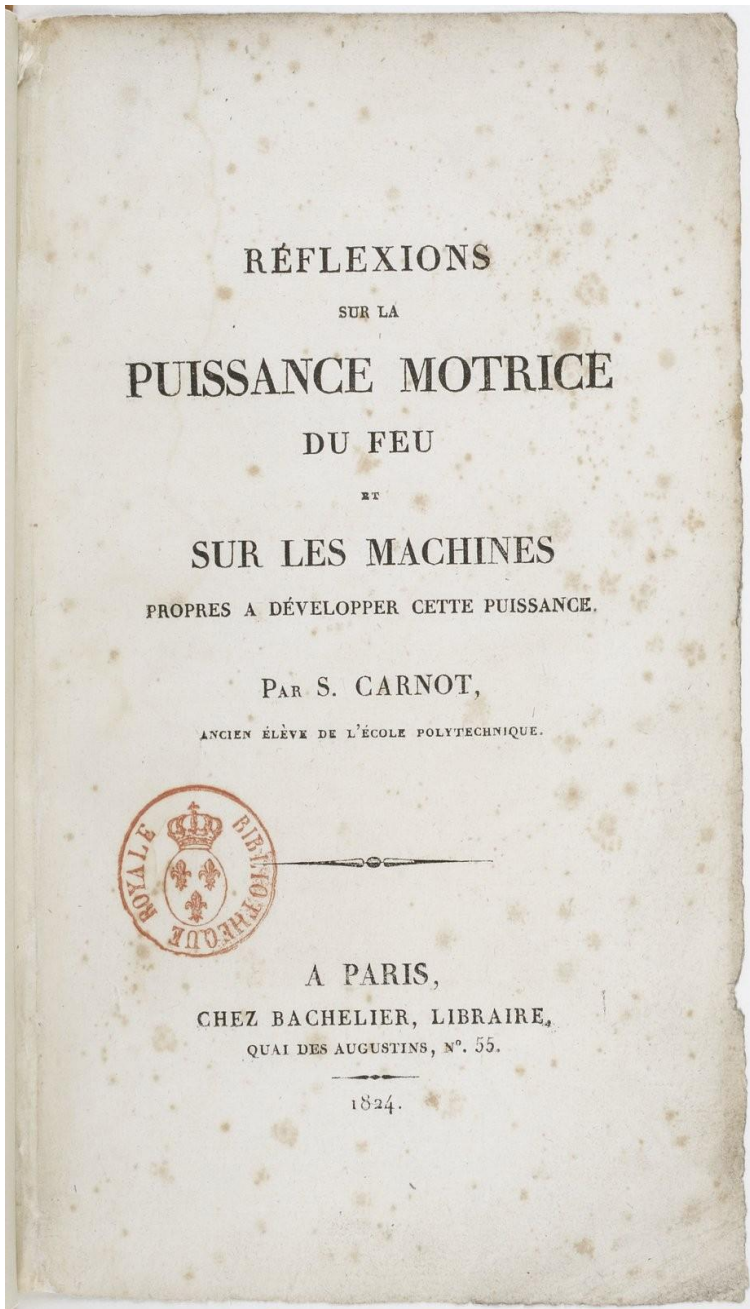
## 5.1 The Research: A New Collaborative Inquiring Approaches

Science and technology are without a doubt among the most potent forces driving human development. Furthermore, over the course of centuries it became more and more evident that science and technology have an interrelationship with their social, economic, and political contexts. This is especially obvious when considering the developments that happened during the last century with notably the impact of scientific research done both before and during times of social–economic–political crisis. Indeed, the development of science was not only done by a continuous effort to build on prior knowledge and results motivated by curiosity; but it was also pushed forward by innovation. For instance, this relationship between science and society can be easily illustrated by numerous examples such as the birth of planes from their creation to their development through aeronautics and related scientific fields which was definitely stimulated by military applications; the invention of radio; the elaboration and polio vaccination campaign; the Space Race between the USSR and the United States during the Cold War; and so forth.

At the end of the day science and technology shape our existence, both on an individual level and for humanity as a whole by defining what it is possible to do and how to accomplish things. This is thanks to the explanatory power of scientific models and theories and the structures they rely on, i.e. the organization of science, research, scientific institutions and communities on one hand but also communications, energy, transportation, and technological infrastructures on the other.

Historically, science started with both practical needs –such as quantifying and counting for trading purposes, dividing lands and territories, making architectural plans or blueprints, and so forth–, and with philosophical needs –such as finding explanations for physical phenomena or justifying religious beliefs–; while technical work or technology are arguably purely the result of practical needs in the first place –think of the first ever tools which were used: sticks and stones. Nevertheless, beyond these kinds of simple tools with basic uses, the development of science stimulated the development of technologies and vice versa. Indeed, the study of natural phenomena through the scope of mathematics and notably geometry produced a new discipline called natural philosophy which is nowadays called physics (Pisano 2009).

Furthermore, this led to the development of a new scientific approach with applied disciplines and the creation of machines, machineries and their own disciplinary field with the science of machines (Pisano 2014b, 2015a). This approach exposed the relationship between science and machines through their construction and their study; perhaps best exemplified by Sadi Carnot (1796–1832) and his *Reflexions sur la puissance motrice du feu et sur les machines propres à développer cette puissance* of 1824 (Cfr. Figure below; Carnot 1824).



Source gallica.bnf.fr / Bibliothèque nationale de France

**Fig.5.1.** Sadi Carnot's 1824 *Réflexions sur la puissance motrice du feu et sur les machines propres à développer cette puissance*, Frontispice. Source: Gallica, Public Domain | <https://gallica.bnf.fr/ark:/12148/btv1b86266609/f11.image>.

Far from its beginning when some very talented individuals were single-handedly responsible for great scientific advancements and paradigm shifts in their contemporary scientific community, and who are nowadays often referred to as geniuses or the greatest minds of their era and the likes; more recently, science is a not just work, but a professional career. As such, and because of the organization of science and research within scientific institutions and communities, the development of science and its advances are definitively socially and societally determined. Indeed, the time when isolated individuals make significant major discoveries, especially theoretical ones triggering paradigm shifts, appears to be over.

This matter of fact can be explained by the professionalization of the status of scientists and researchers, which includes information monitoring and reading publications in order to stay up to date, elaborating a research project, gathering interest and resources, conducting research, producing results and presenting them in convincing communications for peer-review, and so forth. Through these activities they become a sort of highly trained and qualified employee of institutions such as universities, laboratories and departments. From this follows that contemporary science is a collaborative effort and as such, by definition, a social endeavour. Therefore, it is no surprise that scientific work is associated with and revolves around notions such as scientific knowledge, scientific culture, scientific practices and methods, and so forth. Moreover, in our information age, scientists are also subject to societal problems and are expected to know and present solutions on how to solve them, irrespective of whether these problems are of an economic, environmental, or social nature.

Furthermore, the argument that science is necessarily social in nature has many implications. First of all, on an individual basis, this implies that being a scientist –or even merely scientifically educated– is associated with a specific social status: scientists are expected to have received a special kind of education and to have been trained in a specific way in order for them to be able to make observations and extract the truth from reality.

This has the consequence of making them appear as the holders of a certain authority and/or wisdom that only they possess, as long as they are not associated with the stereotypical image of the misunderstood genius; or even worse with the mad or evil scientist (Haynes 2003). In turn, science is certainly shaped by scientists whose knowledge, methods, practices and disciplinary culture are based on logics and evidence, but also influenced by their interactions.

Therefore, it seems logical that applied scientific knowledge grows in directions largely guided by socio-economic research interests, while fundamental research is much more unrestricted in this way. Indeed, when considering the allocation of resources and funding, applied research is preferred over fundamental research as the former has the potential of making a return on a short or medium term basis, compared to a long term return, if any, with fundamental research.

However, we have to recognize that the socio-cultural and political contexts play a significant role on the actors involved in research and innovation; and by extension on the expectations and perspective of society. Indeed, as scientific knowledge grows, so do expectations and in turn, these expectations act akin to roadmaps organizing research priorities and often explicating milestones to attain. Some immediate examples come to mind thanks to the media and science communications or pop culture –especially science fiction–: for instance, the research and development of artificial intelligence and artificial neural networks and their development and integration in the industry with self-driving cars; the research and development of fusion reactors revolving around the problematic of the environment and renewable energy; or more recently, the impact of the coronavirus – COVID 19– crisis which led to the commitment of €137.5 million in funding research and development projects<sup>111</sup>; and so forth. This being justified by the expectation that investing in research will lead to greater capabilities in particular for quality of life, health and security.

Furthermore, the organization of research in different scientific fields, also shapes how investments, and the gathering and sharing of resources is done. Indeed, it follows from this that certain specializations are much more attractive for investors than others, and therefore get better funding.

Additionally, beside the understandable fact that research with immediate, concrete applications usually gets more funding, whether from public or private sources, this can lead to ethical problems for the researchers as this situation can bring conflicts of interest; conversely, this can also put pressure on the researchers to favour some kind of research over another or otherwise.

However, there is also an upside in regards to great funding of particular areas of research; in particular with the rise of Big Science and Big Data. Indeed, the strategies employed for this category of research has the advantage of centralizing resources for a common goal; and thus allows for greater scientific structures and greater equipment, devices, instruments or other apparatus that would be otherwise out of reach of smaller groups whether because of the price of acquisition or because of technical challenges involved in their development. Some examples of this are large collaborations such as, of course, the LIGO-Virgo Collaboration, but also the HL-LHC Collaboration, the Planck Collaboration, the Human Brain Project, and many others. It is important to note that such big scientific structures are multidisciplinary and international; and furthermore some of them also rely on the general public.

This is especially the case for collaborations involving volunteers from the general public through the scope of citizen science, which is designed as a context in which scientific research is partially done by non-professional scientists; in fact their scientific work is undertaken in concert with professional scientists and institutions. For example: “Planet Hunters” which was a citizen science project that aimed to find exoplanets, now part of the

---

<sup>111</sup> Cfr. <https://www.nature.com/articles/s41564-020-0768-z>

zooniverse.org platform for people-powered research or “Foldit” which is a gamified application for protein folding research.

As these kinds of initiatives are more and more present, the scientific communities involved are able to transmit their cognitive framework, vocabulary, perspectives, methods, techniques, and expectations. Therefore, through these interactions, the gap between scientists and non-scientists closes more and more. Indeed, in such context, the citizens are made aware of the impact of their contribution to the advances of science, as well as the science and stakes behind the initiative or the project.

This in turn influences both society as a whole, but primarily scientific organization and politics, as it is now demonstrated that some of the public is interested in helping the scientific community and therefore that under certain situations, scientists can delegate some of its workload to good-willed people.

In fact, societies make themselves not only through knowledge but also through the design, construction, and use of material devices, infrastructures and practices of science and technology. Furthermore, these types of large collaborations legitimize the activities of scientists while also providing inspiring challenges and narratives promising a better future.

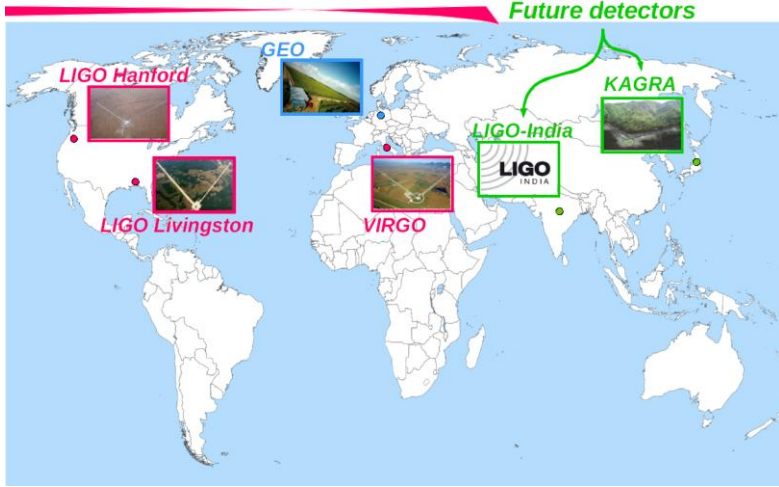
In fact, these narratives and the expectations associated with them are without a doubt a great driving force for technological and social advancement, whether the expectations are positive or negative, e.g. curing a disease, an upcoming environmental catastrophe, and so forth.

## **5.2 Science & Technologies: New Devices to Detect**

The development of science and the development of technologies evidently go together. Therefore, it is of no surprise to see that the recent discovery of gravitational waves led to new ideas, new models and innovations in order to improve our understanding of the phenomena.

Nowadays, gravitational wave detection is essentially done with interferometers or by indirect detection.

## GW detectors network



**Fig. 5.2.** Map of the gravitational waves detectors network. Source: Courtesy of Julia Casanueva.

However, new ideas, tools, techniques, and measurements have been and are continuously developed.

Among those are:

- From Quantum metrology, is the investigation of the use of a Bose-Einstein condensate (BEC) as a high frequency gravitational wave detector (Robbins 2019). Indeed, it has been showed that small spacetime distortions can produce phononic<sup>112</sup> excitations in a BEC that could be used for gravitational wave detection (Sabin 2014);
- The experimental proof of the theoretical bypassing of the standard quantum limit (SQL) –the limit to the precision with which the position of an object can be measured continuously– by measurements done with the Advanced LIGO mirrors (Yu 2020);
- The use of gravitational waves to determine the composition of the core of Neutron Stars (Chatziioannou 2020)
- The use of artificial neural networks in order to detect continuous gravitational waves from BNS in real-time (Dreissigacker 2020; Krastev 2020)
- A study of the image formation process within an Einstein ring produced from the Sun’s gravitational lensing effect for potential use for exoplanets research –the solar gravitational lens (SGL)–. (Turyshev 2020)

---

<sup>112</sup> A phonon is the analogous elementary vibrational motion counterpart to a photon (Simon 2013, p. 82).

### 5.3 The Universe in Society: a Revolutionary Change of View

Cosmology is the study of the Universe; it is probably as old as mankind with the first myths of the conceptions of the world and the universe. Cosmology has been revolutionized many times from the religious cosmogonic myths to nowadays and our current understanding of the Universe. Indeed, since mankind looked up to the sky and wondered about its place in the world, several attempts to explain the origin of the universe have been made, among which the most commonly well-known are the ones of the major religions.

Nevertheless, with the advances in science, the readers will be certainly most familiar with certain milestones reached during the development of Cosmology as we understand it today; namely that the Earth was considered to be flat until Antiquity and the Greeks understood that it was actually more like a globe; that the Earth was the centre of the Universe and that the other celestial bodies, like the Sun and the Moon, were revolving around it, until Copernicus; and so forth.

In this type of context, the place of humanity in the world and the conceptions of the origins of the universe, it is no surprise that this type of questioning impacted society; beyond the scientific nature invoked there are philosophical, spiritual and religious implications that necessarily influenced –and are still influencing– society and its development. Indeed, while it had always been rather dangerous to express views diverging from the general consensus, it was especially dangerous to oppose religious entities. However, although it would be pleasant and comforting to think that such things belong to the past and that science prevailed, we are unfortunately forced to recognize that even contemporarily there are a number of vestiges of old philosophies, superstitions and conceptions that have survived and are still thriving, despite their blunt defiance of logic; for example: Astrology and the Modern flat Earth societies. Though, Science and Religions are not necessarily incompatible in the sense that we should distinguish an important difference between the two: which is that they differ by the very nature of the questions they ask. More specifically, Religions give explanatory reasons for *Why* things happen while Science is charged with answering questions about *How* things happen.

In the end, Cosmology is mainly an observational science –since the actual objects studied are for the major part too far away to experiment on– and as such it is heavily dependent on the tools available to scientists and their precision to confirm or refute cosmological and astrophysical theories.



*Observational Cosmology.* Advances in Cosmology relied on both theoretical discoveries and technological inventions. In particular, thermodynamics, Quantum Mechanics and General Relativity, and the invention of telescopes, spectroscopy, the measurement of parallaxes of stars and the invention of photography to record images. Indeed, while key concepts evolved from naked eye observations of the first astronomers who noticed that certain stars had quite peculiar motions, planets, contrary to the rest of the stars which were fixed (Ferne 1970, p. 1190) in their relative position on the celestial sphere, which led to the different planetary models, it was nevertheless the invention of the telescope, which allowed an artificial extension of vision, that enabled the understanding that most of the stars in the sky were actually celestial bodies akin to the Sun, but seen from very far away. This invention almost single-handedly gave the final blow to the anthropocentric view of the Universe in which the Earth is located at its centre.

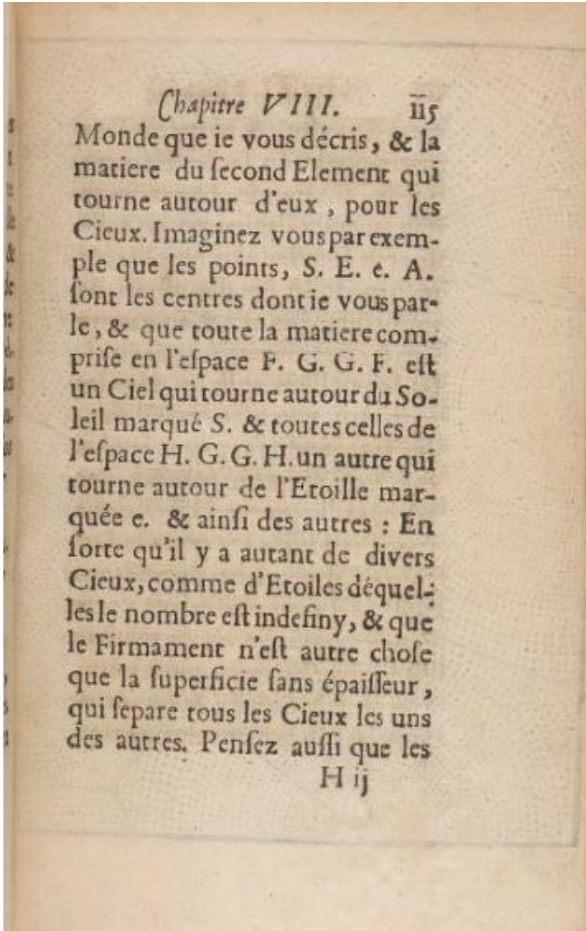
Actually, it is notably thanks to this –at the time– new instrument that Galileo Galilei (1564-1642) and Johannes Kepler (1571-1630), who figured out the mathematical relationship between the movements of planets on their orbits, were able to lay an exploitable basis for Isaac Newton's (1643-1727) Theory of Gravitation. Since then, the refinement of telescopes, lenses and mirrors have been improved again and again up to almost unconceivable precisions. Much of the technological developments that were ultimately very beneficial to Cosmology were in fact done by military initiatives. (Longair 2001, p. 67)

In particular for radio astronomy, which was started by Karl Guth Jansky (1905-1950; 1933; Longair 2001), the Second World War and following decades made the importance of radio communications and radar technology apparent, and that therefore there was a critical need for improving radio technology. Thus, thanks to military funding, the technology for radio astronomy greatly improved. Furthermore, for Ultraviolet, X-rays, gamma rays, since the atmosphere is opaque to radiation with wavelengths shorter than 330 nm which implies that observations had to be done from space, the race to space that happened during the Cold War, and the development of surveillance projects meant to detect nuclear activity, greatly profited astronomy and therefore Observational Cosmology too.

In fact the whole of the electromagnetic spectrum became available for astronomical observation and completely new approaches to the determination of cosmological parameters and the origin of structure in the Universe became possible.

*From Galactic to extragalactic astronomy.* Until the development of telescopes, the first cosmologies of the modern era had to be speculative. Among the most well-known of these is Descartes' model (Descartes 1664; cfr. Figures 5.3.a & b) and the concept of "island Universe" probably originating from Immanuel Kant (Ferne 1970, p. 1192) who postulated that they were separate "worlds" similar to ours i.e. the Milky Way galaxy; but

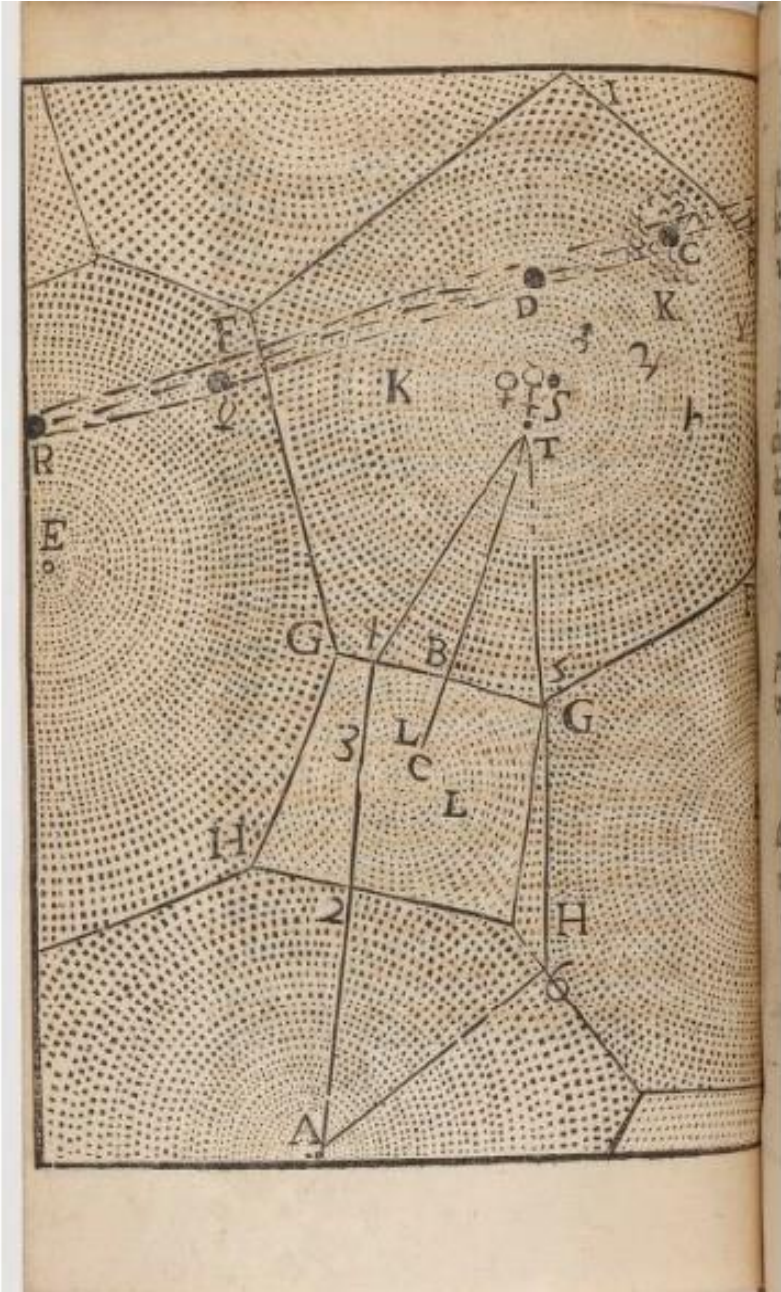
also Thomas Wright’s (1711-1786) *An Original Theory or New Hypothesis of the Universe* of 1750 (Wright 1750; cfr. Figure 5.3.c.) and William Herschel’s (1738-1822) contributions (Fernie 1970, p. 1191-1192).



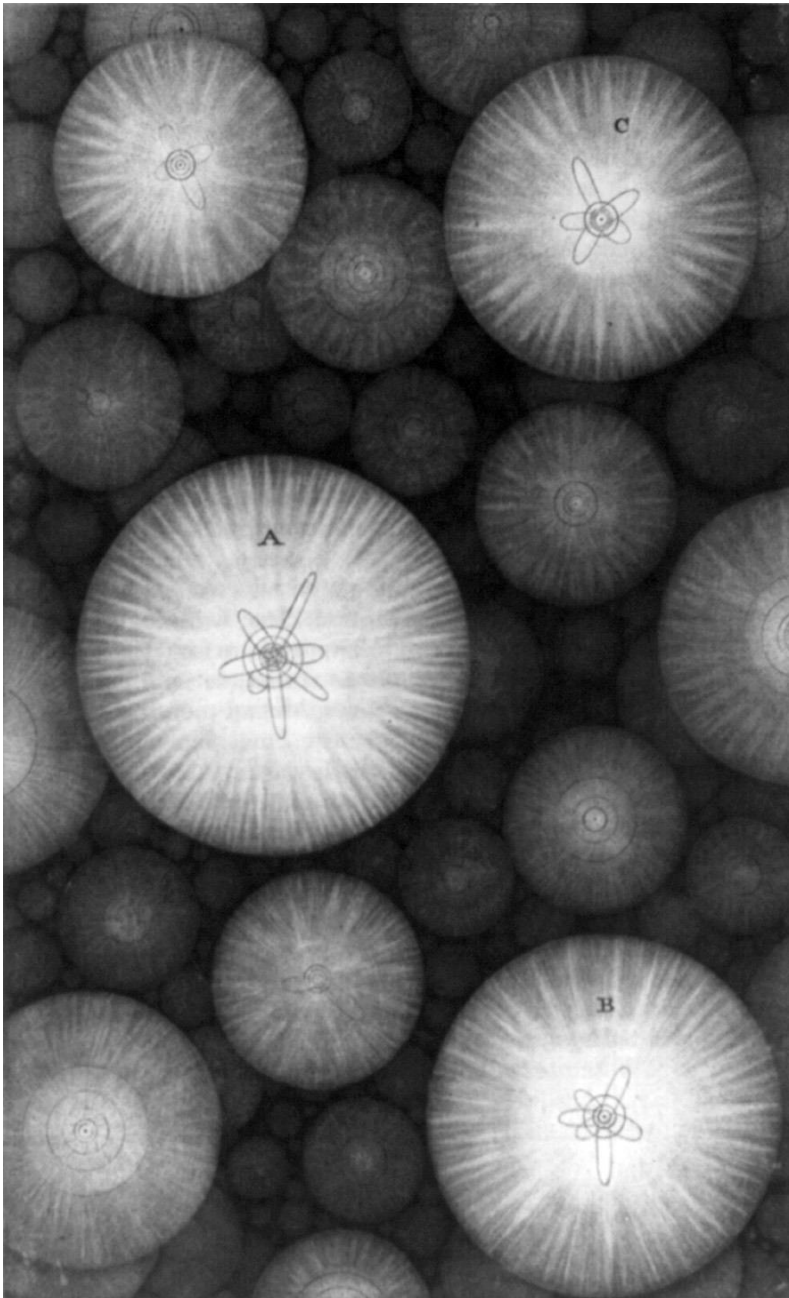
[...] Imagine for example that the points, S. E. e. A. are the centers I am talking about, & that all the matter included in the FGGF space is a Sky which revolves around the Sun marked S. & all those in the HGGH space another which revolves around the marked Star e. & so on: So that there are as many different Heavens, as there are Stars of which the number is indefinite, & that the Firmament is nothing other than the surface without thickness, which separates all the Heavens from one another. other. [...] (Descartes 1664, p. 115 – Translation by PV)<sup>113</sup>

**Fig. 5.3.a.** Le Monde de M. Descartes, ou le Traité de la lumière et des autres principaux objets des sens, page 115. Source: Gallica, Public Domain | <https://gallica.bnf.fr/ark:/12148/btv1b8601516f/f135>

<sup>113</sup> [...] Imaginez vous par exemple que les points, S. E. e. A. sont les centres dont je vous parle, & que toute la matière comprise en l’espace F. G. G. F. est un Ciel qui tourne autour du Soleil marqué S. & toutes celles de l’espace H. G. G. H. un autre qui tourne autour de l’Etoile marquée e. & ainsi des autres : En sorte qu’il y a autant de divers Cieux, comme d’Etoiles déquelles le nombre est indefiny, & que le Firmament n’est autre chose que la superficie sans épaisseur, qui separe tous les Cieux les uns des autres. [...] (Descartes 1664, p. 115)



**Fig. 5.3.b.** Le Monde de M. Descartes, ou le Traité de la lumière et des autres principaux objets des sens, page 115. Source: Gallica, Public Domain | <https://gallica.bnf.fr/ark:/12148/btv1b8601516f/f136>

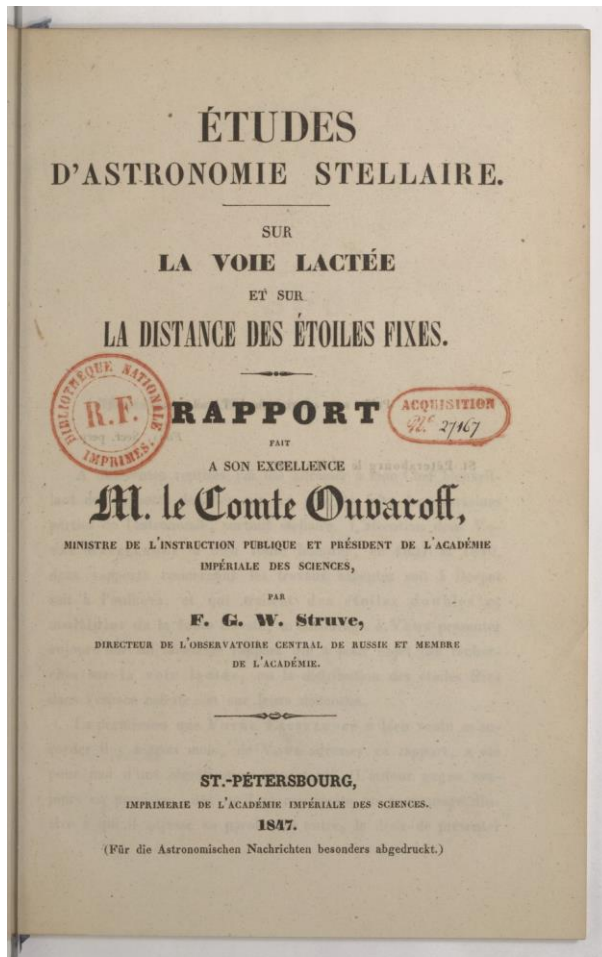


**Fig. 5.3.c.** Illustration of groups of stars, from An original theory or new hypothesis of the Universe, plate XVII. Source: Library of Congress, Public Domain | <http://loc.gov/pictures/resource/cph.3b18348/>

Furthermore, Longair notes:

The problem with these early cosmologies was that they lacked observational validation. When these ideas were put forward, the only star whose distance was known was the Sun. The first parallax measurements of stars were only made in the 1830s by Friedrich Bessel, Friedrich Georg Wilhelm Struve and Thomas Henderson.

The first quantitative estimates of the scale and structure of the Universe were made by William Herschel in the late 18th century. Herschel's model of the large-scale structure of the Universe was based upon star counts and provided the first quantitative evidence for the "island universe" picture of Wright, Kant, Swedenborg and Laplace. (Longair 2004, p. 2)



Source gallica.bnf.fr / Bibliothèque nationale de France

**Fig.5.3.d.** Sur la voie lactée et sur la distance des étoiles fixes : études d'astronomie stellaire, Frontispice (Struve 1847). Source: Gallica, Public Domain | <https://gallica.bnf.fr/ark:/12148/bpt6k42203426/f7>

des distances relatives, p. 81, nous conduit finalement à un tableau des parallaxes et des distances linéaires des étoiles, selon les différentes classes de grandeur apparente. Nous exprimerons toutes les distances par le rayon de l'orbite que décrit la Terre autour du Soleil, et nous ajouterons le temps qu'emploie la lumière pour venir de la distance respective des étoiles jusqu'à l'œil de l'habitant de la Terre. Pour plus de commodité, nous remplacerons dans ce tableau les rayons des sphères successives par les distances des étoiles intermédiaires entre deux grandeurs, exprimées en nombres entiers, de sorte que la distance d'une étoile de la grandeur apparente = 1,5 est égale au rayon qui renferme toutes les étoiles de première grandeur, la distance d'une étoile de la grandeur 2,5 égale au rayon de la sphère qui sépare les étoiles de deuxième et de troisième grandeur, et ainsi de suite. Les grandeurs exprimées en nombres entiers se rapporteront par conséquent à la distance moyenne des étoiles de chaque classe.

**Tableau des parallaxes et des distances linéaires des étoiles au Soleil.**

Grandeur apparente.	Parallaxe.	Distance exprimée en rayons de l'orbite terrestre.	Temps, qu'emploie la lumière, pour venir de cette distance jusqu'au Soleil. Années Jules.
1A.	0,203	986000	15,5
1,5A.	0,166	1246000	19,6
2A.	0,115	1778000	28,0
2,5A.	0,093	2111000	33,3
3A.	0,075	2725000	43,0
3,5A.	0,065	3151000	49,7
4A.	0,054	3850000	60,7
4,5A.	0,047	4375000	69,0
5A.	0,037	5378000	84,8
5,5A.	0,031	6121000	96,6
6A.	0,027	7616000	120,1
6,5A.	0,024	8746000	137,9
6,5B.	0,025	8100000	127,7
7,5B.	0,014	14230000	224,5
8,5B.	0,008	24490000	386,3
9,5B.	0,006	37200000	586,7
H. + 0,5.	0,00092	224500000	3544,0

**Fig.5.3.e.** Sur la voie lactée et sur la distance des étoiles fixes : études d'astronomie stellaire, p. 106 (Struve 1847). Source: Gallica, Public Domain | <https://gallica.bnf.fr/ark:/12148/bpt6k42203426/f114>

Nonetheless, these speculations, works and measurements formed the background that culminated in the “Shapley–Curtis Debate”, or the “Great Debate” (Hetherington 1967; Trimble 1995) on whether there was only one stellar universe or on the contrary a great number of “island universes” similar to our own which took place on April 26, 1920; and which was later settled notably thanks to the work of Edwin Hubble (1889-1953). Indeed, Donald Fernie (1933-) wrote:

The settlement came almost five years later. On New Year’s Day, 1925, in a paper to the American Astronomical Society meeting in Washington, D. C., Edwin Hubble announced the discovery of cepheids in M31 and M33. It was, ironically, Shapley’s own period-luminosity relation which, when applied to these cepheids, showed them to be at such great distances that there could no longer be any doubt that their parent nebulae truly were galaxies (Hubble 1925). (Fernie 1970, p. 1125-1126)

Actually, Hubble did not just prove the existence of galaxies (Hubble 1925), but made other great contributions to Astronomy and Cosmology. Indeed, in 1929 working with Milton Humanson (1891-1972) on spectroscopy, he found that the light from galaxies moving away from the Earth had longer wavelengths than expected and that all galaxies seemed to be moving away from us (cfr. Hubble 1929, 1931) which eventually led to the conclusion that the universe was expanding. The Hubble constant  $H$ , represents the relationship between distance and rate of recession– and the Hubble-Lemaître law:

$$v = H_0 d \quad (5.1)$$

where  $v$  is the recessional velocity –the rate at which an extragalactic astronomical object recedes from an observer because of the expansion of the universe–,  $H_0$  Hubble’s constant at present time, and  $d$  the physical distance.<sup>114</sup>

It is important to note that nowadays the value of this constant is subject to discrepancies and is subject to much debate at present. For instance, using different methods to measure it yields different results, e.g. “[Using TRGB stars] the most recent local measurement is  $H_0 = 74.22 \pm 1.82$  km/sec/Mpc”; and “by detail modeling of the Cosmic Microwave Background peak structure. This procedure yields a value  $H_0 = 67.4 \pm 0.5$  km/sec/Mpc (Jeong 2020)”.

Besides, the discovery and development of spectroscopy by Joseph von Fraunhofer (1787-1826) also played a critical role for Cosmology. Indeed, Fraunhofer interested himself in the solar spectrum and noticed dark lines in its spectrum (cfr. figure below) which he labelled “in order from red to violet, A, a, B, C, D, b, E, F, G, H, F” (Leitner 1975, p. 62).

---

<sup>114</sup> Cfr. <https://starchild.gsfc.nasa.gov/docs/StarChild/questions/redshift.html>

Furthermore:

He found that these dark lines always appear in the same pattern, regardless of the dispersing material, and regardless of whether the heliostat is pointed at the sun, the moon or the planets; but that the spectra of a few of the brightest stars observed by him contained dark lines at entirely different positions in the continuum. (Leitner 1975, p. 62)

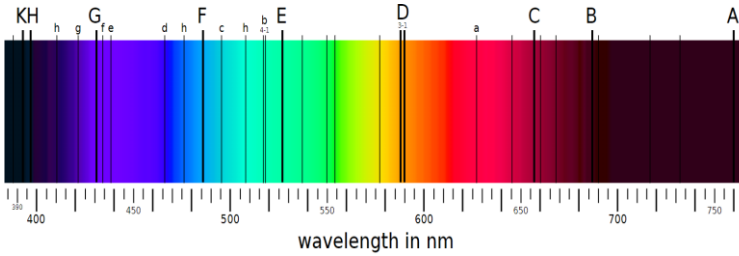


Fig. 5.3.f. Fraunhofer lines. Source: Gebruiker:MaureenV | Public Domain.

However, Leitner also notes:

William Hyde Wollaston (1766-1828) must be given priority for the discovery of dark lines in the spectrum of sunlight. A note on this appeared in England in 1802 and, translated into German, it was published in 1809 in Gilbert’s *Annalen*. (*Ibidem*).

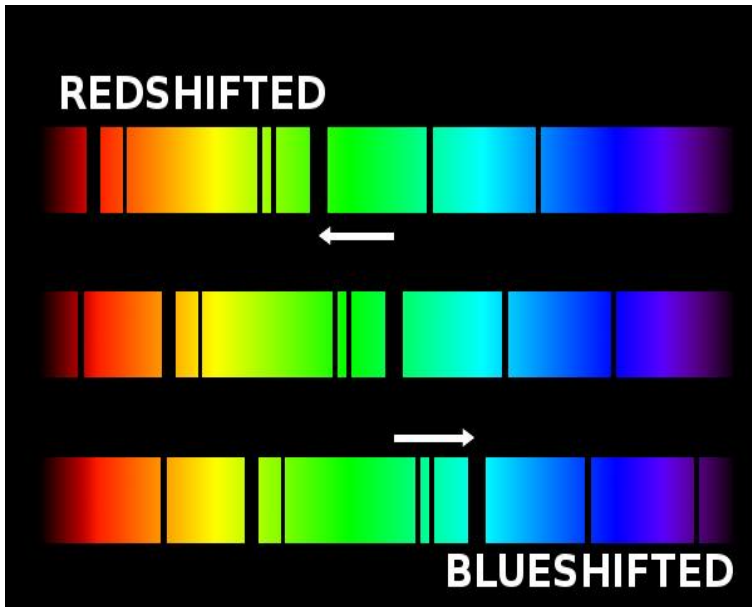
Nevertheless, the Fraunhofer lines are in fact spectral absorption lines resulting from the absorption of photons of the right amount of energy with the by atoms and molecules. In fact, this results from the Planck-Einstein relation (cfr. Section 2.8):

$$E = h\nu \tag{5.2}$$

which explains the discreteness of the lines and in the end allows us to identify atoms and molecules by identifying the characteristic lines in the spectra.

Furthermore, the spectral study of celestial objects allows the correlation of the redshift and apparent magnitudes of nearby galaxies in order to obtain a velocity-distance relation (cfr. figure below). Indeed, by examining the light coming from galaxies, it is possible to determine their velocity relative to us by studying the shift of known characteristic spectral lines (cfr. Section 1.8.1.).





**Fig. 5.3.g.** Illustration of the redshift/blueshift of spectral lines compared to spectral lines as measured on Earth (middle spectrum). Source: <https://sciensite.wordpress.com/2015/11/> | Public Domain

Longair explained:

The velocities of the galaxies inferred from the Doppler shifts of their absorption lines were typically about  $570 \text{ km s}^{-1}$ , far in excess of the velocity of any known object in our Galaxy. Furthermore, most of the velocities corresponded to the galaxies moving away from the Solar System, that is, the lines were *redshifted* to longer (red) wavelengths. In 1921, Carl Wilhelm Wirtz concluded that, when the data were averaged in a suitable way, “an approximate linear dependence of velocity upon apparent magnitude is visible” (Wirtz 1921<sup>115</sup>). By 1929, Hubble had assembled approximate distances of 24 galaxies for which velocities had been measured, mostly by Slipher<sup>116</sup>, all within 2 Mpc of our Galaxy. (Longair 2004, p.6)

Longair also notes that “Even before 1929, however, it was appreciated that Hubble’s law was expected according to world models based upon the general theory of relativity”. (Longair 2004, p. 6)

Indeed, Hubble’s law is a consequence of the cosmological principle – homogeneity and isotropy– of the expanding universe as evidenced by the works of Alexander Alexandrovich Friedman (1888-1925) and Georges Lemaître’s (1894-1966) –especially his paper of 1927 (Lemaître 1927) also infirming the static picture of the universe. And later, building the Friedmann-Lemaître-Robertson-Walker (FLRW or FRW) cosmological model by applying the Robertson-Walker metric of Howard Percy Robertson

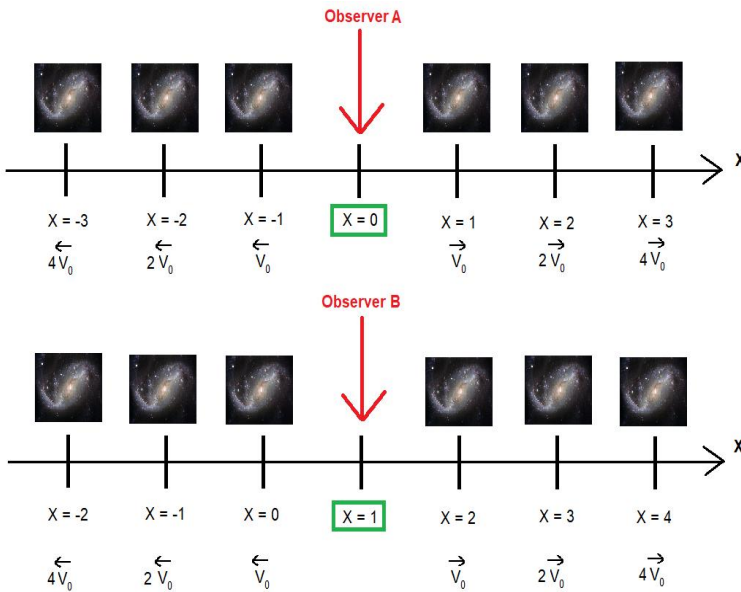
<sup>115</sup> Wirtz, C. W. 1921, *Astronomische Nachrichten*, 215, 349 (Cfr. Wirtz 1921, 1921a)

<sup>116</sup> Slipher, V. M. 1917, *Proc. Amer. Phil. Soc.*, 56, 403 (Cfr. Slipher 1917)

(1903-1961) and Arthur Geoffrey Walker (1909-2001) to the Friedmann equations (cfr. Friedman A 1922, 1999). Actually, the source of the redshift is not only due to the relative motion of the galaxies, i.e. it cannot be fully explained by a Doppler shift due to the relative motion of the galaxies; indeed, since the light from other galaxies travels through space, and since the universe is expanding –at every point and in every direction as implied by the cosmological principle–, the photons are also stretched by the expansion. The cosmological redshift is measured by the quantity:

$$z = \frac{\lambda_{obs} - \lambda_0}{\lambda_0} \tag{5.3}$$

where the redshift  $z$  is equal to  $\lambda_{obs}$  which is the observed wavelength and  $\lambda_0$  which is the wavelength measured in laboratory.



**Fig 5.3.h.** Illustration of the expansion of the Universe from the point of view of observers located in different galaxies. Source: PV, MS Paint.

Using an adapted version of the image of a galaxy from: Public Domain pictures | <https://www.publicdomainpictures.net/pictures/90000/velka/space-galaxy-1401467040F0s.jpg>

This milestone in the history of cosmology is particularly important as the conception of the universe shifted from certainly being static and potentially eternal to the universe is expanding and its future is thus depending on its spatial curvature. Indeed, Longair wrote:

One of objectives of Einstein’s program was to incorporate into the structure of general relativity what he called *Mach’s Principle*, meaning that the local inertial

frame of reference should be determined by the large-scale distribution of matter in the Universe. There was, however, a further problem, first noted by Newton, that static model universes are unstable under gravity. Einstein proposed to solve both problems by introducing an additional term into the field equations, the *cosmological constant*  $\Lambda$ . (Longair 2004, p 7)

This addition of the cosmological constant is now famously known to be, according to himself, his “biggest blunder” while in the end it turned out to be extremely useful (O’Raifeartaigh 2018):

We note finally that it is sometimes argued that Einstein’s real blunder was not the introduction of the cosmological constant in 1917, but his banishment of the term from 1931 onwards. As is well-known, modern measurements of cosmic expansion and of the cosmic microwave background suggest the presence of a significant ‘dark’ component of cosmic energy, a phenomenon that can be described within the context of general relativity by including a cosmological constant term in the field equations (Ivi. p. 23).

Indeed, nowadays the cosmological constant plays an important role in cosmology. For instance, it is the energy density of empty space; the energy associated with vacuum and dark energy, which itself is considered to be the reason behind the fact that the universe is not simply expanding, but it is expanding increasingly faster. From this, and by considering that a) the universe is expanding, and therefore “creating” more empty space and b) that empty space possess energy participating in the expansion; it seems only logical that this expansion is accelerating.

In turn, this poses the question of the future of the universe which depends on the *critical density* of the universe and the curvature of the universe. On one hand, the critical density is the density of matter required to stop the expansion of the universe; The *current* critical density is approximately  $1.06 \times 10^{-29} \text{ g/cm}^3$ . This amounts to six hydrogen atoms per cubic meter on average overall<sup>117</sup>. is given by:

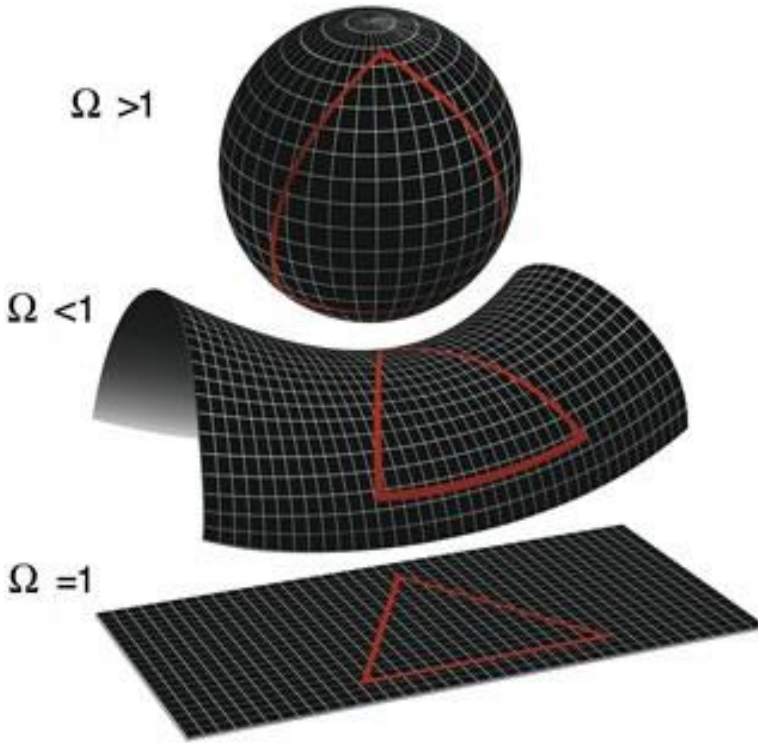
$$\rho_c = \frac{3H^2}{8\pi G} \quad (5.4)$$

where  $H$  is the Hubble constant, and  $G$  is Newton’s gravitational constant.

On the other hand, the density parameter  $\Omega$  is defined as the ratio of the observed density  $\rho$  to the critical density  $\rho_c$  of the Friedmann universe and defines the overall curvature of the universe. There are three possibilities for the spatial curvature of the universe  $\Omega$  depending on its value supposing the spatial dimension homogeneous and isotropic –thus FLRW models– (cfr. figure below):

---

<sup>117</sup> Cfr. <https://www.astronomynotes.com/cosmolgy/s9.htm>



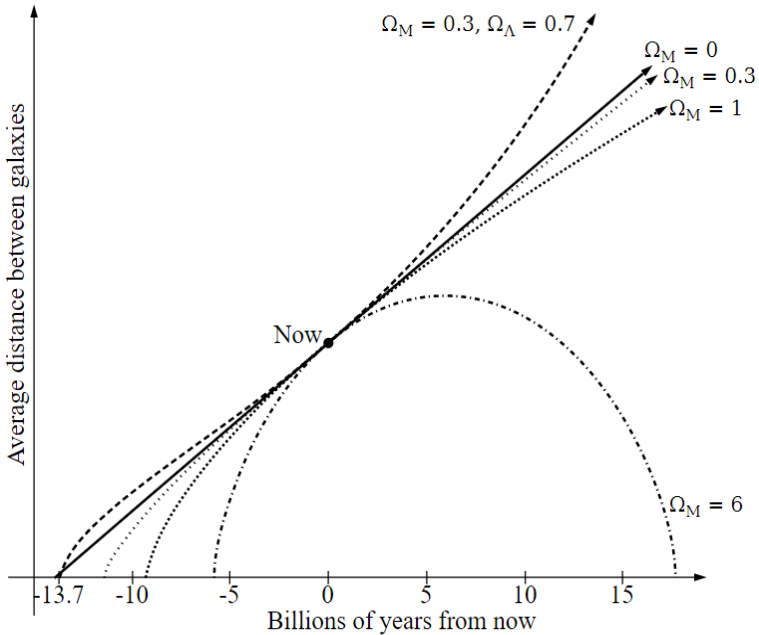
**Fig. 5.3.i.** 2-dimensional representations of the possible shapes of the universe. Adapted from Source: NASA / WMAP Science Team, Public Domain | [https://wmap.gsfc.nasa.gov/universe/uni\\_shape.html](https://wmap.gsfc.nasa.gov/universe/uni_shape.html)

- In the case where  $\Omega$  is positive, the universe is finite and closed.
- In the case where  $\Omega$  is equal to one, the universe is open, infinite and flat.
- In the case where  $\Omega$  is negative, the universe is open, infinite and hyperbolic.

The two main ways to get a value for  $\Omega$  are to calculate the average density of matter-energy observed by the critical energy density (cfr. eq. 5.4), or to measure  $\Omega$  via the geometric properties of the universe on large scales, i.e. by measuring angles of triangles spanning across the universe, e.g. by measuring distant sources such as distant galaxies or the size of hot or cold spots on the CMB<sup>118</sup>. For instance, in the cases where  $\Omega \neq 1$ , the geometry is non-Euclidean, and therefore the sum of the angles of triangles would not add up to  $180^\circ$ . In the case of positive curvature, the sum of the angles of triangles would be greater than  $180^\circ$ ; and conversely less than  $180^\circ$  for negative curvature.

<sup>118</sup> Cfr. [https://map.gsfc.nasa.gov/mission/sgoals\\_parameters\\_geom.html](https://map.gsfc.nasa.gov/mission/sgoals_parameters_geom.html)

Moreover, the curvature of the universe also predicts the fate of the universe in the remote future (cfr. figure below) since this evolution is determined between the momentum of expansion and the pull of gravity; i.e. Hubble constant and matter-energy density of the universe<sup>119</sup>:



**Fig. 5.3.j.** Plot of the possible fates of the universe depending on matter density,  $\Omega_M$  and dark energy density,  $\Omega_\Lambda$ .

Source: BenRG, Public Domain | <https://www.nextpng.com/en/transparent-png-ezsfv>

The three main possibilities are:

- The Big Crunch, in which gravity eventually stops the expansion of the universe, after which it starts to contract until all matter in the universe collapses to a point, a final singularity. This scenario is associated with a closed universe.
- The Big Rip, in which the ever increasing acceleration caused by dark energy eventually becomes so important that it overcomes the effects of the gravitational, electromagnetic and strong binding forces; and therefore ripping everything apart.
- The Big Chill/Freeze or Heat death, in which the universe eventually reaches thermodynamic equilibrium; and therefore gets colder and colder –as no work or heat could be produced– until everything in it eventually decays over unimaginable timescales.

<sup>119</sup> Cfr. [https://map.gsfc.nasa.gov/universe/uni\\_fate.html](https://map.gsfc.nasa.gov/universe/uni_fate.html)

In an open universe where expansion never stops, the supposition is that either one of the last two scenarios would eventually happen. All the same, in all three models of Friedmann, the solutions continue into the past where the whole of the Universe is created in a single explosion: the Big Bang.

The current value of the curvature of the universe within the standard model ( $\Lambda$ CDM) of the Big Bang Cosmology obtained by the Planck Collaboration is consistent with a flat universe with a  $\Omega_K = 0.001 \pm 0.002$  (Aghanim 2018); or even a  $\Omega_K = 0.0004 \pm 0.0018$  (Efstathiou 2020).

Furthermore, it is supposed that this value is no accident, but rather the result of inflation: a theory of an exponential expansion of space that lasted from  $10^{-36}$  to  $10^{-33}$  or  $10^{-32}$  seconds after the Big Bang pioneered by Alan Guth, Andrei Linde and Alexei Starobinsky<sup>120</sup>. Intuitively, this theory solved this problem of the flatness of the universe by stating that the early expansion of the universe during inflation was in fact so fast that it flattened space; “it ironed out any primordial curvature” (*Ibidem*). Moreover, the theory of inflation also solved the “horizon problem” which is related to the apparent homogeneity of the universe. Indeed, it seemed that “opposite parts of the sky would never have been in causal contact with each other” (*Ibidem*); and thus these parts would have no reason to look alike. However, by considering an extreme expansion period as suggested by inflation, this problem disappears as these seemingly causally disconnected regions of space may very well have been very briefly causally connected in the first instants of the Big Bang, until the fast expansion blew them apart from one another (cfr. Guth 1981).

*The age of the Universe.* The age of the universe was determined by combining several methods and contributions, and in particular thanks to Vesto Melvin Slipher (1875-1969), Lemaître and Hubble (Thompson 2011). In essence, by observing the Doppler shift from spiral nebulae, which appeared to be moving away from us at great speeds (Slipher 1915, 1917, 1921; Wirtz 1921, 1921a), by observing particular stars called Cepheid variables whose pulsation rates are proportional to their brightness and by finding a simple period-luminosity relation describing them, astronomers were able to deduce that these stars were located millions of light years away.

Furthermore, even before the addition of the confirmation that the further the galaxies were located, the faster they were receding from us, and therefore that the universe was expanding, Lemaître postulated that an expansion of the universe implied that the universe was smaller when it began. This led Lemaître to refer to the first state of such a universe as a “primeval atom” (Kragh 2007). This theory in which the universe began as a small and hot dense state ended up being called the theory of the Big Bang by Fred Hoyle (1915-2001) in 1949, whose intentions was to mock it (Kragh 2013).

---

<sup>120</sup> Cfr. <https://www.kavlifoundation.org/2014-astrophysics-citation>

On extremely large scales, we consider the Universe as being a completely uniform and homogenous continuous distribution of matter. In fact it is possible to consider an idealized situation in which structures even as large as galaxies are not big enough to be considered noteworthy; i.e. in this case the universe is considered as a –perfect– fluid; like a very diluted gas, for analytical purposes<sup>121</sup>.

Therefore, from this we can identify symmetries:

- *Spatial Homogeneity* – Translational Invariant
- *Spatial Isotropy* – Rotational Invariant

And therefore we can state that the universe has a *maximally symmetric spatial geometry*; i.e. all points in space are equal with respect to one another. This last statement has a rather deep implication in regard to the theory of the Big bang, as it implies that it did not originate from one particular point –hence the common “it happened everywhere at once”<sup>122</sup>.

In fact, according to Longair:

By the end of the 1930s, there was a common view that the solution of the cosmological problem lay in the determination of the parameters which define the Friedmann world models. (Longair 2004, p. 11)

To arrive at our current estimation of 13.8 billion years, scientists had to also take into account the effect of the gravity of the matter in the universe –since gravity is an attractive force counterbalancing the effects of the expansion–, as well as the effects of dark energy which is accelerating the expansion; the latter also implying that the Hubble constant was in fact variable with the age of the universe<sup>123</sup>. Finally, by plugging the observations from the CMB and of the matter content of the observable universe in the equations, the estimation of the composition of the universe yielded that it was around 5% of ordinary matter and energy, 27% dark matter and 68% dark energy<sup>124</sup>. The evidence for dark matter started with Fritz Zwicky who made the first dynamical studies of clusters of galaxies (Zwicky 1933) and continued accumulating up to nowadays. Indeed, there is a *massive quantity of invisible stuff*, whose presence is evidenced by its gravitational effects on visible matter. In particular, since it has mass and does not seem to interact with ordinary matter outside of gravity and we do not know what it is; hence the name *dark*, it influences the characteristic speeds of stars in galaxies, and galaxies’ speeds in clusters will be different from those expected based on the amount of dark matter in their vicinity.

<sup>121</sup> Cfr. [https://www.astro.caltech.edu/~george/ay21/Ay21\\_Lec03.pdf](https://www.astro.caltech.edu/~george/ay21/Ay21_Lec03.pdf)

<sup>122</sup> Cfr. <https://spaceplace.nasa.gov/review/dr-marc-space/center-of-universe.html>

<sup>123</sup> In fact, the Hubble constant corresponds to the current rate of expansion of the universe the value of which is constant through the universe; contrary to that of the Hubble parameter which represents the rate of expansion of the universe which evolves with its age –since the expansion is accelerating–.

<sup>124</sup> Cfr. <https://science.nasa.gov/astrophysics/focus-areas/what-is-dark-energy>

*Multiverses.* When discussing the Universe, a question one could ask is which universe? Indeed, the notion of universe is polysemous: is it the Observable Universe? Is the Universe everything that exists? And if something lies beyond the boundary of our Universe, is there an even bigger Universe encompassing it? Would this Russian doll structure go *ad infinitum*? Is there more than one Universe, and therefore a multiverse? and so forth. Actually, all those questions and more are contemplated by scientists and often discussed in scientific media. In fact, the notion of multiverse has permeated society notably through science-fiction and pop culture.

However, we need to make distinctions: there are two main conceptions of multiverses. On one hand there are the “cosmological” multiverses such as described by Sean Carroll:

At a prosaic level, the average density of matter, or the relative abundances of ordinary matter and dark matter, could vary from place to place. More dramatically, but consistent with many ideas about fundamental physics, even the local laws of physics could appear different in different regions – the number and masses of particles, forms and strengths of interactions between them, or even the number of macroscopic dimensions of space. The case where there exist many such regions of space, with noticeably different local conditions, has been dubbed the “cosmological multiverse”, even if space itself is connected. (Carroll 2019, p. 300)

Or there are “oscillatory” where the universe cycles between phases of expansions and collapse, or “inflationary” scenarios with the theories of bubble multiverse:

- Some invoke “oscillatory” models in which a single universe undergoes cycles of expansion and recollapse (Tolman 1934), though without necessarily understanding what causes the bounce. In this case, the different universes are strung out in time.
- Others invoke the “inflationary” scenario, in which our observable domain is a tiny part of a single bubble that underwent an extra-fast accelerated expansion phase (Carr 2008)

On the other hand, there are the multiverses described by Quantum Mechanics, interpretations related to the problem of the collapse of the wave function famously illustrated by Erwin Schrödinger’s (1887-1961) thought experiment –Schrödinger’s cat–<sup>125</sup>. In this case, the many-worlds interpretation states that there is no collapse of the wave function of the universe; and because there is only one wave function for everything, things

---

<sup>125</sup> In this thought experiment ruled by Quantum Mechanics the destiny of a cat is linked to the decay of a radioactive atom: until the box is opened, both the cat and the atom are in quantum superposition, i.e. their state is a combination of states until the observer opens the box and provokes the decoherence of the system.

A very clear and more modern version of this experiment was made by minutephysics: <https://www.youtube.com/watch?v=IOYyCHGWJq4>



can be entangled with each other and every outcome is objectively real; i.e. after the state of the cat is observed the Universe branches out such that every branch corresponds to an outcome (Everett 1956).

Such theories also have deep epistemological and philosophical implications; notably about abductive reasoning, falsifiability and the place of mankind in the universe. For example, the anthropic principle(s)<sup>126</sup> which states that the act of observing the universe must necessarily be executed by a conscious entity.

The data we collect about the Universe is filtered not only by our instruments' limitations, but also by the precondition that somebody be there to "have" the data yielded by the instruments (and to build the instruments in the first place). This precondition causes observation selection effects - biases in our data that may call into question how we interpret evidence that the Universe is fine-tuned at all.<sup>127</sup>

## 5.4 Towards a New History of Cosmology

Cosmology is one of these subjects which has a very rich history—as should be the case for any subject which has been studied for such a long time. Cosmology has always involved a lot of speculation. At the beginning, these speculations belonged to the spiritual realm and were associated with religious beliefs explaining the creation of the World and the Universe. Then Science arose with the first scientists and Cosmology slowly left the sphere of the mystical to enter the domain of another kind of speculation: the domain of hypotheses and other conjectures relying on theories, theorems, principles, and the likes, themselves postulated on the basis of facts and observations. This latter domain is the one in which Cosmology is now expanding more and more.

The recent developments in theoretical Physics (from the infinitely small with Quantum Mechanics to the infinitely big with General Relativity) as well as technological developments and engineering prowess that are continuously improving pave the way towards a new History of Cosmology. Indeed, since its first debut, Cosmology has been built upon a very particular type of observations. Because of the difficulty of reaching the actual celestial objects, the only possible observations, the only measurements—aside from the occasional collection or extraction of some samples of neighbouring bodies—have been made through our eyes. That is, until recently.

If the development of Cosmology could be divided in perception eras and has mainly been made through our eyes and their mechanical extensions –

---

<sup>126</sup> The *weak* anthropic principle states that what we can expect to observe must be compatible with the conditions necessary for our presence as observers, otherwise we would not be there to observe it. The *strong* anthropic principle postulates that the fundamental parameters on which the Universe depends are adjusted so that it allows the birth and development of observers within it at a certain stage of its development.

<sup>127</sup> Cfr. <http://www.anthropic-principle.com/>

telescopes—, in other words through sight, and then through the counterpart of touch—with probes, particle detectors and rovers—; then Cosmology has entered a new era with the advent of gravitational wave interferometry which has often been described as analogous to hearing. Indeed, if our study of the electromagnetic spectrum with telescopes is equivalent to sight, its counterpart the study of gravitational wave might very well be compared with hearing or at least be considered equivalent to the acquisition of a completely new sense as it allows the exploration of the Universe in an entirely different way.

*On the Next Gravitational Wave Observatories.* Since the detection of GW150914, the efforts for the construction and for the study of gravitational wave astronomy have been reinforced. Localization and parameter estimation need at least three detectors, but this will soon not be an issue anymore with the construction of more detectors and their collaboration towards a gravitational wave detectors network. This network will consist of: the twin detectors of LIGO in the USA, The VIRGO detector in Italy, GEO600 in Germany, KAGRA – formerly known as the Large-Scale Gravitational-wave Telescope, LCGT– in Japan and IndIGO (or LIGO-India).

LIGO-India will be reinforcing the global network of detectors with its design identical to the LIGO detectors in USA and is expected to become operational sometime during 2024.

KAGRA is a cryogenic interferometric gravitational wave detector based in the Kamioka mine in Japan, thus providing a good seismic isolation from human activities and other natural sources of noise. This detector also has 3 km long arms setup in L shape and has the particularity of using 38 kg spherical sapphire mirrors cooled down to  $-253^{\circ}\text{C}$  (around  $20^{\circ}\text{Kelvin}$ ) in order to minimize the thermal noise due to molecular vibrations and is optimized for the detection of signals of 100 Hz. This optimization corresponds to binary neutron stars mergers. (Aso *et al* 2013)

*On eLISA and LISA pathfinder.* The future of gravitational astronomy will eventually get away from Earth in order to remove its associated constraints impacting the measurements such as local noise and gravity gradient by working in a far less “noisy” environment with the evolved Laser Interferometer Space Antenna, eLISA, the first gravitational wave detector in space. eLISA will have with a heliocentric orbit and will consist of three satellites in an equilateral triangle formation separated by 2,5 million kilometers (the arms’ length of the interferometer). This configuration, combined to the fact that each of these spacecrafts contain a set of two free masses that are free flying inside them and playing the role of the mirrors for this interferometer for a total of six lasers for three arms, will allow “Three independent interferometric combinations of the light travel time between the test masses are possible, allowing, in data processing on the ground, the synthesis of two virtual Michelson interferometers plus a third null-stream,

or “Sagnac” configuration” (Danzmann 2017, p. 5) thus “obtaining both polarisations of the Gravitational Waves simultaneously and will measure source parameters with astrophysically relevant sensitivity in a band from below  $10^{-4}$  Hz to above  $10^{-1}$  Hz” (Ivy. p. 4).

For ground based gravitational detectors, the range of observed frequencies goes from about 1 to 10Hz to a few kilohertz. For lower frequencies, however, the limitations are due to gravity gradient noise which are basically local gravitational effects on the Earth (such as cars or trucks passing by, etc.<sup>128</sup>). According to Rainer Weiss in an interview, people have been thinking about LISA since at least 1975 and in particular Peter Bender. The idea was suggested to the European Space Agency in the mid-90s which lead to the mission LISA Pathfinder. This mission serving as a proof of feasibility, started in 2015 and lasted until 2017. The device even outperformed the scientists’ expectations and the performance obtained was significantly better than what is actually required for the eLISA interferometer (Armano *et al* 2016).

This mission, expected to launch in 2034, will last 4 to 10 years and will scan the entire sky as it trails behind the Earth, at a distance of about 50 million kilometres in its orbit. Its objectives are listed below (Danzmann 2017, p. 3):

- “Study the formation and evolution of compact binary stars in the Milky Way Galaxy
- Trace the origin, growth and merger history of massive black holes across cosmic ages, examining systems of black holes with masses ranging from a few  $M_{\odot}$  to  $10^8 M_{\odot}$ .
- Probe the dynamics of dense nuclear clusters using Extreme Mass Ratio Inspirals (EMRIs)
- Understand the astrophysics of stellar origin black holes
- Explore the fundamental nature of gravity and black holes
- Probe the rate of expansion of the Universe
- Understand stochastic Gravitational Wave backgrounds and their implications for the early Universe and TeV-scale particle physics
- Search for GW bursts and unforeseen sources”

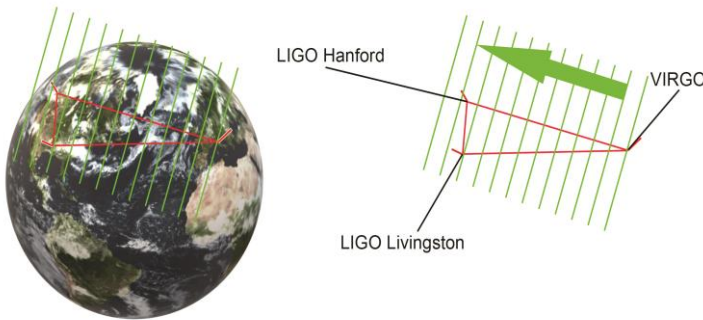
*On Multi-messenger Astronomy.* Multi-messenger Astronomy is defined as the observation of signals of different natures (electromagnetic, particles and now gravitational waves) –the messengers– from the same source at the same time. Up until now, all our telescopes and satellites have been scanning different regions of the sky one by one. Each one of these tools are equipped with instruments which are sensitive to certain wavelengths. Of course, it is common for different telescopes to point at the same objects in order for us

---

<sup>128</sup> During my stay at Virgo, Gabriel Pillant jokingly told me that some researchers even calculated the possible impact of the flight of a bird that would pass right above one of the arms of the detector as it rose some concern.

to study them in the whole electromagnetic spectrum. Unfortunately, with this method alone, it is hardly possible to witness some particular events. Indeed, for example, even if we can survey a number of stars certain regions of the sky, we kind of have to rely on luck—or make educated guesses—as we need to point at the relevant region of the sky at the right time. Therefore, one of the main immediate goals is to finish the construction of the other gravitational wave observatories. Besides the improvement of local noise elimination and the ability to better identify coincident signals of terrestrial origin, this would allow a much better accuracy for the localization of the sources of gravitational waves. Indeed, each detector is more sensible to certain regions of the sky, but even without knowing this, the logic behind this is rather simple: triangulation.

*On Triangulation.* The origin of a signal, the sky location of the source, is traced back through the times of arrival of the signal at each detector. Indeed, due to the fact that all gravitational waves travel at the speed of light, the difference in the times of arrival at the gravitational observatories’ sites depends on the location on the source:



**Fig. 5.4.** Illustration of the difference of gravitational waves arrival times. In this illustration the gravitational waves (in green) are represented travelling in the direction of the green arrow. In this particular case, it is easy to see that the gravitational wave would be first detected by the Virgo site, then by Livingston and finally by Hanford, thus allowing to determine the approximate location of the source in the sky.

Source: Philippe Vincent | Adapted from Microsoft Paint 3D mesh library

Consequently, the more detectors we have, the better the accuracy of the localization of the source of the signal. This in turn, is extremely important because the better and the faster a source of a gravitational wave can be pinpointed in the sky, the faster it becomes possible to point telescopes at this source, thus allowing the study of the event with different methods in a fashion similar to what happened for GW170817 (Abbott *et al.* 2017). Moreover, one of the great advantages of multi-messenger astronomy is that it becomes easier to make discoveries. Apart from the fact that when an event unfolds, we can now look at it in many different ways, it is possible to

identify sub threshold events that would have been missed otherwise. As an example, if different observatories are receiving weak signals that cannot be guaranteed to be actual detections, such as a weak gravitational wave signal or a weak gamma ray burst; it is now possible to gather data from other observatories and check if they also have detected a (maybe also weak) signal thus establishing that the data might be suggesting a potential event or on the contrary suggesting that the weak signal might therefore not be relevant.

## Epilogue II

Cosmology –and Astronomy in general– have always been of great interest to mankind and with the beginning of gravitational wave astronomy we are entering a new era in Cosmology as some astrophysical phenomena are unapproachable with electromagnetic waves alone. Thus, the gravitational wave observatories provide us with new ways to observe the Universe, and are getting us closer and closer to answering fundamental questions such as: “What is the structure of neutron stars? How do they evolve? How common are black holes, how are they distributed in the universe and what is their typical mass? What is the mechanism that leads to a star collapsing into a supernova? What were the physical processes involving matter-energy during the Big Bang? Is Einstein’s General Theory of Relativity the correct description of gravity?” Etc. This new astronomy has already borne fruit. Indeed, the first series of gravitational wave signals confirmed several predictions of General Relativity, but beyond that, they also gave us new information about systems in strong-field gravity, about the propagation of gravity, its speed and even whether there is gravitational leakage into other dimensions, etc. (Yunes 2016) These observations in turn allow us to refine our models by defining new constraints, to test our theories with observational data, etc. thus improving our current understanding of the cosmos. For example, along with each new detection, the properties of the binary black hole population are more refined (LIGO Scientific Collaboration and Virgo Collaboration, 2019a).

As another example, the unexpectedly large masses of the stellar black holes mergers detected recently raised a question about potential gravitational wave lensing. Thus, in a similar fashion that light can be subject to gravitational lensing by galaxies (c.f. Chapter 3, section 3.2), it has been suggested that the gravitational waves from binary black hole mergers detected might have been magnified by an intervening galaxy which would lower the masses involved in the 5 to 15 solar masses range (Broadhurst 2018).

Moreover, gravitational astronomy plays a critical role in the study of the earliest moments of the Universe, namely the Big Bang. The Cosmic Microwave Background (CMB) is often described as the afterglow of the Big Bang and it represents the earliest electromagnetic signature of this event that is reachable through electromagnetic radiation. As we currently understand it, the CMB results from the redshifting due to the expansion of the Universe of the Cosmic Background Radiation which happened around 378 000 years after the Big Bang, during a period called the era of decoupling, during which the temperature of the Universe cooled down to about 3 000°K and allowed photons to travel. Simply put, before that the Universe was opaque to electromagnetic radiation (Gawiser 2000). However, even if the Universe was opaque to electromagnetic radiation, it was not the case for gravitational radiation. As a consequence, future

missions will endeavour the search for the *sounds* of the Big Bang (the gravitational radiation background) with the (BBO) Big Bang Observer<sup>129</sup>(Cutler 2006).

In addition to this, the gravitational wave detectors regularly undergo upgrades to increase their sensitivity, range, noise reduction, etc. With these upgrades many more discoveries are expected. Indeed, the expectations for gravitational wave emission of rotating bodies are growing, the scientists are especially waiting for nonspherical gravitational collapses, nonspherical Supernovae and nonspherical rotating Neutron Stars signals. For instance, for gravitational waves from stellar collapse and formation of a black hole:

“Since  $L_{GW} \sim \left(\frac{M}{R}\right)^5 L_0$ , the most intense gravitational waves reaching Earth must come from a dynamic, deformed system near its gravitational radius ( $L_{GW}$  drops by a factor 100,000 with each increase by 10 of R!).” (Misner 1973, p. 1006)

“Such a star [with a white-dwarf core collapsing into a neutron star or one of the fragments therefrom collapsing through its gravitational radius in a highly nonspherical manner] should terminate life with a last blast of gravitational waves, which carry off a sizeable fraction of its rest mass. Thus an order-of-magnitude estimate gives

$$(\text{energy radiated}) = \int L_{GW} dt \sim L_0 \left( \frac{\text{time during which}}{\text{peak luminosity occurs}} \right) \quad (\textit{Ibidem})$$

The context of supernova collapse has been studied in great detail (Zwergler 1997; Rampp 1998) and the emission of gravitational waves from nonspherical star collapse has been discussed. For instance, in Misner, Thorne and Wheeler’s *Gravitation* one can read:

“According to current theory as verified by pulsar observations, a supernova is triggered by the collapse of the core of a highly evolved star (see §24.3). The collapse itself and the subsequent wild gyrations of the collapsed core (neutron star) should produce a short, powerful burst of gravitational waves. The characteristics of the burst, as estimated with formulas (36.11), and assuming large departures from sphericity, are

$$\begin{aligned} (\text{energy radiated}) &\sim (\text{neutron-star binding energy}) \\ &\sim \frac{M^2}{R} \sim 0.1M \sim 10^{53} \text{ ergs,} \\ (\text{mean frequency}) &\sim \frac{1}{T} \sim \left(\frac{M}{R^3}\right)^{1/2} \sim 0.03 M^{-1} \sim 3000 \text{ Hz,} \\ (\text{power output}) &\sim \left(\frac{M}{R}\right)^5 L_0 \sim 10^{-5} L_0 \sim 3 \times 10^{54} \text{ ergs/sec,} \end{aligned}$$

<sup>129</sup> Cfr. <https://dcc.ligo.org/public/0002/G0900426/001/G0900426-v1.pdf>

$$\left( \begin{array}{l} \text{time for gravitational} \\ \text{radiation to damp the} \\ \text{motion if turbulence,} \\ \text{heat conduction, and other} \\ \text{effects do not damp it} \\ \text{sooner} \end{array} \right) = \tau \sim M(M/R)^{-4} \sim 0.1 \text{ sec} \sim 300 \text{ periods.}$$

(*Ivi.* p. 1007)

The development of gravitational astronomy in conjunction with the construction of more detectors also implies that the need for qualified personnel will grow. Therefore, keeping in mind that gravitational astronomy is one of the next frontiers in Physics, in order to sustain this growth it is necessary to begin the training of the next generation of physicists.



## REFERENCES

### Primary Sources

- Carnot S (1824) *Réflexions sur la puissance motrice du feu et sur les machines propres à développer cette puissance*, Paris.  
Retrieved: <https://gallica.bnf.fr/ark:/12148/btv1b86266609/f11.image>
- Descartes R (1664) *Le Monde de M. Descartes, ou le Traité de la lumière et des autres principaux objets des sens. Avec un discours de l'action des corps et un autre des fièvres, composez selon les principes du même auteur.* Michel Bobin & Nicolas le Gras, Paris. Retrieved: <https://gallica.bnf.fr/ark:/12148/btv1b8601516f/f5.image>
- Everett H (1956) *Theory of the Universal Wavefunction*, Thesis, Princeton University, (1956, 1973), pp 1–140.  
Retrieved: <https://archive.org/details/TheTheoryOfTheUniversalWaveFunction>
- Friedman A (1922) Über die Krümmung des Raumes. *Zeitschrift Für Physik*, 10(1), 377–386. doi:10.1007/bf01332580
- Friedman A (1999) On the Curvature of Space. *General Relativity and Gravitation*, 31(12):1991–2000. doi:10.1023/a:1026751225741
- Hubble E (1925) Cepheids in Spiral Nebulae. *Pop. Astr.* 33:252-255. Retrieved: <http://articles.adsabs.harvard.edu/full/1925PA.....33..252H/0000252.000.html>
- Hubble E (1929) A relation between distance and radial velocity among extra-galactic nebulae. *Proceedings of the National Academy of Sciences*, 15(3):168–173. doi:10.1073/pnas.15.3.168
- Hubble E, Humason ML (1931) The velocity-distance relation among extra-galactic nebulae. *The Astrophysical Journal*, 74, 43. Retrieved: <http://articles.adsabs.harvard.edu/full/1931ApJ....74...43H>
- Jansky KG (1933) Electrical disturbances apparently of extraterrestrial origin. *Proceedings of the Institute of Radio Engineers*, 21(10):1387-1398.
- Lemaître G (1927) Un Univers homogène de masse constante et de rayon croissant rendant compte de la vitesse radiale des nébuleuses extra-galactiques. *Annales de la Société scientifique de Bruxelles*, 47:49-59.
- Simon SH (2013) *The Oxford solid state basics*. OUP Oxford.
- Slipher VM (1915) Spectrographic observations of nebulae. *Popular astronomy*, 23:21-24.
- Slipher VM (1917) Nebulae. *Proceedings of the American Philosophical Society*, 56(5):403-409. Retrieved: <https://www.jstor.org/stable/984028>
- Slipher VM (1921) Two nebulae with unparalleled velocities. *Popular Astronomy*, 29:128.
- Wirtz C (1921) Die Radialbewegungen der Gasnebel. *Astronomische Nachrichten*, 215(13):281–286. doi:10.1002/asna.19212151302
- Wirtz C (1921a) Einiges zur Statistik der Radialbewegungen von Spiralnebeln und Kugelsternhaufen. *Astronomische Nachrichten*, 215(17):349–354. doi:10.1002/asna.19212151703
- Wright T (1750) *An Original Theory Or New Hypothesis of the Universe, Founded Upon the Laws of Nature: And Solving by Mathematical Principles the General Phenomena of the Visible Creation, and Particularly the Via Lactea*. Cambridge University Press.
- Zwicky F (1933) The redshift of extragalactic nebulae. *Helv. Phys. Acta*, 6(110):138.

## Secondary Sources

- Abbott BP and Abbott R and Abbott TD and Acernese F and Ackley K and Adams C and Adams T and Addesso P and Adhikari RX and Adya VB and et al. (2017) Multi-messenger Observations of a Binary Neutron Star Merger. *The Astrophysical Journal Letters*, 848(2):L12. DOI: 10.3847/2041-8213/aa91c9
- Aghanim N, Akrami Y, Ashdown M, Aumont J, Baccigalupi C, Ballardini M, ... Battye R (2018) Planck 2018 results. VI. Cosmological parameters. arXiv preprint arXiv:1807.06209. Retrieved: <https://arxiv.org/abs/1807.06209>
- Armano M *et al* (2016) Sub-Femto-g Free Fall for Space-Based Gravitational Wave Observatories: LISA Pathfinder Results. *Phys. Rev. Lett.* 116:23/1101. DOI: 10.1103/PhysRevLett.116.231101  
Retrieved: <https://journals.aps.org/prl/pdf/10.1103/PhysRevLett.116.231101>
- Aso Y, Michimura Y, Somiya K, Ando M, Miyakawa O, Sekiguchi T, Tatsumi D, Yamamoto H (2013) Interferometer design of the KAGRA gravitational wave detector. *Phys. Rev. D* 88, 043007. Retrieved: <https://doi.org/10.1103/PhysRevD.88.043007>
- Broadhurst T, Diego JM, Smoot G (2018) Reinterpreting Low Frequency LIGO/Virgo Events as Magnified Stellar-Mass Black Holes at Cosmological Distances. arXiv. Retrieved: <https://arxiv.org/abs/1802.05273v3>
- Carr B, Ellis G (2008) Universe or multiverse? *Astronomy & Geophysics*, 49(2):2.29–2.33. doi:10.1111/j.1468-4004.2008.49229.x
- Carroll SM (2019) Beyond falsifiability: Normal science in a multiverse. *Why Trust a Theory?* pp. 300-314.
- Chatziioannou K, Han S (2020) Studying strong phase transitions in neutron stars with gravitational waves. *Physical Review D*, 101(4). doi:10.1103/physrevd.101.044019
- Cutler C, Harms J (2006) Big Bang Observer and the neutron-star-binary subtraction problem. *Phys. Rev. D* 73, 042001. DOI:<https://doi.org/10.1103/PhysRevD.73.042001>.
- Danzmann (2017) LISA Laser Interferometer Space Antenna, A proposal in response to the ESA call for L3 mission concepts.  
Retrieved: [https://www.elisascience.org/files/publications/LISA\\_L3\\_20170120.pdf](https://www.elisascience.org/files/publications/LISA_L3_20170120.pdf)
- Dreissigacker C, Prix R (2020) Deep-Learning Continuous Gravitational Waves: Multiple detectors and realistic noise. arXiv preprint arXiv:2005.04140.
- Efstathiou G, Gratton S (2020) The evidence for a spatially flat Universe. *Monthly Notices of the Royal Astronomical Society: Letters*, 496(1):L91–L95. doi:10.1093/mnrasl/slaa093
- Fernie JD (1970) The Historical Quest for the Nature of the Spiral Nebulae. *Publications of the Astronomical Society of the Pacific*, 82(490):1189-1230. Retrieved: <http://articles.adsabs.harvard.edu/full/1970PASP...82.1189F/0001189.000.html>
- Gawiser E, Silk J (2000) The Cosmic Microwave Background Radiation. *Physics Report* 333-334:245-267. DOI: 10.1016/s0370-1573(00)00025-9
- Guth AH (1981) Inflationary universe: A possible solution to the horizon and flatness problems. *Physical Review D*, 23(2):347–356. doi:10.1103/physrevd.23.347
- Haynes R (2003) From Alchemy to Artificial Intelligence: Stereotypes of the Scientist in Western Literature. *Public Understanding of Science*, 12(3):243–253. doi:10.1177/0963662503123003
- Hetherington NS (1967) The Shapley-Curtis Debate. *Astronomical Society of the Pacific Leaflets*, 10(490):313-320.  
Retrieved: <http://adsabs.harvard.edu/full/1970aspl...10..313h>
- Jeong D, Kamionkowski M (2020) Gravitational Waves, CMB Polarization, and the Hubble Tension. *Physical Review Letters*, 124(4). doi:10.1103/physrevlett.124.041301

- Kragh HS, Lambert D (2007) The Context of Discovery: Lemaître and the Origin of the Primeval-Atom Universe. *Annals of Science*, 64(4):445–470. doi:10.1080/00033790701317692
- Krastev PG (2020) Real-time detection of gravitational waves from binary neutron stars using artificial neural networks. *Physics Letters B*, 803, 135330. doi:10.1016/j.physletb.2020.135330
- Longair MS (2001) The Technology of Cosmology. *Historical Development of Modern Cosmology ASP Conference Series*, Vol. 252. Retrieved: <http://www.aspbooks.org/publications/252/55.pdf>
- Longair MS (2004) *A Brief History of Cosmology*. Carnegie Observatories Astrophysics Series, Vol. 2: Measuring and Modeling the Universe, Cambridge University Press, Cambridge.
- Misner CW, Thorne KS, Wheeler JA (1973) *Gravitation*. W. H. Freeman and Company, USA. ISBN 0-7167-0334-3.
- O’Raifeartaigh C, Mitton S (2018) Interrogating the Legend of Einstein’s “Biggest Blunder”. *Physics in Perspective*, 20(4):318-341. Retrieved: <https://arxiv.org/abs/1804.06768>
- Pisano R (2009) On method in Galileo Galilei’s mechanics. In Hunger H (ed.), *Proceedings of 3<sup>rd</sup> Congress of the European Society for the History of Science*. The Austrian Academy of Science, Vienna, pp. 174–186.
- Pisano R, Bussotti P (2014b) Historical and Philosophical Reflections on the Culture of Machines around the Renaissance. *How Science and Technique Work? Acta Baltica Historiae et Philosophiae Scientiarum* 2(2):20–42.
- Pisano R, Bussotti P (2015a) Historical and Philosophical Reflections on the Culture of Machines around the Renaissance: Machines, Machineries and Perpetual Motion. *Acta Baltica Historiae et Philosophiae Scientiarum* 3(1):69-87.
- Rampp M, Müller E, Ruffert M (1997) Simulations of non-axisymmetric rotational core collapse. Retrieved: <arXiv:astro-ph/9711122>
- Robbins MP, Afshordi N, Mann RB (2019) Bose-Einstein condensates as gravitational wave detectors. *Journal of Cosmology and Astroparticle Physics*, 2019(07):032.
- Sabín C, Bruschi DE, Ahmadi M, Fuentes I (2014) Phonon creation by gravitational waves. *New Journal of Physics*, 16(8):085003.
- Struve FGW (1847) *Sur la voie lactée et sur la distance des étoiles fixes: rapport fait a son excellence M. le Comte Ouvaroff*. Imprimerie de l’Académie impériale des sciences.
- Thompson LA (2011) Vesto Slipher and the first galaxy redshifts. arXiv preprint arXiv:1108.4864. Retrieved: <https://arxiv.org/ftp/arxiv/papers/1108/1108.4864.pdf>
- Trimble V (1995) The 1920 Shapley-Curtis Discussion: Background, Issues, and Aftermath. *Publications of the Astronomical Society of the Pacific*, 107:1133-1144. Retrieved: <https://iopscience.iop.org/article/10.1086/133671/pdf>
- Turyshev SG, Toth VT (2020) Image formation for extended sources with the solar gravitational lens. arXiv preprint arXiv:2002.06492.
- Yu H, McCuller L, Tse M, Barsotti L, Mavalvala N, Betzwieser J, ... Fernandez-Galiana A (2020) Quantum correlations between the light and kilogram-mass mirrors of LIGO. arXiv preprint arXiv:2002.01519. Retrieved: <https://arxiv.org/pdf/2002.01519.pdf>
- Yunes N, Yagi K, Pretorius F (2016) Theoretical Physics Implications of the Binary Black-Hole Mergers GW150914 and GW151226. DOI: 10.1103/PhysRevD.94.084002
- Zwinger T, Müller E (1997) Dynamics and gravitational wave signature of axisymmetric rotational core collapse. *Astronomy and Astrophysics*, 320:209-227. Retrieved: <http://adsabs.harvard.edu/full/1997A%26A...320..209Z>

## Web References

- Interview of Bryce DeWitt and Cecile DeWitt-Morette by Kenneth W. Ford on 1995 February 28, Niels Bohr Library & Archives, American Institute of Physics, College Park, MD USA. Retrieved: [www.aip.org/history-programs/niels-bohr-library/oral-histories/23199](http://www.aip.org/history-programs/niels-bohr-library/oral-histories/23199)
- LIGO-India proposal:  
[https://dcc.ligo.org/public/0075/M1100296/002/LIGO-India\\_1w-v2.pdf](https://dcc.ligo.org/public/0075/M1100296/002/LIGO-India_1w-v2.pdf)
- LISA (2019) official website:  
<https://www.lisamission.org/articles/lisa-mission/lisa-mission-gravitational-universe>
- The Nobel Prize in Physics 2017, NobelPrize.org. Nobel Media AB 2019. Wed. 16 Oct 2019. <https://www.nobelprize.org/prizes/physics/2017/summary/>
- Nature article:  
Prudêncio M, Costa JC (2020) Research funding after COVID-19. Nat. Microbiol 5:986. <https://www.nature.com/articles/s41564-020-0768-z>
- Nasa.gov:  
<https://starchild.gsfc.nasa.gov/docs/StarChild/questions/redshift.html>  
[https://map.gsfc.nasa.gov/mission/sgoals\\_parameters\\_geom.html](https://map.gsfc.nasa.gov/mission/sgoals_parameters_geom.html)  
[https://map.gsfc.nasa.gov/universe/uni\\_fate.html](https://map.gsfc.nasa.gov/universe/uni_fate.html)  
<https://science.nasa.gov/astrophysics/focus-areas/what-is-dark-energy>  
<https://spaceplace.nasa.gov/review/dr-marc-space/center-of-universe.html>
- Astronomy notes:  
<https://www.astronomynotes.com/cosmolgy/s9.htm>
- The Kavli Foundation :  
<https://www.kavlifoundation.org/2014-astrophysics-citation>
- George Djorgovski's CalTech lecture 3: Cosmological Models and Distances:  
[https://www.astro.caltech.edu/~george/ay21/Ay21\\_Lec03.pdf](https://www.astro.caltech.edu/~george/ay21/Ay21_Lec03.pdf)
- Youtube video by minutephysics on Schrödinger's cat thought experiment:  
<https://www.youtube.com/watch?v=IOYyCHGWJq4>
- Prof. Nick Bostrom's website:  
<http://www.anthropic-principle.com/>
- The Big Bang Observer, presentation:  
<https://dcc.ligo.org/public/0002/G0900426/001/G0900426-v1.pdf>

## Selected Additional References on the Subjects – Non-Cited in the Above Running Text

- Adair R (1987) *The Great Design: Particles, Fields and Creation*. The Oxford University Press, NY.
- Balibar F (1993) (ed) *Albert Einstein, œuvres choisies, volume 1 : Quanta*. Éditions du Seuil / Éditions du CNRS, Paris.
- Balibar F (ed) (1993) (ed) *Albert Einstein, œuvres choisies, volume 2 : Relativités*. Éditions du Seuil / Éditions du CNRS, Paris
- Borel É (1914) *Introduction géométrique à quelques théories physiques*. Gauthier–Villars, Paris.
- Brown K (2018) *Reflections on Relativity*, lulu.com, Chap.3.2. Retrieved: <https://www.mathpages.com/rr/s3-02/3-02.htm>
- Campbell WW, Trumpler R (1928). Observations made with a pair of five-foot cameras on the light-deflections in the Sun's gravitational field at the total solar eclipse of September 21, 1922. *Lick Observatory Bulletin* 397(13):130-160.
- Damour T, Darrigol O, Duplantier B, Rivasseau V (2006) (eds) *Einstein, 1905–2005. Poincaré Seminar 2005*. Birkhäuser Verlag, Basel.
- Darrigol O (2006) *The Genesis of the theory of relativity* En : Damour T, Darrigol O, Duplantier B, Rivasseau V (eds) 2006, *Séminaire Poincaré 1:1–22*, op. cit.
- Dirac PAM (1978) *Direction in Physics*. Wiley, NY.
- Einstein A (1905a) *Zur Elektrodynamik bewegter Körper*, *Annalen der Physik* 17: 891
- Einstein A (1905b) *Ist die Trägheit eines Körpers von seinem Energieinhalt abhängig?* *Annalen der Physik* (ser. 4), 18, 639–641.  
Retrieved: <https://onlinelibrary.wiley.com/doi/epdf/10.1002/andp.19053231314>
- Einstein A (1915) *Erklärung der Perihelbewegung des Merkur aus der allgemeinen Relativitätstheorie* Von A. Einstein above theoretical premises. Retrieved: [http://articles.adsabs.harvard.edu/cgi-bin/get\\_file?pdfs/SPAW/1915/1915SPAW.....831E.pdf](http://articles.adsabs.harvard.edu/cgi-bin/get_file?pdfs/SPAW/1915/1915SPAW.....831E.pdf)
- Einstein A (1916) *Die Grundlage der allgemeinen Relativitätstheorie* (The Foundations of the General Theory of Relativity). *Annalen der Physik*. 49:769-822. Retrieved: <https://onlinelibrary.wiley.com/doi/abs/10.1002/andp.200590044>
- Einstein A ([1921] 2005) *Quatre conférences sur la théorie de la relativité*. [Texte de quatre conférences prononcées à l'université de Princeton en 1921] Dunod, Paris.
- Einstein A ([1934] 1983) *Comment je vois le monde*. Flammarion–Champs, Paris.
- Einstein A, Infeld L (1993) *L'évolution des idées en physique*. Flammarion–Champs, Paris.
- Einstein A (1927). *Newtons Mechanik und ihr Einfluss auf die Gestaltung der theoretischen Physik*, *Naturwissenschaften* 15:273–276. Trad. fr. par le Cnel Cros. *La mécanique de Newton et son influence sur l'évolution de la physique théorique*. En : Einstein A [1934]1983, pp. 180–193, op. cit.
- Einstein A (1956) *La théorie de la relativité restreinte et générale*. Gauthier–Villars, Paris
- Einstein A (1991) *Œuvres choisies*. Éditions du Seuil, Paris.
- Feynman R (1985) *QED: The Strange Theory of Light and Matter*. Princeton University, Princeton, NJ.
- Hawking SW, Israel W (1980) (eds) *General relativity. An Einstein centenary survey*. The Cambridge University Press, Cambridge.
- Holton G (1988) *Thematic Origins of Scientific Thought: Kepler to Einstein*. The Harvard University Press, Cambridge–MA.
- Kepler J ([1606] 1859) *De stella nova in pede Serpentarii* [Prague, Ex Officina calcographica Pauli Sessii]. *Opera Omnia*. Vol. II, Frankfurturti et Erlangae [see also: KGW, I, pp. 147-292].
- Kepler J (1596) *Prodromus dissertationum cosmographicarum seu mysterium cosmographicum*. In KGW, I.

- Kepler J (1609) *Astronomia Nova AITIOAOΓETOS seu phisica coelestis tradita de commentariis de motibus stellae Martis ex observationibus G. V. Tychoonis Brahe.* In KGW, III.
- Kepler J (1618–1621) *Epitome astronomiae copernicanae.* In KGW, VII.
- Kepler J (1621) *Mysterium Cosmographicum (editio altera).* In KGW, VIII.
- Kepler J (1624) *Chilias logarithmorum ad totidem numeros rotundus, praemissa demonstratione legitima ortus logarithmorum eorumque usus.* In KGW, IX, pp. 275–352.
- Kepler J (1625) *Supplementum chiliadis logarithmorum, continens praecepta de eorum usu.* In KGW, IX, pp. 353–426.
- Kepler J (1981) *Mysterium Cosmographicum (The Secret of the Universe).* Abaris Book, New York.
- Kepler J (1992) *New Astronomy.* Translation of *Astronomia Nova* by William H. Donahue. The Cambridge University Press, Cambridge.
- Kepler J (1993) *Le Secret du monde.* Gallimard, Paris.
- Kepler J (2010) *Kurze Darstellung der kopernikanischen Astronomie.* Nachwort von Eberhard Knobloch. Deutsche, Übersetzung von Eberhard Knobloch und Otto und Eva Schönberger. Königshausen & Neumann. Würzburg.
- Kepler J (1937–2012) *Johannes Kepler, Gesammelte Werke.* Van Dyck W, Caspar M. et al. (eds.). Revised April 2013. 10 Vols. Deutsche Forschungsgemeinschaft und Bayerische Akademie der Wissenschaften. Beck'sche Verlagsbuchhandlung, München.
- Kragh H, Marage P, Vanapamel G (2002) (eds) *The history of Modern Physics.* Brepols, Liège.
- Lämmerzahl C, Neugebauer G (2001) *The Lense-Thirring Effect: From the Basic Notions to the Observed Effects.* Lecture Notes in Physics book series Vol. 562.
- Lecat M (1924) *Bibliographie de la relativité.* Lamertin, Bruxelles.
- Lense J, Thirring H (1918) *Über den Einfluss der Eigenrotation der Zentralkörper auf die Bewegung der Planeten und Monde nach der Einsteinschen Gravitationstheorie.* *Physikalische Zeitschrift* 19/156-63.
- LIGO Scientific Collaboration and Virgo Collaboration, Abbott BP, *et al.* (2016a) *Binary Black Hole Mergers in the First Advanced LIGO Observing Run.* *Physical Review X* 6, 041015, American Physical Society. DOI: 10.1103/physrevx.6.041015. Retrieved: <https://arxiv.org/abs/1606.04856>
- LIGO Scientific Collaboration and Virgo Collaboration Abbott BP, *et al.* (2016b) *Properties of the Binary Black Hole Merger GW150914.* *Phys. Rev. Lett.* 116, 241102, American Physical Society. DOI: 10.1103/PhysRevLett.116.241102 Retrieved: <https://journals.aps.org/prl/pdf/10.1103/PhysRevLett.116.241102>
- LIGO Scientific Collaboration and Virgo Collaboration Abbott BP, *et al.* (2016c) *Astrophysical Implications of the Binary Black Hole Merger GW150914.* *The Astrophysical Journal Letters, The American Astronomical Society*, 818/2:L22. Retrieved: <https://doi.org/10.3847/2041-8205/818/2/L22>
- LIGO Scientific Collaboration and Virgo Collaboration, Abbott BP, *et al.* (2016d) *Improved Analysis of GW150914 Using a Fully Spin-Precessing Waveform Model.* *Phys. Rev. X* 6, 041014. DOI: 10.1103/PhysRevX.6.041014. Retrieved: <https://journals.aps.org/prx/pdf/10.1103/PhysRevX.6.041014>
- LIGO Scientific Collaboration and Virgo Collaboration, Abbott BP, *et al.* (2016e) *GW151226: Observation of Gravitational Waves from a 22-Solar-Mass Binary Black Hole Coalescence.* *Phys. Rev. Lett.* 116, 241103. DOI: 10.1103/PhysRevLett.116.241103. Retrieved: <https://arxiv.org/ftp/arxiv/papers/1606/1606.04855.pdf>
- LIGO Scientific Collaboration and Virgo Collaboration, Abbott BP, *et al.* (2017) *Observation of a 19-Solar-Mass Binary Black Hole Coalescence.* *The Astrophysical Journal Letters*, 851:L35. DOI: <https://doi.org/10.3847/2041-8213/aa9f0c>

- LIGO Scientific Collaboration and Virgo Collaboration, Abbott BP, *et al.* (2017a) GW170814: A Three-Detector Observation of Gravitational Waves from a Binary Black Hole Coalescence. *Phys. Rev. Lett.* 119, 141101, American Physical Society. DOI:<https://doi.org/10.1103/PhysRevLett.119.141101>
- LIGO Scientific Collaboration and Virgo Collaboration, Abbott BP, *et al.* (2017b) GW170817: Observation of Gravitational Waves from a Binary Neutron Star Inspiral. *Phys. Rev. Lett.* 119, 161101. DOI: 10.1103/PhysRevLett.119.161101
- LIGO Scientific Collaboration and Virgo Collaboration, Abbott BP, *et al.* (2018) Observation of a 50-Solar-Mass Binary Black Hole Coalescence at Redshift 0.2. *Phys. Rev. Lett.* 118, 221101 (2017), Erratum *Phys. Rev. Lett.* 121, 129901 (2018), American Physics Society. Retrieved: <https://arxiv.org/pdf/1706.01812.pdf>
- LIGO Scientific Collaboration and Virgo Collaboration, Abbott BP, *et al.* (2019) GWTC-1: A Gravitational-Wave Transient Catalog of Compact Binary Mergers Observed by LIGO and Virgo during the First and Second Observing Runs. *Phys. Rev. X* 9, 031040, American Physical Society DOI: 10.1103/PhysRevX.9.031040. Retrieved: <https://journals.aps.org/prx/pdf/10.1103/PhysRevX.9.031040>
- LIGO Scientific Collaboration and Virgo Collaboration, Abbott BP, *et al.* (2019a) Binary Black Hole Population Properties Inferred from the First and Second Observing Runs of Advanced LIGO and Advanced Virgo. *Astrophys. J. Lett.* 882, L24. DOI:10.3847/2041-8213/ab3800. Retrieved: <https://arxiv.org/abs/1811.12940>
- Lorentz HA, Einstein A, Minkowski M, Weyl H (1923) *The principle of relativity. A collection of original memoirs on the special and general theory of relativity.* Dover, NY.
- Mapelli M, Giacobbo N (2018) The cosmic merger rate of neutron stars and black holes. *Monthly Notices of the Royal Astronomical Society*, Oxford University Press, Oxford, 479/4:4391-4398. DOI: 10.1093/mnras/sty1613. Retrieved: <https://arxiv.org/abs/1806.04866>
- McKernan B, Ford KES, Bellovary J, Leigh NWC, Haiman Z, Kocsis B, Lyra W, Mac Low MM, Metzger B, O'Dowd M, Endlich S, Rosen DJ (2018) Constraining Stellar Mass Black Hole Mergers In Agn Disks Detectable With Ligo. Retrieved: <https://arxiv.org/pdf/1702.07818.pdf>
- Miller MC, Miller JM (2014) The Masses and Spins of Neutron Stars and Stellar-Mass Black Holes. *Physics Reports*, Elsevier, Volume 548, pp. 1-34. DOI:10.1016/j.physrep.2014.09.003. Retrieved: <https://arxiv.org/abs/1408.4145>
- Max Born M ([1923] 2003) *La théorie de la relativité d'Einstein et ses bases physiques.* Gabay, Paris.
- Nagel E (1961) *The Structure of Science: Problems in the Logic of Scientific Explanation.* Harcourt-Brace & World Inc, New York.
- Nakar E (2007) Short-Hard Gamma-Ray Bursts. *Phys.Rept.*442:166-236, Elsevier. DOI:10.1016/j.physrep.2007.02.005. Retrieved: <https://arxiv.org/abs/astro-ph/0701748>
- Neil Ashby N (2002) Relativity and the Global Positioning System. *Physics Today* 55/5:41-47.
- Newton I ([1713], 1729) *The Mathematical principles of natural philosophy.* Translated by Motte Andrew. Motte B, London.
- Newton I ([1726; 1739-1742], 1822), *Philosophiae Naturalis Mathematica Principia*, auctore Isaaco Newtono, Eq. Aurato, perpetuis commentariis illustrata, communi studio Pp. Thomae Le Seur et Francisci Jacquier ex Gallicana minimorum familia, matheseos professorum. Editio nova (in three volumes). Duncan, Glasgow.
- Newton I (1687) *Philosophiae Naturalis Principia Mathematica.* Imprimatur S. Pepys, Reg. Soc. Preses. Julii 5. 1686. Londini, Jussi Societatus Regiae ac Typis Josephi Streater. Prostat apud plures Bibliopolas. Anno MDCLXXXVII.
- Pais A (2005) *Albert Einstein – Sa vie, son œuvre, Interéditions.* Dunod, Paris.

- Pardo K, Fishbach M, Holz DE, Spergel DN (2018) Limits on the number of spacetime dimensions from GW170817. *Journal of Cosmology and Astroparticle Physics*, IOP Publishing. DOI:10.1088/1475-7516/2018/07/048. Retrieved: <https://arxiv.org/abs/1801.08160>
- Pirani FAE (2009) Republication of: On the physical significance of the Riemann tensor. *Gen. Relativ. Gravit.* 41:1215-1232. DOI: 10.1007/s10714-009-0787-9. *Original paper*: Pirani FAE (1956) On the physical significance of the Riemann tensor. *Acta Physica Polonica* 15, 389-405. Reprinted with the kind permission of the Editors of *Acta Physica Polonica* and of Felix Pirani.
- Paty M (2004) *Albert Einstein, ou la création scientifique du monde*, Belles Lettres, Paris
- Paty M (1979) Sur le réalisme d'Albert Einstein. *La Pensée* 204:18–37.
- Paty M (1999) La création scientifique selon Poincaré et Einstein. En : Serfati M (ed) *La recherche de la vérité : Coll. « L'Écriture des Mathématiques »*, ACL–Éditions du Kangourou, Paris, pp 241–280.
- Paty M (2003) *La physique du XXe siècle*. EDP Sciences, Les Ulis.
- Penrose R (2004) *The Road to Reality. A complete guide to laws of the universe*. Knopf, NY.
- Pisano R (2008) A history of chemistry à la Koyré? Introduction and setting of an epistemological problem. *Khimiya* 2/17:143–161.
- Pisano R (2011) Physics–Mathematics Relationship. Historical and Epistemological notes. In Barbin E, Kronfellner M and Tzanakis C (eds.), *Proceedings of the ESU 6 European Summer University History And Epistemology in Mathematics*. Verlag Holzhausen GmbH–Holzhausen Publishing Ltd., Vienna, pp. 457–472.
- Pisano R (2013a) History Reflections on Physics Mathematics Relationship in Electromagnetic Theory. In Barbin and Pisano 2013, pp. 31–58.
- Pisano R (2014) (ed.) *Isaac Newton and his Scientific Heritage: New Studies in the History and Historical Epistemology of Science*. Special Issue. *Advances in Historical Studies* 3/3.
- Pisano R (2016a) What kind of Mathematics in Leonardo da Vinci and Luca Pacioli? *Bulletin–British Society for the History of Mathematics* 31:104-111.
- Pisano R (2016b) A Development of the Principle of Virtual Laws and its Framework in Lazare Carnot's *Mechanics* as Manifest Relationship between Physics and Mathematics. *Transversal–International Journal for Historiography of Science*, 2:166-203.
- Pisano R, Bussotti P (2012) Galileo and Kepler: On Theoremata Circa Centrum Gravitatis Solidorum and Mysterium Cosmographicum. *History Research* 2/2:110–145.
- Pisano R, Bussotti P (2013) Notes on the Concept of Force in Kepler. In Pisano, Capecchi and Lukešová 2013, pp. 337–344.
- Pisano R, Bussotti P (2014a) Galileo in Padua: architecture, fortifications, mathematics and “practical” science. *Lettera Matematica Pristem International* 2/4:209–221.
- Pisano R, Bussotti P (2015b) Introduction to Exploring Changes in How the Histories of the Exact Sciences from the 18th to through the 20th Century Have Been Written: Interpreting the Dynamics of Change in these Sciences and Interrelations Amongst Them—Past Problems, Future Cures? *Advances in Historical Studies Special Issue* 4/2:65-67.
- Pisano R, Bussotti P (2016) A Newtonian Tale Details on Notes and Proofs in Geneva Edition of Newton's *Principia*. *Bulletin–British Society for the History of Mathematics* 32:1–19.
- Pisano R, Capecchi D (2013) Conceptual and Mathematical Structures of Mechanical Science in the Western Civilization around 18th Century. *Almagest* 4/2:86–121.
- Pisano R, Capecchi D (2015) Tartaglia's science weights. *Mechanics in sixteenth century*. Selection from Quesiti et invention diverse: Books VII–VIII. Dordrecht, Springer.
- Pisano R, Capecchi D, Lukešová A (eds.) (2013) *Physics, Astronomy and Engineering. Critical Problems in the History of Science*. International 32nd Congress for The SISFA–Italian Society of Historians of Physics and Astronomy. The Scientia Socialis UAB & Scientific Methodical Centre Scientia Educologica Press, Šiauliai University, Lithuania.



- Pisano R, Fichant M, Bussotti P, Oliveira ARE (2017) (eds.) *Leibniz and the Dialogue between Sciences, Philosophy and Engineering, 1646-2016*. New Historical and Epistemological Insights. The College Publications, London.
- Pisano R, Gaudiello I (2009a) Continuity and discontinuity. An epistemological inquiry based on the use of categories in history of science. *Organon* 41:245–265.
- Pisano R, Gaudiello I (2009b) On categories and scientific approach in historical discourse. In Hunger H (ed.) *Proceedings of ESHS 3rd conference*. The Austrian Academy of Science, Vienna, pp. 187–197.
- Pisano R, Casolaro F (2011–sôumis) *Historical Inquiring On Geometry In Relativity. A Geometry Model (Part II) [CFV Cahiers]*
- Poincaré HJ (1900a) Les relations entre la physique expérimentale et la physique mathématique. *Revue générale des sciences pures et appliquées* 11:1163–1175
- Poincaré HJ (1900b) La théorie de Lorentz et le principe de réaction, *Archives néerlandaises des sciences exactes et naturelles* 5:252–278.
- Preskill J, Thorne KS (1995) Foreword to Feynman Lectures on Gravitation. In: *Feynman Lectures on Gravitation*, Addison-Wesley, University of Michigan.
- Renn J, Blum A, Damerow P (2011) *The Role of Gravitation in Physics Report from the 1957 Chapel Hill Conference Communicated by Jürgen Renn, Alexander Blum and Peter Damerow*. DeWitt CM, Rickles D (eds.), *Sources* 5, Edition Open Access, Oranienstraße 183, 10999 Berlin. ISBN 978-3-86931-963-6
- Schutz BF (1999) Gravitational wave sources and their detectability. *Class. Quantum Grav.* 6(12):1761-1780. DOI: 10.1088/0264-9381/6/12/006
- Schutz BF (2012) Thoughts About a Conceptual Framework for Relativistic Gravity. In: Lehner *et al.* (eds), *Einstein and the Changing Worldviews of Physics*, Einstein Studies 12, The Center for Einstein Studies, pp. 259-269.
- Taylor JH, Weisberg (1982) A new test of general relativity - Gravitational radiation and the binary pulsar PSR 1913+16. *Astrophysical Journal*, The American Astronomical Society, 253/1:908-920.
- Thorne KS (1987) *Three Hundred Years of Gravitation*. Hawking SW, Israel W (eds), Cambridge: Cambridge Univ. Press, p. 330.
- Taylor EF, Wheeler JA (1992). *Spacetime Physics: Introduction to Special Relativity*. W. H. Freeman. ISBN 978-0-7167-2327-1.
- Thirring H (1918) Über die Wirkung rotierender ferner Massen in der Einsteinschen Gravitationstheorie. *Physikalische Zeitschrift* 19, 33.
- Treschman KJ (2015) Recent astronomical tests of general relativity. *International journal of physical sciences*, Vol. 10(2), pp. 90-105. DOI: 10.5897/IJPS2014.4236
- Virgo Collaboration, Acernese *et al.* (2019) Increasing the Astrophysical Reach of the Advanced Virgo Detector via the Application of Squeezed Vacuum States of Light. *Phys. Rev. Lett.* 123, 231108. DOI:<https://doi.org/10.1103/PhysRevLett.123.231108>
- Wang Y, Stebbins A, Turner EL (1996) Gravitational lensing of gravitational waves from merging neutron star binaries. *Physical Review Letters*, American Physical Society, 77/14:2875-2878. DOI:10.1103/physrevlett.77.2875. Retrieved: <https://arxiv.org/abs/astro-ph/9605140>
- Weiss Rainer (1972) Electronically Coupled Broadband Gravitational Antenna. *Quarterly Progress Report, Research Laboratory of Electronics (MIT)*, N° 105, p. 54. Retrieved: [http://www.hep.vanderbilt.edu/BTeV/test-DocDB/0009/000949/001/Weiss\\_1972.pdf](http://www.hep.vanderbilt.edu/BTeV/test-DocDB/0009/000949/001/Weiss_1972.pdf)
- Whittaker ET (1953) The relativity theory of Poincaré and Lorentz. En: *A History of the theories of aether and electricity*. Vol 2: The modern theories 1900–1926. Nelson, London, pp. 27–77.
- Will CM (2015) Focus issue: Gravity Probe B. *Classical and Quantum*. IOP. 32(22):220301.
- Wolfgang R (2001) *Relativity: special, general and cosmological*. The Oxford University Press, Oxford.

- Zahar E (1987) Les fondements des mathématiques d'après Poincaré et Russell. *Fundamenta Scientiae* VIII 1987:31–56
- Zahar E (1989) *Einstein's Revolution: A Study in Heuristic*. The Open Court Publishing Company, Chicago.





## **PART III**

### **HISTORY OF PHYSICS & TEACHING NATURE OF SCIENCE TEACHING (NOS)**

#### **Gravitational Waves as Nature of Science Teaching**

## CHAPTER VI

### On the Nature of Science Teaching

*An outline.* In this part, I will explore what Nature of Science Teaching is, and how using this framework can be beneficial for the Teaching-Learning of advanced concepts. To begin with, I will start by discussing what science is and therefore what the nature of science is in order to define the theoretical framework for its teaching. Then I will examine the differences and similarities between different scientific fields and disciplines and how they come together in the Nature of Science Teaching framework which is interdisciplinary.

In particular, I will show how this interdisciplinary framework can be especially useful for the Teaching-Learning of the concepts related to the Gravitational Waves which are also interdisciplinary by their nature.

## Prologue III

*On Science and its Nature.* The “Nature of Science” is a more complicated subject than it first appears. Although a simple definition can easily be intuited by most people, a clear, precise definition is rather difficult to obtain from the general audience, non-scientists, pupils and even scientists in training because Science itself is a rather poorly understood concept often mistaken for some kind of dogma. Consequently, one of the main misconceptions is that Science cannot be questioned and is “the Truth”. The explanation behind this lack of understanding on the part of the general public about how science is done and what it is can easily be found when considering science textbooks and science teaching: the emphasis is put on science concepts, content and results rather than scientific education regarding how those were obtained and justified. This in turn can be explained by the (ever increasingly?) dense curricula which are restraining teachers in the content they have to teach and giving them learning objectives for their students or pupils to attain over the course of their teaching. Also, the science teachers themselves have usually not been taught science through the frameworks of History and Philosophy of Science (HPS) or Nature of Science (NoS).

As an introduction to this chapter, a brief attempt at defining Science and the scientific spirit shall be made.

Science is a method of investigation whose object of study is “reality”, what is “real”. It consists of a production and systematisation of knowledge obtained through methodologies and norms based on logic and a fundamental postulate: there is a “reality” that can be –objectively– studied and that exists independently. The fundamental postulate here is the exact opposite of the solipsism.

According to Charles Sanders Peirce (1839-1914), who was an American philosopher, everything that one is experiencing at all times, no matter the state of mind –or rather consciousness– is part of *their* “phaneron”:

[...] by the *phaneron* I mean the collective total of all that is in any way or in any sense present to the mind, quite regardless of whether it corresponds to any real thing or not. If you ask present *when*, and to *whose* mind, I reply that I leave these questions unanswered, never having entertained a doubt that those features of the phaneron that I have found in my mind are present at all times and to all minds. (Peirce 1905, p. 35)

Thus there is only one of two possibilities: either all of what we experience is merely an illusion, just like in solipsism or like a Boltzmann brain<sup>130</sup>, or what we experience is part of an external world that really exists. In the latter case,

---

<sup>130</sup> Loosely, a Boltzmann brain is described as part of a thought experiment in which given enough time (a tremendous amount) random quantum fluctuations in the void which can spontaneously generate particles would eventually give rise to the extremely unlikely event of spontaneously generating a complete brain comprising a set of memories of having existed in our world. (Carroll 2017, p. 7)

this implies that what we perceive of this “real” world is limited by our perceptions. In other words, there exists a world separate from *us* of which we can only perceive a small fraction due to the limited ability of our senses and consciousness. For instance, we can only perceive a very narrow band of the electromagnetic spectrum, i.e. visible light. In either case, the pursuit of discovering the rules underlying this perceived reality can be undertaken –even if it would be pointless in the case of solipsism– in other words, the world is understandable. As a corollary, the fundamental hypothesis at the basis of Science is that if the world is understandable, that necessarily implies that it has an internal logic. Therefore, a simple definition of what Science is could be that Science is the study of reality based on logic.

From this, the questions of Why and How to do Science arise. The question regarding the motivations to do Science is very straight forward, understanding the world is essential for many pragmatic reasons: to survive, to improve our existence, to make predictions, to modify our environment, etc. but there are also more philosophical reasons behind this need to understand the world. For example: curiosity, as learning is one of the basic human functions.

For the second question, the “How”, the first step is to recognize that not all information about reality is available to us. For instance, as previously discussed, there are limiting factors to what information about “reality” can be obtained. The first limiting factor is that no matter what, we are constricted by our *phaneron*. In order to make progress, we are forced to realize that what Peirce calls the *phaneron* is nothing else but the construct of reality interpreted by the brain and at the same time our only window to what is *real*. Therefore, arises the question of how do we explore the rest of the world if we are limited by our senses: with instruments which will serve the purpose of artificially extending our senses.

Putting this and the associated problems aside –such as “To what extent can we trust our senses and by extension our instruments?”–, all things being equal, we are forced to make some more assumptions<sup>131</sup>:

- Isotropy of space: it is possible to rotate things in space and the laws of physics do not change
- Homogeneity of space: it is possible to translate things in space and the laws of physics do not change
- Homogeneity of time: it is possible to translate things in time and the laws of physics do not change
- Principle of Relativity (and the declinations): the laws of physics should take the same form for everyone

Keeping in mind these considerations, Science becomes the endeavour of identifying invariants, patterns and estimating the probability of different outcomes of events in order to extract the rules of nature at play in these events.

---

<sup>131</sup> These assumptions are assumed valid for the universe in general far from any local disturbances (i.e. in an hypothetical lab in deep space)



The pragmatic aim of this case study is the teaching of gravitational waves through a Nature of Science approach, including but not limited to Physics, Mathematics, History of Science, and Epistemology. There is a very wide range (Doneva 2006) of teaching strategies and approaches (including but not limited to: lecturing, project based, inquiry based, problem based, phenomenon-based learning, and many others) which also include common features and variations depending on the usual factors (e.g. material available, location, time constraints, number of students, levels of learners).

For instance, one variation could be the study of different possible approaches and strategies that can include electronic media (Velazquez 2008, p. 19):

- Games and simulations
- Learning based on problem solving
- Role playing
- Presentation
- Discussion panel
- Brainstorming
- Case Study
- Question and answer method
- Project design method

Each of these methods have main advantages and drawbacks. However, the selected approaches are most often chosen based on the constraints limiting the teaching rather than based on which could be the best suited for the learners. Indeed, this matter of fact, although quite unfortunate, is nevertheless an ineluctable consequence of feasibility. For instance, it would be unreasonable to use an individual project based approach for the 400 students of a first semester course in any degree for obvious reasons.

Therefore, pondering the different types of approach for the teaching of gravitational waves, and taking into account that the proposed curricula is mainly aimed towards first year undergraduate students, the selected approach for this case study is a mixed approach of lectures and phenomenon-based/inquiry based on each module and the curricula as a whole.

This mixed approach has been chosen because of its very grounded, anchored in the real world, nature thereby avoiding as much as possible problems such as the epistemological breaks discussed in later in this Chapter. Furthermore, this approach also provides contexts from different fields which allows to demonstrate to the learners the direct utility and value of the concepts and information being studied through examples of their application.

The proposed curricula consists of a modular programme in which each of the modules can be standalone courses/lectures and taught in no particular order. This design feature presents many advantages such as being easily

adaptable because of its interdisciplinarity; as it includes not only scientific disciplinary matters but also interdisciplinary issues including history, historical epistemology, logic and the foundations of physical and mathematical sciences, science and technology studies. Thus, a multidisciplinary teaching approach based on a case study that encompasses large themes, problems, challenges and their history is of tremendous value for a scientific education based on different formulations of the same theories and how each of these formulations relate to one another.

This also has the consequence that the actors are less confronted by problems such as boredom or other kinds of mental saturation coming from the monotony of being confined in one particular scientific disciplinary matter.

Additionally, the modular programme design is very versatile and allows the teacher to engage the students with each module in no –strong– particular order. This particular feature is potentially of great importance as it allows the teacher to have a certain freedom and the possibility to select a more or less demanding module for the students; for example, it is not uncommon for students to be less attentive and involved in lectures during the periods closer to vacations.

## 6 On the Nature of Science Teaching

The Nature of Science is a process for producing knowledge which is subject to change. On that point, one of the key features of this process, as Epistemology taught us, would be that nothing can be proved true with perfect certainty, the only definitively true statements being refutations. As Richard Feynman put it in a casual way:

Suppose that you invented a good guess, calculate the consequences, and discover every time that the consequences you have calculated agree with experiment. The theory is then right? No, it is simply not proved wrong. In the future you could compute a wider range of consequences, there could be a wider range of experiments, and you might then discover that the thing is wrong. That is why laws like Newton's laws for the motion of planets last such a long time. He guessed the law of gravitation, calculated all kinds of consequences for the system and so on, compared them with experiment – and it took several hundred years before the slight error of the motion of Mercury was observed. During all that time the theory had not been proved wrong, and could be taken temporarily to be right. But it could never be proved right, because tomorrow's experiment might succeed in proving wrong what you thought was right. We never are definitely right, we can only be sure we are wrong. (Feynman 1965, p. 157-158)

In this thesis, the theoretical framework of Nature of Science which we will use is the same one as defined by Prof. William F. McComas:

The phrase “history and philosophy of science” (HPS) has been used to describe the interplay of disciplines that inform science education about the character of

science itself. However, a more encompassing phrase to describe the scientific enterprise for science education is the “nature of science” (NOS). The nature of science is a fertile hybrid arena which blends aspects of various social studies of science including the history, sociology, and philosophy of science combined with research from the cognitive sciences such as psychology into a rich description of what science is, how it works, how scientists operate as a social group and how society itself both directs and reacts to scientific endeavors. The intersection of the various social studies of science is where the richest view of science is revealed for those who have but a single opportunity to take in the scenery. The nature of science is not particularly concerned with the natural world in the way that science itself is, at least not directly. The scientific community consists of individuals who devote their careers to better understanding the natural world. This community of experts determines which ideas best account for natural phenomena. Those who study the nature of science come from many diverse fields and investigate science and scientists by asking questions such as “What, if anything, demarcates science from other human endeavors?”, “Are science ideas discovered or invented?”, and “How is consensus reached in the scientific community?” (Mc Comas 2002, p. 4)

The Nature of Science is an interdisciplinary product of science and its foundations, whether historical, epistemological or scientific. In particular, it incorporates in its investigations the notions of limits, modelling, methods and methodologies in scientific practices. It is not just the addition of History and Philosophy of Science as another item on top of the science curricula, but the incorporation of approaches and HPS elements to teaching science based on the assumption that using adjacent and surrounding fields contributes to a greater understanding of science items, content, and therefore to a better understanding of science.

The study, and by extension the teaching of the Nature of Science, should be considered as essential as it is a complex subject encompassing many elements that are key both to our cultural heritage and to teaching science in order to produce scientists. These elements include discussions on the scientific method and objectivity, how to differentiate science from pseudo-science, how evidence is obtained in its historical and philosophical context, how the gathering of evidence impacts theories, etc.

This framework studies the relevance and added value of philosophical and historical knowledge for the development of teaching courses. However, it should be noted that this does not imply that history or history of science make an appearance in the designed lessons as such. In fact, it has been argued (cfr. the Piagetian thesis; Radford 1997, p. 28) that individual psychological development is similar to the development of concepts in the history of science. The main goal being teaching the history of science and the right methods rather than just the results.

From this it logically follows that the objectives of NoS Teaching are pluridisciplinary and/or interdisciplinary in essence.

## 6.1 Interdisciplinary Comparative Teachings

Science is subdivided into many fields. Without having the need to refer to the –perhaps overused– different types of scientific fields (formal sciences, exact sciences, biology, humanities), it seems essential to recognize that there is a Russian doll component. For instance, biological results can be explained by Chemistry which in turn can be explained by Physical processes; a more straightforward example to illustrate the interdisciplinarity that so very often arises would be the wave–particle duality which involves both the Physics of Wave and the Physics of Particles or maybe simply the use of Mathematics and mathematical tools in Physics.

However, all the scientific fields –by definition– have the common feature that they rely on logic and evidence to make progress. This implies that there is common ground on which to stand on for all NoS teaching units. At this point it would seem reasonable to reflect on the question about the benefits of such lectures in order to evaluate their relevance in comparison to standard science lectures.

This interdisciplinarity is intrinsically omnipresent in Science –although a case could be made for “pure” mathematics– and interdisciplinary teachings have many benefits. Similarly, comparative didactics seek to study the interplays of disciplinary didactics. The idea is to compare disciplinary didactics in order to identify the common and specific parts which depend both on the teaching and learning objects and on the interactions between the elements of the studied system (content, teacher, learners). Each disciplinary didactics has its own history; which is explained on the one hand by the institutional environment with a separation of the different subjects of study (e.g., Languages, Civic Education, Science, Physical Education, Plastic Arts) themselves subdivided into different subjects (e.g., French, English, Spanish, Mathematics, Physics, Biology); and on the other hand by their different epistemological foundations (Sarremejane 2001; Sensevy 2013).

At present, the different disciplinary didactics are differentiated precisely by their object: the discipline they study, which has the consequence of greatly restricting the global vision, or the number of facets in which an object or content can be perceived and studied (for example, think of the different nuances that exist for mathematicians and physicists when asked to consider derivatives). However, the theoretical framework of NoS is a naturally interdisciplinary framework (conceived and designed as such).

The idea here is therefore to identify the specificities of the different disciplinary didactics conveyed by the NoS framework and to combine them as best as possible with each other and with related disciplines.

Thus, it will be a question of taking a point of view focusing on content and its teaching–learning rather than a more restricted point of view taking into account educational institutions and learning environments. This teaching–learning perspective will widen the horizon linked to the objects, concepts and knowledge taught in order to best study the epistemological

perspectives offered by the prism of NoS within the framework of educational sciences. It is a matter of trying as best as possible to have a global vision and of avoiding some sort of disciplinary isolation while delimiting the field of research so as to achieve a certain balance between the different fields studied and their interactions; it is not a question of trying to study or develop a kind of universal didactics, but rather to do research within the framework of the nature of science more on the substance than the form. Indeed:

Beyond merely gaining a better understanding of classroom practice, the purpose of this comparative stance is to elaborate a new comprehensive network of concepts and methods through theoretical/empirical clarifications, supported by pragmatist philosophical considerations. (Ligozat 2015)

The subject matter of gravitational waves and the history of their discovery alone calls upon a certain number of disciplines (e.g., physics, mathematics, history, epistemology) and its teaching invokes even more (e.g., psychology, neurosciences, philosophy). The comparison will therefore rather be made on the disciplinary teachings and learnings as they are described by the didactics by comparing in particular concepts common to several disciplines (Sensevy 2002, Ligozat 2017), their differences in use (Dias-Chiaruttini 2017e) and their foundations: e.g., epistemological obstacles, didactic transposition; joint action theory (Brun 2017).

Finally, it will be a question of explaining the choice of the conceptual system applied to this theoretical framework that tries to combine the specificities of different didactics, which is justified by the epistemological foundations and the multidisciplinary nature of NoS.

Putting aside the neuro-biological aspects of how knowledge is acquired and stored, one certain thing is that learning involves repetition and association (Gallistel 2011). Although the case could be made that repetition is not necessary for certain individuals –with photographic memory for example– association at the very least is a *sine qua non* component of learning –whether done intentionally or not.

From this last point results the natural assumption that the richer the associations of an item, concept or idea, the easier it is to recall and use. More particularly, for Nature of Science Teaching, the contextualisation of science in History contributes to science teaching on many aspects, e.g.:

- it motivates pupils and students by providing them with often compelling stories and stimulates their imagination through the use of make believe situations through which they can place themselves in the shoes of the scientists and their era, and thus can better appreciate the limitations that they encountered
- it humanises the subject matter, for example, by providing them with examples of everyday life solutions or errors scientists made, confirmation bias, moral and ethical problems, etc.
- it promotes better comprehension of the scientific concepts by tracing their development and refinement or even by using the replication of historical experiments
- it demonstrates that science is not fixed and can be changeable, and consequently, that current scientific knowledge and its understanding is subject to transformations
- it contests (pseudo-)scientific ideologies
- it allows a richer understanding of scientific methods, development and application
- it illustrates the changes in accepted methodology, paradigm shifts, etc.

We will examine how Nature of Science Teachings have positive effects on the learning of science, the didactical understanding of students and teachers, the development of the understanding of the nature of science, scientific and technological activities, the development of the teachers' pedagogical resources, the interest in science; and a better understanding that science is a cultural, intellectual and human endeavour.

## **6.2 History of Mathematics and Mathematics Teaching**

The addition of an historical perspective in science teaching aims to use history as a framework in which the problematization of the objects or concepts of the science lecture emerges naturally rather than a framework describing the then problematization. This addition can therefore be considered more like a pedagogical tool usable to help the students understand the taught concepts rather than a formal teaching of history of science (Clark 2016).

This implies that there has to be an identification of the relevant parts of the historical components; which parts ought to be selected and how

much of them are effectively contributing to the lecture has to be determined (Barbin 1997). Whomever has to do this research, in the end the lessons will be given by the teachers who will therefore need to be educated in the matter. From this naturally follows that the teachers need to have knowledge of the historical aspects of what they are teaching along with an epistemological understanding of it. (Clark 2012)

The establishment of an historical perspective in science teaching is often based on the assumptions that the development of concepts is easier when put in its historical context and that it goes through a series of –more or less well defined– steps that can be identified in order, hopefully, to be replicated during the lecture thus leading the students to understand the taught concepts.

For example, learning about the history of quantum physics through the historical narrative is much easier than starting with postulating of the new non-intuitive formalism reflecting a completely new vision of reality. (Galili 2008, p. 2)

This assumption is often based on another, which is the underlying hypothesis that the students attending such lectures will in fact follow a similar step by step process in their intellectual development that is supposed analogous to the historical process the scientists underwent as postulated by Piaget’s genetic epistemology (Piaget 1973).

Studies have shown (Yildiz 2013; Radford 1997; Lakatos 1971, 1980; Gabel 1993; Bage 1999; Schleppegrell 2003; Radelet-de Grave 2009; Kelly 2012; Hodson 2014) that the establishment of an historical perspective in science teaching is also a source of motivation for the learners –and the teachers– but, maybe especially for mathematics, poses the question of the kind of historical content that should be added: should this historical content be an anecdote, a narrative or something else?

For a didactical treatment of the question (Waldegg 1997), which is more concerned with the cognitive aspects, the selection of the historical content should focus on the learning process with an epistemological point of view; ontology and evolution of notions and theories, conditions regarding the construction of knowledge, etc. In our example, the key being to identify the different steps of the cognitive development and select the observables relevant to the theoretical framework considered. In general, the choice should be guided by the determination of the epistemological obstacles (Bachelard 1934) on which the didactical transposition depends without, of course, neglecting the usual variables (culture, social background, institutional background, cognitive, emotional aspects; Radford 1997, p. 28).

Through the use of historical problems, students can appreciate that mathematical problems can be solved in different ways and they can be exposed to different approaches used in history, whether theoretical or more practical. They also can better grasp that mathematical research is a rather “bushy process” often encompassing big chronological lapses, a process in which mathematics are not simply a collection of well-defined

and deductively organized results, but the result of flourishing intellectual activity across time and space.

Replacing mathematics, or physics, in historical context also allows to challenge and evaluate how well a concept is understood by the students by confronting their knowledge of the subject with the same mathematical object in a different environment. Therefore showing how the transition from the historical discovery to the final product happened.

Another, more practical, advantage is that teachers sometimes struggle to find appropriate problems to motivate students and/or confront them with the concepts from other angles. Fortunately, the history of mathematics contains a great number of historical problems which can enrich the teachers' lessons and the students' apprehension of mathematics while keeping them engaged in the object of the lecture.

This also makes sure that mathematics, which is often regarded as a discipline which is difficult, elitist, undecipherable, impenetrable, abstract, frightening, daunting, etc., remains a humane endeavor and not some kind of divine gift. On the contrary, the inclusion of the history of mathematics shows that there are new mathematics developed constantly, that there are elegant proofs, clumsy ones, mistakes, wrong suppositions, and that there are multiple ways<sup>132</sup> to get a demonstration, to a result or to retrieve one, and so on.

Furthermore, an important benefit of using the history of mathematics in mathematics teaching is that it allows to answer a number of questions such as:

It can explain a great deal of the “whys” in mathematics. Why do we use such words as *numerator*, *average*, *radius*, and *hypotenuse*? Why do we have sixty minutes in an hour or seven days in a week? Why do we use symbols in mathematics? Why do we use the equals sign? All conventions arose through various reasons, which can be discovered by reading history and researching etymology. (Bidwell 1993, p. 461)

Beyond displaying mathematics in an unfamiliar way to challenge and engage both the teachers and the students, this also deepens the understanding that mathematical tools are invented and thus are evolving with our understanding –whether mathematics are invented or discovered– and this is also a great way to use the discovery method, in which the students are guided by their teacher in such a way that they should discover the mathematics for themselves.

Furthermore, the incorporation of the history of mathematics also serves a cultural role and the duty of remembrance. The development of mathematics is both acted upon by history and one of its motors. To retake Sir. William Kingdon Clifford's expressions, the history of mathematics and our understanding of mathematics is co-dependant of a “Then” and

---

<sup>132</sup> Different styles also: Gauss, Bolyai, Lobachevsky.



“Now” which take place in specific contexts throughout the development of humanity.

Finally, studies have shown that for the teachers, “the results indicated significant improvement of attitudes, particularly about the satisfaction from and the usefulness of mathematics”. (Philippou 1998; Galante 2014)

### 6.3 History of Physics and Physics Teaching

The introduction of the History of Physics in Physics Teaching is not a new idea. In fact, it was already promoted by Ernst Mach (1838-1916; 1911) and Pierre Duhem (1861-1916; 1906) rather strongly (Galili 2008). Indeed, in his “History and root of the Principle of the conservation of energy” of 1911, Mach wrote:

[...] either one grows accustomed to the puzzles and they trouble one no more, or one learns to understand them by the help of history and to consider them calmly from that point of view. (Mach [1911] 1973, pp. 15-16)

Quite analogous difficulties lie in wait for us when we go to school and take up more advanced studies, when propositions which have often cost several thousand years' labour of thought are represented to us as self-evident. Here too there is only one way to enlightenment: historical studies. (*Ivi.* p.16)

This clearly indicates that he believed that the study of the history of science and its foundations were necessary for teaching science to students to prevent them from falling in disenchantment with their object of study, and to avoid them having to just accept some “self-evident” results; which is a problem students still face sometimes nowadays and usually justified by the lack of time of the professor to cover the material. Here, according to Mach, incorporating the history of science in science teaching has at the very least the added value of allowing the learners to get multiple points of view:

Indeed, if from history one learned nothing else than the variability of views, it would be invaluable. [...]

Whoever knows only one view or one form of a view does not believe that another has ever stood in its place, or that another will ever succeed it; he neither doubts nor tests. If we extol, as we often do, the value of what is called a classical education, we can hardly maintain seriously that this results from an eight-years' discipline of declining and conjugating. We believe, rather, that it can do us no harm to know the point of view of another eminent nation, so that we can, on occasion, put ourselves in a different position from that in which we have been brought up. The essence of classical education is historical education. (*Ivi.* pp. 17-18)

This issue is also evoked by Duhem but his justification came from a slightly different perspective. Indeed, Mach's idea in essence was that studying the history of Physics led to examining different points of view, and thus allowed

in a way to develop the scientists' critical mind and mind openness; while Duhem's was less about understanding the relationship of different scientists with science, but rather about the understanding of the structure of Physics:

Contrary to what we have tried to establish, we generally admit that each assumption of Physics can be separated from the whole and subjected in isolation to the control of experience: naturally, from this erroneous principle we deduce false consequences touching the method by which Physics should be taught. We would like the professor to arrange all the hypotheses of Physics in a certain order: that he would take the first one, that he would give its statement, that he would expose the experimental verifications, then, when these verifications have been recognized sufficient that he would declare the hypothesis accepted: better still, we would like him to formulate this first hypothesis by generalizing by induction a purely experimental law; he would repeat this operation on the second hypothesis, on the third, and so on until Physics was fully constituted: Physics would be taught like Geometry is taught; hypotheses would follow each other like theorems: the experimental proof of each supposition would replace the demonstration of each proposition; we would not put forward anything that is not drawn from the facts or that is not immediately justified by the facts.<sup>133</sup> (Duhem 1906, p. 328-329)

Yet, Duhem reached a similar conclusion:

The legitimate, sure, fruitful method for preparing a mind to receive a physical hypothesis is the historical method. To retrace the transformations by which empirical matter has increased, while theoretical form is taking shape: to describe the long collaboration by which common sense and deductive logic have analyzed this matter and modeled this form until the one fits exactly the other, it is the best, if not the only, way to give those who study Physics a fair idea and a clear view of the complex and living organization of this science.<sup>134</sup>(*Ivi*. p. 442)

---

<sup>133</sup> Contrairement à ce que nous nous sommes efforcés d'établir, on admet en général, que chaque hypothèse de Physique peut être séparée de l'ensemble et soumise isolément au contrôle de l'expérience: naturellement, de ce principe erroné on déduit des conséquences fausses touchant la méthode suivant laquelle la Physique doit être enseignée. On voudrait que le professeur rangeât toutes les hypothèses de la Physique dans un certain ordre: qu'il prit la première, qu'il en donnât l'énoncé, qu'il en exposât les vérifications expérimentales, puis, lorsque ces vérifications auront été reconnues suffisantes, qu'il déclarât l'hypothèse acceptée: mieux encore, on voudrait qu'il formulât cette première hypothèse en généralisant par induction une loi purement expérimentale; il recommencerait cette opération sur la seconde hypothèse, sur la troisième, et ainsi de suite jusqu'à ce que la Physique fût entièrement constituée: la Physique s'enseignerait comme s'enseigne la Géométrie; les hypothèses se suivraient comme se suivent les théorèmes: la preuve expérimentale de chaque supposition remplacerait la démonstration de chaque proposition; on n'avancerait rien qui ne soit tiré des faits ou qui ne soit aussitôt justifié par les faits.

<sup>134</sup> La méthode légitime, sûre, féconde, pour préparer un esprit à recevoir une hypothèse physique, c'est la méthode historique. Retracer les transformations par lesquelles la matière empirique s'est accrue, tandis que la forme théorique s'ébauchait: décrire la longue collaboration par laquelle le sens commun et la logique déductive ont analysé cette matière et modelé cette forme jusqu'à ce que l'une s'adaptât exactement à l'autre, c'est le meilleur moyen, voire le seul moyen, de donner à ceux qui étudient la Physique une idée juste et une vue claire de l'organisation si complexe et si vivante de cette science.

Moreover, Duhem went further by reflecting on the practical implications of teaching history of science:

Undoubtedly, it is not possible to resume step by step the slow, hesitant, groping walk, by which the human mind has arrived at the clear view of each physical principle: it would take too long; for it to enter teaching, [...] it has to be reduced in the relation between the duration of a man's education over the duration of their formation of science [...].<sup>135</sup> (*Ivi.* p. 443)

However, Duhem made a somewhat surprising suggestion regarding this problem for mathematics. He wrote:

This abbreviation, moreover, is almost always easy, provided that one is willing enough to neglect everything that is simply done accidentally, author's name, date of invention, episode or anecdote, to focus on historical facts only which seem essential in the eyes of the physicist, only when the theory has been enriched by a new principle, where it has seen an obscurity dissipate, an erroneous idea disappear.<sup>136</sup> (Duhem 1906, p. 443)

The history of Mathematics is, undoubtedly, the object of a legitimate curiosity; but it is not essential to the intelligence of Mathematics.<sup>137</sup> (*Ivi.* p. 444)

Before arguing that this is only true for mathematics and not physics:

It is not the same in Physics. There, as we have seen, teaching is prohibited from being purely and fully logical. Therefore, the only way to link the formal judgments of theory to the material of the facts that these judgments must represent, and this by avoiding the surreptitious penetration of false ideas, is to justify each essential hypothesis by its history.

To make the history of a physical principle is, at the same time, to make a logical analysis of it. The critique of the intellectual processes that Physics brings into play is inextricably linked to the presentation of the gradual evolution by which deduction perfects the theory, making it an ever more precise, always better ordered image of the laws revealed by observation.

Only the history of Science can keep the physicist from the mad ambitions of Dogmatism as from the despair of Pyrrhonism.

By retracing to him the long series of errors and hesitations which preceded the discovery of each principle, it warns him against false evidence [...] it reminds him

<sup>135</sup> Sans doute, il n'est pas possible de reprendre étape par étape la marche lente, hésitante, tâtonnante, par laquelle l'esprit humain est parvenu à la vue claire de chaque principe physique : il y faudrait trop de temps ; pour rentrer dans l'enseignement, [...] il faut qu'elle se réduise dans le rapport qu'a la durée de l'éducation d'un homme à la durée de la formation de la science [...].

<sup>136</sup> Cette abréviation, d'ailleurs, est presque toujours aisée, pourvu que l'on veuille bien négliger tout ce qui est simplement fait accidentel, nom d'auteur, date d'invention, épisode ou anecdote, pour s'attacher aux seuls faits historiques qui paraissent essentiels aux yeux du physicien, aux seules circonstances où la théorie se soit enrichie d'un principe nouveau, où elle ait vu se dissiper une obscurité, disparaître une idée erronée

<sup>137</sup> L'histoire des Mathématiques est, assurément, l'objet d'une curiosité légitime ; mais elle n'est point essentielle à l'intelligence des Mathématiques.

that the most attractive systems are only provisional representations and not some final explanations.<sup>138</sup> (*Ibidem*)

This difference between Mach and Duhem is explicable by their different standpoints. Mach was certainly preoccupied by the emotional aspect brought by the history of science, cultivating the interest of the students as well as the self-reflecting benefit it provides, while Duhem's standpoint was that teaching the history of physics was a purely logical necessity since "Studying the history of a physical principle, is, at the same time, doing its logical analysis"<sup>139</sup> (*Ibidem*).

While constructivism is probably the most common epistemology among science educators (Matthews 1992, p. 33), we have to recognize that there are good reasons for it to be the case. Matthews wrote:

Constructivism is in the Piagetian, cognitive, learning theory tradition, it is opposed to behaviourism of a Skinnerian or Gagneian type, so long dominant in science education. As with most of this tradition, its theory of mind is fundamentally Kantian. Constructivism's ontology varies from radical idealism (particularly in some of von Glasersfeld's writings), through to Popperian three-world theory. Its pedagogical practice is anti-didactic, and student-centred with an emphasis on student engagement in problem identification, hypothesis development, testing, and argument. (Matthews 1992, p. 34)

Though, while its pedagogical practice might be "student-centered with an emphasis on student engagement in problem identification, hypothesis development, testing, and argument" (*Ibidem*), calling it anti-didactic is perhaps too harsh a statement; especially considering the meaning of didactic(s) in France (cfr. Section 8.1), which is by definition directly concerned by "how to teach and learn (the aspects of transmitting and learning)" (Gundem 2000, pp. 235). Matthews then points out one of the main issues with a constructivist point of view:

One deep-seated problem with much constructivist writing is that it maintains a

<sup>138</sup> Il n'en est pas de même en Physique. Là, nous l'avons vu, il est interdit à l'enseignement d'être purement et pleinement logique. Dès lors, le seul moyen de relier les jugements formels de la théorie à la matière des faits que ces jugements doivent représenter, et cela en évitant la subreptice pénétration des idées fausses, c'est de justifier chaque hypothèse essentielle par son histoire.

Faire l'histoire d'un principe physique, c'est, en même temps, en faire l'analyse logique. La critique des procédés intellectuels que la Physique met en jeu se lie d'une manière indissoluble à l'exposé de l'évolution graduelle par laquelle la déduction perfectionne la théorie, en fait une image toujours plus précise, toujours mieux ordonnée des lois que révèle l'observation.

Seule l'histoire de la Science peut garder le physicien des folles ambitions du Dogmatisme comme des désespoirs du Pyrrhonisme.

En lui retraçant la longue série des erreurs et des hésitations qui ont précédé la découverte de chaque principe, elle le met en garde contre les fausses évidences [...] elle le fait souvenir que les plus séduisants systèmes ne sont que des représentations provisoires et non des explications définitives.

<sup>139</sup> Faire l'histoire d'un principe physique, c'est, en même temps, en faire l'analyse logique.

fundamentally empiricist conception of knowledge, despite their stated antipathy to such views. This is suggested when constructivists say that we are only aware of our sense impressions, we cannot have access to the world as it is, knowledge is the correspondence of mental image or ideas to reality, it is the individual subject who is the locus of knowledge claims. All of these are standard empiricist claims. But scientific knowledge requires idealisations and these cannot by definition mirror or correspond to the world. So either correspondence has to be dropped as a criterion of knowledge, or no branch of modern science can be accepted as knowledge. The former seems more sensible. But if this is done then a large part of the constructivist argument for relativism disappears. (*Ibidem*)

However, even if this understanding of knowledge as justified true belief is the fundamental problem, and despite the apparent contradiction in the fact that “scientific knowledge requires idealisations and these cannot by definition mirror or correspond to the world” (*Ibidem*), the cognitive dissonance that results from this has barely any impact on the actual practice where the ends justifies the means to hyperbole; as the end goal is scientific education. Moreover, overcoming this obstacle –this cognitive dissonance– and accepting the empiricist claims, even as the next best thing to the real world that cannot be truly observed, is the only way to escape from some kind of solipsism.

Piaget is renowned for his work that revolved around the notion of genetic epistemology, and in particular, in his later works, he explored the question of whether the cognitive development of children and their acquisition of concepts mirror the different stages of the development of science. This idea was motivated by similarities established with ancient physical theories therefore seemingly putting the history of science as a potential model for the students’ ways of reasoning and developmental cognitive model for children (Piaget 1927).

Indeed, children seem to possess naive beliefs that are analogous to pre-scientific notions that later develop closer to early scientific notions. This has been largely studied in the Physics field of mechanics (Crapanzano 2018), where “naive conceptions of force and motion mirror the fundamentals of Aristotelian dynamics” (Matthews 1992, p. 23). According to research, the explanation for this view is that: “It is combination of extrapolation based on experience, followed by induction of some heuristic to explain why a particular answer has been given, that we believe has led to the notion of a naive physics” (McLaren 2013, p. 1013).

Although the idea that students’ thoughts and conceptions mature in the exact same way scientists’ thoughts and conceptions did through the history of science seems preposterous, it nevertheless gives us a footing on which to stand to extract pedagogical proposals. The point is that there are undeniable similarities between the two that could be exploited. Another problem is that although some efforts have been made to incorporate some history of physics in teaching physics, it has often been done in a rather clumsy way (McDonald 2017, p. ix).

Depending on the problem or concept to teach, the students can be presented with a variety of solutions or examples taken from historical situations – whether these would be historical reasoning arguments through the use of historical texts, the replication of historical experiments, etc.–. Thus, these can allow the students to use their own reasoning, but also to be confronted with a situation very much resembling that in which the scientists worked. With a mixed approach using both methods, using historical texts to make predictions about an experiment done by the students or in order to confirm the results obtained by the students after the experiment, and so on, the students are thus provided with a meaningful experience, motivating and helping them to overcome their potential problems of understanding “critical points of physics knowledge” (Galili 2008, p. 2).

Teaching the History of Science also advances the duty of remembrance, which is interesting on its own, but incorporating the History of Science in Science is interesting with regards to the conceptual frameworks demanded by the curricula. Aside from providing historical reasoning and arguments, it allows justification of the reasons that led to their development, and also provides the context in which to understand how and why data for experiments were acquired and their limitations. Thus allowing a theoretical explanation of the data gathered and the errors, inaccuracies, etc. found in them.

## **6.4 The Relationship Physics-Mathematics**

The relationship between Physics and Mathematics, or their interplay is fundamental in science; and as a direct consequence, understanding the relationship between Physics and Mathematics is essential to understanding science. Indeed, this relationship is immediately linked to all sorts of considerations, such as some epistemological problems: a more philosophical question regarding whether the structure of reality is a mathematical structure, and by extension if this particular underlying mathematical structure is adequately described by Physics; or a more grounded question regarding the problems of epistemological obstacles encountered by learners (Bachelard 1934, 1940; Brousseau 1983, 1989), i.e. the problem of idealisation where the exactness of mathematics is opposed to physical uncertainty and the impossibility to do infinitely precise measurements. However, beyond these kinds of considerations, we have to recognize a number of features of this relationship and examine the similarities and differences between the two.

Mathematics is a self-consistent field relying on logic, rules, abstractions, axioms and representations. Historically, the development of mathematics certainly have started stimulated by needs: practical purposes such as commerce, trade, land division; and the need to understand physical reality. Since then mathematics have developed as its own construct, its own field

of study, both independently and in relation to physics. Thus, mathematics stem from reality as an abstraction; on one hand, an abstraction of elements –numeration and arithmetic–, and on the other hand, an abstraction of space with geometry.

Taking into account the premise that mathematics are universal and that physics possess an underlying mathematical structure, physics can be understood *de facto* as a subset of mathematics, the part of mathematics which apply to reality, as well as its generator from the historical or empirical point of view. Indeed, as an example, the Euclidean logical axioms of plane geometry directly originate from physical observations.

While logical axioms are by definition self-evident, they are taken as facts in their own right and context; axioms are thus arguably analogies written in the mathematical language of physical facts. The problems arise from the formalization (Paleo 2012) and the consequences of the manipulation of assertions and logical rules in order to build theorems and theories; for instance, think of Gödel's incompleteness theorems; and thus is posed the question of *to what extent is the analogy correct?*

Another point following from this is about *how much and what part of mathematics is in physics?*, since physics which is unable to build theorems still uses mathematical features to describe reality with laws, theories and principles. The use of mathematics in Physics has proven its utility countless times (Pisano 2011, 2013a, 2014a), both analytically, numerically and geometrically. For instance, the discovery of gravitational waves is a great illustration of this as it involves a lot of examples: the geometrization of physics with the development of the concepts of spacetime from the concept of curved spaces and space curvature; the edification of laws and relations for the physics of waves; the analyses of gravitational wave signals; and numerical relativity just to name a few.

Even though the relationship between mathematics and physics might be rather obvious, it is nevertheless riddled with deeply meaningful and subtle implications. Perhaps the most amazing and impactful of these is Noether's theorem, developed by Emmy Noether (1882-1935) which explains how conservative properties of conservation laws emerge from continuous symmetries.

When examining the relationship between mathematics and physics, we are essentially examining the overlap between the two. Therefore, we ought to take a look at the limits of the two fields. For instance, *to what degree do mathematical solutions of physical problems extend in the physical world?* An example of this could be the question regarding the existence of wormholes. Wormholes are special solutions of the Einstein Field Equations, but their existence in real life so far is only speculative. Consequently, we are forced to ask ourselves the –unanswerable– question: *do all rigorously found sound solutions in mathematics really can exist in the physical world?* But also, *what about mathematical results obtained by ignoring the physical world's constraints or bending them?* (cfr. Hill 2012)

Finally, a more grounded aspect of this relationship is addressing the issue of the exactness of mathematics in regards to physics with *mathematical physics*. Indeed, there are a number of mathematical tools and techniques that can be used in a –somewhat– less rigorous, “Physicsy”<sup>140</sup> fashion in order to obtain approximate results approaching the exact solution one is looking for. Nevertheless, not exact results, techniques such as asymptotic methods and perturbation theory allow us to arbitrarily reach approximations as precise as one needs (Bender 2013).

## 6.5 Teaching the Interplay Physics-Mathematics Language

Teaching the interplay Physics-Mathematics might seem automatic at first in a naïve way, as in order to do physics we need to use mathematical tools. On one hand, the specific teaching of this relationship is much more subtle and goes further than the simple fact that mathematics also serve the purpose of experimental confirmations and analyses:

Teaching must make the pupil grasp this capital truth: Experimental verifications are not the basis of theory: they are their crowning achievement; Physics does not progress like Geometry: the latter grows by the continual contribution of a new theorem, demonstrated once and for all, which is added to theorems already demonstrated: the former is a symbolic table to which continual retouching gives more and more extent and unity; the whole of which gives an increasingly resembling image of the whole of the facts of experience, while each detail of this image, cut out and isolated from the whole, loses all meaning and no longer represents anything.<sup>141</sup> (Duhem 1906, p. 336)

On the other hand, the real problem for mathematics teaching and in a similar way for physics teaching, appears to be tied with the development of actual meaning –whether of the existence of *mathematical objects* and the mathematical representations of *physical objects* or of the relationship between law and observations.

The common way of treating problems is by asking the students to somewhat suspend their disbelief. Ironically, this suspension of disbelief is unavoidable as in the treatment of problems or applications of laws, etc. the student is almost always asked to consider “ideal objects” free from certain aspects of phenomena or effects. For instance, ignoring friction, air

---

<sup>140</sup> Cfr. Hübsch 2015, p. 331 for disambiguation.

<sup>141</sup> L’enseignement doit faire saisir à l’élève cette vérité capitale : Les vérifications expérimentales ne sont pas la base de la théorie : elles en sont le couronnement; la Physique ne progresse pas comme la Géométrie: celle-ci grandit par le continuuel apport d’un nouveau théorème, démontré une fois pour toutes, qui s’ajoute à des théorèmes déjà démontrés : celle-là est un tableau symbolique auquel de continuelles retouches donnent de plus en plus d’étendu et d’unité ; dont l’ensemble donne une image de plus en plus ressemblante de l’ensemble des faits d’expérience, tandis que chaque détail de cette image, découpé et isolé du tout, perd toute signification et ne représente plus rien.



resistance, heat production, radiated heat, or other “negligible” effects or quantities, by considering point-like representations of objects, etc.

The use of idealized situations allows for great simplifications of the study of a problem and also gives an explanation of the deviations between the purely rigorous mathematical treatment of the problem and the actual results: the however small variations between the expected results and the actual obtained results being justified by the natural inaccuracies and randomness of the “real world”. Maybe worse, this problem and justification is also present in the repetition of experiments using the exact same experimental protocol; a small insignificant variation in the data is judged acceptable. This –almost– unavoidable problem of using idealized situations and the experimental deviations are unfortunately a source of cognitive dissonance for the students.

In physics we are bound to use assumptions or thought experiments, which obviously cannot be actually realized in experiments, whether from a theoretical point of view like considering infinitesimals but also from a practical one with everlasting motions or neglecting air friction and the problem of practice-based evidence (Sensevy 2018).

This raises the question of the interpretation of the results which is subject to many fallacies and cognitive bias such as confirmation bias (Nickerson 1998) which can happen even if the information or data is actually correct; e.g.: with availability heuristics (Cfr. Carroll 1978).

Another extremely important point about the relationship between Physics and Mathematics has to do with the language used. In fact, there are a number of objects common to both Physics and Mathematics that are approached in different ways; or even identical objects with different notations depending on the user. For instance, derivatives. While there is no doubt that the common concept of a derivative is the same to both the physicist and the mathematician, they use different notations, i.e.  $f'(x)$  vs.  $\frac{df}{dx}(x)$ . Indeed:

Math in science (and particularly math in physics) is not the same as doing math. It has a different purpose—representing meaning about physical systems rather than expressing abstract relationships. It even has a distinct semiotics—the way meaning is put into symbols—from pure mathematics.

It almost seems that the “language” of mathematics we use in physics is not the same as the one taught by mathematicians. There are many important differences in what seems to be the physicist’s “dialect” of speaking math, so, while related, the languages of “math in math” and “math in physics” may need to be considered as separate languages. The key difference is that loading physical meaning onto symbols does work for physicists and leads to differences in how physicists and mathematicians interpret equations. We not only use math in doing physics, we use physics in doing math. (Redish 2015)

Furthermore, this kind of issue regarding notation is only the tip of the iceberg so to speak. The interpretation of an equation will also depend on the

reader. On this point, the authors also wrote the following about the equation  $y = mx + b$ :

With a knowledge of labeling conventions,  $x$  and  $y$  are interpreted as variables capable of taking on many different values, while  $m$  and  $b$  are interpreted as constants. With this addition, the equation takes on the meaning of a relation between the independent variable ( $x$ ) and the dependent variable ( $y$ ). Additionally, the assumed constancy of  $m$  implies that the equation refers to a straight line. The constants now take on additional mathematical meaning:  $m$  as the slope of the line and  $b$  as the intercept on the  $y$ -axis, bringing in ideas from graphs. Thus, the meaning of the equation, understood even within the domains of mathematical conventions, straight lines, and graphs are much richer than the strict “definition” expressing the symbol “ $y$ ” in terms of other symbols. (*Ibidem*)

Therefore, the authors argue that by teaching learners mathematics in Mathematics and a different version of mathematics in Physics, we are essentially asking learners to become bilingual. Indeed, both Mathematics and Physics approach meaning, vocabulary and context in different ways at a fundamental level.

Yet, this is also the case on a sociocultural and behavioral level too. In fact, it is not unusual for physicists to be often more lenient in regard to *heavy* mathematical rigor. As Prof. Carl Bender put it: “There are different styles of doing mathematical physics, one style is a very rigorous approach where it’s all theorem and proof”, “I don’t like theorem and proof type approaches to doing physics, especially mathematics that’s going to be used in physics.”, “I prefer to talk about what I regard is really useful and powerful mathematical techniques [...]” (Bender 2012, online lecture <sup>142</sup> ). Nevertheless, we have to ponder this by the realization that these “really useful and powerful mathematical techniques” even if somewhat presented in opposition to the “very rigorous approach”, *are in actuality perfectly sound and rigorous*. In this particular case, it arguably could be said that: mathematics in Mathematics is to Physics what formal language is to common language.

These problems are well known to the HPS trained teachers, but they need to be discussed for the students to be made aware of them.

## 6.6 History of Science, Epistemology and Philosophy

The question naturally following this is “*How do we know something?*”. This in-between question of the Why and How to do Science is where Epistemology comes in. Etymologically, Epistemology is the study of knowledge, it concerns itself with the study of how we extract knowledge and how more knowledge is built from the obtained knowledge. Thus, it seems only natural that in order to

---

<sup>142</sup> Cfr. <https://www.youtube.com/watch?v=LYNOGk3ZjFM&>

teach effectively, the better one understands how knowledge is built, the easier it will be to teach.

A well-known result of neuropsychology –Educational neuroscience, psychology, learning theory – is the fact that human reasoning –and learning– is driven by association (Quinette 2013). This result can be straightforwardly illustrated by considering the following example which I used countless times during my science mediation at Xperium (from High School students to first year Master’s degree students): *think of the word “carrot”, what do you associate it with?* The usual answers are “Orange”, “vegetables”, or “rabbit”.

However, this association is deeper than one could expect at first. Indeed, besides simply associating words that belong to the same lexical group, what really happens is more complicated than just that. From their perspective, there are a number of successive mechanisms at play. First of all, they hear the soundwaves of the person saying the word, their brain then process the stimuli and associate phonemes which are then concatenated into a word, which in turn is somehow compared to their inner database (vocabulary). Once their minds have identified the word, if multiple meanings are associated, the context of the phrase gives information on what meaning is the right one; then once this process has been done for all the words in the question, the global meaning of the question is evaluated and a response can be given by a reciprocal process; a similar process is also at play during reading. The point being that our way of thinking, our reasoning, is based on these principles which coincidentally are similar –if not the same as– to the processes involved in logic, deduction, inference, and so on.

This whole ordeal is arguably at the basis of science; through the use of associations and comparisons. Indeed, what is science if not the discipline that associates outcomes with possibilities? Knowledge is built upon knowledge, and in the same way, when scientists are confronted with unknown phenomena, they try to bring them back to better understood phenomena by association. For instance, these are the fundamentals of reasoning by parallelism and analogy (Radelet-de Grave 2009; Rahman 2009, 2016). In fact, the type of reasoning which continues to be central in research, scientific investigations and transmission can be found in Arab jurists of the 9th century who reflected on this particular type of reasoning in the same way that Greek philosophers would have had reflected on it. They identified three main –sometimes overlapping– types of reasoning by parallelism and analogy: exemplification, symmetries –where a common relation between two objects, things or concepts can be found– resemblance and analogy.

Some direct results of this in Science are the use of practical, computable or theoretical examples, the designing and use of models, thought experiments, etc. Moreover, on a more down-to-earth level, another direct example, given by Epistemology, is the need for experiments to be reproducible and repeatable, and therefore the development of scientific methods such as the use of experimental protocols.

The inclusion of HPS also has some caveats. Debates around historiography can lead us to ask questions about what can and should be considered as historically important enough to discuss and how relevant those are to Science Education. A major part of history revolves around finding facts about individuals, events, etc. and being able to identify and justify a narrative linking them. This work can be challenging at times, especially considering that since this narrative has to be manufactured by the historian, it is intrinsically susceptible to objectivity issues. For instance, materials and sources have to be selected, extrapolations, speculations or other guesses are made, questions have to be outlined and can be framed... and therefore the historian will necessarily make choices influenced, willingly or not, by their scientific, philosophical and/or religious views, their culture, social and psychological state, etc. just like a scientist or philosopher would (Radford 1997, p. 27). In the same vein, the selection of interesting historical data in the case of epistemological inquiries will depend on the eye of the researcher. This is even true when different historians consider the exact same historical events and draw different interpretations; a prime example of this being the list of priority disputes for theories, inventions or results.

However, the almost inevitable problems involving interpretation in history, or more particularly history of science, justify why teachers need to have seen enough philosophy of science and history of science to help them with the interpretations of the results for students. These different interpretations at the same time provide us with an opportunity to discuss the questions from which they arise with the students; thus offering the opportunity to develop their methodology and critical thinking.

Furthermore, it could be argued that teachers simply need to possess critical knowledge of their discipline and more particularly of the subject matter they teach, whether they use it in their lessons as a pedagogical tool or not. Indeed, it would seem quite peculiar to have a teacher teach about an explanation without understanding the ins and outs of it. Even more so if the teacher is unable to answer students' questions about the subject matter of their own discipline. Having teachers educated in science instead of just teachers trained in science makes a huge difference both for the teachers and the students.

To use a hyperbole, understanding the difference between the real, physical objects of the world and the theoretical objects of science and being able to explain the philosophical–epistemological implications behind this or the subject matter taught is what differentiates a teacher forming scientists from a teacher forming calculators.

## 6.7 Common Knowledge vs. Scientific Knowledge

In its broadest sense, reasoning is understood as the ability to solve problems, to draw conclusions by establishing the necessary logical and causal links between facts, and to consciously learn them. There are different types of reasoning, although we will focus on scientific reasoning vs. non-scientific reasoning using the following definition:

Scientific reasoning (SR), broadly defined, includes the thinking skills involved in inquiry, experimentation, evidence evaluation, inference and argumentation that are done in the service of conceptual change or scientific understanding. (Zimmerman 2005)

From this, we can see that there is a difference between common sense, common knowledge used in its broadest meaning, regardless of epistemological issues such as those presented by Gettier (1963); and scientific thinking and reasoning, which relies on inquiries, experimentation, etc. and which is not an innate process in human beings. The fundamental difference between common knowledge and scientific knowledge is the way in which the knowledge is built (Driver 1994). Furthermore, there are differences in the processes invoked. For instance, according to Bachelard, the ability of abstraction –and formalization– are at the basis of the scientific spirit:

In fact, if we meditate on the evolution of the scientific spirit [6]<sup>143</sup> we quickly detect a momentum that goes from the more or less visual geometric to complete abstraction. (Bachelard 1934, p. 8)<sup>144</sup>

while in scientific reasoning experiences and experiments are processed, common experiences are, on the contrary, taken as facts:

It has often been said that a scientific hypothesis that cannot come up against any contradiction is not far from being a useless hypothesis. Likewise, what is the use of an experiment that does not rectify some error and that is just plain true and indisputable? A *scientific* experiment is thus one that *contradicts common* experience. Moreover, immediate, everyday experience always keeps some kind of tautological character, developing in the realm of words and definitions; it precisely lacks the perspective of *rectified errors* that in our opinion characterises scientific thought. Ordinary, everyday experience is not really *composed*; at the very most it is made up of juxtaposed observations and it is striking that the old epistemology established a continuous link between observation and experimentation, whereas experimentation ought to distance itself from the ordinary conditions of observation. Since everyday experience is not *composed*, according to our opinion,

---

<sup>143</sup> Claude COMIERS, *La Nature et présage des Comètes*. Ouvrage mathématique, physique, chimique et historique, enrichi des prophéties des derniers siècles, et de la fabrique des grandes lunettes, Lyon, 1665. [pp. 7-74.]

<sup>144</sup> En fait, si l'on médite sur l'évolution de l'esprit scientifique [6] on décèle bien vite un élan qui va du géométrique plus ou moins visuel à l'abstraction complète.

it cannot actually be *verified*. It remains a fact. It cannot provide us with a law.<sup>145</sup>  
 (Translated by Philippe Vincent – Ivi. p. 13)

It is interesting to note that Bachelard's views are very close to another of his contemporaries, in Karl Popper (1902-1994). However, Popper made the extra step of differentiating science from pseudo-science. He noticed differences in the methods for doing science of "great thinkers" like Einstein and Freud. On this, Lakatos stated:

But, in 1934, Karl Popper, one of the most influential philosophers of our time, argued that the mathematical probability of all theories, scientific or pseudoscientific, given any amount of evidence is zero. If Popper is right, scientific theories are not only equally unprovable but also equally improbable. A new demarcation criterion was needed and Popper proposed a rather stunning one. [A theory may be scientific even if there is not a shred of evidence in its favour, and it may be pseudoscientific even if all the available evidence is in its favour. That is, the scientific or non-scientific character of a theory can be determined independently of the facts.] *A theory is 'scientific' if one is prepared to specify in advance a crucial experiment (or observation) which can falsify it, and it is pseudoscientific if one refuses to specify such a 'potential falsifier'*. (Emphasis is ours—Lakatos 1973)

The differences between common knowledge and scientific knowledge go further, and although we have to recognize that scientific knowledge is an extension of common knowledge, the objects and by extension the vocabulary involved are different from an ontological perspective.

For instance, a *wave* will have a different meaning for a non-scientist; just like if talking of gravity, the non-scientist and the scientist will have widely different approaches and answers about it.

Moreover, this last example also highlights another difference, which is that common sense seems to be guided primarily by pragmatism while the scientific approach will seek an abstraction for generalisation and finding the rule or law, etc. Therefore, it is understandable that the analysis comparing scientific language with "ordinary language" is not a good indicator of knowledge growth on its own. Indeed, according to Popper:

---

<sup>145</sup> On a dit souvent qu'une hypothèse scientifique qui ne peut se heurter à aucune contradiction n'est pas loin d'être une hypothèse inutile. De même, une expérience qui ne rectifie aucune erreur, qui est platement vraie, sans débat, à quoi sert-elle ? Une expérience *scientifique* est alors une expérience qui *contredit* l'expérience *commune*. D'ailleurs, l'expérience immédiate et usuelle garde toujours une sorte de caractère tautologique, elle se développe dans le règne des mots et des définitions ; elle manque précisément de cette perspective *d'erreurs rectifiées* qui caractérise, à notre avis, la pensée scientifique. L'expérience commune n'est pas vraiment *composée* ; tout au plus elle est faite d'observations juxtaposées et il est très frappant que l'ancienne épistémologie ait établi un lien continu entre l'observation et l'expérimentation, alors que l'expérimentation doit s'écarter des conditions ordinaires de l'observation. Comme l'expérience commune n'est pas *composée*, elle ne saurait être, croyons-nous, effectivement *vérifiée*. Elle reste un fait. Elle ne peut donner une loi. (Ivi. p. 13)

The problem of epistemology may be approached from two sides: (1) as the problem of ordinary or common-sense knowledge, or (2) as the problem of scientific knowledge. Those philosophers who favour the first approach think, rightly, that scientific knowledge can only be an extension of common-sense knowledge, and they also think, wrongly, that common-sense knowledge is the easier of the two to analyse. In this way these philosophers come to replace the ‘new way of ideas’ by an analysis of ordinary language—the language in which common-sense knowledge is formulated. They replace the analysis of vision or perception or knowledge or belief by the analysis of the phrases ‘I see’ or ‘I perceive’, or ‘I know’, ‘I believe’, ‘I hold that it is probable’; or perhaps by that of the word ‘perhaps’. Now to those who favour this approach to the theory of knowledge I should reply as follows. Although I agree that scientific knowledge is merely a development of ordinary knowledge or common-sense knowledge, I contend that the most important and most exciting problems of epistemology must remain completely invisible to those who confine themselves to analysing ordinary or common-sense knowledge or its formulation in ordinary language. I wish to refer here only to one example of the kind of problem I have in mind: the problem of the growth of our knowledge. A little reflection will show that most problems connected with the growth of our knowledge must necessarily transcend any study which is confined to common-sense knowledge as opposed to scientific knowledge. For the most important way in which common-sense knowledge grows is, precisely, by turning into scientific knowledge. Moreover, it seems clear that the growth of scientific knowledge is the most important and interesting case of the growth of knowledge. (Popper 1959, pp. xxi-xxii)

Furthermore, despite the fact that common sense can use logic and be rather complicated it can lead to mistakes and misconceptions in slightly different contexts because of the lack of abstraction and generalisation; the explicit formalisation of rules and theories. A prime example of this being the “Wason problem” (Cfr. Wason 1971). Common sense seems to tend to work better in specific situations, preferably in an everyday life context and when the results have pragmatic ends, while scientific reasoning, on the contrary, is perfectly adequate in both pragmatic and abstract contexts and scientific spirit goes even further by often exploring theoretical objects without the necessity for them to have a physical meaning. Indeed, beyond the purely utilitarian arguments behind the scientific endeavour, the scientific spirit is not just motivated by curiosity, according to Poincaré there is more:

The scientist does not study nature because it is useful; he studies it because he takes pleasure in it and he takes pleasure in it because it is beautiful. If nature was not beautiful, it would not be worth knowing, life would not be worth living. I am not speaking here, of course, of this beauty that strikes the senses, of the beauty of qualities and appearances; not that I ignore it, far from it, but it has nothing to do with science; I mean this more intimate beauty which comes from the harmonious order of the parts, and which a pure intelligence can grasp. (Poincaré 1908, p. 16)

<sup>146</sup>

---

<sup>146</sup> Le savant n’étudie pas la nature parce que cela est utile ; il l’étudie parce qu’il y prend plaisir et il y prend plaisir parce qu’elle est belle. Si la nature n’était pas belle, elle ne vaudrait pas la peine d’être connue, la vie ne vaudrait pas la peine d’être vécue. Je ne parle pas ici, bien entendu, de cette beauté qui frappe les sens, de la beauté des qualités et des apparences ; non que j’en fasse fi, loin de là, mais elle n’a rien à faire avec la science ;

However, it should be noted that scientific knowledge is not build to be universal, but rather as objective as possible, even if this goal is arguably unattainable as suggested Poincaré and Popper:

It is often said that one has to experiment without preconceived ideas. This is not possible; not only would that make any experience sterile, but even if we wanted it would be impossible. Everyone carries with them their conception of the world which they cannot get rid of so easily. For example, we have to use language, and our language is made up of preconceived ideas and cannot be made of anything else. Only these are unconscious preconceptions, a thousand times more dangerous than the others.<sup>147</sup> (Translation by Philippe VINCENT – Poincaré 1902, pp. 169-170)

I am inclined to think that scientific discovery is impossible without faith in ideas which are of a purely speculative kind, and sometimes even quite hazy; a faith which is completely unwarranted from the point of view of science, and which, to that extent, is 'metaphysical'. (Popper [1934] 2005, p. 16)

For Popper, knowledge was built on probability –and contingency– through the use of what he called “probability hypotheses”:

Our question was: How can probability hypotheses—which, we have seen, are non-falsifiable—play the part of natural laws in empirical science? Our answer is this: Probability statements, in so far as they are not falsifiable, are metaphysical and without empirical significance; and in so far as they are used as empirical statements they are used as falsifiable statements. (*Ivi.* p. 196)

On the one hand, we must make the possibility of using probability statements understandable in terms of their logical form. On the other hand, we must analyse the rules governing their use as falsifiable statements. [...]

Our methodological rule, proposed in accordance with the criterion of demarcation, does not forbid the occurrence of atypical segments; neither does it forbid the repeated occurrence of deviations (which, of course, are typical for probability sequences). What this rule forbids is the predictable and reproducible occurrence of systematic deviations; such as deviations in a particular direction, or the occurrence of segments which are atypical in a definite way. Thus it requires not a mere rough agreement, but the best possible one for everything that is reproducible and testable; in short, for all reproducible effects. (*Ivi.* p. 197)

Therefore a theory is as strong as its predictions and can be temporarily taken as right but can never be proven true. The amount of evidence in the favour of the theory simply fails to prove the theory wrong.

Scientific knowledge is constructed by the scientific community and

---

je veux parler de cette beauté plus intime qui vient de l'ordre harmonieux des parties, et qu'une intelligence pure peut saisir.

<sup>147</sup> On dit souvent qu'il faut expérimenter sans idée préconçue. Cela n'est pas possible; non seulement ce serait rendre toute expérience stérile, mais on le voudrait qu'on ne le pourrait pas. Chacun porte en soi sa conception du monde' dont il ne peut se défaire si aisément. Il faut bien, par exemple, que nous nous servions du langage, et notre langage n'est pétri que d'idées préconçues et ne peut l'être d'autre chose. Seulement ce sont des idées préconçues inconscientes, mille fois plus dangereuses que les autres.



solidified when the scientific community reaches an agreement on the studied items; such as theories, laws, explanations, relationships, objects (quarks, atoms, fields...), methods, etc. By extension a somewhat amusing consequence is that what the scientific community does not know, is unable to explain, or more specifically the limits of the knowledge and what, in essence, is impossible to know is also part of scientific knowledge. For example, dark matter and dark energy which are placeholders.

Finally, scientific knowledge is transmitted in formal (schools, high schools, lyceums, universities, social institutions of science, etc.) and informal ways. This implies that in order for someone to learn how to do science and receive a proper scientific education –methods, practices, reasoning, etc.– they have to be taught. A contemporary example of deficiencies about this point might be best exemplified by a recent documentary “Behind the Curve” (2018) on “flat earthers”.

## 6.8 Students’ Difficulties and Misconceptions

Teaching–Learning science has to take into account the nature of the taught items in order to identify the relevant practices and adequate methods for the study of the selected item, and beyond curricula considerations, it is also equally important to take into consideration the learners.

Besides pondering the questions of the cultural and social backgrounds of the learners, there are recurrent difficulties and misconceptions that can be identified in widely different groups.

The more prominent common difficulties and misconceptions can certainly be traced back to the epistemological break with everyday life and abstraction as illustrated by the common questions, views and complaints of students such as, for example, that Physics is an approximation of reality and not the truth, that the situations studied are idealized, that the symbolic treatment of problems is far from reality, that mathematical beauty is irrelevant to nature and just pleasing to the scientists, and so on. According to Bachelard, scientific advancement is a constant struggle with epistemological obstacles; the first one being opinion and preconceived notions:

Science, in its need for achievement as well as in its principle, is absolutely opposed to opinion [...] We cannot base anything on opinion: we must first destroy it. It is the first obstacle to overcome.<sup>148</sup> (Bachelard 1934, p. 17)

---

<sup>148</sup> La science, dans son besoin d'achèvement comme dans son principe, s'oppose absolument à l'opinion [...] On ne peut rien fonder sur l'opinion : il faut d'abord la détruire. Elle est le premier obstacle à surmonter.

The scientific spirit prohibits us from having an opinion on questions that we do not understand, on questions that we do not know how to formulate clearly. Above all, one has to know how to pose problems.<sup>149</sup> (*Ibidem*)

The second one being observation:

Risk and success lie on the experience-reason axis and in the direction of rationalization. Only reason stimulates research, because it is reason alone which suggests beyond the common experience (immediate and specious) scientific experience (indirect and fruitful).<sup>150</sup> (Bachelard 1934, p. 20)

Therefore, we have to start by doubting what we think we already know and distance ourselves from common sense that is built on common experience.

In fact, this problem of abstraction from everyday life is one of the first epistemological obstacles (Cfr. Brousseau 1983, 1989) for scientific knowledge as he wrote: “The first experience or, to bet more precisely, the first observation is always a first obstacle for scientific culture.”<sup>151</sup> (Bachelard 1934, p. 23)

Students’ formal and informal learning, personal experience, social interactions and the resulting common knowledge give them a basic framework on which to rely to interpret everyday life phenomena which shape their common sense. This social aspect is mainly separated from scientific guidance and leads to common views that can ultimately lead to misconceptions and difficulties.

A lot of research has been done on this epistemological break of abstraction from everyday life (Carey 1985; Carmichael 1990) which maybe is best illustrated by the many studies that have been done about informal and formal reasoning (Wason 1971); especially in mechanics where a common misconception is that a constant force is required to keep an object in constant motion (Clement 1982; Viennot 1979; Crapanzano 2018)

Unfortunately, this can have dire consequences for teaching students. Indeed, considering that students’ common sense precedes scientific reasoning, added to the fact that there is some kind of mistrust in science due to the problem of idealisation, it is common for them to encounter difficulties. Those difficulties mostly arise from clashes with common sense of their pre-established conceptions and common knowledge or even beliefs, whether religious or otherwise.

It should be noted that not only the students are victims of their common sense, but teachers and even scientists are subject to this problem; although

<sup>149</sup> L’esprit scientifique nous interdit d’avoir une opinion sur des questions que nous ne comprenons pas, sur des questions que nous ne savons pas formuler clairement. Avant tout, il faut savoir poser des problèmes.

<sup>150</sup> C’est sur l’axe expérience-raison et dans le sens de la rationalisation que se trouvent à la fois le risque et le succès. Il n’y a que la raison qui dynamise la recherche, car c’est elle seule qui suggère au delà de l’expérience commune (immédiate et spécieuse) l’expérience scientifique (indirecte et féconde).

<sup>151</sup> La première expérience ou, pour parier plus exactement, l’observation première est toujours un premier obstacle pour la culture scientifique.

to different degrees. A good example of this could be counterintuitive results, which are counterintuitive on the basis that these kind of intuitions are guided by common sense; such as those encountered in Quantum Mechanics, or just concepts like non-locality, etc. In those cases, common sense logic is inadequate for understanding, let alone problem solving. But without going this far, the main difficulty is about abstraction and idealisation which leads to a dissatisfaction and the belief that physics deals with reality.

Another issue is that whether it is through assumptions, modelling, experiments, thought experiments or problem solving, idealisation is omnipresent in physics lessons. Consequently, the many manipulations of idealized –or abstract– objects adds another layer of separation from the "real world" and its experience. This separation is even more pronounced given that in the eyes of students, mathematics is often considered as some kind of standalone science –almost– completely separated from any physical meaning. Thus, when students ponder upon the exactness of Mathematics compared to the approximations of mathematics in Physics this heightens the problem of students perceiving these fields as far from reality. In this way, idealisation deepens the students' feeling of getting further away from the real world up to the point of losing its purpose and thus making them conceive Science as a mere approximation of reality. The reason behind this is found when considering how students perceive science and therefore the expectations they possess in regard to science and science teaching.

The question arises as to what can be done to help students overcome those difficulties and misconceptions, and how History of Science and Nature of Science teaching can help. The point being that the presentation of a subject which is different from the subject itself can help understanding of the first subject more deeply.

According to Bachelard, the professor's role is not to transmit their knowledge to students but rather to change their knowledge by getting rid of the epistemological obstacles that they meet during everyday life:

[...] the adolescent arrives in the Physics class with empirical knowledge already constituted: it is then a question, not of acquiring an experimental culture, but indeed of changing experimental culture, of overturning the obstacles already piled up by everyday life. (Bachelard 1934, pp. 21-22).

However, when considering learning as the transformation of old knowledge schemes into new ones, we ignore the possibility of instead giving individuals multiple parallel conceptual schemes. This is what is actually happening when considering instances where one of these conceptual schemes is selected according to the context in which the person is put, as it is arguably impossible to "un-learn" something. For instance, this is clearly the case when considering scientific mediation and the different levels of explanation a scientific mediator has to be able to give depending on their audience.

Moreover, just like the more profound the understanding of a concept, the easier it is for a teacher to give different explanations, or adapt or reformulate

one, and considering that different conceptual schemes can coexist on the same subject, tackling a subject from different angles –historical, epistemological, etc.– provide different perspectives and as many different ways of understanding the object of the teaching.

In this perspective, the role of the professor is to educate the students so that they are able to select the right conceptual schemes for the situations they find themselves in. As an example, helping the students to identify if and when air resistance in a problem can soundly be neglected.

As we have seen, the recognition of scientific idealisation is closely linked to the concepts of epistemological obstacles and misconceptions. The questions then arise as *what are and how to avoid misconceptions?* According to Brousseau (1976):

- A learned concept can only be used insofar as it is linked to others, these links constitute its meaning, its label, its activation method.
- But it is only *learned* to the extent that it is usable and used effectively, that is to say only if it is a solution to the problem. These problems, the set of constraints to which it responds, constitute the meaning of the concept. It is only learned if it "succeeds" and therefore requires a territory for implementation. This territory is only rarely general and definitive.
- Due to this localized use, the concept receives particularizations, limitations, distortions of language and meaning [...] (Brousseau 1976, p. 103)<sup>152</sup>

From this, Brousseau explained that errors are not necessarily didactic in nature or due to the cognitive abilities of the student, but can come from the manifestations of epistemological obstacles and therefore that these kinds of errors are constituent of the meaning of the learned knowledge:

Error is not only the effect of ignorance, uncertainty, chance that is believed in the empirical or behavioral theories of learning, but the effect of prior knowledge, which had his interest, his successes, but which now turns out to be false, or simply unsuitable. Mistakes like this are not erratic and unpredictable, they are obstacles. [\*] As well in the functioning of the teacher as in that of the pupil, the error is constitutive of the direction of the acquired knowledge.<sup>153</sup> (*Ivi.* p. 104; [\*] refers to the bibliography at the end of the article).

---

<sup>152</sup> – Une notion apprise n'est utilisable que dans la mesure où elle est reliée à d'autres, ces liaisons constituent sa signification, son étiquette, sa méthode d'activation.

– Mais elle n'est *apprise* que dans la mesure où elle est utilisable et utilisée effectivement, c'est-à-dire seulement si elle est une solution du problème. Ces problèmes, ensemble de contraintes auxquelles elle répond, constituent la signification de la notion. Elle n'est apprise que si elle « réussit » et il faut donc un territoire de mise en œuvre. Ce territoire n'est que rarement général et définitif.

– Du fait de cet emploi localisé, la notion reçoit des particularisations, des limitations, des déformations de langage et de sens [...] (Brousseau 1976, p. 103)

<sup>153</sup> L'erreur n'est pas seulement l'effet de l'ignorance, de l'incertitude, du hasard que l'on croit dans les théories empiristes ou behaviouristes de l'apprentissage, mais l'effet d'une connaissance antérieure, qui avait son intérêt, ses succès, mais qui, maintenant, se révèle fautive, ou simplement inadaptée. Les erreurs de ce type ne sont pas erratiques et imprévisibles, elles sont constituées en obstacles. [\*] Aussi bien dans le fonctionnement du maître que dans celui de l'élève, l'erreur est constitutive du sens de la connaissance

Brousseau then added that what he just described was broadly applicable to other fields such as epistemology or history of science (*Ivi.* p. 105). He then wrote about these kinds of errors, misconceptions and how to get rid of them:

In addition, these errors, in the same subject, are linked together by a common source, a way of knowing, a characteristic, coherent, if not correct, old conception which has succeeded in a whole field of actions.<sup>154</sup> (*Ivi.* p. 106)

The obstacle is constituted like knowledge, with objects, relationships, methods of apprehension, predictions, with obvious facts, forgotten consequences, unforeseen ramifications ... It will resist rejection, it will try as it should, to adapt locally, to modify at the lowest cost, to optimize on a reduced field according to a well-known accommodation process.

This is why, there must be a sufficient flow of new situations, which cannot be assimilated by it, which will destabilize it, make it ineffective, useless, false, which will make it necessary to resume or reject it, forgetfulness, scotomization - until in its ultimate manifestations.<sup>155</sup> (*Ibidem*).

Later, Brousseau expanded on the matter and, after insisting that these kinds of errors had nothing to do with randomness nor other issues from the students' side, provided guidelines for further research:

Continuing along this path, however, requires re-examining the interpretation of students' errors and the methods of their production (SALIN, 1976). Until then, they were all attributed, either to erratic dysfunctions, or to lack of knowledge and therefore connoted very negatively; we must now consider recurring errors as the result (produced by and built around) of conceptions, which, even when they are false, are not accidents, but often positive acquisitions. It is therefore first of all for researchers to:

- Find these recurring errors, show that they are grouped around conceptions,
- Find obstacles in the history of mathematics,
- Confront historical obstacles with learning obstacles and establish their epistemological character.<sup>156</sup> (Brousseau 1989, p. 2)

---

acquise.

[\*] renvoie à la bibliographie en fin d'article.

<sup>154</sup> De plus, ces erreurs, chez un même sujet, sont liées entre elles par une source commune, une manière de connaître, une conception caractéristique, cohérente, sinon correcte, ancienne et qui a réussi dans tout un domaine d'actions.

<sup>155</sup> L'obstacle est constitué comme une connaissance, avec des objets, des relations, des méthodes d'apprehension, des prévisions, avec des évidences, des conséquences oubliées, des ramifications imprévues... Il va résister au rejet, il tentera comme il se doit, de s'adapter localement, de se modifier aux moindres frais, de s'optimiser sur un champ réduit suivant un processus d'accommodation bien connu.

C'est pourquoi, il faut un flux suffisant de situations nouvelles, inassimilables par lui, qui vont le déstabiliser, le rendre inefficace, inutile, faux, qui vont en rendre nécessaire la reprise ou le rejet, l'oubli, la scotomisation – jusque dans ses ultimes manifestations.

<sup>156</sup> Poursuivre dans cette voie exige pourtant le réexamen de l'interprétation des erreurs des élèves et des modalités de leur production (SALIN, 1976). Jusque là, elles étaient attribuées toutes, soit à des dysfonctionnements erratiques, soit à des absences de connaissances et donc connotées très négativement; il faut maintenant envisager les

Students bring their own concepts to class, concepts which originate from a common source that is both common knowledge and scientific knowledge, and build new knowledge through a combination of acquisition of new conceptions, modifications of old ones or rejection. However, misconceptions can be understood as systematic errors –recurrent and non-random– the source of which is not necessarily the students, but rather the concept itself.

Therefore, if this is correct, that since these kind of errors are due to the concepts themselves, this actually suggests that every person learning these types of concepts might be subject to these same misconceptions and thus, that the history of science can help identify those very same misconceptions.

Moreover, as Brousseau's suggestion is that those obstacles are constructed like knowledge and therefore need a "sufficient flow of new situations" (Brousseau 1976, p.106) in order to challenge them so that the students can adapt and optimize their conceptions. Therefore, history of science appears to be a very relevant tool as it can provide us with many examples of misconceptions, the flaws associated with them, their limits, how they influenced the scientific community then and now, and more. Indeed, history of science is not just the history of scientific discoveries; it is also the history of the scientific failures and as it is riddled with examples of sound scientific enquiries, as it is riddled with example of poorly done science.

The later cases are also interesting and very powerful in regards to scientific education as they provide an element of comparison for learners, as evidenced by results from educational psychology:

An important support for the use of the HoP came from educational psychology that revealed the principle of variance.<sup>157</sup> It was found that the differences between the subjects of learning could be more stimulating than the similarities between them.<sup>158</sup> These studies suggest the effectiveness of the strategy to teach a subject in variation of its meaning. Instead of saying "this way", it is preferable if teacher says: "not that way, and neither that way, but this way". Human cognition, very sensitive to contrasts, effectively learns the objective through a comparison

---

erreurs récurrentes comme le résultat (produit par et construit autour) de conceptions, qui, mêmes lorsqu'elles sont fausses, ne sont pas des accidents, mais des acquisitions souvent positives. Il s'agit donc d'abord pour les chercheurs de:

- Trouver ces erreurs récurrentes, montrer qu'elles se regroupent autour de conceptions,
- Trouver des obstacles dans l'histoire des mathématiques,
- Confronter les obstacles historiques aux obstacles d'apprentissage et établir leur caractère épistémologique. (Brousseau 1989, p. 2)

<sup>157</sup>Reference (Marton 1997) cited as:

Marton, F. & Booth, S. (1997). *Learning and Awareness*, Lawrence Erlbaum Associates, NJ.

<sup>158</sup>Reference (Hammer 2004) cited as:

Hammer, R., Herts, T., Hershler, O., Hochstein, S., & Weinshall, D. (2004). 'Category Learning in Humans by Equivalence Constraints'. Department of Neurobiology and Computer Sciences, The Hebrew University of Jerusalem. Available at: [http://www.cs.huji.ac.il/~tomboy/papers/HumanCategoryLearning\\_Tech.pdf](http://www.cs.huji.ac.il/~tomboy/papers/HumanCategoryLearning_Tech.pdf).

between its variations, considered as possible options. For example, in order to teach certain physical conception, this approach suggests teaching several variations of this conception. The student learns the goal conception by discerning its idea by comparison between the presented to him/her alternatives. The HoP naturally provides such a "space of learning". (Galili 2008,p. 4)

Undeniably, as Matthews put it, “a historically and philosophically literate science teacher can assist students to grasp just how science captures, and does not capture, the real, subjective, lived world” (Matthews 1992, p.28). This is one of the essential aspects of teaching that has to be taken care of in the formation, not just of scientifically initiated or educated students, but of all *scientists*.

## 6.9 Critical Mind Training

Thinking critically, critical thinking or reasoning is an essential skill needed for everyday life, but even more so for doing science as science needs to be as objective as possible. Indeed, “Critical thinking comprises the mental processes, strategies, and representations people use to solve problems, make decisions, and learn new concepts”(Sternberg 1986); as such, it is an indispensable skill to possess in our age of information. Furthermore, it also incorporates other notions such as critical reading, the construction and evaluation of arguments and is considered to be a part of the *skills of the 21<sup>st</sup> century* (National Research Council 2012, p. 5-31; Ploj Vrtič 2010a, 2012, 2014, 2014a).

Critical thinking requires judgment, analysis, and synthesis (Halpern 1998, p. 451); it involves but is not limited to seeking evidence to support the arguments presented, carefully examining the reasoning presented and the soundness of the assumptions. For instance, being able to analyze the concepts and tracing out their implications (Richard 1997) is necessary to identify flaws in the arguments or the reasoning. It is also a skill needed in order to evaluate probabilities and which of different sources cited or sources of information are more trustworthy or, at the very least, more likely to be correct.

For these reasons, it represents a crucial skill to possess as it allows to pay attention and to take notice of false implications, syllogisms, and misinterpretations.

When using critical reasoning, it is also important to identify the type of reasoning and limits. For instance, when using analogies for teaching purposes (cfr. Livingstone 1981; Radelet-de Grave 2009; Rahman 2009, 2016) it is imperative to also teach the limits where the analogy breaks down as it prevents the learners from producing misconceptions. Although a case could be made that this also represents an opportunity for the learners to push their reflection themselves and identify where the analogy they are investigating breaks down.

The teaching of critical thinking is not an easy task, especially when considering the facts that it is a reflective, sensitive to context, and self-monitored process. Indeed, identifying and in particular correcting faulty thinking patterns can be very difficult.

However, there are a number of pointers as well as a number of warnings about common fallacies that can be given to the learners. Indeed, it is paramount to make the learners understand that critical thinking is above all a self-reflective process, which is not trivial.

Fortunately, there already are powerful models of human learning that can be used as a guide for the redesign of education for thinking. The basic principles of these models are taken from cognitive psychology, the empirical branch of psychology that deals with questions about how people think, learn, and remember, or more specifically, how people acquire, utilize, organize, and retrieve information. (Halpern 1998, p. 451)

For instance, the critical thinker should be aware of their possible prejudices, beliefs and be concerned with confirmation bias; both at their own level and at the level of the source presenting the information. Indeed, it is often the case that when beliefs are challenged, the believer experiences a pushback effect and there is a somewhat thin line between healthy scepticism and bad faith.

However, it should be noted that even if the source is trustworthy and authoritative, it does not necessarily mean that it is exempt from mistakes, or that it is not pursuing a hidden agenda, whatever that is; whether malicious or not. A prime example of this is certainly the *Sokal affair* (Sokal 1996).

In addition to that, it would be preferable to educate the learner in statistics or at least to inform them on how to identify invariants, what variables are and their different kinds of nature (dependant, independent, confounding) as well as to educate them on the difference between correlation and causation.

Finally, it should be made clear to the learners that the way information is presented to them matters as it can be oriented, deliberately or not; and the media employed. For example, besides the innate ability of our brain to differentiate integers quantities of 0 to 3, the greater the numbers involved the harder it is to imagine; and as a consequence the type of representation chosen to illustrate data matters (and not only data<sup>159</sup>).

(a) verbal reasoning skills--This category includes those skills needed to comprehend and defend against the persuasive techniques that are embedded in

---

<sup>159</sup> For (amusing) examples:

The clever *Legend* film poster:

<https://www.theverge.com/2015/9/9/9288009/legend-movie-poster-advertising-is-evil>

Various examples of misleading graphical representations:

<https://www.businessinsider.fr/us/fox-news-charts-tricks-data-2012-11>

An illustration of correlation vs. causation with ice cream seals and shark attacks:

<https://qph.fs.quoracdn.net/main-qimg-13d22f6fda3811a9108d18b71c46e933>



everyday language; (b) argument analysis skills--An argument is a set of statements with at least one conclusion and one reason that supports the conclusion. In real-life settings, arguments are complex, with reasons that run counter to the conclusion, stated and unstated assumptions, irrelevant information, and intermediate steps; (c) skills in thinking as hypothesis testing--The rationale for this category is that people function like intuitive scientists to explain, predict, and control events. These skills include generalizability, recognition of the need for an adequately large sample size, accurate assessment, and validity, among others; (d) likelihood and uncertainty--Because very few events in life can be known with certainty, the correct use of cumulative, exclusive, and contingent probabilities should play a critical role in almost every decision; (e) decision making and problem-solving skills--In some sense, all of the critical-thinking skills are used to make decisions and solve problems, but the ones that are included here involve generating and selecting alternatives and judging among them. Creative thinking is subsumed under this category because of its importance in generating alternatives and restating problems and goals. (Halpern 1998, p. 452)

## Final Remarks

In this chapter we have seen that Nature of Science Teaching is a very rich environment. This framework, applied in particular to the subject of gravitational waves, appears to be a natural choice as it can provide a fairly well balanced framework able to avoid some singular issues from other fields by allowing a compensation between them. Furthermore, Nature of Science Teaching as a discipline has the potential to invoke extra fields such as Neurosciences or Cognitive psychology for the design of lectures on the nature of science; and has therefore the side-effect of widening the point of view and thus represents a very complete framework from which global structures on large scales are easily perceptible.

In return however, while this framework is ideal when trying to *see the big picture*, it also has potentially the downside of blurring the fine structures appearing on smaller scales such as that of individual learners; therefore it naturally leans toward descriptive, explanatory and hypothetico-deductive or abductive reasoning and methods.

After having discussed the fundamental differences between scientific knowledge and common knowledge, I discussed their epistemological origins and the main problems. In particular, I have determined that these problems revolved, for the better part, around two types of issues; namely how to extract information and how to evaluate its quality. As evidenced by history and research, these issues can be heavily influenced by social background, regardless of the scope or level considered; whether it be the scientific community, the teachers or learners.

However, all things being equal, the main problems encountered are on one hand the capacity for abstraction and the epistemological break with epistemological obstacles, and on the other hand, methodological issues both practical and theoretical, encompassing scientific practices, methods and reasoning.

## REFERENCES

### Primary Sources

- Bachelard G (1934) *La formation de l'esprit scientifique*. Vrin, Paris.
- Bachelard G (1940) *La Philosophie du Non : Essai d'une philosophie du nouvel esprit scientifique*. Quatrième Édition, Presses Universitaires de France, Paris.
- Duhem P (1906) *La théorie physique: son objet et sa structure*. Chevalier & Rivière, Paris.  
Retrieved: <https://gallica.bnf.fr/ark:/12148/bpt6k951903/f1.item>
- Feynman RP (1965) *The Character of Physical Law*, Richard Feynman With New Foreword by Frank Wilczek. MIT Press, Cambridge, Massachusetts, London, England.
- Mach E (1911) *History and Root of the Principle of the Conservation of Energy*, trans. PE Jourdain. Open Court, Illinois (1st German edn 1871).
- Mach E ([1911] 1973) *History and root of the Principle of the conservation of energy*. Facsimile of the original book, produced in 1973 by microfilm-xerography, University Microfilms, A Xerox Company, Ann Arbor, Michigan, U.S.A.
- Peirce CS (1905) *Adirondack Summer School Lectures*. MS [R] 1334, p. 35. Retrieved: <https://www.fromthepage.com/jeffdown1/c-s-peirce-manuscripts/ms-1334-1905-adirondack-summer-school-lectures/display/16735>
- Piaget J (1927) *La causalité physique chez l'enfant*. Librairie Félix Alcan, Paris.
- Piaget, J. (1973). *Introduction à l'épistémologie génétique (1): La pensée mathématique*. FeniXX.
- Popper KR (1959) *The logic of scientific discovery* New York. Science.

### Secondary Sources

- Bage G (1999) *Narrative matters: teaching and learning history through story*. Psychology Press.
- Barbin E (1997) *Histoire et enseignement des mathématiques: Pourquoi? Comment?*. Bulletin AMQ, 37(1):20-25.
- Bender CM, Orszag SA (2013) *Advanced mathematical methods for scientists and engineers I: Asymptotic methods and perturbation theory*. Springer Science & Business Media.
- Bidwell J (1993) *Humanize Your Classroom with the History of Mathematics*. The Mathematics Teacher, 86(6):461-464. Retrieved: [www.jstor.org/stable/27968440](http://www.jstor.org/stable/27968440)
- Brousseau G (1983) *Les obstacles épistémologiques et les problèmes en mathématiques*, Recherches en Didactique des Mathématiques, 4(2):165-198
- Brousseau G (1989) *Les obstacles épistémologiques et la didactique des mathématiques*. In: *Construction des savoirs, obstacles et conflits*, Bednarz N, Garnier C (eds.), Montréal : les éditions Agence d'Arc inc., pp. 41-64.
- Brun S J-L, Morellato M, Sensevy G, Quilio S (2017) *Cooperative engineering as a joint action*. European Educational Research Journal 17:187–208.  
<https://doi.org/10.1177/1474904117690006>
- Caroll JS (1978) *The effect of imagining an event on expectations for the event: An interpretation in terms of the availability heuristic*. Journal of Experimental Social Psychology, 14(1):88-96.
- Carroll SM (2017) *Why Boltzmann brains are bad*. arXiv preprint arXiv:1702.00850.
- Clark K (2012) *History of mathematics: Illuminating understanding of school mathematics concepts for prospective mathematics teachers*. Educational Studies in Mathematics, 81(1):67-84. Retrieved: [www.jstor.org/stable/23254219](http://www.jstor.org/stable/23254219)

- Clark K, Kjeldsen T, Schorcht S, Tzanakis C, Wang X (2016). History of mathematics in mathematics education. Recent developments. Retrieved: <https://hal.archives-ouvertes.fr/hal-01349230/document>
- Crapanzano F (2018) “Strange Trajectories”: Naïve Physics, Epistemology and History of Science. *Transversal: International Journal for the Historiography of Science* 2018 (5):49-65.
- Dias-Chiaruttini A (2017e) Le débat : enjeux didactiques, épistémologiques et disciplinaires. In: Fisher C., Gagnon R., de Pietro J.-F. (dir.) *L’oral aujourd’hui : perspectives didactiques*, Namur, Presses Universitaires de Namur, collection Recherche en didactique du français 9:67-85.
- Gabel DL (1993) *Handbook of Research on Science Teaching and Learning Project*. Macmillan Publishing Company, Division of Macmillan, Inc., 866 Third Avenue, New York, NY 10022.
- Galante D (2014) The Use of the History of Mathematics in the Teaching Pre-Service Mathematics Teachers. *REDIMAT - Journal of Research in Mathematics Education*, 3(2):110-120. DOI: <http://dx.doi.org/10.4471/redimat.2014.45>
- Galili I (2008) The history of physics as a tool of teaching. In: M. Vicentini & E. Sassi (eds.), *Connecting research in physics education with teachers education*, pp. 1-11. International Commission on Physics Education.
- Gallistel CR, King AP (2011) *Memory and the computational brain: Why cognitive science will transform neuroscience*, Vol. 6. John Wiley & Sons.
- Gundem BB (2000) *Understanding European Didactics*. Routledge International Companion to Education, pp. 235-262.
- Hill JM, Cox BJ (2012) Einstein’s special relativity beyond the speed of light. *Proceedings of the Royal Society A: Mathematical, Physical and Engineering Sciences*, 468(2148):4174–4192. doi:10.1098/rspa.2012.0340
- Hübsch T (2015) *Advanced concepts in particle and field theory*. Cambridge University Press.
- Kelly GJ, McDonald S, Wickman PO (2012) Science learning and epistemology. In: *Second international handbook of science education*. Springer, Dordrecht, pp. 281-291.
- Lakatos I (1971) History of science and its rational reconstructions. In: PSA 1970. Springer, Dordrecht, pp. 91-136.
- Lakatos I (1980) *Mathematics, Science and Epistemology: Volume 2, Philosophical Papers*. Cambridge University Press.
- Ligozat F, Amade-Escot C, Östman L (2015) Beyond Subject Specific Approaches of Teaching and Learning: Comparative Didactics. *Interchange*, 46(4):313–321. doi:10.1007/s10780-015-9260-8
- Ligozat F, Orange C, Dufays J-L, Doussot S, Quilio S, Loquet M, Tiberghien A, Martine J, Mercier A (2017) La modélisation des savoirs dans les analyses didactiques des situations d’enseignement et apprentissage. *Numéro thématique Recherches en Education*, 29
- Matthews MR (1992) History, philosophy, and science teaching: The present rapprochement. *Science & Education* 1:11-47.
- Mc Comas WF (2002) *The Nature of Science in Science Education, Rationales and Strategies*. Mc Comas (ed), Kluwer Academic Publishers, New York/Boston/Dordrecht/London/Moscow.
- McDonald CV, Abd-El-Khalick F (eds.) (2017) *Representations of nature of science in school science textbooks: a global perspective*. Taylor & Francis.
- McLaren I, Wood K, McLaren R (2013) Naive Physics – the wrong theory? In: *Proceedings of the Annual Meeting of the Cognitive Science Society*, 35:1008-1013.
- Nickerson RS (1998) Confirmation Bias: A Ubiquitous Phenomenon in Many Guises. *Review of General Psychology*, 2(2), 175–220. Retrieved: <https://doi.org/10.1037/1089-2680.2.2.175>

- Philippou G, Constantinou C (1998) The Effects of a Preparatory Mathematics Program in Changing Prospective Teachers' Attitudes Towards Mathematics. *Educational Studies in Mathematics*, 35, 189-206. Retrieved: <https://doi.org/10.1023/A:1003030211453>
- Paleo BW (2012) Physics and proof theory. *Applied Mathematics and Computation*, 219(1):45–53. doi:10.1016/j.amc.2011.06.058
- Pisano R (2011) Physics–Mathematics Relationship. Historical and Epistemological notes. In: Barbin E, Kronfeller M and Tzanakis C (eds.), *Proceedings of the ESU 6 European Summer University History And Epistemology in Mathematics*. Verlag Holzhausen GmbH–Holzhausen Publishing Ltd., Vienna, pp. 457–472.
- Pisano R (2013a) History Reflections on Physics Mathematics Relationship in Electromagnetic Theory. In: Barbin and Pisano 2013, pp. 31–58.
- Pisano R, Bussotti P (2014a) Galileo in Padua: architecture, fortifications, mathematics and “practical” science. *Lettera Matematica Pristem International* 2(4):209–221.
- Quinette P, Guillery-Girard B, Hainselin M, Laisney M, Desgranges B, Eustache F (2013) Évaluation du buffer épisodique : deux épreuves testant les capacités d'association et de stockage d'informations verbales et spatiales. *Revue de Neuropsychologie*, 5(1):56-62. doi:10.3917/rne.051.0056
- Radelet-de Grave P (2009) L'analogie comme outil de découverte, in *Revue des Questions Scientifiques*, 180(1):1-32.
- Radford L (1997) On Psychology, Historical Epistemology, and the Teaching of Mathematics: Towards a Socio-Cultural History of Mathematics. *For the Learning of Mathematics*, 17(1): 26-33. Retrieved: [www.jstor.org/stable/40248219](http://www.jstor.org/stable/40248219)
- Rahman S, Iqbal M (2016) UNFOLDING PARALLEL REASONING IN ISLAMIC JURISPRUDENCE (I). Epistemic and Dialectical Meaning within Abū Ishāq al-Shīrāzī's System of Co-Relational Inferences of the Occasioning Factor
- Rahman S, Symons J, Gabbay DM, van Bendegem JP (2009) (eds.) *Logic, Epistemology, and the Unity of Science*. Springer, Dordrecht.
- Yildiz C (2013) Historical Problems in the History of Mathematics: Examples for the Classroom. Retrieved: [https://www.researchgate.net/publication/280248513\\_Historical\\_Problems\\_in\\_the\\_History\\_of\\_Mathematics\\_Examples\\_for\\_the\\_Classroom](https://www.researchgate.net/publication/280248513_Historical_Problems_in_the_History_of_Mathematics_Examples_for_the_Classroom)
- Sarremejane P (2001) *Histoire des didactiques disciplinaires, 1960-1995*. Editions L'Harmattan.
- Schleppegrell M, Achugar M (2003) Learning language and learning history: A functional linguistics approach. *Tesol Journal*, 12(2):21-27.
- Sensevy G, Forest D, Quilio S, Morales G (2013) Cooperative engineering as a specific design-based research. *ZDM - Mathematics Education* 45:1–13. <https://doi.org/10.1007/s11858-013-0532-4>
- Sensevy G, Quilio S (2002) Les discours du professeur. Vers une pragmatique didactique. *Revue française de pédagogie*. <https://doi.org/10.3406/rfp.2002.2914>
- Sensevy G, Santini J, Cariou D, Quilio S (2018) Preuves fondées sur la pratique, pratiques fondées sur la preuve: Distinction et mise en synergie. *Education et Didactique* 12:111–125
- Waldegg, G (1997) Histoire, Épistémologie et Méthodologie dans la Recherche en Didactique. *For the Learning of Mathematics*, 17(1):43-46. Retrieved: [www.jstor.org/stable/40248221](http://www.jstor.org/stable/40248221)

## Selected Additional References on the Subjects – Non-Cited in the Above Running Text

- Aristotle (1801) *The metaphysics of Aristotle*, Translated from the Greek; with Copious Notes in which the Pythagoric and Platonic dogmas respecting numbers and ideas are unfolded from ancient sources. Thomas Taylor (ed.). Davis–Wilks–Taylor, Chancery–Lane, London.
- Euclid (300 BC) *Elements*
- Calinger R (1996) *VITA MATHEMATICA*, Historical Research and Integration with Teaching. The Mathematical Association of America.
- Connes A (2000) *Triangle de pensée*, Paris, Odile Jacob.
- De Broglie L (1922) Rayonnement noir et quanta de lumière. *J. Phys. Radium*, Vol. 3, issue 11, pp.422-428. Retrieved: <https://hal.archives-ouvertes.fr/jpa-00204370/document>
- Fauvel J (1991) Using History in Mathematics Education. For the Learning of Mathematics, 11(2): 3-6. Retrieved: from [www.jstor.org/stable/40248010](http://www.jstor.org/stable/40248010)
- Fauvel J, VanMaanen J (2002) *History in Mathematics Education The ICMI Study*. Kluwer Academic Publishers, New York, Boston, Dordrecht, London, Moscow.
- Galili I (2011) Promotion of cultural content knowledge through the use of the history and the philosophy of science. *Science & Education*, 21:1283-1316. Doi:10.1007/s11191-011-9376-x.
- Mach E ([1898]1960) *The science of mechanics; a critical and historical account of its development*. Translated by Thomas J. McCormack, Open Court Publishing Co., Chicago, London. Retrieved: <https://archive.org/details/sciencemechanic01machgoog/page/n8/mode/2up>
- Matthews MR (1994) *Science Teaching: The Role of History and Philosophy of Science*. Routledge, New York.
- Maurines L, Mayrargue A (2003) *Regard croisés de l'histoire des sciences et de la didactique de la physique sur le concept d'onde. La pluridisciplinarité dans les enseignements scientifiques*, 1.
- Niedderer H, Goldberg F, Duit R (1992) Towards learning process studies: A review of the workshop on research in physics learning. *Research in physics learning: Theoretical issues and empirical studies*, pp. 10-28.
- Niedderer H, Schecker H (1992a) Towards an explicit description of cognitive systems for research in physics learning. *Research in physics learning: Theoretical issues and empirical studies*, pp.74-98.
- Pisano R (2008) A history of chemistry à la Koyré? Introduction and setting of an epistemological problem. *Khimiya* 2/17:143–161.
- Pisano R (2009) On method in Galileo Galilei' mechanics. In Hunger H (ed.), *Proceedings of 3<sup>rd</sup> Congress of the European Society for the History of Science*. The Austrian Academy of Science, Vienna, pp. 174–186.
- Pisano R (2014) (ed.) *Isaac Newton and his Scientific Heritage: New Studies in the History and Historical Epistemology of Science*. Special Issue. *Advances in Historical Studies* 3/3.
- Pisano R (2016a) What kind of Mathematics in Leonardo da Vinci and Luca Pacioli? *Bulletin–British Society for the History of Mathematics* 31:104-111.
- Pisano R (2016b) A Development of the Principle of Virtual Laws and its Framework in Lazare Carnot's Mechanics as Manifest Relationship between Physics and Mathematics. *Transversal–International Journal for Historiography of Science*, 2:166-203.
- Pisano R, Bussotti P (2012) Galileo and Kepler: On Theoremata Circa Centrum Gravitatis Solidorum and Mysterium Cosmographicum. *History Research* 2/2:110–145.
- Pisano R, Bussotti P (2013) Notes on the Concept of Force in Kepler. In Pisano, Capecchi and Lukešová 2013, pp. 337–344.

- Pisano R, Bussotti P (2014) Newton's *Philosophiae Naturalis Principia Mathematica* "Jesuit" Edition: The Tenor of a Huge Work. *Accademia Nazionale Lincei–Rendiconti Matematica e Applicazioni* 25(4):413–444.
- Pisano R, Bussotti P (2014b). Historical and Philosophical Reflections on the Culture of Machines around the Renaissance. How Science and Technique Work? *Acta Baltica Historiae et Philosophiae Scientiarum* 2/2:20–42.
- Pisano R, Bussotti P (2015a) Historical and Philosophical Reflections on the Culture of Machines around the Renaissance: Machines, Machineries and Perpetual Motion. *Acta Baltica Historiae et Philosophiae Scientiarum* 3/1:69-87.
- Pisano R, Bussotti P (2015b) Introduction to Exploring Changes in How the Histories of the Exact Sciences from the 18th to through the 20th Century Have Been Written: Interpreting the Dynamics of Change in these Sciences and Interrelations Amongst Them—Past Problems, Future Cures? *Advances in Historical Studies Special Issue* 4/2:65-67.
- Pisano R, Bussotti P (2016) A Newtonian Tale Details on Notes and Proofs in Geneva Edition of Newton's *Principia*. *Bulletin–Journal of the British Society for the History of Mathematics*, 31 (3):160-178.
- Pisano R., Bussotti P. (2017). On the Conceptualization of Force in Johannes Kepler's Corpus: an Interplay between Physics/Mathematics and Metaphysics, in Pisano R., Agassi J. and Drozdova D. (eds.), *Hypothesis and Perspective in History and Philosophy of Science. Homage to Alexandre Koyré 1892-1964*. Springer, Dordrecht, pp. 295-346
- Pisano R, Capecchi D (2013) Conceptual and Mathematical Structures of Mechanical Science in the Western Civilization around 18th Century. *Almagest* 4/2:86–121.
- Pisano R, Capecchi D (2015) Tartaglia's science weights. *Mechanics in sixteenth century. Selection from Quesiti et invention diverse: Books VII–VIII*. Dordrecht, Springer.
- Pisano R, Capecchi D, Lukešová A (eds.) (2013) *Physics, Astronomy and Engineering. Critical Problems in the History of Science. International 32nd Congress for The SISFA–Italian Society of Historians of Physics and Astronomy. The Scientia Socialis UAB & Scientific Methodical Centre Scientia Educologica Press, Šiauliai University, Lithuania.*
- Pisano R, Fichant M, Bussotti P, Oliveira ARE (2017) (eds.) *Leibniz and the Dialogue between Sciences, Philosophy and Engineering, 1646-2016. New Historical and Epistemological Insights*. The College Publications, London.
- Pisano R, Gaudiello I (2009a) Continuity and discontinuity. An epistemological inquiry based on the use of categories in history of science. *Organon* 41:245–265.
- Pisano R, Gaudiello I (2009b) On categories and scientific approach in historical discourse. In Hunger H (ed.) *Proceedings of ESHS 3rd conference. The Austrian Academy of Science, Vienna*, pp. 187–197.
- Radford L (1997) On Psychology, Historical Epistemology, and the Teaching of Mathematics: Towards a Socio-Cultural History of Mathematics. *For the Learning of Mathematics*, 17(1):26-33. Retrieved: [www.jstor.org/stable/40248219](http://www.jstor.org/stable/40248219)
- Redish EF, Kuo E (2015) Language of Physics, Language of Math: Disciplinary Culture and Dynamic Epistemology. *Science & Education*, 24(5-6):561–590. doi:10.1007/s11191-015-9749-7
- Reuter Y, Cohen-Azria C, Daunay B, Delcambre-Derville I, Lahanier-Reuter D (2013) *Dictionnaire des concepts fondamentaux des didactiques. De Boeck Supérieur.*
- Russ S, Ransom P, Perkins P, Arcavi A, Barbin E, Brown G, & Fowler D (1991) The Experience of History in Mathematics Education. *For the Learning of Mathematics*, 11(2):7-16. Retrieved: [www.jstor.org/stable/40248011](http://www.jstor.org/stable/40248011)
- Swetz F (1989) Using Problems from the History of Mathematics in Classroom Instruction. *Mathematics Teacher*, 82(5): 370-77
- Teixeira ES, Greca IM (2012). The history and philosophy of science in physics teaching: a research synthesis of didactic interventions. *Science & Education*, 21(6), 771-796.

- Tytler R, Prain V (2010) A framework for re-thinking learning in science from recent cognitive science perspectives. *International Journal of Science Education*, 32(15):2055-2078.
- Van Heuvelen A (2001) Millikan lecture 1999: The workplace, student minds, and physics learning systems. *American Journal of Physics*, 69(11):1139-1146.
- Velázquez A, Assar S, Defude B, Rojas J (2008) Student Learning Styles Adaptation Method Based on Teaching Strategies and Electronic Media, pp. 778–782.
- Viennot L (1979) Spontaneous Reasoning in Elementary Dynamics. *European Journal of Science Education*, 1(2): 205-221. DOI: 10.1080/0140528790010209
- Viennot L, Bradamante F (2007) Mapping Gravitational and Magnetic Fields with Children 9–11: Relevance, difficulties and prospects. *International Journal of Science Education* 29:349–372. <https://doi.org/10.1080/09500690600718245>







# CHAPTER VII

## Teaching Gravitational Waves

*An outline.* In this chapter, I will evaluate how various scientific tools, methods and practices can be very naturally implemented in lectures using the Nature of Science framework to teach students gravitational waves physics and the history of their discovery.

In particular, special attention will be dedicated to the place of representations and parallel reasoning both in Science in general and as a teaching tool. Finally, I will discuss the methodology and design behind the elaboration of an introductory lecture on the subject, as well as the results of the evaluations of the learners, the research on my teaching at a distance course, hereafter RTDC.

## 7.1 Representations, Parallel Reasoning and Epistemology

In section 6.7, we established that, broadly speaking, scientific reasoning is defined by “the thinking skills involved in inquiry, experimentation, evidence evaluation, inference and argumentation that are done in the service of conceptual change or scientific understanding” (Zimmerman 2005) and that the ability of abstraction and formalization is an essential part of the scientific spirit (Bachelard 1934, p. 8).

According to Immanuel Kant (1724-1804) knowledge is the combination of two kinds of representations: immediate experiences (intuition) and concepts; simply put, concepts are general representations (Wilson 1975) and knowledge is a kind of judgment based on a concept about an objective reality. However, the “intuition of an object” corresponding to experience is itself a construction obtained through an immediate representation –of the object as is– and a mediate representation obtained through the identification of a characteristic shared with other objects –a concept– which allows the object to be pondered:

Knowledge is a judgment from which proceeds a concept which has an objective reality, that is to say to which a corresponding object can be given in experience. But all experience consists in the intuition of an object, that is to say in an immediate and singular representation thanks to which the object is given as it is to be known, and in a concept, it is that is to say in a mediated representation by means of a character which is common to several objects and which thus makes it possible to think of the object. Taken in itself neither of these two kinds of representations constitutes knowledge, and if there must be *a priori* synthetic knowledge there must also be *a priori* intuitions as well as *a priori* concepts; it is therefore necessary to begin by explaining the possibility of it, and then to demonstrate its objective reality by their necessary use with a view to the possibility of experience.<sup>160</sup> (Kant 1793, p. 266, 2000, p. 18)

As previously discussed, a well-known result of neuropsychology – Educational neuroscience, psychology, learning theory –is the fact that human reasoning –and learning– is driven by association. The root of knowledge, and by extension common knowledge and scientific knowledge, is therefore the association of meaning with representations; and thus symbols and language.

Indeed, the fact that thinking process is inextricable from association is

---

<sup>160</sup> La connaissance est un jugement d'où procède un concept qui a une réalité objective, c'est-à-dire auquel peut être donné un objet correspondant dans l'expérience. Mais toute expérience consiste en l'intuition d'un objet, c'est-à-dire en une représentation immédiate et singulière grâce à laquelle l'objet est donné en tant qu'il est à connaître, et en un concept, c'est-à-dire en une représentation médiate au moyen d'un caractère qui est commun à plusieurs objets et qui permet ainsi de penser l'objet. Prise en elle-même aucune de ces deux sortes de représentations ne constitue une connaissance, et s'il doit y avoir des connaissances synthétiques *a priori* il faut aussi qu'il y ait des intuitions *a priori* tout aussi bien que des concepts *a priori* ; il faut par conséquent commencer par en expliquer la possibilité pour en démontrer ensuite la réalité objective par leur usage nécessaire en vue de la possibilité de l'expérience.<sup>160</sup> (Kant 1793, p.266, 2000, p. 18)

well-known in neurosciences and much research has shown throughout the History of Neuroscience that this type of reasoning is actually biologically built-in the brain; down to its cells (cfr. Nobel Prize in Physiology or Medicine 2014<sup>161</sup>).

We can therefore understand that there is a chain that passes through the subject from their perceptions, intuition, to representations –mental image, symbols and concepts– which are associated with meaning thus constituting knowledge that can be manipulated –through a combination of acquisition of new conceptions, modifications of old ones or rejection– as seen in section 6.2.

Using the notions of the “phaneron” (cfr. Peirce 1905; Section 5.1) and Bachelard’s “first experience” (Bachelard 1934), we will now examine how parallel reasoning (exemplification, symmetries, resemblance and analogies) and representations that originate from the natural way the human mind functions –by associations– can be used as guidelines in order to produce an introductory lesson for the teaching of gravitational waves through the framework of Nature of Science.

There are different types of reasoning by parallelism, namely (cfr. Rahman 2016):

- exemplification or paradigmatic inference;
- symmetry, finding a common relation between two objects, ideas or concepts;
- resemblance; and
- analogy

The point is to find a general law and a property, shared by both the branch- and the source case, which allows inferring the ruling we are looking to ground. (Rahman 2016, p. 10)

However, this shows that in order to build a representation, we have to first rely on an intuition that is itself based on the subjects’ first experience and perceptions –and their common knowledge–. Representations in science do not seek to simply present an image of “facts” or objects; their purpose is to allow the establishment of discoveries through their manipulations and therefore the construction of new knowledge by distancing themselves from perception or “immediate experience”, as Bachelard would say, through abstraction in order to attain a certain level of objectivity.

This once more poses the problem of representations, idealization, abstraction, etc. which are arguably only particular cases of association since all these processes involve some kind of projection, whether of qualities or properties:

---

<sup>161</sup> Cfr. <https://www.nobelprize.org/prizes/medicine/2014/summary/>

That humans (and animals) create internal representations of their environment (as well as of themselves) is probably the central notion in the cognitive sciences. It is the appeal to internal, mental representations, for example, that fundamentally distinguishes cognitive psychology from behaviourism. Depending on the particular field within the cognitive sciences, one finds talk of such things as “schemata,” cognitive maps,” “mental models,” or “frames”.

Later I will argue that scientific theories should be regarded as similar to the more ordinary sorts of representations studied by the cognitive sciences. There are differences to be sure. Scientific theories are more often described using written words or mathematical symbols that are the mental modes of the lay person. But fundamentally the two are the same sort of thing.

Here the only feature of representations I wish to remark on is that they are just that—representations. To put it baldly, they are “internal maps” of the external world. (Giere 1988, p. 6)

Furthermore, depending on the object of the representation, there are at the very least two kinds of representations. Indeed, it is possible to make a distinction between the representations of objects that are supposed *real* (real–physical things) and those which are not.

Therefore, on one hand there are representations that can be directly compared with what they represent such as full or *exact* representations (*exact* drawings, sculptures,...), simplified representations in which the most defining or important traits are selected; and hypothetical representations/models based on objects which are supposed to be real but cannot be directly observed (e.g. Bohr’s atomic model).

On the other hand, for the other type of representations (on non-physical objects) the focus will be on the form and or functioning: hierarchy, relations, qualities, functions, etc. (e.g. family tree, classification, conceptual maps, diagrams, plots, graphs, logical graphs...)

These considerations are especially important in regards to visualization, and even more so when the purpose is understanding and teaching. Indeed, if concepts are general representations resulting from the projection/abstraction of particular common properties of things, a visual representation, or visualization in general, seems to be the most natural way to continue the chain and thus make didactic transposition happen.

In short, the whole idea is to use parallel reasoning, the use of analogies, resemblance, etc. in order to help students identify symmetries and to propose experiments as examples to illustrate our points; but also point to the physical–epistemological limits of these representations and explore the historical–physical–epistemological perspectives related by presenting them with “external maps” that they can internalize, while also making sure they understand the limitations of these “maps”.

Therefore, using this as our working hypothesis, we will try to evaluate how to build an introductory lesson on gravitational waves, how well it is understood and how soon it can be taught.

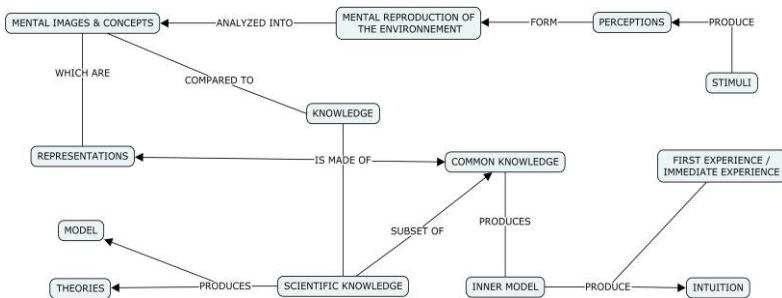
## 7.2 Conceptual Maps

Developed by Joseph Novak<sup>162</sup>, conceptual maps are a great visualization tool to lay out concepts and their relations and can serve multiple purposes, wherever painting a panorama of knowledge can be useful: for simplification, analysis, organization, etc. One of the main ideas behind conceptual maps is to highlight the relations between the concepts and, whenever possible, establish a hierarchy between them.

For example, when designing teaching and learning activities as well as planning them throughout the time provided for teaching, the teacher is expected to determine what and how the subjects, contents, skills and knowledge are going to be taught to the students.

The choice and the organization of the contents depend on many factors, e.g.:

- the organizational constraints (time, class, equipment, etc.)
- the teaching objectives of the program/course/lesson/etc.
- the relative importance of the objectives
- the students (number, level, etc.)



**Fig. 7.2.** An example of one of the possible conceptual maps that can be done based on the previous section (7.1). This graph is readable like sentences, e.g.: Stimuli produce perceptions which form a mental reproduction of the environment which is analyzed into mental images and concepts. Source: PV.

<sup>162</sup> Cfr. <http://sites.estvideo.net/gfritsch/doc/rezo-cfa-410.htm>

## 7.3 Modelling

Models are a type of representations that are indispensable to science as they often provide more than a descriptive value; indeed, beyond the descriptive and explanatory value, models can be used to make predictions.

Remark: One of the best examples of the descriptive power of models is certainly the Lewis dot structures introduced by Gilbert N. Lewis (1875-1946) in “The Atom and the Molecule” in 1916<sup>163</sup> (Lewis 1916) compared to direct images of covalent bonds obtained by Atomic Force Microscopy (AFM)<sup>164</sup>.

In fact, they can somewhat be considered as embodiments of theories as they represent the link between abstraction and the *real* world (Gilbert 2004). From their status of representation, they can fall in the same categories previously discussed. However, models could be divided into two main classes: models that are purely descriptive (e.g. the water cycle), used to simply provide an explanation, and those which are not used in a purely descriptive manner but are rather used as a machinery with input(s) and output(s) able to make predictions about phenomena (e.g. Cell cycle).

For Science Education, according to (Gilbert 2004, p. 117), there are five “modes” of “expressed models”, placed in the public domain, which we have to distinguish from mental models which are by opposition “inaccessible by others”:

A further complication for science education is that any version of a model (i.e. an expressed, scientific, historical, curricular, or hybrid model) is placed in the public domain by use of one or more of five modes of representation.

- The *concrete (or material) mode* is three-dimensional and made of resistant materials, e.g., a plastic ball-and-stick model of an ion lattice, a coloured plastic model of the human circulatory system, a metal model of an aeroplane.
- The *verbal mode* can consist of a description of the entities and the relationships between them in a representation, e.g., of the natures of the balls and sticks in a ball-and-stick representation, of veins and arteries, of the parts of a model aeroplane. It can also consist of an exploration of the metaphors and analogies on which the model is based, e.g., ‘covalent bonding involves the sharing of electrons’ as differently represented by a stick in a ball-and-stick representation and in a space-filling representation. Both versions can be either spoken or written.
- The *symbolic mode* consists of chemical symbols and formula, chemical equations, and mathematical expressions, particularly equations, e.g., the universal gas law, the reaction rate laws.
- The *visual mode* makes use of graphs, diagrams, and animations. Two-dimensional representations of chemical structures (‘diagrams’) fall into this category as do the ‘virtual models’ produced by computer programmes.

---

<sup>163</sup> Cfr. <https://www.britannica.com/biography/Gilbert-N-Lewis/Chemical-bonding-theory>

<sup>164</sup> Cfr. (Gross 2009)



- Lastly, *the gestural mode* makes use of the body or its parts, e.g., the representation of the movement of ions during electrolysis by means of pupils moving in counter-flows. (*Ivi.* pp. 118-119)

Due to the great diversity of model modes, several questions arise. Is there a more effective type of model? What type of model to choose? Etc. However, it is safe to say that regardless of the choice of model(s), the most important thing is to ensure that learners understand the model and whenever possible, that they manipulate it.

For the particular case of the teaching of gravitational waves, the learner can and should be exposed to most modes so as to give them as many opportunities as possible to familiarize themselves with both gravitational waves and to reflect on the use of models, their scope and limitations:

These problems can be addressed by using a mixture of instruction about the utility of different models available in a field of enquiry, about the conventions of interpretation and hence the scope/limitations of the modes/sub-modes of representation used. This instruction should be combined with the direct use by the students of a range of modes/sub-modes to actually construct representations. (*Ivi.* p. 125)

Thanks to the advances in computer modelling, and with the advances in numerical relativity, there is a large number of resources available for free that can be used for the teaching of gravitational waves. For instance, there are beautiful simulations of gravitational waves producing events available on the Simulating Extreme Spacetimes (SXS project) website<sup>165</sup> which is even under the Attribution-Non Commercial 3.0 Unported (CC BY-NC 3.0) licence.

Moreover, thanks to the ever-increasing computing power commonly available and in accordance with the government guidelines to develop 21<sup>st</sup> century skills, the use of simulation software such as Universe Sandbox<sup>166</sup> could be used for didactic–pedagogic purposes.

Simulations and analogical models should not be mistaken one for the other. Indeed, while both are used to see correspondences or make comparisons between the forms, relations or interactions of two objects, systems or things, the two differ on a structural level (Haig 2018, p.50).

Therefore, an analogical model's purpose is to replicate the behaviours of the thing it is trying to emulate. For this reason analogical models are almost always more limited in their descriptive and modelling powers than a theoretical modelling. However, they are still powerful explanatory and investigative tools. Indeed, if analogical models are simpler than what they compare too, the other side of the coin is easier manipulation. Furthermore, sometimes the difference in behaviour of an analogical model compared to what it models is what reveals a characteristic of the latter. On one hand, in order to build an analogical model for teaching purposes, one needs to know

---

<sup>165</sup> Cfr. <https://www.black-holes.org/explore/movies>

<sup>166</sup> Cfr. <http://universesandbox.com/>

at least partially the nature or behavior of what is studied. On the other hand, an analogical model can be built for investigating purposes such as research; and not unlike analogical models for teaching–learning, the structure of the analogies matters and can be exploited in different ways:

From the known nature and behaviour of the source, one builds an analogical model of the unknown subject or causal mechanism. [...] analogical models play an important creative role in theory development. However, this role requires the source, from which the model is drawn, to be different from the subject that is modeled. [...] In evaluating the aptness of an analogical model, the analogy between its source and subject must be assessed, and for this one needs to consider the structure of analogies. The structure of analogies in models comprises a positive analogy in which the source and subject are alike, a negative analogy in which the source and subject are unlike, and a neutral analogy where we have no reliable knowledge about matched attributes in the source and subject of the model. The negative analogy is irrelevant for purposes of analogical modelling. Because we are essentially ignorant of the nature of the hypothetical mechanism of the subject apart from our knowledge of the source of the model, we are unable to specify any negative analogy between the model and the mechanism being modeled. (Haig 2018, p. 50)

Analogical reasoning is important in science and clearly lies at the inferential heart of analogical modelling. (Haig 2018, p. 51)

## 7.4 Thought Experiments

Thought experiments or *gedanken* experiments are a special type of experiments and an essential tool in science, as well as in everyday life. Indeed, just like the ability to anticipate and predict consequences is vital, the ability to predict outcomes from a model is essential in science. While most thought experiments are based on the correspondence between the real world and the internal representation of the real world to make predictions, some rather take the form of a *reduction ad absurdum*; but both types seek to evaluate the model they are based on whether the end goal is to be a future *real* experiment, in which case they are simply the first step of designing experiments; to study a problem or case outside current capacities (e.g. Feynman’s sticky beads argument), or to illustrate something (e.g. Schrödinger’s cat).

As thought experiments are literal representations processed by mental models, they are subject to the same issues of abstraction, idealization, etc. and similar model modes.

Because of that, for Science Education, they provide the teachers with a way to compare and “discuss” with the mental representation of the students. For instance, the teacher can use thought experiments in order to illustrate his discourse by unwinding the logic involved, to point at flaws or give counterexamples; but the teacher can also use this kind of experiment as a tool to evaluate the comprehension of their students by setting them up in a

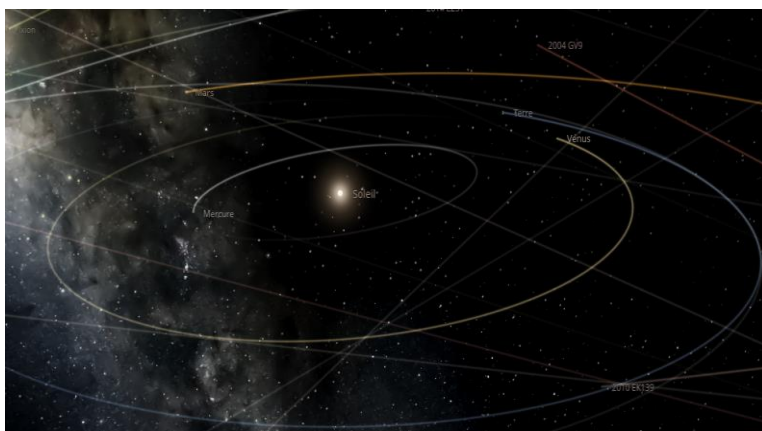
hypothetical situation through which they have to unwind their logic and reach a conclusion, thus providing the teacher with a way to identify the difficulties or misconceptions of the learners.

Furthermore, used in combination with other tools, this type of experiment can allow the teacher to evaluate the mental model of the students; for example, some of the questions the teacher could ask are: “What would happen if instead of the Sun, the Earth was orbiting a black hole of the same mass?” or rather “What would happen to the Solar system if the Sun was replaced with a black hole of the same mass?” and then let the students compare their ideas with virtual simulations on computers.

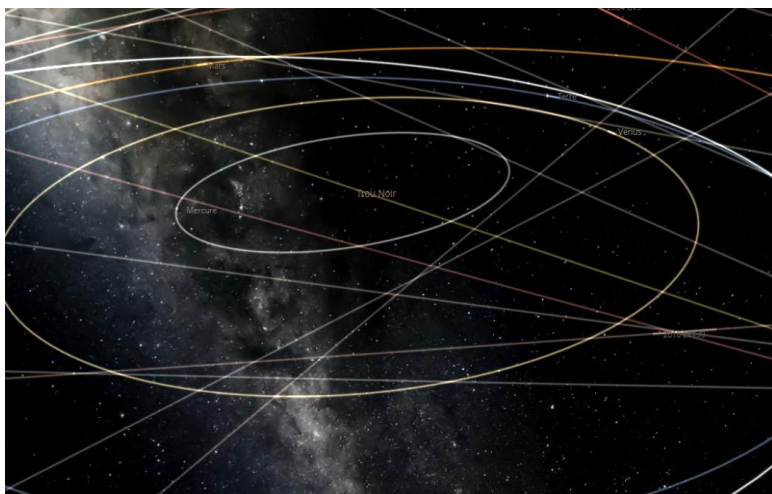
It seems reasonable to think that thought experiments are akin to –if not the same as– mental simulations, however there is a nuance:

To answer the question of whether thought simulations are thought experiments, we should first ask whether simulations are experiments. The answer is *no*: a simulation is a two-part demonstration composed of an experiment and an analogical argument. The question addressed by the simulation concerns variables that are not manipulated in the simulation’s experiment. Its component experiment manipulates variables that are analogous to the ones involved in the simulation’s question. The job of the simulation’s analogical argument is to support this connection. By parity of reasoning, a thought simulation contains a thought experiment but is not itself a thought experiment. (Sorensen 1992, pp. 226-227)

For instance, the students could use a computer simulation of the Solar system, lock the mass of the Sun and reduce its radius until it collapses into a black hole in order to check if there are noticeable effects on the orbits of the planets or trajectories of any object. Thus leading them to the conclusion that only the Sun/Black hole mass at the center of the system is relevant for the orbits.



**Fig. 7.4.a.** Screenshot of a simulation of the Solar System with trailing orbits in Universe Sandbox. Source: PV.



**Fig. 7.4.b.** Screenshot of the same simulation of the Solar System in which (only) the radius of the Sun has been reduced until it collapsed into a black hole. The “show full orbits” option has been enabled for visibility. Source: PV.

This kind of teaching also opens the way to epistemological–philosophical questions about the nature of models, thought experiments and simulations; such as: *what are the differences between them?*

According to Léo Coutellec and Anne-Françoise Schmid (2014):

Modelling starts from known objects, and articulates the knowledge they suppose with “data”, and not only with facts, which are correlates of theory. The coherence between these two aspects can give rise to anomalies, which make it possible to construct propositions which have no direct interpretation in any of the disciplines involved in modelling.

The simulation starts from a combination of knowledge, the consequences of which are unknown. It constructs quasi-empirical scenarios to define these, and to return to the parameters chosen in the models. It passes from terms to relationships and vice versa by bringing into play a multiplicity of models, which is why it appears as a new mode of representation.

Thought experiment starts from the intuition of a supposed datum to reconstruct the application of one fragment of knowledge in another.<sup>167</sup> (Coutellec 2014, pp. 39-40)

---

<sup>167</sup> La modélisation part d’objets connus, et articule les connaissances qu’ils supposent avec des « data », et pas seulement avec des faits, qui sont des corrélats de la théorie. La cohérence entre ces deux aspects peut donner lieu à des anomalies, qui permettent de construire des propositions qui n’ont d’interprétation directe dans aucune des disciplines en jeu dans la modélisation.

La simulation part d’une combinaison de connaissances dont on ne connaît pas les conséquences. Elle construit des scénarios quasi-empiriques pour cerner ces dernières, et revenir sur les paramètres choisis dans les modélisations. Elle passe des termes aux relations et vice-versa par la mise en jeu d’une multiplicité de modèles, c’est pourquoi elle apparaît comme un nouveau mode de représentation.

L’expérience de pensée part de l’intuition d’un donné supposé pour reconstruire

Similar questions could be asked about the difference between thought experiments and experiments, their benefits, their limits; the limits of simulations, and so on.

## 7.5 Experiments

Experiments are an essential component of science and by extension, of science education; both for the teaching-learning of methods and the teaching-learning of concepts. Experiential Education (Dewey 1986), has been and still is greatly studied, in many different disciplines, at different ages, levels and from different perspectives; and has led to the development of a multitude of theories (Smith 2011). For example, it has led to *experiential learning* which has been the object of much research (Lewis 1994; Miettinen 2000; Kolb 2009; Garvin 2003; Camporesi 2017) and has been studied through various fields (Schibrowsky 1995; Frontczak 1998). According to Kolb:

Experiential learning theory defines learning as “the process whereby knowledge is created through the transformation of experience. Knowledge results from the combination of grasping and transforming experience (Kolb 1984, p. 41).” [...] immediate or *concrete experiences* are the basis for observation and *reflections*. These reflections are assimilated and distilled into *abstract concepts* from which new implications for action can be drawn. The implications can be *actively tested* and serve as guides in creating new experiences. (Kolb 2011, p. 228)

However, it should be noted that even if experiential education and experiential learning have been used somewhat synonymously, the key difference is that experiential learning does not require an educator (Itin 1999, p. 92). Indeed, the educational process is created through the interaction of the student with the teacher.

The main difficulty with teaching–learning about gravitational waves is probably the figurative distance between the subject and the students. Gravitational waves are a rather abstract concept which is neither easy to learn nor to teach. The reasons for that are multiple, e.g.:

- The gravitational waves, as a concept, stems from Einstein’s Relativities as they arise as consequences of the theory;
- The understanding of the Physics of gravitational waves rely on a number of other concepts which are often misunderstood;
- The gravitational waves, as physical objects, are extremely difficult to measure and their sources are very far away;
- It is not possible to directly experience gravitational waves (observing or having an immediate experience)

---

l’application d’un fragment de connaissance dans un autre.

- The students might not understand why they should know about the matter (motivation problem);

In order to resolve this problem, the bulk of the work should be put into the efforts to provide the students with a framework as grounded in reality and as concrete as possible through the use of parallel reasoning and hand-on experiences in which the students are actors, actively learning.

In order to achieve this, the LIGO website recommends a few classroom activities specifically about gravitational waves for various audience levels such as:

- Searching for Gravitational Waves in noisy data in which students are asked to compare signal templates (models) by laying the data transparencies over the templates of simulated data;
- A Numerical activity using Gravitational Wave Mathematics in which the students are given formulas and make some calculations;
- Two concrete, practical experiments (Cfr. Fig. 7.5. below):
  - A material experiment exploring a coalescence;

A material experiment exploring the concept of spacetime curvature.

**Activity 1 – Coalescing Black Holes**

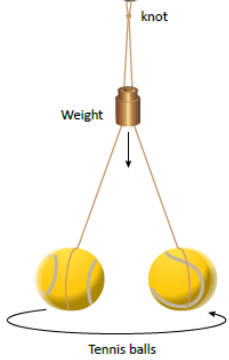
**Brief overview:**  
Students interact with a demonstration of orbiting spheres that have an increasing orbital frequency as they coalesce.


**Science Concepts:**  
Gravitational waves are ripples in spacetime produced by some of the most violent events in the cosmos, such as the collisions and mergers of massive compact stars or black holes. These ripples travel at the speed of light through the Universe, carrying with them information about their origins.

**Duration:** 30 min

**Essential Question:**  
What happens when two black holes spiral in towards each other?

**Grades:** 5 – 12





**Activity 2 – Warping of Spacetime**

**Brief overview:**  
Students explore the behavior of two orbiting spheres in spacetime.

**Science Concepts:**  
A pair of orbiting black holes will produce gravitational waves, which are ripples in the fabric of spacetime. Gravitational waves will carry energy away from the pair, causing their orbit distance to shrink and their orbital period to decrease. Eventually the black holes will coalesce. LIGO's detectors can measure the gravitational waves produced by the system during the coalescence.

**Duration:** 30 min

**Essential Question:**  
How do binary black holes warp spacetime?

**Grades:** 5 – 12

**Fig. 7.5.** LIGO's Educators guide, proposed activities for the teaching of gravitational waves for grades 5-12 (12-18 years old learners), p. 5. Source: Public Domain | <https://dcc.ligo.org/LIGO-P1600015/public>

These last two experiments are particularly interesting in regards to the ideas developed so far about parallel reasoning, representations, models and their limitations.

In activity 1, the two tennis balls –painted black “to simulate black holes” (Ivi. p.15)– are described as “orbiting spheres” by analogy with (non-spinning) black holes which event horizons are supposed to be spherical. Another suggestion is made in an “Optional” section of the steps describing how to reproduce this activity with piezoelectric buzzers that have been placed inside the hollow tennis balls in order to produce “ringdown sounds” (Ibidem), hopefully similar to the ones one can hear when transposing the *chirp* signal in audible frequencies.

At the beginning of the experiment, the tennis balls are set into motion, mimicking the orbital revolutions of two black holes orbiting around each other:

Procedure:

1. Pull the two balls apart forcing the weight up to the top of the string.

2. Carefully, throw the two balls so that they orbit in the same direction (both clockwise or both counter-clockwise) at the same speed. This may take some practice to get right.

As the mass slowly falls and the string winds up, the orbit will contract and the two balls will speed up. The balls will eventually “merge” or come together. This mimics the chirp of the gravitational wave signal. (*Ibidem*)

After that, the guide suggests two questions with their answers:

### Questions

1. What do the two balls represent?
2. The mass sliding down the string removes energy from the system. What is this analogous to in the binary black hole system?

### Answers

1. Each ball represents one of the black holes
2. The mass is absorbing the energy from this simple orbital system. With the merging black holes responsible for GW150914, gravitational waves are carrying away this energy. (Author’s bold, *Ibidem*)

*On the limits of the activities/models/experiments.* The first remark is that the focus of the first activity should be put on the motion of the tennis balls; however special attention should be given to the other components (i.e. the hook, the ropes, the knot and the weight) and their presence should be explained: the hook, ropes and knot are used for the suspension of the model, and the weight, by falling, forces the orbital radius to decrease rapidly, thus making the tennis balls revolve faster.

The main problem is obviously with all the logical disadvantages that come from the fact that the system is located in a classroom, on Earth. Nevertheless, if it is easy to see the analogy between the tennis balls and the black holes, it is more difficult to say the same thing about the weight. Indeed, we have a clear analogy by resemblance between physical objects – between tennis balls and black holes; but the second answer, namely that the mass (weight) removes energy from the system and that “The mass is absorbing the energy from this simple orbital system. With the merging black holes responsible for GW150914, gravitational waves are carrying away this energy” is rather unclear. Using parallel reasoning, it is easy to understand that the weight is actually analogous to the *chirp mass*; and therefore, that the loss of potential energy of the weight is analogous to the loss of potential energy from the two black holes (symmetry).

Finally, what about the initial push? or what about the process by which gravitational waves are emitted? which are not explained. However an analogy could be found by explaining that in the same way that the tennis balls displace air when rotating, massive objects like black holes produce a similar effect in spacetime (e.g. Lense-Thirring effect/Frame dragging: the



tennis balls produce increasing perturbations in air just like orbiting black holes produce increasing perturbations in spacetime).

On the other hand, the second activity/representation (cf. Section 1.9) is very visual and straightforward. The analogy between the heavy balls and the massive celestial objects is well established, just like the analogy between the curvature of the fabric and the curvature of spacetime, etc. However, the students may face more misconceptions than the ones discussed:

**AVOID MISCONCEPTIONS:** This demonstration is only a 2-dimensional representation of the real thing. To avoid misconceptions make sure you ask your students questions like: What is on the “other side” of the black hole in 3-dimensions? Space acts the same in all 3 dimensions. There is no front and back to a black hole. It is a spherical “dent” in spacetime. (*Ivi.* p. 16)

For instance, particular attention should be put on the limits of this representation regarding its dimensionality. The fabric is a 2-D surface embedded in our 3-D space, just like the surface of a sphere would be a 2-D surface embedded in our 3-D space; therefore, if the fabric can bend in the third spatial dimension, it does not automatically translate in that spacetime can curve in a fourth special dimension; in fact, the bending of the fabric actually represents the gravitational gradient.

The questions then arising from that are: what kinds of experiments could be considered for the teaching of gravitational waves? What are their limitations? And for what level of students are they appropriate? and so on.

## **7.6 Lecturing the Gravitational Waves & Additional Frameworks**

The history of the discovery of gravitational waves is a vast interdisciplinary subject matter with a very rich history, and has therefore great potential for NoS Teaching-Learning which by extension allows for many different approaches and lecturing from multiple frameworks.

From the Physics point of view, as the gravitational wave concepts call on other concepts, for instance, the concepts of waves, gravitation, relativities... It would seem reasonable to think that a lecture on the subject could be included in many different places of various curricula. As an example, at High School, since students are already taught notions of relativity through muon disintegration, a lecture on gravitational waves could either be placed before as an introduction to spacetime disturbances with contraction/dilatation effects or at the end of the curricula as a synthesis of concepts called upon in previous lectures. Furthermore, the subject of gravitational waves physics is one of the few frameworks in which Quantum Mechanics concepts and effects are used in order to study General Relativity.

From the Mathematical point of view, lecturing on gravitational waves potentially invokes the use of many mathematical tools and subject matters such as geometry, differential geometry, calculus, matrices, etc.

From the History of science point of view, the history of gravitational waves is a well-documented hot topic the roots of which date as far back as the 19<sup>th</sup> century or even further, thus providing a wide range and important part of history filled with versatile historical resources that can be exploited. From the Epistemological and Philosophical points of view, the history of gravitational waves is filled with opportunities for exploring many different questions regarding the ontology of space, time, spacetime, the evolution of scientific thinking and community, examples of paradigm shifts, the current and past conceptions about the philosophy of science and much more.

### 7.6.1 Prerequisites & Typology of Class

The question of the prerequisites when designing teaching and learning activities depend on a number of factors such as what and how the subjects, contents, skills and knowledge are going to be taught to the students; but also on factors such as the teaching objectives of the program, the number of students, their level, their background, etc.

The prerequisites of an introductory course on gravitational waves in concepts (for high school, lyceum) are:

- Notions of Waves:
  - What waves are,
  - What are their physical and mathematical characteristics,
  - How they propagate;
  - How they interact (Interference, Reflection, Refraction)
- Notions of Media;
- Notions of Geometry:
  - Euclidean Geometry
  - Trigonometry.
- Notions of Force
- Notions of (Newtonian) Gravitation;
- Notions of Mass;
- Notions of Energy:
  - Energy conservation;
  - Notions of Potential Energy;
- Notions of Celestial bodies;
- Notions of the Speed of light;
- Notions of Acceleration;
- Notions of Radiation;
- Notions of Orders of Magnitude
- Notions of Signals

The prerequisites of an introductory course on gravitational waves in concepts (for University) are:

- Notions of Waves:
  - What waves are,
  - What are their physical and mathematical characteristics,
  - How they propagate;
  - Interference, Reflection, Refraction, Diffraction
- Notions of Media: What is a medium;
- Notions of Relativity Principles;

- Notions of Geometry:
  - Euclidean Geometry
  - Trigonometry;
- Notions of Gravitation:
  - Newtonian;
  - Notions of General Relativity;
- Notions of Mass;
- Notions of Acceleration;
- Notions of Energy:
  - Potential Energy;
  - Energy conservation;
- Notions of Celestial bodies;
- Notion of the Speed of light;
- Notions of Radiation;
- Notions of Orders of Magnitude;
- Notions of Signals;
- Notions of Quantum Effects

The prerequisites of an advanced introductory course on gravitational waves in concepts (for University) are:

- Notions of Waves:
  - What waves are,
  - What are their physical and mathematical characteristics,
  - How they propagate;
  - Interference, Reflection, Refraction, Diffraction
  - Redshift
- Notions of Media: What is a medium;
- Notions of Fields;
- Notions of Gravitation:
  - Newtonian;
  - General Relativity;
- Notions of Special Relativity:
  - Speed of light,
  - Causality;
- Notions of Geometry:
  - Trigonometry;
  - Differential Geometry:
    - Notions of Euclidean Space;
    - Notions of Curved Spaces;
- Notions of Mass;
- Notions of Energy:
  - Energy conservation;

- Notions of Potential Energy;
- Luminosity
- Notions of Celestial bodies:
  - Black Holes,
  - Neutron Stars;
- Notions of Radiations;
- Notions of Calculus;
- Notions of Signal Analysis;
- Notions of Matrices;
- Notions of Tensor Calculus;
- Notions of Orders of Magnitude
- Notions of Quantum Mechanics

## 7.6.2 Cognitive Objectives

Physics:

- Defining what Energy is
- Understanding Energy Conservation
- Defining what a Wave is
  - Waves Properties
  - Waves Interactions
- Defining what Mass is
- Defining what Space is
- Defining what Time is
- Defining what Noise is
- Defining what Spacetime is
- Defining what a Signal is
- Identifying a Chirp Signal
- Knowing how to Identify Gravitational Wave Signals
- Identifying Gravitational Waves Inspiral, Merger and Ringdown
- Knowing the Physical Sources of Gravitational Waves and their Properties
- Describing the Evolution of Compact Binary Systems
- Being able to conduct simple Calculations

Philosophy of Science and Epistemology:

- What is Science
- What are Hypotheses, Theories, Theorems, Laws, Principles, Axioms;
- What are variables and invariants;

- Parallel Reasoning and Analogies
  - Differences between Analogy, symmetry, etc.
- Problem of Objectivity
- Problem of Interpretation
- Fallacies
- Critical Thinking
- Immediate Experience
- Problems with Learning, Knowing, Understanding
- Defining the Scientific Method
- Explaining the difference between Verification and Falsification
- Paradigms and Paradigm Shifts
- Defining Ontology
- Difference between Models and Simulations
  - For Science Research
  - For Teaching-Learning
- Being able to identify limits of:
  - Experiments and thought experiments
  - Representations, models, etc.
- Formulating Hypotheses
- Describing scientific methods

#### History of Science:

- What is the History of Science
- Evolution of Science
- Evolution of the Concept of Space
  - Euclidean
  - Non-Euclidean
- Newtonian Gravitation
- Principles of Relativity
- Einstein's Theory of Relativity:
  - General Relativity
  - Special Relativity
- Historical Texts Vocabulary
- Problem of Interpretation
- Fallacies
- Priority Disputes

### 7.6.3 Operative Objectives

- Analysis of the scientific method
- Analysis of the nature and structure of scientific concepts and theories
- Analysis of the relationship science–society in the history of science
- Analysis of the boundaries and the values of the scientific enterprise.
- Knowing the historical foundations of the theories considered.
- Interdisciplinarity.
- Knowing the meaning of historical hypothesis and epistemological interpretation.
- Knowledge of the main facts of the history of science proposed by the teacher.
- Knowledge of the main facts of historical epistemology proposed by the teacher.
- Parallel Reasoning
- Constructing Representations
- Manipulating Representations
  - Manipulating Computer Simulations
  - Manipulating Variables
- Extracting information through Parallel Reasoning
- Calculations
- Extracting information from Historical Texts.
- Critical reading of primary and secondary sources of the history of science and technology in relation to epistemological, philosophical and literary culture also to the political, social and institutional environment of their times..
- Knowing how to define terms and concepts and possibly perform calculations.
- To be able to present written or oral works while correctly respecting the time and chronology of historical events.
- Knowing how to correctly bring back the problems confronted to the thought of the authors examined.
- Compare and contextualize the different answers of scientists throughout history.
- Grasp analogies, differences, revolutions, conflicts, anomalies, models and methods in the history of science.
- Seeking to recognize and support the mixture of science-technology in different scientific theories tackled from the historical point of view.
- Putting in context the scientific foundations of science and its relations with society in historical discourse.

## 7.6.4 Methodology

The original plan was to test the NoS Introductory Module on the physics of gravitational waves and their discovery that I had prepared. Prof. Etienne Milent kindly offered to do (at least one of the) lectures with some of his students (Licence 1 IEEA – Electronic, Electrotechnical and Automatic Data Processing). Unfortunately, because the COVID-19 pandemic happened, the Universities (and Lyceums) had to close down.

Therefore I had to resolve myself to try the next best thing and proceeded to do a special lecture online open to any students which became the RTDC. In the end, I only managed to get 9 participants.

Original planned approach:

Pre-test (cf. Appendix)

First step:

- The professor distributes the “student sheet” and the historical texts (cf. Appendix)
- The students read the “student sheet” and are invited to write their reflections if any on a separate piece of paper

Second step:

- The professors starts the lecture
- Some time is allocated to the reading of the historical texts
- The students are asked if they have any questions regarding the texts
- The students are asked to answer oral questions
- It could be possible to include a time for the manipulation of different simulations on a computer

Third step (at the end of the lecture):

- The professor asks the students to write the changes/evolution of their ideas on the different subjects invoked during the lecture

Post-test (cf. Appendix)

Analyses of the tests and students’ productions.



## 7.7 Expected Results

The expected results on the learners were specifically the following:

Expectation 0: *Students understand that there are other kinds of geometry besides Euclidean Geometry.*

Expectation 1: *Students are comfortable with the concept of Spacetime.*

Expectation 2: *Students understand that Spacetime curvature depends on the Mass–Energy density.*

Expectation 3: *Students understand that Gravitational Waves are Spacetime perturbations propagating in Spacetime.*

Expectation 3-1: *Students understand that Gravitational Waves are produced by accelerating masses.*

Expectation 4: *Students are able to use their recent concepts to make predictions about different situations.*

Expectation 5: *Students have a sound understanding of what Black Holes are.*

Expectation 6: *Students are able to make simple calculations using gravitational waves mathematics.*

Expectation 7: *Students understand the logical progression that led to the discovery of Gravitational Waves.*

Expectation 8: *Progress in Science is not linear: different scientific theories can coexist and new theories replace older ones.*

Expectation 9: *Students understand that science is a human endeavour.*

Expectation 10: *Students understand the scientific method.*

Expectation 11: *Students understand how to evaluate theories.*

Expectation 12: *Students' preference for studying leans toward the Nature of Science framework.*

## 7.7.1 Selected Readings: Documents, Handbooks and Historical Resources

Extracts from key documents related to the fundamental concepts of gravitational waves used for teaching:

- Clifford WK (1870) Lecture delivered to the Cambridge Philosophical Society February 1870, Abstract Reprint In: *Mathematical Papers W.K. Clifford*. Ed. Robert Tucker (ed). London Macmillan & Co, 1882. Reproduced in P. Pesic *Beyond Geometry* (2007) p. 73, Dover N.Y.
- Clifford W.K. (1901b). *The Postulates of the Science of Space*, in F.R.S. Stephen L., Pollock F. (eds.), *Lectures and essays by the late William Kingdon Clifford*, MacMillan and Co., Limited, New-York, 1901, Vol. 1, pp. 352-388.
- Poincaré HJ (1905) *Sur la dynamique de l'électron* (The Dynamics of the electron by Henri Poincaré). In: *Henri Poincaré, La mécanique nouvelle, conférence, mémoire et note sur la théorie de la relativité*, introduction de M. Édouard Guillaume. 1924, Gauthier-Villars et Cie, pp. 18-76, 77–81. Poincaré HJ (1913) *Dernières pensées*. Flammarion, Paris.
- Riemann B. (1854). "Ueber die Hypothesen, welche der Geometrie zu Grunde liegen". (Habilitationsschrift, 1854, *Abhandlungen der Königlichen Gesellschaft der Wissenschaften zu Göttingen*, 13).

### 7.7.1.1 Primary Sources: Reading Texts

- Balibar F (1993) (ed) *Albert Einstein, œuvres choisies, volume 1 : Quanta*. Éditions du Seuil / Éditions du CNRS, Paris.
- Balibar F (ed) (1993) (ed) *Albert Einstein, œuvres choisies, volume 2 : Relativité*. Éditions du Seuil / Éditions du CNRS, Paris.
- Clifford WK (1870) Lecture delivered to the Cambridge Philosophical Society February 1870, Abstract Reprint In: *Mathematical Papers W.K. Clifford*. Ed. Robert Tucker (ed). London Macmillan & Co, 1882. Reproduced in P. Pesic *Beyond Geometry* (2007) p. 73, Dover N.Y.
- Clifford W.K. (1901b). *The Postulates of the Science of Space*, in F.R.S. Stephen L., Pollock F. (eds.), *Lectures and essays by the late William Kingdon Clifford*, MacMillan and Co., Limited, New-York, 1901, Vol. 1, pp. 352-388.
- Duhem P ([1906]1981) *La théorie physique*. Vrin, Paris.
- Eddington AS (1919). *The total eclipse of 1919 May 29 and the influence of gravitation on light*. *Observatory* 42:119-122.
- Einstein A (1925) *Sur l'électrodynamique des corps en mouvement*. Gauthier-Villars, Paris. [réimprimé aux Éditions Jacques Gabay, Paris en 2005]
- Einstein A (1991) *Œuvres choisies*. Éditions du Seuil, Paris.
- Einstein A ([1934] 1983) *Comment je vois le monde*. Flammarion-Champs, Paris.
- Einstein A, Infeld L (1993) *L'évolution des idées en physique*. Flammarion-Champs, Paris.
- Kepler J (1992) *New Astronomy*. Translation of *Astronomia Nova* by William H. Donahue. The Cambridge University Press, Cambridge.
- Mach E ([1898]1960) *The science of mechanics; a critical and historical account of its development*. Translated by Thomas J. McCormack, Open Court Publishing Co., Chicago, London.
- Retrieved:  
<https://archive.org/details/sciencemechanic01machgoog/page/n8/mode/2up>

- Newton I ([1713], 1729) *The Mathematical principles of natural philosophy*. Translated by Motte Andrew. Motte B, London.
- Poincaré HJ (1889) *Théorie mathématique de la lumière*. Carré & Naud, Paris.
- Poincaré HJ (1900a) Les relations entre la physique expérimentale et la physique mathématique. *Revue générale des sciences pures et appliquées* 11:1163–1175.
- Poincaré HJ (1900b) La théorie de Lorentz et le principe de réaction, *Archives néerlandaises des sciences exactes et naturelles* 5:252–278.
- Poincaré H (1902) La science et l'hypothèse. Flammarion, Paris. Retrieved: <https://gallica.bnf.fr/ark:/12148/btv1b86263141/f184.image.r=la%20science%20et%20l'hypoth%C3%A8se>
- Poincaré HJ (1905) Sur la dynamique de l'électron (*The Dynamics of the electron* by Henri Poincaré). In: Henri Poincaré, *La mécanique nouvelle, conférence, mémoire et note sur la théorie de la relativité*, introduction de M. Édouard Guillaume. 1924, Gauthier-Villars et Cie, pp. 18-76, 77–81. Poincaré HJ (1913) *Dernières pensée*. Flammarion, Paris.
- Poincaré HJ (1913) *Dernières pensée*. Flammarion, Paris.
- Popper K ([1934] 2005) *The Logic of Scientific Discovery*. Routledge, London and New York. Retrieved; <http://strangebeautiful.com/other-texts/popper-logic-scientific-discovery.pdf>
- Riemann B. (1854). “Ueber die Hypothesen, welche der Geometrie zu Grunde liegen”. (*Habilitationsschrift*, 1854, *Abhandlungen der Königlich Gesellschaft der Wissenschaften zu Göttingen*, 13).

### 7.7.1.2 A first specific bibliography on the module

- Adair R (1987) *The Great Design: Particles, Fields and Creation*. The Oxford University Press, NY.
- Bachelard G ([1934] 1967) *La formation de l'esprit scientifique*. Vrin, Paris.
- Bachelard G ([1940] 1966) *La Philosophie du Non : Essai d'une philosophie du nouvel esprit scientifique*. Quatrième Édition, Presses Universitaires de France, Paris.
- Bachelard G (1951) *L'activité rationaliste de la physique contemporaine*. Presses Universitaires de France, Paris
- Borel É (1913), *La théorie de la relativité et la cinématique*. *Comptes Rendus des séances de l'Académie des Sciences* 156: 215–218.
- Borel É (1914) *Introduction géométrique à quelques théories physiques*. Gauthier-Villars, Paris
- Bradamante F, Viennot L (2007) Mapping Gravitational and Magnetic Fields with Children 9–11: Relevance, difficulties and prospects. *International Journal of Science Education*, 29(3):349-372. DOI: 10.1080/09500690600718245.
- Brousseau G (1976) Les obstacles épistémologiques et les problèmes en mathématiques. In: J. Vanhamme & W. Vanhamme (eds.), *La problématique et l'enseignement des mathématiques*. *Comptes rendus de la XXVIIIe rencontre organisée par la Commission Internationale pour l'Etude et l'Amélioration de l'Enseignement des Mathématiques*, Louvain la Neuve, pp. 101-117.
- Brousseau G, Bednarz N, Garnier C (1989) Les obstacles épistémologiques et la didactique des mathématiques. *Construction des savoirs Obstacles et Conflits*, CIRADE, Les éditions Agence d'Arc inc., pp.41-63.
- Calinger R (1996) *VITA MATHEMATICA, Historical Research and Integration with Teaching*. The Mathematical Association of America.
- Cepni S, Tas E, Kose S (2006) The effects of computer-assisted material on students' cognitive levels, misconceptions and attitudes towards science. *Computer Education* 46(2):192-205.
- Cohen FH (1994) *The Scientific Revolution: A Historiographical Inquiry*. The University of Chicago Press, Chicago.

- Coles P (2001) Einstein, Eddington and the 1919 Eclipse. In: *Historical Development of Modern Cosmology*; Martínez VJ, Trimble V, Pons-Bordería MJ (eds), *Astronomical Society of the Pacific*: San Francisco, CA, USA, 2001; Volume 252, pp. 1-25.
- Crapanzano F (2018) “Strange Trajectories”: Naive Physics, Epistemology and History of Science. *Transversal: International Journal for the Historiography of Science*, (5):49-65 ISSN 2526-2270. DOI: <http://dx.doi.org/10.24117/2526-2270.2018.i5.06>.
- Crombie AC (1963) (ed.) *Scientific change: historical studies in the intellectual, social and technical conditions for scientific discovery and technical invention, from antiquity to the present—Symposium on the history of science*, University of Oxford, 9–15 July 1961. Heinemann education books, London.
- Damour T, Darrigol O, Duplantier B, Rivasseau V (2006) (eds) *Einstein, 1905–2005. Poincaré Seminar 2005*, Birkhäuser Verlag, Basel.
- Darrigol O (2000) *Electrodynamics from Ampère to Einstein*. The Oxford University Press, Oxford.
- Darrigol O (2004) The Mystery of the Einstein–Poincaré Connection. *Isis* 95/4:614–626.
- Darrigol O (2006) The Genesis of the theory of relativity En : Damour T, Darrigol O, Duplantier B, Rivasseau V (eds) 2006, *Séminaire Poincaré 1*:1–22, op. cit.
- De Broglie L (1922) Rayonnement noir et quanta de lumière. *J. Phys. Radium*, Vol. 3, issue 11, pp.422-428. Retrieved: <https://hal.archives-ouvertes.fr/jpa-00204370/document>
- Dirac PAM (1978) *Direction in Physics*. Wiley, NY.
- Einstein A ([1921] 2005) *Quatre conférences sur la théorie de la relativité*. [Texte de quatre conférences prononcées à l’université de Princeton en 1921] Dunod, Paris.
- Einstein A (1927). *Newtons Mechanik und ihr Einfluss auf die Gestaltung der theoretischen Physik*, *Naturwissenschaften* 15:273–276. Trad. fr. par le Cnel Cros. *La mécanique de Newton et son influence sur l’évolution de la physique théorique*. En : Einstein A [1934]1983, pp. 180–193, op. cit.
- Einstein A (1956) *La théorie de la relativité restreinte et générale*. Gauthier–Villars, Paris.
- Einstein A, Freud S ([1933] 2005) *Pourquoi la guerre ?* Rivages, Paris.
- Fauvel J (1991) Using History in Mathematics Education. *For the Learning of Mathematics*, 11(2): 3-6. Retrieved: from [www.jstor.org/stable/40248010](http://www.jstor.org/stable/40248010)
- Fauvel J, VanMaanen J (2002) *History in Mathematics Education* The ICMI Study. Kluwer Academic Publishers, New York, Boston, Dordrecht, London, Moscow.
- Feynman R (1970) *The Feynman Lectures on Physics Vol II: Mainly electromagnetism and matter*, Addison-Wesley, Boston, USA, Chapter 1-2. Available online: [http://www.feynmanlectures.caltech.edu/II\\_toc.html](http://www.feynmanlectures.caltech.edu/II_toc.html)
- Feynman R (1985) *QED: The Strange Theory of Light and Matter*. Princeton University, Princeton, NJ.
- Galili I (2011) Promotion of cultural content knowledge through the use of the history and the philosophy of science. *Science & Education*, 21:1283-1316. Doi:10.1007/s11191-011-9376-x.
- Gillispie CC (ed) (1970–1980) *Dictionary of Scientific Biography*. Charles Scribner’s Sons, New York.
- Hawking SW, Israel W (1980) (eds) *General relativity. An Einstein centenary survey*. The Cambridge University Press, Cambridge.
- Holton G (1988) *Thematic Origins of Scientific Thought: Kepler to Einstein*. The Harvard University Press, Cambridge–MA.
- Jaballah HD (1999) *La formation du concept de force dans la physique moderne*. Vol. II. Contribution à une épistémologie historique. Alpha Edition, Tunis.
- Jahnke HN (ed) (2003) *A history of analysis*. Proceedings of the American Mathematical Society and The London Mathematical Society, London.
- Jammer M (1957) *Concept of Force: a Study in the Foundations of Dynamics*. The Harvard University Press, Cambridge–Ma.

- Kennefick D (2005) Einstein versus the Physical Review. *Physics Today* 58(9): 43-48. DOI: 10.1063/1.2117822
- Keswani G H, Kilmister CW (1983) Intimations Of Relativity: Relativity Before Einstein. *The British Journal of Philosophy of Science* 34/4:343–354.
- Kragh H, Marage P, Vanapaemel G (2002) (eds) *The history of Modern Physics*. Brepols, Liège
- Kuhn T ([1962]1980), *La structure des révolutions scientifiques*. Champs-Flammarion, Paris.
- Lämmerzahl C, Neugebauer G (2001) *The Lense-Thirring Effect: From the Basic Notions to the Observed Effects*. Lecture Notes in Physics book series Vol. 562.
- Lecat M (1924) *Bibliographie de la relativité*. Lamertin, Bruxelles.
- LIGO Scientific Collaboration, Abbott B, et al. (2005) First all-sky upper limits from LIGO on the strength of periodic gravitational waves using the Hough transform. *Physical Review D*, 72/102004. DOI: 10.1103/PhysRevD.72.102004. Retrieved: arXiv:gr-qc/0508065
- LIGO Scientific Collaboration, Abbott B, et al. (2005a) Search for gravitational waves from galactic and extra-galactic binary neutron stars. *Physical Review D*, 72/082001. Retrieved: <https://arxiv.org/abs/gr-qc/0505041>
- LIGO Scientific Collaboration, Abbott B, et al. (2005b) Search for gravitational waves from binary black hole inspirals in LIGO data. *Physical Review D*, 73/062001:10. Retrieved: <https://arxiv.org/abs/gr-qc/0509129>
- LIGO Scientific Collaboration and Virgo Collaboration, Abbott BP, et al. (2016) Observation of Gravitational Waves from Binary Black Hole Merger. *Physical Review Letters*. 116. 061102. Retrieved: <https://journals.aps.org/prl/pdf/10.1103/PhysRevLett.116.061102>
- LIGO Scientific Collaboration and Virgo Collaboration, Abbott BP, et al. (2016b) Tests of general relativity with GW150914. *Phys. Rev. Lett.* 116, 221101. P.8. Retrieved: <https://arxiv.org/abs/1602.03841>
- LIGO Scientific Collaboration and Virgo Collaboration, Abbott BP, Abbott R, Abbott TD, Acernese F, Ackley K, Adams C, et al. (2017) GW170817: Observation of Gravitational Waves from a Binary Neutron Star Inspiral. *Physical Review Letters* 119/16:161101. <https://doi.org/10.1103/PhysRevLett.119.161101>.
- Lindsey B, Heron P, Shaffer PS (2012) Student understanding of energy: Difficulties related to systems. *American Journal of Physics* 80(2):154-163.
- Lorentz HA, Einstein A, Minkowski M, Weyl H (1923) *The principle of relativity. A collection of original memoirs on the special and general theory of relativity*. Dover, NY.
- Max Born M ([1923] 2003) *La théorie de la relativité d'Einstein et ses bases physiques*. Gabay, Paris.
- Mintz R (1993) Computerized simulation as an inquiry tool. *School Science and Mathematics*, 93(2):76-80.
- Nagel E (1961) *The Structure of Science: Problems in the Logic of Scientific Explanation*. Harcourt–Brace & World Inc, New York.
- Naylor RH (1976) Galileo: the Search for the Parabolic Trajectory. *Annals of Science* 33:153–172.
- Neil Ashby N (2002) Relativity and the Global Positioning System. *Physics Today* 55/5:41–47
- Pais A (2005) *Albert Einstein – Sa vie, son œuvre*, Interéditions. Dunod, Paris.
- Paty M (2004) *Albert Einstein, ou la création scientifique du monde*, Belles Lettres, Paris.
- Paty M (1979) Sur le réalisme d'Albert Einstein. *La Pensée* 204:18–37.
- Paty M (1999) La création scientifique selon Poincaré et Einstein. En : Serfati M (ed) *La recherche de la vérité : Coll. « L'Écriture des Mathématiques »*, ACL–Éditions du Kangourou, Paris, pp. 241–280.
- Paty M (2003) *La physique du XXe siècle*. EDP Sciences, Les Ulis.
- Penrose R (2004) *The Road to Reality. A complete guide to laws of the universe*. Knopf, NY.

- Pisano R (2014) (ed.) Isaac Newton and his Scientific Heritage: New Studies in the History and Historical Epistemology of Science. Special Issue. *Advances in Historical Studies* 3/3.
- Pisano R, Bussotti P (2015b) Introduction to Exploring Changes in How the Histories of the Exact Sciences from the 18th to through the 20th Century Have Been Written: Interpreting the Dynamics of Change in these Sciences and Interrelations Amongst Them—Past Problems, Future Cures? *Advances in Historical Studies* Special Issue 4/2:65-67.
- Pisano R, Capecchi D, Lukešová A (eds.) (2013) *Physics, Astronomy and Engineering. Critical Problems in the History of Science. International 32nd Congress for The SISFA—Italian Society of Historians of Physics and Astronomy. The Scientia Socialis UAB & Scientific Methodical Centre Scientia Educologica Press, Šiauliai University, Lithuania.*
- Pisano R, Gaudiello I (2009a) Continuity and discontinuity. An epistemological inquiry based on the use of categories in history of science. *Organon* 41:245–265.
- Rahman S, Symons J, Gabbay DM, van Bendegem JP (2009) (eds.) *Logic, Epistemology, and the Unity of Science*. Springer, Dordrecht.
- Scherz Z, Oren M (2006) How to change students' images of science and technology. *Science Education*, 90(6):965-985.
- Viennot L (1979) Spontaneous Reasoning in Elementary Dynamics. *European Journal of Science Education*, 1(2): 205-221. DOI: 10.1080/0140528790010209
- Walker J, Halliday D, Resnick R (2011) *Fundamentals of physics*. Hoboken, NJ, Wiley. Retrieved: <https://archive.org/details/FundamentalsOfPhysicsHallidayResnickWalker/page/n3>.
- Wason PC, Shapiro D (1971) Natural and Contrived Experience in a Reasoning Problem. *Quarterly Journal of Experimental Psychology* 23(1):63-71. DOI: 10.1080/0033557143000068.
- Weinberger P (2006) Revisiting Louis de Broglie's famous 1924 paper in the *Philosophical Magazine*. *Philosophical Magazine Letters*, Taylor & Francis, Vol. 86, issue 7, pp. 405-410. Retrieved: <https://doi.org/10.1080/09500830600876565>
- Whitehead AN (1897) On the Geodesic Geometry of Surfaces in non-Euclidean Space. *Proceedings of the London Mathematical Society*, s1-29: 275-324. doi:10.1112/plms/s1-29.1.275
- Whitehead AN (1922) *The Principle of Relativity with applications to Physical Science*. Cambridge University Press, UK. Retrieved: <https://archive.org/details/cu31924004208165>
- Whittaker ET (1953) The relativity theory of Poincaré and Lorentz. En: *A History of the theories of aether and electricity*. Vol 2: The modern theories 1900–1926. Nelson, London, pp. 27–77.
- Wolfgang R (2001) *Relativity: special, general and cosmological*. The Oxford University Press, Oxford.
- Zahar E (1987) Les fondements des mathématiques d'après Poincaré et Russell. *Fundamenta Scientiae* VIII 1987:31–56.
- Zahar E (1989) *Einstein's Revolution: A Study in Heuristic*. The Open Court Publishing Company, Chicago.
- Zimmerman C (2005) The development of scientific reasoning skills: What psychologists contribute to an understanding of elementary science learning, National Research Council, Washington, DC.

## 7.8 Assessment

For the RTDC, the data collection (only 9 participants; cfr. Sections 7.6.4 & 9.3) consisted of a set questions about their level of agreement or disagreement with statements and a “True or False” questionnaire consisting of questions testing their knowledge and understanding:

- Attitudes toward a subject (pre) and a comparison with an increase in interest

<b>Question:</b> <b>I am interested in (Pre) vs. Increased interest in (Post)</b>	<b>Pre-test</b>	<b>Post-test</b>
Science	3,4	3,7
Mathematics	2,9	3
Physics	3,2	3,6
History	2,7	2,5
History of Science	2,5	2,8
Philosophy	2,4	2,6
Philosophy of Science	2,1	2,1

**Table 7.8.a.** Means of the preliminary survey results about interests. Responses scored as: 1–strongly disagree, 2–disagree, 3–neutral, 4–agree, 5–strongly agree; and X–I do not know (no one selected this answer)

- Familiarity with terms,

<b>Question:</b> <b>I am familiar with:</b>	<b>Pre-test</b>	<b>Post-test</b>
Waves	3,2	3,7
Gravitation	3	3,6
Gravitational Waves	2,3	3,3
Trigonometry	2,7	3,2
Euclidean Geometry	2	3,3
Non-Euclidean Geometry	1,8	3,2
Analogies	2,5	3,2

**Table 7.8.b.** Means of the preliminary survey results about familiarity with terms. Responses scored as: 1–strongly disagree, 2–disagree, 3–neutral, 4–agree, 5–strongly agree; and X–I do not know (no one selected this answer)

- Self-evaluated knowledge about subject matters

<b>Question: I know:</b>	<b>Pre-test</b>	<b>Post-test</b>
Newton's Theory of Gravitation	2,8	3,6
Special Relativity	2	2,5
General Relativity	2,2	2,6
The concept of Spacetime	2,3	3
Trigonometry	2,7	3,1
Euclidean Geometry	2,2	3,1
Non-Euclidean Geometry	1,8	3

**Table 7.8.c.** Means of the preliminary survey results about self-evaluated knowledge about subject matters.

Responses scored as: 1–strongly disagree, 2–disagree, 3–neutral, 4–agree, 5–strongly agree; and X–I do not know (no one selected this answer)



- Self-evaluated understanding about subject matters

---

**Question:**

<b>I have a good understanding of:</b>	<b>Pre-test</b>	<b>Post-test</b>
Newton's Theory of Gravitation	2,4	3,4
Special Relativity	1,7	2,6
General Relativity	1,7	2,6
The concept of Spacetime	1,9	2,7
Trigonometry	2,4	2,9
Euclidean Geometry	1,8	2,7
Non-Euclidean Geometry	1,7	2,9

**Table 7.8.d.** Means of the preliminary survey results about self-evaluated understanding of subject matters.

Responses scored as: 1–strongly disagree, 2–disagree, 3–neutral, 4–agree, 5–strongly agree; and X–I do not know (no one selected this answer)

---

- Self-evaluation of the ability to use physical–mathematical tools

---

**Question:**

<b>I can use (manipulate):</b>	<b>Pre-test</b>	<b>Post-test</b>
First degree equations	3,3	3
Derivatives	2,7	2,6
Integrals	2,4	2,6
Vectors	2,4	3,1
Tensors	1,1	1,7

**Table 7.8.e.** Means of the preliminary survey results about self-evaluated ability of using physical–mathematical tools.

Responses scored as: 1–strongly disagree, 2–disagree, 3–neutral, 4–agree, 5–strongly agree; and X–I do not know (no one selected this answer)

---

- Post-test interest in subject matters

<b>Question: I would like to learn more about:</b>	<b>Post-test</b>
Gravitational Waves	3,7
Special Relativity	3,6
Non-Euclidean Geometry	3,4
Matrices	3,2
Tensors	2,9
Einstein's Field Equations	3,4
Physics	3,6
Astronomy	3,9
Cosmology	3,9
Optics	3,2
History of Science	2,8
Epistemology	3
Mathematics	3,6
Differential Geometry	2,9
The infinitely big	3,6
The infinitely small	3,6
Other?	–

**Table 7.8.f.** Means of the preliminary survey results about interest in various subject matters (post lecture).

Responses scored as: 1–strongly disagree, 2–disagree, 3–neutral, 4–agree, 5–strongly agree; and X–I do not know (no one selected this answer)

- Self-evaluation of the confidence in the ability to explain subject matters to someone

<b>Question:</b>	<b>Post-test</b>
<b>I can explain to someone what is:</b>	
A Gravitational Wave	3
Non-Euclidean Geometry	2,8
Einstein's Principle of Relativity	2,3
Special Relativity	2
General Relativity	3,1
Spacetime	2,5
Gravitation	3,1
An Inertial Frame of Reference	2,5
Redshift / Blueshift	2,8
A Black Hole	3,2
An Interferometer	2,3
LIGO/VIRGO	3,4

**Table 7.8.g.** Means of the preliminary survey results about the confidence in the ability to explain various subject matters (post lecture).

Responses scored as: 1–strongly disagree, 2–disagree, 3–neutral, 4–agree, 5–strongly agree; and X–I do not know (no one selected this answer)

The evaluation of students' perceptions of their knowledge is essential for the interpretation of the assessment of their learning progress. Furthermore, the students being tested on this metric both before and after the lecture allows to gauge how their perception of subject matter evolved after having being presented with a lecture on these subject matters. For example, depending on the shift in their self-evaluation of their knowledge on a specific subject could illustrate that either they think they know more on a subject if they scored higher or on the contrary that they thought their knowledge is more lacking than their first estimation if they score less.

## The “True or False” test:

Statements:	Pre-test	Post-test
1- Velocity is a measurement comparing two objects	0,6	0,6
2- The direction and speed of an observer may affect the order of a series of events	0,7	0,7
3- There is an absolute correct order for any series of events	0,5	0,6
4- There is a single reference frame with correct measurements of time and length	0,5	0,7
5- The observed colour of an object may change depending on the relative speed of the observer	0,6	0,9
6- An object’s length changes depending on the relative velocity of an observer	0,4	0,9
7- An observer 2 light seconds away from a clock will read the time from 2 seconds earlier	0,3	0,8
8- Observers travelling at different velocities relative to an object can have the same reference frame	0,2	0,2
9- Two observers at the same location must share a reference frame	0,3	0,7
10- If you observe a photon moving at $c$ on a spaceship that is travelling at $0.5c$ , relative to you the photon must be travelling at $0.5c$ or $1.5c$	0,1	0,6
11- If two events are observed simultaneously they must have occurred simultaneously	0,4	0,8
12- Nothing can escape a black hole, not even light	0,8	0,9
13- It is possible to leave the orbit of a black hole	0,1	0,5
14- Only very massive objects produce gravitational waves	0,5	0,7
15- Gravitational waves carry energy	0,8	0,2
16- Gravitational waves are invisible	0,7	0,6
17- Gravitational waves travel at the speed of light	0,5	0,5
18- A spaceship travelling at $0,5c$ produce gravitational waves	0	0,4
19- A spaceship in orbit around a black hole travelling at $0,5c$ produce gravitational waves	0,2	0,7

**Table 7.8.h.** Means in percentage of the number of correct assessments of each statement.

Responses scored as: 1–strongly disagree, 2–disagree, 3–neutral, 4–agree, 5–strongly agree; and X–I do not know (no one selected this answer)

*Description of the sample.* The number of participants I managed to gather was very small and quite heterogeneous. It consisted of:

Participant 1: Asked to remain anonymous, Baccalaureate (Belgium), non-scientific education<sup>168</sup>.

Participant 2: Asked to remain anonymous, Baccalaureate +5 (Master degree level), non-scientific.

Participant 3: Asked to remain anonymous, Baccalaureate, non-scientific education.

Participant 4: Coralie, Baccalaureate +3 (degree level), non-scientific education.

Participant 5: Florian, Baccalaureate +2, scientific studies.

Participant 6: Charles-André, Baccalaureate +2, scientific studies.

Participant 7: Chloé, Baccalaureate +3, non-scientific studies.

Participant 8: Sylvain, BTS (Advanced Technician's Certificate), "Yes and No, only notions of applied physics".

Participant 9: Marianne, Baccalaureate +5 (Master degree level), non-scientific studies.

Unfortunately, due to the small number of participants (whom I nonetheless thank deeply), I was unable to do more than superficial analyses of the data collected. Indeed, during my Licence Degree, thanks in particular to Biostatistics and Statistical Analyses with Prof. Christine Malot-Tuleau<sup>169</sup>, I learned that a correct sample size would have been 33 in order to be able to correctly estimate the mean, variance, standard deviations and in order to be able to proceed to hypotheses tests with a reasonable acceptance/rejection value.

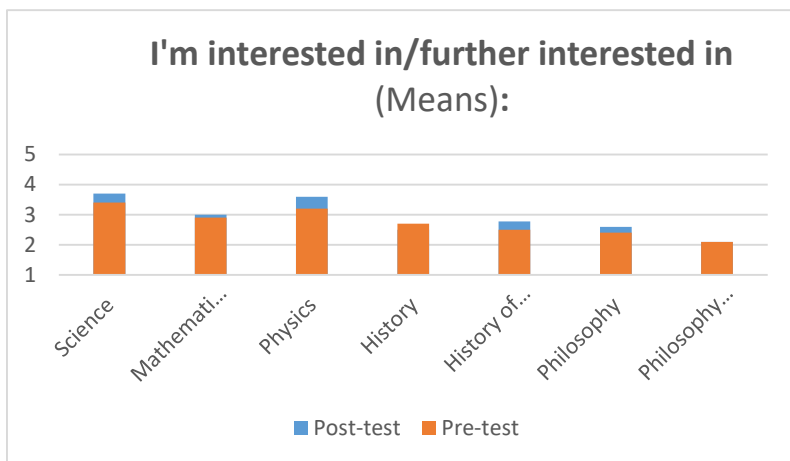
---

<sup>168</sup> The scientificity/non-scientificity of was self-evaluated by the participants.

<sup>169</sup> Cfr. <https://math.unice.fr/~malot/liste-enseignement2.html>

## 7.8.1 Learning

From Table 7.8.a., testing the attitudes toward a subject (pre) and the increase in interest (cfr. Fig. 7.8.1.a. below), the data indicates a relative reinforced interest in the scientific fields which is especially predominant in Physics. Noteworthy points are that the lecture seems not have had a significant impact on participants' interest in History nor in Philosophy of Science; though their interest in History of Science and Philosophy have been a bit more stimulated.



**Fig. 7.8.1.a.** Graphical representation of Table 7.8.a. Means of the preliminary survey results about interests.

*Interpretation of the preliminary results.* The participants seem to be mildly interested in Science, as the increase in interest in Mathematics and Physics shows; nevertheless the difference in these amounts could without much doubt be attributed to their perceptions of Mathematics as a “much more abstract and difficult field”<sup>170</sup>, “with too many equations” and “precise [in the sense of rigorous] rules”; both generally speaking as a theoretical framework and for physical applications.

The differences between History and History of Science could be attributed to the idea that History of Science represents a particular theme of History rather than a different discipline. Moreover, they reported being rather unfamiliar with the field of History of Science but seemed attracted by the idea of discovering it; thus, explaining why History and History of Science scored about the same pre-test, but differently post-test.

On the other hand, for Philosophy and Philosophy of Science, their perception was that although philosophical considerations about doing science were interesting, the field was too specialized and thus relatively

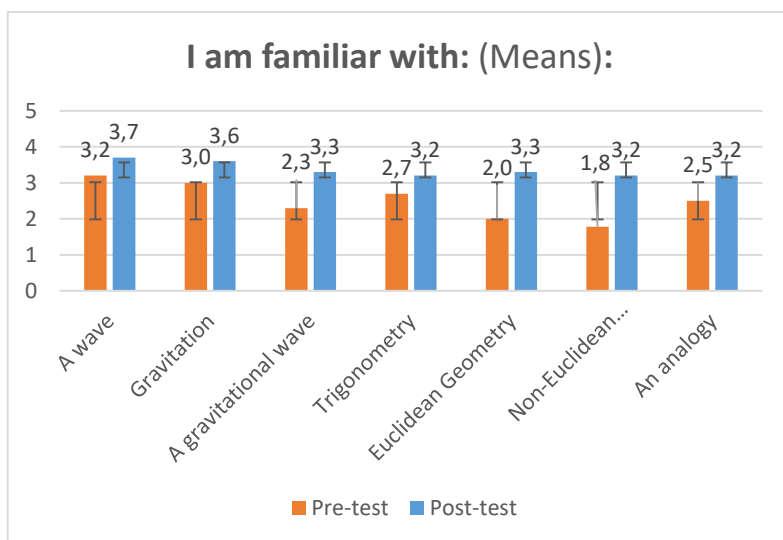
<sup>170</sup> These quotations are from remarks made by the participants after the lecture.

inaccessible and perhaps less worth the investment.

Table 7.8.b., tested their familiarity with some terms (cfr. Fig. 7.8.1.b. down below). As expected, after participating in a lecture exploring the subjects, it is logical that their familiarity with those terms and concepts increased.

However, noteworthy points are that:

- Although they were all familiar with the concept of waves, most of them knew that different kinds of kinds of waves existed (e.g. electromagnetic waves and the newly encountered concept of gravitational waves); however, they were also aware that they did not understand the subtleties differentiating them<sup>171</sup>.
- While they unanimously reported that gravity was the force “keeping them on the floor”, most of them were using “gravity” and “gravitation” interchangeably.
- Even though they all have worked with Euclidean Geometry, they did not recognize it for what it is.

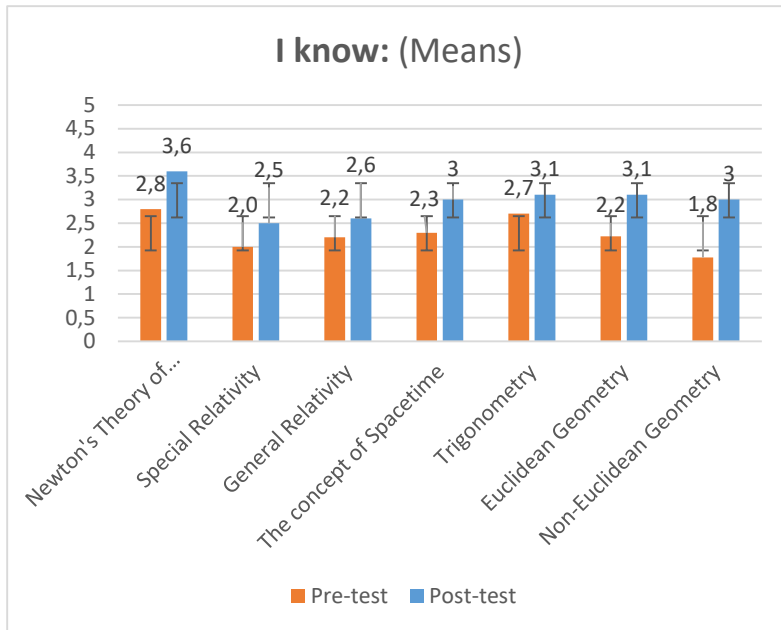


**Fig. 7.8.1.b.** Graphical representation of Table 7.8.b. Means of the preliminary survey results about familiarity with terms, with Mean Standard Deviation<sup>172</sup>.

<sup>171</sup> In retrospect, it could be interesting to ask the participants to define each of the terms of the tests. However, doing so should be the main focus of a study as the questionnaires would probably be perceived as too big and unpleasant to fill.

<sup>172</sup> Due to the smallness of the sample, the Mean Standard Deviation has been represented to give a rough idea because its significance has to be considered with caution.

From Table 7.8.c., testing the self-evaluated *knowledge* about subject matters (cfr. Fig. 7.8.1.c), as expected the data indicates that the items were mostly somewhat foreign to the participants; with the exception of Newton’s Theory of Gravitation and Trigonometry of which they had a notion.



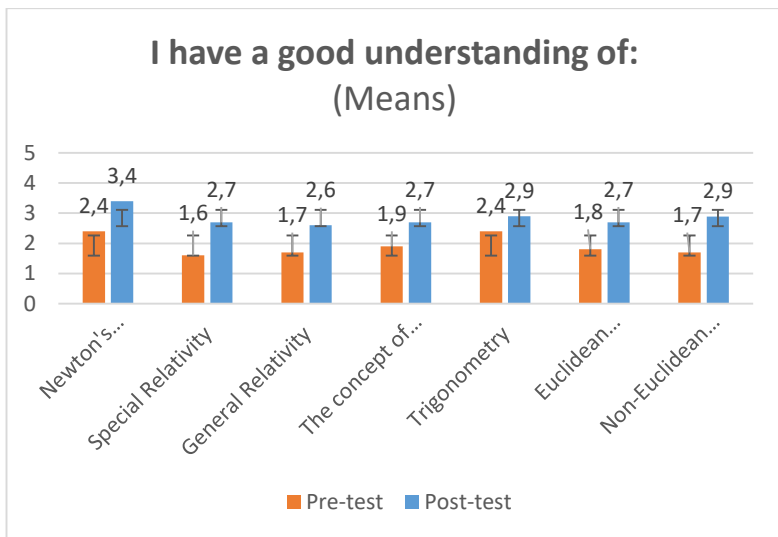
**Fig. 7.8.1.c.** Graphical representation of Table 7.8.c. Means of the preliminary survey results about self-evaluated knowledge about subject matters, with Mean Standard Deviation.

This plot also shows that Newton’s Theory of Gravitation and both Euclidean and Non-Euclidean Geometry are the areas in which they perceive having deepened their knowledge the most.

An interesting point is that even though they managed to give right answers to many of the “True or False” questionnaire (Cfr. Table 7.8.h) requiring a basic understanding of Special Relativity and General Relativity, the increase in their self-evaluation for these categories is rather small despite the fact that they learned many things. The explanation here is certainly that they recognize that even though they learned a lot, there is much (much) more to these fields that they do not know.



From Table 7.8.d., testing the self-evaluated *understanding* about subject matters (cfr. Fig. 7.8.1.d.), and comparing it to the previous figure (Fig. 7.8.1.c), we can see that the two are very similar. However, an interesting point can be made about Special and General Relativity as the difference is bigger.



**Fig. 7.8.1.d.** Graphical representation of Table 7.8.d. Means of the preliminary survey results about self-evaluated understanding of subject matters, with Mean Standard Deviation.

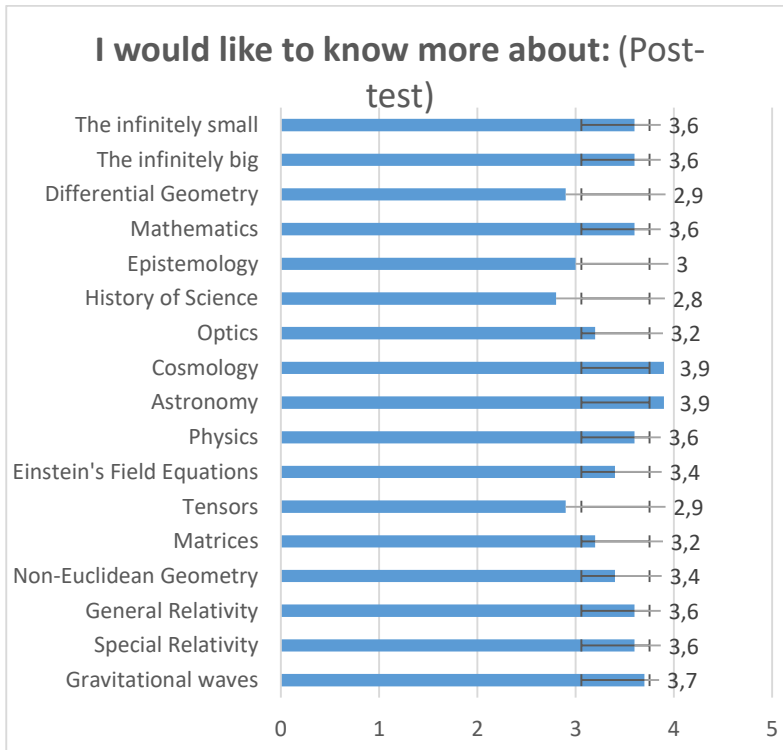
The explanation for the increased difference here is certainly that they feel having learned a number of facts, concepts and having a basic understanding while still finding the subjects “not very intuitive” and “hard to grasp without visual aids [visual representations including graphs, drawings and analogies]”; “without [your] drawings on paint or a blackboard, I wouldn’t have understood a thing”.

Table 7.8.e. tested the self-evaluation of the ability to use physical–mathematical tools of the participants to indicate that most of them did not receive a scientific training beyond High School (cfr. Section 7.8).

I can use:	Pre-test	Post-test
First degree equations	3,3	3,0
Derivatives	2,7	2,6
Integrals	2,4	2,6
Vectors	2,4	3,1
Tensors	1,1	1,8

**Fig. 7.8.1.e.** Adapted from Table 7.8.e. Means of the preliminary survey results about self-evaluated ability of using physical–mathematical tools.

Table 7.8.f., tested the participants' interests in subject matters after the lecture:



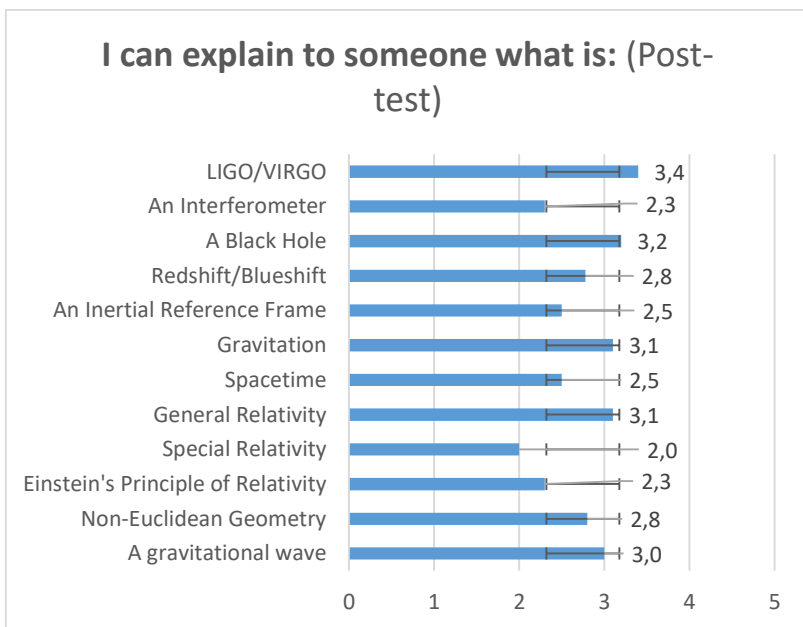
**Fig. 7.8.1.f.** Graphical representation of Table 7.8.f. Means of the preliminary survey results about interest in various subject matters (post lecture), with Mean Standard Deviation.

This figure is interesting insofar as it adds further confirmation to the results of Fig. 7.8.1.a., but also seems to indicate that subject matters involving calculations and relatively advanced mathematical tools scored less. The explanation being without much doubt that a) the participants do not have mastery of those tools (cfr. Fig. 7.8.1.e.); and b) as some reported, they feel like there is too much formal work to do to understand them “It’s only worth it if you are going to have a job in it [the field(s) where they are needed]”.

From Table 7.8.g., which tested the self-evaluation of the confidence in the ability to explain subject matters to someone else, the interesting points are that participants scored above neutral (3) for explaining what are:

- LIGO and Virgo,
- Black holes,
- Gravitation, and
- General Relativity.

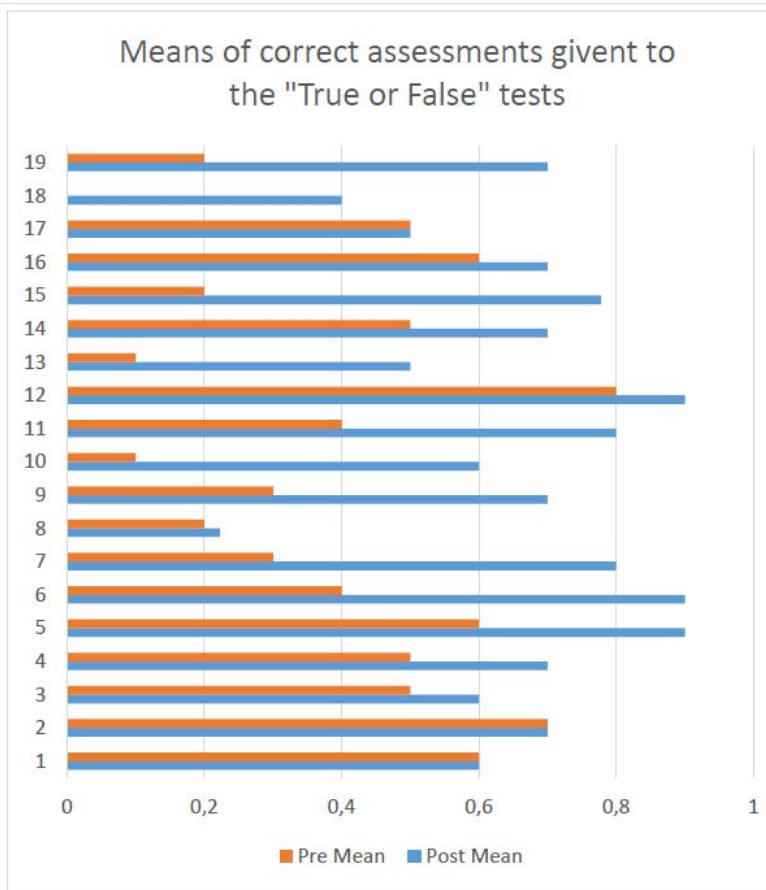
while they globally were not very confident in their ability to explain what an interferometer (2.3) or spacetime (2.5) are, and neutral on gravitational waves (3). This indicates a relatively correct understanding of the gravitational wave observatories as a whole, despite a shallow understanding of concepts on which they rely on.



**Fig. 7.8.1.g.** Graphical representation of Table 7.8.g. Means of the preliminary survey results about the confidence in the ability to explain various subject matters (post lecture), with Mean Standard Deviation.

### 7.8.2 Outcomes

From Table 7.8.h., The “True or False” questionnaire:



**Fig. 7.8.1.h.** Graphical representation of the means of correct assessments given to the "True or False" tests

The statements to assess<sup>173</sup> were:

- 1) Velocity is a measurement comparing two objects.\* (True)
- 2) The direction and speed of an observer may affect the order of a series of events.\* (True)
- 3) There is an absolute correct order for any series of events. \* (False)
- 4) There is a single reference frame with correct measurements of time and length.\* (False)

<sup>173</sup> Some questions asked were identical to (McGrath 2010, p.866) in order to have grounds for comparisons with an independent study; they are marked with an (\*).

The order of the statements were randomized for each participant of the same session.

- 5) The observed colour of an object may change depending on the relative speed of the observer.\* (True)
- 6) An object's length changes depending on the relative velocity of an observer.\* (True)
- 7) An observer 2 light seconds away from a clock will read the time from 2 seconds earlier.\* (True)
- 8) Observers travelling at different velocities relative to an object can have the same reference frame.\* (False)
- 9) Two observers at the same location must share a reference frame.\* (False)
- 10) If you observe a photon moving at  $c$  on a spaceship that is travelling at  $0.5c$ , relative to you the photon must be travelling at  $0.5c$  or  $1.5c$ .\* (False)
- 11) If two events are observed simultaneously they must have occurred simultaneously.\* (False)
- 12) Nothing can escape a black hole, not even light. (True)
- 13) It is possible to leave the orbit of a black hole. (True)
- 14) Only very massive objects produce gravitational waves. (False)
- 15) Gravitational waves carry energy. (True)
- 16) Gravitational waves are invisible. (True)
- 17) Gravitational waves travel at the speed of light. (True)
- 18) A spaceship travelling at  $0,5c$  produces gravitational waves. (False)
- 19) A spaceship in orbit around a black hole travelling at  $0,5c$  produces gravitational waves. (True)

Preliminary results show that there was a global improvement in the ability of the participants to assess the validity of the statements; except for questions n°2 and n°7.

#### *Explanatory assumptions.*

Statement n°2: "The direction and speed of an observer may affect the order of a series of events." which is True

From the results (cfr. Fig. 7.8.1.h.), it appears that even though the statements n°4 and n°11 which are also related to the notion of simultaneity in the context of Special Relativity were correctly identified as false, this one was problematic. This result is without much doubt due to the fact that it requires a deeper understanding than the knowledge that in Special Relativity there are no absolute time nor absolute space; unlike with Newton's theory of Gravitation.

As for statement n°17: "Gravitational waves travel at the speed of light." which is True, I believe that this is my fault as I might have failed to insist or clarify that during the reading of the excerpt of Poincaré's text (Poincaré 1905).

## **Final Remarks**

In this chapter, we have examined the ins and outs of how to teach gravitational waves through diverse disciplinary frameworks and how to merge these frameworks in order to build a Nature of Science framework. In particular, we evaluated some tools and practices that seemed adequate for this type of interdisciplinary teaching. We reflected on the prerequisites for lecturing gravitational waves physics and the history of their discovery, but also on the cognitive and operative objectives. We then discussed the methodology used for the elaboration of the lectures and presented the results of the students' pre and post-test evaluations.

Although the sample size was too small to do a deeper analysis, the data served the role of a preliminary data collection whose analyses nevertheless revealed interesting points and clear tendencies which seem consistent with expectations; therefore encouraging more research.

## REFERENCES

### Primary Sources

- Bachelard G ([1934] 1967) *La formation de l'esprit scientifique*. Vrin, Paris.
- Kant I ([1793] 2000) *Les progrès de la métaphysique en Allemagne depuis le temps de Leibniz et de Wolf*. Traduction par Louis Guillermit, Vrin, Paris.
- Lewis GN (1916) THE ATOM AND THE MOLECULE. *Journal of the American Chemical Society*, 38(4):762-785. Retrieved: <https://doi.org/10.1021/ja02261a002>
- Poincaré H (1905) Sur la dynamique de l'électron (The dynamics of the electron by Henri Poincaré) pour l'académie des sciences. C.R. T.140 (1905) 1504-1508. Retrieved: [https://www.academie-sciences.fr/pdf/dossiers/Poincare/Poincare\\_pdf/Poincare\\_CR1905.pdf](https://www.academie-sciences.fr/pdf/dossiers/Poincare/Poincare_pdf/Poincare_CR1905.pdf)

### Secondary Sources

- Bradamante F, Viennot L (2007) Mapping Gravitational and Magnetic Fields with Children 9-11: Relevance, difficulties and prospects. *International Journal of Science Education*, 29(3):349-372. DOI: 10.1080/09500690600718245.
- Camporesi T, Catalano G, Florio M, Giffoni F (2017) Experiential learning in high energy physics: a survey of students at the LHC. *European Journal of Physics*, 38 025703.
- Coutellec L, Schmid AN (2014) Chapitre 1. Modélisation, simulation, expérience de pensée : la création d'un espace épistémologique. Regards à partir des œuvres de Vernadsky et de Poincaré. In: *Modéliser & simuler – Tome 2: Epistémologies et pratiques de la modélisation et de la simulation*, Varenne F, Silberstein M, Dutreuil S, Huneman P (eds), Editions Matériologiques, Paris, pp. 19-47.
- Dewey J (1986) Experience and Education, *The Educational Forum*, 50:3, 241-252, DOI: 10.1080/00131728609335764.
- Frontczak NT (1998) A Paradigm for the Selection, Use and Development of Experiential Learning Activities in Marketing Education. *Marketing Education Review*, 8(3):25-33. DOI: 10.1080/10528008.1998.11488641.
- Garvin MR, Ramsier RD (2003) Experiential learning at the university level: a US case study. *Education + Training*, 45(5):280-285. Retrieved: <https://doi.org/10.1108/00400910310484349>
- Gilbert JK (2004) Models and Medelling : Routes to More Authentic Science Education. *International Journal of Science and Mathematics Education*, 2(1):115–130. DOI: 10.1007/s10763-004-3186-4.
- Gross L, Mohn F, Moll N, Liljeroth P, Meyer G (2009) The Chemical Structure of a Molecule Resolved by Atomic Force Microscopy. *Science*, 325(5944):1110-1114. DOI: 10.1126/science.1176210.
- Itin C (1999) Reasserting the Philosophy of Experiential Education as a Vehicle for Change in the 21st Century. *The Journal of Experiential Education*, 22(2):91–98. DOI:10.1177/105382599902200206.
- Kolb DA (1984) *Experiential Learning: Experience as the source of learning and development*. Englewoods Cliffs, Prentice-Hall, New Jersey.
- Kolb DA (2011) Chapter 9. Experiential Learning Theory: Previous Research and New Directions. In: Sternberg RJ, Zhang LF (eds) *Perspectives on Thinking, and Cognitive Styles*. Routledge, London, New York, pp. 227-247.

- Kolb AY, Kolb DA (2009) Chapter 3. Experiential Learning Theory. A Dynamic, Holistic Approach to Management Learning, Education and Development. In: The SAGE Handbook of Management Learning, Education and Development, Armstrong SJ, Fukami CV (eds), SAGE, London, Los Angeles, Washington DC, New Delhi, Singapore, pp. 42-68.
- McGrath D, Wegener M, McIntyre TJ, Savage C, Williamson M (2010) Student experiences of virtual reality: A case study in learning special relativity. *American Journal of Physics*, 78(8):862–868. doi:10.1119/1.3431565.
- Miettinen R (2000) The concept of experiential learning and John Dewey's theory of reflective thought and action, *International Journal of Lifelong Education*, 19:1:54-72. DOI: 10.1080/026013700293458.
- Radelet-de Grave P (2009) L'analogie comme outil de découverte, in *Revue des Questions Scientifiques*, 180(1):1-32.
- Rahman S., Symons J., Gabbay D.M., van Bendegem J.P. (eds.) (2009). *Logic, Epistemology, and the Unity of Science*. Springer, Dordrecht.
- Rahman S, Iqbal M (2016) UNFOLDING PARALLEL REASONING IN ISLAMIC JURISPRUDENCE (I). Epistemic and Dialectical Meaning within Abū Ishāq al-Shīrāzī's System of Co-Relational Inferences of the Occasioning Factor . Retrieved: (halshs-01265206v4)
- Schibrowsky JA, Peltier JW (1995) The Dark Side of Experiential Learning Activities. *Journal of Marketing Education*, 17(1):13-24.  
Retrieved: <https://doi.org/10.1177/027347539501700103>
- Smith TE, Knapp CE (eds)(2011) *Sourcebook of Experiential Education*. Routledge, London, New York.
- Sorensen RA (1992) *Thought Experiments*. Oxford University Press, Oxford New York.
- Sternberg RJ, Zhang LF (eds)(2011) *Perspectives on Thinking, and Cognitive Styles*. Routledge, London, New York.
- Viennot L (1979) Spontaneous Reasoning in Elementary Dynamics. *European Journal of Science Education*, 1(2): 205-221. DOI: 10.1080/0140528790010209
- Walker J, Halliday D, Resnick R (2011) *Fundamentals of physics*. Hoboken, NJ, Wiley.  
Retrieved: <https://archive.org/details/FundamentalsOfPhysicsHallidayResnickWalker/page/n3>
- Wason PC, Shapiro D (1971) Natural and Contrived Experience in a Reasoning Problem. *Quarterly Journal of Experimental Psychology* 23(1):63-71. DOI: 10.1080/00335557143000068.
- Wilson KD (1975) Kant on Intuition. *The Philosophical Quarterly* (1950-), 25(100):247-265. DOI:10.2307/2217756.
- Zimmerman C (2005) The development of scientific reasoning skills: What psychologists contribute to an understanding of elementary science learning, National Research Council, Washington, DC.



## Web References

- Conceptual Maps:  
<http://sites.estvideo.net/gfritsch/doc/rezo-cfa-410.htm>
- Encyclopaedia Britannica:  
<https://www.britannica.com/biography/Gilbert-N-Lewis/Chemical-bonding-theory>
- Nobel Prize Organisation:  
<https://www.nobelprize.org/prizes/medicine/2014/summary/>
- Simulating eXtreme Spacetimes (SXS project):  
<https://www.black-holes.org/explore/movies>
- Universe Sandbox physics-based space simulator:  
<http://universesandbox.com/>

## Selected Additional References on the Subjects – Non-Cited in Above Running Text

- Bachelard G ([1940] 1966) *La Philosophie du Non : Essai d'une philosophie du nouvel esprit scientifique*. Quatrième Édition, Presses Universitaires de France, Paris.
- Bacon F (1620) *Novum Organum*.
- Braunstein JF (2008) *L'histoire des sciences: Méthodes, styles et controverses*. Vrin, Paris.
- Barnes J (2002) *The Presocratic Philosophers*, Routledge, New York, p. 313.
- Brousseau G (1976) Les obstacles épistémologiques et les problèmes en mathématiques. In: J. Vanhamme & W. Vanhamme (eds.), *La problématique et l'enseignement des mathématiques*. Comptes rendus de la XXVIII<sup>e</sup> rencontre organisée par la Commission Internationale pour l'Etude et l'Amélioration de l'Enseignement des Mathématiques, Louvain la Neuve, pp. 101-117.
- Brousseau G, Bednarz N, Garnier C (1989) Les obstacles épistémologiques et la didactique des mathématiques. *Construction des savoirs Obstacles et Conflits*, CIRADE, Les éditions Agence d'Arc inc., pp.41-63.
- Carey S (1985) *Conceptual change in childhood*. MIT Press, Cambridge, USA.
- Carmichael P, Driver R, Holding B, Phillips I, Twigger D, Watts M (1990) *Research on students' conceptions in science: A bibliography*. Children's Learning in Science Research Group, Centre for Studies in Science and Mathematics Education, University of Leeds, UK.
- Cepni S, Tas E, Kose S (2006) The effects of computer-assisted material on students' cognitive levels, misconceptions and attitudes towards science. *Computer Education* 46(2):192-205.
- Champagne AB, Klopfer LE, Anderson J (1980) Factors Influencing Learning of Classical Mechanics. *American Journal of Physics*, 48(12):1074-1079.
- Clement J (1982) Students' preconceptions in introductory mechanics. *American Journal of Physics* 50(1):66-71. Retrieved: <https://doi.org/10.1119/1.12989>.
- Cook M (2008) Students' comprehension of science concepts depicted in textbook illustrations. *Electronics Journal of Science Education*, 12(1):39-52.
- Crapanzano F (2018) "Strange Trajectories": Naive Physics, Epistemology and History of Science. *Transversal: International Journal for the Historiography of Science*, (5):49-65 ISSN 2526-2270. DOI: <http://dx.doi.org/10.24117/2526-2270.2018.i5.06>.
- Duhem P ([1906]1981) *La théorie physique*. Vrin, Paris.
- Feynmann RP (1965) *The Character of Physical Law*, Richard Feynmann With New Foreword by Frank Wilczek. MIT Press, Cambridge, Massachusetts, London, England.

- Fisher BW (1997) Computer modelling for thinking about and controlling variable. *School Science Review*, 79(287):87-90.
- Gettier E (1963) Is Justified True Belief Knowledge? *Analysis*, 23/6:121-123. Retrieved: <https://doi.org/10.1093/analys/23.6.121>
- James T (1990) Kurt Hahn and the Aimes of Education. *Journal of Experiential Education*, 13(1):6-13. Retrieved: <https://doi.org/10.1177/105382599001300101>.
- Kose S (2008) Diagnosing student misconceptions: Using drawings as a research method. *World Applied Science Journal*, 3(2):283-293.
- Kuhn T ([1962]1980), *La structure des révolutions scientifiques*. Champs-Flammarion, Paris.
- Lakatos I (1973) “Science and Pseudoscience” BBC Transcript, with additional passages. Retrieved: <http://www.lse.ac.uk/philosophy/science-and-pseudoscience-overview-and-transcript/>
- Latour B (2012) *Visualisation and Cognition: Drawing Things Together*. DOI:10.22394/0869-5377-2017-2-95-151
- Lewis LH, Williams CJ (1994) *Experiential learning: Past and present*. *New Directions for Adult and Continuing Education*, 1994(62):5-16. DOI:10.1002/ace.36719946203.
- Lindsey B, Heron P, Shaffer PS (2012) Student understanding of energy: Difficulties related to systems. *American Journal of Physics* 80(2):154-163. doi: 10.1119/1.3660661
- Mintz R (1993) Computerized simulation as an inquiry tool. *School Science and Mathematics*, 93(2):76-80.
- Moon J (2004) *A Handbook of Reflective and Experiential Learning: Theory and Practice*. Routledge, London, New York.
- Pisano R (2008) A history of chemistry à la Koyré? Introduction and setting of an epistemological problem. *Khimiya* 2/17:143–161.
- Pisano R (2009) On method in Galileo Galilei’ mechanics. In Hunger H (ed.), *Proceedings of 3<sup>rd</sup> Congress of the European Society for the History of Science*. The Austrian Academy of Science, Vienna, pp. 174–186.
- Pisano R (2011) Physics–Mathematics Relationship. Historical and Epistemological notes. In Barbin E, Kronfellner M and Tzanakis C (eds.), *Proceedings of the ESU 6 European Summer University History And Epistemology in Mathematics*. Verlag Holzhausen GmbH–Holzhausen Publishing Ltd., Vienna, pp. 457–472.
- Pisano R (2013a) History Reflections on Physics Mathematics Relationship in Electromagnetic Theory. In Barbin and Pisano 2013, pp. 31–58.
- Pisano R (2014) (ed.) *Isaac Newton and his Scientific Heritage: New Studies in the History and Historical Epistemology of Science*. Special Issue. *Advances in Historical Studies* 3/3.
- Pisano R (2016a) What kind of Mathematics in Leonardo da Vinci and Luca Pacioli? *Bulletin–British Society for the History of Mathematics* 31:104-111.
- Pisano R (2016b) A Development of the Principle of Virtual Laws and its Framework in Lazare Carnot’s *Mechanics as Manifest Relationship between Physics and Mathematics*. *Transversal–International Journal for Historiography of Science*, 2:166-203.
- Pisano R, Bussotti P (2012) Galileo and Kepler: On *Theoremata Circa Centrum Gravitatis Solidorum and Mysterium Cosmographicum*. *History Research* 2/2:110–145.
- Pisano R, Bussotti P (2013) Notes on the Concept of Force in Kepler. In Pisano, Capecci and Lukešová 2013, pp. 337–344.
- Pisano R., Bussotti P. (2014). “Newton’s *Philosophiae Naturalis Principia Mathematica* “Jesuit” Edition: The Tenor of a Huge Work”. *Accademia Nazionale Lincei–Rendiconti Matematica e Applicazioni* 25 (4), pp. 413–444.
- Pisano R, Bussotti P (2014a) Galileo in Padua: architecture, fortifications, mathematics and “practical” science. *Lettera Matematica Pristem International* 2/4:209–221.
- Pisano R, Bussotti P (2014b). *Historical and Philosophical Reflections on the Culture of Machines around the Renaissance. How Science and Technique Work?* *Acta Baltica Historiae et Philosophiae Scientiarum* 2/2:20–42.

- Pisano R, Bussotti P (2015a) Historical and Philosophical Reflections on the Culture of Machines around the Renaissance: Machines, Machineries and Perpetual Motion. *Acta Baltica Historiae et Philosophiae Scientiarum* 3/1:69-87.
- Pisano R, Bussotti P (2015b) Introduction to Exploring Changes in How the Histories of the Exact Sciences from the 18th to through the 20th Century Have Been Written: Interpreting the Dynamics of Change in these Sciences and Interrelations Amongst Them—Past Problems, Future Cures? *Advances in Historical Studies Special Issue* 4/2:65-67.
- Pisano R., Bussotti P. (2016). “A Newtonian Tale Details on Notes and Proofs in Geneva Edition of Newton’s *Principia*”. *Bulletin–Journal of the British Society for the History of Mathematics*, 31 (3), pp. 160-178.
- Pisano R., Bussotti P. (2017). On the Conceptualization of Force in Johannes Kepler’s *Corpus*: an Interplay between Physics/Mathematics and Metaphysics, in Pisano R., Agassi J. and Drozdova D. (eds.), *Hypothesis and Perspective in History and Philosophy of Science. Homage to Alexandre Koyré 1892-1964*. Springer, Dordrecht, pp. 295-346
- Pisano R, Capecchi D (2013) Conceptual and Mathematical Structures of Mechanical Science in the Western Civilization around 18th Century. *Almagest* 4/2:86–121.
- Pisano R, Capecchi D (2015) Tartaglia’s science weights. *Mechanics in sixteenth century. Selection from Quesiti et invention diverse: Books VII–VIII*. Dordrecht, Springer.
- Pisano R, Capecchi D, Lukešová A (eds.) (2013) *Physics, Astronomy and Engineering. Critical Problems in the History of Science. International 32nd Congress for The SISFA–Italian Society of Historians of Physics and Astronomy. The Scientia Socialis UAB & Scientific Methodical Centre Scientia Educologica Press, Šiauliai University, Lithuania.*
- Pisano R, Fichant M, Bussotti P, Oliveira ARE (2017) (eds.) *Leibniz and the Dialogue between Sciences, Philosophy and Engineering, 1646-2016. New Historical and Epistemological Insights*. The College Publications, London.
- Pisano R, Gaudiello I (2009a) Continuity and discontinuity. An epistemological inquiry based on the use of categories in history of science. *Organon* 41:245–265.
- Pisano R, Gaudiello I (2009b) On categories and scientific approach in historical discourse. In Hunger H (ed.) *Proceedings of ESHS 3rd conference*. The Austrian Academy of Science, Vienna, pp. 187–197.
- Poincaré H (1902) *La science et l’hypothèse*. Flammarion, Paris. Retrieved: <https://gallica.bnf.fr/ark:/12148/btv1b86263141/f184.image.r=la%20science%20et%20l'hypoth%C3%A8se>
- Poincaré H (1908) *Science et méthode (Edition définitive)*. Flammarion, Paris. Retrieved: <https://gallica.bnf.fr/ark:/12148/bpt6k9691658b/f32.image>
- Poincaré H (1920) *Dernières pensées*. Ernest Flammarion, éditeur. 26, Rue Racine, Paris.
- Popper K ([1934] 2005) *The Logic of Scientific Discovery*. Routledge, London and New York. Retrieved; <http://strangebeautiful.com/other-texts/popper-logic-scientific-discovery.pdf>
- Scherz Z, Oren M (2006) How to change students’ images of science and technology. *Science Education*, 90(6):965-985.
- Towne DM, de Jong T, Spada H (eds)(1993) *Simulation-Based Experiential Learning*. Springer.
- Warren K (1995) *The Theory of Experiential Education*. 3<sup>rd</sup> Revised ed. Kendall/Hunt Publishing Co., US.
- Weinberger P (2006) Revisiting Louis de Broglie’s famous 1924 paper in the *Philosophical Magazine*. *Philosophical Magazine Letters*, Taylor & Francis, Vol. 86, issue 7, pp. 405-410. Retrieved: <https://doi.org/10.1080/09500830600876565>



## CHAPTER VIII

### **A Didactic Inquiring: Which Teaching Approach for Gravitational Waves?**

*An outline.* In this chapter, I will explore various kinds of approaches for the teaching of Physics through the framework of the Nature of Science and *ad hoc* curricula; especially in regards to the design of a complete curricula on the subject of gravitational waves and the history of their discovery, consisting of different complementary modules. Furthermore, as this thesis is concerned with History of Physics and NoS Teaching, we will discuss how curricula in the form of a modular program, where each module can be used as a completely standalone course of lectures, can be easily modified and adapted to the level of the audience. Finally, I will discuss the particular design of the introductory module on gravitational waves.

## 8.1 Didactics, Methods and Methodologies

This section will essentially use definitions from the *Routledge International Companion to Education* (Ben-Peretz 2004) and the *Dictionnaire des Concepts Fondamentaux des Didactiques* (Reuter 2013).

The word “didactics” is polysemous on multiple levels: at the level of its meaning in the English language but also in the educational context where its meaning depends to a certain degree upon the country of the user (Gundem 2000). Accordingly, the consequences of this fact are that:

A uniform or unambiguous understanding of the subject matter, scope, methodology and system of didactics as part of education as a scientific discipline does not exist. Differing schools, traditions and models may be clearly discerned. There exists consequently a variety of definitions which all claim to be legitimate both historically and in contemporary contexts. [...]

Simplified we may say that the concerns of didactics are:

- what should be taught and learnt (the content aspect)
- how to teach and learn (the aspects of transmitting and learning)
- to what purpose or intention something should be taught and learnt (the goal/aims aspect)(Künzli, 1994<sup>174</sup>) (Gundem 2000, pp. 235-236)

However, taking in account the national specificities, we have to consider and recognize that:

In France didactics is based on psychology, pedagogy and epistemology. Even so, a specific frame of reference or theory of its own has been developed. Three basic concepts may be identified:

- the didactic situation [*le concept de situation didactique*]
- the transposition [*le concept de transposition*]
- the contract [*le concept de contrat didactique*] (Gundem 2000, p. 255)

Whereby:

- *didactic situation*, a concept that was mainly developed by Brousseau (Cfr. Brousseau 1998) we contemplate a “slice of reality” [une coupe dans la réalité] (Reuter 2013, p. 197) chosen by the researcher, which is characterised by the emergence of something new, whether this something is a new element or a new configuration of elements, usually belonging but not limited to the time and space of the classroom since it is –merely– correlated with institutional timeframes.

---

<sup>174</sup> Künzli, Rudolf (1994) *Didaktik : Modelle der Darstellung, des Umgangs und der Erfahrung*, Zurich: Zurich University, Didaktikum Aarau.

- *didactic transposition*, a concept that was mainly developed by Chevallard (Cfr. Chevallard 1985), which defines the process by which a designated knowledge content is transformed –whether by simplification, reduction, deformation or else– into a content ready to be taught (Reuter 2013, p. 221).
- *didactic contract*, also from Brousseau (Cfr. Brousseau 1990), which uses the analogy of the social contract/social pact in order to examine the reciprocal interplay between teacher and student(s) (Reuter 2013, p. 55).

Gundem explained that as a consequence of this, research in didactics can be considered as the study of the disciplinary link between knowledge – scientific knowledge, theories– and praxis:

Research in didactics may be said to be related to practice as well as to relevant educational theories like learning theories, curriculum theories, anthropological theories, theories related to media, and social theories in general. This double binding on the one hand to practice and on the other to theory is characteristic of research in didactics.

The praxis of education is a complex reality, a more or less permanent experiment between interacting people, contexts and circumstances characterized by constant unrest and crisis. In this praxis, experience-based ‘practical theories’ develop and are applied. [...]

- Research in didactics may be understood as a bridge between theory and praxis.
- Didactic research has to take theory into consideration: theories represent the collective results from research. Theories serve as a systematic knowledge ‘reservoir’, and at the same time research is necessary for theory production.
- Didactical research is always dependent on praxis for defining the research objects – the problem of praxis – and as an applied science (Kron 1994<sup>175</sup>, pp. 194-195)(Gundem 2000, pp. 256-257)

Therefore, it logically follows from this that the research methods associated with didactics are essentially of an empirical nature. Moreover, the objects of study of didactics are of two main different types. On one hand there are theoretical objects –knowledge, theories, relations and interactions– and on the other hand there are physical objects –learners, teachers, classrooms, tools and other elements, their compositions and configurations–. Because of this duality, added to the fact that teachers and learners are part of the didactic systems, the data collection methods are borrowed from human sciences. Indeed, as an integral part of the social sciences and humanities dealing with systems characterised by an overwhelming number of variables of different natures –dependant, independent, qualitative, quantitative,

---

<sup>175</sup> Kron, Friedrich W. (1994) *Grundwissen Didaktik* (2<sup>nd</sup> edn), Munich : Ernst Reinhardt Verlag.

hierarchical, non-hierarchical— research in didactics has to rely on the same tools and is therefore for the greater part relying on empirical data.

However, this is simply a very vast depiction of the field of didactics. More particularly, research in didactics is also interested in:

- *Curriculum research* as research on the cultural content, its selection, administration and form in historical, contemporary and comparative perspectives. This is one of the most central fields within didactic research (Hopmann<sup>176</sup>, 1988). (Gundem 2000, p. 257)
- [...]
- *Media research* as research on teaching and learning technologies, information and mediation strategies including the process and its consequences on all levels (Kron, 1994, pp. 197-199) (Gundem 2000, pp. 258)

The latter being especially important and increasingly studied as technological development has generated a need for learners to also acquire special sets of skills aligned with the new practices of the 21<sup>st</sup> century (Ploj Vrtič 2009a, 2009b, 2009c, 2010, 2010a, 2010b, 2012, 2013, 2014, 2016). Indeed, the world is changing, and the learners need those skills to adapt and face the challenges of contemporary society.

## 8.2 Frameworks from Selected Literatures

The Nature of Science, including for my aims, teaching (NoS) is an interdisciplinary product of inquiring science and its fundamentals, through different, yet blended, standpoints—historical, epistemological or scientific—by using curricula & modelling. In particular, it incorporates in its investigations the notions of analogies (Radelet-de Grave 2009), modelling (Louca 2012), limits, methods and methodologies in scientific practices.

It is both an additional item in History and Epistemology/Philosophy of Science (HPS) e.g., on top of the science curricula, and the incorporation of approaches elements to teaching science<sup>177</sup> based on learning theories and hypotheses of different fields and the historical and foundational scientific assumptions, in which adjacent—and—surrounding fields contribute to a greater understanding of science and its applications; therefore to a better understanding of science.

The inclusion of the History of Science for Teaching Science and Science Education has been well researched. Indeed, the subject along with HPS and

---

<sup>176</sup> Hopmann, Stefan (1988) *Lehrplanarbeit als Verwaltungshandeln* [Curriculum Work as Administration] Kiel : IPN.

<sup>177</sup> Taking into account my doctoral thesis aims, an incomplete but selected list of authors is: Chevallard 1985, McComas 1998, 2002, Pisano 2019, 2020, Ploj-Vrtič 2009b, 2014, Recami 2011, Rocha 2009, Kouneiher 2005, 2018, Freire 2016, Viennot 1979, 2007.



NoS, has spilled a lot of ink, i.e. Mach (1898) Duhem (1906), Bachelard (1934, 1940), Piaget (1927, 1970), Kuhn (1962, 2005), and still is.<sup>178</sup>

Moreover, with regards to the renewal of teaching and the need to develop learners' 21<sup>st</sup> century skills such as the evaluation of hypotheses and *critical thinking*, the selected theoretical hypotheses and reflections are those related to the importance of Nature of Science in Education Science, hypotheses from Neurosciences, Cognitive psychology and surrounding fields<sup>179</sup>.

In addition to that, the design of the curricula was elaborated with a number of didactic principles (Doneva 2006; Marius-Costel 2010) in mind which are also relevant for 21<sup>st</sup> century skills training and e-learning, namely:

- *modularity* (learning courses represent subject fields and for that reason the curriculum may consist of different courses depending on the individual and group educational necessities);
- *interactivity* (indirect personal interactions student-student, student-teacher, etc.); [...]
- *personality-oriented* nature of the educational curricula (marketing approach, consideration of the educational necessities of the learners);
- *practical orientation* of the content and the activities;
- *activeness and independence* of the learners as major subjects in the learning process;
- *case studies* (the interaction during the learning process has dialogical and case oriented nature due to virtual simulators and communication);
- *problem-oriented* nature of the content and dialogic al nature of the interaction during the learning process;

---

<sup>178</sup> Taking into account my doctoral thesis aims, an incomplete but selected list of authors is: Aubin 2004, Condé 2017, Dhombres 1978, Gatto 1994, Lévy-Leblond 1996, Navarro 2012, Oliveira 2014, Pisano 2011, 2012, 2013, 2019, 2020, Duit 1991, Galili 2001, 2008, Maurines 2003, Barbin 2013.

<sup>179</sup> Taking into account my doctoral thesis aims, an incomplete but selected list of authors is: Physics: Friedmann 1922; Misner 1973; Schutz 1989; Saulson 1994; Van Heuvelen 2001; Kokkotas 2002; Longair 2004; Buonanno 2007; Fairhurst 2009; Sathyaprakash 2009; Zacharia 2011, Pisano and Sozzo 2020. History of Science: Pisano's works (Cfr. references below); Lakatos 1971; Gabel 1993; Bage 1999; Schleppegrell 2003; Braund 2006; Radelet-de Grave 1999, 2009, 2009a, 2010, 2012; Ramadas 2009; Kim 2010; Kelly 2012; Hodson 2014; Bracco 2006, 2015, 2017, 2018, Kouneiher 2005, 2018. Epistemology of science: Lakatos 1980; Livingstone 1981; Goldman 1986; Kuhn 2002; Schommer-Aikins 2002; Brownlee 2003; Steup 2005; Rahman 2018; Crapanzano 2018. Teaching/Science Education: Dykstra 1992; Niedderer 1992; Gautreau 1997; Boxtel 2000; Hammer 2003; Adams 2006; Perkins 2006; Chang 2008; Sahin 2009, 2010; Teixeira 2012, Burko 2017. Cognitive Psychology: DiSessa 1982; Carey 1986; Glaser 1988; Prosser 1989; Niedderer 1992a; Nersessian 2003; Chater 2008; Reif 2008; Tytler 2010; Gallistel 2011, Neurosciences: Kosslyn 1995; Liston 1996; Kéri 2003; Fanselow 2005; Daw 2008; de de Jong 2009 Goswami 2008; Carew 2010; Willis 2010 Johnson 2011; Buonomano 2017.

- *reflexivity* (learners’ awareness of the content and the ways to participate in the learning activities, and especially – of their own personal development and acquisitions);
- *variety* of the educational curricula – the learning content should reflect multiple viewpoints to the problems and their possible solutions;
- principle of the supporting *motivation*;
- *module-block principle* in the educational programs and the learning activities. (Doneva 2006, pp. 2-3)

The objective being to develop a NoS curricula articulated around modelling and analogies in order to keep the learners in a state close to Vygotsky (1896-1934)’s notion of “zone of proximal development” (Chaiklin 2003) with a number of didactic teaching strategies (Velazquez 2008, p.19) that can be analysed in various ways, including in particular comparative didactics, and used to evaluate its effectiveness.

### 8.3 Structuring the main Physical Principles: A Proposal

Starting from a phenomenological approach, to understand the phenomenon of gravitational waves, one has to understand (at least in concept) a number of physical concepts which themselves rely on other physical concepts and principles. In order to build a coherent structure on which we can rely to build the modular curricula, it seems only natural that the most straightforward way to do so is to revisit the history of science and identify its different parts relevant to the teaching of gravitational waves. The inquiry which was done in Part II of this document lets us build a simplified timeline of the main events that lead to the discovery of gravitational waves and therefore represents *de facto* the needed core on which to build the proposal. Starting as early as reasonably possible, from a physics point of view this leads us to try to build a timeline for each of the physical aspects of gravitational waves; thus giving the (very broad) following, e.g.:

- The Case of Gravitation and the motion of matter (Gravitational Part)
  - Natural and un-natural, violent motion (Aristotle)
  - Science of weights (Galileo Galilei)
    - Notions of impetus, ratios, principle of relativity
  - Gravitation (Isaac Newton)
    - Notions of force, absolute time, absolute space
  - Special and General Relativity (Albert Einstein)
    - Principle of Relativity, invariance of the speed of light, spacetime, curvature, mass-energy equivalence, gravitational waves

- The Physics of Waves (Wave Part)
  - Speed of propagation, medium, reflection, refraction, diffraction, transverse, longitudinal
  - Soundwaves and Musicology
    - Harmonics, intervals, frequency, tones
  - Light as a wave
    - Polarization, Huygens' Principle, refractory index
  - Quantum Mechanics
    - Associated wavelength, Schrödinger's equation, wave-particle duality

However, when proceeding like this, one of the obvious disadvantages of this draft list is that the mathematics notions called upon are somewhat left aside, as their presence is implicit, and thus fails to convey the testimony of the existence of a rich mathematics-physics interplay. Moreover, this representation also fails to convey a sense of unity between the wave-like and gravitational aspects of gravitational waves.

Considering this, the next representations candidates are a graph (network) or a timeline (Cfr. Fig. 8.5.a); keeping in mind that the ideal visual representation would probably be a 3D time oriented network diagram.

### 8.3.1 Observations and Hypotheses

From the literature (Radford 1997; Sensevy 2002, 2018; Ligozat 2017; Dias-Chiaruttini 2017e; Brun 2017), it appears that the understanding of many of the physical concepts are riddled with epistemological obstacles. However, those studies also show that through proper methodologies and clear explanations and representations, the acquisition of knowledge of those concepts for the learners is far from being impossible (Viennot 1979, 2007; Caramazza 1981; Crapanzano 2018).

Therefore, the main hypotheses will be about how well these epistemological obstacles are overcome thanks to the use of Nature of Science teaching-learning and analogies (Radelet- de Grave 2009; Rahman 2009; 2016).

For instance, it is a question of examining how presenting the learners with a complex concept to acquire (gravitational waves) relying on other concepts, which are also judged difficult to comprehend, they can first acquire the latter concepts more easily thanks to the use of analogies and ultimately comprehend the end goal concept.

In other words, by presenting the rather complex concept of gravitational waves as the end goal of the teachings and therefore by putting the concepts on which it relies on in a somewhat secondary light – on a lesser level of difficulty to understand – the hypothesis is that by using NoS and analogies to keep them in a zone of proximal development, the concepts on which the

end goal is based are acquired more easily as they are perceived as much smaller steps to climb. Another hypothesis is that the use of analogies and *ad absurdum* proofs in this context is an effective tool for the acquisition of new concepts. And finally, based on neuroscience results in regards of the process of association and in regards to long term potentiation, that the more a concept is called upon, and from various sources, the more easily it is acquired, manipulated and retained.

### 8.3.2 Testing the Hypotheses

In order to test the hypotheses, the learners would be subjected to pre-tests and post-test evaluations. The RTDC, the pre-test and post-test of the introductory module on gravitational waves of the curricula (Cfr. Appendix, RTDC) are modelled in particular after the study of (McGrath 2010) for a partial comparison. The tests are mixed questionnaires with quantitative features (including a 1 to 5 scale, a true or false) and more qualitative features with open questions (regarding how they understand the process of scientific advancement or about the difficulties they encountered, comments on the content and other commentaries).

The pre-test and post-test which are used to measure a number of observables related to the learners, and the lectures were designed with respect to a number of didactical considerations. The main considerations are the following (adapted from Reuter 2013, pp. 175-178):

- The domain areas in which the modules of the curricula are based on and to what extent they are explored;
- What is the –main– scientific problem that is studied in the module, how it fits into the curricula (relevance, coherence) and its place in scientific knowledge;
- What and how are the specific representations of science, practices and attitudes are being studied;
- What and how knowledge, concepts or theories are expected to be learnt;
- What kind of instruments, materials are being used;
- What kind of intellectual approaches are being used;
- How is the History of Science called upon and taught in the module;
- What are the similarities and limits between the practices of the learners and of the scientists;
- How to show the human endeavour and technological sides of science; and
- How complete and in depth are the depiction of the context and scientific concepts of the curricula.

## 8.4 An Early Modelling of Curricula

The early modelling of the curricula first consisted of general propaedeutic modules/lectures on Nature of Science teachings from which 3 particular modules were designed specifically for NoS teachings of gravitational waves physics and history:

- Module 1  
Science Teaching-Learning: On the Didactics of Physics and Nature of Science Teaching / NoS
- Module 2  
Science Teaching-Learning: History and Epistemology of the Concept of Waves / NoS
- Module 3  
Science Teaching-Learning: History and Epistemology of Gravitational Waves / NoS

Each of the modules were designed to be aimed at different levels of audience; respectively Lyceum (Premières et Terminales), Licence Degree and Masters Degree from multidisciplinary courses (C1, C2, C3). Furthermore, each of these modules were designed to specifically put forward one aspect of the Nature of Science. This choice, especially for the first module, was prompted by the necessity for learners to first understand the importance of epistemology. Indeed, there is little to no formal training in epistemology through the course of pupils' education, but this issue is on the way to be addressed. In fact, as Prof. Thierry Fayard – at the Centre National d'Études Spatiales (CNES) – told me in a conversation, there is a great concern on the subject and there is a recommendation letter for the government being written on this very problem.

Moreover, as the learners progress, the difficulty of the modules slightly increases. The following courses are adapted from the works and teachings of my thesis director, Prof. dr. Raffaele Pisano, documents and speeches.

## **Title of the Course 1: *History, Philosophy of Foundations of Sciences & Technology Studies***

**Level: Undergraduate/Graduate/Ph.D.**

*An outline.* At present, it seems that mathematics and physics teachings generally proceed according to the strict assumption that in schools (e.g., secondary *high* schools) only the teaching of a rudimentary amount of mathematical and physical principles, as well as of basic experiments, is required, regardless of their role in the learning process. This type of teaching seems to be of natural inheritance and, let us say, the consequence of a typically mechanistic–positivist perspective and, in some aspects, of *mechanistic* science. Many European centres and history of science & technologies institutions like the *European Society for the History of Science, Inter-Divisional Teaching Commission of the Division of Logic, Methodology and Philosophy of Science* (DLMPS) and the *International Union for History and Philosophy of Science and Technology* (IUHPST) are good examples of a brilliant reflection of higher scientific education and the improvements required at the secondary level. It is unthinkable to learn and understand the scientific sense of a subject without deepening its intellectual and cultural background, e.g. its history and foundations: *how is it possible to continue teaching sciences being unaware of their origins, cultural reasons and eventual conflicts and values? And how is it possible to teach and comment on the contents and certainties of physics and mathematics as sciences without having first introduced reasonable doubt regarding the inadequacy and fluidity of such sciences in particular contexts?*

A larger base of foundational analysis including not only scientific–disciplinary matters but also interdisciplinary issues including history, historical epistemology, logic and the foundations of physical and mathematical sciences, science and technology studies should be adopted. A multidisciplinary teaching approach based on large themes–problems toward a scientific education based on different formulations of the same theory would be beneficial because the interconnections and interdependencies are not currently evident between: physics and logic (classical and non–classical), space and time in mechanics, mechanics and thermodynamics, *ad absurdum* proofs, non–Euclidean geometries and space in physics, the planetary model and quantum mechanics, *infinite–infinitesimal* and measurements in the laboratory, heat–temperature–friction, reversibility, continuum–discrete models in mechanics, *ad hoc* hypotheses, local–global interpretations and differential equations–integral, point–range, constructive mathematics, the kinetic model of gases and thermodynamics, etc.

Additionally, in the modern era, many other mathematical and physical theories of an importance comparable to that of geometry developed. This pushes us to deal with, rather than a single theory, all of the theories and to find among them those which have more important roles compared to others –and possibly that which all other theories are based on. Therefore, we will also have to refer to the foundations of mathematical theory and to the foundations of physical theory, which in previous centuries were made up of techniques (line and compass), then of basic concepts (point, infinitesimal, together), then of the principles of a theory (Euclidean axioms), then of entire theories (geometry, analysis, set theory).

To identify these aspects which are also epistemological, we need a research program of data and formulations of scientific theories, case by case, period by period. To begin with, we can focus our attention, for example, on critical periods and minor authors to understand analogies and conflicts between theories in the history of science. For example, the role of geometry in renaissance mechanics, the role of fortifications in architectural-mathematical design, the logical structure of certain formulations, irrational numbers, *non-Euclidean geometry*, *antinomy*, studies based on Gödel's theorem and the incompleteness regarding the theory, the revolutions of the birth of chemistry and thermodynamics, the role of the latter in the birth of quantum theory, the role of the physical component and mathematical space and time in physical theories, analysis and mechanics, the physical-mathematical relationship, the physical-logical relationship, etc. These historical facts and disciplinary considerations, interpreted epistemologically, uncover those fundamental points which, in periods of normal science, could remain intuitive.

Therefore, the history of science could also be understood as a source of complementary discussion to possibly founded criticism of the developments of both physics and mathematics. We could think, for example, of the historical and epistemological reflections of Duhem, Mach, Poincaré, Koyré, Kuhn on the history of science and its foundations. For this reason, we must clarify which methods exist today for studying the history of science that also include its foundations without invoking metaphysical ideas (cause, ideas, *a priori* knowledge, separation of body and mind, etc.).

***The course in brief.*** The course aims at distinguishing between various ways of formulating scientific theory in history and therefore understanding in what profound sense these formulations are different (for example, Euclidean geometry and non-Euclidean geometry, thermodynamics and quantum statics, Newton's mechanics and Lazare Carnot's mechanics, etc.). This will consist of the examination of various formulations both in their applications and their principles, their argumentative techniques and general theoretical characteristics. To this end, mathematical, logical and general discourse (reflections of a philosophical nature) will be employed, since we will be reasoning about entire theories. In short:

- 1) The history of science does not allow for free association of ideas or analogies. It requires a specific vocabulary—it is a mathematical language.
- 2) The study of *history of science & technology* also includes the historical analysis of the foundations of science (i.e., mathematics and physics) defining them through mathematical language.
- 3) The research on the foundations of a scientific theory proposes a program method of historical research which proceeds by comparing the various formulations of scientific theories.
- 4) The languages of logic and mathematics are used to study the history of foundations.
- 5) Such an extension also allows for cultural opening in the most general sense of the term, which is at the core of all full comprehension of any scientific argument including mathematics and physics. It is therefore also at the core of the didactics of science, mathematics and physics.
- 6) Dissemination and sharing difficult theoretical experiential works.
- 7) Making students understand that the history of scientific ideas is closely related to the history of techniques and of technologies; that is why they are different from one another.
- 8) Making others understand that scientists were once people studying in poor conditions.
- 9) Showing the real breakthrough of scientific discoveries through the study of the history of fundamentals, not yet influenced by the (modern) pedagogical requirements. For example: understanding the historical progression of the principles of classical thermodynamics and the common teaching of physics.

The research program has an original format insofar as its results also suggest historical hypotheses in correlation with the foundations of science, thereby suggesting a solution to an age old problem with which a great number of epistemologists, historians, philosophers and scientists have dealt. For example, around 1925 quantum mechanics was proposed and taught according to a particular philosophy (i.e., *spirit of Copenhagen*); relativity also has a conception of reality that cannot be defined as merely experimental (the observer, intended as a frame of reference, is part of the theory).

The crises within science have helped scientists to recognize its dependence on facts which are not strictly experimental (see, for example, Newtonian science). During these crises (in physics and in mathematics and logic) old and ancient conceptions, albeit in new terms, were brought up again; this made the *utopic* objective of the unification of all science (through one equation [in physical theory] or more generally through one method considered to be the only scientific method possible) even more unfeasible. In fact, for years physical theory aimed at unifying the entire heritage of classical theories; in reality it produced two different theories (relativity and



quantum mechanics), each of which suggests this unification according to methods which are incompatible with the other (the same scientists separated irreparably, for example, Einstein from quantum theorists). These crises and their subsequent divergences within the accredited scientific corps once again led the same scientists to pursue different research programs, also from a philosophical point of view; this produced a philosophical reflection within science which suggested new terms although they were quite reductive compared to the great themes of past philosophy. For example, Leibniz did not complete his scientific-philosophical research program due to obvious time constraints and a lack of contributions from others to such a vast program, but also because he did not have the opportunity to see that phenomenon which in the end dominated the entire history of science and has only recently been reconsidered in a modern form by Kuhn and Feyerabend: *incommensurability*. The Greeks discovered it among different types of numbers (the incommensurability of the measurement of a diagonal line compared to that of the side of a square) whereas modern science, having constructed numerous, systematically organized theories, experimented with it in entire theories. When faced with incommensurability, the Greeks recognized it and deliberately limited themselves, renouncing the re-foundation of arithmetic and preferring geometry as the basis of all mathematics. The West was obviously subjected to the incommensurability of scientific theories, just when they were suggesting these theories as the height of human consciousness, superior to every other form of consciousness.

Additionally, despite the innovations introduced by Kuhn and Koyré in the history of physics, we do not yet have a sturdy method for the historical interpretation of science. It is maintained (rightly or wrongly) that this should not be surprising since on a philosophical level these excellent studies must be considered as mere attempts because they obtained only an approximate insight into the foundations of physics (over which the scientific philosophers found themselves in great difficulty). In effect, Koyré and Kuhn's time was decades ago.

In the meantime there has been an increase in just as excellent historical and epistemological studies both in extension (on a greater number of scientists) in intensity (on particular problems), on primary literature (the original sources) and on secondary literature (the studies on the history of science). Surely today we can use many more instruments and analysis results than those used by Koyré and Kuhn. Additionally, there has been an increase in just as excellent contributions from philosophers of science. Therefore, a research program (and also a course) on history and epistemology that also draws the eye to the history of the foundations has an even more interesting mission today by contributing to beat this challenge: doing research on what these foundations are today and trying to characterize them to have a better understanding of all science acquired and of its historical perspective within the field of *History of Foundations/Education*

*of Science & Technology Studies*. Students examine a selection of such works through case studies.

Textbooks, however, being pedagogic vehicles for the perpetuation of normal science, have to be rewritten in whole or in part whenever the language, problem–structure, or standards of normal science change. In short, they have to be rewritten in the aftermath of each scientific revolution, and, once rewritten, they inevitably disguise not only the role but the very existence of the revolutions that produced them. [...] Textbooks thus begin by truncating the scientist’s sense of his discipline’s history and then proceed to supply a substitute for what they have eliminated. Characteristically, textbooks of science contain just a bit of history, either in an introductory chapter or, more often, in scattered references to the great heroes of an earlier age. From such references both students and professionals come to feel like participants in a long–standing historical tradition. Yet the textbook–derived tradition in which scientists come to sense their participation is one that, in fact, never existed.<sup>180</sup>

---

<sup>180</sup> Kuhn TS (1962) *The Structure of Scientific Revolutions*. The Chicago University Press. Chicago, pp 137–138, line 23.

**Title of the Course 2: *History of Science/Science & Society Studies***  
**Level: Undergraduate/Graduate/Ph.D.**

**An Outline.** Since ancient times, society has generally constructed a perception that science is synonymous with *progress & modernity*; especially during periods of modernization. We know that anomalies, inversions and controversies also belong erroneously to the so-called concepts of *progress & modernity*. It would therefore be interesting to investigate author by author to understand just how science worked and how society worked, i.e., the concept of civilization. For example Newton's science certainly produced a strong impact on humanity, particularly on Western civilization both concerning the *scientific* and *supernatural* background of the law of nature, including mathematical interpretations of phenomena like non-physical laws; sometimes outside the context of the theory (i.e. providence, religion etc.). Certainly by combining scientific traditions and contributions of scholars, i.e., like Copernicus, Kepler, Galileo and Descartes, he provided a scientific framework based on an adequate form of mathematics (and geometry) for interpreting terrestrial and celestial physical phenomena which, *a priori*, were geometrically idealized to easily become *citizens* in his new revolutionary, *a posteriori*, *mathematization of nature*. A parallel problem related to dialogue as communication-language between specialists (advanced and applied research) and non-specialists (versus a scientific civilization) is a troubling matter, i.e. *how is it possible to go from science to technique and to technologies? And who was really able to be a mediator in any other context of society?* The idea that a human mind can produce an intellectual revolution within science and its approaches (methods and methodologies also integrated with contradictions and criticisms) strongly crossed a *paradigm* both in the history of sciences and disciplines-literatures (reasoning, early enlightenment, positivism, etc.). Newton's science and Newtonian science in history made comprehensible both science according his physical paradigm (mechanics) and sciences alternative to his paradigm, i.e. Lazare Carnot's mechanics, geometry and mathematics. In this sense, the birth of modern science and science in general, in all its contradictions, anomalies and developments certainly also represents a cultural phenomenon. Finally, the civilization of science (and works produced by scientists) are an historical scientific attestation.

**The course in brief.** The course introduces the history of science and technology from the main scientific accounts from antiquity (i.e., Heron, Aristotle, Archimedes..., Fibonacci, Leonardo, Tartaglia, Galileo, di Giorgio Martini, Lorini, Torricelli, Cauchy, Fourier, Lazare Carnot, Sadi Carnot, Machines' authors, Faraday, Maxwell, Darwin, Einstein, among others) to the present. The undergraduate/graduate/Ph.D. students will examine the impact of scientific knowledge (or what was "scientific" at that time) within philosophy, workmanship, social structures, and move on to the scientific knowledge & technology regarding the development of science: from

investigation to science to discipline to line of work in history, especially in Western civilization. Physics, mathematics, chemistry, astronomy and the mind sciences will be studied. A history and technology of scientific concepts (correlated with devices) should also be included; i.e., matter, nature, motion, body, and mind as these have been shaped over the course of history. Particularly, with regard to *Science & Society*, the course explores recent historiographical approaches within the history of sciences, by interpreting different theoretical scientific approaches with a social impact at different levels of a society in history (social history of science) and what makes for good and interesting history of science. This aims to explain the connection between social factors and science and technology while avoiding the demystification of the prominent fields of science and technology, treating them as they do other common social phenomena. In fact, the social studies of science and technology have been a source of significant *controversy*. We will try to study the concept of controversy and some examples are proposed.

**Title of the Course 3: *History, Philosophy of Science and Technology/Technosciences Studies*****Level: Undergraduate/Graduate/Ph.D.**

**An outline.** It is very common to read concepts like those found in the following:

*Technosciences* is a concept widely used in the interdisciplinary community of science and technology studies to designate the technological and social context of science. The notion indicates a common recognition that scientific knowledge is not only socially coded and historically situated but sustained and made durable by material (non-human) networks. The term was coined by French philosopher Gaston Bachelard in 1953. It was popularized in the French-speaking world by Belgian philosopher Gilbert Hottois in the late 1970s/early 1980s, and entered common usage in English in the early 2000s. [Generally speaking] technosciences is considered within three levels: a *descriptive-analytic level*, a *deconstructivist level*, and a *visionary level*.

*Descriptive-analytic level.* On a descriptive-analytic level, techno-scientific studies examine the decisive role of science and technology in how knowledge is developed. What is the role played by large research labs in which experiments on organisms are undertaken, when it comes to a certain way of looking at the things surrounding us? To what extent do such investigations, experiments and insights shape the view on ‘nature’, and on ‘our’ bodies? How do these insights link to the concept of living organisms as bio-facts? To what extent do such insights inform technological innovation? Can the laboratory be understood as a metaphor for social structures in their entirety?

*Deconstructivist level.* On a deconstructive level, theoretical work is being undertaken on Technoscience to address scientific practices critically, e.g. by Bruno Latour (sociology), by Donna Haraway (history of science), and by Karen Barad (theoretical physics). It is pointed out that scientific descriptions may be only allegedly objective; that descriptions are of a performative character, and that there are ways to de-mystify them. Likewise, new forms of representing those involved in research are being sought.

*Visionary level.* The concept of technoscience comprises a number of social, literary, artistic and material technologies from western cultures in the third millennium. This is undertaken in order to focus on the interplay of hitherto separated areas and to question traditional boundary-drawing: this concerns the boundaries drawn between scientific disciplines as well as those commonly upheld for instance between research, technology, the arts and politics. One aim is to broaden the term ‘technology’ (which by the Greek etymology of ‘techné’ connotes all of the following: arts, handicraft, and skill) so as to negotiate possibilities of participation in the production of

knowledge and to reflect on strategic alliances. Technoscience can be juxtaposed with a number of other innovative interdisciplinary areas of scholarship which have surfaced in these recent years such as technoetic, technoethics and technocriticism.”

A discussion will introduce the students to the broad fields of the history of science and technology/technoscience which study past science and technology respectively.

***The course in brief.*** With respect to the cited definitions, on my side we will particularly focus on *Deconstructivist level*. Before Galileo, scientific studies followed the ancient standard of obtaining knowledge about an object that was regarded as unchangeable. It did not occur to anyone to practically change the real object of investigation (as it would then be considered to be another object). On the contrary, scientists strove to improve their theoretical model so that it would fully describe the behaviour of the real object. In Galileo's view, the real object corresponds exactly to the ideal object but is interpreted as a distortion of the ideal object's behaviour under the action of various factors, for instance friction. This made it possible for Galileo to modify the real object by acting on it in a practical way. As a result, its *negative* properties, which prevented it from being identical to the ideal object, became neutralized. Galileo chose an unusual approach for scholastic science: technology began to lean on mathematical knowledge and models. The orientation towards both engineering practice and mathematical knowledge (obtained strictly analytically) largely determined the line of development of Galileo's ideas.

Various interpretations will be studied, i.e., the classical kuhnian paradigm of science, methods and attitudes from history proper, examining scientific developments in connection with social, cultural, and even personal forces and values. There will be particular emphasis placed on the boundary between legitimate science and pseudoscience, continuity and discontinuity, revolutions, and modern science, encouraging the development of technology and its relations with society and culture (i.e., how social and cultural factors help shape scientific and technological developments and decisions, among others).

In this course, we will include discussions of the history of science and the history of technology by several practitioners, as well as case studies from the past two centuries. For example: The science of Albert Einstein (1879–1955) seems to be more a work of art of human rationality than a physical theory. Its beauty manifests the “harmony of the natural laws” arousing, as he affirmed, a “rapturous amazement” to superior “intelligence” that reveals itself in the world of existence (Einstein [1954] 1994, 43). In 1905, with the publication of three extraordinary papers, Einstein laid the foundations of relativity and quantum theory and gave the definitive proof of the molecular structure of matter. The applications of his theories to modern technology are of an unprecedented scale and they are not only the basis for the creation of the atomic bomb but also for the production of

electricity in nuclear power plants. Faced with a possible new nuclear war that could endanger the very existence of humanity, Einstein used his fame to call for commitment to peace by scientists, politicians and ordinary citizens. In this sense the undergraduate/graduate/Ph.D. students will see the impact of scientific knowledge within:

- Knowing the conceptual deficiencies of classical physics that led to the introduction of quantum theory and the theory of relativity
- Understanding the dispute between Bohr and Einstein on the causality of events in quantum mechanics; comprehending scientists' ethics in the vision of Albert Einstein and being familiar with the Einstein-Russell Manifesto.

After making significant contributions in several areas of fundamental physics, J. Robert Oppenheimer (1904 – 1967) led the Manhattan Project; he was, however, deeply troubled by the suffering inflicted by the atomic bombing of Hiroshima and Nagasaki. Subsequently, Oppenheimer opposed the construction of the H-bomb, but he was tried for having slowed its development with his influence on American scientists. He developed the belief that the only prospect for humanity to contrast the destructive power of new weapons would be a united world. To him we owe notable publications on the relationship between science, ethics and society. Franco Rasetti (1901–2001) was perhaps the greatest Italian experimental physicist of the last century. He refused to participate in the research for the military use of nuclear energy. After Hiroshima, he left physics to devote himself to palaeontology and botany. He was a promoter of natural consciousness. In this sense, the undergraduate/graduate/Ph.D. students will see the impact of scientific knowledge within:

- Knowing the different positions taken by Italian physicists towards the creation of the atomic bomb;
- Understanding the problems concerning the relationship between technology and nature;
- Interdisciplinary lesson with the philosophy teacher about the ethics of responsibility by Hans Jonas

Leo Szilard (1898–1964) was the first scientist to become interested in nuclear chain reactions for the production of energy. He realized that this mechanism could be used to make a powerful means of destruction. It is well known that the letter written by Szilard and Einstein to U.S. President Roosevelt led to the development of the Manhattan Project.

Before that, however, Szilard tried to persuade the nuclear physicists not to publish the results of their research on neutrons emitted in the fission process in order to prevent the results of this research from being used against humanity. Frédéric Joliot published the results of his research, making Szilard's efforts inconsequential. In this sense the

undergraduate/graduate/Ph.D. students will see the impact of scientific knowledge within:

- ✓ Understanding the importance of internal confrontation in the scientific community about the possible consequences of scientific research
- ✓ Reflecting on the historical conditions that led to the physicists' choices regarding military use of atomic energy
- ✓ The origins of the concept of atomic energy Rutherford and Soddy's research on natural radioactivity (1903)
- ✓ The chain reaction and the release of nuclear energy
- ✓ The postponement of the publication of Szilard and Fermi's research on the emission of neutrons in the fission of uranium
- ✓ The nuclear reactor & Society



**Title of the Course 4: *History and Epistemology of Science & Technology Studies*****Level: Undergraduate/Graduate/Ph.D.**

**An outline.** Physics and Mathematics, and science in general, are disciplines that originated at the beginning of human consciousness. From the beginnings of humankind, distinguishing between one and two (and so forth) was a sign of consciousness. In the same way, knowing how to draw shapes and recognize their properties also demonstrated consciousness. Since the dawn of civilization, man has learned to number and carry out the first basic operations (addition and subtraction), helping himself with objects and his own fingers. In general, every primitive culture has elaborated its own type of mathematical culture at the most opportune time and in the most opportune ways. The same is true for natural sciences as well, with some differences according to the interpretive use of mathematics and geometry over the course of the centuries.

Asserting that certain knowledge is scientific means attributing said knowledge to a special rank. It involves undergoing various trials and verifications, analyses of the risk of statistical error and assumes criteria of rationality which imply complete coherence with other shared, equally scientific and adequately verified knowledge. Science, in this way, provides us with a reassuring view of itself: it proceeds methodically, extends its control and reduces the mystery surrounding it. However, representing and recounting science as a linear undertaking which is progressive, monotonous and only capable of proceeding from certainty to certainty, always (and only) guided by the wisdom of Occam, by rigorous demonstrations and appropriate verifications, is false and misleading. Rather than assigning its pretences to the idea that the world is generally knowable (since it was originally *written* in a mathematical language), contemporary science finds its distinctive feature in an ethical criterion: a criterion connected to the thesis according to which scientific findings are always conjectures which can be modified, the fruit of other conjectures suggested by some empirical clue, supported by a significant number of conventions. It is this anti-dogmatic attitude that distinguishes (or should distinguish) a scientific undertaking from other human activities. This is because the most interesting object in science is made up of that which is not yet known. By its very nature, science cannot have characteristics of an activity that proceeds monotonously for the mere iteration of its own principles, of its own conceptual instruments, of its own procedures, of its own methods and verification criteria; on the contrary, it is within scientific practice that the reasons for its perpetual refinement and its periodical revisions arise.

Therefore, an historical-epistemological and social teaching–research program must obviously go far beyond a timeline, the collection of data, discoveries and the names of discoverers: *there is never a limit to the accumulation of events since even minimal facts might have contributed to a great discovery.*

Furthermore, even by accumulating a heap of historical facts, we would still be left without answers to the *whys* and *hows* in history: for example, why this particular succession of discoveries? Why was the beginning of science at that time? Why did the development of science stop at certain times (for example, between the Romans and Italy after 1650) and in certain places (in China)? And why in certain other times and places (for example, in Italy after 1250, in Paris during the French Revolution) did it develop frenetically?

Therefore, the History of science (in my case physics and mathematics) is useful if it responds to the *whys*, and bases the facts for finding them, on organizing discourse epistemologically, that is to say, by interpretation. In order to obtain hypotheses based on these responses, it is necessary to move to a critical and social history of science.

***The course in brief.*** This course begins with lectures on the *History and Epistemology of Science and Technology* and examining the nature of science according to various epistemological perspectives. A technological change is the major factor in historical change and it tends to lead to historical progress. Currently, that is generally assumed as correct. But what is the role played by technology in history? We will try to answer this focusing on: the emergence of humans as a history-making species, the emergence of agriculture-based civilizations, the industrial revolution and the rise of the human empire on the planet. In this sense, the undergraduate/graduate/Ph.D. students will see the impact of scientific knowledge through a combination of textbooks and specialized supplementary epistemological and sociological readings and other critical and cultural studies of science and technology from important thinkers who have contributed significantly to these subfields or approaches.

However, the field is best understood by the ways in which it approaches science and technology. The students will be introduced to (possibly) new key terms necessary for understanding these perspectives. *What counts as knowledge? How is knowledge derived? What is science?* What does it mean to practice science? While we cannot be exhaustive in our survey of the answers, this unit will be able to provide some characteristic responses from the major philosophical perspectives on epistemology.

By epistemology, we mean theories about how knowledge is to be defined and in particular what counts as scientific knowledge. Of course, the epistemological interpretations are based on historical facts and methods (historical epistemology of science, sources, etc.) allowing for a critical understanding of the main problems in the *History and Epistemology of Science and Technology*. Therefore, we will avoid focusing on the *philosophy of technology*. On the contrary, at the end of the course, the students *should be able* to explain developments in science and technology in terms of their interactions with social, cultural, environmental, and other critical epistemological issues, preparing them for an eventual Ph.D. in history of science or history of science and technology.

## **Development of a related teaching program with a corresponding Research Program, University of Lille 1**

### **Course 1 to Module 1 (C1 to M1 in (including training for teaching professions)) the XVII<sup>th</sup> -XX<sup>th</sup> centuries**

#### **An Introduction to Modular Programming**

One of the commitments that the university must constantly face is to address the problem centred on the attitudes of young people to science and the history of science, their relationship with school and the role of education, humanities and technology content. In order to do so and encourage the instrument of cultural orientation, it is necessary to propose reflections on the shaping of the history of science as an emerging discipline in the twentieth century from a highly complex intellectual and political context, and to aim for tolerance and pluralism in historiographical methods and approaches. These aspects are part of a broader spectrum of analysis that includes history, epistemology and philosophy, as well as psychology and sociology. Indeed, today it is unthinkable to learn and understand the scientific essence of a discipline without deepening its most intellectual and cultural form, that is, the historical and philosophical development that allowed it to enter scholarly institutions, teaching institutions and textbooks. For instance, Thomas Kuhn noted that a paradigm, to remain robust, must determine its role in teaching, which must achieve consistency through textbooks; since he considered the book as a representative object that was the object of an entire paradigm.

The debate on didactic and pedagogical problems beginning with school education, at the base of the historical and epistemological reflections that one could meet in university courses of history, epistemology and philosophy of science, seems unfavoured compared to the attention manifested in regard to the other themes considered more crucial.

Let us consider, for example, the epistemological problems of mechanics in relation to those of thermodynamics which have not yet been solved from a didactic point of view, rather than those of the teaching of non-Euclidean geometry, or of the introduction of Bohr's planetary model as an introduction to the study of quantum mechanics. Nowadays, quantum mechanics seems to open the door to a more expansive challenge: to clarify the role of its new foundations in order to analyse the cultural frame of reference of about two centuries of mechanism and almost a century of teaching that was almost entirely mechanistic. One may wonder whether it has really proposed an autonomous clarification of the theory or has only rejected the past by introducing an *ad hoc* formalism like with the early axiomatic formalization of relativity which was tried and in which even with the isotropy of space, or the law of propagation, there is always a constant to be determined or a parameter to be specified.

We must also highlight the problem of understanding concretely the kind of revolution that happened to the physics and mathematics of the twentieth century: *Only fundamental? Also cultural? Methodological?* For example, the techniques used in equation theory with the mathematics teacher are the same ones used in Newtonian mechanics when one has to calculate dimensions, acceleration, and time and these are the same ones used in the lessons of applied mathematics in technical and commercial establishments. Therefore, a different teaching approach would not allow other similar disciplines to re-qualify certain concepts and generate confusion for the students.

In other disciplines, the critical comprehension of any literary work almost always involves framing the author in their historical-politico-cultural methods and context. *Could this be done also for the teaching of mathematical and physical theories with emphasis on history and epistemology?*

Furthermore, it should be noted that the history of science is not limited to the simple chronology of hagiographic discoveries or hagiographic biographies of scientists, but involves the comparison of the competition of scientific paradigms, other conceptual interpretations of experiments or analysis results, the acquisition and development of basic principles, and so on. In this sense, the teaching of History of Science at school seems to become more and more important. Furthermore, each of the pedagogical choices in the design of a teaching plan should (desirably) also take into account the results of the teacher's research (Cfr. below the modular plan). In general, one of the most debated questions on the teaching of the history of science, still asked today, can be formulated as follows:

- (a) Is a teaching (for principles or major themes) of area or unit (external history) more appropriate?
- (b) Is a teaching (for the principles or big questions, as you want) that relies on internal elements of the discipline, or a presentation that emphasizes the relationship between developments, facts and events (internal history) more appropriate?

Without extending much, and taking into account the high culture of readers, I make only a few comments to clarify my point of view of the candidate teacher-researcher.

In the first case (a), it is a history distinct from the individual disciplines that could ensure a certain continuity of the discourse, and would make some chronological partitions historically acceptable. However, such continuity and order often seem to be achieved at the cost of an almost total isolation from the growth of the discipline of which one is producing a history didactically. Thus, historical assumptions seem to be precarious because, even if contextualized, they seem to be devoid of a linear development and therefore marked by conflicts, revolutions and anomalies of individual disciplines.

In the second case (b), the inner history of science would tend to draw a divisive line between rational arguments and social, philosophical or psychological reasons in both the *context of discovery* and the *context of justification*. But the exclusive use of the inner story tends to be limited to a certain identification of the history of science with the epistemology of science. Thus, the history of science could be assimilated as a field of the philosophy of science, and so, because of the legitimate new objectives of epistemology which are part of it, would also lose the fundamental characters of its being. *e.g.* with the study of different sources (manuscripts, editions, articles, diaries, laboratory notes, draft articles, letters, notes on works consulted, images, tools and machines used, natural collections, protocols and documents of scientific institutions and so on) and historical hypothesis based on historical facts.

Since to propose a history of science without even making reference to any of the technical and fundamental factors upon which the answer to a scientific problem in history depends, would inevitably lead to a distorted image and reading of the laws and scientific theories that ideas and thoughts invade and that have no national boundaries, I propose a balanced teaching (below).

This teaching is characterized by the role of science in (external) history, but with (internal) case studies in order to detect internal conflicts and the similarities between the foundations of these formulations or between the different theoretical currents. For example, to understand the birth of the revolution of Sadi Carnot's thermodynamics, we could examine his handwritten notes archived at the *École Polytechnique* where he translated Watt's work on machines from English in order to understand the versatility of scientists in their historical (inner) context.

Furthermore, a teaching of science that rehabilitates the historical teaching of science as an integral part of human culture should be able to build an autonomy of scientific discourse. In this sense, in relation to the hypothesis mentioned the History of Science would still be confined within its limits, while retaining its original characteristics. Likewise, this also depends on the specificity of the subjects being dealt with (history of physics, mathematics and chemistry), on the cultural background of the historian and of course the cultural background of the students.

However in order to achieve this, the caveat is that a consistent supply of new research (publications), where perhaps the epistemological interpretation addressed is based on historical assumptions, (which may be internal or external) would be necessary.

## A Modular Programming Hypothesis

There are a number of teaching requirements that need to be considered. Since we are discussing university teaching, a course for students and not a seminar for specialists, it is necessary that the contents of epistemology and history of science are also presented. This is done through the expository methodology sedimented in the texts of primary literature and at the same time in the historiography of secondary literature. In this sense, through recorded work students can express their culture both in the learning process and during the final exam; as this kind of culture of learning-teaching is a crucial didactic key which the teachers have to pass on to their students.

The work plan states that while each module is designed to be a course divided into teaching units to carry out, including case studies (special education units), they are also easily reducible to standalone lectures. The choice depending on the available time, objectives (cognitive and operative) and on the events during the course. For example, it will be possible to delete or add teaching units and / or case studies to the module. The objective to be pursued with modularity is essentially a hereditary and portable educational structure based on:

- ✓ Modules divided into teaching units (UE) with case studies (special education units, UES) or reduced to their core as standalone lectures.
- ✓ Scientific language
- ✓ Explanation of historical categories of investigation
- ✓ The problems and themes of science
- ✓ Establishment of the student in a problematic situation (theoretical and / or experimental) in which they realize the insufficiency and precariousness of the scientific knowledge of the time
- ✓ Construction and reproductions of simple scientific experiments or even historical replications
- ✓ Links and contextualization between modules and between teaching units and case studies
- ✓ Correlation of interpretations (epistemology) and hypotheses (history) between the different modules
- ✓ *Modelling* of historical and theoretical assumptions of knowledge
- ✓ Selection of knowledge
- ✓ Possible small lessons in mathematical analysis, classical and non-classical logic and physics.

Below:

- ✓ A table that systematically summarizes the objectives and terms.
- ✓ A schema that expresses a cyclical modular teaching hypothesis for teaching (CNU sections 72 / 17)
- ✓ Contents summarized in 20 modules. Each module could be a course done in an academic session.

Of course, like all teaching activities, the modular teaching plan may be subject to variations in the prerequisites and cognitive and operational objectives that the group-class (teacher-student) together can meet in *itinerare*.

However, we have to recognize that the technical parts are not completely reducible at will without suffering from inconsistencies. Indeed, it is necessary to base everything on rigorous demonstrations and theories, even if simplified either for exams or during the lectures; in which cases this must be made very clear to whomever wants to draw historical or more general conclusions. *Therefore, it should be made clear to the students that they also have to understand the technical-formal necessity behind the simplification.* As with the other examinations of mathematics and physics, it is necessary to refer to the scientific demonstrations and theories presented (including the consequences implied by some of the simpler passages, looking for counter-examples, for the change of the hypotheses of the theorem, including the strategy of the demonstration, the role of a theorem in the context of the theory, and so on). Indeed, the passages of demonstrations and the theorems are very important, and in this way, at the end of the course, one can reach a better level of comprehension of the arguments treated in the related courses of physics–mathematics; thus going beyond the didactic presentation.

## Synthetic course plan: history and epistemology of science; philosophy of science (physics, mathematics)

### *The specific objective of the course*

The course has as its specific training objective to give the students the bases and general instruments in epistemology and history of sciences in order to acquire a scientific culture other than technical and allowing them to engage in a reflection on contemporary science, its practice and its stakes: the critical study of the principles, the hypotheses and the results of the various formulations.

So, the course intends to make available the logical-scientific instruments to investigate the history of science. In particular, this will provide the students with theoretical and historical knowledge of the connections between historical-philosophical reflection and scientific inquiry.

Finally, reading original texts and secondary literatures of group activities will make the proposed analyses more concrete. Emphasis will be placed on self guided learning.

#### *Educational functions*

**Cognitive operative prerequisites**

- Basic elements of geometry
- Basic elements of mathematical analysis
- Basic elements of general physics

**Cognitive objectives**

Analysis of the nature and structure of scientific concepts and theories, sometimes called the syntax of theories.

Analysis of the scientific method

Analysis of the relationship science society in the history of science

Analysis of the boundaries and the values of the scientific enterprise.

Knowing the historical foundations of the theories faced.

Interdisciplinarity.

Knowing the meaning of *historical hypothesis* and *epistemological interpretation*.

Systematic knowledge of the main facts of the history of the *interior science* proposed by the teacher.

Systematic knowledge of the main facts of the history of *external science* proposed by the teacher.



**Operative  
objectives – skills**

Systematic knowledge of the main facts of historical epistemology proposed by the teacher.

Critical reading of primary and secondary sources of the history of science and technology in relation to epistemological, philosophical and literary culture also to the political, social and institutional environment of their times.

Knowing how to define terms and concepts and possibly perform calculations.

To be able to present written or oral works while correctly respecting the time of events and historical events.

Knowing how to correctly bring back the problems confronted to the thought of the authors examined.

Compare and contextualize the different answers of scientists throughout history.

Grasp analogies, differences, revolutions, conflicts, anomalies, models and methods in the history of science.

Seeking to recognize and support the mixture of science-technology in different scientific theories tackled from the historical point of view.

Putting in context the scientific foundations of science and its relations with society in historical discourse.

**Contents and  
modules**

The modules are characterized by general research.

<p><b>The formative nature of the course</b></p>	<p>The proposition is a course in history and epistemology of physics and mathematics :</p> <p>1) <i>The logic of science</i> for the identification and analysis of logical problems raised by science and the structure of scientific theories. For example, problems of <i>validity of foundations</i>: how to formalize a theory? What kind of logic suits the amazing results of quantum mechanics? Is it still the so-called classical logic?</p> <p>2) <i>The methodology and categories of science</i>, that is to say, the study of the scientific method and the question of the possible existence of methods specific to certain sciences. For example, <i>problems of the method</i>: can the same method involve different techniques? Physical-Mathematical and Physical-Logical Relationships? Do the social and human science have a rigorous method and, if so, is it the same as that of so-called exact sciences?</p> <p>3) <i>The theory of scientific knowledge</i>, what is the status of this type of knowledge and the question of the demarcation between science and non-science. For example, problems of the limits and value of the <i>scientific enterprise</i>: what is scientific and what is not? Are there any false sciences? Is our knowledge constantly progressing or are there limits in nature or in our instruments of observation and measurement?</p>
<p><b>Duration of the didactic intervention</b> <b>Types of teaching activity</b></p>	<p>According to the terms of the university</p> <p>General and specialized bibliography proposed by the teacher</p> <p>Notebook</p> <p>Reflection sheets</p> <p>Didactical software</p> <p>Didactical <i>Applets</i> on the Internet</p> <p>Interventions-seminars of teachers specialized in certain sectors</p>

<b>Teaching methodologies</b>	<p>Lectures during which students are invited to take part in discussing the subject matter of the program as well as the texts whose reading will be suggested (and in some cases mandatory).</p> <p>Vis-à-vis</p> <p>Brainstorming</p> <p>Group work on models and mathematical and logical calculations</p> <p>Results Forum</p> <p>Problem solving</p>
<b>Evaluation</b>	<p>Attend and participate in the course :</p> <p>Continuous exams on the table</p> <p>Presence and participation for listeners [30%]</p> <p>Presence and participation for the final exam for students [70%] or other university terms...</p>
<b>Validation</b>	<p>A text summary (from some texts of the collection) of 5 pages. (to be returned to 1/3 of the course)</p> <p>A short dissertation (10 pages) topics will be proposed. (to be returned to 1/2 of the course)</p> <p>Forum and discussion of the results</p> <p>Final test and a power point presentation</p> <p>Reproduction of an old scientific instrument (optional)</p> <p>Or other university terms</p>
<b>Correction criteria</b>	<p>Clarity and originality</p> <p>Comprehension</p> <p>The use of calculations on the foundations</p> <p>The logical articulation and the internal coherence</p> <p>Relevance</p>
<b>Calendar</b>	<p>According to the terms of the university</p>

**Some first recommendations**

A course in history of science requires a great deal of text readings and of different natures: texts from primary literature and texts from secondary literature, textbooks.

The use of mathematical and physical texts as manuals on fundamental questions is necessary.

The use of biographies and a chronological diagram as a first complementary historical analysis of an event and / or a problem to develop a sensitivity to the problems that arise at different times.

Texts of different natures require different (and competent) reading strategies to develop a sensitivity to the use of categories of historical and epistemological interpretations.

In the story a "final truth" of a subject is complicated to find and perhaps not even necessary. The historian must commit to finding historical hypotheses based on historical documents and facts; or epistemological interpretations based on historical assumptions.

*So, the truth of the historical discourse on the sciences lies in the intellectual force of the facts and the proposed documents.*

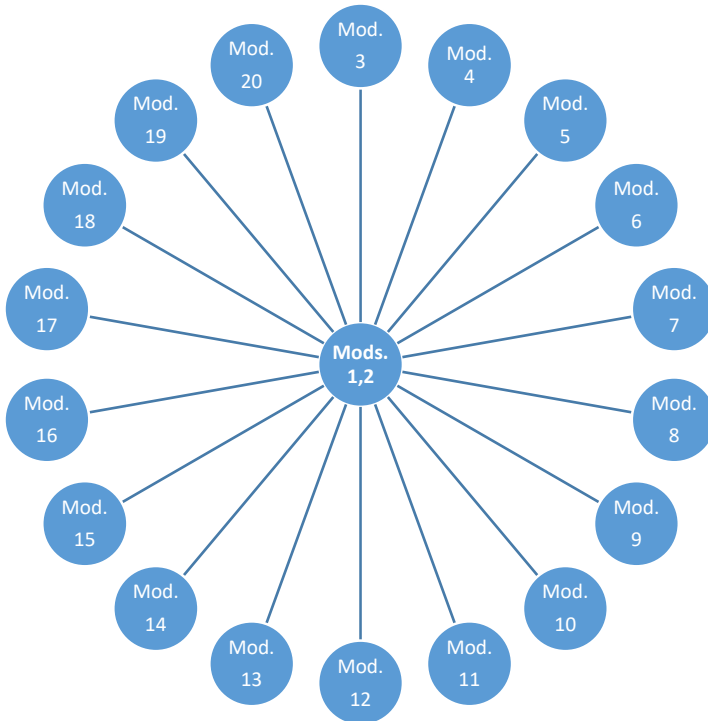
As a result, the historical discourse on science is not pure imagination.

Philosophy, epistemology and historical epistemology are essential for the interpretation of events in the history of science.

### A cyclical modular teaching hypothesis in history and epistemology, philosophy of science

<b>Module</b>	<b>Argument</b>
<b>Module 1</b>	<i>In epistemology, the history of science and technology: orientations and methods of study</i>
<b>Module 2</b>	<i>The roles of categories in the historical investigation of science and its relation to society</i>
<b>Module 3</b>	<i>Scientific Paradigms: The Logical-Structural Organization of Ancient Sciences</i>
<b>Module 4</b>	<i>The role of mechanics and machines: versus the birth of modern science</i>
<b>Module 5</b>	<i>A history of science and technique in the architecture of the Italian Renaissance</i>
<b>Module 6</b>	<i>A history of the revolutionary birth of modern science and the advent of analytic mechanics</i>
<b>Module 7</b>	<i>A history of the equilibrium of fluid bodies</i>
<b>Module 8</b>	<i>A little history of scientific networks and circulations of knowledge of some scientific organizations</i>
<b>Module 9</b>	<i>A History of the Main Laws and Fundamentals of Optics During the History of Science</i>
<b>Module 10</b>	<i>Newtonian natural philosophy as the only scientific paradigm? An epistemological history of the birth of chemistry</i>
<b>Module 11</b>	<i>Newtonian natural philosophy as the only scientific paradigm? A Case Study: A History of Mechanical Science and Mathematics by Lazare Carnot</i>
<b>Module 12</b>	<i>Newtonian natural philosophy as the only scientific paradigm? A case study: A history of the principle of virtual powers</i>
<b>Module 13</b>	<i>Newtonian natural philosophy as the only scientific paradigm? : a history of the analytic theory of heat</i>
<b>Module 14</b>	<i>Newtonian natural philosophy as the only scientific paradigm? : a history of classical thermodynamics to statistical physics</i>
<b>Module 15</b>	<i>Newtonian natural philosophy as the only scientific paradigm? : a case study: A history of the scientific</i>

<b>Module 16</b>	<i>revolution on the birth of the thermodynamics of Sadi Carnot</i>
<b>Module 17</b>	<i>Newtonian natural philosophy as the only scientific paradigm? Versus mathematical physics and the birth of celestial mechanics</i>
<b>Module 18</b>	<i>A History of Faraday's Experiments and Maxwell's Mathematization</i>
<b>Module 19</b>	<i>A history of the foundations of mathematics and logic</i>
<b>Module 20</b>	<i>A history of the foundations of the birth of quanta and quantum mechanics</i>
<b>Module 20</b>	<i>A history of the foundations of Einstein's two theories of relativity</i>



**Fig. 8.4.** Modular program graph. Source: Prof. dr. Raffaele Pisano.

## A HYPOTHESIS OF *CYCLIC MODULAR* TEACHING IN HISTORY OF PHYSICS (AND RELATIONSHIP WITH MATHEMATICS)

### General Program

#### History of physics (XVIIe-XXe siècle)

<b>Main modules</b>	
<b>Module 1</b>	<i>The role of mechanics and machines: versus the birth of modern science</i>
<b>Module 2</b>	<i>A history of the revolutionary birth of modern science and the advent of analytic mechanics; History of science and impact in society</i>
<b>Module 3</b>	<i>A history of the equilibrium of fluid bodies</i>
<b>Module 4</b>	<i>A History of the Main Laws and Fundamentals of Optics During the History of Science</i>
<b>Module 5</b>	<i>Newton's "natural philosophy" as the only scientific paradigm? A Case Study: A History of Mechanical Science and Mathematics by Lazare Carnot</i>
<b>Module 6</b>	<i>Newton's "natural philosophy" as the only scientific paradigm? A case study: A history of the principle of virtual powers</i>
<b>Module 7</b>	<i>Newton's "natural philosophy" as the only scientific paradigm? : a history of the analytic theory of heat</i>
<b>Module 8</b>	<i>Newton's "natural philosophy" as the only scientific paradigm? : a history of classical thermodynamics to statistical physics</i>
<b>Module 9</b>	<i>Newton's "natural philosophy" as the only scientific paradigm? A case study: A history of the scientific revolution on the birth of the thermodynamics of Sadi Carnot</i>
<b>Module 10</b>	<i>Newton's "natural philosophy" as the only scientific paradigm? Mathematical physics and the birth of celestial mechanics</i>
<b>Module 11</b>	<i>A History of Faraday's Experiments and Maxwell's Mathematization</i>
<b>Module 12</b>	<i>A history of the foundations of the birth of quanta and quantum mechanics</i>
<b>Module 13</b>	<i>A history of the foundations of Einstein's two theories of relativities</i>

*Lesson Plan.* Each module consists of didactic units and case studies. These are like special didactic units. Considering the versatility of modular programming, interdisciplinarity and the connection between teaching units is absolutely required to produce a robust teaching-learning. Naturally, interventions and seminars by experts or by the department team on questions not belonging to my research competence are welcome. The proposed references are to be discussed and consolidated during the course. We will try to focus attention on primary sources and those found on the Internet. For example, on "Gallica", international projects, for example "Archimedes" from *The Planck Institute for the History of Science, Massachusetts Institute of Technology* and others that will be provided during the course.

The modules of history of physics in detail with the first bibliographic references

### **Module 1: HISTORY, EPISTEMOLOGY AND HISTORIOGRAPHY OF CLASSICAL MECHANICS**

*The role of mechanics and machines: versus the birth of modern science*

1. Imagine a prospective *nova*
2. On arabesque mechanics
3. The mechanical science of the *Paris School* and the *Oxford School*
4. Nicolas de Cues : astronomy of the late Middle Ages
5. Nicholas Copernicus. *De revolutionibus orbium coelestium* (1543). The revolutionary conception of astronomy and the cosmology of man in the universe
6. Giordano Bruno: the science and ecclesiastical system of the sixteenth century.
7. Girolamo Cardano: *Liber de ludo alaea* (1564). First studies on the calculation of the probability
8. Simeon Stevin : studies on static and hydrostatic

*Study cases:* Aristotle and Buridan, Leonardo da Vinci, Niccolò Tartaglia, Tartaglia and Jordanus de Nemore

Aristotle and Buridan. Biographies and works

1. On the history of the mechanical theory of the *Impetus*

Leonardo da Vinci. Biography and works.

2. Mechanics in the work of Leonardo: *Scritti, Codiques Madrid, Forster et Atlantic*
3. The mathematics of Leonardo
4. The machines of Leonardo
5. A problem of deformation of Leonardo da Vinci

Niccolò Tartaglia. Biography and works.

6. *Nova Scientia* and the practice of gunners
7. The Static in *Quesiti et Inventioni diverse and Iordani Opusculum*



8. Tartaglia's criticism of the sensitivity of Aristotle's balance

Niccolò Tartaglia and Jordanus de Nemore. Biography and works

9. On the *gravitas secundum situm*

10. Reflections on mathematics, physics and geometry in the history of science

*History and historiographies: reading texts*

Duhem's thought on the history of science between the Middle Ages and the Renaissance

Clagett's thought on the *scientia de ponderibus*

Gille's thought on Leonardo and Renaissance engineers

Grant's thought on the history and philosophy of science during the Middle Ages

Singer's thought on history and technique during the Middle Ages and the Renaissance

*Primary sources: reading texts*

De Nemore J (1533) Liber Iordani Nemorarii viri clarissimi, de ponderibus propositiones XIII & earundem demonstrationes, multarumque rerum rationes sanè pulcherrimas complectens, nunc in lucem editus. Cum gratia & priuilegio Imperiali, Petro Apiano Mathematico Ingolstadiano ad xxx. annos concesso. M. D. XXXIII.

Tartaglia N ([1554] 1959) La nuova edizione dell'opera Quesiti et inventioni diverse de Nicolo Tartaglia brisciano Riproduzione in facsimile dell'edizione del 1554. Masotti A (ed), Commentari dell'Ateneo di Brescia, Tipografia La Nuova cartografica, Brescia.

Tartaglia N (1565) Iordani Opvscvlvm de Ponderositate, Nicolai Tartaleae Stvdio Correctvm Novisqve Figvrisavctvm. Cvm Privilegio Traiano Cvrtio, Venetiis, Apvd Curtivm Troianvm. M D Lxv.

*A first bibliography on the module*

Brown EJ (1967–1968) The Scientia de Ponderibus in the later Middle Ages. Ph.D. dissertation [Tutor Clagett M], The University of Wisconsin Madison.

Capecchi D, Pisano R (2012) Tartaglia's science weights. Mechanics in XVI century. MMS Springer Book Series, *en cours*

Clagett M, Moody EA (1952) The medieval science of weights. The University of Wisconsin, Madison.

Duhem PM (1905–1906) Les origines de la statique. 2 vols, Hermann, Paris.

Duhem PM (1906–1913) Études sur Leonard de Vinci. Hermann, Paris.

Gille B (1964) Les ingénieurs de la Renaissance. Hermann, Paris.

Gillispie CC (ed) (1970–1980) Dictionary of Scientific Biography. Charles Scribner's Sons, New York.

Koyré A (1934) Nicolas Copernic, Des révolutions des orbes celeste. Alcand, Paris.

Koyré A (1961) Du monde de « à-peu-près » à l'univers de la précision. M Leclerc et Cie – Armand Colin Librairie, Paris (Id, Les philosophes et la machine. Du monde de l'«à-peu-près» à l'univers de la précision. Études d'histoire de la pensée philosophique).

- Laird WR, Sophie Roux S (2008) (eds) *Mechanics and Natural Philosophy before the Scientific Revolution*. Springer, Dordrecht.
- Pisano R (2009b) Continuity and discontinuity. On method in Leonardo da Vinci' mechanics. *Organon* 41:165–182.
- Rossi P (1999) *Aux origines de la science moderne*. Seuil–Points/sciences, Paris.
- Rossi P (2006) *Cose prima mai viste*. In: Rossi P (ed) *Collana di storia della scienza*, GEE, Roma, pp 85–128.
- Singer C ([1954–58] 1993) *A History of technology*. The Clarendon Press, Oxford, vols 2–3.
- Taton R (1965) Alexandre Koyré, historien de la « révolution astronomique. *Revue d'histoire des sciences et de leurs applications* 18/2:147–154.

## Module 2: HISTORY, EPISTEMOLOGY AND HISTORIOGRAPHIES OF MODERN SCIENCE

### - *A history of the revolutionary birth of modern science and the advent of analytic mechanics*

1. Mechanics and motions
2. The mathematical-geometry-physics relation
3. Nicholas Copernicus. *De revolutionibus orbium coelestium* (1543). The revolutionary conception of astronomy and the cosmology of man in the universe
4. Friedrich Johannes Kepler : planet observations and fundamental laws
5. Christian Huygens : the mechanics (and the friction) of the body systems and the study of the pendulum
6. René Descartes: Analytical geometry and readers of Galileo: Mersenne and Descartes

*Study cases:* René Descartes, Galileo Galilei, Evangelista Torricelli, Isaac Newton, Lagrange

Galileo Galilei. Biography and work.

- a. The role of mathematics and experimentation in mechanical science
- b. Notes on the *Meccaniche* di Guidobaldo dal Monte
- c. The science of the equilibrium : *Le Mekaniche et Discorsi e dimostrazioni matematiche*
- d. The physical-mathematical relationship in the Galilean centrobatic
- e. A Galilei resistance problem
- f. The relationship between rupture and force of the bodies in Galilei's analyses
- g. The law of leverage and the role of the Momento concept in *Mekaniche* and in the *Discorsi*
- h. The birth of *solid mechanics*
- i. Notes on the *Theoremata* of Galilei
- j. The fall of the bodies and the trajectory of the projectiles in the *Quesiti* of Tartaglia and in the *Discorsi* of Galilei
- k. Galilean Manuscript Analysis, *Ms 72*

Evangelista Torricelli and Archimedes. Biography and works

- l. *Opera Geometrica*, 1644
- m. Torricelli's principle in mechanics
- n. Logic as a category of historical investigation
- o. The logical basis of Archimedes' mechanics
- p. The logical basis of Torricelli's mechanics
- q. A correlation: Archimedes Torricelli

- r. Torricelli's demonstration of Galilei's theorem

Isaac Newton. Biography and works.

- s. *Principia Philosophia Naturalis*, 1687
  - t. The invention of the infinitesimal calculus: Leibniz and Newton
  - u. The dynamics of *Principia*
  - v. Analyses of the three laws of motion
  - w. The mathematical-physical relationship in Newton's dynamics
  - x. Problems still unsolved in mechanics and optics
  - y. George Berkeley's methodological criticism for Newton's infinitesimal calculus
1. A little history of the *virtual power principles*
  2. The vector mechanics of Euler

Joseph-Louis *Lagrange*. Biography and works.

- z. *Recherches sur la libration de lune*, 1764
  - aa. *Mécanique analytique*, 1788
  - bb. Reformulations of classical mechanics
  - cc. *The principle of virtual power and generalization*
3. The ontology of the concept of force
  4. The mechanics of d'Alembert and the concept of force

*History and historiographies: reading texts*

Alexandre Koyré's thought on the birth of modern science

Westfall's thought on the birth and development of modern science

Redondi's thought on Galilei

*Primary Sources: reading texts*

Galilei G (1890–1909) *Le opere di Galileo Galilei*. Edizione nazionale sotto gli auspici di sua maestà il re d'Italia. 20 vols. Favaro A (ed). Barbera, Firenze

—— Discorsi e dimostrazioni matematiche. In: Galilei G 1890–1909. *Opere*, vol. VIII, pp 41–458, op. cit.

—— Appendix – In qua continentur theoremata eorumque demonstrationes, quae ab eodem Autore circa centrum gravitatis solidorum olim conscripta fuerunt. In: Galilei G 1890–1909. *Opere*, vol. I, pp 187–208, op. cit.

—— *Le Mécaniche*. In: Galilei G 1890–1909. *Opere*, vol. II, pp 155–193, op. cit.

Torricelli E (1644) *Opera geometrica*. Massa-Landi, Firenze.

Newton I (1803) *The Mathematical Principles Of Natural Philosophy*, by Sir Isaac Newton. Translated into English by Motte A. Symonds, London.

Lagrange JL (1973) *Œuvres de Lagrange*. Seconde édition. Courcier, I–XIV vols. (in X). Gauthier-Villars, Paris.

Lagrange JL (1788) *Mécanique Analytique*. Desaint, Paris.

*A first bibliography on the module*

- Blay M (1992) *La naissance de la mécanique analytique la science du mouvement au tournant des XVIIe et XVIIIe siècles*, Presses Universitaires de France, Paris.
- Blay M (2002) *La science du mouvement de Galilée à Lagrange* Belin, Paris.
- Costabel P (1960) *Leibniz et la dynamique : les textes de 1692. Histoire de la pensée*—Hermann, Paris.
- De Gandt F (1995) *Force and Geometry in Newton's Principia*. The University of Princeton Press, Princeton, NJ.
- Dugas R (1955) *Histoire de la Mécanique*. Translated by Maddox JR [1950: Editions du Griffon, Neuchâtel], Dover, New York.
- Festa E. (1995) *L'erreur de Galilée*. Austral, Paris.
- Gillispie CC (ed) (1970–1980) *Dictionary of Scientific Biography*. Charles Scribner's Sons, New York.
- Koyré A (1965) *Newtonian Studies*. The Harvard University Press, Cambridge—MA.
- Koyré A (1966) *Études galiléennes*. Hermann. Paris.
- Osler MJ (2000) (ed) *Rethinking the Scientific Revolution*. The Cambridge University Press, Cambridge.
- Panza M (2007) Euler's *Introductio in analysin infinitorum* and the program of algebraic analysis: quantities, functions and numerical partitions. In: Backer R (ed) *Euler Reconsidered. Tercentenary essays*. The Kendrick Press, Heber City (Utah), pp 119-166.
- Panza M (2004) *Newton*. Belles Lettres, Paris.
- Panza M (2003) *The Origins of Analytic Mechanics in the 18th Century*. In: Jahnke HN (ed). *A history of analysis. Proceedings of the American Mathematical Society*, pp 137-153.
- Pisano R (2009) *On method in Galileo Galilei's mechanics*. In: Hunger H (ed) *Proceedings of ESHS 3rd Conférence*. Austrian Academy of Science, Vienna, pp 147–186.
- Redondi P ([1983] 1987) *Galileo Heretic*. Princeton University Press, Princeton, NJ.
- Rossi P (1999) *Aux origines de la science moderne*. Seuil—Points/sciences, Paris
- Schuhl PM (1947) *Machinisme et philosophie*. Vrin, Paris.
- Singer C ([1954–58] 1993) *A History of technology*. The Clarendon Press, Oxford, vols 2–3.
- Taton R (1966) (ed) *Histoire générale des sciences*. 5 vols. PUF, Quadrige Paris.
- Truesdell C (1968a) *Essay in the history of mechanics*. Springer, New York.
- Truesdell CA (1968b) *Whence the law of the moment of momentum?* [Lecture 202, *Whence the law of moment of momentum? Colloquium in Engineering Science, Mechanical Engineering Department, Columbia University, January 8, 1963*] In: *Essays in the History of Mechanics*, Springer—Verlag, Berlin—New York, pp 239–271.
- Westfall RS (1971) *The Construction of Modern Science. Mechanism and Mechanic*. Wiley & Sons Inc., NY.

### Module 3: HISTORY AND EPISTEMOLOGY OF STATIC BODY FLUIDS

- *A story about the equilibrium of fluid bodies*
  1. Aristotle's dynamic equilibrium theory and Archimedes' equilibrium static theory
  2. The static equilibrium theory of Archimedes
  3. On pea science: Jordanus de Nemore, Leonardo da Vinci, Girolamo Cardano, Tartaglia
  4. Concept and measurement of atmospheric pressure
  5. The concept of *horror vacui* and *Raritatis violentia*
  6. Galilei : *horror vacui* and *force des vacui*
  7. Simeon Stevin's *hydrostatic* studies
  8. Torricelli's experience and Blaise Pascal's principle
  9. Otto von Guericke : *Mechanica hydraulico-pneumatica* (1657)
  10. The Robert Boyle and Robert Hooke studies on the pneumatic machine
  11. Epistemological Reflections Boyle's Law. Mariotte (*De la nature de l'air*, 1676)
  12. From the elasticity of air to the elasticity of solids

#### *History and historiographies*

Heath's contribution on Archimedes' work

The thought and the contribution of Duhem on the birth of the hydrostatic

Darrigol's contribution on the history of hydrodynamics

#### *Primary Sources: reading texts*

Aristotle (1949) Aristotle's Prior and Posterior Analytics. A Revised Text with Introduction and Commentary Ross WD (ed), The Oxford University Press, Oxford.

Tartaglia N (1565) Archimedes De insidentibus aqueae, L. I–II, apud Curtium Troianum Navò, Venetia.

Stevin S ([1605] 1608) Liber primus Staticae. De staticae elementis. In: Tomus quartus mathematicorum hypomnematum de statica, Lugodini Batavoru.

Boyle R (1999–2000) The works of Robert Boyle. 14 vols. Hunter M, Davis EB (eds), The Pickering Masters series, Pickering & Chatto, London, [vol 3].

Galilei G (1890–1909) Le opere di Galileo Galilei. Edizione nazionale sotto gli auspici di sua maestà il re d'Italia. 20 vols. Favaro A (ed). Barbera, Firenze

— Discorso intorno alle cose che stanno in su l'acqua o che in quella si muovono. In: Galilei 1890–1909, vol 4, pp 63–141, op. cit.

Pascal B (1663) Traité de l'équilibre des liqueurs, et de la pesanteur de la masse de l'air. Chez Guillaume Desprez, Paris.

Pascal B (1998–1999) Œuvres complète. Michel Le Guern (ed), coll. Bibliothèque de la Pléiade, Gallimard, Paris.

Torricelli E (1919–1944) Opere di Evangelista Torricelli. Loria G, Vassura G (eds). Montanari, Faenza, vol 3, [p 187].

Guericke O (1672) Experimenta nova (ut vocantur) Magdeburgica de vacuo spatio. Amstelodami.

Bernoulli D (1738) *Hydrodynamica sive de viribus et motibus fluidorum commentarii*. Opus academicum, Sumptibus Johannis Reinholdi Dulseckeri, Typis Joh. Henr. Deckeri, Typographi Basiliensis, Strasbourg.

*A first bibliography on the module*

Archimedes (2002) *The works of Archimedes*. Heath TL (ed). Dover, Mineola, NY

Clagett M (1964) *Archimedes in the Middle Ages*. vol 1. The University of Wisconsin Press, Madison–Philadelphia, American Philosophical Society. 5 vols in 10 Tomes, The Clarendon Press, Oxford.

Darrigol O (2005) *Worlds of Flow: A History of Hydrodynamics from the Bernoullis to Prandtl*. The Oxford University Press, NY.

Dijksterhuis EJ (1957) *Archimedes*. Humanities Press, New York.

Duhem PM (1905–1906) *Les origines de la statique*. 2 vols. Hermann, Paris.

Gillispie CC (ed) (1970–1980) *Dictionary of Scientific Biography*. Charles Scribner's Sons, New York.

Knowles Middleton WE (1964) *The History of barometer*. The Johns Hopkins University Press, Baltimore.

Pisano R (2009b) Continuity and discontinuity. On method in Leonardo da Vinci' mechanics. *Organon* 41:165–182.

Rossi P (1999) *Aux origines de la science moderne*. Seuil–Points / sciences, Paris.

Singer C ([1954–58] 1993) *A History of technology*. The Clarendon Press, Oxford, vols 2–3.

Tokaty GA (1994) *A History and Philosophy of Fluid Mechanics*. Dover, New York.

#### Module 4: HISTORY AND EPISTEMOLOGY OF OPTICS

- *A history of the main laws and fundamental phenomena of optics during the history of science*
  1. The ancient approach and the Muslim period
  2. Geometric optics and the birth of the first idea on perspective
  3. Roger Bacon. Studies on the *perspectiva*
  4. Francesco Maurolico. Biographies and work on mechanics and optics
  5. Kepler : the functioning of the eye
  6. Snell and Descartes: Laws of Refraction and the Rainbow Phenomenon.
  7. Development of geometrical optics - Fermat principle
  8. Newton : the theory of color
  9. Newton : corpuscular nature of light
  10. Newton : The case of *Newton's ring*
  11. Newton and Fludd : the case of the *chromatic circle*
  12. Huygens and Fresnel : the first corpuscular nature of light and the principle of Huygens and Fresnel
  13. Grimaldi, Fresnel, Fraunhofer, Young : diffraction studies
  14. Technical progress: astronomical glasses (Galileo), microscope (Leeuwenhoek), telescope (Newton)
  15. Römer: first measurement of the speed of light
  16. Gauss : the phenomenon of stigmatism
  17. Brewster and Malus : The phenomenon of polarization
  18. Young and Fresnel : the theory of wave optics
  19. The Diffraction Theory and Young's Slits
  20. Fraunhofer, Airy, Rayleigh : the phenomenon of interference
  21. Measurements of the speed of light: Foucault and Fizeau's experiment
  22. The phenomenon of the Doppler-Fizeau effect
  23. Herschel, Ritter : Infrared and Ultraviolet phenomena
  24. Helmholtz ; Maxwell : the phenomenon of Trichromy
  25. Hertz, Maxwell et al. : the theory of the electromagnetic wave
  26. Abbe : the phenomenon of spherical aberration and coma images
  27. Rayleigh : the theory of light scattering
  28. Kirchhoff : The spectroscopy
  29. Michelson, Morley : the measurement of Michelson-Morley's speed and experience
  30. Einstein : Einstein's theories on the quantum of light
  31. Einstein : notions of special relativity and general relativity
  32. Einstein: photoelectric effect, relation of Planck-Einstein



33. New measurements of the speed of light
34. Einstein, De Broglie, Schrödinger, Heisenberg, Dirac, Bose, Fermi et al. : matter waves
35. Electronic optics and microscopes
36. Modern optics based on the notion of Fourier transform
37. Einstein: the principle of stimulated emission
38. The mathematical-geometry-physics relation

*History and historiographies: reading texts*

Blay's contribution to the role of optics in history

*Primary sources: reading texts*

Descartes R (1897–1913) Œuvres de Descartes. 12 vols. Adams C, Tannery P (eds). Paris; Discours de la méthode et Essais, Specimina philosophiae. vol VI ; Physico–mathematica vol X, Le Monde ou Traité de la lumière, vol XI (Id, 1964–1974 par Rochot B, Costabel P, Beaudé J et Gabberly A, Paris)

Descartes R (1964–1974) Oeuvres. Adam J et Tannery A. Nouvelle présentation par Rochot E, et Costabel P, 11 vols. Vrin, Paris.

Halley E (1693) An Instance of the Excellence of the Modern Algebra in the Resolution of the Problem of the Foci of Optick Glasses Universally. Philosophical Transaction 17:960–969.

*A first bibliography on the module*

Blay M (1983) La conceptualisation newtonienne des phénomènes de la couleur, Vrin, Paris.

Buchwald JZ (1989) The Rise of the Wave Theory of Light: Optical Theory and Experiment in the Early Nineteenth Century. The University of Chicago Press, Chicago.

Crombie, AC ([1953] 1971) Robert Grosseteste and the Origins of Experimental Science, 1100–1700. The Clarendon Press, Oxford.

Dumas M (1968) (ed) Histoire générale des techniques. Presses Universitaires de France, Paris.

Gillispie CC (ed) (1970–1980) Dictionary of Scientific Biography. Charles Scribner's Sons, New York.

Hall AR (1993) All was light. An Introduction to Newton's Optick. The Clarendon Press, Oxford.

Maitte B (1981) La lumière. Seuil, Paris.

Rashed R (1992) Optique et mathématiques. Recherches sur l'histoire de la pensée scientifique en arabe. Variorum, Aldershot–UK.

Ronchi V (1956) Histoire de la lumière. Colin, Paris.

Rosmorduc J, Rosmorduc V, Dutour F (2004) Les révolutions de l'optique et l'œuvre de Fresnel. Adapt–Vuiber.

## Module 5: HISTORY AND EPISTEMOLOGY OF ALTERNATIVE MECHANICS

- **Newton's "natural philosophy" as the only scientific paradigm? A Case Study: A History of Mechanical Science and Mathematics by Lazare Carnot**
  1. A major change in the paradigm of the foundations of science
  2. Leibniz's search for an alternative mechanics
  3. Lazare Carnot. Biography and works
  4. The revival of the old synthetic method for infinitesimal analysis
  5. The mechanical machines in *general* of Lazare Carnot.:
    - a. The *Mémoire* of 1778
    - b. The *Mémoire* of 1780
    - c. *Essai sur les machines en général*, 1786
    - d. *Principes fondamentaux de l'équilibre et du mouvement*, 1803
    - e. *Réflexions sur la métaphysique du calcul infinitésimal*, 1813
  6. Principle of *l'impossibilité du mouvement virtuel*
  7. The mechanics of body interaction
  8. The vincula and the production of mechanical work
  9. *Assumptions* of balance and movement of Lazare Carnot
  10. The principle of inertia
  11. The *moment of activity*
  12. Analysis of Lazare Carnot's *hypotheses* with mathematical logic
  13. The principle of the *virtual powers* of Lazare Carnot
  14. The first *fundamental equation* of Lazare Carnot
  15. Geometric movements
  16. The *second fundamental equation* of Lazare Carnot
  17. A historical development of mechanics
  18. Mathematics at the service of mechanics
  19. The logical organization of the mechanical theory of Lazare Carnot
  20. Epistemological Reflections on the *Principle of Virtual Powers*
  21. Lazare and Sadi Carnot, Father and Son: a Scientific Affiliation

### *History and historiographies: reading texts*

The thought and contribution of Charles Coulston Gillispie on all the mechanical science and mathematics of Lazare Carnot

The contribution of Jean d'Hombres on Lazare Carnot

*Primary sources: reading texts*

Carnot L (1780) *Mémoire sur la théorie des machines pour concourir au prix que l'Académie Royale des Sciences de Paris doit adjuger en 1781*. Béthune : 15 July 1780. Archives de l'Académie des sciences, Institut de France, 191 sections, 106 folios. Sections 101–160 : Gillispie 1971, Appendix C, pp 299–343, op. cit.

Carnot L (1778) *Mémoire sur la théorie des machines pour concourir au prix de 1779 propose par l'Académie Royale des Sciences de Paris*. Archives de l'Académie des sciences, Institut de France, 85 sections, 63 folios. Sections 27–60 : Gillispie 1971, Appendix B, pp 271–296, op. cit.

Carnot L (1786) *Essai sur les machines en général*. Defay, Dijon.

Carnot L (1803) *Principes fondamentaux de l'équilibre et du mouvement*. Deterville, Paris.

Carnot L (1813) *Réflexions sur la métaphysique du calcul infinitésimal*. Courcier, Paris.

*A first bibliography on the module*

Gillispie CC (1970–1979) Carnot Lazare–Nicolas–Marguerite. In: Gillispie (ed) 1970–1980 III:70–79.

Gillispie CC (1971) *Lazare Carnot Savant. A monograph treating Carnot's scientific work, with facsimile reproduction of his unpublished writings on mechanics and on the calculus, and an essay concerning the latter by Youschkevitch AP*, Princeton University Press, Princeton, NJ.

Gillispie CC (1976) The scientific work of Lazare Carnot, and its influence on that of his son. En: Taton (ed) (1976), pp. 23–33.

Gillispie CC (1980) *Science and Polity in France at the End of the Old Regime*. Princeton University Press, Princeton NJ.

Gillispie CC (2004) *Science and Policy in France: The Revolutionary and Napoleonic Years*. Princeton University Press, Princeton NJ.

Gillispie CC (ed) (1970–1980) *Dictionary of Scientific Biography*. Charles Scribner's Sons, New York.

Gillispie CC, Pisano R (2013) *Lazare and Sadi Carnot. A scientific and filial relationship*. Springer, Dordrecht.

Gillispie CC, Youschkevitch AP (1979) *Lazare Carnot savant et sa contribution à la théorie de l'infini mathématique*. Vrin, Paris [Collection des Travaux de l'Académie Internationale d'Histoire des Sciences, 20].

Gillispie CC, Youschkevitch AP (1982) *Lazare Carnot Savant et sa contribution à la théorie de l'infini mathématique*. *Revue d'histoire des sciences* XXXV/1:79–82.

Taton A (ed) (1976) *Sadi Carnot et l'essor de la thermodynamique, Table Ronde du Centre National de la Recherche Scientifique*. École Polytechnique, 11–13 Juin 1974. Éditions du Centre National de la Recherche Scientifique, Paris.

## Module 6: HISTORY AND EPISTEMOLOGY OF ALTERNATIVE MECHANICS

- **Newtonian natural philosophy as the only scientific paradigm? A case study: *A history of the principle of virtual powers***
  1. The *principles of virtual power and virtual displacements*
  2. The logical *status* of the law of virtual powers
  3. The theorem and the principle. The demonstrations in the literature
  4. Primitive Concepts: Work? Strength? Poinso't's demonstration
  5. The principle of action by Vincenzo Angiulli
  6. The principle of action and the principles of statics
  7. The principle and applications of simple machines
  8. The principle of action by Vincenzo Riccati
  9. The contribution of Lagrange: *Researches on the libration of moon, Theory of the libration of the moon, Analytical mechanics*
  10. First applications
  11. Generalizations of the *Virtual Power Principle* for Dynamics
  12. On the calculation of variations
  13. The principle of d'Alembert
  14. Prony and the *Polythetic School*
  15. The *principle of virtual power* and cardinal equations
  16. The principle of virtual speeds in the alternative mechanics of Lazare Carnot
  17. The debate at the *Polythetic School*: three demonstrations
  18. Criticisms of Poinso't: The *principle of virtual speeds* and the principles of mechanics
  19. The Ampère and Laplace considerations
  20. Cauchy: the principle of virtual forces

### *History and historiographies: reading texts*

The thought and contribution of Duhem on the principle of virtual power in the history and epistemology of static

Capecchi's contribution to the historical epistemology of the virtual power principle

Truesdell's contribution to the principle of virtual power in the history of mechanics

### *Primary sources: reading texts*

Lagrange JL (1764) Recherches sur la libration de la Lune. In: Œuvres, t VI, pp 5–61, op. cit.

Lagrange JL (1788) Mécanique Analytique. Desaint, Paris.

Lagrange JL (1973) Œuvres de Lagrange. Seconde édition, Courcier (ed), I–XIV vols. Gauthier–Villars, Paris.

Vailati G (1896–1897) Il principio dei lavori virtuali da Aristotele a Erone d’Alessandria. Atti della R. Accademia delle Scienze di Torino XXXII. Clausen Torino.

*A first bibliography on the module*

Ampère AM (1806) Démonstration du principe des vitesses virtuelles, dégagée de toute considération des infiniment petits. Journal de l’École Polytechnique 6/13:247–269.

Aristotle (1963) Minor Works. Transaltion by Hett WS. The Harvard University Press–Heinemann W LTD, Cambridge MA–London.

Capecchi D (2012) The History of virtual work laws. A point of view in History of Mechanics. Birkhäuser, Basel–Boston–Berlin.

Capecchi D, Drago A (2005) On Lagrange’s history of mechanics. Meccanica 40:19–33.

Costabel P (1972) Fourier et le principe des vitesses virtuelles. Sciences 3:235–238

Duhem PM (1905–06) Les origines de la Statique. 2 vols. Hermann, Paris.

Fraser C (1982) Lagrange’s early contribution to the principles and the methods of mechanics. Archive for History of the Exact Sciences 28:197–241.

Galilei G (1890–1909) Le opere di Galileo Galilei. Edizione nazionale sotto gli auspici di sua maestà il re d’Italia. 20 vols. Favaro A (ed). Barbera, Firenze

Gillispie CC (ed) (1970–1980) Dictionary of Scientific Biography. Charles Scribner’s Sons, New York.

Grattan–Guinness I (1990) Convolutions in French Mathematics. Birklausen, Basel

Jouguet E (1924), Lectures de mécanique. La mécanique enseignée par les auteurs originaux. 2 vols, Gauthier–Villars, Paris.

Mach E (1883 [1996]) The Science Of Mechanics – A Critical And Historical Account Of Its Development. 4th edition. Open Court–Merchant Books, La Salle.

Timoshenko SP (1983) History of strength of materials. Dover, New York.

Truesdell C (1968) Essay in the history of mechanics. Springer, New York.

## Module 7: HISTORY AND EPISTEMOLOGY OF THE THEORY OF HEAT

- **Newton's "natural philosophy" as the only scientific paradigm?  
: a history of heat theory**
  1. The historical panorama on thermometry and *heat grades*
  2. Lavoisier: the scientific revolution of the birth of chemistry
  3. Temperature, caloric and heat: a new theory with new magnitudes?
  4. The experiments of Joseph Black
  5. The nature of heat and the problem of measurement
  6. The determination of the specific heat and the birth of the calorimeter
  7. Lavoisier: *heat, caloric and light*: chemistry for the specification of heat typologies
  8. Lavoisier and Laplace: *Memoirs on the Heat*, 1780-1784

*Case study: Jean Baptiste Joseph Fourier, Gabriel Lamé*

Jean Baptiste Joseph Fourier. Biography and works.

- a. *The analytical theory of heat (1822) and the propagation of heat*
- b. The role of speed in the *communication of heat*
- c. The role of mathematics in heat theory

Gabriel Lamé. Biography and works.

- d. *Lessons on the Analytical Theory of Heat (1861) and the Propagation of Heat*
- e. The consolidation of mathematical physics
- f. The logical organization of the theory: primordial facts and "without presupposing the laws of heat exchange"
- g. Temperature and heat as mathematical functions
9. The mathematical physical relation in the scientific theory of the XIX<sup>th</sup> century.

*History and historiographies: reading texts*

Robert Fox's contribution to the history of the science of heat and thermodynamics

Grattan-Guinness's contribution to the analytic theory of heat in the history of mathematics

*Primary sources: reading texts*

Fourier JBJ (1888–1890) Œuvres de Fourier par les soins de M. Gaston Darboux 2 vols. Gauthier–Villars, Paris.

Fourier JBJ (1822) Théorie analytique de la chaleur. Firmin Didot Paris

Lamé G (1861) Discours préliminaire. In: Leçons sur la théorie analytique de la chaleur. Mallet–Bachelier, Paris.

Lamé G (1861) Leçons sur la théorie analytique de la chaleur. Mallet–Bachelier, Paris.

*A first bibliography on the module*

- Bachelard G ([1928] 1973) *Étude sur l'évolution d'un problème de physique. La propagation thermique dans les solides*. Vrin, Paris.
- Dhombres J, Robert JB (2000) *Fourier, créateur de la physique mathématique*. Belin, Paris.
- Fox R (1992) *The Culture of Science in France, 1700–1900*. Variorum Collected Studies Series 381, Ashgate Variorum.
- Gillispie CC (1980) *Science and Polity in France at the End of the Old Regime*. Princeton University Press, Princeton NJ.
- Gillispie CC (2004) *Science and Policy in France: The Revolutionary and Napoleonic Years*. Princeton University Press, Princeton NJ.
- Gillispie CC (ed) (1970–1980) *Dictionary of Scientific Biography*. Charles Scribner's Sons, New York.
- Grattan–Guinness I (2005) *Joseph Fourier, Theorie analytique de la chaleur, (1822)*. In: Grattan–Guinness I (ed), *Landmark. Writings in Western Mathematics 1640–1940*. Elsevier, Amsterdam–Boston, pp. 856–870.
- Lervig P (1982) *What Is Heat? C. Truesdell's View of Thermodynamics. A Critical Discussion*. *Centaurus* 26/2:85–122.
- Maxwell JC (1871) *Theory of Heat*. Longmann Green–Roberts & Green, London.
- Pisano R, Capecchi D (2009) *La Théorie Analytique de la Chaleur. Notes on Fourier and Lamé*. In: Barbin E (ed): *Gabriel Lamé, les pérégrinations d'un ingénieur du XIXe siècle*. *Bulletin de la Sabix* 44:83–90.
- Redondi P (1980) *L'accueil des idées de Sadi Carnot et la technologie française de 1820 à 1860. De la légende à l'histoire*. Vrin, Paris.
- Truesdell C (1980) *The Tragicomical History of Thermodynamics. 1822–1854*. Springer, Berlin.

## Module 8: HISTORY AND EPISTEMOLOGY OF THERMODYNAMICS AND GAS THEORY

### - Newtonian natural philosophy as the only scientific paradigm? : *A history of classical thermodynamics to statistical physics*

1. The first machines and experiments
2. Temperature, caloric and heat: a new theory with new magnitudes?
3. The experiments of Joseph Black
4. The nature of heat and the problem of measurement
5. Introduction: Changing the Paradigm of the Foundations of Science
6. Instruments and measurements of new magnitudes
7. The caloric theory
8. Latent heat and specific heat
9. The relationship between heat and matter
10. Change of states
11. Heat as a form of energy?

*Case studies:* Sadi Carnot and Paul de Saint-Robert

Sadi Carnot. Biography and works.

- a. *Reflections on the motive power of the fire on the machines proper to develop this power*, 1824
- b. On the principles of thermodynamics of Sadi Carnot
- c. The birth of the cycle concept : the battery of Alessandro Volta and the thermal machine from Sadi Carnot
- d. The calculation and the epistemological interpretation of the mathematical note in the *Reflections*
- e. The "suppression" of the two adiabatic curves in the *Reflections*. Why?
- f. The roles of two adiabatic for the determination of the complete cycle
- g. The concept of energy and conservation of energy in the *Reflections* of Sadi Carnot
- h. The concepts of reversibility and irreversibility
- i. Lazare and Sadi Carnot, Father and Son: a scientific filiation
12. Second principle of thermodynamics by Sadi Carnot
13. Second principle of thermodynamics by Sadi Carnot in a work by Clapeyron
14. Kelvin: statement of the second principle of thermodynamics
15. Clausius: formulation of the second principle of thermodynamics
16. First principle of thermodynamics: an extension of the principle of conservation of total mechanical energy
17. Mayer: mechanical equivalent of heat



Paul of Saint-Robert. Biography and works.

- j. *Principle of thermodynamics*, 1865
- k. *Treatise of thermodynamics*, 1870
- l. The *principle of thermodynamics* by Paul de Saint–Robert (1865 et 1870) : two analyses comparatives with the *Réflexions* by Sadi Carnot
- 18. The mechanistic approach of thermodynamics
- 19. The role of probability in the new statistical mechanics
- 20. Statistical physics: order (work) and disorder (heat)
- 21. The kinetic model of gases
- 22. Brownian motion
- 23. Boltzmann: a mechanical theory for thermodynamics
- 24. Boltzmann: the ergodic hypothesis
- 25. The work of Van der Waals
- 26. Entropy as the third principle of thermodynamics
- 27. Gibbs: generalizing and justifying a posteriori the principles of thermodynamics
- 28. Electrical and magnetic properties of the material
- 29. Equiprobability and information theory
- 30. The role of thermodynamics in Planck's theory
- 31. On modern physics
- 32. On Fermi-Dirac statistics
- 33. On the Bose-Einstein statistic

*History and historiographies: reading texts*

The thought and contribution of Robert Fox on all the scientific work of Sadi Carnot

The contributions of "Sadi Carnot and the rise of thermodynamics" on the science of Sadi Carnot

The contribution of Robert Locqueneux on the history of thermodynamics

Contributions from the History of Statistical Mechanics Group of the Berlin Max Planck Institute for the History of Science

*Primary sources: reading texts*

Carnot S (1978) *Réflexions sur la puissance motrice du feu sur les machines propres à développer cette puissance*, édition critique par Fox Robert. Vrin J, Paris.

Carnot S (1978) Recherche d'une formule propre à représenter la puissance motrice de la vapeur d'eau. In: Carnot S 1978, pp. 223–234.

Carnot S (s.d.) Notes sur les mathématiques, la physique et autres sujets. In: Carnot S 1878b, pp. 89–102.

Carnot S (1878b) *Réflexions sur la Puissance Motrice du Feu sur les machines propres à développer cette puissance*. Gauthier–Villars, Paris.

Saint–Robert P (1870) *Traité de Thermodynamique*. Loescher (ed), 2nd ed., Torino.

Saint–Robert P (1870) Sadi Carnot – Notice biographique In: Saint–Robert 1870, pp. 431–450.

*A first bibliography on the module*

- Drago A, Pisano R (2005) La nota matematica nelle *Réflexions sur la Puissance Motrice du Feu* di Sadi Carnot: interpretazione del calcolo col metodo sintetico. *Quaderni di Storia della Fisica–Giornale di Fisica* 13:37–57.
- Fox R (1969) James Prescott Joule, 1818–1889. In: North J (ed) *Nineteenth–Century Scientists*. Pergamon Press, New York, pp. 72–103.
- Fox R (1970) Watt’s expansive principle in the work of Sadi Carnot and Nicolas Clément. *Notes and records of the Royal Society of London* 24:233–253.
- Fox R (1971a) The intellectual environment of Sadi Carnot: a new look. In: *Actés de XII Congres International d’Histoire des sciences*. Blanchard, Paris, vol IV, pp. 67–72.
- Fox R (1971b) *The Caloric Theory of Gases: From Lavoisier to Regnault*. The Clarendon Press, Oxford.
- Fox R (1974) The rise and fall of Laplacian physics. *Historical Studies in the Physical Sciences* 4:89–136.
- Fox R (1976) The challenge of new technology: theorists and the high–pressure steam engine before 1824. En: Taton (ed) (1976), pp. 149–168.
- Gillispie CC (ed) (1970–1980) *Dictionary of Scientific Biography*. Charles Scribner’s Sons, New York.
- Gillispie CC (1976) The scientific work of Lazare Carnot, and its influence on that of his son. In: Taton (ed) (1976), pp. 23–33 .
- Locqueneux R (1996) *Préhistoire & Histoire de la thermodynamique Classique (Une histoire de la chaleur)*, *Cahiers d’Histoire & de Philosophie des Sciences n°45*, société Française d’Histoire des Sciences & des Techniques (Décembre 1996).
- Pisano R (2007) Note sui Principes de Thermodynamique di P de Saint Robert. In: *Actés de XXIV SISFA Congrès, Bibliopolis, Napoli–Avellino*, pp. 129–134
- Pisano R (2010) On Principles In Sadi Carnot’s *Thermodyamics* (1824). *Epistemological Reflections. Almagest International Interdisciplinary Journal* 2/2010:128–179.
- Redondi P (1976) Sadi Carnot et la recherche technologique en France de 1825 à 1850. *Revue d’histoire des sciences* XXIX/3:243–259.
- Redondi P (1980) L’accueil des idées de Sadi Carnot et la technologie française de 1820 à 1860. *De la légende al l’histoire*, Vrin, Paris.
- Taton A (ed) (1976) *Sadi Carnot et l’essor de la thermodynamique*, *Table Ronde du Centre National de la Recherche Scientifique. École Polytechnique, 11–13 Juin 1974*. Éditions du Centre National de la Recherche Scientifique, Paris.
- Truesdell CA, Bharatha S (1977) *The Concepts and Logic of Classical Thermodynamics as a Theory of Heat Engines*. Springer–Verlag, Berlin–Heidelberg–New York.

## Module 9: HISTORY AND EPISTEMOLOGY OF THE THERMODYNAMICS OF SADI CARNOT

- **Newton's "natural philosophy" as the only scientific paradigm?**  
*A case study: a history of the scientific revolution on the birth of the thermodynamics of Sadi Carnot*
  1. The scientific revolution of the birth of chemistry
  2. Temperature and heat: new magnitudes for new theory?
  3. Introduction: paradigm shift in the foundations of science
  4. Sadi Carnot. Biography and works.
  5. A philological study of the works of Sadi Carnot
  6. Thermal machines in general of Sadi Carnot
    - b. *Réflexions sur la puissance motrice du feu sur les machines propres à développer cette puissance*, 1824
    - c. *Recherche d'une formule propre à représenter la puissance motrice de la vapeur d'eau*, ca. 1819–1827
    - d. *Notes sur les mathématiques, la physique et autres sujets*, s.d.
  7. On the principles of thermodynamics of Sadi Carnot
  8. The history of science and the categories of epistemological investigations
  9. The logical organization of the thermodynamic theory of Sadi Carnot
  10. The birth of the cycle concept: the Alessandro Volta battery and the Sadi Carnot thermal machine
  11. Analogies: hydraulic machine and thermal machine
  12. *Reflections*: a book without mathematics?
  13. The calculation and the epistemological interpretation of the mathematical note in the *Reflections*
  14. The "suppression" of the two adiabatic curves in the *Reflections*. Why ?
  15. The roles of two adiabatic for the determination of the complete cycle
  16. The *synthetic method* of his father Lazare for the determination of complete cycle
  17. The mathematical specificity of the note of the mathematical note in the *Reflections*
  18. How did Sadi Carnot use the adiabatics?
  19. A reflection on the calculation of the efficiency of a thermal machine
  20. The concept of energy and conservation of energy in Sadi Carnot's work
  21. The concept of reversibility and the three mathematics: infinitesimal analyzes, the infinitesimal calculus *à la* Cauchy, constructive mathematics
  22. The dynamic extension of the theory of Sadi Carnot by Ferdinand Reech (1853)

### 23. Lazare and Sadi Carnot, Father and Son: a Scientific Affiliation

#### *History and historiographies: reading texts*

The thought and contribution of Robert Fox on all the scientific work of Sadi Carnot

The contributions of "Sadi Carnot and the rise of thermodynamics" on the science of Sadi Carnot

The thought and contribution of Charles Coulston Gillispie on the thermodynamic science of Sadi Carnot

#### *Primary sources: reading texts*

Carnot S (1978) Réflexions sur la puissance motrice du feu sur les machines propres à développer cette puissance, édition critique par Fox Robert. Vrin J, Paris.

Carnot S (1978) Recherche d'une formule propre à représenter la puissance motrice de la vapeur d'eau. In: Carnot S 1978, pp. 223–234.

Carnot S (1878b) Réflexions sur la Puissance Motrice du Feu sur les machines propres à développer cette puissance. Gauthier–Villars, Paris.

Saint–Robert P (1870) Traité de Thermodynamique. Loescher, Torino.

Saint–Robert P (1870) Sadi Carnot – Notice biographique. In: Saint–Robert 1870, pp. 431–450.

#### *A first bibliography on the module*

Drago A, Pisano R (2005) La nota matematica nelle Réflexions sur la Puissance Motrice du Feu di Sadi Carnot : interpretazione del calcolo col metodo sintetico. Quaderni di Storia della Fisica–Giornale di Fisica 13:37–57.

Dumas M (1968) (ed) Histoire générale des techniques. Presses Universitaires de France, Paris.

Fox R (1969) James Prescott Joule, 1818–1889. En: North J (ed) Mid–Nineteenth–Century Scientists. Pergamon Press, New York, pp. 72–103.

Fox R (1970) Watt's expansive principle in the work of Sadi Carnot and Nicolas Clément. Notes and records of the Royal Society of London 24:233–253.

Fox R (1970) Watt's expansive principle in the work of Sadi Carnot and Nicolas Clément. Notes and records of the Royal Society of London 24:233–253.

Fox R (1971a) The intellectual environment of Sadi Carnot: a new look. In: Actes de XII Congrès International d'Histoire des sciences. Blanchard, Paris, vol IV, pp. 67–72.

Fox R (1971b) The Caloric Theory of Gases: From Lavoisier to Regnault. The Clarendon Press, Oxford.

Fox R (1988) Les Réflexions sur la puissance motrice du feu de Sadi Carnot et la leçon sur leur édition critique. La vie des sciences – Comptes rendus, série générale 5/4:283–301.

Gillispie CC (1976) The scientific work of Lazare Carnot, and its influence on that of his son. En: Taton (ed) (1976), pp. 23–33.

- Gillispie CC (ed) (1970–1980) *Dictionary of Scientific Biography*. Charles Scribner's Sons, New York.
- Kuhn TS (1955) Carnot's version of cycle. *The American Journal of Physics* 23:91–94.
- Lervig P (1972) On the Structure of Carnot's Theory of Heat. *Archive for History of Exact Sciences* 9/2:222–239.
- Lervig P (1985) Sadi Carnot and the steam engine: Nicolas Clément's lectures on industrial chemistry, 1823–28. *The British Journal for the History of Science* 18/59:147–196.
- Pisano R (2012) On Lazare and Sadi Carnot. A synthetic view of a historical epistemological research program. In: *Proceedings of XXX SISFA Congress*, Urbino
- Pisano R (2003) Il ciclo di S Carnot e la pila di A Volta. In: Garuccio A (ed) *Actés de XXIII SISFA Congress*, Progedit, Bari, pp. 327–348.
- Pisano R (2007) Note sui Principes de Thermodynamique di P de Saint Robert. In: *Actés de XXIV SISFA Congrès*. Bibliopolis, Napoli–Avellino, pp 129–134.
- Pisano R (2010) On Principles In: Sadi Carnot's Thermodynamics (1824). *Epistemological Reflections*. *Almagest International Interdisciplinary Journal* 2/2010:128–179.
- Redondi P (1980) L'accueil des idées de Sadi Carnot et la technologie française de 1820 à 1860. De la légende à l'histoire. Vrin, Paris.
- Taton A (ed) (1976) Sadi Carnot et l'essor de la thermodynamique, Table Ronde du Centre National de la Recherche Scientifique. École Polytechnique, 11–13 Juin 1974. Éditions du Centre National de la Recherche Scientifique, Paris.

## Module 10: HISTORY AND EPISTEMOLOGY OF MATHEMATICAL PHYSICAL SCIENCE

- **Newton's "natural philosophy" as the only scientific paradigm?**  
*Mathematical physics and the birth of celestial mechanics*
  1. Cosmology and astronomy
  2. A historiographical problem of astronomy: the history of astronomy is older in the history of physics
  3. An epistemological characterization of the history of astronomy
  4. Nicholas Copernicus. *De revolutionibus orbium coelestium* (1543). The revolutionary conception of astronomy and cosmology of man in the universe
  5. Coulomb's electrostatic theory: the attempt to obtain a new theory based on Newtonian mechanics
  6. Versus mathematical physics: mechanics absorbs other disciplines
    - a. Planetary: geodesy, cartography
    - b. Engineering: mechanics, instruments, friction, structures, analytical theories
    - c. Body: static, dynamic, hydrodynamic, crystallographic, sound
    - d. Molecular: elasticity
    - e. Applications of mechanics in astronomy
    - f. Astronomy is not a single theory, but it is part of mechanics
    - g. The fall of astronomy and the birth of mathematical physics in *celestial mechanics*
    - h. The climax of Laplace: *celestial mechanics* (1805) and the *exposition of the world system* (1836)
  7. Physics after Laplace
    - i. Physics is divided into sub-disciplines
    - j. Beyond the cultural and scientific revolution of the seventeenth century?
    - k. An example of the new theory of thermodynamics: the statistical mechanics of Boltzmann
    - l. Mathematical physics programs without classical astronomy
  8. From mechanical design of the world to electromagnetic design?
    - a. Electromagnetic Theory: Faraday's Experiments and Maxwell's Mathematical Interpretations
  9. A historiographical problem of astronomy: history of physics without astronomy

*History and historiographies: reading texts*

The thought and contribution of Poincaré on celestial mechanics

Duhem's thought and contribution to the world system

Paty's contribution to the history and philosophy of nineteenth-century physics.

Contributions of "Dialectic Relation between Physics and Mathematics in the XIXth Century"

*Primary sources: reading texts*

Laplace PS (1805) *Traité de mécanique céleste*. Courcier, Paris.

Ampère AM (1827) *Théorie mathématiques des phénomènes électro-dynamiques uniquement déduite de l'expérience*. Chez Firmin Didot, Paris.

Laplace PS (1836 [1984]) *Exposition du système du monde*. Fayard, Paris.

*A first bibliography on the module*

Autolykos de Pitane (1979) *La sphère en mouvement. Levers et couchers héliques*. Testimonia, Paris.

Bailly F, Longo G (2006) *Mathématiques et sciences de la nature. La singularité physique du vivant*. Hermann, Paris.

Barbin E, Pisano R (2011 en cours) (eds) *The Dialectic Relation Between Physics and Mathematics in The XIXth Century*. Springer, Dordrecht.

Berggren JL, Thomas RSD (1992) *Mathematical astronomy in the fourth century B.C. as found in Euclid's « Phaenomena »*. *Physis* 29/1:7–33.

Beth EW (1959). *The foundations of mathematics. A study in the philosophy of sciences*, *Studies in Logic*. Amsterdam, North Holland.

Blay M (1992) *La naissance de la mécanique analytique la science du mouvement au tournant des XVIIe et XVIIIe siècles*, *Presses Universitaires de France*, Paris.

Duhem P (1913–1959) *Le Système du Monde. Histoire des Doctrines cosmologiques de Platon à Copernic*. 10 vols. Hermann, Paris.

George A, Velleman DJ (2002) *Philosophies of Mathematics*. Blackwell, Oxford

Gillispie CC (1997) *Pierre Simon Laplace 1749–1827: A Life in Exact Science*. Princeton University Press, Princeton.

Gillispie CC (ed) (1970–1980) *Dictionary of Scientific Biography*. Charles Scribner's Sons, New York.

Houzel C (1992). *Physique et géométrie*. *Universalis* 92. Enclopaedia Universalis, Paris.

Humbert P (1957) *L'astronomie de la Renaissance aux nos jours*. In: Dumas M (ed) : *Histoire de la Science*. Gallimard, Paris.

Klein M (1980) *Mathematics. The loss of certainty*. The Oxford University Press, Oxford.

Kragh H (2008) *The Moon that Wasn't*. Birkhäuser-Verlag, Basel.

Lamé G (1861) *Leçons sur la théorie analytique de la chaleur*. Mallet-Bachelier, Paris.

Levy J (1961) *Exploration de l'Univers stellaire*. In: Taton A (ed) : *Histoire Général des Sciences*, vol III–I, PUF, Paris, pp. 123–160.

- Neugebauer O (1945) The history of ancient astronomy: Problems and Method. Publications of the –Astronomical Society of the Pacific 58/340:17–43.
- Paty M (1994) Le caractère historique de l'adéquation des mathématiques à la physique. In: Garma S, Flament D, Navarro V (eds) : *Contra los titanes de la rutina. Contre les titans de la routine*, Comunidad de Madrid/C.S.I.C., Madrid, pp. 401–428.
- Pisano R, Casolaro F (2011–soumis) Historical Inquiring On Geometry In Relativity. *Geometry–Physics Relationship (Part I) [CFV Cahiers]*.
- Poincaré HJ (1892–1899) *Les méthodes nouvelles de la mécanique céleste*. 3 vols. Gauthiers–Villars, Paris.
- Poincaré HJ (1897) Les rapports de l'analyse et de la physique mathématique. *Revue générale des sciences pures et appliquées* 8:857–861.
- Poincaré HJ (1900) Les relations entre la physique expérimentale et la physique mathématique. *Revue générale des sciences pures et appliquées* 11:1163–1175.
- Poincaré HJ (1905–1910] 2003) *Leçons de mécanique céleste*. 3 tomes. Gabay, Paris.
- Swerdlow NM, Neugebauer O (1984) *Mathematical Astronomy in Copernicus's De Revolutionibus*, Springer–Verlag, Berlin–New–York–Heidelberg.
- Taton R (1965) Alexandre Koyré, historien de la « révolution astronomique». *Revue d'histoire des sciences et de leurs applications* 18/2:147–154.
- Youschkevitch AP (1976) *Les mathématiques arabes (viiiie–xve siècles)* par Cazenaze M, Jaouiche K. Vrin, Paris.



## Module 11: HISTORY AND EPISTEMOLOGY OF ELECTROMAGNETIC THEORY

### – A history of Faraday's experiments and Maxwell's mathematization

1. Ancient and classical panorama on phenomena
2. The roles of electricity and magnetic studies during the Middle Ages and Renaissance
3. Stephen Gray's (1729) studies of the first differences between driver and non-driver
4. Galvani and Volta: the experiments
5. 1785. The mechanical theory of Coulomb's electrostatic phenomena
6. 1799. The *electric motor* of Alessandro Volta
7. The *chimaera* of perpetual motion
8. 1805. Laplace Mathematical Physics of the *Treatise on Celestial Mechanics*
9. The magnetic consequences of the electric current
10. 1820. The experiment of Ørsted
11. 1820. The law of Jean-Baptiste Biot and Félix Savart
12. 1820. Studies of Arago (and Davy in England) on the phenomena of solenoids
  1. The importance of the consequences of the theory on the conduction of Fourier heat
  2. 1820-1828. Ampère's mathematical physics theory on electrodynamics
  3. Studies on the resistance of electrical conductors
  4. Ohm's studies and law and electrical measurements (1825-1827)
  5. The thermal consequences of the electric current and the law of Joule

### Case Studies: Michael Faraday and James Clerk Maxwell

#### Michael Faraday. Biography and works

- a. 1821. The first experiments on electromagnetic rotation
- b. 1831-1845. Countless Experiments and News from Faraday
- c. 1849. *Experimental Researches in Electricity*
- d. 1 1852. *On the Physical Character of the Lines of Magnetic Force*
- e. The phenomenon of electromagnetic induction and the birth of the concept of electromagnetic field
- f. Elements of Potential Theory

#### James Clerk Maxwell. Biography and works

- g. Electro-thermal and electro-magnetic studies
- h. 1855. On Faraday's lines of force
- i. 1864. A dynamical theory of the electromagnetic field
- j. A genesis of Maxwell's equations
- k. Maxwell mechanical « vortex » phenomenon
- l. 1873. *A Treatise on Electricity and Magnetism*
6. A relationship between Lazare Carnot's science and Maxwell's electromagnetism

## 7. Epistemological Reflections between the Faraday and Maxwell Approaches

### *History and historiographies: reading texts*

Poincaré's thought and contribution on electrodynamics in the history of science

Whewell's thought and contribution to the experiences of the inductive sciences

### *Primary sources: reading texts*

Coulomb CA (1785) Premier mémoire sur l'électricité et le magnétisme. Construction et usage d'une balance électrique, fondée sur la propriété qu'ont les fils de métal, d'avoir une force de réaction de torsion proportionnelle à l'angle de torsion. In: Histoire et mémoires de l'Académie [royale] des sciences avec les mémoires de mathématiques et de physique, Partie « Mémoires », pp. 569–577.

Ørsted HC (1820) Expériences sur l'effet du conflit électrique sur l'aiguille aimantée. Annales de chimie et physique 14:417–425.

Fufay CF ([1733] 1735) Quatrième mémoire sur l'électricité. De l'attraction et répulsion des corps électriques. In: Histoire et mémoires de l'Académie [royale] des sciences avec les mémoires de mathématiques et de physique, partie « Mémoires » pp. 457–476.

Faraday M (1839–1855) *Experimental Researches in Electricity*, 3 vols. Taylor, London.

Maxwell JC (1855–1856 ; 1861–1862) On physical lines of forces. *Philosophical Magazine* XXI:161–175, 281–291, 338–348 ; *Philosophical Magazine* XXII : 12–24, 85–95.

Maxwell JC (1864) A dynamical theory of the Electromagnetic field. *Philosophical Transactions* CLV :459–512.

Maxwell JC (1873) *A Treatise on Electricity and Magnetism*, The Clarendon Press, Oxford.

### *A first bibliography on the module*

Agassi J (1971) *Faraday as a Natural Philosopher*. The University of Chicago Press, Chicago.

Campbell L, Garnett W (1969) *The life of James Clerk Maxwell*. Kargon RH. Johnson Reprint Corp., NY.

Darrigol O (2000) *Electrodynamics from Ampère to Einstein*. The Oxford University Press, Oxford.

Darrigol O (2005) *Les équations de Maxwell : De McCullagh à Lorentz*. Belin, Paris.

Fox R (1974) The rise and fall of Laplacian physics. *Historical Studies in the Physical Sciences* 4:89–136.

Gillispie CC (ed) (1970–1980) *Dictionary of Scientific Biography*. Charles Scribner's Sons, New York.

Heilbron JL (1979) *Electricity in the 17th and 18th Centuries*. The University of California Press, Berkeley.

Kragh H (2002) The vortex atom: a Victorian theory of everything. *Centaurus* 44:32–114.

Lanczos C (1964) *The Variational Principle of Mechanics*. The University of Toronto Press, Toronto.

- Lindsay R, Margenau B, Margenau H (1946) *Foundations of Physics*. John Wiley & Sons, NY.
- Maxwell JC (1890) *The Scientific Papers*. The Cambridge University Press, Cambridge.
- Pearce WL (1965) *Michael Faraday: A Biography*. Basic Books, NY.
- Pisano R (2003) Il ciclo di S Carnot e la pila di A Volta. In: Garuccio A (ed) *Atti del XXIII SISFA Congresso*, Progedit, Bari, pp. 327–348.
- Pisano R (2011) Physics-mathematics relationship. Historical and Epistemological notes. In: Barbin E, Kronfeller M, Tzanakis C. (eds), *ESU-6 European Summer University on The History And Epistemology In Mathematics*, The University of Vienna Press, pp. 457-472.
- Pisano R (2012) Historical Reflections On Physics Mathematics Relationship In Electromagnetic Theory. In: Barbin E, Pisano R (eds) *The Dialectic Relation between Physics And Mathematics In The XIXth Century*, Springer, Dordrecht.
- Pisano R, Casolaro F (2011) An Historical Inquiry On Geometry In Relativity. Reflections on Early Relationship Geometry–Physics. (Part one and two). *History Research*.
- Poincaré H (1890) *Électricité et optique*. Les théories de Maxwell. Carré. Paris.
- Poincaré HJ (1892–1899). *Les méthodes nouvelles de la mécanique céleste*. 3 vols. Gauthiers–Villars, Paris.
- Poincaré HJ (1897) Les rapports de l'analyse et de la physique mathématique. *Revue générale des sciences pures et appliquées* 8:857–861.
- Simpson TK (1966) Maxwell and direct experimental test of his electromagnetic theory *Dynamical Theory of Electromagnetic field on the Treatise on Electricity and Magnetism*, *Isis* 57:423ff.
- Simpson TK (1970) Some Observations on Maxwell's Treatise on Electricity and Magnetism On the Role of the « Dynamical Theory of the Electromagnetic Field » in Part IV of the Treatise. *Studies in History and Philosophy of Science Part A* 1/3:249–263.
- Simpson TK (2005) *Figures of Thought. A Literary Appreciation of Maxwell's Treatise on Electricity and Magnetism*. Green Lion Press, Santa Fe, New Mexico.
- Tyndall J (1868) *Faraday as discover*. Longmans, London.
- Whewell W (1837) *History of the Inductive Sciences from the Earliest to the Present Times*. 3 vols. Longmans–Green & Company, London.
- Whewell W (1840) *The Philosophy of the Inductive Sciences, founded upon their History*. 2 vols. Longmans–Green & Company, London.

## **Module 12: HISTORY AND EPISTEMOLOGY OF THE MODERN PHYSICS OF THE XX CENTURY**

### **- *A history of the foundations of the birth of quanta and quantum mechanics***

1. Mathematical physics during XIX-XX century.
2. The birth of the electron
3. Measurement of charge and mass of the electron
4. On the history of the phenomenon of radioactivity
5. The role of thermodynamic theory in quantum studies
6. A revolution of the announced foundations? The birth of the crisis of the mechanistic model
7. The nature of irreversible phenomena and the principle of entropy reduces the role of mechanics

1859-1907. The historical development of studies and laws on the black body:

- a. The problem of the black body
- b. 1859. Kirchhoff: spectroscopic examination of sunlight
- c. The phenomenological character of the problem of radiation
- d. A fundamental hypothesis about the black body
- e. The search for a universal distribution function
- f. 1877. Michelson: heuristic analyzes of the distribution function
- g. The law of Stefan (1879) -Boltzmann (1884)
- h. 1879 Weber: the hypothesis of a new formula
- i. 1893-1896. Wien's law on the distribution function with a new constant,  $\gamma$
- j. Rayleigh's law (1900) -Jeans (1905) on the distribution function
- k. First hypothesis on the walls of the black body
- l. Boltzmann's criticism for Planck's work
- m. Second hypothesis of Planck based on the work of Boltzmann
- n. Planck's third hypothesis based on Boltzmann's work
- o. 1899-1900. Planck: the quantum hypothesis
- p. 1905. Einstein's reflections on the discovery of Planck
- q. The development of statistical mechanics and the birth of the first contradictions
- r. The facts of observations of specific heat (Dulong and Petit, ca. 1819)
- s. 1871. Statistical Interpretation of Boltzmann

- t. 1907. Einstein's progress on theory: the *ad hoc* hypothesis

1923-1925. *A first line of development of quantum mechanics*

- a. 1923. (Sept. 10). Louis de Broglie proposes in his thesis the theory on the wave behavior of matter
- b. 1924. (2 July). Satyendra Nath Bose proposes new procedure for statistical analysis of physical data
- c. 1924. (10 July). Einstein spreads the Bose procedure for monoatomic gases
- d. 1924 (10 July). Einstein combines energy and frequency and strengthens de Broglie's theory
- e. 1925. (Jan. 16). Pauli's Principle
- f. 1925. (25 July). 1925. (July 25). Heisenberg the first article on the interpretation of the new mechanics
- g. 1925 (Sept. 25). (Max Born-) Jordan strengthens the work of Heisenberg

1925-1927. *A second line of development of quantum mechanics*

- h. 1925. (Nov. 7). Dirac generalizes and strengthens the work of Heisenberg
- i. 1925. (Nov. 16). Born, Heisenberg and Jordan publish first complete essay on quantum mechanics of matrices
- j. 1926. (Jan. 17) Pauli applies the mechanics of matrices for calculating the discrete spectrum of hydrogen atom
- k. 1926. (Jan. 27) Schrödinger publishes the problem of the autovaleurs. The street for the wave interpretation of quantum mechanics
- l. 1926. (7 Feb.). Fermi publishes statistical theory on the problems of statistical quantum physics
- m. 1926. (25 Jun). Born publishes the statistical interpretation of the wave function
- n. 1926. (August 26th). Dirac reinterprets Planck's theory and the formulation of the Fermi-Dirac statistical theory
- o. 1927. (March 23). Heisenberg presents the indeterminacy relationship of the new mechanics

1927-1935. *A third line of development on the interpretation of the foundations of quantum mechanics*

- p. -1927-. Copenhagen interpretation: works by Niels Bohr and Werner Karl Heisenberg, Pascual Jordan and Max Born

- q. 1927-1932. Von Neumann's interpretation.
- r. 1935. The Einstein-Podolsky-Rosen paradox: “*Can Quantum-Mechanical Description of Physical Reality Be Considered Complete?*”

*Epistemological Reflections on the Foundations of Quantum Mechanics*

- 8. Equivalence of two Heisenberg and Schrödinger approaches: matrices and waves
- 9. The ontological *status* of interpretations of quantum mechanics
- 10. Comparison of interpretations based mainly on: determinism, waveform, development process, hidden variables, collapse, role of the observatory
- 11. Indeterminism
- 12. The logical organization of quantum mechanics
- 13. 1936. Birkhoff and von Neumann on the unconventional logic of quantum mechanics

*History and historiographies: reading texts*

The thought of Poincaré on: new mathematical formalism for the quantum phenomenon?

Einstein-Podolsky-Rosen's thought and contribution on the physical description of reality

Feynman's contribution to double interpretation of light and probability problems

*Primary sources: reading texts*

De Broglie L (1953) *La physique quantique restera-t-elle indéterministe ?* Gauthier-Villars, Paris.

Kragh H, Marage P, Vanapaemel G (2002) (eds) *The history of Modern Physics*. Brepols, Liège.

Feynman R (1985) *QED: The Strange Theory of Light and Matter*. Princeton University, Princeton, NJ.

*A first bibliography on the module*

Agazzi E (1997) ed) *Realism and quantum physics*. Rodopi, Amsterdam

Barbour J (2000) *The End of Time. The Next Revolution in Physics*. The Oxford University Press, NY.

Bevir M (1999) *The Logic of the History of Ideas*. The Cambridge University Press, Cambridge.

Birkhoff G, von Neumann J. (1936) *The logic of Quantum Mechanics*. *Annals of Mathematics* 37: 823–843.

Bitbol M, Darrgol O (1993) (eds) *Erwin Schrödinger: Philosophy and the Birth of Quantum Mechanics*. Éditions Frontières, Paris.

Bohr N ([1958] 1991) *Physique atomique et connaissance humaine*. Trad. par Bauer E et Omnès R. Gallimard, Paris.

Brush, SG (1983) *Statistical Physics and the Atomic Theory of Matter: From Boyle and Newton to Landau and Onsager*. Princeton University Press, Princeton, NJ.

Buchwald JZ (1985) *From Maxwell to microphysics*. The University of Chicago Press, Chicago.

- De Broglie L ([1937] 1986) *La physique nouvelle e les quanta*. Flammarion, Paris
- DeWitt B, Graham RN (1973) (eds) *The Many–Worlds Interpretation of Quantum Mechanics*, Princeton Series in Physics. Princeton series in Physics. Princeton University Press, Princeton, NJ.
- Dirac PAM ([1930] 1931) *Le principes de la mécanique quantique*. Presses Universitaires de France, Paris.
- Dirac PAM (1971) *The development of Quantum Thoery*. J. Robert Oppenheimer Memorial Prize Acceptance Speech. Gordon and Breach, NY
- Dirac PAM (1978) *Direction in Physics*. Wiley, NY.
- Einstein A, Podolsky B, Rosen N (1935) *Can Quantum–Mechanical Description of Physical Reality Be Considered Complete?*. *Physics Review* 47:777–780.
- Ghirardi G (2004) *Sneaking a Look at God's Cards*. Gerald Malsbary. Princeton University Press, Princeton, NJ.
- Giles R (1970) *Foundations for Quantum Mechanics*. *Journal of Mathematical Physics* 11:2139–2151.
- Gillispie CC (ed) (1970–1980) *Dictionary of Scientific Biography*. Charles Scribner's Sons, New York.
- Greenberger D, Hentschel K, Weinert F, (2009) (eds) *Compendium of quantum physics, Concepts, experiments, history and philosophy*, Springer–Verlag, Berlin, Heidelberg.
- Jammer M (1966) *The Conceptual Development of Quantum Mechanics*. McGraw Hill, NY.
- Kragh H, Marage P, Vanapaemel G (2002) (eds) *The history of Modern Physics*. Brepols, Liège.
- Kuhn TS (1978) *Black–body theory and the quantum discontinuity, 1894–1912*. The Clarendon Press, Oxford.
- Mackey G (2004). *The mathematical foundations of quantum mechanics*. Dover Publications, NY.
- Messiah A ([1959–1960] 1995) *Mécanique quantique*. 2 vols. Dunod.
- Nagel E (1961) *The Structure of Science: Problems in the Logic of Scientific Explanation*. Harcourt–Brace & World Inc, New York.
- Paty M (2003) *La physique du XXe siècle*. EDP Siences, Les Ulis.
- Poincaré HJ (1913) *Dernières pensée*. Flammarion, Paris.
- Poincaré HJ (1992) *La science et l'hypothèse*. Bohême, Rueil–Malmaison.
- Rosenfeld L (1979) *selected papers*. Cohen RS, Stachel J (eds). Reidel, Dordrecht.
- Stengers I (1993) *L'invention des sciences modernes*. La Découverte, Paris.
- Weyl H (1950) *The Theory of Groups and Quantum Mechanics*, Dover Publications, NY.

### Module 13: HISTORY AND EPISTEMOLOGY OF THE NEW FOUNDATIONS OF 20TH CENTURY SCIENCE

#### - *A history of the foundations of Einstein's two theories of relativity*

1. Physics and mathematics of the twentieth century.
2. The role of thermodynamic theory in quantum studies
3. The nature of irreversible phenomena and the entropy principle reduces the role of mechanics
4. A revolution of the announced foundations? The birth of the crisis of the mechanistic model
5. The problem of Aether
6. 1892-. The electromagnetic theory of Lorentz
7. Criticism of the Newtonian originals
8. On the measurement of the speed of light and the principle of relative motion
9. Studies on the black body
10. 1904. The electromagnetic model-theory of Lorentz
11. 1900-1905. Poincaré's studies on electron dynamics

#### Albert Einstein. Biography and works

- f. 1905. The three fundamental articles on the theory of special relativity
- g. 1907. On mass and energy equivalence
- h. 1916. On the theory of general relativity
- i. 1921 (-2). *Nobel prize*
- j. 1926. Investigations on Brownian Movement Theory
- k. 1936. *Evolution of ideas in physics*

#### *On the theory of special relativity*

1. Galilean relativity and the principle of inertia
2. The black body and the quantum hypothesis
3. A heuristic point of view: the quantum of light
4. On the problems of the atomic model
5. A problem of asymmetry
6. The concepts of space and time of Einstein's relativity
7. The postulates of special relativity
8. The experimental confirmations of the new theory
9. Relativity and simultaneity

#### *On physical space-time and geometry and in the theory of special relativity*

10. Physical space-time in Minkowski's theory
11. Vector notation
12. The transformation of Lorentz without the second postulate
13. Non-Euclidean Geometry and Time Coordinates. The case of hyperbolic geometry
14. The dilation of time and the twins paradox
15. The problem of hard bodies and the Ehrenfest paradox
16. 1911-1912. Acceptance of special relativity



*On the theory of general relativity*

17. The problem of the laws of physics for the non-inertial system
18. Gravitation and acceleration
19. *Weighting mass and mass of inertia*
20. The role of Ricci Curvatures and Levi-Civita's results in relativity
21. The laws of the new theory

*On the geometry of the theory of general relativity*

22. Geometry and gravitation
23. The gravitational field
24. The sources of gravitation
25. Einstein's equations
26. A short story about astrophysical applications: gravitational waves, black holes, cosmology

*Epistemological reflections on the foundations of Einstein's relativity*

27. *Small historical reflections on controversies about the theory of special relativity*
28. The logical organization of Einstein's theories of relativity
29. The large number of researches on relativity and the bibliography edited by Lecat (1924)
30. Field theory as a unification of quantum mechanics and relativity? Perspectives?

*History and historiographies: reading texts*

Poincaré's thought and contribution to modern science

Einstein-Podolsky-Rosen's thought and contribution on the physical description of reality

Einstein's thought and contribution to the world

Darrigol's thought and contribution to the mystery of the Einstein-Poincaré connection

*Primary Sources: reading texts*

Balibar F (1993) (ed) Albert Einstein, œuvres choisies, volume 1 : Quanta. Éditions du Seuil / Éditions du CNRS, Paris.

Balibar F (ed) (1993) (ed) Albert Einstein, œuvres choisies, volume 2 : Relativités. Éditions du Seuil / Éditions du CNRS, Paris.

Einstein A (1925) Sur l'électrodynamique des corps en mouvement. Gauthier-Villars, Paris [réimprimé aux Éditions Jacques Gabay, Paris en 2005]

Einstein A (1991) Œuvres choisies. Éditions du Seuil, Paris.

Einstein A ([1934] 1983) Comment je vois le monde. Flammarion-Champs, Paris

Einstein A, Infeld L (1938) L'évolution des idées en physique. Flammarion-Champs, Paris.

*A first specific bibliography on the module*

Adair R (1987) The Great Design: Particles, Fields and Creation. The Oxford University Press, NY.

- Bachelard G (1951) *L'activité rationaliste de la physique contemporaine*. Presses Universitaires de France, Paris.
- Borel É (1913), *La théorie de la relativité et la cinématique*. Comptes Rendus des séances de l'Académie des Sciences 156: 215–218.
- Borel É (1914) *Introduction géométrique à quelques théories physiques*. Gauthier–Villars, Paris.
- Damour T, Darrigol O, Duplantier B, Rivasseau V (2006) (eds) *Einstein, 1905–2005. Poincaré Seminar 2005*, Birkhäuser Verlag, Basel.
- Darrigol O (2000) *Electrodynamics from Ampère to Einstein*. The Oxford University Press, Oxford.
- Darrigol O (2004) *The Mystery of the Einstein–Poincaré Connection*. *Isis* 95/4:614–626.
- Darrigol O (2006) *The Genesis of the theory of relativity* In: Damour T, Darrigol O, Duplantier B, Rivasseau V (eds) 2006, *Séminaire Poincaré* 1:1–22, op. cit.
- Dirac PAM (1978) *Direction in Physics*. Wiley, NY.
- Einstein A ([1921] 2005) *Quatre conférences sur la théorie de la relativité*. [Texte de quatre conférences prononcées à l'université de Princeton en 1921] Dunod, Paris.
- Einstein A (1927). *Newtons Mechanik und ihr Einfluss auf die Gestaltung der theoretischen Physik*, *Naturwissenschaften* 15:273–276. Trad. fr. par le Cnel Cros. *La mécanique de Newton et son influence sur l'évolution de la physique théorique*. In: Einstein A [1934]1983, pp. 180–193, op. cit.
- Einstein A (1956) *La théorie de la relativité restreinte et générale*. Gauthier–Villars, Paris.
- Einstein A, Freud S ([1933] 2005) *Pourquoi la guerre ?* Rivages, Paris.
- Feynman R (1985) *QED: The Strange Theory of Light and Matter*. Princeton University, Princeton, NJ.
- Gillispie CC (ed) (1970–1980) *Dictionary of Scientific Biography*. Charles Scribner's Sons, New York.
- Hawking SW, Israel W (1980) (eds) *General relativity. An Einstein centenary survey*. The Cambridge University Press, Cambridge.
- Holton G (1988) *Thematic Origins of Scientific Thought: Kepler to Einstein*. The Harvard University Press, Cambridge–MA.
- Keswani G H, Kilmister CW (1983) *Intimations Of Relativity: Relativity Before Einstein*. *The British Journal of Philosophy of Science* 34/4:343–354.
- Kragh H, Marage P, Vanapaemel G (2002) (eds) *The history of Modern Physics*. Brepols, Liège.
- Lecat M (1924) *Bibliographie de la relativité*. Lamertin, Bruxelles.
- Lorentz HA, Einstein A, Minkowski M, Weyl H (1923) *The principle of relativity. A collection of original memoirs on the special and general theory of relativity*. Dover, NY.
- Max Born M ([1923] 2003) *La théorie de la relativité d'Einstein et ses bases physiques*. Gabay, Paris.
- Nagel E (1961) *The Structure of Science: Problems in the Logic of Scientific Explanation*. Harcourt–Brace & World Inc, New York.

- Neil Ashby N (2002) Relativity and the Global Positioning System. *Physics Today* 55/5:41–47.
- Pais A (2005) Albert Einstein – Sa vie, son œuvre, Interéditions. Dunod, Paris.
- Paty M (2004) Albert Einstein, ou la création scientifique du monde, Belles Lettres, Paris.
- Paty M (1979) Sur le réalisme d'Albert Einstein. *La Pensée* 204:18–37.
- Paty M (1999) La création scientifique selon Poincaré et Einstein. In: Serfati M (ed) *La recherche de la vérité: Coll. « L'Écriture des Mathématiques »*, ACL-Éditions du Kangourou, Paris, pp. 241–280.
- Paty M (2003) *La physique du XXe siècle*. EDP Sciences, Les Ulis.
- Penrose R (2004) *The Road to Reality. A complete guide to laws of the universe*. Knopf, NY.
- Pisano R, Casolaro F (2011–soumis) Historical Inquiring On Geometry In Relativity. A Geometry Model (Part II) [CFV Cahiers].
- Poincaré HJ (1889) *Théorie mathématique de la lumière*. Carré & Naud, Paris.
- Poincaré HJ (1900a) Les relations entre la physique expérimentale et la physique mathématique. *Revue générale des sciences pures et appliquées* 11:1163–1175.
- Poincaré HJ (1900b) La théorie de Lorentz et le principe de réaction, *Archives néerlandaises des sciences exactes et naturelles* 5:252–278.
- Poincaré HJ (1913) *Dernières pensées*. Flammarion, Paris.
- Whittaker ET (1953) The relativity theory of Poincaré and Lorentz. En: *A History of the theories of aether and electricity. Vol 2: The modern theories 1900–1926*. Nelson, London, pp. 27–77.
- Wolfgang R (2001) *Relativity: special, general and cosmological*. The Oxford University Press, Oxford.
- Zahar E (1987) Les fondements des mathématiques d'après Poincaré et Russell. *Fundamenta Scientiae VIII* 1987:31–56.
- Zahar E (1989) *Einstein's Revolution: A Study in Heuristic*. The Open Court Publishing Company, Chicago.

## **A MODULAR CYCLIC (POSSIBLE) TEACHING HYPOTHESIS IN HISTORY-EPISTEMOLOGY OF PHYSICS (AND RELATIONSHIP WITH MATHEMATICS)**

**History-epistemologies of the century physics including the training courses in the trades of the teaching professions (17th-20th century)**

---

### **Main Modules**

<b>Module 14</b>	<i>In epistemology, the history of the physical sciences: orientations and methods of study</i>
<b>Module 15</b>	<i>The roles of categories in the historical investigation of science</i>
<b>Module 16</b>	<i>A history of the foundations of physics, mathematics and logic</i>
<b>Module 17</b>	<i>A short history of scientific networks and circulations of knowledge of some scientific organizations</i>

## MODULES IN HISTORY OF PHYSICS DETAILED WITH THE FIRST BIBLIOGRAPHIC REFERENCES

### MODULE 14: INTRODUCTION TO THE STUDY OF EPISTEMOLOGY, HISTORY OF THE PHYSICAL SCIENCES

- *In epistemology, the history of science and technology: orientations and methods of study*

1. Introduction to the course: maximum programming, pre-requisites content and time, cognitive objectives, operational objectives, validations
2. Historical research I: the use of Latin, Italian *vulgare* and English languages
3. Historical Research II: The Roles of Primary and Secondary Sources
4. Historical Research III: Roles and Methods of Electronic Fonts
5. Introduction of concepts: *historical assumptions and epistemological interpretations*
6. Initiation to research and teaching of history and epistemology of science
7. Examples of readings of original texts and secondary literatures
8. Research and online works by *Gallica*, *Google books*, *Berlin's Max Planck Institute for the History of Science*, *Academies et al.*
9. Perspectives and possibilities for the historian of science?
10. Varia

*History and historiographies: reading texts*

- Braunstein J-F (2008) (ed) *L'histoire des sciences : méthodes, styles et controverses*. Vrin, Paris.
- Gillispie CC (ed) (1970–1980) *Dictionary of Scientific Biography*. Charles Scribner's Sons, New York.
- Kragh H (1987) *An Introduction to the Historiography of Science*. The Cambridge University Press, Cambridge.
- Kuhn TS (1983) *La Structure des révolutions scientifiques*, trad. Laure Meyer, Gallimard, Paris.
- Latour B (1995) *La Science en action : introduction à la sociologie des sciences*, Gallimard, Paris.
- Pestre D (2006) *Introduction aux « science studies »*. La Découverte, Paris.

## MODULE 15: HISTORY, EPISTEMOLOGY AND FOUNDATIONS OF SCIENCE

### – *The roles of categories in the historical investigation of science*

11. Categories and scientist approach in historical discourse: Mach, Koyré, Kuhn
12. Objective History, Subjective History and Effective History
13. On specificity and scientificity in historical discourse
14. On the conscience in the historical discourse
15. Categories in historical discourse
16. The concepts of *historical assumptions* and *epistemological interpretations*
17. Logic and mathematics as categories of historical investigation
18. The mathematics of logic or the logic of mathematics?
19. The ambiguous use of formal language
20. "True", "False" and "undecidable"
21. Elements of mathematical logic and non-classical logic
22. Mathematics, logic and physics
23. Examples:
  - a. On the history of mechanics
  - b. On the history of chemistry
  - c. On the history of thermodynamics
24. Continuity and discontinuity in the history of science

### *Case studies: Evangelista Torricelli and Archimedes*

Evangelista Torricelli and Archimedes. Biography and works.

- d. *Opera Geometrica*, 1644
- e. Torricelli's principle in mechanics
- f. Logic as a category of historical investigation
- g. The logical basis of Archimedes' mechanics
- h. The logical basis of Torricelli's mechanics
- i. A correlation: Archimedes and Torricelli
- j. Torricelli's demonstration of Galilei's theorem
25. Reflections on physics and logic in the history of science

### *History and historiographies: reading texts*

Condillac's thought about logic in science

Mach's thought on the history of mechanics

Duhem's thought on the history of science

Koyré's thought on the history of mechanics

Kuhn's thought on the history of science

Popper's thought on the investigation of the history of science

Crombie's thought on the history of science

Thackray's thought on the history of science

*Primary sources: reading texts*

Aristotle (1949) Aristotle's Prior and Posterior Analytics. A Revised Text with Introduction and Commentary Ross WD (ed). The Oxford University Press, Oxford.

Condillac EB (1821) *La logique par Condillac*. Verdier Quai Des Augustins, Paris.

Torricelli E (1644) *Opera geometrica*. Massa-Landi, Firenze .

*A first bibliography on the module*

Capecchi D, Pisano R (2010) Reflections On Torricelli's Principle in Mechanics. *Organon* 42:81–98.

Duhem PM (1977) *Aim and Structure of Physical Theory*. Princeton University Press, Princeton NJ.

Feyerabend P (1991) *Dialogues sur la connaissance*. Seuil, Paris.

Gillispie CC (ed) (1970–1980) *Dictionary of Scientific Biography*. Charles Scribner's Sons, New York.

Koyré A (1957) *From the Closed World to the Infinite Universe*. The Johns Hopkins University Press, Baltimore.

Koyré A (1961) *Du monde de « à-peu-près » à l'univers de la précision*. M Leclerc et Cie – Armand Colin Librairie, Paris (Id, *Les philosophes et la machine. Du monde de l'«à-peu-près» à l'univers de la précision. Études d'histoire de la pensée philosophique*).

Kuhn TS (1983) *La Structure des révolutions scientifiques*. trad. Laure Meyer, Gallimard, Paris.

Lakatos I (1978) *The Methodology of Scientific Research Programmes*. 2 vols. The Cambridge University Press, Cambridge.

Mach E (1883 [1996]) *The Science Of Mechanics – A Critical And Historical Account Of Its Development*. 4th edition. Open Court–Merchant Books, La Salle.

Nagel E (1961) *The Structure of Science: Problems in the Logic of Scientific Explanation*. Harcourt–Brace & World Inc, NY.

Nagel T (1997) *The Last Word*. The Oxford University Press, Oxford.

Pisano R (2010) On Principles In Sadi Carnot's Thermodynamics (1824). *Epistemological Reflections*. *Almagest International Interdisciplinary Journal* 2/2010:128–179.

Pisano R, Gaudiello I (2009a) Continuity and discontinuity. An epistemological inquiry based on the use of categories in history of science. *Organon* 41:245–265.

Poincaré H ([1923]1970) *La valeur de la science*. Flammarion, Paris.

Poincaré H ([1935]1968) *La science et l'hypothèse*. Flammarion, Paris.

Popper K ([1935]1973) *Logique de la découverte scientifique*. Payot, Paris.

Popper K ([1963]1985) *Conjectures et réfutations. La croissance du savoir scientifique*. Payot, Paris.

Taton R (1965) Alexandre Koyré, historien de la « révolution astronomique». *Revue d'histoire des sciences et de leurs applications* 18/2:147–154.

## Module 16: PHILOSOPHY AND FOUNDATIONS OF SCIENCE

### – *A history of the foundations of mathematics and logic*

1. Meschkowsky: *Evolution of mathematical thought*
2. *The Greek miracle*
3. The system of Euclidean geometry
4. The problem of infinity

#### On the history and development of infinitesimal analysis

2. The infinitesimal analysis: Leibniz and Newton
3. Berkeley's criticism of the double methodological error in Newton's infinitesimal calculus
4. The infinitesimal analysis and the synthetic method of Lazare Carnot
5. The rigorous foundation of Cauchy
6. Non-standard mathematical analysis
7. Constructive mathematics
8. Problems of the interpretations of physical phenomena with mathematics
9. The case study of the phenomenon of reversibility in thermodynamics
10. Cantor: the theory of sets
11. Antinomies and paradoxes: birth and death of the logicist program
12. Hilbert: geometry and experience as a fundamental program
13. Intuitionism

#### Elements of non-classical mathematical logic and logic:

- a. Boolean algebra on number 0 and 1
- b. Basal and derived operations of Boolean algebra
- c. The logical formula
- d. The formulas of the logical laws as tautologies
- e. The calculation of predicates
- f. Axiomatization of Boolean Algebra
- g. Ambiguous uses of formal language
- h. The intuitionist logic and the law of double negation
- i. Logic and mathematics as categories of historical investigation

#### The development and defeat of formalism

14. Hilbert: the axiomatization program
15. Gödel's theorem and the problems of undecidability
16. Comparison of different axiomatizations. The Bourbaki program
17. General Reflections on Categories in Historical and Philosophical Discourse



*History and historiographies: reading texts*

Meschkowsky's thought and contribution to the history of the foundations of mathematics

The contributions of Carnap on the formalism of logic

Popper's thought and contribution on Conjectures and refutations

Poincaré's thought and contribution on mathematics and logic

Meschkowsky's thought and contribution to the evolution of mathematics

*Primary sources: reading texts*

Berkeley G (1734) *The Analyst*. Fuller S, Globe-in-Meath-Street, Leathly J, Dublin, Sect: XII–XIV.

Condillac EB (1821) *La logique*. Verdier Quai Des Augustins, Paris.

Russel B (1919) *Introduction to Mathematical Philosophy*. Allen and Unwin, London.

Hilbert D (1918) *Axiomatic Thought*. Trad. en deux volumes In: Ewald WB 1996, pp 1107–1115, op. cit.

*A first bibliography on the module*

Agazzi E (1980) *Logic and Methodology of empirical Sciences*. In: Agazzi E (ed): *Modern Logic – A Survey*. Reidel, Dordrecht, pp. 255–282.

Aleksandrov AD, Kolmogorov AN, Lavrentev MA (1965) *Mathematics: its Content Methods & Meaning*, 2 Vols. The MIT Press, Cambridge–MA.

Beaudet J (2002) *Nouvel Abrégé d'histoire des mathématiques*. Vuibert, Paris.

Beth EW (1961) *Semantic of physical Theories*. In: Freudenthal H (ed): *The concept & The Role of the Model, in Mathematics and Natural and Social Sciences*. Reidel, Dordrecht pp. 48–51.

Bevir M (1999) *The Logic of the History of Ideas*. The Cambridge University Press, Cambridge.

Bourbaki N (1960) *Éléments d'histoire des mathématiques*. Hermann, Paris.

Brouwer LEJ (1913) *Intuitionism and Formalism*. Trad. Dresden A. (Bulletin of the American Mathematical Society XX:81–96.

Brown JR (1999) *Philosophy of Mathematics: An Introduction to the World of Proofs and Pictures*, Routledge, London.

Carnap R (1943) *Formalisation of Logic*. The Harvard University Press, Cambridge–MA.

Crombie AC (1963) (ed) *Scientific Change : Historical Studies in the intellectual, social and technical conditions for scientific discovery and technical Invention, from antiquity to the present – Symposium on the History of Science*, University of Oxford, 9–15 July 1961. Heinemann education books, London.

Duhem PM (1914) *La théorie physique : son objet et sa structure*. Marcel Rivière & Cie, Paris.

Dummett M (1975) *Principles of Intuitionism*. The Clarendon Press, Oxford.

Ewald WB (1996) *From Kant to Hilbert. A Source book in the Foundations of Mathematics*. The Clarendon Press, Oxford.

Fauvel J, Gray J (1987) *The History of Mathematics : A Reader*. Palgrave MacMillan & The Open University, NY.

- Feynman R (1965) *The Character of Physical Law*. MIT Press, Cambridge–MA
- Gabbay D, Guentner F (1984) (eds) *Handbook of Philosophical Logic*. Springer Dordrecht.
- Gauthier Y (1991) *La logique intern*. Vrin, Paris, pp. 107–109.
- George A, Velleman DJ (2002) *Philosophies of Mathematics*. Blackwell, Oxford.
- Giles R (1970) *Foundations for Quantum Mechanics*. *Journal of Mathematical Physics* 11:2139–2151.
- Gillispie CC (ed) (1970–1980) *Dictionary of Scientific Biography*. Charles Scribner's Sons, New York.
- Goldstein C, Gray J, Ritter J (1996) (eds) *L'Europe mathématique – Mathematical Europe*. *Maison des sciences de l'homme*, Paris.
- Grattan–Guinness I (1991) (ed) *Selected Essays on the History of Set Theory and Logics (1906–1918)*. CLUEB, Bologna.
- Guerlac H (1963) *Some Historical Assumptions of the History of Science*. In: Crombie 1963, 797–817.
- Haack S (1974) *Deviant Logics*. The Cambridge University Press, Cambridge.
- Heijenoort J van (1967) (ed) *From Frege to Geomlidel: A Source Book in Mathematical Logic 1879–1931*. The Harvard University Press, Cambridge MA.
- Hilbert D (1927) *The foundations of mathematics*. In: Heijenoort van J 1967, pp 464–479, op. cit.
- Hodges W (1983) *Elementary Predicate Logic*. In: Gabbay DM, Guentner F (eds), *Handbook of Philosophical Logic – Elements of Classical Logic*. Reidel, Dordrecht, vol I, pp. 1–131.
- Hodges W (1997) *A shorter model theory*. The Cambridge University Press, Cambridge.
- Hodges W (1998) *The Laws of Distribution for Syllogism*. *Notre Dame Journal of Formal Logic* 39:221–230.
- Kiesepä IA (2000) *Rationalism, Naturalism, and Methodological Principles*. *Erkenntnis* 53(3):337–352.
- Kline M (1980) *Mathematics. The Loss of Certainty*, The Oxford University Press, Oxford.
- Kolmogorov AN (1925) *On The Principle « Tertium Non Datur »*. *Matematicheskij Sbornik* 32: 646–667 (Engl. Transl. in Kolmogorov 1991–1993, I:40–68).
- Kolmogorov AN (1991–1993) *Selected Works of A.N. Kolmogorov*. Tikhomirov VM (ed). Translated from the Russian by Volosov VM. 3 vols. Kluwer Academic Publishers, Dordrecht–Boston.
- Koyré A (2003) *Du monde clos à l'univers infini*. Gallimard, Paris.
- Meschkowsky H (1965) *Evolution of mathematical thought*. Holden–Day, San Francisco.
- Nagel E (1961) *The Structure of Science: Problems in the Logic of Scientific Explanation*. Harcourt–Brace & World Inc, New York.
- Nickles T (2001) *The Logic and Methodology of Science in Early Modern Thought : Seven Studies by Fred Wilson*. *Isis* 92/4:775–776.

- Poincaré HJ (1908) *Science et Méthode*. Flammarion, Paris.
- Poincaré JH (1905) *Les mathématiques et la logique*. *Revue de métaphysique et de morale*, vol. 13:815–835.
- Popper K ([ca. 1940–1963] 1985) *Conjectures et réfutations. La croissance du savoir scientifique*. Payot, Paris.
- Popper K (1973) *Logique de la découverte scientifique*. Payot, Paris.
- Prawitz D (1965) *Natural deduction. A Proof–Theoretical Study*. Almqvist & Wilksell, Uppsala.
- Prawitz D (1977) *Meaning and Proof. The conflict between the classical and intuitionistic logic*. *Theoria* 43:6–39.
- Prawitz D, Melmnaas PE (1968) *A survey of some connections between classical, intuitionistic and minimal logic*. In: Schmidt A, Schuette H (eds): *Contributions to Mathematical Logic*. North–Holland, Amsterdam, pp 215–229.
- Przelecki M (1969) *The Logic of Empirical Theories*. Routledge & Kegan Paul, London.
- Russel B (1919) *Introduction to Mathematical Philosophy*. Allen and Unwin, London.
- Shapiro S (1991) *Foundations without Foundationalisms*, The Oxford University Press, Oxford.
- Skolem T ([1920] 1967) *Logico–Combinatorial Investigations in the Satisfiability or Provability of Mathematical Propositions*. In: Heijenoort J van 1967, pp 252–263, op. cit.
- Szczeciniarz JJ (2005) *Philosophie et géométrie : la montée de la géométrie, ses effets philosophiques*”. In: Kouneiher J. Et al (ed.) *Géométrie au XXe siècle, 1930-2000. Histoire et horizons*, Hermann, Paris, pp 334–350.
- Weizsacker von CF (1973) *Classical and quantum descriptions*. In: Mehra J (ed), *The Physicist’s Conception of Nature*. Reidel, Dordrecht, pp. 635–667.
- Wittgenstein L (1978) *Remarks on the foundations of Mathematics*. Blackwell, Oxford.
- Zahar E (1987) *Les fondements des mathématiques d’après Poincaré et Russell*. *Fundamenta Scientiae* VIII 1987:31–56.

## **Module 17: HISTORY OF THE ORGANIZATION OF SCIENTIFIC RESEARCH, XVII-XVIII s.**

### **- A short history of scientific networks and knowledge flows of some scientific organizations**

1. The roles of academies of science in scientific research
2. 1603. *Accademia dei Lincei*
3. 1657. *Accademia del Cimento*
4. 1660. *The Royal society of London*
5. 1666–1699. *Académie des sciences*
6. 1699. *Académie royale des sciences*
7. 1700–1744. *Societas regia scientiarum* de Berlin
8. 1725–1803. *Academia Scientiarum Imperialis Petropolitanae* of St. Petersburg
9. Science pre–post revolution in France
10. Scientific periodicals and the circulations of knowledge

### *History and historiographies*

Rossi's thought and contribution to scientific organizations

Ben David's thought and contribution on sociology and history of science

Hahn's contribution to scientific organizations

### *A first bibliography on the module*

Belhoste B (2003) *La formation d'une technocratie. L'École polytechnique et ses élèves de la Révolution au Second Empire*. Belin, Paris.

Ben David J (1984) *The Scientist's Role in Society*, The University of Chicago Press, Chicago.

Ben David J (1997) *Éléments d'une sociologie historique des sciences*, textes réunis et introduits par Gad Freudenthal ; trad. de Michelle de Launay, PUF, Paris.

Birch Th ([1756–1757] 1967) *The History of the Royal Society of London for Improving of Natural Knowledge*, 4 vols. Millar, London.

Fox R (1992) *The Culture of Science in France, 1700–1900*. Variorum Collected Studies Series 381, Ashgate Variorum.

Galluzzi P (1981) *L'Accademia del Cimento : gusti del principe, filosofia e ideologia dell'esperienza*. Quaderni storici 48:788–844.

Gillispie CC (ed) (1970–1980) *Dictionary of Scientific Biography*. Charles Scribner's Sons, New York.

Hahn R (1971) *The anatomy of a scientific institution : the Paris Academy of Sciences (1666–1803)*. The University of California Press, Berkeley.

Knowles Middleton WE (1971) *The Experimenters. A Study of Accademia del Cimento*. The Johns Hopkins Press, Baltimore and London.

Latour B (1995) *La Science en action : introduction à la sociologie des sciences*, Gallimard, Paris.

Merton R (1997) *Éléments de théorie et de méthode sociologique*, trad. par Henri Mendras. Colin, Paris.

Rossi P (1999) *Aux origines de la science moderne*. Seuil–Points/sciences, Paris

Webster Ch (1974) (ed) *The intellectual revolution of the XVIIth century*. Kegan Paul, London.

**A MODULAR CYCLIC (POSSIBLE) TEACHING HYPOTHESIS IN HISTORY-EPISTEMOLOGY OF PHYSICS (AND RELATIONSHIP WITH MATHEMATICS) SPECIFICALLY ON GRAVITATIONAL WAVES**

**History-epistemologies of the 17th-21th century**

<b>Main Modules</b>	
<b>Module 18</b>	<p><i>SCIENCE TEACHING-LEARNING: ON THE DIDACTICS OF PHYSICS AND NATURE OF SCIENCE TEACHING / NoS</i></p> <p>- <i>On the Relationship Epistemology-History &amp; Teaching-Learning</i></p>
<b>Module 19</b>	<p>SCIENCE TEACHING-LEARNING: HISTORY AND EPISTEMOLOGY OF THE CONCEPT OF WAVES / NoS</p> <p>- On the Conceptualization of Waves – Early Times Newtonian Paradigm &amp; 19th centuries</p>
<b>Module 20</b>	<p>SCIENCE TEACHING-LEARNING: HISTORY AND EPISTEMOLOGY OF GRAVITATIONAL WAVES / NoS</p> <p>- The Conceptualization of Gravitational Waves – Late Times Einstein's Two Theories of Relativity</p>

**MODULE 18****SCIENCE TEACHING-LEARNING: ON THE DIDACTICS OF PHYSICS AND NATURE OF SCIENCE TEACHING / NoS****- A history of the relationship Epistemology-History & Teaching-Learning***On History and Epistemology and Teaching Science*

1. Karl Popper and scientific reasoning
2. Causality and correlation
3. Explications and tautologies
4. On falsifiability and repeatability
5. Theories, Theorems, Laws and other Principles
6. On Paradigms
7. On Confirmation bias & interpretations

*On History of Science and Teaching Analysis: Case studies*

8. On the importance of History of Science
  - a. On the role of History of Science for History
  - b. On the role of History of Science for Science
  - c. On the role of History of Science for Teaching-Learning
  - d. On the role of History of Science for Society
9. Antiquity, the relationship between knowledge and teaching
10. Galileo Galilei
11. The scientific method
12. The actual scientific method
13. On minor works and less known science contributors

*On Teaching-Learning*

14. On Teaching-Learning & Scientific Pedagogy
15. A recent invention
16. "Didactics", A content specific discipline
17. On theoretical frameworks
18. On the variables
  - a. Qualitative variables
  - b. Quantitative variables
19. The didactics vocabulary
20. The issue of falsifiability & the problem of repeatability
21. On learners' representations and misconceptions
22. On the experimental confirmations of theories

*On Interdisciplinary Teaching – Nature of Science Teaching-Learning*

23. On the importance of NoS in the science curriculum
24. On teachers' NoS knowledge
25. On teachers' pedagogical decision-making
26. On the effectiveness of NoS instruction in science teacher education
27. On the experimental confirmations of theories

*On Teaching-Learning of Physics*

28. The frameworks
29. On the representation of Science
30. The relationship between guidance and delivery
31. On the acquisition of concepts
32. On memorization vs. understanding
33. Students preconceptions and misconceptions
34. Critical mind training
35. The different approaches

*On Modern Issues and Methodologies for Teaching-Learning with History of Physics*

36. History of Scientific thinking
37. The study of historical conceptions
38. Designing content
39. The place of History of Science in Physics Teaching
40. The place of History of Science in teachers training

*History and Historiographies: Reading Texts*

Poincaré's thoughts and contribution to modern science

Einstein-Podolsky-Rosen's thoughts and contribution on the physical description of reality

Einstein's thoughts and contribution to the world

Darrigol's thoughts and contribution to the mystery of the Einstein-Poincaré connection

*An Early Specific Bibliography on the Module*

Abimbola OA (1983) The relevance of the “new” philosophy of science for the science curriculum. *School Science and Mathematics* 83:183–190.

Astolfi JP, Peterfalvi B (1993) Obstacles et construction de situations didactiques en sciences expérimentales. In: Aster, éditions INRP, n°16, pp.100-110.

Arons AB (1996) *Teaching Introductory Physics*. John Wiley & Sons, Hoboken, New Jersey, USA.

Ballini P, Robardet G, Rolando JM (1997) L'intuition, obstacle à l'acquisition de concepts scientifiques: propositions pour l'enseignement du concept d'énergie en première S. In: Aster, éditions INRP, n°24, pp. 81-112.

Bell R, Lederman NG, Abd-El-Khalick F (1997) Developing and Acting Upon One's Conception of Science: The Reality of Teacher Preparation. Paper presented at the Annual Meeting of the Association for the Education of Teachers in Science, Cincinnati, 9–12, January.

Benseghir A (1989) Transition électrostatique-électrocinétique ; point de vue historique et analyse des difficultés des élèves. Thèse, Université Paris 7.

Bentley ML, Garrison JW (1991) The Role of Philosophy of Science in Science Teacher Education. *Journal of Science Teacher Education* 2:67–71.

- Berthelot JM (2003) *Figures du texte scientifique*. (dir) Science histoire et société, PUF, Paris.
- Berthelot JM, Collinet C, Martin O (2005) *Savoirs et savants : Les études sur la science en France*. PUF, Paris, France.
- Bitbol M, Gayon J (2015) *L'épistémologie française, 1830-1970*. Editions Matériologiques, Paris, France.
- Brush SG (1989) History of Science and Science Education. *Interchange* 20:60–71.
- Burbules NC (1991) Science Education and Philosophy of Science: Congruence of Contradiction? *International Journal of Science Education* 13:227–241.
- Carey LR, Strauss AN (1968) An analysis of the understanding of the nature of science by prospective secondary science teachers. *Science Education* 52, 358–363.
- Cawthron FR, Rowell JA (1978) Epistemology and Science Education. *Studies in Science Education* 7:279–304.
- Chareix F (2002) *Le mythe Galilée*. Science histoire et société, PUF, Paris, France.
- Clough MP (1997) Strategies and Activities for Initiating and Maintaining Pressure on Students Naive Views Concerning the Nature of Science. *Interchange* 28:191–204.
- Conant AB (1951) *On Understanding Science: An Historical Approach*, New York, New American Library.
- Connelly FM, Wahlstrom MW, Finegold M, Elhaz F (1977) *Enquiry Teaching in Science: A Handbook for Secondary School Teachers*. Toronto, Ontario Institute for Studies in Education.
- DeBoer G (1991) *A History of Ideas in Science Education: Implications for Practice*. Teachers College Press, New York.
- Dirac PAM (1978) *Direction in Physics*. Wiley, NY
- Duschl RA (1994) Research on the History and Philosophy of Science. In: Dorothy LG (ed), *Handbook of Research on Science Teaching and Learning*, MacMillan, New York.
- Eichinger DC, Abell SK, Dagher ZR (1997) Developing a Graduate Level Science Education Course on the Nature of Science. *Science and Education* 6:417–429.
- Eisner EW (1985) *Educational Imagination: On the Design and Evaluation of School Programs*. Second Edition, MacMillan, New York.
- Elkana Y (1970) Science, Philosophy of Science and Science Teaching. *Educational Philosophy and Theory* 2:15–35.
- Eylon B, Linn M (1989) Learning and Instruction: an Examination of How Research Perspective in Science Education. *Review of Educational Research* 58:251–301.
- Fawaz A, Viennot L (1986) Image optique et vision. In B.U.P., 686:1125–1146.
- Gallagher JJ (1991) Prospective and Practicing Secondary School Science Teacher's Knowledge and Beliefs about the Philosophy of Science. *Science Education* 75:121–133.



- Galili I (1996) Students' conceptual change in geometrical optics. *Int.J.Sci.Educ*, 18(7):847-868.
- Gillispie CC (ed) (1970–1980) *Dictionary of Scientific Biography*. Charles Scribner's Sons, New York.
- Ginev D (1990) *Towards a New Image of Science: Science Teaching and Non-analytical Philosophy of Science*. *Studies in Philosophy and Education* 10, 63–71.
- Guilbert L, Méloche D (1993) L'idée de science chez les enseignants en formation : un lien entre l'histoire des sciences et l'hétérogénéité des visions ? In *Didaskalia*, éditions DeBoeck, n°2, pp.23-46.
- Guionnet C (1999) Y. Jeanneret, L'affaire Sokal ou la querelle des impostures [note critique]. *Politix, Revue des sciences sociales du politique*, pp. 147-149.
- Haggerty SM (1992) *Student Teachers Perceptions of Science and Science Teaching*. In: Hills S (ed), *The History and Philosophy of Science in Science Education*, Kingston, Ontario: Queen's University.
- Harms H, Yager RE (1981) *What Research Says to the Science Teacher*. Vol. 3, Washington D.C.: National Science Teachers Association.
- Hulin N (2002) *Les Femmes et l'enseignement scientifique*. Avec la collaboration de Bénédicte Bilodeau. Postface de Claudine Hermann. PUF, Paris, IX-227
- Klein E (2000) *L'unité de la physique*. PUF, Paris, France.
- Klopfers L (1969) *The Teaching of Science and the History of Science*. *Journal of Research in Science Teaching* 6:87–95.
- Klopfers L (1964) *History of Science Cases (HOSC)*, Science Research Associates, Chicago.
- Kuhn TS (1970) *The Structure of Scientific Revolutions*. The University of Chicago Press, Chicago.
- Lederman NG (1992) *Students' and Teachers' Conceptions of the Nature of Science: A Review of the Research*. *Journal of Research in Science Teaching* 29:331–359.
- Manuel DE (1981) *Reflections on the Role of History and Philosophy of Science in School Science Education*. *School Science Review* 62:769–771.
- Martinand JL (1993) *Histoire et didactique de la physique et de la chimie: quelles relations ?* INRP, Lyon, France.  
Retrieved: <https://doi.org/10.4267/2042/20187>
- Martinand JL (1993) *Histoire et didactique de la physique et de la chimie : quelles relations ?* In: *Didaskalia*, éditions de Boeck, n°2, pp.89-99.
- Matthews MR (1989) *A Role for History and Philosophy in Science Teaching*, *Interchange* 20:3–15.
- Matthews MR (1990) *History, Philosophy and Science Teaching: What Can Be Done in an Undergraduate Course?*. *Studies in Philosophy and Education* 10:93–97.
- Maurines L (2001) *Le raisonnement géométrique en terme d'objet dans la physique des ondes*. Mémoire d'habilitation à diriger des recherches, Université Paris 11.

- McComas WF, Almazroa H, Clough MP (1998) *Science & Education*. Kluwer Academic Publishers, Springer. 7:511. <https://doi.org/10.1023/A:1008642510402>
- McComas WF, Almazroa H, Clough M (1998) *The Nature of Science in Science Education: An Introduction*. *Science & Education*. 7. 511-532. 10.1023/A:1008642510402.
- Mendibil D (2003) Berthelot J.-M.(dir) *Figures du texte scientifique*, Paris, PUF , p. 312, *Cybergeog : European Journal of Geography [Online]*, Book Reviews, Online since 21 November 2005, connection on 22 April 2019. Retrieved: <http://journals.openedition.org/cybergeog/753>
- Meyling H (1997) How to Change Students' Conceptions of the Epistemology of Science. *Science and Education* 6:397–416.
- Mialaret G (2011) *Le nouvel esprit scientifique et les sciences de l'éducation*, PUF, Paris.
- Mialaret G (2017) *Les sciences de l'éducation*. Presses Universitaires de France, « Que sais-je ? », Paris.
- Mulkay M, Gilbert N (1982) Accounting For Error: How Scientists Construct Their Social World When They Account For Correct and Incorrect Belief. *Sociology* 16:165–183.
- Munby AH (1967) Some implications for language in science education. *Science Education* 60:115–124.
- Piaget J, Garcia R (1983) *Psychogénèse et histoire des sciences*, éditions Flammarion.
- Pisano R, Vincent P (2018) Methods and Cognitive Modelling in the History and Philosophy of Science–&–Education Special Issue *Transversal Historiography of Science* 5:3-9.
- Pisano R, Anakkar A (2017) Reading Science, Technology and Education: A Tradition Dating back to Science into the History and Historiography. *Transversal Historiography of Science* 3:77-97.
- Pisano R, Bussotti P (2017) The Fiction of the Infinitesimals in Newton's Works: A note on the Metaphoric use of Infinitesimals in Newton. *Special Issue Isonomia* 9:141-160.
- Pisano R (2017) A Development of the Principle of Virtual Laws and its Framework in Lazare Carnot's Mechanics as Manifest Relationship between Physics and Mathematics. *Transversal Historiography of Science* 2:166-203.
- Pisano R, Bussotti P (2016) A Newtonian Tale Details on Notes and Proofs in Geneva Edition of Newton's Principia (avec Paolo Bussotti). *Bulletin–Journal of the British Society for the History of Mathematics* 31(3): 160-178.
- Pisano R, Bussotti P (2015) Historical and Philosophical Reflections on the Culture of Machines around the Renaissance: Machines, Machineries and Perpetual Motion. *Acta Baltica Historiae et Philosophiae Scientiarum* 3(1):69–87.

- Pisano R, Bussotti P (2015) Exploring Changes in How the Histories of the Exact Sciences Have Been Written: Interpreting the Dynamics of Change in These Sciences and Interrelations amongst Them—Past Problems, Future Cures? *Advances in Historical Studies Special Issue 4(2)*:65–67.
- Pisano R, Bussotti P (2015) Newton's *Philosophiae Naturalis Principia Mathematica* « Jesuit » Edition: The Tenor of a Huge Work. *Atti Accademia Nazionale Lincei Rendiconti Lincei Matematica e Applicazioni 25*:413–444.
- Pisano R, Bussotti P (2014) Notes on mechanics and mathematics in Torricelli as physics mathematics relationships in the history of science. *Problems of Education In The 21st Century International Journal. Special Issue 61(61)*:88–97.
- Pisano R, Bussotti P (2013) On Popularization of Scientific Education In Italy Between 12th And 16th Centuries. *Problems of Education in the 21st Century 57*:90–101.
- Pisano R, Bussotti P (2013) Open problems in mathematical modelling and physical experiments: exploring exponential function. *Problems of education in the 21st century 50(50)*:56–69.
- Pisano R, Mellone M (2012) Learning Mathematics In Physics Phenomenology and Historical Conceptual Streams. *Problems of Education in The 21st Century 46*:93–100.
- Pisano R, Casolaro F (2012) An Historical Inquiry On Geometry In Relativity. *Reflections on Late Relationship Geometry–Physics (Part II)*. *HR 2(1)*:56–64.
- Pisano R, Casolaro F (2012) An Historical Inquiry On Geometry In Relativity. *Reflections on Early Relationship Geometry–Physics (Part I)*. *HR 1(1)*:47–60.
- Pisano R (2011) Physics-mathematics relationship. Historical and Epistemological notes. In: Barbin E, Kronfellner M, Tzanakis C. (eds), *ESU–6 European Summer University on The History And Epistemology In Mathematics*, The University of Vienna Press, pp. 457–472.
- Pisano R (2010) On Principles In Sadi Carnot's Thermodynamics (1824). *Epistemological Reflections. Almagest International Interdisciplinary Journal 2(2010)*:128–179.
- Pisano R (2009) Continuity and discontinuity. On method in Leonardo da Vinci' mechanics. *Organon 41*:165–182.
- Pisano R (2009a) On method in Galileo Galilei' mechanics. In: Hunger H (ed) *Proceedings of ESHS 3rd Conférence*. Austrian Academy of Science, Vienna, pp. 147–186.
- Pisano R, Gaudiello I (2009b) On categories and scientific approach in historical discourse. In: Hunger H (ed) : *Proceedings of ESHS 3rd Conference*. Austrian Academy of Science, Vienna, pp. 187–197.
- Pisano R (2007) Note sui Principes de Thermodynamique di P de Saint Robert. In: *Actés de XXIV SISFA Congrès*, Bibliopolis, Napoli–Avellino, pp. 129–134.

- Ritter, G. (1961). Scientific History, Contemporary History, and Political Science. *History and Theory*, 1(3):261-279. doi:10.2307/2504316
- Rowell JA, Cawthron ER (1982) Image of Science: an Empirical Study. *European Journal of Science Education* 4:79–94.
- Rubba PA, Horner JK, Smith JM (1981) A study of two misconceptions about the nature of science among junior high school students. *School Science and Mathematics* 81:221–226.
- Ryan AG, Aikenhead GS (1992) Students' Preconceptions about the Epistemology of Science. *Science Education* 76:559–580.
- Schwab JJ (1964) The Teaching of Science as Enquiry. In: Schwab JJ, Brandwein PF (eds.), *The Teaching of Science*, Harvard University Press, Cambridge, MA.
- Songer N, Linn M (1991) How Do Students' Views of Science Influence Knowledge Integration?. *Journal of Research in Science Teaching* 28:761–784.
- Stake RE, Easley JA (1978) *Case Studies in Science Education, Volumes I and II*. U.S. Government Printing Office, Washington, DC.
- Taton R (1965) Alexandre Koyré, historien de la « révolution astronomique. *Revue d'histoire des sciences et de leurs applications* 18(2):147–154.
- Toussaint J, Gréa J (1996) Construire des concepts et mettre en œuvre des raisonnements, ce que peut apporter un regard sur l'histoire des sciences. In: *Didactique appliquée de la physique chimie*, éditions Nathan, pp.86-118.
- Viennot L (1996) *Raisonnement en physique*, éditions De Boeck.
- Viennot L (2003) *Enquête sur le concept de causalité*. PUF, Paris, France.
- Viennot L (2008) *Didactique, épistémologie et histoire des sciences : Penser l'enseignement*. PUF, Paris, France. doi:10.3917/puf.vienn.2008.01.
- Wandersee J (1986) Can the History of Science Help Science Educators Anticipate Students' Misconceptions. *Journal of Research in Science Teaching* 23:581–597.
- Weiss IR (1993) Science Teachers Rely on the Textbook. In: Yager RE (ed.), *What Research Says to the Science Teacher, Volume and Seven: The Science, Technology, Society Movement*, National Science Teachers Association, Washington, DC.
- Zeidler D, Lederman N (1989) The Effects of Teachers' Language on Students' Conceptions of the Nature of Science. *Journal of Research in Science Teaching* 26:771–783.

**MODULE 19****SCIENCE TEACHING-LEARNING: HISTORY AND EPISTEMOLOGY OF THE CONCEPT OF WAVES / NoS****- *The conceptualisation of waves – Early Times Newtonian Paradigm & 19<sup>th</sup> centuries****On Teaching – Conceptualisation of Waves*

41. Antiquity
  - a. The pre-Socratic ideas
  - b. Aristotle's Natural philosophy
42. The various types of waves
  - a. Focus on the history of acoustics

*On Teaching - Nature of Light – Electromagnetic Waves*

43. Snell and Descartes: Laws of Refraction and the Rainbow Phenomenon.
44. development of geometrical optics - Fermat principle
45. Newton : the theory of color
46. Newton : corpuscular nature of light
47. Newton : The case of *Newton's ring*
48. Newton and Fludd : the case of the *chromatic circle*
49. Huygens and Fresnel : the first corpuscular nature of light and the principle of Huygens and Fresnel
50. Physics and mathematics of the twentieth century
51. Hertz, Maxwell et al.: the theory of the electromagnetic wave
52. Grimaldi, Fresnel, Fraunhofer, Young : diffraction studies
53. Young and Fresnel : the theory of wave optics
54. The Diffraction Theory and Young's Slits
55. Fraunhofer, Airy, Rayleigh : the phenomenon of interference
56. Rayleigh : the theory of light scattering

*On Teaching - Einstein. Biography and Works*

57. Modern optics based on the notion of Fourier transform
58. Einstein: the principle of stimulated emission
59. The mathematical-geometry-physics relation
60. The problem of Aether
61. The Michelson-Morley experiment
  - a. On the measurement of the speed of light and the principle of relative motion
62. The founding text of relativity: 1905, "Sur la dynamique de l'électron" - Poincaré

*On Teaching - Theory of Special Relativity*

63. A heuristic point of view: the quantum of light
64. The concepts of space and time of Einstein's relativity

- 65. The postulates of special relativity
- 66. The experimental confirmations of the new theory
- 67. Relativity and simultaneity

*On Teaching - Physical Space-Time and Geometry and in the Theory of Special Relativity*

- 68. Physical space-time in Minkowski's theory
- 69. The transformation of Lorentz
- 70. Non-Euclidean Geometry and Time Coordinates. The case of hyperbolic geometry
- 71. Spacetime diagrams & Penrose diagrams
- 72. The dilation of time and train paradox
- 73. Riemannian Geometry: curved spaces
- 74. A short story about astrophysical implications: gravitational waves, black holes, cosmology

*On Teaching - Concept of Waves of Quantum Mechanics*

- 75. 1926. (Jan. 27) Schrödinger publishes the problem of the autovaleurs. The street for the wave interpretation of quantum mechanics
- 76. Equivalence of two Heisenberg and Schrödinger approaches: matrices and waves
- 77. Feynman's contribution to double *interpretation of light* and probability problems

*History and Historiographies: Reading Texts*

- Poincaré's thought and contribution to modern science
- Einstein-Podolsky-Rosen's thought and contribution on the *physical description of reality*
- Einstein's thought and contribution to *the world*
- Darrigol's thought and contribution to *the mystery of the Einstein-Poincaré connection*

*Teaching-Learning Bibliography*

- Astolfi JP, Peterfalvi B (1993) Obstacles et construction de situations didactiques en sciences.  
expérimentales. In: Aster, éditions INRP, n°16, pp.100-110.
- Ballini P, Robardet G, Rolando JM (1997) L'intuition, obstacle à l'acquisition de concepts scientifiques: propositions pour l'enseignement du concept d'énergie en première S. In: Aster, éditions INRP, n°24, pp.81-112.
- Benseghir A (1989) Transition électrostatique-électrocinétique ; point de vue historique et analyse des difficultés des élèves. Thèse, Université Paris 7.
- Dirac PAM (1978) *Direction in Physics*. Wiley, NY.
- Fawaz A, Viennot L (1986) Image optique et vision. In B.U.P., n°686, pp.1125-1146.
- Galili I (1996) Students' conceptual change in geometrical optics. *Int.J.Sci.Educ*, 18(7):847-868.

- Guilbert L, Méloche D (1993) L'idée de science chez les enseignants en formation : un lien entre l'histoire des sciences et l'hétérogénéité des visions ? In *Didaskalia*, éditions DeBoeck, n°2, pp.23-46.
- Martinand JL (1993) Histoire et didactique de la physique et de la chimie : quelles relations ? In: *Didaskalia*, éditions de Boeck, n°2, pp.89-99.
- Maurines L (2001) Le raisonnement géométrique en terme d'objet dans la physique des ondes. Mémoire d'habilitation à diriger des recherches, Université Paris 11.
- Mialaret G (2011) Le nouvel esprit scientifique et les sciences de l'éducation, PUF, Paris.
- Mialaret G (2017) Les sciences de l'éducation. Presses Universitaires de France, « Que sais-je ? », Paris.
- Piaget J, Garcia R (1983) *Psychogénèse et histoire des sciences*, éditions Flammarion.
- Pisano R, Gaudiello I (2009b) On categories and scientific approach in historical discourse. In: Hunger H (ed) : *Proceedings of ESHS 3rd Conference*. Austrian Academy of Science, Vienna, pp. 187–197.
- Toussaint J, Gréa J (1996) Construire des concepts et mettre en œuvre des raisonnements, ce que peut apporter un regard sur l'histoire des sciences. In: *Didactique appliquée de la physique chimie*, éditions Nathan, pp.86-118.
- Viennot L (1996) *Raisonner en physique*, éditions De Boeck.
- Primary Sources: Reading Texts*
- Balibar F (1993) (ed) Albert Einstein, œuvres choisies, volume 1 : *Quanta*. Éditions du Seuil / Éditions du CNRS, Paris.
- Balibar F (ed) (1993) (ed) Albert Einstein, œuvres choisies, volume 2 : *Relativités*. Éditions du Seuil / Éditions du CNRS, Paris.
- Bitbol M, Darrgol O (1993) (eds) Erwin Schrödinger: *Philosophy and the Birth of Quantum Mechanics*. Éditions Frontières, Paris
- Blay M (1983) *La conceptualisation newtonienne des phénomènes de la couleur*, Vrin, Paris.
- Buchwald JZ (1989) *The Rise of the Wave Theory of Light: Optical Theory and Experiment in the Early Nineteenth Century*. The University of Chicago Press, Chicago.
- Crombie, AC ([1953] 1971) *Robert Grosseteste and the Origins of Experimental Science, 1100–1700*. The Clarendon Press, Oxford.
- Descartes R (1897–1913) *Œuvres de Descartes*. 12 vols. Adams C, Tannery P (eds). Paris; *Discours de la méthode et Essais, Specimina philosophiae*. vol VI ; *Physico-mathematica* vol X, *Le Monde ou Traité de la lumière*, vol XI (Id, 1964–1974 par Rochot B, Costabel P, Beaudé J et Gabbery A, Paris).
- Descartes R (1964–1974) *Oeuvres*. Adam J et Tannery A. Nouvelle présentation par Rochet E, et Costabel P, 11 vols. Vrin, Paris.
- Einstein A (1925) *Sur l'électrodynamique des corps en mouvement*. Gauthier–Villars, Paris [réimprimé aux Éditions Jacques Gabay, Paris en 2005].
- Einstein A (1991) *Œuvres choisies*. Éditions du Seuil, Paris.

- Einstein A ([1934] 1983) *Comment je vois le monde*. Flammarion–Champs, Paris.
- Einstein A, Infeld L (1993) *L'évolution des idées en physique*. Flammarion–Champs, Paris.
- Dumas M (1968) (ed) *Histoire générale des techniques*. Presses Universitaires de France, Paris.
- Gillispie CC (ed) (1970–1980) *Dictionary of Scientific Biography*. Charles Scribner's Sons, New York.
- Hall AR (1993) *All was light. An Introduction to Newton's Optick*. The Clarendon Press, Oxford.
- Maitte B (1981) *La lumière*. Seuil, Paris.
- Rashed R (1992) *Optique et mathématiques. Recherches sur l'histoire de la pensée scientifique en arabe*. Variorum, Aldershot–UK.
- Ronchi V (1956) *Histoire de la lumière*. Colin, Paris.
- Rosmorduc J, Rosmorduc V, Dutour F (2004) *Les révolutions de l'optique et l'œuvre de Fresnel*. Adapt–Vuiber.
- An Early Specific Bibliography on the Module*
- Bachelard G (1951) *L'activité rationaliste de la physique contemporaine*. Presses Universitaires de France, Paris.
- Borel É (1914) *Introduction géométrique à quelques théories physiques*. Gauthier–Villars, Paris.
- Damour T, Darrigol O, Duplantier B, Rivasseau V (2006) (eds) *Einstein, 1905–2005. Poincaré Seminar 2005*, Birkhäuser Verlag, Basel.
- Darrigol O (2000) *Electrodynamics from Ampère to Einstein*. The Oxford University Press, Oxford.
- Darrigol O (2004) *The Mystery of the Einstein–Poincaré Connection*. *Isis* 95/4:614–626.
- Darrigol O (2006) *The Genesis of the theory of relativity* In: Damour T, Darrigol O, Duplantier B, Rivasseau V (eds) 2006, *Séminaire Poincaré* 1:1–22, op. cit.
- Einstein A ([1921] 2005) *Quatre conférences sur la théorie de la relativité*. [Texte de quatre conférences prononcées à l'université de Princeton en 1921] Dunod, Paris.
- Einstein A (1956) *La théorie de la relativité restreinte et générale*. Gauthier–Villars, Paris.
- Feynman R (1985) *QED: The Strange Theory of Light and Matter*. Princeton University, Princeton, NJ.
- Gillispie CC (ed) (1970–1980) *Dictionary of Scientific Biography*. Charles Scribner's Sons, New York.
- Holton G (1988) *Thematic Origins of Scientific Thought: Kepler to Einstein*. The Harvard University Press, Cambridge–MA.
- Keswani G H, Kilmister CW (1983) *Intimations of Relativity: Relativity Before Einstein*. *The British Journal of Philosophy of Science* 34(4):343–354
- Kragh H, Marage P, Vanapaemel G (2002) (eds) *The history of Modern Physics*. Brepols, Liège.
- Laird WR, Sophie Roux S (2008) (eds) *Mechanics and Natural Philosophy before the Scientific Revolution*. Springer, Dordrecht.



- Lecat M (1924) *Bibliographie de la relativité*. Lamertin, Bruxelles.
- Lorentz HA, Einstein A, Minkowski M, Weyl H (1923) *The principle of relativity*. A collection of original memoirs on the special and general theory of relativity. Dover, NY.
- Max Born M ([1923] 2003) *La théorie de la relativité d'Einstein et ses bases physiques*. Gabay, Paris.
- Nagel E (1961) *The Structure of Science: Problems in the Logic of Scientific Explanation*. Harcourt–Brace & World Inc, New York.
- Neil Ashby N (2002) Relativity and the Global Positioning System. *Physics Today* 55(5):41–47.
- Pais A (2005) *Albert Einstein – Sa vie, son œuvre*, Interéditions. Dunod, Paris.
- Paty M (2004) *Albert Einstein, ou la création scientifique du monde*, Belles Lettres, Paris.
- Paty M (1979) Sur le réalisme d'Albert Einstein. *La Pensée* 204:18–37.
- Paty M (1999) La création scientifique selon Poincaré et Einstein. In: Serfati M (ed) *La recherche de la vérité*: Coll. « L'Écriture des Mathématiques », ACL–Éditions du Kangourou, Paris, pp. 241–280.
- Paty M (2003) *La physique du XXe siècle*. EDP Sciences, Les Ulis.
- Penrose R (2004) *The Road to Reality*. A complete guide to laws of the universe. Knopf, NY.
- Pisano R, Gaudiello I (2009b) On categories and scientific approach in historical discourse. In: Hunger H (ed) : *Proceedings of ESHS 3rd Conference*. Austrian Academy of Science, Vienna, pp. 187–197.
- Pisano R, Vincent P (2018) Methods and Cognitive Modelling in the History and Philosophy of Science–&–Education Special Issue *Transversal Historiography of Science* 5:3-9.
- Pisano R, Anakkur A (2017) Reading Science, Technology and Education: A Tradition Dating back to Science into the History and Historiography. *Transversal Historiography of Science* 3:77-97.
- Pisano R, Bussotti P (2017) The Fiction of the Infinitesimals in Newton's Works: A note on the Metaphoric use of Infinitesimals in Newton. *Special Issue Isonomia* 9:141-160.
- Pisano R, Bussotti P (2016) A Newtonian Tale Details on Notes and Proofs in Geneva Edition of Newton's Principia (avec Paolo Bussotti). *Bulletin–Journal of the British Society for the History of Mathematics* 31(3): 160-178.
- Pisano R, Bussotti P (2015) Historical and Philosophical Reflections on the Culture of Machines around the Renaissance: Machines, Machineries and Perpetual Motion. *Acta Baltica Historiae et Philosophiae Scientiarum* 3(1):69–87.
- Pisano R, Bussotti P (2015) Exploring Changes in How the Histories of the Exact Sciences Have Been Written: Interpreting the Dynamics of Change in These Sciences and Interrelations amongst Them—Past Problems, Future Cures? *Advances in Historical Studies Special Issue* 4(2):65–67.

- Pisano R, Bussotti P (2015) Newton's *Philosophiae Naturalis Principia Mathematica* « Jesuit » Edition: The Tenor of a Huge Work. *Atti Accademia Nazionale Lincei Rendiconti Lincei Matematica e Applicazioni* 25:413–444
- Pisano R (2014) (ed.) *Isaac Newton and his Scientific Heritage: New Studies in the History and Historical Epistemology of Science*. Special Issue. *Advances in Historical Studies* 3/3.
- Pisano R, Bussotti P (2014) Notes on mechanics and mathematics in Torricelli as physics mathematics relationships in the history of science. *Problems of Education In The 21st Century International Journal*. Special Issue 61(61):88–97.
- Pisano R, Capecchi D, Lukešová A (eds.) (2013) *Physics, Astronomy and Engineering. Critical Problems in the History of Science. International 32nd Congress for the SISFA–Italian Society of Historians of Physics and Astronomy. The Scientia Socialis UAB & Scientific Methodical Centre Scientia Educologica Press, Šiauliai University, Lithuania.*
- Pisano R, Bussotti P (2013) On Popularization of Scientific Education In Italy Between 12th And 16th Centuries. *Problems of Education in the 21st Century* 57:90–101.
- Pisano R, Bussotti P (2013) Open problems in mathematical modelling and physical experiments: exploring exponential function. *Problems of education in the 21st century* 50(50):56–69.
- Pisano R, Bussotti P (2012) Galileo and Kepler: On *Theoremata Circa Centrum Gravitatis Solidorum* and *Mysterium Cosmographicum*. *History Research* 2(2):110–145.
- Pisano R, Mellone M (2012) Learning Mathematics In Physics Phenomenology and Historical Conceptual Streams. *Problems of Education in The 21st Century* 46:93–100.
- Pisano R, Casolaro F (2012) An Historical Inquiry On Geometry In Relativity. *Reflections on Late Relationship Geometry–Physics (Part II)*. *HR* 2(1):56–64.
- Pisano R, Casolaro F (2012) An Historical Inquiry On Geometry In Relativity. *Reflections on Early Relationship Geometry–Physics (Part I)*. *HR* 1(1):47–60.
- Pisano R (2011) Physics-mathematics relationship. Historical and Epistemological notes. In: Barbin E, Kronfellner M, Tzanakis C. (eds), *ESU–6 European Summer University on The History And Epistemology In Mathematics*, The University of Vienna Press, pp. 457–472.
- Pisano R (2010) On Principles In Sadi Carnot's Thermodynamics (1824). Epistemological Reflections. *Almagest International Interdisciplinary Journal* 2(2010):128–179.
- Pisano R (2009) Continuity and discontinuity. On method in Leonardo da Vinci' mechanics. *Organon* 41:165–182.
- Pisano R (2009a) On method in Galileo Galilei' mechanics. In: Hunger H (ed) *Proceedings of ESHS 3rd Conférence*. Austrian Academy of Science, Vienna, pp. 147–186.

- Pisano R, Gaudiello I (2009b) On categories and scientific approach in historical discourse. In: Hunger H (ed) : Proceedings of ESHS 3rd Conference. Austrian Academy of Science, Vienna, pp. 187–197.
- Poincaré HJ (1889) *Théorie mathématique de la lumière*. Carré & Naud, Paris.
- Poincaré HJ (1900a) Les relations entre la physique expérimentale et la physique mathématique. *Revue générale des sciences pures et appliquées* 11:1163–1175.
- Poincaré HJ (1900b) La théorie de Lorentz et le principe de réaction, *Archives néerlandaises des sciences exactes et naturelles* 5:252–278.
- Poincaré HJ (1913) *Dernières pensées*. Flammarion, Paris.
- Poincaré HJ (1992) *La science et l'hypothèse*. Bohême, Rueil–Malmaison.
- Rahman S, Symons J, Gabbay DM, van Bendegem JP (2009) (eds.) *Logic, Epistemology, and the Unity of Science*. Springer, Dordrecht.
- Pisano R, Casolaro F (2011–soumis) *Historical Inquiring On Geometry In Relativity. A Geometry Model (Part II) [CFV Cahiers]*.
- Stengers I (1993) *L'invention des sciences modernes*. La Découverte, Paris.
- Whittaker ET (1953) The relativity theory of Poincaré and Lorentz. In: *A History of the theories of aether and electricity*. Vol 2: The modern theories 1900–1926. Nelson, London, pp 27–77.
- Wolfgang R (2001) *Relativity: special, general and cosmological*. The Oxford University Press, Oxford.

**MODULE 20****SCIENCE TEACHING-LEARNING: HISTORY AND EPISTEMOLOGY OF GRAVITATIONAL WAVES / NoS****- *The conceptualisation of waves – Late Times Einstein's two theories of relativity***

38. Physics and mathematics of the twentieth century.
39. The role of Galileo's heritage for mechanics
40. The role of Newton's heritage for mechanics
41. The founding text of relativity: 1905, "Sur la dynamique de l'électron" - Poincaré
42. The problem of Aether
43. The Michelson-Morley experiment
44. The electromagnetic theory of Maxwell
45. The Lorentz transformations
46. The birth of Special Relativity
  - a. On the measurement of the speed of light and the principle of relative motion
  - b. On the addition of a description of gravitation
47. The development of General Relativity
48. General Relativity predictions
  - a. On gravitational waves

*Teaching - Albert Einstein. Biography and Works*

- a. 1905. The three fundamental articles on the theory of special relativity
- b. 1907. On mass and energy equivalence
- c. 1916. On the theory of general relativity
- d. 1921 (-2). *Nobel prize*
- e. 1937. On gravitational waves

*On Teaching - Theory of Special Relativity*

49. Galilean relativity and the principle of inertia
50. A heuristic point of view: the quantum of light
51. The concepts of space and time of Einstein's relativity
52. The postulates of special relativity
53. The experimental confirmations of the new theory
54. Relativity and simultaneity

*On Teaching - Physical Space-Time and Geometry and in the Theory of Special Relativity*

55. Physical space-time in Minkowski's theory
56. The transformation of Lorentz without the second postulate
57. Non-Euclidean Geometry and Time Coordinates. The case of hyperbolic geometry
58. The dilation of time and the twins paradox
59. The train in tunnel paradox
60. The problem of hard bodies and the Ehrenfest paradox

## 61. 1911-1912. Acceptance of special relativity

*On Teaching - Theory of General Relativity*

62. The problem of the laws of physics for the non-inertial system

63. Gravitation and acceleration

64. *Weighing mass and mass of inertia*

65. The role of Ricci Curvatures and Levi-Civita's results in relativity

66. The laws of the new theory

*On Teaching - Geometry of the Theory of General Relativity*

67. Riemannian Geometry: curved spaces

68. Geometry and gravitation

69. The gravitational field

70. The sources of gravitation

71. Einstein's equations

72. A short story about astrophysical implications: gravitational waves, black holes, cosmology

*On Teaching Epistemology - Epistemological Reflections on the Foundations of Einstein's Relativity*73. *Small historical reflections on controversies about the theory of special relativity*

74. The logical organization of Einstein's theories of relativity

*Teaching-Learning Bibliography*

Astolfi JP, Peterfalvi B (1993) Obstacles et construction de situations didactiques en sciences expérimentales. In: Aster, éditions INRP, n°16, pp.100-110.

Ballini P, Robardet G, Rolando JM (1997) L'intuition, obstacle à l'acquisition de concepts scientifiques: propositions pour l'enseignement du concept d'énergie en première S. In: Aster, éditions INRP, n°24, pp.81-112.

Benseghir A (1989) Transition électrostatique-électrocinétique ; point de vue historique et analyse des difficultés des élèves. Thèse, Université Paris 7.

Fawaz A, Viennot L (1986) Image optique et vision. In B.U.P., n°686, pp.1125-1146.

Galili I (1996) Students' conceptual change in geometrical optics. *Int.J.Sci.Educ*, vol.18, n°7, pp. 847-868.

Guilbert L, Méloche D (1993) L'idée de science chez les enseignants en formation : un lien entre l'histoire des sciences et l'hétérogénéité des visions ? In *Didaskalia*, éditions DeBoeck, n°2, pp.23-46.

Martinand JL (1993) Histoire et didactique de la physique et de la chimie : quelles relations ? In: *Didaskalia*, éditions de Boeck, n°2, pp.89-99.

Maurines L (2001) Le raisonnement géométrique en terme d'objet dans la physique des ondes. Mémoire d'habilitation à diriger des recherches, Université Paris 11.

- Mialaret G (2011) *Le nouvel esprit scientifique et les sciences de l'éducation*, PUF, Paris.
- Mialaret G (2017) *Les sciences de l'éducation*. Presses Universitaires de France, « Que sais-je ? », Paris.
- Piaget J, Garcia R (1983) *Psychogénèse et histoire des sciences*, éditions Flammarion.
- Toussaint J, Gréa J (1996) *Construire des concepts et mettre en œuvre des raisonnements, ce que peut apporter un regard sur l'histoire des sciences*. In: *Didactique appliquée de la physique chimie*, éditions Nathan, pp.86-118.
- Viennot L (1996) *Raisonner en physique*, éditions De Boeck.
- History and Historiographies: Reading Texts*
- Poincaré's thought and contribution to modern science
- Einstein-Podolsky-Rosen's thought and contribution on the physical description of reality
- Einstein's thought and contribution to the world
- Darrigol's thought and contribution to the mystery of the Einstein-Poincaré connection
- Primary Sources: Reading Texts*
- Balibar F (1993) (ed) *Albert Einstein, œuvres choisies, volume 1 : Quanta*. Éditions du Seuil / Éditions du CNRS, Paris.
- Balibar F (ed) (1993) (ed) *Albert Einstein, œuvres choisies, volume 2 : Relativité*. Éditions du Seuil / Éditions du CNRS, Paris.
- Einstein A (1925) *Sur l'électrodynamique des corps en mouvement*. Gauthier-Villars, Paris [réimprimé aux Éditions Jacques Gabay, Paris en 2005]
- Einstein A (1991) *Œuvres choisies*. Éditions du Seuil, Paris.
- Einstein A ([1934] 1983) *Comment je vois le monde*. Flammarion-Champs, Paris.
- Einstein A, Infeld L (1993) *L'évolution des idées en physique*. Flammarion-Champs, Paris.
- A First Specific Bibliography on the Module*
- Adair R (1987) *The Great Design: Particles, Fields and Creation*. The Oxford University Press, NY.
- Bachelard G (1951) *L'activité rationaliste de la physique contemporaine*. Presses Universitaires de France, Paris.
- Borel É (1913), *La théorie de la relativité et la cinématique*. *Comptes Rendus des séances de l'Académie des Sciences* 156: 215–218.
- Borel É (1914) *Introduction géométrique à quelques théories physiques*. Gauthier-Villars, Paris.
- Damour T, Darrigol O, Duplantier B, Rivasseau V (2006) (eds) *Einstein, 1905–2005. Poincaré Seminar 2005*, Birkhäuser Verlag, Basel.
- Darrigol O (2000) *Electrodynamics from Ampère to Einstein*. The Oxford University Press, Oxford.
- Darrigol O (2004) *The Mystery of the Einstein–Poincaré Connection*. *Isis* 95(4):614–626.

- Darrigol O (2006) The Genesis of the theory of relativity In: Damour T, Darrigol O, Duplantier B, Rivasseau V (eds) 2006, Séminaire Poincaré 1:1–22, op. cit.
- Dirac PAM (1978) *Direction in Physics*. Wiley, NY.
- Einstein A ([1921] 2005) *Quatre conférences sur la théorie de la relativité*. [Texte de quatre conférences prononcées à l'université de Princeton en 1921] Dunod, Paris.
- Einstein A (1927). Newtons Mechanik und ihr Einfluss auf die Gestaltung der theoretischen Physik, *Naturwissenschaften* 15:273–276. Trad. fr. par le Cnel Cros. La mécanique de Newton et son influence sur l'évolution de la physique théorique. In: Einstein A [1934]1983, pp. 180–193, op. cit.
- Einstein A (1956) *La théorie de la relativité restreinte et générale*. Gauthier–Villars, Paris.
- Einstein A, Freud S ([1933] 2005) *Pourquoi la guerre ?* Rivages, Paris
- Feynman R (1985) *QED: The Strange Theory of Light and Matter*. Princeton University, Princeton, NJ.
- Gillispie CC (ed) (1970–1980) *Dictionary of Scientific Biography*. Charles Scribner's Sons, New York.
- Hawking SW, Israel W (1980) (eds) *General relativity. An Einstein centenary survey*. The Cambridge University Press, Cambridge.
- Holton G (1988) *Thematic Origins of Scientific Thought: Kepler to Einstein*. The Harvard University Press, Cambridge–MA.
- Keswani G H, Kilmister CW (1983) *Intimations Of Relativity: Relativity Before Einstein*. The British Journal of Philosophy of Science 34(4):343–354.
- Kragh H, Marage P, Vanapaemel G (2002) (eds) *The history of Modern Physics*. Brepols, Liège.
- Lecat M (1924) *Bibliographie de la relativité*. Lamertin, Bruxelles.
- Lorentz HA, Einstein A, Minkowski M, Weyl H (1923) *The principle of relativity. A collection of original memoirs on the special and general theory of relativity*. Dover, NY.
- Max Born M ([1923] 2003) *La théorie de la relativité d'Einstein et ses bases physiques*. Gabay, Paris.
- Nagel E (1961) *The Structure of Science: Problems in the Logic of Scientific Explanation*. Harcourt–Brace & World Inc, New York.
- Neil Ashby N (2002) *Relativity and the Global Positioning System*. *Physics Today* 55(5):41–47.
- Pais A (2005) *Albert Einstein – Sa vie, son œuvre, Interéditions*. Dunod, Paris
- Paty M (2004) *Albert Einstein, ou la création scientifique du monde*, Belles Lettres, Paris.
- Paty M (1979) *Sur le réalisme d'Albert Einstein*. *La Pensée* 204:18–37.
- Paty M (1999) *La création scientifique selon Poincaré et Einstein*. In: Serfati M (ed) *La recherche de la vérité : Coll. « L'Écriture des Mathématiques »*, ACL–Éditions du Kangourou, Paris, pp. 241–280.
- Paty M (2003) *La physique du XXe siècle*. EDP Sciences, Les Ulis.

- Penrose R (2004) *The Road to Reality. A complete guide to laws of the universe*. Knopf, NY.
- Pisano R, Vincent P (2018) *Methods and Cognitive Modelling in the History and Philosophy of Science—&—Education Special Issue Transversal Historiography of Science* 5:3-9.
- Pisano R, Anakkar A (2017) *Reading Science, Technology and Education: A Tradition Dating back to Science into the History and Historiography. Transversal Historiography of Science* 3:77-97.
- Pisano R, Bussotti P (2017) *The Fiction of the Infinitesimals in Newton's Works: A note on the Metaphoric use of Infinitesimals in Newton. Special Issue Isonomia* 9:141-160.
- Pisano R, Bussotti P (2016) *A Newtonian Tale Details on Notes and Proofs in Geneva Edition of Newton's Principia (avec Paolo Bussotti). Bulletin—Journal of the British Society for the History of Mathematics* 31(3): 160-178.
- Pisano R, Bussotti P (2015) *Historical and Philosophical Reflections on the Culture of Machines around the Renaissance: Machines, Machineries and Perpetual Motion. Acta Baltica Historiae et Philosophiae Scientiarum* 3(1):69–87.
- Pisano R, Bussotti P (2015) *Exploring Changes in How the Histories of the Exact Sciences Have Been Written: Interpreting the Dynamics of Change in These Sciences and Interrelations amongst Them—Past Problems, Future Cures? Advances in Historical Studies Special Issue* 4(2):65–67.
- Pisano R, Bussotti P (2015) *Newton's Philosophiae Naturalis Principia Mathematica « Jesuit » Edition: The Tenor of a Huge Work. Atti Accademia Nazionale Lincei Rendiconti Lincei Matematica e Applicazioni* 25:413–444
- Pisano R (2014) (ed.) *Isaac Newton and his Scientific Heritage: New Studies in the History and Historical Epistemology of Science. Special Issue. Advances in Historical Studies* 3/3.
- Pisano R, Bussotti P (2014) *Notes on mechanics and mathematics in Torricelli as physics mathematics relationships in the history of science. Problems of Education In: The 21st Century International Journal. Special Issue* 61(61):88–97.
- Pisano R, Capecchi D, Lukešová A (eds.) (2013) *Physics, Astronomy and Engineering. Critical Problems in the History of Science. International 32nd Congress for the SISFA—Italian Society of Historians of Physics and Astronomy. The Scientia Socialis UAB & Scientific Methodical Centre Scientia Educologica Press, Šiauliai University, Lithuania.*
- Pisano R, Bussotti P (2013) *On Popularization of Scientific Education In Italy Between 12th And 16th Centuries. Problems of Education in the 21st Century* 57:90–101.
- Pisano R, Bussotti P (2013) *Open problems in mathematical modelling and physical experiments: exploring exponential function. Problems of education in the 21st century* 50(50):56–69.



- Pisano R, Mellone M (2012) Learning Mathematics In Physics Phenomenology and Historical Conceptual Streams. *Problems of Education in The 21st Century* 46:93–100.
- Pisano R, Casolaro F (2012) An Historical Inquiry On Geometry In: Relativity. Reflections on Late Relationship Geometry–Physics (Part II). *HR* 2(1):56–64.
- Pisano R, Casolaro F (2012) An Historical Inquiry On Geometry In: Relativity. Reflections on Early Relationship Geometry–Physics (Part I). *HR* 1(1):47-60.
- Pisano R (2011) Physics-mathematics relationship. Historical and Epistemological notes. In: Barbin E, Kronfellner M, Tzanakis C. (eds), *ESU–6 European Summer University on The History And Epistemology In Mathematics*, The University of Vienna Press, pp. 457-472.
- Pisano R (2010) On Principles In Sadi Carnot’s Thermodynamics (1824). Epistemological Reflections. *Almagest International Interdisciplinary Journal* 2(2010):128–179.
- Poincaré HJ (1889) *Théorie mathématique de la lumière*. Carré & Naud , Paris
- Poincaré HJ (1900a) Les relations entre la physique expérimentale et la physique mathématique. *Revue générale des sciences pures et appliquées* 11:1163–1175.
- Poincaré HJ (1900b) La théorie de Lorentz et le principe de réaction, *Archives néerlandaises des sciences exactes et naturelles* 5:252–278.
- Poincaré HJ (1913) *Dernières pensée*. Flammarion, Paris.
- Whittaker ET (1953) The relativity theory of Poincaré and Lorentz. En: *A History of the theories of aether and electricity*. Vol 2: The modern theories 1900–1926. Nelson, London, pp. 27–77.
- Wolfgang R (2001) *Relativity: special, general and cosmological*. The Oxford University Press, Oxford.
- Zahar E (1987) Les fondements des mathématiques d'après Poincaré et Russell. *Fundamenta Scientiae VIII* 1987:31–56.
- Zahar E (1989) *Einstein's Revolution: A Study in Heuristic*. The Open Court Publishing Company, Chicago.

This is the end of the documents adapted from the works and teaching of my thesis director, Prof. dr. Raffaele Pisano.

## 8.5 Designing an Experiment

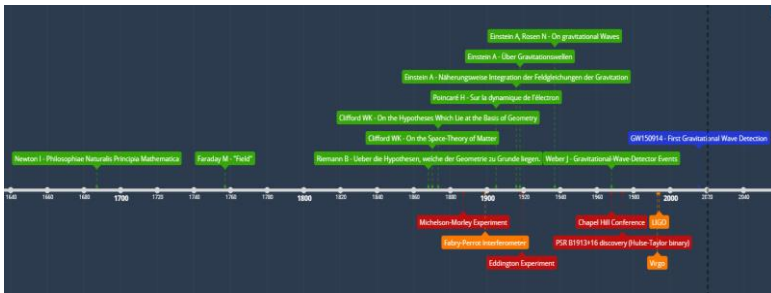
The RTDC, the experiment consisted of an introductory lecture focussing mainly on the core concepts at the basis of the gravitation waves. This introductory lecture aims to present the timeline of the discovery and to describe the main key moments at which the core concepts emerged. During the exploration of this timeline, these key concepts are overviewed and taught through examples and analogies when deemed necessary.

This introductory lecture serves multiple purposes, e.g.:

- as an introduction to the curricula and the following lectures described in the modules;
- as a first encounter with the concepts on which the physics of gravitational waves are based on;
- painting how science progresses (paradigm shifts, timescales, human endeavour);
- familiarizing the learners to Epistemology, HPS and NoS teachings;

*The introductory lecture.*

- After a brief presentation on NoS teaching-learning, the students are informed that this lecture is an introductory lecture on gravitational waves that is part of a wider curricula which is divided into independent modules.
- Learners are told that a new discovery in physics happened on September, 14<sup>th</sup> 2015 with GW150914; this discovery being the first measurement of gravitational waves which, as their name suggest, are related to both the Physics of Waves and Gravitation and the existence of which were predicted almost exactly a century ago by Albert Einstein and his theory of General Relativity.
- Learners are then told that this amazing discovery is unique for several reasons; in particular because the phenomenon that produced these gravitational waves is a phenomenon of the infinitely great (Binary Black Holes collision) measured in the infinitely small (which considering the scales involved is the realm of Quantum Mechanics).
- The learners are then taught about the fundamental concepts involved in gravitational waves phenomena through their historical and epistemological contexts; in order to do so, the teacher provides a simplified timeline of the main discoveries and concepts emergence.



**Fig. 8.5.a.** Timeline of the main key events that led to the discovery of gravitational waves. *Legenda:* In green publications and conceptual developments, in red historical events, in orange technological advances, and in blue the first gravitational wave detection. Source: PV

- The sequence being a quick conceptual overview:
  - Starting with Physics of Waves
    - Recap;
  - Newton and his theory of Gravitation
    - Recap;
  - The concepts of fields and gravitational field
    - Examples and analogies;
  - Riemannian Geometry (Curved Spaces)
    - Examples of flat, positively and negatively curved spaces;
    - notions of distances,
    - geodesics,
    - curvature,
    - parallel transport;
  - Clifford's conceptions of physical space
    - *On the Space-Theory of Matter* excerpt (Clifford 1870);
  - Poincaré's *Sur la dynamique de l'électron* excerpt (Poincaré 1905)
    - Speed of gravity,
    - Coined the term *gravitational wave*,
    - Speed of light,
    - Lorentz transform,
    - Michelson-Morley experiment (1887)
  - Einstein's Relativities
    - Special Relativity
      - Invariance of the speed of light
      - Events, worldlines,
      - No simultaneity
    - General Relativity
      - Inertial Reference Frames

- Predictions
  - Precession of the perihelion of Mercury
  - Bending of light
  - Black Holes
  - Gravitational waves
  - The detection of Gravitational Waves
    - Impossibility to detect? *On Gravitational Waves* (Einstein 1937)
    - Weber bars
    - LIGO/Virgo
  - Towards a new Cosmology

Estimated total time: 1h30

This introductory lecture to gravitational waves and their history is without a doubt very dense, however the preliminary results of the RTDC (Section 7.8) were very encouraging all things considered.

## 8.6 An *ad hoc* Modelling, A Proposition

An overview of the modules and their content (Cfr. Appendix for more details):

Module 1: Bernhard Riemann (1826-1866) & William Kingdon Clifford (1845-1879)

- Historical Context
- Epistemology and Natural Philosophy in the 19<sup>th</sup> century
- Geometry (Clifford)
  - points, lines, surfaces and volumes
- Geometry (Riemann)
  - Magnitudes (dimensions)
  - Extended Magnitudes (spaces)
  - Measure-relationship (distances)
  - Different kinds of Spaces
  - Curved Spaces, Euclidean and Non-Euclidean Geometry
  - Riemannian surfaces
- Differential Geometry
  - Topology and manifolds
  - Geodesics
- On physical space conceptions
  - Riemann
  - Clifford
- Metric
- Riemann Curvature Tensor

Module 2: Henri Poincaré's 1905 paper (1854-1912)

- Historical context
- Epistemology and Science in the Early 20<sup>th</sup> century
  - William Thomson, Lord Kelvin (1824-1907)
  - Ernst Mach (1838-1916)
  - Pierre Duhem (1861-1916)
- Speed of gravity,
- coined the term gravitational wave,
- Speed of light and Michelson-Morley experiment (1887)
- Lorentz transform
- Towards Einstein's Relativities

Module 3: Special Relativity

- Historical context
- Epistemology and Science, the principles of relativity
- Galileo's and Einstein's Principles of Relativity

- Special Relativity
  - From Newton's Absolute time and space
  - Invariance of the speed of light
    - No Simultaneity
  - Speed of causality
  - Minkowski space
  - Spacetime
    - Events, worldlines and spacetime interval
      - Pythagorean theorem and generalization
      - Proper time
    - Spacetime diagrams
    - Light cones
    - Paths
    - Difference with everyday life
  - Lorentz transform
    - time dilation, length contraction, Lorentz factor
  - Metric

#### Module 4: General Relativity

- Generalisation of Newton's Theory
  - Newton's Gravitation
  - Laplace's gravitational field
- Principle of Equivalence
- Gravitation as space curvature
- Geodesics, Parallel transport and Riemann Curvature Tensor
- Pythagoras theorem generalization to any space
- Tensors
  - Metric tensor
  - Metric tensor and a perturbation
- Stress Energy Tensor
- Other types of Tensors, Ricci curvature Tensor, Weyl Tensor
- Einstein Tensor, Einstein field Equations
- Tensor Calculus

#### Module 5: Quantum Mechanics, Physics of Waves and Optical Measurements

- Historical context
- Epistemology and Science of the Physics of Waves
- Waves
  - Types of Waves
  - Sources, Media and Interactions
  - Adding Waves
- Interferometers

- Charles Fabry's (1867-1945) *Les applications des interferences lumineuses* (Fabry 1923)
- The Wave-particle duality of light and the Ultraviolet Catastrophe
  - Max Planck (1858-1947)
  - Light as a wave
    - Huygens principle
    - Young's Double Slit Experiment
  - Light as a particle
    - Photoelectric Effect
    - Bohr model of the atom
    - Schrödinger Equation and Matrix Mechanics
      - Matrices
- Some principles
  - Mass-Energy equivalence
  - De Broglie's associated wavelength
  - Heisenberg's Uncertainty principle
  - Quantum noises, thermal, shot, back radiation

#### Module 6: Astronomy and Cosmology

- Different types of distances
- Doppler Effect, Redshift/Blueshift
- Types of Stars
- Black Holes
- Einstein Field Equations
- Cosmological Constant
- Expansion of the Universe
- The Universe
  - Composition and Structure
  - The Big Bang Theory
    - Inflation
    - Cosmic Microwave Background
  - Hubble Constant
    - Measurement Problem
  - The Future of the Universe
- Numerical Investigations
- Gravitational Waves
  - Findings
  - Perspectives
  - Multimessenger Astronomy

## 8.7 Discussion & Generalisation

The preliminary results showed that the RTDC had potential. Indeed, the amount of correct assessments of the statements of the “True or False” test (Cfr. Fig. 7.8.1.h) greatly increased in the post-lecture evaluation; notably statements n°5 (redshift), 6 (length contraction), 7 (relativity of spacetime), 9 (reference frames), 10 (invariance of the speed of light), 13 (Black holes and gravitational fields) and 18 (non-emission of gravitational waves by non-accelerating masses). This is especially remarkable concerning some of these statements; in particular when considering the notions and concepts called upon by some statements which are certainly accompanied by some of the hardest epistemological obstacles to overcome as well as by common misconceptions.

Furthermore, the lecture showed an increase in the interest of the participants in all the scientific fields presented as items of the questionnaire; with the only exception for the Philosophy of Science.

Participants globally enjoyed the experience:

- “That’s really great. The issue is that we try to represent ourselves things but it is not always feasible and all this seems less accessible. Very good but don’t go in too many directions at once.”(Participant 1)<sup>181</sup>
- “Very interesting lecture and good vulgarization for audiences with rather weak scientific background”<sup>182</sup> (Participant 2)
- “Clear and very interesting content. The explanations were detailed. I learned a lot through this course even if I don’t have the basics in science.”<sup>183</sup>

They became more self-assured in their comprehension of the subject matters related to gravitational waves and the history of their discovery; even if some felt that the lecture was very dense and definitely not easy:

- “The concepts which were approached were very abstract and sometimes confusing because they call into question our perception of time and its progress. The images, and analogies to explain the concepts have greatly helped to understand certain concepts and sometimes, it made me want to see the

---

<sup>181</sup> “C’est vraiment génial. Le problème, c’est qu’on essaie de se représenter les choses mais ce n’est pas toujours faisable et donc tout cela paraît moins accessible. Très bien mais ne va pas dans trop de directions à la fois.” (Participant 1)

<sup>182</sup> “Cours Très intéressant et bien vulgariser pour un public avec un bagage scientifique assez faible.” (Participant 2)

<sup>183</sup> “Contenu clair et très intéressant. Les explications étaient détaillées. J’ai appris beaucoup par ce cours même si je n’ai pas les bases en science.” (Marianne Zorzi Della Vedova)



mathematical aspect to go further. Space and its mysteries are centres of interest for me and these notions aroused a beginning of passion which if I had the means would have been a good motivation to resume my studies.”<sup>184</sup>

However, because of the small sample size, the high variation in the learners types and to the less than optimal conditions –not being at the university in a fully equipped amphitheatre or classroom–, the only sensible comment is that these preliminary results are encouraging but the data collected is not sufficient to draw any conclusion with a reasonable confidence index; therefore, this study need more investigation.

## 8.8 An Epistemological Inquiring: Methods and Falsifiability

Research shows that science education involves more than simple factual information exchanges and transmissions. Indeed, it also involves Nature of science and epistemology. Research has also shown that learning in an educational context is a social activity and therefore that the nature of science and science education is social; based on communities and driven by collaborations, cultures, practices, etc. (Cfr. Haré 1972)

The common goal of Epistemology, Science and Science education revolves around learning. If Science is about understanding the world, Epistemology is about the study of the understanding itself and Education is about how to pass on knowledge. However, while the specific purposes of the three disciplines slightly vary, they go beyond the simple accumulation or addition of knowledge.

In the general sense, Epistemology is the study of knowledge itself and poses questions such as “What is knowledge?”, “How is knowledge acquired?” and by extension “What is learning?”, “How do we learn?”, and so on.

The study of knowledge relies on many different concepts it attempts to define, e.g. experience, concepts, truth, beliefs, justification... but also raises questions about those concepts. For instance, there are arguably<sup>185</sup> three conditions required to assert that one has knowledge about something;

---

<sup>184</sup> “Les notions qui ont été abordées étaient très abstraites et parfois déroutantes car elle remettent en question notre perception du temps et de son déroulement. Les images, et analogies pour expliquer les concepts ont fortement aidés à comprendre certaines notions et quelques fois, cela m'a donné envie de voir l'aspect mathématique pour aller plus loin. L'espace et ses mystères sont des centres d'intérêt pour moi et ces notion ont éveillé un début de passion qui si j'en avais les moyens aurait été un bon moteur pour reprendre mes études.” (Charles-André)

<sup>185</sup> Cfr. (Gettier 1963)

according to the Stanford Encyclopedia of Philosophy <sup>186</sup>: “the three conditions—truth, belief, and justification—are individually necessary and jointly sufficient for knowledge of facts.”; but at the same time there are different ways of acquiring this knowledge; whether through direct experience, intuition, beliefs, from books, research papers, teachers, experiments, logical reasoning, and so forth. In fact, according to Petrie: “[W]e can ask how well our cognitive structures as wholes—representational schemes, theories, basic concepts and beliefs, methodologies for inquiry, and so on—allow us to deal with the world. (Petrie 2011, p. 71)”.

An Epistemological Inquiring is essential for several reasons; for instance, it provides the tools for a distancing that helps objectivity and inference, whether this distancing is relative to the History, History of Science or the foundations of the theory used and or studied, or in regards to the object of the study itself. Indeed, this provides the didactician with comparative grounds for their analyses; what led to the introduction or appearance of a concept, what were the Epistemological obstacles, etc. but the choice of the methods and their type (qualitative, quantitative or mixed) used in a research depends on many different factors such as the researchers’ ontological beliefs (e.g. realism versus relativism) which can influence the research’s philosophy (realism, pragmatism, positivism, constructivism, interpretivism); or the research question which determines the type of the research (applied versus fundamental); the type and size of data needed to be collected and influences the type of approach (inductive versus deductive), and so on.

*On The scientific method.* The general audience idea is that *the* scientific method is some kind of recipe that scientists follow in order to do scientific research in a reliable methodically fashion (Bauer 1992, p. 48, p. 63). The mainstream model consisting of 6 (or 7) steps:

- 1) Identify a problem
- 2) Do research
- 3) Formulate an hypothesis
- 4) Do experiments to test the hypothesis
- 5) Analyse data
- 6) Draw a conclusion

And sometime an additional step:

- 7) Communicate results

However, this extremely simplified and limited model is far from a good representation of the actual practice of science, for instance this depiction of *the* scientific method, unlike actual research, is very linear, fixed in time and poses several problems: could one be on different steps at the same time?

---

<sup>186</sup> Cfr. <https://plato.stanford.edu/index.html>

Could you go back to a previous step? and so on.

In actuality, there is no such thing as *the* scientific method; for instance, in behavioural sciences alone, “scientists use a plethora of specific research methods and a number of different investigative strategies” (Haig 2018, p. 35).

*On Scientific Philosophies Determining Methods.* Science is not the result of one unique scientific method neither is it the result of one theory. Different theories can be involving different methods, or different methods can be leading to different theories; theories can and *do* coexist. For instance, this might be best exemplified by the common idea that Quantum Mechanics and General Relativity are incompatible while both are used and furthermore, while both led to practical inventions and technological progress (e.g. respectively hard drives and the GPS system), both theories played a role for the same discovery: the measurement of gravitational waves. One of the roles of the philosophers of science is to reflect on all of these aspects:

How one construes theories usually determines his or her philosophical bent. The method by which one arrives at a theory, the interpretation of the language associated with it, the relation of one theory to another, the role theory plays in observation and subsequent experimentation are but a few of the questions typically dealt with by philosophers of science. (Loving 1997, p. 427)

As previously discussed, we are not only seeking the understanding of theories or concepts by students; the primary objective is to teach students about the nature of science in a reflective way so that they acquire an attitude and understanding of the nature of science and are able to assess evidence and knowledge claims, i.e. the validity and robustness of theories (Hogan 2000, p. 54):

Aspects of the nature of science that are considered to be important objectives of science education include understanding the nature, production, and validation of scientific knowledge; the internal and external sociology of science; and the people and processes of science (Aikenhead & Ryan, 1992). (Hogan 2000, p. 52)

Furthermore, this implies that in the same way that different theories are related to different methods, there are different philosophies of science with different points of view:

One extreme view is that we can never know the truth, but we can value theories for their usefulness toward some kind of clarity. Rather than either/or answers to positions regarding these and other notions, there are sometimes subtle shades and degrees of support or rejection.

- history or social setting can be used to judge science
- criteria are used for acceptance or rejection of theories
- knowledge is cumulative or noncumulative
- rationality or irrationality plays a role in theory justification or choice
- theories can be thought of as mere instruments or truth-seeking models
- presuppositions control the direction of a scientific endeavour (Loving 1997, p. 433)

Therefore, the fact that there is a spectrum of philosophies of science show that science is a human endeavour. Nevertheless, even if science is a human endeavour with all the consequent flaws and factors to consider, the question ultimately boils down to whether scientific results are invented or discovered:

[T]he argument surrounding the nature of science and the knowledge it reveals is often reduced to two opposing views. On the one hand, because of the centrality of sociocultural dimensions to all knowledge seeking, all or at least many explanations and methods of arriving at those explanations are equally valid—since validity may be a moot point and impossible to achieve by individually constructing human beings. On the other hand, there is a superior explanation—maybe even an ultimate truth— which involves rational thought and careful methods, rendering all sociocultural dimensions insignificant. My concern is that too few science educators are aware of the spectrum of current philosophies, their historical connections, and their answers to fundamental questions. (Loving 1997, p. 435)

However, either it is an invention and science teachers should educate their students in a balanced way with the sociocultural dimensions at the centre, providing them with various positions leading to equally valid explanations; or it is discovered and science educators should still educate their students in this way to adopt a wider view in order to reach the objectivity needed for doing science; thus both interpretations result in the same main objective as a consequence:

Science teacher education should strive for neutral ground, involving the best of various positions. First, it should provide science methods *and* science classes that promote active engagement, higher level thinking, real problem solving, and some depth in the history of science and explicit discussions of views on the nature of scientific inquiry. (Loving 1997, p. 447)

In order to do so, an Epistemological inquiring can help science educators identify points of interest to teach their students scientific criteria, e.g.:

- Identifying the different forms of scientific knowledge (theories, laws, theorems, etc.)
- The difference between observation and inference
- Understanding the difference between empirical knowledge and theoretical knowledge
- The problem of the objectivity versus subjectivity
- Scientific knowledge involves imagination
- Scientific knowledge validity, falsification, reproducibility, repeatability; therefore it is subject to change

*On falsifiability.* Falsifiability is a criterion of Popper’s idea about the analysis of theories in regards to what constitute a scientific theory from a “purely logical” point of view: that a theory is as strong as its predictions and can be temporarily taken as right but it can never be proven true; it can only be proven wrong (Cfr. Section 6.1).

However, Popper warned that this standpoint has its faults in regards to empirical sciences:

I am quite ready to admit that there is a need for a purely logical analysis of theories, for an analysis which takes no account of how they change and develop. But this kind of analysis does not elucidate those aspects of the empirical sciences which I, for one, so highly prize. (Popper 2005, p. 28).

Indeed, Popper argued that because of “those who uphold [their theories] dogmatically” (*Ibidem*), the ability to find a conclusive disproof is compromised in practice and gave an historical example to illustrate his point:

In point of fact, no conclusive disproof of a theory can ever be produced; for it is always possible to say that the experimental results are not reliable, or that the discrepancies which are asserted to exist between the experimental results and the theory are only apparent and that they will disappear with the advance of our understanding. (In the struggle against Einstein, both these arguments were often used in support of Newtonian mechanics, and similar arguments abound in the field of the social sciences.) If you insist on strict proof (or strict disproof\*1) in the empirical sciences, you will never benefit from experience, and never learn from it how wrong you are. (*Ibidem*)

Therefore, this implies that even if Popper’s argument that proof and disproof are not on equal footing from the theoretical standpoint, since theories can only be proven wrong, in practice the problem goes further as proofs and disproofs are downgraded to experimental results seemingly agreeing or disagreeing with the theory in the eye of the scientist willingly or unwillingly upholding his theory.

Thankfully, Popper stated that the solution of this problem lies in the methods:

Such are my reasons for proposing that empirical science should be characterized by its methods: by our manner of dealing with scientific systems: by what we do with them and what we do to them. (*Ivi*. p. 29)

Popper then explained that he was opposed to the view considering methodology as an empirical science even if there could be value in such a consideration:

This view, according to which methodology is an empirical science in its turn—a study of the actual behaviour of scientists, or of the actual procedure of ‘science’—may be described as ‘*naturalistic*’. A naturalistic methodology (sometimes called an ‘inductive theory of science’<sup>187</sup>) has its value, no doubt. [...] But what I call ‘methodology’ should not be taken for an empirical science. I do not believe that it is possible to decide, by using the methods of an empirical science, such controversial questions as whether science actually uses a principle of induction or not. And my doubts increase when I remember that what is to be called a ‘science’

---

<sup>187</sup> 5 Dingler, Physik und Hypothesis, Versuch einer induktiven Wissenschaftslehre, 1921; similarly V. Kraft, Die Grundformen der wissenschaftlichen Methoden, 1925

and who is to be called a ‘scientist’ must always remain a matter of convention or decision.

[...] Thus I reject the naturalistic view. It is uncritical. Its upholders fail to notice that whenever they believe themselves to have discovered a fact, they have only proposed a convention. (*Ivi.* pp. 30-31)

And gave very virulent reasons on his views of the conventionalists:

I admit, a conventionalist might say, that the theoretical systems of the natural sciences are not verifiable, but I assert that they are not falsifiable either. For there is always the possibility of ‘... attaining, for any chosen axiomatic system, what is called its “correspondence with reality”’ (*Ivi.* p. 60)

Indeed, short of accusing them or calling them frauds, he argues that when their system is threatened this “correspondence with reality” can be attained in a number of ways –using *ad hoc* hypotheses, modifying “ostensive definitions” or “explicit definitions”, “adopting sceptical attitudes as to the reliability of the experimenter”, consider observations as “insufficiently supported, unscientific, or not objective” or even calling the experimenter a “liar”,... (*Ivi.* pp. 60-61)–; the question then raised is about how to find the demarcation:

Indeed, it is impossible to decide, by analysing its logical form, whether a system of statements is a conventional system of irrefutable implicit definitions, or whether it is a system which is empirical in my sense; that is, a refutable system. [...]

The question whether a given *system* should as such be regarded as a conventionalist or an empirical one is therefore misconceived. *Only with reference to the methods applied* to a theoretical system is it at all possible to ask whether we are dealing with a conventionalist or an empirical theory. (*Ivi.* p. 61)

Therefore, it is not through the system itself, but through the methods used that we can discriminate between a conventionalist and an empirical theory.

Popper then gave guidelines on how to establish the methodological rules and avoid what he called “conventionalist stratagems”; for example:

As regards auxiliary hypotheses we propose to lay down the rule that only those are acceptable whose introduction does not diminish the degree of falsifiability or testability of the system in question, but, on the contrary, increases it. [...] If the degree of falsifiability is increased, then introducing the hypothesis has actually strengthened the theory: the system now rules out more than it did previously: it prohibits more. (*Ivi.* p.62)

Nevertheless, according to Popper knowledge was built on probability (Cfr. Section 6.1), therefore he clarified that there was a need to assess the significance of any contradicting occurrence:

We say that a theory is falsified only if we have accepted basic statements which contradict it (cf. section 11, rule 2). This condition is necessary, but not sufficient; for we have seen that non-reproducible single occurrences are of no significance to science. Thus a few stray basic statements contradicting a theory will hardly induce

us to reject it as falsified. We shall take it as falsified only if we discover a reproducible effect which refutes the theory. [...]

The requirement that the falsifying hypothesis must be empirical, and so falsifiable, only means that it must stand in a certain logical relationship to possible basic statements; thus this requirement only concerns the logical form of the hypothesis. (*Ivi.* pp. 66-67)

From all this, it is easy to see that conducting Epistemological Inquiries is very important in regards to the soundness of any theory. Furthermore for science education, an epistemological inquiring can also serve as a tool both for the didactician and the science educator to identify the differences between the knowledge to teach and the knowledge actually taught.

## 8.9 What About Falsifiability in Didactics of Physics– Mathematics

Didactics of Physics and Didactics of Mathematics are part of Didactics which is itself part of social science and humanities as discussed in Section 8.1. Therefore it is no surprise to see that it has to submit to the same problems. Indeed, they are about some of the most complex systems: humans; and therefore are burdened with systems to study with an incredible number of variables, whether dependant or independent, qualitative or quantitative, hierarchical or non-hierarchical, etc.

This problem is even more acute for sciences of education as they study systems within systems. For instance, considering a teaching activity in a classroom, the complete system involves at the very least each one of the individual students, the professor, the environment itself; and therefore all the variables of each one of the components of this complete system although, admittedly, not all variables are –always– relevant, nor do they have the same relevance.

For example:

- Classroom:
  - Temperature
  - Hygrometry
  - Luminosity
  - Windows:
    - number of windows
    - state of windows
    - weather:
      - sunny
      - ...
    - ...
  - ...
  - Equipment available:
    - white board:
      - size
      - distance from students
      - ...
    - computers
      - computing power available
      - operating system
      - ...
    - internet
    - seats
    - desks
    - ...



- Student 1:
  - Age
  - Temperature
  - Sugar level
  - Hormonal levels
  - ...
  - Psychological state:
    - Mood
    - Cognitive capacities
    - ...
- ...

These constraints have an effect to make data highly dependent on the experiment and, as a consequence, make repeatability and reproducibility a real challenge.

These common problems of the humanities, and social sciences, are well-known and widely recognized but still of great concern among many different disciplines.

Furthermore, research has shown that this led to trust problems regarding the scientific value of a lot of research papers and practices.

Indeed, probably because of the arduousness of replicating results, it seems that an overwhelming majority of research articles in sciences of education focus on experimental designs rather than replications; likewise, the replication of results seems to be less likely when the replications were done by third parties (Makel 2014).

Common solutions in education research, just like for other social sciences, involve randomization in order to make the conditions of the experiment as irrelevant as possible; the identification of relevant variables and their type; the idealization of students; data cleaning and so on (Osborne 2013).

However, even if the methods are relying on sound basis and done correctly, there is an inherent falsifiability resistance (Heene 2013) in these fields because of the complexity of the systems studied. While maximizing falsifiability is without a doubt vital, it is often extremely difficult to attain a satisfying level of it depending on the situation (especially when qualitative variables are considered). Therefore, in those cases, it is common to use *ad absurdum* proofs which are also an important type of scientific reasoning.

This type of reasoning has explanatory value; it is important for building theories which are in fact sets of inductive and empirical statements, and special attention should be accorded to statements confirmable by observation, to consequences of the theory, and to the principles used to make those claims.

However, beyond those, we have to recognize that the Didactics of a subject matter are not only submitted to the problems regarding these, but also to the problems of their specific subject matter (Tomamichel 2005). For instance,

when considering research articles, popular science articles or even textbooks, it appears that the very notion of refutability varies greatly:

[P]opular science articles view scientific findings as provisional rather than as incontrovertible fact as they are presented in textbooks or as they appear to be presented in research articles. Another feature of popular articles is that they are peopled with large numbers of specific scientists, thus representing scientists as ordinary people rather than as a few exceptional people of iconic status as is the case in textbooks. (Parkinson 2004, p. 379)

In textbooks, scientific knowledge and findings are often presented as objective facts to which a great level of certainty (if not absolute) is granted. On the other hand, from the noticeable use of hedging in research papers, it appears that the opposite is true. Indeed, authors are subject to different constraints such as much more critical readers and therefore are prone to being more careful (Parkinson 2005, p. 215).

Scientific research as an activity sharing these goals of established knowledge does not result in producing absolute truths, final explanations, or radical solutions. All new solutions are partial because, given the complexity of the situations, each solution favours the elements of the problem that seem to have priority in a moment and in a place. They are temporary because the situations evolve and priorities change.

Additionally, we have to recognize that an essential aspect of great theories left aside in textbooks is their ability to explain phenomena and/or point to the next steps to follow in order to solve yet unexplained phenomena or results. However, this could be explained by the fundamental unprovable nature of principles (e.g. the principle of least action in Physics), axiomatic definitions or postulates considered true or taken at face value (e.g. The Riemann Hypothesis in Mathematics).

Beyond that, the actual source of the data is another subject of problems and concern; including the methods both for the analyses of the quality of the samples and for the treatment of the data for analysis and interpretation:

Initial Data Analysis. The initial examination of data (Chatfield, 1985)<sup>188</sup> refers to the first informal scrutiny and description of data that is undertaken before exploratory data analysis proper begins. It involves screening the data for its quality. Initial data analysis variously involves checking for the accuracy of data entries, identifying and dealing with missing and outlying data, and examining the data for their fit to the assumptions of the data analytic methods to be used. Data screening thus enables one to assess the suitability of the data for the type of analysis intended. This important, and time-consuming, preparatory phase of data analysis has failed to receive the amount of explicit attention that it deserves in behavioural science education. (Haig 2018, p. 42)

---

<sup>188</sup> Chatfield, C. (1985). The initial examination of data. *Journal of the Royal Statistical Society, Series A*, 148, 214–254.

## 8.10 Teaching–Learning: Formal, Informal and Non-formal

As there are different social situations, social environments, settings, roles, relations and interactions, so too there are different types of teaching that can be identified. The discrimination between these types is primarily based on context, the knowledge provider and the structure of the teaching–learning. The literature on the subject of formal, informal and non-formal learning shows that there are no definitive consensus on the definition on each of these three types as there is overlap between the notions; in particular between informal and non-formal (Malcolm 2003, p. 315).

However, it could be argued that those differences are in fact nuances; just like in parallel reasoning where there are the nuanced concepts of exemplification, symmetry, resemblance and analogy. The argument goes as follows:

Our analysis strongly suggests that such attributes of formality/informality are present in all learning situations, but that the inter-relationships between such informal and formal attributes vary from situation to situation. It is important not to see informal and formal attributes as somehow separate, waiting to be integrated. This is the dominant view in the literature, and it is mistaken. Thus, the challenge is not to somehow combine informal and formal learning, for informal and formal attributes are present and inter-related, whether we will it so or not. The challenge is to recognise and identify them, and understand the implications. (*Ibidem*)

From this we are pressed to draw the conclusion that what matters for the distinctions are in fact the attributes of the learning situation themselves and their inter-relations, and not the learning situation as a whole. The authors propose a “heuristic device” (*Ibidem*) focussing on four main parameters in order to analyse these attributes (Cfr. Malcolm 2003, p. 315-316):

- *Process and Assessment,*
- *Location and setting,*
- *Purposes,*
- *Content.*

Moreover, with the development of technology and internet, the frontiers become more and more blurry when trying to categorise learning in those terms. Indeed, what about a student watching a recorded lecture on the internet?

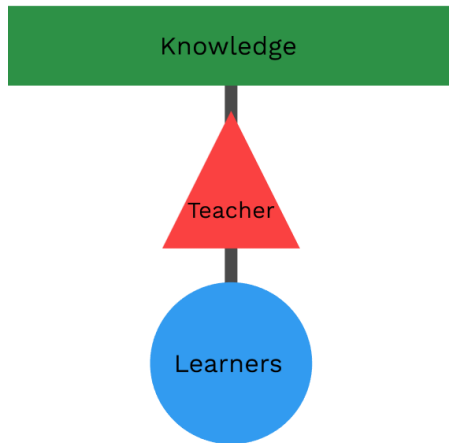
- The *process* can be considered formal as it is a university lecture or informal as it is incident of everyday activity. There are no *assessments* (unless the students does an auto-evaluation, e.g. using exercises with corrections).

- *Location and setting*, the student can be at home or in a library, watching the lecture passively or taking notes; or in a museum, exposition, or similar setting as Xperium.
- The student can be watching the video intentionally or not, for his personal development or for academic/work *purposes*.
- However, in this example of a recorded lecture, the *content* is most certainly of a formal nature. Although the nature of the *content* is not necessarily a clear discriminant.

Therefore we can see that the norms, values, patterns of behaviour, context and social roles which are crucial in the determining of the type of learning are in fact at the same time the issue.

*A proposal.* An attempt to find a solution could be to try to focus on the teaching aspect instead and judge the nature of the teaching–learning relationship based on the teacher and his position in regards to the learners and the directness of the interaction with knowledge:

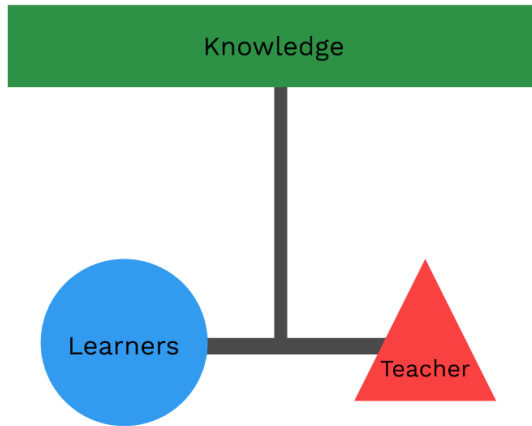
- Is this a setup in which the teacher who detains knowledge is transmitting it vertically?



**Fig. 8.10.a.** Vertical setup. The Teacher, located between Knowledge and Learners, is the intermediary. Example: Lectures (*Cours Magistraux*); Giving a fact. Source: PV

In this case, the focus should be put on the *Location, setting, and purpose*.

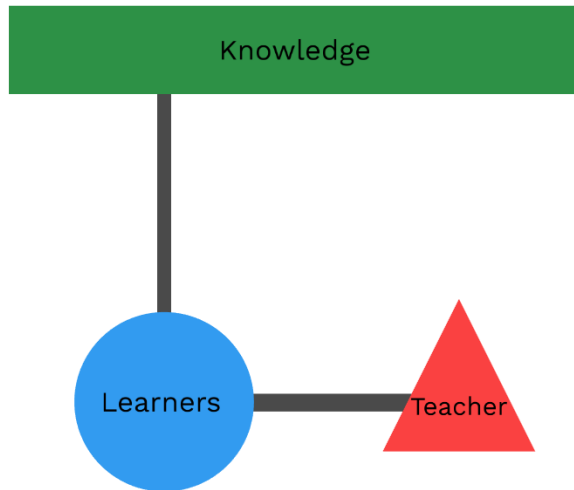
- Is this a horizontal setup?



**Fig. 8.10.b.** Horizontal setup. The Learners have a direct access to knowledge and to the Teacher who can help them reach it if needed. Example: Inquiry-based Learning; Trainer or work colleague. Source: PV

In this case the focus should be put on the *process, assessment* and *setting*.

- Is this a mixed setup?



**Fig. 8.10.c.** An example of a mixed setup: The Teacher asks a question or poses a problem and the Learners have to structure their learning and research themselves. Example: Exposés assignments. Source: PV

In which case the focus should be put on *assessment* and *purpose*.

Of course, besides considerations on the nature of the teaching–learning relation, this modelling can help the researcher structure their reasoning and setting their theoretical framework. And this, whether they are didactician, epistemologist or philosopher of science. It can also be useful for the parties involved to know in which situation they are as teachers and students naturally organize, consciously or not, in hierarchies.

Another value of this representation is that by formalizing the teaching–learning relationship with this model, the shifts that happen during a didactic situation and the shifts in behaviour appear explicitly.

As an example, during a Lecture a student asks the Professor a question. We thus have a transition as the teacher gives a direct answer; a transition from (Fig. 9.2.a.) to (Fig. 9.2.b) if the teacher gives elements of the answer to the student in order for them to reach the correct conclusion; or a transition to (Fig. 9.2.c) if the teacher answers the question by another question, or if the teacher poses a question aimed at testing the student’s knowledge, explicitly evaluating them.

After which, by transitioning back to (Fig. 9.2.a), the formal lecture resumes.

## **8.11 Scientific, Didactic and Epistemological Debate on the Results**

The original plan was to test the NoS Introductory module on the physics of gravitational waves and their discovery with Prof. Etienne Milent, who kindly offered to do (at least one of the) lectures, and some of his students (Licence IEEA – Electronic, Electrotechnical and Automatic Data Processing) that would have participated on a voluntary basis. Prof. Milent would have delivered the lecture, thus allowing me to focus on observing the situation.

Unfortunately, the COVID-19 pandemic happened and the Universities had to close.

Therefore, not too discouraged by the circumstances, I decided to try and do the next best thing and proceeded to do an online open lecture. Despite the less than engaging context, I still managed to get 9 participants.

Considering the global situation and their specific personal situations it is still something, although this number of participant is not even close to a bare minimum for a statistical analysis as the sample is much too small.

Besides the number of participants, there were other various limitations of the present study:

- No control groups
- The RTDC and Introductory Module lectures were performed (remotely) instead of at the University. In order to perform the

- teaching I had to use a VoIP software (Voice over Internet Protocol) which included the possibility of sharing my screen.
- One major problem with that was my inability to draw on a blackboard; I had to resort to using other means (e.g. native software)
  - Another major problem was that I could not see the learners
  - Due to planning constraints, I had to resort to do multiple lectures.
    - The major problem with that is the intrinsic resulting variability in my teaching and performance
    - Another issue is of course that the learners missed the questions asked by the other groups and their answers
    - I had a maximum of 4 participants at the same time which does not even compare to half of a standard classroom population
  - The composition of participants was very heterogeneous on several levels:
    - Education
    - Scientific Education
    - Age
    - Social and Economic Background
    - Interests
  - As an actor part of the system I could not observe the situation.
  - The post tests were sent back to me up to 48h after the lecture took place.

In the end, despite the fact that the original plan was to test the Introductory Module in the academic milieu, in a formal setup, in the end the RTDC was *de facto* much closer to a Scientific Mediation Conference.

Therefore, to my great regret it follows from this that the hypotheses could not be tested. For this reason, the *conceptual validity* could not be assessed beyond a theoretical standpoint as it only relies on preliminary results of a very small sample:

*Conceptual validity* (or construction, with reference to conceptual constructivism) consists of a simultaneous evaluation of the test and the theory (concept) which made it possible to build the test and whose test represents an operationalization. Although the most appreciated by theorists, conceptual validity seems to empiricists as a tautological validation: if the theory of the concept is coherent and consistent, and if the test measuring the concept is strictly founded (deduced, constructed from the theory), then all the measurements made with the test under different conditions must correspond to the predictions that theory provides for these conditions. The failure of the predictions deduced from the theory means that either the theory has problems of consistency or solidity, or the test is not a valid operationalization of the concepts of the theory, or both the test and the theory have faults. Conceptual validation is carried out by comparing all the classifications or all the predictions that can be made based on all of the theoretical propositions

relating to the concept under consideration. (Van der Maren 1996, p. 340 – Translation by PV)<sup>189</sup>

Therefore, the only certain statement that can be made is that this study needs further investigation.

In the perspective of a comparative didactics, it would be interesting to evaluate the results from different didactics on this exact subject in order to better understand their similarities and their differences. Moreover, with a larger scale study, the opportunity to analyse students productions, which could be especially interesting if done through the framework of comparative didactics.

## 8.12 Qualitative and Quantitative Choices

The qualitative and quantitative choices refer to general categories of the nature of variables examined:

Often the distinction between qualitative research and quantitative research is framed in terms of using words (qualitative) rather than numbers (quantitative), or using closed-ended questions (quantitative hypotheses) rather than open-ended questions (qualitative interview questions) (Creswell 2003, p. 4)

These variables can be further differentiated in regards to their hierarchical or non-hierarchical characteristics (if they can be organised in a specific, logic order, put on a scale or spectrum), or discrete and continuous characteristics. For instance:

- Qualitative variables
  - Non-hierarchical, e.g. Hobbies, Genre of films or books;

---

<sup>189</sup> La *validité conceptuelle* (ou de construction, en référence au constructivisme conceptuel) consiste en une évaluation simultanée du test et de la théorie (concept) qui a permis de construire le test et dont le test représente une opérationnalisation. Bien que la plus appréciée par les théoriciens, la validité conceptuelle paraît aux empiristes comme une validation tautologique: si la théorie du concept est cohérente et consistante, et si le test mesurant le concept est strictement fondé (dédit, construit à partir de la théorie), alors toutes les mesures effectuées avec le test dans des conditions différentes doivent correspondre aux prédictions que la théorie fournit pour ces conditions. L'échec des prédictions déduites de la théorie signifie que, ou bien la théorie a des problèmes de cohérence ou de consistence, ou bien le test n'est pas une opérationnalisation valide des concepts de la théorie, ou bien tant le test que la théorie ont des défauts. La validation conceptuelle s'effectue par la comparaison de tous les classements ou de toutes les prédictions que l'on peut faire en se basant sur l'ensemble des propositions théoriques se rapportant au concept envisagé. (Van der Maren 1996, p. 340)



- Hierarchical, e.g. Preferences or appreciations (for example: Not at all – not really – neutral – somewhat – absolutely);
- Quantitative variable:
  - Discrete (bijection with the set of natural numbers), e.g. number of persons, number of good or false answers;
  - Continuous (can take an infinite number of values), e.g. variables which can take real values such as precise measurements of temperature or weight.

However, it is important to note that the approach taken can influence the nature of these variables. For example, colour: asking people what is their favourite colour of tomato vs. asking to pinpoint their favourite colour on the spectrum of light.

The variables were chosen in order to evaluate several observables:

- To evaluate the interest of the participants on various fields in order to better ponder the impact of the lecture, as it is more probable that learners interested in the topic would perform better;
- To evaluate a shift in the interest of the participants about those fields, for essentially the same reason;
- To evaluate their familiarity and perceived knowledge of different terms and concepts linked to and surrounding the concepts invoked through the module;
- To evaluate their scientific skills, reasoning and perceived ability to manipulate mathematical tools, as many of these are necessary to get a good understanding of the subject matter;
- To evaluate their perceived capacity at explaining complicated concepts by mobilizing newly learned concepts, facts and tools;
- To evaluate their capacity at manipulating complicated concepts by mobilizing newly learned concepts to solve simple problems and discriminate correct from incorrect statement.

The primary end goal was to evaluate their understanding of the concepts necessary to comprehend gravitational waves, their physics, and how to detect them through the framework of a Nature of Science Lecture.

### **8.13 Structuring an Epistemological Framework: Modular Program**

At present, as discussed in Section 8.4, there is a lack of Epistemology teachings at all levels of scientific education. It appears that mathematics and physics teachings generally proceed according to the certainly flawed assumption that in schools (e.g., secondary high schools) only the teaching of a basic amount of mathematical and physical principles, as well as of equally basic experiments, is necessary.

Regardless of the role of Epistemology in the learning process, receiving an education in Epistemology is vital to scientific education and therefore to scientific progress. The skills developed thanks to the teachings including formal and informal epistemology are crucial for problem solving, critical thinking, and in order to make progress in academia as well as in the industry. However, only a rudimentary amount of epistemological considerations are taken into account in classic science teaching; hardly ever in a formal way, and most often brushed over as if it were a necessary evil despite the universal recognition of its utility.

Ideally, epistemological teaching should begin as early as possible, probably in conjunction with science teachings. However, not to put the cart before the horse, until a reform has taken place, the next best thing is to set science teachings in an epistemological framework.

Supported by Neuroscience and Cognitive Psychology, the rationale behind adopting an epistemological framework for a Nature of Science curricula is in essence of a deceptive simplicity. It is for this reason that this Modular Program could be conceptualized as a collection of intertwined historical standalone narratives teaching both about the real world and the greatest human endeavour that is science. Likewise, the use of analogies serves the –explicit– purpose of developing epistemological–philosophical aspects through the limits of the analogical models which also give rise to opportunities to question the ontological nature of the object of study.

## Epilogue III

In this chapter, we have gone through an analysis of what are the best approaches for the teaching of gravitational waves physics and discovery, and settled on a Nature of Science teaching using History of Science as a narrative in order to keep the learners grounded in fact and concrete examples.

To this end, we also put an emphasis on the use of analogies as a wonderful tool for learning and doing science in general.

Then, we ended up with an example of how to apply what was developed before by producing a complete curricula starting with a first module which is an introductory lecture to the physics and history of gravitational waves. The Introductory lecture having being tested despite a number of hardships, we proceeded to do the RTDC, a series of preliminary analyses of the pre-test and post-test of the lecture and justified by the fact that there is more to science than just the hypothetico-deductive reasoning (Cfr. Rozeboom 1997).

The experiment was a positive experience for the learners, but in order to bring a more conclusive answer, the data collection needs to be done on a larger sample, and certainly with less variance in the learners. Furthermore, the other Modules should also be tested in order to determine their impact and if they are also able to yield positive results. If possible, this should be done with the entire curricula over a longer period of time –a semester– and with multiple classes of the same level, but also of different levels for maximum efficiency.

But for now, future research will need to go deeper and examine different contexts (e.g., different teachers, grade levels, topics, cultural backgrounds, gender composition, socioeconomic background) keeping in mind that such research seems likely to provide science educators with valuable insights into how to effectively communicate science to learners; and learners with new exciting ways of discovering science.

# REFERENCES

## Primary Sources

- Bachelard G (1934) *La formation de l'esprit scientifique*. Vrin, Paris.
- Bachelard G (1940) *La Philosophie du Non : Essai d'une philosophie du nouvel esprit scientifique*. Quatrième Édition, Presses Universitaires de France, Paris.
- Duhem P (1906) *La théorie physique*. Vrin, Paris.
- Einstein A, Rosen N (1937) On gravitational waves. *Journal of the Franklin Institute*, 223/1:43–54. Doi:10.1016/S0016-0032(37)90583-0.
- Kuhn T (1962) *La structure des révolutions scientifiques*. Champs-Flammarion, Paris.
- Mach E (1898) *The science of mechanics; a critical and historical account of its development*. Translated by Thomas J. McCormack, Open Court Publishing Co., 1960, Chicago, London.  
Retrieved:  
<https://archive.org/details/sciencemechanic01machgoog/page/n8/mode/2up>
- Piaget J (1927) *La causalité physique chez l'enfant*. Librairie Félix Alcan, Paris.
- Piaget J, Duckworth E (1970) Genetic epistemology. *American Behavioral Scientist*, 13(3):459-480.

## Secondary Sources

- Adams WK, Perkins KK, Podolefsky NS, Dubson M, Finkelstein ND, Wieman CE (2006) New instrument for measuring student beliefs about physics and learning physics: The Colorado Learning Attitudes about Science Survey. *Physical review special topics-physics education research*, 2(1):010101.
- Aubin D (2004) Quelques tendances actuelles en histoire des mathématiques. A propos de trois livres récents. *Gazette des mathématiciens*, 102:91-100.
- Bage G (1999) *Narrative matters: teaching and learning history through story*. Psychology Press.
- Barbin E, Pisano R (2013) Historical Reflections on Physics Mathematics Relationship In: *Electromagnetic Theory* In: Barbin E, Pisano R, (eds). *The dialectic relation between physics and mathematics in the XIXth Century*. Springer, Dordrecht, pp. 31–57.
- Ben-Peretz M, Brown S, Moon B (eds.) (2004) *Routledge international companion to education*. Routledge.
- Boxtel CV, van der Linden J, Kanselaar G (2000) The use of textbooks as a tool during collaborative physics learning. *The Journal of Experimental Education*, 69(1):57-76.
- Bracco C (2015) L'environnement scientifique du jeune Albert Einstein: La période milanaise (1899-1901). *Revue d'histoire des sciences*, 68/1:109-144.
- Bracco C (2017) *Quand Albert devient Einstein*. Cnrs.
- Bracco C, Provost JP (2006) The quanta in Einstein's 1905 relativity theory. In: *AIP Conference Proceedings*, American Institute of Physics, 861/1:1076-1080.
- Bracco C, Provost JP (2018) Les années italiennes du jeune Einstein-La thèse oubliée sur les forces moléculaires. *Reflète de la physique*, (56):31-34.
- Braund M, Reiss M (2006) Towards a more authentic science curriculum: The contribution of out-of-school learning. *International journal of science education*, 28(12):1373-1388.
- Brousseau G (1990) *Le contrat didactique: le milieu*.
- Brousseau G, Balacheff N (1998) *Théorie des situations didactiques: Didactique des mathématiques 1970-1990. La pensée sauvage*, Grenoble.

- Brownlee JM (2003) Paradigm shifts in preservice teacher education students: A case study of changes in epistemological beliefs for two teacher education students. *Australian Journal Educational and Developmental Psychology* 3:1-6.
- Brun S J-L, Morellato M, Sensevy G, Quilio S (2017) Cooperative engineering as a joint action. *European Educational Research Journal* 17:187–208. <https://doi.org/10.1177/1474904117690006>
- Buonanno A (2007) Gravitational Waves. *Les Houches*, 3–52. doi:10.1016/s0924-8099(07)80027-8
- Buonomano D (2017) Your brain is a time machine: The neuroscience and physics of time. WW Norton & Company.
- Burko LM (2017) Gravitational Wave Detection in the Introductory Lab, *The Physics Teacher*, 55:288-292.
- Caramazza A, McCloskey M, Green B (1981) Naive beliefs in "sophisticated" subjects: misconceptions about trajectories of objects. *Cognition*, 9(2):117-123. Retrieved: [https://doi.org/10.1016/0010-0277\(81\)90007-X](https://doi.org/10.1016/0010-0277(81)90007-X)
- Carew TJ, Magsamen SH (2010) Neuroscience and education: An ideal partnership for producing evidence-based solutions to guide 21st century learning. *Neuron*, 67(5):685-688.
- Carey S (1986) Cognitive science and science education. *American psychologist*, 41(10):1123.
- Chaiklin S (2003) The zone of proximal development in Vygotsky's analysis of learning and instruction. *Vygotsky's educational theory in cultural context*, 1(2):39-64.
- Chang KE, Chen YL, Lin HY, Sung YT (2008) Effects of learning support in simulation-based physics learning. *Computers & Education*, 51(4):1486-1498.
- Chater N, Oaksford M (Eds.) (2008) *The probabilistic mind: Prospects for Bayesian cognitive science*. OUP Oxford.
- Chevallard Y, Johsua MA (1985) *La transposition didactique: du savoir savant au savoir enseigné*. La Pensée sauvage.
- Condé M, Salomon M (2017) Historiography of Science: The Link between History and Philosophy in Understanding Science. *Transversal: International Journal for the Historiography of Science*, 2:1-2. Retrieved: <http://dx.doi.org/10.24117/2526-2270.2017.i2.01>
- Crapanzano F (2018) "Strange Trajectories": Naive Physics, Epistemology and History of Science. *Transversal: International Journal for the Historiography of Science* 49. <https://doi.org/10.24117/2526-2270.2018.i5.06>
- Daw ND, Shohamy D (2008) The cognitive neuroscience of motivation and learning. *Social Cognition*, 26(5):593-620.
- de de Jong T, Van Gog T, Jenks K, Manlove S, Van Hell J, Jolles J, ... Boschloo A (2009) *Explorations in learning and the brain: On the potential of cognitive neuroscience for educational science*. Springer Science & Business Media.
- Dhombres J (1978) *Nombre, mesure et continu : épistémologie et histoire*. Cedic–Nathan, Paris.
- DiSessa AA (1982) Unlearning Aristotelian physics: A study of knowledge-based learning. *Cognitive science*, 6(1):37-75.
- Dias-Chiaruttini A (2017e) Le débat : enjeux didactiques, épistémologiques et disciplinaires. In: Fisher C., Gagnon R., de Pietro J.-F. (dir.) *L'oral aujourd'hui : perspectives didactiques*, Namur, Presses Universitaires de Namur, collection Recherche en didactique du français 9:67-85.
- Doneva R, Denev D, Totkov G (2006) On the didactic principles, models and E-Learning. *International Journal: Information Theories and Applications*, pp. 1-6.
- Duit R (1991) On the role of analogies and metaphors in learning science. *Science education*, 75(6): 649-672.
- Dykstra Jr DI, Boyle CF, Monarch IA (1992) Studying conceptual change in learning physics. *Science Education*, 76(6):615-652.
- Fairhurst S (2009) Triangulation of gravitational wave sources with a network of detectors. *New Journal of Physics*, 11(12), 123006. doi:10.1088/1367-2630/11/12/123006

- Fanselow MS, Poulos AM (2005) The neuroscience of mammalian associative learning. *Annu. Rev. Psychol.*, 56:207-234.
- Freire O (2016) Contemporary Science and the History and Philosophy of Science. Retrieved: <https://www.mprl-series.mpg.de/proceedings/8/8/>
- Friedmann A (1922) 125. On the curvature of space. *Zeitschrift für Physik*, 10:377-386.
- Gabel DL (1993) Handbook of Research on Science Teaching and Learning Project. Macmillan Publishing Company, Division of Macmillan, Inc., 866 Third Avenue, New York, NY 10022.
- Galili I (2001) Weight versus gravitational force: Historical and educational perspectives. *International Journal of Science Education*, 23(10):1073-1093.
- Gallistel CR, King AP (2011) Memory and the computational brain: Why cognitive science will transform neuroscience, Vol. 6. John Wiley & Sons.
- Gatto R (1994) Tra scienza e immaginazione: le matematiche presso il collegio gesuitico napoletano (1552-1670 ca.). LS Olschki.
- Gautreau R, Novemsky L (1997) Concepts first—A small group approach to physics learning. *American Journal of Physics*, 65(5):418-428.
- Glaser R (1988) Cognitive Science and Education. *International Social Science Journal*, 40(1):21-44.
- Goldman AI (1986) Epistemology and cognition. Harvard University Press.
- Goswami U (2008) Principles of learning, implications for teaching: A cognitive neuroscience perspective. *Journal of Philosophy of Education*, 42(3-4):381-399.
- Gundem BB (2000) Understanding European Didactics. Routledge International Companion to Education, pp. 235-262.
- Hammer D, Elby A (2003) Tapping epistemological resources for learning physics. *The Journal of the Learning Sciences*, 12(1):53-90.
- Hodson D (2014) Learning science, learning about science, doing science: Different goals demand different learning methods. *International Journal of Science Education*, 36(15):2534-2553.
- Hopmann S (1988) Lehrplanarbeit als Verwaltungshandeln. IPN.
- Johnson S, Taylor K (eds.) (2011) The Neuroscience of Adult Learning: New Directions for Adult and Continuing Education, 81(110). John Wiley & Sons.
- Kelly GJ, McDonald S, Wickman PO (2012) Science learning and epistemology. In: Second international handbook of science education. Springer, Dordrecht, pp. 281-291.
- Kéri S (2003) The cognitive neuroscience of category learning. *Brain Research Reviews*, 43(1):85-109.
- Kim SY, Irving KE (2010) History of science as an instructional context: Student learning in genetics and nature of science. *Science & Education*, 19(2):187-215.
- Kouneihier J (2005) Géométrie au XXe siècle, 1930-2000: histoire et horizons. Presses internationales Polytechnique.
- Kokkotas KD (2002) Gravitational wave physics. *Encyclopedia of Physical Science and Technology*, 7(3):67-85.
- Kosslyn SM, Behrmann M, Jeannerod M (1995) The cognitive neuroscience of mental imagery. *Neuropsychologia*.
- Kouneihier J (2005) Géométrie au XXe siècle, 1930-2000: histoire et horizons. Presses internationales Polytechnique.
- Kouneihier J (Ed.) (2018) Foundations of Mathematics and Physics One Century After Hilbert: New Perspectives. Springer.
- Kron FW (1994) Grundwissen didaktik. Reinhardt, München.
- Kuhn D, Weinstock M (2002) What is epistemological thinking and why does it matter?. Lawrence Erlbaum Associates Publishers.
- Kuhn L, Reiser B (2005) Students constructing and defending evidence-based scientific explanations. A paper presented at the annual meeting of the National Association for Research in Science Teaching, Dallas, Texas.
- Künzli R (1994) Didaktik: Modelle der Darstellung, des Umgangs und der Erfahrung. Zurich University, Didaktikum Aarau, Zurich.

- Lakatos I (1971) History of science and its rational reconstructions. In: PSA 1970. Springer, Dordrecht, pp. 91-136.
- Lakatos I (1980) Mathematics, Science and Epistemology: Volume 2, Philosophical Papers. Cambridge University Press.
- Lévy-Leblond JM (1996) Aux Contraires l'Exercice de la Pensée Et la Pratique de la Science.
- Ligozat F, Orange C, Dufays J-L, Doussot S, Quilio S, Loquet M, Tiberghien A, Martine J, Mercier A (2017) La modélisation des savoirs dans les analyses didactiques des situations d'enseignement et apprentissage. [Numéro thématique REE 29]
- Liston DD (1996) Changing Our Minds: The Struggle To Generate a Humanistic Neuroscience Language through Metaphors from Quantum Physics.
- Livingstone DN, Harrison RT (1981) Meaning through metaphor: analogy as epistemology. *Annals of the Association of American Geographers*, 71(1):95-107.
- Longair MS (2004) A brief history of cosmology. *Measuring and modeling the universe*, 2, 1-18.
- Louca LT, Zacharia ZC (2012) Modelling-based learning in science education: cognitive, metacognitive, social, material and epistemological contributions. *Educational Review*, 64(4):471-492.
- Marius-Costel E (2010) The Didactic Principles and Their Applications in the Didactic Activity. *Sino-US English Teaching*, Online Submission, 7(9):24-34.
- Maurines L, Mayrargue A (2003) Regard croisés de l'histoire des sciences et de la didactique de la physique sur le concept d'onde. La pluridisciplinarité dans les enseignements scientifiques, 1.
- Misner CW, Thorne KS, Wheeler JA (1973) GRAVITATION. W. H. Freeman and Company, San Francisco
- McComas WF (2002) The Nature of Science in Science Education, Rationales and Strategies. McComas (ed), Kluwer Academic Publishers, New York, Boston, Dordrecht, London, Moscow.
- McComas WF, Almazroa H, Clough MP (1998) The Nature of Science in Science Education: An Introduction. *Science & Education*, 7:511. Doi:10.1023/A:1008642510402
- McGrath D, Wegener M, McIntyre, TJ, Savage C, Williamson M (2010) Student experiences of virtual reality: A case study in learning special relativity. *American Journal of Physics*, 78(8):862–868. doi:10.1119/1.3431565
- Navarro J (2012) A History of the Electron: JJ and GP Thomson. Cambridge University Press.
- Nersessian NJ (2003) Kuhn, conceptual change, and cognitive science. Thomas Kuhn, pp. 178-211.
- Niedderer H, Goldberg F, Duit R (1992) Towards learning process studies: A review of the workshop on research in physics learning. *Research in physics learning: Theoretical issues and empirical studies*, pp. 10-28.
- Niedderer H, Schecker H (1992a) Towards an explicit description of cognitive systems for research in physics learning. *Research in physics learning: Theoretical issues and empirical studies*, pp.74-98.
- Oliveira ARE (2014) A history of the work concept. Springer, Dordrecht.
- Perkins K, Adams W, Dubson M, Finkelstein N, Reid S, Wieman C, LeMaster R (2006) PhET: Interactive simulations for teaching and learning physics. *The physics teacher*, 44(1):18-23.
- Ploj Vrtič M (2009a) Model of ICT Implementation in the Technical Education. *Problems of Education in the 21st Century*, 14:144-158.
- Ploj Vrtič M (2009b) The Computer as a Modern Form of Communication in the Educational Process From the Teachers' Point of View. *Informatologia* 42(1):10-17
- Ploj Vrtič M (2009c) Enhancement of Educational Process Using Experience Based Tutoring Approaches. *Problems of Education in the 21st Century*, 14:7-22.

- Ploj Vrtič M (2012) The role of internet in education. Proceedings of DIVAI 2012-9th International Scientific Conference on Distance Learning in Applied Informatics, Štúrovo, Slovakia, pp. 243-249.
- Ploj Vrtič M (2014) Gamification of learning : an effective teaching method of a modern school or a fashion fad? Conference: 9th IOSTE Symposium for Central and Eastern Europe.
- Ploj Vrtič M, Pšunder M (2010) Future Teachers' Opinions on the Digital Competencies Obtained During Their Studies.
- Ploj Vrtič M, Pšunder M (2010a) Future Teachers' Opinions on the Digital Competencies Obtained During Their Studies. *Problems of Education in the 21st Century*, 24:95-105. Retrieved: [https://www.researchgate.net/profile/Mateja\\_Vrtic/publication/283345140\\_Future\\_teachers'\\_opinions\\_on\\_the\\_digital\\_competencies\\_obtained\\_during\\_their\\_studies/links/565d7af208aeafc2aac7b3fa/Future-teachers-opinions-on-the-digital-competencies-obtained-during-their-studies.pdf](https://www.researchgate.net/profile/Mateja_Vrtic/publication/283345140_Future_teachers'_opinions_on_the_digital_competencies_obtained_during_their_studies/links/565d7af208aeafc2aac7b3fa/Future-teachers-opinions-on-the-digital-competencies-obtained-during-their-studies.pdf)
- Ploj Vrtič M, Pšunder M (2010b) The Influence of the Field of Study on the Use of Modern Information and Communication Technologies Among Student and Teachers. *Informatologia*, 43(4):269-279.
- Ploj Vrtič M, Pšunder M (2014) Innovative pedagogy: Developing of pupils' competencies through the use of modern technologies in the classroom. In 10th International Scientific Conference on Distance Learning in Applied Informatics, Štúrovo, pp. 5-7.
- Ploj Vrtič M, Šorgo A (2016) Can we expect to recruit future engineers among students who have never repaired a toy? *Eurasia Journal of Mathematics, Science & Technology Education*, 12(2):249-266.
- Ploj Vrtič M, Župerl U, Javornik Krečič M (2013) Pedagogy 1: 1 In Higher Education: A Case Study. *Problems of Education in the 21st Century*, 57:102-110.
- Pisano R (2011) Physics–Mathematics Relationship. Historical and Epistemological notes. In Barbin E, Kronfellner M and Tzanakis C (eds.), *Proceedings of the ESU 6 European Summer University History And Epistemology in Mathematics*. Verlag Holzhausen GmbH–Holzhausen Publishing Ltd., Vienna, pp. 457–472.
- Pisano R, Bussotti P (2012) Galileo and Kepler: On Theoremata Circa Centrum Gravitatis Solidorum and Mysterium Cosmographicum. *History Research* 2/2:110–145.
- Pisano R, Bussotti P (2013) Notes on the Concept of Force in Kepler. In Pisano, Capecchi and Lukešová 2013, pp. 337–344.
- Pisano R, Sozzo S (2020) A Unified Theory of Human Judgements and Decision-making under Uncertainty. Submitted to Entropy Special Issue. *Quantum Models of Cognition and Decision-Making*. Andrei Khrennikov A, Bagarello F (eds).
- Pisano R, Vincent P (2019) Introduction. In: *IDTC Dossier Methods and Cognitive Modelling in the History and Philosophy of Science–&–Education, Transversal International Journal for the Historiography of Science* 5:3-9.
- Pisano R, Vincent P, Dolenc K, Ploj-Vrtič M (2020) Historical Foundations of Physics & Applied Technology as Dynamic Frameworks in Pre-Service STEM, *Foundations of Science* (Springer) <https://link.springer.com/article/10.1007%2Fs10699-020-09662-4>
- Prosser M, Millar R (1989) The “how” and “what” of learning physics. *European Journal of Psychology of Education*, 4(4):513.
- Radelet-de Grave P (1999) Relativité galiléenne et lois de conservation. In: *Revue des Questions Scientifiques*, 170(3):209-260
- Radelet-de Grave P (2009) L'analogie comme outil de découverte, in *Revue des Questions Scientifiques*, 180(1):1-32.
- Radelet-de Grave P (2009a) Guarini et la structure de l'Univers. *Nexus Network Journal* 11/3:393–414.
- Radelet-de Grave P (2010) Publishing Complete Works of the Great Scientists, An International Undertaking. In: *Crossroads : History of Science, History of Art, Essays by David Speiser*, Birkhäuser, Bâle, pp. 127-147



- Radelet-de Grave P (2012) Des montres pour calculer des vitesses: ou comment Kepler explique sa découverte des deux premières lois. In: *Philosophica*, 41-42(I-II):13-79.
- Radford L (1997) On Psychology, Historical Epistemology, and the Teaching of Mathematics: Towards a Socio-Cultural History of Mathematics. For the *Learning of Mathematics*, 17(1):26-33. Retrieved: [www.jstor.org/stable/40248219](http://www.jstor.org/stable/40248219)
- Rahman S, Iqbal M (2016) UNFOLDING PARALLEL REASONING IN ISLAMIC JURISPRUDENCE (I). Epistemic and Dialectical Meaning within Abū Ishāq al-Shīrāzī's System of Co-Relational Inferences of the Occasioning Factor
- Rahman S, Symons J, Gabbay DM, van Bendegem JP (2009) (eds.) *Logic, Epistemology, and the Unity of Science*. Springer, Dordrecht.
- Rahman S, Iqbal M (2018) UNFOLDING PARALLEL REASONING IN ISLAMIC JURISPRUDENCE: Epistemic and Dialectical Meaning in Abū Ishāq al-Shīrāzī's System of Co-Relational Inferences of the Occasioning Factor. *Arabic Sciences and Philosophy*, 28(1):67-132.
- Ramadas J (2009) Visual and spatial modes in science learning. *International Journal of Science Education*, 31(3):301-318.
- Recami E (2011). Einstein: le mie idee sull'Educazione. pp. 69-100.
- Reif F (2008) *Applying cognitive science to education: thinking and learning in scientific and other complex domains*. MIT press.
- Reuter Y, Cohen-Azria C, Daunay B, Delcambre-Derville I, Lahanier-Reuter D (2013) *Dictionnaire des concepts fondamentaux des didactiques*. De Boeck Supérieur.
- Rocha GR (2009) CONTROVÉRSIAS CIENTÍFICAS: O caso do modelo padrão da cosmologia. *Caderno de física da UEFS*, 7(01):65-85.
- Sahin M (2009) Exploring University Students' Expectations and Beliefs about Physics and Physics Learning in a Problem-Based Learning Context. *Eurasia Journal of Mathematics, Science & Technology Education*, 5(4).
- Sahin M (2010) Effects of problem-based learning on university students' epistemological beliefs about physics and physics learning and conceptual understanding of Newtonian mechanics. *Journal of Science Education and Technology*, 19(3):266-275.
- Sathyaprakash BS, Schutz BF (2009) Physics, astrophysics and cosmology with gravitational waves. *Living reviews in relativity*, 12(1):2.
- Saulson PR (1994) Fundamentals of interferometric gravitational wave detectors.
- Schlepppegrell M, Achugar M (2003) Learning language and learning history: A functional linguistics approach. *Tesol Journal*, 12(2):21-27.
- Schommer-Aikins M, Hutter R (2002) Epistemological beliefs and thinking about everyday controversial issues. *The journal of Psychology*, 136(1):5-20.
- Schutz BF (1989) Gravitational wave sources and their detectability. *Classical and Quantum Gravity* 6:1761–1780. <https://doi.org/10.1088/0264-9381/6/12/006>
- Sensevy G, Quilio S (2002) Les discours du professeur. Vers une pragmatique didactique. *Revue française de pédagogie*. <https://doi.org/10.3406/rfp.2002.2914>
- Sensevy G, Quilio S (2002) Teacher's discourse: Towards pragmatist didactics. 141:47–56
- Sensevy G, Santini J, Cariou D, Quilio S (2018) Preuves fondées sur la pratique, pratiques fondées sur la preuve: Distinction et mise en synergie. *Education et Didactique* 12:111–125
- Steup M, Neta R (2005) *Epistemology*.
- Teixeira ES, Greca IM (2012). The history and philosophy of science in physics teaching: a research synthesis of didactic interventions. *Science & Education*, 21(6), 771-796.
- Tytler R, Prain V (2010) A framework for re-thinking learning in science from recent cognitive science perspectives. *International Journal of Science Education*, 32(15):2055-2078.
- Van Heuvelen A (2001) Millikan lecture 1999: The workplace, student minds, and physics learning systems. *American Journal of Physics*, 69(11):1139-1146.

- Velázquez A, Assar S, Defude B, Rojas J (2008) Student Learning Styles Adaptation Method Based on Teaching Strategies and Electronic Media, pp 778–782.
- Viennot L (1979) Spontaneous Reasoning in Elementary Dynamics. *European Journal of Science Education*, 1(2): 205-221. DOI: 10.1080/0140528790010209
- Viennot L, Bradamante F (2007) Mapping Gravitational and Magnetic Fields with Children 9–11: Relevance, difficulties and prospects. *International Journal of Science Education* 29:349–372. <https://doi.org/10.1080/09500690600718245>
- Willis J (2010) The current impact of neuroscience on teaching and learning. *Mind, brain and education: Neuroscience implications for the classroom*, pp. 45-68.
- Zacharia ZC, Olympiou G (2011) Physical versus virtual manipulative experimentation in physics learning. *Learning and instruction*, 21(3):317-331

## Selected Additional References on the Subjects – Non-Cited in Above Running Text

- Bacon F (1620) *Novum Organum*.
- Braunstein JF (2008) *L'histoire des sciences: Méthodes, styles et controverses*. Vrin, Paris.
- Cepni S, Tas E, Kose S (2006) The effects of computer-assisted material on students' cognitive levels, misconceptions and attitudes towards science. *Computer Education* 46(2):192-205.
- Champagne AB, Klopfer LE, Anderson J (1980) Factors Influencing Learning of Classical Mechanics. *American Journal of Physics*, 48(12):1074-1079.
- Cook M (2008) Students' comprehension of science concepts depicted in textbook illustrations. *Electronics Journal of Science Education*, 12(1):39-52.
- Dias-Chiaruttini A (2010a) Dysfonctionnements et évaluations dans des débats interprétatifs : la place particulière de l'EI (erreur interprétative). *Les Cahiers Théodile* 9:111–137
- Dias-Chiaruttini A (2010b) Comment les performances-apprentissages en lecture sont analysés en didactique du français ? *Recherches en Didactiques: Les Cahiers Théodile* 10:9–30
- Dias-Chiaruttini A (2011a) Former les enseignants au débat interprétatif : places et enjeux des styles enseignants. *Repères*, pp. 117–134. <https://doi.org/10.4000/reperes.182>
- Dias-Chiaruttini A (2012b) Le discours des enseignants sur les œuvres lues en classe. In: Isabelle et Ferrier Béatrice (dir.) *Enseigner les “ classiques ” aujourd'hui*, Bruxelles, Peter Lang, Collection Théocrit 5:275-288.
- Dias-Chiaruttini A (2014a) *Actualités de la recherche en didactiques, Recherches en didactiques*, n17, Villeneuve d'Ascq, Presses Universitaires du Septentrion.
- Dias-Chiaruttini A (2017c) Introduction de la conférence de Jean-Paul Bronckart : Apports et limites de la quête d'identité disciplinaire. In: *Colloque Invention des espaces de travail : entre chemins individuels et pistes collectives*, Villeneuve d'Ascq, France
- Dias-Chiaruttini A (2017g) La forme scolaire des visites scolaires muséales : la scolarisation des médiations muséales. In: *Journée d'études PROSCITEC - Renouveler l'attractivité de la médiation scientifique, technique et industrielle auprès des jeunes publics*, Arras, France
- Dias-Chiaruttini A (2019h) Place du numérique et des médias sociaux dans l'expérience du visiteur scolaire au musée. *Revue de recherches en littérature médiatique multimodale*. <https://doi.org/https://doi.org/10.7202/1062030ar>
- Dias-Chiaruttini A, Cohen-Azria C, Souplet C (2016g) La visite scolaire au musée éclairée par des didactiques contrastées. In: *4ème colloque international de l'ARCD, Analyses didactiques des pratiques d'enseignement et de formation : quelles perspectives ?* Toulouse, France
- Fisher BW (1997) Computer modelling for thinking about and controlling variable. *School Science Review*, 79(287):87-90.

- Kose S (2008) Diagnosing student misconceptions: Using drawings as a research method. *World Applied Science Journal*, 3(2):283-293.
- Lindsey B, Heron P, Shaffer PS (2012) Student understanding of energy: Difficulties related to systems. *American Journal of Physics* 80(2):154-163.
- Mintz R (1993) Computerized simulation as an inquiry tool. *School Science and Mathematics*, 93(2):76-80.
- Pisano R (2008) A history of chemistry à la Koyré? Introduction and setting of an epistemological problem. *Khimiya* 2(17):143–161.
- Pisano R (2009) On method in Galileo Galilei's mechanics. In Hunger H (ed.), *Proceedings of 3<sup>rd</sup> Congress of the European Society for the History of Science*. The Austrian Academy of Science, Vienna, pp. 174–186.
- Pisano R (2013a) History Reflections on Physics Mathematics Relationship in Electromagnetic Theory. In Barbin and Pisano 2013, pp. 31–58.
- Pisano R (2014) (ed.) Isaac Newton and his Scientific Heritage: New Studies in the History and Historical Epistemology of Science. Special Issue. *Advances in Historical Studies* 3/3.
- Pisano R (2016a) What kind of Mathematics in Leonardo da Vinci and Luca Pacioli? *Bulletin–British Society for the History of Mathematics* 31:104-111.
- Pisano R (2016b) A Development of the Principle of Virtual Laws and its Framework in Lazare Carnot's Mechanics as Manifest Relationship between Physics and Mathematics. *Transversal–International Journal for Historiography of Science*, 2:166-203.
- Pisano R, Bussotti P (2014) Newton's *Philosophiae Naturalis Principia Mathematica* "Jesuit" Edition: The Tenor of a Huge Work. *Accademia Nazionale Lincei Rendiconti Lincei Matematica e Applicazioni* 25:413–444.
- Pisano R, Bussotti P (2014a) Galileo in Padua: architecture, fortifications, mathematics and "practical" science. *Lettera Matematica Pristem International* 2(4):209–221.
- Pisano R, Bussotti P (2014b) Historical and Philosophical Reflections on the Culture of Machines around the Renaissance. How Science and Technique Work? *Acta Baltica Historiae et Philosophiae Scientiarum* 2(2):20–42.
- Pisano R, Bussotti P (2015a) Historical and Philosophical Reflections on the Culture of Machines around the Renaissance: Machines, Machineries and Perpetual Motion. *Acta Baltica Historiae et Philosophiae Scientiarum* 3/1:69-87.
- Pisano R, Bussotti P (2015b) Introduction to Exploring Changes in How the Histories of the Exact Sciences from the 18th to through the 20th Century Have Been Written: Interpreting the Dynamics of Change in these Sciences and Interrelations Amongst Them—Past Problems, Future Cures? *Advances in Historical Studies Special Issue* 4(2):65-67.
- Pisano R, Bussotti P (2016) A Newtonian Tale Details on Notes and Proofs in Geneva Edition of Newton's *Principia* (avec Paolo Bussotti). *Bulletin–Journal of the British Society for the History of Mathematics* 31(3):160-178
- Pisano R, Bussotti P (2017) On the Conceptualization of Force in Johannes Kepler's *Corpus*: an Interplay between Physics/Mathematics and Metaphysics. In: Pisano R, Agassi J and Drozdova D (eds.), *Hypothesis and Perspective in History and Philosophy of Science. Homage to Alexandre Koyré 1892-1964*. Springer, Dordrecht, pp. 295-346
- Pisano R, Bussotti P (2017a) The Fiction of the Infinitesimals in Newton's Works: A note on the Metaphoric use of Infinitesimals in Newton. *Special Issue Isonomia* 9:141-160
- Pisano R, Capecchi D (2013) Conceptual and Mathematical Structures of Mechanical Science in the Western Civilization around 18th Century. *Almagest* 4(2):86–121.
- Pisano R, Capecchi D (2015) Tartaglia's science weights. *Mechanics in sixteenth century. Selection from Quesiti et invention diverse: Books VII–VIII*. Dordrecht, Springer.

- Pisano R, Capecchi D, Lukešová A (eds.) (2013) *Physics, Astronomy and Engineering. Critical Problems in the History of Science*. International 32nd Congress for The SISFA–Italian Society of Historians of Physics and Astronomy. The Scientia Socialis UAB & Scientific Methodical Centre Scientia Educologica Press, Šiauliai University, Lithuania.
- Pisano R, Gaudiello I (2009a) Continuity and discontinuity. An epistemological inquiry based on the use of categories in history of science. *Organon* 41:245–265.
- Pisano R, Gaudiello I (2009b) On categories and scientific approach in historical discourse. In Hunger H (ed.) *Proceedings of ESHS 3rd conference*. The Austrian Academy of Science, Vienna, pp. 187–197.
- Scherz Z, Oren M (2006) How to change students' images of science and technology. *Science Education*, 90(6):965-985.
- Sensevy G, Forest D, Quilio S, Morales G (2013) Cooperative engineering as a specific design-based research. *ZDM - Mathematics Education* 45:1–13. <https://doi.org/10.1007/s11858-013-0532-4>
- Weinberger P (2006) Revisiting Louis de Broglie's famous 1924 paper in the *Philosophical Magazine*. *Philosophical Magazine Letters*, Taylor & Francis, 86(7):405-410. Retrieved: <https://doi.org/10.1080/09500830600876565>





# **PART IV**

## **CONCLUSION**

# **CHAPTER IX**

## **Concluding Remarks**



## 9.1 General Conclusion

This interdisciplinary thesis (History and Epistemology of Science, Physics and Mathematics, Intellectual History of Science, Nature of Science) is inscribed in gravitational wave–astronomy and treats the case study of the history of the discovery of gravitational waves –which are invisible undulations in space generated by moving masses–. The narrative I reconstructed with this thesis, represents a synthesis consisting of the most major historical developments and events where the role, motivations and impact of different kinds of scientific figures has been examined.

I built an original History of Science synthesis in the field that encompasses the bulk of the most important discoveries that goes beyond purely historiographical–epistemological considerations of the last two centuries. In order to show and enrich this history via specific results and findings uncovered by my *in situ* research at Virgo (EGO, Italy) and at the Niels Bohr Library (*American Institute of Physics*, USA), I produced at the same time the bases of a framework that has great potential and interest for the Nature of Science discipline and its teaching. Specifically, the study of the historical roots of the concept of gravitational waves, brings to light lesser known scientific figures whose work should be examined deeper, but first and foremost, this historical study characterizes a prime example of how scientific theories, discoveries, research, and other endeavours interact and piece together in order to merge in an amazing final product.

Actually, beyond the fact that this is an astonishing discovery in itself which resulted from the cumulated efforts of great minds over many generations, what is perhaps the most interesting feature of this history is how it showcases the marriage of the scientific knowledge of the infinitely big and the infinitesimally small by using theories which are notoriously difficult to make coexist: General Relativity and Quantum Mechanics. Indeed, by seeking to complete Albert Einstein’s (1879-1955) General Relativity, this endeavour finally found its main remaining key. Even more extraordinary are the number of very recent results that are still heavily studied because of their theoretical implications for our understanding of the Universe, but also the new results that keep coming on a regular basis as the number of detections increases. This last point making us expect an increase in the strains on the various current theories and models coming from the constraints revealed by the detections, thus allowing to reduce the number of alternative theories. Furthermore, thanks to the success of this technological achievement come new projects (in space such as eLISA<sup>190</sup>, and on Earth such as third generation gravitational wave observatories<sup>191</sup>), expectations and hopes for more surprising and ground-breaking discoveries.

I had to make choices and I decided to focus on the key events and characters who either played a major role and without whom the story of this discovery

---

<sup>190</sup> Chapter 5

<sup>191</sup> *Ibidem*

would lose its meaning, or whose work and implications are less known, yet relevant and quite interesting. It should also be remarked that a number of ideas and discoveries were just lurking around, waiting to be discovered and were quite often discovered independently. In such contexts, like it is the case when trying to resolve priority questions, I showed that the comprehension of the problems and scientific questions were more akin to justified true beliefs with real theoretical weights rather than speculations or “What if?” questions.

Moreover, because of the wealth of such historical scientific contexts, it appears only natural that the framework of the Nature of Science is the logical best candidate for teaching-learning science. Indeed, the study of the historical development of concepts within their historical context including the study of the limits involved, whether technological, theoretical, methodological or otherwise brings an enormous added value to scientific teaching that goes beyond what one can expect from a purely physical/mathematical teaching. The only real objections on this issue being more about the form and not the substance; e.g. objectivity/bias, Ethics, relevance, teaching methods or approaches. However, we have to recognize that the benefits of NoS Teaching-Learning have to be balanced both in their content and against the costs of their practical implementations; i.e. the time investment of the teachers preparing the lectures, the time spent on the lectures, the students’ level of understanding aimed for and so on.

With respect to the general introduction (see above Part I), I examined and developed (see specific conclusion below) a historical and contemporary account on the role played by mathematics and physics within the history of gravitational waves. I also examined the role played by various scientists, including less known scientific figures; I studied my research dealt with technical studies by scientists and engineers whose contributions led to the discovery of gravitational waves. Furthermore, beyond the examination of the history of science relevant to the study of the roots of the concepts that lead to the discovery of gravitational waves, one of the aims of this thesis is also to contribute to the development of a NoS teaching account/curricula applying historical, physical, NoS and surrounding fields results through an *ad hoc* curricula. In particular, one of the main points I wanted to develop in this thesis is about the usefulness and recommended usage of representations; and in particular analogies as a tool for scientific teaching. Indeed, analogies are without a doubt one of the most powerful tools that can be used as a driving mechanism for comprehension, and by extension, for both theoretical insights and discoveries.

I also sought to demonstrate that the physics involved in the phenomenon of gravitational waves, especially General Relativity, is much more accessible than what is commonly thought among the field of scientific teaching.

As we have seen with regard to the teaching of physics, and more particularly fields such as Quantum Mechanics or General Relativity, which are notoriously very difficult to understand and therefore also to teach, the use of analogies and parallel reasoning is extremely reliable provided it is done correctly; i.e. by pushing the analogies and exploring their limits. Moreover,

complimented by the natural tendency of the NoS framework to prove solid foundations rooted in reality through the use of concrete examples, the use of analogies and parallel reasoning helps learners to overcome epistemological obstacles and avoid epistemological breaks.

## 9.2 Specific Conclusion

The problem I sought to resolve was I) how a scientific endeavour, spanning over centuries in which many scientists of different disciplines across different scientific fields participated, culminated in an extremely significant discovery, and II) how this created an innovative framework for scientific teaching.

The work I have done covers the time period that spans from the Renaissance through to present day, and the history of the roots of the concepts directly related to the concept of gravitational waves as well as adjacent ones which ultimately lead to their discovery, the current status of the research, and its future.

In the first part of this thesis, *The Physics of Waves* (see above pp. 1-49), I sought to provide the potentially unfamiliar readers with the tools required to have a sound comprehension of the concept of waves in Physics before introducing them to the current concept of gravitational waves, as this concept is far from being trivial.

In the first chapter, *The Waves* (see above pp. 1-49), I made the choice of addressing the physical aspects of waves and then the physical aspects of gravitational waves because an introduction on the Physics is necessary to better appreciate the history and implications of their development. Through my research, I obtained a part that also presents the readers with the recent discoveries made from the search for gravitational waves and the impact of the discovery on our understanding of current theories and the Universe. The result of this chapter is that, rather obviously, the concept of gravitational waves is based on the independently well-understood concepts of waves and gravity/gravitation, and therefore on the work of Newton and even those of Galileo which predate them as explained in the next part.

The second part of the thesis, *A History of Waves and the Case of Gravitation* (see above pp. 62-266), is the first core of the thesis. At this stage, there are no in depth books on the roots of the history of gravitational waves, therefore I analysed the historical fundamental roots on which gravitational waves are based. I traced the different paradigm shifts, the development of theories, their refutation, replacement and confirmation, chronologically from Antiquity through to our current understanding, and included the technological milestones and developments that ultimately lead to our contemporary techniques and achievements. I obtained the result that from the point of view of the History of Science, the concept of gravitational waves as we understand it today is not directly related to Newtonian theories, but instead to Einstein's theories. In addition, I explained that it belongs to the theory of General

Relativity in which time and space are unified in a single entity: spacetime; and that in this framework the properties of spacetime to deform and bend propagate these deformations under certain conditions. Furthermore, this part also explains the importance of this discovery for the future of research, especially in the fields of Astronomy and Cosmology. Indeed, the first measurement of gravitational waves was the first step towards a completely new way of surveying and investigating the Universe. As evidenced by the number of – often unexpected– discoveries that happened since I began writing this thesis, and judging by the number of future projects relevant to the study of this new Physics frontier, it is incontestable that we passed an extremely important milestone that marked the birth of a new kind of Astronomy and opened a completely new window from which to study the Universe. Since then, much progress has already been made, for instance, the results of the first observing runs have brought precisions and significantly increased a number of constraints on theories which in turn have risen and fallen.

In the second chapter, *Researching and Inquiring Waves into History* (see above pp. 62-130), I examined the foundations of the concept of Newton’s Theory of Gravitation in order to set the pieces for the main historical part. This part began with the roots of the concepts of gravitational waves starting from Antiquity with the Aristotelian ideas of motions through to and the science of weights and the development of modern science with Galileo Galilei (1564-1642) and then Isaac Newton (1643-1727). Following this, I examined the concepts of curved spaces and non-Euclidean Geometry with Bernhard Riemann (1826-1866) and obtained the results that:

1. Riemann played a fundamental role in Mathematics, particularly for the extension of Geometry, including differential geometry,
2. that he had an instrumental subsequent influence on the conceptions of space of Sir William Kingdon Clifford (1845-1879) who had very interesting ideas about the ontological nature of space;
3. that Clifford postulated that the actual geometry of space on infinitesimally small scales was not only non-Euclidean but could be curved and distorted,
4. additionally, he postulated that these properties of space of being curved or distorted propagated themselves “after the manner of a wave” which can be considered as a first ancestor of the concept of gravitational waves.

I implemented a historical comparative analysis between two Clifford and Poincaré’s remarkable works in regard to the concept of gravitational waves. It seems that my analysis between them is the first one. I obtained:

5. Very interesting change of dialectic upon similar subjects in the period of time. My analysis will impact further historical

analyses because there remains a list of things that ought to be investigated.

I then studied Oliver Heaviside's (1850-1925) analogy between electromagnetism and gravitation which he explored via parallel reasoning (resemblance between formulas) and which led him to postulate:

6. that the speed of the propagation of gravity was the same as that of light and
7. the possibility of the existence of perturbations that he nevertheless estimated not being measurable.

I developed an account on some of Henri Poincaré's (1854-1912) works which was extremely influential for the development of the Relativities, but not only, as he also played a role in the birth of Quantum Mechanics. From this, I obtained the result that he was the first to mention gravitational waves (*onde gravifique*) *per se* and thus coined the term. I also discuss the historical context of the birth of Special Relativity and how it was perceived at the time. I found, in particular through Émile Picard's (1856-1941) recollection of the events:

8. how and why Picard –and others– were first against the idea that the old conceptions of space and time had to be replaced, and
9. that he changed his position on the subject and ended up being so convinced that he wrote the first textbooks on Special and General Relativity.

I then discuss the *Ultraviolet Catastrophe* with most notably Max Planck (1858-1947) which is key to the development of Quantum Mechanics as well as discoveries related to Cosmology. I continued with Charles Fabry (1867-1945) and Alfred Perot (1863-1925) whose contributions to optics and the applications for wave interferences led to the Fabry-Perot cavities used in the current laser interferometers that detect gravitational waves. Finally, I concluded this chapter with an account on Louis de Broglie (1892-1929) and some of his contributions to the Physics of Waves and Quantum Mechanics, such as his idea of associated wavelength, because Relativity theories and Quantum Mechanics, and the development and applications of the Physics of Waves, are required for a more profound understanding of the principles at play in the detection of gravitational waves.

The third chapter, *Gravitational Waves: Theoretical Methods & Data* (see above pp. 139-179), is dedicated to the actual development of the current conception of gravitational waves, therefore it explores both Albert Einstein's Special and General Theories of Relativity in detail with examples and analogies. Furthermore, this chapter incorporates a study of Poincaré's text featuring most notably, but not only:

10. the first mention of gravitational waves and how he obtained this result,
11. that he worked with a speed of gravity that was
  - a. finite and
  - b. actually the same as the speed of light,
12. that he thought that the Michelson-Morley experimental result was correct and providing an ontological insight on the nature of space.

From this, I analysed the bases of the principles of the Relativities, the explanatory analogies justifying them and their implications for physical phenomena. As a final point, I finished with an account on Einstein's debate on the actual existence of gravitational waves which underscores the difficulty encountered with the development of both the concept and the start of the search.

The fourth chapter, *Gravitational Waves: Experimental Observations & Data* (see above pp. 187-225), explores the history of the search for gravitational waves from how to detect gravitational waves in theory through to the actual detection methods which led to the Nobel Prize in Physics in 2017. In particular, I obtained:

13. the role played by Joseph Weber (1919-2000) who pioneered the search for gravitational waves with his first ideas and attempts involving his bar detectors set everything in motion and
14. that the 1957 Chapel Hill Conference had a most significant positive impact on both the actual search, but also on the research in General Relativity and how it gave it a second breath as
15. General Relativity had been perceived as a very peculiar and unappealing discipline in the decades prior to this conference.

I then proceed to explain how the interferometer method for the detection of gravitational waves came to be what it is today, before delving into the ins-and-out of the actual detectors of LIGO and Virgo, with a particular focus on the Virgo detector which I had the chance of being invited to visit. Finally, I studied some of the most interesting signals detected and discussed their implications and importance. Thus obtaining the results that scientific research about gravitational waves is multidisciplinary, at the frontier of both our knowledge and technological abilities, but most importantly paramount to understanding astronomical phenomena and the beginning of the Universe.

In the fifth chapter, *Gravitational Waves: A History of Science & Technology in Society* (see above pp. 235-266), the last chapter of this part, I gave a brief account of Science, technologies, and the new collaborative inquiring approaches to science, thus showing that science is more than ever a human endeavour. Then I finished this chapter with a brief history of Cosmology and how the discovery of gravitational waves has had an impact on Cosmology so far. Indeed, I gathered:

16. how it shapes our expectations for the future both in terms of discoveries and some of the future projects.

Moreover, since we are entering a new era in Astronomy, I obtained the results that:

17. the development of gravitational wave observatories led to the birth of multi-messenger astronomy and
18. that thanks to the first results it brought, there are deep implications for Cosmology that are currently being investigated.

Furthermore, gravitational astronomy is also expected to bring insights in areas that we simply cannot inquire through the study of the electromagnetic spectrum alone. e.g. The investigation of the first moments of the Big Bang.

Lastly, in the last part of this thesis, *Gravitational Waves as Nature of Science Teaching* (see above pp. 280-501), I examine the framework of the Nature of Science and study its relevance for the case study of teaching Physics through the history of the discovery of gravitational waves. I obtained that:

19. in addition to its direct scientific impact on Physics disciplines (Astronomy, Cosmology and Quantum Mechanics), the discovery of gravitational waves also had an impact on the scientific community itself through excitement for the achievement, inspiration and the new perspectives. Moreover, it has begun to enter *mainstream knowledge*, reaching the general public and students/pupils as evidenced by scientific mediation events and contests such as the *Olympiades de Physique* (Physics Olympiad). And thus that
20. it created the need to prepare and develop a dedicated framework for its teaching.

In the sixth chapter, *On the Nature of Science Teaching* (see above pp. 280-316), I discussed what the Nature of Science is, and therefore what its framework is and how it is constituted. I studied the relevance of teaching the history of mathematics for mathematics teaching, the relevance of teaching the history of physics for physics teaching, the interplay of physics and mathematics and its teaching; the relevance of History of Science, Epistemology and Philosophy for scientific teaching and the interdisciplinary comparative didactic implications of the combination of all these elements on teaching-learning science and for scientific teaching. In particular, I analysed how Nature of Science manages the relation between common and scientific knowledge, students' difficulties, misunderstandings and critical thinking training by bringing up methodological issues both practical and theoretical, encompassing scientific practices, methods and reasoning. By doing so, I obtained a comprehensive theoretical framework on the subject from which to adapt a specific NoS framework for teaching gravitational wave physics and

history that minimises epistemological breaks and which provides guidelines to deal with the most common epistemological obstacles.

In the seventh chapter, *Teaching Gravitational Waves* (see above pp. 325-368), I studied different scientific tools, methods and practices in order to identify which ones to focus on for the designing of a NoS teaching on gravitational waves. In particular, I obtained that:

21. the study of representations, parallel reasoning, and modelling through an epistemological point of view, appears to be the best way to extract the fundamental items needed to design and teach gravitational waves physics, history and additional frameworks.
22. my research allowed me to identify the prerequisites and to define both the cognitive and operative objectives, but also to
23. discuss the methodology,
24. expected results,
25. and how to evaluate them through
26. a preliminary inquiring of my research and the
27. analyses of the pre- and post-tests of
28. my at a distance course on gravitational waves and their history.

Thus, I obtained:

- a. a teaching framework for the teaching of gravitational waves and
- b. a dedicated framework for the analyses of the learners.

Finally, in the eighth and final chapter, *A Didactic Inquiring: Which Teaching Approach for the Gravitational Waves?* (see above pp. 375-501), I examined the didactics, methods and methodologies, and frameworks from the current literatures in order to structure a proposal for the main physical principles using what I determined were the best approaches for the teaching of gravitational waves physics and discovery. I obtained:

29. a. a NoS curricula revolving around modelling and analogies was certainly the most indicated, and
30. b. helped students stay in a “zone of proximal development”. From this, I developed
31. c. an *ad hoc* curricula consisting of independent modules starting with an introductory module corresponding to my at a distance course.

After a discussion and generalization, I focussed on the methods and falsifiability of epistemological inquiring and the issues of the falsifiability in didactics of physics-mathematics. Unsurprisingly, I obtained that these issues were intrinsic to human sciences and that they were thus subjected to very similar problems (especially regarding repeatability and reproducibility) which are currently a grave matter of concern. Then, I explored the differences between formal, informal and non-formal teaching and their implications;



discussed the scientific, didactic and epistemological debate on the results, and the qualitative and quantitative choices. Finally, I justified the choice of using a modular programme adopting an epistemological point of view through the use of parallel reasoning in a Nature of Science framework in which each module is a standalone lecture consisting in a rich historical narrative in order to prevent students from experiencing epistemological breaks, providing them with all the necessary tools to avoid misconceptions and to help them overcome the epistemological obstacles on their path.

In the end, the experiment yielded positive and encouraging results, according to the preliminary analyses, which therefore prompt further investigation on a larger scale.



# **APPENDIX**

## **1. Documents from Virgo**

1.1. Invitation Letter

1.2. Some Resources

## **2. Documents from the Niels Bohr Library**

2.1. Invitation Letter

2.2. Some Resources

## **3. Articles Previews**

## **4. Administrative Documents**

## **5. Copyright Permissions**

## **6. Research Annex to my Teaching at a Distance Course**

## **7. Table of Acronyms**

## **8. Pre/Post Tests Data**

## 1. Documents From Virgo

### 1.1. Invitation Letter



Cascina, 22/01/2019  
Ref. EGO-DIR-12-2019

**To the attention of:**

Philippe VINCENT  
Ph.D. Candidate  
Lille University, France  
Mobile: +33 6 48458948  
Email: [philippe.vincent@etu.univ-lille3.fr](mailto:philippe.vincent@etu.univ-lille3.fr)

**Subject: Invitation to come to the site at EGO for scientific purposes**

Dear Philippe Vincent,

Within the framework of your research on "History and Discovery of Gravitational Waves", in your second doctoral year, you have requested the opportunity to visit the site of EGO in Cascina. I herewith confirm that EGO will welcome you with pleasure.

As agreed, the dates of your visit at EGO will be June 9<sup>th</sup> to 15<sup>th</sup>, 2019.

On this occasion, it is my pleasure to inform you that:

- The cost of your accommodation in Pisa will be paid directly by EGO;
- Lunches provided in our internal canteen will be offered to you;
- EGO will refund the dinners taken during your stay in Pisa upon submission of all original receipts.

Do not hesitate to contact my assistant, Sarodia Vydellingum (e-mail: [Sarodia.vydellingum@ego-gw.it](mailto:Sarodia.vydellingum@ego-gw.it) – tel.: +39 050 752 325) to organize your visit.

I look forward to meet you in Cascina,  
Best regards,

*Thank you very much for  
the invitation,  
Lille, 23/05/2019  
P. Vincent*

The Director of EGO  
Prof. Stavros Katsanevas

EGO – European Gravitational Observatory  
Via E. Amaldi 5, 56021 Santo Stefano a Macerata – Cascina (Pisa), Italy  
Tel. +39 050 752 511 – Fax +39 050 752 356

1.2. Some Resources from Virgo

“G/c<sup>5</sup> very small, c<sup>5</sup>/G will be better” © J. Weber (1974)

$$P = \frac{5c^5}{G} \varepsilon^2 \frac{R_s^2 v^6}{R^2 c^6}$$

- $\varepsilon$  asymétrie de la source
- $R_s$  rayon de Schwarzschild de la source
- $R$  rayon de la source
- $v$  vitesse typique de la source

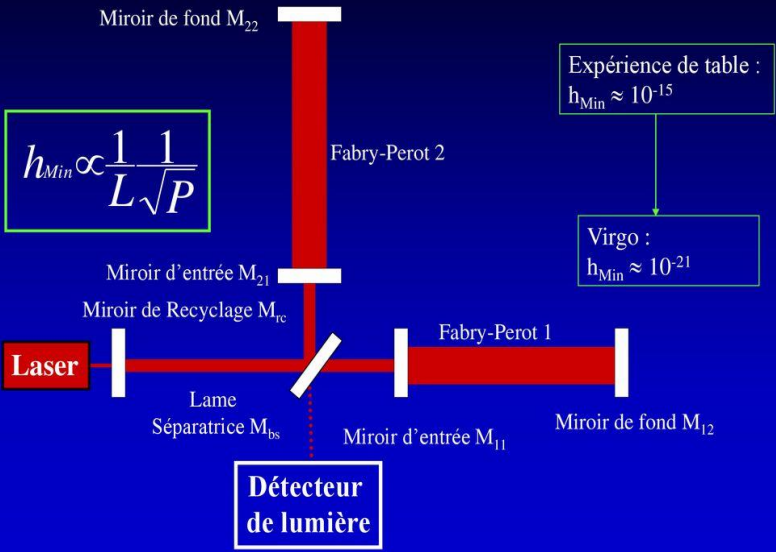
Taille du trou noir qui aurait la masse de la source

⇒ Seuls les phénomènes astrophysiques cataclysmiques peuvent émettre des ondes gravitationnelles détectables

source	distance	$h$	$P$ (W)
Supernova 10 $M_\odot$ , asymétrie 3%	10 Mpc	$10^{-21}$	$10^{14}$
Coalescence de 2 trous noirs de 1 $M_\odot$	10 Mpc	$10^{-20}$	$10^{50}$

1pc = 3,26 année-lumière

La détection interférométrique en pratique





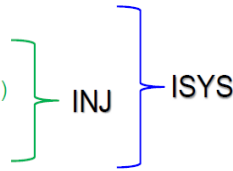
## Tutorial and introduction on AdV Laser & Injection system

Gabriel PILLANT and Eric GENIN  
European Gravitational Observatory



### Outline

- INJ subsystem overview
- Optical Basics
- The main Benches
  - Input : Laser Bench (PSL)
  - External Injection Bench (EIB)
  - Suspended Injection Bench (SIB1)
  - Input Mode Cleaner (IMC)
  - SIB2
  - Output : Interferometer
- The standard state: a procedure is now available online.
- How-to in Control Room





## Role of INJ subsystem

The Injection system (INJ) of AdV takes care of the optics downstream of the high power laser, and of the interface of these optics with the laser and the Interferometer.

Main components:

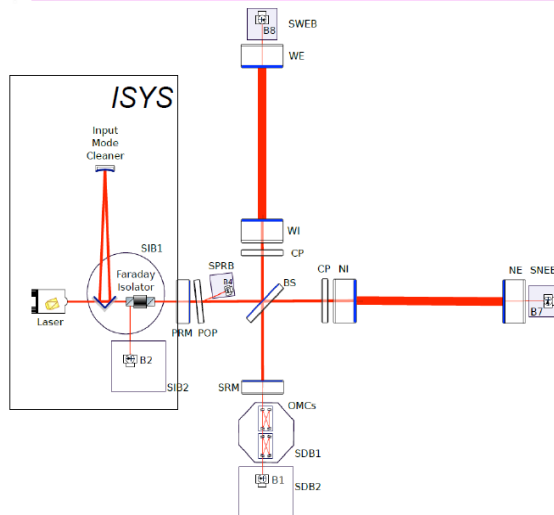
- Electro optic modulation system: Phase modulation of the laser beam to be able to control the ITF optical cavities.
- Input Mode Cleaner cavity: passively filter out amplitude, frequency and beam jitter noise
- Mode matching optics: Adjust the beam dimension to properly match it on the interferometer to reduce as much as possible the light lost from the Laser bench to the ITF
- Reference cavity: Laser frequency pre-stabilization and in science mode low frequency reference in frequency.

What is required?

- A frequency stability of the laser sufficient to lock the interferometer and reach AdV sensitivity goal (close interaction with *PSL subsystem* needed).
- A beam pointing stability sufficient to reach AdV sensitivity goal.
- An adjustable ITF input power (two orders of magnitude) keeping beam properties unchanged to help during the lock acquisition phase.

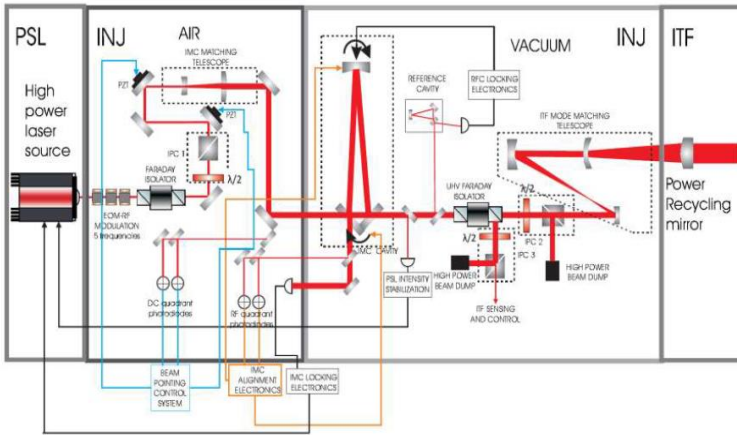


## Where is located INJ in Virgo?





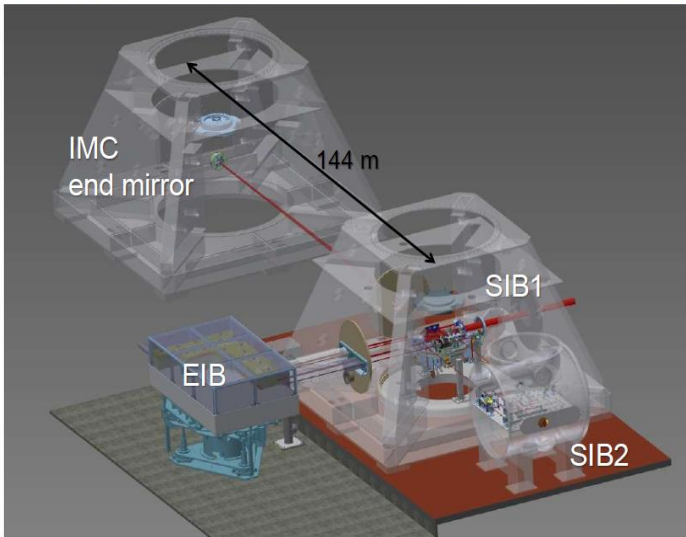
### INJ overview



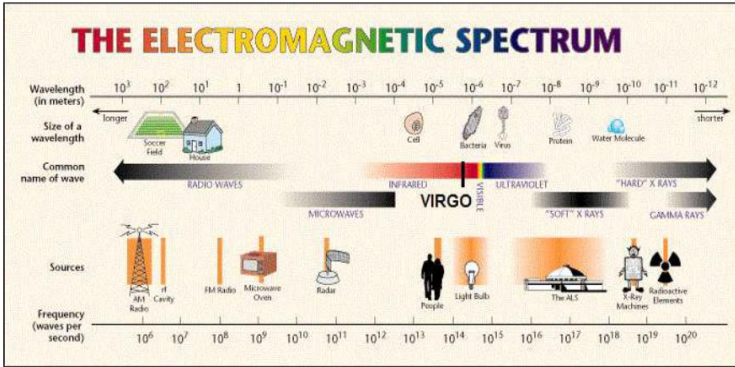
Requirements from the Technical report



### 3D view of INJ subsystem







Laser Nd:YAG

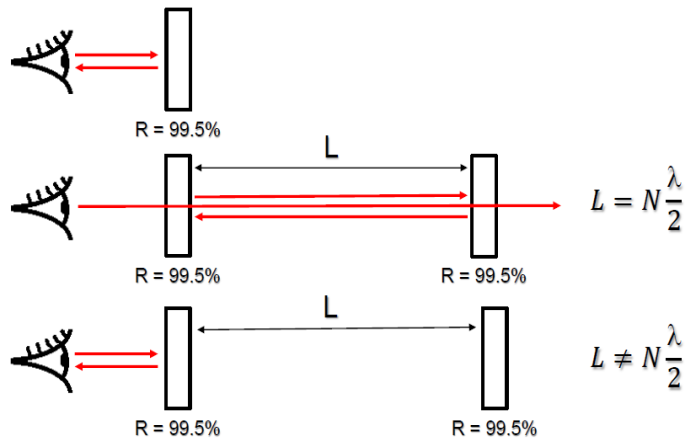
$$v = \frac{c}{\lambda}$$

Frequency :  $\nu \sim 300 \text{ THz}$   
 Wave Length :  $\lambda = 1.064 \mu\text{m}$

Goal:  $\frac{\delta\nu}{\nu} \sim 10^{-20}$



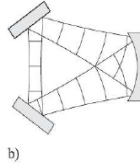
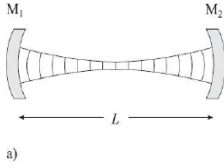
Fabry-Perot interferometer also called (optical) cavity or (optical) resonator is a multi-waves interferometer.



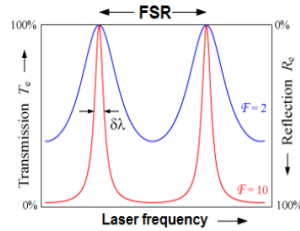


## Optical Basics

□ Different geometries :



a) Linear optical resonator. b) Optical ring resonator.



A laser beam can pass through an optical cavity if :

- The cavity length is a multiple of an half of the wavelength
  - The laser frequency is a integer multiple of the FSR
  - The beam is aligned to the cavity axis
  - The cavity mirrors are aligned one respect to the other one
  - The beam has the right dimensions / divergence
- } Same condition



## Optical Basics

□ The Fabry–Perot cavities are used for :

- Laser frequency stabilization (spectral mode cleaning).
- Beam jitter cancelation.
- Laser Shape Filtering (Spatial Mode cleaning).

In order to keep the beam always completely transmitted by an optical resonator the laser frequency has to be stabilized respect to the cavity or the contrary...

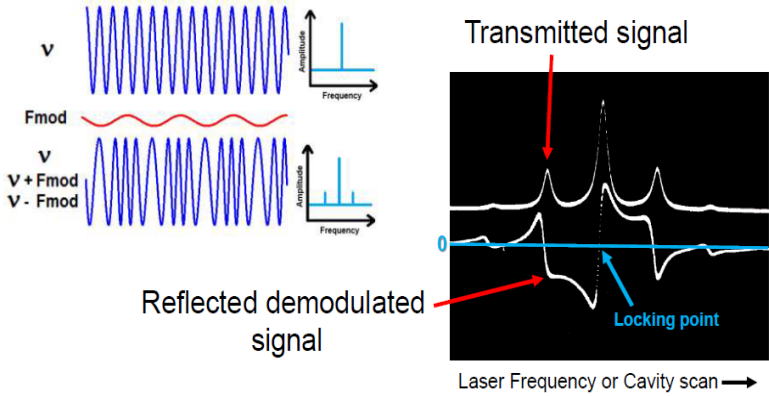
The transmitted power is not a good-enough error signal because it has no sign so we use the Pound-Drever-Hall locking technique.

Optical side-bands are needed using optical phase modulation.



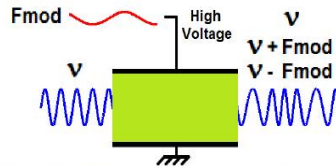
□ Pound-Drever-Hall locking technique :

Using phase modulation, two new frequencies are present in the laser frequency spectrum, these two frequencies are reflected by the cavity.



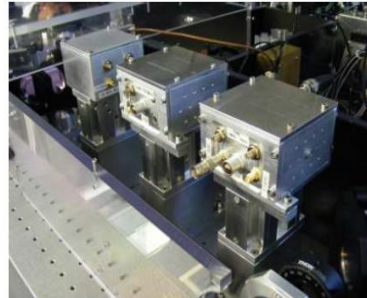
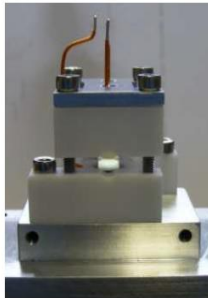
□ **Electro-Optic-Modulator (EOM)** Refraction index changing with electric field (speed of light variation into the crystal)

Located on the External Injection Bench (EIB)



6 different Fmod :

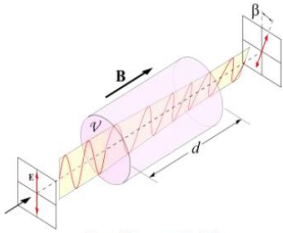
- 14 MHz (PSL)
- 6 MHz
- 8 MHz
- 22 MHz
- 56 MHz
- 119 MHz





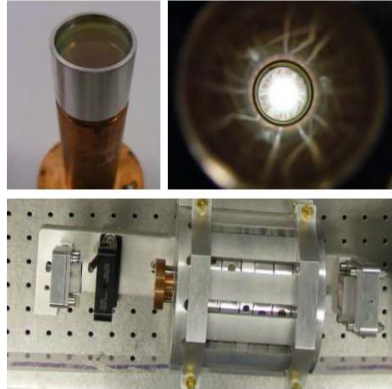
□ Faraday Isolator (FI)

Optical diode, avoid back reflected light. Used for example before an optical linear cavity.



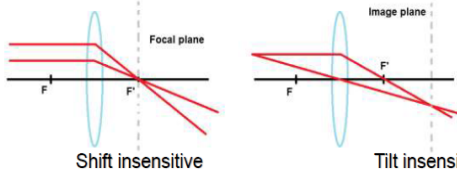
Another crystal + Magnetic field

5 FI overall +1 on DET



□ Lenses

Lenses are one of the most important element in optics, used for telescopes design and useful for shift / tilt separation :

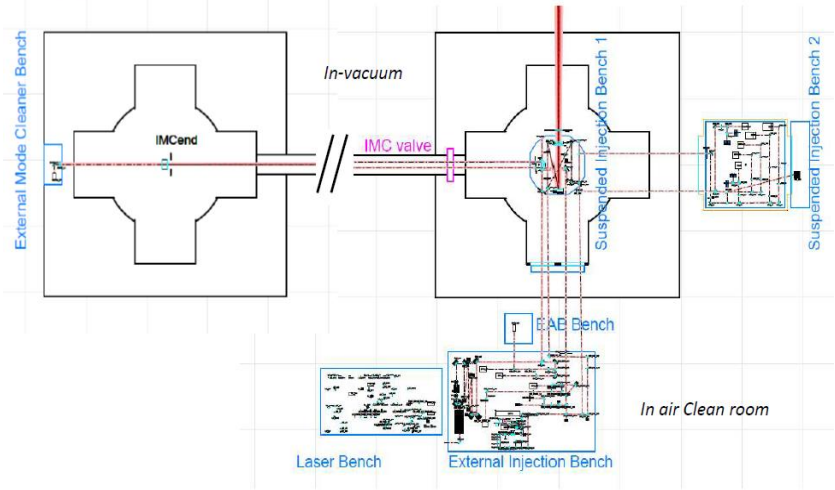


Used for beam pointing control on EIB and for local control

□ Telescopes

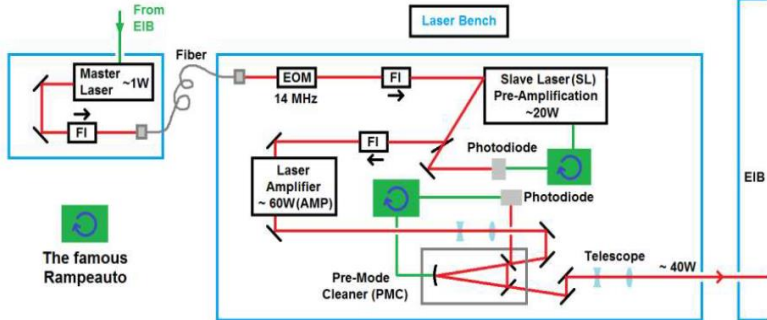
Many telescopes are located on the benches in order to reach the beam size adapted for cavity matching or components aperture. Composed by two lenses or curved mirrors.





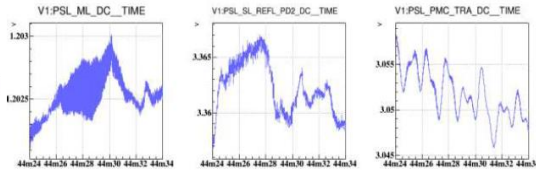


### Laser Bench

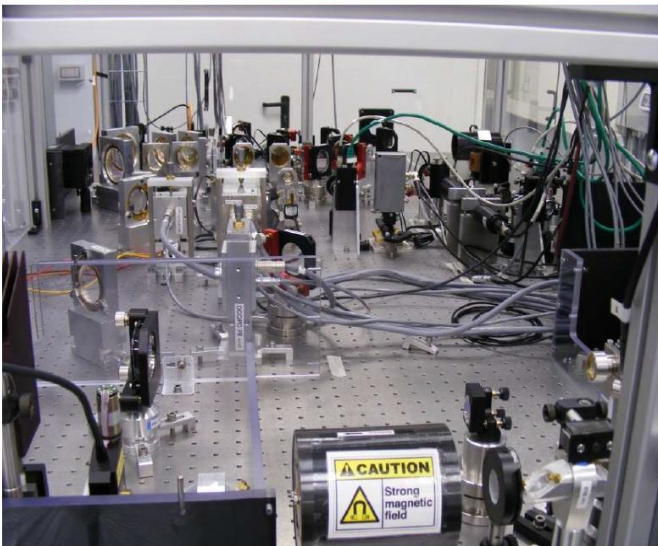


Several loops engaged :

- Slave Laser is a resonator Locked on the Master Laser
- Pre-Mode Cleaner Locked on the Master Laser

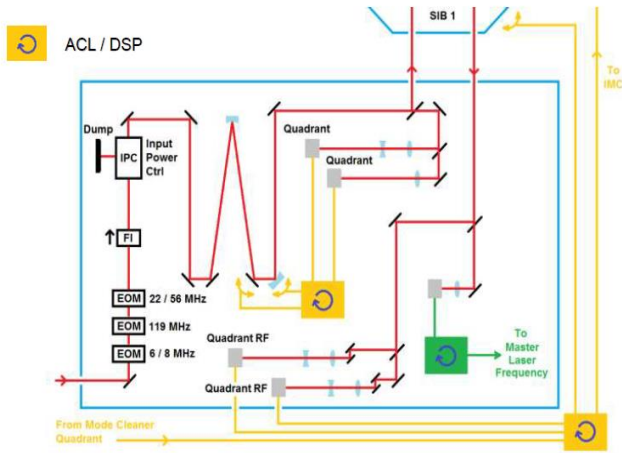


### External Injection Bench (EIB)

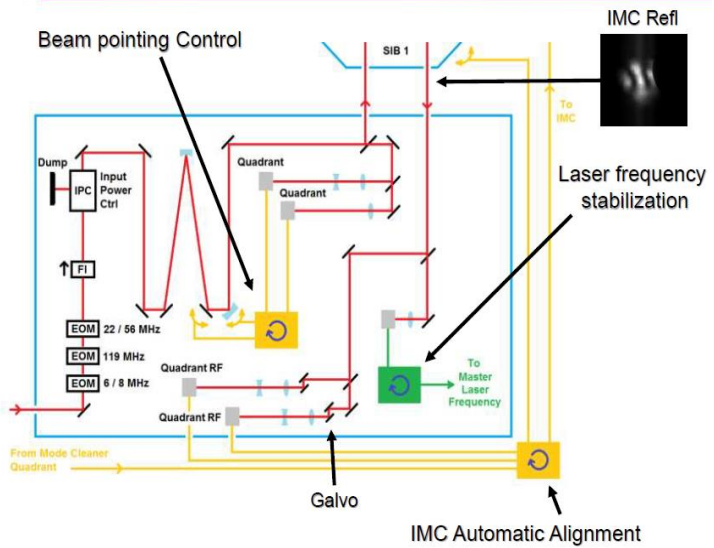




### External Injection Bench (EIB)

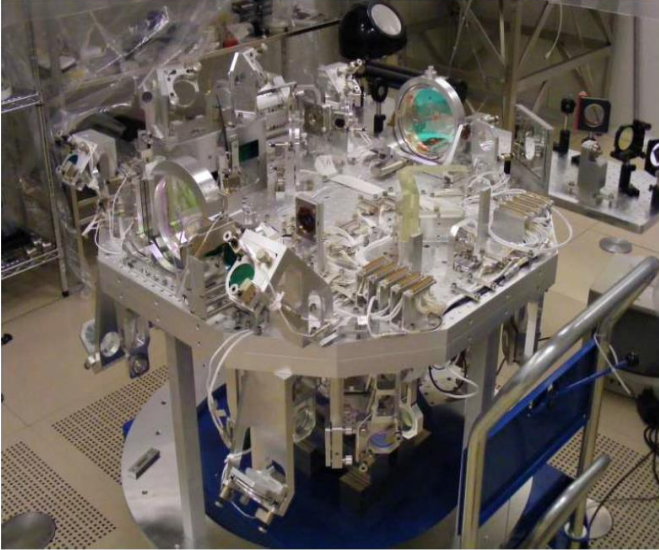


### External Injection Bench (EIB)

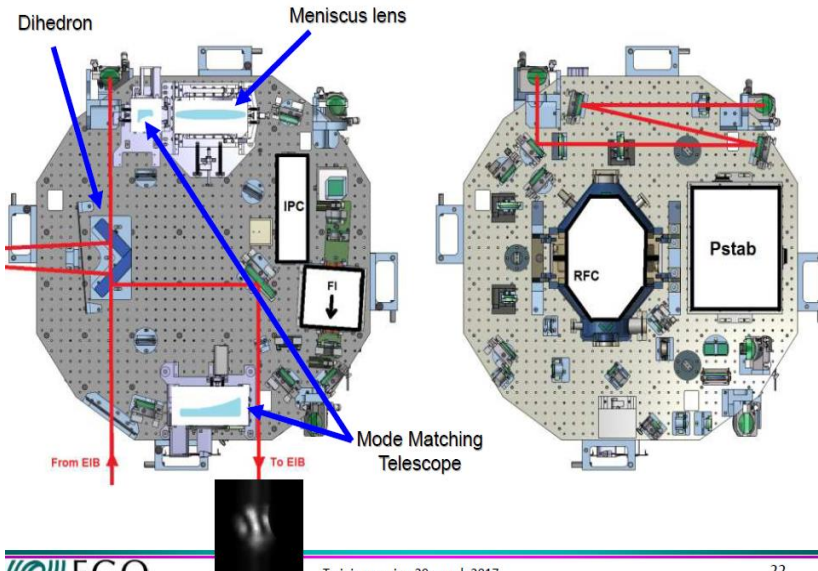




### Suspended Injection Bench 1 (SIB1)



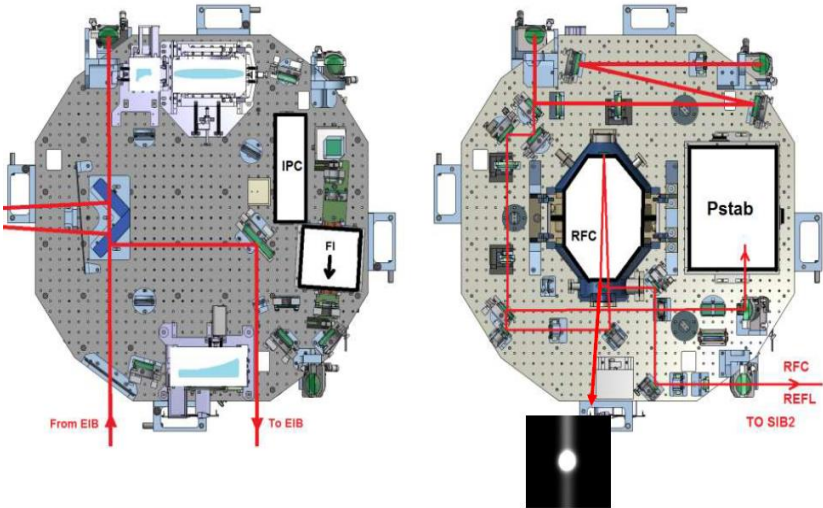
### Suspended Injection Bench 1 (SIB1)



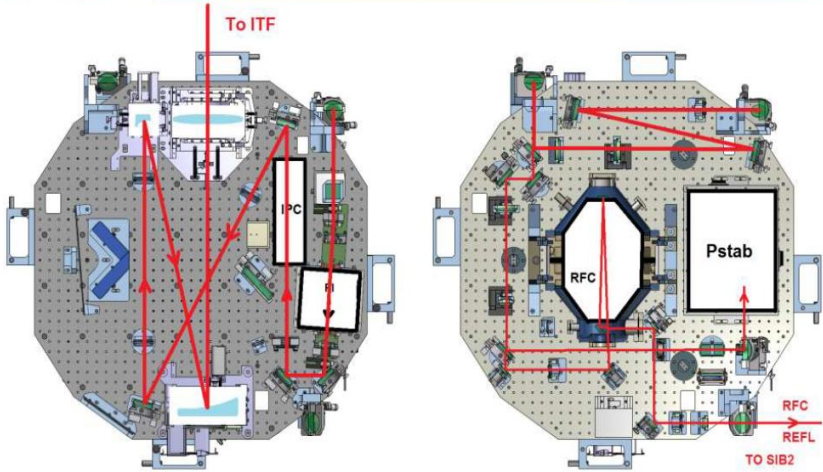




### Suspended Injection Bench 1 (SIB1)

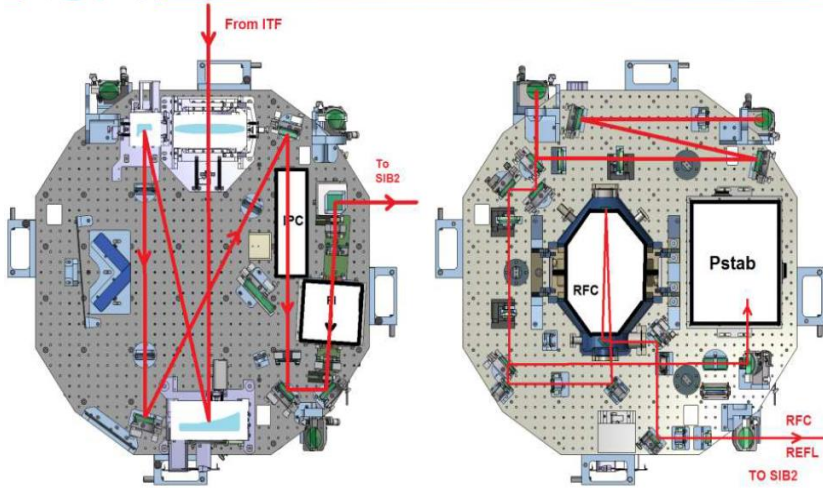


### Suspended Injection Bench 1 (SIB1)

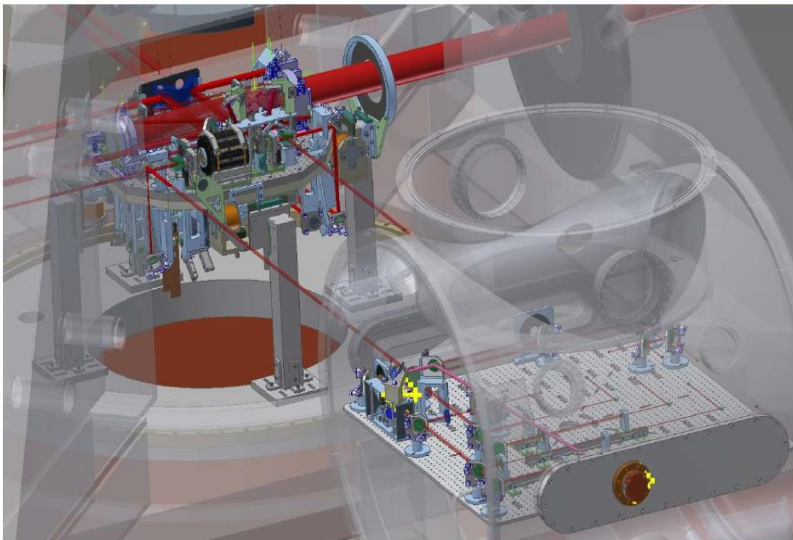




### Suspended Injection Bench 1 (SIB1)



### (Not yet) Suspended Injection Bench 2 (SIB2)





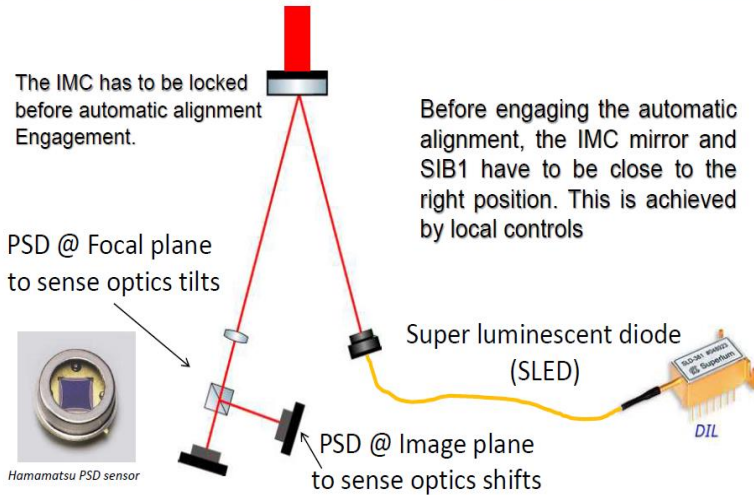
*Input Mode Cleaner*



*MC payload in MC tower*



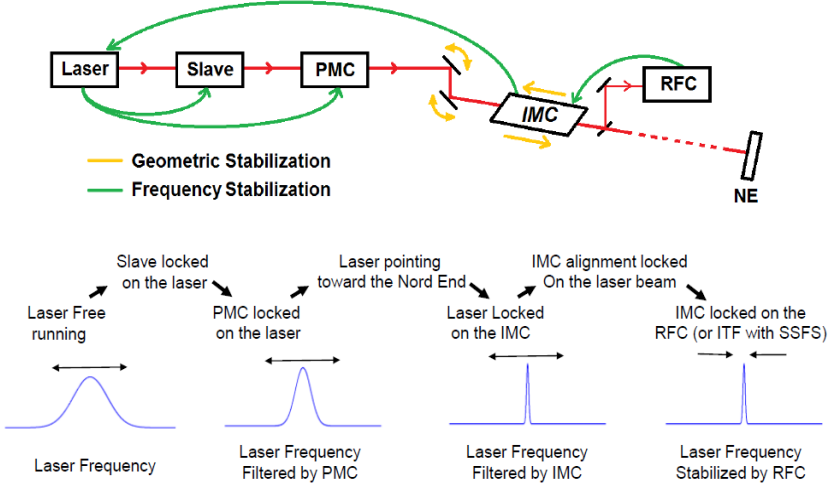
*Injection system local controls working principle*



NB: the hardware (PSDs and SLED) is the same than the one used for AdV payloads controls.



# Summary



# The standard state

ISYS Web page (prepared by A.Magazzù)

<https://scientists.virgo-gw.eu/ISYS/>

**INJECTION SYSTEM WEBPAGE**

The Laser and injection system consists of a high power laser delivering up to 60W and of the optical interfacing of the laser with the Interferometer. The whole system delivers a beam at the interferometer input port with the required power, geometrical shape, frequency and angular stability. An EDM system is providing the RF modulators needed for control and sensing purposes. The Input Mode Cleaner (IMC) cavity geometrically cleans the beam and reduces its amplitude and lateral fluctuation. The resonant IMC of which the length is locked on the reference cavity (RFC) constitutes a first stage of frequency pre-stabilization. After the IMC a photodiode provides the signal for intensity stabilization of the laser. An in-vacuum Faraday isolator prevents spoiling laser power stability and finally, a mode matching parabolic telescope is used to properly match the beam on the Interferometer.

Injection System DMS									
	SL_S1	SL_S2	SL_S3	SL_S4	SL_S5	SL_S6	SL_S7	SL_S8	SL_S9
Injection	PMC_S1	PMC_S2	PMC_S3	PMC_S4	PMC_S5	PMC_S6	PMC_S7	PMC_S8	PMC_S9
	IMC_S1	IMC_S2	IMC_S3	IMC_S4	IMC_S5	IMC_S6	IMC_S7	IMC_S8	IMC_S9



## The standard state

□ INJ standard state wiki page is available (new wiki pages for ITF procedures has been prepared by F. Berni)

<https://wikioperators.virgo-gw.eu/v1r0/index.php>

The screenshot shows a web browser window titled "wiki Operators". The page content is as follows:

**Login**  
You are not logged in  
username: \_\_\_\_\_  
password: \_\_\_\_\_

**Menu**  
Available documents  
See changes log  
Search document  
Form to upload files

**Links**  
Logbook  
DMS - Detector Monitoring System  
TDS - Technical Documentation

**The Injection System** (v1r1p3 ARCHIVED VERSION)  
The Local control error signals should fluctuate within few urad for the IB and between 1 and 2 urad for the MC. High or low frequency oscillation could be due to instabilities in the control loop. Please contact the expert. Moreover if the power on the PSDs is low, even if the error signals seems to be good, a malfunctioning of the local control or of the upper part (damping) can be occurred. Please check the damping part and then call the expert.

**Beam Pointing Control (BPC) in standard state**  
Assuming that the laser system works, the Beam Pointing Control system (BPC) loops should be closed in order to ensure a proper position and pointing of the laser beam towards the IMC cavity.

**Check the BPC status with dataDisplay**  
Check the BPC error signals and corrections on the dataDisplay with:  
`dataDisplay /virgo/Data/ISIS/dataDisplay/BPC.caf`  
They should be similar to what is presented in the following picture:

File: bpc\_standardstate.bmp

The image shows a screenshot of a data display window with several plots and numerical readouts, representing the BPC status.

→ we have created some datadisplay configuration files which are available from that wiki page.



## Gravitational Waveforms

Patricia Schmidt  
 LAAC Retreat  
 LVC March Meeting 2015, Pasadena  
 March 15, 2015

DCC [LIGO-G1500424](#)

## What is a waveform?

- Most generally:
  - "A waveform is the shape and form of a signal"
  - "A signal is a function that conveys information about the attributes and the behaviour of certain phenomena"

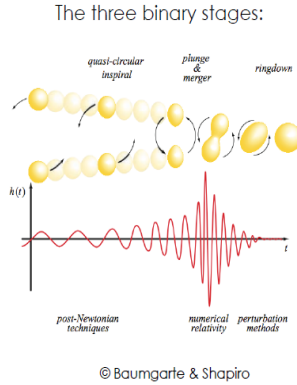
$$h = A e^{-i\Phi}$$

amplitude phase

- For gravitational waves (GWs): signatures of
  - **Compact binary coalescences → chirps (focus of this presentation)**
  - Bursts such as supernovae
  - Rotating neutron stars
  - Cosmological processes & incoherent astrophysical sources

# Compact Binary Coalescences

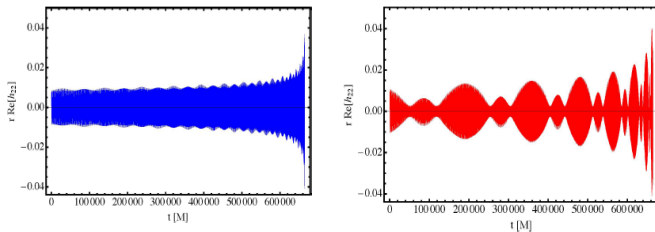
- Two compact objects in a gravitationally bound orbit:
  - Black hole – black hole (BBH)
  - Neutron star – black hole (NSBH)
  - Neutron star – neutron star (BNS)
- In General Relativity (GR):
  - Binary separation gradually decays due to the emission of gravitational radiation
  - GWs carry characteristic information about the source → GWs are the source's "fingerprints"
  - Characteristics depend on source parameters



2

# The binary parameter space

- Intrinsic vs. extrinsic parameters:
  - Intrinsic: mass ratio, (total mass), spins, eccentricity, tidal deformation parameters
  - Extrinsic: binary orientation, polarisation, time of coalescence, phase of coalescence, position in the sky

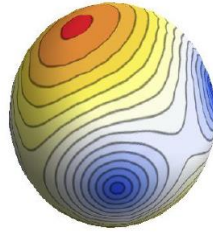
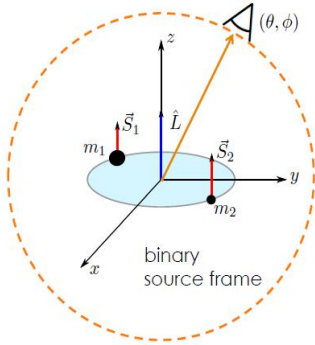


3

# GW strain & modes

$$h(t; \theta, \phi) = h_+ - ih_\times \equiv \sum_{\ell=2}^{\infty} \sum_{m=-\ell}^{\ell} \underbrace{h_{\ell m}(t)}_{\text{GW modes}}^{-2} Y_{\ell m}(\theta, \phi)$$

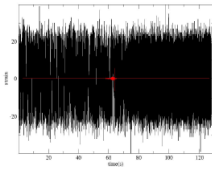
GW strain



radiation field incl. all  $\ell=2$  modes projected onto the unit sphere at some time  $t$

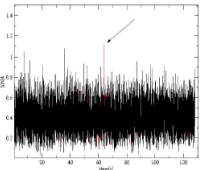
# Why do we need waveforms?

- Flagship search for CBCs: “matched filter”
  - Requires a priori knowledge of the waveform
  - Use “templates” to filter the data



$$\langle d|t \rangle = 4\text{Re} \int_{f_1}^{f_2} \frac{\tilde{d}(f)\tilde{t}^*(f)}{S_n(f)}$$

$$\rho \equiv \frac{\langle d|t \rangle}{\sqrt{\langle t|t \rangle}}$$



We need waveform templates!

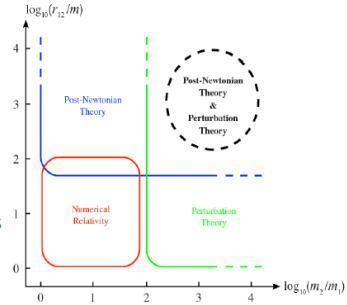
© <http://www.astro.cardiff.ac.uk/research/gravity/tutorial>

- Parameter estimation



## How do we generate waveforms?

- For CBCs:
  - Analytic techniques
    - Post-Newtonian theory
    - Effective – one – body
    - Perturbation theory
  - Numerical Relativity
  - Hybrid approaches
    - Phenomenological waveforms
    - EOB + NR waveforms



© L. Blanchet, Living Reviews

- For bursts:
  - Analytic templates
  - Numerical templates

6

## PN in a nutshell

- Perturbative expansion of the Einstein field equations in terms of the characteristic velocity  $v$  to find approximate solutions to GR when
  - the gravitational fields are weak and
  - the objects move slowly, i.e.  $v \ll c$
- This yields expressions for
  - the gravitational binding energy  $E$
  - the gravitational wave luminosity  $F$
 → Compute the evolution of the orbital phase of the binary !
- Characteristic velocity:  $v = (M\omega_{\text{orb}})^{1/3}$
- Assume that  $\omega_{\text{GW}} = m\omega_{\text{orb}}$

7

## PN in a nutshell

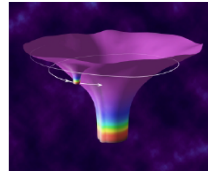
- Under the assumption of energy balance, the phasing (frequency evolution) of the GW is specified by two ordinary differential equations:

$$\mathcal{F} = -\frac{dE}{dt} \quad \longrightarrow \quad \begin{aligned} \frac{d\phi_{\text{orb}}}{dt} &\equiv \omega_{\text{orb}} = \frac{v^3}{M} \\ \frac{dv}{dt} &= -\frac{\mathcal{F}(v)}{dE(v)/dv} \end{aligned}$$

- Different ways of solving the equations  $\rightarrow$  TaylorTX approximants
- PN amplitude as a series expansion
- PN fails when the binary becomes relativistic:
  - Last stable orbit (LSO, ISCO):  $f_{\text{LSO}} = (6^{3/2}\pi M)^{-1}$ 
    - 1.4 + 1.4 BNS: 1570Hz
    - 10 + 10 BBH: 220Hz

## The basics of EOB

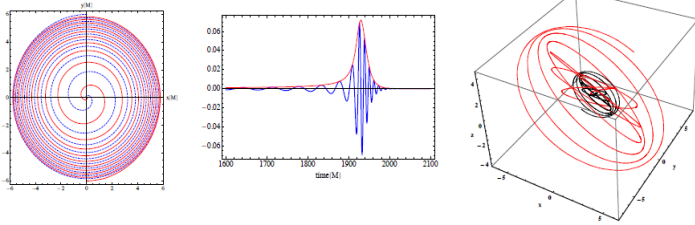
- Goal: accurate analytical description of motion and radiation of BBH covering inspiral, merger & ringdown
- Dynamics of two black holes mapped into the dynamics of an effective particle moving in a deformed Kerr background
- Motion of the body described by an effective Hamiltonian  $H$ , obtained by resummation of the conservative PN dynamics
- Resummed PN radiation flux enters Hamilton's equations as external force term
- Waveforms are obtained by resummation of PN expressions and matching it to BH perturbation theory results after merger



For details see work by Buonanno, Damour, Nagar

## Numerical Relativity

- Merger waveforms: no exact solutions for the relativistic two-body problem → need to solve the Einstein field equations numerically
- Possible only since 2005 (Pretorius)!
- Computationally expensive to sample the whole binary parameter space numerically: sparse sampling



Public numerical waveforms: [black-holes.org](http://black-holes.org) (SXS collaboration)

10

## Combining analytics & NR

- Aim: combine analytic and numerical relativity information to construct complete waveforms → inspiral-merger-ringdown (IMR) waveforms
- Phenomenological approach: IMRPhenom
  - (Exact) analytic description of the inspiral (PN for example)
  - Functional ansatz with free parameters for the continuation of the signal through merger and ringdown
  - Surjective map between physical parameter  $\leftrightarrow$  phenomenological parameters
  - Use NR results to determine the phenomenological coefficients
- Calibrate the free parameters in EOB models to NR results: (S)EOBNR

11

## LAL Waveforms

	Inspiral Waveforms	IMR Waveforms
<b>Time Domain (TD)</b>	TaylorX: T1, T2, T3, T4, Et	IMRPhenomA
		IMRPhenomB, IMRPhenomC
	SpinDominatedWf	EOBNRv2, EOBNRv2HM
	SpinTaylorX: T2, T4	SEOBNRv1, SEOBNRv2
		SEOBNRv3
	PhenSpinTaylor, PhenSpinTaylorRD IMRPhenomP	
<b>Frequency Domain (FD)</b>	TaylorF2	IMRPhenomA, IMRPhenomB, IMRPhenomC
	TaylorF2RedSpin, TaylorF2RedSpinTidal, SpinTaylorF2	SEOBNRv1_ROM_SingleSpin, SEOBNRv1_ROM_DoubleSpin, SEOBNRv2_ROM_SingleSpin, SEOBNRv2_ROM_DoubleSpin
	SpinTaylorT4Fourier, SpinTaylorT2Fourier	IMRPhenomP

## Generating a waveform in LAL

■ In `lalsuite/lalsimulation/test: GenerateSimulation.c`

```
make check      %runs unit tests for all waveform families

./GenerateSimulation --help      %lists all options and shows
                                  default values

%Generate a waveform data file simulation.dat with (t, h+, hx) with
minimal input:
./GenerateSimulation
  --domain TD
  --approximant SpinTaylorT4
  --m1 10
  --m2 10
  --spin1z 0.5
  --spin2z 0.8
  --fmin 10

%Other options:
--amp-phase --phase-order --amp-order --sample-rate/--deltaF
--inclination --distance --outname ...
```

## Generating a waveform in LAL

- Call through a Python interface: XLALSimInspiral.c (source code)

```
import lal as lal
import lalsimulation as lalsim
# Waveform parameters:
m1 = 10.
m2 = 40.
dist = 100. # Mpc
phi0 = 0.
inclination = 0.
slx = 0.
sly = 0.
slz = 0.6
s2x = 0.
s2y = 0.
s2z = -0.2
ampOrder = -1 # highest available order
phOrder = -1 # highest available order
m1_SI = m1 * lal.MSUN_SI # mass 1 in SI units
m2_SI = m2 * lal.MSUN_SI # mass 2 in SI units
distance = dist * 1.e6 * lal.PC_SI # distance in SI units
fs = 4096
fmin = 20.
fref = fmin
deltaT = 1. / fs
```

14

## Visualisation

```
#####
# Generate a TD waveform:
approx = lalsim.SEOBNRv2
[hpt, hct] = lalsim.SimInspiralChooseTDWaveform(phi0, deltaT, m1_SI, m2_SI, slx,
sly, slz, s2x, s2y, s2z, fmin, fref, distance, inclination, 0., 0., None ,
None , ampOrder , phOrder , approx)

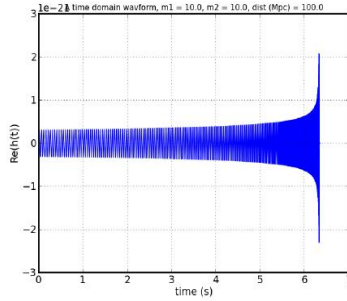
# time vector:
hptlen = hpt1.data.length
t = np.arange(hpt.data.length, dtype=float) * hpt.deltaT
# h+ data:
dp = hpt.data.data

# Generate plot:
titl = 'A time domain wavform, m1 = '+str(m1)+' , m2 = '+str(m2)+' , dist
(Mpc) = '+str(dist)
plt.figure()
plt.plot(t, dp, 'b', label='SEOBNRv2')
plt.xlabel('time (s)')
plt.ylabel('Re(h(t))')
plt.grid()
plt.title(titl, fontsize=11)
plt.savefig("SEOBNRv2.png", bbox_inches='tight')
```

15

## Visualisation

- Simple example in Python:



- Alternatively: use pyCBC waveform.py

16

## Points of Contact

- Waveforms subgroup:
  - Wiki page: <https://www.lsc-group.phys.uwm.edu/lqogvirgo/cbcnote/Waveforms>
  - Email list: [cbc+waveforms@ligo.org](mailto:cbc+waveforms@ligo.org)
  - Current waveform chairs:
    - Frank Ohme, Cardiff University
    - Riccardo Sturani, ICTP-SAIFR
- Weekly telecon sources+waveforms: Mon 8am PST

17

2016 restera l'année de la découverte des ondes gravitationnelles, annoncée par les collaborations LIGO et Virgo. En effet, les deux détecteurs LIGO ont enregistré en septembre et décembre 2015 deux signaux émis lors de la fusion de trous noirs de plusieurs dizaines de masses solaires au total. Des analyses longues et complexes ont permis de repérer ces ondes gravitationnelles dans le bruit de mesure et de démontrer l'origine astrophysique de ces signaux.

C'est à la fois l'aboutissement d'un programme de recherche qui couvre plusieurs décennies et l'ouverture d'une nouvelle fenêtre sur l'Univers. Cet article raconte cette découverte du point de vue de l'expérience.

## Les premières détections des ondes gravitationnelles

Nicolas Arnaud (narnaud@lal.in2p3.fr)

Laboratoire de l'Accélérateur linéaire UMR8607 CNRS-Université Paris Sud, BP 34, 91898 Orsay Cedex et European Gravitational Observatory, Via E. Amaldi, 56021 S. Stefano a Macerata, Cascina (PI), Italie.

11 février 2016 : les collaborations internationales LIGO et Virgo annoncent la première détection directe des ondes gravitationnelles (OG). L'événement, nommé « GW150914 », a été enregistré par les deux détecteurs LIGO situés aux États-Unis (pour l'un à Hanford dans l'état de Washington, pour l'autre à Livingston en Louisiane) et analysé pendant cinq mois avant de pouvoir conclure qu'il s'agissait bien d'un signal provenant du cosmos, émis par la fusion de deux trous noirs d'une trentaine de masses solaires chacun, situés à environ 1,3 milliards d'années-lumière de la Terre. Cette annonce sera suivie d'une autre, le 15 juin 2016, à nouveau pour une fusion de trous noirs – l'événement « GW151226 ».

Hasard du calendrier, ces découvertes surviennent un siècle après l'introduction du concept d'OG par Einstein, quelques mois après la publication de la théorie de la relativité générale en novembre 1915. C'est l'aboutissement d'un long feuilleton scientifique riche en rebondissements, frustrations, progrès, controverses... et dont la conclusion heureuse est un bon exemple de collaboration fructueuse entre théorie et expérience.

### Les détecteurs interférométriques d'ondes gravitationnelles

S'il fallait rédiger l'acte de naissance de la recherche des OG, on y inscrirait probablement « Chapel Hill, janvier 1957 ». En effet, une conférence d'une semaine sur « le rôle de la gravitation en physique » eut lieu à cette date à l'Université de Caroline du Nord et on y clarifia le statut des OG sur le plan théorique : elles avaient une réalité physique et pouvaient, au moins en principe, être détectées. Côté expérience, le défi à relever était immense :

réussir à observer des signaux très ténus en provenance du cosmos. En effet, la gravitation étant de loin la plus faible des quatre interactions fondamentales, aucune source terrestre d'OG n'est assez puissante pour générer un signal observable.

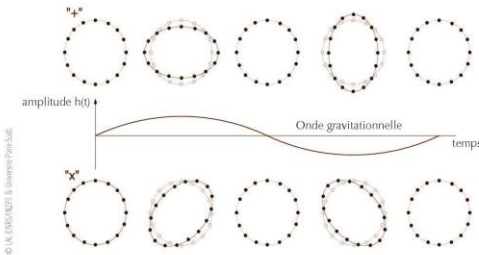
Joseph Weber, l'un des participants à cette conférence, allait consacrer toute sa carrière à la recherche des OG. Dans les années 1960, il conçut un premier type de détecteur : une barre de métal résonante qui vibre au passage d'une OG, laquelle y dépose un peu d'énergie, convertie en signal électrique par un transducteur. Il réfléchit également aux moyens d'améliorer la sensibilité des détecteurs et aux méthodes d'analyse des données. Par ses travaux, il a vraiment lancé un domaine de recherche auquel très peu de gens s'intéressaient à l'époque. Plusieurs générations de « barres de Weber » de plus en plus perfectionnées ont été construites depuis, mais les défauts de ce type de détecteur – faible bande passante et physique de l'interaction barre résonante-OG complexe – ont fait qu'ils ont été supplantés par d'autres instruments : les interféromètres aux miroirs suspendus, comme LIGO et Virgo.

Le choix de cette technologie se comprend en revenant aux caractéristiques des OG. Une OG est une perturbation quadrupolaire de l'espace-temps, créée par une masse accélérée ; elle déforme localement cet espace-temps dans le plan transverse à sa direction de propagation (fig. 1). Pour mesurer ces variations, on peut utiliser un faisceau laser : celui-ci se propage à vitesse constante, et donc son temps de parcours entre deux points sera allongé (raccourci) si l'espace-temps qui les sépare est étiré (comprimé). Virgo et LIGO utilisent un laser de puissance infrarouge (longueur d'onde : 1064 nm).



Vues aériennes des détecteurs Virgo (a), LIGO Hanford (b) et LIGO Livingston (c).

► Images de la physique



1. Visualisation de l'effet des deux polarisations « + » et « x » d'une onde gravitationnelle sur l'espace-temps. On suppose l'OG périodique et se propageant perpendiculairement au plan de l'image. Un anneau de particules test initialement rond est déformé et se transforme en une ellipse : les longueurs se contractent et s'étirent alternativement dans deux directions perpendiculaires lors du passage de l'OG.

Dans un interféromètre de Michelson (fig. 2), la puissance lumineuse détectée en sortie dépend de l'état d'interférence entre les deux faisceaux qui se recombinaient au niveau de la lame séparatrice. Cette interférence reflète le déphasage entre les faisceaux, dû aux variations de longueur des bras (si l'on suppose le laser stable)... et donc potentiellement au passage d'une OG ! Prenons le cas optimal d'une OG d'amplitude  $h$  (un nombre sans dimension) se propageant perpendiculairement au plan contenant l'interféromètre. Dans chaque

bras de longueur  $L$ , l'espace-temps se déforme d'une quantité

$$\delta L = \frac{1}{2} \times h \times L$$

de manière différentielle : l'espace-temps s'étire le long d'un bras et se comprime dans la direction perpendiculaire, celle de l'autre bras. Si  $h$  vaut  $10^{-21}$ ,  $\delta L$  est de l'ordre de  $10^{-18}$  m pour une longueur de bras  $L = 3$  km.

L'équation ci-dessus montre que l'effet mesuré est directement proportionnel à l'amplitude de l'OG et qu'il est d'autant plus important que les bras du détecteur

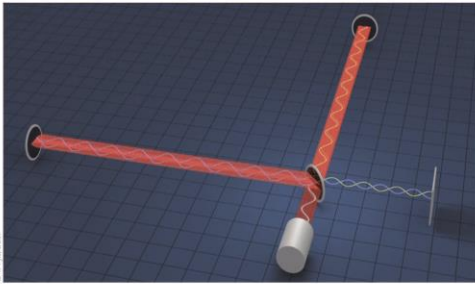
sont longs : deux observations sur lesquelles nous aurons l'occasion de revenir. De plus, utiliser un interféromètre plutôt qu'une cavité optique simple permet de faire une mesure relative et non absolue. L'impact de nombreuses sources de bruit qui pourraient obérer la sensibilité de l'instrument est ainsi réduit de manière importante.

Puisqu'on veut mesurer une variation de puissance lumineuse en sortie du détecteur, toute source de bruit la faisant varier aura un impact sur sa sensibilité. C'est en particulier le cas du bruit de grenaille, lié à la nature quantique de la lumière (le nombre de photons détectés en sortie de l'interféromètre, et donc la puissance mesurée, fluctuent). Comme c'est un processus gouverné par la statistique de Poisson, le calcul montre que la sensibilité de l'interféromètre s'améliore comme la racine carrée de la puissance du laser incidente sur la lame séparatrice. Et qu'elle est maximale lorsque le détecteur est réglé sur la « frange noire » - c'est-à-dire que les deux faisceaux recombinaient destructivement de manière destructive en l'absence d'OG.

Nous disposons maintenant de tous les éléments pour comprendre les améliorations apportées à la configuration des instruments LIGO et Virgo par rapport à un interféromètre de Michelson simple. Tout d'abord, nous avons vu plus haut que les bras doivent être le plus long possible : ils font trois kilomètres pour Virgo, quatre

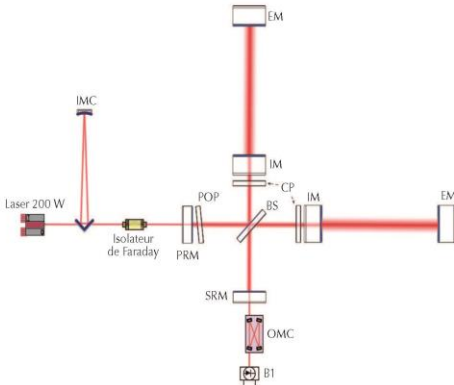
»»»





© L. Juhanon

**2. Schéma d'un interféromètre de Michelson réglé sur la frange noire.** Un faisceau laser (produit par le cylindre blanc) est divisé en deux par une lame séparatrice inclinée à 45 degrés. Chaque faisceau se propage dans un bras de l'instrument, est réfléchi par un miroir (noir) avant de se recombiner avec l'autre faisceau sur la lame séparatrice. La puissance lumineuse résultant de ces interférences est détectée en sortie du détecteur (par le disque le plus à droite). La frange noire correspond à des interférences destructives entre les deux faisceaux.



© The Virgo Collaboration

**3. Configuration optique finale du détecteur Virgo avancé.** Dans cette vue d'artiste, le détecteur n'est pas représenté à l'échelle, tandis que l'épaisseur du trait rouge reflète la puissance du faisceau laser circulant à cet endroit.

- BS : lame séparatrice.
  - IM et EM : miroirs d'entrée et de fond des cavités Fabry-Perot, longues de 3 km.
  - PRM : miroir de recyclage de puissance.
  - SRM : miroir de recyclage du signal.
  - IMC : *Input Mode Cleaner*, cavité triangulaire de 144 m de long dont la fonction est de mettre en forme spatialement le faisceau pour ne laisser entrer dans l'interféromètre que le mode fondamental du laser.
  - OMC : *Output Mode Cleaner*, un dispositif chargé de nettoyer spatialement le faisceau en sortie de l'interféromètre et en amont du banc de détection.
  - RI : banc de détection.
  - POP : *Pick-Off-Plate*, un dispositif permettant de récupérer une petite partie du faisceau stocké dans l'interféromètre, afin d'obtenir des informations sur sa configuration.
  - CP : *Compensating Plate* ; la puissance lumineuse incidente sur les miroirs de Virgo est tellement importante que leurs surfaces se déforment ; pour compenser cet effet et maintenir leur courbure nominale, on chauffe des plaques situés derrière eux.
- Le cylindre jaune entre l'IMC et le miroir de recyclage de puissance est un isolateur de Faraday qui ne laisse passer la lumière laser que dans un seul sens : de l'IMC vers le laser.

» pour LIGO. Un miroir supplémentaire, partiellement réfléchissant (IM), est installé à l'entrée de chaque bras, juste après la lame séparatrice (BS), pour former une cavité Fabry-Perot avec le miroir de fond (EM). La lumière laser y est stockée, ce qui revient à dire que le faisceau laser effectue de nombreux allers-retours dans la cavité. La longueur effective des bras est ainsi augmentée d'un facteur important – presque 300 pour le détecteur de deuxième génération Virgo avancé, décrit plus en détails dans la suite et schématisé dans la figure 3.

Les miroirs de Virgo et LIGO sont parmi les meilleurs au monde. Leur substrat en silice amorphe, lisse et sans défaut, est recouvert d'un revêtement multicouche (réalisé par le Laboratoire des Matériaux Avancés de Villeurbanne, CNRS) qui assure des pertes minimales (quelques parties par million) et offre aux miroirs de fond des bras une réflectivité record, très proche de 100%. La lumière présente dans l'interféromètre (réglé sur la frange noire) est donc réfléchi en totalité vers la source laser. Cette situation est exploitée en rajoutant un miroir (PRM) entre la source et la lame séparatrice ; celui-ci « recycle » la lumière et la stocke dans le détecteur, ce qui revient à augmenter d'un facteur 50 la puissance effective du laser.

Le laser fournit une puissance continue de plusieurs dizaines de watts ; il est ultra-stable en fréquence, en puissance et en direction. Son faisceau gaussien est également purifié spatialement par l'IMC, afin que seul son mode fondamental entre dans l'interféromètre. L'ensemble de ces performances est obtenu grâce à un système d'injection complexe, situé en amont du miroir de recyclage de puissance (PRM). Enfin, les faisceaux laser circulent sous ultraviolette (pression résiduelle de l'ordre du milliardième de milliardième d'atmosphère). Le tube qui les contient fait un peu plus d'un mètre de diamètre : LIGO et Virgo ont donc les plus grandes enceintes sous ultraviolette au monde.

Les données fournies par un interféromètre contiennent essentiellement du bruit. Celui-ci provient de sources très variées, qui sont chacune active dans une bande de fréquences donnée.

- À basse fréquence (quelques Hz), c'est le bruit sismique qui domine : micro-séismes, activités anthropiques, etc. Pour s'en affranchir, les miroirs de LIGO et

Virgo sont accrochés à des suspensions complexes – par exemple, les « super-atténuateurs » de Virgo mesurent près de sept mètres de long, pour un poids d'une tonne. Chaque étage de ces suspensions est l'équivalent d'un pendule simple qui filtre les vibrations au-dessus de sa fréquence de résonance, choisie la plus basse possible. Toujours pour Virgo, l'atténuation totale du bruit sismique au niveau des miroirs dépasse 14 ordres de grandeur à 10 Hz, rendant ce bruit négligeable à partir de cette fréquence.

- À haute fréquence (plusieurs centaines de Hz), le bruit dominant est le bruit de grenaille du laser dont nous avons déjà parlé, augmenté de l'effet de filtrage des cavités Fabry-Perot (l'appareillage est moins sensible aux phénomènes qui évoluent plus rapidement que le temps de stockage de la lumière dans les bras kilométriques).
- C'est aux fréquences intermédiaires que la sensibilité est la meilleure. Elle est limitée par les bruits thermiques, causés par l'excitation à température ambiante des molécules des substrats des miroirs, de leurs revêtements multicouche et de leurs suspensions.

Virgo et LIGO sont bien entendu soumis à de nombreuses autres sources de bruits, certaines « fondamentales » comme celles que nous venons de voir (c'est-à-dire qu'il est impossible de s'en affranchir : la conception du détecteur permet simplement de les minimiser), d'autres d'origine instrumentale (par exemple les vibrations d'un moteur d'une pompe à vide) et que l'on cherche à éliminer une fois leur cause identifiée.

À mesure que les détecteurs s'améliorent, des bruits qui dominaient la sensibilité se retrouvent atténués, laissant la place à d'autres qui deviennent limitants. On peut citer dans cette catégorie la fluctuation de la pression de radiation, un autre bruit fondamental d'origine quantique, important à basse fréquence et causé par les fluctuations du nombre de photons incidents sur les miroirs. Ce bruit a un comportement opposé par rapport au bruit de grenaille : il augmente comme la racine carrée de la puissance du laser. La puissance utilisée dans les détecteurs actuels est donc un compromis entre ces deux effets antagonistes. Pour dépasser à terme cette limite quantique, des recherches basées sur des méthodes d'optique quantique

(utilisation d'états comprimés de la lumière, *squeezing* en anglais) sont en cours.

Un dernier impératif à mentionner est que ces détecteurs doivent être maintenus en permanence à leur point de fonctionnement pour être sensibles aux OG. Ce point de fonctionnement (cavités optiques résonantes et interféromètre de Michelson réglé sur la frange noire) est d'autant plus « étroit » que l'instrument est performant. Cela demande de contrôler avec une très bonne précision les positions et orientations des différents miroirs les uns par rapport aux autres : au niveau du picomètre, voire du femtomètre, pour les longueurs des cavités, et à quelques nanoradians près pour les désalignements. Pour atteindre cet objectif, des informations sur l'état du détecteur sont recueillies en permanence. Elles permettent de comparer la configuration actuelle de l'interféromètre à son point de fonctionnement optimal. On calcule alors des corrections qui sont appliquées aux positions des différents miroirs *via* leurs suspensions.

Si cette stratégie marche bien lorsque l'instrument est déjà proche de son point de fonctionnement, elle est inopérante lorsqu'il s'agit de partir d'une configuration où tout ou partie du détecteur est non contrôlé. Cette situation peut se produire pour de multiples raisons : une perte du contrôle de l'interféromètre due à un problème sur un composant ou à une augmentation du niveau d'un bruit (par exemple un tremblement de terre, y compris de faible magnitude), une période de maintenance ou de test, etc. Dans ce cas, il faut employer d'autres méthodes pour amener progressivement l'instrument dans une configuration où la stratégie décrite plus haut peut prendre le relais.

Enfin, sur chaque site, des milliers de capteurs (photodiodes, caméras, accéléromètres, sondes magnétiques, micros, etc.) surveillent l'instrument et son environnement. Il s'agit de détecter les perturbations qui pourraient nuire à la qualité des données et d'identifier les périodes pendant lesquelles celles-ci ne doivent pas être analysées car elles contiennent trop de bruit. Cette surveillance est un élément clef du processus qui permet d'aboutir à la détection d'une OG : sans elle, la quantité de « faux signaux » serait si importante qu'identifier une vraie OG reviendrait à chercher une aiguille dans une meule de foin.

## Un réseau mondial de détecteurs

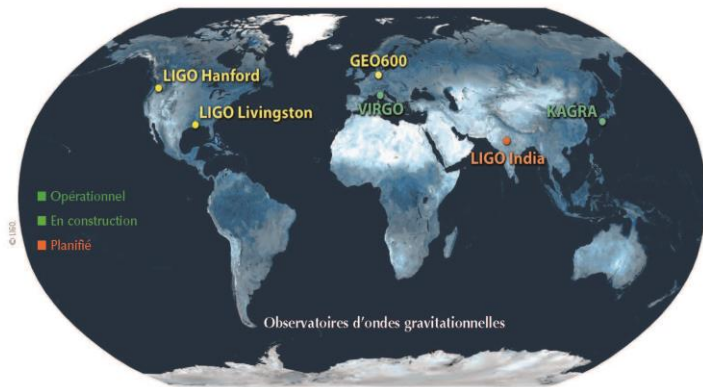
LIGO et Virgo sont des projets à long terme qui ont été lancés dans les années 1990, une vingtaine d'années après les premières études sur la possibilité d'utiliser des interféromètres pour chercher les OG. Après avoir été approuvés et financés (respectivement par la NSF américaine et par le CNRS et l'INFN italien), les trois détecteurs ont été construits au tournant des années 2000 (voir les photos p. 15). Ils ont mené plusieurs campagnes de prises de données entre 2005 et 2011 et ont atteint leurs sensibilités nominales, sans toutefois détecter d'OG. Des programmes d'amélioration d'une durée de plusieurs années ont donc été lancés, avec pour objectif de gagner un facteur 10 en sensibilité et donc d'observer un volume d'Univers 1000 fois plus important.

Les principales différences entre les détecteurs Virgo et Virgo avancé sont résumées ci-dessous.

- Augmentation de la puissance du laser (200 W à terme).
- Ajout du miroir de recyclage du signal (SRM, fig. 3), pour pouvoir optimiser la sensibilité dans une gamme de fréquences donnée.
- Miroirs deux fois plus massifs pour diminuer leur bruit thermique.
- Suspensions monolithiques en silice amorphe (au lieu de fils d'acier) pour les miroirs, également pour réduire leur contribution au bruit thermique.
- Augmentation de la taille du faisceau laser (6 cm de diamètre) sur les miroirs de fond des cavités Fabry-Perot, afin de diminuer les effets thermiques sur leur substrat.
- Amélioration de la capacité de pompage, avec l'ajout de pièges cryogéniques aux extrémités des bras kilométriques. Ceux-ci adsorbent les molécules de gaz résiduelles qui vont se coller sur les parois.
- L'ensemble de l'instrumentation – dont les différents bancs optiques – est suspendu et sous vide.

Les détecteurs LIGO avancés ont été les premiers à entrer en service : ils ont pris des données entre septembre 2015 et janvier 2016, et ont commencé leur seconde campagne de mesures fin novembre 2016. Virgo avancé est actuellement en phase de démarrage ; l'objectif est de rejoindre LIGO au printemps 2017 pour une première campagne de prise de données commune.





4. Le réseau mondial de détecteurs interférométriques d'ondes gravitationnelles en février 2016. En jaune, les instruments en fonctionnement : les deux détecteurs LIGO avancés et GEO600, un interféromètre situé en Allemagne dont les bras font 600 m et qui sert de plateforme R&D à la collaboration LIGO. En vert, les instruments en cours de démarrage ou en construction : Virgo avancé en Italie et KAGRA (un détecteur cryogénique et souterrain) au Japon. En orange, le projet de troisième interféromètre LIGO qui serait installé en Inde.

>>>

Depuis 2007, Virgo et LIGO sont liés par des accords de collaboration qui sont venus formaliser une longue tradition d'échanges scientifiques, tant au niveau de l'instrumentation que de l'analyse des données. En effet, les interféromètres sont sensibles aux mêmes OG ; il est donc bien plus intéressant de mettre en commun toutes les données recueillies et de les analyser de manière conjointe. En premier lieu, la détection d'une OG transitoire (fusion de deux astres compacts, supernova de type II, etc.) demande au moins deux instruments pour s'assurer que le signal observé n'est pas une fluctuation de bruit. De plus, trois détecteurs au minimum sont nécessaires pour reconstruire par triangulation la position de la source dans le ciel : comme les OG se propagent à la vitesse de la lumière (très grande mais finie), elles arrivent légèrement décalées (jusqu'à une trentaine de ms entre Virgo et LIGO Hanford par exemple) dans les différents interféromètres. Le réseau mondial de détecteurs pourrait compter à terme jusqu'à cinq instruments (fig. 4) : les deux interféromètres LIGO construits aux États-Unis, Virgo, un détecteur japonais qui doit entrer en service avant la fin de la décennie (KAGRA), suivi peut-être

quelques années plus tard par un troisième instrument LIGO, installé en Inde.

Les OG ouvrent une nouvelle fenêtre sur l'Univers, qui vient compléter les moyens d'observation actuels : l'ensemble du spectre électromagnétique, les rayons cosmiques et les neutrinos. Des accords ont donc été passés avec plus de 70 collaborations qui reçoivent des alertes (de l'ordre de une par mois en moyenne) quand il y a une forte suspicion de détection d'une OG. Les télescopes ont accès aux coordonnées de la région du ciel où devrait se trouver la source et peuvent ainsi y chercher une contrepartie au signal gravitationnel. L'observation par exemple d'une supernova galactique de type II (issue de l'effondrement d'une étoile massive) en optique, en neutrinos et en OG serait une découverte sensationnelle !

La clef du succès de ce type de recherche est la rapidité de réaction, car la source peut n'être visible que pendant une très courte période (quelques jours, voire quelques heures). C'est pour cela que LIGO et Virgo ont développé un système d'analyse en temps réel des données enregistrées. Réciproquement, les recherches ciblées de contrepartie OG pour un événement détecté par ailleurs

(par exemple un sursaut gamma) sont une autre voie prometteuse. L'heure à laquelle le phénomène a été observé et la position de la source dans le ciel sont deux informations supplémentaires qui permettent de gagner en sensibilité.

### Les premières détections directes des ondes gravitationnelles

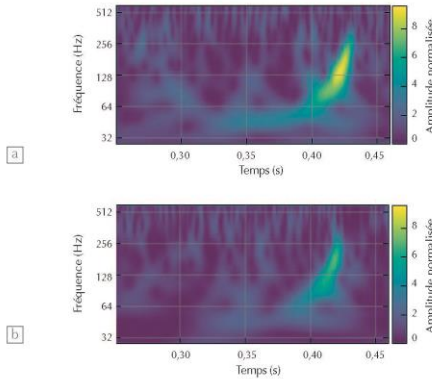
Entre mi-septembre 2015 et mi-janvier 2016, les deux détecteurs LIGO avancés ont accumulé un peu plus de 51 jours de données en coïncidence, dont environ 49 ont été conservés pour analyse après application des critères de sélection visant à garantir la bonne qualité des données. Deux signaux de fusion (ou coalescence) d'un système binaire de trous noirs y ont été observés :

- GW150914, enregistré le 14 septembre 2015 et annoncé le 11 février 2016 (fig. 5),
- GW151226, enregistré le 26 décembre 2015 et annoncé le 15 juin 2016, tandis qu'un troisième candidat du même type (« LVT151012 », enregistré le 12 octobre 2015) a été mis en évidence, mais avec une signification statistique trop faible pour qu'on puisse parler de détection dans son cas. D'autres sources recherchées

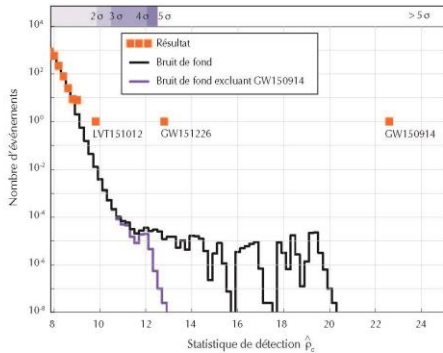
(comme les coalescences étoile à neutrons-trou noir ou de systèmes binaires d'étoiles à neutrons) n'ont pas été observées, ce qui a permis de mettre des limites supérieures sur le taux d'occurrence de ces événements dans l'Univers. Certaines analyses, comme la recherche de signaux continus émis par des pulsars qui ne seraient pas parfaitement sphériques, sont encore en cours.

Deux méthodes principales ont été utilisées pour chercher des signaux d'OG transitoires, d'une durée allant de quelques millisecondes à plusieurs secondes. La première ne fait aucune hypothèse sur la forme d'onde cherchée. Elle utilise les cartes temps-fréquence construites à partir des données enregistrées, y sélectionne des excès par rapport au niveau de bruit attendu et retient ceux qui sont cohérents entre les deux détecteurs. Un algorithme de ce type a identifié l'événement GW150914 (d'une durée d'environ trois dixièmes de seconde) comme prometteur trois minutes à peine après l'acquisition des données.

La seconde méthode suppose connu le signal d'OG : c'est le filtrage adapté. Elle s'applique parfaitement au cas des coalescences de systèmes binaires d'astres compacts grâce aux progrès théoriques enregistrés depuis les années 1990 (voir l'article de L. Blanchet, pp. 6-12). Elle consiste à corrélérer ce signal, appelé « calque », aux données et à identifier des périodes où la corrélation mesurée est importante. Là où les choses se compliquent, c'est que cet algorithme n'est efficace que si le calque et le vrai signal sont très ressemblants. Or, l'OG produite lors d'une coalescence particulière dépend des paramètres du système (inconnus *a priori*), notamment des masses et des moments angulaires des deux astres compacts. Il s'agit donc en pratique de balayer un espace des paramètres multidimensionnel qui contient toutes les configurations de systèmes binaires recherchés par Virgo et LIGO. Ce sont ainsi plus de 200 000 calques qui ont été utilisés en parallèle pour la recherche de fusions trou noir-trou noir. Leur nombre est un compromis entre la volonté de couvrir au mieux l'espace des paramètres dans son ensemble et les ressources informatiques, forcément limitées, disponibles pour mener à bien cette analyse. Cette méthode a également détecté le signal GW150914, lequel a donc été identifié par deux analyses complètement indépendantes, ce qui renforce son statut de découverte.



5. Diagrammes temps-fréquence montrant le signal GW150914 observé dans les détecteurs LIGO avancés de Hanford (a) et Livingston (b). Dans ces cartes, plus la couleur imprimée est chaude (du bleu foncé au jaune) et plus l'énergie de la bande de fréquence correspondante, mesurée à un instant donné, est importante. On observe dans les deux cas une augmentation de la fréquence et de l'amplitude du signal au cours du temps, une évolution caractéristique de la fusion de deux astres compacts.



6. Résultats de l'analyse des données des détecteurs LIGO avancés par une méthode de recherche d'OG utilisant le filtrage adapté. En abscisse, on a la statistique de détection utilisée pour ordonner les candidats OG sélectionnés dans les données et dont la distribution est indiquée par les carrés orange. Les histogrammes en trait plein montrent la distribution de la statistique de détection en l'absence d'OG, calculée de deux manières différentes – selon que l'on prend en compte (histogramme noir) ou pas (histogramme violet) le très fort signal GW150914 pour estimer le bruit de fond. Les événements GW150914, GW151226 et LVT151012 sont bien visibles : les trois carrés orange de droite à gauche.

© The LIGO Scientific Collaboration and the Virgo Collaboration, URL: <https://arxiv.org/abs/1602.03832>.

► Images de la physique

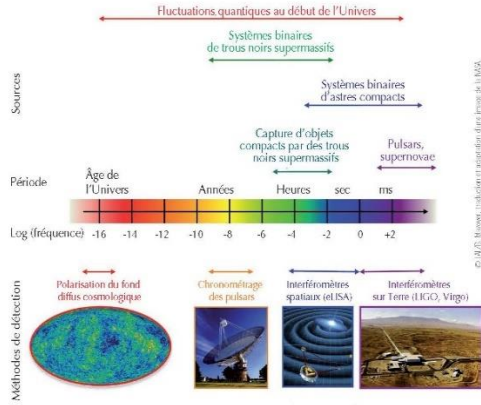
© The LIGO Scientific Collaboration and the Virgo Collaboration, URL: <https://arxiv.org/abs/1602.03832>.



Chaque algorithme fournit une liste de candidats OG potentiels, classés par « statistique de détection » croissante : il s'agit d'un nombre d'autant plus élevé que le signal ressort nettement du bruit de mesure. La statistique de détection est propre à une analyse donnée ; elle inclut toutes les informations disponibles sur les candidats ; force du signal dans les différents détecteurs, cohérence entre ces signaux, ressemblance avec le calque sélectionné dans le cadre du filtrage adapté, etc. C'est cette quantité qui est utilisée pour calculer la signification statistique du candidat et donc décider finalement s'il s'agit ou pas d'une OG. Pour cela, une fois écartée la possibilité que le signal observé soit dû à un problème instrumental ou à l'interaction de l'environnement avec les détecteurs, on utilise les données enregistrées pour estimer la distribution de la statistique de détection en l'absence d'OG.

Au final, et pour reprendre un vocabulaire utilisé en physique des hautes énergies pour estimer le niveau de confiance d'un résultat, la probabilité que GW150914 soit une OG dépasse les « cinq sigmas », le seul communément admis pour une détection (environ une chance sur 3,5 millions de se tromper). Idem pour GW151226. En revanche, le troisième candidat identifié, LVT151012, n'a pas une signification statistique suffisante pour pouvoir prétendre au titre de détection (fig. 6).

Des méthodes statistiques bayésiennes exploitant la relation entre formes d'onde et paramètres des systèmes binaires compacts ont permis de mesurer certaines des caractéristiques des astres progéniteurs (et finaux) des événements GW150914 et GW151226. Il s'agit des premières détections directes de trous noirs, des premières détections de systèmes binaires de trous noirs et des premières détections tout court de trous noirs dans cette gamme de masses. GW150914 est également l'événement le plus puissant jamais observé dans l'Univers, puisque l'équivalent de trois masses solaires ont été converties en OG au moment de la fusion. Les données recueillies permettent aussi de valider la relativité générale dans un régime de champ fort, jusque-là inaccessible à l'expérience. Avec seulement deux événements confirmés, il est encore difficile d'estimer avec précision le taux des coalescences de systèmes binaires de trous noirs. Mais au minimum on devrait en observer



7. Le spectre des ondes gravitationnelles. Il existe de très nombreuses sources attendues d'OG. Différents types de détecteurs ou de méthodes de détection doivent être utilisés selon la bande de fréquence du signal cherché. Les détecteurs interférométriques comme Virgo et LIGO sont des instruments à large bande, sensibles entre quelques dizaines de Hz et 10 kHz.

d'autres lors des prochaines prises de données LIGO-Virgo.

### Perspectives

Les événements GW150914 et GW151226 ouvrent une nouvelle fenêtre sur l'Univers. L'astronomie des OG devrait se développer dans les prochaines années, avec des interféromètres terrestres plus sensibles et plus nombreux ainsi que d'autres méthodes de détection (fig. 7). On peut citer notamment le chronométrage de pulsars millisecondes effectué par des réseaux de radiotélescopes (dont celui de Nançay en France) ou le projet d'interféromètre spatial LISA, prévu pour la fin de la prochaine décennie et dont la mission de démonstration LISA Pathfinder, lancée en décembre 2015, a obtenu des résultats très prometteurs. À suivre !

L'auteur souhaite remercier Fabien Cavalier pour ses conseils et ses relectures du présent article.

### Pour en savoir plus

- Site internet public et en français de l'expérience Virgo : <http://public.virgo-gw.eu/langage/fr>
- Site internet des détecteurs LIGO (en anglais) : [www.ligo.caltech.edu](http://www.ligo.caltech.edu)
- Site internet de la collaboration scientifique LIGO (en anglais) : [www.ligo.org](http://www.ligo.org)
- Compilation de ressources pédagogiques à destination des enseignants et de leurs élèves : <http://public.virgo-gw.eu/ressources-pedagogiques>
- Communiqué de presse du CNRS pour la première détection (GW150914) : [www2.cnrs.fr/presse/communiqu/4409.htm](http://www2.cnrs.fr/presse/communiqu/4409.htm)
- Communiqué de presse du CNRS pour la deuxième détection (GW151226) : [www.in2p3.fr/recherche/actualites/2016/cp\\_ondes\\_gravitationnelles\\_juin.html](http://www.in2p3.fr/recherche/actualites/2016/cp_ondes_gravitationnelles_juin.html)
- Communiqué de presse du CNRS sur le satellite LISA Pathfinder : [www2.cnrs.fr/presse/communiqu/4575.htm](http://www2.cnrs.fr/presse/communiqu/4575.htm)
- Site internet de l'European Pulsar Timing Array : [www.epta.eu.org](http://www.epta.eu.org) (en anglais).



## 2. Documents From the Niels Bohr Library

### 2.1. Invitation Letter



One Physics Ellipse, College Park, MD 20740-3843

Center for History of Physics

<http://www.aip.org/history>  
 Fax + 1 301 209 0882  
[www.aip.org](http://www.aip.org)

June 20, 2019

Gregory A. Good  
 Director  
 Tel. 301 209 3174  
 E-mail: [ggood@aip.org](mailto:ggood@aip.org)

Dear Philippe Vincent,

Melanie Mueller  
 Director  
 Niels Bohr Library & Archives  
 Tel. 301 209 3179  
 E-mail: [mmueller@aip.org](mailto:mmueller@aip.org)

The American Institute of Physics is pleased to be able to award you and a Grant-in-Aid to support your "research your thesis: *The Role Played by the History of the Discovery of Gravitational Waves. Hypotheses and Perspectives.*" We will provide up to \$2500.00 reimbursement of your airfare and housing expenses in support of the work outlined in your application. The grant is effective immediately and extends until December 31, 2019. If more time is needed in order to achieve your research, please contact us for an extension into 2020.

Niels Bohr Library  
 & Archives  
 Tel. 301 209 3177  
 E-mail: [nbl@aip.org](mailto:nbl@aip.org)

Reimbursement will be made in response to bills or travel vouchers signed and submitted by you. Be sure to save and attach receipts for air fare, hotel bills, and other major expenses. It would be most convenient if you would use the attached AIP travel voucher. Our Accounting department requires a W-8 or 9 form be signed and sent in with the travel voucher. W-9 is for U.S. residents, W-8 is for foreign born residents. As you know, we can provide free transcription of a small number of interviews, provided you feel they are of general interest and you are willing to go to the considerable extra work of editing the transcript, sending it to the person interviewed for correction, etc.

#### Member Societies

Acoustical Society of America  
 American Association of  
 Physicists in Medicine  
 American Association of  
 Physics Teachers  
 American Astronomical Society  
 American Crystallographic  
 Association  
 American Meteorological Society  
 American Physical Society  
 AVS Science and Technology  
 of Materials, Interfaces, and  
 Processing  
 OSA - The Optical Society  
 The Society of Rheology

We expect that any oral history interviews conducted with the aid of this grant will be recorded digitally or on tape, and if the person interviewed agrees, that a copy of the interview will be deposited in our Niels Bohr Library. (If you like, we can keep the material closed to others for several years while you complete your project.) For such interviews to be useful to future scholars, two requirements are indispensable.

First, the person interviewed must state the terms under which others may listen to the audio or read a transcript and quote from them. This statement could be done on the audio itself, at the end of the interview, or it could be done in writing using our permission form. This form (OHI-prelim-agreement.pdf) is attached to this email. We also request such a statement from you, so please print out a second form, signed and send it to us. Once the interview has been reviewed, we require a second statement (permission form) to be filled out by both the interviewee and Yourself. This form is also attached to the email as 2nd agreement-Permission form and allows us to post the interview online.

#### Other Member Organizations

Sigma Pi Sigma Physics  
 Honor Society  
 Society of Physics Students  
 Corporate Associates

Second, you must provide a summary of the contents of the interview (Abstract), which might be a detailed running table of contents, or, as a minimum, a paragraph of a few sentences—without such information the interview is much harder for us to index so that scholars can find and use it.

June 20, 2019  
Page 2 of 2

In any resulting publication or announcement, kindly acknowledge that your work was partly supported by “a grant-in-aid from the Friends of the Center for History of Physics, American Institute of Physics.” We also ask that after the money is spent, you send us a brief letter reporting on how you used the grant and its value for your work.

We're glad to be able to give some help in what we all agree is a valuable project.

I am sending this by e-mail to give you a fast response; let me know if you also want a formal letter.

Sincerely,



Gregory A. Good, Ph.D.  
Director  
Center for History of Physics  
American Institute of Physics  
One Physics Ellipse  
College Park, MD 20740  
[ggood@aip.org](mailto:ggood@aip.org)  
Tel +1 301-209-3174



## 2.2. Some Resources from the Niels Bohr Library (AIP)

Faculté des Sciences  
de  
l'Université de Paris

Paris, 16 Décembre 1913.

—+—  
Analyse Supérieure  
—+—

Cher ami,

J'ai présenté lundi dernier votre note à l'Académie; elle m'a paru très intéressante, et cela méritera d'être développée.

J'ai deux choses à vous demander. Je vais me rappeler que Poincaré a fait à Berlin une communication à la Société Mathématique sur les surfaces algébriques. Comme je vous reprenne dans mon cours cette année cette question des surfaces algébriques qui m'a tant occupé, je serais heureux de savoir ce qu'il y avait dans cette communication.

Je voudrais aussi avoir votre avis sur les travaux récents sur le principe de relativité en ce qui concerne ses rapports avec la gravitation (Abraham, Einstein); cela m'a l'air d'un beau gâchis. Il est vraiment extraordinaire que, avec des bases expérimentales assez fragiles, on veuille changer les idées de l'humanité sur l'espace et le temps. Je n'ai pas craint d'écrire cela dans une notice sur l'œuvre de Poincaré, que j'ai publiée aujourd'hui la Revue Scientifique et que reproduit le cahier d'Octobre des Annales de l'École Normale. Je ne me dissimule pas que cela va m'attirer le mépris des physiciens.

Je serai très heureux de vous voir au mois de

Jamais. Veuillez présenter mon respectueux  
souvenir à M<sup>me</sup> Korn, et verse à mes sentiments  
bien dévoués,

Emilien

Chas. Emile Picard

## GRAVITATIONAL-WAVE-DETECTOR EVENTS\*

J. Weber

Department of Physics and Astronomy, University of Maryland, College Park, Maryland

(Received 4 April 1968)

A new series of experiments is described, involving two gravitational wave detectors spaced about 2 km. A number of coincident events have been observed, with extremely small probability that they are statistical. It is clear that on rare occasions these instruments respond to a common external excitation which may be gravitational radiation.

Two aluminum cylinders have been instrumented to record the Fourier transform of the Riemann tensor<sup>1-3</sup> in the vicinity of the angular frequency  $\omega = 10^3$  rad sec<sup>-1</sup>. One detector has a diameter of 2 ft, the other has a diameter of 8 in. Both are about 5 ft long. The larger cylinder employs cryogenic electronics and has been employed with a relatively fixed bandwidth  $\Delta\omega \approx 0.1$  rad sec<sup>-1</sup>. The smaller cylinder does not ordinarily employ cryogenics. Its electronics differ from that of the larger instrument in many respects, resulting in electronically adjustable bandwidth over a wide range, and adjustable center frequency.

These detectors are spaced about 2 km. An earlier<sup>3</sup> paper reported observation of coincident events. During the remainder of 1967 roughly one coincidence a month was noted. The relaxation time of these detectors is about 30 sec. Pen-and-ink recorders preceded by circuits averaging over more than the relaxation time were employed. The time resolution was about 1 min.

A gravitational wave detector is a harmonic oscillator driven by the Riemann curvature tensor. The response to a sudden increase in the driving force is a fast rise with decay governed by the relaxation time. It is therefore feasible to re-

solve signals from the two detectors with precision determined by our ability to resolve the leading edges of the response envelopes.

A two-channel coincidence detector was developed. An average of the envelope is taken over a short interval  $\tau$  in one channel. If a given threshold is crossed in the positive direction a pulse is generated. Similar functions are performed in the second channel. If the pulses overlap in time an output pulse is generated. Measurements indicated that only pairs of events with leading edges spaced closer than about 0.20 sec generated event-marker pulses. Experiments established that the large detector (with longest relaxation time) required ordinarily less than 0.20 sec between excitation and receiver output. A telephone line joins the small detector to the coincidence apparatus at the large detector site.

Observation of events.—During the past 3 months of operation, events were observed coincident at least to within 0.20 sec. For each coincidence I have listed in Table I the probability and frequency of a random coincidence with the same power. The probability of random coincidences was measured for the last two events listed in the following ways. A chart recorder gives

Table I. Observed coincidences January-March 1968.

Event	(Large-detector power)/mean	No. of large-detector events per day exceeding given power	(Small-detector power)/mean	No. of small-detector events per day exceeding given power	Probability of a random coincidence	Frequency of random coincidence	Date and Greenwich mean time
A	18	Too infrequent to determine by experiment	2.2	43	$7.7 \times 10^{-13}$	Once in 8000 yr	7 February 2101
B	11	Too infrequent to determine by experiment	2.2	43	$1.5 \times 10^{-12}$	Once in 40 yr	13 March 1150
C	6	40	2.3	39	$8 \times 10^{-9}$	Once in 300 d	29 March 0732
D	5	80	2.3	39	$1.6 \times 10^{-8}$	Once in 150 d	29 March 0358

No. 203. VOL. XXXIV. NOVEMBER, 1887.

Established by BENJAMIN SILLIMAN in 1818.

THE

AMERICAN

JOURNAL OF SCIENCE.

EDITORS

JAMES D. AND EDWARD S. DANA.

ASSOCIATE EDITORS

PROFESSORS ASA GRAY, JOSIAH P. COOKE, AND JOHN TROWBRIDGE, OF CAMBRIDGE,

PROFESSORS H. A. NEWTON AND A. E. VERRILL, OF NEW HAVEN,

PROFESSOR GEORGE F. BARKER, OF PHILADELPHIA.

THIRD SERIES.

VOL. XXXIV.—[WHOLE NUMBER, CXXXIV.]

WITH PLATES 10 TO 12.

No. 203—NOVEMBER, 1887.

NEW HAVEN, CONN.: J. D. & E. S. DANA. 1887.

TUTTLE, MORSEHOUS & TAYLOR, PRINTERS, 21 STATE STREET.

Five dollars per year (postage prepaid). \$4.40 to foreign subscribers of countries in the Postal Union. Remittances should be made either by money orders, registered letters, or bank checks.

THE

AMERICAN JOURNAL OF SCIENCE.

[THIRD SERIES.]

ART. XXXVI.—On the Relative Motion of the Earth and the Luminiferous Ether; by ALBERT A. MICHELSON and EDWARD W. MORLEY.\*

The discovery of the aberration of light was soon followed by an explanation according to the emission theory. The effect was attributed to a simple composition of the velocity of light with the velocity of the earth in its orbit. The difficulties in this apparently sufficient explanation were overlooked until after an explanation on the undulatory theory of light was proposed. This new explanation was at first almost as simple as the former. But it failed to account for the fact proved by experiment that the aberration was unchanged when observations were made with a telescope filled with water. For if the tangent of the angle of aberration is the ratio of the velocity of the earth to the velocity of light, then, since the latter velocity in water is three-fourths its velocity in a vacuum, the aberration observed with a water telescope should be four-thirds of its true value.†

\* This research was carried out with the aid of the Harkness Fund.  
 † It may be noticed that most writers admit the sufficiency of the explanation according to the emission theory of light; while in fact the difficulty is even greater than according to the undulatory theory. For on the emission theory the velocity of light must be greater in the water telescope, and therefore the angle of aberration should be less; hence, in order to reduce it to its true value, we must make the absurd hypothesis that the motion of the water in the telescope carries the ray of light in the opposite direction!

Am. Jour. Sci.—Third Series, Vol. XXIV, No. 203.—Nov., 1887.  
 21

384 *Michelson and Morley—Motion of the Earth, etc.*

On the undulatory theory, according to Fresnel, first, the ether is supposed to be at rest except in the interior of transparent media, in which secondly, it is supposed to move with a velocity less than the velocity of the medium in the ratio  $\frac{n^2-1}{n^2}$ , where  $n$  is the index of refraction. These two hypotheses give a complete and satisfactory explanation of aberration. The second hypothesis, notwithstanding its seeming improbability, must be considered as fully proved, first, by the celebrated experiment of Fizeau,\* and secondly, by the ample confirmation of our own work.† The experimental trial of the first hypothesis forms the subject of the present paper.

If the earth were a transparent body, it might perhaps be conceded, in view of the experiments just cited, that the intermolecular ether was at rest in space, notwithstanding the motion of the earth in its orbit; but we have no right to extend the conclusion from these experiments to opaque bodies. But there can hardly be question that the ether can and does pass through metals. Lorenz cites the illustration of a metallic harmonic tube. When the tube is inclined the ether in the space above the mercury is certainly forced out, for it is incompressible.‡ But again we have no right to assume that it makes its escape with perfect freedom, and if there be any resistance, however slight, we certainly could not assume an opaque body such as the whole earth to offer free passage through its entire mass. But as Lorenz aptly remarks: "quoi qu'il en soit, on fera bien, à mon avis, de ne pas se laisser guider, dans une question aussi importante, par des considérations sur le degré de probabilité ou de simplicité de l'une ou de l'autre hypothèse, mais de s'adresser à l'expérience pour apprendre à connaître l'état, de repos ou de mouvement, dans lequel se trouve l'éther à la surface terrestre."<sup>§</sup>

In April, 1881, a method was proposed and carried out for testing the question experimentally.¶

In deducing the formulae for the quantity to be measured, the effect of the motion of the earth through the ether on the path of the ray at right angles to this motion was overlooked.¶¶

\* Comptes Rendus xxxiii, 840, 1851; Pogg Ann. Ergänzungsband, xl, 457, 1853; Ann. Chim. Phys., III, lvi, 285, 1859.  
 † Smithsonian of Motion of the Medium on the Velocity of Light. This Journal, III, xxvi, 377, 1886.

‡ It may be objected that it may escape by the space between the mercury and the walls, but this could be prevented by surrounding the walls.  
 § Archives Néerlandaises, xxi, 5<sup>me</sup> livr.

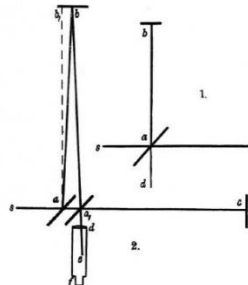
¶ The relative motion of the earth and the luminiferous ether, by Albert A. Michelson, this Jour., III, xxi, 130.

¶¶ It may be mentioned here that the error was pointed out to the author of the former paper by M. A. Poincaré, of Paris, in the winter of 1881.

*Michelson and Morley—Relative Motion of the* 385

The discussion of this oversight and of the entire experiment forms the subject of a very searching analysis by H. A. Lorentz,\* who finds that this effect can by no means be disregarded. In consequence, the quantity to be measured had in fact but one-half the value supposed, and as it was already barely beyond the limits of errors of experiment, the conclusion drawn from the result of the experiment might well be questioned; since, however, the main portion of the theory remains unquestioned, it was decided to repeat the experiment with such modifications as would insure a theoretical result much too large to be masked by experimental errors. The theory of the method may be briefly stated as follows:

Let  $az$ , fig. 1, be a ray of light which is partly reflected in  $ab$ , and partly transmitted in  $ac$ , being returned by the mirrors  $b$  and  $c$ , along  $ba$  and  $ca$ .  $ba$  is partly transmitted along  $ad$ ,



and  $ca$  is partly reflected along  $ad$ . If then the paths  $ad$  and  $ac$  are equal, the two rays interfere along  $ad$ . Suppose now, the ether being at rest, that the whole apparatus moves in the direction  $az$ , with the velocity of the earth in its orbit, the direc-

\* De l'Influence du Mouvement de la Terre sur les Phén. Lum. Archives Néerlandaises, xxi, 5<sup>me</sup> livr., 1898.

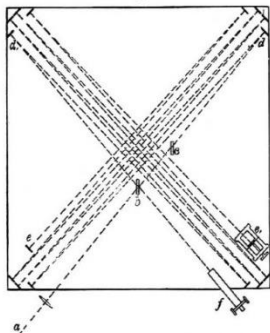
tions and distances traveled by the rays will be altered thus:—The ray *as* is reflected along *ab*, fig. 2; the angle *bab* being equal to the aberration  $\alpha$ , is returned along *ba*, (*ab*,  $=2\alpha$ ), and goes to the focus of the telescope, whose direction is unaltered. The transmitted ray goes along *ac*, is returned along *ca*, and is reflected at *a*, making *ca*  $\alpha$  equal  $90-\alpha$ , and therefore still coinciding with the first ray. It may be remarked that the rays *ba*, and *ca*, do not now meet exactly in the same point *a*, though the difference is of the second order; this does not affect the validity of the reasoning. Let it now be required to find the difference in the two paths *aba*, and *aca*.

Let  $V$  = velocity of light.  
 $v$  = velocity of the earth in its orbit.  
 $D$  = distance *ab* or *ac*, fig. 1.  
 $T$  = time light occupies to pass from *c* to *a*.  
 $T$  = time light occupies to return from *c* to *a*, (fig. 2).  
 Then  $T = \frac{D}{V-v}$ ,  $T' = \frac{D}{V+v}$ . The whole time of going and coming is  $T+T' = 2D \frac{V}{V^2-v^2}$ , and the distance traveled in this time is  $2D \frac{V^2}{V^2-v^2} = 2D(1 + \frac{v^2}{V^2})$ , neglecting terms of the fourth order. The length of the other path is evidently  $2D / (1 + \frac{v^2}{V^2})$ , or to the same degree of accuracy,  $2D(1 - \frac{v^2}{2V^2})$ . The difference is therefore  $D \frac{v^2}{V^2}$ . If now the whole apparatus be turned through  $90^\circ$ , the difference will be in the opposite direction, hence the displacement of the interference fringes should be  $2D \frac{v^2}{V^2}$ . Considering only the velocity of the earth in its orbit, this would be  $2D \times 10^{-8}$ . If, as was the case in the first experiment,  $D = 2 \times 10^4$  waves of yellow light, the displacement to be expected would be 0.04 of the distance between the interference fringes.

In the first experiment one of the principal difficulties encountered was that of revolving the apparatus without producing distortion; and another was its extreme sensitiveness to vibration. This was so great that it was impossible to see the interference fringes except at brief intervals when working in the city, even at two o'clock in the morning. Finally, as before remarked, the quantity to be observed, namely, a displacement of something less than a twentieth of the distance between the interference fringes may have been too small to be detected when masked by experimental errors.

their surfaces measured 5.0 by 7.5 centimeters. The second of these was placed in the path of one of the pencils to compensate for the passage of the other through the same thickness of glass. The whole of the optical portion of the apparatus was kept covered with a wooden cover to prevent air currents and rapid changes of temperature.

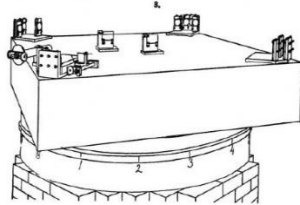
The adjustment was effected as follows: The mirrors having been adjusted by screws in the castings which held the



mirrors, against which they were pressed by springs, till light from both pencils could be seen in the telescope, the lengths of the two paths were measured by a light wooden rod reaching diagonally from mirror to mirror, the distance being read from a small steel scale to tenths of millimeters. The difference in the lengths of the two paths was then annulled by moving the mirror *s*. This mirror had three adjustments; it had an adjustment in altitude and one in azimuth, like all the other mirrors,

The first named difficulties were entirely overcome by mounting the apparatus on a massive stone floating on mercury, and the second by increasing, by repeated reflection, the path of the light to about ten times its former value.

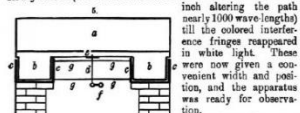
The apparatus is represented in perspective in fig. 2, in plan in fig. 3, and in vertical section in fig. 5. The stone *c* (fig. 5) is about 1.5 meter square and 0.8 meter thick. It rests on an annular wooden float *bb*, 1.5 meter outside diameter, 0.7 meter inside diameter, and 0.25 meter thick. The float rests on mercury contained in the cast-iron trough *cc*, 1.5 centimeter thick, and of such dimensions as to leave a clearance of about one centimeter around the float. A pin *d*, guided by arms *gggg*, fits into a socket *e* attached to the float. The pin may be passed into the socket or be withdrawn, by a lever pivoted at *f*. This pin keeps the float concentric with the trough, but does not bear any part of the weight of the stone. The annular iron trough rests on a bed of cement on a low brick pier built in the form of a hollow octagon.



At each corner of the stone were placed four mirrors *dd ee* fig. 4. Near the center of the stone was a plano-parallel glass *h*. These were so disposed that light from an ignited burner *a*, passing through a lens, fell on *h* so as to be in part reflected to *d*; the two pencils followed the paths indicated in the figure, *bdhd* and *bd'ed'* respectively, and were observed by the telescope *f*. Both *f* and *a* revolved with the stone. The mirrors were of speculum metal carefully worked to optically plane surfaces five centimeters in diameter, and the glasses *h* and *c* were plane-parallel and of the same thickness, 1.56 centimeter;

but finer; it also had an adjustment in the direction of the incident ray, sliding forward or backward, but keeping very accurately parallel to its former plane. The three adjustments of this mirror could be made with the wooden cover in position.

The paths being now approximately equal, the two images of the source of light or of some well-defined object placed in front of the condensing lens, were made to coincide, by the telescope *f*. Both *f* and *a* revolved with the stone. The mirrors were now adjusted for distinct vision of the expected interference bands, and sodium light was substituted for white light, when the interference bands appeared. These were now made as clear as possible by adjusting the mirror *s*, then white light was restored, the screw altering the length of path was very slowly moved (one turn of a screw of one hundred threads to the inch altering the path nearly 1000 wave lengths) till the colored interference fringes reappeared in white light. These were now given a convenient width and position, and the apparatus was ready for observation.



The observations were conducted as follows: Around the cast-iron trough were sixteen equidistant marks. The apparatus was revolved very slowly (one turn in six minutes) and after a few minutes the cross wire of the micrometer was set on the clearest of the interference fringes at the instant of passing one of the marks. The motion was so slow that this could be done readily and accurately. The reading of the screw-head on the micrometer was noted, and a very slight and gradual impulse was given to keep up the motion of the stone; on passing the second mark, the same process was repeated, and this was continued till the apparatus had completed six revolutions. It was found that by keeping the apparatus in slow uniform motion, the results were much more uniform and consistent than when the stone was brought to rest for every observation; for the effects of strains could be noted for at least half a minute after the stone came to rest, and during this time effects of change of temperature came into action.

The following tables give the means of the six readings; the first, for observations made near noon, the second, those near six o'clock in the evening. The readings are divisions of the screw-heads. The width of the fringes varied from 40 to 60 divisions, the mean value being near 50, so that one division

340 Earth and the Luminiferous Ether.

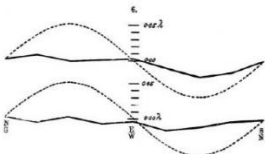
means 0.02 wave-length. The rotation in the observations at noon was contrary to, and in the evening observations, with, that of the hands of a watch.

NOON OBSERVATIONS.	
	16. 17. 18. 19. 20. 21. 22. 23. 24. 25. 26. 27. 28. 29. 30.
July 10.....	487 448 438 437 437 437 437 437 437 437 437 437 437 437 437
July 11.....	574 573 567 567 567 567 567 567 567 567 567 567 567 567 567
July 12.....	773 773 770 770 770 770 770 770 770 770 770 770 770 770 770
Mean.....	481 418 417 394 377 361 379 379 393 384 343 341 341 359 359 379 379
Mean in w. l.	582 582 581 581 581 581 581 581 581 581 581 581 581 581 581
Final mean.	738 742 743 738 733 733 715 693 681

P. M. OBSERVATIONS.	
	16. 17. 18. 19. 20. 21. 22. 23. 24. 25. 26. 27. 28. 29. 30.
July 10.....	457 458 458 458 458 458 458 458 458 458 458 458 458 458 458
July 11.....	599 598 592 592 592 592 592 592 592 592 592 592 592 592 592
July 12.....	698 698 698 698 698 698 698 698 698 698 698 698 698 698 698
Mean.....	453 419 423 398 378 361 379 379 393 384 343 341 341 359 359
Mean in w. l.	598 598 598 598 598 598 598 598 598 598 598 598 598 598 598
Final mean.	1067 1067 1067 1067 1067 1067 1067 1067 1067 1067 1067 1067 1067 1067 1067

The results of the observations are expressed graphically in fig. 6. The upper is the curve for the observations at noon, and the lower that for the evening observations. The dotted curves represent one-half of the theoretical displacements. It seems fair to conclude from the figure that if there is any displacement due to the relative motion of the earth and the luminiferous ether, this cannot be much greater than 0.01 of the distance between the fringes.



Considering the motion of the earth in its orbit only, this

Michelson and Morley—Relative Motion of the 341

displacement should be  $2Dv^2 = 2D \times 10^{-8}$ . The distance  $D$  was about eleven meters, or  $9 \times 10^7$  wave-lengths of yellow light; hence the displacement to be expected was 0.4 fringe. The actual displacement was certainly less than the twentieth part of this, and probably less than the fortieth part. But since the displacement is proportional to the square of the velocity, the relative velocity of the earth and the ether is probably less than one-sixth the earth's orbital velocity, and certainly less than one-fourth.

In what precedes, only the orbital motion of the earth is considered. If this is combined with the motion of the solar system, concerning which but little is known with certainty, the result would have to be modified; and it is just possible that the resultant velocity at the time of the observations was small though the chances are much against it. The experiment will therefore be repeated at intervals of three months, and thus all uncertainty will be avoided.

It appears from all that precedes, reasonably certain that if there be any relative motion between the earth and the luminiferous ether, it must be small; quite small enough entirely to refute Fresnel's explanation of aberration. Stokes has given a theory of aberration which assumes the ether at the earth's surface to be at rest with regard to the latter, and only requires in addition that the relative velocity have a potential; but Lorentz shows that these conditions are incompatible. Lorentz then proposes a modification which combines some ideas of Stokes and Fresnel, and assumes the existence of a potential, together with Fresnel's coefficient. If now it were legitimate to conclude from the present work that the ether is at rest with regard to the earth's surface, according to Lorentz there could not be a velocity potential, and his own theory also fails.

Supplement.

It is obvious from what has gone before that it would be hopeless to attempt to solve the question of the motion of the solar system by observations of optical phenomena at the surface of the earth. But it is not impossible that at even moderate distances above the level of the sea, at the top of an isolated mountain peak, for instance, the relative motion might be perceptible in an apparatus like that used in these experiments. Perhaps if the experiment should ever be tried in these circumstances, the cover should be of glass, or should be removed. It may be worth while to notice another method for multiplying the square of the aberration sufficiently to bring it within the range of observation, which has presented itself during the

342 Earth and the Luminiferous Ether.

preparation of this paper. This is founded on the fact that reflection from surfaces in motion varies from the ordinary laws of reflection.

Let  $ab$  (fig. 1) be a plane wave falling on the mirror  $ms$  at an incidence of  $45^\circ$ . If the mirror is at rest, the wave front after reflection will be  $ac$ .

Now suppose the mirror to move in the direction which makes an angle  $\alpha$  with its normal, with a velocity  $\alpha$ . Let  $V$  be the velocity of light in the ether supposed stationary, and let  $\alpha$  be the increase in the distance the light has to travel to reach  $d$ . In this time the mirror will have moved a distance  $\frac{cd}{\sqrt{2} \cos \alpha}$ .

We have  $\frac{cd}{\sqrt{2} \cos \alpha} = \frac{\omega \sqrt{2} \cos \alpha}{V}$  which put  $r = \frac{c}{V}$  and  $\frac{ac}{ad} = 1 - r$ .

In order to find the new wave front, draw the arc  $abc$  with  $b$  as a center and  $ad$  as radius; the tangent to this arc from  $d$  will be the new wave front, and the normal to the tangent from  $d$  will be the new direction. This will differ from the direction  $db$  by the angle  $\theta$  which it is required to find. From the equality of the triangles  $adb$  and  $adb$  it follows that  $\theta = 2\rho$ ,  $ab = ac$ ,

$$\tan \alpha db = \tan \left( 45^\circ - \frac{\theta}{2} \right) = \frac{1 - \tan \frac{\theta}{2}}{1 + \tan \frac{\theta}{2}} = \frac{ac}{ad} = 1 - r,$$

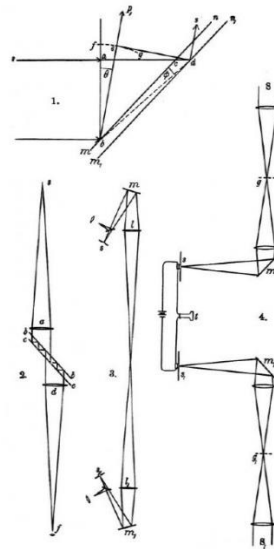
or neglecting terms of the order  $r^2$ ,

$$\theta = r + \frac{r^2}{2} = \frac{\sqrt{2} \omega \cos \alpha}{V} + \frac{\omega^2 \cos^2 \alpha}{V^2}$$

Now let the light fall on a parallel mirror facing the first, we should then have  $\theta = \frac{-\sqrt{2} \omega \cos \alpha}{V} + \frac{\omega^2 \cos^2 \alpha}{V^2}$ , and the total deviation would be  $\theta + \theta = 2\rho' \cos^2 \alpha$  where  $\rho'$  is the angle of aberration, if only the orbital motion of the earth is considered. The maximum displacement obtained by revolving the whole apparatus through  $90^\circ$  would be  $d = 2\rho' \cos^2 \alpha = 0.004''$ . With fifty such couples the displacement would be  $0.2''$ . But astronomical observations in circumstances far less favorable than those in which these may be taken have been made to hundredths of a second; so that this new method bids fair to be at least as sensitive as the former.

The arrangement of apparatus might be as in fig. 2;  $e$  is the focus of the lens  $\alpha$ , is a slit;  $bb'$  are two glass mirrors optically plane and so silvered as to allow say one-twentieth of the light to pass through, and reflecting say sixty per cent. The intensity of the light falling on the observing telescope  $af$

Michelson and Morley—Relative Motion of the 343



would be about one-millionth of the original intensity, so that if sunlight or the electric arc were used it could still be readily seen. The mirrors  $b_1$  and  $c_1$  would differ from parallelism sufficiently to separate the successive images. Finally, the apparatus need not be mounted so as to revolve, as the earth's rotation would be sufficient.

If it were possible to measure with sufficient accuracy the velocity of light without returning the ray to its starting point, the problem of measuring the first power of the relative velocity of the earth with respect to the ether would be solved. This may not be as hopeless as might appear at first sight, since the difficulties are entirely mechanical and may possibly be surmounted in the course of time.

For example, suppose (fig. 5)  $m$  and  $n$ , two mirrors revolving with equal velocity in opposite directions. It is evident that light from  $s$  will form a stationary image at  $s_1$  and similarly light from  $s_2$  will form a stationary image at  $s_2$ . If now the velocity of the mirrors be increased sufficiently, their phases still being exactly the same, both images will be deflected from  $s$  and  $s_1$  in inverse proportion to the velocities of light in the two directions; or, if the two deflections are made equal, and the difference of phase of the mirrors be simultaneously measured, this will evidently be proportional to the difference of velocity in the two directions. The only real difficulty lies in this measurement. The following is perhaps a possible solution:  $g_1$ , (fig. 6) are two gratings on which sunlight is concentrated. These are placed so that after falling on the revolving mirrors  $m$  and  $n$ , the light forms images of the gratings at  $s$  and  $s_1$ , two very sensitive selenium cells in circuit with a battery and a telephone. If everything be symmetrical, the sound in the telephone will be a maximum. If now one of the slits  $s$  be displaced through half the distance between the image of the grating bars, there will be silence. Suppose now that the two deflections having been made exactly equal, the slit is adjusted for silence. Then if the experiment be repeated when the earth's rotation has turned the whole apparatus through  $180^\circ$ , and the deflections are again made equal, there will no longer be silence, and the angular distance through which  $s$  must be moved to restore silence will measure the required difference in phase.

There remain three other methods, all astronomical, for attacking the problem of the motion of the solar system through space.

1. The telescopic observation of the proper motions of the stars. This has given us a highly probably determination of the direction of this motion, but only a guess as to its amount.
2. The spectroscopic observation of the motion of stars in the line of sight. This could furnish data for the relative

motions only, though it seems likely that by the immense improvements in the photography of stellar spectra, the information thus obtained will be far more accurate than any other.

3. Finally there remains the determination of the velocity of light by observations of the eclipses of Jupiter's satellites. If the improved photometric methods practiced at the Harvard observatory make it possible to observe these with sufficient accuracy, the difference in the results found for the velocity of light when Jupiter is nearest to and farthest from the line of motion will give, not merely the motion of the solar system with reference to the stars, but with reference to the luminiferous ether itself.

THE INTERNATIONAL SCIENTIFIC SERIES.

THE  
COMMON SENSE  
OF THE  
EXACT SCIENCES

BY THE LATE ✓  
WILLIAM KINGDON CLIFFORD ✓

WITH ONE HUNDRED FIGURES.

'For information commences with the senses but the whole business terminates in works. . . . The chief cause of failure in work (especially after natures have been diligently investigated) is the ill determination and measurement of the forces and actions of bodies. Now the forces and actions of bodies are circumscribed and measured, either by distances of space, or by moments of time, or by concentration of quantity, or by predominance of virtue; and unless these four things have been well and carefully weighed, we shall have sciences, fair perhaps in theory, but in practice inefficient. The four instances which are useful in this point of view I class under one head as Mathematical Instances and Instances of Measurement.'—*Novum Organum*, Lib. ii, Aph. xlv.

NEW YORK  
D. APPLETON AND COMPANY  
1, 3, AND 5 BOND STREET

1891







### 3. Articles Previews

Pisano R, Vincent P (2018)

#### Notes on discoveries of gravitational waves as new History of Physics frontier research programme

Raffaele Pisano - Lille University; University of Sydney;| London School of Economics - [raffaele.pisano@univ-lille.fr](mailto:raffaele.pisano@univ-lille.fr)

Philippe Vincent - Lille University - [philippe.vincent@etu.univ-lille.fr](mailto:philippe.vincent@etu.univ-lille.fr)

*Abstract:* The detection on September 14, 2015 at 09:50:45 UTC of the LIGO Scientific Collaboration and Virgo Collaboration opened a scientific era towards a new cosmology. The physics of waves is one of the main current frontier fields of physics, although these detections happened 100 years after their predicted existence by Albert Einstein's (1879-1955) *Theory of Relativity*. Recent roots reach as far back as to Sir William Kingdon Clifford (1845–1879). The latter proposed that the nature of space was non-Euclidean, and worked on the shift in light polarization during an eclipse. However, an early mention of gravitational waves *per se* seems belong to Henri Poincaré's (1854-1912) *Sur la dynamique de l'électron* (1905) in which he talks about the existence of "onde gravifique". We briefly present historical notes on the discovery of gravitational waves as currently object of doctoral research by one of us.

*Keywords:* Astronomy, History and Epistemology of Physics, Nature of Science Teaching, Gravitational waves, Physics–Mathematics Relationship, Intellectual History

#### 1. What is the story?


##### 1.1. On gravitational waves (1920; 1937; 2015-present)

The LIGO (Laser Interferometer Gravitational-Wave Observatory) and Virgo (Virgo Cluster) Scientific Collaborations addressed to the direct<sup>1</sup> detection of gravitational waves in the emerging field of gravitational waves: science as a tool for astronomy-and-cosmology research, upgrading and exploitation of detectors, in order to inquire the fundamental physics of gravity.

Albert Einstein's theory of General Relativity made predictions, for instance, about the perihelion precession of Mercury, the Universe as dynamic structure, problems with trajectory of light (Einstein 1920, pp. 148-159), to name a few, and of course, gravita-

<sup>1</sup> As in <https://www.ligo.caltech.edu/> through the use of interferometers and by opposition of the indirect proof of the existence of gravitational waves made by observing the orbital decay of the Hulse-Taylor binary pulsar that lead to the Nobel Prize in Physics of 1993.

Pisano R, Vincent P (2018)


  
 International Journal for the Historiography of Science

Transversal: International Journal for the Historiography of Science 2018 (5): 3-9  
 ISSN 2526-2270  
 www.historiographyofscience.org  
 Belo Horizonte – MG / Brazil  
 © The Authors 2018 – This is an open access article


**IDTC Dossier**  
**Methods and Cognitive Modelling in the**  
**History and Philosophy of Science-&-Education**

Guest Editor (Raffaele Pisano, Lille University, France | IDTC President)

**Introduction**

Raffaele Pisano<sup>1</sup>  
 Philippe Vincent<sup>2</sup>

DOI: <http://dx.doi.org/10.24117/2526-2270.2018.15.02>

 This work is licensed under a Creative Commons Attribution 4.0 International License.

3

In order to inquire into the foundations of the History and Philosophy of Science & its connection to Education, more specifically, teaching science-NoS, the Inter-Divisional Teaching Commission (IDTC)<sup>3</sup> reached high-level researchers to share their most recent works and findings in methods and cognitive modelling as the IDTC Special Issue on HPS-&-Education. By combining approaches of natural sciences & humanities in the investigation of the topics and promoting the cooperation between teaching educators, historians of science, historians and philosophers of science and specialist, the following articles offer an interesting influence on the actual debate from scientific, educationally and culturally standpoints.

In the context of nowadays constraints and technological progress regarding the teaching of physical and mathematical sciences, the investigation of the relevant scientific-educational questions is becoming more and more emergent. As such, and since science is synonymous with modernity and progress, research has to be evolving with its time as well as *Nature of Science*, *Scientific Mediation*, *Popularization of Science and Technique*, and *Teaching methods and contents*. Moreover, physics (Pisano 2009; Pisano and Capecchi 2015),

<sup>1</sup> Raffaele Pisano [Orcid: 0000-0002-8040-5088] is a Full Professor at the Lille University. Address: Building B, 3rd floor, Office 221, France. He is also associated to Archive Poincaré, Lorraine University, France and affiliated to HPS School, Sydney University, Australia and Centre for Philosophy of Natural and Social Science, London School of Economics and Political Science, United Kingdom. Email: [raffaele.pisano@univ-lille.fr](mailto:raffaele.pisano@univ-lille.fr)

<sup>2</sup> Philippe Vincent [Orcid: 0000-0002-8632-2566] is a Ph.D. Student at the Lille University. Address: Building B, 3rd floor, Office 221, France. E-mail: [philippe.vincento6@gmail.com](mailto:philippe.vincento6@gmail.com)

<sup>3</sup> The Inter-Divisional Teaching Commission (IDTC) is an inter-commission of the Division of Logic, Methodology, and Philosophy of Science and Technology (DLMPT) and The Division of History of Science and Technology (DHST); as parts of the International Union of History and Philosophy of Science and Technology (IUHPST). The General Assembly of the DLMPT at its Nancy Congress (July 2011) agreed to an earlier DHST (IUHPST/DLMPT/DHST) resolution to establish an Inter-Divisional Teaching Commission (IDTC) and its officers. The Inter-divisional Teaching Commission wants to offer a website-platform to promote its activities, opening discussions, grants and news and publications relevant to the History and Philosophy of Science & Education. More detail here: <https://www.idtc-iuhps.com>



Pisano R, Vincent P (2020)

## Reading the Discoveries of Gravitational Waves as New History of Physics Frontier Research Programme Part two

Raffaele Pisano – IEMN, Lille University, Lille, France; IIPS, University of Sydney, Australia; CPNSS, LSE, UK – [raffaele.pisano@univ-lille.fr](mailto:raffaele.pisano@univ-lille.fr)  
Philippe Vincent – PhD Student, Lille University, Lille, France

*Abstract:* The detection on September 14, 2015 at 09:50:45 UTC of the LIGO (Laser Interferometer Gravitational-Wave Observatory) Scientific Collaboration and Virgo (for the Virgo Cluster) Collaboration opened a scientific era towards a new cosmology (Moskowitz 2014; Cfr. Castelvechi and Witze 2016; LIGO Scientific Collaboration 2016; Cervantes-Cota, Galindo-Uribarri 2016). This detection happened 100 years after their predicted existence by Albert Einstein's (1879-1955; Einstein 1916, 1920, 1937, 2005). Theory of Relativity and while the frontiers of Physics are pushed back again and again, essential concepts at the roots of this discovery can be traced as far back as Isaac Newton (1642-1727; Newton [1713] 1729; [1726; 1739-1742] 1822; Pisano, Bussotti 2014, 2016, 2017) obviously, and Bernhard Riemann's (1826-1866) geometry of curved spaces and to Sir William Kingdon Clifford (1845-1879) and his intuitions about the ontology of our actual physical space. Also well-known for his mathematical works (Clifford's *algebra* in Clifford 1873; Oziewicz and Sitarczyk 1992) Philosophical and Epistemological contributions with his *The Ethics of Belief* of 1876 and *The Common Sense of the Exact Sciences* of 1885, Clifford made interesting points in a lecture made to the Cambridge Philosophical Society on February 21<sup>st</sup>, 1870, titled *On the Space-Theory of Matter*. In fact, his intuition pushed him to embark on an expedition to work on the shift in light polarization due to the passage of the Moon in front of the Sun during an eclipse. In this talk, we briefly present historical notes on Clifford's views and how this historical context is related to and was foreshadowing the paths and advancements that produced the theories that ultimately lead to the discovery of gravitational waves. This is part of a work in progress of a doctoral research program.

*Keywords:* Astronomy, History Physics, NoS, Gravitational waves, Physics-Mathematics Relationship, Intellectual, History of Science and Technology.

Pisano R, Mauricio P, Vincent P (2020)

Foundations of Science  
<https://doi.org/10.1007/s10699-020-09680-2>



## Introduction to IDTC Special Issue: Joule's Bicentenary History of Science, Foundations and Nature of Science

Raffaële Pisano<sup>1,2,3</sup> · Paulo Mauricio<sup>4</sup> · Philippe Vincent<sup>5</sup>

© Springer Nature B.V. 2020

### Abstract

James Prescott Joule's (1818–1889) bicentenary took place in 2018 and commemorated by the IDTC with a Symposium—'James Joule's Bicentenary: Scientific and Pedagogical Issues Concerning Energy Conservation'—at the European Society for the History of Science (ESHS & BSHS), 14th–17th September, 2018, in London. This symposium had three main objectives: It aimed specifically to celebrate James Joule's achievements considering the most recent historiographical works with a particular focus on the *principle of conservation of energy*; It served the purpose of discussing the scientific and pedagogical issues related to heat, energy and work and how they are presented in textbooks and worked out in classrooms; It also provided discussions on the present situation of teaching and learning science through the use of History of Science, both in K-12 and college level with an emphasis on energy and related concepts. In the following, the Introduction of this Special Issue on Joule is presented.

*Inter-Divisional Teaching Commission* is an inter-commission of *Division of Logic, Methodology, and Philosophy of Science and Technology* (DLMPST) and *Division of History of Science and Technology* (DHST) as parts of the *International Union of History and Philosophy of Science and Technology* (IUHPST). The IDTC aims to promote, publish and share world cooperation in the field of the History of sciences, Epistemology and Historical epistemology of sciences, Philosophy of Science/Foundations & Education/Teaching Science, and Nature of Science, understood in the broadest interdisciplinary sense and in agreement with DLMPST and DHST objectives and rules. For further info: <https://www.idtc-iuhps.com> This is the second special issue published under IDTC activities. The first one was guest edited by Pisano Raffaële, President of the IDTC. See the *Introduction* (Pisano and Vincent 2018).

✉ Raffaële Pisano  
[raffaële.pisano@univ-lille.fr](mailto:raffaële.pisano@univ-lille.fr)

Paulo Mauricio  
[paulom@esetx.ipl.pt](mailto:paulom@esetx.ipl.pt)

Philippe Vincent  
[philippe.vincent06@gmail.com](mailto:philippe.vincent06@gmail.com)

<sup>1</sup> IEMN, Lille University, Villeneuve d'Ascq, France

<sup>2</sup> Associate to Archive Poincaré, Lorraine University, Nancy, France

<sup>3</sup> Associate to CPNSS, LSE, London, UK

<sup>4</sup> Lisbon School of Education, Lisbon Polytechnic Institution, Lisbon, Portugal

<sup>5</sup> Lille University, Villeneuve d'Ascq, France

Pisano R, Vincent P, Dolenc K, Ploj Vrtič M (2020)

Foundations of Science  
<https://doi.org/10.1007/s10699-020-09662-4>



## Historical Foundations of Physics & Applied Technology as Dynamic Frameworks In Pre-Service STEM

Raffaele Pisano<sup>1,2,3</sup> · Philippe Vincent<sup>4</sup> · Kosta Dolenc<sup>5</sup> · Mateja Ploj Vrtič<sup>5</sup>

© Springer Nature B.V. 2020

### Abstract

In recent decades, the development of sciences and technologies had a significant impact in society. This impact has been object of analysis from several standpoints, i.e., scientific, communication, historical and anthropological. Consequently, serious changes were required by the society. One of these has been the emerging relationship science in society and its foundations of applied sciences. A related foundational challenging is the educational process, which was and still is an unlimited challenge for teachers and professors: i.e., levels of understanding, curricula, activating critical engagement, transfer knowledge—and—skills, management, classroom and subsequently pre-service teachers need special teacher education. Taking into account Joule's bicentenary commemoration in physics and *Nature of Science* teaching (NoS) this paper introduces to a level of inquiring within historical and NoS approaches in the pre-service teachers, typically science, technology, engineering and mathematics. In particular, history and historiography of Joule's physics (e.g., his arguments on electric-magnetic engine, mechanical equivalent of heat and free expansion) are dealt with.

**Keywords** Joule · Historical foundations of physics · Pre-service STEM · Equivalent · Modelling · Free expansion · Exhibit

---

✉ Raffaele Pisano  
[raffaele.pisano@univ-lille.fr](mailto:raffaele.pisano@univ-lille.fr)

Philippe Vincent  
[philippe.vincent06@gmail.com](mailto:philippe.vincent06@gmail.com)

Kosta Dolenc  
[kosta.dolenc@um.si](mailto:kosta.dolenc@um.si)

Mateja Ploj Vrtič  
[mateja.plojvrtic@um.si](mailto:mateja.plojvrtic@um.si)

<sup>1</sup> IEMN, Lille University, Lille, France

<sup>2</sup> Associate to: Archive Poincaré, Lorraine University, Nancy, France

<sup>3</sup> Associate to: CPNSS, LSE, London, UK

<sup>4</sup> Lille University, Lille, France

<sup>5</sup> University of Maribor, Maribor, Slovenia

#### 4. Administrative Documents

- Certificates of attendance



Messina, 6 October 2018

#### CERTIFICATE OF ATTENDANCE

This is to certify that

Philippe Vincent

attended the 38<sup>th</sup> yearly *National Congress of the Italian Society for the History of Physics and Astronomy*, which was held in Messina from 3 to 6 October 2018.

The Secretary

Roberto Mantovani

(roberto.mantovani@uniurb.it)







This is to certify the attendance of the undernamed delegate at:

**European Society for the History of Science  
Biennial Conference 2018  
in conjunction with the  
British Society for the History of Science  
London, 14-17 September  
Theme: Unity and Disunity**

Held at the Institute of Education, 20 Bedford Way, London, WC1H 0AL

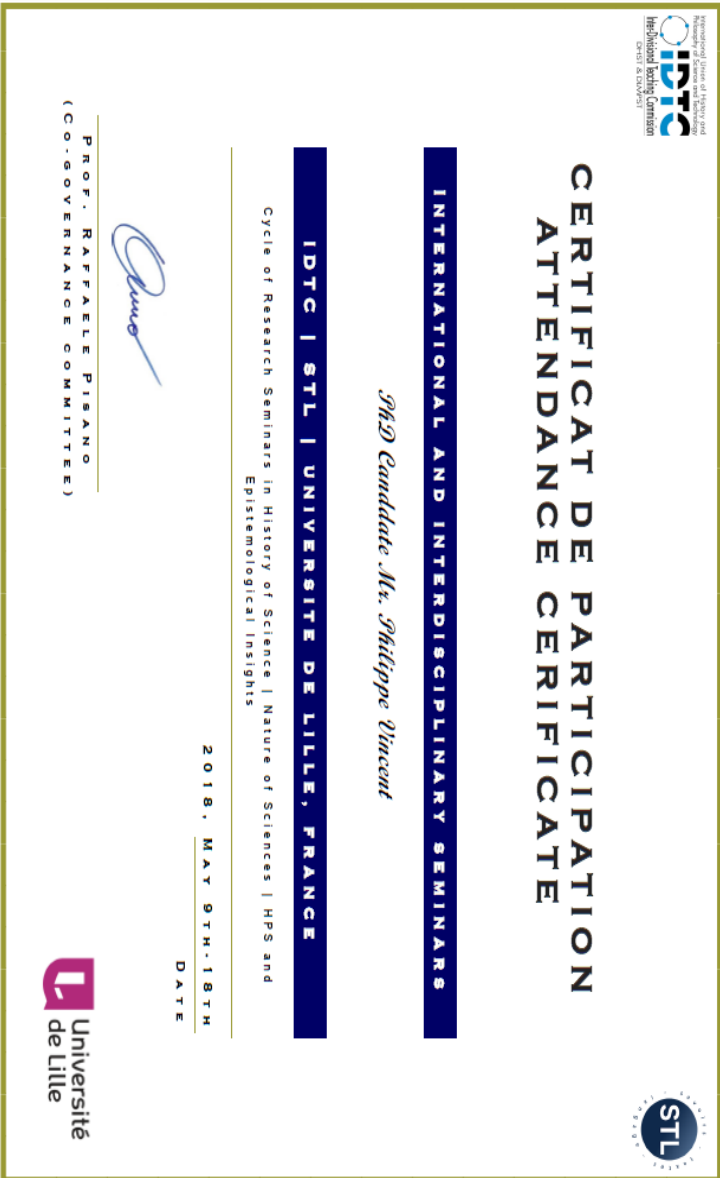
Name of delegate: Philippe Vincent

Lucy Santos

Executive Secretary

British Society for the History of Science

15<sup>th</sup> September 2018





Pisa, 22 September 2019

## CERTIFICATE OF ATTENDANCE

This is to certify that

**PHILIPPE VINCENT**

attended the 39<sup>th</sup> yearly *National Congress of the Italian Society for the History of Physics and Astronomy*, which was held in Pisa from 9 to 12 September 2019.

**SISFA**  
Società Italiana degli Storici della Fisica e dell'Astronomia  
Sede Legale: Via Giulio Cesare, 7 - 80125 NAPOLI (NA)  
Cod. Fisc. 97495670156

The SISFA Secretary  
Roberto Mantovani  
([roberto.mantovani@uniurb.it](mailto:roberto.mantovani@uniurb.it))

**Società Italiana degli Storici della Fisica e dell'Astronomia**  
Sede legale: Via Giulio Cesare 7 - 80125 Napoli  
C.F. 97495670156

# Certificate of Attendance

I certify that

Mr. Philippe Vincent, PhD Student at the Lille University, France

*Attended*

James Joule's Bicentenary: Scientific and Pedagogical Issues Concerning Energy Conservation  
Organized by Intern-Divisional Teaching Commission (IDTC) and Lisbon University

on 2018, September 16<sup>th</sup>

at the ESIS Biennial Conference 2018, Institute of Education, UCL, London, 2018, 14<sup>th</sup>-17<sup>th</sup>, UK

*And*

*Gave the following Talk*

*"The Gravitational Waves: Historical and Nature of Science Teaching Reflections"*


*R. Lopes*

Chairperson

Ricardo Lopes Coshe  
Professor of History and didactics of Physics  
University of Lisbon, Portugal

London, 2018, September 16<sup>th</sup>

- Co-Organising Committee Documents

 **Université de Lille**



International Programme  
*Professeur invité*  
Université de Lille –  
ouverts au public,  
enseignants-chercheurs, y  
compris aux doctorants et  
edutiands de M2

Governance  
Scientific Committee  
Raffaele Pisano (France)  
Shahid Rahman (France)

Organizing Committee  
Raffaele Pisano (France)  
Shahid Rahman (France)  
Philippe Vincent (France)

Université de Lille  
École Doctorale—Bat F,  
Rooms F041, F013, F107

Contact  
raffaele.pisano@univ-lille3.fr  
La réservation est très appréciée


 Pont de Bois, Metro 1.

Raffaele Pisano Graphics © 2018



**2018, May 9th-18th**

**Cycles des Séminaires de  
Recherche en  
Histoire des Sciences |  
*Nature of Sciences*  
HPS and Epistemological  
Insights**

**Prof. Dr. Mohammed Abattouy  
Mohamed V University, Rabat, Morocco**



- 1. La tradition arabe de la mécanique théorique et appliquée : État des connaissances et révision de son statut dans l'histoire de la mécanique**  
Mercredi 9 Mai : 10h00-13h00, Bat. F, Salle F041
- 2. Le corpus de la science arabe des poids : Tradition textuelle et signification historique**  
Vendredi 11 Mai : 10h00-13h00, Bat. F, Salle F041
- 3. Les sources grecques de la science arabe des poids : Un cas exemplaire d'interculturalité dans la transmission gréco-arabe des sciences**  
Lundi 14 Mai : 14h30-17h30, Bat. F, Salle F041
- 4. La famille des textes arabes sur la balance romaine (qaraḥān) et leur prolongement latin (9ème-13ème siècles) : Etude comparative et historique**  
Mardi 15 Mai : 14h30-17h30, Bat. F, Salle F041
- 5. Les De motu antiquiora vs. Le Mecanice : Analyse d'une première transition conceptuelle dans l'oeuvre de Galilée**  
Mercredi 16 Mai : 10h00-13h00, Bat. F, Salle F041
- 6. Al-Isfizari's Long Neglected Corpus of Mechanics: Its Structure and Significance in the Context of Arabic Mechanics**  
Jeudi 17 mai : International Colloquium, Lille University  
Bld. F, Room F013, Pont de Bois  
<https://www.idtc-iuhps.com/idtc-international-colloquium.html>
- 7. La genèse de la nouvelle science du mouvement de Galilée dans le Manuscrit 772 : Ses enjeux historiographiques et son contexte scientifique**  
Vendredi 18 Mai : 14h30-17h30, Bat. F, Salle F107

Une coffee break sera offert à la fin des sessions



**3RD IDTC INTERNATIONAL SUMMER SCHOOL**  
**HISTORY AND PHILOSOPHY OF SCIENCE, APPLIED SCIENCE**  
**& TECHNOLOGY, FOUNDATIONS, TEACHING**

International Union of History and  
 Philosophy of Science and Technology  
**IDTC**  
 Inter-Divisional Teaching Commission  
 CHAIRS & CHAIRPERSONS

**AIP**  
 American Institute  
 of Physics

**IDTC**



**ISSHPSE-2019**

**Hosted by**

Inter-Divisional Teaching Commission (IDTC)  
 American Institute of Physics, USA  
 Sydney Centre for the Foundations of Science,  
 Sydney University, Australia  
 History and Philosophy of Science School,  
 Sydney University, Australia  
 Lille University, France  
 Lilliad, Learning Center Innovation, France  
 Institute of Electronics, Microelectronics,  
 and Nanotechnology (IEMN), CNRS-Lille University  
 Federal University of Bahia, Brazil  
 State University of Feira de Santana, Brazil.

**Venue**

**2019, June 3rd-6th**  
 LILLIAD LEARNING CENTER INNOVATION,  
 Lille University  
 Villeneuve D'Ascq, France  
 8h30 - 17h30

**Governance & Chairpersons**

Raffaele Pisano  
*(Lille University, France | IDTC  
 President of the Inter-Divisional Teaching Commission*  
 Gregory Good,  
*Head of the American Institute of Physics*  
 Gustavo Rodrigues Rocha,  
*Federal University of Bahia, Brazil &  
 the State University of Feira de Santana, Brazil*

**History of Physics, Theory  
 and Nature of Science & People  
 without Frontiers**

Main Topics: Architecture, Art/Museum, Astronomy, Biology, Chemistry, Engineering, Medicine/Psychology, Physics, Mathematics, Instruments, History and Historical Epistemology of Sciences, Applied Science, Techniques & Technologies, Literature/Women Writing, Nature of Science, Innovative pedagogy/Dispositives, Philosophy of Sciences, Foundations of Science, Teaching-Learning, CLIL, Teaching Science, Reasoning and learning, Conceptual frameworks, Reasoning & Changes, Critical attitude, Theories & Situations, Didactic transposition, Schooling, Professionalization, Psychology & Education, Institutions, Science & Society

**Programme and Speakers:**

<http://summerschoollille2019.historyofscience.it/en/>

**Special Evening Event "Ettore Majorana - The Case"**

Conference Movies & Debate, 2019, 4th June

**Université  
 de Lille**

**A2HPS3**  
 Association for the History and Philosophy of Science

**LILLIAD  
 LEARNING CENTER  
 INNOVATION**

**iemn**

**CAMPION  
 COLLEGE AUSTRALIA**  
[www.campion.edu.au](http://www.campion.edu.au)

**SISPA**

**UNIVERSITY OF  
 SYDNEY**

Global Centre  
 for the Foundations  
 of Science

History  
 and Philosophy  
 of Science School

**UFBA**  
 Universidade Federal  
 de Bahia

**UFES**  
 Universidade Federal  
 do Espírito Santo

**CIREL**

UFV de desenvolvimento social,  
 educação, cultura, comunicação,  
 informação, documentação

- **Miscellaneous**

## Olympiades de Physique 2019



« Advanced Arago »

Louise Richard, Hugo Montan, Ségolène Mosser, Maël Jeannot, Antoine Tondou

Elèves de Terminale S du lycée Aragon d'Héricourt

Avec l'aide d'Alain Froidurot leur professeur de physique.

**Lycée Aragon d'Héricourt 70400**

### Résumé

Les détecteurs américains LIGO et européen VIRGO ont permis dernièrement de détecter des ondes gravitationnelles issues de la fusion de trous noirs et d'étoiles à neutrons.

Depuis 2017 le club scientifique du lycée est parti à la découverte de ces ondes et de leur détection.

Sur le principe des interféromètres LIGO et VIRGO, nous simulons un détecteur d'ondes gravitationnelles en utilisant un faisceau d'ultrason plutôt qu'un faisceau laser.

Les oscillations de l'espace-temps induites par le passage de l'onde gravitationnelle sont générées en utilisant le mouvement des membranes de deux haut-parleurs.

Cette « déformation de l'espace-temps » est ensuite détectée puis analysée afin de déterminer les paramètres de l'évènement responsable : masse des objets fusionnant et distance à la Terre.

Pour coller à la réalité, les signaux produits sont de plus en plus faibles ce qui nécessitera l'utilisation de techniques d'analyse similaires à celles utilisées réellement.

Tout comme LIGO et VIRGO, notre interféromètre ARAGO a subi plusieurs améliorations, d'où son nom Advanced ARAGO.



- **AIP History Newsletter Vol. 52 (2020), p. 17:**

Retrieved: <https://www.aip.org/history-programs/history-newsletter>

## AIP'S GRANTS-IN-AID PROGRAM: ENCOURAGING NEW PROJECTS IN HISTORY OF PHYSICAL SCIENCE

By Corinne Mona, Assistant Librarian, NBL&A

The Grants-in-Aid program at the Center for History of Physics supports research in the history of the physical sciences. Recipients have included academics in history of science, as well as economists, educators, and science writers. Grantees' projects bring them to the manuscripts and other sources in the Niels Bohr Library & Archives or to other institutions with resources in history of physical science. Grants-in-Aid also support the conducting of new oral history interviews. Here are two recent Grant-in-Aid visitors to the Niels Bohr Library & Archives.

### GRANT-IN-AID: PHILIPPE VINCENT

#### About Philippe:

Philippe Vincent is a PhD student of the University of Lille in France, working under the supervision of Prof. Raffaele Pisano. After obtaining his license degree in biology, computing and mathematics at the Université de Nice-Sophia Antipolis and his masters degree in scientific mediation in Draguignan jointly with the Universities of Nice, Marseille, and Toulon, he shifted his interest to history of science and nature of science teaching-learning. He is currently working on the history of the discovery of gravitational waves.

#### *What were you researching in your time at the Niels Bohr Library & Archives (NBL&A)?*

I came to NBL&A to research documents that were relevant for my thesis—the history of the discovery of gravitational waves and the historical roots of the concepts that led to the discovery—which I could not find anywhere else.

#### *What collections and items did you consult at NBL&A in the course of your research?*

I consulted books and writings by Sir William Kingdon Clifford, microfilms with correspondence of Henri Poincaré, Émile Picard, and Arthur Korn, and many other things!



Philippe presenting scientific research at Xperium, at the LILLIAD Learning Center Innovation of Lille University. Credit: Prof. Sophie Picard.

### GRANT-IN-AID: VIJENDRA AGARWAL, PhD.

#### About Vijendra:

Vijendra Agarwal is an emeritus professor and a life member of APS. He has served in various academic leadership positions at several institutions and has held a fellowship at the White House Office of Science and Technology Policy.

#### *What were you researching in your time at NBL&A?*

As a novice physics historian with interest in women in physics, I was looking for reference books about legendary women physicists, their life, what inspired them, and their contributions to physics.

#### *What collections and items did you consult at NBL&A in the course of your research?*

Books on Nobel Prize-winning women in science, their lives, struggles, and momentous discoveries, as well as books on physics represented in postage stamps.

For more information about the program and how to apply, please visit <https://www.aip.org/history-programs/physics-history/grants>. If you have received a Grant-in-Aid and would like to be featured in this newsletter, please send an email to [cmona@aip.org](mailto:cmona@aip.org).



Photo of Vijendra Agarwal, PhD.  
Credit: Unknown.







## 5. Copyright Permissions

15/08/2020

Gmail - Copyright Sound Waves in Air - HyperPhysics



Philippe VINCENT &lt;philippe.vincent06@gmail.com&gt;

### Copyright Sound Waves in Air - HyperPhysics

3 messages

Philippe VINCENT <philippe.vincent06@gmail.com>  
 À : RodNave@gsu.edu

20 avril 2019 à 18:08

Dear Dr. Rod Nave,

My name is Philippe Vincent, I am a PhD Student of Lille University. I am contacting you for your kind assistance: I would like your permission to use the image corresponding to the link below for my thesis.

<http://hyperphysics.phy-astr.gsu.edu/hbase/Sound/imgsou/wav2.gif>

If you have any questions, please feel free to contact me. Thank you very much for your time.

Best Regards,

Philippe Vincent

-



Philippe VINCENT  
 Ph.D. Student  
 Lille University, France  
 Mobile: +33 6 48458948  
[philippe.vincent.etu@univ-lille.fr](mailto:philippe.vincent.etu@univ-lille.fr) / [philippe.vincent06@gmail.com](mailto:philippe.vincent06@gmail.com)

*This message and any attachments is intended solely for the addressees and is confidential. It may be privileged and confidential. If you receive this message in error, it and immediately notify the sender, and please delete it, without saving a copy. Your receipt of this message is not intended to waive any applicable privilege. Please do not disseminate this message without the permission of the author. Any use not in accord with its purpose, totally or partially, any dissemination or disclosure, either whole or partial, is prohibited except formal approval. The internet cannot guarantee the integrity of this message. I shall (will) not therefore be liable for the message if modified.*

*Ce message et toutes les pièces jointes sont confidentiels et transmis à l'intention exclusive de leurs destinataires. Toute utilisation de ce message non conforme à sa destination, toute diffusion ou toute publication, totale ou partielle, ne peut être faite qu'avec l'autorisation expresse de l'émetteur. Si vous recevez ce message par erreur, merci de le détruire sans en conserver de copie et d'en avertir immédiatement l'émetteur. Internet ne permettant pas d'assurer l'intégrité de ce message, je décline toute responsabilité au titre de ce message, dans l'hypothèse où il aurait été modifié.*

Rod Nave <rodnave@gsu.edu>  
 À : Philippe VINCENT <philippe.vincent06@gmail.com>  
 Cc : rodnave <rodnave@mail.phy-astr.gsu.edu>

20 avril 2019 à 22:10

Dear Philippe,

You are welcome to use the illustration from HyperPhysics as you describe.

Best wishes with the completion of your thesis.

Regards,  
 Rod Nave [RodNave@gsu.edu](mailto:RodNave@gsu.edu)  
 HyperPhysics Project  
 Department of Physics and Astronomy  
 Georgia State University  
 Atlanta, GA 30302-5060

[Texte des messages précédents masqué]

15/08/2020

Gmail - Copyright Sound Waves in Air - HyperPhysics

**Philippe VINCENT** <philippe.vincent06@gmail.com>  
À : Rod Nave <rodnave@gsu.edu>

20 avril 2019 à 22:12

Dear Dr. Nave,

Thank you very much for your prompt reply and your encouragements !

Best regards,

Philippe Vincent

[Texte des messages précédents masqué]

15/08/2020

Gmail - Re: Form Submission - Contact - Copyrights



Philippe VINCENT &lt;philippe.vincent06@gmail.com&gt;

**Re: Form Submission - Contact - Copyrights**

2 messages

**Grant Sanderson** <grant@3blue1brown.com>  
A: philippe.vincent06@gmail.com

28 novembre 2018 à 17:28

Sure, you have my permission. Best of luck with the Thesis!

On Wed, Nov 28, 2018 at 1:20 AM Squarespace <no-reply@squarespace.info> wrote:

**Name:** Philippe VINCENT**Email Address:** philippe.vincent06@gmail.com**Subject:** Copyrights**Message:** Dear Grant Sanderson,

My name is Philippe Vincent, I'm a PhD Student at the Lille University, France. I work under the supervision of Prof. Dr. Raffaele Pisano and my thesis subject is: "Teaching and Didactics of Physics in High School and University: A Role played by the History of the Discovery of Gravitational Waves. Hypotheses and Perspectives".

As you may expect from my thesis subject, it includes a part on the Physics of Waves. I would like to know if you could give me the permission to use some of your content (mainly screenshots of your YouTube videos) ?

On a side note, thank you for all your great work, I love your videos.

Best Regards,

Philippe

(Sent via 3Blue1Brown)

**Philippe VINCENT** <philippe.vincent06@gmail.com>  
A: Grant Sanderson <grant@3blue1brown.com>

28 novembre 2018 à 17:31

Thank you very much!  
Have a nice day :D

Philippe

[Texte des messages précédents masqué]

15/08/2020

Gmail - Copyrights



Philippe VINCENT &lt;philippe.vincent06@gmail.com&gt;

## Copyrights

2 messages

**Philippe VINCENT** <philippe.vincent06@gmail.com>  
 À : physicsopenlab@gmail.com

26 novembre 2018 à 17:36

Dear PhysicsOpenLab,

My name is Philippe Vincent, I am currently a PhD Student at the Lille University under the supervision of Prof. Dr. Raffaele Pisano. The title of my thesis is:  
 "Teaching and Didactics of Physics in High School and University: A Role Played by the History of the Discovery of Gravitational Waves. Hypotheses and Perspectives"

I was roaming on the internet looking for pictures and illustration, and I landed on your website. I was wondering if you would let me use images from it ?  
 As required by copyrights law, I am hereby asking for your permission to use and modify illustrations that I find on your website in order to fit my needs for my thesis only.

Best Regards,

Philippe Vincent

--



Philippe VINCENT  
 Ph.D. Candidate  
 Lille University, France  
 Mobile: +33 6 48458948  
 philippe.vincent.etu@univ-lille.fr / philippe.vincent06@gmail.com

**Lappetito Lodovico** <lodovico.lappetito@telecomitalia.it>  
 À : Philippe VINCENT <philippe.vincent06@gmail.com>

26 novembre 2018 à 21:00

Hello Philippe,

of course you can !

Good luck for your PhD and for your career.

Kind Regards

Lodovico

**Da:** Philippe VINCENT [mailto:philippe.vincent06@gmail.com]  
**Inviato:** lunedì 26 novembre 2018 17:36  
**A:** physicsopenlab@gmail.com  
**Oggetto:** [EXT] Copyrights

[Texte des messages précédents masqué]

Questo messaggio e i suoi allegati sono indirizzati esclusivamente alle persone indicate. La diffusione, copia o qualsiasi altra azione derivante dalla conoscenza di queste informazioni sono rigorosamente vietate. Qualora abbiate ricevuto questo documento per errore siete cortesemente pregati di darne immediata comunicazione al mittente e di provvedere alla sua distruzione. Grazie.

*This e-mail and any attachments is confidential and may contain privileged information intended for the addressee(s) only. Dissemination, copying, printing or use by anybody else is unauthorised. If you are not the intended recipient, please delete this message and any attachments and advise the sender by return e-mail. Thanks.*

Rispetta l'ambiente. Non stampare questa mail se non è necessario.

<https://mail.google.com/mail/u/0?ik=73fcec5646&view=pt&search=all&permthid=thread-a%3A45154798596938750&simlFmsg-a%3A4236421...> 1/2

15/08/2020

Gmail - Copyright request



Philippe VINCENT &lt;philippe.vincent06@gmail.com&gt;

## Copyright request

2 messages

Philippe VINCENT <philippe.vincent06@gmail.com>  
 À : support@aglasem.com

20 avril 2019 à 18:46

Hello,

My name is Philippe Vincent, I a PhD Student of the Lille University, France. Can I please have your permission to use Fig. 11.5 of the following page: <https://schools.aglasem.com/34154> for my thesis ?

Best Regards,

Philippe Vincent.

-



Philippe VINCENT  
 Ph.D. Student  
 Lille University, France  
 Mobile: +33 6 48458948  
[philippe.vincent.etu@univ-lille.fr](mailto:philippe.vincent.etu@univ-lille.fr) / [philippe.vincent06@gmail.com](mailto:philippe.vincent06@gmail.com)

*This message and any attachments is intended solely for the addressees and is confidential. It may be privileged and confidential. If you receive this message in error, it and immediately notify the sender, and please delete it, without saving a copy. Your receipt of this message is not intended to waive any applicable privilege. Please do not disseminate this message without the permission of the author. Any use not in accord with its purpose, totally or partially, any dissemination or disclosure, either whole or partial, is prohibited except formal approval. The internet cannot guarantee the integrity of this message. I shall (will) not therefore be liable for the message if modified.*

*Ce message et toutes les pièces jointes sont confidentiels et transmis à l'intention exclusive de leurs destinataires. Toute utilisation de ce message non conforme à sa destination, toute diffusion ou toute publication, totale ou partielle, ne peut être faite qu'avec l'autorisation expresse de l'émetteur. Si vous recevez ce message par erreur, merci de le détruire sans en conserver de copie et d'en avertir immédiatement l'émetteur. Internet ne permettant pas d'assurer l'intégrité de ce message, je décline toute responsabilité au titre de ce message, dans l'hypothèse où il aurait été modifié.*

AglaSem <support@aglasem.com>  
 Répondre à : AglaSem <support@aglasem.com>  
 À : philippe.vincent06@gmail.com

22 avril 2019 à 10:01

Hi Philippe VINCENT,

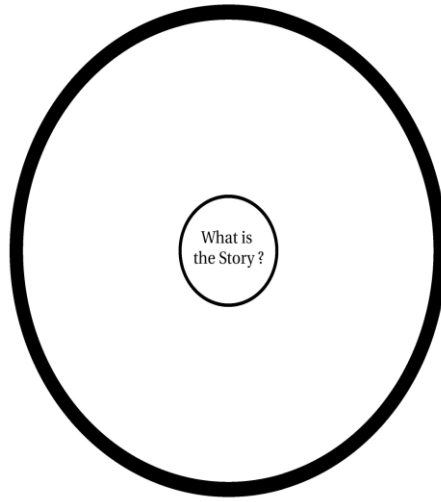
Yes

[Texte des messages précédents masqué]



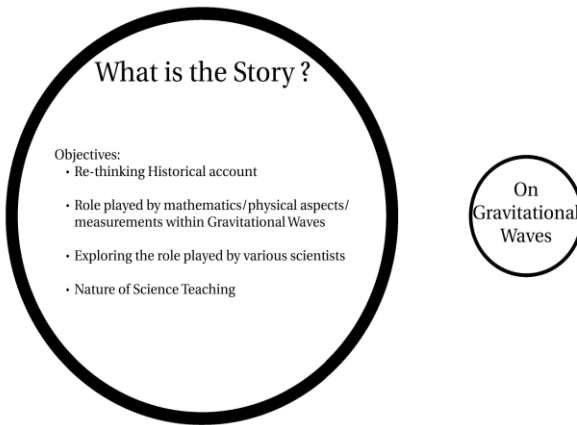






---

3.



---

4.

## On Gravitational Waves

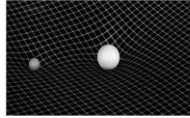
Albert Einstein's (1879-1955) General Relativity:

Spacetime tells Matter how to move and  
Matter tells Spacetime how to curve

Several predictions came with General Relativity:

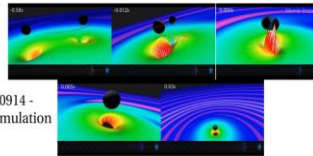
- Perihelion precession of Mercury
- The Universe is dynamic
- The trajectory of light can be bent
- Black Holes
- Gravitational Waves
- [...]

GW150914



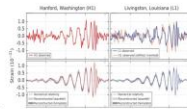
5.

## Black Hole - Black Hole Merger



GW150914 -  
SXS Simulation

LIGO measurement at the Livingston and Hanford  
detectors compared with theoretical predicted values from  
General Relativity



6.

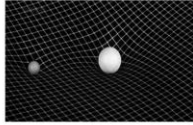
## On Gravitational Waves

Albert Einstein's (1879-1955) General Relativity:

Spacetime tells Matter how to move and  
Matter tells Spacetime how to curve

Several predictions came with General Relativity:

- Perihelion precession of Mercury
- The Universe is dynamic
- The trajectory of light can be bent
- Black Holes
- Gravitational Waves
- [...]



GW150914

---

7.

## What is the Story ?

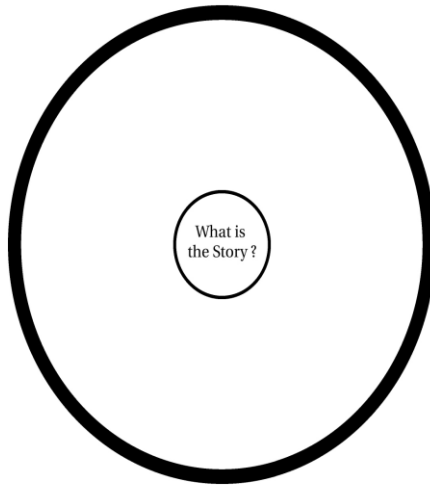
Objectives:

- Re-thinking Historical account
- Role played by mathematics/physical aspects/  
measurements within Gravitational Waves
- Exploring the role played by various scientists
- Nature of Science Teaching

On  
Gravitational  
Waves

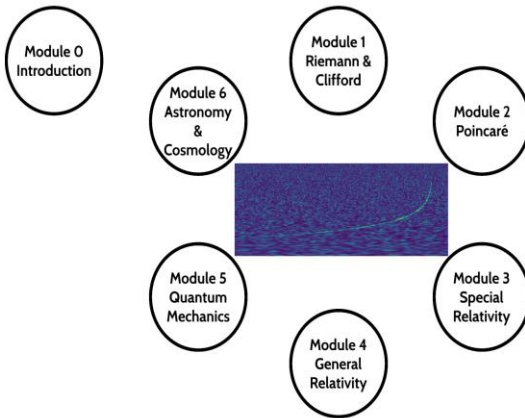
---

8.



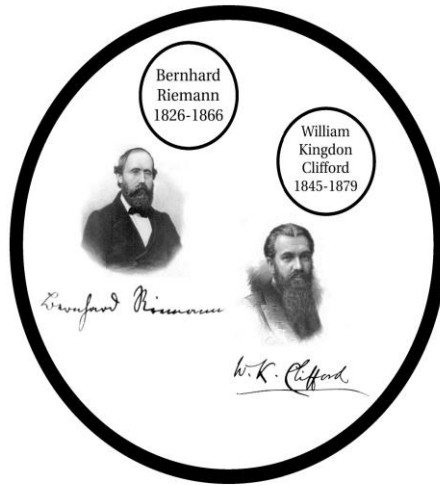
---

9.



---

10.




---

11.

**Bernhard Riemann**  
**1826-1866**


- Great German mathematician (Riemannian geometry, Riemann hypothesis, ...)
- Worked on differential geometry, complex analysis, number theory, ...
- 1867- after Riemann's death Richard Dedekind published:  
*"Ueber die Hypothesen, welche der Geometrie zu Grunde liegen"* in *Abhandlungen der Königlichen Gesellschaft der Wissenschaften zu Göttingen*, vol. 13.

On the Hypotheses which lie at the Bases of Geometry

On the infinitely great

---


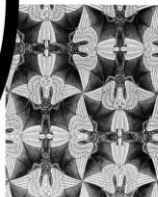
12.



### On the Hypotheses which lie at the Bases of Geometry

I have in the first place, therefore, set myself the task of constructing the notion of a multiply extended magnitude out of general notions of magnitude. It will follow from this that a multiply extended magnitude is capable of different measure-relations, and consequently that **space is only a particular case of a triply extended magnitude**. But hence flows as a necessary consequence that **the propositions of geometry cannot be derived from general notions of magnitude**, but that the properties which distinguish space from other conceivable triply extended magnitudes are only to be **deduced from experience**.

Thus arises the problem, to discover the simplest matters of fact from which the **measure-relations** of space may be determined;[...] the most important system for our present purpose being that which Euclid has laid down as a foundation. These matters of fact are - like all matters of fact - not necessary, but only of empirical certainty; **they are hypotheses**.


---

13.



### Bernhard Riemann 1826-1866

- Great German mathematician (Riemannian geometry, Riemann hypothesis, ...)
- Worked on differential geometry, complex analysis, number theory, ...
- 1867- after Riemann's death Richard Dedekind published:  
"Ueber die Hypothesen, welche der Geometrie zu Grunde liegen" in *Abhandlungen der Königlichen Gesellschaft der Wissenschaften zu Göttingen*, vol. 13.

On the Hypotheses which lie at the Bases of Geometry

On the infinitely great

---

14.



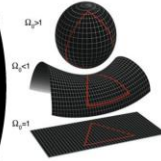
## On the infinitely great

In the extension of space-construction **to the infinitely great, we must distinguish between unboundedness and infinite extent** [...] **That space is an unbounded three-fold manifoldness, is an assumption** which is developed by every conception of the outer world; according to which every instant the region of real perception is completed and the possible positions of a sought object are constructed, and which by these applications is **forever confirming itself**.

The unboundedness of space possesses in this way a greater **empirical certainty** than any external experience. **But its infinite extent by no means follows from this**; on the other hand **if we assume independence of bodies from position, and therefore ascribe to space constant curvature, it must necessarily be finite provided this curvature has ever so small a positive value**. If we prolong all the geodesics starting in a given surface-element, we should obtain an unbounded surface of constant curvature, i.e., a surface which in a flat manifoldness of three dimensions would take the form of a sphere, and consequently be finite.

The questions about the infinitely great are for the interpretation of nature useless questions. But this is not the case with the questions about the infinitely small.

[...]the infinitely small do not conform to the hypotheses of geometry; and we ought in fact to suppose it, if we can thereby obtain a simpler explanation of phenomena.



This leads us into the domain of another science, of physics, into which the object of this work does not allow us to go to-day.



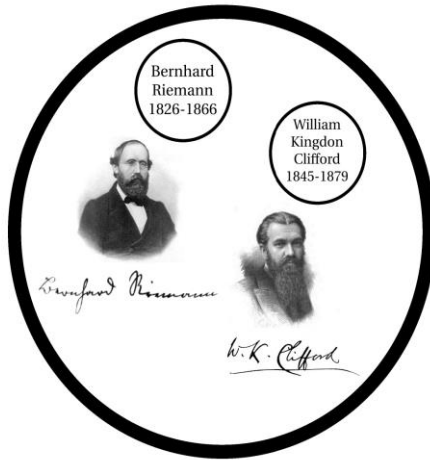
## Bernhard Riemann 1826-1866

- Great German mathematician (Riemannian geometry, Riemann hypothesis, ...)
- Worked on differential geometry, complex analysis, number theory, ...
- 1867- after Riemann's death Richard Dedekind published:  
*"Ueber die Hypothesen, welche der Geometrie zu Grunde liegen"* in *Abhandlungen der Königlichen Gesellschaft der Wissenschaften zu Göttingen*, vol. 13.

On the Hypotheses which lie at the Bases of Geometry

On the infinitely great





17.

**Geometer and Philosopher**

Mathematics:  
*Clifford numbers, Clifford algebras, Clifford-Klein surfaces*

Philosophy:  
*Ethics of belief*

**William Kingdon Clifford  
1845-1879**

- Was Riemann's "follower": translated into English Riemann's 1854 Habilitation paper on the new non-Euclidean geometries "*On the Hypotheses which lie at the Bases of Geometry.*"
- Developed a proposal in which the intrinsic nature of space is non-Euclidean and gravitation could be formally represented by this underlying geometry
- February 21st 1870, lecture to the Cambridge Philosophical Society: "*On the Space-Theory of Matter*"

*On the Space-Theory of Matter*

On Clifford's concept of Space & Later works

18.

**On the Space-Theory of Matter**

February 21st, 1870

To Clifford, geometry was a physical science

The interesting points (*speculations*) of this lecture in retrospect to our more recent discoveries and understanding:

- space is curved, but curvature depends of scale
- the distortions of space travel like waves
- that these variations are responsible for "the motion of matter"

*Focus on points (1), (2) and (3)*

187

On the Space-Theory of Matter, by W. K. Clifford

Read at the Cambridge Philosophical Society, on the 21st of February 1870.

188

189

190

191

192

193

194

195

196

197

198

199

200

201

202

203

204

205

206

207

208

209

210

211

212

213

214

215

216

217

218

219

220

221

222

223

224

225

226

227

228

229

230

231

232

233

234

235

236

237

238

239

240

241

242

243

244

245

246

247

248

249

250

251

252

253

254

255

256

257

258

259

260

261

262

263

264

265

266

267

268

269

270

271

272

273

274

275

276

277

278

279

280

281

282

283

284

285

286

287

288

289

290

291

292

293

294

295

296

297

298

299

300

**Geometer and Philosopher**

Mathematics:  
*Clifford numbers, Clifford algebras, Clifford-Klein surfaces*

Philosophy:  
*Ethics of belief*


**William Kingdon Clifford**

**1845-1879**

- Was Riemann's "follower": translated into English Riemann's 1854 Habilitation paper on the new non-Euclidean geometries "*On the Hypotheses which lie at the Bases of Geometry.*"
- Developed a proposal in which the intrinsic nature of space is non-Euclidean and gravitation could be formally represented by this underlying geometry
- February 21st 1870, lecture to the Cambridge Philosophical Society: "*On the Space-Theory of Matter*"

*On the Space-Theory of Matter*

On Clifford's concept of Space & Later works



### On Clifford's concept of Space & Later works


- He never (explicitly?) developed or wrote down his Space-theory of Matter
- Tensor calculus was not developed at the time which lead Clifford to elaborate his own mathematical system (biquaternions)
- Clifford was open to the idea that the properties of space may change with time:  
"[...] he [the geometer of to-day] knows nothing about the properties of the present space in a past or a future eternity"
- He also taught his students that:  
"Space exists independently of the things in it"
- ...

*On the Free Motion Under No Forces of a Rigid System in an N-Fold Homaloid*

*Preliminary Sketch of Biquaternions*

*The Postulates of the Science of Space*

Clifford, W.K. (1873) On the Free Motion under no Forces of a Rigid System in an n-Fold Homaloid. Proceedings of the London Mathematical Society, 4: 7-47. The doi:10.1112/jlms/4.1.7.1-47



### On the Free Motion Under No Forces of a Rigid System in an N-Fold Homaloid

- Clifford's idea here was to find an equivalence between "ordinary three-dimensional space" and the motion "on a surface of a sphere" in order to study the motion (rotation) of an object
- He also wrote:  
"In general, the problem of free motion in elliptic space of n dimensions is identical with that of free motion, or motion about a fixed point, in parabolic space of n+1 dimensions"

XXVI.


ON THE FREE MOTION UNDER NO FORCES OF A RIGID SYSTEM IN AN N-FOLD HOMALOID. (Continued from p. 21.)

This problem of the motion under no forces of a rigid body about a fixed point in elliptic three-dimensional space is the same as the problem of the motion about a fixed point in parabolic space of n+1 dimensions. In order to study the motion of the rigid system in elliptic space of n dimensions, we consider a system of three axes of the free motion, or motion about a fixed point, in parabolic space of n+1 dimensions. It is to be understood that the axes of the motion, or motion about a fixed point, in parabolic space of n+1 dimensions, are the axes of the motion, or motion about a fixed point, in elliptic space of n dimensions.

The free motion under no forces of a rigid body in elliptic space of n dimensions is identical with that of free motion, or motion about a fixed point, in parabolic space of n+1 dimensions.

— On the Structure of the Linear Homaloid. See, for example, the paper of the author in the Proceedings of the London Mathematical Society, 4: 7-47. The doi:10.1112/jlms/4.1.7.1-47






### On Clifford's concept of Space & Later works

- He never (explicitly?) developed or wrote down his Space-theory of Matter
- Tensor calculus was not developed at the time which lead Clifford to elaborate his own mathematical system (biquaternions)
- Clifford was open to the idea that the properties of space may change with time:  
"[...] he [the geometer of to-day] knows nothing about the properties of the present space in a past or a future eternity"
- He also taught his students that:  
"Space exists independently of the things in it"
- ...

*On the Free Motion Under No Forces of a Rigid System in an N-Fold Homaloid*

*Preliminary Sketch of Biquaternions*

*The Postulates of the Science of Space*



### The Postulates of the Science of Space

After Epistemological/Philosophical considerations in the introduction, and clarifications (about boundaries of solids in space, lines, surfaces and points), Clifford shared his understanding of space and commented the postulates attached to this conception:

- Space continuity
- Elementary flatness (if the more you magnify something the flatter it looks)
- Superposition : a body can be moved about in space without altering its size or shape - All parts of space are exactly alike
- Similarity: any figure may be magnified or diminished in any degree without altering its shape

"The geometer of to-day knows nothing about the nature of actually existing space at an infinite distance; he knows nothing about the properties of the present space in a past or a future eternity. He knows, indeed, that the laws assumed by Euclid are true with an accuracy that no direct experiment can approach, not only in this place where we are, but in places at a distance from that no astronomer has conceived; but he knows this as of Here and Now; beyond his range is a There and Then of which he knows nothing at present"

Clifford's Comments

lecture delivered at The Royal Institution in March 1873

## Clifford's Comments

"In regard to the second postulate, we have merely to point to the example of polished surfaces. The smoothest that can be made is the one most completely covered with the minutest ruts and furrows. Yet geometrical constructions can be made with extreme accuracy upon such a surface, on the supposition that it is an exact plane. If, therefore, the sharp points, edges, and furrows of space are only small enough, there will be nothing to hinder our conviction of its elementary flatness. It has even been remarked by Riemann that we must not shrink from this supposition if it is found useful in explaining physical phenomena."

---

27.

## Clifford's Comments

Space continuity

Superposition

Elementary flatness

Similarity

"The first two postulates may therefore be doubted on the side of the very small.

We may put the third and fourth together, and doubt them on the side of the very great. For if the property of elementary flatness exist on the average, the deviations from it being, as we have supposed too small to be perceived, then, whatever were the true nature of space, we should have exactly the conceptions of it which we now have, if only the regions we can get at were small in comparison with the areas of curvature. If we suppose the curvature to vary in an irregular manner, the effect of it might be very considerable in a triangle formed by the nearest fixed stars; but if we suppose it approximately uniform to the limit of telescopic reach, it will be restricted to very much narrower limits."

---

28.

### *The Postulates of the Science of Space*

After Epistemological/Philosophical considerations in the introduction, and clarifications (about boundaries of solids in space, lines, surfaces and points), Clifford shared his understanding of space and commented the postulates attached to this conception:

- Space continuity
- Elementary flatness (if the more you magnify something the flatter it looks)
- Superposition : a body can be moved about in space without altering its size or shape - All parts of space are exactly alike
- Similarity: any figure may be magnified or diminished in any degree without altering its shape

"The geometer of to-day knows nothing about the nature of actually existing space at an infinite distance; he knows nothing about the properties of the present space in a past or a future eternity. He knows, indeed, that the laws assumed by Euclid are true with an accuracy that no direct experiment can approach, not only in this place where we are, but in places at a distance from that no astronomer has conceived; but he knows this as of Here and Now; beyond his range is a There and Then of which he knows nothing at present"

Clifford's  
Comments

lecture delivered at The Royal Institution in March 1873

### On Clifford's concept of Space & Later works

- He never (explicitly?) developed or wrote down his Space-theory of Matter
- Tensor calculus was not developed at the time which lead Clifford to elaborate his own mathematical system (biquaternions)
- Clifford was open to the idea that the properties of space may change with time:  
"[...] he [the geometer of to-day] knows nothing about the properties of the present space in a past or a future eternity"
- He also taught his students that:  
"Space exists independently of the things in it"  
\* ...

*On the Free Motion Under No Forces of a Rigid System in an N-Fold Homaloid*

*Preliminary Sketch of Biquaternions*

*The Postulates of the Science of Space*

**Geometer and Philosopher**

Mathematics:  
*Clifford numbers, Clifford algebras, Clifford-Klein surfaces*

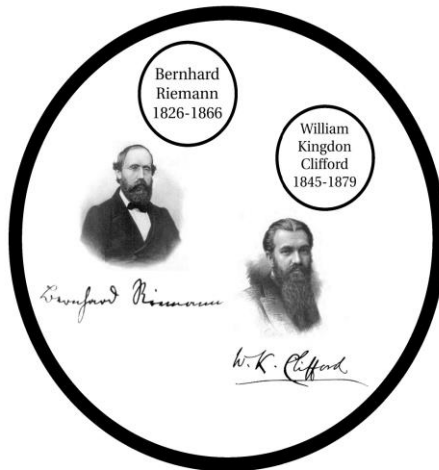
Philosophy:  
*Ethics of belief*

**William Kingdon Clifford  
1845-1879**

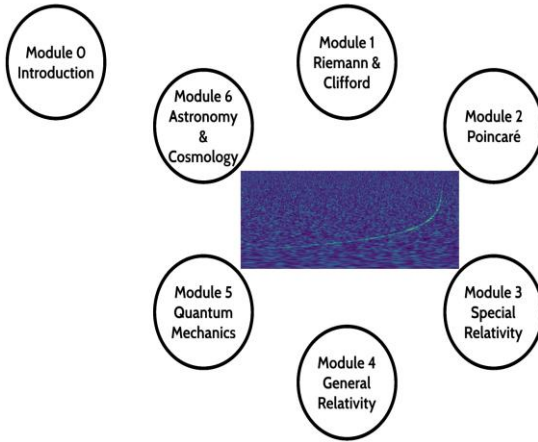
- Was Riemann's "follower": translated into English Riemann's 1854 Habilitation paper on the new non-Euclidean geometries "*On the Hypotheses which lie at the Bases of Geometry*."
- Developed a proposal in which the intrinsic nature of space is non-Euclidean and gravitation could be formally represented by this underlying geometry
- February 21st 1870, lecture to the Cambridge Philosophical Society: "*On the Space-Theory of Matter*"

*On the Space-Theory of Matter*

On Clifford's concept of Space & Later works







"Sur la dynamique de l'électron" - 1905

Il importait d'examiner cette hypothèse de plus près et en particulier de rechercher quelles modifications elle nous obligerait à apporter aux lois de la gravitation. C'est ce que j'ai cherché à déterminer; j'ai été d'abord conduit à supposer que la propagation de la gravitation n'est pas instantanée, mais se fait avec la vitesse de la lumière. Cela semble en contradiction avec un résultat obtenu par Laplace qui annonce que cette propagation est, sinon instantanée, du moins beaucoup plus rapide que celle de la lumière. Mais, en réalité, la question que s'était posée Laplace diffère considérablement de celle dont nous nous occupons ici. Pour Laplace, l'introduction d'une vitesse finie de propagation était la seule modification qu'il apportait à la loi de Newton. Ici, au contraire, cette modification est accompagnée de plusieurs autres; il est donc possible, et il arrive en effet, qu'il se produise entre elles une compensation partielle.

Quand nous parlerons donc de la position ou de la vitesse du corps attiré, il s'agira de cette position ou de cette vitesse à l'instant où l'onde gravifique est partie de ce corps; quand nous parlerons de la position ou de la vitesse du corps attiré, il s'agira de cette position ou de cette vitesse à l'instant où ce corps attiré a été atteint par l'onde gravifique émanée de l'autre corps; il est clair que le premier instant est antérieur au second.

- Need for some adjustments in gravitation
- The propagation of gravity is not instantaneous and IS the speed of light

- Poincaré uses the term "onde gravifique"



*Poincaré*

Henri Poincaré  
1854-1912

Conclusion

## Concluding Remarks

Main ideas:

- Laplace postulated that the transmission of *gravity* was not instantaneous; later Poincaré sets it to the speed of light
- The roots of the concept of space curvature date as far back as several decades before Albert Einstein's *spacetime*
- The first mention of *Gravitational Waves* can be attributed to Henri Poincaré

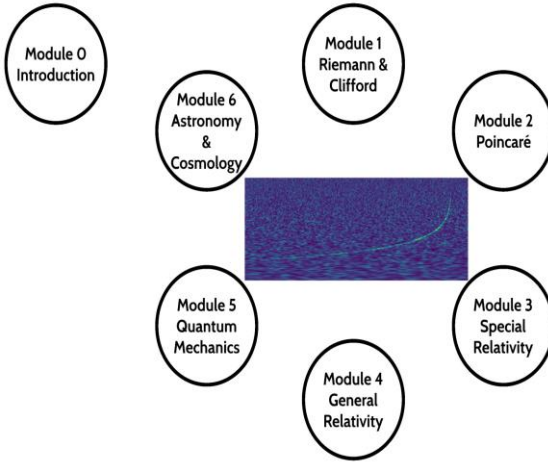
The use of such historical texts for Teaching-Learning along with modern tools, analogies, etc. provides a great environment in which the students can better understand the chronology, the context, the difficulties scientists faced and allows them to follow the sequential insights that lead to our contemporary understanding of Gravitational Waves



A handwritten signature of Henri Poincaré in cursive script.

Henri  
Poincaré  
1854-1912

Conclusion



## 7. Table of Acronyms

AAPT	American Association of Physics Teachers
AIP	American Institute of Physics
APS	American Physical Society
BNF	Bibliothèque Nationale de France
DESY	Deutsches Elektronen-Synchrotron
DOAJ	Directory of Open Access Journals
EGO	European Gravitational Observatory
HAL	Archive ouverte HAL, Hyper Articles en Ligne
LIGO	Laser Interferometer Gravitational-Wave Observatory
MPI	Max Planck Institute
NASA	National Aeronautics and Space Administration
NBL	Niels Bohr Library
MIT	Massachusetts Institute of Technology



## 8. Pre/Post Tests Data

		Sky	
I'm interested in:		Post-test	Pre-test
	Science		5
Mathematics		5	4
Physics		5	4
History		1	2
History of Science		3	1
Philosophy		3	4
Philosophy of Science		3	3

I have heard about:		Post-test	Pre-test
	A wave		3
Gravitation		3	3
A gravitational wave		3	4
Trigonometry		3	3
Euclidean Geometry		3	3
Non-Euclidean Geometry		3	3
An analogy		3	4

<b>I know:</b>
----------------

	Post-test	Pre-test
Newton's Theory of Gravitation	3	4
Special Relativity	3	4
General Relativity	3	4
The concept of Spacetime	3	4
Trigonometry	3	4
Euclidean Geometry	3	4
Non-Euclidean Geometry	3	4

<b>I have a good understanding of:</b>
--

	Post-test	Pre-test
Newton's Theory of Gravitation	3	3
Special Relativity	3	3
General Relativity	2	3
The concept of Spacetime	2	3
Trigonometry	2	3
Euclidean Geometry	2	3
Non-Euclidean Geometry	2	2



<b>I can use:</b>
-------------------

	Post-test	Pre-test
First degree equations	3	4
Derivatives	3	3
Integrals	3	3
Vectors	3	3
Tensors	3	1

<b>I'd like to know more about:</b>
-------------------------------------

Gravitational waves	5
Special Relativity	5
General Relativity	5
Non-Euclidean Geometry	5
Matrices	5
Tensors	5
Einstein's Field Equations	5
Physics	5
Astronomy	5
Cosmology	5
Optics	5
History of Science	4
Epistemology	4
Mathematics	5
Differential Geometry	5
The infinitely big	5
The infinitely small	5

**I can explain to someone what is:**

A gravitational wave	3
Non-Euclidean Geometry	3
Einstein's Principle of Relativity	3
Special Relativity	2
General Relativity	2
Spacetime	3
Gravitation	3
An Inertial Reference Frame	3
Redshift/Blueshift	3
A Black Hole	3
An Interferometer	3
LIGO/VIRGO	3

True or False			
Question #		Pre	Post
1 True	1	0	1
2 True	2	1	0
5 True	5	1	1
6 True	6	0	1
7 True	7	<i>void 0</i>	1
12 True	12	0	1
13 True	13	1	1
15 True	15	0	1
16 True	16	0	1
17 True	17	1	1
19 True	19	<i>void 0</i>	1
3 False	3	<i>void 0</i>	1
4 False	4	0	1
8 False	8	0	1
9 False	9	1	1
10 False	10	<i>void 0</i>	1
11 False	11	0	1
14 False	14	1	1
18 False	18	<i>void 0</i>	1

Marianne ZORZI DELLA VEDOVA		
-----------------------------	--	--

<b>I'm interested in:</b>			
---------------------------	--	--	--

	Post-test	Pre-test
Science	5	3
Mathematics	2	2
Physics	5	2
History	2	2
History of Science	5	2
Philosophy	2	1
Philosophy of Science	2	2

<b>I have heard about:</b>			
----------------------------	--	--	--

	Post-test	Pre-test
A wave	4	3
Gravitation	4	3
A gravitational wave	4	1
Trigonometry	2	1
Euclidean Geometry	4	1
Non-Euclidean Geometry	4	1
An analogy	2	1

<b>I know:</b>			
----------------	--	--	--

	Post-test	Pre-test
Newton's Theory of Gravitation	4	1
Special Relativity	2	1
General Relativity	2	1
The concept of Spacetime	4	1
Trigonometry	2	1
Euclidean Geometry	4	1
Non-Euclidean Geometry	4	1

**I have a good understanding of:**

	Post-test	Pre-test
Newton's Theory of Gravitation	3	1
Special Relativity	3	1
General Relativity	3	1
The concept of Spacetime	2	1
Trigonometry	2	1
Euclidean Geometry	3	1
Non-Euclidean Geometry	3	1

**I can use:**

	Post-test	Pre-test
First degree equations	1	3
Derivatives	1	1
Integrals	1	1
Vectors	1	1
Tensors	1	1

<b>I'd like to know more about:</b>		
	Gravitational waves	4
	Special Relativity	4
	General Relativity	4
	Non-Euclidean Geometry	4
	Matrices	3
	Tensors	3
	Einstein's Field Equations	5
	Physics	5
	Astronomy	5
	Cosmology	5
	Optics	4
	History of Science	2
	Epistemology	4
	Mathematics	1
	Differential Geometry	1
	The infinitely big	4
	The infinitely small	4

<b>I can explain to someone what is:</b>		
	A gravitational wave	2
	Non-Euclidean Geometry	2
	Einstein's Principle of Relativity	2
	Special Relativity	2
	General Relativity	2
	Spacetime	2
	Gravitation	4
	An Inertial Reference Frame	2
	Redshift/Blueshift	2
	A Black Hole	4
	An Interferometer	2
	LIGO/VIRGO	5

<b>True or False</b>			
<b>Question #</b>		<b>Pre</b>	<b>Post</b>
1 True	1	0	1
2 True	2	1	1
5 True	5	0	1
6 True	6	0	1
7 True	7	<i>void 0</i>	1
12 True	12	1	1
13 True	13	0	0
15 True	15	<i>void 0</i>	1
16 True	16	1	1
17 True	17	1	1
19 True	19	1	1
3 False	3	1	1
4 False	4	1	1
8 False	8	<i>void 0</i>	0
9 False	9	<i>void 0</i>	1
10 False	10	<i>void 0</i>	1
11 False	11	<i>void 0</i>	1
14 False	14	1	1
18 False	18	0	0



		Participant 2	
I'm interested in:		Post-test	Pre-test
	Science		5
Mathematics		3	2
Physics		5	4
History		3	4
History of Science		4	5
Philosophy		2	1
Philosophy of Science		2	1

I have heard about:		Post-test	Pre-test
	A wave		5
Gravitation		4	3
A gravitational wave		4	2
Trigonometry		5	3
Euclidean Geometry		5	1
Non-Euclidean Geometry		5	1
An analogy		3	1

I know:		Post-test	Pre-test
	Newton's Theory of Gravitation		4
Special Relativity		3	1
General Relativity		3	1
The concept of Spacetime		4	2
Trigonometry		4	2
Euclidean Geometry		5	1
Non-Euclidean Geometry		5	1

**I have a good understanding of:**

	Post-test	Pre-test
Newton's Theory of Gravitation	4	2
Special Relativity	3	1
General Relativity	3	1
The concept of Spacetime	4	2
Trigonometry	4	2
Euclidean Geometry	4	1
Non-Euclidean Geometry	4	1

**I can use:**

	Post-test	Pre-test
First degree equations	4	3
Derivatives	1	1
Integrals	1	1
Vectors	4	1
Tensors	1	1

<b>I'd like to know more about:</b>		
	Gravitational waves	3
	Special Relativity	3
	General Relativity	3
	Non-Euclidean Geometry	3
	Matrices	4
	Tensors	4
	Einstein's Field Equations	3
	Physics	3
	Astronomy	3
	Cosmology	3
	Optics	3
	History of Science	4
	Epistemology	3
	Mathematics	4
	Differential Geometry	4
	The infinitely big	4
	The infinitely small	4

**I can explain to someone what is:**

A gravitational wave	4
Non-Euclidean Geometry	5
Einstein's Principle of Relativity	2
Special Relativity	2
General Relativity	2
Spacetime	3
Gravitation	3
An Inertial Reference Frame	4
Redshift/Blueshift	
A Black Hole	4
An Interferometer	3
LIGO/VIRGO	4

True or False			
Question #		Pre	Post
1 True	1	1	1
2 True	2	void 0	0
5 True	5	void 0	1
6 True	6	void 0	1
7 True	7	void 0	1
12 True	12	1	1
13 True	13	void 0	1
15 True	15	void 0	
16 True	16	1	1
17 True	17	1	1
19 True	19	void 0	1
3 False	3	void 0	1
4 False	4	0	1
8 False	8	void 0	
9 False	9	void 0	1
10 False	10	void 0	1
11 False	11	0	1
14 False	14	void 0	0
18 False	18	void 0	0

Participant 3		
I'm interested in:	Post-test	Pre-test
	Science	3
Mathematics	2	2
Physics	3	3
History	4	4
History of Science	4	4
Philosophy	3	3
Philosophy of Science	3	3

I have heard about:	Post-test	Pre-test
	A wave	4
Gravitation	4	3
A gravitational wave	4	2
Trigonometry	3	4
Euclidean Geometry	3	
Non-Euclidean Geometry	3	
An analogy	3	3

I know:	Post-test	Pre-test
	Newton's Theory of Gravitation	3
Special Relativity	2	
General Relativity	3	2
The concept of Spacetime	3	2
Trigonometry	3	3
Euclidean Geometry	3	
Non-Euclidean Geometry	3	

**I have a good understanding of:**

	Post-test	Pre-test
Newton's Theory of Gravitation	3	1
Special Relativity	3	1
General Relativity	3	2
The concept of Spacetime	3	2
Trigonometry	3	2
Euclidean Geometry	3	1
Non-Euclidean Geometry	3	1

**I can use:**

	Post-test	Pre-test
First degree equations	2	2
Derivatives	1	1
Integrals	1	1
Vectors	3	2
Tensors	2	

<b>I'd like to know more about:</b>		
	Gravitational waves	4
	Special Relativity	3
	General Relativity	3
	Non-Euclidean Geometry	2
	Matrices	1
	Tensors	1
	Einstein's Field Equations	2
	Physics	3
	Astronomy	4
	Cosmology	4
	Optics	3
	History of Science	3
	Epistemology	3
	Mathematics	4
	Differential Geometry	1
	The infinitely big	2
	The infinitely small	2



<b>I can explain to someone what is:</b>	A gravitational wave	4
	Non-Euclidean Geometry	3
	Einstein's Principle of Relativity	3
	Special Relativity	2
	General Relativity	3
	Spacetime	3
	Gravitation	4
	An Inertial Reference Frame	3
	Redshift/Blueshift	3
	A Black Hole	4
	An Interferometer	2
	LIGO/VIRGO	3

True or False			
Question #		Pre	Post
1 True	1	1	1
2 True	2	1	1
5 True	5	1	1
6 True	6	1	1
7 True	7	0	1
12 True	12	1	1
13 True	13	0	1
15 True	15	0	1
16 True	16	0	1
17 True	17	<i>void 0</i>	0
19 True	19	<i>void 0</i>	1
3 False	3	1	1
4 False	4	1	1
8 False	8	0	0
9 False	9	0	1
10 False	10	0	1
11 False	11	1	1
14 False	14	0	1
18 False	18	<i>void 0</i>	1

		Florian DANTIER	
I'm interested in:		Post-test	Pre-test
	Science		4
Mathematics		4	4
Physics		4	4
History		3	3
History of Science		3	4
Philosophy		3	3
Philosophy of Science		3	3

I have heard about:		Post-test	Pre-test
	A wave		4
Gravitation		4	4
A gravitational wave		4	3
Trigonometry		5	5
Euclidean Geometry		4	4
Non-Euclidean Geometry		3	2
An analogy		4	4

I know:		Post-test	Pre-test
	Newton's Theory of Gravitation		4
Special Relativity		2	2
General Relativity		2	2
The concept of Spacetime		3	2
Trigonometry		5	4
Euclidean Geometry		3	4
Non-Euclidean Geometry		2	1

**I have a good understanding of:**

	Post-test	Pre-test
Newton's Theory of Gravitation	4	3
Special Relativity	2	1
General Relativity	2	1
The concept of Spacetime	3	1
Trigonometry	5	5
Euclidean Geometry	3	3
Non-Euclidean Geometry	3	4

**I can use:**

	Post-test	Pre-test
First degree equations	5	5
Derivatives	5	5
Integrals	5	5
Vectors	5	5
Tensors	1	1

<b>I'd like to know more about:</b>		
	Gravitational waves	3
	Special Relativity	4
	General Relativity	4
	Non-Euclidean Geometry	4
	Matrices	4
	Tensors	2
	Einstein's Field Equations	3
	Physics	4
	Astronomy	4
	Cosmology	4
	Optics	3
	History of Science	3
	Epistemology	2
	Mathematics	4
	Differential Geometry	3
	The infinitely big	4
	The infinitely small	4

**I can explain to someone what is:**

A gravitational wave	3
Non-Euclidean Geometry	3
Einstein's Principle of Relativity	2
Special Relativity	2
General Relativity	3
Spacetime	3
Gravitation	4
An Inertial Reference Frame	2
Redshift/Blueshift	4
A Black Hole	4
An Interferometer	3
LIGO/VIRGO	4

True or False			
Question #		Pre	Post
1 True	1	1	1
2 True	2	0	1
5 True	5	1	1
6 True	6	<i>void 0</i>	1
7 True	7	1	1
12 True	12	1	1
13 True	13	<i>void 0</i>	0
15 True	15	<i>void 0</i>	1
16 True	16	1	1
17 True	17	1	1
19 True	19	<i>void 0</i>	1
3 False	3	<i>void 0</i>	1
4 False	4	1	1
8 False	8	0	0
9 False	9	<i>void 0</i>	0
10 False	10	<i>void 0</i>	1
11 False	11	1	1
14 False	14	1	1
18 False	18	<i>void 0</i>	0

Coralie ALBINET		
I'm interested in:	Post-test	Pre-test
	Science	1
Mathematics	2	2
Physics	1	1
History	2	2
History of Science	1	1
Philosophy	4	4
Philosophy of Science	1	1

I have heard about:	Post-test	Pre-test
	A wave	4
Gravitation	4	4
A gravitational wave	2	1
Trigonometry	2	1
Euclidean Geometry	2	1
Non-Euclidean Geometry	2	1
An analogy	4	4

I know:	Post-test	Pre-test
	Newton's Theory of Gravitation	4
Special Relativity	2	2
General Relativity	2	2
The concept of Spacetime	2	2
Trigonometry	2	2
Euclidean Geometry	2	2
Non-Euclidean Geometry	2	2



**I have a good understanding of:**

	Post-test	Pre-test
Newton's Theory of Gravitation	4	4
Special Relativity	1	1
General Relativity	1	1
The concept of Spacetime	2	2
Trigonometry	1	1
Euclidean Geometry	1	1
Non-Euclidean Geometry	void	1

**I can use:**

	Post-test	Pre-test
First degree equations	void	5
Derivatives	void	5
Integrals	void	2
Vectors	void	2
Tensors	void	1

<b>I'd like to know more about:</b>		
	Gravitational waves	3
	Special Relativity	3
	General Relativity	3
	Non-Euclidean Geometry	3
	Matrices	2
	Tensors	1
	Einstein's Field Equations	1
	Physics	1
	Astronomy	3
	Cosmology	3
	Optics	1
	History of Science	2
	Epistemology	3
	Mathematics	4
	Differential Geometry	1
	The infinitely big	2
	The infinitely small	2

<b>I can explain to someone what is:</b>	A gravitational wave	2
	Non-Euclidean Geometry	1
	Einstein's Principle of Relativity	1
	Special Relativity	
	General Relativity	11
	Spacetime	1
	Gravitation	2
	An Inertial Reference Frame	1
	Redshift/Blueshift	1
	A Black Hole	2
	An Interferometer	1
	LIGO/VIRGO	4

<b>True or False</b>			
<b>Question #</b>		<b>Pre</b>	<b>Post</b>
1 True	1	0	0
2 True	2	1	1
5 True	5	1	1
6 True	6	1	1
7 True	7	<i>void 0</i>	<i>void 0</i>
12 True	12	1	1
13 True	13	<i>void 0</i>	1
15 True	15	<i>void 0</i>	<i>void 0</i>
16 True	16	<i>void 0</i>	<i>void 0</i>
17 True	17	<i>void 0</i>	<i>void 0</i>
19 True	19	<i>void 0</i>	<i>void 0</i>
3 False	3	<i>void 0</i>	<i>void 0</i>
4 False	4	1	1
8 False	8	<i>void 0</i>	<i>void 0</i>
9 False	9	<i>void 0</i>	<i>void 0</i>
10 False	10	<i>void 0</i>	<i>void 0</i>
11 False	11	0	0
14 False	14	<i>void 0</i>	1
18 False	18	<i>void 0</i>	<i>void 0</i>

Sylvain SANTIAGO		
I'm interested in:	Post-test	Pre-test
Science	5	5
Mathematics	4	4
Physics	5	5
History	4	4
History of Science	3	2
Philosophy	2	2
Philosophy of Science	3	1

I have heard about:	Post-test	Pre-test
A wave	5	5
Gravitation	5	4
A gravitational wave	5	4
Trigonometry	5	5
Euclidean Geometry	5	3
Non-Euclidean Geometry	5	3
An analogy	5	2

I know:	Post-test	Pre-test
Newton's Theory of Gravitation	5	4
Special Relativity	4	3
General Relativity	4	4
The concept of Spacetime	5	5
Trigonometry	5	5
Euclidean Geometry	5	3
Non-Euclidean Geometry	5	3

**I have a good understanding of:**

	Post-test	Pre-test
Newton's Theory of Gravitation	5	4
Special Relativity	5	3
General Relativity	5	3
The concept of Spacetime	5	4
Trigonometry	5	5
Euclidean Geometry	5	3
Non-Euclidean Geometry	5	3

**I can use:**

	Post-test	Pre-test
First degree equations	5	5
Derivatives	5	5
Integrals	5	5
Vectors	5	5
Tensors	4	3

<b>I'd like to know more about:</b>		
	Gravitational waves	5
	Special Relativity	4
	General Relativity	4
	Non-Euclidean Geometry	4
	Matrices	4
	Tensors	4
	Einstein's Field Equations	5
	Physics	5
	Astronomy	5
	Cosmology	5
	Optics	5
	History of Science	3
	Epistemology	4
	Mathematics	4
	Differential Geometry	4
	The infinitely big	5
	The infinitely small	5

**I can explain to someone what is:**

A gravitational wave	5
Non-Euclidean Geometry	5
Einstein's Principle of Relativity	4
Special Relativity	3
General Relativity	3
Spacetime	5
Gravitation	4
An Inertial Reference Frame	4
Redshift/Blueshift	5
A Black Hole	5
An Interferometer	5
LIGO/VIRGO	5



True or False			
Question #		Pre	Post
1 True	1	1	1
2 True	2	1	1
5 True	5	1	1
6 True	6	0	1
7 True	7	1	1
12 True	12	1	1
13 True	13	0	0
15 True	15	1	1
16 True	16	1	1
17 True	17	0	<i>void 0</i>
19 True	19	1	1
3 False	3	1	<i>void 0</i>
4 False	4	0	<i>void 0</i>
8 False	8	<i>void 0</i>	0
9 False	9	<i>void 0</i>	1
10 False	10	<i>void 0</i>	0
11 False	11	1	1
14 False	14	1	1
18 False	18	0	1

Chloé Manganneau		
I'm interested in:	Post-test	Pre-test
	Science	4
Mathematics	3	4
Physics	3	4
History	4	4
History of Science	4	4
Philosophy	5	4
Philosophy of Science	1	4

I have heard about:	Post-test	Pre-test
	A wave	4
Gravitation	4	4
A gravitational wave	4	4
Trigonometry	4	3
Euclidean Geometry	4	3
Non-Euclidean Geometry	4	3
An analogy	4	3

I know:	Post-test	Pre-test
	Newton's Theory of Gravitation	4
Special Relativity	4	3
General Relativity	4	4
The concept of Spacetime	4	4
Trigonometry	4	3
Euclidean Geometry	4	3
Non-Euclidean Geometry	4	3

**I have a good understanding of:**

	Post-test	Pre-test
Newton's Theory of Gravitation	4	3
Special Relativity	4	3
General Relativity	4	3
The concept of Spacetime	4	3
Trigonometry	4	3
Euclidean Geometry	4	3
Non-Euclidean Geometry	4	3

**I can use:**

	Post-test	Pre-test
First degree equations	2	1
Derivatives	2	1
Integrals	2	1
Vectors	2	1
Tensors	2	1

**I'd like to know more about:**

Gravitational waves	5
Special Relativity	5
General Relativity	5
Non-Euclidean Geometry	5
Matrices	5
Tensors	5
Einstein's Field Equations	5
Physics	5
Astronomy	5
Cosmology	5
Optics	5
History of Science	5
Epistemology	5
Mathematics	5
Differential Geometry	5
The infinitely big	5
The infinitely small	5

<b>I can explain to someone what is:</b>		
	A gravitational wave	3
	Non-Euclidean Geometry	3
	Einstein's Principle of Relativity	3
	Special Relativity	3
	General Relativity	3
	Spacetime	3
	Gravitation	3
	An Inertial Reference Frame	3
	Redshift/Blueshift	3
	A Black Hole	3
	An Interferometer	3
	LIGO/VIRGO	3

True or False			
Question #		Pre	Post
1 True	1	1	0
2 True	2	1	1
5 True	5	1	1
6 True	6	1	1
7 True	7	1	1
12 True	12	1	1
13 True	13	0	0
15 True	15	1	1
16 True	16	1	0
17 True	17	0	0
19 True	19	<i>void 0</i>	1
3 False	3	1	0
4 False	4	1	1
8 False	8	1	1
9 False	9	1	1
10 False	10	0	<i>void 0</i>
11 False	11	1	1
14 False	14	1	1
18 False	18	<i>void 0</i>	0

Manganneau Charles-André		
I'm interested in:	Post-test	Pre-test
	Science	5
Mathematics	5	5
Physics	5	5
History	2	2
History of Science	2	2
Philosophy	2	2
Philosophy of Science	3	3

I have heard about:	Post-test	Pre-test
	A wave	4
Gravitation	4	2
A gravitational wave	3	2
Trigonometry	3	2
Euclidean Geometry	3	2
Non-Euclidean Geometry	3	2
An analogy	4	3

I know:	Post-test	Pre-test
	Newton's Theory of Gravitation	5
Special Relativity	3	2
General Relativity	3	2
The concept of Spacetime	2	1
Trigonometry	3	3
Euclidean Geometry	2	2
Non-Euclidean Geometry	2	1

**I have a good understanding of:**

	Post-test	Pre-test
Newton's Theory of Gravitation	4	3
Special Relativity	3	2
General Relativity	3	2
The concept of Spacetime	2	1
Trigonometry	3	2
Euclidean Geometry	2	2
Non-Euclidean Geometry	2	1

**I can use:**

	Post-test	Pre-test
First degree equations	5	5
Derivatives	5	5
Integrals	5	5
Vectors	5	4
Tensors	2	1



<b>I'd like to know more about:</b>		
	Gravitational waves	5
	Special Relativity	5
	General Relativity	5
	Non-Euclidean Geometry	4
	Matrices	4
	Tensors	4
	Einstein's Field Equations	5
	Physics	5
	Astronomy	5
	Cosmology	5
	Optics	3
	History of Science	2
	Epistemology	2
	Mathematics	5
	Differential Geometry	5
	The infinitely big	5
	The infinitely small	5

**I can explain to someone what is:**

A gravitational wave	4
Non-Euclidean Geometry	3
Einstein's Principle of Relativity	3
Special Relativity	2
General Relativity	2
Spacetime	2
Gravitation	4
An Inertial Reference Frame	3
Redshift/Blueshift	4
A Black Hole	3
An Interferometer	1
LIGO/VIRGO	3

True or False			
Question #		Pre	Post
1 True	1	1	0
2 True	2	1	1
5 True	5	0	1
6 True	6	1	1
7 True	7	0	1
12 True	12	1	1
13 True	13	0	1
15 True	15	0	1
16 True	16	1	1
17 True	17	1	1
19 True	19	0	0
3 False	3	1	1
4 False	4	0	0
8 False	8	1	0
9 False	9	1	1
10 False	10	1	1
11 False	11	0	1
14 False	14	0	0
18 False	18	0	1



## References

In this chapter, the readers are provided with the complete list of references found at the end of each chapter of this thesis. In addition, the readers are provided with a list of references which I did not use for this thesis, but which are part of the corpus of the state-of-the-art of the subjects discussed.

### Locations for the Manuscripts/Documents in situ

Virgo Interferometer, European Gravitational Observatory, Cascina, Italy.  
Niels Bohr Library, 1 Physics Ellipse Dr, College Park, MD 20740, USA.  
Dibner Library, 12th & Conston Ave NW #1041, Washington, DC 20560, USA.  
Library of Congress, 101 Independence Ave SE, Washington, DC 20540, USA.

### General Primary Sources

- Adams WS (1925) The relativity displacement of the spectral lines in the companion of Sirius. The Observatory, UK. 48:337-342. Retrieved: <http://adsabs.harvard.edu/full/1925Obs....48..337A>
- Appell P (1925) Henri Poincaré par Paul Appell de l'Académie des Sciences. Librairies Plan, Paris.
- Aristotle (1979) Physics Books I and II. Translated with introduction, commentary, note on recent work and revised bibliography by William Charlton, Clarendon Press.
- Bachelard G (1934) La formation de l'esprit scientifique. (Bibliothèque des textes philosophiques) Librairie philosophique J VRIN 50, Paris.
- Bondi H (1957) Plane gravitational waves in general relativity. Nature 179:1072-1073. <https://doi.org/10.1038/1791072a0>
- Clifford WK (1873) On the Hypothesis which lie at the Bases of Geometry, Nature, vol 8(183,184), pp.14-17, pp.36-37.
- Clifford WK (1873a) The postulates of the science of space. Wm. Benton
- Clifford WK (1873b) Preliminary Sketch of Biquaternions. Proceedings of the London Mathematical Society s1-4:381–395. <https://doi.org/10.1112/plms/s1-4.1.381>
- Clifford WK (1875) On the Free Motion under no Forces of a Rigid System in an n-fold Homaloid. Proceedings of the London Mathematical Society s1-7:67–70. <https://doi.org/10.1112/plms/s1-7.1.67>
- Clifford WK (1879) Lectures and Essays by William Kingdon Clifford. Macmillan
- Clifford WK (1886) Lectures and essays. Macmillan
- Clifford WK (2010) The ethics of belief and other essays. Prometheus Books
- De Broglie L (1924) Recherches sur la théorie des Quanta. Theses, Migration - université en cours d'affectation
- Dewey J (1986) Experience and Education. The Educational Forum 50:241–252. <https://doi.org/10.1080/00131728609335764>

- Eddington AS (1919) The total eclipse of 1919 May 29 and the influence of gravitation on light. *The Observatory* 42:119–122
- Eddington AS (1922) The Propagation of gravitational waves. *Proc R Soc Lond A* 102(716).  
<https://doi.org/10.1098/rspa.1922.0085>
- Eddington AS (1923) The Propagation of gravitational waves. *Proc. Roy. Soc. A* 102: 268–282.
- Einstein A (1905) Ueber einen die Erzeugung und Verwandlung des Lichtes betreffenden heuristischen Gesichtspunkt, *Annalen der Physik*, ser. 4, XVII, 1905, 132-148. (CP, 2, p. 150-166). Trad. fr., Un point de vue heuristique concernant la production et la transformation de la lumière, O.C., 1, p. 39-53.
- Einstein A (1905a) Ist die Trägheit eines Körpers von seinem Energieinhalt abhängig?. *Annalen der Physik*, 323(13):639-641.
- Einstein A (1936) LENS-LIKE ACTION OF A STAR BY THE DEVIATION OF LIGHT IN THE GRAVITATIONAL FIELD. *Science* 84:506–507.  
<https://doi.org/10.1126/science.84.2188.506>
- Einstein A (1989) The collected works of Albert Einstein, vol. 2, tranl. A. Beck. Princeton University Press
- Einstein A (1916) Approximative integration of the field equations of gravitation. *Sitzungsber Preuss Akad Wiss Berlin (Math Phys)* 1916:688–696
- Einstein A (1918) Über Gravitationswellen. *Sitzungsberichte der Königlich Preußischen Akademie der Wissenschaften Berlin*, 154–167
- Einstein A, Infeld L, Hoffmann B (1938) The Gravitational Equations and the Problem of Motion. *Annals of Mathematics* 39:65–100.  
<https://doi.org/10.2307/1968714>
- Einstein A, Rosen N (1937) On gravitational waves. *Jour Frank Inst* 223(1):43-54.  
[https://doi.org/10.1016/S0016-0032\(37\)90583-0](https://doi.org/10.1016/S0016-0032(37)90583-0)
- Galilei G (1632) *Dialogo di Galileo Galilei linceo matematico sopraordinario.... : massimi sistemi del mondo tolemaico, e Copernicano* ([Reprod. en fac-sim.])
- Galilei G (1890) *Il Saggiatore* [Galilei 1890-1909, VI, 197-372].
- Galilei G (2001) *Dialogue concerning the two chief world systems, Ptolemaic and Copernican*. Modern Library Classics.
- Heaviside O (1893) A Gravitational and Electromagnetic analogy. In: *Electromagnetic Theory by Oliver Heaviside Vol. 1. "The Electrician"* Printing and Publishing Company Limited, London, pp. 455-466.
- Heaviside O (1893a) A gravitational and electromagnetic analogy. *The Electrician*, 31(Part I):281-282.
- Heinzmann G, Stump D (2017) *Henri Poincaré*. The Stanford Encyclopedia of Philosophy, Metaphysics Research Lab, Stanford University, USA.  
 Retrieved: <https://plato.stanford.edu/archives/win2017/entries/poincare/>
- Hulse RA, Taylor JH (1975) Discovery of a pulsar in a binary system. *Astrophysical Journal* 195:L51–L53. <https://doi.org/10.1086/181708>
- Lorentz HA (1892) The relative motion of the earth and the ether. *Zittingsverlag Akad. V. Wet*, 1:74-79.
- Michelson AA, Morley EW (1887) On the relative motion of the earth and the luminiferous ether. *Amer. J. Sci*, 34:333.
- Michelson AA, Morley EW (1887a) LVIII. On the relative motion of the earth and the luminiferous Æther. *The London, Edinburgh, and Dublin Philosophical Magazine and Journal of Science*, 24(151):449-463.
- Newton I (1687) *Philosophiæ Naturalis Principia Mathematica*. Imprimatur S. Pepys, Reg. Soc. Preses. Julii 5. 1686. Londini, Jussi Societatus Regiæ ac Typis Josephi Streater. Prostat apud plures Bibliopolas. Anno MDCLXXXVII.
- Newton I ([1713], 1729) *The Mathematical principles of natural philosophy*. Translated by Motte Andrew. Motte B, London.

- Newton I ([1726; 1739–1742], 1822) *Philosophiae Naturalis Mathematica Principia*, auctore Isaaco Newtono, Eq. Aurato, perpetuis commentariis illustrata, communi studio Pp. Thomae Le Seur et Francisci Jacquier ex Gallicana minimorum familia, matheseos professorum. Editio nova (in three volumes). Duncan, Glasgow.
- Newton I ([1729] 1846) *Mathematical Principles of Natural Philosophy*, by Sir Isaac Newton; Translated into English by Andrew Motte. To Which is Added Newton's System of the World ; With a portrait taken from the bust in the royal observatory at Greenwich. First American Edition, Carefully Revised and Corrected, With a Life of the Author, by N. W. Chittenden, M. A., &c. New-York Published by Daniel Adee, 45 liberty street.
- Newton I (1833) *Philosophiae naturalis principia mathematica*. G. Brookman
- Newton I (1999) *The Principia: mathematical principles of natural philosophy*. Univ of California Press
- Picard CE (1913) Letter from Émile Picard to Arthur Korn – dated Paris, 6 Décembre 1913. Source: Niels Bohr Library, courtesy of the American Institute of Physics, USA.
- Picard CE (1913a) *L'Oeuvre de Henri Poincaré*, par Émile Picard, membre de l'institut et du bureau des longitudes. Gauthier-Villars, Imprimeur-Libraire du bureau des longitudes de l'École Polytechnique, Quai des Grands-Augustins, 55, Paris.
- Pirani FAE (1957) Invariant formulation of gravitational radiation theory. *Phys Rev* 105:1089. <https://doi.org/10.1103/PhysRev.105.1089>
- Pirani FAE (1956) On the physical significance of the Riemann tensor. *Acta Phys. Polon*, 15(6)
- Pirani FAE (2009) Republication of: On the physical significance of the Riemann tensor. *General Relativity and Gravitation* 41:1215–1232. <https://doi.org/10.1007/s10714-009-0787-9>
- Planck M (2012) *Eight lectures on theoretical physics*. Courier Corporation
- Planck M (2013) *Treatise on thermodynamics*. Courier Corporation
- Poincaré H (190?) *Œuvres philosophiques (Édition définitive)*, Flammarion, Paris. Retrieved: <https://gallica.bnf.fr/ark:/12148/bpt6k9691658b/f11>
- Poincaré H (19??) *La valeur de la science : œuvres philosophiques de Henri Poincaré*. Flammarion, Paris. Retrieved : <https://gallica.bnf.fr/ark:/12148/bpt6k2071994/f72.image.r=Poincar%C3%A9.%20Henri>
- Poincaré H (1920) *Dernières pensées*. Ernest Flammarion, éditeur. 26, Rue Racine, Paris.
- Poincaré H (1923) *La mécanique nouvelle: conférence, mémoire et note sur la théorie de la relativité; introduction de M. Édouard Guillaume*. Retrieved: <https://gallica.bnf.fr/ark:/12148/bpt6k9801836f>
- Riemann B (1868) Ueber die Hypothesen, welche der Geometrie zu Grunde liegen, *Abhandlungen der Königlichen Gesellschaft der Wissenschaften zu Göttingen*, 13:133-150. Retrieved: [http://www.deutschestextarchiv.de/riemann\\_hypothesen\\_1867/7](http://www.deutschestextarchiv.de/riemann_hypothesen_1867/7)
- Von Helmholtz H (2010) *On the Sensations of Tone as a Physiological Basis for the Theory of Music*. Translated by Alexander John Ellis. Nabu Press.
- Weber J (1970) Anisotropy and Polarization in the Gravitational-Radiation Experiments. *Physical Review Letters* 25:180–184. <https://doi.org/10.1103/physrevlett.25.180>
- Weber J (1960) Detection and generation of gravitational waves. *Phys Rev* 117, 306. <https://doi.org/10.1103/PhysRev.117.306>
- Weber J (1969) Evidence for discovery of gravitational radiation. *Phys Rev Lett* 22, 1320. <https://doi.org/10.1103/PhysRevLett.22.1320>

- Weber J (1966) Observation of the Thermal Fluctuations of a Gravitational-Wave Detector. *Physical Review Letters* 17:1228–1230. <https://doi.org/10.1103/physrevlett.17.1228>
- Weber J (1971) The Detection of Gravitational Waves. *Scientific American* 224:22–29. <https://doi.org/10.1038/scientificamerican0571-22>
- Weber J, Wheeler JA (1957) Reality of the cylindrical gravitational waves of Einstein and Rosen. *Rev Mod Phys* 29:509. <https://doi.org/10.1103/RevModPhys.29.509>
- Whitehead AN (1897) The Geodesic Geometry of Surfaces in non-Euclidean Space. *Proceedings of the London Mathematical Society* s1-29:275–324. <https://doi.org/10.1112/plms/s1-29.1.275>



## General Secondary Sources

- Aasi J, Abbott B, Abbott R, et al (2015b) Advanced ligo. Classical and quantum gravity 32:074001
- Abadie J, Abbott BP, Abbott R, et al (2010) Predictions for the rates of compact binary coalescences observable by ground-based gravitational-wave detectors. Classical and Quantum Gravity 27:173001. <https://doi.org/10.1088/0264-9381/27/17/173001>
- Abadie J, Abbott BP, Abbott R, et al (2012) Search for gravitational waves from low mass compact binary coalescence in LIGO's sixth science run and Virgo's science runs 2 and 3. Phys Rev D 85:082002. <https://doi.org/10.1103/PhysRevD.85.082002>
- Abattouy M (2018) Seminars Abattouy at Lille University (May 2018). Retrieved: [https://www.researchgate.net/publication/326440942\\_Seminars\\_Abattouy\\_at\\_Lille\\_University\\_May\\_2018](https://www.researchgate.net/publication/326440942_Seminars_Abattouy_at_Lille_University_May_2018)
- Abbott B, Abbott R, Abbott T, et al (2017) A gravitational-wave standard siren measurement of the Hubble constant. Nature 551:85–88. <https://doi.org/10.1038/nature24471>
- Abbott B, Abbott R, Adhikari R, et al (2004a) Analysis of LIGO data for gravitational waves from binary neutron stars. Physical Review D 69:122001. <https://doi.org/10.1103/physrevd.69.122001>
- Abbott B, Abbott R, Adhikari R, et al (2004c) First upper limits from LIGO on gravitational wave bursts. Physical Review D 69:102001. <https://doi.org/10.1103/physrevd.69.102001>
- Abbott B, Abbott R, Adhikari R, et al (2004d) Setting upper limits on the strength of periodic gravitational waves from PSRJ1939+2134 using the first science data from the GEO 600 and LIGO detectors. Physical Review D 69:082004. <https://doi.org/10.1103/physrevd.69.082004>
- Abbott B, Abbott R, Adhikari R, et al (2005b) Search for gravitational waves associated with the gamma ray burst GRB030329 using the LIGO detectors. Physical Review D 72:042002.
- Abbott B, Abbott R, Adhikari R, et al (2005f) Upper Limits on a Stochastic Background of Gravitational Waves. Physical Review Letters 95:221101. <https://doi.org/10.1103/physrevlett.95.221101>
- Abbott B, Abbott R, Adhikari R, et al (2005g) Upper limits on gravitational wave bursts in LIGO's second science run. Physical Review D 72:062001. <https://doi.org/10.1103/physrevd.72.062001>
- Abbott BP, Abbott R, Abbott T, et al (2016a) GW150914: First results from the search for binary black hole coalescence with Advanced LIGO. Physical Review D 93:122003
- Abbott BP, Abbott R, Abbott T, et al (2016b) Localization and broadband follow-up of the gravitational-wave transient GW150914. The Astrophysical journal letters 826:L13
- Abbott BP, Abbott R, Abbott T, et al (2016c) Observing gravitational-wave transient GW150914 with minimal assumptions. Physical Review D 93:122004
- Abbott BP, Abbott R, Abbott T, et al (2016d) Properties of the binary black hole merger GW150914. Physical review letters 116:241102
- Abbott BP, Abbott R, Abbott TD, et al (2016e) All-sky search for long-duration gravitational wave transients with initial LIGO. Phys Rev D 93:042005. <https://doi.org/10.1103/PhysRevD.93.042005>
- Abbott BP, Abbott R, Abbott TD, et al (2016f) ASTROPHYSICAL IMPLICATIONS OF THE BINARY BLACK HOLE MERGER GW150914. The Astrophysical Journal 818:L22. <https://doi.org/10.3847/2041-8205/818/2/L22>

- Abbott BP, Abbott R, Abbott TD, et al (2016g) Binary Black Hole Mergers in the First Advanced LIGO Observing Run. *Phys Rev X* 6:041015. <https://doi.org/10.1103/PhysRevX.6.041015>
- Abbott BP, Abbott R, Abbott TD, et al (2016i) GW150914: Implications for the Stochastic Gravitational-Wave Background from Binary Black Holes. *Physical Review Letters* 116:131102. <https://doi.org/10.1103/physrevlett.116.131102>
- Abbott BP, Abbott R, Abbott TD, et al (2016j) GW151226: Observation of Gravitational Waves from a 22-Solar-Mass Binary Black Hole Coalescence. *Phys Rev Lett* 116:241103. <https://doi.org/10.1103/PhysRevLett.116.241103>
- Abbott BP, Abbott R, Abbott TD, et al (2016l) Observation of Gravitational Waves from a Binary Black Hole Merger. *Phys Rev Lett* 116:061102. <https://doi.org/10.1103/PhysRevLett.116.061102>
- Abbott BP, Abbott R, Abbott TD, et al (2016o) Tests of General Relativity with GW150914. *Physical Review Letters* 116:221101. <https://doi.org/10.1103/physrevlett.116.221101>
- Abbott BP, Abbott R, Abbott TD, et al (2016p) the rate of binary black hole mergers inferred from advanced ligo observations surrounding GW150914. *The Astrophysical Journal* 833:L1. <https://doi.org/10.3847/2041-8205/833/1/11>
- Abbott BP, Abbott R, Abbott TD, et al (2016q) Upper Limits On The Rates Of Binary Neutron Star And Neutron Star–Black Hole Mergers From Advanced Ligo’s First Observing Run. *The Astrophysical Journal* 832:L21. <https://doi.org/10.3847/2041-8205/832/2/L21>
- Abbott BP, Abbott R, Abbott TD, et al (2017c) Gravitational Waves and Gamma-Rays from a Binary Neutron Star Merger: GW170817 and GRB 170817A. *The Astrophysical Journal* 848:L13. <https://doi.org/10.3847/2041-8213/aa920c>
- Abbott BP, Abbott R, Abbott TD, et al (2017d) GW170104: Observation of a 50-Solar-Mass Binary Black Hole Coalescence at Redshift 0.2. *Phys Rev Lett* 118:221101. <https://doi.org/10.1103/PhysRevLett.118.221101>
- Abbott BP, Abbott R, Abbott TD, et al (2017e) GW170608: Observation of a 19 Solar-mass Binary Black Hole Coalescence. *The Astrophysical Journal* 851:L35. <https://doi.org/10.3847/2041-8213/aa9f0c>
- Abbott BP, Abbott R, Abbott TD, et al (2017f) GW170814: A Three-Detector Observation of Gravitational Waves from a Binary Black Hole Coalescence. *Phys Rev Lett* 119:141101. <https://doi.org/10.1103/PhysRevLett.119.141101>
- Abbott BP, Abbott R, Abbott TD, et al (2017g) Multi-messenger Observations of a Binary Neutron Star Merger. *The Astrophysical Journal* 848:L12. <https://doi.org/10.3847/2041-8213/aa91c9>
- Abbott BP, Abbott R, Abbott TD, et al (2017h) Upper Limits on the Stochastic Gravitational-Wave Background from Advanced LIGO’s First Observing Run. *Phys Rev Lett* 118:121101. <https://doi.org/10.1103/PhysRevLett.118.121101>
- Abbott BP, Abbott R, Abbott TD, et al (2019a) Binary Black Hole Population Properties Inferred from the First and Second Observing Runs of Advanced LIGO and Advanced Virgo. *The Astrophysical Journal* 882:L24. <https://doi.org/10.3847/2041-8213/ab3800>
- Abbott BP, Abbott R, et al (2017) GW170817: Observation of Gravitational Waves from a Binary Neutron Star Inspiral. *Phys Rev Lett* 119:161101. <https://doi.org/10.1103/PhysRevLett.119.161101>
- Abbott R, Abbott TD, Abraham S, Acernese F, Ackley K, Adams C, ... Agatsuma K (2020) GW190814: Gravitational waves from the coalescence of a 23 solar mass black hole with a 2.6 solar mass compact object. *The Astrophysical Journal Letters*, 896(2), L44.

- Abd-El-Khalick F, Myers JY, Summers R, Brunner J, Waight N, Wahbeh N, Zeineddin AA, Belarmino J (2017) A longitudinal analysis of the extent and manner of representations of nature of science in U.S. high school biology and physics textbooks. *Journal of Research in Science Teaching*, 54:82-120. doi:10.1002/tea.21339
- Aiton E J (1978) Kepler's Path to the Construction and Rejection of his First Oval Orbit for Mars. *Annals of Science* 35/2:173–190.
- Alvarez C, Dhombres J (2011) Une histoire de l'Imaginaire mathématique. Hermann, Paris.
- Amaldi E, Bonifazi P, Coccia E, Frasca S, Modena I, Pallottino GV, Pizzella G, Ricci F (1982) THE GRAVITATIONAL WAVE EXPERIMENT OF THE ROME GROUP. 3rd Marcel Grossmann Meeting on the Recent Developments of General Relativity, pp. 655-666.
- Amaldi E, Bonifazi P, Frasca S, Gabellieri M, Gretz D, Pallottino GV, Pizzella G, Weber J and Wilmot G (1988) Analysis of the data recorded by the Maryland and Rome room temperature gravitational wave antennas in the period of the SN 1987A. In: Kafatos M and Michalitsianos AG (eds.) *Supernova 1987A in the Large Magellanic Cloud*, Cambridge University Press, Cambridge, pp. 453–462.
- Bachelard G (1938) *La formation de l'esprit scientifique*. Vrin, Paris.
- Bächtold M, Guedj M (2014) Teaching Energy Informed by the History and Epistemology of the Concept with Implications for Teaching Education. In: *International Handbook of Research in History, Philosophy and Science Teaching*. Springer, Dordrecht, pp. 211–243.
- Bächtold M, Munier V (2018) Teaching energy in high school by making use of history and philosophy of science. *Journal of Research in Science Teaching*, 56(6), 1–32.
- Baird D (2004) *Thing Knowledge: A Philosophy of Scientific Instruments*. University of California Press, London.
- Ballard MS (2010) Doppler Effect. *The Journal of the Acoustical Society of America* 127/3, 1912, Published Online. Retrieved: <https://doi.org/10.1121/1.3384841>
- Barbin E, Pisano R (2013) Historical Reflections on Physics Mathematics Relationship In *Electromagnetic Theory* In: Barbin E, Pisano R, (eds). *The Dialectic Relation between Physics And Mathematics In The XIXth Century*. Springer, Dordrecht, pp. 31–57.
- Barish BC, Weiss R (1999) LIGO and the Detection of Gravitational Waves. *Physics Today* 52:44–50. <https://doi.org/10.1063/1.882861>
- Barker A (2007) *The Science of Harmonics in Classical Greece*. Cambridge University Press, Cambridge.
- Barker P, Goldstein BR (2001) Theological Foundations of Kepler's Astronomy. *Osiris* 16:88-113.
- Bartusiak M (1998) Interview with Joseph Weber, University of Maryland, May 6, 1998. Recordings/transcripts available at Niels Bohr Library Archives, 1 Ellipse Road, College Park, Maryland.
- Berberan-Santos MN (2005) Analytical inversion of the Laplace transform without contour integration: application to luminescence decay laws and other relaxation functions. *Journal of Mathematical Chemistry*, 38(2):165–173. doi:10.1007/s10910-005-4961-3
- Bernard C, De Rújula A, Lautrup B (1984) Sonic search for monopoles, gravitational waves and newtonites. *Nuclear Physics B*, 242/1: 93-144. Retrieved: [https://doi.org/10.1016/0550-3213\(84\)90136-6](https://doi.org/10.1016/0550-3213(84)90136-6)
- Bizouard C (1999)  $E = mc^2$ . L'équation de Poincaré, Einstein et Planck. In: *Colloquium Lecture, Observatoire de Paris, Vol. 4*.

- Bouzid A, Zaoui H, Luca Palla P, Ori G, Boero M, Massobrio C, Cleri F, Lampin E (2017) Thermal conductivity of glassy GeTe<sub>4</sub> by first-principles molecular dynamics. *Physical Chemistry Chemical Physics*, 19(15):9729–9732. doi:10.1039/c7cp01063j
- Bryce T, MacMillan K (2005) Encouraging conceptual change: the use of bridging analogies in the teaching of action–reaction forces
- Brun S J-L, Morellato M, Sensevy G, Quilio S (2017) Cooperative engineering as a joint action. *European Educational Research Journal* 17:187–208. <https://doi.org/10.1177/1474904117690006>
- Burko LM (2017) Gravitational Wave Detection in the Introductory Lab, *The Physics Teacher*, 55:288-292.
- Bussotti P, Pisano R (2014a) Newton’s *Philosophiae Naturalis Principia Mathematica* “Jesuit” Edition: The Tenor of a Huge Work. *Accademia Nazionale Lincei-Rendiconti Matematica e Applicazioni* 25/4:413-444.
- Bussotti P, Pisano R (2014b) On the Jesuit Edition of Newton’s *Principia*. *Science and Advanced Researches in the Western Civilization*. In Pisano 2014, 3/1:33–55.
- Campeti P, Komatsu E, Poletti D, Baccigalupi C (2020) Measuring the spectrum of primordial gravitational waves with CMB, PTA and Laser Interferometers. arXiv preprint arXiv:2007.04241.
- Caramazza A, McCloskey M, Green B (1981) Naive beliefs in "sophisticated" subjects: misconceptions about trajectories of objects. *Cognition*, 9(2):117-123. Retrieved: [https://doi.org/10.1016/0010-0277\(81\)90007-X](https://doi.org/10.1016/0010-0277(81)90007-X)
- Castelvecchi D (2015) Hunt for gravitational waves to resume after massive upgrade. *Nature* 525:301–302. <https://doi.org/10.1038/525301a>
- Chatziioannou K, Han S (2020) Studying strong phase transitions in neutron stars with gravitational waves. *Physical Review D*, 101(4). doi:10.1103/physrevd.101.044019
- Cleri F, Rosato V (1993) Tight-binding potentials for transition metals and alloys. *Physical Review B*, 48(1):22–33. doi:10.1103/physrevb.48.22
- Cohen F (1994) *The Scientific Revolution: A Historiographical Inquiry*. The University of Chicago Press, Chicago.
- Cohen SM (1994) Aristotle on Elemental Motion. *Phronesis*, 39(2):150–159. Retrieved: [www.jstor.org/stable/4182465](http://www.jstor.org/stable/4182465)
- Cohen-Azria C, Dias-Chiaruttini A (2014) Analyser les contenus en jeu dans la visite scolaire au Musée : questions méthodologiques. In: Daunay B., Fluckiger C. et Hassan R. (dir.) *Les Contenus d’enseignement et d’apprentissage. Approches didactiques*, Bordeaux, Presses Universitaires de Bordeaux, p. 109-119.
- Cohen-Azria C, Dias-Chiaruttini A (2017) De La petite taupe qui voulait savoir qui lui avait fait sur la tête : Quand un album de jeunesse devient scénario d’exposition. *Pratiques : linguistique, littérature, didactique* 175-176:
- Crapanzano F (2018) “Strange Trajectories”: Naive Physics, Epistemology and History of Science. *Transversal: International Journal for the Historiography of Science* 49. <https://doi.org/10.24117/2526-2270.2018.i5.06>
- Crinon J, Dias-Chiaruttini A (2017) Interroger l’efficacité des pratiques d’enseignement de la lecture-écriture au cours préparatoire. *Repères : Recherches en didactique du français langue maternelle* 55:7–20
- Crombie AC (1961) *Augustine to Galileo*, Vol. 1. Harvard University Press, Cambridge, MA.
- Crombie AC (1963) (ed.) *Scientific change: historical studies in the intellectual, social and technical conditions for scientific discovery and technical Invention, from antiquity to the present—Symposium on the history of science*, University of Oxford, 9–15 July 1961. Heinemann education books, London.

- Cumming AV, Bell AS, Barsotti L, et al (2012) Design and development of the advanced LIGO monolithic fused silica suspension. *Classical and Quantum Gravity* 29:035003. <https://doi.org/10.1088/0264-9381/29/3/035003>
- Cutler C (1998) Angular resolution of the LISA gravitational wave detector. *Phys. Rev. D*, 57(12):7089. <https://doi.org/10.1103/PhysRevD.57.7089>
- Cutler C, Flanagan EE (1994) Gravitational waves from merging compact binaries: How accurately can one extract the binary's parameters from the inspiral waveform? *Physical Review D* 49:2658–2697. <https://doi.org/10.1103/physrevd.49.2658>
- Delambre JB ([1821], 1969) *Histoire de l'astronomie moderne*. Johnson Reprint Corporation, New York and London.
- DeWitt CM, Rickles D: Conference on the role of gravitation in physics. In: Proceedings of conference at Chapel Hill, North Carolina, January 18–23, 1957. (Wright Air Development Center (WADC) technical report 57–216, United States Air Force, Wright-Patterson air force base, Ohio (1957))
- DeWitt CM, Rickles D et al. (2016) An Expanded Version of the Remarks by R.P. Feynman on the Reality of Gravitational Waves. In: *The Role of Gravitation in Physics, Report from the 1957 Chapel Hill Conference*. Retrieved <http://www.edition-open-sources.org/sources/5/34/index.html>
- Dhombres J (1978) *Nombre, mesure et continu : épistémologie et histoire*. Cedic–Nathan, Paris.
- Dhombres J (2013) *Pierre–Simon de Laplace (1749–1827). Le parcours d'un savant*. Hermann, Paris.
- Di Martino P, Zan R (2010) 'Me and maths': towards a definition of attitude grounded on students' narratives. *J Math Teacher Educ* 13(1):27–48. Retrieved: <https://doi.org/10.1007/s10857-009-9134-z>
- Di Sessa AA (2011) Toward an Epistemology of Physics. *Cognition and Instruction* 10(2-3):105-225.
- Dias-Chiaruttini A (2010a) Dysfonctionnements et évaluations dans des débats interprétatifs : la place particulière de l'EI (erreur interprétative). *Les Cahiers Théodile* 9:111–137
- Dias-Chiaruttini A (2011a) Former les enseignants au débat interprétatif : places et enjeux des styles enseignants. *Repères* 117–134. <https://doi.org/10.4000/reperes.182>
- Dias-Chiaruttini A (2017e) Le débat : enjeux didactiques, épistémologiques et disciplinaires. In: Fisher C., Gagnon R., de Pietro J.-F. (dir.) *L'oral aujourd'hui : perspectives didactiques*, Namur, Presses Universitaires de Namur, collection Recherche en didactique du français n9, p. 67-85.
- Dias-Chiaruttini A (2018e) Rapport à la littérature et à son enseignement : comprendre ce qui s'enseigne sous le nom littérature, Tréma
- Dias-Chiaruttini A (2020b) Le débat interprétatif / Communauté interprétative. In: (ed) Goff F L, Rannou N, et J.-F. Massol M-J *F Dictionnaire de didactique de la littérature*. Honoré Champion, Coll. Didactique des textes et des cultures
- Dias-Chiaruttini A, Cohen-Azria C (2015) La visite scolaire au musée ou la construction du sujet élève visiteur en didactiques. In: *Colloque international en éducation du CRIFPE, Enjeux actuels et futurs de la formation et de la profession enseignante*, Montréal, France
- Dias-Chiaruttini A, Cohen-Azria C, Maczek E (2016) Rencontres au musée : élève-médiateur-enseignant. In: *Congrès de l'AGEEM, L'estime de soi : quels enjeux pour les enfants et les adultes à l'école maternelle ?* Dijon, France
- Dias-Chiaruttini A, Lebrun M (2020d) La question de la relation entre les disciplines scolaires : le cas de l'enseignement du français,

- Dias-Chiaruttini A, Salagnac N (2016i) Recherches en didactiques n21, Pratiques et recherches en didactiques, Villeneuve-d'Ascq, Presses Universitaires du Septentrion.
- Donahue WH (1981) The dissolution of celestial spheres 1595–1650. Arno Press, New York.
- Donahue WH (1993) Kepler's first thoughts on oval orbits: text, translation and commentary. *Journal for the History of Astronomy* 24(1–2):71–100.
- Drago A (2017) What Was the Role of Galileo in the Century-Long Birth of Modern Science? *Philosophia Scientiae*, 21(1):35-54. Retrieved: <https://doi.org/10.4000/philosophiascientiae.1238>
- Drake S (1964) Galileo and the Law of Inertia. *American Journal of Physics*, 32(8):601–608. doi:10.1119/1.1970872
- Drake S (1999) *Essays on Galileo and the History and Philosophy of Science*, Vol. 1. University of Toronto Press.
- Durfee DS, Colton JS (2015) The physics of musical scales: Theory and experiment. *American Journal of Physics* 83/10:835-842.
- Easterher R, Giblin JT, Lim EA (2007) Gravitational Wave Production at the End of Inflation. *Physical Review Letters*, 99(22). doi:10.1103/physrevlett.99.221301
- Elders L (2013) ST. THOMAS AQUINAS'S COMMENTARY ON ARISTOTLE'S "PHYSICS". *The Review of Metaphysics*, 66(4):713–748. Retrieved: [www.jstor.org/stable/23597906](http://www.jstor.org/stable/23597906)
- Escobar JM (2008) Kepler's Theory of the Soul: A Study on Epistemology. *Studies in History and Philosophy of Science* 39:15-41.
- Faraoni V (2013) The Lorentz Transformation. *Undergraduate Lecture Notes in Physics*, 29–57. doi:10.1007/978-3-319-01107-3\_2
- Forward RL (1978) Wideband laser-interferometer gravitational-radiation experiment. *Phys Rev D* 17:379–390. <https://doi.org/10.1103/PhysRevD.17.379>
- Fushchich WI, Cherniha RM (1985) The Galilean relativistic principle and nonlinear partial differential equations. *Journal of Physics A: Mathematical, Nuclear and General*, 18(18):3491-3503.
- Fryer CL, Woosley SE, Heger A (2001) Pair-Instability Supernovae, Gravity Waves, and Gamma-Ray Transients. *The Astrophysical Journal* 550:372–382. <https://doi.org/10.1086/319719>
- Galindo S, Cervantes-Cota JL (2018) Clifford's attempt to test his gravitation hypothesis. *Revista Mexicana de Física E* 64:162. <https://doi.org/10.31349/revmexfise.64.162>
- Galili I (2008) The history of physics as a tool of teaching. In: Vicentini M, Sassi E (eds.), *Connecting research in physics education with teachers education*, pp. 1-11. International Commission on Physics Education.
- Gatto R (2017) "It is Impossible to Deceive Nature". Galileo's *Le Meccaniche*, a Bridge Between the Science of Weights and the Modern Statics. *Philosophia Scientiae* 21(1):71-91. Retrieved: <https://doi.org/10.4000/philosophiascientiae.1242>
- Gaukroger S, Schuster J, Sutton J (2000) (eds.) *Descartes' natural philosophy*. Routledge, London and New York.
- Giarè W, Melchiorri A (2020) Probing the inflationary background of gravitational waves from large to small scales. arXiv preprint arXiv:2003.04783.
- Grünbaum A (1973) *Philosophical Problems of Space and Time* Second, enlarged edition. Boston Studies in the Philosophy of Science, vol. XII, D. Reidel Publishing Company, Dordrecht, Boston.
- Guisasola J, Almudi JM, Furió C (2005) The Nature of Science and Its Implications for Physics Textbooks: The Case of Classical Magnetic Field Theory. *Science & Education* 14:321-328.

- Hahn R, Radelet-de Grave P, Vandersmissen J, Mozdziej T (2013) Correspondance de Pierre Simon Laplace (1749-1827) Publiée et annotée par Roger Hahn, Texte préparé pour la publication par Patricia Radelet-de Grave, Jan Vandersmissen, Thierry Mozdziej.
- Haig BD (2013) Analogical modeling: a strategy for developing theories in psychology. *Frontiers in Psychology* 4:348. <https://doi.org/10.3389/fpsyg.2013.00348>
- Handschy, M. A. (1982). Re-examination of the 1887 Michelson–Morley experiment. *American Journal of Physics*, 50(11):987–990. doi:10.1119/1.12938
- Hogan K (2000) Exploring a process view of students' knowledge about the nature of science. *Science Education* 84:51–70. [https://doi.org/10.1002/\(SICI\)1098-237X\(200001\)84:1<51::AID-SCE5>3.0.CO;2-H](https://doi.org/10.1002/(SICI)1098-237X(200001)84:1<51::AID-SCE5>3.0.CO;2-H)
- Holden C (1992) Study Flunks Science and Math Tests. *Science*, 258(5082):541–541. doi:10.1126/science.258.5082.541-a
- Jaballah HD (1999) La formation du concept de force dans la physique moderne. Vol. II. Contribution à une épistémologie historique. Alpha Edition, Tunis.
- Jammer M (1957) *Concept of Force: a Study in the Foundations of Dynamics*. The Harvard University Press, Cambridge, MA.
- Janiak A (2019) Newton's Philosophy. In: (ed) Zalta E N *The Stanford Encyclopedia of Philosophy*, Winter 2019. Metaphysics Research Lab, Stanford University
- Javornik Krečič M, Kovše S, Ploj Virtič M (2013) The Role and Meaning of School Counseling When Dealing With Peer Violence. *Croatian Journal of Education* [Internet]. [pristupljeno 28.05.2020.]; 15(2):521-541. Dostupno na: <https://hrcak.srce.hr/105554>
- Jeans J (1968) *Science and Music*. Dover, New York.
- Jeong D, Kamionkowski M (2020) Gravitational Waves, CMB Polarization, and the Hubble Tension. *Physical Review Letters*, 124(4). doi:10.1103/physrevlett.124.041301
- Katsanevas S (1986) Results on neutrino oscillations from an appearance experiment in BEBC.
- Katsanevas S (1993) Prospects for supersymmetry at LEP200. Report DELPHI-93-109 PHYS 336, 7.
- Katsanevas S (1995) Long baseline neutrino oscillation beams and experiments. 30th Rencontres de Moriond: Electroweak Interactions and Unified Theories, pp. 481-489.
- Katsanevas S (1998) Supersymmetry at LEP, experimental review. *Journal of Physics G: Nuclear and Particle Physics*, 24(2):337–352. doi:10.1088/0954-3899/24/2/008
- Katz VJ (2000) *Using history to teach mathematics: An international perspective*. Cambridge University Press
- Katz VJ, Michalowicz KD (2005) *Historical modules for the teaching and learning of mathematics*. Mathematical Association of America Washington, DC
- Katz VJ, Parshall KH (2014) *Taming the unknown. History of algebra from antiquity to the early twentieth century*. The Princeton University Press. Princeton, New Jersey.
- Kennefick D (2005b) Einstein Versus the Physical Review. *Physics Today* 58:43–48. <https://doi.org/10.1063/1.2117822>
- Kennefick D (2019) *No Shadow of a Doubt: The 1919 Eclipse That Confirmed Einstein's Theory of Relativity*. Princeton University Press, Princeton.
- Koyré A (1943) Galileo and Plato. *Journal of the History of Ideas*, 4(4):400-428.
- Koyré A (1961) *La révolution astronomique: Copernic, Kepler, Borelli*. Hermann, Paris.
- Koyré A (1963) Scientific Change. In Crombie 1963, pp. 847–857.

- Koyré A (1965) *Newtonian Studies*. The Harvard University Press, Cambridge, MA.
- Koyré A (1966) *Études galiléennes*. Hermann, Paris.
- Koyré A (1971) *Études d'histoire de la pensée philosophique*. Gallimard, Paris.
- Koyré A (1973) *Études d'histoire de la pensée scientifique*. Gallimard, Paris.
- Kuhn T (1962) *The structure of scientific revolutions*. University of Chicago Press, Chicago.
- Lampin E, Palla PL, Francioso P-A, Cleri F (2013) Thermal conductivity from approach-to-equilibrium molecular dynamics. *Journal of Applied Physics*, 114(3):033525. doi:10.1063/1.4815945
- Landuzzi F, Viader-Godoy X, Cleri F, Pastor I, Ritort F (2020) Detection of single DNA mismatches by force spectroscopy in short DNA hairpins. *The Journal of Chemical Physics*, 152(7):074204. doi:10.1063/1.5139284
- LIGO Scientific Collaboration, Virgo Collaboration (2020) GW190412: Observation of a Binary-Black-Hole Coalescence with Asymmetric Masses. arXiv preprint arXiv:2004.08342.
- Ligozat F, Orange C, Dufays J-L, Doussot S, Quilio S, Loquet M, Tiberghien A, Martine J, Mercier A (2017) La modélisation des savoirs dans les analyses didactiques des situations d'enseignement et apprentissage. Numéro thématique *Recherches en Education*, 29
- Logunov AA (2005) *Henri Poincaré and Relativity Theory*, Translated by G. Pontecorvo and V.O. Soloviev, Petrov VA (ed), Nauka, Russia.
- Mach E (2014) *History and Root of the Principle of the Conservation of Energy*. Cambridge University Press
- Mapelli M, Giacobbo N (2018) The cosmic merger rate of neutron stars and black holes. *Monthly Notices of the Royal Astronomical Society* 479:4391–4398. <https://doi.org/10.1093/mnras/sty1613>
- Manca F, Giordano S, Palla PL, Cleri F (2014) On the equivalence of thermodynamics ensembles for flexible polymer chains. *Physica A: Statistical Mechanics and Its Applications*, 395:154–170. doi:10.1016/j.physa.2013.10.042
- Marcacci F (2005) L'induzione e la conoscenza scientifica in Aristotele: un'analisi di An. Pr. II 23.
- Marcacci F (2005) Sul ruolo dell'induzione nell'epistemologia di Aristotele. *AQUINAS-ROME-*, 48 (1/2):33.
- Marcacci F (2008) *Alle origini dell'assiomatica: gli Eleati, Aristotele, Euclide*. Roma: Aracne.
- Marcacci F (2009) *Bibliografia tematica galileiana*. In: Galileo Galilei, *Sidereus Nuncius*, traduzione e commento di P. A. Giustini, a cura di Flavia Marcacci. Lateran University Press, Roma, pp. 221-328.
- Marcacci F (2009) From the sky to maps: observation and theory of the heavens between the 16th and the 18th century (con versione italiana Dal cielo alle carte: osservazione e teoria del cielo tra XVI e XVIII secolo). In: *Magna longeuque ad mirabilia. Astronomia e cosmologia nel fondo antico della Biblioteca Beato Pio IX*, a cura di F. Marcacci, F. C. Panini e Lateran University Press, Modena, Città del Vaticano, 24-52.
- Marcacci F (Ed.) (2009) *Magna longeuque admirabilia: astronomia e cosmologia nel fondo antico della Biblioteca Beato Pio IX*; [29 novembre-11 dicembre 2009]. Panini.
- Marcacci F (2010) Metaphors of Galileo between cosmography and astronomy: some brief reflections. In: Altamore A, Antonini G (eds.), *Galileo and the renaissance scientific discourse*. Edizioni Nuova Cultura, pp. 103-110.
- Marcacci F (2014) Illusions, Ghosts and Movies in the history of scientific instruments. *Gino Tarozzi Philosopher of Physics. Studies in the philosophy of entanglement on his 60th birthday: Studies in the philosophy of entanglement on his 60th birthday*, pp. 148-158.



- Marcacci F (2015) Galileo Galilei: una storia da osservare. Lateran University Press.
- Marcacci F (2015) History of Science, Epistemology, and Ontology. In *Science Between Truth and Ethical Responsibility*. Springer, pp. 231-241.
- Marcacci F (2015) The World-System of Giovanni Battista Riccioli and the Phases of Venus and Mercury. *Advances in Historical Studies*, 4(2):106-117. doi: 10.4236/ahs.2015.42011.
- Marcacci F (2018) Creazione e cosmologia scientifica: Problemi epistemologici e opportunità speculative. *Aquinas*, 61(1/2):147-164.
- Martin E, Palla PL, Cleri F, Bouzid A, Ori G, Le Roux S, Boero M, Massobrio C (2018). On the occurrence of size effects in the calculation of thermal conductivity by first-principles molecular dynamics: The case of glassy GeTe 4. *Journal of Non-Crystalline Solids*, 498:190–193. doi:10.1016/j.jnoncrysol.2018.05.014
- Martinand JL (1993) Histoire et didactique de la physique et de la chimie: Quelles relations? *Didaskalia*, 2:89-99.
- Maurines L, Mayrargue A (2003) Regards croisés de l'histoire des sciences et de la didactique de la physique sur le concept d'onde. In: *Desco (coord.) La pluridisciplinarité dans les enseignements scientifiques : 1er tome Histoire des sciences. Sélection des actes de l'université d'été "L'histoire des sciences comme instrument d'une approche pluridisciplinaire de l'enseignement au collège et au lycée"*, I.R.E.M. de Poitiers, 2001, CRDP Basse-Normandie, pp. 111-129.
- McComas WF, Almazroa H, Clough MP (1998) The Nature of Science in Science Education: An Introduction. *Science & Education*, 7:511. Doi:10.1023/A:1008642510402
- McDermott LC (1984) Research on conceptual understanding in mechanics. *Physics Today* 37(7):24-32.
- McLaren IPL, Wood K, McLaren R (2013) Naïve Physics – the wrong theory? *Cognitive Science*, 35.
- Morellato M, Quilio S (2012) Obstacles à l'usage du nombre et à l'enquête sur ses propriétés dans l'implantation d'une ingénierie sur la soustraction
- Nahin PJ (2002) *Oliver Heaviside: the life, work, and times of an electrical genius of the Victorian age*. JHU Press.
- Ogan-Bekiroglu F (2007) To What Degree Do the Currently Used Physics Textbooks Meet the Expectations? *Journal of Science Teacher Education* 18(4):599-628.
- Oliveira A (2019) Emerging technologies as pedagogical tools for teaching and learning science: A literature review. *Human Behaviour and Emerging Technologies*, 1(2):149-160.
- Pais A (1982) *Subtle is the Lord: The Science and the Life of Albert Einstein*, Oxford University Press, New York.
- Palla PL, Patera G, Cleri F, Giordano S (2020) A stochastic force model for the ballistic-diffusive transition of heat conduction. *Physica Scripta*. doi:10.1088/1402-4896/ab8d56
- Palla PL, Zampa S, Martin E, Cleri F (2019). Interface thermal behavior in nanomaterials by thermal grating relaxation. *International Journal of Heat and Mass Transfer*, 131:932–943. doi:10.1016/j.ijheatmasstransfer.2018.11.064
- Pesic P (2007) *Beyond Geometry: Classic Papers from Riemann to Einstein*. Dover, New York.
- Pisano R (2011) Physics–Mathematics Relationship. Historical and Epistemological notes. In: Barbin E, Kronfeller M and Tzanakis C (eds.), *Proceedings of the ESU 6 European Summer University History And Epistemology in Mathematics*. Verlag Holzhausen GmbH–Holzhausen Publishing Ltd., Vienna, pp. 457–472.

- Pisano R (2013a) History Reflections on Physics Mathematics Relationship in Electromagnetic Theory. In Barbin and Pisano 2013, pp. 31–58.
- Pisano R (2014) (ed.) Isaac Newton and his Scientific Heritage: New Studies in the History and Historical Epistemology of Science. Special Issue. *Advances in Historical Studies* 3/3.
- Pisano R (2020) A Tale of Tartaglia's *Libro Sesto* & Gionta in *Quesiti et Inventioni diverse* (1546-1554). Exploring the Historical and Cultural Foundations. *Foundations of Science*, Springer, 25(2):477–505. Retrieved: <https://doi.org/10.1007/s10699-019-09635-2>
- Pisano R (2020) Review: Reflections on the History of Science and the Modern University. *Metascience* 1-3. Retrieved: <https://link.springer.com/article/10.1007/s11016-020-00516-0>
- Pisano R, Bussotti P (2012) Galileo and Kepler: On *Theoremata Circa Centrum Gravitatis Solidorum* and *Mysterium Cosmographicum*. *History Research* 2(2):110–145.
- Pisano R., Bussotti P (2014) Newton's *Philosophiæ Naturalis Principia Mathematica* "Jesuit" Edition: The Tenor of a Huge Work. *Accademia Nazionale Lincei Rendiconti Lincei Matematica e Applicazioni* 25:413–444.
- Pisano R, Bussotti P (2014a) Galileo in Padua: architecture, fortifications, mathematics and "practical" science. *Lettera Matematica Pristem International* 2(4):209–221.
- Pisano R, Bussotti P (2014b) Historical and Philosophical Reflections on the Culture of Machines around the Renaissance. How Science and Technique Work? *Acta Baltica Historiae et Philosophiæ Scientiarum* 2(2):20–42.
- Pisano R, Bussotti P (2015b) Introduction to Exploring Changes in How the Histories of the Exact Sciences from the 18th to through the 20th Century Have Been Written: Interpreting the Dynamics of Change in these Sciences and Interrelations Amongst Them—Past Problems, Future Cures? *Advances in Historical Studies Special Issue* 4(2):65-67.
- Pisano R, Bussotti P (2016) A Newtonian Tale Details on Notes and Proofs in Geneva Edition of Newton's *Principia*. *Bulletin—British Society for the History of Mathematics* 32:1–19.
- Pisano R, Bussotti P (2017) Introduction. 1564-2014. *Hommage à Galileo Galilei. Philosophia Scientiæ. Travaux d'histoire et de philosophie des sciences*, 21(1):7-15.
- Pisano R, Bussotti P (2020) Historical and Foundational Details on the Method of Infinite Descent: Every Prime Number of the Form  $4n+1$  is the Sum of Two Squares. *Foundations of Science*, Springer, 1:1-32
- Pisano R, Bussotti P (2020) Newton's Geneva Edition: Some Considerations on the Integral Calculus. In: *International 39th Congress of the Italian Society for the History of Physics and Astronomy (Pisa/VIRGO 2019, 9-12 Sept.)*, La Rana A, Rossi P (ess). Pavia University Press, pp. 127-134.
- Pisano R, Capecchi D (2013) Conceptual and Mathematical Structures of Mechanical Science in the Western Civilization around 18th Century. *Almagest* 4(2):86–121.
- Pisano R, Capecchi D (2015) Tartaglia's Science of Weights and Mechanics in the Sixteenth Century. *Selections from Quesiti et inventioni diverse: Books VII–VIII*. Springer.
- Pisano R, Capecchi D, Lukešová A (2013) (eds.) *Physics, Astronomy and Engineering. Critical Problems in the History of Science*. *International 32nd Congress for the SISFA—Italian Society of Historians of Physics and Astronomy*. The Scientia Socialis UAB & Scientific Methodical Centre Scientia Educologica Press, Šiauliai University, Lithuania.

- Pisano R, Casolaro F (2011) An Historical Inquiry On Geometry In Relativity. Reflections on Early Relationship Geometry–Physics (Part I). *History Research* 1(1):47-60
- Pisano R, Casolaro F (2012) An Historical Inquiry On Geometry In Relativity. Reflections on Late Relationship Geometry–Physics (Part II). *HR* 2(1):56–64
- Pisano R, Ciocci V (2020) Galileo's Free fall into History Physics and Nature of Science Teaching. In: International 38th Congress for The SISFA–Italian Society of Historians of Physics and Astronomy (Messina, Italy, 3-6, October), Pavia University Press, pp. 271-278
- Pisano R, Ciocci V (2020) Nature of Science Experiments: Exploring Galilean Physics of the Motion. In: International 39th Congress of the Italian Society for the History of Physics and Astronomy (Pisa/VIRGO 2019, 9-12 Sept.), La Rana A, Rossi P (ess). Pavia University Press, pp. 117-124.
- Pisano R, Coopersmith J, Peacke M (2020) Essay on Machines in General (1786). Monograph. Text, Translations and Commentaries. Lazare Carnot's Mechanics, 1. Springer. Retrieved: [www.springer.com/gp/book/9783030443849](http://www.springer.com/gp/book/9783030443849)
- Pisano R, Paulo M, Vincent P (2020) Introduction. In: IDTC Joule's Bicentenary Special Issue. *Foundations of Science*, Springer
- Pisano R, Sozzo S (2020) A Unified Theory of Human Judgements and Decision-making under Uncertainty. Submitted to *Entropy* Special Issue. Quantum Models of Cognition and Decision-Making. Andrei Khrennikov A, Bagarello F (eds).
- Pisano R, Vincent P (2019) Introduction. In: IDTC Dossier Methods and Cognitive Modelling in the History and Philosophy of Science–&–Education, *Transversal International Journal for the Historiography of Science* 5:3-9.
- Pisano R, Vincent P, Dolenc K, Ploj-Vrtič M (2020) Historical Foundations of Physics & Applied Technology as Dynamic Frameworks in Pre-Service STEM, *Foundations of Science*, Springer <https://link.springer.com/article/10.1007%2Fs10699-020-09662-4>
- Pisano R, Vincent P (2020) Reading the Discoveries of Gravitational Waves as New History of Physics Frontier Research Programme Part two, *SISFA Proceedings* 2019. Pavia University Press, pp. 359-366.
- Pisano R, Vincent P (2020) Notes on Discoveries of Gravitational Waves as New History of Physics Frontier Research Programme, *SISFA Proceedings* 2018. Pavia University Press, pp. 279-283
- Ploj Vrtič M (2009a) Model of ICT Implementation in the Technical Education. *Problems of Education in the 21st Century*, 14:144-158.
- Ploj Vrtič M (2009b) The Computer as a Modern Form of Communication in the Educational Process From the Teachers' Point of View. *Informatologia* 42(1):10-17
- Ploj Vrtič M (2009c) Enhancement of Educational Process Using Experience Based Tutoring Approaches. *Problems of Education in the 21st Century*, 14:7-22.
- Ploj Vrtič M (2012) The role of internet in education. *Proceedings of DIVAI 2012-9th International Scientific Conference on Distance Learning in Applied Informatics*, Štúrovo, Slovakia, pp. 243-249.
- Ploj Vrtič M (2014) Gamification of learning: an effective teaching method of a modern school or a fashion fad? Conference: 9th IOSTE Symposium for Central and Eastern Europe.

- Ploj Vrtič M, Pšunder M (2010a) Future Teachers' Opinions on the Digital Competencies Obtained During Their Studies. *Problems of Education in the 21st Century*, 24:95-105. Retrieved: [https://www.researchgate.net/profile/Mateja\\_Vrtic/publication/283345140\\_Future\\_teachers'\\_opinions\\_on\\_the\\_digital\\_competencies\\_obtained\\_during\\_their\\_studies/links/565d7af208aeafc2aac7b3fa/Future-teachers-opinions-on-the-digital-competencies-obtained-during-their-studies.pdf](https://www.researchgate.net/profile/Mateja_Vrtic/publication/283345140_Future_teachers'_opinions_on_the_digital_competencies_obtained_during_their_studies/links/565d7af208aeafc2aac7b3fa/Future-teachers-opinions-on-the-digital-competencies-obtained-during-their-studies.pdf)
- Ploj Vrtič M, Pšunder M (2010b) The Influence of the Field of Study on the Use of Modern Information and Communication Technologies Among Student and Teachers. *Informatologia*, 43(4):269-279.
- Ploj Vrtič M, Pšunder M (2014) Innovative pedagogy: Developing of pupils' competencies through the use of modern technologies in the classroom. In 10th International Scientific Conference on Distance Learning in Applied Informatics, Štúrovo, pp. 5-7.
- Ploj Vrtič M, Šorgo A (2016) Can we expect to recruit future engineers among students who have never repaired a toy? *Eurasia Journal of Mathematics, Science & Technology Education*, 12(2):249-266.
- Ploj Vrtič M, Župerl U, Javornik Krečič M (2013) Pedagogy 1: 1 In Higher Education: A Case Study. *Problems of Education in the 21st Century*, 57:102-110.
- Prasher RS, Hu XJ, Chalopin Y, Mingo N, Lofgreen K, Volz S, Cleri F, Keblinski P (2009) Turning Carbon Nanotubes from Exceptional Heat Conductors into Insulators. *Physical Review Letters*, 102(10). doi:10.1103/physrevlett.102.105901
- Preskill J, Thorne KS (1995) Foreword. In: Hatfield B (ed) *Feynman lectures on gravitation*. Addison-Wesley, Reading MA
- Pulte H, Mandelbrote S (2011) (eds.) *The Reception of Isaac Newton in Europe*. Continuum–Publishing Corporation, London.
- Quilio S (2012) Une forme caractéristique de condition de l'étude dans la réalisation d'une ingénierie didactique en mathématiques à l'école primaire. *Éducation et didactique* 6:9–26. <https://doi.org/10.4000/educationdidactique.1470>
- Quilio S, Forest D (2011) Comment initier en mathématiques la production d'une notation et ses usages à partir de l'activité des élèves ? Un exemple d'entrelacement de phénomènes langagiers et non-langagiers dans la construction conjointe d'un milieu pour l'étude à l'école primaire
- Radelet-de Grave P (1988) Les forces et leur loi de composition chez Newton. *Revue Philosophique de Louvain*, 86(4):505-522.
- Radelet-de Grave P; Speiser D (1990) Editer les œuvres complètes des grands scientifiques, une entreprise internationale. *Impact, science et société*, 40(4):369-378.
- Radelet-de Grave P (1996) Andreas Speiser (1885-1978) et Herman Weyl (1885-1955), scientifiques, historiens et philosophes des sciences. *Revue Philosophique de Louvain*, 94(3):502–535. doi:10.2143/rpl.94.3.541800
- Radelet-de Grave P (1999) Relativité galiléenne et lois de conservation. In: *Revue des Questions Scientifiques*, 170(3):209-260
- Radelet-de Grave P (2008) Introduction aux œuvres de mécanique de Sturm.
- Radelet-de Grave P (2009) L'analogie comme outil de découverte, in *Revue des Questions Scientifiques*, 180(1):1-32.
- Radelet-de Grave P (2009a) Guarini et la structure de l'Univers. *Nexus Network Journal* 11(3):393–414.
- Radelet-de Grave P (2010) Gottfried Wilhelm Leibniz. *Sämtliche Schriften und Briefe*, Isis 101(2):430-431. Retrieved: <https://doi.org/10.1086/655716>

- Radelet-de Grave P (2010a) Publishing Complete Works of the Great Scientists, An International Undertaking. In: Crossroads : History of Science, History of Art, Essays by David Speiser, Birkhäuser, Bâle, pp. 127-147
- Radelet-de Grave P (2010b) The beginnings of elasticity and interaction with the development of the Calculus in Mechanics and architecture, between epistème and t chne, ed Anna Sinopoli.
- Radelet-de Grave P (2012) Des montres pour calculer des vitesses: ou comment Kepler explique sa d couverte des deux premi res lois. In: *Philosophica*, 41-42(I-II):13-79.
- Radford L (1997) On Psychology, Historical Epistemology, and the Teaching of Mathematics: Towards a Socio-Cultural History of Mathematics. For the Learning of Mathematics, 17(1):26-33. Retrieved: [www.jstor.org/stable/40248219](http://www.jstor.org/stable/40248219)
- Rahman S, Iqbal M (2016) UNFOLDING PARALLEL REASONING IN ISLAMIC JURISPRUDENCE (I). Epistemic and Dialectical Meaning within Ab  Ish q al-Sh r zi's System of Co-Relational Inferences of the Occasioning Factor
- Rahman S, Symons J, Gabbay DM, van Bendegem JP (2009) (eds.) Logic, Epistemology, and the Unity of Science. Springer, Dordrecht.
- Recami E (2011). Einstein: le mie idee sull'Educazione. pp. 69-100.
- Reif F (2008) Applying cognitive science to education: thinking and learning in scientific and other complex domains. MIT press.
- Renn J, Blum A, Damerow P (2011) The Role of Gravitation in Physics Report from the 1957 Chapel Hill Conference Communicated by J rgen Renn, Alexander Blum and Peter Damerow. DeWitt CM, Rickles D (eds.), Sources 5, Edition Open Access, Oranienstra e 183, 10999 Berlin. ISBN 978-3-86931-963-6
- Richards J (1988) Mathematical Visions: The Pursuit of Geometry in Victorian England. Academic Press Boston, New York.
- Rocha GR (2009) CONTROV RSIAS CIENT FICAS: O caso do modelo padrao da cosmologia. Caderno de f sica da UEFS, 7(01):65-85.
- Romero M, Brunel M, Santini J, Quilio S, Calistri C, De Smet C, Douek N (2017) De l'innovation  ducative aux usages cr atifs des TIC: pr sentation du Laboratoire d'Innovation et Num rique pour l' ducation (LINE)
- Russo L (2004) The Forgotten Revolution How Science Was Born in 300 BC and Why It Had to Be Reborn. First published as La rivoluzione dimenticata, Giangiacomo Fr trinelli Editore, Milano, 1996. Springer, Berlin.
- Salagnac N, Dias-Chiaruttini A (2016) Pratiques et recherches en didactiques. Presses Universitaires du Septentrion
- Seroglou F, Koumaras P (2001) The Contribution of the History of Physics in Physics Education: A Review. Science & Education 10(1):153-172. Retrieved: <https://doi.org/10.1023/A:1008702000098>
- Sensevy G, Quilio S (2002) Les discours du professeur. Vers une pragmatique didactique. Revue fran aise de p dagogie. <https://doi.org/10.3406/rfp.2002.2914>
- Sensevy G, Quilio S (2002) Teacher's discourse: Towards pragmatist didactics. 141:47-56
- Sensevy G, Forest D, Quilio S, Morales G (2013) Cooperative engineering as a specific design-based research. ZDM - Mathematics Education 45:1-13. <https://doi.org/10.1007/s11858-013-0532-4>
- Sensevy G, Santini J, Cariou D, Quilio S (2018) Preuves fond es sur la pratique, pratiques fond es sur la preuve: Distinction et mise en synergie. Education et Didactique 12:111-125
- Shankland RS (1964) Michelson-Morley Experiment. American Journal of Physics, 32(1):16-35. doi:10.1119/1.1970063
- Sherry L, Trigg M (1996) Epistemic Forms and Epistemic Games. Educational Technology, 36/3:38-44. Retrieved: [www.jstor.org/stable/44428338](http://www.jstor.org/stable/44428338)

- Slowik E (2005) Spacetime, Ontology, and Structural Realism. *International Studies in the Philosophy of Science*, 19(2):147–166. doi:10.1080/02698590500249456
- Stachel J, Cassidy DC, Renn J, Schulmann R (1989) *The Collected Papers of Albert Einstein*. Volume 2. The Swiss Years: Writings, 1900-1909, p. 174.
- Stinner A, McMillan BA, Metz D, Jilek JM, Klassen S (2003) The Renewal of Case Studies in Science Education. *Science & Education* 12(1):617–643. Retrieved: <https://doi.org/10.1023/A:1025648616350>
- Strauss M (1968) Einstein's Theories and the Critics of Newton: An Essay in Logico-Historical Analysis. *Synthese*, 18(2/3):251-284. Retrieved: [www.jstor.org/stable/20114606](http://www.jstor.org/stable/20114606)
- Suyama T (2020) On Arrival Time Difference Between Lensed Gravitational Waves and Light. *The Astrophysical Journal*, 896(1):46. doi:10.3847/1538-4357/ab8d3f
- Taylor JH, Fowler LA, McCulloch PM (1979) Measurements of general relativistic effects in the binary pulsar PSR1913+16. *Nature* 277:437-440. <https://doi.org/10.1038/277437a0>
- Taylor JH, Weisberg JM (1982) A new test of general relativity - Gravitational radiation and the binary pulsar PSR 1913+16. *apj* 253:908–920. <https://doi.org/10.1086/159690>
- Torretti R (1978) *Philosophy of Geometry from Riemann to Poincaré*. Springer, Dordrecht.
- Treagust DF, Duit R (2008) Conceptual change: a discussion of theoretical, methodological and practical challenges for science education. *Cultural Studies of Science Education* – Springer.
- Trimble V (2017) Wired by Weber: The story of the first searcher and searches for gravitational waves. *Eur. Phys. J. H* 42:261–291. Retrieved: <https://doi.org/10.1140/epjh/e2016-70060-5>
- Unguru S (1991) (ed.) *Physics, Cosmology and Astronomy, 1300–1700: Tension and Accommodation*. The Boston Studies in the Philosophy.
- Viennot L (1979) Spontaneous Reasoning in Elementary Dynamics. *European Journal of Science Education* 1:205–221. <https://doi.org/10.1080/0140528790010209>
- Vilette B, Fischer J-P, Sander E, Sensevy G, Quilio S, Richard J-F (2017) Peut-on améliorer l'enseignement et l'apprentissage de l'arithmétique au CP ? Le dispositif ACECan we improve the teaching and learning of arithmetic during first grade? The ACE program. *Revue française de pédagogie* 105–120. <https://doi.org/10.4000/rfp.7296>
- Von Glasersfeld E (1989) *Cognition, Construction of Knowledge and Teaching*. *Synthese* 80(1):121-140.
- Vosniadou S, Brewer WF (1992) Mental models of the earth: A study of conceptual change in childhood. *Cognitive Psychology*, 24(4):535-585. Retrieved: [https://doi.org/10.1016/0010-0285\(92\)90018-W](https://doi.org/10.1016/0010-0285(92)90018-W)
- Walter S (1906) *Rendiconti del Circolo Matematico di Palermo* 21:129–176.
- Warren A (2020) Bayesian updating activities on student epistemologies. *Phys. Rev. Phys. Educ. Res.* 16(1):010101. Retrieved: <https://doi.org/10.1103/PhysRevPhysEducRes.16.010101>
- Weisberg JM, Taylor JH (2004) Relativistic Binary Pulsar B1913+16: Thirty Years of Observations and Analysis. In: arXiv:astro-ph/0407149
- Weisberg JM, Taylor JH (2005) Relativistic Binary Pulsar B1913+16: Thirty Years of Observations and Analysis. In: ASP Conference Series, Rasio FA & Stairs IH (eds.), 328:25-31.
- Wheeler JA, Ford KW (2000) *Geons, Black Holes, and Quantum Foam – A life in Physics*, Norton & Company, New York, p. 235
- Westfall RS (1971) *The Construction of Modern Science. Mechanism and Mechanic*. Wiley & Sons Inc., New York.

- Wilkins DR (1998) On the Hypotheses which lie at the Bases of Geometry. Bernhard Riemann Translated by William Kingdon Clifford. *Nature*, 8(183-184):14-17,36-37.
- Yildiz C (2013) Historical Problems in the History of Mathematics: Examples for the Classroom. Retrieved: [https://www.researchgate.net/publication/280248513\\_Historical\\_Problems\\_in\\_the\\_History\\_of\\_Mathematics\\_Examples\\_for\\_the\\_Classroom](https://www.researchgate.net/publication/280248513_Historical_Problems_in_the_History_of_Mathematics_Examples_for_the_Classroom)
- Yu H, McCuller L, Tse M, Barsotti L, Mavalvala N, Betzwieser J, ... & Fernandez-Galiana A (2020) Quantum correlations between the light and kilogram-mass mirrors of LIGO. arXiv preprint arXiv:2002.01519.
- Yu Cao T (1997) *Conceptual Developments of 20th Century Field Theories*. Cambridge University Press, Cambridge.
- Yves M, Gueudet G, Krysinska M, Rogalski M, Trouche L, Winsløw C, Quilio S, Sierra T (2016) Enjeux et débats en didactique des mathématiques : XVIIIe école d'été de didactique des mathématiques
- Zaoui H, Palla PL, Cleri F, Lampin E (2017) Fourier-like conduction and finite one-dimensional thermal conductivity in long silicon nanowires by approach-to-equilibrium molecular dynamics. *Physical Review B*, 95(10). doi:10.1103/physrevb.95.104309
- Zaoui H, Palla PL, Giordano S, Cleri F, Verdier M, Lacroix D, Robillard JF, Termentzidis K, Martin E (2018) Thermal conductivity of decanometric patterned Si membranes by multiscale simulations. *International Journal of Heat and Mass Transfer*, 126:830–835. doi:10.1016/j.ijheatmasstransfer.2018.06.004
- Župerl U, Ploj Vrtič M (2013) Remote Controlled Laboratory as a Modern Form of Engineering Education. *Journal of Elementary Education / Revija za Elementarno Izobraževanje*, 6(1):27-42.

## Curricula Sources

Official Program 10<sup>th</sup> Grade

<http://www.education.gouv.fr/cid51321/mene1007262a.html>

[http://cache.media.education.gouv.fr/file/18/95/5/ensel512\\_physique\\_757955.pdf](http://cache.media.education.gouv.fr/file/18/95/5/ensel512_physique_757955.pdf)

[http://cache.media.education.gouv.fr/file/special\\_4/72/9/physique\\_chimie\\_143729.pdf](http://cache.media.education.gouv.fr/file/special_4/72/9/physique_chimie_143729.pdf)

Official Program 11<sup>th</sup> Grade

<http://www.education.gouv.fr/cid53327/mene1019556a.html>

[http://cache.media.education.gouv.fr/file/special\\_9/21/3/physique-chimieS\\_155213.pdf](http://cache.media.education.gouv.fr/file/special_9/21/3/physique-chimieS_155213.pdf)

Official Program 12<sup>th</sup> Grade

[http://cache.media.eduscol.education.fr/file/SPC/50/4/Temps\\_et\\_relativite\\_221504.pdf](http://cache.media.eduscol.education.fr/file/SPC/50/4/Temps_et_relativite_221504.pdf)

[http://cache.media.eduscol.education.fr/file/PC/45/7/reperes\\_formation\\_filiere\\_S\\_380457.pdf](http://cache.media.eduscol.education.fr/file/PC/45/7/reperes_formation_filiere_S_380457.pdf)

[http://cache.media.education.gouv.fr/file/special\\_8\\_men/99/0/physique\\_chimie\\_S\\_195990.pdf](http://cache.media.education.gouv.fr/file/special_8_men/99/0/physique_chimie_S_195990.pdf)

## Sources cited by the Authors – which I did not study – in order to complete the state of art in the field

### Primary Sources cited by Authors

- Adams WS (1914) An A-Type Star of Very Low Luminosity. *Publications of the Astronomical Society of the Pacific*, 26:198.
- Adams WS (1915) The Spectrum of the Companion of Sirius. *Publications of the Astronomical Society of the Pacific*, 27:236-237.
- Bondi H, van der Burg MGJ, Metzner AWK (1962) Gravitational Waves in General Relativity. VII. Waves from Axi-Symmetric Isolated Systems. *Proceedings of the Royal Society A: Mathematical, Physical and Engineering Sciences*, 269(1336):21–52. doi:10.1098/rspa.1962.0161
- Coblentz WW (1922) New measurements of stellar radiation. *Astrophysical Journal*, 55:20-23. Doi: 10.1086/142653.
- Curtis W (1968) Kepler's Derivation of the Elliptical Path. *Isis*, 59(1):4-25. doi:10.1086/350331.
- Dirac PAM (1931) Quantised Singularities in the Electromagnetic Field. *Proc. Roy. Soc.* 133(821):60-72. Retrieved: <https://doi.org/10.1098/rspa.1931.0130>
- Dirac PAM (1948) The Theory of Magnetic Poles. *Phys. Rev.* 74(7):817-830. Retrieved: <https://link.aps.org/doi/10.1103/PhysRev.74.817>
- Eddington AS (1924) *The Mathematical Theory of Relativity*, 2nd Ed., Cambridge University Press, Cambridge, sect. 57.
- Fladt K (1962) *Das Keplersche Ei.. Elemente der Mathematik* 17:73-78.
- Kepler, J. (1596). *Mysterium Cosmographicum*. Georgius Gruppenbachius, Tübingen.
- Kepler J (1906) *Astronomia nova ..., seu physica coelestis, tradita commentariis de motibus stellae martis*, Heidelberg, Vögelin. Retrieved: <http://www.rarebookroom.org/Control/kepast/index.html>
- Kepler, J (1937) *Gesammelte Werke*. Von Dyck W, Caspar M, Hammer F and List M (eds.), 14:278–278.
- Kepler J, Caspar M (1929) *Neue astronomie*. R. Oldenbourg, Munchen-Berlin.
- Pirani FAE (1957). Invariant Formulation of Gravitational Radiation Theory. *Physical Review*, 105(3):1089–1099. doi:10.1103/physrev.105.1089

### Secondary Sources cited by Authors

- Aasi J, Abadie J, Abbott B, et al (2015a) Characterization of the LIGO detectors during their sixth science run. *Classical and Quantum Gravity* 32:115012
- Aasi J, Abadie J, Abbott BP, et al (2013) Search for gravitational waves from binary black hole inspiral, merger, and ringdown in LIGO-Virgo data from 2009–2010. *Phys Rev D* 87:022002. <https://doi.org/10.1103/PhysRevD.87.022002>
- Abbott B, Abbott R, Adhikari R, et al (2004b) Detector description and performance for the first coincidence observations between LIGO and GEO. *Nuclear Instruments and Methods in Physics Research Section A: Accelerators, Spectrometers, Detectors and Associated Equipment* 517:154–179. <https://doi.org/10.1016/j.nima.2003.11.124>
- Abbott B, Abbott R, Adhikari R, et al (2005a) Limits on Gravitational-Wave Emission from Selected Pulsars Using LIGO Data. *Physical Review Letters* 94:181103. <https://doi.org/10.1103/physrevlett.94.181103>



- Abbott B, Abbott R, Adhikari R, et al (2005c) Search for gravitational waves from galactic and extra-galactic binary neutron stars. *Physical Review D* 72:082001. <https://doi.org/10.1103/physrevd.72.082001>
- Abbott B, Abbott R, Adhikari R, et al (2005d) Search for gravitational waves from primordial black hole binary coalescences in the galactic halo. *Physical Review D* 72:082002. <https://doi.org/10.1103/physrevd.72.082002>
- Abbott B, Abbott R, Adhikari R, et al (2005e) Upper limits from the LIGO and TAMA detectors on the rate of gravitational-wave bursts. *Physical Review D* 72:122004. <https://doi.org/10.1103/physrevd.72.122004>
- Abbott B, Abbott R, Adhikari R, et al (2006) Search for gravitational waves from binary black hole inspirals in LIGO data. *Physical Review D* 73:062001. <https://doi.org/10.1103/physrevd.73.062001>
- Abbott BP, Abbott R, Abbott TD, et al (2016h) Characterization of transient noise in Advanced LIGO relevant to gravitational wave signal GW150914. *Classical and Quantum Gravity* 33:134001. <https://doi.org/10.1088/0264-9381/33/13/134001>
- Abbott BP, Abbott R, Abbott TD, et al (2016k) Improved Analysis of GW150914 Using a Fully Spin-Precessing Waveform Model. *Phys Rev X* 6:041014. <https://doi.org/10.1103/PhysRevX.6.041014>
- Abbott BP, Abbott R, Abbott TD, et al (2016m) Prospects for Observing and Localizing Gravitational-Wave Transients with Advanced LIGO and Advanced Virgo. *Living Reviews in Relativity* 19:1. <https://doi.org/10.1007/lrr-2016-1>
- Abbott BP, Abbott R, Abbott TD, et al (2016n) SUPPLEMENT: “THE RATE OF BINARY BLACK HOLE MERGERS INFERRED FROM ADVANCED LIGO OBSERVATIONS SURROUNDING GW150914” (2016, *ApJL*, 833, L1). *The Astrophysical Journal Supplement Series* 227:14. <https://doi.org/10.3847/0067-0049/227/2/14>
- Abbott BP, Abbott R, Abbott TD, et al (2017a) Calibration of the Advanced LIGO detectors for the discovery of the binary black-hole merger GW150914. *Physical Review D* 95:062003. <https://doi.org/10.1103/physrevd.95.062003>
- Abbott BP, Abbott R, Abbott TD, et al (2017b) Exploring the sensitivity of next generation gravitational wave detectors. *Classical and Quantum Gravity* 34:044001. <https://doi.org/10.1088/1361-6382/aa51f4>
- Abbott BP, Abbott R, Abbott TD, et al (2018) Prospects for observing and localizing gravitational-wave transients with Advanced LIGO, Advanced Virgo and KAGRA. *Living Reviews in Relativity* 21:3. <https://doi.org/10.1007/s41114-018-0012-9>
- Abbott BP, Abbott R, Abbott TD, et al (2019b) GWTC-1: A Gravitational-Wave Transient Catalog of Compact Binary Mergers Observed by LIGO and Virgo during the First and Second Observing Runs. *Phys Rev X* 9:031040. <https://doi.org/10.1103/PhysRevX.9.031040>
- Abbott BP, Abbott R, Adhikari R, et al (2009) LIGO: the Laser Interferometer Gravitational-Wave Observatory. *Reports on Progress in Physics* 72:076901. <https://doi.org/10.1088/0034-4885/72/7/076901>
- Abbott BP, others (2016) GW150914: The Advanced LIGO Detectors in the Era of First Discoveries. *Phys Rev Lett* 116:131103. <https://doi.org/10.1103/PhysRevLett.116.131103>
- Abramovici A, Althouse WE, Drever RWP, et al (1992) LIGO: The Laser Interferometer Gravitational-Wave Observatory. *Science* 256:325–333. <https://doi.org/10.1126/science.256.5055.325>
- Accadia T, Acernese F, Alshourbagy M, et al (2012) Virgo: a laser interferometer to detect gravitational waves. *Journal of Instrumentation* 7:P03012–P03012. <https://doi.org/10.1088/1748-0221/7/03/p03012>

- Accadia T, Acernese F, Antonucci F, et al (2011) Status of the Virgo project. *Classical and Quantum Gravity* 28:114002. <https://doi.org/10.1088/0264-9381/28/11/114002>
- Acernese F, Agathos M, Agatsuma K, et al (2014) Advanced Virgo: a second-generation interferometric gravitational wave detector. *Classical and Quantum Gravity* 32:024001
- Ade PAR, Aghanim N, Arnaud M, et al (2016) Planck2015 results. *Astronomy & Astrophysics* 594:A13. <https://doi.org/10.1051/0004-6361/201525830>
- Adhikari R, Gonzalez G, Landry M, Collaboration) BOR (for the LS (2003) Calibration of the LIGO detectors for the First LIGO Science Run. *Classical and Quantum Gravity* 20:S903–S914. <https://doi.org/10.1088/0264-9381/20/17/332>
- Adler RJ, Bazin HJ, Shifter H (1975) *Introduction to General Relativity*, 2nd Ed. McGraw Hill.
- Affeldt C, Danzmann K, Dooley K, et al (2014) Advanced techniques in GEO 600. *Classical and quantum gravity* 31:224002
- Agassi J (1967) The kirchhoff-planck radiation law. *Science* 156:30–37
- Agathos M, Del Pozzo W, Li TGF, et al (2014) TIGER: A data analysis pipeline for testing the strong-field dynamics of general relativity with gravitational wave signals from coalescing compact binaries. *Physical Review D* 89:082001. <https://doi.org/10.1103/physrevd.89.082001>
- Agathos M, Meidam J, Del Pozzo W, et al (2015) Constraining the neutron star equation of state with gravitational wave signals from coalescing binary neutron stars. *Phys Rev D* 92:023012. <https://doi.org/10.1103/PhysRevD.92.023012>
- Ahlen SP, Kinoshita K (1982) Calculation of the stopping power of very-low-velocity magnetic monopoles. *Physical Review D*, 26(9):2347–2363. doi:10.1103/physrevd.26.2347
- Ajith P (2011) Addressing the spin question in gravitational-wave searches: Waveform templates for inspiralling compact binaries with nonprecessing spins. *Physical Review D* 84:084037. <https://doi.org/10.1103/physrevd.84.084037>
- Ajith P, Babak S, Chen Y, et al (2007) A phenomenological template family for black-hole coalescence waveforms. *Classical and Quantum Gravity* 24:S689–S699. <https://doi.org/10.1088/0264-9381/24/19/s31>
- Ajith P, Babak S, Chen Y, et al (2008) Template bank for gravitational waveforms from coalescing binary black holes: Nonspinning binaries. *Physical Review D* 77:104017. <https://doi.org/10.1103/physrevd.77.104017>
- Ajith P, Hannam M, Husa S, et al (2011) Inspiral-Merger-Ringdown Waveforms for Black-Hole Binaries with Nonprecessing Spins. *Physical Review Letters* 106:241101. <https://doi.org/10.1103/physrevlett.106.241101>
- Ajzen I, Fishbein M (1975) A Bayesian analysis of attribution processes. *Psychological Bulletin* 82:261–277. <https://doi.org/10.1037/h0076477>
- Akerlof CW (1982) Limits on the thermoacoustic detectability of electric and magnetic charges. *Physical Review D*, 26(5):1116–1127. doi:10.1103/physrevd.26.1116
- Akmal A, Pandharipande VR, Ravenhall DG (1998) Equation of state of nucleon matter and neutron star structure. *Phys Rev C* 58:1804–1828. <https://doi.org/10.1103/PhysRevC.58.1804>
- Alexander S, Yunes N (2009) Chern–Simons modified general relativity. *Physics Reports* 480:1–55. <https://doi.org/10.1016/j.physrep.2009.07.002>
- Allen B (2005)  $\chi^2$ time-frequency discriminator for gravitational wave detection. *Physical Review D* 71:062001. <https://doi.org/10.1103/physrevd.71.062001>

- Allen B, Anderson WG, Brady PR, et al (2012) FINDCHIRP: An algorithm for detection of gravitational waves from inspiraling compact binaries. *Physical Review D* 85:122006. <https://doi.org/10.1103/physrevd.85.122006>
- Allen B, Papa MA, Schutz BF (2002) Optimal strategies for sinusoidal signal detection. *Physical Review D* 66:102003. <https://doi.org/10.1103/physrevd.66.102003>
- Allen PB (1978) New method for solving Boltzmann's equation for electrons in metals. *Physical Review B*, 17(10):3725–3734. doi:10.1103/physrevb.17.3725
- Allen WD, Christodoulides C (1975) Gravitational radiation experiments at the University of Reading and the Rutherford Laboratory. *Journal of Physics A: Mathematical and General* 8:1726–1733. <https://doi.org/10.1088/0305-4470/8/11/007>
- Ambrose BS, Heron PRL, Vokos S, McDermott LC (1999) Student understanding of light as an electromagnetic wave: Relating the formalism to physical phenomena. *American Journal of Physics* 67:891–898. <https://doi.org/10.1119/1.19144>
- Anderson OR (1992) Some interrelationships between constructivist models of learning and current neurobiological theory, with implications for science education. *Journal of Research in Science Teaching*, 29(10):1037–1058.
- Andersson N (2003) Gravitational waves from instabilities in relativistic stars. *Classical and Quantum Gravity* 20:R105–R144. <https://doi.org/10.1088/0264-9381/20/7/201>
- Andersson N, Kokkotas KD, Stergioulas N (1999) On the Relevance of the Mode Instability for Accreting Neutron Stars and White Dwarfs. *The Astrophysical Journal* 516:307–314. <https://doi.org/10.1086/307082>
- Ando M, Arai K, Takahashi R, et al (2001) Stable Operation of a 300-m Laser Interferometer with Sufficient Sensitivity to Detect Gravitational-Wave Events within Our Galaxy. *Physical Review Letters* 86:3950–3954. <https://doi.org/10.1103/physrevlett.86.3950>
- Anninos P, Daues G, Massó J, Seidel E, Suen WM (1995) Horizon boundary condition for black hole spacetimes. *Physical Review D*, 51(10):5562–5578. doi:10.1103/physrevd.51.5562
- Anonymous. 2016. *The Economist*, 13 February, p. 77.
- Antoniadis J, Freire PCC, Wex N, et al (2013) A Massive Pulsar in a Compact Relativistic Binary. *Science* 340(6131):1233232. <https://doi.org/10.1126/science.1233232>
- Apostolatos TA (1995) Search templates for gravitational waves from precessing, inspiraling binaries. *Physical Review D* 52:605–620. <https://doi.org/10.1103/physrevd.52.605>
- Apostolatos TA, Cutler C, Sussman GJ, Thorne KS (1994) Spin-induced orbital precession and its modulation of the gravitational waveforms from merging binaries. *Phys Rev D* 49:6274–6297. <https://doi.org/10.1103/PhysRevD.49.6274>
- Apostolatos TA, Cutler C, Sussman GJ, Thorne KS (1994) Spin-induced orbital precession and its modulation of the gravitational waveforms from merging binaries. *Physical Review D*, 49(12):6274–6297. doi:10.1103/physrevd.49.6274
- Armano M, Audley H, Auger G, et al (2016) Sub-Femto-g Free Fall for Space-Based Gravitational Wave Observatories: LISA Pathfinder Results. *Phys Rev Lett* 116:231101. <https://doi.org/10.1103/PhysRevLett.116.231101>
- Armendariz-Picon C, Mukhanov V, Steinhardt PJ (2000) Dynamical Solution to the Problem of a Small Cosmological Constant and Late-Time Cosmic Acceleration. *Physical Review Letters*, 85(21):4438–4441. doi:10.1103/physrevlett.85.4438

- Armitage PJ, Natarajan P (2002) Accretion during the Merger of Supermassive Black Holes. *ApJ*, 567, L9. DOI: <https://doi.org/10.1086/339770>
- Arun KG, Blanchet L, Iyer BR, Qusailah MSS (2004) The 2.5PN gravitational wave polarizations from inspiralling compact binaries in circular orbits. *Classical Quantum Gravity*, 21, 3771
- Arun KG, Buonanno A, Faye G, Ochsner E (2009) Higher-order spin effects in the amplitude and phase of gravitational waveforms emitted by inspiraling compact binaries: Ready-to-use gravitational waveforms. *Physical Review D* 79:104023. <https://doi.org/10.1103/physrevd.79.104023>
- Arun KG, Buonanno A, Faye G, Ochsner E (2011) Erratum: Higher-order spin effects in the amplitude and phase of gravitational waveforms emitted by inspiraling compact binaries: Ready-to-use gravitational waveforms [Phys. Rev. D 79, 104023 (2009)]. *Phys Rev D* 84:049901. <https://doi.org/10.1103/PhysRevD.84.049901>
- Arun KG, Iyer BR, Qusailah MSS, Sathyaprakash BS (2006) Probing the nonlinear structure of general relativity with black hole binaries. *Physical Review D* 74:024006. <https://doi.org/10.1103/physrevd.74.024006>
- Arun KG, Iyer BR, Sathyaprakash BS, Sundararajan PA (2005) Parameter estimation of inspiralling compact binaries using 3.5 post-Newtonian gravitational wave phasing: The nonspinning case. *Physical Review D* 71:084008. <https://doi.org/10.1103/physrevd.71.084008>
- Aso Y, Michimura Y, Somiya K, et al (2013) Interferometer design of the KAGRA gravitational wave detector. *Phys Rev D* 88:043007. <https://doi.org/10.1103/PhysRevD.88.043007>
- Aston SM, Barton MA, Bell AS, et al (2012) Update on quadruple suspension design for Advanced LIGO. *Classical and Quantum Gravity* 29:235004. <https://doi.org/10.1088/0264-9381/29/23/235004>
- Astone P, Baggio L, Bassan M, et al (2010) IGEC2: A 17-month search for gravitational wave bursts in 2005–2007. *Phys Rev D* 82:022003. <https://doi.org/10.1103/PhysRevD.82.022003>
- Astone P, Borkowski KM, Jaranowski P, Królak A (2002) Data analysis of gravitational-wave signals from spinning neutron stars. IV. An all-sky search. *Physical Review D* 65:042003. <https://doi.org/10.1103/physrevd.65.042003>
- Ausubel DP (1963) *The Psychology of Meaningful Verbal Learning*. Grune and Stratton, New York.
- Ausubel DP (1968) *Educational Psychology: A Cognitive View*. Holt, Rinehart and Winston, New York.
- Ausubel DP, Novak JD, Hanesian H (1978) *Educational Psychology: A Cognitive View*, 2nd ed. New York: Holt, Rinehart and Winston. Reprinted, Warbel & Peck, New York.
- Babak S, Biswas R, Brady PR, et al (2013) Searching for gravitational waves from binary coalescence. *Phys Rev D* 87:024033. <https://doi.org/10.1103/PhysRevD.87.024033>
- Babak S, Taracchini A, Buonanno A (2017) Validating the effective-one-body model of spinning, precessing binary black holes against numerical relativity. *Physical Review D*, 95(2):024010. doi:10.1103/physrevd.95.024010
- Baiotti L, Rezzolla L (2017) Binary neutron star mergers: a review of Einstein's richest laboratory. *Reports on Progress in Physics* 80:096901. <https://doi.org/10.1088/1361-6633/aa67bb>
- Bais FA, Ellis J, Nanopoulos DV, Olive KA (1983) More about baryon number violation catalyzed by grand unified monopoles. *Nuclear Physics B*, 219(1):189–219. doi:10.1016/0550-3213(83)90434-0
- Baker J, Campanelli M, Lousto CO (2002a) The Lazarus project: A pragmatic approach to binary black hole evolutions. *Physical Review D* 65:044001. <https://doi.org/10.1103/physrevd.65.044001>

- Baker J, Campanelli M, Lousto CO, Takahashi R (2002b) Modeling gravitational radiation from coalescing binary black holes. *Physical Review D* 65:124012. <https://doi.org/10.1103/physrevd.65.124012>
- Baker JG, Centrella J, Choi D-I, et al (2006) Gravitational-Wave Extraction from an Inspirling Configuration of Merging Black Holes. *Phys Rev Lett* 96:111102. <https://doi.org/10.1103/PhysRevLett.96.111102>
- Ball DL, Thames MH, Phelps G (2008) What Makes It Special?
- Barack L, Cutler C (2004) LISA capture sources: Approximate waveforms, signal-to-noise ratios, and parameter estimation accuracy. *Phys. Rev. D*, 69(8):082005
- Barausse E, Buonanno A (2010) Improved effective-one-body Hamiltonian for spinning black-hole binaries. *Physical Review D* 81:084024. <https://doi.org/10.1103/physrevd.81.084024>
- Bardeen JM, Carter B, Hawking SW (1973) The four laws of black hole mechanics. *Communications in Mathematical Physics* 31:161–170. <https://doi.org/10.1007/bf01645742>
- Barish R, Cooper RG, Lane CE, Liu G (1983) ACOUSTIC DETECTION OF MONOPOLES. *NATO Sci. Ser. B* 102 [CALTECH preprint CALT-68-988 (Jan. 1983)].
- Barker BM, O'Connell RF (1975) Gravitational two-body problem with arbitrary masses, spins, and quadrupole moments. *Physical Review D* 12:329–335. <https://doi.org/10.1103/physrevd.12.329>
- Barron THK, Collins JG, White GK (1980) Thermal expansion of solids at low temperatures. *Advances in Physics*, 29(4):609–730.
- Barsotti L, Evans M, Fritschel P (2010) Alignment sensing and control in advanced LIGO. *Classical and Quantum Gravity* 27:084026
- Bartholomew H, Osborne J, Ratcliffe M (2004) Teaching students' ideas-about-science?: Five dimensions of effective practice. *Science Education* 88:655–682. <https://doi.org/10.1002/sce.10136>
- Bartos I, Bork R, Factourovich M, et al (2010) The Advanced LIGO timing system. *Classical and Quantum Gravity* 27:084025
- Bartusiak M (2000) *Einstein's Unfinished Symphony: Listening to the Sounds of Space-Time*. Joseph Henry Press; 1st edition.
- Bartusiak M (2016) The long road to detecting gravity waves. *Science News* 189: 24–27.
- Bartusiak M (2017) *Einstein's Unfinished Symphony: The Story of a Gamble, Two Black Holes, and a New Age of Astronomy*. Yale University Press; Reprint edition.
- Bascones J, Novak JD (1985) Alternative instructional systems and the development of problem-solving skills in physics. *European Journal of Science Education*, 7(3):253-261.
- Basov NG, Prokhorov AH (1954) Application of molecular beams for radiospectroscopic study of molecular rotational spectra. *Journal of Experimental and Theoretical Physics* 27:431–438 (the page numbers are different in the English translation).
- Bauer HH (1992) *Scientific Literacy and the Myth of the Scientific Method*
- Baumgarte TW, Shapiro SL (1998) Numerical integration of Einstein's field equations. *Physical Review D*, 59(2). doi:10.1103/physrevd.59.024007
- Belczynski K, Bulik T, Fryer CL, et al (2010) ON THE MAXIMUM MASS OF STELLAR BLACK HOLES. *The Astrophysical Journal* 714:1217–1226. <https://doi.org/10.1088/0004-637x/714/2/1217>
- Belczynski K, Kalogera V, Bulik T (2002) A Comprehensive Study of Binary Compact Objects as Gravitational Wave Sources: Evolutionary Channels, Rates, and Physical Properties. *The Astrophysical Journal* 572:407–431. <https://doi.org/10.1086/340304>

- Bergmann PG (1962) Allocation de Cloture/Summary of the Colloque International de Royaumont. In Lichnerowicz and Tonnelat, pp. 463–471 in English, 451–462 in French.
- Bernuzzi S, Nagar A, Balmelli S, et al (2014) Quasiuniversal Properties of Neutron Star Mergers. *Phys Rev Lett* 112:201101. <https://doi.org/10.1103/PhysRevLett.112.201101>
- Bernuzzi S, Nagar A, Dietrich T, Damour T (2015) Modeling the Dynamics of Tidally Interacting Binary Neutron Stars up to the Merger. *Phys Rev Lett* 114:161103. <https://doi.org/10.1103/PhysRevLett.114.161103>
- Berry CPL, Mandel I, Middleton H, et al (2015) PARAMETER ESTIMATION FOR BINARY NEUTRON-STAR COALESCENCES WITH REALISTIC NOISE DURING THE ADVANCED LIGO ERA. *The Astrophysical Journal* 804:114. <https://doi.org/10.1088/0004-637x/804/2/114>
- Berti E, Barausse E, Cardoso V, et al (2015) Testing general relativity with present and future astrophysical observations. *Classical and Quantum Gravity* 32:243001. <https://doi.org/10.1088/0264-9381/32/24/243001>
- Berti E, Cardoso V, Gonzalez JA, et al (2007) Inspiral, merger, and ringdown of unequal mass black hole binaries: A multipolar analysis. *Physical Review D* 76:064034. <https://doi.org/10.1103/physrevd.76.064034>
- Berti E, Cardoso V, Will CM (2006) Gravitational-wave spectroscopy of massive black holes with the space interferometer LISA. *Physical Review D* 73:064030. <https://doi.org/10.1103/physrevd.73.064030>
- Bertolotti M (1983) *Masers and Lasers: An Historical Approach*. Adam Hilger, Bristol.
- Bidwell JK (1993) Humanize Your Classroom with the History of Mathematics. *The Mathematics Teacher* 86:461–464
- Bieri L, Garfinkle D, Yunes N (2017) *Gravitational Waves and Their Mathematics*. arXiv:171003272 [gr-qc]
- Bildsten L (1998) Gravitational Radiation and Rotation of Accreting Neutron Stars. *The Astrophysical Journal* 501:L89–L93. <https://doi.org/10.1086/311440>
- Bildsten L, Cutler C (1992) Tidal interactions of inspiraling compact binaries. *The Astrophysical Journal* 400:175. <https://doi.org/10.1086/171983>
- Binnington T, Poisson E (2009) Relativistic theory of tidal Love numbers. *Phys Rev D* 80:084018. <https://doi.org/10.1103/PhysRevD.80.084018>
- Blanchet L (1987) Radiative Gravitation Fields in General Relativity II. Asymptotic Behaviour at Future Null Infinity. *Proceedings of the Royal Society A: Mathematical, Physical and Engineering Sciences*, 409(1837):383–399. doi:10.1098/rspa.1987.0022
- Blanchet L (1995) Second-post-Newtonian generation of gravitational radiation. *Physical Review D*, 51(6):2559–2583. doi:10.1103/physrevd.51.2559
- Blanchet L (1996) Energy losses by gravitational radiation in inspiraling compact binaries to 5/2 post-Newtonian order. *Physical Review D*, 54(2):1417–1438. doi:10.1103/physrevd.54.1417
- Blanchet L (1998) Gravitational-wave tails of tails. *Classical and Quantum Gravity* 15:113–141. <https://doi.org/10.1088/0264-9381/15/1/009>
- Blanchet L (2002) Gravitational Radiation from Post-Newtonian Sources and Inspiralling Compact Binaries. *Living Reviews in Relativity* 5,3. <https://doi.org/10.12942/lrr-2002-3>
- Blanchet L (2003) ON THE ACCURACY OF THE POST-NEWTONIAN APPROXIMATION. 2001: A Relativistic Spacetime Odyssey. doi:10.1142/9789812791368\_0022
- Blanchet L (2005) Erratum: Energy losses by gravitational radiation in inspiraling compact binaries to 5/2 post-Newtonian order [Phys. Rev. D54, 001417 (1996)]. *Physical Review D*, 71(12). doi:10.1103/physrevd.71.129904

- Blanchet L (2014) Gravitational radiation from post-Newtonian sources and inspiralling compact binaries. *Living Reviews in Relativity* 17:2
- Blanchet L (2014) Gravitational Radiation from Post-Newtonian Sources and Inspiralling Compact Binaries. *Living Reviews in Relativity*, 17(1). doi:10.12942/lrr-2014-2
- Blanchet L, Buonanno A, Faye G (2006) Higher-order spin effects in the dynamics of compact binaries. II. Radiation field. *Phys Rev D* 74:104034. <https://doi.org/10.1103/PhysRevD.74.104034>
- Blanchet L, Buonanno A, Faye G (2010) Erratum: Higher-order spin effects in the dynamics of compact binaries. II. Radiation field [*Phys. Rev. D* 74, 104034 (2006)]. *Phys Rev D* 81:089901. <https://doi.org/10.1103/PhysRevD.81.089901>
- Blanchet L, Damour T (1986) Radiative Gravitational Fields in General Relativity I. General Structure of the Field outside the Source. *Philosophical Transactions of the Royal Society of London. Series A, Mathematical and Physical Sciences*, 320(1555):379-430. Retrieved: [www.jstor.org/stable/37878](http://www.jstor.org/stable/37878)
- Blanchet L, Damour T (1988) Tail-transported temporal correlations in the dynamics of a gravitating system. *Physical Review D*, 37(6):1410-1435. doi:10.1103/physrevd.37.1410
- Blanchet L, Damour T (1989) Post-Newtonian generation of gravitational waves. *Annales de l'I.H.P., section A*, 50(4):377-408.
- Blanchet L, Damour T (1992) Hereditary effects in gravitational radiation. *Physical Review D*, 46(10):4304-4319. doi:10.1103/physrevd.46.4304
- Blanchet L, Damour T, Esposito-Farèse G, Iyer BR (2004) Gravitational Radiation from Inspiralling Compact Binaries Completed at the Third Post-Newtonian Order. *Phys. Rev. Lett.*, 93:091101
- Blanchet L, Damour T, Esposito-Farèse G, Iyer BR (2004) Gravitational Radiation from Inspiralling Compact Binaries Completed at the Third Post-Newtonian Order. *Physical Review Letters* 93:091101. <https://doi.org/10.1103/physrevlett.93.091101>
- Blanchet L, Damour T, Iyer BR (1995a) Gravitational waves from inspiralling compact binaries: Energy loss and waveform to second-post-Newtonian order. *Physical Review D* 51:5360-5386. <https://doi.org/10.1103/physrevd.51.5360>
- Blanchet L, Damour T, Iyer BR, et al (1995b) Gravitational-Radiation Damping of Compact Binary Systems to Second Post-Newtonian Order. *Phys Rev Lett* 74:3515-3518. <https://doi.org/10.1103/PhysRevLett.74.3515>
- Blanchet L, Damour T, Iyer BR, Will CM, Wiseman AG (1995) Gravitational-Radiation Damping of Compact Binary Systems to Second Post-Newtonian Order. *Physical Review Letters*, 74(18):3515-3518. doi:10.1103/physrevlett.74.3515
- Blanchet L, Faye G (2000) Hadamard regularization. *Journal of Mathematical Physics*, 41(11):7675-7714. doi:10.1063/1.1308506
- Blanchet L, Faye G, Iyer BR, Joguet B (2005) Erratum: Gravitational-wave inspiral of compact binary systems to 7/2 post-Newtonian order [*Phys. Rev. D* 65, 061501(R) (2002)]. *Physical Review D* 71:129902. <https://doi.org/10.1103/physrevd.71.129902>
- Blanchet L, Iyer BR, Will CM, Wiseman AG (1996) Gravitational waveforms from inspiralling compact binaries to second-post-Newtonian order. *Classical and Quantum Gravity* 13:575-584. <https://doi.org/10.1088/0264-9381/13/4/002>
- Blanchet L, Sathyaprakash BS (1994) Signal analysis of gravitational wave tails. *Classical and Quantum Gravity* 11:2807-2831. <https://doi.org/10.1088/0264-9381/11/11/020>

- Blanchet L, Sathyaprakash BS (1995) Detecting a Tail Effect in Gravitational-Wave Experiments. *Physical Review Letters*, 74(7):1067–1070. doi:10.1103/physrevlett.74.1067
- Blanchet L, Schafer G (1993) Gravitational wave tails and binary star systems. *Classical and Quantum Gravity* 10:2699–2721. <https://doi.org/10.1088/0264-9381/10/12/026>
- Blanchet L, Schafer G (1993) Gravitational wave tails and binary star systems. *Classical and Quantum Gravity*, 10(12):2699–2721. doi:10.1088/0264-9381/10/12/026
- Blatt JM (1964) *Theory of superconductivity*. Academic Press, Inc.
- Bloembergen N (1956) Proposal for a new type solid state maser. *Phys. Rev.* 104: 324–327.
- Bloom BS (1956) *Taxonomy of Educational Objectives-The Classification of Educational Goals*. David McKay, New York.
- Blum AS, Lalli R, Renn J (2015) The Re-invention of General Relativity: A Historiographical Framework for Assessing One Hundred Years of Curved Space-time. *ISIS* 106: 598–620.
- Bohé A, Faye G, Marsat S, Porter EK (2015) Quadratic-in-spin effects in the orbital dynamics and gravitational-wave energy flux of compact binaries at the 3PN order. *Classical and Quantum Gravity* 32:195010. <https://doi.org/10.1088/0264-9381/32/19/195010>
- Bohé A, Marsat S, Blanchet L (2013) Next-to-next-to-leading order spin-orbit effects in the gravitational wave flux and orbital phasing of compact binaries. *Classical and Quantum Gravity* 30:135009. <https://doi.org/10.1088/0264-9381/30/13/135009>
- Bohé A, Shao L, Taracchini A, et al (2017) Improved effective-one-body model of spinning, nonprecessing binary black holes for the era of gravitational-wave astrophysics with advanced detectors. *Phys Rev D* 95:044028. <https://doi.org/10.1103/PhysRevD.95.044028>
- Bondi H (1957) Plane gravitational waves in general relativity. *Nature* 179:1072–1073.
- Bondi H (1962) On the physical characteristics of gravitational waves. In: Lichnerowicz and Tonnelat, pp. 129–135.
- Bondi H (1965) Some special solutions of the Einstein equations. In: Trautman A, Pirani FAE, and Bondi H (eds.), *Lectures on General Relativity*. Prentice Hall, Englewood Cliffs NS, pp. 375–489.
- Bondi H, McCrea WH (1960) Energy transfer by gravitation in Newtonian Theory. *Proceedings of the Cambridge Philosophical Society* 56: 410–413.
- Bondu F, Hello P, Vinet J-Y (1998) Thermal noise in mirrors of interferometric gravitational wave antennas. *Physics Letters A* 246:227–236. [https://doi.org/10.1016/s0375-9601\(98\)00450-2](https://doi.org/10.1016/s0375-9601(98)00450-2)
- Bonnor WB (1957) Non-singular fields in general relativity. *J. Math & Mech.* 6: 213.
- Bordé ChJ (1985) *Méthodes optiques de détection des ondes gravitationnelles - Préface*. *Annales de Physique* 10:R1–R2. <https://doi.org/10.1051/anphys:019850010030r500>
- Bose S, Chakravarti K, Rezzolla L, et al (2018) Neutron-Star Radius from a Population of Binary Neutron Star Mergers. *Physical Review Letters* 120:031102. <https://doi.org/10.1103/physrevlett.120.031102>
- Boughton RI, Olsen JL, Palmy C (1970) Chapter 4 Pressure Effects in Superconductors. *Progress in Low Temperature Physics*, 6:163–203. doi:10.1016/s0079-6417(08)60063-3
- Boya LJ (2004) The thermal radiation formula of Planck (1900). arXiv preprint physics/0402064
- Boyle M (2011) Uncertainty in hybrid gravitational waveforms: Optimizing initial orbital frequencies for binary black-hole simulations. *Physical Review D* 84:064013. <https://doi.org/10.1103/physrevd.84.064013>



- Boyle M, Brown DA, Kidder LE, Mroué AH, Pfeiffer HP, Scheel MA, ... Teukolsky SA (2007) High-accuracy comparison of numerical relativity simulations with post-Newtonian expansions. *Physical Review D*, 76(12). doi:10.1103/physrevd.76.124038
- Boyle M, Brown DA, Pekowsky L (2009) Comparison of high-accuracy numerical simulations of black-hole binaries with stationary-phase post-Newtonian template waveforms for initial and advanced LIGO. *Classical and Quantum Gravity*, 26(11):114006. doi:10.1088/0264-9381/26/11/114006
- Boyle M, Buonanno A, Kidder LE, Mroué AH, Pan Y, Pfeiffer HP, Scheel MA (2008) High-accuracy numerical simulation of black-hole binaries: Computation of the gravitational-wave energy flux and comparisons with post-Newtonian approximants. *Physical Review D*, 78(10). doi:10.1103/physrevd.78.104020
- Bradamante F, Viennot L (2007) Mapping Gravitational and Magnetic Fields with Children 9–11: Relevance, difficulties and prospects. *International Journal of Science Education* 29:349–372. <https://doi.org/10.1080/09500690600718245>
- Brady PR, Creighton JDE, Wiseman AG (2004) Upper limits on gravitational-wave signals based on loudest events. *Classical and Quantum Gravity* 21:S1775–S1781. <https://doi.org/10.1088/0264-9381/21/20/020>
- Brady PR, Creighton T (2000) Searching for periodic sources with LIGO. II. Hierarchical searches. *Physical Review D* 61:082001. <https://doi.org/10.1103/physrevd.61.082001>
- Brady PR, Creighton T, Cutler C, Schutz BF (1998) Searching for periodic sources with LIGO. *Physical Review D* 57:2101–2116. <https://doi.org/10.1103/physrevd.57.2101>
- Braginskii VB (1966) GRAVITATIONAL RADIATION AND THE PROSPECT OF ITS EXPERIMENTAL DISCOVERY. *Soviet Physics Uspekhi* 8:513–521. <https://doi.org/10.1070/pu1966v008n04abeh002989>
- Braginskii VB, Manukin AB, Popov EI, et al (1973) Search for Gravitational Radiation of Extraterrestrial Origin. *Soviet Physics Uspekhi* 15:831–832. <https://doi.org/10.1070/pu1973v015n06abeh005074>
- Brans C, Dicke RH (1961) Mach's principle and a relativistic theory of gravitation. *Physical Review* 124: 925–935.
- Brill D (1959) On the positive definite mass of the Bondi-Weber-Wheeler time-symmetric gravitational waves. *Annals of Physics* 7:466–483.
- Brillet A (1985) Interferometric gravitational wave antennae. *Annales de Physique* 10:219–226. <https://doi.org/10.1051/anphys:01985001003021900>
- Broadhurst T, Diego JM, III GS (2018) Reinterpreting Low Frequency LIGO/Virgo Events as Magnified Stellar-Mass Black Holes at Cosmological Distances
- Brocco L, Frasca S, Palomba C, Ricci F (2003) The search for continuous sources in the Virgo experiment. Full-sky incoherent step: local and grid tests. *Classical and Quantum Gravity* 20:S655–S664. <https://doi.org/10.1088/0264-9381/20/17/309>
- Broeck CVD (2005) The gravitational wave spectrum of non-axisymmetric, freely precessing neutron stars. *Classical and Quantum Gravity* 22:1825–1839. <https://doi.org/10.1088/0264-9381/22/9/022>
- Brogie\$ast\$ LD (2006) XXXV. A Tentative Theory of Light Quanta. *Philosophical Magazine Letters* 86:411–423. <https://doi.org/10.1080/09500830600914721>
- Brown DA, Harry I, Lundgren A, Nitz AH (2012) Detecting binary neutron star systems with spin in advanced gravitational-wave detectors. *Phys Rev D* 86:084017. <https://doi.org/10.1103/PhysRevD.86.084017>

- Brown DA, Kumar P, Nitz AH (2013) Template banks to search for low-mass binary black holes in advanced gravitational-wave detectors. *Phys Rev D* 87:082004. <https://doi.org/10.1103/PhysRevD.87.082004>
- Brügmann B, González JA, Hannam M, et al (2008) Calibration of moving puncture simulations. *Physical Review D* 77:024027. <https://doi.org/10.1103/physrevd.77.024027>
- Brush SG (2002) Cautious revolutionaries: Maxwell, Planck, Hubble. *American Journal of Physics* 70:119–127
- Bulik T, Gondek-Rosinska D, Belczynski K (2004) Expected masses of merging compact object binaries observed in gravitational waves. *Monthly Notices of the Royal Astronomical Society* 352:1372–1380. <https://doi.org/10.1111/j.1365-2966.2004.08028.x>
- Buonanno A, Chen Y, Vallisneri M (2003a) Detecting gravitational waves from precessing binaries of spinning compact objects: Adiabatic limit. *Physical Review D* 67:104025. <https://doi.org/10.1103/physrevd.67.104025>
- Buonanno A, Chen Y, Vallisneri M (2003b) Detection template families for gravitational waves from the final stages of binary–black-hole inspirals: Nonspinning case. *Physical Review D* 67:024016. <https://doi.org/10.1103/physrevd.67.024016>
- Buonanno A, Cook GB, Pretorius F (2007a) Inspiral, merger, and ring-down of equal-mass black-hole binaries. *Physical Review D* 75:124018. <https://doi.org/10.1103/physrevd.75.124018>
- Buonanno A, Damour T (1999) Effective one-body approach to general relativistic two-body dynamics. *Physical Review D* 59:084006. <https://doi.org/10.1103/physrevd.59.084006>
- Buonanno A, Damour T (2000) Transition from inspiral to plunge in binary black hole coalescences. *Physical Review D* 62:064015. <https://doi.org/10.1103/physrevd.62.064015>
- Buonanno A, Iyer BR, Ochsner E, et al (2009a) Comparison of post-Newtonian templates for compact binary inspiral signals in gravitational-wave detectors. *Physical Review D* 80:084043. <https://doi.org/10.1103/physrevd.80.084043>
- Buonanno A, Pan Y, Baker JG, et al (2007b) Approaching faithful templates for nonspinning binary black holes using the effective-one-body approach. *Physical Review D* 76:104049. <https://doi.org/10.1103/physrevd.76.104049>
- Buonanno A, Pan Y, Pfeiffer HP, et al (2009b) Effective-one-body waveforms calibrated to numerical relativity simulations: Coalescence of nonspinning, equal-mass black holes. *Physical Review D* 79:124028. <https://doi.org/10.1103/physrevd.79.124028>
- Buonanno A, Pan Y, Pfeiffer HP, Scheel MA, Buchman LT, Kidder LE (2009) Effective-one-body waveforms calibrated to numerical relativity simulations: Coalescence of nonspinning, equal-mass black holes. *Physical Review D*, 79(12). doi:10.1103/physrevd.79.124028
- Burgay M, D’Amico N, Possenti A, et al (2003) An increased estimate of the merger rate of double neutron stars from observations of a highly relativistic system. *Nature* 426:531–533. <https://doi.org/10.1038/nature02124>
- Burko LM (2017) Gravitational Wave Detection in the Introductory Lab, *The Physics Teacher*, 55:288–292.
- Cabibbo N, Doniach S (1963) Qualitative mechanism for supercurrent destruction by  $\alpha$ -particles. *Physics Letters*, 4(1):29–30. doi:10.1016/0031-9163(63)90573-0
- Cabrera B (1982) First Results from a Superconductive Detector for Moving Magnetic Monopoles. *Phys. Rev. Lett.* 48(20):1378–1381. Retrieved: <https://link.aps.org/doi/10.1103/PhysRevLett.48.137>

- Cahillane C, Betzwieser J, Brown DA, et al (2017) Calibration uncertainty for Advanced LIGO's first and second observing runs. *Physical Review D* 96:102001. <https://doi.org/10.1103/physrevd.96.102001>
- Callan CG (1982) Dyon-fermion dynamics. *Physical Review D*, 26(8):2058–2068. doi:10.1103/physrevd.26.2058
- Cameron AGW (ed.) (1963) *Interstellar Communication*. Benjamin Press, New York.
- Campanelli M, Lousto CO, Marronetti P, Zlochower Y (2006) Accurate Evolutions of Orbiting Black-Hole Binaries without Excision. *Phys Rev Lett* 96:111101. <https://doi.org/10.1103/PhysRevLett.96.111101>
- Campbell C (1960) The design of a two-level solid state maser. Ph.D. Thesis, Univ. of St. Andrews.
- Camporesi T, Catalano G, Florio M, Giffoni F (2017) Experiential learning in high energy physics: a survey of students at the LHC. *European Journal of Physics* 38:025703. <https://doi.org/10.1088/1361-6404/aa5121>
- Cannon K, Cariou R, Chapman A, et al (2012) TOWARD EARLY-WARNING DETECTION OF GRAVITATIONAL WAVES FROM COMPACT BINARY COALESCENCE. *The Astrophysical Journal* 748:136. <https://doi.org/10.1088/0004-637x/748/2/136>
- Canton TD, Harry IW (2017) Designing a template bank to observe compact binary coalescences in Advanced LIGO's second observing run
- Cardoso V, Franzin E, Maselli A, et al (2017a) Publisher's Note: Testing strong-field gravity with tidal Love numbers [Phys. Rev. D 95, 084014 (2017)]. *Phys Rev D* 95:089901. <https://doi.org/10.1103/PhysRevD.95.089901>
- Cardoso V, Franzin E, Maselli A, et al (2017b) Testing strong-field gravity with tidal Love numbers. *Phys Rev D* 95:084014. <https://doi.org/10.1103/PhysRevD.95.084014>
- Cardoso V, Hopper S, Macedo CFB, et al (2016) Gravitational-wave signatures of exotic compact objects and of quantum corrections at the horizon scale. *Phys Rev D* 94:084031. <https://doi.org/10.1103/PhysRevD.94.084031>
- Caron B, Dominjon A, Drezen C, et al (1997) The VIRGO interferometer for gravitational wave detection. *Nuclear Physics B - Proceedings Supplements* 54:167–175. [https://doi.org/10.1016/s0920-5632\(97\)00109-6](https://doi.org/10.1016/s0920-5632(97)00109-6)
- Carroll JS (1978) The effect of imagining an event on expectations for the event: An interpretation in terms of the availability heuristic. *Journal of Experimental Social Psychology* 14:88–96. [https://doi.org/10.1016/0022-1031\(78\)90062-8](https://doi.org/10.1016/0022-1031(78)90062-8)
- Carter B (1971) Axisymmetric Black Hole Has Only Two Degrees of Freedom. *Physical Review Letters* 26:331–333. <https://doi.org/10.1103/physrevlett.26.331>
- Casares J, Jonker P (2014) Mass measurements of stellar and intermediate-mass black holes. *Space Science Reviews* 183:223–252
- Castelvecchi D (2016) Gravitational waves: How LIGO forged the path to victory. *Nature* 530:261–262. <https://doi.org/10.1038/530261a>
- Caves CM (1981) Quantum-mechanical noise in an interferometer. *Phys Rev D* 23:1693. <https://doi.org/10.1103/PhysRevD.23.1693>
- Caves CM, Thorne KS, Drever RWP, et al (1980) On the measurement of a weak classical force coupled to a quantum-mechanical oscillator. I. Issues of principle. *Rev Mod Phys* 52:341. <https://doi.org/10.1103/RevModPhys.52.341>
- Çepni S, Taş E, Köse S (2006) The effects of computer-assisted material on students' cognitive levels, misconceptions and attitudes towards science. *Computers & Education* 46:192–205. <https://doi.org/10.1016/j.compedu.2004.07.008>

- Champagne AB, Klopfer LE, Anderson JH (1980) Factors influencing the learning of classical mechanics. *American Journal of Physics* 48:1074–1079. <https://doi.org/10.1119/1.12290>
- Chandrasekhar S, Detweiler S (1975) The quasi-normal modes of the Schwarzschild black hole. *Proceedings of the Royal Society of London A Mathematical and Physical Sciences* 344:441–452
- Chatterji S, Blackburn L, Martin G, Katsavounidis E (2004) Multiresolution techniques for the detection of gravitational-wave bursts. *Classical and Quantum Gravity* 21:S1809
- Chen H-Y, Holz DE (2016) Finding the One: Identifying the Host Galaxies of Gravitational-Wave Sources
- Chen H-Y, Holz DE, Miller J, et al (2017) Distance measures in gravitational-wave astrophysics and cosmology
- Choquet-Bruhat Y, Geroch R (1969) Global aspects of the Cauchy problem in general relativity. *Communications in Mathematical Physics* 14:329–335. <https://doi.org/10.1007/bf01645389>
- Chornock R, Berger E, Kasen D, et al (2017) The Electromagnetic Counterpart of the Binary Neutron Star Merger LIGO/Virgo GW170817. IV. Detection of Near-infrared Signatures of r-process Nucleosynthesis with Gemini-South. *The Astrophysical Journal* 848:L19. <https://doi.org/10.3847/2041-8213/aa905c>
- CHOUDHURY S (2004) Probing large distance higher dimensional gravity from lensing data. *Astroparticle Physics* 21:559–563. <https://doi.org/10.1016/j.astropartphys.2004.04.001>
- Choudhury S, SenGupta S (2014) A step toward exploring the features of Gravidilaton sector in Randall–Sundrum scenario via lightest Kaluza–Klein graviton mass. *The European Physical Journal C* 74:3159. <https://doi.org/10.1140/epjc/s10052-014-3159-x>
- Christensen N, Meyer R, Libson A (2003) A Metropolis–Hastings routine for estimating parameters from compact binary inspiral events with laser interferometric gravitational radiation data. *Classical and Quantum Gravity* 21:317–330. <https://doi.org/10.1088/0264-9381/21/1/023>
- Christensen N, Shawhan P, Gabriela G (for the LIGO collaboration) (2004) Vetoes for inspiral triggers in LIGO data. *Classical and Quantum Gravity* 21:S1747–S1755. <https://doi.org/10.1088/0264-9381/21/20/017>
- Chu T, Fong H, Kumar P, et al (2016) On the accuracy and precision of numerical waveforms: effect of waveform extraction methodology. *Classical and Quantum Gravity* 33:165001. <https://doi.org/10.1088/0264-9381/33/16/165001>
- Ciufolini I, Pavlis EC (2004) A confirmation of the general relativistic prediction of the Lense–Thirring effect. *Nature* 431:958–960. <https://doi.org/10.1038/nature03007>
- Clark JA, Bauswein A, Stergioulas N, Shoemaker D (2016) Observing gravitational waves from the post-merger phase of binary neutron star coalescence. *Classical and Quantum Gravity* 33:085003. <https://doi.org/10.1088/0264-9381/33/8/085003>
- Clark KM (2011) History of mathematics: illuminating understanding of school mathematics concepts for prospective mathematics teachers. *Educational Studies in Mathematics* 81:67–84. <https://doi.org/10.1007/s10649-011-9361-y>
- Clemence GM (1943) The motion of Mercury 1765–1937. *Astronomical Journal* 50:126–127. <https://doi.org/10.1086/105746>
- Clement J (1982) Students’ preconceptions in introductory mechanics. *American Journal of Physics* 50:66–71. <https://doi.org/10.1119/1.12989>
- Collaboration) DAB (for the LS (2004) Testing the LIGO inspiral analysis with hardware injections. *Classical and Quantum Gravity* 21:S797–S800. <https://doi.org/10.1088/0264-9381/21/5/060>

- Collins H (2004) *Gravity's Shadow*. Univ. of Chicago Press, Chicago.
- Collins H (2011) *Gravity's Ghost*. Univ. of Chicago Press, Chicago.
- Cook GB, Shapiro SL, Teukolsky SA (1994) Rapidly rotating neutron stars in general relativity: Realistic equations of state. *Astrophysical Journal*, 424(2):823-845
- Cook M (2008) Students' comprehension of science concepts depicted in textbook illustrations. *Electronic Journal of Science Education* 12.
- Corbin J, Strauss A (2014) *Basics of qualitative research: Techniques and procedures for developing grounded theory*. Sage publications
- Cornish N, Sampson L, Yunes N, Pretorius F (2011) Gravitational wave tests of general relativity with the parameterized post-Einsteinian framework. *Physical Review D* 84:062003. <https://doi.org/10.1103/physrevd.84.062003>
- Cornish NJ, Littenberg TB (2015) Bayeswave: Bayesian inference for gravitational wave bursts and instrument glitches. *Classical and Quantum Gravity* 32:135012
- Coulter DA, Foley RJ, Kilpatrick CD, et al (2017) Swope Supernova Survey 2017a (SSS17a), the optical counterpart to a gravitational wave source. *Science* 358:1556–1558. <https://doi.org/10.1126/science.aap9811>
- Creighton JDE (1999) Search techniques for gravitational waves from black-hole ringdowns. *Physical Review D* 60:022001. <https://doi.org/10.1103/physrevd.60.022001>
- Crook AC, Huchra JP, Martimbeau N, et al (2007) Groups of Galaxies in the Two Micron All Sky Redshift Survey. *The Astrophysical Journal* 655:790–813. <https://doi.org/10.1086/510201>
- Crook AC, Huchra JP, Martimbeau N, et al (2008) Erratum: "Groups of Galaxies in the Two Micron All Sky Redshift Survey" (*ApJ*, 655, 790 [2007]). *The Astrophysical Journal* 685:1320–1323. <https://doi.org/10.1086/590385>
- Cullen T, Harry I, Read J, Flynn E (2017) Matter effects on LIGO/Virgo searches for gravitational waves from merging neutron stars. *Classical and Quantum Gravity* 34:245003. <https://doi.org/10.1088/1361-6382/aa9424>
- Cutler C (2002) Gravitational waves from neutron stars with large toroidal fields. *Physical Review D* 66:084025. <https://doi.org/10.1103/physrevd.66.084025>
- Cutler C, Apostolatos TA, Bildsten L, et al (1993) The last three minutes: Issues in gravitational-wave measurements of coalescing compact binaries. *Physical Review Letters* 70:2984–2987. <https://doi.org/10.1103/physrevlett.70.2984>
- Cutler C, Apostolatos TA, Bildsten L, Finn LS, Flanagan EE, Kennefick D, ... Thorne KS (1993). The last three minutes: Issues in gravitational-wave measurements of coalescing compact binaries. *Physical Review Letters*, 70(20):2984–2987. doi:10.1103/physrevlett.70.2984
- Cutler C, Gholami I, Krishnan B (2005) Improved stack-slide searches for gravitational-wave pulsars. *Physical Review D* 72:042004. <https://doi.org/10.1103/physrevd.72.042004>
- Cutler C, Harms J (2006) Big Bang Observer and the neutron-star-binary subtraction problem. *Phys Rev D* 73:042001. <https://doi.org/10.1103/PhysRevD.73.042001>
- D'Avanzo P (2015) Short gamma-ray bursts: A review. *Journal of High Energy Astrophysics* 7:73–80. <https://doi.org/10.1016/j.jheap.2015.07.002>
- Dal Canton T, Lundgren AP, Nielsen AB (2015) Impact of precession on aligned-spin searches for neutron-star–black-hole binaries. *Physical Review D* 91:062010. <https://doi.org/10.1103/physrevd.91.062010>

- Damour T (1984) The Motion of Compact Bodies and Gravitational Radiation. *General Relativity and Gravitation*, 89–106. doi:10.1007/978-94-009-6469-3\_7
- Damour T (1987) The problem of motion in Newtonian and Einsteinian gravity. In: Hawking SW and Israel W (eds.) *300 Years of Gravitation*. Cambridge University Press, Cambridge, pp. 128–198.
- Damour T (2001) Coalescence of two spinning black holes: An effective one-body approach. *Physical Review D* 64:124013. <https://doi.org/10.1103/physrevd.64.124013>
- Damour T, Esposito-Farese G (1992) Tensor-multi-scalar theories of gravitation. *Classical and Quantum Gravity* 9:2093–2176. <https://doi.org/10.1088/0264-9381/9/9/015>
- Damour T, Iyer BR (1991) Post-newtonian generation of gravitational waves. II. The spin moments. *Annales de l'I.H.P. Physique théorique*, 54(2):115–164. [http://www.numdam.org/item/AIHPA\\_1991\\_\\_54\\_2\\_115\\_0/](http://www.numdam.org/item/AIHPA_1991__54_2_115_0/)
- Damour T, Iyer BR, Jaranowski P, Sathyaprakash BS (2003) Gravitational waves from black hole binary inspiral and merger: The span of third post-Newtonian effective-one-body templates. *Physical Review D* 67:064028. <https://doi.org/10.1103/physrevd.67.064028>
- Damour T, Iyer BR, Sathyaprakash BS (1998) Improved filters for gravitational waves from inspiraling compact binaries. *Physical Review D* 57:885–907. <https://doi.org/10.1103/physrevd.57.885>
- Damour T, Iyer BR, Sathyaprakash BS (2001a) Comparison of search templates for gravitational waves from binary inspiral. *Physical Review D* 63:044023. <https://doi.org/10.1103/physrevd.63.044023>
- Damour T, Iyer BR, Sathyaprakash BS (2002) Comparison of search templates for gravitational waves from binary inspiral: 3.5PN update. *Physical Review D* 66:027502. <https://doi.org/10.1103/physrevd.66.027502>
- Damour T, Iyer BR, Sathyaprakash BS (2005) Erratum: Comparison of search templates for gravitational waves from binary inspiral [*Phys. Rev. D* 63, 044023 (2001)]. *Physical Review D*, 72(2). doi:10.1103/physrevd.72.029902
- Damour T, Jaranowski P, Schäfer G (2000) Determination of the last stable orbit for circular general relativistic binaries at the third post-Newtonian approximation. *Physical Review D* 62:084011. <https://doi.org/10.1103/physrevd.62.084011>
- Damour T, Jaranowski P, Schäfer G (2001) Dimensional regularization of the gravitational interaction of point masses. *Physics Letters B*, 513(1-2):147–155. doi:10.1016/s0370-2693(01)00642-6
- Damour T, Jaranowski P, Schäfer G (2001b) Dimensional regularization of the gravitational interaction of point masses. *Physics Letters B* 513:147–155. [https://doi.org/10.1016/S0370-2693\(01\)00642-6](https://doi.org/10.1016/S0370-2693(01)00642-6)
- Damour T, Jaranowski P, Schäfer G (2008a) Effective one body approach to the dynamics of two spinning black holes with next-to-leading order spin-orbit coupling. *Physical Review D* 78:024009. <https://doi.org/10.1103/physrevd.78.024009>
- Damour T, Nagar A (2009a) Improved analytical description of inspiraling and coalescing black-hole binaries. *Physical Review D* 79:081503. <https://doi.org/10.1103/physrevd.79.081503>
- Damour T, Nagar A (2009b) Relativistic tidal properties of neutron stars. *Phys Rev D* 80:084035. <https://doi.org/10.1103/PhysRevD.80.084035>
- Damour T, Nagar A (2010) Effective one body description of tidal effects in inspiraling compact binaries. *Phys Rev D* 81:084016. <https://doi.org/10.1103/PhysRevD.81.084016>
- Damour T, Nagar A (2014) New effective-one-body description of coalescing nonprecessing spinning black-hole binaries. *Physical Review D* 90:044018. <https://doi.org/10.1103/physrevd.90.044018>

- Damour T, Nagar A, Bernuzzi S (2013) Improved effective-one-body description of coalescing nonspinning black-hole binaries and its numerical-relativity completion. *Physical Review D* 87:084035. <https://doi.org/10.1103/physrevd.87.084035>
- Damour T, Nagar A, Dorband EN, et al (2008b) Faithful effective-one-body waveforms of equal-mass coalescing black-hole binaries. *Physical Review D* 77:084017. <https://doi.org/10.1103/physrevd.77.084017>
- Damour T, Nagar A, Hannam M, et al (2008c) Accurate effective-one-body waveforms of inspiralling and coalescing black-hole binaries. *Physical Review D* 78:044039. <https://doi.org/10.1103/physrevd.78.044039>
- Damour T, Nagar A, Trias M (2011) Accuracy and effectualness of closed-form, frequency-domain waveforms for nonspinning black hole binaries. *Physical Review D* 83:024006. <https://doi.org/10.1103/physrevd.83.024006>
- Damour T, Nagar A, Villain L (2012) Measurability of the tidal polarizability of neutron stars in late-inspiral gravitational-wave signals. *Phys Rev D* 85:123007. <https://doi.org/10.1103/PhysRevD.85.123007>
- Damour T, Soffel M, Xu C (1992) General-relativistic celestial mechanics II. Translational equations of motion. *Phys Rev D* 45:1017–1044. <https://doi.org/10.1103/PhysRevD.45.1017>
- Damour T, Taylor JH (1991) On the Orbital Period Change of the Binary Pulsar PSR 1913+16. *apj* 366:501. <https://doi.org/10.1086/169585>
- Davis H, Gretz D, Richard JP and Weber J (1977) Development of cryogenic gravitational wave antennas at the University of Maryland. 8th International Conference on General Relativity and Gravitation, Waterloo, Canada, August 10, 1977.
- De Feo P, Sacerdoti G (1962) Decay of trapped-flux in a superconducting ring subjected to irradiation by  $\alpha$ -particles from a Po210 source. *Physics Letters*, 2(6):264. doi:10.1016/0031-9163(62)90028-8
- De Pietri R, Feo A, Maione F, Löffler F (2016) Modeling equal and unequal mass binary neutron star mergers using public codes. *Phys Rev D* 93:064047. <https://doi.org/10.1103/PhysRevD.93.064047>
- De Rham C (2014) Massive Gravity. *Living Reviews in Relativity* 17,7. <https://doi.org/10.12942/lrr-2014-7>
- Del Pozzo W, Li TGF, Agathos M, et al (2013) Demonstrating the Feasibility of Probing the Neutron-Star Equation of State with Second-Generation Gravitational-Wave Detectors. *Phys Rev Lett* 111:071101. <https://doi.org/10.1103/PhysRevLett.111.071101>
- Del Pozzo W, Veitch J, Vecchio A (2011) Testing general relativity using Bayesian model selection: Applications to observations of gravitational waves from compact binary systems. *Physical Review D* 83:082002. <https://doi.org/10.1103/physrevd.83.082002>
- Dietrich T, Bernuzzi S, Tichy W (2017a) Closed-form tidal approximants for binary neutron star gravitational waveforms constructed from high-resolution numerical relativity simulations. *Physical Review D* 96:121501. <https://doi.org/10.1103/physrevd.96.121501>
- Dietrich T, Hinderer T (2017) Comprehensive comparison of numerical relativity and effective-one-body results to inform improvements in waveform models for binary neutron star systems. *Phys Rev D* 95:124006. <https://doi.org/10.1103/PhysRevD.95.124006>
- Dietrich T, Ujevic M, Tichy W, et al (2017b) Gravitational waves and mass ejecta from binary neutron star mergers: Effect of the mass ratio. *Phys Rev D* 95:024029. <https://doi.org/10.1103/PhysRevD.95.024029>
- Dimopoulos S, Glashow SL, Purcell EM, Wilczek F (1982) Is there a local source of magnetic monopoles? *Nature*, 298(5877):824–825. doi:10.1038/298824a0

- Dimopoulos S, Preskill J, Wilczek F (1982) Catalyzed nucleon decay in neutron stars. *Physics Letters B*, 119(4-6):320–322. doi:10.1016/0370-2693(82)90679-7
- Dooley KL, Leong JR, Adams T, et al (2016) GEO 600 and the GEO-HF upgrade program: successes and challenges. *Classical and Quantum Gravity* 33:075009. <https://doi.org/10.1088/0264-9381/33/7/075009>
- Douchin F, Haensel P (2001) A unified equation of state of dense matter and neutron star structure. *Astronomy & Astrophysics* 380:151–167. <https://doi.org/10.1051/0004-6361:20011402>
- Drell SD, Kroll NM, Mueller MT, Parke SJ, Ruderman MA (1983) Energy Loss of Slowly Moving Magnetic Monopoles in Matter. *Physical Review Letters*, 50(9):644–648. doi:10.1103/physrevlett.50.644
- Drever RWP (1961) A search for anisotropy of inertial mass using a free precession technique. *Philosophical Magazine* 6:683–687. <https://doi.org/10.1080/14786436108244418>
- Dreyer O, Kelly B, Krishnan B, et al (2004) Black-hole spectroscopy: testing general relativity through gravitational-wave observations. *Classical and Quantum Gravity* 21:787–803. <https://doi.org/10.1088/0264-9381/21/4/003>
- Driggers JC, Evans M, Pepper K, Adhikari R (2012) Active noise cancellation in a suspended interferometer. *Review of Scientific Instruments* 83:024501. <https://doi.org/10.1063/1.3675891>
- Droz S (1999) Gravitational waves from inspiraling compact binaries: Second post-Newtonian waveforms as search templates. II. *Physical Review D* 59:064030. <https://doi.org/10.1103/physrevd.59.064030>
- Droz S, Knapp DJ, Poisson E, Owen BJ (1999) Gravitational waves from inspiraling compact binaries: Validity of the stationary-phase approximation to the Fourier transform. *Physical Review D* 59:124016. <https://doi.org/10.1103/physrevd.59.124016>
- Droz S, Poisson E (1997) Gravitational waves from inspiraling compact binaries: Second post-Newtonian waveforms as search templates. *Physical Review D* 56:4449–4454. <https://doi.org/10.1103/physrevd.56.4449>
- Dyson FJ (1963) In: Cameron (1963), p. 115.
- Eardley DM, Lee DL, Lightman AP, et al (1973) Gravitational-Wave Observations as a Tool for Testing Relativistic Gravity. *Physical Review Letters* 30:884–886. <https://doi.org/10.1103/physrevlett.30.884>
- Echeverria F (1989) Gravitational-wave measurements of the mass and angular momentum of a black hole. *Physical Review D* 40:3194–3203. <https://doi.org/10.1103/physrevd.40.3194>
- Edwards C (ed.) (1980) *Gravitational radiation, collapsed objects and exact solutions*. Springer.
- Edwards J, Fraser K (1983) Concept maps as reflectors of conceptual understanding. *Research in Science Education*, 13(1):19-26.
- Effler A, Schofield R, Frolov V, et al (2015) Environmental influences on the LIGO gravitational wave detectors during the 6th science run. *Classical and Quantum Gravity* 32:035017
- Eichler D, Livio M, Piran T, Schramm DN (1989) Nucleosynthesis, neutrino bursts and  $\gamma$ -rays from coalescing neutron stars. *Nature* 340:126–128. <https://doi.org/10.1038/340126a0>
- Epstein R, Wagoner RV (1975) Post-Newtonian generation of gravitational waves. *Astrophysical Journal*, 197(1):717-723.
- Everitt CF, DeBra D, Parkinson B, et al (2011) Gravity probe B: final results of a space experiment to test general relativity. *Physical Review Letters* 106:221101



- Farr B, Berry CPL, Farr WM, et al (2016) PARAMETER ESTIMATION ON GRAVITATIONAL WAVES FROM NEUTRON-STAR BINARIES WITH SPINNING COMPONENTS. *The Astrophysical Journal* 825:116. <https://doi.org/10.3847/0004-637x/825/2/116>
- Farr WM, Gair JR, Mandel I, Cutler C (2015) Counting and confusion: Bayesian rate estimation with multiple populations. *Phys Rev D* 91:023005. <https://doi.org/10.1103/PhysRevD.91.023005>
- Fauvel J (1991) Using history in mathematics education. *For the learning of mathematics* 11:3–6
- Fauvel J, van Maanen JA (2006) *History in mathematics education: The ICMI study*. Springer Science & Business Media
- Favata M (2014) Systematic Parameter Errors in Inspiring Neutron Star Binaries. *Phys Rev Lett* 112:101101. <https://doi.org/10.1103/PhysRevLett.112.101101>
- Finkelstein D (1958) Past-Future Asymmetry of the Gravitational Field of a Point Particle. *Phys Rev* 110:965–967. <https://doi.org/10.1103/PhysRev.110.965>
- Finkelstein ND, Pollock SJ (2005) Replicating and understanding successful innovations: Implementing tutorials in introductory physics. *Phys Rev ST Phys Educ Res* 1:010101. <https://doi.org/10.1103/PhysRevSTPER.1.010101>
- Finn LS (1992) Detection, measurement, and gravitational radiation. *Physical Review D*, 46(12):5236–5249. doi:10.1103/physrevd.46.5236
- Finn LS (1996) Binary inspiral, gravitational radiation, and cosmology. *Phys. Rev. D*, 53(6):2878
- Finn LS, Chernoff DF (1993) Observing binary inspiral in gravitational radiation: One interferometer. *Phys Rev D* 47:2198–2219. <https://doi.org/10.1103/PhysRevD.47.2198>
- Finn LS, Chernoff DF (1993) Observing binary inspiral in gravitational radiation: One interferometer. *Phys. Rev. D*, 47(6):2198
- Finn LS, Sutton PJ (2002) Bounding the mass of the graviton using binary pulsar observations. *Phys Rev D* 65:044022. <https://doi.org/10.1103/PhysRevD.65.044022>
- Finnemore DK, Stromberg TF, Swenson CA (1966) Superconducting Properties of High-Purity Niobium. *Physical Review*, 149(1):231–243. doi:10.1103/physrev.149.231
- Fixsen DJ (2009) THE TEMPERATURE OF THE COSMIC MICROWAVE BACKGROUND. *The Astrophysical Journal* 707:916–920. <https://doi.org/10.1088/0004-637x/707/2/916>
- Flanagan ÉÉ, Hinderer T (2008) Constraining neutron-star tidal Love numbers with gravitational-wave detectors. *Phys Rev D* 77:021502. <https://doi.org/10.1103/PhysRevD.77.021502>
- Ford GW (1982) Energy loss by slow magnetic monopoles traversing a metal. *Physical Review D*, 26(9):2519–2521. doi:10.1103/physrevd.26.2519
- Fourès-Bruhat Y (1952) Théorème d'existence pour certains systèmes d'équations aux dérivées partielles non linéaires. *Acta Mathematica* 88:141–225. <https://doi.org/10.1007/bf02392131>
- Freire PCC, Wex N, Esposito-Farèse G, et al (2012) The relativistic pulsar-white dwarf binary PSR J1738+0333 - II. The most stringent test of scalar-tensor gravity. *Monthly Notices of the Royal Astronomical Society* 423:3328–3343. <https://doi.org/10.1111/j.1365-2966.2012.21253.x>
- French AP, Roelofs L (2001) Vibrations and Waves. *American Journal of Physics* 69:922–922. <https://doi.org/10.1119/1.4765679>
- Fricke TT, Smith-Lefebvre ND, Abbott R, et al (2012) DC readout experiment in Enhanced LIGO. *Classical and Quantum Gravity* 29:065005. <https://doi.org/10.1088/0264-9381/29/6/065005>

- Fried MN (2001) Can mathematics education and history of mathematics coexist? *Science & Education* 10:391–408
- Frontczak NT (1998) A Paradigm for the Selection, Use and Development of Experiential Learning Activities in Marketing Education. *Marketing Education Review* 8:25–33. <https://doi.org/10.1080/10528008.1998.11488641>
- Furinghetti F (1997) History of mathematics, mathematics education, school practice: Case studies in linking different domains. *For the learning of mathematics* 17:55–61
- Furinghetti F (2000) The history of mathematics as a coupling link between secondary and university teaching. *International Journal of Mathematical Education in Science and Technology* 31:43–51
- Furinghetti F (2007) Teacher education through the history of mathematics. *Educational Studies in Mathematics* 66:131–143
- Garvin MR, Ramsier RD (2003) Experiential learning at the university level: a US case study. *Education + Training* 45:280–285. <https://doi.org/10.1108/00400910310484349>
- Gawiser E, Silk J (2000) The cosmic microwave background radiation. *Physics Reports* 333–334:245–267. [https://doi.org/10.1016/s0370-1573\(00\)00025-9](https://doi.org/10.1016/s0370-1573(00)00025-9)
- Georgi H, Glashow SL (1974) Unity of All Elementary-Particle Forces. *Physical Review Letters*, 32(8):438–441. doi:10.1103/physrevlett.32.438
- Georgi H, Quinn HR, Weinberg S (1974) Hierarchy of Interactions in Unified Gauge Theories. *Physical Review Letters*, 33(7):451–454. doi:10.1103/physrevlett.33.451
- Geroch R, Xanthopoulos BC (1978) Asymptotic simplicity is stable. *Journal of Mathematical Physics*, 19(3):714–719. doi:10.1063/1.523716
- Gerstenshtein M, Pustovoi V (1963) On the detection of low frequency gravitational waves. *Journal of Experimental and Theoretical Physics* 16:433–435
- Gettier EL (1963) Is Justified True Belief Knowledge? *Analysis* 23:121–123. <https://doi.org/10.1093/analys/23.6.121>
- Ghosh A, Ghosh A, Johnson-McDaniel NK, et al (2016) Testing general relativity using golden black-hole binaries. *Physical Review D* 94:021101. <https://doi.org/10.1103/physrevd.94.021101>
- Giacomelli G (1982) Proc. magnetic monopole workshop, Wingspread, Wisconsin.
- Giazotto A (1989) Interferometric detection of gravitational waves. *Physics Reports* 182:365–424
- Gibbons GW, Hawking SW (1971) Theory of the detection of short bursts of gravitational radiation. *Phys Rev D* 4:2191. <https://doi.org/10.1103/PhysRevD.4.2191>
- Gilbert JK (2004) Models and Modelling: Routes to More Authentic Science Education. *International Journal of Science and Mathematics Education* 2:115–130. <https://doi.org/10.1007/s10763-004-3186-4>
- Giulini D, Straumann N (2000) “.. I didn’t reflect much on what I was doing..” How Planck discovered his radiation formula
- Goddard P, Olive DI (1978) Magnetic monopoles in gauge field theories. *Reports on Progress in Physics*, 41(9):1357–1437. doi:10.1088/0034-4885/41/9/001
- Goetz E, Savage Jr R, Garofoli J, et al (2010) Accurate calibration of test mass displacement in the LIGO interferometers. *Classical and Quantum Gravity* 27:084024
- Gogala B (1980) Torsion and related concepts: An introductory overview. *International Journal of Theoretical Physics* 19:573–586. <https://doi.org/10.1007/bf00669602>

- Goldberg FM, McDermott LC (1986) Student difficulties in understanding image formation by a plane mirror. *The Physics Teacher* 24:472–481. <https://doi.org/10.1119/1.2342096>
- Goldberg FM, McDermott LC (1987) An investigation of student understanding of the real image formed by a converging lens or concave mirror. *American Journal of Physics* 55:108–119. <https://doi.org/10.1119/1.15254>
- Goldberg JN (1955) Gravitational radiation. *Phys Rev* 99:1873. <https://doi.org/10.1103/PhysRev.99.1873>
- Goldberg JN (1992) US air force support of general relativity 1956–1972. In: Eisenstaedt J, Kox AJ (eds) *Studies in the history of general relativity (Einstein studies, volume 3)*. Birkhauser, Boston
- Goldberger WD, Rothstein IZ (2006) Effective field theory of gravity for extended objects. *Phys Rev D* 73:104029. <https://doi.org/10.1103/PhysRevD.73.104029>
- Goldhaber AS, Nieto MM (1974) Mass of the graviton. *Phys Rev D* 9:1119–1121. <https://doi.org/10.1103/PhysRevD.9.1119>
- Goldstein A, Veres P, Burns E, et al (2017) An Ordinary Short Gamma-Ray Burst with Extraordinary Implications: Fermi -GBM Detection of GRB 170817A. *The Astrophysical Journal* 848:L14. <https://doi.org/10.3847/2041-8213/aa8f41>
- Gossan S, Veitch J, Sathyaprakash BS (2012) Bayesian model selection for testing the no-hair theorem with black hole ringdowns. *Physical Review D* 85:124056. <https://doi.org/10.1103/physrevd.85.124056>
- Gossler S, Casey MM, Freise A, et al (2002) The modecleaner system and suspension aspects of GEO 600. *Classical and Quantum Gravity* 19:1835–1842. <https://doi.org/10.1088/0264-9381/19/7/382>
- Granata M, Saracco E, Morgado N, et al (2016) Mechanical loss in state-of-the-art amorphous optical coatings. *Phys Rev D* 93:012007. <https://doi.org/10.1103/PhysRevD.93.012007>
- Groom DE, Loh EC, Ritson DM (1982) A Search for a Slow-Moving Flux of Massive Magnetic Monopoles. Univ. of Utah preprint UUHEP 82/2, XXI International Conference on High Energy Physics, Paris, 1982.
- Gross L, Mohn F, Moll N, et al (2009) The Chemical Structure of a Molecule Resolved by Atomic Force Microscopy. *Science* 325:1110–1114. <https://doi.org/10.1126/science.1176210>
- Gupta A, Gopakumar A, Iyer BR, Iyer S (2000) Padé approximants for truncated post-Newtonian neutron star models. *Physical Review D*, 62(4). doi:10.1103/physrevd.62.044038
- Guth A H, Tye SHH (1980) Phase Transitions and Magnetic Monopole Production in the Very Early Universe. *Physical Review Letters*, 44(10):631–635. doi:10.1103/physrevlett.44.631
- Guth AH, Weinberg EJ (1981) Cosmological consequences of a first-order phase transition in the SU5 grand unified model. *Physical Review D*, 23(4):876–885. doi:10.1103/physrevd.23.876
- Guth AH, Weinberg EJ (1983) Could the universe have recovered from a slow first-order phase transition? *Nuclear Physics B*, 212(2):321–364. doi:10.1016/0550-3213(83)90307-3
- Haberl F (2004) AXPs and X-ray-dim isolated neutron stars: recent XMM-Newton and Chandra results. *Advances in Space Research* 33:638–644. <https://doi.org/10.1016/j.asr.2003.07.022>
- Hahn R, Radelet-de Grave P, Vandersmissen J, Mozdziej T (2013) Correspondance de Pierre Simon Laplace (1749-1827) Publiée et annotée par Roger Hahn, Texte préparé pour la publication par Patricia Radelet-de Grave, Jan Vandersmissen, Thierry Mozdziej.
- Hake RR (1969) Thermodynamics of Type-I and Type-II Superconductors. *Journal of Applied Physics*, 40(13):5148–5160. doi:10.1063/1.1657366

- Hall LJ, Nomura Y (2002) Gauge coupling unification from unified theories in higher dimensions. *Physical Review D* 65:125012. <https://doi.org/10.1103/physrevd.65.125012>
- Hannam M (2014) Modelling gravitational waves from precessing black-hole binaries: progress, challenges and prospects. *General Relativity and Gravitation* 46:1767. <https://doi.org/10.1007/s10714-014-1767-2>
- Hannam M, Brown DA, Fairhurst S, et al (2013) WHEN CAN GRAVITATIONAL-WAVE OBSERVATIONS DISTINGUISH BETWEEN BLACK HOLES AND NEUTRON STARS? *The Astrophysical Journal* 766:L14. <https://doi.org/10.1088/2041-8205/766/1/114>
- Hannam M, Husa S, Brüggmann B, Gopakumar A (2008) Comparison between numerical-relativity and post-Newtonian waveforms from spinning binaries: The orbital hang-up case. *Physical Review D* 78:104007. <https://doi.org/10.1103/physrevd.78.104007>
- Hannam M, Husa S, Ohme F, Ajith P (2010b) Length requirements for numerical-relativity waveforms. *Physical Review D* 82:124052. <https://doi.org/10.1103/physrevd.82.124052>
- Hannam M, Husa S, Ohme F, et al (2010a) Simulations of black-hole binaries with unequal masses or nonprecessing spins: Accuracy, physical properties, and comparison with post-Newtonian results. *Physical Review D* 82:124008. <https://doi.org/10.1103/physrevd.82.124008>
- Hannam M, Schmidt P, Bohé A, et al (2014) Simple Model of Complete Precessing Black-Hole-Binary Gravitational Waveforms. *Physical Review Letters* 113:151101. <https://doi.org/10.1103/physrevlett.113.151101>
- Harden J, Arp V (1963) The lower critical field in the Ginzburg-Landau theory of superconductivity. *Cryogenics*, 3(2):105–108. doi:10.1016/0011-2275(63)90029-8
- Harms E, Bernuzzi S, Nagar A, Zenginoğlu A (2014) A new gravitational wave generation algorithm for particle perturbations of the Kerr spacetime. *Classical and Quantum Gravity* 31:245004. <https://doi.org/10.1088/0264-9381/31/24/245004>
- Harry GM (2010) Advanced LIGO: the next generation of gravitational wave detectors. *Classical and Quantum Gravity* 27:084006. <https://doi.org/10.1088/0264-9381/27/8/084006>
- Harry GM, Abernathy MR, Becerra-Toledo AE, et al (2006) Titania-doped tantala/silica coatings for gravitational-wave detection. *Classical and Quantum Gravity* 24:405–415. <https://doi.org/10.1088/0264-9381/24/2/008>
- Harry IW, Nitz AH, Brown DA, et al (2014) Investigating the effect of precession on searches for neutron-star–black-hole binaries with Advanced LIGO. *Physical Review D* 89:024010. <https://doi.org/10.1103/physrevd.89.024010>
- Hawking SW (1971) Gravitational Radiation from Colliding Black Holes. *Physical Review Letters* 26:1344–1346. <https://doi.org/10.1103/physrevlett.26.1344>
- Healy J, Lousto CO, Zlochower Y (2014) Remnant mass, spin, and recoil from spin aligned black-hole binaries. *Phys Rev D* 90:104004. <https://doi.org/10.1103/PhysRevD.90.104004>
- Heene M (2013) Additive conjoint measurement and the resistance toward falsifiability in psychology. *Frontiers in Psychology* 4:246. <https://doi.org/10.3389/fpsyg.2013.00246>
- Heilbron J, Aubrecht GJ (1987) The dilemmas of an upright man. *American Association of Physics Teachers*
- Hessels JWT (2006) A Radio Pulsar Spinning at 716 Hz. *Science* 311:1901–1904. <https://doi.org/10.1126/science.1123430>

- Heuvel EPJ van den (2003) Testing time for gravity. *Nature* 426:504–505. <https://doi.org/10.1038/426504a>
- Hinder I, Buonanno A, Boyle M, et al (2013) Error-analysis and comparison to analytical models of numerical waveforms produced by the NRAR Collaboration. *Classical and Quantum Gravity* 31:025012. <https://doi.org/10.1088/0264-9381/31/2/025012>
- Hinderer T (2008) Tidal Love Numbers of Neutron Stars. *The Astrophysical Journal* 677:1216–1220. <https://doi.org/10.1086/533487>
- Hinderer T, Lackey BD, Lang RN, Read JS (2010) Tidal deformability of neutron stars with realistic equations of state and their gravitational wave signatures in binary inspiral. *Phys Rev D* 81:123016. <https://doi.org/10.1103/PhysRevD.81.123016>
- Hinderer T, Taracchini A, Foucart F, et al (2016) Effects of Neutron-Star Dynamic Tides on Gravitational Waveforms within the Effective-One-Body Approach. *Phys Rev Lett* 116:181101. <https://doi.org/10.1103/PhysRevLett.116.181101>
- Hoepfl MC (1997) Choosing Qualitative Research: A Primer for Technology Education Researchers. *Journal of Technology Education* 9,1. <https://doi.org/10.21061/jte.v9i1.a.4>
- Hoffman B (1962) *The Tyranny of Testing*. Corwell-Collier, New York.
- Holz DE, Linder E V (2005) Safety in Numbers: Gravitational Lensing Degradation of the Luminosity Distance–Redshift Relation. *The Astrophysical Journal* 631:678–688. <https://doi.org/10.1086/432085>
- Holz DE, Wald R M (1998) New method for determining cumulative gravitational lensing effects in inhomogeneous universes. *Physical Review D* 58: <https://doi.org/10.1103/physrevd.58.063501>
- Hooft G (1974) Magnetic monopoles in unified gauge theories. *Nuclear Physics B*, 79(2):276–284. doi:10.1016/0550-3213(74)90486-6
- Hotokezaka K, Kyutoku K, Sekiguchi Y, Shibata M (2016) Measurability of the tidal deformability by gravitational waves from coalescing binary neutron stars. *Phys Rev D* 93:064082. <https://doi.org/10.1103/PhysRevD.93.064082>
- Hotokezaka K, Piran T (2017) Implications of the Low Binary Black Hole Aligned Spins Observed by LIGO. *The Astrophysical Journal* 842:111. <https://doi.org/10.3847/1538-4357/aa6f61>
- Hu W (1999) Power Spectrum Tomography with Weak Lensing. *The Astrophysical Journal* 522:L21–L24. <https://doi.org/10.1086/312210>
- Husa S, González JA, Hannam M, et al (2008) Reducing phase error in long numerical binary black hole evolutions with sixth-order finite differencing. *Classical and Quantum Gravity* 25:105006. <https://doi.org/10.1088/0264-9381/25/10/105006>
- Husa S, Khan S, Hannam M, et al (2016) Frequency-domain gravitational waves from nonprecessing black-hole binaries. I. New numerical waveforms and anatomy of the signal. *Phys Rev D* 93:044006. <https://doi.org/10.1103/PhysRevD.93.044006>
- Isaacson RA (1968) Gravitational Radiation in the Limit of High Frequency. I. The Linear Approximation and Geometrical Optics. *Physical Review* 166:1263–1271. <https://doi.org/10.1103/physrev.166.1263>
- Israel W (1967) Event Horizons in Static Vacuum Space-Times. *Physical Review* 164:1776–1779. <https://doi.org/10.1103/physrev.164.1776>
- Itin CM (1999) Reasserting the Philosophy of Experiential Education as a Vehicle for Change in the 21st Century. *Journal of Experiential Education* 22:91–98. <https://doi.org/10.1177/105382599902200206>
- Itoh N (1970) Hydrostatic Equilibrium of Hypothetical Quark Stars. *Progress of Theoretical Physics* 44:291–292. <https://doi.org/10.1143/ptp.44.291>

- Jacobson T, Mattingly D (2001) Gravity with a dynamical preferred frame. *Physical Review D* 64:024028. <https://doi.org/10.1103/physrevd.64.024028>
- James T (1990) Kurt Hahn and the Aims of Education. *Journal of Experiential Education* 13:6–13. <https://doi.org/10.1177/105382599001300101>
- Jaranowski P, Królak A (2012) Gravitational-Wave Data Analysis. Formalism and Sample Applications: The Gaussian Case. *Living Reviews in Relativity*, 15(1). doi:10.12942/lrr-2012-4
- Jaranowski P, Królak A, Schutz BF (1998) Data analysis of gravitational-wave signals from spinning neutron stars: The signal and its detection. *Physical Review D* 58:063001. <https://doi.org/10.1103/physrevd.58.063001>
- Javornik Krečič M, Kovše S, Ploj Vrtič M (2013) The Role and Meaning of School Counseling When Dealing With Peer Violence. *Croatian Journal of Education* [Internet]. [pristupljeno 28.05.2020.]; 15(2):521-541. Dostupno na: <https://hrcak.srce.hr/105554>
- Johnson DW, et al (1981) Effects of cooperative, competitive, and individualistic goal structures on achievement: A meta-analysis. *Psychological Bulletin*, 89(1):47–62. doi:10.1037/0033-2909.89.1.47
- Jones DI, Andersson N (2002) Gravitational waves from freely precessing neutron stars. *Monthly Notices of the Royal Astronomical Society* 331:203–220. <https://doi.org/10.1046/j.1365-8711.2002.05180.x>
- Jost J (2016) *Bernhard Riemann on the Hypotheses which Lie at the Bases of Geometry*. Springer
- Kafka P, Schnupp L (1978) Final result of the Munich-Frascati gravitational radiation experiment. *Astron Astrophys* 70:(1/2):97-103
- Kaiser N (1992) Weak Gravitational Lensing of Distant Galaxies. 388:272. <https://doi.org/10.1086/171151>
- Kalogera V, Kim C, Lorimer DR, et al (2004a) Erratum: “The Cosmic Coalescence Rates for Double Neutron Star Binaries”. *The Astrophysical Journal* 614:L137–L138. <https://doi.org/10.1086/425868>
- Kalogera V, Kim C, Lorimer DR, et al (2004b) The Cosmic Coalescence Rates for Double Neutron Star Binaries. *The Astrophysical Journal* 601:L179–L182. <https://doi.org/10.1086/382155>
- Kalogera V, Narayan R, Spergel DN, Taylor JH (2001) The Coalescence Rate of Double Neutron Star Systems. *The Astrophysical Journal* 556:340–356. <https://doi.org/10.1086/321583>
- Kamaretsos I, Hannam M, Husa S, Sathyaprakash BS (2012) Black-hole hair loss: Learning about binary progenitors from ringdown signals. *Physical Review D* 85:024018. <https://doi.org/10.1103/physrevd.85.024018>
- Kangro H (1976) *Early history of Planck’s radiation law*, Taylor and Francis.
- Kanner JB, Littenberg TB, Cornish N, et al (2016) Leveraging waveform complexity for confident detection of gravitational waves. *Phys Rev D* 93:022002. <https://doi.org/10.1103/PhysRevD.93.022002>
- Katsanevas S (1993) Prospects for supersymmetry at LEP200. Report DELPHI-93-109 PHYS 336, 7.
- Katsanevas S (1995) Long baseline neutrino oscillation beams and experiments. 30th Rencontres de Moriond: Electroweak Interactions and Unified Theories, pp. 481-489.
- Katsanevas S (1998) Supersymmetry at LEP, experimental review. *Journal of Physics G: Nuclear and Particle Physics*, 24(2):337–352. doi:10.1088/0954-3899/24/2/008
- Kaup DJ (1968) Klein-Gordon Geon. *Physical Review* 172:1331–1342. <https://doi.org/10.1103/physrev.172.1331>
- Kaye GWC, Laby TH (1973) *Tables of physical and chemical constants*. Longman.

- Keith JT (2015) Recent astronomical tests of general relativity. *International Journal of Physical Sciences* 10:90–105. <https://doi.org/10.5897/ijps2014.4236>
- Kennefick D (2005a) Controversies in the history of the radiation reaction problem in general relativity. In: Goenner H, Renn J, Ritter J, Sauer T (eds) *The expanding worlds of general relativity* (Einstein studies, volume 7). Birkhauser, Boston
- Kennefick D (2007) *Traveling at the speed of thought: Einstein and the quest for gravitational waves*. Princeton University Press, Princeton
- Keppel D, Ajith P (2010) Constraining the mass of the graviton using coalescing black-hole binaries. *Physical Review D* 82:122001. <https://doi.org/10.1103/physrevd.82.122001>
- Kerr RP (1963) Gravitational Field of a Spinning Mass as an Example of Algebraically Special Metrics. *Phys Rev Lett* 11:237–238. <https://doi.org/10.1103/PhysRevLett.11.237>
- Khan S, Husa S, Hannam M, et al (2016) Frequency-domain gravitational waves from nonprecessing black-hole binaries. II. A phenomenological model for the advanced detector era. *Phys Rev D* 93:044007. <https://doi.org/10.1103/PhysRevD.93.044007>
- Khan S, Husa S, Hannam M, Ohme F, Pürrer M, Forteza X J, Bohé A (2016) Frequency-domain gravitational waves from nonprecessing black-hole binaries. II. A phenomenological model for the advanced detector era. *Physical Review D* 93. <https://doi.org/10.1103/physrevd.93.044007>
- Kidder L E, Will C M, Wiseman A G (1993) Coalescing binary systems of compact objects to (post)52-Newtonian order. III. Transition from inspiral to plunge. *Physical Review D* 47:3281–3291. <https://doi.org/10.1103/physrevd.47.3281>
- Kidder L E, Will C M, Wiseman A G (1993) Spin effects in the inspiral of coalescing compact binaries. *Physical Review D* 47:R4183–R4187. <https://doi.org/10.1103/physrevd.47.r4183>
- Kidder LE (1995) Coalescing binary systems of compact objects to (post)52-Newtonian order. V. Spin effects. *Physical Review D* 52:821–847. <https://doi.org/10.1103/physrevd.52.821>
- Kim C, Kalogera V, Lorimer DR (2003) The Probability Distribution of Binary Pulsar Coalescence Rates. I. Double Neutron Star Systems in the Galactic Field. *The Astrophysical Journal* 584:985–995. <https://doi.org/10.1086/345740>
- Kim C, Perera BBP, McLaughlin MA (2015) Implications of PSR J0737–3039B for the Galactic NS–NS binary merger rate. *Monthly Notices of the Royal Astronomical Society* 448:928–938. <https://doi.org/10.1093/mnras/stu2729>
- Kjeldsen TH (2011) Uses of history in mathematics education: Development of learning strategies and historical awareness. In: CERME 7, Proceedings of the seventh Congress of the European Society for Research in Mathematics Education. pp 1700–1709
- Klainerman S, Rodnianski I, Szeftel J (2012) Overview of the proof of the Bounded  $L^2$  Curvature Conjecture. Retrieved: <https://arxiv.org/abs/1204.1772>
- Klein MJ (1961) Max Planck and the beginnings of the quantum theory. *Archive for History of Exact Sciences* 1:459–479
- Klimenko S, Vedovato G, Drago M, et al (2016) Method for detection and reconstruction of gravitational wave transients with networks of advanced detectors. *Phys Rev D* 93:042004. <https://doi.org/10.1103/PhysRevD.93.042004>
- Klimenko S, Yakushin I, Mercer A, Mitselmakher G (2008) A coherent method for detection of gravitational wave bursts. *Classical and Quantum Gravity* 25:114029

- Knop R A, Aldering G, Amanullah R, Astier P, Blanc G, Burns M S, Conley A, Deustua S E, Doi M, Ellis R, et al. (2003) New Constraints on  $\Omega_M$ ,  $\Omega_\Lambda$ , and  $w$  from an Independent Set of 11 High-Redshift Supernovae Observed with the Hubble Space Telescope. *The Astrophysical Journal* 598:102–137. <https://doi.org/10.1086/378560>
- Kocsis B, Frei Z, Haiman Z, Menou K (2006) Finding the Electromagnetic Counterparts of Cosmological Standard Sirens. *The Astrophysical Journal* 637:27–37. <https://doi.org/10.1086/498236>
- Kolb EW, Colgate SA, Harvey JA (1982) Monopole Catalysis of Nucleon Decay in Neutron Stars. *Physical Review Letters*, 49(19):1373–1375. doi:10.1103/physrevlett.49.1373
- Köse S (2008) Diagnosing student misconceptions: Using drawings as a research method. *World Applied Sciences Journal* 3:283–293
- Koushiappas S M, Zentner A R (2006) Testing Models of Supermassive Black Hole Seed Formation through Gravity Waves. *The Astrophysical Journal* 639:7–22. <https://doi.org/10.1086/499325>
- Kragh H (2000) Max Planck: the reluctant revolutionary. *Physics World* 13:31–36. <https://doi.org/10.1088/2058-7058/13/12/34>
- Kreidberg L, Bailyn CD, Farr WM, Kalogera V (2012) MASS MEASUREMENTS OF BLACK HOLES IN X-RAY TRANSIENTS: IS THERE A MASS GAP? *The Astrophysical Journal* 757:36. <https://doi.org/10.1088/0004-637x/757/1/36>
- Krishnan B (for the LIGO Collaboration) the LS (2005) Wide parameter search for isolated pulsars using the Hough transform. *Classical and Quantum Gravity* 22:S1265–S1275. <https://doi.org/10.1088/0264-9381/22/18/s40>
- Krishnan B, Sintès AM, Papa MA, et al (2004) Hough transform search for continuous gravitational waves. *Physical Review D* 70:082001. <https://doi.org/10.1103/physrevd.70.082001>
- Krolak A, Schutz BF (1987) Coalescing binaries—Probe of the universe. *General Relativity and Gravitation* 19:1163–1171. <https://doi.org/10.1007/BF00759095>
- Kruskal MD (1960) Maximal extension of Schwarzschild metric. *Physical review* 119:1743
- Kuhn L, Reiser B (2005) Students constructing and defending evidence-based scientific explanations
- Kumar P, Barkett K, Bhagwat S, et al (2015) Accuracy and precision of gravitational-wave models of inspiraling neutron star-black hole binaries with spin: Comparison with matter-free numerical relativity in the low-frequency regime. *Physical Review D* 92:102001. <https://doi.org/10.1103/physrevd.92.102001>
- Kumar P, Chu T, Fong H, et al (2016) Accuracy of binary black hole waveform models for aligned-spin binaries. *Physical Review D* 93:104050. <https://doi.org/10.1103/physrevd.93.104050>
- Lackey BD, Bernuzzi S, Galley CR, et al (2017) Effective-one-body waveforms for binary neutron stars using surrogate models. *Phys Rev D* 95:104036. <https://doi.org/10.1103/PhysRevD.95.104036>
- Lackey BD, Nayyar M, Owen BJ (2006) Observational constraints on hyperons in neutron stars. *Phys Rev D* 73:024021. <https://doi.org/10.1103/PhysRevD.73.024021>
- Lackey BD, Wade L (2015) Reconstructing the neutron-star equation of state with gravitational-wave detectors from a realistic population of inspiralling binary neutron stars. *Phys Rev D* 91:043002. <https://doi.org/10.1103/PhysRevD.91.043002>
- Lampin E, Palla PL, Francioso P-A, Cleri F (2013) Thermal conductivity from approach-to-equilibrium molecular dynamics. *Journal of Applied Physics*, 114(3):033525. doi:10.1063/1.4815945
- Landau L, Lifschitz E (1967) *Théorie de l'élasticité*. MIR, Moscow.



- Landau LD, Lifchitz E (1960) *Electrodynamics of continuous media*. Pergamon Press, p. 174.
- Landry P, Poisson E (2015) Tidal deformation of a slowly rotating material body: External metric. *Phys Rev D* 91:104018. <https://doi.org/10.1103/PhysRevD.91.104018>
- Landuzzi F, Viader-Godoy X, Cleri F, Pastor I, Ritort F (2020) Detection of single DNA mismatches by force spectroscopy in short DNA hairpins. *The Journal of Chemical Physics*, 152(7):074204. doi:10.1063/1.5139284
- Lasky PD, Glampedakis K (2016) Observationally constraining gravitational wave emission from short gamma-ray burst remnants. *Monthly Notices of the Royal Astronomical Society* 458:1660–1670. <https://doi.org/10.1093/mnras/stw435>
- Lattimer JM, Prakash M (2016) The equation of state of hot, dense matter and neutron stars. *Physics Reports* 621:127–164. <https://doi.org/10.1016/j.physrep.2015.12.005>
- Lave J, Wenger E (1991) *Situated Learning*. Cambridge University Press
- Lehto H J, Valtonen M J (1996) OJ 287 Outburst Structure and a Binary Black Hole Model. 460:207. <https://doi.org/10.1086/176962>
- Leplae L, Mancini F, Umezawa H (1972) Computation of the magnetization curve for vanadium at  $T = 0^\circ\text{C}$ . *Physics Letters A*, 40(2):177–178. doi:10.1016/0375-9601(72)90848-1
- Lewis GN (1916) THE ATOM AND THE MOLECULE. *Journal of the American Chemical Society* 38:762–785. <https://doi.org/10.1021/ja02261a002>
- Lewis LH, Williams CJ (1994) *Experiential learning: Past and present. New Directions for Adult and Continuing Education* 1994:5–16. <https://doi.org/10.1002/ace.36719946203>
- Li TGF, Del Pozzo W, Vitale S, et al (2012) Towards a generic test of the strong field dynamics of general relativity using compact binary coalescence. *Phys Rev D* 85:082003. <https://doi.org/10.1103/PhysRevD.85.082003>
- Liebling SL, Palenzuela C (2012) Dynamical Bosen Stars. *Living Reviews in Relativity* 15,6. <https://doi.org/10.12942/lrr-2012-6>
- Linde A (1981) Confinement of monopoles at ultrahigh temperature. *JETP Lett.* 32(8)516-518.
- Lindsey BA, Heron PRL, Shaffer PS (2012) Student understanding of energy: Difficulties related to systems. *American Journal of Physics* 80:154–163. <https://doi.org/10.1119/1.3660661>
- Lipunov VM, Postnov KA, Prokhorov ME (1997) Formation and coalescence of relativistic binary stars: the effect of kick velocity. *Monthly Notices of the Royal Astronomical Society* 288:245–259. <https://doi.org/10.1093/mnras/288.1.245>
- Liu P-H (2003) Do teachers need to incorporate the history of mathematics in their teaching. *Mathematics Teacher* 96:416–421
- Lo K-W, Lin L-M (2011) THE SPIN PARAMETER OF UNIFORMLY ROTATING COMPACT STARS. *The Astrophysical Journal* 728:12. <https://doi.org/10.1088/0004-637x/728/1/12>
- Lorimer DR (2001) Binary and Millisecond Pulsars at the New Millennium. *Living Reviews in Relativity* 4,5. <https://doi.org/10.12942/lrr-2001-5>
- Lorimer DR, Bailes M, McLaughlin MA, et al (2007) A Bright Millisecond Radio Burst of Extragalactic Origin. *Science* 318:777–780. <https://doi.org/10.1126/science.1147532>
- Lynch R, Vitale S, Essick R, et al (2017) Information-theoretic approach to the gravitational-wave burst detection problem. *Physical Review D* 95:104046. <https://doi.org/10.1103/physrevd.95.104046>
- Lynch RS, Freire PCC, Ransom SM, Jacoby BA (2012) THE TIMING OF NINE GLOBULAR CLUSTER PULSARS. *The Astrophysical Journal* 745:109. <https://doi.org/10.1088/0004-637x/745/2/109>
- Lynton EA (1962) *Superconductivity*. Methuen.

- Lyons L, others (2008) Open statistical issues in particle physics. *The Annals of Applied Statistics* 2:887–915
- Macbeth D (2003) Hugh Mehan’s “Learning Lessons” Reconsidered: On the Differences between the Naturalistic and Critical Analysis of Classroom Discourse. *American Educational Research Journal* 40:239–280
- MacDonald I, Mroué AH, Pfeiffer HP, et al (2013) Suitability of hybrid gravitational waveforms for unequal-mass binaries. *Physical Review D* 87:024009. <https://doi.org/10.1103/physrevd.87.024009>
- MacDonald I, Nissanke S, Pfeiffer HP (2011) Suitability of post-Newtonian/numerical-relativity hybrid waveforms for gravitational wave detectors. *Classical and Quantum Gravity* 28:134002. <https://doi.org/10.1088/0264-9381/28/13/134002>
- Macnamara J (1982) *Names for Things: A Study of Human Learning*. M.I.T. Press, Cambridge, MA.
- Makel MC, Plucker JA (2014) Facts Are More Important Than Novelty. *Educational Researcher* 43:304–316. <https://doi.org/10.3102/0013189x14545513>
- Manca F, Giordano S, Palla PL, Cleri F (2014) On the equivalence of thermodynamics ensembles for flexible polymer chains. *Physica A: Statistical Mechanics and Its Applications*, 395:154–170. doi:10.1016/j.physa.2013.10.042
- Manchester RN, Hobbs GB, Teoh A, Hobbs M (2005) The Australia Telescope National Facility Pulsar Catalogue. *The Astronomical Journal* 129:1993–2006. <https://doi.org/10.1086/428488>
- Marcacci F (2005) L’induzione e la conoscenza scientifica in Aristotele: un’analisi di An. Pr. II 23.
- Marcacci F (2005) Sul ruolo dell’induzione nell’epistemologia di Aristotele. *AQUINAS-ROME-*, 48 (1/2):33.
- Marcacci F (2008) *Alle origini dell’assiomatica: gli Eleati, Aristotele, Euclide*. Roma: Aracne.
- Marcacci F (2009) *Bibliografia tematica galileiana*. In: Galileo Galilei, *Sidereus Nuncius*, traduzione e commento di P. A. Giustini, a cura di Flavia Marcacci. Lateran University Press, Roma, pp. 221-328.
- Marcacci F (2009) From the sky to maps: observation and theory of the heavens between the 16th and the 18th century (con versione italiana Dal cielo alle carte: osservazione e teoria del cielo tra XVI e XVIII secolo). In: *Magna longeque ad mirabilia. Astronomia e cosmologia nel fondo antico della Biblioteca Beato Pio IX*, a cura di F. Marcacci, F. C. Panini e Lateran University Press, Modena – Città del Vaticano, 24-52.
- Marcacci F (Ed.) (2009) *Magna longeque admirabilia: astronomia e cosmologia nel fondo antico della Biblioteca Beato Pio IX; [29 novembre-11 dicembre 2009]*. Panini.
- Marcacci F (2010) *Metaphors of Galileo between cosmography and astronomy: some brief reflections*. In: Altamore A, Antonini G (eds.), *Galileo and the renaissance scientific discourse*. Edizioni Nuova Cultura, pp. 103-110.
- Marcacci F (2014) *Illusions, Ghosts and Movies in the history of scientific instruments*. Gino Tarozzi *Philosopher of Physics*. *Studies in the philosophy of entanglement on his 60th birthday: Studies in the philosophy of entanglement on his 60th birthday*, pp. 148-158.
- Marcacci F (2015) *Galileo Galilei: una storia da osservare*. Lateran University Press.
- Marcacci F (2015) *History of Science, Epistemology, and Ontology*. In *Science Between Truth and Ethical Responsibility*. Springer, pp. 231-241.
- Marcacci F (2015) *The World-System of Giovanni Battista Riccioli and the Phases of Venus and Mercury*. *Advances in Historical Studies*, 4(2):106-117. doi: 10.4236/ahs.2015.42011.

- Marcacci F (2018) Creazione e cosmologia scientifica: Problemi epistemologici e opportunità speculative. *Aquinas*, 61(1/2):147-164.
- Marciano W, Pagels H (1978) Quantum chromodynamics. *Physics Reports*, 36(3):137–276. doi:10.1016/0370-1573(78)90208-9
- Markovic D (1993) Possibility of determining cosmological parameters from measurements of gravitational waves emitted by coalescing, compact binaries. *Phys. Rev. D* 48:4738–4756. <https://doi.org/10.1103/PhysRevD.48.4738>
- Marsat S (2015) Cubic-order spin effects in the dynamics and gravitational wave energy flux of compact object binaries. *Classical and Quantum Gravity* 32:085008. <https://doi.org/10.1088/0264-9381/32/8/085008>
- Martin E, Palla PL, Cleri F, Bouzid A, Ori G, Le Roux S, Boero M, Massobrio C (2018). On the occurrence of size effects in the calculation of thermal conductivity by first-principles molecular dynamics: The case of glassy GeTe 4. *Journal of Non-Crystalline Solids*, 498:190–193. doi:10.1016/j.jnoncrysol.2018.05.014
- Mateo M (1998) DWARF GALAXIES OF THE LOCAL GROUP. *Annual Review of Astronomy and Astrophysics* 36:435–506. <https://doi.org/10.1146/annurev.astro.36.1.435>
- Matichard F, Lantz B, Mittleman R, et al (2015) Seismic isolation of Advanced LIGO: Review of strategy, instrumentation and performance. *Classical and Quantum Gravity* 32:185003. <https://doi.org/10.1088/0264-9381/32/18/185003>
- Mazur PO, Mottola E (2004) Gravitational vacuum condensate stars. *Proceedings of the National Academy of Sciences* 101:9545–9550. <https://doi.org/10.1073/pnas.0402717101>
- McDermott LC (1991) Millikan Lecture 1990: What we teach and what is learned—Closing the gap. *American Journal of Physics* 59:301–315. <https://doi.org/10.1119/1.16539>
- McKechan DJA, Robinson C, Sathyaprakash BS (2010) A tapering window for time-domain templates and simulated signals in the detection of gravitational waves from coalescing compact binaries. *Classical and Quantum Gravity* 27:084020. <https://doi.org/10.1088/0264-9381/27/8/084020>
- McKernan B, Saavik Ford KE, Bellovary J, et al (2018) Constraining Stellar-mass Black Hole Mergers in AGN Disks Detectable with LIGO. *The Astrophysical Journal* 866:66. <https://doi.org/10.3847/1538-4357/aadae5>
- Mead CA (1964) Possible Connection Between Gravitation and Fundamental Length. *Phys Rev* 135:B849–B862. <https://doi.org/10.1103/PhysRev.135.B849>
- Mead CA (1966) Observable Consequences of Fundamental-Length Hypotheses. *Physical Review* 143:990–1005. <https://doi.org/10.1103/physrev.143.990>
- Meadors GD, Kawabe K, Riles K (2014) Increasing LIGO sensitivity by feedforward subtraction of auxiliary length control noise. *Classical and Quantum Gravity* 31:105014. <https://doi.org/10.1088/0264-9381/31/10/105014>
- Meers BJ (1988) Recycling in laser-interferometric gravitational-wave detectors. *Phys Rev D* 38:2317–2326. <https://doi.org/10.1103/PhysRevD.38.2317>
- Messiah A (1966) *Quantum mechanics*. 2 (1966). North-Holland Publishing Company
- Messick C, Blackburn K, Brady P, et al (2017) Analysis framework for the prompt discovery of compact binary mergers in gravitational-wave data. *Phys Rev D* 95:042001. <https://doi.org/10.1103/PhysRevD.95.042001>

- Metzger BD, Martínez-Pinedo G, Darbha S, et al (2010) Electromagnetic counterparts of compact object mergers powered by the radioactive decay of r-process nuclei. *Monthly Notices of the Royal Astronomical Society* 406:2650–2662. <https://doi.org/10.1111/j.1365-2966.2010.16864.x>
- Miettinen R (2000) The concept of experiential learning and John Dewey's theory of reflective thought and action. *International Journal of Lifelong Education* 19:54–72. <https://doi.org/10.1080/026013700293458>
- Mikóczy B, Vasúth M, Gergely LÁ (2005) Self-interaction spin effects in inspiralling compact binaries. *Physical Review D* 71:124043. <https://doi.org/10.1103/physrevd.71.124043>
- Miller MC, Miller JM (2015) The masses and spins of neutron stars and stellar-mass black holes. *Physics Reports* 548:1–34. <https://doi.org/10.1016/j.physrep.2014.09.003>
- Milosavljević M, Phinney E S (2005) The Afterglow of Massive Black Hole Coalescence. 622:L93–L96. <https://doi.org/10.1086/429618>
- Mintz R (1993) Computerized Simulation as an Inquiry Tool. *School Science and Mathematics* 93:76–80. <https://doi.org/10.1111/j.1949-8594.1993.tb12198.x>
- Mintzes J, Wandersee J, Novak J (1998) *Teaching Science For Understanding*. Academic Press, San Diego.
- Mintzes J, Wandersee J, Novak J (2000) *Assessing Science Understanding*. Academic Press, San Diego.
- Mishra CK, Arun KG, Iyer BR, Sathyaprakash BS (2010) Parametrized tests of post-Newtonian theory using Advanced LIGO and Einstein Telescope. *Phys Rev D* 82:064010. <https://doi.org/10.1103/PhysRevD.82.064010>
- Mishra CK, Kela A, Arun KG, Faye G (2016) Ready-to-use post-Newtonian gravitational waveforms for binary black holes with nonprecessing spins: An update. *Phys Rev D* 93:084054. <https://doi.org/10.1103/PhysRevD.93.084054>
- Mizuno J, Strain KA, Nelson PG, et al (1993) Resonant sideband extraction: a new configuration for interferometric gravitational wave detectors. *Physics Letters A* 175:273–276. [https://doi.org/10.1016/0375-9601\(93\)90620-F](https://doi.org/10.1016/0375-9601(93)90620-F)
- Mohanty SD (2002) Median based line tracker (MBLT): model independent and transient preserving line removal from interferometric data. *Classical and Quantum Gravity* 19:1513–1519. <https://doi.org/10.1088/0264-9381/19/7/338>
- Mohanty SD, Mukherjee S (2002) Towards a data and detector characterization robot for gravitational wave detectors. *Classical and Quantum Gravity* 19:1471–1476. <https://doi.org/10.1088/0264-9381/19/7/332>
- Mohon L (2018) GRB 150101B: A Distant Cousin to GW170817. In: NASA. [http://www.nasa.gov/mission\\_pages/chandra/images/grb-150101b-a-distant-cousin-to-gw170817.html](http://www.nasa.gov/mission_pages/chandra/images/grb-150101b-a-distant-cousin-to-gw170817.html)
- Moore T A, Hellings R W (2002) Angular resolution of space-based gravitational wave detectors. *Phys. Rev. D* 65:62001. <https://doi.org/10.1103/PhysRevD.65.062001>
- Moser E, Seidl E, Weber HW (1982) Superconductive properties of vanadium and their impurity dependence. *Journal of Low Temperature Physics*, 49(5-6):585–607. doi:10.1007/bf00681903
- Moskowitz C (2014) Gravity Waves from Big Bang Detected. *Scientific American*.
- Moss G, Miller L, Forward R (1971) Photon-noise-limited laser transducer for gravitational antenna. *Applied Optics* 10:2495–2498

- Mroué A H, Scheel M A, Szilágyi B, Pfeiffer H P, Boyle M, Hemberger D A, Kidder L E, Lovelace G, Ossokine S, Taylor N W, Zenginoğlu A, Buchman L T, Chu T, Foley E, Giesler M, Owen R, Teukolsky S A (2013) Catalog of 174 Binary Black Hole Simulations for Gravitational Wave Astronomy. *Physical Review Letters* 111: <https://doi.org/10.1103/physrevlett.111.241104>
- Mroué AH, Scheel MA, Szilágyi B, et al (2013) Catalog of 174 Binary Black Hole Simulations for Gravitational Wave Astronomy. *Phys Rev Lett* 111:241104. <https://doi.org/10.1103/PhysRevLett.111.241104>
- Müller H, Serot BD (1996) Relativistic mean-field theory and the high-density nuclear equation of state. *Nuclear Physics A* 606:508–537. [https://doi.org/10.1016/0375-9474\(96\)00187-x](https://doi.org/10.1016/0375-9474(96)00187-x)
- Müther H, Prakash M, Ainsworth TL (1987) The nuclear symmetry energy in relativistic Brueckner-Hartree-Fock calculations. *Physics Letters B* 199:469–474. [https://doi.org/10.1016/0370-2693\(87\)91611-x](https://doi.org/10.1016/0370-2693(87)91611-x)
- Nagar A, Damour T, Reisswig C, Pollney D (2016) Energetics and phasing of nonprecessing spinning coalescing black hole binaries. *Physical Review D* 93:044046. <https://doi.org/10.1103/physrevd.93.044046>
- Nagar A, Riemenschneider G, Pratten G (2017) Impact of numerical relativity information on effective-one-body waveform models. *Physical Review D* 96:084045. <https://doi.org/10.1103/physrevd.96.084045>
- Nakagawa N, Auld B, Gustafson E, Fejer M (1997) Estimation of thermal noise in the mirrors of laser interferometric gravitational wave detectors: Two point correlation function. *Review of scientific instruments* 68:3553–3556
- Nakamura T, Oohara K, Kojima Y (1987) General Relativistic Collapse to Black Holes and Gravitational Waves from Black Holes. *Progress of Theoretical Physics Supplement*, 90:1–218. doi:10.1143/ptps.90.1
- NAKAR E (2007) Short-hard gamma-ray bursts. *Physics Reports* 442:166–236. <https://doi.org/10.1016/j.physrep.2007.02.005>
- Narayan R, Piran T, Shemi A (1991) Neutron Star and Black Hole Binaries in the Galaxy. *Astrophysical Journal Letters*, 379:L17
- Nättilä J, Miller MC, Steiner AW, et al (2017) Neutron star mass and radius measurements from atmospheric model fits to X-ray burst cooling tail spectra. *Astronomy & Astrophysics* 608:A31. <https://doi.org/10.1051/0004-6361/201731082>
- Nickerson RS (1998) Confirmation Bias: A Ubiquitous Phenomenon in Many Guises. *Review of General Psychology* 2:175–220. <https://doi.org/10.1037/1089-2680.2.2.175>
- Nitz AH (2018) Distinguishing short duration noise transients in LIGO data to improve the PyCBC search for gravitational waves from high mass binary black hole mergers. *Classical and Quantum Gravity* 35:035016. <https://doi.org/10.1088/1361-6382/aaa13d>
- Nitz AH, Dent T, Dal Canton T, et al (2017) Detecting Binary Compact-object Mergers with Gravitational Waves: Understanding and Improving the Sensitivity of the PyCBC Search. *The Astrophysical Journal* 849:118. <https://doi.org/10.3847/1538-4357/aa8f50>
- Nitz AH, Lundgren A, Brown DA, et al (2013) Accuracy of gravitational waveform models for observing neutron-star–black-hole binaries in Advanced LIGO. *Physical Review D* 88:124039. <https://doi.org/10.1103/physrevd.88.124039>
- Novak JD (1977) *A Theory of Education*. Cornell University Press, Ithaca, NY.
- Novak JD (1990) Concept maps and Vee diagrams: two metacognitive tools to facilitate meaningful learning. *Instructional Science*, 19(1):29–52. doi:10.1007/bf00377984
- Novak JD (1991) Clarify with concept maps. *The Science Teacher*, 58(7):45–49.

- Novak JD, Gowin DB (1984) *Learning How to Learn*. Cambridge University Press, New York and Cambridge, UK.
- Novak JD, Musonda D (1991) A twelve-year longitudinal study of science concept learning. *American Educational Research Journal*, 28(1):117-153.
- Novak JD, Wandersee J (1991) Coeditors, Special Issue on Concept Mapping of *Journal of Research in Science Teaching*, 28(10).
- Nuttall LK, Massinger T, Areeda J, et al (2015) Improving the data quality of Advanced LIGO based on early engineering run results. *Classical and Quantum Gravity* 32:245005
- Nutzman P, Kalogera V, Finn LS, et al (2004) Gravitational Waves from Extragalactic Inspiring Binaries: Selection Effects and Expected Detection Rates. *The Astrophysical Journal* 612:364–374. <https://doi.org/10.1086/422572>
- O’Shaughnessy R, Kim C, Fragos T, et al (2005) Constraining Population Synthesis Models via the Binary Neutron Star Population. *The Astrophysical Journal* 633:1076–1084. <https://doi.org/10.1086/468180>
- O’Shaughnessy R, London L, Healy J, Shoemaker D (2013) Precession during merger: Strong polarization changes are observationally accessible features of strong-field gravity during binary black hole merger. *Physical Review D* 87:044038. <https://doi.org/10.1103/physrevd.87.044038>
- Ohanian HC (2009) Did Einstein prove  $E=mc^2$ ? *Studies in History and Philosophy of Science Part B: Studies in History and Philosophy of Modern Physics* 40:167–173. <https://doi.org/10.1016/j.shpsb.2009.03.002>
- Ohme F, Hannam M, Husa S (2011) Reliability of complete gravitational waveform models for compact binary coalescences. *Physical Review D* 84:064029. <https://doi.org/10.1103/physrevd.84.064029>
- Ohme F, Nielsen AB, Keppel D, Lundgren A (2013) Statistical and systematic errors for gravitational-wave inspiral signals: A principal component analysis. *Phys Rev D* 88:042002. <https://doi.org/10.1103/PhysRevD.88.042002>
- Olive KA (1983) CERN preprint TH.3587
- Osborne JW (2013) Is data cleaning and the testing of assumptions relevant in the 21st century? *Frontiers in Psychology* 4:370. <https://doi.org/10.3389/fpsyg.2013.00370>
- Owen BJ (1996) Search templates for gravitational waves from inspiraling binaries: Choice of template spacing. *Physical Review D* 53:6749–6761. <https://doi.org/10.1103/physrevd.53.6749>
- Owen BJ (2005) Maximum Elastic Deformations of Compact Stars with Exotic Equations of State. *Physical Review Letters* 95:211101. <https://doi.org/10.1103/physrevlett.95.211101>
- Owen BJ, Lindblom L, Cutler C, et al (1998) Gravitational waves from hot young rapidly rotating neutron stars. *Physical Review D* 58:084020. <https://doi.org/10.1103/physrevd.58.084020>
- Owen BJ, Sathyaprakash BS (1999) Matched filtering of gravitational waves from inspiraling compact binaries: Computational cost and template placement. *Physical Review D* 60:022002. <https://doi.org/10.1103/physrevd.60.022002>
- Özel F, Freire P (2016) Masses, Radii, and the Equation of State of Neutron Stars. *Annual Review of Astronomy and Astrophysics* 54:401–440. <https://doi.org/10.1146/annurev-astro-081915-023322>
- Özel F, Psaltis D, Narayan R, McClintock JE (2010) THE BLACK HOLE MASS DISTRIBUTION IN THE GALAXY. *The Astrophysical Journal* 725:1918–1927. <https://doi.org/10.1088/0004-637x/725/2/1918>
- Pai A, Dhurandhar S, Bose S (2001) Data-analysis strategy for detecting gravitational-wave signals from inspiraling compact binaries with a network of laser-interferometric detectors. *Physical Review D* 64:042004. <https://doi.org/10.1103/physrevd.64.042004>

- Palla PL, Patera G, Cleri F, Giordano S (2020) A stochastic force model for the ballistic-diffusive transition of heat conduction. *Physica Scripta*. doi:10.1088/1402-4896/ab8d56
- Palla PL, Zampa S, Martin E, Cleri F (2019). Interface thermal behavior in nanomaterials by thermal grating relaxation. *International Journal of Heat and Mass Transfer*, 131:932–943. doi:10.1016/j.ijheatmasstransfer.2018.11.064
- Palmy C, Fisher ES (1970) Superconductivity of an  $\alpha$ -uranium single crystal under pressure. *Solid State Communications*, 8(8):655–657. doi:10.1016/0038-1098(70)90168-7
- Palomba C (2005) Simulation of a population of isolated neutron stars evolving through the emission of gravitational waves. *Monthly Notices of the Royal Astronomical Society* 359:1150–1164. <https://doi.org/10.1111/j.1365-2966.2005.08975.x>
- Pan Y, Buonanno A, Baker JG, et al (2008) Data-analysis driven comparison of analytic and numerical coalescing binary waveforms: Nonspinning case. *Physical Review D* 77:024014. <https://doi.org/10.1103/physrevd.77.024014>
- Pan Y, Buonanno A, Boyle M, Buchman L T, Kidder L E, Pfeiffer H P, Scheel M A (2011) Inspiral-merger-ringdown multipolar waveforms of nonspinning black-hole binaries using the effective-one-body formalism. *Physical Review D* 84: <https://doi.org/10.1103/physrevd.84.124052>
- Pan Y, Buonanno A, Boyle M, et al (2011) Inspiral-merger-ringdown multipolar waveforms of nonspinning black-hole binaries using the effective-one-body formalism. *Physical Review D* 84:124052. <https://doi.org/10.1103/physrevd.84.124052>
- Pan Y, Buonanno A, Buchman L T, Chu T, Kidder L E, Pfeiffer H P, Scheel M A (2010) Effective-one-body waveforms calibrated to numerical relativity simulations: Coalescence of nonprecessing, spinning, equal-mass black holes. *Physical Review D* 81: <https://doi.org/10.1103/physrevd.81.084041>
- Pan Y, Buonanno A, Buchman LT, et al (2010) Effective-one-body waveforms calibrated to numerical relativity simulations: Coalescence of nonprecessing, spinning, equal-mass black holes. *Physical Review D* 81:084041. <https://doi.org/10.1103/physrevd.81.084041>
- Pan Y, Buonanno A, Taracchini A, et al (2014) Inspiral-merger-ringdown waveforms of spinning, precessing black-hole binaries in the effective-one-body formalism. *Physical Review D* 89:084006. <https://doi.org/10.1103/physrevd.89.084006>
- Pan Y, Buonanno A, Taracchini A, Kidder L E, Mroué A H, Pfeiffer H P, Scheel M A, Szilágyi B (2014) Inspiral-merger-ringdown waveforms of spinning, precessing black-hole binaries in the effective-one-body formalism. *Physical Review D* 89: <https://doi.org/10.1103/physrevd.89.084006>
- Pan Y-C, Kilpatrick CD, Simon JD, et al (2017) The Old Host-galaxy Environment of SSS17a, the First Electromagnetic Counterpart to a Gravitational-wave Source. *The Astrophysical Journal* 848:L30. <https://doi.org/10.3847/2041-8213/aa9116>
- Pani P, Gualtieri L, Maselli A, Ferrari V (2015) Tidal deformations of a spinning compact object. *Phys Rev D* 92:024010. <https://doi.org/10.1103/PhysRevD.92.024010>
- Pardo K, Fishbach M, Holz DE, Spergel DN (2018) Limits on the number of spacetime dimensions from GW170817. *Journal of Cosmology and Astroparticle Physics* 2018:048–048. <https://doi.org/10.1088/1475-7516/2018/07/048>
- Parisi G (2001) Planck's Legacy to Statistical Mechanics

- Parker E (1983) Magnetic Fields in the Cosmos. *Scientific American*, 249(2):44-57. Retrieved: [www.jstor.org/stable/24968964](http://www.jstor.org/stable/24968964)
- Parker EN (1970) The Origin of Magnetic Fields. *Ap. J.* 160:383-404. Retrieved: <http://adsabs.harvard.edu/full/1970ApJ...160..383P>
- Parker EN (1971) The Generation of Magnetic Fields in Astrophysical Bodies. III. Turbulent Diffusion of Fields and Efficient Dynamos. *Astrophysical Journal*, 163:279-286. Retrieved: <http://adsabs.harvard.edu/full/1971ApJ...163..279P>
- Parker EN (1971) The Generation of Magnetic Fields in Astrophysical Bodies. VI. Periodic Modes of the Galactic Field. *Astrophysical Journal*, 166:295-300. Retrieved: <http://adsabs.harvard.edu/full/1971ApJ...166..295P>
- Parker L (1988) Book Review: Three Hundred Years of Gravitation. S. W. Hawking and W. Israel, Eds. Cambridge University Press, New York. *Science* 240:1069-1070. <https://doi.org/10.1126/science.240.4855.1069>
- Parkinson J, Adendorff R (2004) The use of popular science articles in teaching scientific literacy. *English for Specific Purposes* 23:379-396. <https://doi.org/10.1016/j.esp.2003.11.005>
- Parkinson J, Adendorff R (2005) Science books for children as a preparation for textbook literacy. *Discourse Studies* 7:213-236. <https://doi.org/10.1177/1461445605050367>
- Parks RD (ed.) (1969) *Superconductivity*. Volumes 1 & 2, Marcel Dekker, Inc., New York, Basel.
- Pati M E, Will C M (2000) Post-Newtonian gravitational radiation and equations of motion via direct integration of the relaxed Einstein equations: Foundations. *Physical Review D* 62: <https://doi.org/10.1103/physrevd.62.124015>
- Peccei RD (1983) Max Planck inst. preprint MPI-PAE/PTh 22/83, Munich.
- Peres A, Rosen N (1960) Quantum Limitations on the Measurement of Gravitational Fields. *Physical Review* 118:335-336. <https://doi.org/10.1103/physrev.118.335>
- Pescic P (2007) *Beyond geometry: Classic papers from Riemann to Einstein*. Courier Corporation
- Peters PC, Mathews J (1963) Gravitational Radiation from Point Masses in a Keplerian Orbit. *Phys Rev* 131:435-440. <https://doi.org/10.1103/PhysRev.131.435>
- Philippou GN, Christou C (1998) The Effects of a Preparatory Mathematics Program in Changing Prospective Teachers' Attitudes Towards Mathematics. *Educational Studies in Mathematics* 35:189-206. <https://doi.org/10.1023/a:1003030211453>
- Phinney ES (1991) The rate of neutron star binary mergers in the universe - Minimal predictions for gravity wave detectors. *The Astrophysical Journal* 380:L17. <https://doi.org/10.1086/186163>
- Pippard AB (1951) The surface energies of superconductors. *Mathematical Proceedings of the Cambridge Philosophical Society*, 47(03):617. doi:10.1017/s0305004100027018
- Pippard AB (1953) An Experimental and Theoretical Study of the Relation between Magnetic Field and Current in a Superconductor. *Proceedings of the Royal Society A: Mathematical, Physical and Engineering Sciences*, 216(1127):547-568. doi:10.1098/rspa.1953.0040
- Piro AL, Giacomazzo B, Perna R (2017) The Fate of Neutron Star Binary Mergers. *The Astrophysical Journal* 844:L19. <https://doi.org/10.3847/2041-8213/aa7f2f>
- Pitkin M, Reid S, Rowan S, Hough J (2011) Gravitational Wave Detection by Interferometry (Ground and Space). *Living Reviews in Relativity* 14: <https://doi.org/10.12942/lrr-2011-5>



- Ploj Vrtič M (2009) Model of ICT Implementation in the Technical Education. *Problems of Education in the 21st Century*, 14:144-158. *Problems of Education in the 21st Century*, 24:95-105. Retrieved: [https://www.researchgate.net/profile/Mateja\\_Vrtic/publication/283345140\\_Future\\_teachers'\\_opinions\\_on\\_the\\_digital\\_competencies\\_obtained\\_during\\_their\\_studies/links/565d7af208aeafc2aac7b3fa/Future-teachers-opinions-on-the-digital-competencies-obtained-during-their-studies.pdf](https://www.researchgate.net/profile/Mateja_Vrtic/publication/283345140_Future_teachers'_opinions_on_the_digital_competencies_obtained_during_their_studies/links/565d7af208aeafc2aac7b3fa/Future-teachers-opinions-on-the-digital-competencies-obtained-during-their-studies.pdf)
- Ploj Vrtič M, Pšunder M (2010) The Influence of the Field of Study on the Use of Modern Information and Communication Technologies Among Student and Teachers. *Informatologia*, 43(4):269-279.
- Ploj Vrtič M, Pšunder M (2014) Innovative pedagogy: Developing of pupils' competencies through the use of modern technologies in the classroom. In 10th International Scientific Conference on Distance Learning in Applied Informatics, Štúrovo, pp. 5-7.
- Ploj Vrtič M, Šorgo A (2016) Can we expect to recruit future engineers among students who have never repaired a toy? *Eurasia Journal of Mathematics, Science & Technology Education*, 12(2):249-266.
- Ploj Vrtič M, Župerl U, Javornik Krečič M (2013) Pedagogy 1: 1 In Higher Education: A Case Study. *Problems of Education in the 21st Century*, 57:102-110.
- Poisson E (1993) Gravitational radiation from a particle in circular orbit around a black hole. I. Analytical results for the nonrotating case. *Physical Review D* 47:1497-1510. <https://doi.org/10.1103/physrevd.47.1497>
- Poisson E (1998) Gravitational waves from inspiraling compact binaries: The quadrupole-moment term. *Physical Review D* 57:5287-5290. <https://doi.org/10.1103/physrevd.57.5287>
- Poisson E, Will C M (1995) Gravitational waves from inspiraling compact binaries: Parameter estimation using second-post-Newtonian waveforms. *Phys. Rev. D* 52:848-855. <https://doi.org/10.1103/PhysRevD.52.848>
- Poisson E, Will CM (1995) Gravitational waves from inspiraling compact binaries: Parameter estimation using second-post-Newtonian waveforms. *Physical Review D* 52:848-855. <https://doi.org/10.1103/physrevd.52.848>
- Polyakov A (1974) Particle Spectrum in the Quantum Field Theory. *Pisma Zh.Eksp.Teor.Fiz.* 20 (1974) 430-433; [*JEPT Lett.*, 20(6):194]
- Postnikov S, Prakash M, Lattimer JM (2010) Tidal Love numbers of neutron and self-bound quark stars. *Phys Rev D* 82:024016. <https://doi.org/10.1103/PhysRevD.82.024016>
- Pound RV, Rebka GA (1960) Apparent Weight of Photons. *Phys Rev Lett* 4:337-341. <https://doi.org/10.1103/PhysRevLett.4.337>
- Prasher RS, Hu XJ, Chalopin Y, Mingo N, Lofgreen K, Volz S, Cleri F, Keblinski P (2009) Turning Carbon Nanotubes from Exceptional Heat Conductors into Insulators. *Physical Review Letters*, 102(10). doi:10.1103/physrevlett.102.105901
- Prentis JJ (1995) Poincaré's proof of the quantum discontinuity of nature. *American Journal of Physics* 63:339-350
- Preskill JP (1979) Cosmological Production of Superheavy Magnetic Monopoles. *Physical Review Letters*, 43(19):1365-1368. doi:10.1103/physrevlett.43.1365
- Press WH (1971) Long Wave Trains of Gravitational Waves from a Vibrating Black Hole. *apjl* 170:L105. <https://doi.org/10.1086/180849>
- Press WH, Thorne KS (1972) Gravitational-Wave Astronomy. *Annual Review of Astronomy and Astrophysics* 10:335-374. <https://doi.org/10.1146/annurev.aa.10.090172.002003>
- Pretorius F (2005) Evolution of Binary Black-Hole Spacetimes. *Phys Rev Lett* 95:121101. <https://doi.org/10.1103/PhysRevLett.95.121101>

- Privitera S, Mohapatra SRP, Ajith P, et al (2014) Improving the sensitivity of a search for coalescing binary black holes with nonprecessing spins in gravitational wave data. *Phys Rev D* 89:024003. <https://doi.org/10.1103/PhysRevD.89.024003>
- Prix R, Itoh Y (2005) Global parameter-space correlations of coherent searches for continuous gravitational waves. *Classical and Quantum Gravity* 22:S1003–S1012. <https://doi.org/10.1088/0264-9381/22/18/s14>
- Pürrer M (2014) Frequency-domain reduced order models for gravitational waves from aligned-spin compact binaries. *Classical and Quantum Gravity* 31:195010. <https://doi.org/10.1088/0264-9381/31/19/195010>
- Pürrer M (2016) Frequency domain reduced order model of aligned-spin effective-one-body waveforms with generic mass ratios and spins. *Physical Review D* 93:064041. <https://doi.org/10.1103/physrevd.93.064041>
- Pürrer M, Hannam M, Ajith P, Husa S (2013) Testing the validity of the single-spin approximation in inspiral-merger-ringdown waveforms. *Physical Review D* 88:064007. <https://doi.org/10.1103/physrevd.88.064007>
- Pürrer M, Hannam M, Ohme F (2016) Can we measure individual black-hole spins from gravitational-wave observations? *Phys Rev D* 93:084042. <https://doi.org/10.1103/PhysRevD.93.084042>
- Racine É (2008) Analysis of spin precession in binary black hole systems including quadrupole-monopole interaction. *Phys Rev D* 78:044021. <https://doi.org/10.1103/PhysRevD.78.044021>
- Radebaugh R, Keesom PH (1966) Low-Temperature Thermodynamic Properties of Vanadium. I. Superconducting and Normal States. *Physical Review*, 149(1):209–216. doi:10.1103/physrev.149.209
- Radebaugh R, Keesom PH (1966) Low-Temperature Thermodynamic Properties of Vanadium. II. Mixed State. *Physical Review*, 149(1):217–231. doi:10.1103/physrev.149.217
- Radelet-de Grave P (1988) Les forces et leur loi de composition chez Newton. *Revue Philosophique de Louvain*, 86(4):505-522.
- Radelet-de Grave P; Speiser D (1990) Editer les œuvres complètes des grands scientifiques, une entreprise internationale. *Impact, science et société*, 40(4):369-378.
- Radelet-de Grave P (1996) Andreas Speiser (1885-1978) et Herman Weyl (1885-1955), scientifiques, historiens et philosophes des sciences. *Revue Philosophique de Louvain*, 94(3):502–535. doi:10.2143/rpl.94.3.541800
- Radelet-de Grave P (1999) Relativité galiléenne et lois de conservation. In: *Revue des Questions Scientifiques*, 170(3):209-260
- Radelet-de Grave P (2008) Introduction aux œuvres de mécanique de Sturm.
- Radelet-de Grave P (2009) Guarini et la structure de l'Univers. *Nexus Network Journal* 11/3:393–414.
- Radelet-de Grave P (2010) Gottfried Wilhelm Leibniz. *Sämtliche Schriften und Briefe*, Isis 101(2):430-431. Retrieved: <https://doi.org/10.1086/655716>
- Radelet-de Grave P (2010) Publishing Complete Works of the Great Scientists, An International Undertaking . In: *Crossroads : History of Science, History of Art, Essays by David Speiser*, Birkhäuser, Bâle, pp. 127-147
- Radelet-de Grave P (2010) The beginnings of elasticity and interaction with the development of the Calculus in Mechanics and architecture, between epistème and téchne, ed Anna Sinopoli.
- Radelet-de Grave P (2012) Des montres pour calculer des vitesses: ou comment Kepler explique sa découverte des deux premières lois. In: *Philosophica*, Vol. 41-42(I-II):13-79.
- Rampp M, Mueller E, Ruffert M (1997) Simulations of non-axisymmetric rotational core collapse

- Read JS, Lackey BD, Owen BJ, Friedman JL (2009a) Constraints on a phenomenologically parametrized neutron-star equation of state. *Phys Rev D* 79:124032. <https://doi.org/10.1103/PhysRevD.79.124032>
- Read JS, Markakis C, Shibata M, et al (2009b) Measuring the neutron star equation of state with gravitational wave observations. *Phys Rev D* 79:124033. <https://doi.org/10.1103/PhysRevD.79.124033>
- Redish EF, Saul JM, Steinberg RN (1997) On the effectiveness of active-engagement microcomputer-based laboratories. *American Journal of Physics* 65:45–54. <https://doi.org/10.1119/1.18498>
- Riess A G, Filippenko A V, Challis P, Clocchiatti A, Diercks A, Garnavich P M, Gilliland R L, Hogan C J, Jha S, Kirshner R P, et al. (1998) Observational Evidence from Supernovae for an Accelerating Universe and a Cosmological Constant. *The Astronomical Journal* 116:1009–1038. <https://doi.org/10.1086/300499>
- Riess A G, Press W H, Kirshner R P (1995) Using Type IA Supernova Light Curve Shapes to Measure the Hubble Constant. 438:L17. <https://doi.org/10.1086/187704>
- Roberts BW (1976) Survey of superconductive materials and critical evaluation of selected properties. *Journal of Physical and Chemical Reference Data*, 5(3):581–822. doi:10.1063/1.555540
- Rodriguez CL, Morscher M, Pattabiraman B, et al (2015) Binary Black Hole Mergers from Globular Clusters: Implications for Advanced LIGO. *Phys Rev Lett* 115:051101. <https://doi.org/10.1103/PhysRevLett.115.051101>
- Roll PG, Krotkov R, Dicke RH (1964) The equivalence of inertial and passive gravitational mass. *Annals of Physics* 26:442–517. [https://doi.org/10.1016/0003-4916\(64\)90259-3](https://doi.org/10.1016/0003-4916(64)90259-3)
- Rubakov VA (1981) Superheavy magnetic monopoles and decay of the proton. *JETP Lett.* 33(12):644–646.
- Ruthen R (1992) Catching the Wave. *Scientific American* 266:90–99. <https://doi.org/10.1038/scientificamerican0392-90>
- Saint James D, Sarma G, Thomas EJ (1969) Type II superconductivity. Pergamon.
- Salgado M, Bonazzola S, Gourgoulhon E, Haensel P (1994) High precision rotating neutron star models 1: Analysis of neutron star properties. *Astronomy and Astrophysics*, 291(1):155–170
- Salpeter EE, Shapiro SL, Wasserman I (1982) Constraints on Cosmic Magnetic Monopoles Imposed by the Galactic Magnetic Field. *Physical Review Letters*, 49(15):1114–1117. doi:10.1103/physrevlett.49.1114
- Sandenaw TA (1982) Causes for the variable superconducting transition temperature in uranium metal. *Solid State Communications*, 43(5):361–364. doi:10.1016/0038-1098(82)90494-x
- Santamaría L, Ohme F, Ajith P, et al (2010) Matching post-Newtonian and numerical relativity waveforms: Systematic errors and a new phenomenological model for nonprecessing black hole binaries. *Physical Review D* 82:064016. <https://doi.org/10.1103/physrevd.82.064016>
- Sathyaprakash BS, Dhurandhar SV (1991) Choice of filters for the detection of gravitational waves from coalescing binaries. *Physical Review D* 44:3819–3834. <https://doi.org/10.1103/physrevd.44.3819>
- Sathyaprakash BS, Schutz BF (2009) Physics, Astrophysics and Cosmology with Gravitational Waves. *Living Reviews in Relativity* 12, 2. <https://doi.org/10.12942/lrr-2009-2>
- Saulson PR (1997a) How an interferometer extracts and amplifies power from a gravitational wave. *Class. Quantum Gravity* 14:2435. <https://doi.org/10.1088/0264-9381/14/9/005>
- Saulson PR (1997b) If light waves are stretched by gravitational waves, how can we use light as a ruler to detect gravitational waves? *Am Jour Phys* 65, 501. <https://doi.org/10.1119/1.18578>

- Saulson PR (2011) Josh Goldberg and the physical reality of gravitational waves. *General Relativity and Gravitation* 43:3289–3299. <https://doi.org/10.1007/s10714-011-1237-z>
- Savchenko V, Ferrigno C, Kuulkers E, et al (2017) INTEGRAL Detection of the First Prompt Gamma-Ray Signal Coincident with the Gravitational-wave Event GW170817. *The Astrophysical Journal* 848:L15. <https://doi.org/10.3847/2041-8213/aa8f94>
- Schawlow AL (1958) Penetration of Magnetic Fields through Superconducting Films. *Physical Review*, 109(5):1856–1857. doi:10.1103/physrev.109.1856.2
- Scheel MA, Giesler M, Hemberger DA, et al (2015) Improved methods for simulating nearly extremal binary black holes. *Classical and Quantum Gravity* 32:105009. <https://doi.org/10.1088/0264-9381/32/10/105009>
- Scherz Z, Oren M (2006) How to change students' understanding of science and technology. *Science Education* 90:965–985. <https://doi.org/10.1002/sce.20159>
- Schibrowsky JA, Peltier JW (1995) The Dark Side of Experiential Learning Activities. *Journal of Marketing Education* 17:13–24. <https://doi.org/10.1177/027347539501700103>
- Schmidt P, Hannam M, Husa S (2012) Towards models of gravitational waveforms from generic binaries: A simple approximate mapping between precessing and nonprecessing inspiral signals. *Physical Review D* 86:104063. <https://doi.org/10.1103/physrevd.86.104063>
- Schmidt P, Ohme F, Hannam M (2015) Towards models of gravitational waveforms from generic binaries: II. Modelling precession effects with a single effective precession parameter. *Physical Review D* 91:024043. <https://doi.org/10.1103/physrevd.91.024043>
- Schucking EL, Surowitz EJ (2007) Einstein's Apple: His First Principle of Equivalence
- Schutz B F (1986) Determining the Hubble constant from gravitational wave observations. 323:310–311. <https://doi.org/10.1038/323310a0>
- Schutz BF (1989) Gravitational wave sources and their detectability. *Classical and Quantum Gravity* 6:1761–1780. <https://doi.org/10.1088/0264-9381/6/12/006>
- Schwartz RS, Lederman NG (2002) "It's the nature of the beast": The influence of knowledge and intentions on learning and teaching nature of science. *Journal of Research in Science Teaching* 39:205–236. <https://doi.org/10.1002/tea.10021>
- Schwartz W (1982) Superconductivity Data. Physik Daten, Fachinformationszentrum Energie, Physik, Mathematik GmbH.
- Schwarz CV, White BY (2005) Metamodeling Knowledge: Developing Students' Understanding of Scientific Modeling. *Cognition and Instruction* 23:165–205. [https://doi.org/10.1207/s1532690xci2302\\_1](https://doi.org/10.1207/s1532690xci2302_1)
- Schwarzschild K (1999) On the gravitational field of a mass point according to Einstein's theory
- Sciama DW, Field GB, Rees MJ (1969) Upper Limit to Radiation of Mass Energy Derived from Expansion of Galaxy. *Physical Review Letters* 23:1514–1515. <https://doi.org/10.1103/physrevlett.23.1514>
- Sciama, D., Weber, J., Kafka, P., Drever, R., Tyson T. (1974) Gravitational waves: panel discussion. In: Shaviv, G., Rosen, J. (eds.) *General relativity and gravitation, proceedings of GR7*, Tel Aviv University, June 23–28, 1974, pp. 243–298. Wiley, New York
- Seljak U, Zaldarriaga M (1999) Direct signature of an evolving gravitational potential from the cosmic microwave background

- Seto N (2002) Effects of finite armlength of LISA on analysis of gravitational waves from massive-black-hole binaries. *Phys. Rev. D* 66:122001. <https://doi.org/10.1103/PhysRevD.66.122001>
- Shibata M, Nakamura T (1995) Evolution of three-dimensional gravitational waves: Harmonic slicing case. *Physical Review D* 52:5428–5444. <https://doi.org/10.1103/physrevd.52.5428>
- Shibata M, Uryu K (2000) Simulation of merging binary neutron stars in full general relativity:  $\Gamma=2$  case. *Phys Rev D* 61:064001. <https://doi.org/10.1103/PhysRevD.61.064001>
- Shoemaker D, Schilling R, Schnupp L, et al (1988) Noise behavior of the Garching 30-meter prototype gravitational-wave detector. *Physical Review D* 38:423–432. <https://doi.org/10.1103/physrevd.38.423>
- Shoenberg D (1952) *Superconductivity*. Cambridge Univ. Press, p. 75.
- Sigurdsson S, Hernquist L (1993) Primordial black holes in globular clusters. *Nature* 364:423–425. <https://doi.org/10.1038/364423a0>
- Singer LP, Chen H-Y, Holz DE, et al (2016) Going the distance: mapping host galaxies of ligo and virgo sources in three dimensions using local cosmography and targeted follow-up. *The Astrophysical Journal* 829:L15. <https://doi.org/10.3847/2041-8205/829/1/L15>
- Singer LP, Price LR (2016) Rapid Bayesian position reconstruction for gravitational-wave transients. *Phys Rev D* 93:024013. <https://doi.org/10.1103/PhysRevD.93.024013>
- Sitter W de (1916) On Einstein's Theory of Gravitation and its Astronomical Consequences. Second Paper. *Monthly Notices of the Royal Astronomical Society* 77:155–184. <https://doi.org/10.1093/mnras/77.2.155>
- Smith R, Field SE, Blackburn K, et al (2016) Fast and accurate inference on gravitational waves from precessing compact binaries. *Phys Rev D* 94:044031. <https://doi.org/10.1103/PhysRevD.94.044031>
- Smith TF, Fisher ES (1973) Superconductivity and phase transitions in single-crystal and polycrystal ?-U at high pressure. *Journal of Low Temperature Physics*, 12(5-6):631–641. doi:10.1007/bf00654962
- Smoot GF (2003) P139 - Relativity Problem Set 12: GRAVITATIONAL WAVES 2003 April. 27
- Sormani C (2017) A Two-Part Feature: The Mathematics of Gravitational Waves. *Notices of the American Mathematical Society* 64:684–685. <https://doi.org/10.1090/noti1551>
- Spergel D N, Verde L, Peiris H V, Komatsu E, Nolta M R, Bennett C L, Halpern M, Hinshaw G, Jarosik N, Kogut A, et al. (2003) First-Year Wilkinson Microwave Anisotropy Probe (WMAP) Observations: Determination of Cosmological Parameters. *The Astrophysical Journal Supplement Series* 148:175–194. <https://doi.org/10.1086/377226>
- Staley A, Martynov D, Abbott R, et al (2014) Achieving resonance in the Advanced LIGO gravitational-wave interferometer. *Classical and Quantum Gravity* 31:245010
- Steiner AW, Gandolfi S, Fattoyev FJ, Newton WG (2015) Using neutron star observations to determine crust thicknesses, moments of inertia, and tidal deformabilities. *Phys Rev C* 91:015804. <https://doi.org/10.1103/PhysRevC.91.015804>
- Steiner AW, Heinke CO, Bogdanov S, et al (2018) Constraining the mass and radius of neutron stars in globular clusters. *Monthly Notices of the Royal Astronomical Society* 476:421–435. <https://doi.org/10.1093/mnras/sty215>
- Steinhoff J, Hinderer T, Buonanno A, Taracchini A (2016) Dynamical tides in general relativity: Effective action and effective-one-body Hamiltonian. *Phys Rev D* 94:104028. <https://doi.org/10.1103/PhysRevD.94.104028>
- Studart N (2001) The invention of the quantum energy concept according to Planck

- Szeftel J (2012) Parametrix for wave equations on a rough background I: regularity of the phase at initial time. Retrieved: <https://arxiv.org/abs/1204.1768>
- Szeftel J (2012) Parametrix for wave equations on a rough background II: construction and control at initial time. Retrieved: <https://arxiv.org/abs/1204.1769>
- Szeftel J (2012) Parametrix for wave equations on a rough background III: space-time regularity of the phase. Retrieved: <https://arxiv.org/abs/1204.1770>
- Szeftel J (2012) Parametrix for wave equations on a rough background IV: control of the error term. Retrieved: <https://arxiv.org/abs/1204.1771>
- Szilágyi B, Blackman J, Buonanno A, et al (2015) Approaching the Post-Newtonian Regime with Numerical Relativity: A Compact-Object Binary Simulation Spanning 350 Gravitational-Wave Cycles. *Physical Review Letters* 115:031102. <https://doi.org/10.1103/physrevlett.115.031102>
- Tagoshi H, Nakamura T (1994) Gravitational waves from a point particle in circular orbit around a black hole: Logarithmic terms in the post-Newtonian expansion. *Physical Review D*, 49(8):4016–4022. doi:10.1103/physrevd.49.4016
- Tagoshi H, Sasaki M (1994) Post-Newtonian Expansion of Gravitational Waves from a Particle in Circular Orbit around a Schwarzschild Black Hole. *Progress of Theoretical Physics*, 92(4):745–771. doi:10.1143/ptp/92.4.745
- Takahashi R, Nakamura T (2003) Wave Effects in the Gravitational Lensing of Gravitational Waves from Chirping Binaries. *The Astrophysical Journal* 595:1039–1051. <https://doi.org/10.1086/377430>
- Taketani M (2001) The formation and logic of quantum mechanics. World Scientific
- Talmadge C, Berthias J-P, Hellings RW, Standish EM (1988) Model-Independent Constraints on Possible Modifications of Newtonian Gravity. *Phys Rev Lett* 61:1159–1162. <https://doi.org/10.1103/PhysRevLett.61.1159>
- Tanvir NR, Levan AJ, Fruchter AS, et al (2013) A ‘kilonova’ associated with the short-duration  $\gamma$ -ray burst GRB 130603B. *Nature* 500:547–549. <https://doi.org/10.1038/nature12505>
- Taracchini A, Buonanno A, Khanna G, Hughes SA (2014a) Small mass plunging into a Kerr black hole: Anatomy of the inspiral-merger-ringdown waveforms. *Physical Review D* 90:084025. <https://doi.org/10.1103/physrevd.90.084025>
- Taracchini A, Buonanno A, Pan Y, et al (2014b) Effective-one-body model for black-hole binaries with generic mass ratios and spins. *Physical Review D* 89:061502. <https://doi.org/10.1103/physrevd.89.061502>
- Taracchini A, Pan Y, Buonanno A, et al (2012) Prototype effective-one-body model for nonprecessing spinning inspiral-merger-ringdown waveforms. *Physical Review D* 86:024011. <https://doi.org/10.1103/physrevd.86.024011>
- Tauris TM, Kramer M, Freire PCC, et al (2017) Formation of Double Neutron Star Systems. *The Astrophysical Journal* 846:170. <https://doi.org/10.3847/1538-4357/aa7e89>
- Ter Haar D (2016) *The old quantum theory*. Elsevier
- Teukolsky SA (1972) Rotating Black Holes: Separable Wave Equations for Gravitational and Electromagnetic Perturbations. *Physical Review Letters*, 29(16):1114–1118. doi:10.1103/physrevlett.29.1114
- Thorne KS (1980) Multipole expansions of gravitational radiation. *Reviews of Modern Physics*, 52(2):299–339. doi:10.1103/revmodphys.52.299
- Thorne KS (1987) Gravitational radiation. *thyg* 330–458
- Thorsett SE, Chakrabarty D (1999) Neutron Star Mass Measurements. I. Radio Pulsars. *The Astrophysical Journal* 512:288–299. <https://doi.org/10.1086/306742>

- Tinkham M (1975) Introduction to superconductivity. McGraw Hill, New York.
- Tiwari V, Drago M, Frolov V, et al (2015) Regression of environmental noise in LIGO data. *Classical and Quantum Gravity* 32:165014. <https://doi.org/10.1088/0264-9381/32/16/165014>
- Tomamichel S, Clerc F (2005) La recherche en sciences de l'éducation. État des lieux et points de vue. *Recherche en soins infirmiers* N° 83:4. <https://doi.org/10.3917/rsi.083.0004>
- Tonry J L, Schmidt B P, Barris B, et al (2003) Cosmological Results from High- $z$  Supernovae. 594:1–24. <https://doi.org/10.1086/376865>
- Troja E, Ryan G, Piro L, et al (2018) A luminous blue kilonova and an off-axis jet from a compact binary merger at  $z = 0.1341$ . *Nature Communications* 9:4089. <https://doi.org/10.1038/s41467-018-06558-7>
- Turner MS, Parker EN, Bogdan TJ (1982) Magnetic monopoles and the survival of galactic magnetic fields. *Physical Review D*, 26(6):1296–1305. Doi:10.1103/physrevd.26.1296
- Tversky A, Kahneman D (1973) Availability: A heuristic for judging frequency and probability. *Cognitive Psychology* 5:207–232. [https://doi.org/10.1016/0010-0285\(73\)90033-9](https://doi.org/10.1016/0010-0285(73)90033-9)
- Uhlenbeck GE, Ornstein LS (1930) On the Theory of the Brownian Motion. *Physical Review*, 36(5):823–841. doi:10.1103/physrev.36.823
- Unruh WG (1976) Notes on black-hole evaporation. *Physical Review D* 14:870–892. <https://doi.org/10.1103/physrevd.14.870>
- Ushomirsky G, Cutler C, Bildsten L (2002) Deformations of accreting neutron star crusts and gravitational wave emission. *Monthly Notices of the Royal Astronomical Society* 319:902–932. <https://doi.org/10.1046/j.1365-8711.2000.03938.x>
- Usman SA, Nitz AH, Harry IW, et al (2016) The PyCBC search for gravitational waves from compact binary coalescence. *Classical and Quantum Gravity* 33:215004
- Vallisneri M (2012) Testing general relativity with gravitational waves: A reality check. *Physical Review D* 86:082001. <https://doi.org/10.1103/physrevd.86.082001>
- Vallisneri M, Yunes N (2013) Stealth bias in gravitational-wave parameter estimation. *Physical Review D* 87:102002. <https://doi.org/10.1103/physrevd.87.102002>
- Valtonen M J, Lehto H J (1997) Outbursts in OJ 287: A New Test for the General Theory of Relativity. *The Astrophysical Journal* 481:L5–L7. <https://doi.org/10.1086/310642>
- Vecchio A (2004) LISA observations of rapidly spinning massive black hole binary systems. *Phys. Rev. D* 70:42001. <https://doi.org/10.1103/PhysRevD.70.042001>
- Veitch J, Raymond V, Farr B, et al (2015) Parameter estimation for compact binaries with ground-based gravitational-wave observations using the LALInference software library. *Phys Rev D* 91:042003. <https://doi.org/10.1103/PhysRevD.91.042003>
- Vines J, Flanagan ÉÉ, Hinderer T (2011) Post-1-Newtonian tidal effects in the gravitational waveform from binary inspirals. *Phys Rev D* 83:084051. <https://doi.org/10.1103/PhysRevD.83.084051>
- Vinet J-Y (2013) Some basic principles of a “LISA.” *Comptes Rendus Physique* 14:366–380. <https://doi.org/10.1016/j.crhy.2013.02.002>
- Vishveshwara C (1970) Scattering of gravitational radiation by a Schwarzschild black-hole. *Nature* 227:936–938
- Vitale S, Del Pozzo W (2014) How serious can the stealth bias be in gravitational wave parameter estimation? *Physical Review D* 89:022002. <https://doi.org/10.1103/physrevd.89.022002>

- Vokos S, Shaffer PS, Ambrose BS, McDermott LC (2000) Student understanding of the wave nature of matter: Diffraction and interference of particles. *American Journal of Physics* 68:S42–S51. <https://doi.org/10.1119/1.19519>
- Volonteri M, Haardt F, Madau P (2003) The Assembly and Merging History of Supermassive Black Holes in Hierarchical Models of Galaxy Formation. 582:559–573. <https://doi.org/10.1086/344675>
- Wade L, Creighton JDE, Ochsner E, et al (2014) Systematic and statistical errors in a Bayesian approach to the estimation of the neutron-star equation of state using advanced gravitational wave detectors. *Phys Rev D* 89:103012. <https://doi.org/10.1103/PhysRevD.89.103012>
- Wagoner R V, Will C M (1976) Post-Newtonian gravitational radiation from orbiting point masses. 210:764–775. <https://doi.org/10.1086/154886>
- Wald RM (1994) Quantum field theory in curved spacetime and black hole thermodynamics. University of Chicago press
- Walsh T (1982) LOOKING FOR THE GUT MONOPOLE. *Journal de Physique Colloques*, 43(C3):C3-213-C3-219.
- Wang L, Goldhaber G, Aldering G, Perlmutter S (2003) Multicolor Light Curves of Type Ia Supernovae on the Color-Magnitude Diagram: A Novel Step toward More Precise Distance and Extinction Estimates. *The Astrophysical Journal* 590:944–970. <https://doi.org/10.1086/375020>
- Wang Y, Holz D E, Munshi D (2002) A Universal Probability Distribution Function for Weak-lensing Amplification. *The Astrophysical Journal* 572:L15–L18. <https://doi.org/10.1086/341604>
- Wang Y, Stebbins A, Turner E L (1996) Gravitational Lensing of Gravitational Waves from Merging Neutron Star Binaries. *Phys. Rev. Lett.* 77:2875–2878. <https://doi.org/10.1103/PhysRevLett.77.2875>
- Wang Y, Stebbins A, Turner EL (1996) Gravitational Lensing of Gravitational Waves from Merging Neutron Star Binaries. *Physical Review Letters* 77:2875–2878. <https://doi.org/10.1103/physrevlett.77.2875>
- Wang Y, Turner E L (1997) Cosmological constant and advanced gravitational wave detectors. *Phys. Rev. D* 56:724–729. <https://doi.org/10.1103/PhysRevD.56.724>
- Wason PC, Shapiro D (1971) Natural and contrived experience in a reasoning problem. *Quarterly Journal of Experimental Psychology* 23:63–71. <https://doi.org/10.1080/00335571430000068>
- Watts AL, Andersson N, Chakrabarty D, et al (2016) Colloquium: Measuring the neutron star equation of state using x-ray timing. *Rev Mod Phys* 88:021001. <https://doi.org/10.1103/RevModPhys.88.021001>
- Webster BL, Murdin P (1972) Cygnus X-1—a Spectroscopic Binary with a Heavy Companion? *Nature* 235:37–38
- Weinberger P (2006) Revisiting Louis de Broglie’s famous 1924 paper in the *Philosophical Magazine*. *Philosophical Magazine Letters* 86:405–410. <https://doi.org/10.1080/09500830600876565>
- Weinstein G (2016) Einstein’s Discovery of Gravitational Waves 1916-1918
- Weiss R (1972) Electromagnetically coupled broadband gravitational antenna, Quarterly Progress Report of the MIT Research Laboratory of Electronics, 105:54–76. Retrieved: [http://dspace.mit.edu/bitstream/handle/1721.1/56271/RLE\\_QPR\\_105\\_V.pdf?sequence=1](http://dspace.mit.edu/bitstream/handle/1721.1/56271/RLE_QPR_105_V.pdf?sequence=1)
- Will C (2014) The Confrontation between General Relativity and Experiment. *Living Reviews in Relativity*, 17(4). Retrieved: <https://arxiv.org/abs/1403.7377>
- Will C M (1994) Testing scalar-tensor gravity with gravitational-wave observations of inspiralling compact binaries. *Physical Review D* 50:6058–6067. <https://doi.org/10.1103/physrevd.50.6058>



- Will C M (1999) Generation of Post-Newtonian Gravitational Radiation via Direct Integration of the Relaxed Einstein Equations. *Progress of Theoretical Physics Supplement* 136:158–167. <https://doi.org/10.1143/ptps.136.158>
- Will C M, Wiseman A G (1996) Gravitational radiation from compact binary systems: Gravitational waveforms and energy loss to second post-Newtonian order. *Physical Review D* 54:4813–4848. <https://doi.org/10.1103/physrevd.54.4813>
- Will CM (1998) Bounding the mass of the graviton using gravitational-wave observations of inspiralling compact binaries. *Phys Rev D* 57:2061–2068. <https://doi.org/10.1103/PhysRevD.57.2061>
- Will CM (2014) The Confrontation between General Relativity and Experiment. *Living Reviews in Relativity* 17, 4. <https://doi.org/10.12942/lrr-2014-4>
- Will CM (2015) Focus issue: Gravity Probe B. *Classical and Quantum Gravity* 32:220301. <https://doi.org/10.1088/0264-9381/32/22/220301>
- Williams R E, Blacker B, Dickinson M, Dixon W V D, Ferguson H C, Fruchter A S, Giavalisco M, Gilliland R L, Heyer I, Katsanis R, Levay Z, Lucas R A, McElroy D B, Petro L, Postman M, Adorf H-M, Hook R (1996) The Hubble Deep Field: Observations, Data Reduction, and Galaxy Photometry, 112:1335. <https://doi.org/10.1086/118105>
- Willke B, Aufmuth P, Aulbert C, et al (2002) The GEO 600 gravitational wave detector. *Classical and Quantum Gravity* 19:1377–1387. <https://doi.org/10.1088/0264-9381/19/7/321>
- Wilson KD (1975) Kant on Intuition. *The Philosophical Quarterly* 25:247. <https://doi.org/10.2307/2217756>
- Wiseman A G (1992) Coalescing binary systems of compact objects to (post)5/2-Newtonian order. II. Higher-order wave forms and radiation recoil. *Physical Review D* 46:1517–1539. <https://doi.org/10.1103/physrevd.46.1517>
- Wosilait K, Heron PRL, Shaffer PS, McDermott LC (1999) Addressing student difficulties in applying a wave model to the interference and diffraction of light. *American Journal of Physics* 67:S5–S15. <https://doi.org/10.1119/1.19083>
- Yagi K, Yunes N (2014) Love number can be hard to measure. *Phys Rev D* 89:021303. <https://doi.org/10.1103/PhysRevD.89.021303>
- Yıldız C (2013) Historical Problems in the History of Mathematics: Examples for the Classroom
- Yunes N, Berti E (2008) Accuracy of the post-Newtonian approximation: Optimal asymptotic expansion for quasicircular, extreme-mass ratio inspirals. *Physical Review D* 77: <https://doi.org/10.1103/physrevd.77.124006>
- Yunes N, Buonanno A, Hughes SA, et al (2010) Modeling Extreme Mass Ratio Inspirals within the Effective-One-Body Approach. *Physical Review Letters* 104:091102. <https://doi.org/10.1103/physrevlett.104.091102>
- Yunes N, Hughes SA (2010) Binary pulsar constraints on the parametrized post-Einsteinian framework. *Physical Review D* 82:082002. <https://doi.org/10.1103/physrevd.82.082002>
- Yunes N, Pretorius F (2009) Fundamental theoretical bias in gravitational wave astrophysics and the parametrized post-Einsteinian framework. *Physical Review D* 80:122003. <https://doi.org/10.1103/physrevd.80.122003>
- Yunes N, Siemens X (2013) Gravitational-Wave Tests of General Relativity with Ground-Based Detectors and Pulsar-Timing Arrays. *Living Reviews in Relativity* 16(9). <https://doi.org/10.12942/lrr-2013-9>
- Yunes N, Yagi K, Pretorius F (2016) Theoretical physics implications of the binary black-hole mergers GW150914 and GW151226. *Physical Review D* 94: <https://doi.org/10.1103/physrevd.94.084002>
- Yunes N, Yagi K, Pretorius F (2016) Theoretical physics implications of the binary black-hole mergers GW150914 and GW151226. *Physical Review D* 94:084002. <https://doi.org/10.1103/physrevd.94.084002>

- Zaoui H, Palla PL, Cleri F, Lampin E (2017) Fourier-like conduction and finite one-dimensional thermal conductivity in long silicon nanowires by approach-to-equilibrium molecular dynamics. *Physical Review B*, 95(10). doi:10.1103/physrevb.95.104309
- Zaoui H, Palla PL, Giordano S, Cleri F, Verdier M, Lacroix D, Robillard JF, Termentzidis K, Martin E (2018) Thermal conductivity of decanometric patterned Si membranes by multiscale simulations. *International Journal of Heat and Mass Transfer*, 126:830–835. doi:10.1016/j.ijheatmasstransfer.2018.06.004
- Župerl U, Ploj Virtič M (2013) Remote Controlled Laboratory as a Modern Form of Engineering Education. *Journal of Elementary Education / Revija za Elementarno Izobraževanje*, 6(1):27-42.
- Zeldovich YB, Khlopov MY (1978) On the concentration of relic magnetic monopoles in the universe. *Physics Letters B*, 79(3):239–241. doi:10.1016/0370-2693(78)90232-0
- Zeldovich YB, Polnarev AG (1974) Radiation of gravitational waves by a cluster of superdense stars. *Soviet Astronomy*, 18:17. Retrieved: <http://adsabs.harvard.edu/full/1974SvA....18...17Z>
- Zhang Z, Yunes N, Berti E (2011) Accuracy of the post-Newtonian approximation. II. Optimal asymptotic expansion of the energy flux for quasicircular, extreme mass-ratio inspirals into a Kerr black hole. *Physical Review D* 84: <https://doi.org/10.1103/physrevd.84.024029>
- Zwart SFP, McMillan SLW (2000) Black Hole Mergers in the Universe. *The Astrophysical Journal* 528:L17–L20. <https://doi.org/10.1086/312422>
- Zwinger T, Mueller E (1997) Dynamics and gravitational wave signature of axisymmetric rotational core collapse. *ApJ* 320:209–227.





# INDEX

## 1. Names and Subjects Index

### Names index

---

#### A

Aristotle · iii, xi, xv, liv, 49, 54, 65, 131, 134, 135, 181, 320, 380, 389, 410, 411, 416, 423, 449, 463  
Arnaud, Nicolas · i, xlvi, 202

---

#### B

Babson, Roger W. · 189, 193, 226  
Bachelard, Gaston · ix, xxvii, xxxvii, liv, 182, 289, 296, 303, 304, 307, 308, 309, 317, 326, 327, 349, 369, 371, 379, 391, 425, 444, 466, 472, 502  
Barish, Barry Clark · xxv, 224  
Bender, Peter · 261, 298, 300, 317  
Bergmann, Peter G. · 194, 195  
Bohr, Niels · i, ii, xix, xxii, xxiii, xlv, xlvi, liii, liv, lvi, lvii, 79, 88, 89, 117, 128, 129, 132, 145, 146, 147, 193, 226, 229, 270, 328, 393, 439, 440, 481  
Boltzmann, Ludwig · 110, 112, 113, 125, 281, 317, 427, 432, 438  
Bonnec, Etienne · i, 5, 9, 10, 11, 19, 20, 22, 23, 24, 26, 38, 39, 43, 47, 209  
Boschi, Valerio · i, xlvi, 211, 212

---

#### C

Carnot, Sadi · xlii, 54, 56, 58, 95, 136, 184, 232, 236, 237, 267, 274, 320, 372, 385, 389, 399, 407, 408, 409, 420, 421, 422, 425, 426, 427, 428, 429, 430, 431, 435, 437, 449, 450, 460, 461, 468, 475, 509  
Casanueva, Julia · i, xvi, xlvi, 208, 210, 211, 241  
Cervantes-Cota, Jorge L. · i, viii, xvi, xx, xlvi, xlix, lviii, 82  
Chapman, Philip · xxiv, 199  
Chiaruttini, Ana · 287, 318  
Cioci Vincenzo · i  
Cleri, Fabrizio · xxxvii, xxxix, xl, xliii, xliv  
Clifford, William Kingdon · ix, xii, xx, xxvii, xxviii, xxxi, xxxii, xlv, xlvi, liv, lvii, lviii, lxi, lxii, lxx, 50, 76, 77, 78, 79, 80, 81, 82, 83, 84, 88, 96, 97, 98, 99, 100, 102, 130, 131, 133, 134, 135, 226, 290, 348, 477, 479  
Copernicus, Nicolaus · iii, liv, lvii, 56, 57, 66, 80, 242, 389, 410, 413, 432, 434

---

#### D

de Broglie, Louis Victor Pierre Raymond · xv, liv, 112, 116, 119, 124, 125, 126, 127, 128, 129, 131, 135, 137, 140, 180, 320, 350, 352, 373, 419, 439, 440, 481, 510  
de Sitter, Willem · 172, 176

Descartes, René · 23, 50, 51, 54, 56, 57, 59, 243, 244, 245, 267, 389, 413, 418, 419, 463, 465  
 Dewey, John · liv, 335, 369, 370  
 Dias-Chiaruttini, Ana · xiii, xxxvii, xxxviii, 381, 503, 508  
 Drever, Ronald · 224  
 Duhem, Pierre · ix, xxvii, xxviii, liv, 291, 292, 293, 294, 298, 317, 348, 371, 379, 385, 411, 416, 417, 422, 423, 433, 448, 449, 451, 479, 502  
 Durlo, Andrea · i  
 Dyson, Freeman · xxiii, 190

## *E*

Ehrenfest, Paul · xxxiv, 109, 113, 442, 470  
 Einstein, Albert · i, v, ix, xii, xiv, xv, xx, xxii, xxiii, xxvii, xxxi, xxxii, xxxiv, xxxv, xxxvi, xxxvii, xxxviii, xxxix, xl, xlv, xlvi, liv, lv, lvii, lviii, lix, lx, lxi, lxii, lxiv, 21, 34, 36, 50, 53, 75, 82, 84, 88, 90, 113, 115, 116, 124, 125, 128, 129, 131, 133, 134, 139, 140, 141, 143, 148, 151, 162, 163, 168, 170, 171, 176, 177, 178, 179, 180, 181, 182, 183, 185, 191, 192, 193, 194, 198, 226, 227, 229, 230, 231, 233, 241, 252, 253, 264, 269, 271, 273, 274, 275, 276, 297, 304, 318, 335, 344, 348, 350, 351, 352, 356, 357, 380, 387, 389, 392, 393, 408, 409, 418, 419, 427, 436, 438, 439, 440, 441, 442, 443, 444, 445, 455, 457, 463, 464, 465, 466, 467, 470, 471, 472, 473, 475, 476, 477, 478, 479, 480, 481, 487, 502, 507  
 Euclid · 66, 76, 79, 80, 131, 320, 433

## *F*

Fabry, Charles · xlv, 116, 117, 118, 119, 120, 121, 122, 123, 131, 132, 200, 204, 208, 481  
 Faraday, Michael · 118, 203, 389, 408, 409, 432, 435, 436, 437  
 Feynman, Richard · iii, xxix, xxxviii, lii, lix, 4, 55, 183, 193, 195, 196, 197, 226, 229, 230, 271, 275, 284, 317, 332, 350, 440, 444, 451, 464, 466, 473  
 Fraunhofer, Joseph von · xxv, 249, 250, 418, 463  
 Freud, Sigmund · xxxviii, 304, 350, 444, 473  
 Friedman, Alexander Alexandrovich · 251, 252, 267

## *G*

Galilei, Galileo · iii, xi, xv, xxxiv, xxxix, xl, lv, lxiii, 49, 58, 64, 66, 67, 68, 69, 130, 132, 133, 134, 135, 136, 140, 183, 184, 192, 232, 243, 269, 274, 319, 320, 351, 372, 380, 389, 392, 413, 414, 415, 416, 418, 423, 456, 461, 468, 470, 479, 506, 509  
 Galindo-Uribarri, Salvador · i, xvi, xlix, lviii  
 Gödel, Kurt · 297, 385, 450  
 Good, Gregory · i  
 Guth, Alan · 243, 256, 268

## *H*

Heaviside, Oliver · 84, 86, 87, 88, 130, 132, 134  
 Herschel, William · 244, 247, 418  
 Hubble, Edwin · vii, xxv, lx, 53, 249, 251, 253, 255, 256, 257, 267, 268, 481

Hulse, Russel Alan · xxiv, lx, 42, 219, 226  
 Humanson, Milton · 249

---

## *I*

Infeld, Leopold · xxxvi, 176, 178, 183, 193, 230, 271, 348, 443, 465, 472

---

## *J*

Jansky, Karl Guth · 243, 267

---

## *K*

Kant, Immanuel · 102, 243, 247, 326, 369, 370, 451  
 Karl Schwarzschild · 162, 176, 181  
 Katsanevas Stavros · i, x, xxxviii, xxxix, lx, lxi  
 Kennefick, Daniel · i, viii, xii, xvi, xxii, xxxvi, lxi, 176, 177, 178, 181, 351  
 Kepler, Johannes · iii, xv, xxxviii, xliii, lv, lxiv, 40, 41, 50, 51, 54, 55, 56, 57, 58, 59,  
 60, 135, 136, 137, 183, 184, 230, 231, 232, 243, 271, 272, 274, 320, 321, 348, 350,  
 372, 373, 389, 413, 418, 444, 466, 468, 473, 506, 507, 509  
 Kirchhoff, Gustave Robert · 109, 132, 418, 438  
 Korn, Arthur · xlvi, lvi, 88, 89, 90, 132  
 Kounieher, Joseph · i, ix, xxvii, xxviii, xlv, xlix, lxi, 378, 379, 453, 504  
 Koyré, Alexandre · xv, lxi, 49, 50, 56, 57, 58, 67, 136, 137, 183, 232, 274, 320, 321,  
 372, 373, 385, 387, 411, 412, 414, 415, 434, 448, 449, 452, 462, 509  
 Kuhn, Thomas Samuel · xi, xxvii, xlv, lv, lxi, lxii, 50, 109, 112, 113, 115, 132, 351,  
 372, 379, 385, 387, 388, 397, 431, 441, 447, 448, 449, 459, 502, 504, 505

---

## *L*

Laplace, Pierre-Simon de · 55, 84, 133, 174, 175, 247, 422, 424, 432, 433, 435, 480  
 Lemaître, Georges · 251, 256, 267, 269  
 Lense, Josef · 172, 173, 180, 181, 231, 272, 338, 351  
 Linde, Andrei · 256  
 Lorentz, Hendrick · xxii, xxxiv, xxxix, xliii, xlv, 42, 92, 93, 103, 105, 116, 129, 140,  
 148, 156, 157, 174, 175, 180, 181, 183, 184, 185, 231, 233, 273, 275, 349, 351,  
 352, 436, 442, 444, 445, 464, 466, 469, 470, 473, 475, 477, 479, 480

---

## *M*

Mach, Ernst · ix, xxvii, xxviii, lv, 75, 101, 252, 291, 294, 317, 320, 348, 379, 385, 423,  
 448, 449, 479, 502  
 Maignant, Catherine · i  
 Marcacci, Flavia · xi, xiii, xxxix, xl  
 Maxwell, James Clerk · xxxiv, 20, 50, 84, 86, 101, 112, 115, 118, 125, 140, 156, 389,  
 408, 409, 418, 425, 432, 435, 436, 437, 440, 463, 470  
 McComas, William F. · ix, xxviii, lxii, 284, 378, 460, 505

---

**N**

Nave, Carl Rod · i, 12, 13

Newton, Isaac · iii, vi, xi, xv, xxvii, xxxiv, xxxviii, xli, lv, lvi, lxii, lxiii, lxxv, 21, 36, 41, 46, 54, 55, 58, 59, 69, 70, 71, 72, 73, 74, 75, 84, 86, 94, 125, 130, 132, 134, 136, 137, 140, 149, 162, 168, 176, 183, 184, 189, 230, 231, 232, 243, 253, 271, 273, 274, 284, 320, 321, 349, 350, 352, 354, 355, 362, 367, 372, 373, 380, 385, 389, 409, 413, 414, 415, 418, 419, 420, 424, 429, 432, 440, 444, 450, 460, 461, 463, 466, 467, 468, 470, 473, 474, 477, 480, 509

Noether, Emmy · 297

Novak, Joseph · 329

---

**P**

Peirce, Charles Sanders · 281, 282, 317, 327

Perot, Alfred · 116, 117, 119, 120, 121

Piaget, Jean · x, xxvii, xxxvi, lvi, 289, 295, 317, 379, 460, 465, 472, 502

Picard, Charles Émile · xx, xxii, xlv, xlvi, lvi, 88, 89, 90, 91, 92, 93, 94, 132

Pillant, Gabriel · i, xlvi, 203, 206, 261

Pirani, Felix · xxiv, 194, 196, 199, 229, 274

Pisano, Raffaele · i, xv, xxii, xxvii, xxviii, xli, xlii, xliv, xlviii, lvii, lxii, lxiii, 50, 54, 56, 58, 59, 67, 136, 137, 183, 184, 232, 233, 236, 269, 274, 275, 297, 319, 320, 321, 352, 372, 373, 378, 379, 411, 412, 415, 417, 421, 425, 428, 430, 431, 433, 434, 437, 445, 449, 460, 461, 465, 467, 468, 469, 474, 475, 502, 506, 509, 510

Planck, Max · 94, 112, 113, 114, 115, 124, 126, 127, 132, 133, 134, 181, 239, 250, 256, 268, 410, 418, 427, 438, 439, 447, 481

Poincaré, Henri · xx, xxi, xxii, xxvii, xxviii, xxix, xxxiv, xxxvi, xxxvii, xl, xliii, xliv, xlvi, lvi, lxii, lxxv, 52, 82, 88, 90, 91, 92, 93, 94, 95, 96, 97, 98, 99, 100, 101, 102, 103, 104, 105, 106, 130, 131, 132, 133, 134, 139, 140, 174, 175, 180, 181, 182, 183, 184, 185, 199, 230, 231, 233, 271, 274, 275, 276, 305, 306, 348, 349, 350, 351, 352, 367, 369, 373, 385, 433, 434, 436, 437, 440, 441, 442, 443, 444, 445, 449, 451, 452, 453, 457, 463, 464, 466, 467, 469, 470, 472, 473, 475, 477, 479

Popper, Karl · 304, 305, 306, 349, 373, 449, 451, 453, 456, 486, 487, 488

Preskill, John · 193, 197, 229, 275

---

**Q**

Quilio, Serge · xxxvii, xxxix, xliii, xliv, lviii, lxi, lxii, lxiii, lxiv, lxxv, 317, 318, 319, 503, 505, 507, 510

---

**R**

Radelet-de Grave, Patricia · ix, xi, xliii, xliv, lxiv, 59, 289, 301, 313, 319, 370, 378, 379, 381, 506, 507

Rahman, Shahid · i, xliv, xlix, lxiv, 56, 59, 77, 134, 301, 313, 319, 327, 352, 370, 379, 381, 469, 507

Rideout, George M. · 189

Riemann, Bernhard · ix, xii, xx, xxvii, xlviii, lvi, lviii, lx, lxii, lxxv, 75, 76, 77, 78, 79, 80, 81, 83, 96, 97, 99, 102, 130, 133, 134, 163, 164, 167, 199, 229, 274, 348, 349, 479, 480, 492

Robarts, Julie Louise · i, iii



Robertson, Howard Percy · 178, 251  
Rosen, Nathan · xxxvi, lv, 131, 177, 178, 180, 194, 228, 273, 440, 441, 443, 457, 464,  
472, 502

---

## *S*

Sanderson, Grant · i  
Schrödinger, Erwin · 124, 135, 193, 258, 270, 332, 381, 419, 439, 440, 464, 465, 481  
Starobinsky, Alexei · 256  
Stefan, Josef · 110, 133, 378, 438  
Strutt, John William - Lord Rayleigh · 109, 110

---

## *T*

Taylor, Joseph Hooton · xxiv, lx, lxvi, 42, 54, 135, 137, 141, 182, 219, 226, 229, 233,  
275, 318, 320, 352, 373, 436, 504, 510  
Thirring, Hans · 173, 180, 181, 231, 233, 272, 275, 338  
Thorne, Kip S. · i, xxv, xxxii, lxii, 51, 181, 193, 219, 224, 228, 229, 265, 269, 275, 505  
Tuleau, Christine · 359

---

## *V*

Vincent, Philippe · ii, i, iii, xvi, xvii, xviii, xix, xx, xxvi, 23, 90, 92, 93, 94, 95, 96, 97,  
100, 101, 112, 116, 117, 118, 119, 123, 124, 125, 126, 127, 129, 143, 150, 153,  
154, 160, 161, 164, 165, 167, 173, 201, 202, 205, 206, 207, 212, 244, 252, 262,  
329, 333, 334, 408, 477, 494, 495, 498

---

## *W*

Walker, Arthur Geoffrey · 4, 14, 53, 110, 134, 252, 352, 370  
Weber, Joseph · xii, xix, xx, xxiii, xxxii, lvi, lvii, lxv, 187, 189, 190, 191, 192, 225,  
226, 227, 438, 478  
Weiss, Rainer · i, xxiv, xxv, xxxii, lxvi, 199, 224, 229, 261, 275, 462  
Wheeler, John Archibald · xxxii, lxii, 51, 163, 181, 182, 190, 192, 193, 194, 228, 233,  
265, 269, 275, 505  
Wien, Wilhelm · 110, 133, 438  
Wright, Thomas · 244, 247, 267

---

## *Z*

Zwicky, Fritz · xxiii, 190, 257, 267



# Subjects index

---

## A

- aberration · 87, 144, 148, 174, 418
- absolute motion · 105, 174, 199
- absolute space · 72, 73, 156, 367, 380, 480
- absolute time · 72, 73, 140, 156, 367, 380
- absorption lines · 250, 251
- abstraction · xxix, 97, 119, 297, 303, 304, 305, 307, 308, 309, 316, 326, 327, 328, 330, 332
- acceleration · v, xxxv, 43, 70, 140, 149, 167, 255, 341, 342, 398, 443, 471
- activeness · 379
- activities, activity · xxviii, xlix, lxvi, 158, 201, 240, 243, 260, 288, 290, 329, 336, 337, 338, 339, 341, 379, 380, 395, 401, 402, 404, 420, 483, 490, 492, 493
- addition of speeds, combinations of speeds · 67
- advantage · xxviii, 101, 222, 239, 290
- age of the universe · xxv, 219, 256, 257
- aluminium cylinders · 190
- American Astronomical Society · 226, 227, 229, 249, 272, 275
- American Institute of Physics · i, ii, xix, xxii, xxiii, xxxvi, xlv, xlvi, l, liii, lvi, lvii, 79, 89, 132, 145, 146, 147, 193, 229, 270, 502
- American Journal of Science · 145, 146
- American Physical Society · ii, liii
- amplitude · v, 5, 6, 10, 15, 27, 29, 30, 37, 39, 41, 42, 43, 44, 45, 196, 198, 215, 216, 222, 223
- analogical models · 331, 332, 500
- analogies, analogy · v, vi, xxx, xlvii, lii, lix, lxi, 35, 36, 43, 84, 86, 87, 88, 102, 130, 132, 169, 172, 297, 301, 313, 327, 328, 330, 332, 337, 338, 339, 345, 363, 377, 378, 380, 381, 382, 385, 386, 403, 476, 477, 482, 483, 493, 500, 501, 503, 505
- analogous · 35, 81, 102, 127, 128, 176, 241, 260, 289, 291, 295, 333, 338
- analyses, analysis · iv, xxix, xxxi, xxxiii, xxxvii, xxxix, l, lii, lvii, lx, lxi, 46, 56, 67, 76, 77, 84, 86, 88, 96, 103, 105, 115, 130, 159, 175, 197, 216, 217, 220, 293, 294, 297, 298, 304, 305, 313, 315, 318, 329, 350, 359, 368, 384, 385, 386, 387, 395, 397, 398, 400, 402, 404, 406, 415, 420, 439, 450, 458, 484, 486, 487, 492, 493, 496, 501, 503, 505, 508
- Ancient Greeks, Ancient Greece · 65
- angular frequency · 5, 8, 9, 40
- angular number · 8
- Annalen der Physik · 50, 132, 140, 142, 180, 230, 271
- anthropic principle(s) · 259
- antinode · 16
- Antiquity · xii, 64, 65, 242, 456, 463
- approaches · v, xxviii, xxix, xxxi, lii, 98, 102, 124, 162, 191, 211, 235, 243, 283, 285, 289, 300, 304, 340, 375, 378, 382, 389, 390, 396, 397, 440, 457, 464, 501
- Aristotelian dynamics · 295
- artificial intelligence · 239
- artificial neural networks · 239, 241, 269
- association · 287, 301, 319, 326, 327, 382, 386
- assumption · xxviii, 65, 77, 79, 83, 86, 116, 119, 174, 285, 288, 289, 292, 384, 500
- Astronomy · ii, iii, iv, v, viii, xiv, xxv, xl, li, lviii, 36, 54, 56, 62, 67, 73, 162, 187, 225, 235, 243, 260, 262, 264, 266, 267, 390, 410, 413, 432, 433, 434

Astrophysics · xxxii, xlvi, lxxv, 52, 123, 229, 256, 257, 261, 269, 270, 507  
 Axioms of Geometry · 76

---

## **B**

background · x, lx, 170, 249, 253, 265, 289, 316, 341, 384, 389, 399, 482, 501  
 bar · 191  
 beam · xxxiii, 198, 200, 201, 202, 203, 204, 205, 206, 207, 209, 210  
 beam splitter · 198, 204, 206  
 behavioral · 300, 310  
 beliefs · xxx, xxxii, lvii, lviii, lxiv, lxxv, 65, 67, 236, 259, 308, 314, 483, 484, 502, 503, 507  
 bending of light · 25, 167, 168, 169, 170, 171  
 Bern · 140, 148  
 Big Bang · vii, viii, xxiv, 136, 226, 256, 264, 265, 268, 270, 481  
 Big Bang Observer · xxv, 226, 265, 268, 270  
 Big Chill, Big Freeze · 255  
 Big Crunch · 255  
 Big Data · 239  
 Big Rip · 255  
 Big Science · 239  
 binaries, binary · xiv, xxiv, xxvii, lvii, lx, 34, 35, 36, 41, 42, 43, 45, 51, 53, 214, 215, 216, 217, 218, 219, 220, 221, 222, 223, 226, 227, 229, 260, 261, 264, 268, 269, 275, 338, 351  
 binary neutron star system, BNS · 214, 241  
 binary pulsar · 219, 229, 275  
 binary system · lx, 41, 42, 45, 216, 217, 221, 226  
 binding energy · 41, 265  
 biological results · 286  
 Biostatistics · 359  
 black body · 109, 438, 442  
 black hole · iv, v, vi, vii, xiv, xxvii, xxxiii, xxxv, lvii, 35, 36, 42, 43, 45, 46, 51, 52, 192, 214, 215, 217, 219, 220, 221, 222, 226, 227, 228, 261, 264, 265, 268, 272, 273, 333, 334, 337, 338, 339, 343, 347, 351, 357, 358, 365, 367, 443, 464, 471, 476, 478, 481, 482  
 blackbody spectrum · 112, 113  
 blueshift · xxv, 34, 171, 251, 357, 481  
 Bohr's stability conditions · 128, 129  
 Bose-Einstein condensate, BEC · 241, 269  
 brain · lviii, lix, lx, lxi, lxvi, 281, 282, 301, 314, 318, 327, 503, 504, 508  
 bubble multiverse · 258

---

## **C**

California Institute of Technology · 197, 224, 270  
 Cambridge Philosophical Society · liv, 80, 131, 348  
 Cartesian coordinates · 66  
 case study · viii, x, xii, xxx, xliii, xlvi, l, lviii, lxii, 283, 284, 369, 370, 407, 409, 420, 422, 424, 429, 450, 503, 505, 506  
 causality · 42, 149, 161, 342, 393, 456  
 causally disconnected · 256

- celerity · 18, 19, 25, 68, 141, 151, 171, 188
- cells · 327
- Cepheid variables · 256
- Chapel Hill Conference · xxiii, xlv, lix, lxiv, 187, 192, 225, 229, 275
- chirp signal · 216, 217, 337
- citizen science · 239
- clock · 153, 154, 155, 156, 157, 158, 358, 367
- closed path · 164, 165, 166
- coalescence · vii, viii, lvii, 46, 217, 221, 336
- coating · 208
- cognition, cognitive · x, xxxi, lviii, lix, lx, lxi, lxii, lxiv, lxv, 240, 285, 289, 294, 295, 299, 310, 312, 314, 318, 320, 322, 328, 349, 368, 371, 401, 447, 484, 503, 504, 505, 507, 508
- cognitive aspect · 289
- cognitive development · x, 289, 295
- cognitive dissonance · 295, 299
- cognitive objectives · 343, 402, 447
- cognitive psychology · xxxi, xliv, lxvi, 314, 328, 379, 500
- coherence · 127, 209, 334, 382, 395, 405
- Cold War · 192, 236, 243
- collapse · 45, 229, 258, 265, 269, 440
- common knowledge · v, xxix, xxx, 303, 304, 308, 312, 316, 326, 327
- common sense · xxix, xxx, xlv, 78, 79, 93, 98, 100, 131, 151, 292, 303, 304, 305, 308, 309
- Compensating Plates · 204
- Comptes Rendus of the French Academy of Sciences · xxxvii, 174, 182, 349, 444, 472
- concept · i, ii, iii, x, xi, xiv, xv, xxvi, xxxi, xxxv, xlvii, lxii, 3, 56, 64, 82, 86, 97, 105, 109, 116, 130, 139, 140, 179, 192, 243, 281, 288, 290, 296, 297, 299, 309, 310, 320, 326, 335, 336, 340, 347, 350, 354, 355, 361, 370, 376, 377, 380, 381, 382, 389, 390, 391, 394, 413, 414, 416, 426, 429, 435, 451, 457, 462, 464, 471, 484, 497, 498, 505
- constraint · 113
- Constructivism · xlviii, 294, 295, 484, 497
- content · x, xii, xiii, xv, xxv, xxviii, xxix, xlvi, xlvii, xlix, 90, 141, 257, 281, 285, 286, 289, 320, 350, 376, 377, 378, 379, 380, 382, 397, 447, 456, 457, 479, 482, 494
- contingency · 82, 306
- continuous gravitational waves · 241, 268
- contract · 39, 42, 190, 196, 255, 338, 376, 377
- Cosmic Microwave Background, CMB · vii, viii, lviii, lx, 227, 249, 254, 257, 264, 268, 481
- cosmological constant · vi, 36, 253
- cosmological parameter · 243
- cosmological principle · 251, 252
- cosmological redshift · 252
- Cosmology · i, iii, iv, vi, vii, xiv, xvi, xxv, xxxv, lxi, lxv, 35, 49, 52, 54, 55, 56, 60, 62, 181, 194, 228, 235, 242, 243, 249, 252, 253, 256, 259, 260, 264, 269, 274, 350, 356, 410, 413, 432, 443, 464, 471, 478, 481, 505, 507
- courses · xxviii, 283, 285, 375, 379, 397, 401, 446
- COVID · 239, 270, 346, 496
- critical density · 253
- critical thinking · xxix, 302, 313, 314, 379, 500
- cultural heritage · xxviii, 285
- curricula · i, viii, ix, x, xi, xii, xv, xxvii, xxviii, xxxi, xxxii, xxxiv, xlvii, xlviii, 281, 283, 285, 296, 307, 340, 375, 378, 379, 380, 382, 383, 476, 500, 501

curvature · ii, vi, xxv, lv, 34, 35, 36, 77, 81, 82, 83, 102, 163, 164, 165, 166, 167, 169, 170, 171, 172, 196, 200, 204, 253, 254, 255, 256, 267, 297, 339, 347, 380, 477, 480, 504  
 curved spaces · xii, xx, xxxv, 64, 80, 81, 82, 297, 464, 471, 477

## D

dark energy · 223, 253, 255, 257, 307  
 dark fringe · 198, 200  
 dark matter · 257, 258, 307  
 De Sitter Effect · 172  
 debate · xx, 117, 190, 249, 397, 422  
 decoupling · 264  
 deduction · 46, 293, 301, 453  
 density · vi, 25, 36, 39, 45, 86, 169, 216, 253, 254, 255, 258, 347  
 description, descriptive · i, xi, xxviii, xxxiv, xxxvi, lxii, 3, 100, 118, 119, 140, 143, 162, 167, 187, 202, 264, 285, 316, 320, 330, 331, 391, 440, 443, 457, 464, 470, 472, 492, 505  
 detector · i, vi, vii, xvi, xvii, xxiii, xxv, xxvi, xxxiii, 13, 14, 38, 46, 51, 188, 190, 191, 197, 198, 200, 204, 213, 214, 215, 216, 221, 224, 226, 241, 260, 261, 262, 268  
 didactic principle · 379, 503  
 didactic situation · 376, 496  
 didactic transposition · xiii, 287, 328, 377  
 Didactics · xii, xiii, l, li, lxxv, 49, 286, 287, 318, 376, 377, 378, 380, 383, 386, 456, 490, 491, 498, 504, 507  
 differential form · 66, 70  
 Differential Geometry · 76, 77, 340, 342, 356, 479  
 diffraction · 27, 50, 204, 381, 418, 463  
 dilation · xxxiv, 442, 464, 470  
 disbelief · 298  
 disciplinary didactics · xii, xiii, 286  
 disciplines · xiii, xxx, 67, 236, 286, 290, 291, 301, 302, 316, 360, 376, 388, 390, 397, 398, 456  
 discovery, discoveries · ii, iv, v, vii, viii, ix, x, xi, xii, xiii, xiv, xv, xxiv, xxv, xxvii, xxx, xxxii, xlvi, xlviii, xlix, l, li, lii, lvi, lx, lxiii, 23, 35, 42, 49, 55, 60, 62, 67, 82, 96, 113, 115, 124, 140, 168, 179, 192, 224, 226, 238, 240, 243, 249, 250, 262, 265, 269, 287, 290, 293, 297, 306, 312, 325, 327, 340, 346, 347, 349, 350, 368, 373, 375, 380, 386, 395, 396, 398, 399, 438, 451, 476, 477, 482, 485, 496, 501  
 discrepancies · vii, 249, 487  
 dispersion · 18, 223  
 distance · iii, v, xxv, xxxii, xxxiii, xlii, xliii, 7, 8, 11, 32, 33, 42, 45, 55, 66, 72, 74, 75, 76, 83, 84, 87, 98, 99, 114, 145, 147, 149, 150, 151, 158, 169, 171, 188, 189, 196, 197, 198, 204, 214, 217, 219, 223, 247, 248, 249, 250, 261, 267, 269, 308, 335, 490, 506  
 Doppler Effect · 32, 33, 50, 171, 481  
 Doppler shift · 251, 252, 256  
 Dynamics · xxii, xxviii, xxix, xxxvii, xxxix, xl, xli, xliv, lvi, lxiii, lxvi, 48, 51, 56, 59, 69, 92, 93, 94, 96, 137, 139, 174, 181, 184, 194, 229, 232, 261, 269, 274, 321, 322, 348, 349, 350, 352, 369, 370, 373, 414, 422, 442, 461, 467, 474, 508, 509  
 Dyson Sphere · 190

**E**

- Educational Neurosciences · 301, 326  
 Educational Psychology · 312  
 Educational Sciences · xiii, 287  
 Einstein's happiest thought · 140  
 Einstein's Theories of Relativity · i, ii, iii, vi, xi, xiv, xx, xxii, xxiii, xxiv, xxxii, xxxiv, xxxv, xxxix, xl, xlii, xlv, xlviii, lv, lvi, lix, lxii, lxiii, 3, 34, 35, 52, 82, 84, 88, 90, 103, 105, 125, 127, 130, 131, 133, 134, 136, 139, 140, 141, 143, 144, 148, 149, 155, 156, 158, 162, 163, 167, 168, 169, 171, 172, 176, 179, 180, 181, 182, 183, 184, 185, 188, 190, 192, 193, 194, 216, 223, 227, 230, 231, 233, 243, 259, 264, 267, 271, 273, 275, 335, 340, 341, 342, 344, 351, 352, 354, 355, 356, 357, 362, 363, 365, 367, 380, 434, 437, 442, 444, 445, 455, 461, 463, 464, 466, 467, 468, 469, 470, 471, 473, 475, 476, 477, 479, 480, 485  
 electromagnetic spectrum · iii, 20, 33, 34, 35, 222, 243, 260, 262, 282  
 electromagnetic wave · v, viii, 13, 16, 18, 19, 20, 21, 24, 25, 33, 38, 39, 43, 116, 118, 144, 176, 192, 222, 264, 361, 418, 463  
 electromagnetism · 42, 55, 84, 86, 130, 140, 176, 350, 435  
 eLISA · xxiv, 260, 261  
 Empirism, empirical · lxii, 73, 77, 110, 112, 119, 287, 292, 297, 306, 309, 310, 314, 320, 334, 377, 378, 395, 451, 486, 487, 488, 489, 491, 505  
 empty space · 118, 253  
 energy · vi, xxiv, xxv, xxix, xxxiv, lii, 4, 10, 11, 18, 19, 20, 21, 34, 36, 39, 41, 42, 43, 84, 86, 87, 93, 94, 110, 112, 113, 115, 116, 119, 124, 125, 126, 127, 128, 129, 140, 141, 162, 163, 169, 172, 195, 196, 197, 217, 218, 236, 239, 250, 253, 254, 257, 264, 265, 270, 338, 351, 358, 367, 369, 372, 393, 394, 426, 429, 439, 442, 470, 509  
 energy density · xxv, 112, 162, 163, 253, 254  
 entanglement · xl  
 envelope · 9, 10  
 environment · xv, xvii, xxx, 201, 221, 239, 260, 282, 290, 316, 328, 428, 430, 490  
 epistemological break · xxix, 283, 307, 308, 316  
 epistemological obstacle · x, xiii, xlviii, li, 287, 289, 296, 307, 308, 309, 310, 316, 381, 482  
 Epistemology · viii, xxxiv, xxxv, xl, xli, xlii, xlv, xlvii, xlviii, xlix, l, lix, lx, lxi, lxii, lxx, 55, 58, 59, 134, 136, 183, 184, 232, 274, 283, 284, 300, 301, 318, 319, 320, 321, 326, 343, 350, 352, 356, 370, 371, 372, 378, 379, 383, 395, 396, 437, 455, 456, 458, 460, 461, 462, 468, 469, 471, 474, 475, 476, 479, 480, 483, 500, 503, 504, 505, 506, 507, 509  
 equation · 16, 70, 73, 112, 124, 163, 193, 196, 218, 299, 300, 381, 386, 420  
 equations of motion · 67  
 essays · 189, 421, 439  
 ether · 86, 87, 88, 93, 105, 144, 145, 148, 180  
 ethical problems · 239, 288  
 Euclidean Geometry · xxxiv, 97, 164, 341, 342, 347, 353, 354, 355, 356, 357, 361, 362, 442, 464, 470, 479  
 European Gravitational Observatory · i, ii, vi, xlvi, liii, liv  
 European Society for the History of Science · 58, 136, 183, 232, 269, 320, 372, 384, 509  
 European Southern Observatory · 169  
 evaluations · xxix, 303, 313, 326, 355, 357, 362, 363, 365, 379, 482, 493, 497  
 Event · iv  
 exactness · 296, 298  
 exemplification · 327, 493  
 expanding · xxv, 45, 249, 251, 252, 253, 256, 259  
 expansion · vii, xv, xxv, 36, 100, 197, 249, 252, 253, 255, 256, 257, 258, 261, 264

expectation · 239  
 expected results · i, 299, 347  
 experiences · xi, xxiii, xxix, xlv, xlvi, 3, 24, 68, 76, 77, 81, 93, 101, 112, 116, 118, 148,  
 169, 188, 281, 292, 295, 296, 298, 306, 308, 326, 327, 334, 335, 377, 416, 418,  
 450, 482, 483, 484, 487, 501  
 experimental confirmation · xxxiv, 298, 456, 464, 470  
 experimental method · 67  
 experiments · iv, xxxi, xxxviii, lx, 49, 81, 102, 112, 117, 119, 144, 145, 148, 172, 174,  
 181, 195, 199, 242, 258, 284, 296, 304, 306, 332, 333, 336, 337, 377, 418, 435,  
 476, 491, 501

## ***F***

Fabry-Pérot cavities · 200, 204, 208  
 falsifiability · 259, 268, 456, 486, 488, 491  
 Faraday Isolator · 203  
 feasibility · 261, 283  
 Feynman's Sticky Bead Argument · 195, 196, 332  
 fields · i, iii, ii, iv, vi, viii, ix, x, xiii, xiv, xv, xvi, xxii, xxiii, xxviii, xxxii, xlviii, 4, 14,  
 19, 35, 36, 76, 77, 84, 92, 96, 115, 118, 176, 180, 193, 195, 236, 253, 264, 287,  
 295, 296, 311, 318, 328, 331, 360, 364, 378, 387, 396, 399, 435, 436, 437, 480, 487  
 filters · 200, 211, 212, 214, 259  
 flat space · 36, 37, 39, 76, 143, 188, 198  
 flux · 84, 86, 311  
 fluxions · 69  
 forces · i, xv, xxix, xxxix, xl, lx, 34, 35, 46, 47, 56, 65, 69, 70, 72, 74, 75, 84, 86, 87,  
 88, 93, 149, 196, 240, 257, 295, 308, 350, 361, 380, 406, 413, 414, 416, 435, 436,  
 504  
 formal · xxix, 286, 288, 293, 300, 307, 308, 364, 383, 448, 450, 493, 494, 496, 497,  
 500  
 formalization · xii, 64, 297, 303, 326, 397  
 foundations · 74, 77, 189, 387, 450  
 Frame Dragging Effect · 173  
 Frame of reference · lxxv, 67, 93, 126, 143, 150, 151, 153, 155, 156, 157, 158, 159, 188,  
 358, 366, 367, 376, 386, 397, 477, 482  
 frameworks · ix, x, xii, xiii, xv, xx, xxviii, xxix, xxx, xxxi, xlvii, xlviii, l, li, lxxv, 64,  
 101, 105, 127, 140, 172, 188, 198, 240, 280, 284, 285, 286, 287, 288, 289, 308,  
 316, 322, 325, 327, 336, 347, 360, 368, 375, 389, 496, 498, 499, 500, 507  
 Fraunhofer lines · xxv, 250  
 French Academy of Science · 174  
 frequencies, frequency · vii, xvii, 7, 8, 9, 16, 18, 20, 21, 25, 32, 33, 34, 39, 40, 41, 43,  
 44, 45, 109, 110, 112, 113, 115, 116, 124, 126, 128, 171, 190, 191, 200, 204, 208,  
 210, 213, 216, 218, 241, 261, 265, 337, 381, 439  
 Friedmann universe · 253  
 Friedmann-Lemaître-Robertson-Walker (FLRW or FRW) cosmological model · 251,  
 253  
 funding · 191, 239, 243, 270  
 fused silica · 208  
 fusion reactors · 239  
 future of the universe · 253, 255, 481



---

**G**

- galaxies · iv, xxv, 34, 42, 46, 169, 170, 222, 243, 252, 264, 269
- gamma rays · 4, 172, 222, 243, 263
- gedanken experiments · 199, 332
- General Relativity, GR · i, ii, iii, vi, xi, xiv, xxii, xxiii, xxiv, xxxii, xxxiv, xxxv, xlvi, li, lix, lxiv, 3, 34, 35, 52, 103, 132, 136, 140, 141, 162, 163, 167, 168, 169, 171, 172, 176, 182, 192, 193, 194, 223, 227, 243, 259, 264, 267, 340, 342, 344, 354, 355, 357, 362, 363, 365, 380, 470, 471, 476, 477, 480, 485, 507
- generalisation · 304, 305
- genetic epistemology · 289, 295
- GEO600 · xxiv, 260
- geodesics · 50, 99, 169, 352
- geometry · ix, xi, xii, xx, xxx, xxxiv, xxxv, xlii, xlvi, l, liv, lxii, lxiii, lxiv, lxv, 37, 50, 55, 64, 66, 76, 77, 79, 80, 81, 88, 94, 96, 100, 101, 102, 119, 131, 134, 162, 164, 184, 233, 236, 254, 257, 275, 292, 297, 298, 340, 341, 342, 347, 348, 352, 385, 387, 389, 395, 397, 402, 411, 413, 415, 419, 434, 437, 442, 443, 445, 450, 461, 463, 464, 468, 469, 470, 471, 475, 477, 479
- GPS system · 151, 485
- gravitation · i, ii, iii, ix, xi, xv, xxii, xxiv, xxvii, xxxii, xxxiv, xxxv, xlvi, xlvi, xlix, l, liv, lviii, lix, lxiv, 3, 42, 56, 60, 62, 64, 69, 72, 74, 75, 80, 81, 82, 84, 86, 90, 92, 93, 105, 130, 131, 133, 140, 162, 168, 174, 175, 180, 182, 189, 190, 192, 193, 194, 226, 228, 229, 243, 265, 267, 269, 275, 284, 340, 341, 342, 344, 348, 353, 354, 355, 357, 361, 362, 365, 367, 380, 443, 470, 471, 476, 477, 480
- Gravitational blueshift/redshift · xxiv, 167, 172
- gravitational collapse · 265
- gravitational constant · vi, 36, 72, 171, 253
- gravitational field · xxii, xxxv, 36, 46, 92, 162, 167, 168, 169, 171, 172, 181, 192, 196, 230, 271, 443, 471, 477, 480, 482
- gravitational gradient · 47, 169, 171, 172, 339
- gravitational lensing · 167, 170, 241, 264
- gravitational luminosity · 41, 43
- gravitational radiation · vii, xxiii, xxiv, lx, 36, 42, 43, 217, 218, 223, 227, 264, 265
- gravitational wave candidates · 216
- gravitational waves · i, ii, v, vi, vii, viii, ix, x, xi, xii, xiii, xiv, xv, xvi, xvii, xix, xx, xxi, xxii, xxiii, xxiv, xxv, xxvi, xxvii, xxix, xxx, xxxi, xxxii, xxxiii, xxxiv, xxxv, xxxvi, xlvi, xlvi, xlvi, xlvi, xlvi, xlix, l, li, lii, lv, lvi, lvii, lviii, lix, lx, lxi, lxiii, lxv, 1, 3, 4, 34, 35, 36, 37, 38, 39, 40, 41, 42, 43, 44, 45, 46, 49, 50, 51, 52, 53, 62, 64, 82, 86, 88, 96, 102, 105, 107, 117, 119, 124, 130, 131, 133, 139, 175, 176, 178, 179, 180, 181, 187, 188, 189, 190, 191, 192, 193, 194, 195, 196, 197, 198, 199, 200, 204, 210, 211, 213, 215, 216, 217, 218, 219, 220, 221, 222, 223, 224, 225, 226, 227, 228, 229, 235, 240, 241, 260, 261, 262, 263, 264, 265, 268, 269, 272, 273, 275, 279, 280, 283, 287, 297, 316, 325, 327, 328, 331, 335, 336, 337, 338, 339, 340, 341, 342, 343, 346, 347, 351, 353, 356, 357, 358, 361, 365, 367, 368, 375, 380, 381, 382, 383, 443, 455, 464, 470, 471, 476, 477, 478, 479, 481, 482, 485, 496, 499, 501, 502, 503, 504, 507
- gravity · i, lix, lxv, 34, 35, 46, 47, 48, 72, 74, 75, 84, 86, 87, 88, 105, 114, 130, 136, 143, 162, 174, 175, 176, 182, 189, 190, 191, 192, 193, 195, 196, 197, 227, 229, 233, 253, 255, 257, 260, 261, 264, 275, 304, 361, 477, 479, 507
- Gravity Probe B · 174, 182, 233, 275
- Gravity Research Foundation · 189, 190, 193
- gravity waves · i, 46, 48, 190, 191, 193, 196, 197
- Great Debate · xxv, 249
- gyroscopes · 174

---

**H**

- harmonics · 5, 16  
 Heat death · 255  
 historical context · xxix, 116, 179, 187, 192, 289, 290, 399  
 historical experiments · 288, 296  
 History · i, iii, viii, ix, xv, xix, xx, xxv, xxvii, xxviii, xxx, xxxii, xxxiv, xxxvi, xl, xli, xlii, xliii, xlv, xlviii, xlix, l, lv, lviii, lix, lxi, lxii, lxiii, lxiv, lxvi, 51, 52, 54, 55, 56, 58, 59, 60, 62, 63, 133, 136, 137, 144, 181, 183, 184, 185, 192, 227, 232, 233, 235, 259, 269, 274, 275, 281, 283, 285, 288, 291, 296, 300, 309, 317, 318, 319, 320, 321, 327, 340, 344, 350, 352, 353, 356, 360, 371, 372, 373, 375, 378, 379, 382, 383, 384, 387, 389, 391, 395, 396, 407, 408, 409, 410, 411, 412, 414, 415, 416, 417, 419, 420, 422, 423, 424, 425, 427, 430, 431, 433, 436, 437, 440, 443, 445, 446, 447, 448, 450, 451, 452, 454, 455, 456, 457, 458, 459, 460, 461, 462, 464, 467, 468, 469, 472, 474, 475, 484, 501, 503, 504, 505, 506, 507, 509, 510  
 History and Philosophy of Science, HPS · xxvii, xxviii, xli, lix, lxiii, 54, 55, 58, 137, 281, 284, 285, 300, 302, 320, 321, 373, 378, 384, 437, 458, 459, 460, 467, 474, 476, 504, 506, 509  
 History of Physics · i, ix, xix, xlv, xlix, l, lxiii, 144, 227, 291, 312, 313, 375, 457  
 History of Science · viii, xxv, xxvii, xl, xli, xliii, xlv, xlix, l, lix, lxiii, lxiv, 54, 55, 56, 59, 137, 184, 232, 235, 274, 283, 296, 300, 309, 318, 321, 344, 350, 352, 353, 356, 360, 371, 373, 378, 379, 382, 389, 407, 409, 410, 427, 431, 447, 451, 452, 456, 457, 458, 459, 462, 468, 474, 484, 501, 503, 506, 510  
 HL-LHC Collaboration · 239  
 homogeneity · 83, 208, 251, 256, 257, 282  
 Homogeneity of space · 282  
 Homogeneity of time · 282  
 horizon problem · 256  
 Hubble constant · vii, 249, 253, 255, 257  
 Hubble parameter · xxv, 257  
 Hubble-Lemaître law · 249  
 Hulse-Taylor · xxiv, 42  
 Human Brain Project · 239  
 human endeavour · 288, 347, 382, 476, 486, 500  
 hypotheses · xxii, xxix, xlvii, lii, lviii, lx, 49, 76, 77, 82, 86, 87, 92, 95, 103, 105, 117, 118, 125, 126, 127, 133, 144, 174, 175, 195, 199, 223, 246, 259, 282, 289, 292, 293, 294, 306, 315, 328, 345, 359, 378, 379, 381, 382, 384, 386, 396, 399, 400, 401, 402, 406, 407, 420, 427, 438, 442, 484, 488, 489, 497, 498

---

**I**

- ideal objects · 110, 298, 392  
 idealisation · 296, 310  
 ideologies · 288  
 impulsion · 12, 141  
 incompleteness · 297, 385  
 induction · 109, 292, 295, 435, 487  
 inertial · xxxv, 67, 140, 141, 143, 148, 149, 151, 153, 163, 252, 443, 471  
 Inertial frames of reference · 140, 141, 148, 149, 151, 253  
 inference · 73, 215, 301, 303, 326, 327, 484, 486  
 infinitesimal calculus · 69, 414, 429, 450

- inflation · 256  
 informal · xxix, xlviii, 307, 308, 492, 493, 500  
 infrared · xvii, 4, 112, 202, 208  
 Injection System · xvi, 203  
 Input Mode Cleaner · 202, 203  
 inquiries · xlix, lv, lvi, 59, 137, 184, 232, 275, 283, 302, 303, 321, 326, 351, 352, 372, 373, 380, 402, 449, 484, 486, 509, 510  
 inquiry based · 59, 137, 184, 232, 275, 283, 321, 352, 373, 449, 510  
 inspiral · 41, 43, 46, 51, 215, 217, 218, 222, 226, 227  
 instantaneous · 86, 158, 162, 175  
 institutional environment · xii, 286, 345, 403  
 intensity · 10, 86, 87, 110, 115, 116, 121, 197, 387  
 interactions · 27, 29, 162, 195, 204, 335, 379, 420, 494  
 interdisciplinarity, interdisciplinary · viii, xiii, xxvii, xxix, l, li, lii, 280, 284, 285, 286, 340, 368, 378, 384, 391, 392, 410  
 Inter-Divisional Teaching Commission of the Division of Logic · 384  
 interference · 16, 26, 27, 29, 30, 31, 52, 122, 123, 145, 147, 197, 198, 418, 463  
 interferometer · i, xvi, xvii, xxiv, xxxiii, 116, 120, 121, 144, 145, 188, 190, 192, 198, 199, 200, 201, 203, 207, 208, 209, 213, 225, 227, 260, 261, 365  
 International Union for History and Philosophy of Science and Technology · 384  
 interplay · xlviii, 284, 296, 298, 377, 381, 391  
 interpretation · xlvii, 67, 72, 77, 113, 115, 117, 128, 129, 140, 163, 258, 299, 302, 311, 317, 331, 334, 345, 357, 387, 396, 399, 402, 406, 426, 429, 439, 440, 464, 485, 492  
 intuitions · iv, xxxv, 88, 116, 130, 195, 326, 327, 334, 457, 464, 471, 484  
 invariance, invariant · 42, 66, 67, 98, 141, 143, 148, 151, 156, 380, 482  
 inverted pendulum · 210, 211, 212  
 Island Universes · xxv, 243, 247, 249  
 isotropy · 83, 251, 257, 282, 397  
 Isotropy of Space · 282, 397  
 issues · iii, xv, xxv, 131, 134, 135, 137, 168, 182, 188, 195, 233, 260, 275, 291, 298, 320, 350, 352, 373, 383, 456, 482, 494, 497

---

## *J*

- joint action theory · xiii, 287  
 judgment · 313, 326  
 justification · 54, 128, 129, 158, 291, 299, 399, 483, 484, 485  
 justified true beliefs · 295

---

## *K*

- KAGRA, Large-Scale Gravitational-wave Telescope, LCGT · xxiv, 226, 260, 268  
 knowledge · x, xiii, xiv, xxviii, xxix, xlvii, lii, lix, lx, 49, 65, 151, 168, 236, 238, 240, 281, 284, 285, 286, 287, 289, 290, 295, 296, 300, 301, 302, 303, 304, 305, 306, 307, 309, 310, 311, 312, 320, 326, 327, 329, 332, 334, 335, 341, 350, 353, 354, 357, 362, 367, 377, 381, 382, 385, 391, 392, 395, 396, 400, 402, 403, 404, 407, 446, 454, 456, 483, 484, 485, 486, 488, 489, 492, 493, 494, 495, 496, 499, 503  
 Kyoto · 148

**L**

- language · lli, lxv, 66, 67, 297, 299, 300, 304, 305, 306, 310, 315, 319, 326, 376, 386, 388, 389, 395, 400, 448, 450, 460, 485, 507
- Laplace transform · 84, 133
- laser · xvii, xviii, xxiv, xxxiii, xlvi, 189, 190, 192, 198, 200, 202, 204, 205, 206, 207, 208, 209
- law · 11, 40, 46, 51, 55, 57, 59, 69, 70, 72, 75, 82, 84, 86, 87, 95, 96, 102, 109, 110, 112, 113, 114, 115, 116, 126, 127, 132, 133, 174, 175, 251, 284, 292, 298, 304, 317, 327, 330, 371, 389, 397, 413, 415, 416, 422, 435, 438, 450, 451
- laws of motion · 69, 94, 414
- learning · x, xii, xiii, xxix, xxx, xxxi, xxxii, xxxiv, xlii, xlviii, lii, lvii, lviii, lix, lx, lxi, lxii, lxiii, lxiv, lxv, lxvi, 281, 282, 283, 286, 287, 288, 289, 294, 301, 308, 309, 310, 311, 312, 313, 314, 317, 318, 319, 320, 322, 326, 329, 332, 335, 336, 341, 352, 357, 369, 370, 372, 376, 377, 378, 379, 380, 381, 384, 400, 410, 476, 483, 493, 494, 495, 496, 500, 501, 502, 503, 504, 505, 506, 507, 508
- learning objectives · 281
- learning theory · 294, 301, 326, 335
- lecture · xii, xxviii, xxxi, xxxvii, xlv, lxvi, 80, 81, 82, 83, 270, 288, 289, 290, 300, 322, 325, 340, 346, 356, 357, 360, 361, 364, 365, 476, 478, 482, 493, 494, 496, 497, 499, 501, 507, 508
- length contraction · 172, 198, 480, 482
- Lense-Thirring Effect · 172, 173, 181, 231, 272, 351
- light · v, vi, vii, viii, xv, xvi, xvii, xxv, xxxiv, xxxviii, xlviii, lv, lvi, lxv, lxvi, 4, 10, 14, 17, 20, 22, 24, 25, 26, 27, 34, 35, 42, 46, 51, 57, 68, 69, 73, 86, 88, 93, 105, 109, 110, 112, 115, 116, 117, 118, 119, 120, 121, 122, 124, 125, 127, 128, 129, 131, 132, 141, 143, 144, 147, 148, 149, 151, 152, 153, 155, 157, 158, 161, 162, 168, 169, 170, 171, 172, 176, 180, 181, 183, 187, 188, 189, 190, 195, 198, 199, 200, 203, 204, 208, 209, 213, 214, 216, 230, 233, 249, 250, 252, 256, 260, 264, 269, 271, 275, 282, 341, 342, 348, 350, 358, 367, 381, 418, 419, 424, 440, 442, 444, 463, 464, 465, 466, 470, 473, 477, 478, 479, 480, 481, 499
- light cone · 151, 152, 161, 162, 480
- light-like · 151, 157, 158
- LIGO · ii, i, vii, xiv, xxiv, xxv, xxvi, xxxiii, xlvii, liii, lvii, lxi, lxvi, 34, 35, 36, 38, 41, 42, 44, 46, 51, 136, 191, 198, 200, 208, 215, 216, 218, 219, 220, 221, 222, 223, 224, 226, 227, 228, 229, 239, 241, 260, 264, 268, 269, 270, 272, 273, 336, 337, 351, 357, 365, 478
- LIGO-India (IndIGO) · 198, 208, 229, 260, 270
- LIGO-Virgo Collaboration · xlvii, 224, 226, 239, 268, 357, 478
- limits · iii, vii, viii, 36, 110, 127, 149, 161, 166, 167, 176, 208, 220, 241, 395
- LISA pathfinder · xxiv, 260
- logics · xxx, lii, 65, 101, 242, 262, 282, 284, 286, 292, 309, 332, 333, 349, 373, 384, 386, 400, 404, 408, 420, 440, 446, 448, 450, 451, 453, 498
- longitudinal waves · 12, 13, 22, 23, 27
- Loop Quantum Gravity · 114
- Lorentz factor,  $\gamma$  · 480
- Lorentz transforms · xxii, xxxiv, 92, 105, 175, 470, 477, 479, 480
- luminiferous aether · 199
- luminiferous ether · 144, 148, 180
- luminosity · 199, 215, 219, 220, 221, 223, 224, 265
- luminosity distance · 215, 219, 221, 222, 223, 224

**M**

- machineries · 236  
 machines · 54, 236, 237, 267, 399, 407, 409, 410, 420, 421, 422, 426, 427, 429, 430  
 manifold · 163, 164, 479  
 many-worlds interpretation · 258  
 mass · vii, xxxiii, xxxiv, xxxv, xl, xlv, xlvii, lvii, lxvi, 18, 19, 36, 39, 41, 42, 44, 45, 46, 70, 72, 82, 84, 109, 114, 124, 125, 126, 127, 128, 129, 140, 141, 149, 151, 162, 163, 169, 170, 171, 176, 194, 196, 198, 211, 214, 217, 218, 219, 220, 221, 222, 223, 226, 227, 228, 257, 261, 264, 265, 268, 269, 272, 273, 333, 338, 341, 342, 343, 347, 380, 438, 442, 443, 470, 471, 481  
 mass-energy · 39, 141, 149, 169, 170, 380  
 match filtering technique · 216  
 mathematical objects · 76, 298  
 Mathematics · i, ii, viii, ix, x, xii, xiii, xxvii, xxviii, xxx, xxxiii, xxxiv, xli, xlii, xliii, xlv, l, lvii, lviii, lxi, lxii, lxiii, lxiv, lxv, lxvi, 6, 50, 52, 54, 55, 56, 58, 59, 66, 67, 70, 76, 78, 93, 136, 137, 143, 183, 184, 232, 236, 274, 283, 286, 287, 288, 289, 290, 291, 293, 296, 297, 298, 299, 300, 311, 317, 318, 319, 320, 321, 336, 347, 350, 351, 353, 356, 360, 369, 371, 372, 373, 381, 384, 385, 386, 387, 389, 390, 395, 396, 398, 399, 401, 402, 404, 407, 408, 409, 410, 411, 413, 420, 423, 424, 425, 429, 433, 437, 440, 442, 446, 448, 450, 451, 452, 453, 457, 460, 461, 462, 463, 467, 468, 470, 474, 475, 490, 492, 500, 502, 504, 505, 506, 507, 509, 510  
 Mathematics Teaching · 288  
 Matter-energy density · 169, 170, 255  
 Maxwell equations · 156  
 measurements · iii, ix, xxiv, 42, 109, 113, 118, 119, 123, 189, 198, 223, 241, 247, 249, 253, 259, 260, 296, 358, 366, 384, 418, 426, 435, 497, 499  
 mechanical waves · 4, 18, 19  
 media, medium · xxii, 4, 7, 8, 15, 16, 18, 19, 21, 23, 24, 25, 34, 35, 48, 52, 53, 86, 92, 94, 118, 144, 162, 169, 199, 223, 238, 239, 258, 283, 314, 341, 342, 377, 381  
 mental image · lxi, 295, 327, 504  
 merger · xxvii, lvii, 35, 41, 43, 44, 45, 46, 214, 215, 217, 219, 220, 221, 222, 228, 261, 273  
 methodologies · i, xxvii, xxviii, xlix, l, 168, 281, 285, 288, 302, 325, 368, 376, 378, 381, 389, 400, 404, 405, 484, 487  
 methods · ii, xlii, xlviii, lii, lxiii, 58, 136, 183, 190, 232, 262, 269, 281, 283, 290, 292, 310, 320, 372, 386, 387, 398, 404, 412, 415, 417, 420, 429, 450, 461, 468, 485, 506, 509  
 Michelson Interferometer · i, xvi, xvii, xxiv, xxxiii, 116, 120, 121, 144, 145, 188, 190, 192, 198, 199, 200, 201, 203, 207, 208, 209, 213, 225, 227, 260, 261, 365  
 Michelson-Morley experiment · xxxiv, 103, 143, 156, 199, 463, 470, 477, 479  
 Milent, Etienne · 346, 496  
 military · 191, 236, 243, 393, 394  
 mirage · 25, 169  
 mirror · 22, 122, 170, 189, 204, 207, 208, 209, 210, 211, 295  
 mistakes · 171, 176, 178  
 mixed approach · 283, 296  
 modelling · ix, xxii, xxvii, xxviii, xxxii, xlii, xlv, xlvii, 4, 119, 285, 331, 332, 372, 378, 380, 383, 461, 468, 474, 496, 508  
 models · iii, xxvi, xxx, xxxi, xl, xlviii, li, 34, 41, 49, 51, 82, 121, 128, 129, 196, 223, 243, 247, 251, 253, 295, 328, 330, 331, 332, 333, 338, 384, 392, 397, 427, 438, 442, 452, 481, 484, 496  
 modern science · xv, xxvii, xxxvi, 67, 130, 295, 387, 389, 392, 407, 409, 410, 413, 414, 443, 457, 464, 472

modes · lv, 16, 85, 91, 111, 113, 114, 132, 133, 136, 202, 209, 320, 330, 331, 334, 348, 502  
 modular programme · xxxiv, 283, 284  
 modules · i, xxxiv, 283, 284, 346, 349, 375, 380, 382, 383, 400, 401, 410, 411, 414, 417, 419, 421, 423, 425, 428, 430, 433, 436, 440, 443, 449, 451, 454, 496, 499, 501  
 motivation · x, xxxi, lix, 289, 336, 380, 483, 503  
 multidisciplinary · xiii, xxxi, xlvii, xlviii, 239, 284, 287, 384  
 Multi-messenger Astronomy · 261  
 multiverse · 258, 268

## N

naive beliefs · 295  
 narratives · 289, 302, 501  
 natural philosophers · xxix, 67, 77, 130  
 natural philosophy · xi, lv, lvi, 56, 58, 64, 66, 94, 96, 132, 136, 183, 231, 236, 273, 349, 407, 408, 409, 420, 422, 424, 426, 429, 432  
 natural places · xi, 64, 65, 130  
 Nature of Science · i, viii, ix, x, xv, xxvii, xxviii, xxix, xlviii, xlix, l, lii, lx, lxii, 49, 279, 280, 281, 283, 284, 285, 288, 309, 316, 318, 325, 327, 347, 368, 375, 378, 379, 381, 383, 456, 458, 459, 460, 462, 499, 500, 501, 505  
 Nature of Science Teaching · i, viii, ix, x, xv, xxvii, xlviii, xlix, l, 279, 280, 284, 288, 316, 383, 456  
 nature of variables · 498  
 Neuropsychology · 301, 326  
 neutron stars · vi, vii, xxxiii, lviii, 42, 44, 45, 46, 51, 172, 173, 214, 219, 222, 223, 226, 228, 229, 241, 260, 264, 265, 268, 269, 273, 275, 343, 351  
 Newton's first law of motion · 69, 149  
 Nobel Prize · i, ii, xii, xxiv, xxv, 42, 53, 113, 115, 124, 224, 229, 270, 327, 371  
 noises · 191, 200, 208, 209, 210, 211, 212, 213, 215, 216, 260, 261, 262, 265, 268  
 non-formal · 493  
 notation · xliii, lxiv, 299, 442  
 notions · xii, 64, 69, 72, 76, 82, 86, 92, 97, 100, 162, 163, 169, 196, 199, 258, 295, 310, 328, 362, 367, 380, 391, 419, 463, 483, 492

## O

objectivity · xxviii, 285, 302, 327, 484, 486  
 observational cosmology · xxv, 243  
 observations · i, ii, viii, xxiv, xxv, xxxix, xliv, 46, 69, 74, 98, 102, 164, 168, 222, 224, 243, 259, 261, 293, 294, 304, 308, 335, 404, 485, 486, 491  
 observers · 13, 14, 32, 33, 34, 67, 68, 81, 92, 98, 126, 128, 150, 151, 153, 154, 155, 156, 158, 160, 170, 173, 249, 258, 358, 366, 367, 386  
 Ontology · vi, x, xl, lxv, 93, 289, 294, 340, 344, 414  
 operative objectives · 368  
 Operative Objectives · 345  
 orbital decay · xxiv, 219  
 oscillations · xii, xxxiii, xxxviii, lx, 4, 6, 7, 11, 12, 13, 14, 16, 18, 19, 36, 64, 65

**P**

- paradigm shift · xviii, 49, 238, 288, 340, 429, 476  
 Parallel transport · 163, 164, 480  
 parallelism · 123, 301, 327  
 participants · 359, 366, 482, 496  
 pedagogical tool · xxviii, lxii, 288, 302  
 pedagogy · xliii, 376, 456, 506  
 perceptions · xxviii, 101, 193, 259, 305, 327, 357, 360, 389, 482, 483  
 period · ii, iii, xx, xxiii, xxiv, xxvii, 6, 7, 8, 18, 39, 40, 45, 118, 190, 192, 215, 249, 256, 264, 385, 418, 501  
 period-luminosity relation · 249, 256  
 phaneron · xlvii, 281, 282, 327  
 phase velocity · 8, 9  
 phases · lviii, 5, 7, 8, 9, 19, 28, 30, 124, 125, 127, 128, 129, 209, 217, 258, 268, 492  
 phenomenon-based · 283
- philosophical, philosophy · xiii, xxviii, xl, lxii, lxxv, 56, 65, 67, 74, 93, 101, 111, 133, 236, 242, 259, 282, 284, 285, 287, 296, 302, 318, 320, 321, 334, 340, 345, 350, 360, 372, 385, 386, 387, 389, 393, 396, 397, 399, 402, 403, 407, 411, 433, 441, 457, 463, 484, 485, 500, 507  
 photoelectric effect · 115, 116, 117, 418  
 photon · 21, 127, 149, 150, 151, 152, 160, 171, 241, 358, 367  
 physical objects · xi, 3, 6, 298, 302, 328, 335, 338, 377  
 Physical Review · xiv, xxiii, xxxvi, xxxvii, xliii, xlv, lvi, lvii, lviii, lix, lx, lxi, 51, 177, 178, 181, 226, 227, 229, 268, 272, 275, 351  
 Physics · i, iii, vi, viii, ix, xi, xii, xv, xix, xxiv, xxv, xxviii, xxx, xxxiv, xxxvi, xxxvii, xxxviii, xxxix, xl, xli, xlii, xlv, xlvii, xlviii, xlix, l, liv, lvii, lviii, lix, lx, lxi, lxii, lxiii, lxiv, lxv, lxvi, 1, 6, 15, 35, 42, 49, 50, 51, 52, 53, 54, 55, 56, 57, 58, 59, 60, 64, 65, 69, 78, 93, 94, 112, 113, 115, 116, 117, 124, 130, 131, 134, 136, 137, 141, 181, 182, 183, 184, 189, 192, 193, 200, 224, 227, 228, 229, 230, 231, 232, 233, 259, 266, 268, 269, 270, 271, 272, 273, 274, 275, 283, 286, 291, 292, 293, 295, 296, 297, 298, 299, 300, 307, 309, 318, 319, 320, 321, 322, 335, 340, 343, 350, 351, 352, 353, 356, 360, 369, 370, 371, 372, 373, 379, 381, 383, 390, 395, 431, 432, 433, 434, 437, 440, 441, 442, 444, 445, 457, 458, 460, 461, 463, 464, 466, 467, 468, 470, 473, 474, 475, 476, 477, 480, 490, 492, 502, 503, 504, 505, 506, 507, 508, 509, 510  
 Physics Teaching · 291, 457  
 Planck Collaboration · 239, 256  
 Planck-Einstein relation · 250  
 pluridisciplinary, pluridisciplinarity · 285  
 polarization · 37, 38, 39, 136, 222, 418  
 positivism, positivist · 384, 389, 484  
 postulate · xxx, xxxiv, 83, 105, 140, 143, 174, 281, 442, 470  
 practices · 238, 240, 307, 325, 368, 378, 382, 483, 491  
 pragmatism · 304, 484  
 Precession of Mercury's perihelion · iii, 167, 168, 478  
 predictions · i, vi, xxii, xxiv, 168  
 principle · xi, xxii, xxx, xxxiii, xxxiv, xxxix, xlvi, lv, 26, 27, 50, 58, 67, 69, 74, 90, 92, 93, 95, 99, 102, 120, 122, 127, 128, 136, 140, 141, 144, 163, 172, 182, 183, 184, 188, 195, 208, 231, 232, 252, 259, 270, 273, 274, 282, 291, 292, 293, 294, 307, 312, 317, 320, 351, 352, 357, 372, 380, 381, 400, 407, 409, 413, 414, 416, 418, 419, 420, 422, 426, 427, 428, 430, 436, 438, 439, 442, 444, 448, 449, 452, 460, 463, 466, 470, 473, 480, 481, 487, 492, 509  
 Principle of Relativity · 50, 282, 352, 357, 380

Principle of the conservation of energy · 113, 291, 317, 426, 429  
 prisms · xiii, 24, 25, 287  
 probability, probabilities · xxiii, 115, 127, 282, 304, 306, 313, 315, 410, 427, 440, 464, 488  
 problem solving · xxx, 283, 309, 486, 500  
 project · i, xxvi, xxxiii, xlv, xlvi, 193, 238, 239, 240, 243, 283, 331, 371  
 Project Mogul · 193  
 protocols · 67, 299  
 Prussian Academy · 140  
 pseudo-science · xxviii, 285, 304  
 Psychology · xiii, xlv, lvii, lviii, lxiii, lxv, lxvi, 285, 287, 301, 314, 316, 317, 318, 319, 321, 326, 352, 370, 376, 379, 397, 502, 503, 506, 507  
 Pythagorean Theorem · 66

## Q

qualitative · 101, 377, 382, 484, 490, 491, 498  
 quanta · xxxvi, lvii, 94, 95, 113, 115, 116, 124, 125, 126, 127, 128, 129, 135, 320, 350, 408, 409, 438, 440, 502  
 quantitative · 101, 247, 377, 382, 484, 490, 498  
 quantum effects · xvii, 213  
 Quantum Mechanics · vi, vii, xxv, xxx, 27, 96, 113, 124, 130, 192, 243, 258, 259, 309, 340, 343, 381, 440, 441, 452, 464, 465, 476, 480, 485

## R

radiation · 19, 21, 42, 46, 96, 109, 110, 112, 114, 115, 116, 119, 120, 132, 133, 134, 141, 198, 204, 223, 229, 243, 264, 266, 275, 438, 481  
 radio · 4, 26, 219, 227, 236, 243  
 radio astronomy · 243  
 reasoning · xxix, xxx, lii, 74, 76, 86, 99, 102, 110, 127, 128, 259, 295, 296, 301, 303, 307, 308, 313, 314, 316, 325, 326, 327, 328, 332, 333, 336, 337, 338, 385, 389, 484, 491, 493, 496, 499, 501  
 recycling cavity · 208  
 redshift · xxv, 34, 172, 217, 219, 221, 222, 224, 228, 249, 250, 251, 252, 267, 270, 273, 342, 357, 481, 482  
 reference frame · lxv, 67, 93, 126, 143, 151, 153, 155, 156, 157, 158, 159, 188, 358, 366, 367, 482  
 referential · 47, 141, 151, 160, 161, 162  
 reflection, reflective · 21, 22, 73, 148, 305, 313, 314, 370, 381, 387, 402, 429, 485  
 refraction · 23, 25, 51, 57, 59, 82, 169, 199, 209, 381  
 relationship Physics-Mathematics · xlix, 134, 296, 298, 435, 441, 452  
 Relativity · xi, xx, xxxiv, xxxv, xxxix, xl, xlii, xlv, lv, lix, lxii, lxiii, 3, 52, 82, 125, 127, 130, 131, 133, 134, 140, 141, 168, 180, 181, 183, 184, 185, 188, 190, 193, 216, 230, 231, 233, 264, 271, 273, 275, 341, 344, 351, 352, 434, 437, 442, 444, 445, 455, 461, 464, 466, 467, 468, 469, 470, 471, 473, 475, 479  
 Relativity theory · 168, 216  
 religion · ii, 389  
 repeatability · xlviii, 67, 191, 456, 486, 491  
 repetition · 287, 299  
 replication · 288, 296, 491



- representations · 4, 5, 6, 8, 10, 11, 12, 13, 14, 15, 17, 19, 20, 22, 23, 26, 27, 29, 30, 31, 38, 39, 109, 151, 152, 160, 188, 314, 326, 327, 328, 330, 331, 332, 334, 339, 360, 361, 362, 363, 364, 365, 366, 381, 457, 484, 496  
 reproducibility · 67, 486, 491  
 research · i, iii, ii, viii, x, xiii, xiv, xvi, xix, xx, xxix, xlv, xlv, xlv, xlvii, xlviii, l, lii, lvii, lx, lxi, lxii, lxx, 3, 35, 40, 46, 62, 67, 78, 81, 82, 88, 109, 112, 140, 189, 192, 193, 195, 200, 236, 238, 239, 240, 241, 285, 287, 289, 295, 308, 311, 316, 318, 319, 320, 321, 327, 332, 335, 368, 372, 377, 378, 385, 386, 387, 389, 391, 393, 394, 395, 398, 399, 410, 431, 447, 454, 484, 485, 491, 492, 495, 498, 501, 502, 505, 507, 509, 510  
 research methods · 377, 485  
 resources · xlv, lx, 17, 238, 239, 331, 340, 504  
 Riemann Curvature Tensor · 163, 164, 167, 479, 480  
 Riemann Hypothesis · 76, 492  
 Rigid bodies · 162  
 Ring Heater · 209, 210  
 ringdown · 41, 215, 217, 337  
 Robertson-Walker metric · 251  
 Royal Swedish Academy of Sciences · i, xxiv, 224

---

## S

- scale · 36, 73, 81, 102, 114, 158, 162, 188, 198, 206, 209, 210, 247, 253, 261, 382, 392, 498  
 science educators · 294, 486, 489, 501  
 scientific community · xxii, 76, 92, 116, 117, 189, 190, 191, 193, 238, 240, 285, 306, 307, 312, 316, 394  
 scientific culture · 238, 308, 402  
 scientific education · x, 284, 295, 307, 312, 359, 384, 500  
 scientific fields · 192, 236, 239, 280, 286, 360, 482  
 scientific knowledge · ix, xxix, 238, 239, 288, 295, 304, 305, 306, 307, 308, 312, 316, 326, 377, 382, 389, 391, 393, 394, 396, 400, 404, 485, 486, 492  
 scientific methods · xxviii, xxx, 285, 288, 301, 344, 345, 347, 386, 402, 404, 456, 484, 485  
 scientific practices · xxvii, xxviii, 238, 285, 316, 378, 391, 395  
 scientific reasoning · xxix, 303, 305, 308, 326, 352, 370, 456, 491  
 scientific spirit · 281, 303, 305, 308, 326  
 scientific structures · 239  
 Second World War · 192, 243  
 self-reflective process · 314  
 sensitivity · vi, xvi, xvii, xxvii, 44, 190, 198, 201, 203, 204, 208, 210, 213, 214, 216, 261, 265, 406, 411  
 sensitivity plot · xvi, 213  
 shapes · xxix, 6, 9, 31, 32, 43, 83, 97, 98, 99, 113, 236, 254, 260, 292, 308, 391, 392  
 Shapley–Curtis Debate · 249  
 shot noise · 208  
 signal · viii, xviii, xxvii, 31, 32, 43, 44, 45, 46, 191, 200, 201, 204, 214, 215, 216, 217, 218, 219, 220, 221, 222, 223, 262, 263, 336, 338, 343  
 Signal Recycling · xviii, 204  
 signal-to-noise ratio, SNR · 214, 215, 219, 220, 221, 223  
 simulations · xlvii, lviii, 331, 333, 334, 351, 369, 372, 503, 509  
 simultaneity · xxxiv, lxx, 92, 140, 149, 162, 367, 442, 464, 470, 477, 497  
 SISFA · 59, 184, 232, 274, 321

SISFA, Society of Historians of Physics and Astronomy · xli, lxiii, 137, 352, 373, 428, 431, 437, 461, 468, 474, 510  
 skills of the 21st century · 313, 331, 379  
 sky localization · vii, viii, 215, 222  
 slits · 22, 23, 26, 27, 117  
 Society of Historians of Physics and Astronomy · 59, 184, 232, 274, 321  
 sociocultural · 300, 486  
 Solar Gravitational Lens, SGL · 241, 269  
 solipsism · 281, 282, 295  
 sources · ii, iii, vii, viii, x, xii, 4, 11, 25, 32, 33, 34, 36, 39, 41, 42, 46, 64, 93, 119, 120, 122, 141, 143, 190, 197, 198, 200, 202, 205, 215, 216, 220, 221, 223, 252, 261, 262, 289, 299, 311, 312, 314, 327, 332, 369, 385, 390, 399, 492  
 space · ii, v, vi, xx, xxvii, xxx, xxxi, xxxii, xxxiii, xxxiv, xlvi, xlviii, liv, lv, lx, 4, 6, 7, 9, 20, 27, 34, 38, 42, 44, 45, 46, 47, 50, 66, 72, 75, 76, 77, 80, 81, 82, 83, 84, 88, 90, 92, 93, 97, 98, 99, 100, 101, 102, 103, 107, 114, 118, 124, 128, 130, 131, 135, 141, 143, 151, 162, 163, 164, 165, 166, 169, 170, 171, 193, 196, 197, 199, 223, 226, 227, 236, 243, 244, 252, 256, 257, 258, 260, 261, 267, 268, 270, 282, 290, 297, 313, 330, 339, 340, 342, 343, 344, 348, 352, 371, 376, 384, 385, 442, 463, 464, 470, 477, 479, 480, 483, 504  
 spacetime · ii, v, vi, viii, xi, xxx, xlvii, lxxv, 3, 4, 34, 35, 36, 38, 45, 64, 66, 82, 84, 127, 141, 143, 151, 152, 155, 156, 157, 158, 160, 161, 162, 163, 167, 169, 170, 172, 173, 182, 188, 223, 228, 233, 241, 274, 275, 297, 336, 338, 339, 340, 343, 347, 354, 355, 357, 365, 380, 464, 480, 482  
 spacetime curvature · ii, xlvii, 34, 36, 162, 336  
 Spacetime diagrams · 151, 464, 480  
 spatial curvature · 252, 253  
 Special Relativity · xxxiv, 84, 88, 105, 140, 141, 143, 144, 148, 149, 155, 156, 158, 162, 163, 182, 233, 275, 342, 344, 354, 355, 356, 357, 362, 367, 463, 464, 470, 477, 479, 480  
 spectra · 109, 250  
 spectral lines · 34, 50, 250, 251  
 spectroscopy · xxv, xxxix, 123, 243, 249, 418  
 spectrum · vii, lviii, 20, 25, 109, 119, 215, 235, 249, 250, 397, 439, 486, 498, 499  
 speculation, speculative · xl, 103, 243, 297, 306  
 speculations, speculative · 259  
 speed · v, vi, xxi, xxix, xxxiv, 7, 8, 18, 20, 21, 23, 36, 42, 43, 45, 67, 68, 86, 87, 88, 92, 93, 105, 113, 118, 127, 130, 140, 141, 143, 144, 148, 149, 150, 151, 152, 156, 158, 159, 160, 161, 174, 175, 176, 188, 191, 216, 262, 264, 318, 338, 358, 366, 367, 380, 418, 424, 442, 463, 470, 477, 480, 482  
 speed of causality · 151, 480  
 speed of light · vi, xxxiv, 20, 21, 36, 42, 43, 45, 86, 87, 92, 93, 105, 113, 130, 140, 141, 143, 144, 148, 149, 150, 151, 152, 156, 158, 160, 174, 175, 176, 188, 191, 216, 262, 318, 358, 367, 380, 418, 442, 463, 470, 477, 480, 482  
 spin · 217, 218, 219, 220, 221  
 spin · 218  
 spiral nebulae · 256  
 standard model · 256  
 standard quantum limit · 241  
 standing waves · 15, 16, 17, 28  
 stationary waves · 16  
 statistics · 314, 427  
 strain · 191, 198, 208, 215, 216  
 strategies · 239, 283, 312, 313, 378, 380, 401, 406, 485  
 String Theory · 114

structures · xliii, lv, lxiv, 23, 59, 127, 129, 152, 211, 243, 247, 249, 252, 258, 264, 292, 296, 297, 317, 332, 345, 351, 372, 380, 385, 388, 392, 400, 402, 404, 451, 493, 495, 496, 502, 506  
 student engagement · 294, 486  
 superattenuators · xvi, 200, 206, 210, 211  
 supernova, supernovae · xxiii, 42, 45, 52, 190, 191, 222, 227, 264, 265  
 symbols · 110, 300  
 symmetries · 257, 297, 327, 328, 338, 344, 493  
 synthesis · ix, xi, l, lii, lxv, 158, 260, 313, 321, 340, 507

---

## *T*

teachers · xii, xlviii, lviii, lxii, 284, 286, 290, 302, 309, 310, 312, 313, 329, 332, 333, 335, 345, 377, 379, 393, 398, 400, 401, 402, 403, 404, 456, 476, 486, 494, 496, 503, 505  
 Technology Studies · 384, 387, 395  
 technology, technological · iii, vi, xiv, xxx, xxxii, lii, 36, 151, 200, 235, 236, 240, 243, 259, 284, 288, 345, 352, 373, 378, 382, 384, 386, 389, 390, 391, 392, 393, 396, 403, 407, 412, 415, 417, 428, 447, 477, 485, 493, 510  
 telescope · iv, v, 67, 144, 243, 418  
 temperature · 25, 26, 109, 110, 112, 113, 114, 169, 191, 204, 264, 384, 499  
 templates · 216  
 tensor calculus · xx, xxxi, 82  
 tensors · vi, xx, xxxi, 36, 39, 82, 99, 163, 167, 196, 197, 199, 229, 274, 343, 480  
 tests · lviii, lxvi, 36, 38, 39, 49, 82, 99, 133, 171, 174, 192, 195, 198, 211, 229, 260, 264, 275, 346, 353, 354, 355, 356, 357, 358, 360, 368, 382, 405, 437, 482, 484, 496, 497, 498, 501  
 Thermal Compensation system · 209, 210  
 thermal energy · xl, 109, 112, 114, 133, 189, 196, 197, 204, 209, 255, 266, 299, 384, 407, 409, 424, 426, 427, 429, 435, 438  
 Thermodynamics · 95, 109, 425, 428  
 thought experiments · 148, 196, 258, 270, 281, 299, 301, 332, 333, 334, 335, 344  
 tidal forces · 46, 47  
 time · i, ii, iii, v, vi, vii, viii, xi, xii, xiv, xvi, xx, xxiv, xxvi, xxx, xxxi, xxxii, xxxiii, xxxiv, xlv, xlvi, lviii, lxv, 5, 6, 7, 15, 16, 25, 31, 33, 34, 36, 37, 39, 41, 46, 49, 62, 64, 66, 70, 72, 73, 74, 75, 83, 86, 90, 92, 93, 98, 100, 101, 102, 105, 112, 114, 115, 116, 118, 121, 124, 125, 127, 128, 140, 141, 143, 144, 148, 149, 150, 151, 152, 153, 154, 155, 157, 159, 160, 162, 167, 171, 172, 188, 190, 191, 192, 193, 195, 198, 199, 200, 201, 204, 208, 211, 213, 214, 216, 218, 219, 220, 221, 222, 223, 238, 241, 243, 249, 258, 259, 260, 261, 262, 265, 266, 269, 281, 282, 283, 284, 290, 291, 293, 294, 302, 304, 329, 340, 345, 346, 358, 366, 367, 376, 377, 381, 384, 385, 387, 389, 395, 396, 398, 400, 403, 442, 447, 463, 464, 470, 478, 480, 482, 484, 492, 494, 497, 501, 503  
 time dilation · xxiv, 149, 151, 167, 172, 480  
 Time-like · 151  
 tool · v, xiv, xxxi, li, lvii, lx, lxiv, 84, 129, 152, 156, 312, 318, 325, 329, 332, 340, 351, 372, 382, 489, 501, 502, 509  
 transposition · x, lviii, 289, 376, 503  
 transverse waves · 13, 14, 39, 196  
 triangulation · 43, 46, 262

---

## U

ultraviolet · 4, 96, 109, 112, 243, 418, 481  
 Ultraviolet Catastrophe · 96, 109, 112, 481  
 uniform constant motion · 67  
 Universal constants · 113, 140  
 universe · ii, iii, vii, viii, xi, xiv, xvi, xxv, xxxii, xxxvi, xli, xlvii, lviii, lx, lxi, 3, 35, 36, 49, 56, 57, 65, 67, 86, 100, 133, 135, 144, 162, 167, 183, 194, 229, 231, 235, 242, 243, 244, 246, 247, 249, 251, 252, 253, 254, 255, 256, 257, 258, 259, 260, 261, 264, 267, 268, 269, 270, 272, 274, 282, 331, 333, 351, 371, 410, 413, 432, 445, 449, 467, 474, 481, 505  
 University of Maryland · xix, xx, lvii, 190, 226  
 University of Rome · 191  
 utilitarian argument · 305

---

## V

vector · v, 27, 149, 163, 164, 165, 166, 167, 196, 414, 442  
 velocity · v, 7, 9, 18, 23, 24, 33, 34, 42, 45, 54, 67, 69, 70, 86, 105, 119, 128, 143, 144, 148, 149, 150, 151, 154, 158, 160, 175, 198, 249, 250, 251, 267, 358, 366, 367  
 views · viii, ix, xxix, xxxiii, xlvi, 83, 96, 101, 102, 117, 242, 291, 295, 302, 304, 307, 308, 486, 488  
 violent motion · xii, 64, 65, 380  
 violin modes · xvii, 213  
 Virgo · i, ii, vi, vii, xiv, xvi, xvii, xxiv, xxvi, xxxiii, xlv, liii, liv, lxi, 35, 41, 42, 46, 51, 200, 201, 202, 203, 208, 209, 210, 211, 212, 213, 214, 215, 218, 219, 220, 221, 222, 223, 224, 225, 227, 228, 233, 260, 261, 262, 264, 272, 273, 275, 351, 365  
 visualization · 129, 164, 328, 329

---

## W

wave function · 258, 439  
 wave function of the universe · 258  
 waveforms · 31, 32, 41, 216, 221, 226, 440  
 wavelengths · 7, 8, 10, 11, 15, 16, 18, 20, 21, 22, 23, 25, 26, 27, 33, 39, 109, 110, 112, 118, 124, 190, 191, 202, 205, 208, 252, 381, 481  
 wave–particle duality · 286  
 waves · i, xxiii, 1, 4, 5, 6, 7, 8, 9, 10, 11, 12, 13, 14, 15, 16, 18, 19, 21, 23, 27, 28, 29, 30, 31, 32, 36, 40, 52, 81, 82, 86, 88, 102, 115, 124, 125, 127, 128, 129, 130, 189, 196, 197, 198, 222, 223, 258, 286, 304, 381, 418, 439, 463, 464, 481  
 weak gravitational fields · 143  
 worldlines · 151, 160

---

## X

X-rays · 4, 20, 243

---

**A**

$\Lambda$ CDM · 256



## 2. Image Index

Thesis Chapter	Figure	Source	Kind of use	Copyright
Introduction	1	<a href="https://www.eso.org/public/images/eso1907a/">https://www.eso.org/public/images/eso1907a/</a>	Research & Teaching	CC BY 4.0
	2	<a href="https://www.virgo-gw.eu/status.html">https://www.virgo-gw.eu/status.html</a>	Research & Teaching	CC BY 4.0
	3	<a href="https://doi.org/10.1103/PhysRevLett.116.061102">https://doi.org/10.1103/PhysRevLett.116.061102</a>	Research & Teaching	Creative Commons Attribution 3.0
	4	Photo taken by Philippe Vincent	Research & Teaching	Philippe Vincent
	5	Photo taken by Philippe Vincent	Research & Teaching	Public Domain
	6	Photo taken by Philippe Vincent	Research & Teaching	Philippe Vincent
	7	Photo taken by Philippe Vincent	Research & Teaching	Philippe Vincent
	8	Photo taken by Philippe Vincent	Research & Teaching	Public Domain
	9	Photo taken by Philippe Vincent	Research & Teaching	Public Domain
	10	Photo taken by Philippe Vincent	Research & Teaching	Public Domain
	11	<a href="https://www.academiciens.fr/">https://www.academiciens.fr/</a>	Research & Teaching	Public domain
	12	Niels Bohr Library, Courtesy of the American Institute of Physics, USA	Research & Teaching	Public domain
	13	Niels Bohr Library, Courtesy of the American Institute of Physics, USA	Research & Teaching	American Institute of Physics, USA
	14	<a href="https://arxiv.org/">https://arxiv.org/</a>	Research & Teaching	<a href="http://arxiv.org/licenses/nonexclusive-distrib/1.0/">http://arxiv.org/licenses/nonexclusive-distrib/1.0/</a>
	Table 1	Philippe Vincent	Research & Teaching	Public domain
	15	Philippe Vincent	Research & Teaching	Public domain
	16	Antoine Tondeu	Research & Teaching	Permission granted 03/02/19
17	Niels Bohr Library, Courtesy of the American Institute of Physics, USA	Research & Teaching	American Institute of Physics, USA	

<b>Chapter 1</b>
------------------

1.1	Etienne Bonnac - 06/01/20	Research & Teaching	Public Domain
1.2.a	Etienne Bonnac	Research & Teaching	Public Domain
1.2.b	Etienne Bonnac	Research & Teaching	Public Domain
1.2.c	Etienne Bonnac	Research & Teaching	Public Domain
1.2.d	Etienne Bonnac	Research & Teaching	Public Domain
1.2.e	Etienne Bonnac	Research & Teaching	Public Domain
1.2.f	Etienne Bonnac	Research & Teaching	Public Domain
1.3.1.a	Christophe Dang Ngoc Chan	Research & Teaching	CC-BY-SA-3.0
1.3.1.b	Dr. Rod Nave	Research & Teaching	Permission granted 20/04/19
1.3.1.c	Dr. Rod Nave	Research & Teaching	Permission granted 20/04/19
1.3.2.a	Etienne Bonnac	Research & Teaching	Public Domain
1.3.2.b	Etienne Bonnac	Research & Teaching	Public Domain
1.3.2.c	Textbook	Research & Teaching	Non-Commercial The University of Tennessee, Department of Physics and Astronomy   Public domain
1.3.3.a	<a href="http://labman.phys.utk.edu">http://labman.phys.utk.edu</a>	Research & Teaching	CC BY-SA 3.0
1.2.2.b	CK-12 Foundation	Research & Teaching	Public Domain
1.5.2.a	Etienne Bonnac	Research & Teaching	Public Domain
1.5.2.b	Etienne Bonnac	Research & Teaching	Public Domain
1.6.1.a	Etienne Bonnac	Research & Teaching	Public Domain
1.6.1.b	Etienne Bonnac	Research & Teaching	Public Domain
1.6.2.a	Freesciencelessons YouTube video	Research & Teaching	Non-Commercial
1.6.2.b	Freesciencelessons YouTube video	Research & Teaching	Non-Commercial
1.6.2.c	<a href="https://schools.aglasem.com/">https://schools.aglasem.com/</a>	Research & Teaching	Permission granted 22/04/19
1.6.2.d	Aleksandrs Timofejev	Research & Teaching	CC-BY 2.5
1.6.2.e	Etienne Bonnac	Research & Teaching	Public Domain



1.6.3.a	Arne Nordmann	Research & Teaching	CC BY-SA 3.0
1.6.3.b	<a href="http://physicsopenlab.org">http://physicsopenlab.org</a>	Research & Teaching	Permission granted 26/11/18
1.7.2	"Inductiveload"	Research & Teaching	Public Domain
1.7.3	"Inductiveload"	Research & Teaching	Public Domain
1.7.4.a	<a href="http://galleryhip.com">http://galleryhip.com</a>	Research & Teaching	CC BY-SA 3.0
1.7.4.b	"Fffred"	Research & Teaching	Public Domain
1.7.5	"Omegatron"	Research & Teaching	CC BY-SA 3.0
1.8.1.	Zappys Technology Solutions	Research & Teaching	CC BY 2.0
1.9.a	<a href="https://www.ligo.caltech.edu">https://www.ligo.caltech.edu</a>	Research & Teaching	Courtesy Caltech/MIT/LIGO Laboratory
1.9.b	<a href="https://www.ligo.caltech.edu">https://www.ligo.caltech.edu</a>	Research & Teaching	Courtesy Caltech/MIT/LIGO Laboratory
1.9.2.a	Etienne Bonnet	Research & Teaching	Public Domain
1.9.2.b	Etienne Bonnet	Research & Teaching	Public Domain
1.9.2.c	Etienne Bonnet	Research & Teaching	Public Domain
1.9.2.d	<a href="https://science.gsfc.nasa.gov/663/research/">https://science.gsfc.nasa.gov/663/research/</a>	Research & Teaching	Courtesy of NASA
1.9.2.e	<a href="https://arxiv.org/">https://arxiv.org/</a>	Research & Teaching	<a href="http://arxiv.org/licenses/nonexclusive-distrib/1.0/">http://arxiv.org/licenses/nonexclusive-distrib/1.0/</a>
1.9.3.a	Etienne Bonnet	Research & Teaching	Public Domain
1.9.3.b	<a href="https://arxiv.org/abs/gr-qc/0509129">https://arxiv.org/abs/gr-qc/0509129</a>	Research & Teaching	<a href="http://arxiv.org/licenses/nonexclusive-distrib/1.0/">http://arxiv.org/licenses/nonexclusive-distrib/1.0/</a>
1.9.4.3.a	Etienne Bonnet	Research & Teaching	Public Domain
1.9.4.3.b	Etienne Bonnet	Research & Teaching	Public Domain
1.9.4.3.c	Etienne Bonnet	Research & Teaching	Public Domain

<b>Chapter 2</b>
------------------

2.2	<a href="https://gallica.bnf.fr/">https://gallica.bnf.fr/</a>	Research & Teaching	Public Domain
2.3	<a href="http://redlightrobber.com/red/links_pdf/Isaac-Newton-Principia-English-1846.pdf">http://redlightrobber.com/red/links_pdf/Isaac-Newton-Principia-English-1846.pdf</a>	Research & Teaching	Public Domain
2.5.a	<a href="https://archive.org/">https://archive.org/</a>	Research & Teaching	Public Domain
2.5.b	<a href="https://archive.org/">https://archive.org/</a>	Research & Teaching	Public Domain
2.6	<a href="https://archive.org/">https://archive.org/</a>	Research & Teaching	Public Domain
2.7.a	Niels Bohr Library, Courtesy of the American Institute of Physics, USA	Research & Teaching	American Institute of Physics, USA
2.7.b	<a href="https://archive.org/">https://archive.org/</a>	Research & Teaching	Public Domain
2.7.c	<a href="https://gallica.bnf.fr/">https://gallica.bnf.fr/</a>	Research & Teaching	Public Domain
2.8.a	<a href="https://gallica.bnf.fr/">https://gallica.bnf.fr/</a>	Research & Teaching	Public Domain
2.8.b	<a href="https://gallica.bnf.fr/">https://gallica.bnf.fr/</a>	Research & Teaching	Public Domain
2.9.a	<a href="https://archive.org/">https://archive.org/</a>	Research & Teaching	Public Domain
2.9.b	<a href="https://archive.org/">https://archive.org/</a>	Research & Teaching	Public Domain
2.10.a	<a href="http://hdl.handle.net/">http://hdl.handle.net/</a>	Research & Teaching	Public Domain
2.10.b	<a href="http://hdl.handle.net/">http://hdl.handle.net/</a>	Research & Teaching	Public Domain
2.10.c	<a href="http://hdl.handle.net/">http://hdl.handle.net/</a>	Research & Teaching	Public Domain
2.10.d	<a href="https://gallica.bnf.fr/">https://gallica.bnf.fr/</a>	Research & Teaching	Public Domain
2.11	Philippe Vincent	Research & Teaching	Public Domain

<b>Chapter 3</b>
------------------

3.2	<a href="https://gallica.bnf.fr/">https://gallica.bnf.fr/</a>	Research & Teaching	Public Domain
3.2.1.a	Philippe Vincent	Research & Teaching	Public Domain
3.2.1.b	Niels Bohr Library, Courtesy of the American Institute of Physics, USA	Research & Teaching	American Institute of Physics, USA
3.2.1.c	Niels Bohr Library, Courtesy of the American Institute of Physics, USA	Research & Teaching	American Institute of Physics, USA
3.2.1.d	Niels Bohr Library, Courtesy of the American Institute of Physics, USA	Research & Teaching	American Institute of Physics, USA
3.2.1.1.a	Philippe Vincent	Research & Teaching	Public Domain

3.2.1.1.b	Philippe Vincent	Research & Teaching	Public Domain
3.2.1.1.c	Philippe Vincent	Research & Teaching	Public Domain
3.2.1.1.d	<a href="http://abuledu.org/full/min-kowski-le-trajet-d-un-photon-50ad7bd4.svg">http://abuledu.org/full/min-kowski-le-trajet-d-un-photon-50ad7bd4.svg</a> <a href="http://www.physicscentral.com/explore/action/memory-and-time.cfm">http://www.physicscentral.com/explore/action/memory-and-time.cfm</a>	Research & Teaching	CC BY-SA 2.0 FR
3.2.1.1.e	Philippe Vincent	Research & Teaching	Attribution-ShareAlike 3.0 Unported
3.2.1.1.f	Philippe Vincent	Research & Teaching	Public Domain
3.2.1.1.g	<a href="https://www.desmos.com/">https://www.desmos.com/</a>	Research & Teaching	Public Domain
3.2.1.1.h	<a href="https://www.desmos.com/">https://www.desmos.com/</a>	Research & Teaching	Public Domain
3.2.1.1.i	<a href="https://www.desmos.com/">https://www.desmos.com/</a>	Research & Teaching	Public Domain
3.2.1.1.j	Philippe Vincent	Research & Teaching	Public Domain
3.2.2.a	Philippe Vincent	Research & Teaching	Public Domain
3.2.2.b	Philippe Vincent	Research & Teaching	Public Domain
3.2.2.c	Philippe Vincent	Research & Teaching	Public Domain
3.2.2.d	Philippe Vincent	Research & Teaching	Public Domain
3.2.2.e	<a href="https://publicdomainvector.s.org/">https://publicdomainvector.s.org/</a>	Research & Teaching	Public Domain
3.2.2.f	Philippe Vincent	Research & Teaching	Public Domain
3.2.2.3.a	<a href="https://www.eso.org/public/images/">https://www.eso.org/public/images/</a>	Research & Teaching	CC BY 4.0 International License
3.2.2.3.b	<a href="https://apod.nasa.gov/">https://apod.nasa.gov/</a>	Research & Teaching	Courtesy of NASA
3.2.2.3.c	<a href="http://hubblesite.org/">http://hubblesite.org/</a>	Research & Teaching	Courtesy of NASA, ESA, and STScI
3.2.2.4.a	<a href="https://www.astron.nl/">https://www.astron.nl/</a>	Research & Teaching	CC-BY-AS
3.2.2.4.b	Philippe Vincent	Research & Teaching	Public Domain
3.4.a	Courtesy of Prof. Daniel Kennefick	Research & Teaching	Permission granted 12/09/19
3.4.b	Courtesy of Prof. Daniel Kennefick	Research & Teaching	Permission granted

<b>Chapter 4</b>
------------------

4.5	“Maksim”	Research & Teaching	CC BY-SA 3.0
4.6.1.a	Philippe Vincent	Research & Teaching	Public Domain
4.6.1.b	Philippe Vincent	Research & Teaching	Public Domain
4.6.1.c	Philippe Vincent	Research & Teaching	Public Domain
4.6.1.d	Courtesy of Nicolas Arnaud	Research & Teaching	Commons License Attribution - Non-commercial - Share Alike 4.0 International
4.6.1.e	Courtesy of Gabriel Pillant	Research & Teaching	Permission granted 09/06/19
4.6.1.f	Courtesy of Gabriel Pillant	Research & Teaching	Permission granted
4.6.1.g	Philippe Vincent	Research & Teaching	Public Domain
4.6.1.h	Philippe Vincent	Research & Teaching	Public Domain
4.6.1.i	Philippe Vincent	Research & Teaching	Public Domain
4.6.1.j	Philippe Vincent	Research & Teaching	Public Domain
4.6.1.k	Philippe Vincent	Research & Teaching	Public Domain
4.6.1.l	Philippe Vincent	Research & Teaching	Public Domain
4.6.1.m	Philippe Vincent	Research & Teaching	Public Domain
4.6.1.n	Philippe Vincent	Research & Teaching	Public Domain
4.6.1.o	Etienne Bonnet	Research & Teaching	Public Domain
4.6.1.p	Etienne Bonnet	Research & Teaching	Public Domain
4.6.1.q	Courtesy of Julia Casanueva	Research & Teaching	Permission granted 09/06/19
4.6.1.r	Courtesy of Julia Casanueva	Research & Teaching	Permission granted
4.6.1.s	Courtesy of Julia Casanueva	Research & Teaching	Permission granted
4.6.1.t	Courtesy of Valerio Boschi	Research & Teaching	Permission granted 10/06/19
4.6.1.u	Philippe Vincent	Research & Teaching	Public Domain

4.6.1.v	Courtesy of Julia Casanueva	Research & Teaching	Permission granted
4.6.1.w	Courtesy of Julia Casanueva	Research & Teaching	Permission granted
4.6.1.x	<a href="http://www.virgo-gw.eu/status.html">http://www.virgo-gw.eu/status.html</a>	Research & Teaching	CC BY 4.0

## Chapter 5

5.1	<a href="https://gallica.bnf.fr/">https://gallica.bnf.fr/</a>	Research & Teaching	Public Domain
5.2	Courtesy of Julia Casanueva	Research & Teaching	Permission granted
5.3.a	<a href="https://gallica.bnf.fr/">https://gallica.bnf.fr/</a>	Research & Teaching	Public Domain
5.3.b	<a href="https://gallica.bnf.fr/">https://gallica.bnf.fr/</a>	Research & Teaching	Public Domain
5.3.c	<a href="http://loc.gov/">http://loc.gov/</a>	Research & Teaching	Public Domain
5.3.d	<a href="https://gallica.bnf.fr/">https://gallica.bnf.fr/</a>	Research & Teaching	Public Domain
5.3.e	<a href="https://gallica.bnf.fr/">https://gallica.bnf.fr/</a>	Research & Teaching	Public Domain
5.3.f	Gebruiker: MaureenV	Research & Teaching	Public Domain
5.3.g	<a href="https://sciensite.wordpress.com/2015/11/">https://sciensite.wordpress.com/2015/11/</a>	Research & Teaching	Public Domain
5.3.h	Philippe Vincent - <a href="https://www.publicdomainpictures.net/">https://www.publicdomainpictures.net/</a>	Research & Teaching	Public Domain
5.3.i	<a href="https://wmap.gsfc.nasa.gov/universe/uni_shape.html">https://wmap.gsfc.nasa.gov/universe/uni_shape.html</a>	Research & Teaching	Courtesy of NASA
5.3.j	<a href="https://www.nextpng.com/">https://www.nextpng.com/</a>	Research & Teaching	Public Domain
5.4	Philippe Vincent - MS Paint 3D mesh library	Research & Teaching	Public Domain

## Chapter 6

<b>Chapter 7</b>
------------------

7.2	Philippe Vincent	Research & Teaching	Public Domain
7.4.a	Philippe Vincent - Sandbox Universe	Research & Teaching	Public Domain
7.4.b	Philippe Vincent - Sandbox Universe	Research & Teaching	Public Domain
7.5	<a href="https://dcc.ligo.org/LIGO-P1600015/public">https://dcc.ligo.org/LIGO-P1600015/public</a>	Research & Teaching	Public Domain
7.8.1.a	Philippe Vincent	Research & Teaching	Public Domain
7.8.1.b	Philippe Vincent	Research & Teaching	Public Domain
7.8.1.c	Philippe Vincent	Research & Teaching	Public Domain
7.8.1.d	Philippe Vincent	Research & Teaching	Public Domain
7.8.1.e	Philippe Vincent	Research & Teaching	Public Domain
7.8.1.f	Philippe Vincent	Research & Teaching	Public Domain
7.8.1.g	Philippe Vincent	Research & Teaching	Public Domain
7.8.1.h	Philippe Vincent	Research & Teaching	Public Domain

<b>Chapter 8</b>
------------------

8.4	Prof. Dr. Raffaele Pisano	Research & Teaching	On demand to the author
8.5	Philippe Vincent	Research & Teaching	Public Domain
8.10.a	Philippe Vincent	Research & Teaching	Public Domain
8.10.b	Philippe Vincent	Research & Teaching	Public Domain
8.10.c	Philippe Vincent	Research & Teaching	Public Domain

