



HAL
open science

Enzymatically triggered polymeric drug delivery systems for colon targeting

Youcef Benzine

► **To cite this version:**

Youcef Benzine. Enzymatically triggered polymeric drug delivery systems for colon targeting. Human health and pathology. Université de Lille, 2019. English. NNT : 2019LILUS036 . tel-03217727

HAL Id: tel-03217727

<https://theses.hal.science/tel-03217727>

Submitted on 5 May 2021

HAL is a multi-disciplinary open access archive for the deposit and dissemination of scientific research documents, whether they are published or not. The documents may come from teaching and research institutions in France or abroad, or from public or private research centers.

L'archive ouverte pluridisciplinaire **HAL**, est destinée au dépôt et à la diffusion de documents scientifiques de niveau recherche, publiés ou non, émanant des établissements d'enseignement et de recherche français ou étrangers, des laboratoires publics ou privés.

Université de Lille
Faculté des Sciences Pharmaceutiques et Biologiques
Ecole Doctorale Biologie Santé

**ENZYMATICALLY TRIGGERED POLYMERIC DRUG DELIVERY
SYSTEMS FOR COLON TARGETING**

**FORMES GALÉNIQUES INNOVANTES SENSIBLES AUX BACTERIES
POUR LE CIBLAGE DU COLON**

Thesis submitted to obtain the degree of Doctor in Pharmaceutical Sciences

Defended on 18th December 2019

by

Youcef BENZINE

Supervised

by

Dr. Youness KARROUT

Laboratoire de Pharmacotechnie Industrielle (INSERM U1008)

3, rue du Professeur Laguesse

59006 Lille, France

Jury members:

Dr. Mohamed SKIBA (referee)

Prof. Dr. Amélie BOCHOT (referee)

Prof. Dr. Juergen SIEPMANN (president of the jury, examinant)

Dr. Youness KARROUT (supervisor)

ACKNOWLEDGEMENTS

First of all, I would like to thank Prof. Juergen Siepmann, for his expertise, guidance and his funding of this thesis. This project has received funding from the Interreg 2 Seas programme 2014-2020, co-funded by the European Regional Development Fund under subsidy contract 2S01-059_IMODE. The authors are very grateful for this support.

I would like to extend my sincere gratitude to my supervisor Dr. Youness Karrout for his continuous support, his generous and helpful suggestions throughout this project and during the writing of this thesis; without your help this paper would not have been possible. Allow me to express my highest consideration and respect.

Also, I would like to thank Prof. Florence Siepmann, for her welcoming, assistance and help during this thesis.

Thanks are also extended to Prof. Amélie Bochot and Dr. Mohamed Skiba for taking time to read this manuscript and serving as members of my thesis jury.

I am extremely grateful to Dr. Christel Neut and all the members at the laboratory INSERM U 995 for their help and advices during my microbiological experiments. Also, to Dr. Jean-François Willart at the laboratory CNRS UMR 8207 for his help, interesting discussions and also for his insightful suggestions and comments during the redaction of my first article.

Furthermore, I deeply thank Dr. Mounira Hamoudi, Dr. Susanne Muschert and all my friends and colleagues at the laboratory INSERM U1008 for their help, good humour and support; they have made my time during this 3 years more positive and enjoyable.

Last of all, I would like to give special thanks to my parents, for their continuous support, encouragement and endless love despite of the distance.

TABLE OF CONTENTS

I. INTRODUCTION.....	1
1. General.....	3
2. Oral controlled drug delivery	5
3. Hot melt extrusion and injection molding technology	8
4. Colon targeting.....	19
5. Purposes of this work.....	27
II. MATERIALS AND METHODS	29
1. Materials	31
2. Preparation of dosage forms	33
3. Physicochemical characterizations.....	36
III. RESULTS AND DISCUSSIONS	41
CHAPTER 1: POLYVINYL ACETATE:POLYSACCHARIDE BLENDS FOR COLON TARGETING	43
1. Effect of polysaccharide nature and amount in thin polymeric films.....	46
2. Effect of polysaccharide nature on pH level.....	49
3. Impact of hydrophobic polymer nature in thin polymeric films.....	51
4. Effect of the amount of polysaccharide in hot melt extrudates	54
5. Impact of drug loading in hot melt extrudates.....	66
CHAPTER 2: POLYURETHANE:POLYSACCHARIDE BLENDS FOR COLON TARGETING	73
1. Influence of polyurethane nature in hot melt extrudates.....	76
2. Effect of polysaccharide and plasticizer nature in hot melt extrudates.....	84
3. Impact of polymer:polymer blend ratio in hot melt extrudates	87

4. Influence of polymer:polymer blend ratio in injection-molded capsules	92
CHAPTER 3: HOT MELT EXTRUDED POLYSACCHARIDE BLENDS FOR CONTROLLED DRUG DELIVERY	97
1. Impact of the type of polymer blend & plasticizer addition	101
2. Ethylcellulose:guar gum blends.....	111
IV. CONCLUSIONS AND PERSPECTIVES	129
V. RESUME IN DETAIL (FRENCH)	133
VI. REFERENCES.....	151
VII. PUBLICATIONS AND PRESENTATIONS	179

I. INTRODUCTION

1. General

Inflammatory bowel diseases (IBD) are either intermittent or continuous inflammatory diseases of different parts of the intestinal mucosa that mostly affect young adults. It is a term that refers in particular to two diseases of the gastro intestinal tract (GIT): Crohn's disease and Ulcerative Colitis. They are characterized by the inflammation of the mucosa of a part of the digestive tract linked to a hyper-activation of the digestive immune system. Although, the etiology of inflammatory bowel diseases remains unknown. Several risk factors are suspected, including microbiota dysbiosis, genetic and environmental such as pollution, smoking [1,2]. Both are chronic diseases that involve inflammation of the gut mucosa [3]. The main difference between Crohn's disease and Ulcerative Colitis is the location and nature of the inflammation (figure 1). Crohn's disease can affect any part of GIT from the mouth to the anus but in most cases attacks the ileum. In contrast, Ulcerative Colitis is restricted to the colon and the rectum [4].

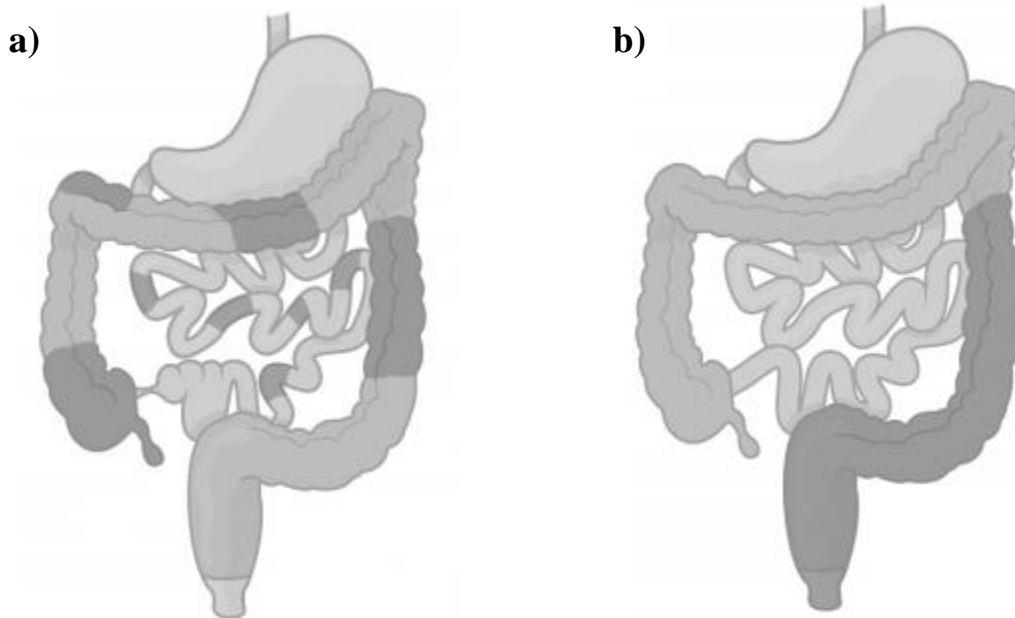

Figure 1: Location of inflammation of gastro intestinal tract (dark areas) in the case of a) Crohn's disease and b) Ulcerative Colitis (Printed from [5]).

Symptoms consist of pain, diarrhea, and diminished appetite. Complications can occur such as toxic dilation of the colon that sometimes cause colon cancer, hence, the need for regular monitoring [6].

The different therapeutic strategies used to treat chronic inflammatory bowel diseases can be related to drug treatments, biological drugs, immunosuppressants, symptomatic treatments and surgery in case of the failure of the treatment. Drug treatments include anti-inflammatory drugs that require frequently and high dose administration in order to control the state of the disease (more prolonged remission) [7].

Colonic site specific delivery can provide major advantages such as:

- Reducing drug dosing ensured by local drug delivery at the site of action [8].
- Oral administration of peptide and protein drugs, which are fragile in the upper gastro intestinal tract [9].
- The colon is a site, where both local and systemic drug delivery could be achieved (topical treatment of inflammatory bowel disease, e.g. Ulcerative Colitis or Crohn's disease). Such inflammatory conditions are usually treated with glucocorticoids and 5-aminosalicylic acid (5-ASA) [9].
- A number of others serious diseases of the colon, e.g. colorectal cancer, might also be capable of being treated more effectively if drugs were targeted to the colon [8].
- Reducing systemic side effects [8].

Conventional dosage forms cannot be used due to its premature drug release in the stomach and small intestine. Thus, drug will be absorbed into the blood stream, provoking considerable side effects. Nevertheless, drug concentration will be very low at the site of the action (distal part of GIT), which can lead to less efficacy of the treatment. In order to overcome this problem, an ideal dosage form should effectively protect the drug in the upper GIT and subsequently release the drug

in the distal part of GIT in a time controlled manner, depending on the disease state. Reservoir systems (coated pellets, capsules...) or matrices systems (tablets, extrudates...) can be used to protect the drug in the upper GIT. Polysaccharides that are only degraded by bacterial enzymes localized in the colon can offer a very useful tool for colonic dosage forms in the treatment of IBD.

2. Oral controlled drug delivery

2.1. Definitions

There are many routes of administration of active pharmaceutical ingredients (API): local, oral, rectal, and parenteral. Therefore, the oral route is the most used route due to its several advantages, such as ease of administration, the ambulant treatment, the less psychological anxiety during the administration and the reduction of the infectious risks. In addition, it allows relatively easy industrial production and therefore low production costs (pharmaceutical dosage forms are not sterilized for instance) [10]. However, many disadvantages can be occurred. Indeed, the API can be toxic for certain tissues and aggressive if drugs are absorbed in inappropriate location. It can also be degraded before reaching the site of action and then loss of the efficacy of the treatment. This requires the administration of several doses and thus increases in side effects. Furthermore, drug absorption and the bioavailability of a drug can be different from a patient to another due to several physiopathological factors (e.g. gastric transit, pH variations in the gastro intestinal tract, food administration and also the state of the mucosa) and therefore, in-vitro studies should take in consideration all these factors [11].

Controlled release systems have been developed for years, allowing the administration of high amounts of drugs and releasing them according to a desired profile. An active substance is mixed with specific excipients in order to improve drug efficacy and minimize undesirable side effects. These systems can (i) protect a drug against gastric degradation and therefore, avoiding gastric

irritation and loss of drug efficacy, (ii) release a drug progressively in time, (iii) delay drug release in order to reach a specific absorption window or (iv) deliver site specifically drugs (e.g. colon targeting) [12].

Furthermore, controlled drug delivery systems are very useful tools in order to achieve and maintain an optimal therapeutic drug plasma concentration during a desired period of time (figure 2).

By controlling the delivery rate of the drug, the duration of the therapeutic action can be sustained.

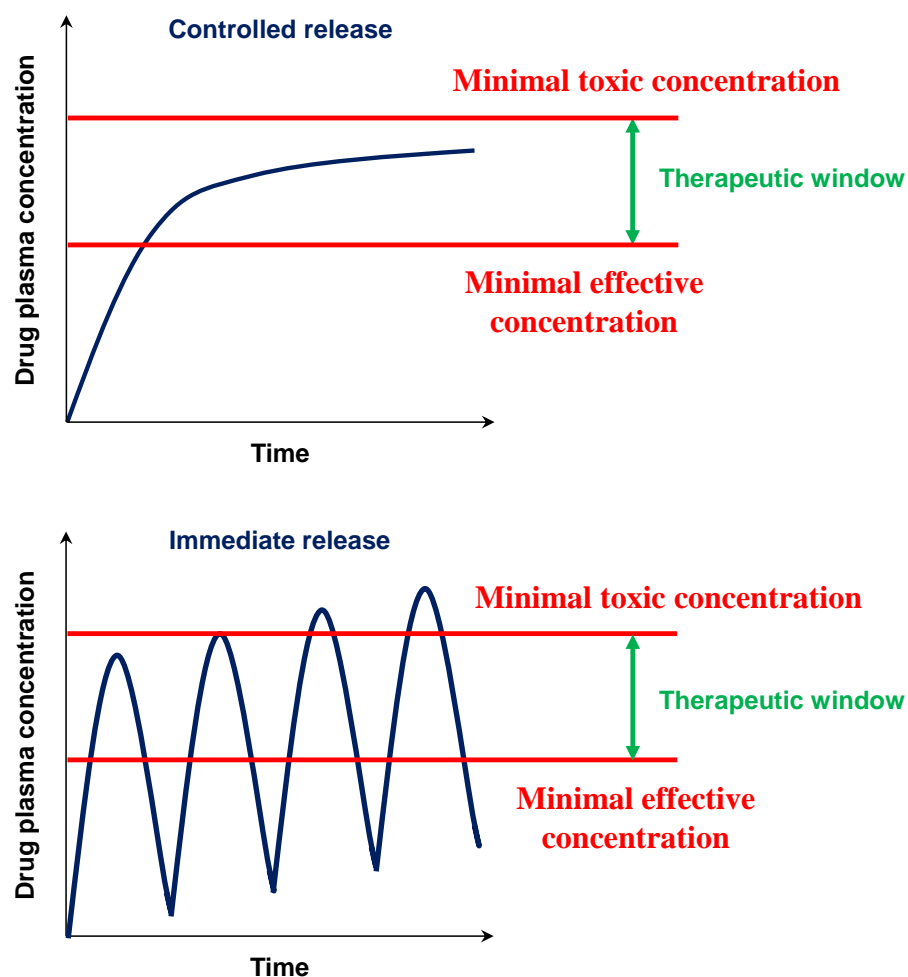

Figure 2: Plasma concentrations of an immediate versus controlled release dosage form.

In general, the development of controlled release formulations offers many benefits over conventional dosage forms: controlled administration of a therapeutic dose at the desired delivery rate, which leads to less fluctuations of plasma concentrations [12]. This results in reduced toxicity

as well as serious side effects and increased efficacy of the therapy. That can decrease the frequency of the drug dose and improve patient compliance. Disadvantages include the longer time required to achieve therapeutic blood concentrations, which can increase the variation in bioavailability after oral administration, enhanced first-pass effect, risk on dose dumping (especially for reservoir-based systems), lack of dose flexibility and usually higher costs [13].

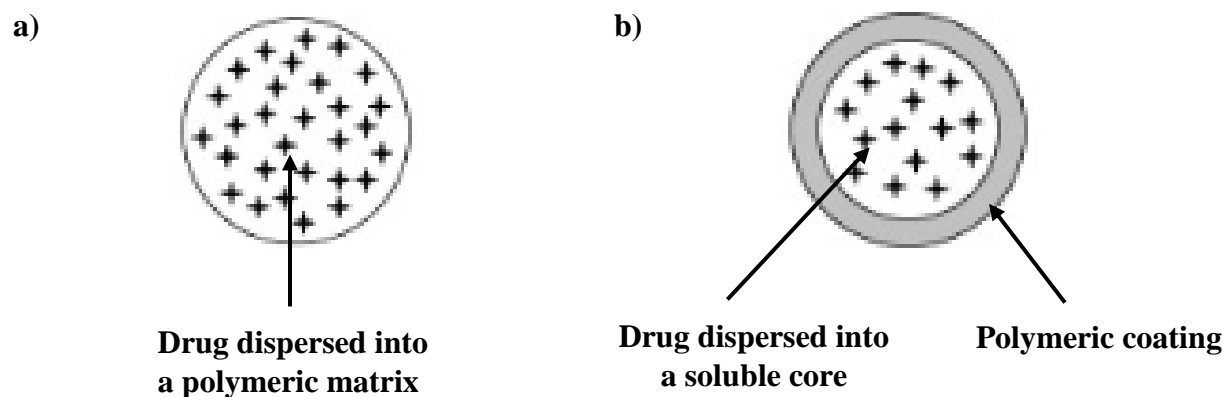

Figure 3: Schematic representation of a) a matrix and b) a reservoir system (Printed from [14]).

Generally, controlled release delivery systems can be divided in two groups (figure 3):

- Matrix systems where a drug is homogeneously dissolved/dispersed in a polymeric network to obtain a system allowing for controlled drug release. These systems have several advantages including the easy-manufacture, the capacity for incorporating a high amount of drug and avoiding toxic concentrations if the system gets accidentally damaged. Various types of matrix systems can be achieved and thus, the drug release mechanisms will be different [15-17].
- Reservoir systems in this case, the drug is layered around an inert core or incorporated into a water-soluble excipient matrix. The API core is surrounded by a coating layer.

Different drug release profiles can be achieved by varying the polymer nature and properties [18,19].

2.2. Drug release mechanisms

The presence of the appropriate macromolecular networks can avoid immediate drug release and then, different types of mass transport processes can be involved in the control of drug release. This includes for instance, water diffusion into the system, drug dissolution, polymer swelling, polymer dissolution and potentially matrix erosion [20-22]. The resulting drug release kinetics can strongly depend on the drug properties (e.g. solubility in water) and drug loading. Sometimes, it can be very challenging to provide desired drug release kinetics for a given drug and drug dose [23].

It is therefore possible to mathematically predict the drug release rate. However, numerous parameters should be taken into account including type of the drug, the dosage form and the environmental conditions during drug release. Importantly, drug release is impacted by several factors such as the solubility and permeability; the preparation process of different types of dosage forms (e.g. matrix or reservoir); the initial drug concentration in the system compared to drug solubility, drug-polymer/excipients interactions and the device geometry (e.g. cubic, sphere, cylinder, film) [24,25].

3. Hot melt extrusion and injection molding technology

3.1. Definitions

Hot melt extrusion (HME) has been used in many diverse industrial fields, mostly with the processing of foods and the manufacturing of plastics. The first industrial use of single-screw extruders was in the mid-nineteenth century with the extrusion of thermoplastic materials. Since then, it became a very interesting technique used in the pharmaceutical industry with proven

robustness for numerous drug delivery systems (DDS) [26,27]. Hot melt extrusion related patents, which have been issued for pharmaceutical systems have steadily increased since the early 1980's. So far, the U.S.A and Germany are the leading of issued patents for hot melt extrusion in the market [28].

Hot melt extrusion is a continuous process in which material melts or softens under elevated temperatures and is further forced through a die, usually with the help of one or two conveyer screws in a barrel. During the process, the material is exposed to heating and intense shear allowing a homogeneous distribution of drug particles in a molten carrier [29].

The marked hot melt extruders have either one screw or two screws. The latter leads to better mixing of the drug and polymer. Two screws are disposed side-by-side, allowing for different configurations in all zones from the start of the product mixing to the output of the dosage form. Moreover, the screws are either rotated in the same (co-rotating) or in the opposite direction (counter rotating). The latter option is able to blend drug and polymer even in case of high viscosity, which required high shear forces. Furthermore, the friction between the barrel, blending, and rotating screws provides the driving force for the material in order to reach the die. It is to emphasize that depending on the marked hot melt extruder, the material can be fed at different locations, which can be very practically beneficial in case of the addition of additives during the process. Importantly, liquids can also be introduced using a liquid pump and liquid injection system [29]. Due to increased barrel temperature, the materials melts or fuses after it enters into the transition zone. The drug is embedded homogenously within the carrier (polymer) with help of screws and the mixture moves along the barrel towards the die. When the material reaches the output, it is delivered through the die cavity and sized to obtain its final shape (figure 4) [30].

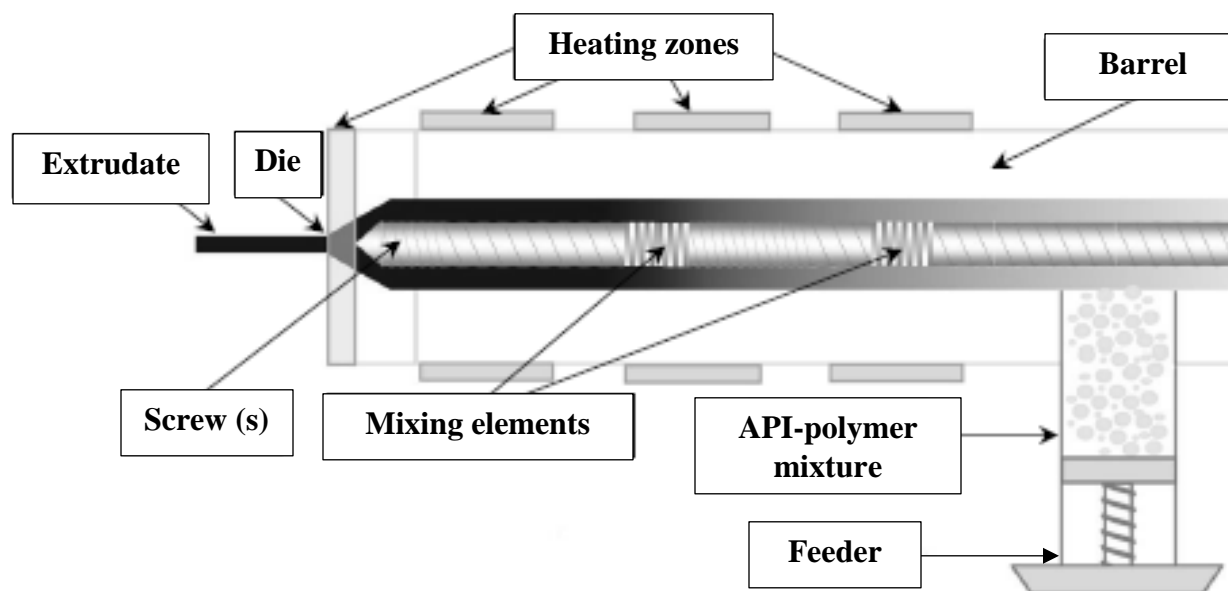

Figure 4: Schematic representation of the hot melt extruder (Printed from [30]).

The adjustment of extrusion parameters is of utmost importance in the manufacturing of such polymeric drug delivery systems. Adjustable parameters include screw speed, processing temperature and feeding rate, which impact the shear stress (torque) and mean residence time and in the long term also dissolution rate and stability of the final product [29]. In this purpose, extruder sensors are able to measure the barrel and die temperatures, the torque generated, the melt pressure, the feed rate, the screw speed and the melt temperature during the process. Moreover, other thermos analytical techniques such as hot-stage microscopy, differential scanning calorimetry, micro calorimetry, X-ray diffraction (XRD), dynamic mechanical thermal analysis (DMTA) and thermogravimetric analysis (TGA) are often applied to investigate the chemical stability, thermal behavior and crystalline properties of actives: and/or excipients in the final dosage form [31].

3.2. Pharmaceutical applications of hot melt extrusion

Hot melt extrusion is a continuous and free solvent process allowing for the preparation of solid dispersions or solutions, depending on drug solubility in the matrix former (often a polymer) as well as drug concentration in the system. Such solid dosage forms have the potential to improve drug bioavailability, efficacy and safety of the drug treatment. Hot melt extrusion is used to produce different polymeric drug delivery systems administered via oral route such as polymeric films [32,33] and tablets [34-36] but also transdermal [37], transmucosal [38,39] and intra ocular (implants) route [40,41]. The production of three types of solid dispersions are described: (i) an amorphous solid dispersion where both the drug and the carrier are amorphous but the drug is dispersed in a particular form within the polymer (DSC thermogramm shows two Tg corresponding to those of drug and polymer) (ii) a crystalline solid dispersion, where all/a fraction of the drug remains crystalline in an amorphous polymer (DSC thermogramm shows a Tg corresponding to the polymer and a fusion/dissolution pic corresponding to the drug) and (iii) an amorphous solid solution where both the drug and the carrier are amorphous and completely miscible, which can be indicated by one Tg in the DSC thermogramm. Note that the drug is dispersed at the molecular level in case of an amorphous solid solution [42]. An amorphous solution have the advantage to increase drug availability by improving its solubility. In a crystalline suspension, the drug crystals are dispersed in the amorphous matrix which is suitable for a controlled drug delivery. Amorphous solid suspension are the less stable with a high tendency to recrystallization. Indeed, the drug is in an amorphous state and is dispersed in the formulation. The type of the solid dispersion obtained depends on the drug solubility in the polymer, the stability of the final form and the drug - polymer interactions [43].

The choice of the polymer nature is critical in the formulation process and its application. Some of the most well-known applications of hot melt extrusion are:

- Taste masking of drugs [44-47].
- Solubility enhancement of poorly water-soluble compounds for an immediate drug release [48-51].
- Sustained and time controlled release [52-55], and extended drug delivery systems [56].
- Site specific drug delivery systems [57-59].

In addition to these current applications, some recent innovations have to be mentioned, such as co-extrusion [60-62], co-crystallization [63-66], 3D printing [67-69] and injection molding [70-73].

3.3. Materials used for hot melt extrusion

3.3.1. Drugs

The properties of the active drug substance often limit the formulation and processing choices available to the pharmaceutical scientist in the development of dosage forms. Hot melt extrusion is a free solvent process, which avoids potential hydrolytic degradation pathways. In addition, poorly compactable materials can be prepared as tablets without a compression process by cutting an extruded rod to the desired dimensions. Furthermore, depending on the materials used, hot melt extrusion can be useful to enhance the bioavailability of poorly soluble drugs. It can also protect a drug from enzymatic degradation as well as avoid the irritation of the mucosa in gastro intestinal tract. Moreover, if the drug has a specific absorption window or need to be targeted at a specific area of the gastro intestinal tract for systemic or localized treatment of diseases (e.g. Crohn's disease and Ulcerative Colitis), hot melt extrusion can be used.

Prior to the hot melt extrusion process, deep knowledge of the physicochemical properties of the drug as well as the polymer used is essential for the feasibility of the extrusion process. It is to

emphasize that physicochemical characterization of the drug is extremely important for the development of drug delivery systems (e.g. solubility, physical state, particle size, flowability, melting/glass transition temperature and thermal degradation) [74].

3.3.2. Carriers

In hot melt extruded drug delivery systems, the active compound is embedded in a carrier formulation often comprised of one or more “meltable” substances and other functional excipients. The meltable substance is generally a polymer (natural or synthetic) or a lipid. The selection of the carrier material for pharmaceutical drug delivery systems strongly depends on the application (taste masking, immediate or sustained release). The choice of the pharmaceutically approved polymer is critical in the formulation process as its properties not only dictate the processing conditions but also govern the dissolution characteristics of the dosage form (drug release kinetics and release mechanism).

As for drugs, some relevant characteristics of the carrier should be well investigated proceed to hot melt extrusion [31]. Here there are mostly important factors: the chemical structure, the solubility, the glass transition temperature/melting temperature, the melt viscosity that can be improved by the addition of plasticizer, the flowability, the lipophilicity/hydrophylicity, the thermal stability, the drug-carrier interactions and compatibility. Moreover, the characterization of rheological properties can help in selecting the appropriate carriers and setting the process conditions, which can be cost and time consuming [74].

Some of the carriers used for hot melt extrusion and their appropriate studies are listed below:

- Ethylene vinyl acetate (EVA): a water-insoluble copolymer of ethylene and vinyl acetate (VA). By simple varying the ethylene/VA ratio, large spectrum of drug release profiles can be provided [75-77].

- Poly-vinyl acetate (PVAc): a water insoluble polymer, which is suitable for hot melt extrusion [78,79].
- Cellulose derivatives: Hydroxy Propyl Methyl Cellulose (HPMC) is a non-ionic water soluble polymer, which is widely used for the preparation of controlled release tablets, microparticles and films by HME [80-83]. Hydroxypropyl cellulose (HPC) is also a non-ionic water-soluble and pH insensitive cellulose ether, which has been successfully used as matrix former and solubility-enhancing agent [84,85]. Ethyl Cellulose (EC) is a non-ionic water insoluble polymer [86,87].
- Copolymers derived from esters of acrylic and methacrylic acid have various physicochemical properties due to the nature of their functional groups. Commercially available “Eudragit ®” for immediate release (E100, E PO), delayed release (S100, L100) or sustained release (NE, NM, RL, RS) [88-97].
- Poly Ethylene Oxides (PEO) have the same composition as Poly Ethylene Glycol (PEG) but can be obtained at much higher molecular weights (100 KDa to 7000 KDa), they can be used in controlled drug delivery systems [42,98-100] as well as plasticizers [101-103] depending on their molecular weight.
- Polyurethane are produced by a reaction between polyols (polyethers or polyesters) and diisocyanates. They are copolymers containing soft and hard segments through which they have thermoplastic and elastic properties. Polyurethanes have been used as carriers for hot melt extrusion for the preparation of vaginal rings [104,105] and tablets for oral controlled drug delivery [106,107].
- Biopolymers (e.g. polysaccharides) such as chitosan (animal origin) and xanthan gum have been used as matrix in hot melt extrusion for oral sustained release formulation [108,109].

3.3.3. Plasticizers and additives

The addition of plasticizers can lower the processing extrusion temperatures that can avoid heat degradation of drugs and carriers [110-112]. A plasticizer is a low molecular weight compound that softens the polymer to make it more flexible, decreases the glass transition temperature (T_g) and lowers the melt viscosity [113-115]. The plasticizer can increase the free volume between polymer chains, providing more mobility for the polymer chains, which results softer and more flexible mixture. Being more flexible, the processing temperature can be decreased, which leads to lower torque generated during the process [116,117]. Furthermore, the physical and mechanical properties of the final product can be improved. Most common plasticizers used are low molecular weight polyethylene glycols, triacetin, triethyl citrate, glycerol, dibutyl sebacate...etc. Moreover, several drugs (e.g. ibuprofen, guaifenesin, metoprolol tartrate) have been shown to be effective plasticizers for certain polymers [118-120]. Since the drug and polymer are exposed to elevated temperatures, high pressure and extensive mixing during hot-melt extrusion, it is important to evaluate the stability of the API and polymer after the manufacturing process in order to avoid degradation. In order to be efficient, several prerequisites have to be fulfilled by plasticizers, namely good efficiency, polymer-plasticizer compatibility/affinity and thermostability. The efficiency of a plasticizer refers to the concentration of plasticizer necessary to lower the glass transition temperature of the polymer. Compatibility refers to the similarity in chemical structure between plasticizer and polymer, which results in a better compatibility. The nature of the plasticizer can have an impact on drug release kinetics: a hydrophobic plasticizer could be remained into the polymeric network, retarding the release of a drug into the bulk media but in contrast the leaching out of the hydrophilic plasticizer from the polymeric network can be rapid, which can creat more pores into the system and thus, accelerating drug release [121,122].

Other additives can also be used in these systems (e.g. antioxidants, lubricants). The stability of polymers that are susceptible to degradation can be improved with the addition of antioxidants. The latter can enhance the stability of polymers susceptible to degradation during hot melt extrusion.

3.4. Advantages and disadvantages of hot melt extrusion

As described above, hot melt extrusion is a continuous and free-solvent process. It offers several advantages compared to conventionally available pharmaceutical processing techniques such as [28]:

- Increases solubility and bioavailability of poorly water soluble drugs.
- The final product is free of residual solvent as no solvents are required during the process.
- Improves the stability and avoids the degradation of the final product.
- Reduced the production time (economical process).
- Requires few processing steps.
- A continuous operation with efficient scale-up from laboratory to pilot scale to production.

However, hot melt extrusion has some disadvantages as well. The main inconvenient of hot melt extrusion is the thermal process, which is risks of drug/polymer stability and the physical transformation of the extrusion process. Nevertheless, the use of a plasticizer sometimes solve this problem. Furthermore, continuous industrial production can cause a high energy input and most important costs related to the purchase of the equipment. Moreover, after the extrusion of hydrophobic polymers, the cleaning of the machine can be problematic and time consuming. Specific hydrophilic excipients are available in the market (HME cleaner Plus®) and are required for the cleaning of different parts of the machine (eg. the screw, the barrel) after the extrusion process [28,31].

3.5. Commercially marketed hot melt extrusion formulations

As described above hot melt extrusion is a continuous free solvent process, which show various advantages. It became a very interesting pharmaceutical technology in the industry used in many research studies with an increase of number of publications per year. Despite the large and extensive application in academic and industrial fields, only a few commercialized hot melt extrusion pharmaceutical products (table 1) are currently marketed.

Table 1: Some of hot melt extrusion marketed products. Reported from [123,124]

Name/company	Drug	Carrier (polymer)	Administration route	Indication
Ozurdex®/Allergan	Dexamethasone	PLGA	Intraocular (implants)	Macular edema
Implanon®/Merck	Etonogestrel	EVA	Subcutaneous (amplants)	Contraceptive
Gris-PEG®/Pedinol	Griseofulvin	PEG	Oral (tablets)	Onychomycosis
Kaletra®/Abbott	Lopinavir/ritonavir	PVP/PVA	Oral (tablets)	Viral infection (HIV)
Covera- HS®/Pfizer	Verapamil, HCl	HPC	Oral (tablets)	Hypertension
Noxafil®/Merck	Posaconazole	HPMCAS and PVA	Oral (tablets)	Antifungal
Nurofen®/Reckitt Benckiser Healthcare	Ibuprofen	HPMC	Oral (tablets)	Analgesic
Zithromax®/Pfizer	Azithromycin	Pregelatinized starch	Oral (tablets)	Bacterial infection

4. Colon targeting

4.1. Strategies for colonic drug delivery systems

The site-specific drug delivery to the colon can improve local treatments of inflammatory bowel diseases (IBD), such as Crohn's disease and Ulcerative Colitis. The suppression of premature drug release in the upper part of the gastrointestinal tract (GIT) avoids drug absorption into the blood stream and thus minimizes undesired side-effects. Once the colon is reached, the drug is released, ideally in a time-controlled manner, in order to ensure optimized drug concentration time profiles at the site of action, leading to improved therapeutic effects [125]. Different strategies have been reported in the literature aiming at site-specific drug delivery to the colon [126].

Immediate drug release upon contact with aqueous body fluids is avoided by the presence of the matrix former/film coating. The latter should be insoluble and impermeable for the drug in the stomach and small intestine but should dissolve or become permeable as soon as the target site is reached. To provide the required site-specific system properties, the following approaches have been described in the literature: (i) pH-dependent systems using pH-dependent polymers, which are soluble at different pH levels in the different part of the GIT. The polymers described as pH-dependent in colonic specific drug delivery are insoluble at low pH levels but become increasingly soluble as pH rises [127]. Even if a pH-dependent polymer can protect a drug delivery system in the stomach, the duodenum and the jejunum, it may start to dissolve in the ileum, and the site-specificity of formulations can be poor [128], (ii) time-dependent systems are also very promising drug delivery systems. Nevertheless, due to potentially large variations of gastric transit time for humans, nature and amount of food intake, colonic arrival time is unfortunately unpredictable. This results in poorly colonic drug availability [129]. It had to be pointed out that the transit time, the gastrointestinal movement, especially peristalsis or contraction in the stomach result in change in gastrointestinal transit of the drug [130] but also to the accelerated transit time observed in IBD-

patients [131-133], (iii) bacteria sensitive systems have been found to be the most promising and adapted to the disease state because of the significantly increased colonic microbiota and enzymatic activities in the distal part of the GIT [134]. The use of natural polysaccharides is attracting a lot of attention for colon targeting since these polymers are found in abundance and have wide availability. These polymers are inexpensive and are available in a variety of structures with varied physicochemical properties. They are highly stable, safe, nontoxic, and hydrophilic and in addition, are biodegradable. These include polysaccharides obtained from plant (guar gum, inulin), animal (chitosan), algal (alginates) or microbial (dextran) origin [135]. In combination with a time or pH dependent polymer, the system should be able to minimize or completely suppress drug release in the upper part of the GIT. But in contact with colonic fluid, drug release is triggered by the enzymatic fermentation of these polysaccharides.

The use of multiparticulate dosage forms (e.g. pellets and mini-matrices) can be very interesting and provides major advantages compared to single unit dosage forms (e.g. tablets or capsules) such as the all-or-nothing effect that can be avoided: if a tablet gets accidentally damaged within the upper GIT, the entire drug dose is lost and the gastric emptying time is less variable, because the pylorus can be passed even in the contracted state. Furthermore, significant drug amounts can be incorporated in the core of coated dosage forms. This is particularly important for highly dosed drugs, such as 5-aminosalicylic acid (5-ASA), which is the standard treatment for inflammatory bowel diseases-patients [136-138]. From the literature point of view, care should be taken when using just one approach for targeting the 5-ASA to the colon even for multiparticulate dosage forms because of inter and intra variability of physiopathological conditions of patients. However, the combination of different approaches in one delivery system could make drug delivery to the colon more assured.

4.2. Combination of bacteria sensitive and time-controlled systems

Karrout et al. reported that 5-aminosalicylic acid pellets coated with ethylcellulose and Eurylon 6 HP-PG, a hydroxypropylated and pregelatinized high amylose starch in a ratio of 1:4 (w/w) have been shown to minimize drug release in media simulating the conditions of the upper GIT. Though, drug release occurs as soon as the pellets come into contact with culture medium inoculated with feces from IBD patients or a cocktail of Bifidobacterium, Bacteroides and E. coli as an alternative to fresh fecal samples from IBD patients [139]. Other modified polysaccharides (e.g. nutriose FB 06, a branched dextrin with a high fiber content and nutriose 100 % fibers, partially hydrolyzed starch) were used in combination with ethylcellulose as film coatings. It was also reported that drug release (e.g. 5-ASA or theophylline) from loaded beads were coated with different Nutriose FB 06:ethylcellulose or Nutriose 100 % fibers:ethylcellulose blends, could effectively be suppressed upon exposure to release media simulating the conditions in the upper GIT but as soon as the multiparticulate systems came into contact with fecal samples of inflammatory bowel disease patients, the release rate significantly increased and the drug was released in a time-controlled manner [140,141]. In vivo efficacy were also confirmed in experimental colitis model by Wister rats. Pellets coated with Nutriose FB 06:ethylcellulose (EC) (1:4) or peas starch:ethylcellulose (1:2) blends were studied and showed very promising results in vivo. This study clearly prove the superiority of the proposed microbiota sensitive film coatings based on Nutriose:ethylcellulose and peas starch:ethylcellulose for colon targeting in vivo [142].

Moreover, another study described the potential of coated pellets loaded with budesonide for a colonic administration. Pellets were coated with different time-dependent polymers, namely: Eudragit RS 30D, Eudragit NE 30D or Surelease blended with pectin at different ratios. Importantly, pellets with a coating based on pectin:Surelease (1:3) blend at coating level of 35 % (w/w), could suppress drug release in media simulating the stomach and the intestine, while budesonide release

can be triggered in the presence of rat cecal content. In vivo results confirmed therapeutic efficacy of pectin/Surelease coated pellets loaded with budesonide, indicating the improvement of macroscopic and microscopic parameters of experimental induced colitis [143].

Furthermore, in another study, chitosan was mixed with Aquacoat® ECD 30 (a suspension of ethylcellulose) and used as coating for pellets loaded with 5-ASA. In-vitro dissolution studies upon exposure to simulated intestinal fluid, chitosan level as well as the thickness of the coating layer have been shown to impact/influence drug release profile. Pellets coated with Aquacoat:chitosan blend ratio (23:2) at 60 % coating level released around 5 % of 5-ASA over 12 h in simulating intestinal fluid (SIF). This formulation was selected for further studies. Drug release was more pronounced in presence of fecal rat contents (simulated colonic fluid = SCF) and pores were visible on the surface of the pellets using environmental scanning electron microscopy (ESEM). These multiparticulate coated systems might offer a promising tool for colon targeting. However, further in-vivo test should be investigated in order to confirm the potential of these systems for colonic delivery [144].

Li-Fang et al. reported that tablets contained theophylline and coated with a blend of Kollidon SR:chitosan (3.5:1) is able to protect the drug in fluids simulating the upper part of the GIT. Drug release in simulating colonic fluid have been shown high and more effective digestion of chitosan with rat fecal bacterial enzymes secreted during the test than β -glucosidase enzyme incorporated [145].

In another study, Wilson et al., showed that tablets loaded with mesalazine and coated with amylose:ethylcellulose blend was suitable for the treatment of IBD by targeting the release of mesalazine in the colon. In-vitro tests showed that the ratio of the two polymers as well as the thickness of the film are key parameters to control drug release. Importantly, tablets coated with amylose:ethylcellulose blend ratios of 1:3 and 1:2 at different coating levels (2, 4 or 6 %) are able

to completely suppress mesalazine release in media simulating the stomach and small intestine (less than 10 % of mesalazine released after 6 h upon exposure to dissolution media). Furthermore, drug release significantly increased in contact with human fecal samples, which confirmed these results in vivo [146].

Liu et al., developed a capsule with an enteric coating for pulsatile drug release. The capsule was filled with a rapid-disintegrating tablet of 5-ASA and a pectin-based plug in the opening of capsule body. Pectin-based plug was consisted of either high methoxy pectin (HM-pectin) and lactose or low methoxy pectin (LM-pectin) and HPMC. HM-pectin alone led to a long lag time because of its high viscosity, while the lactose addition can shorten the lag time. LM-pectin due to its weak gel ability was used along with HPMC in order to extend the lag time. The lag time prior to drug release was shortened in the presence of pectinase or rat cecal content in the release medium, which confirmed the responsiveness of pectin plug to the enzymatic action. Determination of 5-ASA in the plasma samples of beagle dogs after administration of a single dose of the orally pulsatile capsule, revealed site-specific delivery to the colon [147].

4.3. Combination of bacteria sensitive and pH-dependent systems

Patole et al., prepared 5-ASA loaded alginate microspheres and filled them in capsules based on HPMC. Capsules were coated with Eudragit FS 30D, an enteric coating. These systems were able to suppress 5-ASA release in gastric fluid due to the enteric coating. However, drug release was triggered in the presence of rat fecal samples by bacterial degradability of alginate. Also, in-vivo studies showed a significant reduction of ulcer index in rats treated with these alginate based microspheres [148].

In two another studies, Jain et al. and Mohanty et al. used Eudragit S 100 coating for microspheres based on pectin and loaded with 5-ASA, or alginate [149] for colonic delivery

multiparticulate systems. 5-ASA microspheres based on pectin were prepared by water-in-oil (w/o) emulsification and then coated with Eudragit S 100. These multiparticulate systems were in vitro evaluated for their drug release. In both studies, it was shown that Eudragit S100 was able to suppress 5-ASA release from pectin microspheres in media simulating the upper GIT (stomach and small intestine) and releasing drug in the colon (around 98 % drug release after 16 h). This can be attributed to the dissolution of the enteric coating (Eudragit S100) at pH above 7 and the biodegradation of pectin by colonic bacteria [150,151].

Eudragit S 100 was also used as an enteric coating for chitosan based microparticules to deliver mesalamine into the colon. In this study, in vitro drug release from chitosan microparticles coated with Eudragit S 100 was compared to mesalamine suspensions. Importantly, 100 % of mesalamine was released from the suspension, contrary to drug release from chitosan coated microparticules, which was almost suppressed in media simulating the stomach and small intestine, while in the presence of rat fecal samples, 71 % of mesalamine was released within 20 h. Furthermore, in vivo tests performed by Sprague Dawley rats showed that microparticles containing chitosan and coated with Eudragit S 100 have the potential to maintain the concentration of mesalamine in the targeted region for a long time (C_{max} of mesalamine in rats' plasma after 8 h of administration). These systems can offer a very interesting tool to treat inflammations localized in the distal part of GIT [152].

Combination of pH-dependent and bacterial degradation approaches for the design of colonic delivery of 5-ASA as a single unit dosage form were also studied. In one study, chitosan capsules filled with 5-ASA were enteric coated to achieve colonic drug delivery. Drug release from the capsules increased significantly when dissolution was performed in media containing rat cecal contents. For the treatment of colitis in rats, 5-ASA chitosan capsules orally administered and better

therapeutic effects were observed compared to administration of 5-ASA in carboxymethyl cellulose suspension [153].

Furthermore, 5-ASA tablets were coated with chitosan and then overcoated with Eudragit L100. Eudragit L100 prevented dissolution of chitosan layer in gastric region and the chitosan layer protected drug release in the small intestine due to its low solubility in basic pH. The developed formulation indicates a degradation of chitosan by bacterial enzymes located in the colon, resulting in colonic delivery of 5-ASA [154].

4.4. Combination of three different approaches

Other studies associated three different approaches: pH-time-enzyme dependent systems for the delivery of 5-ASA to the colon. Multiparticulate systems (coated pellets) were investigated by Fude et al. Three different coating layers were applied on 5-ASA loaded pellets prepared by extrusion-spheronisation. Calcium pectinate as an enzyme dependent polymer, which could be digested by enzymes secreted by colonic bacteria allowing for colonic administration of 5-ASA, ethylcellulose, a time-dependent polymer, which could protect drug release in the small intestine and an enteric coating (Eudragit L 30D-55), which prevented drug release in the stomach. No significant drug release was observed in 0.1 M HCl while the drug release after 3-4 h lag time at pH 6.8 was observed during *in-vitro* dissolution test. An increase in drug release in contact with colonic enzymes might support the suitability of using this system to achieve colon targeted drug delivery [155].

Design of 5-ASA microparticulates with matrix structure using combination of different approaches was studied by Mladenovska et al. Microparticles consisting of 5-ASA dispersed in the chitosan-Ca-alginate matrix were prepared by spray drying. Both pH dependency and bacterial degradability were used as main mechanisms for colonic delivery of the drug in these particles. This system was evaluated *in vitro* as well as *in vivo* by Wistar rats. It was shown that chitosan-alginate

complex was able to erode slowly upon medium with pH values higher than 6.5. This property prevented drug release in the upper parts of GIT and controlled drug release in the colon. In addition, degradation of chitosan by the colonic microflora resulted in specific drug release in the colon. Colonic delivery of the microparticles was confirmed in biodistribution studies in rats, resulting in suggested usefulness of the system for clinical treatment in human IBD [156,157].

The combination of three approaches for colonic delivery of 5-ASA tablets was studied by Nunthanid et al., who proposed a delivery system which was sensitive to time, pH and enzyme. 5-ASA tablets were coated by combinations of spray-dried chitosan acetate (as a pH-dependent and bacterial sensitive polymer) and HPMC (as a time-dependent polymer) at different ratios. The pH-dependent swellability and solubility of spray-dried chitosan acetate, its degradation by the β -glucosidase enzyme and gradual dissolution of HPMC contributed to drug release underlying mechanisms. The results clearly demonstrated the suitability of the combination of HPMC and spray-dried chitosan acetate at an appropriate ratio as a coating material for 5-ASA colonic delivery [158].

5. Purposes of this work

The major objective of this work was to develop novel dosage forms prepared by hot melt extrusion/injection molding allowing for site-specific drug delivery to the colon in the treatment of inflammatory bowel diseases such as Crohn's disease and Ulcerative Colitis.

The strategy used is a combination of a polysaccharide (pectin, guar gum, inulin, maltodextrin...), which permits for colon targeting by enzymatic degradation and a hydrophobic thermoplastic polymer (ethylcellulose, polyurethane, polyvinyl acetate...), which can reduce the hydrophilicity of the biodegraded polysaccharide. However, the mixture of the two polymers should not hinder bacterial enzymatic degradation of the polysaccharide. Furthermore, hot melt extruded polysaccharide blends for controlled drug delivery were studied. Particular aims included:

- The Preparation and physicochemical characterization of thin polymeric films of different polysaccharide:hydrophobic polymer blends suitable for colonic delivery.
- The preparation of hot melt extrudates and injection-molded capsules for colonic delivery and the set of the process parameters.
- The physicochemical characterization of extrudates and capsules and the identification of promising systems for colonic drug delivery.
- The preparation of polysaccharides-based hot melt extrudates for controlled drug delivery and the optimization of the process parameters.

II. MATERIALS AND METHODS

1. Materials

1.1. Polymer aqueous dispersions

Polyvinyl acetate (Kollicoat SR 30D; BASF, Ludwigshafen, Germany); ethyl acrylate methyl methacrylate copolymer (Eudragit NE 30D; Evonik Degussa GmbH, Darmstadt, Germany); ammonioalkyl methacrylate copolymers (Eudragit RL 30D and Eudragit RS 30D; Evonik Degussa GmbH, Darmstadt, Germany).

1.2. Polymer powders

Polyvinyl acetate (Kollidon SR 30D; BASF, Ludwigshafen, Germany); hydrophobic grades of polyurethane: Carbothane PC-3575A (Carbothane) and Techothane TT-1074A (Techothane); hydrophilic grades of polyurethane: Tecophilic SP 93A-100 (Tecophilic SP93) and Tecophilic SP 60D-60 (Tecophilic SP60) (Lubrizol corporation, Wilmington, MA, USA); ethylcellulose (EC, Ethocel Standard 10 premium; Colorcon, Massy, France); hydroxypropyl methylcellulose (HPMC, Methocel E5 Premium LV; Colorcon, Kent, England).

1.3. Polysaccharide powders

Pectin and maltodextrin (UniPectin and C*Actistar 11700 Tapioca maltodextrin, Cargill, Krefeld, Germany); maize starch (C*PharmGel 03406; Cargill, Gent, Belgium); guar gum (viscosity of a 1 % solution in water at 25 °C: ~5000 cP; Cooper, Melun, France); inulin (Inulin HPX and Inulin Synergy 1; Beneo, Oreye, Belgium); chitosan (Crab Shell chitosan, Mw = 800 kDa, degree of deacetylation = 80-90 %; Bio 21, Chonburi, Thailand); sodium alginate (Keltone LVCR; FMC Bio-polymer, Girvan, UK); carrageenan (Gelcarine GP-91-NF; Philadelphia, USA); Arabic gum (Cooper, Melun, France); xanthan gum (Keltrol*TF; Kelco, London, UK).

1.4. Plasticizers

Dibutyl sebacate (DBS; Stearinerie Dubois, Boulogne-Billancourt, France); triethyl citrate (TEC; Alfa Aesar, Karlsruhe, Germany); poly ethylene glycol (PEG 1500; Pluracare E 1500 Flasks; BASF, Ludwigshafen, Germany).

1.5. Drug powders

Anhydrous theophylline and diprophylline (BASF, Ludwigshafen, Germany)

Table 2: Physicochemical properties of model drugs [159-161].

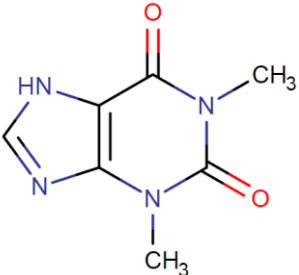
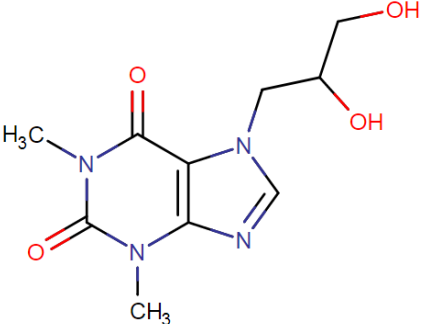
Drug	Anhydrous theophylline	Diprophylline
Chemical structure		
Chemical formula	$C_7H_8N_4O_2$	$C_{10}H_{14}N_4O_4$
Molecular weight	180.17 g/mol	254.24 g/mol
Solubility (in water at 25 °C)	7.36 g/L	333 g/L
Melting point	270 - 274 °C	155 - 157 °C
pKa	8.81	13.91
Log P	- 0.02	- 1.9

1.6. Ingredients for culture medium preparation

Extracts from beef and tryptone (Pancreatic digest of casein; Becton Dickinson, Sparks, USA); yeast extract (Oxoid Ltd, Hants, UK); sodium chloride (J. T. Baker, Deventer, Netherlands); L-cysteine hydrochloride hydrate (Acros Organics, Geel, Belgium); Ringer solution (Merck, Darmstadt, Germany).

1.7. Ingredients for mobile phase preparation

Acetonitrile (CWR, Fontenay sous bois, France); sodium acetate (Sodium acetate, anhydrous, 99 %, ThermoFisher GmbH, Kandel, Germany).

2. Preparation of dosage forms

2.1. Thin polymeric films

Thin polymeric films were prepared by casting blends of different aqueous hydrophobic polymer dispersions and a polysaccharide into Teflon molds and subsequent drying for 1 day at 60 °C. The polysaccharide was dispersed in purified water. Aqueous polymer dispersion (30 % w/w solids content) was plasticized for 24 h with 30 % DBS or TEC (w/w, referred to the solid content of the dispersion) under stirring. The polysaccharide and plasticized polymer dispersions were blended at room temperature at different polymer:polymer (w/w) blend ratios. The mixtures were stirred for 6 h prior to casting.

2.2. Hot melt extrudates

Drug and polymer powders were blended for 10 min at 98 rpm in a Turbula T2A (Willy A. Bachofen Maschinenfabrik, Muttenz, Switzerland), followed by manual mixing in a mortar with a

plasticizer (TEC, DBS or PEG 1500). The compositions were varied as indicated. Polymer:polymer blend ratios are expressed in weight:weight, plasticizer percentages are referring to the mass of 1st polymer (mass of 1st polymer = 100 %), drug percentages refer to the total mass of the hot melt extrudates (mass of extrudate = 100 %). The plasticized blends were kept at room temperature for 24 h, followed by extrusion with a Nano 16 twin screw extruder (Leistritz, Nuremberg, Germany), equipped with a 4 mm diameter die (screw diameter = 16 mm, length/diameter ratio = 26.25). Figure 5 shows the setting of the screw elements. The process temperatures were kept constant at 170 – 170 – 170 – 170 °C, 130 – 130 – 130 – 130 °C or 100 – 100 – 100 – 100 °C [zone 4 (die) – zone 3 – zone 2 – zone 1], as indicated. The feed rate was set at 3 mL/min. After cooling, the hot melt extrudates were manually cut into cylinders.

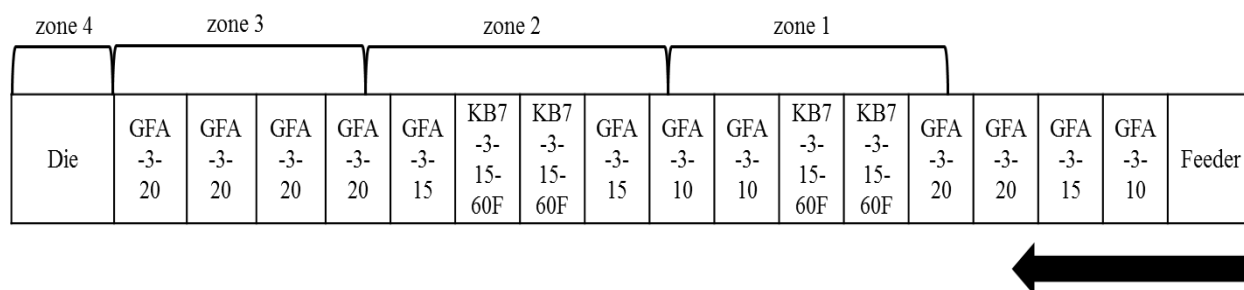

Figure 5: Setting of the screw elements used for hot melt extrusion.

2.3. Injection-molded capsules

Injection molding process was performed with a bench-top micromolding machine (BabyPlast 6/10P; Cronoplast S.L., Barcelona, Spain; Rambaldi S.r.l., Molteno, Lecco, IT) equipped with a capsular mold furnished with a hot-runner and with two interchangeable inserts for the manufacturing of matching cap and body items of 600 µm thickness. Hot melt extrudates prepared as mentioned before were manually cut into cylinders of 2 mm length prior to manually load in the

plasticizing unit of the injection molding machine and successively pushed in the injection chamber by means of the loading plunger. Figure 6 shows the different zones of the micromolding machine.

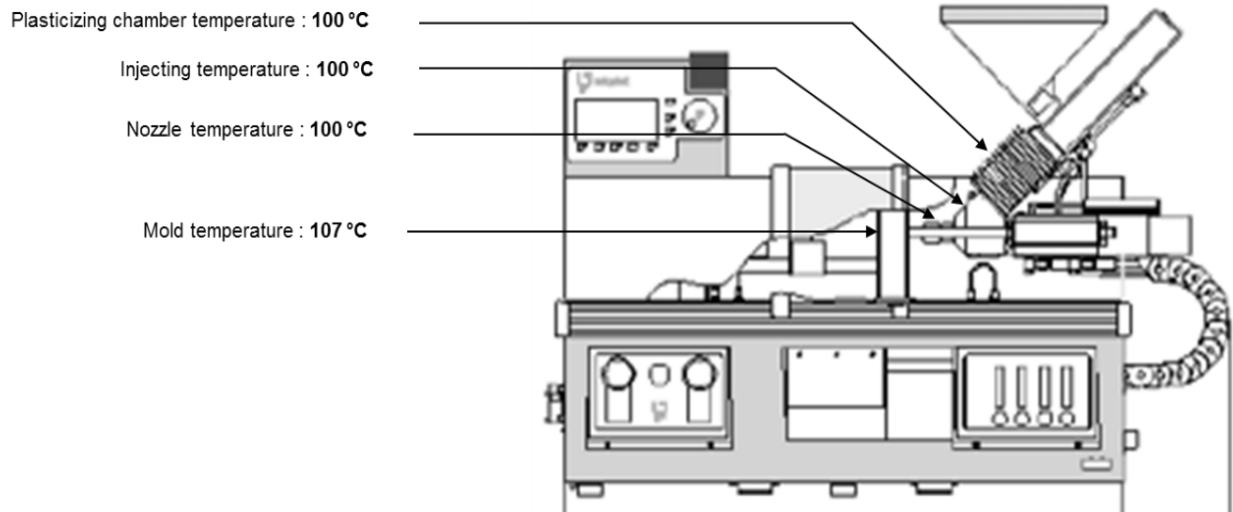

Figure 6: Zones and temperatures of the micromolding machine used for the preparation of capsules (printed from babyplast® 6/10P instruction manual).

Afterwards, two different and consecutives injection pressures (P1 - P2), maintained for a selected time (t1 - t2) in order to inject the polymeric melt into the mold cavity. The injection molding temperatures were set as during the hot melt extrusion process and then adjusted. For the injection pressures and times, minimum values were set up and progressively increased until the obtaining of complete capsule shell. Final process parameters for the manufacturing of 600 µm capsules are reported in table 3.

Table 3: Injection molding conditions for the manufacturing of capsules

Plasticizing chamber temperature	Injecting temperature	Nozzle temperature	Mold temperature	Pressure P1 – P2	Injection time t1 – t2	Cooling time
100 °C	100 °C	100 °C	107 °C	100-80 bar	6-5 s	10 s

3. Physicochemical characterizations

3.1. Optical microscopy

Macroscopic pictures of hot melt extrudates and capsules were taken with an optical image analysis system (Nikon SMZ-U; Nikon, Tokyo, Japan), equipped with a Zeiss camera (Axiocam ICc1; Zeiss, Jena, Germany). Cross-sections of hot melt extrudates were obtained by manual breaking.

3.2. Fermentation studies

Polysaccharide powders (approximately 500 mg) were incubated 24 h in (i) culture medium inoculated with feces from inflammatory bowel disease patients (ii) culture medium inoculated with bacterial strains: *Bacterioides*, *Bifidobacterium* and *E.coli*, (iii) culture medium free of feces and bacteria for reasons of comparison.

Culture medium was prepared by dissolving 1.5 g beef extract, 3 g yeast extract, 5 g tryptone, 2.5 g NaCl and 0.3 g L-cysteine hydrochloride hydrate in 1 L distilled water (pH 7.0 ± 0.2) and subsequent sterilization in an autoclave. Feces of patients (approximately 1 g) with Crohn's disease or ulcerative colitis were diluted 1:200 with cysteinated Ringer solution; 2.5 ml of this suspension was diluted with culture medium to 100 ml. The samples were agitated (50 rpm; Stuart, Cole-Parmer; Villepinte, France) at 37 °C under anaerobic conditions (AnaeroGen 2.5 L; Thermo Scientific; Illkirch, France). The pH was measured using color-fixed pH indicator sticks (Fisher Scientific; Leicestershire, UK).

3.3. Water content and dry mass

The water content and the dry mass loss kinetics of hot melt extrudates and thin polymeric films were measured gravimetrically upon exposure to (i) simulated gastric fluid (0.1 M HCl pH 1.2) (ii) simulated intestinal fluid (phosphate buffer pH 6.8; USP 41) (iii) simulated colonic fluid (culture medium inoculated with feces from inflammatory bowel disease patients) (iv) culture medium inoculated with bacterial strains: *Bacterioides*, *Bifidobacterium* and *E.coli* as substitutes of fecal samples and (v) culture medium free of feces for reasons of comparison.

Samples were placed into flasks (1 sample per flask), filled with 200 mL 0.1 M HCl or phosphate buffer pH 6.8 and agitated at 80 rpm (in a horizontal shaker, 37 °C; GFL 3033, Gesellschaft fuer Labortechnik, Burgwedel, Germany). The incubation with fecal samples was performed under anaerobic conditions (AnaeroGen 2.5 L; Thermo Scientific; Illkirch, France). Culture medium was prepared as described above. Samples were placed into 120 ml containers filled with 100 ml pre-heated medium, followed by horizontal shaking at 37 °C (50 rpm; Stuart, Cole-Parmer; Villepinte, France). At predetermined time points, samples were withdrawn and rinsed with water. Excess water was removed by careful blotting with Kimtech precision wipes (Kimberly Clark, Roswell, GA). Samples were accurately weighed (wet mass) and dried to constant weight at 60 °C (dry mass). The water uptake and the dry mass (%) at time t was calculated as follows:

$$\text{Water content (\%)} (t) = \frac{\text{wet mass (t)} - \text{dry mass (t)}}{\text{wet mass (t)}} \cdot 100 \% \quad (1)$$

$$\text{Dry mass (\%)} (t) = \frac{\text{dry mass (t)}}{\text{dry mass (t = 0)}} \cdot 100 \% \quad (2)$$

3.4. In vitro drug release

Under conditions simulating the upper gastro intestinal tract: Hot melt extrudates or injection-molded capsules (filled with 10 mg of drug) were placed into flasks (1 sample per flask), filled with 200 mL 0.1 M HCl and agitated at 80 rpm (in a horizontal shaker, 37 °C; GFL 3033, Gesellschaft fuer Labortechnik, Burgwedel, Germany). After 2 h, the release medium was completely exchanged with phosphate buffer pH 6.8 (USP 41). At pre-determined time points, 3 mL samples were withdrawn and analyzed UV-spectrophotometrically (UV-1800; Shimadzu, Kyoto, Japan) at $\lambda = 275$ nm (theophylline) or $\lambda = 274$ nm (diprophylline) for their drug content.

Under conditions simulating the entire gastro intestinal tract: Hot melt extrudates or injection-molded capsules (filled with 10 mg of drug) were exposed to 0.1 M HCl for 2 h and subsequently to phosphate buffer pH 6.8 (USP 41) for 6 h, in a USP Apparatus 3 (20 dpm, 37 °C, Bio-Dis; Varian, Paris, France). Afterwards, the samples were transferred into 120 mL flasks filled with: (i) 100 mL culture medium inoculated with human fecal samples, or (ii) culture medium free of feces for reasons of comparison.

Culture medium was prepared as described above. The samples were agitated (50 rpm; Stuart, Cole-Parmer; Villepinte, France) at 37 °C under anaerobic conditions (AnaeroGen 2.5 L; Thermo Scientific; Illkirch, France). At pre-determined time points, 2 mL samples were withdrawn, centrifuged at 10000 rpm for 10 min (Centrifuge Universal 320; Hettich, Tuttlingen, Germany), filtered (0.45 μ m, Millex-HU; Merck Millipore, Tullagreen, Ireland) and analyzed by HPLC for their drug content using a Thermo Fisher Scientific Ultimate 3000, equipped with a LPG 3400 SD/RS pump, an auto sampler (WPS-3000 SL) and a UV-Vis detector (VWD-3400RS) (Thermo Fisher Scientific, Waltham, USA). In the case of theophylline, the mobile phase consisted of 10 % acetonitrile and 90 % water (v/v). Samples were injected into a C18 column (Kinetex 5 μ m EVO C18 100 Å, 250 mm x 4.6 mm; Phenomenex, Le Pecq, France) and the flow rate was set

at 1.0 mL/min. The drug was detected UV-spectrophotometrically at $\lambda = 275$ nm. In the case of diprophylline, the mobile phase consisted of 35 % acetonitrile and 65 % 0.01 M aqueous sodium acetate solution (v/v). Samples were injected into a Polar C18 column (Luna Omega 3 μ m Polar C18 100 Å, 150 mm x 4.6 mm; Phenomenex, Le Pecq, France) and the flow rate was set at 1.0 mL/min. The drug was detected UV-spectrophotometrically at $\lambda = 274$ nm.

3.5. Differential scanning calorimetry (DSC)

DSC thermograms were recorded with a Q200 calorimeter (TA Instruments, Guyancourt, France). During all measurements the calorimeter head was flushed with highly pure nitrogen gas. Temperature and enthalpy readings were calibrated using pure indium at the same scan rates as used in the experiments. The samples were placed in hermetic high volume pans, resistant to pressure. Approximately 6 mg samples were heated from - 40 to 300 °C at 10 °C/min.

3.6. Powder X-ray diffraction (PXRD)

PXRD experiments were conducted with a PanAlytical X'PERT PRO MPD diffractometer ($\lambda_{\text{CuK}\alpha} = 1.5418$ Å for combined $\text{K}\alpha_1$ and $\text{K}\alpha_2$), equipped with an X'celerator detector (Almlo, The Netherlands). Samples were placed into Lindemann glass capillaries (diameter = 0.7 mm) and installed on a rotating sample holder to avoid artifacts due to preferential orientations of crystallites. Heating experiments have been performed in situ, at 10 °C/min, using the furnace HTC 9634 from Huber (Rimsting, Germany).

3.7. Thermogravimetric analysis (TGA)

TGA experiments were conducted with a Q500 TGA from TA Instruments (Guyancourt, France). Samples were placed in open aluminum pans, and the furnace was flushed with highly pure

nitrogen gas (50 mL/min). The temperature reading was calibrated using the Curie points of alumel and nickel, while the mass reading was calibrated using balance tare weights provided by TA Instruments. All scans were performed at 10 °C/min.

III. RESULTS AND DISCUSSIONS

CHAPTER 1:
POLYVINYL ACETATE:POLYSACCHARIDE
BLENDS FOR COLON TARGETING

POLYVINYL ACETATE:POLYSACCHARIDE BLENDS FOR COLON TARGETING

Insoluble polymers such as polyvinyl acetate (PVAc) are widely used as oral controlled release matrix prepared by hot melt extrusion [78,79]. Commercially available Kollidon® SR is a matrix retarding agent based on 80 % PVAc, 19 % povidone, 0.8 % sodium lauryl sulfate and 0.2 % Silica [162]. It was reported in the literature that polyvinyl acetate and different polysaccharides blends are suitable for a colonic drug delivery [145]. Li-Fang et al. showed that tablets contained theophylline and coated with a blend of Kollidon SR:chitosan (3.5:1) is able to protect the drug in fluids simulating the upper part of the gastro intestinal tract (GIT). Drug release in simulating colonic fluid have been shown high and more effective digestion of chitosan in contact with rat fecal samples than β -glucosidase enzyme incorporated [145].

The aim of this study was to evaluate the ability of blends of Kollidon SR with a second polysaccharide as hot melt extrudates to provide site-specific drug delivery to the colon. Kollidon SR was used to minimize drug release in the upper GIT due to its hydrophobicity. Thus, the second polysaccharide (inulin and maltodextrin) allowing for colon targeting is more permeable and fermentable by colonic bacteria. Dibutyl sebacate was added as a plasticizer in order to reduce the process temperature of hot melt extrudates containing theophylline as model drug. The water content and dry mass loss kinetics of hot melt extrudates free of drug as well as in vitro drug release from hot melt extrudates containing different amounts of theophylline were measured under conditions simulating the contents of the entire GIT (0.1 M HCl, phosphate buffer pH 6.8 and culture medium inoculated with fecal samples from IBD-patients). For reasons of comparison, in vitro drug release was also performed upon exposure to 0.1 M HCl, followed by phosphate buffer pH 6.8, followed by culture medium free of fecal samples.

1. Effect of polysaccharide nature and amount in thin polymeric films

Figures 7 and 8 show the impact of different types of polysaccharides and their amount (as indicated in the figures) in thin polymeric films on the water content and dry mass loss kinetics upon exposure to culture medium inoculated with a cocktail of *Bifidobacterium*, *Bacterioides* and *E.coli* (solid curves). For reasons of comparison, the films were also exposed to culture medium free of bacteria (dashed curves). Thin polymeric films contained blends of kollicoat SR (polyvinyl acetate suspension) and different types of polysaccharides. The polymer:polymer blend ratio was varied as indicated and the films were plasticized with 30 % TEC (based on the solid mass of Kollicoat SR).

Importantly, water content and dry mass loss rate and extent increased by increasing the amount of the water soluble polysaccharide in the film. This can be explained by the increase of the hydrophilicity of the systems, which leads to the formation of more pores in the polymeric network, allowing for high amount of water penetration into the system (figures 7 and 8).

Furthermore, all blends did not show any significant difference of water content and dry mass loss either in the presence or in the absence of bacteria. This can be attributed to the fact that Kollicoat SR in this mixture (Kollicoat SR and the 2nd polysaccharide) protect the polysaccharides from enzymatic degradation.

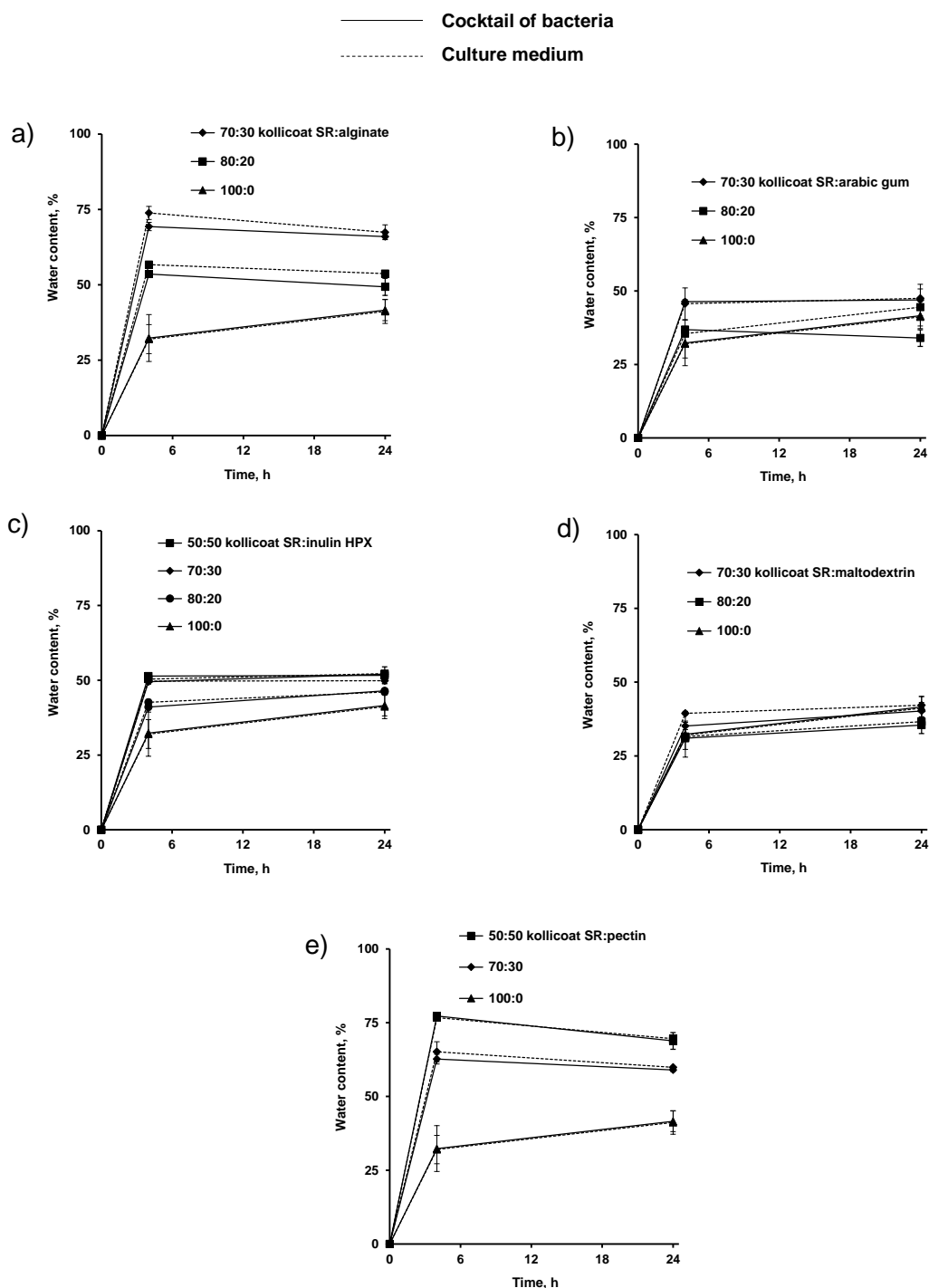

Figure 7: Water uptake of thin films based on: a) kollicoat SR:alginate, b) kollicoat SR:arabic gum, c) kollicoat SR:inulin HPX, d) kollicoat SR:maltodextrin and e) kollicoat SR:pectin blends upon exposure to culture medium inoculated with a cocktail of *Bifidobacterium*, *Bacterioides* and *E.coli* and culture medium free of bacteria for reasons of comparison. The polymer:polymer blend ratio was varied as indicated, the films were plasticized with 30 % TEC (referring to kollicoat SR).

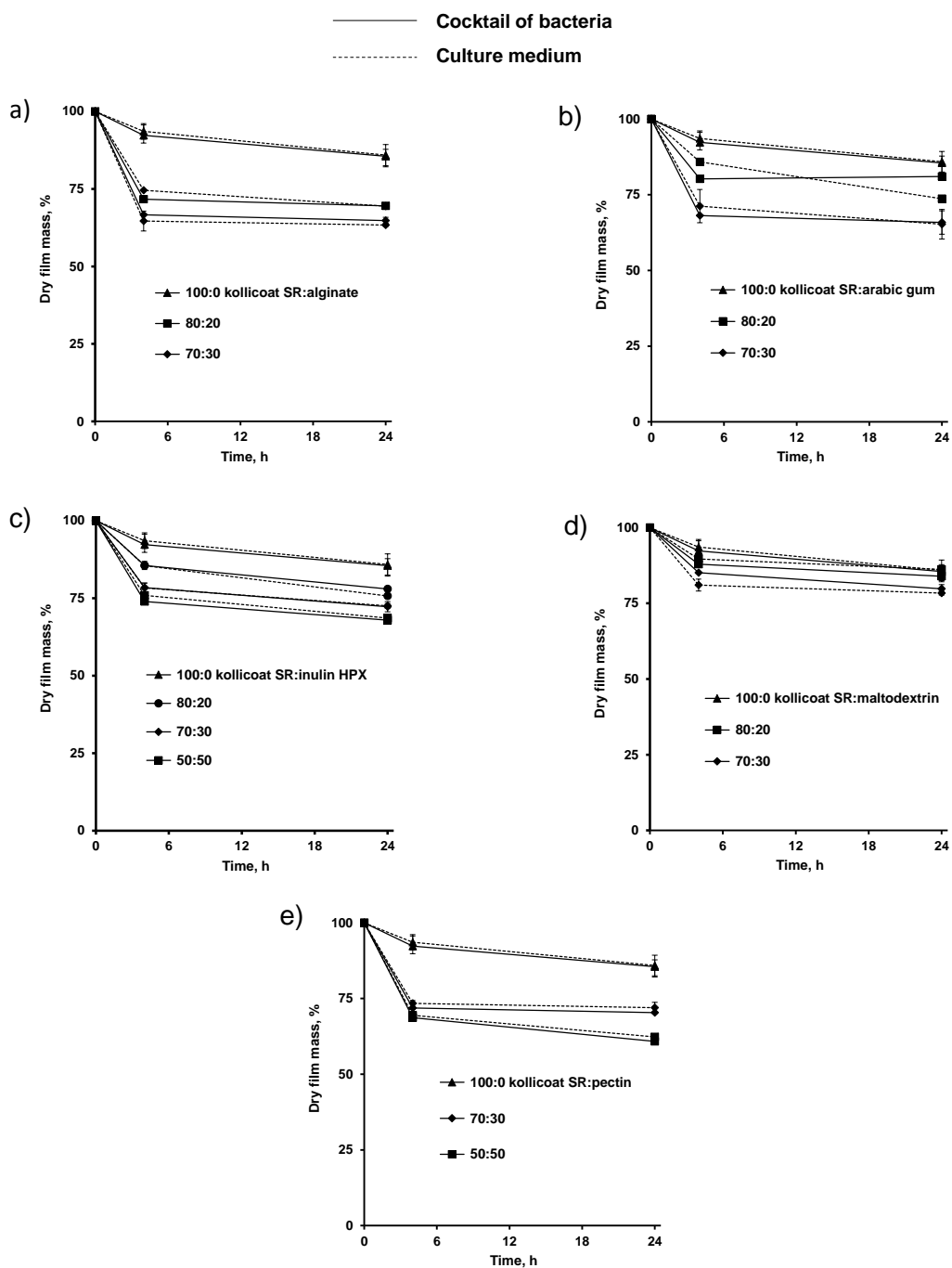

Figure 8: Dry mass of thin films based on: a) kollicoat SR:alginate, b) kollicoat SR:arabic gum, c) kollicoat SR:inulin HPX, d) kollicoat SR:maltodextrin and e) kollicoat SR:pectin blends upon exposure to culture medium inoculated with a cocktail of *Bifidobacterium*, *Bacterioides* and *E.coli* and culture medium free of bacteria for reasons of comparison. The polymer:polymer blend ratio was varied as indicated, the films were plasticized with 30 % TEC (referring to kollicoat SR).

2. Effect of polysaccharide nature on pH level

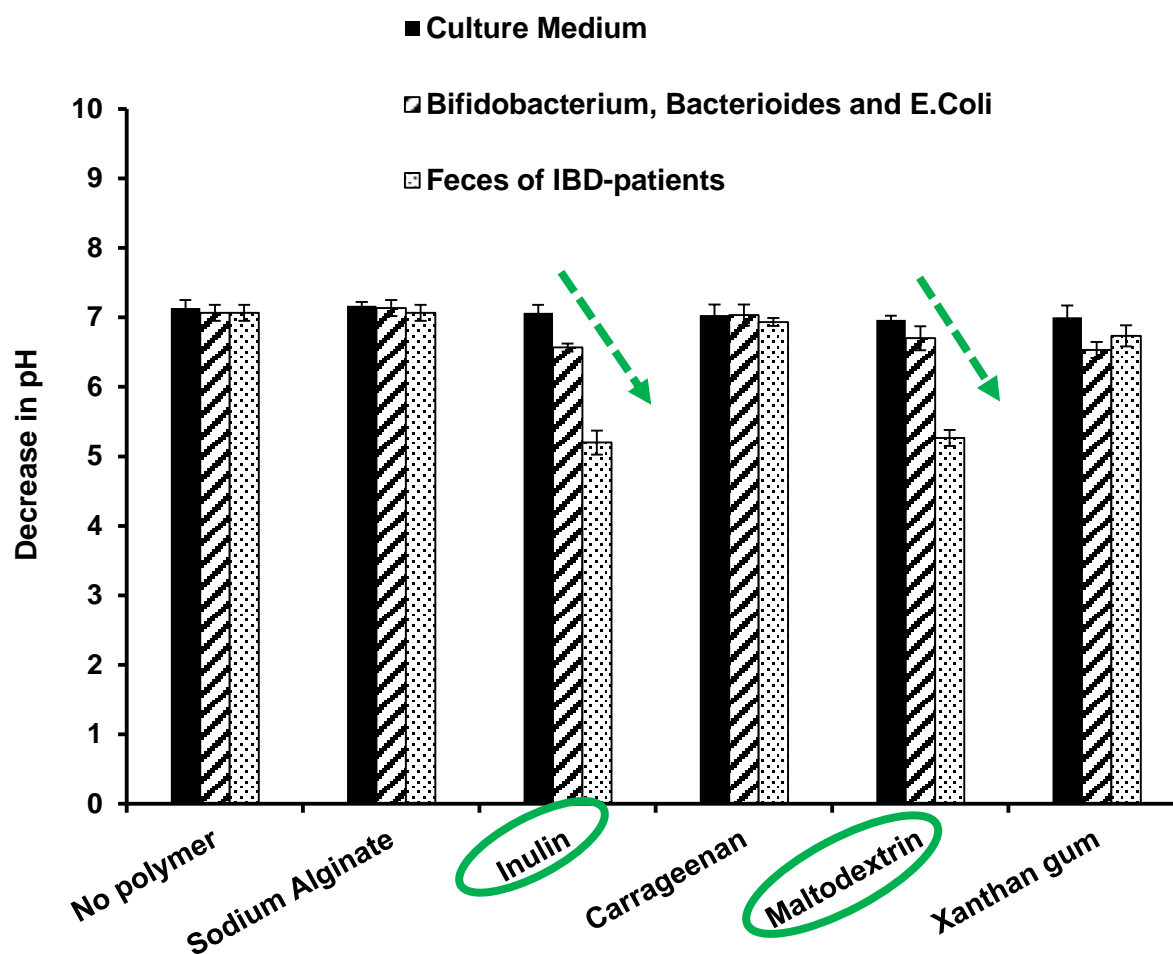

Figure 9: Impact of polysaccharide nature on pH level of culture medium (i) inoculated with a cocktail of *Bifidobacterium*, *Bacterioides* and *E.coli*, (ii) inoculated with feces of patients suffering from crohn's disease and (iii) free of fecal samples for reasons of comparison.

Polysaccharides fermentation results in a final stage to short-chain fatty acid production [163] such as acetate and butyrate [164]. These final products could have an impact on the pH of the release media and could be used as indicator for polysaccharides fermentation by bacterial enzymes in the colon. Figure 9 shows the impact of different polysaccharides on the pH of culture medium under anaerobic conditions in the presence of fecal samples from patients suffering of inflammatory bowel diseases or a cocktail of different bacterial strains (*E.Coli*, *Bacterioides* and *Bifidobacterium*) as a substitutes of fecal samples [140,141]. For reasons of comparison, polysaccharides were also incubated in culture medium free of fecal samples.

The initial pH of culture medium was around 7 (± 0.2) and remained constant in the absence of polymer after 24 h incubation with fecal samples or with the cocktail of bacteria. As it can be seen, for samples containing inulin and maltodextrin, pH values of the medium decreased in the presence of fecal samples (approximately from 7 to 5). This can be attributed to the fact that inulin and maltodextrin served as substrate for bacteria in the fecal samples. The decrease of pH of culture medium inoculated with the cocktail of bacteria was not pronounced as with fecal samples (approximately from 7 to 6.5) even in the case of inulin and maltodextrin. This can be explained by the fact that probably the quantitative and qualitative composition of the cocktail of bacterial strains (*E.Coli*, *Bacterioides* and *Bifidobacterium*) is not sufficient to degrade the polysaccharides into short chain fatty acids. Thus, this cocktail of bacteria can be used only with precaution as an alternative drug release media simulating colonic conditions, and also depending on the type of polysaccharide and the film polymeric mixture.

In case of sodium alginate, carrageenan and xanthan gum, no changes in pH values was observed neither in the presence of fecal samples nor upon exposure to bacterial strains. It is to emphasize that inulin as well as maltodextrin might offer an interesting tool as excipients for colon targeting and therefore they will be selected for further studies in this work.

3. Impact of hydrophobic polymer nature in thin polymeric films

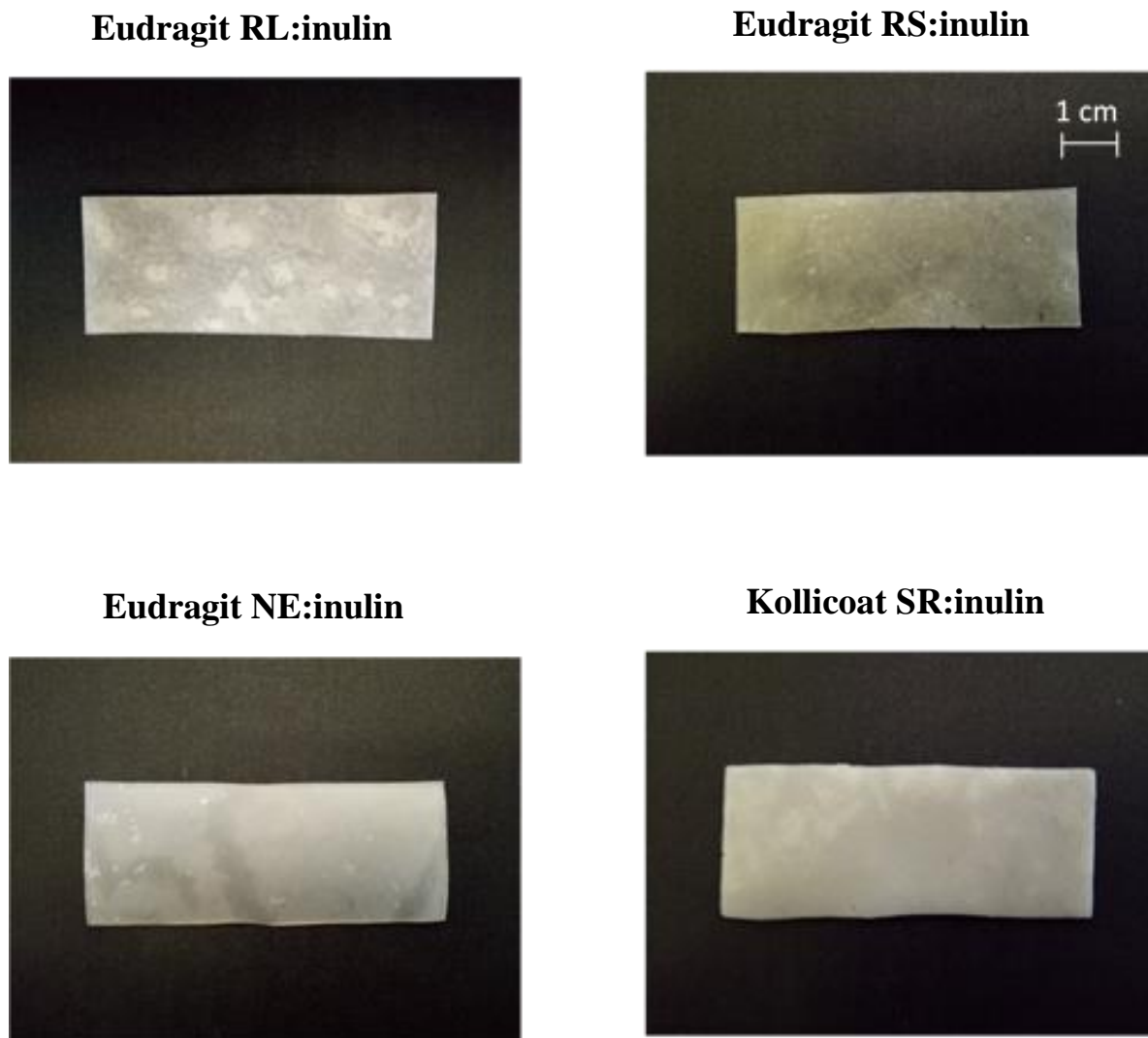

Figure 10: Macroscopic pictures of thin polymeric films consisting of different types of polymers blended with inulin. The 1st polymer:inulin blend ratio was 80:20, the films were plasticized with 30 % DBS (referring to the 1st polymer).

Figure 10 shows the macroscopic pictures of casted thin polymeric films (pieces obtained by manual cutting) based on different types of hydrophobic polymers and inulin blends. Figure 11 shows the impact of different hydrophobic polymers nature (as indicated) in thin films based on inulin blends on the water content and dry mass loss kinetics upon exposure to culture medium inoculated with fecal samples from IBD-patients (white bars). For reasons of comparison, thin polymeric films based on inulin blends upon exposure to culture medium free of feces are shown (black bars). The polymer:polymer blend ratio was 80:20. Films were plasticized with 30 % DBS (referring to the 1st hydrophobic polymer).

Importantly, dry mass loss of kollicoat SR:inulin blend upon contact to fecal samples was much more pronounced than upon exposure to culture medium free of feces (around 25 % vs 5 %). This can be attributed to the fact that inulin is degraded by the enzymes secreted by the bacteria present in the human feces. Furthermore, the water content of the films was even higher in the presence of fecal samples. This can be explained by the fermentation of inulin, which allows high amount of water penetration into the polymeric network. Other polymer blends did not show this difference neither in the presence nor in the absence of feces. This can be attributed to the hydrophobic nature of the 1st polymer, which probably covered entirely the polysaccharide that should be digested by bacterial enzymes.

Clearly, kollidcoat SR:inulin blends can offer a promising tool for colon targeting by releasing an incorporated drug as soon as the target site is reached.

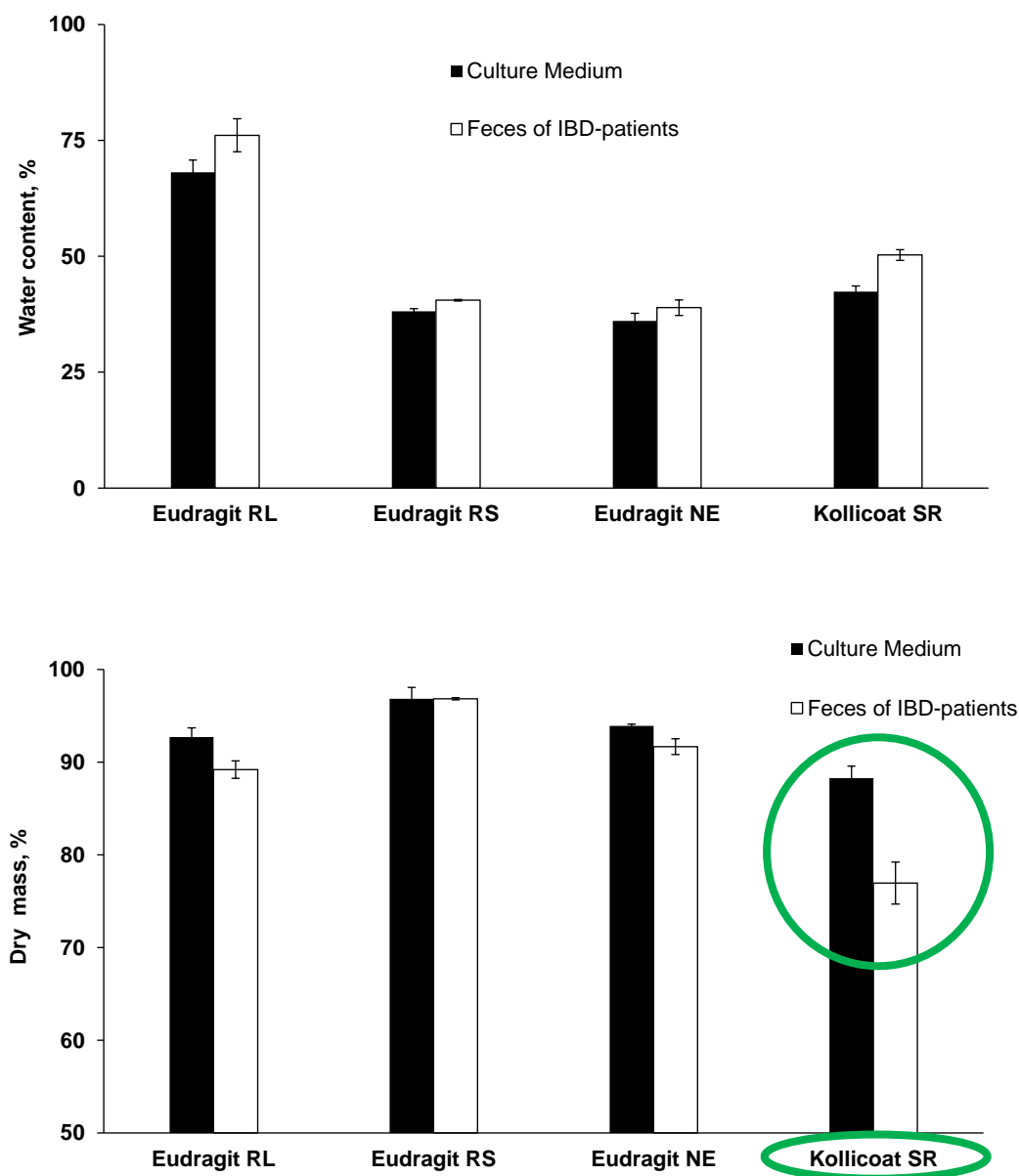

Figure 11: Water content and dry mass of thin polymeric films consisting of different types of polymers blended with inulin upon exposure to culture medium inoculated with feces of patients suffering from inflammatory bowel diseases (white bars) and culture medium free of feces (black bars) for reasons of comparison. The 1st polymer:inulin blend ratio was 80:20, the films were plasticized with 30 % DBS (referring to the 1st polymer).

4. Effect of the amount of polysaccharide in hot melt extrudates

4.1. Processability of hot melt extrudates

Figure 12 shows microscopic pictures of hot melt extrudates surfaces' (obtained by manual breaking) based on different types of polymer:polymer blends: Kollidon SR (polyl vinyl acetate) was blended with inulin or maltodextrin. The Kollidon SR:2nd polysaccharide blend ratio was varied as indicated in the figure. Hot melt extrudates were plasticized with 30 % DBS (referring to Kollidon SR) prior to hot melt extrusion at 100 °C. For reasons of comparison, hot melt extrudates based “only” on Kollidon SR are shown (plasticized with 30 % DBS). Clearly, the structure of all systems appeared to be rather homogeneous and the surface relatively smooth, except for Kollidon SR:maltodextrin blend at the ratio of 20:80, which lead to breakable extrudates with a granular surface.

Moreover, no visible sign of polymer degradation was observed. The cross-section of hot melt extrudates based “only” on Kollidon SR (plasticized with 30 % DBS) increases by die output (this phenomenon is called die swelling). The extent of swelling, which was not observed in case of Kollidon SR:2nd polysaccharide blends depends on the viscoelastic properties of the material, a lower viscosity leads to less extensive polymer swelling on the viscosity of the blend [165].

This can be at least confirmed by the torque measurement during the extrusion, which remained stable (around 30 %) in case of Kollidon SR:inulin blends. Please note that low and stable torque will lead to simple extrusion processing (figure 13a). However, the manufacturing of 20:80 Kollidon SR:maltodextrin blend showed variations of torque measurement during the process (high standard deviation, around 13), which can be explained by the fact that maltodextrin remained in a solid state at 100 °C and the amount of Kollidon SR was not enough to embed all the polysaccharide powder (figure 13b).

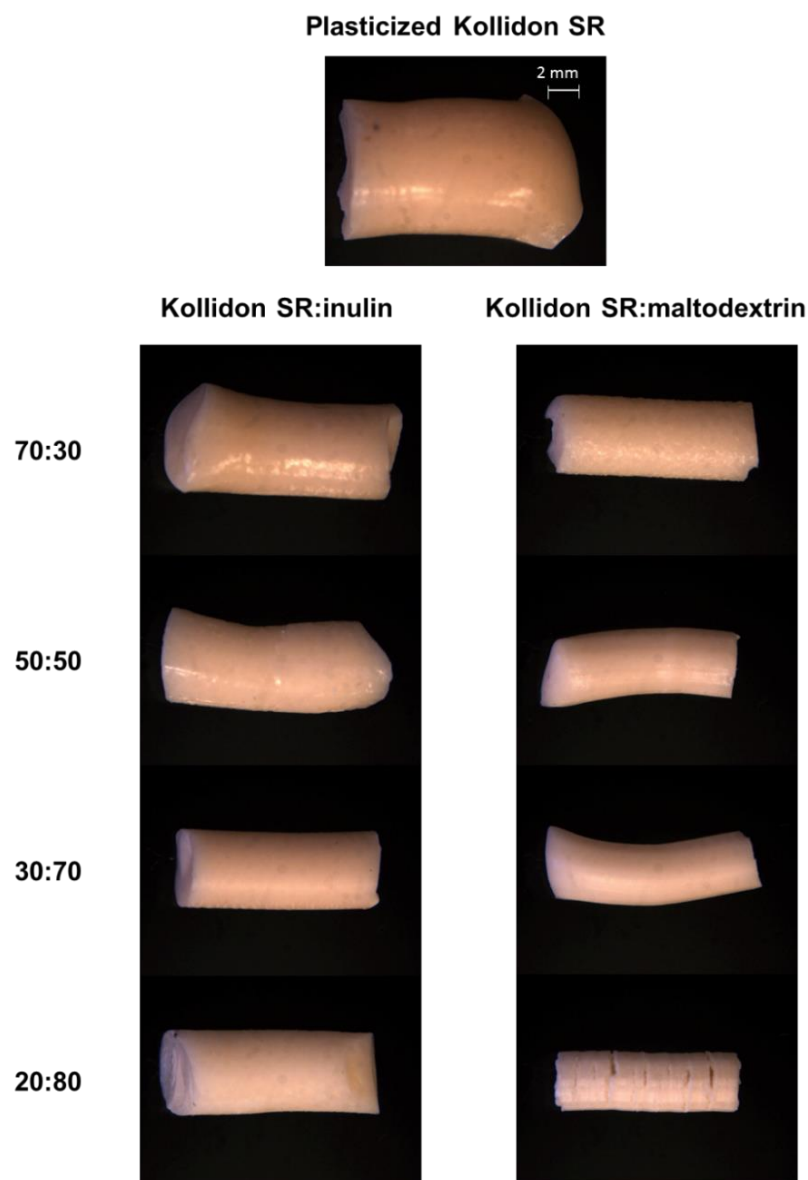

Figure 12: Macroscopic pictures of hot melt extrudates based on Kollidon SR and different types of a polysaccharide (inulin or maltodextrin, as indicated in the figure). The polymer:polymer blend ratio is indicated in the figure, the extrudates were extruded at 100 °C and plasticized with 30 % DBS (referring to Kollidon SR). For reasons of comparison, also hot melt extrudates based “only” on Kollidon SR (plasticized with 30 % DBS) are illustrated.

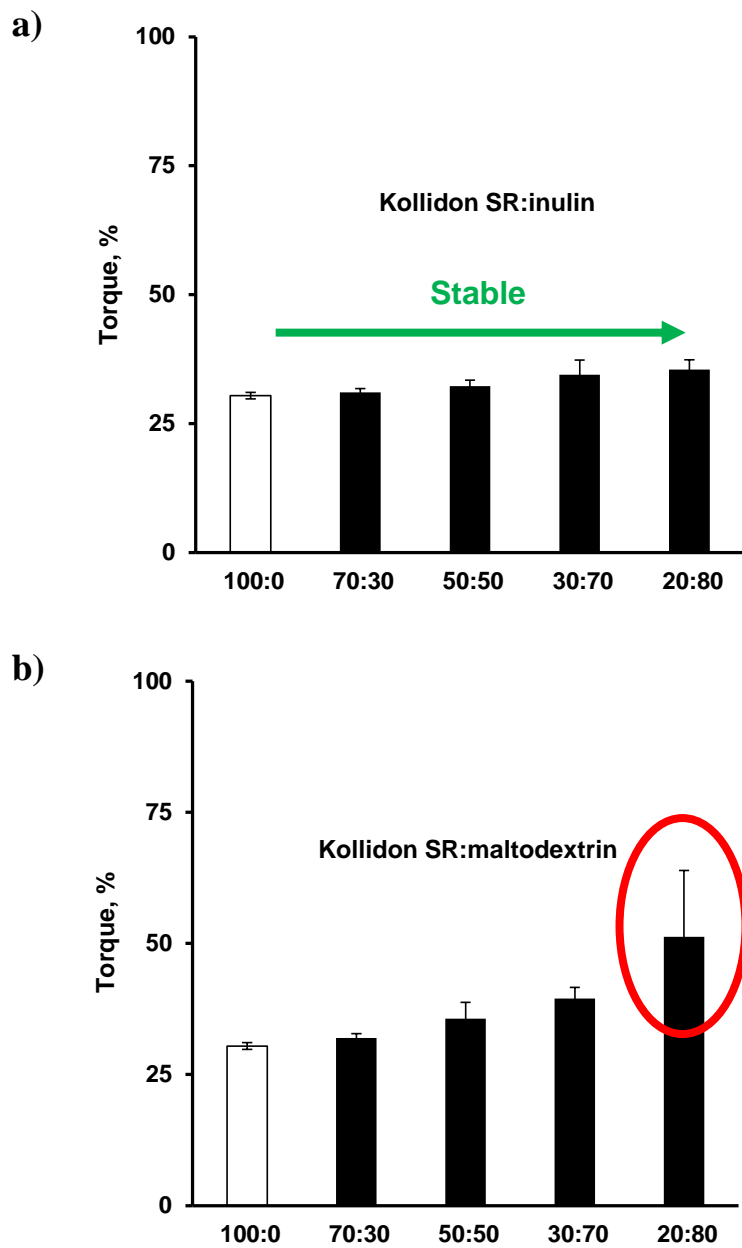

Figure 13: Impact of the polymer:polymer blend ratio on the torque generated during the preparation of hot melt extrudates based on a) Kollidon SR:inulin and b) Kollidon SR:maltodextrin. The extrudates were extruded at 100 °C and plasticized with 30 % DBS (referring to Kollidon SR).

4.2. Hot melt extrudates properties in the upper gastro intestinal tract

The water content and dry mass loss kinetics of a polymeric system can be used as indicators for its permeability to drug, upon exposure to the release medium. With increasing water content and increasing dry mass loss, the density of the macromolecular network decreases, resulting in increased polymer chain mobility and, thus, increased drug permeability.

Figures 14 to 17 shows the impact of polymer:polymer blend ratio on the water content and dry mass loss kinetics of hot melt extrudates upon exposure to 0.1 M HCl (figures a) and phosphate buffer pH 6.8 (figures b) simulating the gastric and intestinal fluid respectively. Hot melt extrudates based on kollidon SR:inulin (figures 14 and 15) or Kollidon SR:maltodextrin (figures 16 and 17) blends are shown. Extrudates were plasticized with 30 % DBS (referring to Kollidon SR) and extruded at 100 °C. For reasons of comparison, water content and dry mass loss of hot melt extrudates based “only” on plasticized Kollidon SR are shown (Kollidon SR:2nd polysaccharide 100:0). As it can be seen, water content and dry mass loss kinetics upon exposure to 0.1 M HCl and phosphate buffer pH 6.8 increased by increasing the 2nd polysaccharide amount for all cases with a higher rate for Kollidon SR:inulin blends compared to Kollidon:maltodextrin blends (for instance, 25 % water content vs 15 % and 30 % dry mass loss vs 2 % for the blend ratio 30:70, respectively upon exposure to 0.1 M HCl for 2 h). This can be probably due to the physicochemical properties of polysaccharides and particularly their solubility.

Furthermore, the investigated 2nd polysaccharides (inulin and maltodextrin) exhibit a higher affinity to water, more than Kollidon SR, which is insoluble in water. It was also noticed that pure (plasticized) Kollidon SR hot melt extrudates loose minor amounts of dry mass. The low dry mass loss can be attributed to the leaching out of povidone (polyvinylpyrrolidone: a water soluble component) into the bulk media.

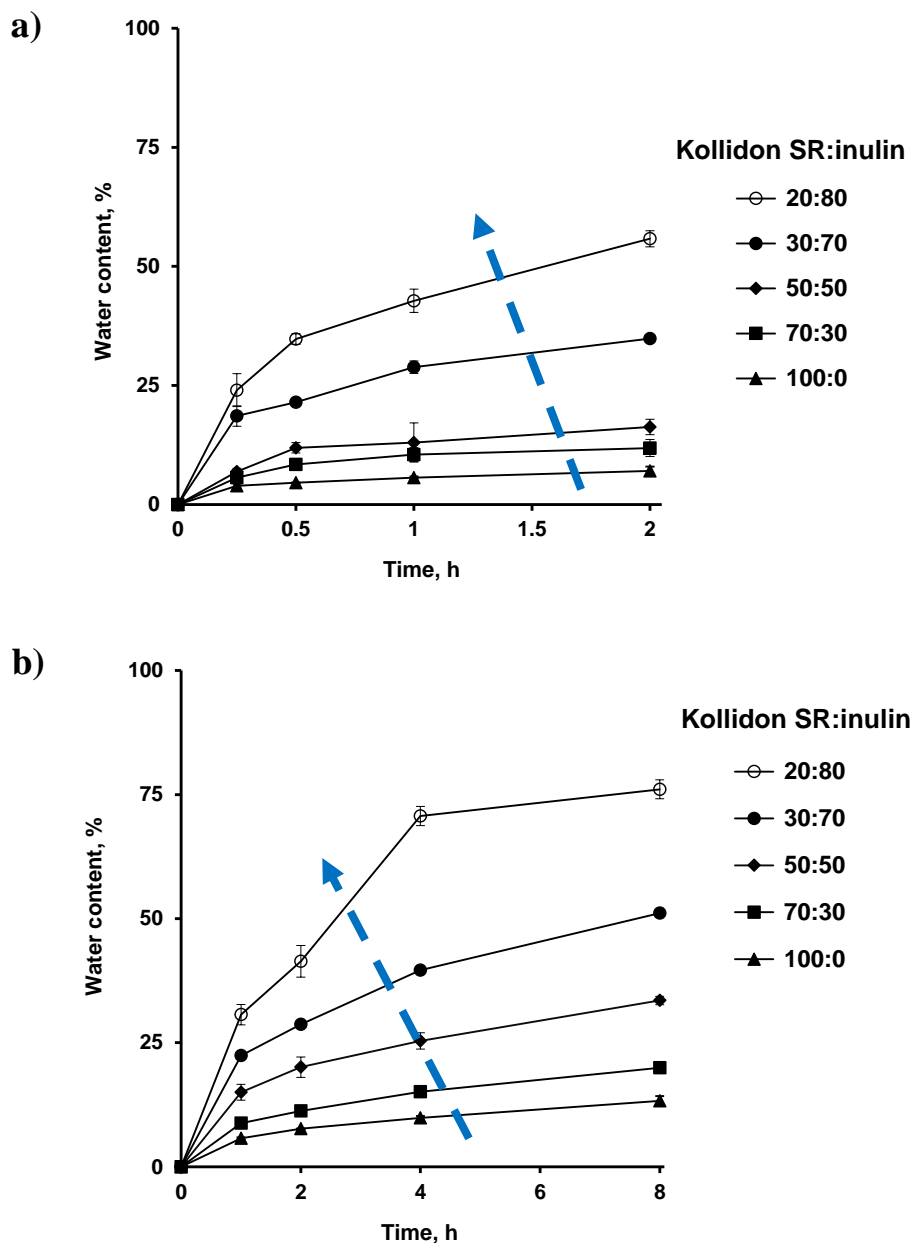

Figure 14: Water content kinetics of hot melt extrudates consisting of different Kollidon SR:inulin blend ratios (indicated in the figures) upon exposure to: a) 0.1 M HCl and b) phosphate buffer pH 6.8. The extrudates were extruded at 100 °C and plasticized with 30 % DBS (referring to Kollidon SR). Extrudates consisting “only” on Kollidon SR (plasticized with 30 % DBS) are shown for reasons of comparison.

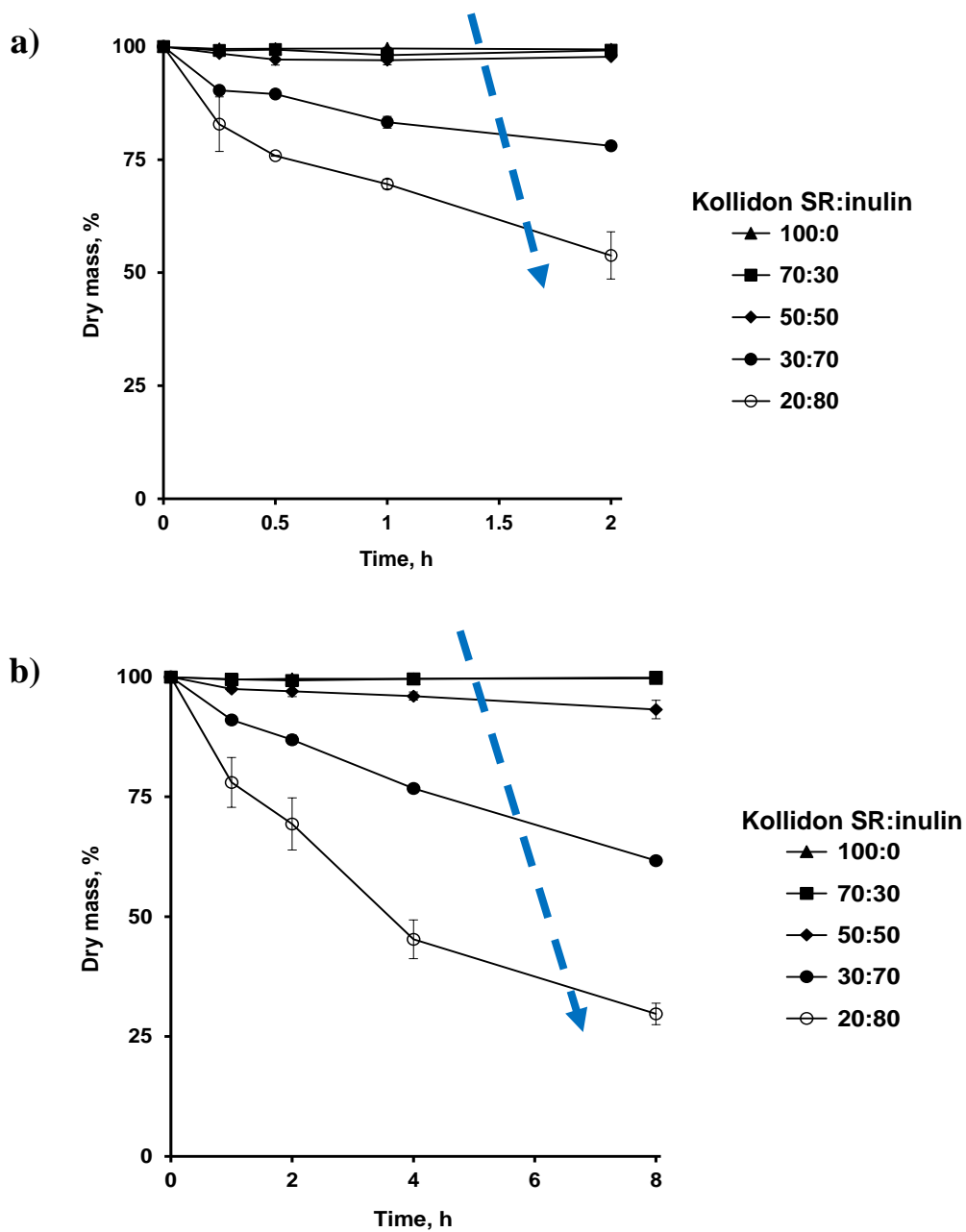

Figure 15: Dry mass loss kinetics of hot melt extrudates consisting of different Kollidon SR:inulin blend ratios (indicated in the figures) upon exposure to: a) 0.1 M HCl and b) phosphate buffer pH 6.8. The extrudates were extruded at 100 °C and plasticized with 30 % DBS (referring to Kollidon SR). Extrudates consisting “only” on Kollidon SR (plasticized with 30 % DBS) are shown for reasons of comparison.

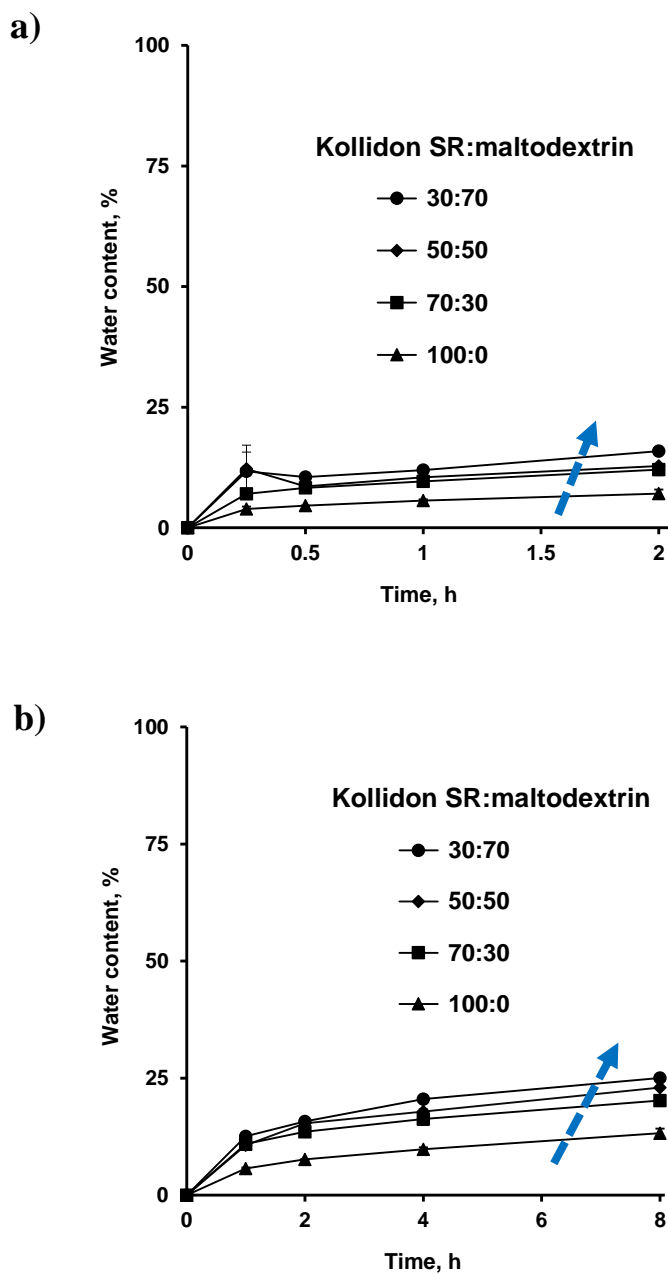

Figure 16: Water content kinetics of hot melt extrudates consisting of different Kollidon SR:maltodextrin blend ratios (indicated in the figures) upon exposure to: a) 0.1 M HCl and b) phosphate buffer pH 6.8. The extrudates were extruded at 100 °C and plasticized with 30 % DBS (referring to Kollidon SR). Extrudates consisting “only” on Kollidon SR (plasticized with 30 % DBS) are shown for reasons of comparison.

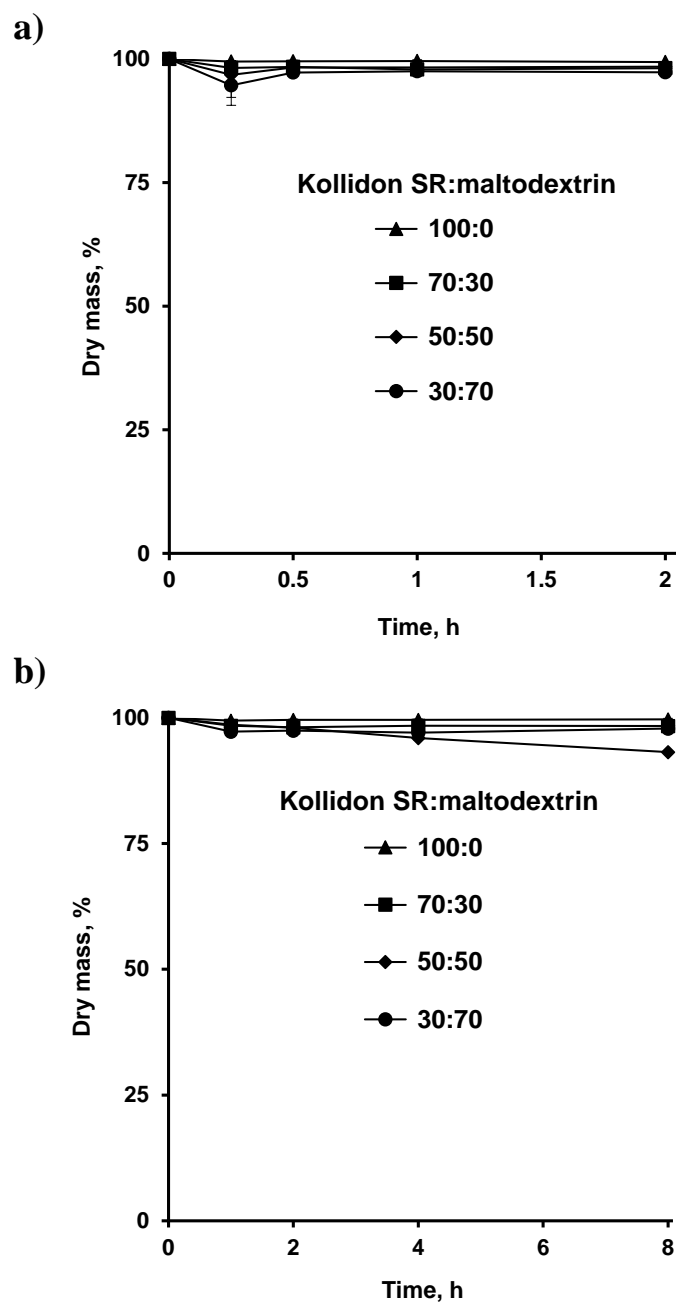

Figure 17: Dry mass loss kinetics of hot melt extrudates consisting of different Kollidon SR:maltodextrin blend ratios (indicated in the figures) upon exposure to: a) 0.1 M HCl and b) phosphate buffer pH 6.8. The extrudates were extruded at 100 °C and plasticized with 30 % DBS (referring to Kollidon SR). Extrudates consisting “only” on Kollidon SR (plasticized with 30 % DBS) are shown for reasons of comparison.

In order to avoid premature drug release in the stomach and small intestine, a polymeric system allowing for colon targeting should be poorly permeable for the incorporated drug upon exposure to media simulating the conditions in the stomach and the small intestine. Thus, the most promising systems for a colonic administration should show a very low water content and dry mass loss extent. Comparing the water content and dry mass loss kinetics of hot melt extrudates upon exposure to 0.1 M HCl and phosphate buffer pH 6.8 in figures 14 to 17, it can be seen that the type of 2nd polysaccharide as well as the polymer:polymer blend ratio have a significant impact on the polymeric network and drug mobility. Importantly, hot melt extrudates based on Kollidon SR:maltodextrin blends showed the lowest water content and dry mass loss and can effectively decrease the drug release in media simulating the upper GIT. Furthermore, Kollidon SR:Inulin hot melt extrudates at the ratio 70:30 and 50:50 showed a low rate and amount of water content and dry mass loss (less than 10 % of dry mass loss upon exposure to phosphate buffer pH 6.8 for 8 h) and might be a very promising tool for a colonic administration. However, hot melt extrudates based on Kollidon SR:inulin blends (ratio of 30:70 and 20:80) showed a high water content and dry mass loss (75 % of dry mass loss for kolidon SR:inulin 20:80 blend upon exposure to phosphate buffer pH 6.8 for 8 h), which can probably lead to a premature drug release from these hot melt extrudates in the upper part of GIT. Further studies are required in order to determine if these promising systems are able to release the incorporated drug at the site of action in a time controlled manner (by enzymatic fermentation of the polysaccharide).

4.3. Hot melt extrudates properties in the colon

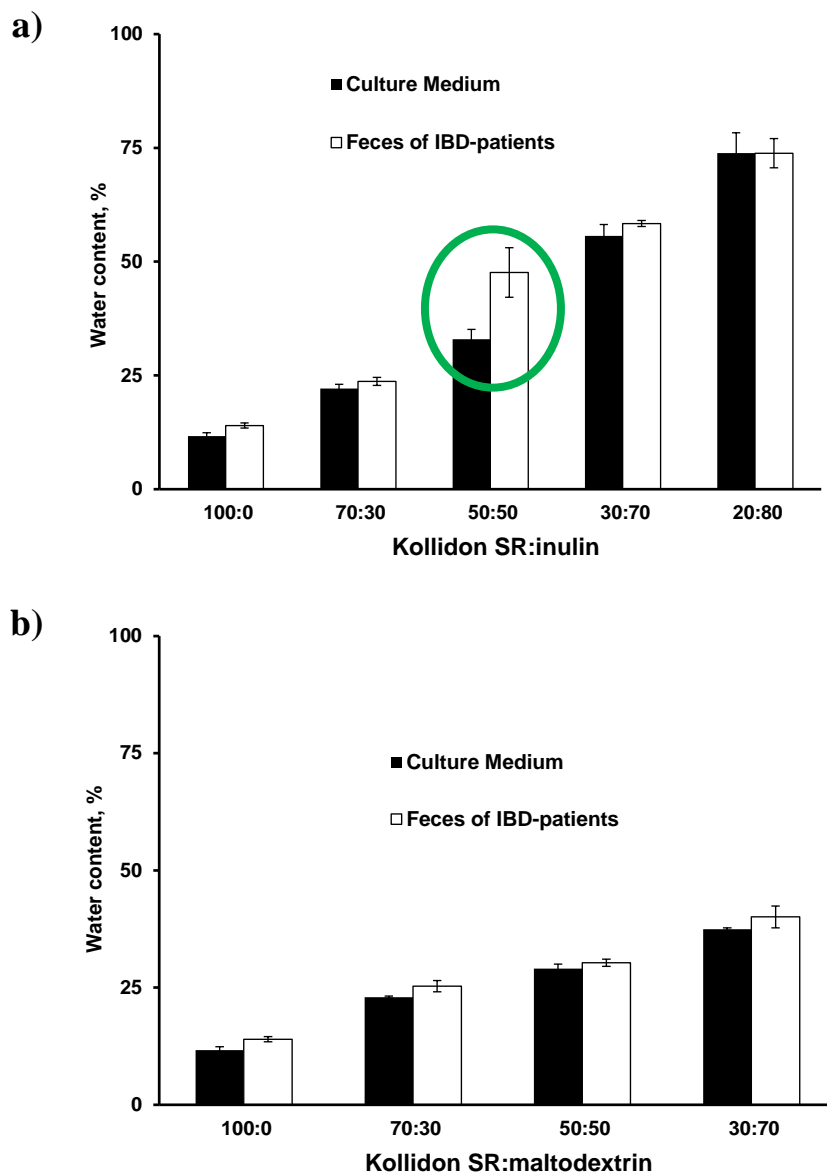

Figure 18: Water content of hot melt extrudates consisting of different a) Kollidon SR:inulin and b) Kollidon SR:maltodextrin blend ratios (as indicated) upon exposure to culture medium and culture medium inoculated with feces of patients suffering from inflammatory bowel diseases (as indicated in the figures). The extrudates were extruded at 100 °C and plasticized with 30 % DBS (referring to Kollidon SR). Extrudates consisting “only” on Kollidon SR (plasticized with 30 % DBS) are shown for reasons of comparison.

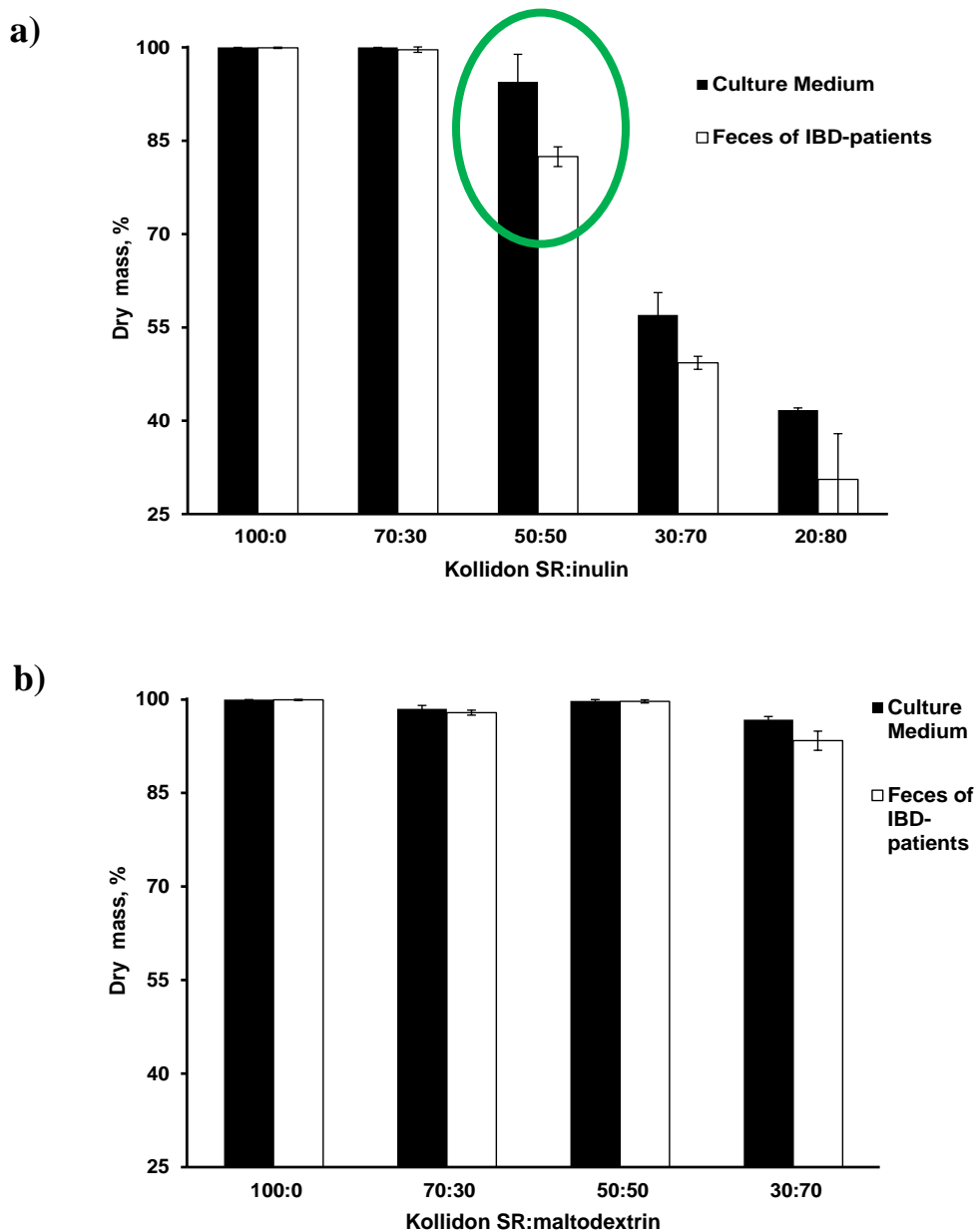

Figure 19: Dry mass of hot melt extrudates consisting of different a) Kollidon SR:inulin and b) Kollidon SR:maltodextrin blend ratios (as indicated) upon exposure to culture medium and culture medium inoculated with feces of patients suffering from inflammatory bowel diseases (as indicated in the figures). The extrudates were extruded at 100 °C and plasticized with 30 % DBS (referring to Kollidon SR). Extrudates consisting “only” on Kollidon SR (plasticized with 30 % DBS) are shown for reasons of comparison.

Experimental water content and dry mass loss of hot melt extrudates were studied (figures 18 and 19) upon exposure to culture medium inoculated with fecal samples from IBD-patients. For reasons of comparison, also water content and dry mass loss kinetics of hot melt extrudates upon exposure to culture medium free of feces are studied. Hot melt extrudates based on Kollidon SR:inulin or Kollidon SR:maltodextrin blends have been shown in figures 18 and 19. Thirty percent of DBS was added to powders blends prior to hot melt extrusion at 100 °C.

Clearly, in case of hot melt extrudates based on Kollidon SR:inulin blends (ratios 50:50, 30:70 and 20:80), dry mass loss was more pronounced upon exposure to culture medium inoculated with feces than culture medium free of fecal samples (around 20 % *vs* 5 % for the ratio 50:50). This indicates that inulin serves as a substrate for the enzymes secreted by the colonic bacteria (figure 19a). Furthermore, the water content of extrudates, which were exposed to patient feces was higher than those exposed to sterile culture medium free of feces (figure 18a). However, these differences in water content and dry mass loss were not observed in case of extrudates containing Kollidon SR:maltodextrin blends (figures 18b and 19b). This can be probably due to the fact that Kollidon SR protects the maltodextrin against enzymatic degradation, thus, these systems were not studied any further.

Appropriate hot melt extrudates for colon targeting should take up considerable amounts of water and show significant dry mass loss upon exposure to fecal samples from IBD-patients in order to trigger the embedded drug release at the site of inflammation in the distal part of GIT. As it can be seen in figures 18a and 19a, hot melt extrudates based on Kollidon SR:inulin 50:50 showed significant water uptake and dry mass loss upon exposure to fecal samples of patients suffering from IBD. Interestingly, these extrudates showed a low water content and dry mass loss extent in media simulating the upper GIT. Moreover, also blends ratio of 30:70 and 20:80 (Kollidon SR:inulin) look very promising for a colonic drug delivery (significant water content and dry mass

loss behavior upon exposure to fecal samples). However, these systems already take up considerable amounts of water and remarkably loose in dry mass upon contact with media simulating the contents of the upper GIT (figures 14 and 15).

5. Impact of drug loading in hot melt extrudates

5.1. Processability of hot melt extrudates

In order to investigate the potential of hot melt extrudates used as matrices systems for a colonic administration, extrudates based on Kollidon SR:inulin 50:50 blend were prepared and loaded with different amounts of theophylline as model drug.

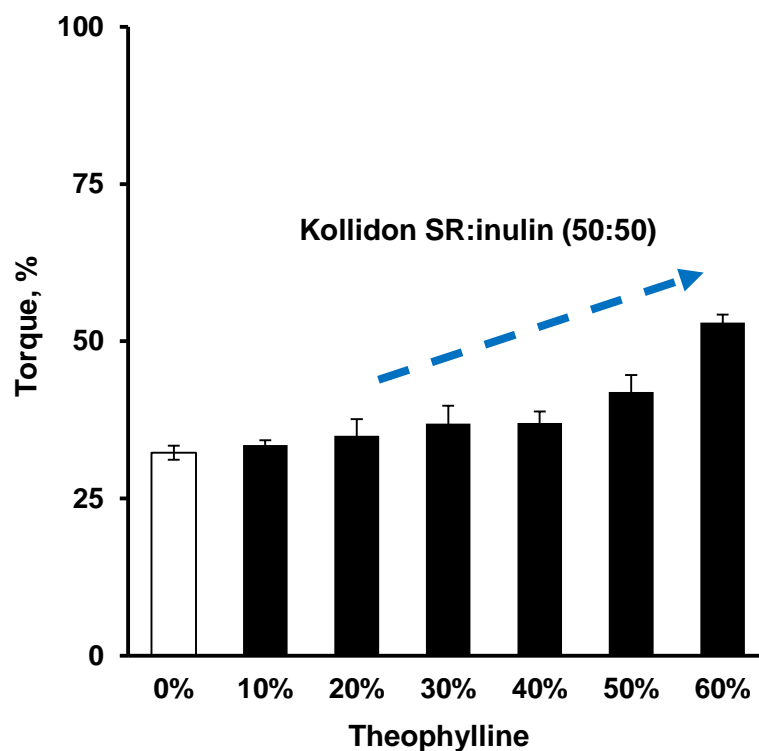

Figure 20: Impact of the theophylline loading on the torque generated during the preparation of hot melt extrudates based on Kollidon SR:inulin (50:50). The extrudates were extruded at 100 °C, loaded with 10 to 60 % theophylline and plasticized with 30 % DBS (referring to Kollidon SR). For reasons of comparison, also hot melt extrudates free of drug are shown.

Hot melt extrudates based on Kollidon SR:inulin containing various concentrations of theophylline, which is a slightly water-soluble drug were prepared by varying the drug loading (10, 20, 30, 40, 50 and 60 %, referring to the total extrudate mass). In all formulations, the Kollidon SR:inulin blend ratio was kept constant: 50:50 (w/w). Hot melt extrudates were plasticized with 30 % DBS (referring to Kollidon SR) and extruded at 100 °C. In all cases a homogeneous system structures and relatively smooth surfaces were obtained. Please note that in no cases, any visible sign of polymer degradation was observed.

Figure 20 shows the respective torque values observed during extrusion. As it can be seen, the torque values were stable and constant (around 35 %) during the extrusion for the formulation loaded from 0 to 40 % theophylline. However, torque values increased with increasing the drug loading from 40 to 60 % (around 35 % to 55 %), which is in good agreement with data reported in the literature [45]. This can probably be attributed to the fact that theophylline do not melt at 100 °C (figure 55; chapter 3) and the relative amounts of the plasticized polymer blends in the formulations decrease (increase viscosity). Besides, this increase in torque values were still in the limits of the extruder and did not cause any difficulty during processing.

5.2. Physical characterization of hot melt extrudates

Since blends powder were exposed to heating during hot melt extrusion process, it was important to evaluate the physical state modifications of drug during the manufacturing process.

The X-ray diffraction patterns of the raw materials and of the investigated hot melt extrudates are shown in figure 21. Hot melt extrudates were based on Kollidon SR:inulin (50:50) blend containing various amounts of theophylline (0, 20, 40 and 60 % referring to the total extrudate mass). Extrudates were plasticized with 30 % DBS (referring to Kollidon SR) and extruded at 100 °C. As it can be seen, the pure drug exhibited sharp X-ray diffraction, indicates that drug is in crystalline

nature. In contrast, Kollidon SR and inulin powders as well as hot melt extrudates free of drug were X-ray amorphous and showed any Bragg pics. Importantly, X-ray diffraction Bragg peaks of theophylline were clearly visible in the investigated hot melt extrudates of Kollidon SR:inulin blend (50:50) even at 20 % drug loading but mostly in the range between 20 and 30 degrees. Importantly, theophylline is at least partially distributed in the form of small crystals throughout the hot melt extrudates at all the investigated drug loadings (figure 21).

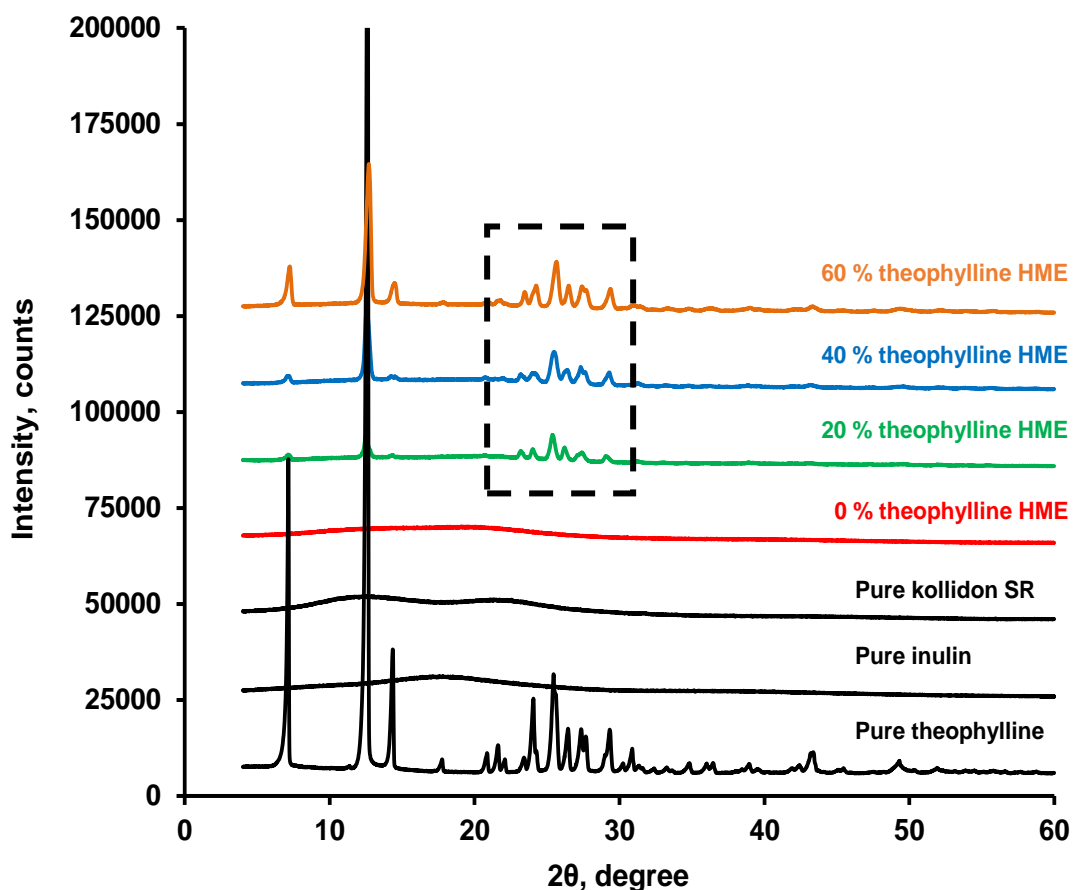

Figure 21: X-ray diffractograms of hot melt extrudates based on 50:50 Kollidon SR:inulin blend. The amount of theophylline was varied as indicated. The extrusion temperature was 100 °C, the extrudates were plasticized with 30 % DBS (referring to Kollidon SR). For reasons of comparison, also the X-ray diffractograms of hot melt extrudates free of drug as well as the pure theophylline, Kollidon SR and inulin powders (all as received) are illustrated.

5.3. In vitro drug release from hot melt extrudates

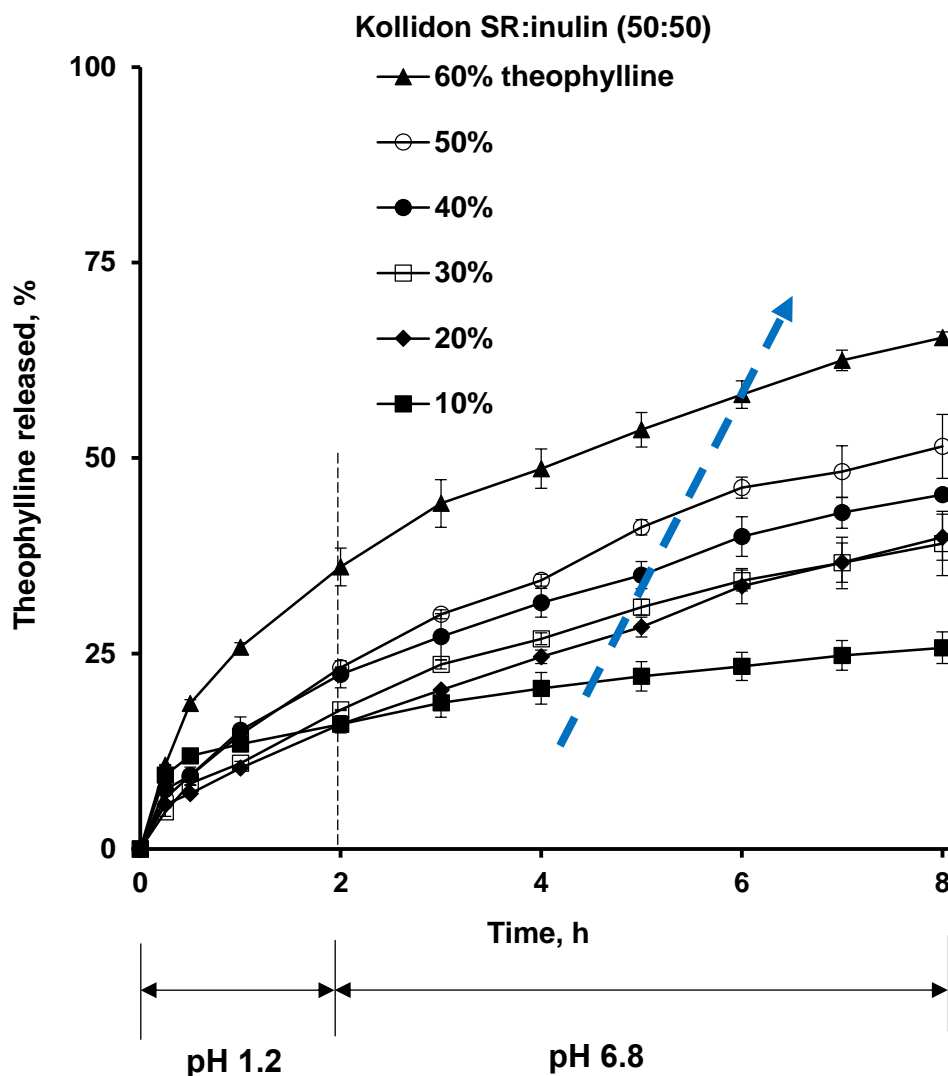

Figure 22: Impact of the theophylline loading on drug release from hot melt extrudates in 0.1 M HCl for 2 h, followed by phosphate buffer pH 6.8. The systems were based on 50:50 Kollidon SR:inulin blends, the extrusion temperature was 100 °C, the extrudates were plasticized with 30 % DBS (referring to Kollidon SR).

The impact of drug loading on the experimental in vitro drug release was studied. The percentages of slightly water-soluble theophylline were varied from 10 to 60 %. Figure 22 shows

the resulting drug release kinetics from hot melt extrudates of Kollidon SR:inulin blend (50:50) containing different drug loading in 0.1 M HCl for 2 h, followed by phosphate buffer pH 6.8 for 6 h. Hot melt extrudates were plasticized with 30 % DBS (referring to Kollidon SR) and extruded at 100 °C. As it can be seen, the resulting drug release rates clearly increased with increasing drug loading. This can be explained by the fact that less drug release retarding polymer is present in the systems. On the other hand, the systems upon contact to the release media, which facilitate the ingress of water into the systems and subsequently increasing the solubility and diffusion of drug. Most of the drug (almost 75 %) is released during 8 h at an initial drug loading of 60 %.

An ideal dosage form allowing for the site-specific drug delivery to the colon should completely suppress drug release in the upper GIT. However, once the colon is reached, drug release should be triggered in a time controlled manner. Importantly, at a drug loading of 10 %, premature drug release from these hot melt extrudates based of Kollidon SR:inulin blend (50:50) could be minimized (less than 25 % of theophylline was released after 8 h upon exposure to the release media). Thus, these type of systems shows a promising potential for colon targeting. Based on results shown in figure 22, hot melt extrudates of Kollidon SR:inulin (50:50) containing 10 % theophylline were selected for drug release studies in media simulating colonic fluid.

This system was exposed to 0.1 M HCl for 2 h, followed by 6 h in phosphate buffer pH 6.8 followed by 10 h in culture medium inoculated with feces from inflammatory bowel disease patients (solid curve in figure 23). For reasons of comparison, the extrudates were also exposed to 0.1 M HCl, followed by phosphate buffer pH 6.8 and culture medium free of feces (dotted curve in figure 23). As it can be seen, the drug release rate did not increase upon contact with fecal samples (approximately the same percentage of drug released in presence or absence of fecal samples: around 30 %). This can be at least explained by the fact that despite of the considerable amount of water uptake (figure 18a) by these hot melt extrudates and the significant dry mass loss (figure 19a)

upon exposure to fecal samples from IBD-patients, this system was not susceptible to bacterial enzymes located in the colon of IBD-patients (figure 23).

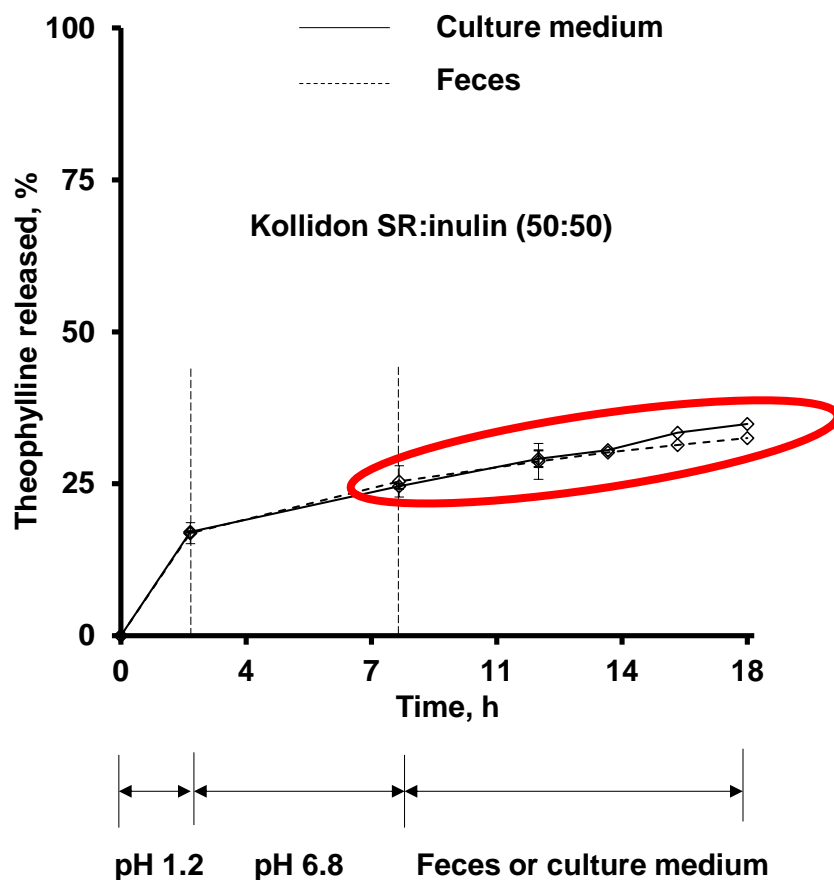

Figure 23: Theophylline release from hot melt extrudates based on 50:50 Kollidon SR:inulin blends under conditions simulating the transit through the entire gastro intestinal tract: 2 h in 0.1 M HCl, followed by 6 h in phosphate buffer pH 6.8, followed by culture medium inoculated with feces of patients suffering from inflammatory bowel diseases (solid curves). For reasons of comparison also drug release in 0.1 M HCl, phosphate buffer pH 6.8 and culture medium without fecal samples is shown (dotted curves). The drug loading was 10 %, the extrudates were extruded at 100 °C and plasticized with 30 % DBS (referring to Kollidon SR).

CHAPTER 2:
POLYURETHANE:POLYSACCHARIDE
BLENDS FOR COLON TARGETING

POLYURETHANE:POLYSACCHARIDE BLENDS FOR COLON

TARGETING

Recently, thermoplastic polyurethanes (TPU) were found to be promising matrix formers for the production of high drug loaded oral sustained release formulations prepared by hot melt extrusion and injection molding (HME/IM). They are used in order to reduce the amount of excipients needed and creating a major advantage for patient's compliance [166]. These polymers are produced by a reaction between polyols (polyethers or polyesters) and diisocyanates. They are copolymers containing soft and hard segments through which they have thermoplastic and elastic properties. Polyurethanes have been used as carriers for hot melt extrusion for the preparation of vaginal rings [104,105] as well as tablets for oral controlled drug delivery [106,107].

The aim of this study was to evaluate the suitability of different thermoplastic polyurethane blends with a second polysaccharide for hot melt extrudates and injection-molded capsules, providing colonic site-specific drug delivery. Carbothane, tecothane, tecophilic SP 60 and tecophilic SP93 were used to minimize drug release in conditions simulating the upper gastro intestinal tract (GIT). Thus, these polysaccharides (inulin, maltodextrin, guar gum and maize starch) allowing for colon targeting are more permeable and fermentable by colonic bacteria. Dibutyl sebacate was added as a plasticizer in order to reduce the process temperature of hot melt extrudates and injection-molded capsules containing theophylline as model drug. The water content and dry mass loss kinetics of hot melt extrudates free of drug were measured under conditions simulating the contents of the entire GIT (0.1 M HCl, phosphate buffer pH 6.8 and culture medium inoculated with fecal samples from IBD-patients). Capsules were prepared via injection molding and in vitro drug release was measured under conditions simulating the contents of the upper GIT (0.1 M HCl and phosphate buffer pH 6.8), as well as the colon (upon exposure to human fecal samples). For reasons of

comparison, in vitro drug release, water uptake and dry mass loss kinetics were also performed upon exposure to 0.1 M HCl, phosphate buffer pH 6.8 and culture medium free of fecal samples.

1. Influence of polyurethane nature in hot melt extrudates

1.1. Processability of hot melt extrudates

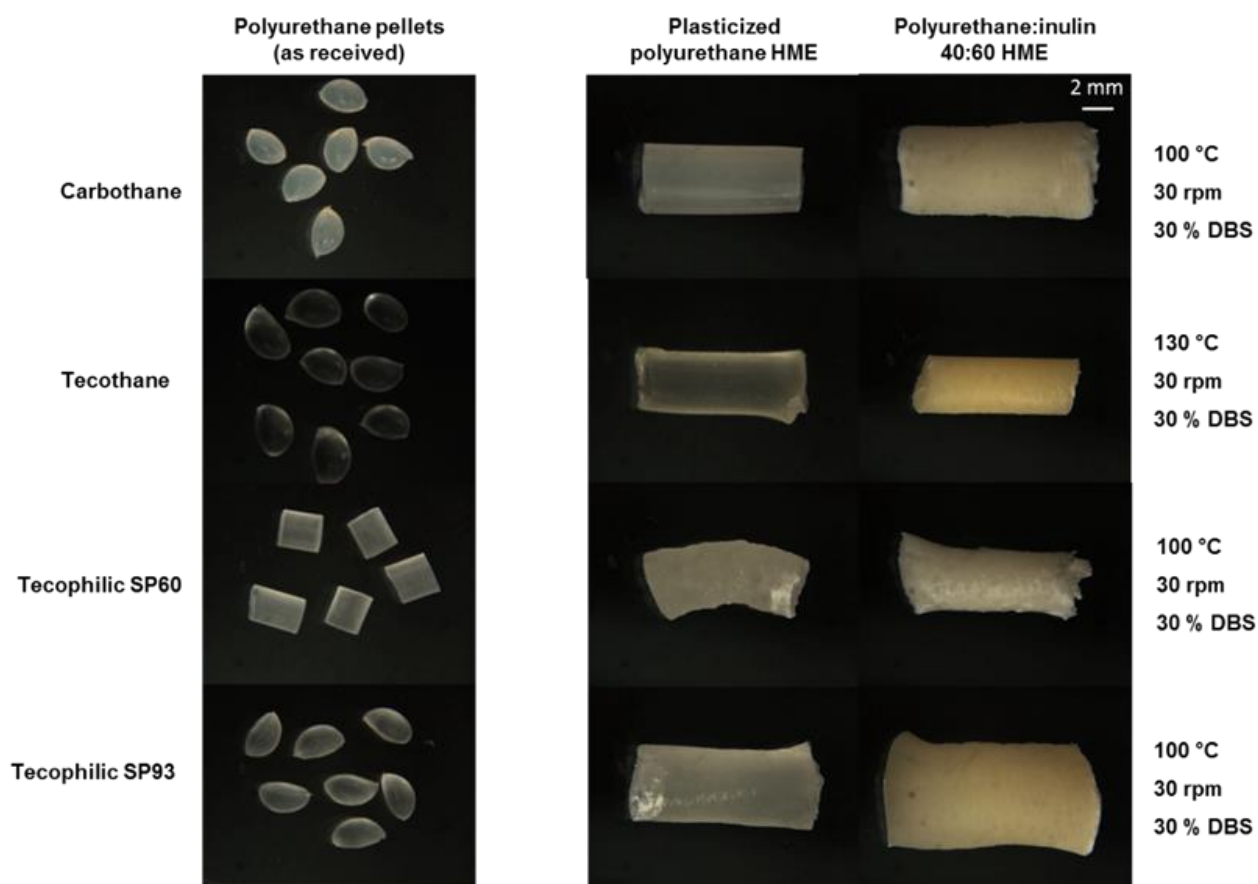

Figure 24: Macroscopic pictures of (i) different grades of polyurethane pellets as received (ii) hot melt extrudates based on different polyurethane grades, extrudates were plasticized with 30 % DBS, and (iii) hot melt extrudates based on different polyurethane grades blended with inulin, the polymer:polymer blend ratio was 40:60, extrudates were plasticized with 30 % DBS (referring to polyurethane). The extrusion temperature and screw speed were varied as indicated.

Figure 24 shows macroscopic appearance of hot melt extrudates (obtained by manual breaking): different types of polyurethane (hydrophobic and hydrophilic) were blended with inulin. The polyurethane:inulin blend ratio was kept constant at 40:60. Hot melt extrudates were plasticized with 30 % DBS (referring to polyurethane weight) prior to hot melt extrusion at 100 °C. Please note that it was not possible to extrude blends based on tecothane:inulin at 100 °C (the torque values were too high). This is why these extrudates were obtained at 130 °C processing temperature. For reasons of comparison, hot melt extrudates based “only” on different polyurethane grades (plasticized with 30 % DBS) as well as polyurethanes pellets as received are shown. Clearly, the structure of all systems appears to be rather homogeneous and the surface, which is relatively smooth. Moreover, any visible sign of polymer degradation was observed. Hot melt extrudates based on carbothane: inulin and tecophilic SP93:inulin blends showed an swelling behavior which was not observed in case of other formulations.

Moreover, the torque measured during extrusion of hot melt extrudates based on “only” polyurethane grades (plasticized with 30 % DBS) was similar and stable (55 % on average), which leads to easy extrusion process. However, torque values decreased during the preparation of hot melt extrudates of polyurethane:inulin blends (figure 25). This can be explained by the fact that inulin is in a rubbery state at the extrusion temperature. During the extrusion process, the viscosity of blends decreased and facilitate more the preparation of hot melt extrudates based on carbothane:inulin blends.

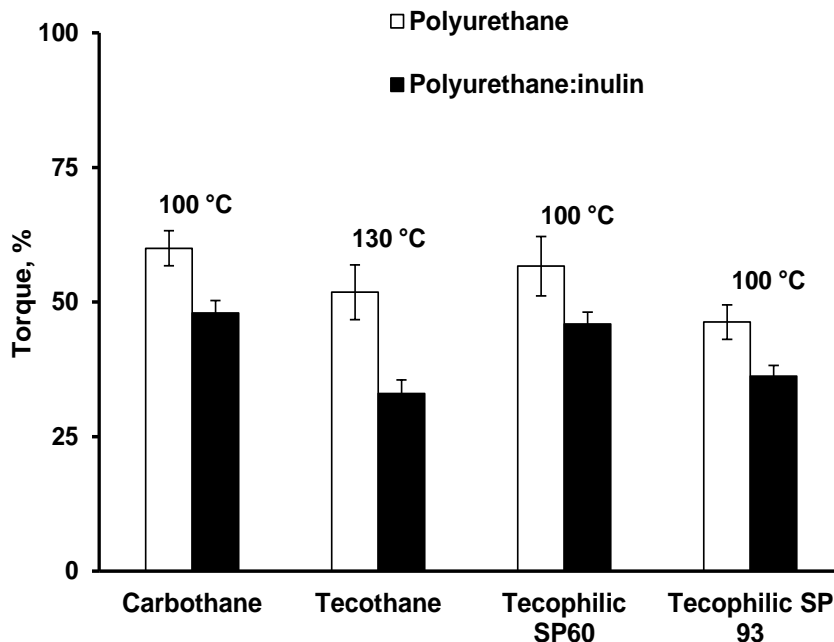

Figure 25: Impact of the polyurethane nature on the torque generated during the preparation of hot melt extrudates based on different types of polyurethane blended with inulin (black histograms), the polymer:polymer blend ratio was 40:60, extrudates were plasticized with 30 % DBS (referring to polyurethane). For reasons of comparison, also plasticized extrudates based “only” on different types of polyurethane (white histograms) are illustrated.

1.2. Hot melt extrudates properties in the upper gastro intestinal tract

In many cases polymeric drug delivery systems upon exposure to dissolution media can reach a critical water content, which leads to a significant increase in polymer chains mobility and, thus, an increase permeability of the polymeric network for a drug. Moreover, the water content and dry mass loss kinetics of polymeric reservoir/matrices systems can give an important insight to its permeability for a drug. Water content and dry mass loss kinetics of hot melt extrudates of different polyurethane:inulin blends were investigated upon exposure to media simulating conditions in the upper GIT (figures 26 and 27).

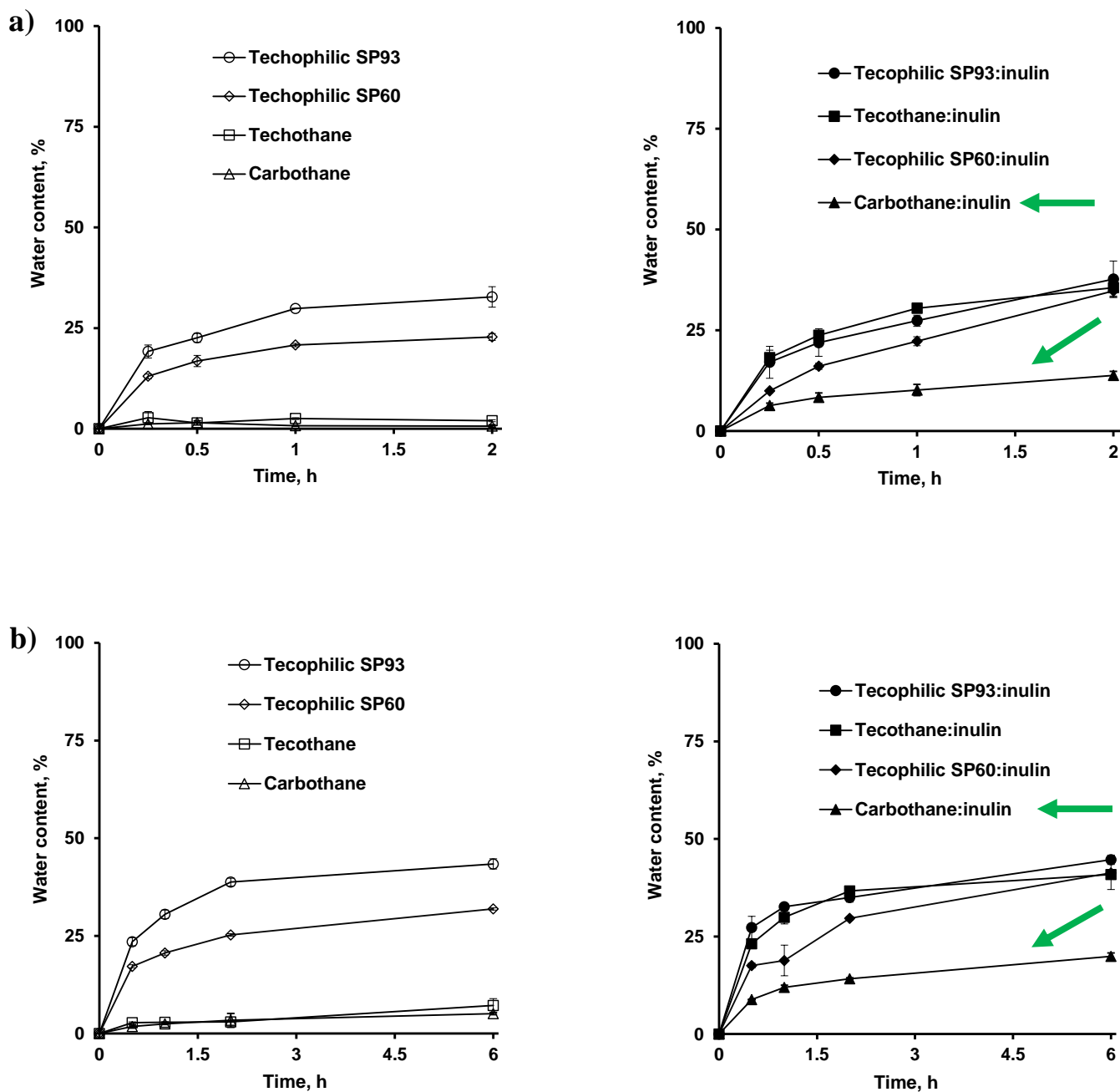

Figure 26: Water content kinetics of hot melt extrudates based on different polyurethane:inulin blends (right hand side) plasticized with 30 % DBS (referring to polyurethane) upon exposure to: a) 0.1 M HCl and b) phosphate buffer pH 6.8. The polyurethane:inulin blend ratio was 40:60. For reasons of comparison, also water content of plasticized hot melt extrudates based “only” on different types of polyurethane (left hand side) are illustrated.

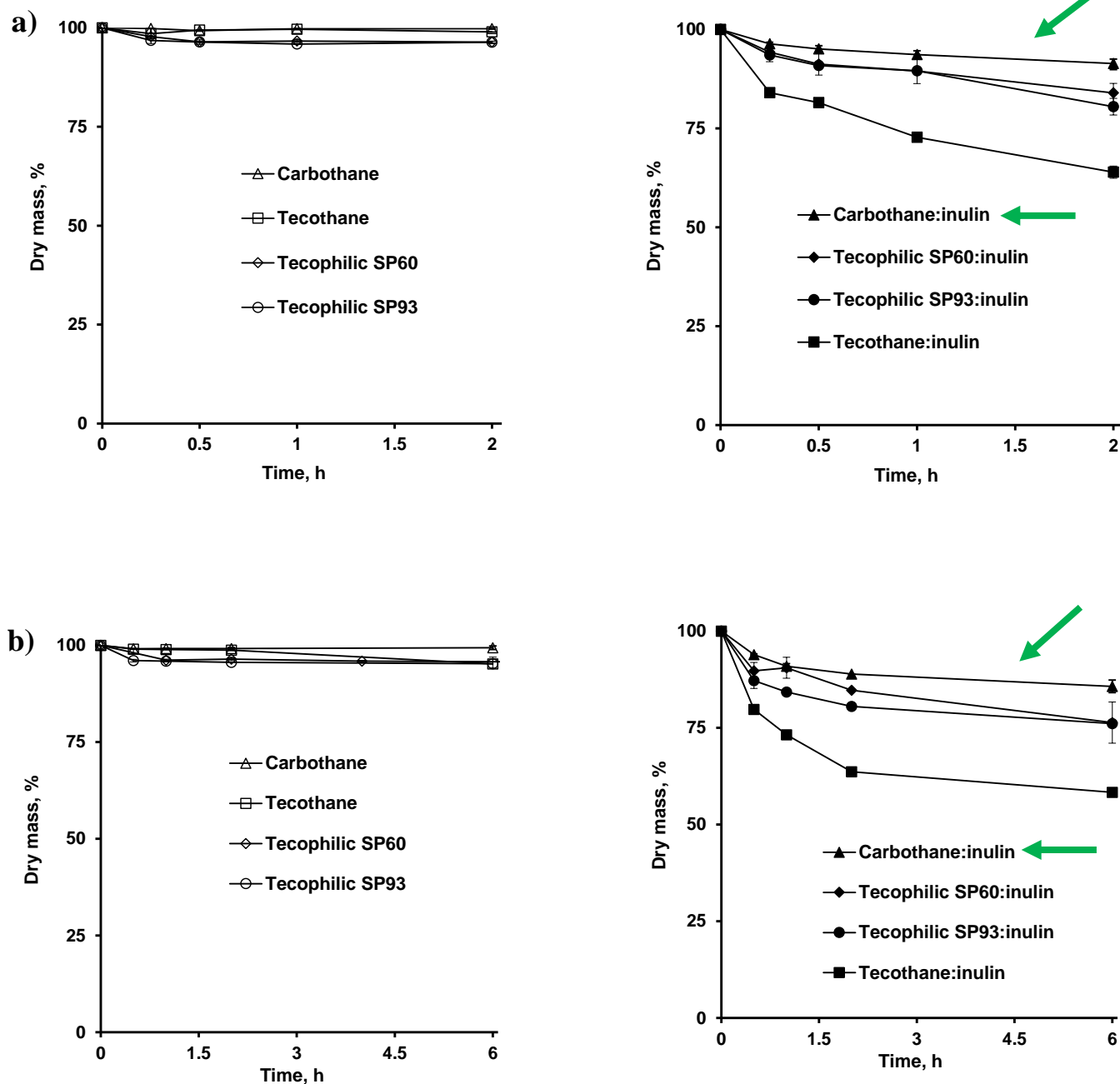

Figure 27: Dry mass loss kinetics of hot melt extrudates based on different polyurethane:inulin blends (right hand side) plasticized with 30 % DBS (referring to polyurethane) upon exposure to: a) 0.1 M HCl and b) phosphate buffer pH 6.8. The polyurethane:inulin blend ratio was 40:60. For reasons of comparison, also dry mass of plasticized hot melt extrudates based “only” on different types of polyurethane (left hand side) are illustrated.

The polyurethane:inulin blend ratio was kept constant in all cases at 40:60. Extrudates were plasticized with 30 % DBS (referring to polyurethane) and extruded at 100 °C or 130 °C in case of tecothane:inulin blend. For reasons of comparison, water content and dry mass loss of hot melt extrudates on pure polyurethane grades are shown (plasticized with 30 % DBS). As it can be seen, water content rates upon exposure to 0.1 M HCl and phosphate buffer pH 6.8 (figure 26) were much more higher for tecophilic SP 60 and tecophilic SP 93 hot melt extrudates compared to hot melt extrudates of tecothane and carbothane (e.g. around 25 % of water uptake for tecophilic SP 93 vs less than 5 % for carbothane hot melt extrudates upon exposure to 0.1 M HCl for 2 h). This can be probably due to the fact that hydrophilic polyurethanes have more affinity to water compared to polyurethane of hydrophobic nature (tecophilic SP 93 and SP 60 are water soluble polyurethane grades while carbothane and tecothane are insoluble in water). Furthermore, the investigated polyurethane:inulin hot melt extruded blends exhibit similar water content profiles as for hot melt extrudates based “only” on polyurethane grades, more than Kollidon SR which is insoluble in water. It was also noticed that pure (plasticized) Kollidon SR hot melt extrudates loose minor amounts of dry mass. This can be attributed to leaching out of povidone, which is soluble in water (polyvinylpyrrolidone: a water soluble component) into the bulk media.

The most promising systems for a colonic administration should show a very low water content and dry mass loss extent. Comparing the water content and dry mass loss kinetics of hot melt extrudats upon exposure to 0.1 M HCl and phosphate buffer pH 6.8 (figures 26 and 27), it can be observed that the type of polyurethane have a significant impact on the polymeric network mobility and thus, drug diffusion. Importantly, hot melt extrudates based on 40:60 carbothane;inulin blend showed the lowest water content and dry mass loss in both media simulating the stomach and the intestine (less than 20 % of water content and dry mass loss upon exposure to phosphate buffer pH 6.8 for 6 h) and, thus, can effectively decrease the drug release in media simulating the upper GIT.

1.3. Hot melt extrudates properties in the colon

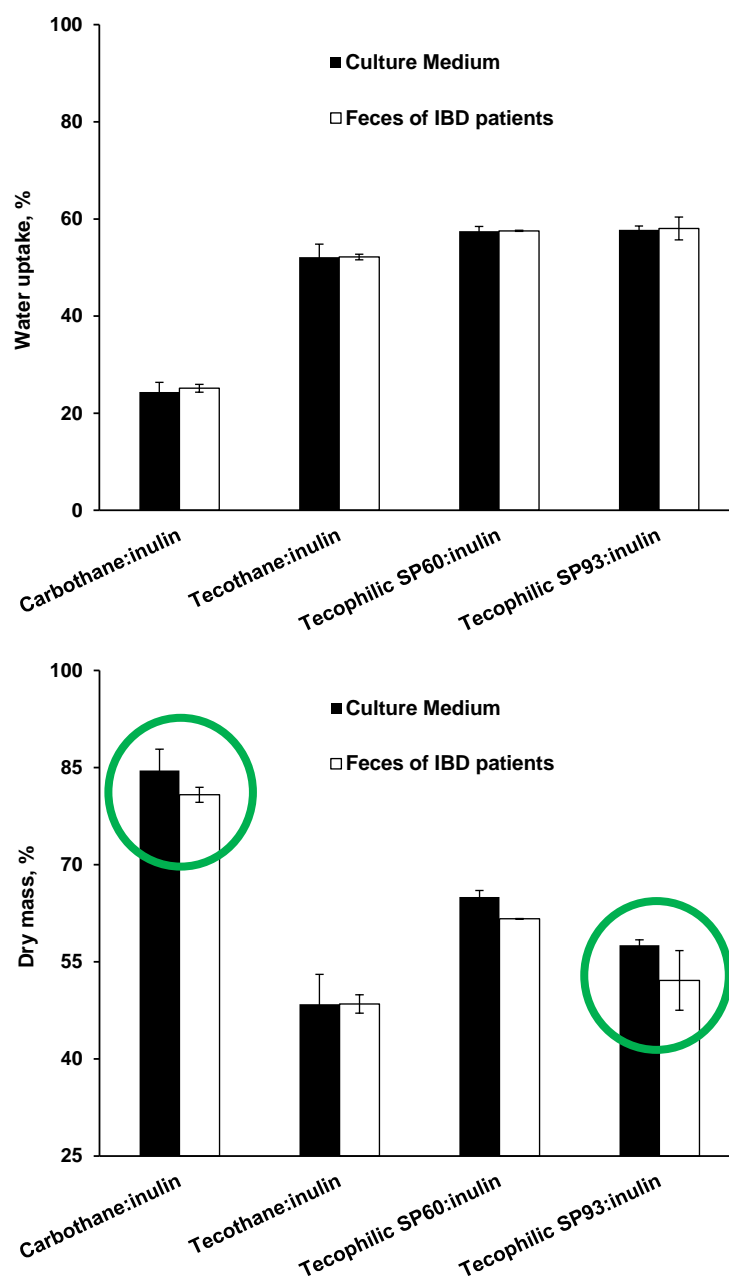

Figure 28: Water content and dry mass of hot melt extrudates consisting of different types of polyurethane blended with inulin upon exposure to culture medium and culture medium inoculated with feces of patients suffering from inflammatory bowel diseases (as indicated in the figures). The polymer:polymer blend ratio was 40:60, the extrudates were plasticized with 30 % of DBS (referring to polyurethane).

Water content and dry mass loss kinetics of hot melt extrudates were based on different types of polyurethane blended with inulin as a 2nd polysaccharide upon exposure to culture medium inoculated with fecal samples from IBD-patients are illustrated in figure 28. For reasons of comparison, also water content and dry mass loss kinetics of hot melt extrudates upon exposure to culture medium free of feces are shown. The polyurethane:inulin blend ratio was kept constant at 40:60. Extrudates were plasticized with 30 % DBS (referring to polyurethane) and extruded at 100 °C or at 130 °C in case of tecothane:inulin blend. Importantly, dry mass loss of hot melt extrudates of carbothane or tecophilic SP 93:inulin blends (ratio 40:60) are more pronounced upon exposure to culture medium inoculated with feces than culture medium free of fecal samples. This can be at least attributed to the fact that inulin serves as a substrate for the enzymes secreted by the colonic bacteria. Furthermore, the water content of extrudates, which were exposed to patient feces was similar to hot melt extrudates which, were exposed to sterile culture medium free of feces. Appropriate hot melt extrudates that could be used for a site-specific delivery in the colon should take up considerable amounts of water and show significant dry mass loss upon exposure to fecal samples from IBD-patients. As it can be seen, hot melt extrudates based on carbothane:inulin blend are the most promising systems for colonic drug delivery systems. A slightly significant dry mass loss upon exposure to fecal samples of patients suffering from IBD compared to culture medium free of feces and showed lower water content and dry mass loss in media simulating the upper GIT (figures 26, 27). Moreover, hot melt extrudates based on tecophilic SP93:inulin blend showed the same properties in media simulating colonic fluid (a slightly significant dry mass loss upon exposure to fecal samples). Nevertheless, these systems showed a high water content and dry mass loss extent and rate upon exposure to media simulating the stomach and the intestine, which could lead to premature drug release in the upper GIT. Systems based on 40:60 carbothane:inulin might be promising for a colonic drug delivery and should be further investigated.

2. Effect of polysaccharide and plasticizer nature in hot melt extrudates

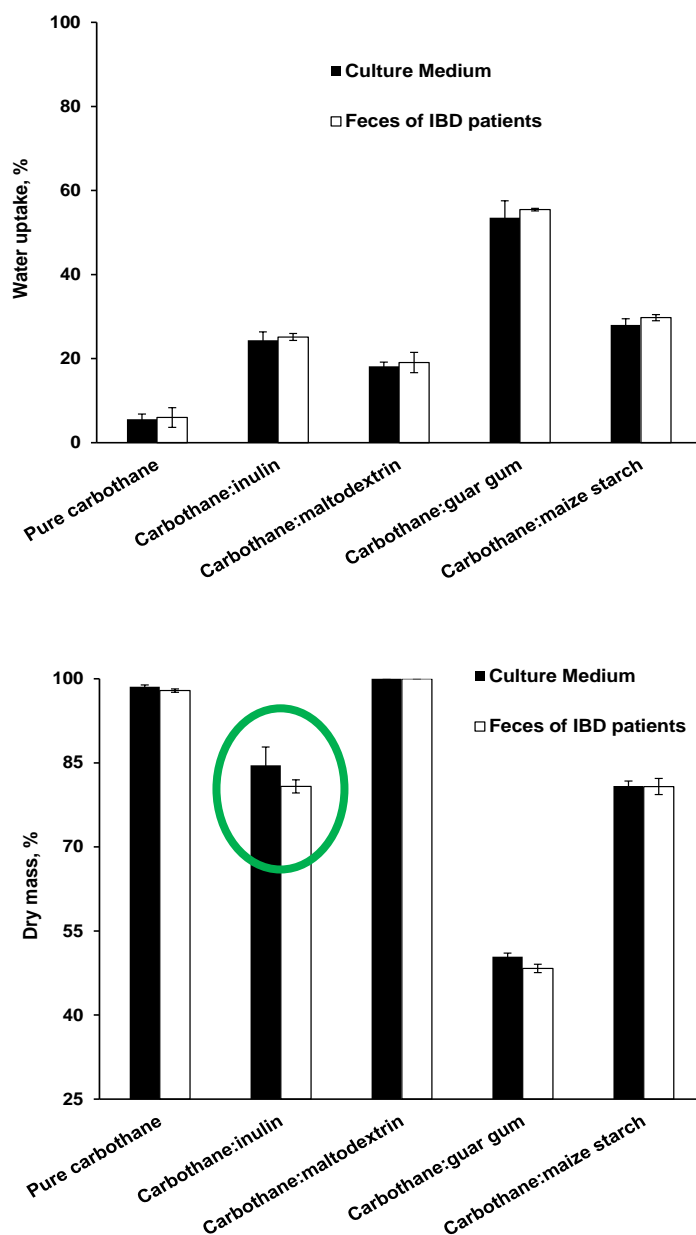

Figure 29: Water content and dry mass of hot melt extrudates consisting of carbothane blended with different types of polysaccharides (as indicated) upon exposure to culture medium and culture medium inoculated with feces of patients suffering from inflammatory bowel diseases (as indicated in the figures). The polymer:polymer blend ratio was 40:60. The extrudates were extruded at 100 °C and plasticized with 30 % of DBS (referring to carbothane).

Carbothane, a hydrophobic grade of polyurethane was selected for the rest of the study. Hot melt extrudates based on 40 % carbothane blended with 60 % inulin (weight/weight) showed the most promising behavior of water content and dry mass loss upon exposure to media simulating the distal part of GIT (figure 29). For reasons of comparison hot melt extrudates based on carbothane blended with different types of 2nd polysaccharides namely guar gum, maltodextrin and maize starch, were investigated for their water content and dry mass loss upon exposure to feces from IBD-patients or culture medium free of feces. The hot melt extrudates of carbothane:2nd polysaccharide blends (40:60) were plasticized with 30 % DBS and extruded at 100 °C. Clearly, no significant dry mass loss difference from the investigated extrudates was observed in the presence or absence of fecal bacteria compared to those of carbothane:inulin blend. This can probably attributed to the fact that guar gum, maltodextrin and maize starch are not susceptible to bacterial enzymes in the colon, contrary to inulin, which serve as substrate and is more accessible for bacterial degradation. These systems were not studied any further.

Furthermore, the impact of the plasticizer nature on physicochemical properties of hot melt extrudates in the colon was studied. Water content and dry mass loss were measured upon exposure to fecal samples from IBD-patients from hot melt extrudates of carbothane:inulin blend 40:60 containing 30 % DBS the hydrophobic plasticizer or TEC the hydrophilic plasticizer referring to the solid mass of carbothane (extruded at 100 °C). For reasons of comparison, water content and dry mass loss were measured upon exposure to culture medium free of feces (figure 30). Importantly, dry mass loss from hot melt extrudates plasticized with TEC did not show any significant difference after exposure to fecal samples or culture medium free of feces, this can partially indicate that enzymes secreted by fecal bacteria did not degrade inulin. Moreover, hot melt extrudates plasticized with TEC showed a pronounced water content and dry mass loss compared to hot melt extrudates plasticized with DBS. This can be due to leaching out of the water soluble

plasticizer [121], which can lead to the formation of pores and subsequently increased water penetration into the system. A premature drug release in the upper GIT can be expected from these systems.

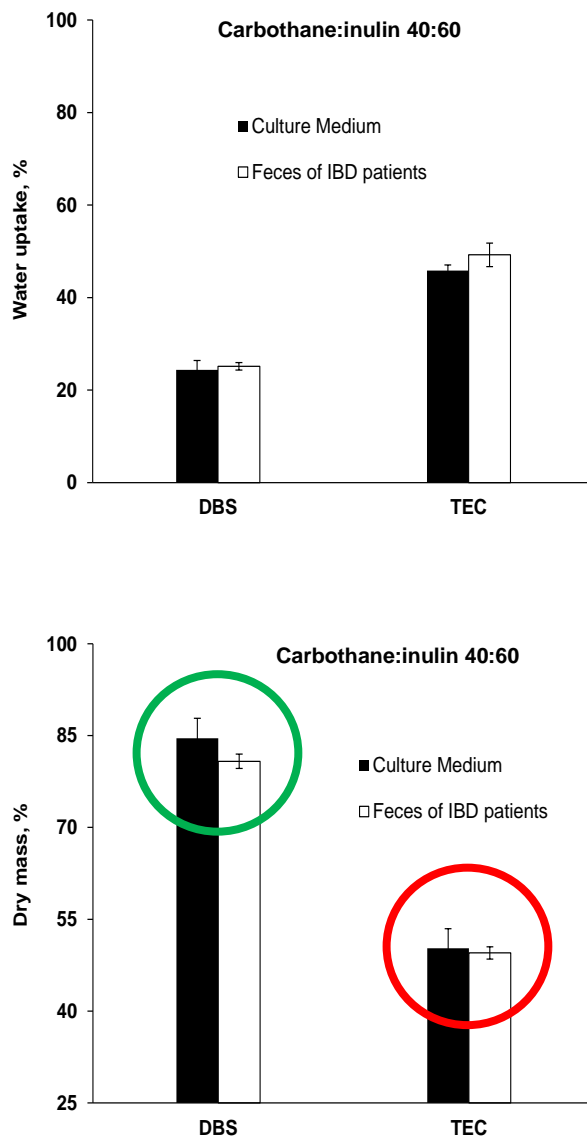

Figure 30: Water content and dry mass of hot melt extrudates consisting of carbothane:inulin blends plasticized with 30 % of DBS or TEC referring to carbothane (as indicated) upon exposure to culture medium and culture medium inoculated with feces of patients suffering from inflammatory bowel diseases (as indicated in the figures). The polymer:polymer blend ratio was 40:60. The extrudates were extruded at 100 °C.

3. Impact of polymer:polymer blend ratio in hot melt extrudates

3.1. Processability of hot melt extrudates



Figure 31: Macroscopic pictures of hot melt extrudates based on carbothane:inulin blends. The polymer:polymer blend ratio was varied as indicated, the extrudates were extruded at 100 °C and plasticized with 30 % DBS (referring to carbothane). For reasons of comparison, also hot melt extrudates based “only” on carbothane (plasticized with 30 % DBS) are illustrated.

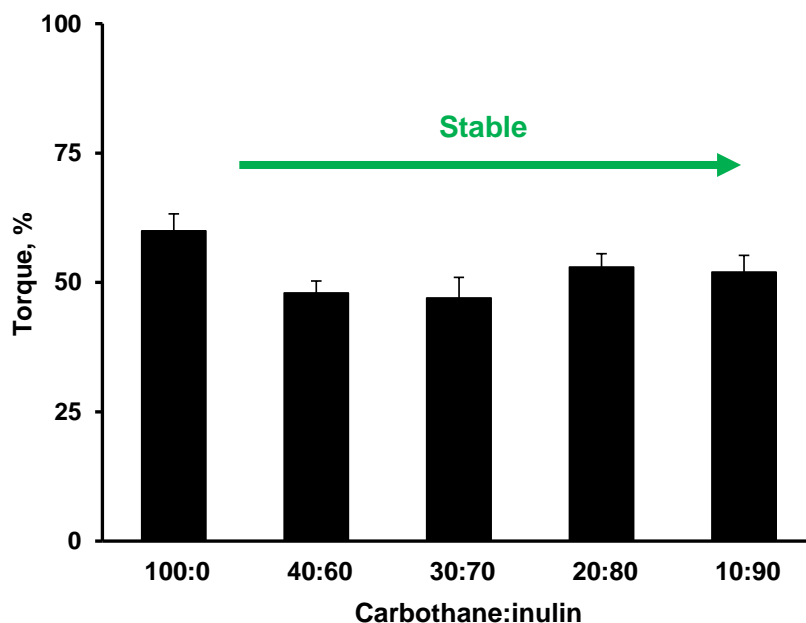

Figure 32: Impact of the polymer:polymer blend ratio on the torque generated during the preparation of hot melt extrudates based on carbothane:inulin blends. The polymer:polymer blend ratio was varied as indicated, the extrudates were extruded at 100 °C and plasticized with 30 % DBS (referring to carbothane).

Macroscopic appearance of hot melt extrudates based on carbothane used as a 1st hydrophobic polymer, blended with inulin as a 2nd polysaccharide are illustrated in figure 31. The carbothane:inulin blend ratio was varied as indicated in the figure. Hot melt extrudates were plasticized with 30 % (w/w) DBS (referring to carbothane) and extruded at 100 °C. For reasons of comparison, hot melt extrudates based “only” on carbothane plasticized with 30 % DBS are shown. As it can be seen, the morphology of all systems appears to be rather homogeneous and the surface relatively smooth. Hot melt extrudates with a ratio of 40:60 and 30:70 were flexible, contrary to those with a ratio of 20:80 and 10:90, which were hard and brittle. This is due to less amount of DBS into hot melt extrudates. Moreover, any visible sign of polymer degradation was observed. Hot melt extrudates of carbothane:inulin blend 40:60 showed an increase of diameter at the output of die. This swelling behavior was not observed by increasing the amount of inulin into hot melt extrudates (polymer:polymer ratios: 30:70, 20:80 and 10:90).

In all cases, the torque measured during the extrusion process remained stable (around 60 %), which have been identified to be beneficial for the extrusion process (Figure 32). The torque value was higher during the preparation of hot melt extrudates of pure carbothane plasticized with 30 % DBS. This can be explained by the fact that inulin is in a rubbery state at the extrusion temperature (100 °C). During the extrusion process, the viscosity of blends is decreased with increasing inulin amount, which facilitate more the preparation of hot melt extrudates under these conditions.

3.2. Hot melt extrudates properties in the upper gastro intestinal tract

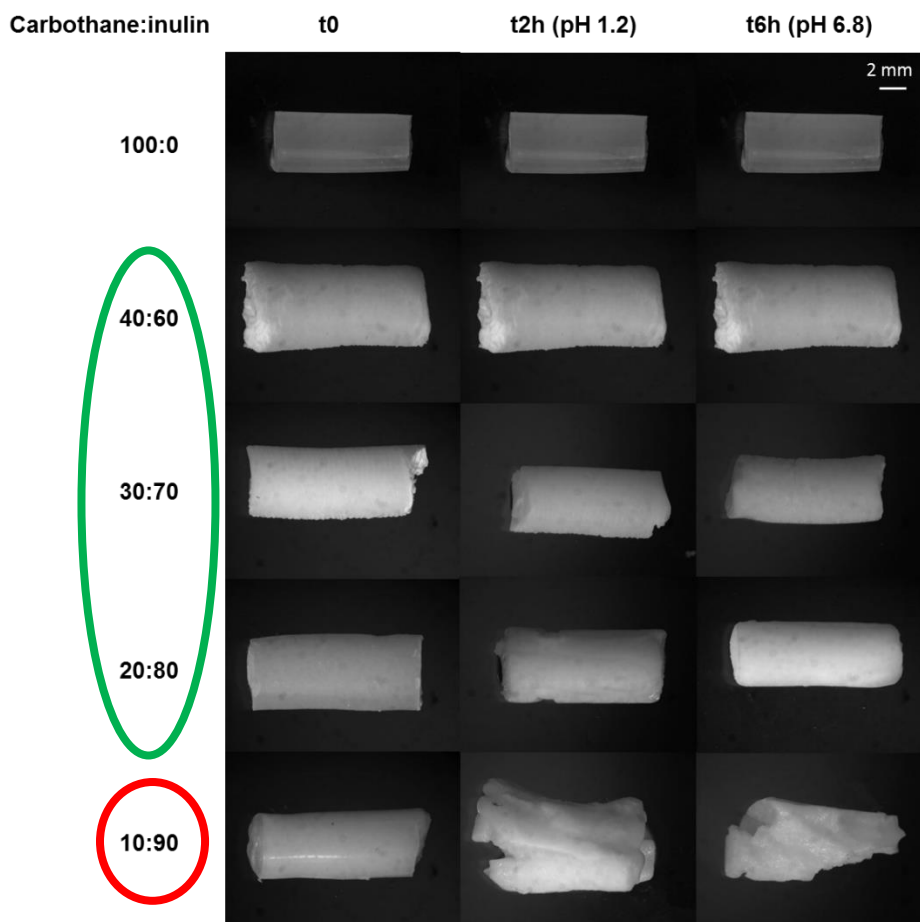

Figure 33: Macroscopic pictures of hot melt extrudates based on carbothane:inulin blends after exposure to (i) 0.1 M HCl pH 1.2 for 2 h, (ii) phosphate buffer pH 6.8 for 6 h. The polymer:polymer blend ratio was varied as indicated, the extrudates were extruded at 100 °C and plasticized with 30 % DBS (referring to carbothane). For reasons of comparison, the dry state of hot melt extrudates is illustrated.

Figure 33 shows macroscopic images of hot melt extrudates based on different blend ratios of carbothane:inulin after contact with media simulating the stomach (2 h into 0.1 M HCl) and the small intestine (6 h into phosphate buffer pH 6.8). For reasons of comparison, extrudate appearance prior to incubation are shown. Clearly, no visual changing of the surface was observed after 2 h exposure to 0.1 M HCl and 6 h to phosphate buffer pH 6.8 except for the blend ratio (10:90).

This can be explained by the increase of the hydrophilicity of the system when increasing the inulin amount into the extrudates. Systems based on 40:60, 30:70 or 20:80 carbothane:inulin blends can be very promising for colonic drug delivery because of the very low drug release in the upper GIT.

3.3. Hot melt extrudates properties in the colon

Physicochemical properties of hot melt extrudates in the colon upon exposure to culture medium inoculated with fecal samples from IBD-patients are shown in figure 34. For reasons of comparison, also water content and dry mass loss of hot melt extrudates upon exposure to culture medium free of feces are shown. Hot melt extrudates were based on carbothane:inulin blends and the ratio of blend was varied as indicated. Extrudates were plasticized with 30 % DBS (referring to carbothane mass) and prepared at 100 °C. Clearly, in case of dry mass loss was more pronounced upon exposure to culture medium inoculated with feces compared to culture medium free of fecal samples (around 55 % vs 45 % for the ratio 30:70). This can be attributed to the fact that inulin serves as a substrate for colonic bacterial enzymes. Furthermore, the water content of extrudates, which were exposed to patient feces was higher than the one to sterile culture medium free of feces. This indicates that the new developed systems contain more pores created by the fermentation of inulin. In order to trigger the drug release at the site of inflammation in the distal part of GIT, appropriate hot melt extrudates should take up considerable amounts of water and show significant dry mass loss upon exposure to fecal samples. As it can be seen in figure 33, hot melt extrudates of carbothane:inulin blends (40:60, 30:70 and 20:80) show a significant water uptake and dry mass loss upon exposure to fecal samples of patients suffering from IBD. Furthermore, these extrudates show no visible changing of the initial structure upon exposure to media simulating the upper GIT. Moreover, also blend ratio of 10:90 (carbothane:inulin) look promising for a colonic drug delivery (significant water uptake and weight

loss of extrudates upon exposure to fecal sample) but unfortunately, they are more exposed to a premature drug release in the upper GIT.

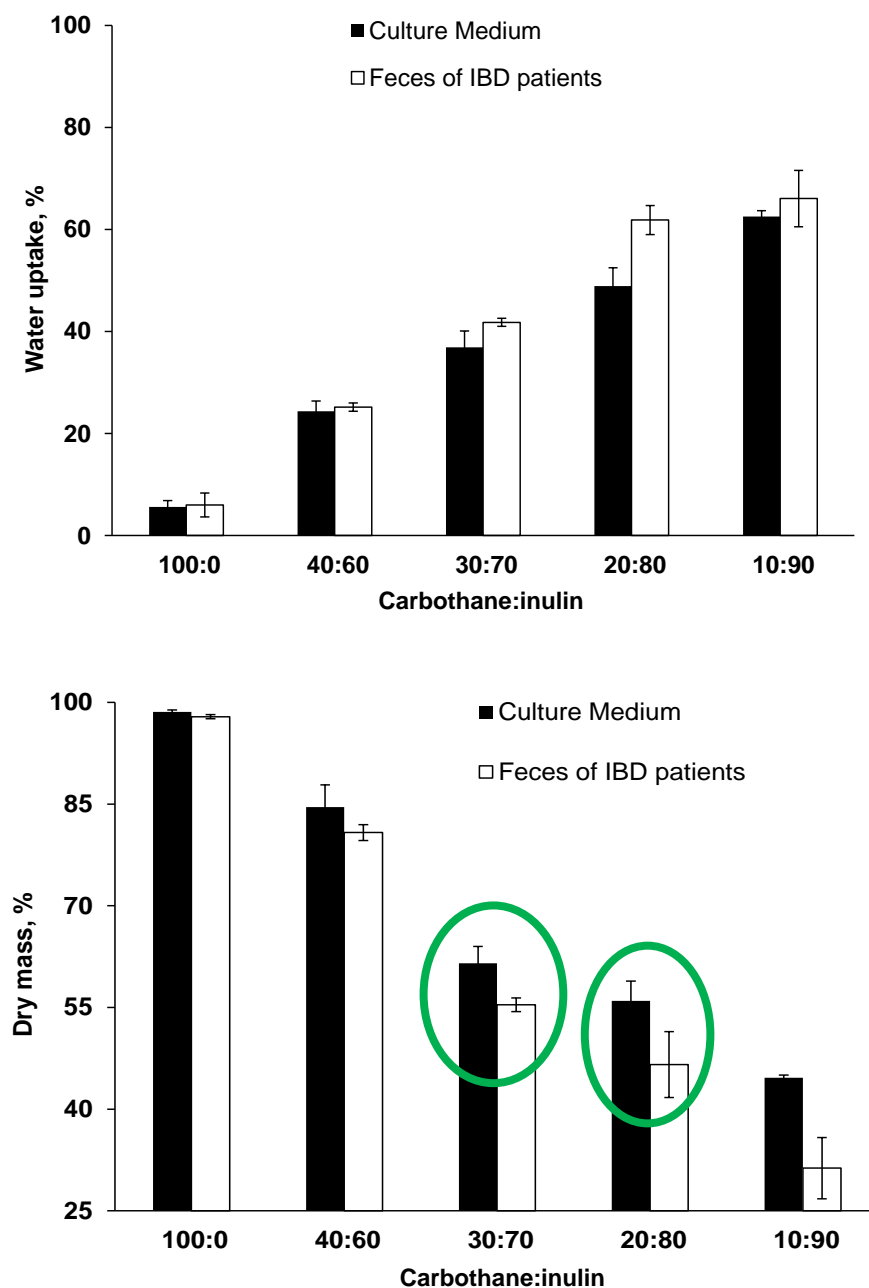

Figure 34: Water content and dry mass of hot melt extrudates based on carbothane:inulin blends upon exposure to culture medium and culture medium inoculated with feces of patients suffering from inflammatory bowel diseases (as indicated in the figures). The polymer:polymer blend ratio was varied as indicated. The extrudates were plasticized with 30 % DBS and extruded at 100 °C.

4. Influence of polymer:polymer blend ratio in injection-molded capsules

4.1. Processability of injection-molded capsules

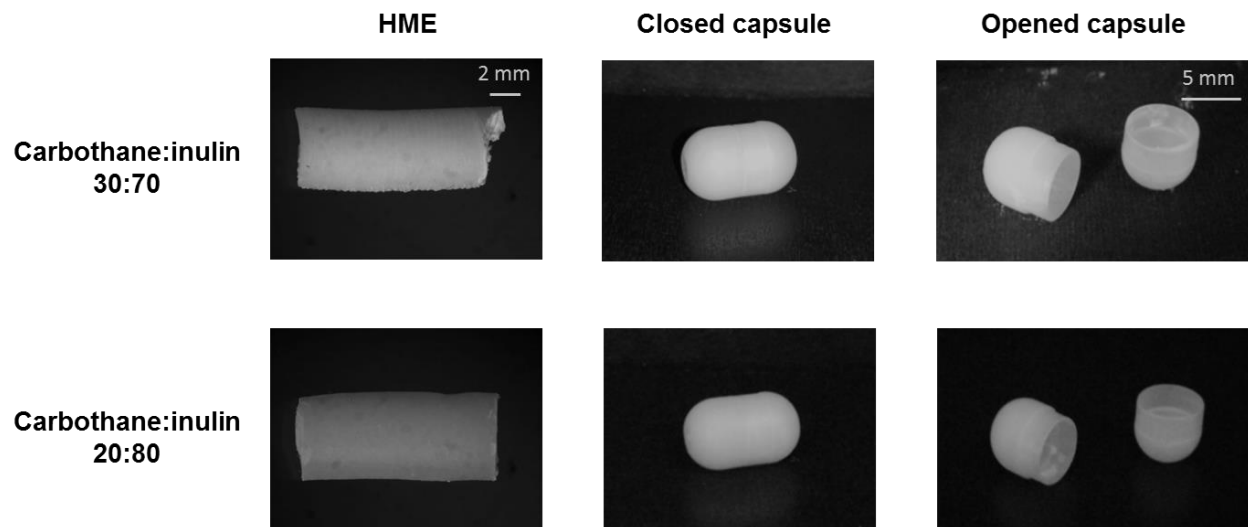

Figure 35: Macroscopic pictures of injecting-molded capsules based on carbothane:inulin blends. The polymer:polymer blend ratio was varied as indicated, the capsules were prepared at 100 °C and injected into a mold at 107 °C. For reasons of comparison, also hot melt extrudates based on carbothane:inulin blends (plasticized with 30 % DBS referring to carbothane) are illustrated.

Figure 35 shows macroscopic appearance of closed and opened capsules prepared by injection molding process. Hot melt extrudates based on carbothane:inulin blend ratios (30:70 and 20:80) extruded at 100 °C (plasticized with 30 % DBS referred to carbothane weight) were manually cut prior to injection molding. The plasticizing chamber, injecting chamber and nozzle temperatures were set at 100 °C. The blends were injected into a mold heated at 107 °C. Importantly, the injection was complete and capsules obtained showed a regular and smooth surface for all polymer:polymer ratios (carbothane:inulin 30:70, 20:80 and 10:90).

4.2. In vitro drug release from capsules and hot melt extrudates

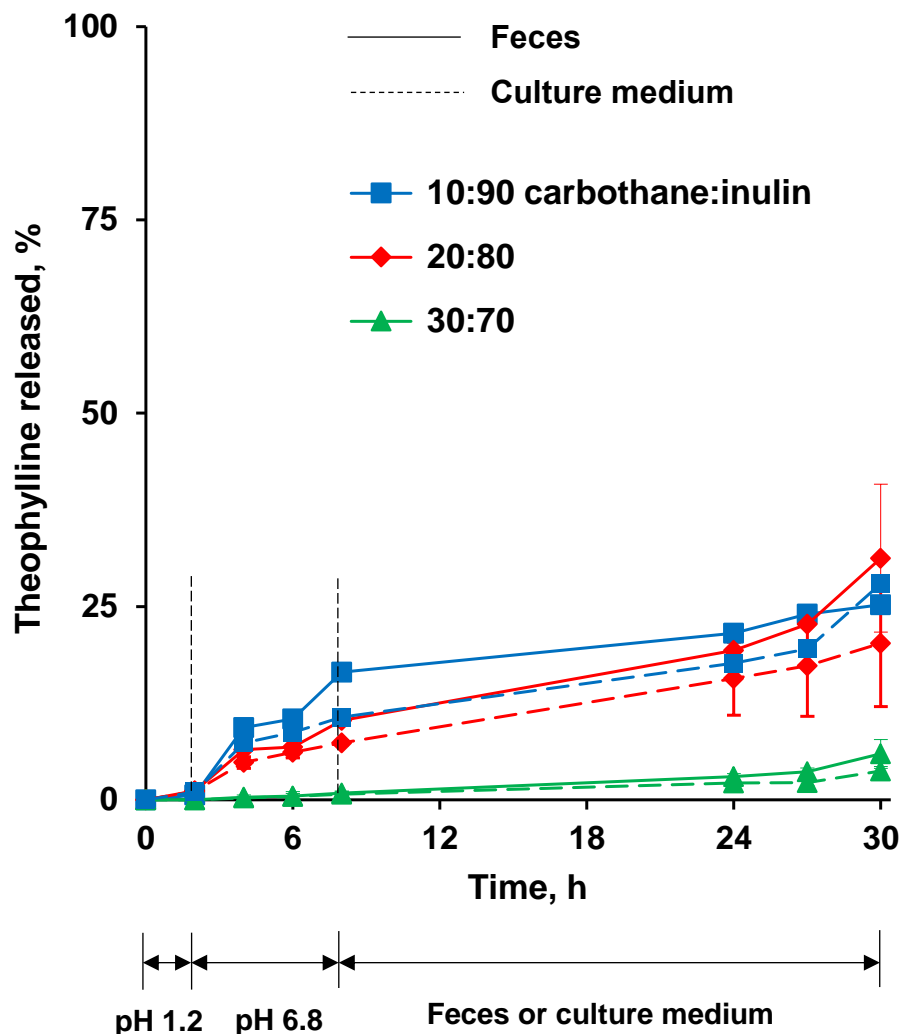

Figure 36: Theophylline release from injection-molded capsules based on carbothane:inulin blends under conditions simulating the transit through the entire gastro intestinal tract: 2 h in 0.1 M HCl, followed by 6 h in phosphate buffer pH 6.8, followed by culture medium inoculated with feces of patients suffering from inflammatory bowel diseases (solid curves). For reasons of comparison also drug release in 0.1 M HCl, phosphate buffer pH 6.8 and culture medium without fecal samples is shown (dotted curves).

The best candidates of hot melt extrudates have been selected for further analysis as well as capsules manufacturing. The selected blend ratios (30:70, 20:80 and 10:90) of injection-molded capsules bases on carbothane:inulin were characterized for their drug release kinetics in media simulating the entire GIT. Capsules were filled with 10 mg of theophylline and then exposed to 0.1 M HCl for 2 h, followed by 6 h in phosphate buffer pH 6.8 and then 22 h in culture medium inoculated with fecal samples from inflammatory bowel disease patients (solid curve in figure 36). For reasons of comparison, the extrudates were also exposed to 0.1 M HCl, followed by phosphate buffer pH 6.8 and culture medium free of feces (dotted curve in figure 36). As it can be seen, theophylline release rate did not increase upon contact with fecal samples. Approximately the same percentage of drug released in presence or absence of fecal samples. For instance, around 25 % for the blend ratios 20:80 and 5 % for the ratio 30:70. This can be at least explained by the fact that despite of the considerable amount of water uptake by hot melt extrudates and the significant dry mass loss of hot melt extrudates (figure 34) upon exposure to fecal samples from IBD-patients, capsules prepared from these extrudates did not show the same behavior due probably to non-fermentation of the polysaccharide under these conditions. For reasons of comparison, hot melt extrudates of carbothane:inulin blends (30:70, 20:80 and 10:90) containing 10 % theophylline were prepared. Hot melt extrudates were plasticized with 30 % DBS referring to the dry mass of carbothane and extruded at 100 °C. The in-vitro drug release from these hot melt extrudates was performed upon exposure to 0.1 M HCl for 2 h, followed by phosphate buffer pH 6.8 (figure 37). Clearly, almost 100 % of theophylline was released from these hot melt extrudates into the dissolution media for all ratios. However, less than 30 % was released from injection-molded capsules. This can be probably explained by the thermoplastic polymer “carbothane”, which is able to coat the polysaccharide and then hinders the bacterial fermentation.

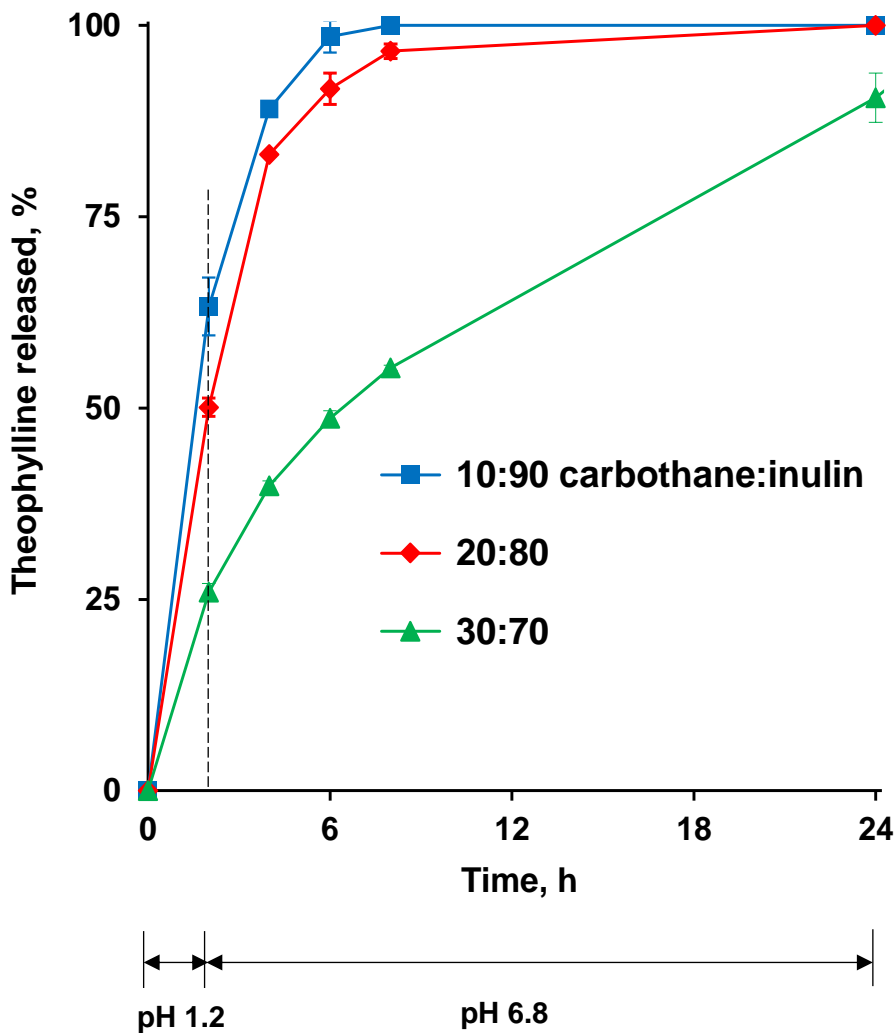

Figure 37: Theophylline released from hot melt extrudates based on carbothane:inulin in 0.1 M HCl for 2 h, followed by phosphate buffer pH 6.8. Hot melt extrudates were loaded with 10 % theophylline. The polymer:polymer blend ratio was varied as indicated. The extrudates were plasticized with 30 % DBS and extruded at 100 °C.

CHAPTER 3:
HOT MELT EXTRUDED POLYSACCHARIDE
BLENDS FOR CONTROLLED DRUG DELIVERY

HOT MELT EXTRUDED POLYSACCHARIDE BLENDS FOR CONTROLLED DRUG DELIVERY

Polymer blends offer an interesting potential for controlled drug delivery systems [167-172], both as matrix formers [173-176] and as coating materials [177-181]. By simply varying the polymer:polymer blend ratio, the resulting key properties of the systems can be effectively varied, allowing to provide large spectra of possible drug release kinetics [182-184]. For example, a variety of blends of enteric and non-enteric polymer blends has been used to control the resulting drug release kinetics from coated pellets [185,186].

Importantly, the presence of the non-enteric polymer can effectively hinder the leaching of the enteric polymer out of the film coating at neutral pH [187]. Thus, one polymer can efficiently “mask” key properties of the other polymer, if the two compounds are intimately mixed [188]. The polymer:polymer blend ratio as well as the manufacturing technique (determining the inner system structure) can strongly affect the efficiency of such “masking” phenomena [189]. The type of polymers used, the polymer blend ratio as well as the manufacturing conditions determine the resulting system properties and, thus, the control of drug release. The basic principle is that the drug is “trapped” within the polymeric system and different types of mass transport phenomena can be involved in the control of drug release, such as water diffusion into the system, drug dissolution and diffusion, polymer swelling and dissolution, osmotic effects, polymer degradation and pore formation upon leaching of water soluble compounds into the surrounding bulk fluid (to mention just a few). In the case of polymer blends, the properties of both compounds might be decisive, or one of them might dominate. For example, when blending a polymer that is permeable for many drugs with a polymer that is poorly permeable, broad spectra of drug release patterns might be obtained by simply varying the polymer:polymer blend ratio [190]. Also differences in drug solubility or drug loading might be compensated by adjusting the polymer:polymer blend ratio. For

example, high loadings of a freely water-soluble drug in a matrix system generally lead to fast drug release. This might be compensated by increasing the portion of the poorly permeable polymer in the dosage form. Also, one polymer might assure the mechanical stability of the drug delivery system within the gastrointestinal tract, whereas the other polymer might trigger drug release in specific segments (e.g. small intestine or colon) [191-196].

Furthermore, the solubilities of the two polymers might be complementary: For example, ethylcellulose:guar gum blends have been proposed as film coating materials to provide controlled drug release that is not susceptible to the co-consumption of alcoholic beverages [197-199]. The basic idea is that ethylcellulose is not soluble in water, but in ethanol. Viceversa, guar gum is soluble in water, but not in ethanol. Appropriate ethylcellulose:guar gum blends were shown to be able to release theophylline from coated pellets with release rates that were very similar in release media containing 0, 20 or 40 % ethanol.

The aim of this study was to explore the potential of blends of ethylcellulose with a second polysaccharide as matrix former in controlled release hot melt extrudates. Ethylcellulose was chosen to provide good mechanical stability of the systems. But it is known to be poorly permeable for many drugs [200]. Thus, it was combined with different types and amounts of a more permeable second polysaccharide, namely hydroxypropyl methylcellulose (HPMC), pectin, maize starch, inulin, maltodextrin, guar gum, and chitosan. Optionally, different types and amounts of plasticizers (dibutyl sebacate, triethyl citrate and polyethylene glycol) were added. Theophylline was selected as model drug exhibiting slight water solubility, diprophylline as freely water-soluble model drug. The drug loading was varied from 10 to 60 %. The key manufacturing parameters (temperature and screw speed) as well as the polymer:polymer blend ratio were varied. Drug release was measured under conditions simulating the contents of the upper GIT (0.1 M HCl and phosphate buffer pH 6.8), as well as the colon (upon exposure to human fecal samples).

1. Impact of the type of polymer blend & plasticizer addition

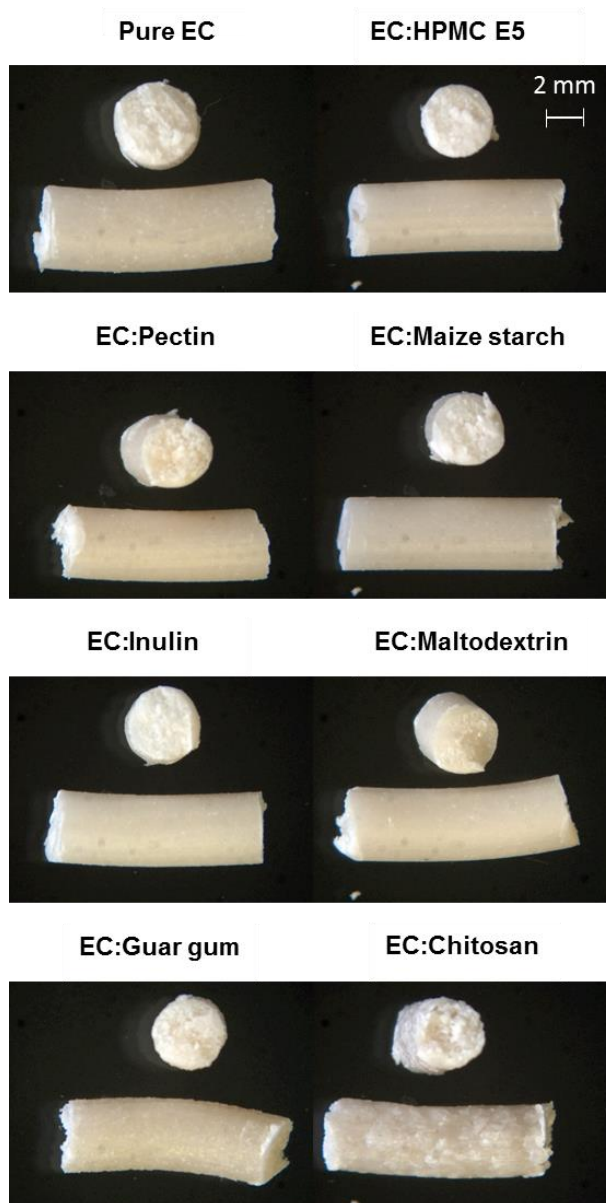

Figure 38: Macroscopic pictures of hot melt extrudates (cross-sections and surfaces) based on ethylcellulose and different types of a 2nd polymer (indicated in the figure). The polymer:polymer blend ratio was 80:20, the extrudates were extruded at 100 °C, loaded with 10 % theophylline and plasticized with 30 % DBS (referring to ethylcellulose). For reasons of comparison, also hot melt extrudates based “only” on ethylcellulose (loaded with 10 % theophylline, and plasticized with 30 % DBS) are illustrated.

Figure 38 shows optical macroscopy pictures of hot melt extrudates based on different types of polymer:polymer blends: Ethylcellulose was blended with a selection of other polysaccharides, as indicated. The ethylcellulose:2nd polysaccharide blend ratio was 80:20 (weight:weight) in all cases. Thirty percent DBS (referring to ethylcellulose) was added as a plasticizer, the systems were loaded with 10 % theophylline, and the extrusion temperature was 100 °C in all cases. Cross-sections of the hot melt extrudates (obtained by manual breaking) are shown at the top, pictures of surfaces right below. As it can be seen, the inner structure of all systems appeared to be rather homogeneous and the surface relatively smooth, except for ethylcellulose:chitosan blends, which lead to extrudates with a slightly rough surface and somehow “granular” inner structure.

Importantly, in all cases the torque measured during extrusion was similar (around 30 %), not causing any difficulty during processing (figure 39a). The resulting drug release kinetics upon exposure to 0.1 M HCl for 2 h, followed by phosphate buffer pH 6.8 for 22 h are illustrated in figure 39b. Clearly, the type of polymer blend had a pronounced effect on theophylline release. This can be attributed to the different chemical structures of the polysaccharides and the resulting difference in permeability of the polymeric matrices for the drug. In many cases, the observed release rates were too low for oral administration (e.g. less than about 18 % after 24 h). For this reason, only the 3 most rapidly releasing polymer blends were selected for further studies: ethylcellulose:chitosan, ethylcellulose:guar gum and ethylcellulose:pectin.

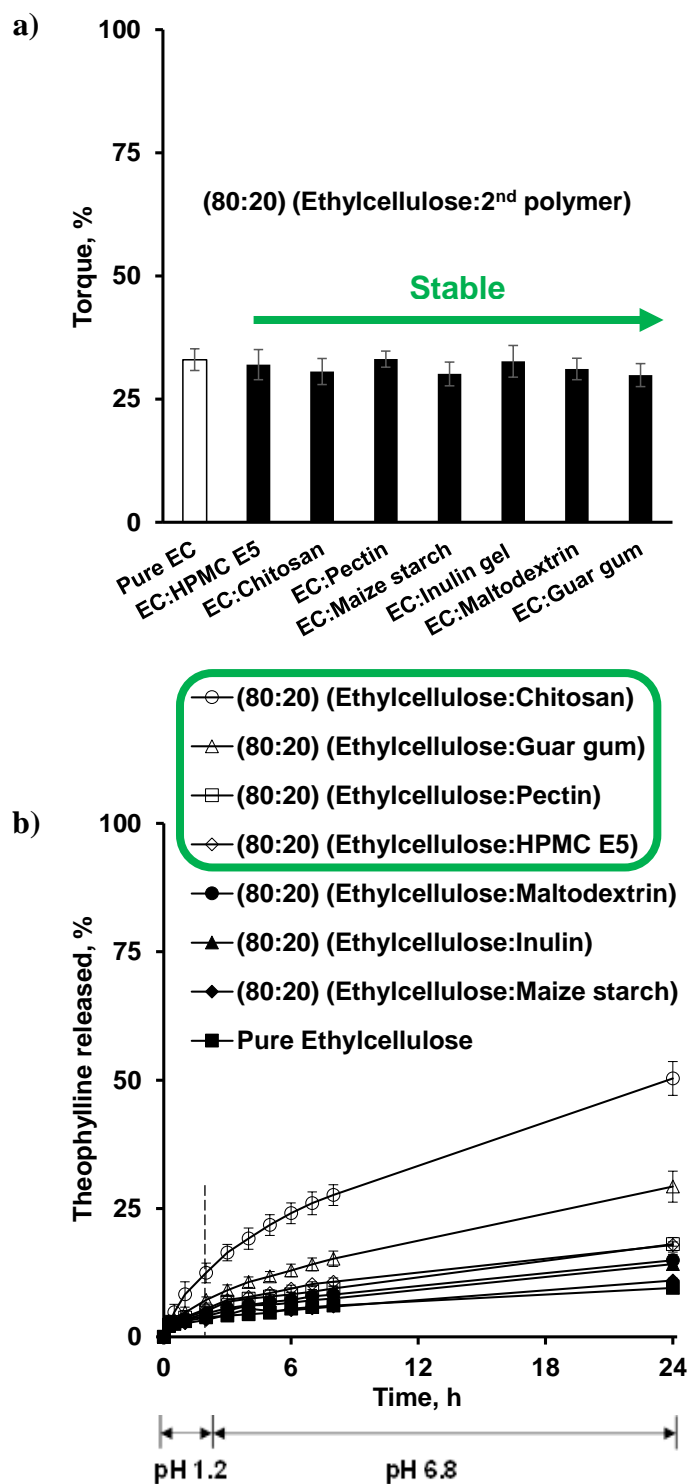

Figure 39: Impact of the type of polymer blend (indicated in the diagrams) used as matrix former on: a) the torque generated during hot melt extrusion, and b) theophylline release from the extrudates in 0.1 M HCl for 2 h, followed by phosphate buffer pH 6.8. The extrudates were extruded at 100 °C, loaded with 10 % drug and plasticized with 30 % DBS (referring to ethylcellulose).

In an attempt to simplify the formulation, the plasticizer DBS was omitted. Figure 40 shows macroscopic pictures of cross-sections and surfaces of hot melt extrudates based on ethylcellulose:pectin/guar gum/chitosan blends free of plasticizer. The blend ratio was varied as indicated, hot melt extrudates based “only” on ethylcellulose (loaded with 10 % theophylline) are shown for reasons of comparison. To allow for extrusion without a plasticizer, the processing temperature had to be increased, here to 170 °C. As it can be seen in the top row, this temperature degraded pectin under the given conditions. Also, in the case of hot melt extrudates loaded with high amounts of chitosan some color changes at the systems’ surface was observed (Figure 40, bottom row). Due to the important pectin degradation, these hot melt extrudates were not studied any further.

The resulting theophylline release kinetics of systems based on different ethylcellulose:guar gum and ethylcellulose:chitosan blends are illustrated in figure 41. The release medium was 0.1 M HCl for the first 2 h, followed by phosphate buffer pH 6.8 for the subsequent 6 h. The ethylcellulose:2nd polysaccharide blend ratio was varied as follows: 100:0, 90:10, 80:20, 70:30 and 60:40. As it can be seen, the resulting release rate was very low at all blend ratios in the case of ethylcellulose:chitosan (4 - 15 % after 8 h). Also in the case of ethylcellulose:guar gum blends, theophylline release from the plasticizer-free implants was relatively slow, much slower compared to the respective DBS-plasticized systems extruded at 100 °C: For example, after 8 h only 6 versus 15 % drug was released in the case of ethylcellulose:guar gum 80:20 blends (see also figure 41 versus figure 39b). This reduced drug release rate in plasticizer-free systems can at least partially be attributed to the fact that the presence of the plasticizer increases the mobility of the polymer chains and, thus, also of the drug molecules.

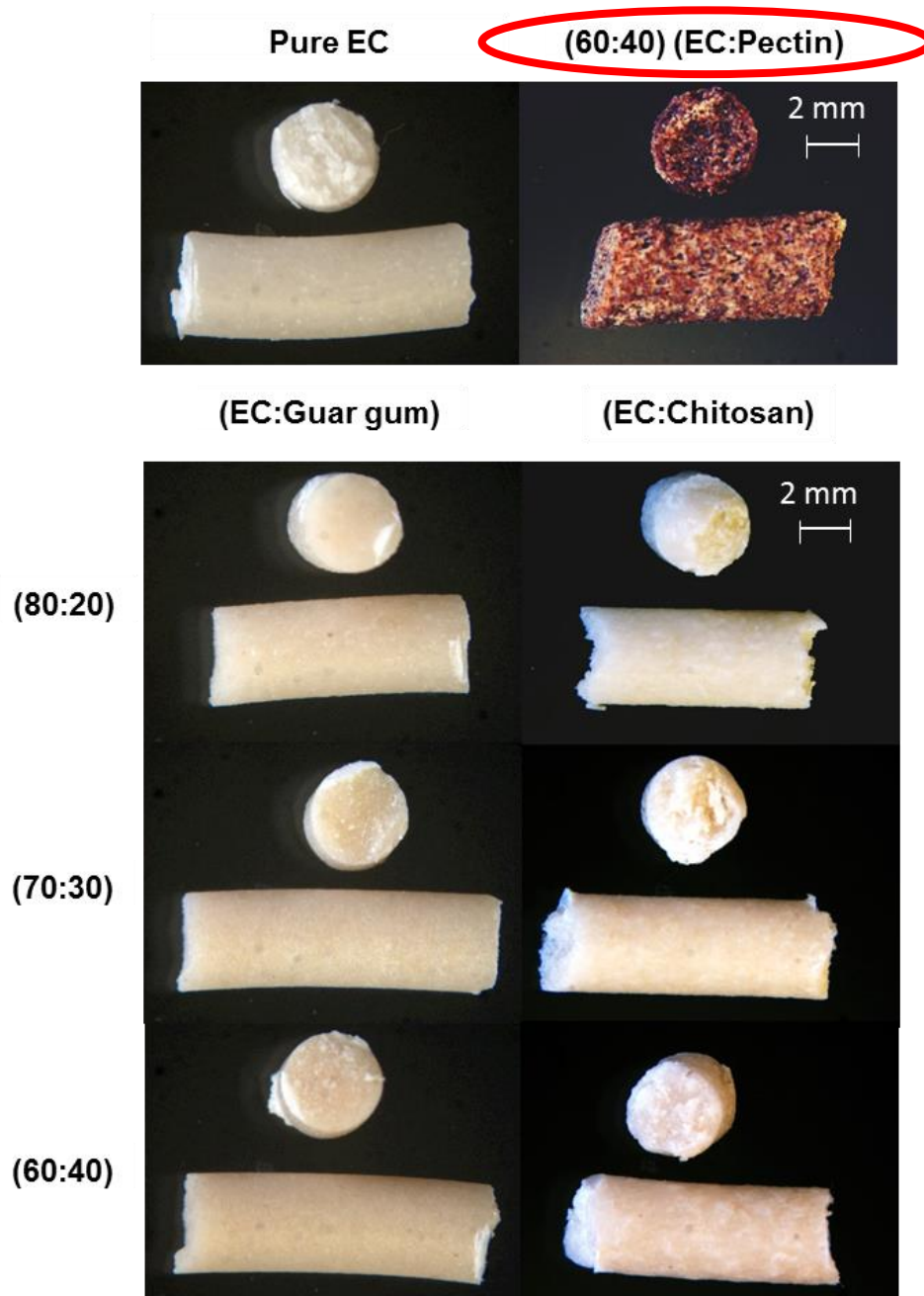

Figure 40: Macroscopic pictures of hot melt extrudates (cross-sections and surfaces) based on ethylcellulose and different types of a 2nd polymer (indicated in the figure). The polymer:polymer blend ratio is indicated in the figure, the extrudates were extruded at 170 °C, loaded with 10 % theophylline and free of plasticizer.

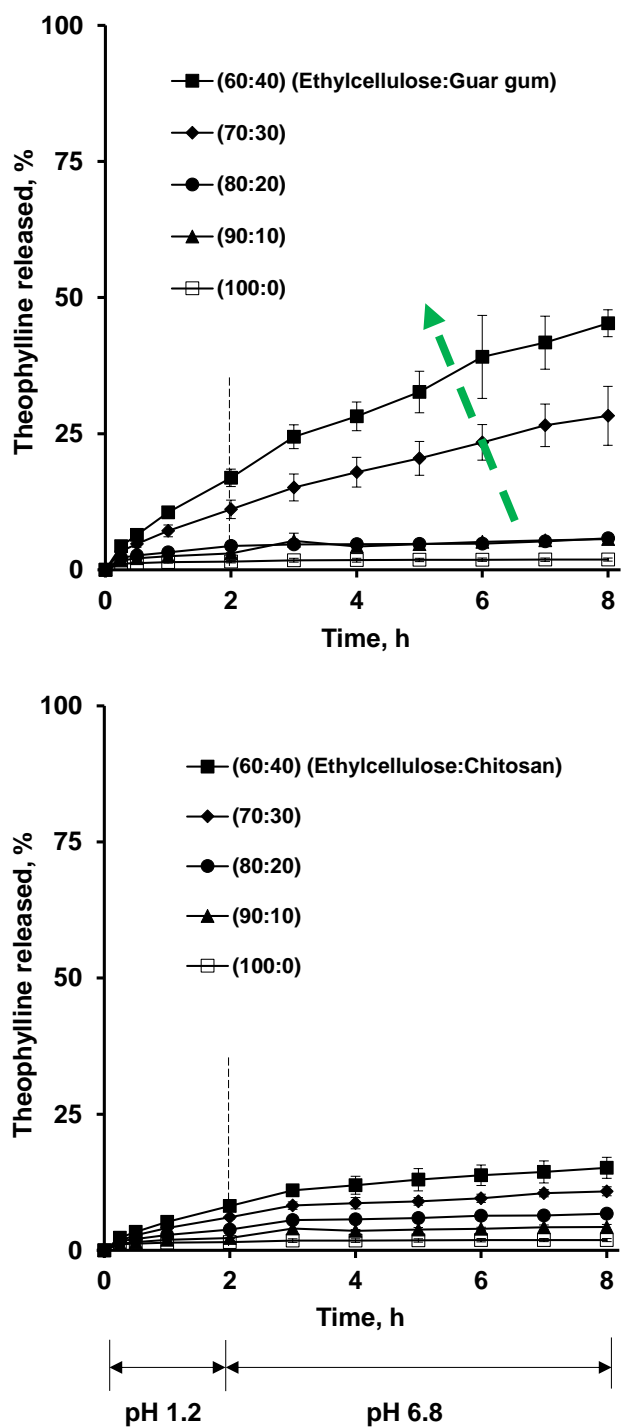

Figure 41: Impact of the polymer:polymer blend ratio (indicated in the diagrams) on theophylline release from hot melt extrudates based on ethylcellulose:guar gum or ethylcellulose:chitosan blends (as indicated) in 0.1 M HCl for 2 h, followed by phosphate buffer pH 6.8. The extrudates were extruded at 170 °C, loaded with 10 % drug and free of plasticizer.

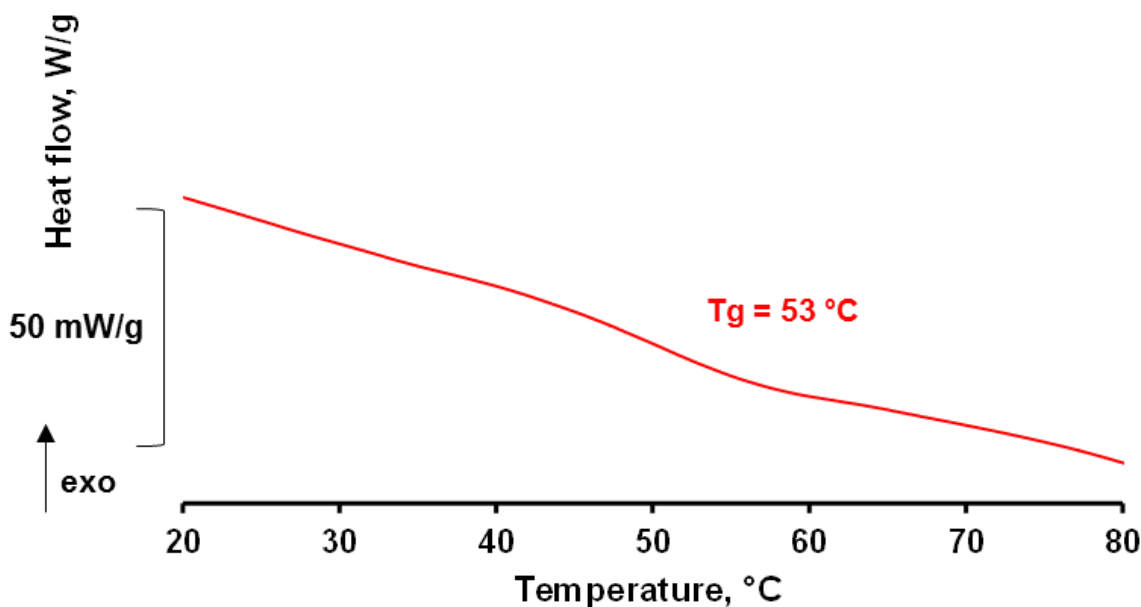

Figure 42: DSC thermogram of ethylcellulose plasticized with 30 % DBS.

For example, figure 42 shows the DSC thermogram of ethylcellulose plasticized with 30 % DBS. The glass transition temperature decreased from about 130 to 53 °C in the dry state compared to pure ethylcellulose (figure 55 vs. figure 42). In addition to DBS, water can also be expected to be acting as a plasticizer for this polymer during drug release. Since the observed release rates were too low in plasticizer-free hot melt extrudates, these systems were not studied any further.

Instead, the suitability of ethylcellulose:guar gum, ethylcellulose:chitosan and ethylcellulose:HPMC E5 blends, plasticized with 30 % DBS (referring to ethylcellulose) were studied in more detail (note that “pectin was replaced by HPMC E5”, since it showed important thermal degradation at 170 °C, and similar drug release rates: figure 40 and figure 39b). In the presence of the plasticizer, the extrusion temperature was again reduced to 100 °C.



Figure 43: Macroscopic pictures of hot melt extrudates (cross-sections and surfaces) based on ethylcellulose and different types of a 2nd polymer (indicated in the figure). The polymer:polymer blend ratio was varied as indicated in the figure, the extrudates were extruded at 100 °C, loaded with 10 % theophylline and plasticized with 30 % DBS (referring to ethylcellulose).

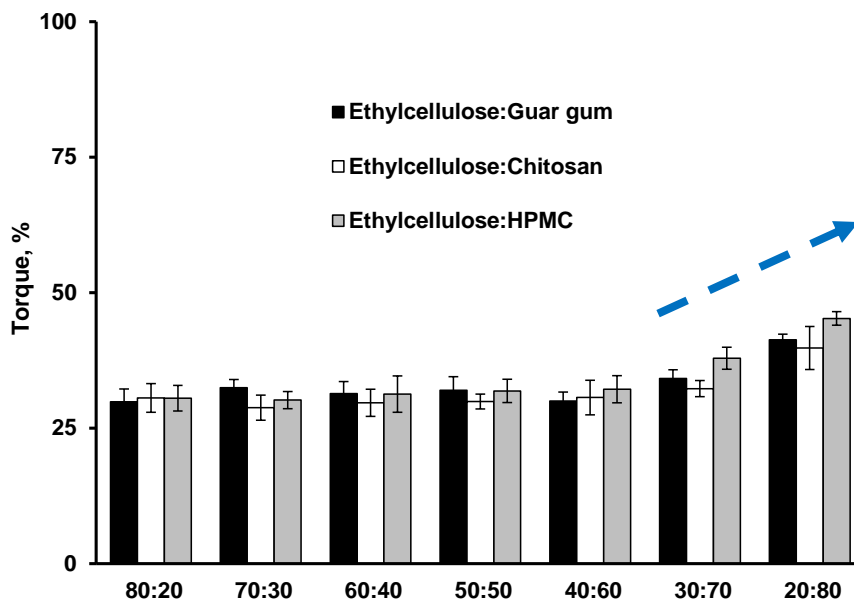

Figure 44: Impact of the type of ethylcellulose and different types of a 2nd polymer blend (indicated in the diagrams) on the torque generated during hot melt extrusion. The polymer:polymer blend ratio was varied as indicated. The extrudates were extruded at 100 °C, loaded with 10 % drug and plasticized with 30 % DBS (referring to ethylcellulose).

Figure 43 shows macroscopic pictures of cross-sections and surfaces of hot melt extrudates based on these polymer:polymer blends, varying the blend ratio from 100:0 to 20:80, in 10 % increments. As it can be seen, the inner structure of all systems appeared to be rather homogeneous and the surface relatively smooth, except for ethylcellulose:chitosan blends, which lead to extrudates with a slightly rough surface and somehow “granular” inner structure for all the blend ratios. Importantly, in all cases the torque measured during extrusion was similar (around 30 %) with a slightly increase for the blends ratio 30:70 and 20:80 (40 - 45 %), without causing any difficulty during processing (figure 44).

Figure 45 shows the resulting theophylline release kinetics from. The release medium was 0.1 M HCl for 2 h, followed by phosphate buffer pH 6.8 for 22 h. Clearly, in all cases a broad spectrum of drug release patterns could be obtained, by simply varying the polymer:polymer blend ratio. In the investigated cases, ethylcellulose was less permeable for theophylline than the other polymers. This is why in all cases, the release rate increased with decreasing ethylcellulose content. Since ethylcellulose:guar gum blends showed the largest spectrum of possible drug release patterns (e.g. the highest theophylline release rate at the 20:80 ethylcellulose:2nd polysaccharide blend ratio), this blend was selected for further studies.

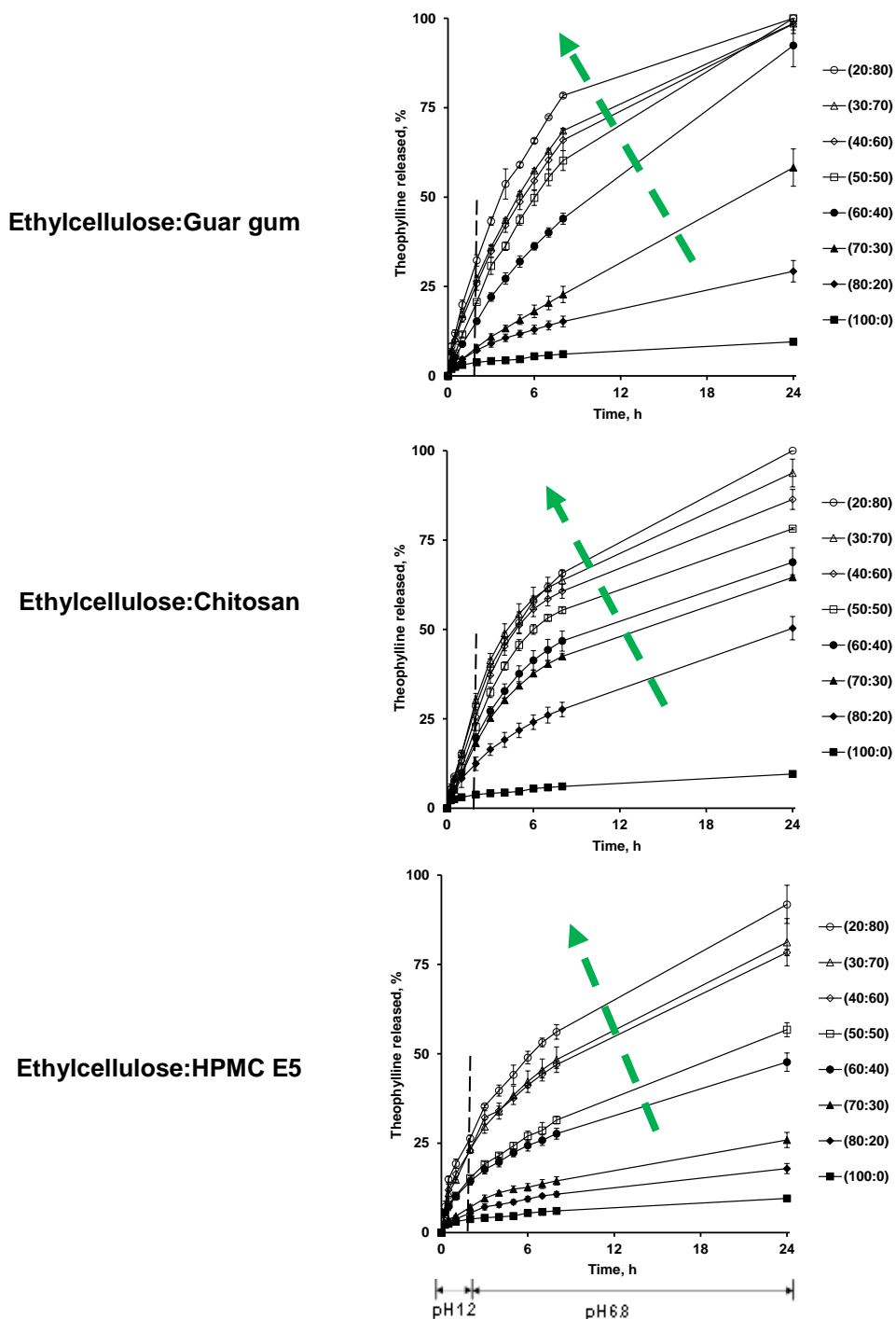

Figure 45: Impact of the polymer:polymer blend ratio (indicated in the figure) on theophylline release from hot melt extrudates based on ethylcellulose and different types of a 2nd polysaccharide in 0.1 M HCl for 2 h, followed by phosphate buffer pH 6.8. The extrudates were extruded at 100 °C, loaded with 10 % drug and plasticized with 30 % DBS (referring to ethylcellulose).

2. Ethylcellulose:guar gum blends

2.1. Impact of the type and amount of plasticizer & extrusion parameters

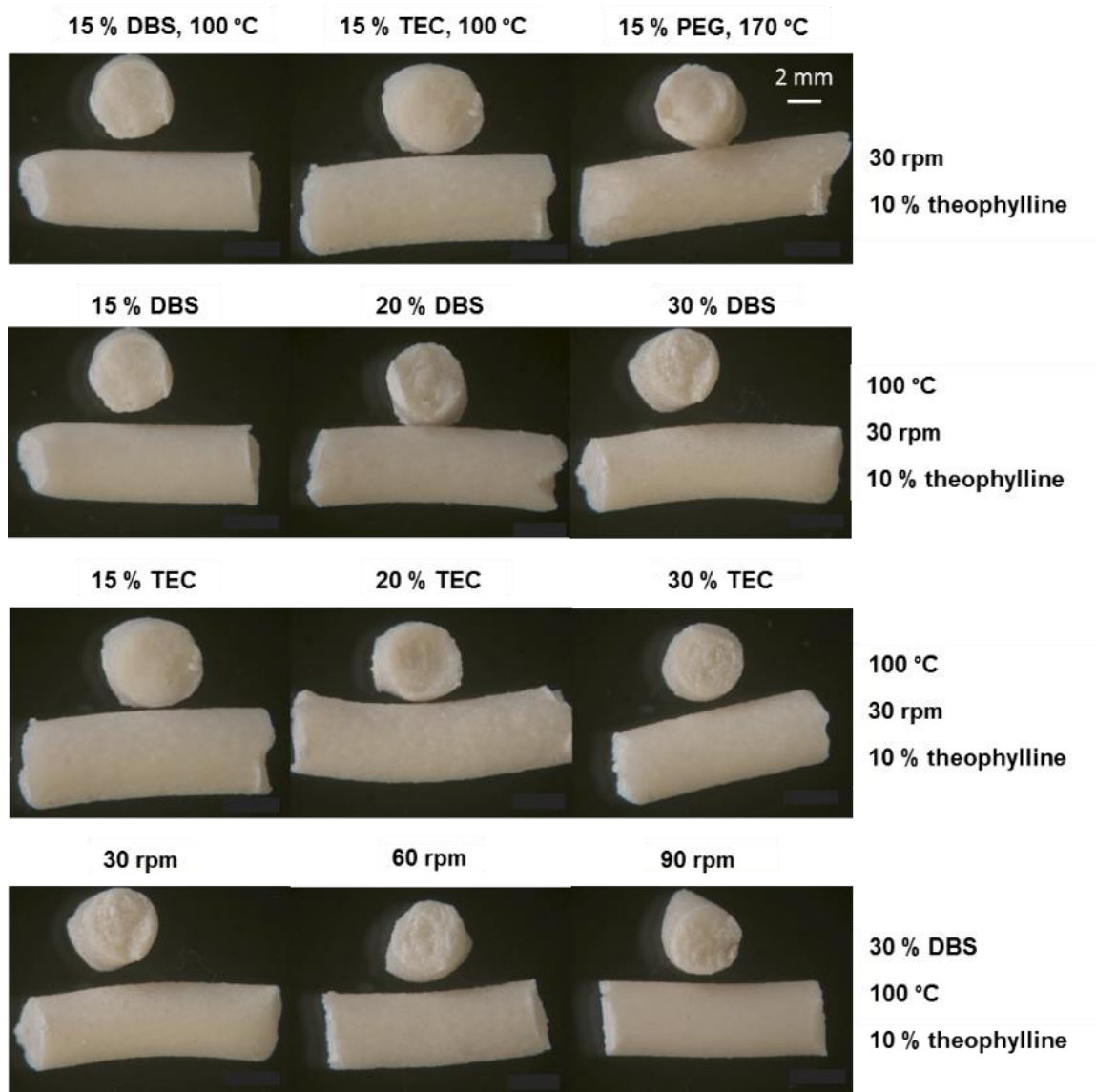

Figure 46: Macroscopic pictures of hot melt extrudates (cross-sections and surfaces) based on 80:20 ethylcellulose:guar gum blends. The drug loading was 10 %. The type and amount of plasticizer, extrusion temperature and screw speed were varied as indicated.

Figure 46 shows macroscopic pictures of cross-sections and surfaces of different types of ethylcellulose:guar gum based hot melt extrudates: The following parameters were varied: (i) the type of plasticizer (DBS, TEC and PEG), (ii) the percentage of plasticizer (15, 20 and 30 %, referring to ethylcellulose), (iii) the extrusion temperature (100 and 170 °C) and (iv) the screw speed (30, 60 and 90 rpm). In all cases, the ethylcellulose:guar gum blend ratio was kept constant: 80:20 (weight:weight). As it can be seen, in all cases rather homogeneous inner system structures and relatively smooth surfaces were obtained. In no case, any visible sign of polymer degradation was observed. Extrudates containing 0, 15 or 20 % plasticizer were hard and brittle. All other systems were flexible.

Figure 47a shows the torque values measured during the extrusion of ethylcellulose:guar gum 80:20 blends plasticized with 15 % PEG (PEG 1500), DBS or TEC. The systems were loaded with 10 % theophylline. For reasons of comparison, also the torque values observed with “pure” ethylcellulose hot melt extrudates (loaded with 10 % theophylline) are shown. Please note that it was not possible to extrude plasticizer-free and 15 % PEG containing formulations at 100 °C (the torque values were too high). This is why these extrudates were obtained at 170 °C processing temperature. In contrast, blends plasticized with 15 % DBS or TEC could be obtained at 100 °C processing temperature, although the corresponding torque values were high (figure 47a). The respective theophylline release kinetics from these hot melt extrudates are illustrated in figure 47b. As it can be seen, the following rank order with respect to the resulting drug release rate was observed: 15 % PEG > 15 % DBS > 15 % TEC > no plasticizer. Thus, the plasticizer facilitates drug release, probably due to increased polymer chain mobility and/or plasticizer leaching into the surrounding bulk fluid. Please note that a direct comparison of PEG with DBS & TEC should be viewed with caution, since the extrusion temperature was different. In all cases, the resulting drug release rates were rather low (e.g., less than 36 % after 6 h).

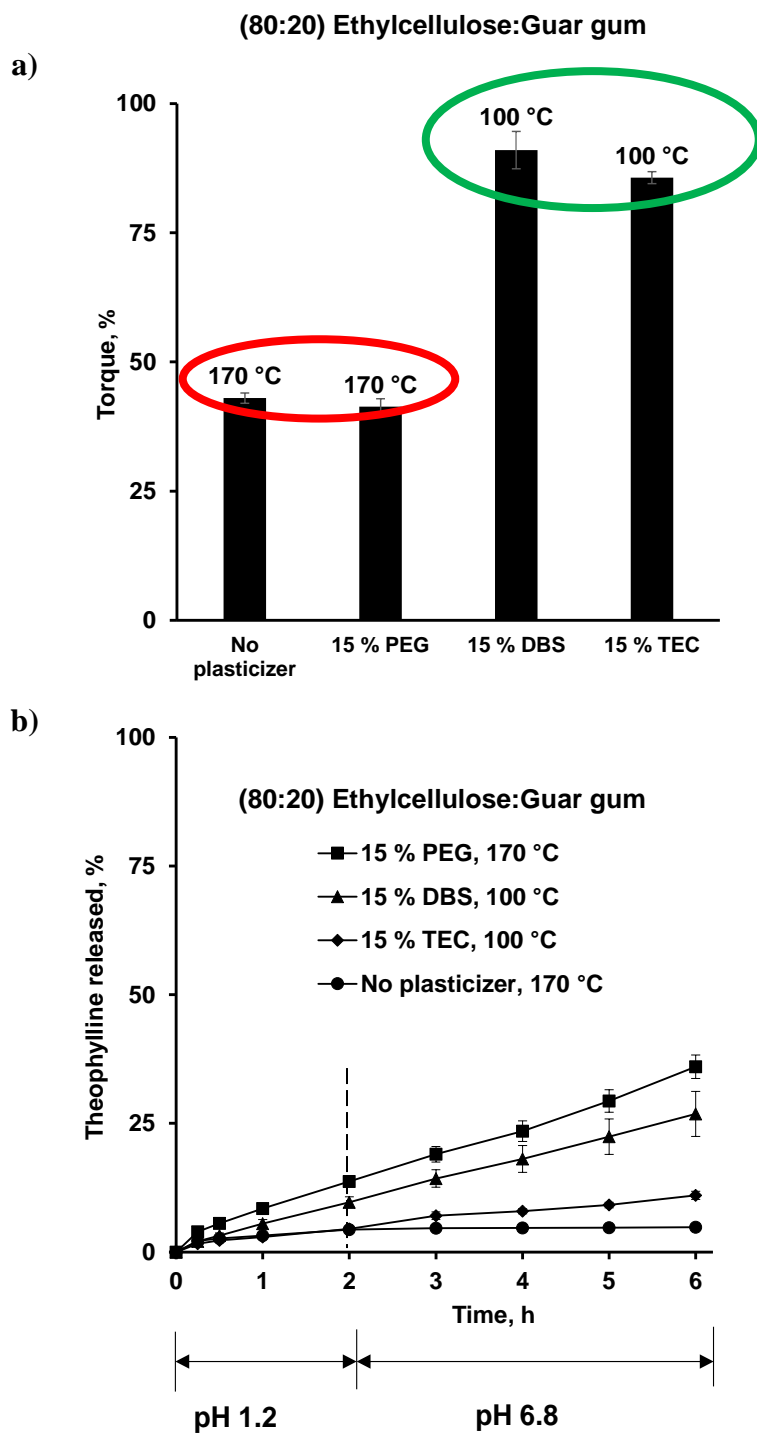

Figure 47: Impact of the type of plasticizer and extrusion temperature on: a) the generated torque, and b) theophylline release from extrudates in 0.1 M HCl for 2 h, followed by phosphate buffer pH 6.8. The systems were based on 80:20 ethylcellulose:guar gum blends, the drug loading was 10 %.

Figure 48a shows the impact of varying the plasticizer content (here DBS and TEC) on the torque measured during extrusion of ethylcellulose:guar gum 80:20 blends, loaded with 10 % theophylline. The extrusion temperature was 100 °C. Clearly, the torque values substantially decreased with increasing plasticizer level, irrespective of the type of plasticizer. The theophylline release kinetics from the obtained hot melt extrudates are shown in figure 48b. Interestingly, the freely water-soluble plasticizer TEC leads to slower drug release rates than the lipophilic plasticizer DBS. Thus, in these cases, the increase in polymer chain mobility seems to play a more important role than potential plasticizer leaching into the surrounding bulk fluid (eventually creating water-filled pores). TEC seems to be a more efficient plasticizer for the polymeric matrix than DBS, resulting in a denser (and less permeable) system (overcompensating potential increased drug mobility effects). But again, in all cases the resulting theophylline release rates were rather low (e.g., less than 27 % drug was released after 6 h).

The effects of varying the screw speed when manufacturing ethylcellulose:guar gum 80:20 based hot melt extrudates loaded with 10 % theophylline at 100 °C (plasticized with 30 % DBS) on: a) the torque measured during extrusion, and b) drug release in 0.1 M HCl for 2 h, followed by phosphate buffer pH 6.8 for subsequent 6 h, are illustrated in figure 49. Clearly, the variation of the screw speed in the investigated range (30 – 60 – 90 rpm) did neither substantially impact the torque, nor theophylline release.

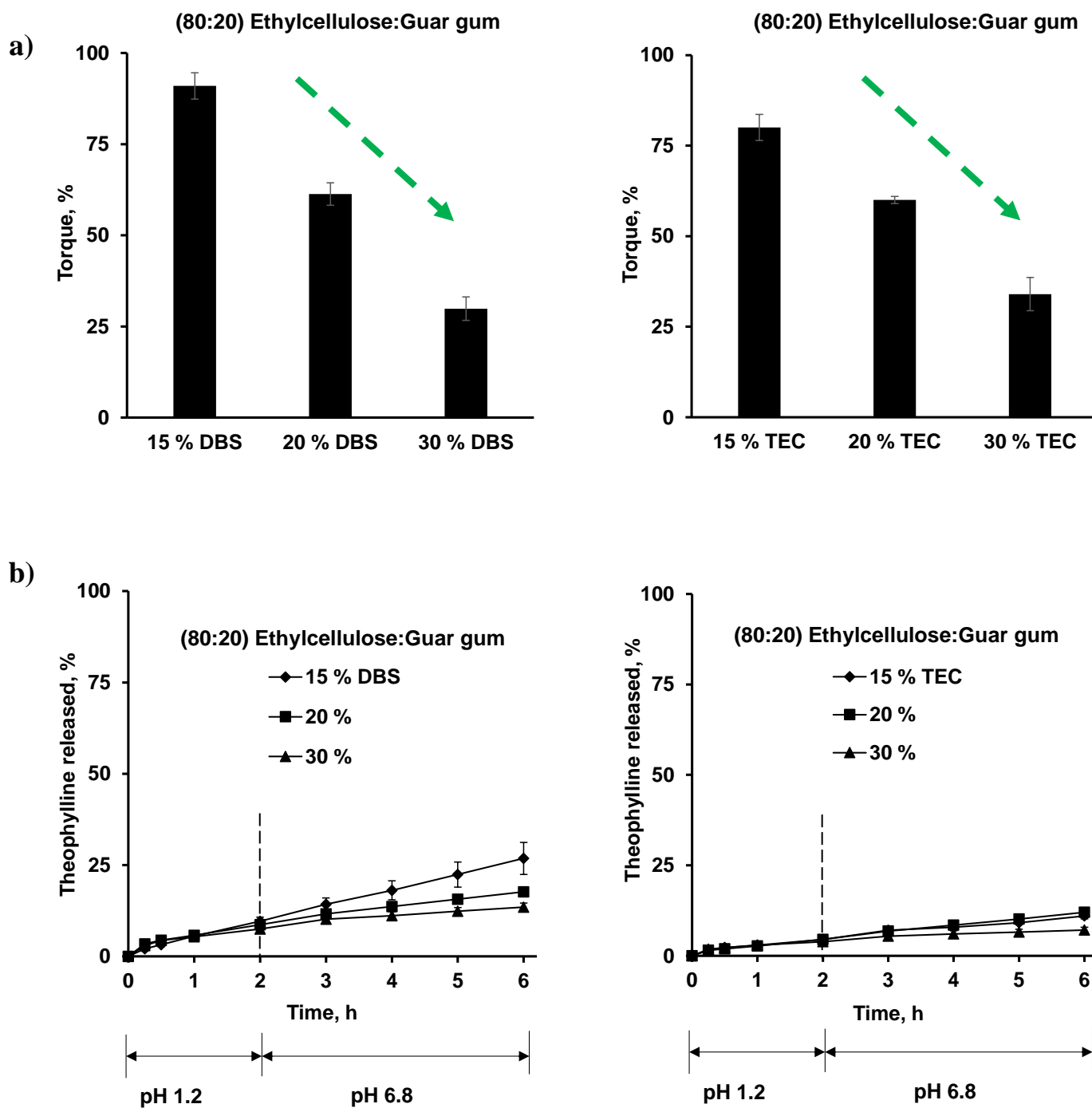

Figure 48: Impact of the type and amount of plasticizer on: a) the generated torque, and b) theophylline release from extrudates in 0.1 M HCl for 2 h, followed by phosphate buffer pH 6.8. The systems were based on 80:20 ethylcellulose:guar gum blends, the extrusion temperature was 100 °C and the drug loading 10 %.

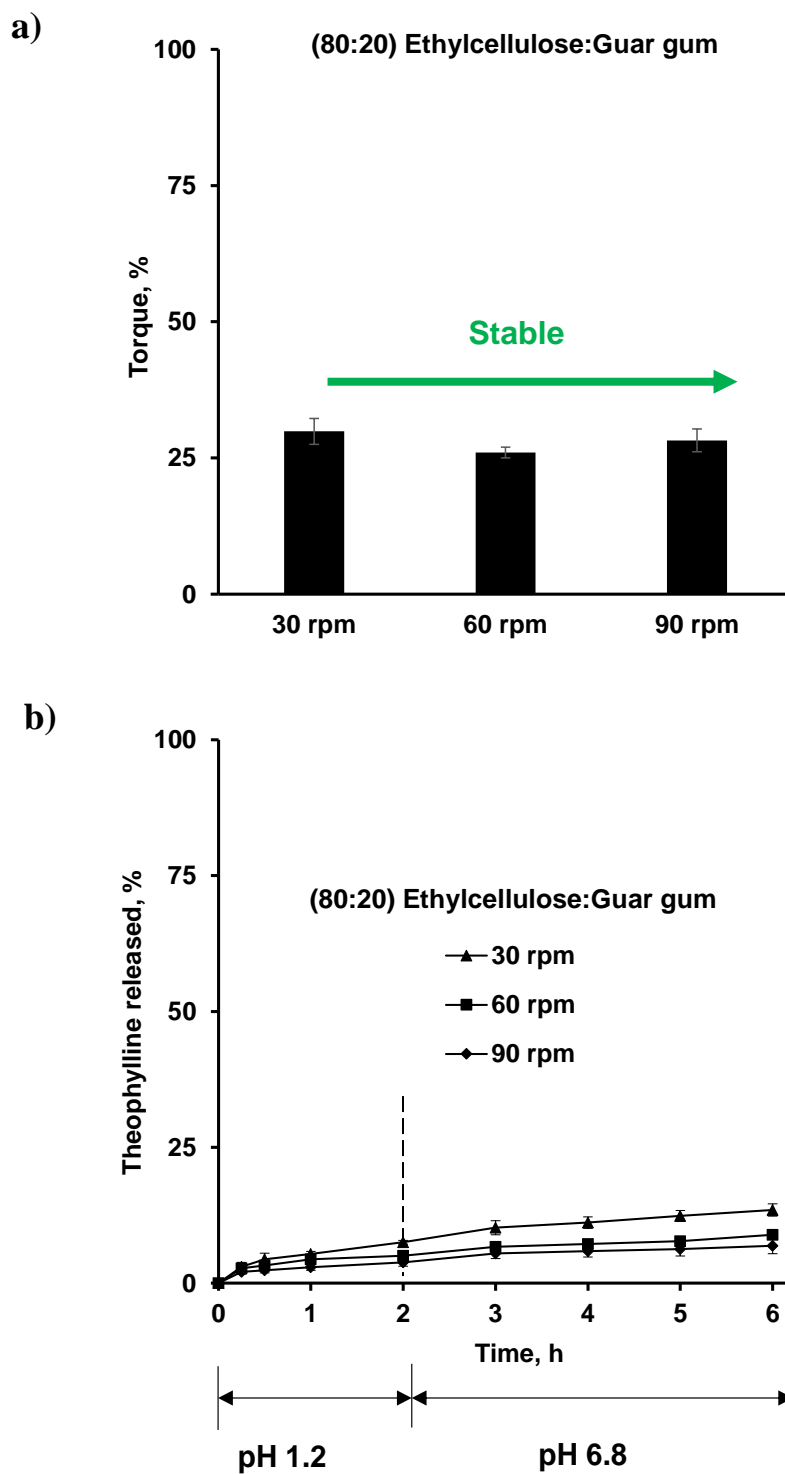

Figure 49: Impact of the screw speed during extrusion of 80:20 ethylcellulose:guar gum blends on: a) the generated torque, and b) theophylline release from extrudates in 0.1 M HCl for 2 h, followed by phosphate buffer pH 6.8. The extrusion temperature was 100 °C, the extrudates were plasticized with 30 % DBS (referring to ethylcellulose), and the drug loading was 10 %.

2.2. Impact of the type and amount of drug

Figure 50 shows macroscopic pictures of cross-sections and surfaces of different types of ethylcellulose:guar gum based hot melt extrudates: The following parameters were varied: (i) the type of drug (theophylline and diprophylline, being slightly and freely water-soluble), and (ii) the drug loading (10, 30 and 60 %, referring to the total extrudate mass). In all cases, the ethylcellulose:guar gum blend ratio was kept constant: 80:20 (weight:weight). As it can be seen, in all cases rather homogeneous inner system structures and relatively smooth surfaces were obtained. In no case, any visible sign of polymer degradation was observed. Extrudates loaded with 60 % drug were hard and brittle. All other systems were flexible.

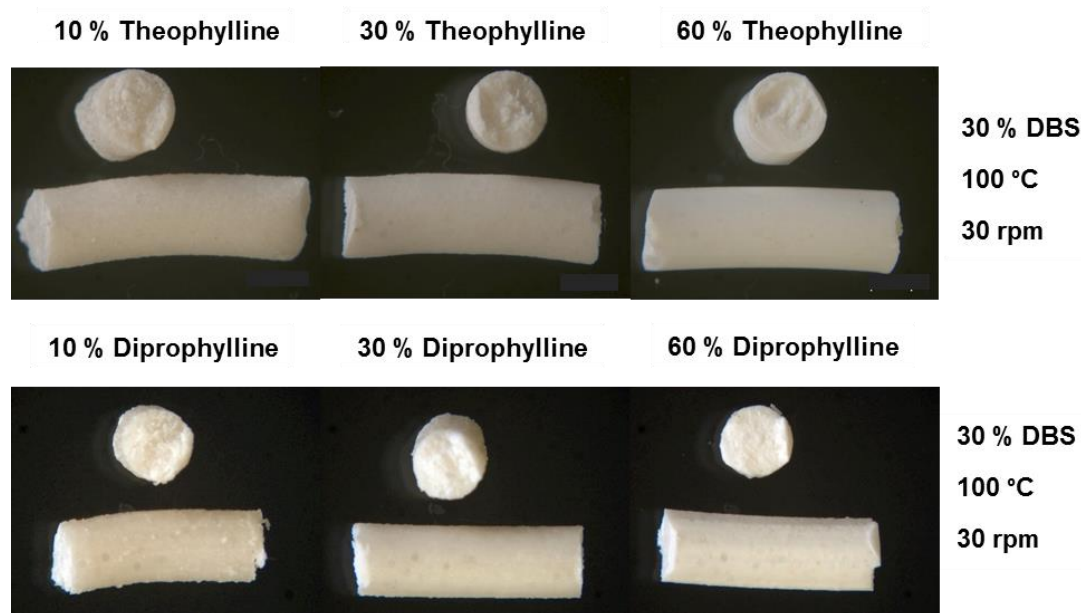

Figure 50: Macroscopic pictures of hot melt extrudates (cross-sections and surfaces) based on 80:20 ethylcellulose:guar gum blends. The extrudates were plasticized with 30 % DBS (referring to ethylcellulose), the extrusion temperature was 100 °C and the screw speed 30 rpm. The type and amount of drug were varied as indicated.

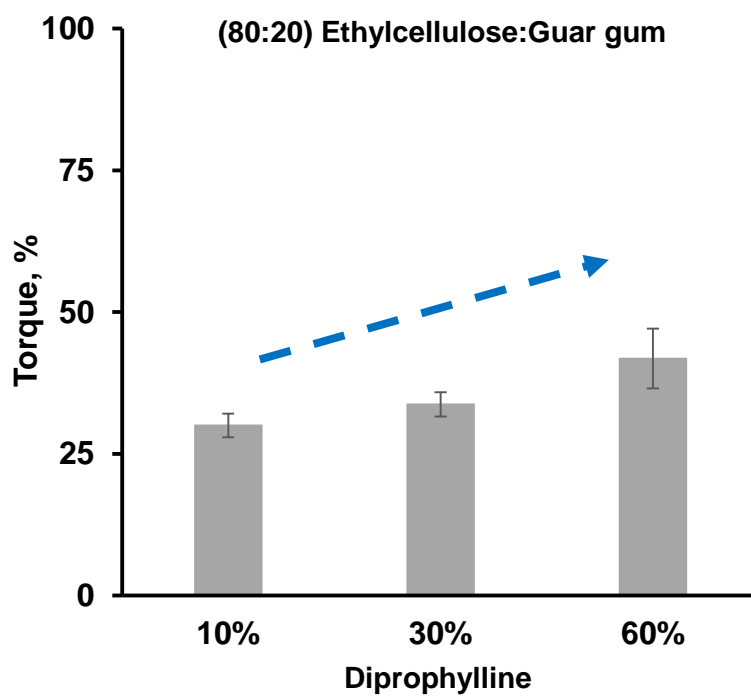
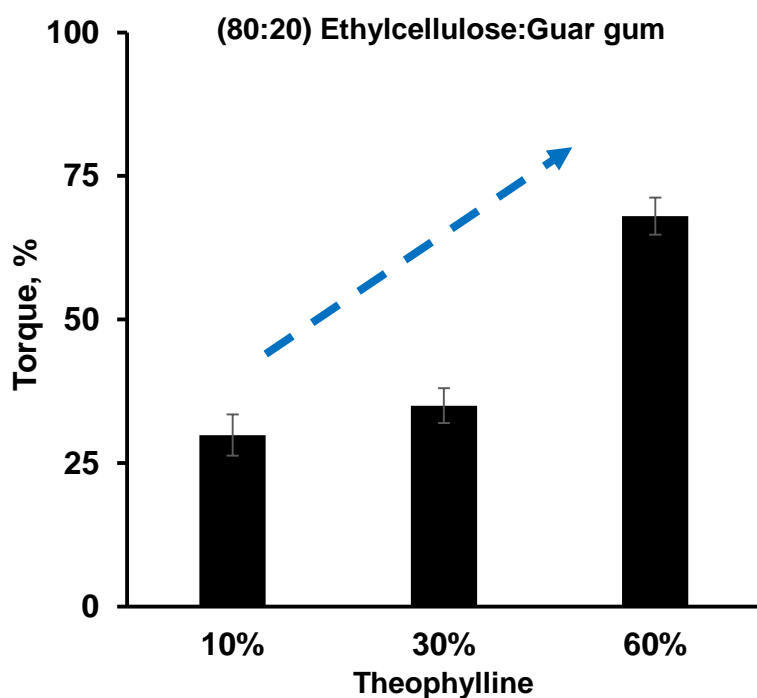

Figure 51: Impact of the theophylline or diprophylline loading on the generated torque during hot melt extrusion. The systems were based on 80:20 ethylcellulose:guar gum blends, the extrusion temperature was 100 °C, the extrudates were plasticized with 30 % DBS.

Furthermore, the impact of the type of drug and drug loading was studied (figures 51 and 52): The percentages of slightly water-soluble theophylline and freely water-soluble diprophylline were varied from 10 to 60 %. Figure 51 shows the respective torque values observed during extrusion (at 100 °C, with 30 % DBS). Figure 52 shows the resulting drug release kinetics in 0.1 M HCl for 2 h, followed by phosphate buffer pH 6.8 for 22 h. As it can be seen, the torque values increased with increasing drug loading (especially in the case of theophylline). This can probably be attributed to the fact that both drugs do not melt at 100 °C (figure 55) and that the relative amounts of more easily extrudable, plasticized polymer blends in the formulations decrease. Figure 52 shows that also the resulting drug release rates clearly increased with increasing drug loading. This can at least partially be explained by the fact that less drug release retarding polymer is present in the systems. Or, in other words: Upon drug release, the systems become more and more porous and remaining drug can more easily diffuse out.

This is very important from a practical point of view: Most of the drug is released after 24 h at an initial drug loading of 60 %. Also, as it can be seen, about zero order release kinetics can be provided during major parts of the release periods: Theophylline and diprophylline were released at a rate of approximately 3 %/h during 24 h. Please note that perfect sink conditions were provided throughout the experiments. Thus, the observed relatively constant drug release rates can probably be attributed to drug saturation effects within the hot melt extrudates: The amounts of water penetrating into the systems are limited and most likely not sufficient to dissolve the entire drug loadings. Thus, non-dissolved and dissolved drug co-exist within the systems. Importantly, only dissolved drug is available for diffusion. This results in about constant drug concentration differences: saturated solutions inside the hot melt extrudates and perfect sink conditions in the surrounding bulk fluids.

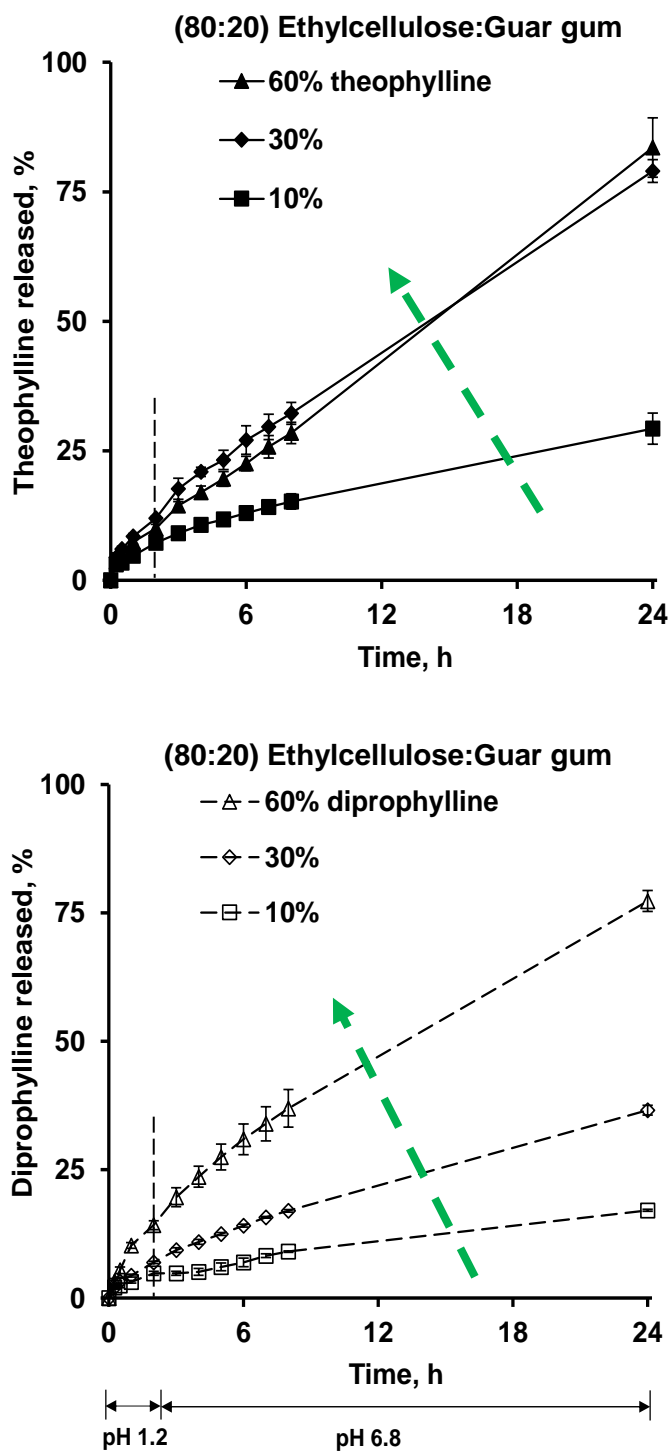

Figure 52: Impact of the theophylline or diprophylline loading on drug release from extrudates in 0.1 M HCl for 2 h, followed by phosphate buffer pH 6.8. The systems were based on 80:20 ethylcellulose:guar gum blends, the extrusion temperature was 100 °C, the extrudates were plasticized with 30 % DBS.

Since guar gum has been reported to be preferentially degraded by enzymes secreted by bacteria present in the colon [201-203] and since the provided drug release periods were rather long, it was important to evaluate whether or not the exposure to fecal samples potentially altered the resulting drug release kinetics from the investigated hot melt extrudates. Due to the intimate mixture of guar gum with ethylcellulose, it might be that the latter effectively protects the guar gum against enzymatic degradation. For this reason, hot melt extrudates loaded with 60 % theophylline or 60 % diprophylline, based on ethylcellulose:guar gum 80:20 blends (plasticized with 30 % DBS referred to ethylcellulose) were prepared at 100 °C and exposed to 0.1 M HCl for 2 h, followed by phosphate buffer pH 6.8 for 6 h, and fecal samples for 10 h (the latter under anaerobic conditions). For reasons of comparison, the extrudates were also exposed to 0.1 M HCl and phosphate buffer pH 6.8, followed by culture medium free of fecal bacteria. The 0.1 M HCl was intended to simulate the conditions in the stomach, the phosphate buffer pH 6.8 in the small intestine, and the fecal samples the conditions in the colon. The solid curves in figure 53 show the experimentally measured drug release rates with this set up using fecal samples, whereas the dashed curves show the respective release rates observed with culture medium free of feces. As it can be seen, the presence of fecal bacteria did not have a noteworthy impact on drug release, irrespective of the type of drug (figure 53).

Furthermore, the long term stability of the investigated hot melt extrudates was studied. Figure 54 shows the release rates of diprophylline and theophylline from ethylcellulose:guar gum 80:20-based systems in 0.1 M HCl for 2 h, followed by 22 h in phosphate buffer pH 6.8. The drug loading were varied from 10 to 60 %, the extrudates were prepared at 100 °C and contained 30 % DBS (referring to ethylcellulose). The solid curves illustrate drug release prior to storage, the dashed curves drug release after 1 year storage at ambient conditions. In all cases, drug release did not change to a noteworthy extent.

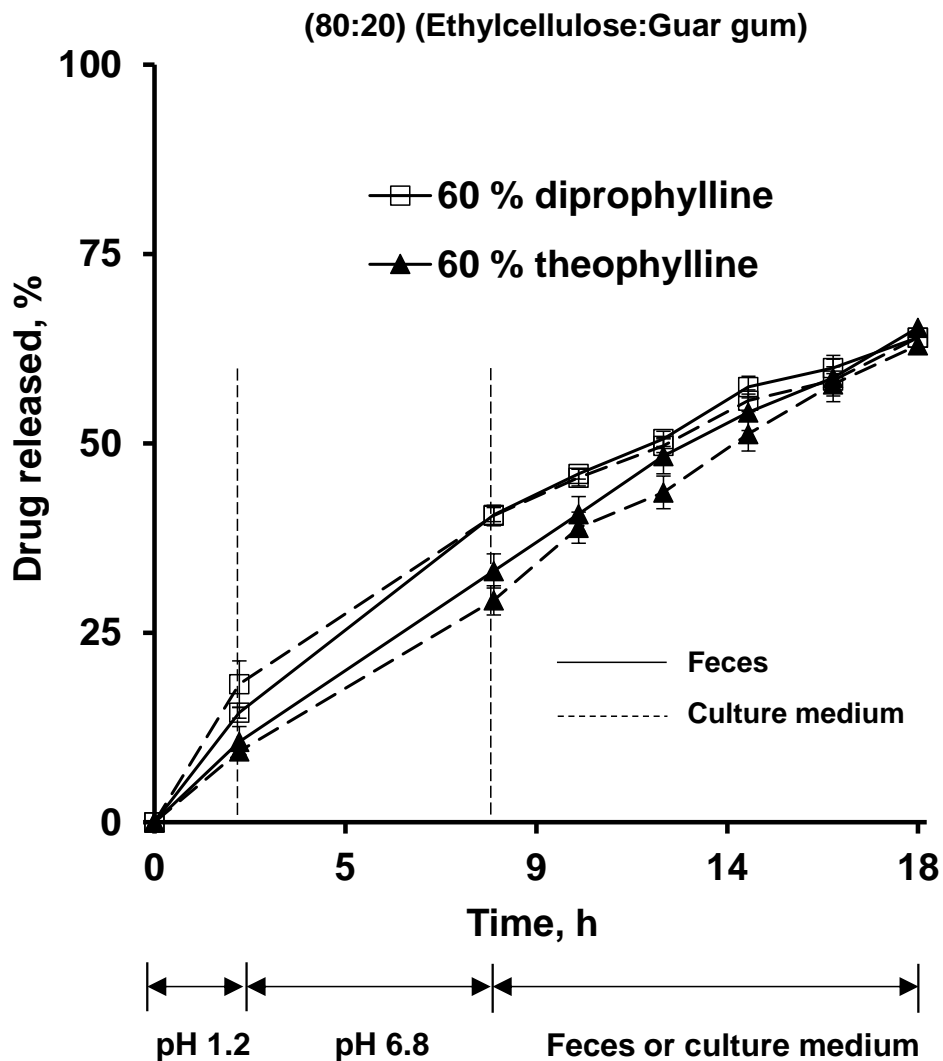

Figure 53: Drug release from hot melt extrudates based on 80:20 ethylcellulose:guar gum blends under conditions simulating the transit through the entire gastro intestinal tract: 2 h in 0.1 M HCl, followed by 6 h in phosphate buffer pH 6.8, followed by culture medium inoculated with human fecal samples (solid curves). For reasons of comparison also drug release in 0.1 M HCl, phosphate buffer pH 6.8 and culture medium without fecal samples is shown (dotted curves). The drug loading was 60 %, the extrusion temperature 100 °C. The extrudates were plasticized with 30 % DBS (referring to ethylcellulose).

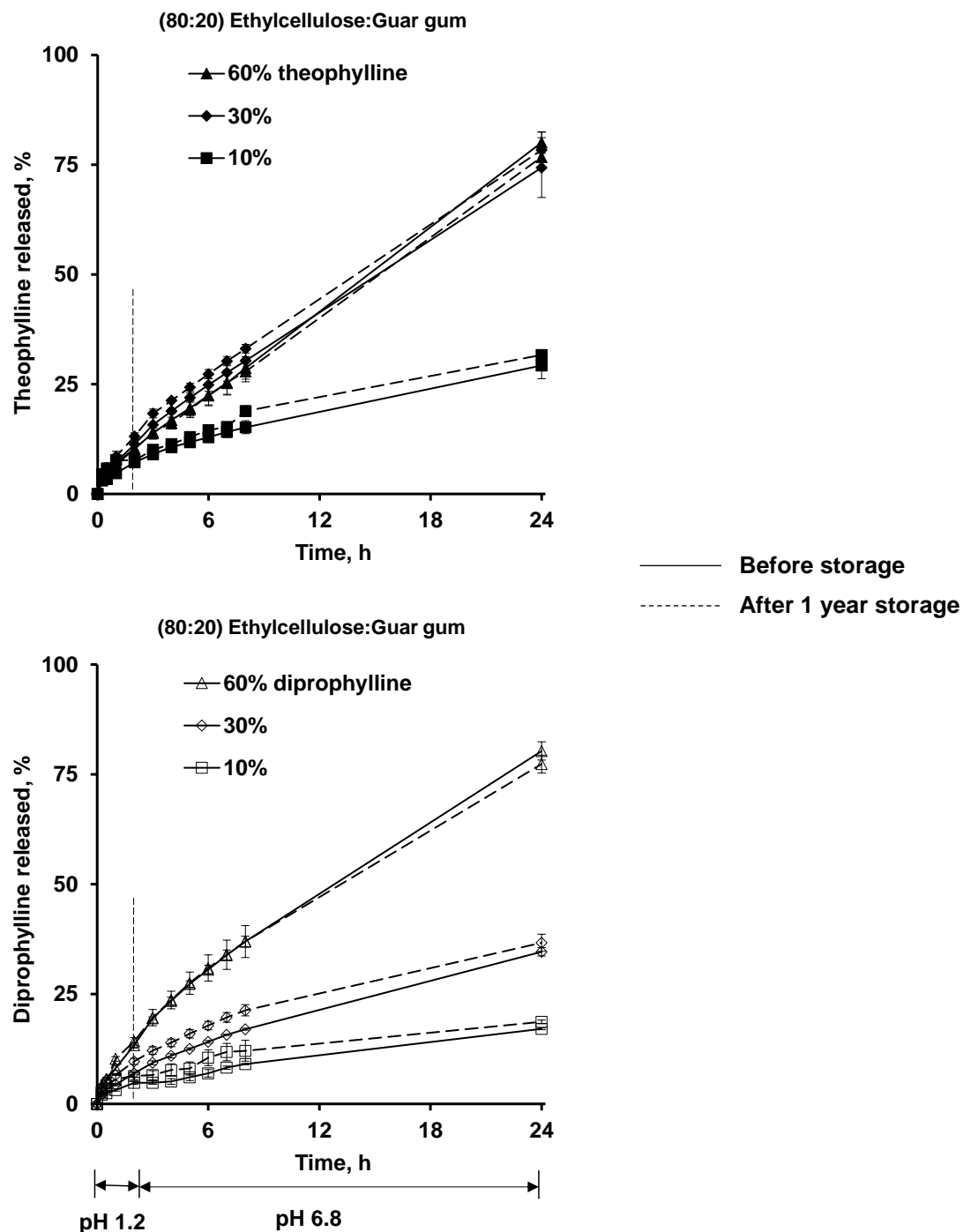

Figure 54: Storage stability of hot melt extrudates based on 80:20 ethylcellulose:guar gum blends loaded with theophylline or diprophylline (as indicated). The extrusion temperature was 100 °C, the extrudates were plasticized with 30 % DBS. Drug release was measured in 0.1 M HCl (for 2 h), followed by phosphate buffer pH 6.8 before (solid curves) and after 1- year open storage at ambient conditions (dotted curves).

2.3. Physical characterization

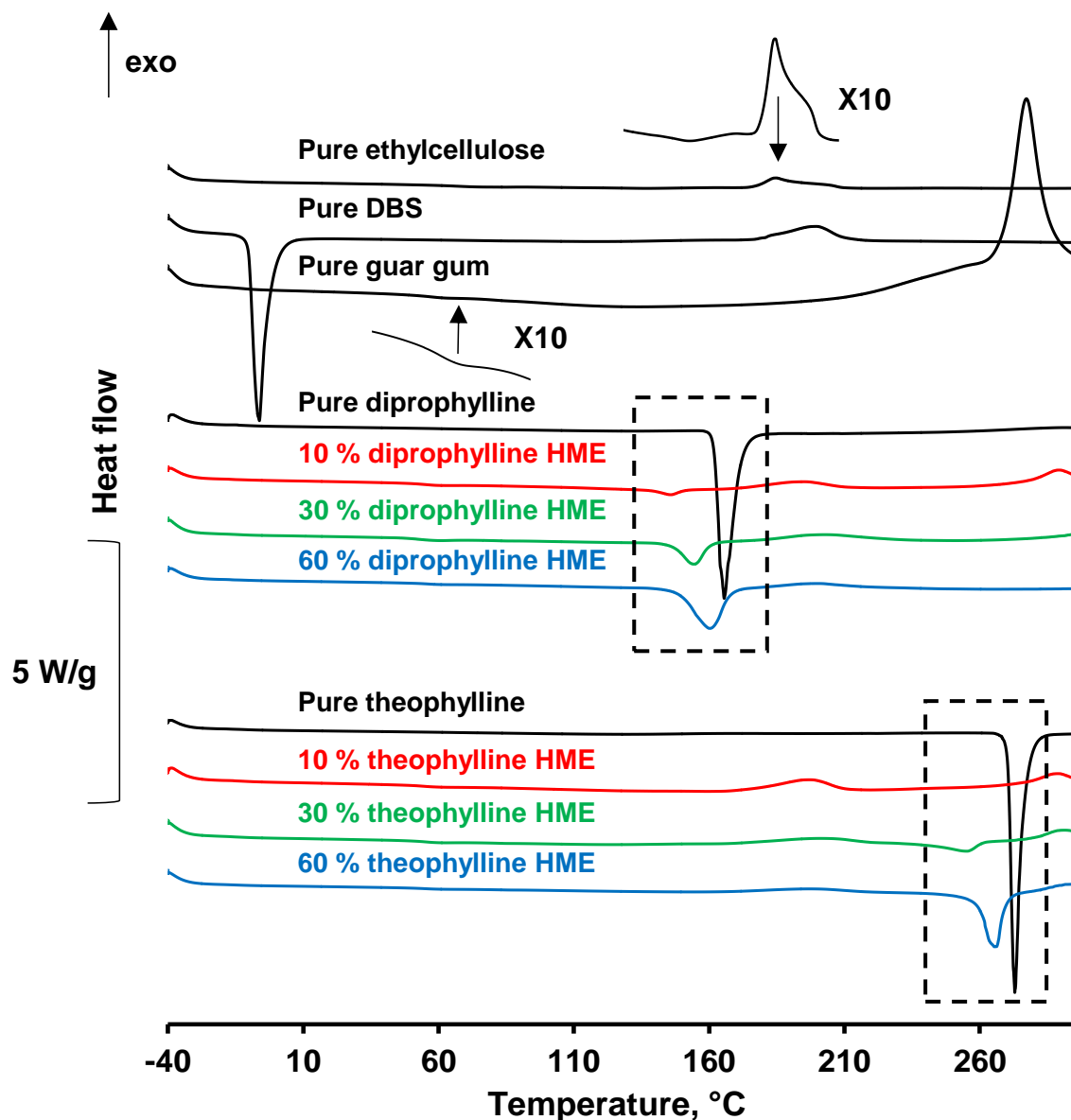

Figure 55: DSC thermograms of hot melt extrudates based on 80:20 ethylcellulose:guar gum blends. The type and amount of drug were varied as indicated. The extrusion temperature was 100 °C, the extrudates were plasticized with 30 % DBS (referring to ethylcellulose). For reasons of comparison, also the DSC thermograms of the pure drugs, polymer powders and DBS (all as received) are illustrated.

Figure 55 shows DSC thermograms of hot melt extrudates loaded with 10 to 60 % diprophylline or theophylline, based on ethylcellulose:guar gum 80:20 blends plasticized with 30 % DBS (referring to ethylcellulose) prepared at 100 °C. For reasons of comparison, also the DSC thermograms of the following raw materials (as received) are illustrated: ethylcellulose, guar gum, DBS, diprophylline and theophylline. Pure ethylcellulose showed 2 thermal events: (i) a glass transition (T_g) at about 130 °C, which is in good agreement with data reported in the literature [204], and (ii) an exothermic event at approximately 185 °C. Lai et al., [205] have shown that for “Ethocel Standard 100 Premium” (an ethylcellulose with a higher molecular weight than the investigated polymer) (Dow, Midland, MI, USA) a similar exotherm corresponded to an oxidative degradation (the pans were hermetically closed, the nitrogen flushing was outside the pans), which masks the melting of a small crystalline fraction

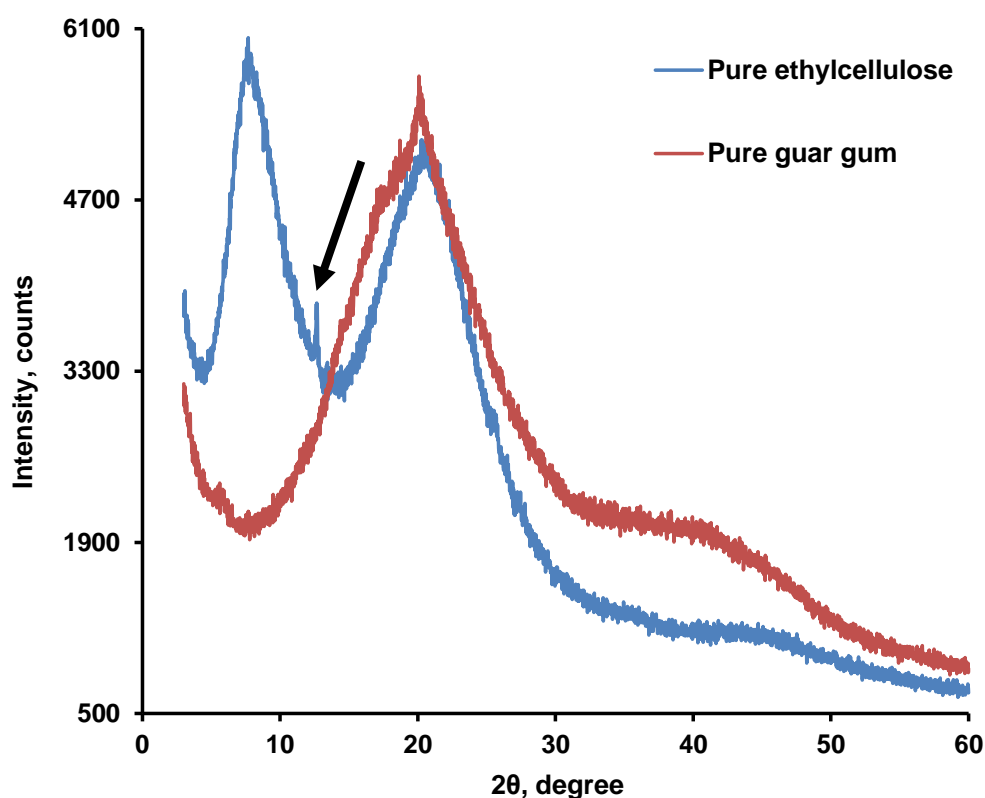

Figure 56: X-ray diffractograms of pure ethylcellulose and pure guar gum powders (as received).

The presence of a small crystalline fraction in the ethylcellulose raw material was further confirmed by X-ray powder diffraction measurements (figure 56). A Bragg peak was visible at about $2\theta = 12^\circ$. Also, Huang et al., [206] reported a Bragg peak for another ethylcellulose (“N7 viscosity grade”, 48.0 – 49.5 w/w ethoxyl groups) (Hercules, Wilmington, DE, USA) in this range. Furthermore, TGA revealed thermal degradation of ethylcellulose above 200° (figure 57).

The guar gum raw material was X-ray amorphous (figure 56). The DSC thermogram showed a glass transition at about 60°C and an exothermic event between 250 and 300°C , corresponding to thermal degradation, as confirmed by TGA (figure 57). This is also consistent with data reported in the literature [207]. The TGA curve also indicates a mass loss of about 10 % between 20°C and approximately 125°C , likely corresponding to water loss. DBS is a liquid at room temperature, melting at approximately -10°C .

Diprophylline and theophylline showed sharp melting endotherms at about 162 and 275°C , respectively (figure 55), indicating their crystalline nature. In the different types of hot melt extrudates (except for hot melt extrudates loaded with 10 % theophylline) such endotherms could also be observed, but shifted toward lower temperatures (probably corresponding more to the dissolution of drug crystallites into their amorphous environment, rather than to melting). So, the diprophylline is at least partially distributed in the form of small crystals throughout the hot melt extrudates at all the investigated drug loadings. In contrast, theophylline is likely completely dissolved and/or amorphous at 10 % drug loading, and at least partially dispersed in the form of small crystals at 30 and 60 % drug loading.

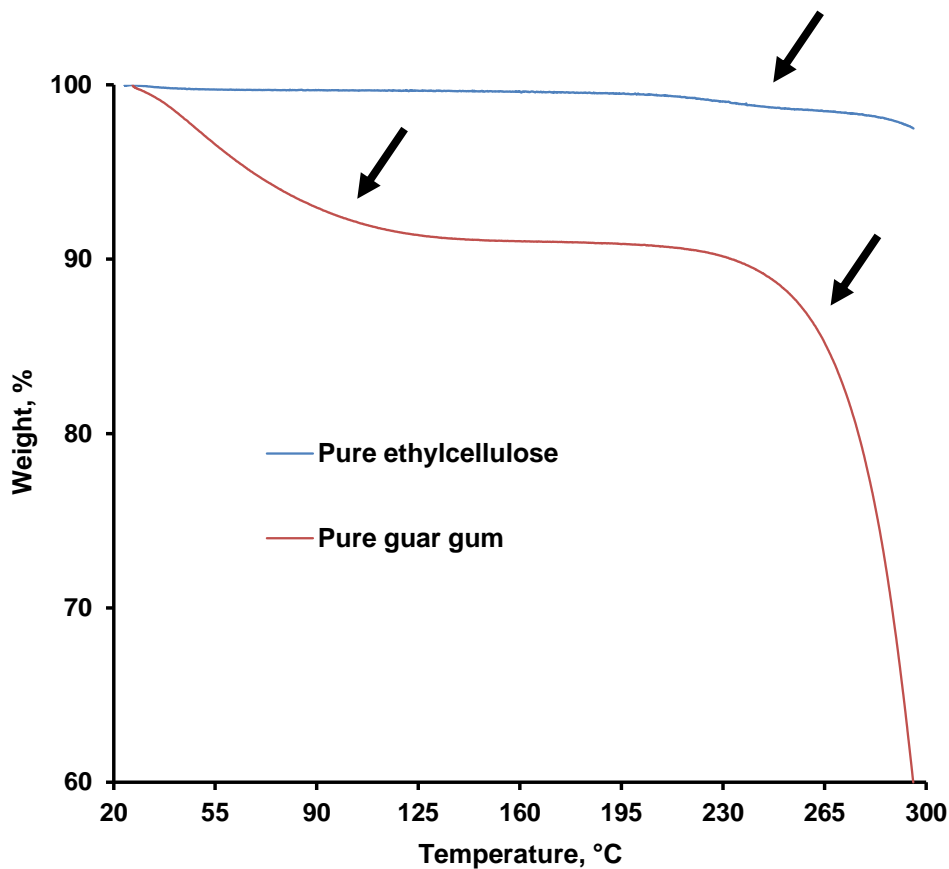

Figure 57: TGA thermograms of pure ethylcellulose and pure guar gum powders (as received).

Hot melt extrudates based on ethylcellulose:guar gum blends offer an interesting potential as controlled drug delivery systems: They can be prepared at temperatures of about 100 °C, provide broad spectra of drug release patterns (in particular about constant drug release rates) and are long term stable. The ethylcellulose can effectively protect the guar gum against potential enzymatic degradation in the colon.

IV. CONCLUSIONS AND PERSPECTIVES

CONCLUSIONS AND PERSPECTIVES

In this work, different dosage forms (thin polymeric films, hot melt extrudates and capsules) have been developed and characterized *in vitro*. These new developed systems are based on polysaccharides; allowing for colon targeting and thermoplastic polymers, which play an important role in controlled drug delivery and especially in the site-specific drug delivery to the colon.

We have identified novel dosage forms for oral colonic drug delivery, which are adapted to the physiopathological conditions of patients. These systems showed low water uptake and mass loss upon exposure to simulated gastric and intestinal fluid. However, in contact with simulated colonic fluid, these systems showed a considerable water content and mass loss due to the fermentation of the polysaccharide by colonic bacteria. Furthermore, novel dosage forms for controlled drug delivery have been developed. These systems offered large spectrum of drug delivery patterns.

These systems should be deeply investigated and studied for optimization. It has been pointed out that care should be taken when changing the dosage form (e.g. manufacturing process) as well as the composition of the formulation. This can result different polymer-polymer distribution into the dosage form.

V. RESUME IN DETAIL (FRENCH)

1. Introduction Générale

Les maladies inflammatoires chroniques de l'intestin (MICI) sont des maladies inflammatoires continues ou intermittentes de différentes parties de la muqueuse intestinale qui touchent principalement les jeunes adultes. Ce terme désigne notamment deux maladies du tractus gastro-intestinal (TGI) : la maladie de Crohn et la rectocolite hémorragique. Elles se caractérisent par une inflammation de la muqueuse d'une partie du tube digestif liée à une hyper-activation du système immunitaire digestif. Bien que l'étiologie des MICI reste inconnue, plusieurs facteurs à risque sont suspectés, notamment génétiques et environnementaux tels que la pollution, le tabagisme, ou bien liés à une dysbiose du microbiote [1,2]. Les deux sont des maladies chroniques impliquant une inflammation de la muqueuse intestinale [3]. La principale différence entre la maladie de Crohn et la rectocolite hémorragique réside dans le lieu et la nature de l'inflammation. La maladie de Crohn peut toucher n'importe quelle partie du tractus gastro-intestinal, de la bouche à l'anus mais dans la plupart des cas, elle atteint l'iléon. En revanche, la rectocolite hémorragique est limitée au côlon et au rectum [4].

Parmi les symptômes on compte des douleurs abdominales, des diarrhées et la perte de poids. Des complications peuvent survenir telles que la dilatation toxique du côlon pouvant parfois causer le cancer du côlon, d'où la nécessité d'une surveillance régulière [6].

Les différentes stratégies thérapeutiques utilisées pour traiter les maladies inflammatoires chroniques de l'intestin peuvent être liées aux traitements médicamenteux, aux médicaments biologiques, aux immunosuppresseurs, aux traitements symptomatiques et enfin à la chirurgie. Les traitements médicamenteux comprennent les anti-inflammatoires qui nécessitent une administration fréquente et élevée de médicaments afin de contrôler la croissance et de maintenir les patients en rémission plus prolongée, ce qui peut entraîner des effets indésirables graves [7].

Une administration locale de médicaments au niveau colique peut fournir des avantages majeurs tels que:

- Réduire les doses d'administration élevées du médicament grâce à l'administration locale au site d'action [8].
- Le système d'administration de médicaments au niveau du colon pourrait permettre l'administration orale de médicaments à base de peptides et de protéines [9].
- Le côlon est un site où l'administration locale ou systémique du médicament pourrait être réalisée (traitement topique des maladies inflammatoires de l'intestin). Ces affections inflammatoires sont généralement traitées avec des glucocorticoïdes et de l'acide 5-aminosalicylique.
- Un certain nombre de maladies graves du côlon, par exemple le cancer colorectal, pourraient également être traitées plus efficacement si les médicaments étaient ciblés au niveau du côlon [8].
- Réduire les effets secondaires systémiques [9].

Les formes classiques ne peuvent pas être utilisées en raison de leur libération prématurée de la substance active dans l'estomac et l'intestin grêle. De ce fait, la substance active sera absorbée dans la circulation sanguine, provoquant des effets secondaires considérables. De plus, la concentration de l'actif sera très faible au site d'action (partie distale du TGI), ce qui peut réduire l'efficacité du traitement. Afin de surmonter ce problème, une forme galénique idéale devrait protéger efficacement le médicament dans le haut TGI et ensuite libérer la substance active dans la partie distale du TGI de manière contrôlée dans le temps, en fonction de l'état pathologique. Des systèmes réservoirs (granules enrobés, capsules...) ou des systèmes matriciels (comprimés, extrudats...) peuvent être utilisés pour protéger le médicament dans la partie supérieure du tube digestif. Les polysaccharides qui ne sont dégradés que par des enzymes bactériennes localisées dans le côlon

ou partiellement dans l'intestin grêle [140] peuvent constituer un outil très utile pour le traitement des maladies inflammatoires chroniques de l'intestin.

2. Libération contrôlée par voie orale

Il existe de nombreuses voies d'administration de substances actives (SA) : locale, orale, rectale et parentérale. La voie orale est la voie la plus utilisée en raison de ses nombreux avantages, tels que la facilité d'administration, le traitement ambulatoire, moins d'anxiété psychologique lors des piqûres intraveineuses et la réduction des risques infectieux. De plus, cela permet une production industrielle relativement facile et donc des coûts de production faibles (les formes pharmaceutiques ne sont pas stérilisées, par exemple) [10]. Cependant, de nombreux inconvénients peuvent être rencontrés. En effet, la substance active peut être toxique pour certains tissus et agressive si elle est absorbée à un endroit inapproprié. Elle peut également être dégradée avant d'atteindre le site d'action, puis perdre l'efficacité du traitement. Cela nécessite l'administration de plusieurs doses et qui entraîne des effets secondaires très importants. En outre, l'absorption et la biodisponibilité d'un médicament peuvent être différentes d'un patient à l'autre en raison de plusieurs facteurs physiopathologiques (ex. le transit gastrique, les variations de pH dans le tractus gastro-intestinal, l'administration de nourriture ainsi que l'état de la muqueuse). De ce fait, les études *in vitro* doivent prendre en compte tous ces facteurs [11].

Des systèmes à libération contrôlée ont été développés pendant des années, permettant l'administration de grandes quantités de substance active et leur libération selon le profil souhaité. Une substance active est mélangée avec des excipients spécifiques afin d'améliorer l'efficacité du médicament et de réduire les effets secondaires indésirables. Ces systèmes peuvent (i) protéger un médicament contre la dégradation gastrique, évitant ainsi les lésions gastriques et la perte

d'efficacité du médicament, (ii) libérer un médicament progressivement, (iii) délivrer spécifiquement des médicaments au niveau du site d'action (ex. le ciblage du colon) [12].

Les systèmes à libération contrôlée sont très utiles pour atteindre et maintenir une concentration plasmatique optimale de substance active pendant une période de temps souhaitée. En contrôlant le taux d'administration de la substance active, la durée d'action thérapeutique peut être prolongée.

En général, le développement de formulations à libération contrôlée offre de nombreux avantages par rapport aux formes galéniques conventionnelles : administration contrôlée d'une dose thérapeutique au débit souhaité, ce qui entraîne moins de fluctuations des concentrations plasmatiques [12]. Il en résulte une toxicité réduite des effets secondaires et une efficacité accrue du traitement. Cela peut diminuer la fréquence de la dose de médicament, améliorant ainsi l'observance du patient. Les inconvénients comprennent le temps plus long nécessaire pour atteindre les concentrations sanguines thérapeutiques ce qui peut augmenter la variation de la biodisponibilité après administration orale, un effet de premier passage accru, le risque de décharge de dose toxique (en particulier pour les systèmes à réservoir) et des coûts généralement plus élevés [13].

En règle générale, les systèmes d'administration à libération contrôlée peuvent être divisés en deux groupes :

- Les systèmes matriciels dans lesquels un médicament est dissous/dispersé de manière homogène dans un réseau polymérique. Ces dispositifs offrent plusieurs avantages tels que la facilité de fabrication, le faible coût et la capacité d'incorporer une grande quantité de substance active. Différents types de systèmes matriciels peuvent être formulés et ainsi les mécanismes de libération de la substance active seront différents [15-17].
- Les systèmes réservoir dans ce cas, la substance active est superposée à un noyau inerte ou incorporé à une matrice formée par un excipient soluble dans l'eau, le tout entouré d'une ou de plusieurs couches polymériques. Selon les propriétés du polymère, les mécanismes de

libération du médicament varient et par conséquent, les profils de libération seront différents [18,20].

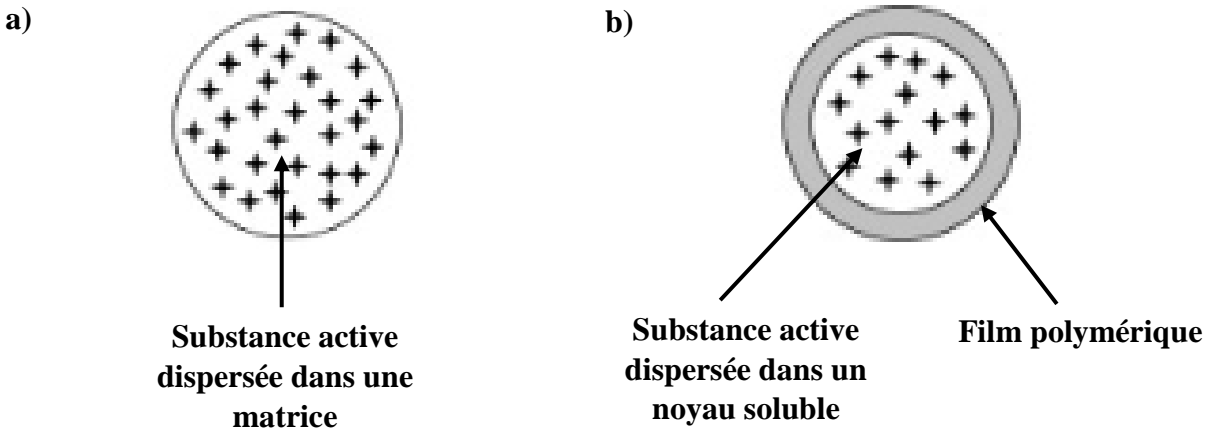

Figure 1 : Représentation schématique d'un système a) matriciel et b) réservoir [14].

3. Extrusion par fusion à chaud et moulage par injection

3.1. Définition

L'extrusion par fusion à chaud a été utilisée dans de nombreux domaines industriels, principalement dans le traitement des aliments et la fabrication de plastiques. La première utilisation industrielle des extrudeuses à une vis remonte au milieu du XIXe siècle avec l'extrusion de matériaux thermoplastiques. Depuis lors, cette technique est devenue très intéressante dans l'industrie pharmaceutique et sa robustesse a été démontrée pour de nombreux systèmes de distribution de médicaments [26,27]. Les brevets relatifs aux systèmes pharmaceutiques fondés sur l'extrusion à chaud ont augmenté régulièrement depuis le début des années 80. Jusqu'à présent, les États-Unis et l'Allemagne sont à la pointe des brevets sur le marché de l'extrusion par fusion [28].

L'extrusion par fusion à chaud est un processus continu dans lequel le matériau fond ou se ramollit à des températures élevées. Il est ensuite forcé à travers une filière, généralement à l'aide d'une ou deux vis de transport dans un cylindre. Au cours du processus, le matériau est soumis à un

chauffage et à un mélange intense permettant une dispersion homogène des particules de substance active dans un mélange de polymères fondus [29].

L'extrudeuse peut avoir une ou deux vis. L'extrudeuse à deux vis est devenue le dispositif préféré en raison de sa meilleure capacité de mélange. Elle utilise deux vis, disposées côte à côte et permettant d'obtenir un certain nombre de configurations différentes dans toutes les zones de chauffe jusqu'à la filière. Les vis peuvent tourner dans le même sens (co-rotation) ou dans le sens opposé (contre-rotation, utilisée lorsque des forces de cisaillement élevées sont requises). Le frottement entre le cylindre, le mélange et les vis en rotation fournit la force motrice nécessaire pour que le matériau atteigne l'orifice. Selon la conception de l'extrudeuse, le matériau peut être alimenté à différents endroits. De plus, des additifs peuvent être ajoutés à la masse fondue à plusieurs endroits en aval, en utilisant un distributeur latéral. Les liquides peuvent également être introduits à l'aide d'une pompe à liquide et d'un système d'injection de liquide [29]. Une fois que le matériau a pénétré dans la zone de transition, il fond en raison de la température accrue dans le cylindre. Le matériau se mélange ensuite à la substance active à l'aide des vis et se déplace le long du cylindre en direction de l'orifice. Lorsque le matériau atteint la fin du cylindre sous forme de masse fondue ou de dispersion homogène, il est acheminé à travers l'orifice et est dimensionné pour obtenir sa forme finale [30].

L'ajustement des paramètres d'extrusion a une importance capitale dans la fabrication de tels systèmes d'administration de substances actives. Les paramètres ajustables comprennent la vitesse des vis, la température de traitement et le taux d'alimentation qui ont une incidence sur la contrainte de cisaillement, le temps de séjour moyen et à long terme le taux de dissolution et la stabilité du produit final [29]. À cet effet, les extrudeuses sont équipées de capteurs capables de mesurer les températures du cylindre et de l'orifice, le débit d'alimentation, la vitesse des vis, la contrainte de cisaillement, la pression et la température de fusion au cours du processus. De plus, d'autres

techniques thermo-analytiques telles que la microscopie, la calorimétrie différentiel à balayage, l'analyse dynamique thermomécanique (DMTA) et l'analyse thermogravimétrique (TGA) sont souvent utilisées pour étudier la stabilité chimique, le comportement thermique et les propriétés cristallines des actifs et/ou excipients dans la forme galénique finale [31].

3.2. Les applications pharmaceutiques de l'extrusion par fusion à chaud

L'extrusion par fusion à chaud est un procédé continu permettant la préparation de dispersions ou de solutions solides, en fonction de la solubilité d'une substance active dans une matrice (souvent un polymère) ainsi que de sa concentration dans le système. De telles formes galéniques solides ont le potentiel d'améliorer la biodisponibilité, l'efficacité et la sécurité du traitement médicamenteux. L'extrusion par fusion à chaud est utilisée pour produire différents systèmes d'administration de substance active par voie orale, tels que des films polymériques [32,33] et des comprimés [34-36] mais également par voie transdermique [37], trans-mucosale [38,39] et intraoculaire (implants). [40,41]. Trois types de dispersions solides peuvent être produites: (i) une dispersion amorphe où la substance active et le polymère sont amorphes mais où elle est dispersée sous une forme particulière dans le polymère, le thermogramme DSC montre deux Tg correspondant à celles de l'actif et celle du polymère, (ii) une dispersion cristalline, dans laquelle toute/une fraction de la substance active reste cristalline dans le polymère amorphe, le thermogramme DSC montre une Tg correspondant à celle du polymère et un pic de fusion/dissolution correspondant à celui de l'actif et enfin (iii) une solution amorphe dans laquelle la substance active et le polymère sont amorphes et complètement miscibles, ce qui peut être indiqué par une seule Tg dans le thermogramme DSC. Notez que dans le cas d'une solution amorphe, la substance active est dispersée au niveau moléculaire [42]. Les solutions amorphes ont l'avantage d'augmenter la disponibilité d'une substance active peu soluble dans l'eau. Dans une dispersion cristalline, les cristaux de substance active sont dispersés

dans la matrice amorphe qui la libère de manière prolongée. Les dispersions amorphes sont les moins stables avec une forte tendance à une recristallisation de la substance active qui est dispersée sous forme amorphe dans la matrice. La formation de l'une de ces trois dispersions solides dépend de la solubilité du médicament dans le polymère, des interactions médicament-polymère et de la stabilité du mélange [43].

Le choix de la nature du polymère est essentiel dans le processus de formulation et de son application. Certaines des applications les plus connues de l'extrusion par fusion à chaud sont:

- Le masquage du goût de substances actives [44-47].
- L'augmentation de la solubilité de substances actives faiblement solubles dans l'eau pour une libération immédiate [48-51].
- La mise au point de systèmes à libération prolongée d'une substance active [52-55].
- La fabrication de systèmes à libération ciblée d'une substance active [57-59].

Outre ces applications actuelles, il convient de mentionner certaines innovations récentes, telles que la co-extrusion [60-62], la co-cristallisation [63-66], l'impression 3D [67-69] et le moulage par injection [70-73].

4. Le ciblage du colon

L'administration de médicaments dans le côlon peut améliorer les traitements locaux des maladies inflammatoires chroniques de l'intestin, telles que la maladie de Crohn et la rectocolite hémorragique. La suppression de la libération prématurée du médicament dans la partie supérieure du tractus gastro-intestinal (TGI) évite l'absorption de la substance active dans le sang et minimise ainsi les effets secondaires indésirables. Une fois le côlon atteint, la substance active est libérée idéalement de manière contrôlée dans le temps, afin d'optimiser les concentrations d'actif au site

d'action, conduisant à de meilleurs effets thérapeutiques [125]. Différentes stratégies ont été rapportées dans la littérature visant à administrer un médicament au niveau du côlon [126].

Des systèmes enrobés peuvent être utilisés pour une administration locale et ciblée au niveau du colon. Cet enrobage doit être insoluble et imperméable à la diffusion de l'actif dans l'estomac et dans l'intestin grêle, mais devrait se dissoudre ou devenir perméable dès que le site cible est atteint. Afin de fournir les propriétés des systèmes spécifiques au site d'action, les approches suivantes ont été décrites dans la littérature: (i) Systèmes dépendant du pH utilisant des polymères sensible à des valeurs de pH, basé sur les différences de niveaux de pH dans les différentes parties du TGI. Les polymères décrits comme dépendant du pH dans l'administration de médicaments spécifiques du côlon sont insolubles à des niveaux de pH bas, mais le deviennent de plus en plus à mesure que le pH augmente [127]. Bien qu'un polymère dépendant du pH puisse protéger une formulation dans l'estomac et l'intestin grêle, il peut commencer à se dissoudre dans l'intestin grêle distale et donc la spécificité de la formulation peut être médiocre [128], (ii) systèmes dépendant du temps sont également des systèmes de libération de substances actives très prometteurs. Cependant, en raison des variations potentiellement importantes du temps de vidange gastrique chez l'homme et du type et de la quantité de nourriture ingérée, l'heure d'arrivée du médicament au côlon ne peut pas être prédit avec précision, ce qui entraîne une faible biodisponibilité au niveau du côlon [129]. La variation du temps de transit peut être provoquée par des mouvements gastro-intestinaux, en particulier le péristaltisme. La contraction de l'estomac entraînerait également une modification du transit gastro-intestinal [130]. Cela peut être également expliqué par le transit accéléré dans différentes régions du côlon chez les patients atteint de MICI [131-133], (iii) systèmes sensibles aux bactéries se sont avérés les plus prometteurs et les mieux adaptés à l'état physiopathologique des patients en raison de la concentration élevée du microbiote colique et des activités enzymatiques dans la partie distale du TGI [134]. L'utilisation de polysaccharides attire beaucoup d'attention pour

le développement de médicaments ciblant le côlon, puisque ces polymères se trouvent en abondance, ont une grande disponibilité, sont peu coûteux et sont disponibles dans des structures aux propriétés variées. Ils sont hautement stables, sûrs, non toxiques, hydrophiles et biodégradables. Ceux-ci comprennent des polysaccharides obtenus à partir de plantes (gomme de guar, inuline), d'origine animale (chitosan), d'algues (alginates) ou microbiennes (dextrane) [135]. En combinaison avec un polymère dépendant du temps ou du pH, le système devrait être capable de minimiser ou de supprimer complètement la libération de la substance active dans la partie supérieure du TGI. Mais au contact du liquide colique, la libération est déclenchée par la fermentation du polysaccharide par l'action d'enzymes sécrétées par les souches bactériennes du côlon.

L'utilisation de formes galéniques multiparticulaires de diamètre entre 1 et 3 mm (ex. les granules ou les mini-matrices) peut être très intéressante et offre un avantage majeur par rapport aux formes galéniques unitaires (ex. les comprimés ou les gélules), comme l'effet tout ou rien qui peut être évité: si un comprimé est accidentellement endommagé dans la partie supérieure du TGI, la dose de substance active entière est perdue et le temps de vidange gastrique est moins variable. De plus, des quantités significatives de substance active peuvent être incorporées dans le noyau des formes galéniques enrobées. Ceci est particulièrement important pour les médicaments fortement dosés en substance active, telle que l'acide 5-aminosalicylique (5-ASA), qui est l'anti-inflammatoire standard utilisé pour le traitement local des maladies inflammatoires chroniques de l'intestin [136-138]. En raison de variations des conditions physiologiques des patients, l'utilisation d'une seule approche pour cibler le côlon ne serait pas fiable, même pour les formes galéniques multiparticulaires. Cependant, la combinaison d'approches différentes dans un même système d'administration pourrait rendre la délivrance de médicaments au côlon plus fiable.

5. Objectifs de la thèse

L'objectif principal de ce travail était de mettre au point de nouvelles formes galéniques préparées par extrusion par fusion à chaud/injection et moulage permettant la libération de substances actives au niveau du colon, destinées au traitement des maladies inflammatoires chroniques de l'intestin telles que la maladie de Crohn et la rectocolite hémorragique.

La stratégie utilisée consiste à associer un polysaccharide (pectine, gomme de guar, inuline, maltodextrine...) permettant le ciblage du colon par dégradation enzymatique et un polymère thermoplastique hydrophobe (éthylcellulose, polyuréthane, polyvinyle acétate...) permettant de réduire le caractère hydrophile du polysaccharide biodégradé. Cependant, le mélange des deux polymères ne doit pas masquer la dégradation enzymatique bactérienne du polysaccharide. De plus, des mélanges de polysaccharides extrudés à chaud pour une libération contrôlée ont été étudiés. Les objectifs particuliers inclus:

- La préparation et la caractérisation physicochimique de films polymériques de différents mélanges de polysaccharides et de polymères hydrophobes adaptés au ciblage du côlon.
- La préparation d'extrudats et des capsules moulées par injection ainsi que l'ajustement de l'ensemble des paramètres des procédés de fabrication.
- La caractérisation physicochimique des extrudats et des gélules et l'identification de systèmes prometteurs pour l'administration de médicaments dans le côlon.
- La préparation d'extrudats à base de polysaccharides pour une libération contrôlée de substances actives et l'optimisation des paramètres du procédé de fabrication.

6. Résultats et discussions

Le premier chapitre avait pour objectif le développement de formes galéniques à base de mélanges de polyvinyle acétate (Kollidon SR) et de différents types de polysaccharides pour une libération colique. Dans un premier temps, un screening de différents polysaccharides a permis d'identifier l'inuline et la maltodextrine comme deux candidats prometteurs pour le développement de formes galéniques permettant la libération de la substance active au niveau du colon. En effet, ces deux polysaccharides ont démontré une sensibilité aux bactéries présentes au niveau du colon. Des extrudats à base de mélanges de Kollidon SR et d'inuline ou de maltodextrine ont été préparés à des températures d'extrusion de 100 °C en ajoutant 30 % de dibutyle sebacate (DBS) comme plastifiant. Le ratio du mélange variait de 80:20, 70:30, 50:50, 30:70 à 20:80. Il a été démontré que des extrudats à base de mélange de Kollidon SR et d'inuline au ratio 50:50 absorbent peu d'eau et perdent peu de masse après exposition aux milieux simulant le haut tractus gastro-intestinal (une solution d'acide HCl 0,1 M pour simuler les conditions de l'estomac et un tampon phosphaté pH 6,8 pour simuler conditions de l'intestin grêle) grâce aux propriétés hydrophobes du Kollidon SR. Cependant, après exposition au milieu simulant le colon (un milieu de cultureensemencé de microbiote dans des selles de patients atteints de MICI), ces systèmes montrent une perte en masse considérable provoquée par la fermentation de l'inuline par des enzymes sécrétées par les bactéries coliques. Ces systèmes prometteurs ont été chargés avec 10 % de théophylline utilisée comme substance active modèle et la libération de la théophylline a été mesurée dans une solution d'acide HCl 0,1 M pendant 2 h, ensuite dans un tampon phosphaté pH 6,8 et enfin du microbiote dans des selles de patients pour simuler le côlon (dans des conditions anaérobies). Les mesures DSC ont été utilisées pour caractériser l'état physique des systèmes. Il est à noter, que ces extrudats à base de mélange de Kollidon SR et d'inuline au ratio 50:50 et contenant 10 % de théophylline libèrent un faible taux de substance active dans les milieux simulant le haut TGI. Cependant, le contact avec le

microbiote dans des selles de patients ne permet pas de déclencher la libération de la substance active et donc de pouvoir administrer localement la substance active au niveau du colon.

Cette étude a été poursuivie dans le deuxième chapitre où le Kollidon SR a été remplacé par différents types de polyuréthanes utilisés comme polymères hydrophobes. Des extrudats à base de mélanges d'inuline et de différents types de polyuréthanes (grades hydrophobes ou hydrophiles) ont été préparés à des températures d'extrusion de 100 °C en ajoutant 30 % de dibutyle sebacate (DBS) comme plastifiant. Le ratio du mélange polyuréthane:inuline était fixé à 40:60. Il a été démontré que des extrudats à base de mélange de carbothane (polyuréthane hydrophobe) et d'inuline absorbent peu d'eau et perdent peu de masse après exposition aux milieux simulant le haut tractus gastro-intestinal (une solution d'acide HCl 0,1 M pour simuler l'estomac et un tampon phosphaté pH 6,8 pour simuler l'intestin grêle) grâce aux propriétés hydrophobes du carbothane. Cependant, après exposition au milieu simulant le colon (un milieu de cultureensemencé de microbiote dans des selles de patients atteints de MICI), ces systèmes montrent une perte en masse plus prononcée que celle obtenue en absence de microbiote dans des selles de patients. Cela peut être expliqué par le fait que l'inuline sert de substrat aux enzymes sécrétées par les bactéries coliques. Des extrudats à base de mélanges de carbothane et d'inuline (à des ratios allant de 40:60, 30:70, 20:80 à 10:90) ont été préparés. Ces extrudats montrent une sensibilité aux bactéries coliques plus importante en augmentant le taux d'inuline dans l'extrudats. Cela est expliqué par le fait que les enzymes sont exposées à une quantité plus importante en substrat (inuline). A partir de ces extrudats, des gélules ont été préparées par moulage par injection à des températures similaires à celles de l'extrusion par fusion à chaud (100 °C). Les gélules ont été remplies avec 10 mg de théophylline et le test de libération de la substance active a été réalisé dans une solution d'acide HCl 0,1 M pendant 2 h, ensuite dans un tampon phosphaté pH 6,8 et enfin des échantillons de microbiote dans des selles de patients pour simuler le côlon (dans des conditions anaérobies). Pour des raisons de comparaisons,

le test de libération a aussi été réalisé sur des extrudats de la même composition que les gélules et contenant 10 % de théophylline. Il est à noter, que ces gélules à base de mélange de carbothane et d'inuline libèrent une faible quantité de substance active dans les milieux simulant le haut TGI mais également dans le milieu simulant le colon. Comparés aux extrudats, qui eux libèrent une quantité beaucoup plus importante et dans certains cas (carbothane:inuline aux ratios 20:80 et 10:90) libèrent 100 % de théophylline après 24 h d'exposition aux milieux de libérations.

Enfin, dans le dernier chapitre, différents types d'extrudats ont été préparés à base de plusieurs mélanges d'éthylcellulose et d'un second polysaccharide, à savoir l'hydroxypropylméthylcellulose (HPMC), la pectine, l'amidon de maïs, l'inuline, la maltodextrine, la gomme de guar et le chitosan. Le ratio du mélange polymère:polymère variait de 80:20, 70:30, 60:40, 50:50, 40:60, 30:70 à 20:80. L'ajout de quantités appropriées de plastifiants (30 % de dibutyl sebacate ou de triéthyl citrate) a permis de réduire la température d'extrusion à environ 100 ° C. Les impacts de la vitesse des vis, de la température d'extrusion, de la quantité et du type de plastifiant ainsi que de la quantité et du type de la substance active (10 à 60 % de théophylline ou de diprophylline) ont été étudiés. La libération de la substance active a été mesurée dans une solution d'acide HCl 0,1 M pendant 2 h, ensuite dans un tampon phosphaté pH 6,8 et (éventuellement) des échantillons de microbiote dans des selles de patients pour simuler le côlon (dans des conditions anaérobies). Les mesures DSC et la microscopie optique ont été utilisées pour caractériser l'état physique et la morphologie des systèmes. Il est intéressant de noter que des extrudats à base de mélanges de gomme de guar et d'éthylcellulose peuvent être facilement préparés et offrent un large spectre de profils de libération de la théophylline ainsi que la diprophylline. Des taux de libération de médicament à peu près constants pourraient être obtenus pendant des périodes prolongées. Il est important de noter que les taux de libération de substance active obtenus à partir d'extrudats à base d'éthylcellulose:gomme de guar au ratio 80:20 étaient similaires en présence et en absence de bactéries du côlon, indiquant que l'éthylcellulose

semble protéger la gomme de guar contre la dégradation lors de l'exposition à des échantillons de microbiote dans des selles de patients. De plus, ces systèmes étaient stables à long terme pendant au moins 1 an dans des conditions ambiantes. De ce fait, ces systèmes peuvent offrir un potentiel intéressant en tant que systèmes à libération contrôlée administrés par voie orale.

7. Conclusions et perspectives

Dans ce travail, différentes formes galéniques (films polymériques, extrudats et capsules) ont été développées et caractérisées *in vitro*. Ces nouveaux systèmes développés sont à base de polysaccharides permettant le ciblage du côlon et de polymères thermoplastiques, qui jouent un rôle important dans la libération contrôlée de la substance active, en particulier pour une administration colique.

Nous avons identifié de nouvelles formes galéniques pour l'administration de médicaments par voie orale dans le côlon, adaptées aux conditions physiopathologiques des patients. Ces systèmes ont montré une faible absorption en eau et une faible perte en masse après exposition aux milieux simulant l'estomac et l'intestin grêle. En outre, au contact de fluides coliques, ces systèmes ont montré une absorption en eau et une perte en masse considérables en raison de la fermentation du polysaccharide par les bactéries coliques. De plus, de nouvelles formes galéniques pour une libération contrôlée de la substance active ont été développées. Ces systèmes offraient un large spectre de profils de libération de substances actives.

Ces systèmes doivent être étudiés en profondeur pour être optimisés. Il a été souligné qu'il fallait prendre des précautions lors du changement de la forme galénique (ex. du procédé de fabrication) ainsi que de la composition de la formulation. Cela peut entraîner une distribution différente du polymère dans la forme finale.

VI. REFERENCES

REFERENCES

- [1] O. Rahmouni, L. Dubuquoy, P. Desreumaux, C. Neut, Microbiote intestinal et développement des maladies inflammatoires chroniques de l'intestin, *médecine/sciences* 32 (2016) 968-973.
- [2] O. Nitzan, M. Elias, A. Peretz, and W. Saliba, Role of antibiotics for treatment of inflammatory bowel disease, *World J. Gastroenterol.* 22 (2016) 1078-1087.
- [3] A. Iannone, M. Ruospo, G. Wong, M. Principi, M. Barone, G.F.M. Strippoli, A. Di Leo, Chromoendoscopy for Surveillance in Ulcerative Colitis and Crohn's Disease: A Systematic Review of Randomized Trials, *Clin. Gastroenterol. H.* 15 (2017) 1684-1697.
- [4] L. Beaugerie, E. Langholz, N. Nybo-Andersen, B. Pigneur, H. Sokol, Differences in epidemiological features between ulcerative colitis and Crohn's disease: The early life-programmed versus late dysbiosis hypothesis, *Med. Hypotheses* 115 (2018) 19-21.
- [5] <https://www.crohnscolitisfoundation.org/diet-and-nutrition/malnutrition-and-ibd>
- [6] <http://www.digestscience.com/fr/pathologies-digestives>.
- [7] N. Singh and R.C. Khanna, Colon targeted drug delivery systems- A Potential Approach, *The pharma journal* 1 (2012) 40-47.
- [8] S. K. Bajpai, M. Bajpai, R. Dengree, Chemically treated hard gelatin capsules for colon-targeted drug delivery: A novel approach. *J. Appl. Polym. Sci.* 89 (2003) 2277-2282.
- [9] M. K. Chourasia, S. K. Jain, Pharmaceutical approaches to colon targeted drug delivery systems, *J. Pharmaceutical. Sci.* 6 (2003) 33-66.
- [10] H. Lennernäs and B. Abrahamsson, The use of biopharmaceutic classification of drugs in drug discovery and development: current status and future extension, *J. Pharm. Pharmacol.* 57 (2005) 273-285.
- [11] P. Fyhr, K. Downie, Extended release drug delivery technology, *Innov. Pharm. Technol.* (2013) 80-86.

- [12] M. N. Kumar, N. Kumar, Polymeric controlled drug-delivery systems: Perspective Issues and opportunities. *Drug Dev. Ind. Pharm.* 27 (2001) 1-30.
- [13] P. Colombo, F. Sonvico, G. Colombo, R. Bettini, Novel platforms for oral drug delivery. *Pharm. Res.* 26 (2009) 601-611.
- [14] J. Siepmann, F. Siepmann, Mathematical modeling of drug delivery, *Int. J. Pharma.* 364 (2008) 328-343.
- [15] P. Veres, A.M. Lopez-Periago, I. Lazar, J. Saurina, C. Domingo, Hybrid aerogel preparations as drug delivery matrices for low water-solubility drugs. *Int. J. Pharm.* 496 (2015) 360-370.
- [16] A. Balogh, B. Farkas, A. Domokos, A. Farkas, B. Demuth. E. Borbas, B. Nagy, G. Marosi, Z. K. Nagy, Controlled-release solid dispersions of Eudragit FS 100 and poorly soluble spironolactone prepared by electrospinning and melt extrusion. *Eur. Polym. J.* 95 (2017) 406-417.
- [17] C. Maderuelo, A. Zarzuelo, J. M. Lanao, Critical factors in the release of drugs from sustained release hydrophilic matrices, *J. Control. Release* 154 (2011) 2-19.
- [18] J. Fahier, S. Muschert, B. Fayard, C. Velghe, G. Byrne, J. Doucet, F. Siepmann, J. Siepmann, Importance of air bubbles in the core of coated pellets: Synchrotron X-ray microtomography allows for new insights, *J. Control. Release* 237 (2016) 125-137.
- [19] R. Soravoot, B. Roland, Modified release from hydroxypropyl methylcellulose compression-coated tablets, *Int. J. Pharma.* 402 (2010) 72-77.
- [20] N.S. Berchane, K.H. Carson, A.C. Rice-Ficht, M.J. Andrews, Effect of mean diameter and polydispersity of PLG microspheres on drug release: experiment and theory, *Int. J. Pharm.* 337 (2007) 118-126.
- [21] S. Chirico, A. Dalmoro, G. Lamberti, G. Russo, G. Titomanlio, Analysis and modeling of swelling and erosion behavior for pure HPMC tablet, *J. Control. Release* 122 (2007) 181-188.

- [22] M. J. Abdekhodaie, X. Y. Wu, Drug release from ion-exchange microspheres: mathematical modeling and experimental verification, *Biomaterials* 29 (2008) 1654-1663.
- [23] J. Siepmann, H. Kranz, R. Bodmeier, N. A. Peppas, HPMC-Matrices for Controlled Drug Delivery: A New Model Combining Diffusion, Swelling, and Dissolution Mechanisms and Predicting the Release Kinetics, *Pharm. Res.* 16 (1999) 1748-1756.
- [24] J. B. Clarke, J. W. Hastie, L. H. E. Kihlberg, R. Metselaar, M. M. Thackeray, Definitions of terms relating to phase transitions of the solid state (IUPAC Recommendations 1994), *Pure Appl. Chem.* 66 (1994) 577-594.
- [25] J. Siepmann, F. Siepmann, Mathematical modeling of drug dissolution, *Int. J. Pharm.* 453 (2013) 12–24.
- [26] M. Wilson, M. A. Williams, D. S. Jones, G. P. Andrews, Hot-melt extrusion technology and pharmaceutical application, *Ther. Deliv.* 3 (2012) 787-797.
- [27] M. Maniruzzaman, J. S. Boateng, M J. Snowden, and D. Douroumis, A review of hot-melt extrusion: process technology to pharmaceutical products, *I. S. R. N. Pharm.* (2012) Article ID 436763.
- [28] S. Bruin, D. J. Van Zuilichem and W. Stolp, Review of Fundamental and Engineering Aspects of Extrusion of Biopolymers in a Single-Screw Extruder, *J. Food. Process. Eng.* 2 (1978) 1-37.
- [29] J. Breitenbach, Melt extrusion: from process to drug delivery technology, *Eur. J. Pharm. Biopharm.* 54 (2002) 107-117.
- [30] D. Douroumis, *Hot-melt Extrusion: Pharmaceutical applications*, John Wiley & Sons, 2012, ISBN: 978-0-470-71118-7.
- [31] D. Markl, P. R. Wahl, J. C. Menezes, D. M. Koller, B. Kavsek, K. Francois, E. Roblegg, J. G. Khinast, Supervisory Control System for Monitoring a Pharmaceutical Hot Melt Extrusion Process, *AAPS Pharm. Sci. Tech.* 14 (2013) 1034-1044.

- [32] M. B. Pimparade, A. Vo, A. S. Maurya, J. Bae, J. T. Morott, X. X. Feng, D. W. Kim, V. I. Kulkarni, R. Tiwari, K. Vanaja, R. Murthy, H. N. Shivakumar, D. Neupane, S. R. Mishra, S. N. Murthy, M. A. Repka, Development and evaluation of an oral fast disintegrating anti-allergic film using hot-melt extrusion technology, *Eur. J. Pharm. Biopharm.* 119 (2017) 81-90.
- [33] I. Speer, M. Preis, J. Breitreutz, Prolonged drug release properties for orodispersible films by combining hot-melt extrusion and solvent casting methods, *Eur. J. Pharm. Biopharm.* 129 (2018) 66-73.
- [34] F. Zhang and J. W. McGinity, Properties of hot-melt extruded theophylline tablets containing poly(vinyl acetate), *Drug Dev. Ind. Pharm.* 26 (2000) 931-942.
- [35] M. M. Crowley, F. Zhang, J. J. Koleng, J. W. McGinity, Stability of polyethylene oxide in matrix tablets prepared by hot-melt extrusion, *Biomaterials* 23 (2002) 4241-4248.
- [36] A. Melocchi, G. Loreti, M. D. Del Curto, A. Maroni, A. Gazzaniga, L. Zema, Evaluation of hot-melt extrusion and injection molding for continuous manufacturing of immediate-release tablets, *J. Pharm. Sci.* 104 (2015) 1971-1980.
- [37] E. Albarahmeh, S. Qi, D. Q. M. Craig, Hot melt extruded transdermal films based on amorphous solid dispersions in Eudragit RS PO: the inclusion of hydrophilic additives to develop moisture-activated release systems, *Int. J. Pharm.* 514 (2016) 270-281.
- [38] N. S. Mendonsa, P. Thipsay, D. W. Kim, S. T. Martin, M. A. Repka, Bioadhesive drug delivery system for enhancing the permeability of a BCS class III drug via hot-melt extrusion technology, *AAPS Pharm. Sci. Tech.* 18 (2017) 2639-2647.
- [39] M. Alhijaj, J. Bouman, N. Wellner, P. Belton, S. Qi, Creating drug solubilization compartments via phase separation in multicomponent buccal patches prepared by direct hot melt extrusion-injection molding, *Mol. Pharm.* 12 (2015) 4349-4362.

- [40] C. Bode, H. Kranz, A. Favez, F. Siepmann, J. Siepmann, Often neglected: PLGA/PLA swelling orchestrates drug release: HME implants, *J. Control. Release* 306 (2019) 97-107.
- [41] C. Bode, H. Kranz, F. Siepmann, J. Siepmann, Coloring of PLGA implants to better understand the underlying drug release mechanisms, *Int. J. Pharma.* 569 (2019) 118563.
- [42] O. Cantin, F. Siepmann, F. Danede, J. F. Willart, Y. Karrouit, J. Siepmann, PEO hot melt extrudates for controlled drug delivery: Importance of the molecular weight, *J. Drug. Deliv. Sci. Technol.* 36 (2016) 130-140.
- [43] D. Ridhurkar, A. Vajdai, and Z. Zsigmond, Hot-melt extrusion (HME) and its application for pharmacokinetic improvement of poorly water soluble drugs, *PTB Reports* 2 (2016) 47-51.
- [44] L. F. B. Malaquias, L. C. L. Sá-Barreto, D. O. Freire, I. C. R. Silva, K. Karan, T. Durig, E. M. Lima, R. N. Marreto, G. M. Gelfuso, T. Gratieri, M. Cunha-Filho, Taste masking and rheology improvement of drug complexed with beta-cyclodextrin and hydroxypropyl-beta-cyclodextrin by hot melt extrusion. *Carbohydr. Polym.* 185 (2018) 19-26.
- [45] A. V. Keating, J. Soto, C. Tuleu, C. Forbes, M. Zhao, D. Q. M. Craig, Solid state characterisation and taste masking efficiency evaluation of polymer based extrudates of isoniazid for paediatric administration, *Int. J. Pharm.* 536 (2018) 536-546.
- [46] R. V. Tiwari, A.N. Polk, H. Patil, X. Ye, M.B. Pimparade, M.A. Repka, Rat Palatability Study for Taste Assessment of Caffeine Citrate Formulation Prepared via Hot-Melt Extrusion Technology, *AAPS Pharm. Sci. Tech.* 18 (2015) 341-348.
- [47] M. B. Pimparade, J. T. Morott, J. B. Park, V. I. Kulkarni, S. Majumdar, S. N. Murthy, Z. Lian, E. Pinto, V. Bi, T. Durig, R. Murthy, H. N. Shivakumar, K. Vanaja, P. C. Kumar, M. A. Repka, Development of taste masked caffeine citrate formulations utilizing hot melt extrusion technology and in vitro–in vivo evaluations, *Int. J. Pharm.* 487 (2015) 167-176.

- [48] H. McFall, S. Sarabu, V. Shankar, S. Bandari, S. N. Murthy, K. Kolter, N. Langley, D. WW. Kim, M. A. Repka, (2018) Formulation of aripiprazole-loaded pH-modulated solid dispersions via hot-melt extrusion technology: in vitro and in vivo studies, *Int. J. Pharm.* 554 (2019) 302-311.
- [49] L. Xi, H. Song, Y. Wang, H. Gao, Q. Fu, Lacidipine amorphous solid dispersion based on hot melt extrusion: good miscibility, enhanced dissolution, and favorable stability. *AAPS Pharm. Sci. Tech.* 19 (2018) 3076-3084.
- [50] L. Martinez-Marcos, D. A. Lamprou, R. T. McBurney, G. W. Halbert, A novel hot-melt extrusion formulation of albendazole for increasing dissolution properties, *Int. J. Pharm.* 499 (2016) 175–185.
- [51] S. S. Penumetcha, L. N. Gutta, H. Dhanala, S. Yamili, S. Challa, S. Rudraraju, V. Rudraraju, Hot melt extruded Aprepitant-Soluplus solid dispersion: preformulation considerations, stability and in vitro study, *Drug Dev. Ind. Pharm.* 42 (2016) 1609-1620.
- [52] U. Quintavalle, D. Voinovich, B. Perissutti, F. Serdoz, G. Grassi, A. Dal Col, M. Grassi, Preparation of sustained release co-extrudates by hot melt extrusion and mathematical modelling of in vitro/in vivo drug release profiles, *Eur. J. Pharm. Sci.* 33 (2003) 282-293.
- [53] A. Cossé, C. König, A. Lamprecht, K.G. Wagner, Hot Melt Extrusion for Sustained Protein Release: Matrix Erosion and In Vitro Release of PLGA-Based Implants, *AAPS Pharm. Sci. Tech.* 18 (2016) 5-26.
- [54] R. Yang, Y. Wang, X. Zheng, J. Meng, X. Tang, X. Zhang, Preparation and evaluation of ketoprofen hot-melt extruded enteric and sustained-release tablets, *Drug Dev. Ind. Pharm.* 34 (2008) 83-89.

- [55] M. Maniruzzaman, M. T. Islam, S. Halsey, D. Amin, D. Douroumis, Novel Controlled Release Polymer-Lipid Formulations Processed by Hot Melt Extrusion, *AAPS Pharm. Sci. Tech.* 17 (2016) 191-199.
- [56] K. P. Sawant, R. Fule, M. Maniruzzaman, P. D. Amin, Extended release delivery system of metoprolol succinate using hot-melt extrusion: effect of release modifier on methacrylic acid copolymer, *Drug Deliv. Transl. Res.* 8 (2018) 1679-1693.
- [57] E. Mehuys, J. P. Remon, C. Vervaet, Production of enteric capsules by means of hot-melt extrusion. *Eur. J. Pharm. Sci.* 24 (2005) 207-212.
- [58] D. A. Miller, J. C. Di Nunzio, W. Yang, J. W. McGinity, R. O. Williams, Targeted intestinal delivery of supersaturated itraconazole for improved oral absorption, *Pharm. Res.* 25 (2008) 1450-1459
- [59] L. D. Bruce, N. H. Shah, A. W. Malick, M. H. Infeld, J. W. McGinity, Properties of hot-melt extruded tablet formulations for the colonic delivery of 5-aminosalicylic acid, *Eur. J. Pharm. Biopharm.* 59 (2005) 85-97.
- [60] A. K. Vynckier, L. Dierickx, J. Voorspoels, Y. Gonnissen, J. P. Remon, C. Vervaet, Hot-melt co-extrusion: requirements, challenges and opportunities for pharmaceutical applications, *J. Pharm. Pharmacol.* 66 (2014) 167-79.
- [61] L. Dierickx, B. Van Snick, T. Monteyne, T. De Beer, J. P. Remon, C. Vervaet, Co-extruded solid solutions as immediate release fixed-dose combinations, *Eur. J. Pharm. Biopharm.* 88 (2014) 502-509.
- [62] E. J. Laukamp, A. K. Vynckier, J. Voorspoels, M. Thommes, J. Breitreutz, Development of sustained and dual drug release co-extrusion formulations for individual dosing, *Eur. J. Pharm. Biopharm.* 89 (2015) 357-364.

- [63] S. Li, T. Yu, Y. Tian, C. P. McCoy, D. S. Jones, G. P. Andrews, Mechanochemical Synthesis of Pharmaceutical Cocrystal Suspensions via Hot Melt Extrusion: Feasibility Studies and Physicochemical Characterization, *Mol. Pharm.* 13 (2016) 3054-3068.
- [64] K. Boksa, A. Otte, R. Pinal, Matrix-Assisted Cocrystallization (MAC) Simultaneous Production and Formulation of Pharmaceutical Cocrystals by Hot-Melt Extrusion, *J. Pharm. Sci.* 103 (2014) 2904-2910.
- [65] X. Liu, M. Lu, Z. Guo, L. Huang, X. Feng, C. Wu, Improving the Chemical Stability of Amorphous Solid Dispersion with Cocrystal Technique by Hot Melt Extrusion, *Pharm. Res.* 29 (2012) 806-817.
- [66] H. G. Moradiya, M. T. Islam, S. Halsey, M. Maniruzzaman, B. Z. Chowdhry, M. J. Snowden and D. Douroumis, Continuous cocrystallisation of carbamazepine and trans-cinnamic acid via melt extrusion processing, *Cryst. Eng. Comm.* 16 (2014) 3573-3583.
- [67] C. I. Gioumouxouzis, O. L. Katsamenis, N. Bouropoulos, D. G. Fatouros, 3D printed oral solid dosage forms containing hydrochlorothiazide for controlled drug delivery, *J. Drug Deliv. Sci. Technol.* 40 (2017) 164-171.
- [68] Q. Li, H. Wen, D. Jia, X. Guan, H. Pan, Y. Yang, S. Yu, Z. Zhu, R. Xiang, W. Pan, Preparation and investigation of controlled-release glipizide novel oral device with three-dimensional printing, *Int. J. Pharma.* 525 (2017) 5-11.
- [69] G. Verstraete, A. Samaro, W. Grymonpré, V. Vanhoorne, B. Van Snick, M. N. Boone, T. Helleman, L. Van Hoorebeke, J. P. Remona, C. Vervaeta, 3D printing of high drug loaded dosage forms using thermoplastic polyurethanes, *Int. J. Pharma.* 536 (2018) 318-325.
- [70] L. Zema, G. Loreti, A. Melocchi, A. Maroni, L. Palugan, A. Gazzaniga, Gastroresistant capsular device prepared by injection molding, *Int. J. Pharma.* 440 (2013) 264-272.

- [71] A. Gazzaniga, M. Cerea, A. Cozzi, A. Foppoli, A. Maroni, and L. Zema, A Novel Injection-Molded Capsular Device for Oral Pulsatile Delivery Based on Swellable/Erodible Polymers, *AAPS Pharm. Sci. Tech.* 12 (2011) 295-303.
- [72] F. Briatico-Vangosa, A. Melocchi, M. Uboldi, A. Gazzaniga, L. Zema, A. Maroni, Effect of Polyethylene Glycol Content and Molar Mass on Injection Molding of Hydroxypropyl Methylcellulose Acetate Succinate-Based Gastroresistant Capsular Devices for Oral Drug Delivery, *Polymers* 11 (3) (2019).
- [73] F. Casati, F. Briatico-Vangosa, F. Baldi, A. Melocchi, A. Maroni, A. Gazzaniga, L. Zema, Assessment of hot-processability and performance of ethylcellulose-based materials for injection-molded prolonged-release systems: An investigational approach, *Int. J. Pharma.* 548 (2018) 400-407.
- [74] R. J. Chokshi, H. K. Sandhu, R. M. Iyer, N. H. Shah, A. W. Malick, H. Zia, Characterization of physic-mechanical properties of indomethacin and polymers to assess their suitability for hot-melt extrusion process as a means to manufacture solid dispersion/solution, *J. Pharm. Sci.* 94 (2005) 2463-2474.
- [75] A. Almeida, S. Possemiers, M. N. Boone, T. De Beer, T. Quinten, L. Van Hoorebeke, J. P. Remon, C. Vervaet, Ethylene vinyl acetate as matrix for oral sustained release dosage forms produced via hot-melt extrusion, *Eur. J. Pharm. Biopharm.* 77 (2011) 297-305.
- [76] N. Genina, J. Holländer, H. Jukarainen, E. Mäkilä, J. Salonen, N. Sandler, Ethylene vinyl acetate (EVA) as a new drug carrier for 3D printed medical drug delivery devices, *Eur. J. Pharm. Sci.* 90 (2016) 53-63.
- [77] A. Almeida, L. Brabant, F. Siepmann, T. De Beer, W. Bouquet, L. Van Hoorebeke, J. Siepmann, J. P. Remon, C. Vervaet, Sustained release from hot-melt extruded matrices based on ethylene vinyl acetate and polyethylene oxide, *Eur. J. Pharm. Biopharm.* 82 (2012) 526-533.

- [78] I. Özgüney, D. Shuwisitkul, R. Bodmeier, Development and characterization of extended release Kollidon SR mini-matrices prepared by hot-melt extrusion, *Eur. J. Pharm. Biopharm.* 73 (2009) 140-145.
- [79] L. Saerens, L. Dierickx, T. Quinten, P. Adriaensens, R. Carler, C. Vervaet, J. P. Remon, T. De Beer, In-line NIR spectroscopy for the understanding of polymer–drug interaction during pharmaceutical hot-melt extrusion, *Eur. J. Pharm. Biopharm.* 81 (2012) 230-237.
- [80] B. Rambali, G. Verreck, L. Baert, D. L. Massart, Itraconazole formulation studies of the melt-extrusion process with mixture design, *Drug Dev. Ind. Pharm.* 29 (2003) 641-652.
- [81] D. A. Miller, J. T. McConville, W. Yang, R. O. Williams III, J. W. McGinity, Hot-melt extrusion for enhanced delivery of drug particles, *J. Pharm. Sci.* 96 (2007) 361-376.
- [82] M. A. Repka, K. Gutta, S. Prodduturi, M. Munjal, S. P. Stodghill, Characterization of cellulosic hot-melt extruded films containing lidocaine, *Eur. J. Pharm. Biopharm.* 59 (2005) 189-196.
- [83] C. De Brabander, C. Vervaet, J. P. Remon, Development and evaluation of sustained release mini-matrices prepared via hot melt extrusion, *J. Control. Release* 89 (2003) 235-247.
- [84] N. N. Mohammed, S. Majumdar, A. Singh, W. Deng, N. S. Murthy, E. Pinto, D. Tewari, T. Durig and M. A. Repka, Klucel EF and ELF polymers for immediate-release oral dosage forms prepared by melt extrusion technology, *AAPS Pharm. Sci. Tech.* 13 (2012) 1158-1169.
- [85] G. Loreti, A. Maroni, M. D. Del Curto, A. Melocchi, A. Gazzaniga, L. Zema, Evaluation of hot-melt extrusion technique in the preparation of HPC matrices for prolonged release, *Eur. J. Pharm. Sci.* 52 (2014) 77-85.
- [86] E. Verhoeven, T. R. M. De Beer, G. Van den Mooter, J. P. Remon, C. Vervaet, Influence of formulation and process parameters on the release characteristics of ethylcellulose sustained-release mini-matrices produced by hot-melt extrusion, *Eur. J. Pharm. Biopharm.* 69 (2008) 312-319.

- [87] Y. Yang, H. Wang, H. Li, Z. Ou, G. Yang, 3D printed tablets with internal scaffold structure using ethyl cellulose to achieve sustained ibuprofen release, *Eur. J. Pharm. Sci.* 115 (2018) 11-18.
- [88] S. Qi, A. Gryczke, P. Belton, D. Q. M. Craig, Characterisation of solid dispersions of paracetamol and Eudragit E prepared by hot-melt extrusion using thermal, microthermal and spectroscopic analysis, *Int. J. Pharm.* 354 (2008) 158-167.
- [89] S. U. Schilling, C. D. Bruce, N. H. Shah, A. W. Malick, J. W. McGinity, Citric acid monohydrate as a release-modifying agent in melt extruded matrix tablets, *Int. J. Pharm.* 361 (2008) 158-168.
- [90] A. Q. Vo, X. Feng, J. T. Morott, M. B. Pimparade, R. V Tiwari, F. Zhang, M. A. Repka, A novel floating controlled release drug delivery system prepared by hot-melt extrusion, *Eur. J. Pharm. Biopharm.* 98 (2015) 108-121.
- [91] B. Claeys, R. Vandeputte, B. G. De Geest, J. P. Remon, C. Vervaet, pH-independent immediate release polymethacrylate formulations – an observational study, *Drug Dev. Ind. Pharm.* 42 (2016) 578-583.
- [92] J. Albers, R. Alles, K. Matthée, K. Knop, J. S. Nahrup, P. Kleinebudde, Mechanism of drug release from polymethacrylate-based extrudates and milled strands prepared by hot-melt extrusion, *Eur. J. Pharm. Biopharm.* 71 (2009) 387-394.
- [93] H. Liu, P. Wang, X. Zhang, F. Shen, C. G. Gogos, Effects of extrusion process parameters on the dissolution behavior of indomethacin in Eudragit E PO solid dispersions, *Int. J. Pharm.* 383 (2010) 161-169.
- [94] C. R. Young, J. J. Koleng, J. W. McGinity, Production of spherical pellets by a hot-melt extrusion and spheronization process, *Int. J. Pharm.* 242 (2002) 87-92.
- [95] M. Fukuda, N. A. Peppas, J. W. McGinity, Floating hot-melt extruded tablets for gastroretentive controlled drug release system, *J. Control. Release* 115 (2006) 121-129.

- [96] Y. Zhu, N. H. Shah, A. W. Malick, M. H. Infeld, J. W. McGinity, Influence of thermal processing on the properties of chlorpheniramine maleate tablets containing an acrylic polymer, *Pharm. Dev. Technol.* 7 (2002) 481-489.
- [97] C. R. Young, C. Dietzsch, M. Cerea, T. Farrell, K. A. Fegely, A. Rajabi-Siahboomi, J. W. McGinity, Physicochemical characterization and mechanisms of release of theophylline from melt-extruded dosage forms based on a methacrylic acid copolymer, *Int. J. Pharm.* 301 (2005) 112-120.
- [98] M. Windbergs, C. J. Strachan, P. Kleinebudde, Influence of structural variations on drug release from lipid/polyethylene glycol matrices, *Eur. J. Pharm. Sci.* 37 (2009) 555-562.
- [99] U. Quintavalle, D. Voinovich, B. Perissutti, F. Serdoz, G. Grassi, A. Dal Col, M. Grassi, Preparation of sustained release co-extrudates by hot-melt extrusion and mathematical modelling of in vitro/in vivo drug release profiles, *Eur. J. Pharm. Sci.* 33 (2008) 282-293.
- [100] J. B. Park, C. Y. Kang, W. S. Kang, H. G. Choi, H. K. Han, B. J. Lee, New investigation of distribution imaging and content uniformity of very low dose drugs using hot-melt extrusion method, *Int. J. Pharm.* 458 (2013) 245-253.
- [101] S. U. Schilling, J. W. McGinity, Novel application of hot-melt extrusion for the preparation of monolithic matrices containing enteric-coated particles, *Int. J. Pharm.* 400 (2010) 24-31.
- [102] S. U. Schilling, N. H. Shah, A. W. Malick, J. W. McGinity, Properties of melt extruded enteric matrix pellets, *Eur. J. Pharm. Biopharm.* 74 (2010) 352-361.
- [103] M. A. Repka, T. G. Gerding, S. L. Repka, J. W. McGinity, Influence of plasticizers and drugs on the physical-mechanical properties of hydroxypropylcellulose films prepared by hot melt extrusion, *Drug Dev. Ind. Pharm.* 25 (1999) 625-633.

- [104] M. R. Clark, T. J. Johnson, R. T. McCabe, J. T. Clark, A. Tuitupou, H. Elgendy, D. R. Friend, P. F. Kiser, A Hot-Melt Extruded Intravaginal Ring for the Sustained Delivery of the Antiretroviral Microbicide UC781, *J. Pharm. Sci.* 101 (2012) 576-587.
- [105] G. Verstraete, L. Vandenbussche, S. Kasmi, L. Nuhn, D. Brouckaert, J. Van Renterghem, W. Grymonpré, V. Vanhoorne, T. Coenye, B. G. De Geest, T. De Beer, J. P. Remon, C. Vervaet, Thermoplastic polyurethane-based intravaginal rings for prophylaxis and treatment of (recurrent) bacterial vaginosis, *Int. J. Pharma.* 529 (2017) 218-226.
- [106] G. Verstraete, P. Mertens, W. Grymonpré, P. J. Van Bockstal, T. De Beer, M. N. Boone, L. Van Hoorebeke, J. P. Remon, C. Vervaet, A comparative study between melt granulation/compression and hot melt extrusion/injection molding for the manufacturing of oral sustained release thermoplastic polyurethane matrices, *Int. J. Pharma.* 513 (2016) 602-611.
- [107] G. Verstraete, J. Van Renterghem, P. J. Van Bockstal, S. Kasmi, B. G. De Geest, T. De Beer, J. P. Remon, C. Vervaet, Hydrophilic thermoplastic polyurethanes for the manufacturing of highly dosed oral sustained release matrices via hot melt extrusion and injection molding, *Int. J. Pharma.* 506 (2016) 214-221.
- [108] M. Fukuda, N. A. Peppas, J. W. McGinity, Properties of sustained release hot-melt extruded tablets containing chitosan and xanthan gum, *Int. J. Pharm.* 310 (2006) 90-100.
- [109] T. Phaechamud, G. C. Ritthidej, Sustained-release from Layered Matrix System Comprising Chitosan and Xanthan Gum, *Drug Dev. Ind. Pharm.* 33 (2008) 595-605.
- [110] H. Karandikar, R. Ambardekar, A. Kelly, T. Gough, A. Paradkar, Systematic identification of thermal degradation products of HPMCP during hot melt extrusion process, *Int. J. Pharm.* 486 (2015) 252-258.
- [111] M. M. Crowley, F. Zhang, J. J. Koleng, J. W. McGinity, Stability of polyethylene oxide in matrix tablets prepared by hot-melt extrusion, *Biomaterials* 23 (2002) 4241-4248.

- [112] S. Thumma, M. A. ElSohly, S. Q. Zhang, W. Gul, M. A. Repka, Influence of plasticizers on the stability and release of a prodrug of Delta(9)-tetrahydrocannabinol incorporated in poly (ethylene oxide) matrices., *Eur. J. Pharm. Biopharm.* 70 (2008) 605-614.
- [113] J. S. La Fontaine, J. W. McGinity, R. O. Williams, Challenges and Strategies in Thermal Processing of Amorphous Solid Dispersions: A Review, *AAPS Pharm. Sci. Tech.* 17 (2016) 43-55.
- [114] S. U. Schilling, H. L. Lirola, N. H. Shah, A. W. Malick, J.W. McGinity, Influence of plasticizer type and level on the properties of Eudragit S100 matrix pellets prepared by hot-melt extrusion, *J. Microencapsul.* 27 (2010) 521-532.
- [115] M. A. Repka, J. W. McGinity, Influence of vitamin E TPGS on the properties of hydrophilic films produced by hot-melt extrusion, *Int. J. Pharm.* 202 (2000) 63-70.
- [116] S. M. Aharoni, Increased glass transition temperature in motionally constrained semicrystalline polymers. *Polym. Adv. Technol.* 9 (1998) 169-201.
- [117] L. Liu, T. Z. Jin, D. R. Coffin, K. B. Hicks, Preparation of antimicrobial membranes: coextrusion of poly(lactic acid) and Nisaplin in the presence of Plasticizers, *J. Agric. Food Chem.* 57 (2009) 8392-8398.
- [118] F. Siepman, V. Le Brun, J. Siepman, Drugs acting as plasticizers in polymeric systems: A quantitative treatment, *J. Control. Release* 115 (2006) 298-306.
- [119] M. M. Crowley, A. Fredersdorf, B. Schroeder, S. Kucera, S. Prodduturi, M. A. Repka, J. W. McGinity. The influence of guaifenesin and ketoprofen on the properties of hot-melt extruded polyethylene oxide films, *Eur. J. Pharm. Sci.* 22 (2004) 409-418.
- [120] Y. Karrout, F. Siepman, Y. Benzine, L. Paccou, Y. Guinet, A. Hedoux, J. Siepman, When drugs plasticize film coatings: Unusual formulation effects observed with metoprolol and Eudragit RS, *Int. J. Pharma.* 539 (2018) 39-49.

- [121] Y. Cuppok, S. Muschert, M. Marucci, J. Hjaertstam, F. Siepman, A. Axelsson, J. Siepman, Drug release mechanisms from Kollicoat SR:Eudragit NE coated pellets. 409 (2011) 30-37.
- [122] J. Kazlauske, M. M. Cafaro, D. Caccavo, M. Marucci, G. Lamberti, A. A. Barba, A. Larsson. Determination of the release mechanism of Theophylline from pellets coated with Surelease – a water dispersion of ethyl cellulose. *Int. J. Pharma.* 528 (2017) 345-353.
- [123] M. Stanković, H. W. Frijlink, W. L. J. Hinrichs, Polymeric formulations for drug release prepared by hot melt extrusion: application and characterization, *Drug Discov. Today.* 20 (2015) 812-823.
- [124] R. V. Tiwari, H. Patil, M. A. Repka, Contribution of hot-melt extrusion technology to advance drug delivery in the 21st century, *Expert. Opin. Drug Deliv.* 13 (2016) 451-464.
- [125] H. K. Han, G. L. Amidon, Targeted prodrug design to optimize drug delivery. *AAPS Pharm. Sci.* 2 (2000) 48-58.
- [126] L. Yang, J.S. Chu, J. A. Fix, Colon-specific drug delivery: new approaches and in vitro/in vivo evaluation. *Int. J. Pharm* 235 (2002) 1–15.
- [127] S. Milojevic, J. M. Newton, J. H. Cummings, G. R. Gibson, R. L. Botham, S. G. Ring, M. Stockham, M. C. Allwood, Amylose as a coating for drug delivery to the colon: preparation and in vitro evaluation using glucose pellets, *J. Control. Release* 38 (1996) 85-94.
- [128] E. Fukui, N. Miyamura, M. Kobayashi, An in vitro investigation of the suitability of press coated tablets with hydroxypropylmethylcellulose acetate succinate (HPMCAS) and hydrophobic additives in the outer shell for colon targeting. *J. Control. Release* 70 (2000) 97-107.
- [129] A. Gazzaniga, P. Iamartino, G. Maffino, M. E. Sangalli, Oral delayed release system for colonic specific drug delivery, *Int. J. Pharmaceut.* 108 (1994) 77-83.

- [130] E. Fukui, N. Miyamura, K. Uemura, M. Kobayashi, Preparation of enteric coated timed-release press-coated tablets and evaluation of their function by in vitro and in vivo tests for colon targeting, *Int. J. Pharmaceut.* 1 (2000) 7-15.
- [131] S. M. Reddy, V. R. Sinha, D. S. Reddy, Novel oral colon-specific drug delivery systems for pharmacotherapy of peptide and non-peptide drugs, *Drug Today* 35 (1999) 537-580.
- [132] M. Vassallo, M. Camilleri, S. F. Phillips, M. L. Brown, N. J. Chapman, G. M. Thomforde, Transit through the proximal colon influences stool weight in the irritable bowel syndrome, *Gastroenterology* 102 (1992) 102-108.
- [133] M. R. Von der Ohe, M. Camilleri, L. K. Kvols, G. M. Thomforde, Motor dysfunction of the small bowel and colon in patients with the carcinoid syndrome and diarrhea, *N. Engl. J. Med.* 329 (1993) 1073-1078.
- [134] Y. Karrouit, C. Neut, D. Wils, F. Siepmann, L. Deremaux, L. Dubreuil, P. Desreumaux, J. Siepmann, Colon targeting with bacteria-sensitive films adapted to the disease state, *Eur. J. Pharm. Biopharm.* 73 (2009) 74-81.
- [135] M. Ashord, J.T. Fell, D. Attwood, H. Sharma, P. Woodhead, An evaluation of pectin as a carrier for drug targeting to the colon, *J. Control. Release* 29 (1993) 213-220.
- [136] P. Desreumaux, L. Dubuquoy, S. Nutten, M. Peuchmaur, W. Englaro, K. Schoonjans, B. Derijard, B. Desvergne, W. Wahli, P. Chambon, M. D. Leibowitz, J. F. Colombel, J. Auwerx, Attenuation of colon inflammation through activators of the retinoid X receptor (RXR)/peroxisome proliferator-activated receptor Y (PPAR Y) heterodimer: a basis for new therapeutic strategies, *J. Exp. Med.* 193 (2001) 827-838.
- [137] C. Rousseaux, B. Lefebvre, L. Dubuquoy, P. Lefebvre, O. Romano, J. Auwerx, D. Metzger, W. Wahli, B. Desvergne, G. C. Naccari, P. Chavatte, A. Farce, P. Bulois, A. Cortot, J. F. Colombel,

- P. J. Desreumaux, Intestinal anti-inflammatory effect of 5-aminosalicylic acid is dependent on peroxisome proliferator-activated receptor- γ , *Exp. Med.* 201 (2005) 1205-1215.
- [138] L. Dubuquoy, C. Rousseaux, X. Thuru, L. Peyrin-Biroulet, O. Romano, P. Chavatte, M. Chamaillard, P. Desreumaux, PPAR as a new therapeutic target in inflammatory bowel diseases, *Gut* 55 (2006) 1341-1349.
- [139] Y. Karrout, C. Neut, F. Siepmann, D. Wils, P. Ravaux, L. Deremaux, M-P. Flament, L. Dubreuil, M. Lemdani, P. Desreumaux and J. Siepmann, Enzymatically degraded Eurylon 6 HP-PG: ethylcellulose film coatings for colon targeting in inflammatory bowel disease, *J. Pharm. Pharmacol.* 62 (2010) 1676-1684.
- [140] Y. Karrout, C. Neut, D. Wils, F. Siepmann, L. Deremaux, M-P. Flament, L. Dubreuil, P. Desreumaux, J. Siepmann, Novel polymeric film coatings for colon targeting: Drug release from coated pellets, *Eur. J. Pharm. Sci.* 37 (2009) 427-433.
- [141] Y. Karrout, C. Neut, D. Wils, F. Siepmann, L. Deremaux, M-P. Flament, L. Dubreuil, P. Desreumaux, J. Siepmann, Enzymatically activated coated multiparticulates containing theophylline for colon targeting, *J. Drug Del. Sci. Technol.* 20 (2010) 193-199.
- [142] Y. Karrout, L. Dubuquoy, C. Piveteau, F. Siepmann, E. Moussa, D. Wils, T. Beghyna, C. Neut, M-P. Flament, L. Guerin-Deremaux, L. Dubreuil, B. Deprez, P. Desreumaux, J. Siepmann, In vivo efficacy of microbiota-sensitive coatings for colon targeting: A promising tool for IBD therapy, *J. Control. Release* 197 (2015) 121-130.
- [143] J. Varshosaz, J. Emami, N. Tavakoli, M. Minaiyan, N. Rahmani, F. Dorkoosh and P. Mahzouni, Pectin Film Coated Pellets for Colon-targeted Delivery of Budesonide: In-vitro/In-vivo Evaluation in Induced Ulcerative Colitis in Rat, *Iran. J. Pharm. Res.* 11 (2012) 733-745.
- [144] W. S. Omwancha, R. Mallipeddi, B. L. Valle, S. H. Neau, Chitosan as a pore former in coated beads for colon specific drug delivery of 5-ASA, *Int. J. Pharmaceut.* 441 (2013) 343-351.

- [145] F. Li-Fang, H. Wei, C. Yong-Zhen, X. Bai, D. Qing, W. Feng, Q. Min, C. De-Ying, Studies of chitosan/Kollocoat SR 30D film-coated tablets for colonic drug delivery, *Int. J. Pharma.* 375 (2009) 8-15.
- [146] P.J. Wilson, A. W. Basit, Exploiting gastrointestinal bacteria to target drugs to the colon: an in vitro study using amylose coated tablets, *Int. J. Pharma.* 300 (2005) 89-94.
- [147] J. Liu, L. Zhang, Y. Jia, W. Hu, J. Zhang, H. Jiang, Preparation and evaluation of pectin-based colon-specific pulsatile capsule in vitro and in vivo, *Arch. Pharm. Res.* 35 (2012) 1927-1934.
- [148] V. C. Patole, A. P. Pandit, Mesalamine-loaded alginate microspheres filled in enteric coated HPMC capsules for local treatment of ulcerative colitis: in vitro and in vivo characterization, *J. Pharm. Investig.* 48 (2018) 257-267.
- [149] H. Duan, S. Lü, C. Gao, X. Bai, H. Qin, Y. Wei, X. Wu, M. Liu, Mucoadhesive microparticulates based on polysaccharide for target dual drug delivery of 5-aminosalicylic acid and curcumin to inflamed colon, *Colloids. Surf. B. Biointerfaces.* 1 (2016) 510-519.
- [150] V. Jain, D. Prasad, D. Jain, S. K. Mishra, R. Singh, Factorial design-based development of mesalamine microspheres for colonic delivery, *Biomatter* 1 (2011) 182-188.
- [151] S. Mohanty, A. K. Panigrahi, Multiparticulate drug delivery system for colon targeting, *Int. J. Pharm. Pharm. Sci.* 7 (2015) 433-436.
- [152] L. Jin, Y. Ding, Y. Zhang, X. Xu, Q. Cao, A novel pH – enzyme-dependent mesalamine colon-specific delivery system, *Drug Des. Dev. Ther.* 10 (2016) 2021-2028.
- [153] H. Tozaki, T. Odoriba, N. Okada, T. Fujita, A. Terabe, T. Suzuki, S. Okabe, S. Muranishi, A. Yamamoto, Chitosan capsules for colon-specific drug delivery: enhanced localization of 5-aminosalicylic acid in the large intestine accelerates healing of TNBS-induced colitis in rats, *J. Control. Release* 82 (2002) 51-61.

- [154] D. A. Quinteros, R. H. Manzo, D. A. Allemandi, Design of a colonic delivery system based on cationic polymethacrylate (Eudragit E100)-mesalamine complexes, *Drug Deliv.* 17 (2010) 208-213.
- [155] C. Fude, Y. Lei, J. Jie, P. Hongze, L. Wenhui, C. Dongmei, C, Preparation and in vitro evaluation of pH, time-based and enzyme-degradable pellets for colonic drug delivery, *Drug Dev. Ind. Pharm.* 33 (2007) 999-1007.
- [156] K. Mladenovska, O. Cruaud, P. Richomme, E. Belamie, R. S. Raicki, M. C. Venier-Julienne, E. Popovski, J. P. Benoit, K. Goracinova, 5-ASA loaded chitosan-Caalginate microparticles: preparation and physicochemical characterization, *Int. J. Pharma.* 345 (2007) 59-69.
- [157] K. Mladenovska, R. S. Raicki, E. I. Janevik, T. Ristoski, M. J. Pavlova, Z. Kavrakovski, M. G. Dodov, K. Goracinova, Colon-specific delivery of 5-aminosalicylic acid from chitosan-Ca-alginate microparticles, *Int. J. Pharma.* 342 (2007) 124-136
- [158] J. Nunthanid, K. Huanbutta, M. Luangtana-anan, P. Sriamornsak, S. Limmatvapirat, S. Puttipipatkachorn, Development of time-, pH-, and enzyme-controlled colonic drug delivery using spray-dried chitosan acetate and hydroxypropyl methylcellulose, *Eur. J. Pharm. Biopharm.* 68 (2008) 253-259.
- [159] <http://www.pharmacopeia.cn/>
- [160] <http://www.drugbank.ca/>
- [161] <https://pubchem.ncbi.nlm.nih.gov/>
- [162] <https://pharmaceutical.basf.com/en/Drug-Formulation/Kollidon-SR.html>.
- [163] F. Turroni, C. Milani, S. Duranti, L. Mancabelli, M. Mangifesta, A. Viappiani, G. A. Lugli, C. Ferrario, L. Gioiosa, A. Ferrarini, Deciphering bifidobacterial-mediated metabolic interactions and their impact on gut microbiota by a multi-omics approach, *ISME J.* 10 (2016) 1656-1668.

- [164] A. Rivière, M. Gagnon, S. Weckx, D. Roy, V. L. De, Mutual cross-feeding interactions between *Bifidobacterium longum* subsp. *Longum* NCC2705 and *Eubacterium rectale* ATCC 33656 explain the bifidogenic and butyrogenic effects of arabinoxylan oligosaccharides, *Appl. Environ. Microbiol.* 81 (2015) 7767-7781.
- [165] A. Patel, D. Sahu, A. Dashora, R. Garg, P. Agrawal, P. Patel, P. Patel, G. Patel, A Review of Hot Melt Extrusion Technique, *Int. J. Innov. Res. Sci. Eng. Technol.* 2 (2013) 2194-2198.
- [166] B. Claeys, Non-conventional polymers as matrix excipients for hot melt extruded oral-release formulations. PhD Thesis. Ghent University, Faculty of Pharmaceutical Sciences, Ghent, Belgium (2015) 171–172.
- [167] L. Palugan, M. Cerea, L. Zema, A. Gazzaniga, A. Maroni, Coated pellets for oral colon delivery, *J. Drug Deliv. Sci. Technol.* 25 (2015) 1-15.
- [168] H. Häbel, H. Andersson, A. Olsson, E. Olsson, A. Särkkä, Characterization of pore structure of polymer blended films used for controlled drug release, *J. Control. Release* 222 (2016) 151-158.
- [169] H. Andersson Moore, M. Marucci, L. Härdelin, J. Hjærtstam, A. Larsson, New insights on the influence of manufacturing conditions and molecular weight on phase-separated films intended for controlled release, *Int. J. Pharma.* 536 (2018) 261-271.
- [170] K. Madhumathi, L. Jeevana Rekha, T. S. Sampath Kumar, Tailoring antibiotic release for the treatment of periodontal infrabony defects using bioactive gelatin-alginate/apatite nanocomposite films, *J. Drug Deliv. Sci. Technol.* 43 (2018) 57-64.
- [171] H. Li, Q. Sang, J. Wu, G. R. Williams, L-M. Zhu, Dual-responsive drug delivery systems prepared by blend electrospinning, *Int. J. Pharma.* 543 (2018) 1-7.
- [172] N.U.Okur, M. Filippousi, M. E. Okur, S. Ayla, P. I. Sifaka, A novel approach for skin infections: Controlled release topical mats of poly(lactic acid)/poly(ethylene succinate) blends containing Voriconazole, *J. Drug Deliv. Sci. Technol.* 46 (2018) 74-86.

- [173] R. Ali, A. Dashevsky, R. Bodmeier, Poly vinyl acetate and ammonio methacrylate copolymer as unconventional polymer blends increase the mechanical robustness of HPMC matrix tablets, *Int. J. Pharma.* 516 (2017) 3-8.
- [174] J. D. N. Ogbonna, A. A. Attama, K. C. Ofokansi, S. B. Patil, G. D. Basarkar, Optimization of formulation processes using Design Expert® software for preparation of polymeric blends-artesunate-amodiaquine HCl microparticles, *J. Drug Deliv. Sci. Technol.* 39 (2017) 36-49.
- [175] Z. Mirzaie, A. Reisi-Vanani, M. Barati, Polyvinyl alcohol-sodium alginate blend, composited with 3D-graphene oxide as a controlled release system for curcumin, *J. Drug Deliv. Sci. Technol.* 50 (2019) 380-387.
- [176] A. Amarjargal, M. Brunelli, G. Fortunato, F. Spano, R. M. Rossi, On-demand drug release from tailored blended electrospun nanofibers, *J. Drug Deliv. Sci. Technol.* 52 (2019) 8-14.
- [177] S. Ensslin, K. P. Moll, H. Metz, M. Otz, K. Mäder, Polymer blends for controlled release coatings, *J. Control. Release* 125 (2008) 1-15.
- [178] Y. Cuppok, S. Muschert, M. Marucci, J. Hjaertstam, J. Siepmann, pH-independent release from coated pellets: Effect of coating composition on solubilization processes and drug release, *Eur. J. Pharm. Biopharm.* 72 (2009) 111-118.
- [179] L. Ho, Y. Cuppok, S. Muschert, K. C. Gordon, M. Pepper, Y. C. Shen, YC, F. Siepmann, J. Siepmann, P. F. Taday, T. Rades, Effects of film coating thickness and drug layer uniformity on in vitro drug release from sustained-release coated pellets: A case study using terahertz pulsed imaging, *Int. J. Pharma.* 382 (2009) 151-159.
- [180] L. Ho, Y. Cuppok, S. Muschert, K. C. Gordon, T. Rades, Drug release mechanisms from Kollicoat SR:Eudragit NE coated pellets, *Int. J. Pharma.* 409 (2011) 30-37.

- [181] E. Villar López, A. Luzardo Álvarez, J. Blanco Méndez, F. J. Otero Espinar, Cellulose-polysaccharide film-coating of cyclodextrin based pellets for controlled drug release, *J. Drug Deliv. Sci. Technol.* 42 (2017) 273-283
- [182] R. T. Liggins, H. M. Burt, Paclitaxel-loaded poly(l-lactic acid) microspheres 3: blending low and high molecular weight polymers to control morphology and drug release, *Int. J. Pharma.* 282 (2004) 61-71.
- [183] Z-W. Ye, P. Rombout, J. P. Remon, C. Vervaet, G. Van den Mooter, Correlation between the permeability of metoprolol tartrate through plasticized isolated ethylcellulose/hydroxypropyl methylcellulose films and drug release from reservoir pellets, *Eur. J. Pharm. Biopharm.* 67 (2007) 485-490.
- [184] Y. El-Malah, S. Nazzal, Novel use of Eudragit® NE 30D/Eudragit® L 30D-55 blends as functional coating materials in time-delayed drug release applications, *Int. J. Pharma.* 357 (2008) 219-227.
- [185] H. Kranz, S. Gutsche, Evaluation of the drug release patterns and long term stability of aqueous and organic coated pellets by using blends of enteric and gastrointestinal insoluble polymers, *Int. J. Pharma.* 380 (2009) 112-119.
- [186] R. Wulff, C. S. Leopold, Coatings from blends of Eudragit® RL and L55: A novel approach in pH-controlled drug release, *Int. J. Pharma.* 476 (2014) 78-87.
- [187] F. Lecomte, J. Siepmann, M. Walther, R. J. MacRae, R. Bodmeier, Blends of enteric and GIT-insoluble polymers used for film coating: physicochemical characterization and drug release patterns, *J. Control. Release* 89 (2003) 457-471.
- [188] F. Lecomte, J. Siepmann, M. W. Ross, J. Mac Rae, R. Bodmeier, Polymer blends used for the Coating of multiparticulates: Comparison of aqueous and organic coating techniques, *Pharm. Res.* 21 (2004) 882-890.

- [189] F. Siepman, J. Siepman, M. Walther, R. J. MacRae, R. Bodmeier, Blends of aqueous polymer dispersions used for pellet coating: Importance of the particle size, *J. Control. Release* 105 (2005) 226-239.
- [190] S. P. Lyu, R. Sparer, C. Hobot, K. Dang, Adjusting drug diffusivity using miscible polymer blends, *J. Control. Release* 102 (2005) 679-687.
- [191] R. Semdé, K. Amighi, D. Pierre, M. J. Devleeschouwer, A. J. Moës, Leaching of pectin from mixed pectin/insoluble polymer films intended for colonic drug delivery, *Int. J. Pharma.* 174 (1998) 233-241.
- [192] L. F. Siew, A. W. Basit, J. M. Newton, The properties of amylose–ethylcellulose films cast from organic-based solvents as potential coatings for colonic drug delivery, *Eur. J. Pharma. Sci.* 11 (2000) 133-139.
- [193] R. Semdé, K. Amighi, M. J. Devleeschouwer, A. J. Moës, Studies of pectin HM/Eudragit® RL/Eudragit® NE film-coating formulations intended for colonic drug delivery, *Int. J. Pharma.* 197 (2000) 181-192.
- [194] L. F. Siew, S. M. Man, J. M. Newton, A. W. Basit, Amylose formulations for drug delivery to the colon: a comparison of two fermentation models to assess colonic targeting performance in vitro, *Int. J. Pharma.* 273 (2004) 129-134.
- [195] P. J. Wilson, A. W. Basit, Exploiting gastrointestinal bacteria to target drugs to the colon: An in vitro study using amylose coated tablets, *Int. J. Pharma.* 300 (2005) 89-94.
- [196] S. Rujivipat, R. Bodmeier, Improved drug delivery to the lower intestinal tract with tablets compression-coated with enteric/nonenteric polymer powder blends, *Eur. J. Pharma. Biopharm.* 76 (2010) 486-492.
- [197] Y. Rosiaux, S. Muschert, R. Chokshi, B. Leclercq, J. Siepman, Ethanol-resistant polymeric film coatings for controlled drug delivery, *J. Control. Release* 169 (2013) 1-9.

- [198] Y. Rosiaux, C. Velghe, S. Muschert, R. Chokshi, J. Siepmann, Ethanol-resistant ethylcellulose/guar gum coatings – Importance of formulation parameters, *Eur. J. Pharma. Biopharm.* 85 (2013) 1250-1258.
- [199] Y. Rosiaux, C. Velghe, S. Muschert, R. Chokshi, B. Leclercq, F. Siepmann, J. Siepmann, Mechanisms controlling theophylline release from ethanol-resistant coated pellets, *Pharm. Res.* 31 (2014) 731-741.
- [200] J. Siepmann, F. Lecomte, R. Bodmeier, Diffusion-controlled drug delivery systems: calculation of the required composition to achieve desired release profiles, *J. Control. Release* 60 (1999) 379-389.
- [201] Y. S. R. Krishnaiah, V. Satyanarayana, B. D. Kumar, R. S. Karthikeyan, In vitro drug release studies on guar gum-based colon targeted oral drug delivery systems of 5-fluorouracil. *Eur. J. Pharm. Sci.* 16 (2002) 185-192.
- [202] S. M. Al-Saidan, Y. S. Krishnaiah, V. Satyanarayana, G. S. Rao, In vitro and in vivo evaluation of guar gum-based matrix tablets of Rofecoxib for colonic drug delivery, *Curr. Drug. Deliv.* 2 (2005) 155-63.
- [203] R. Kaur, M. Gulati, S. K. Singh, Role of synbiotics in polysaccharide assisted colon targeted microspheres of mesalamine for the treatment of ulcerative colitis, *Int. J. Biol. Macromol.* 95 (2017) 438-450.
- [204] M. M. Crowley, B. Schroeder, A. Fredersdorf, S. Obara, M. Talarico, S. Kucera, J. W. McGinity, Physicochemical properties and mechanism of drug release from ethyl cellulose matrix tablets prepared by direct compression and hot-melt extrusion. *Int. J. Pharma.* 269 (2004) 509-522.

- [205] H. L. Lai, K. Pitt, D. Q. M. Craig, Characterisation of the thermal properties of ethylcellulose using differential scanning and quasi-isothermal calorimetric approaches. *Int. J. Pharma.* 286 (2010) 178-184.
- [206] J. Huang, R. J. Wigent, J. B. Schwartz. Drug–Polymer interaction and its significance on the physical stability of nifedipine amorphous dispersion in microparticles of an ammonio methacrylate copolymer and ethylcellulose binary blend. *J. Pharma. Sci.* 97 (2008) 251–262.
- [207] D. Mudgil, S. Barak, B.S. Khatkar. X-ray diffraction, IR spectroscopy and thermal characterization of partially hydrolyzed guar gum. *Int. J. Biol. Macromol.* 50 (2012) 1035-1039.

VII. PUBLICATIONS AND PRESENTATIONS

Original Research Articles

1. **Benzine Y**, Siepmann F, Neut C, Danede F, Willart J-F, Siepmann J, Karrout Y. Hot melt extruded polysaccharide blends for controlled drug delivery. *J. Drug. Deliv. Sci. Technol.* 54 (2019) 101317.
2. **Benzine Y**, Siepmann F, Neut C, Danede F, Willart J-F, Siepmann J, Karrout Y. Oral controlled drug delivery dosage forms based on water insoluble polymers (PVAc or carbothane) blended with inulin – In preparation.

Oral Presentations

1. **Benzine Y**, Siepmann F, Siepmann J, Karrout Y. Hot melt extrudates for colon targeting. Pharmaceutical Solid State Research Cluster (PSSRC), 12th Annual Symposium, Leuven, Belgium, 2018.
2. **Benzine Y**, Siepmann F, Siepmann J, Karrout Y. Formes galéniques pour le ciblage du colon. 2^{ème} Journée de la Recherche, Lille, France, 2018.

Poster Presentations

- 1. Benzine Y**, Siepmann F, Siepmann J, Karrout Y. Hot melt extrudates for colon targeting. 11th World Meeting on Pharmaceutics, Biopharmaceutics and Pharmaceutical technology, (ADRITELF/APGI/APV), Granada, Proceedings # 30, 2018.
- 2. Benzine Y**, Siepmann F, Siepmann J, Karrout Y. Ethylcellulose:guar gum hot melt extrudates for controlled drug release: Impact of plasticizers & processing parameters. 3rd European Conference on Pharmaceutics, (ADRITELF/APGI/APV), Bologna, Italy, Proceedings # 61, 2019.
- 3. Benzine Y**, Siepmann F, Siepmann J, Karrout Y. Hot melt extruded polysaccharide blends for controlled drug delivery. 3rd European Conference on Pharmaceutics, (ADRITELF/APGI/APV), Bologna, Italy, Proceedings # 62, 2019.