



École Doctorale des Sciences de la Vie, Santé, Agronomie, Environnement

## THESE

En vue de l'obtention du grade de

**DOCTEUR DE L'UNIVERSITE CLERMONT AUVERGNE**

---

**Optimisation des stratégies interdisciplinaires de prise en charge de l'obésité pédiatrique :  
de l'évaluation clinique aux effets du timing exercice-repas sur le comportement  
alimentaire de l'adolescent en situation d'obésité.**

---

# ANNEXES

Présentée et soutenue publiquement par

**Alicia FILLON**

*Le 24 Avril 2020*

Devant un jury composé de :

<b>Pr MORIO Béatrice</b>	Université Lyon-Sud	<i>Présidente</i>
<b>Pr DRAPEAU Vicky</b>	Université de Laval	<i>Rapporteuse</i>
<b>Dr LAZZER Stefano</b>	Université de Udine	<i>Rapporteur</i>
<b>Dr MATHIEU Marie-Eve</b>	Université de Montréal	<i>Examineur</i>
<b>Dr MASURIER-CHÂTEAU Julie</b>	UGECAM	<i>Membre invité</i>
<b>Pr BOIRIE Yves</b>	CHU de Clermont-Ferrand	<i>Directeur</i>
<b>Dr THIVEL David</b>	Université Clermont Auvergne	<i>Directeur</i>



École Doctorale des Sciences de la Vie, Santé, Agronomie, Environnement

## THESE

En vue de l'obtention du grade de

**DOCTEUR DE L'UNIVERSITE CLERMONT AUVERGNE**

---

**Optimisation des stratégies interdisciplinaires de prise en charge de l'obésité pédiatrique :  
de l'évaluation clinique aux effets du timing exercice-repas sur le comportement  
alimentaire de l'adolescent en situation d'obésité.**

---

# ANNEXES

Présentée et soutenue publiquement par

**Alicia FILLON**

*Le 24 Avril 2020*

Devant un jury composé de :

<b>Pr MORIO Béatrice</b>	Université Lyon-Sud	<i>Présidente</i>
<b>Pr DRAPEAU Vicky</b>	Université de Laval	<i>Rapporteuse</i>
<b>Dr LAZZER Stefano</b>	Université de Udine	<i>Rapporteur</i>
<b>Dr MATHIEU Marie-Eve</b>	Université de Montréal	<i>Examineur</i>
<b>Dr MASURIER-CHÂTEAU Julie</b>	UGECAM	<i>Membre invité</i>
<b>Pr BOIRIE Yves</b>	CHU de Clermont-Ferrand	<i>Directeur</i>
<b>Dr THIVEL David</b>	Université Clermont Auvergne	<i>Directeur</i>



# Annexes

---

## Annexe 1

### Coût social de l'obésité et du surpoids (en millions d'euros en 2012)

Nature du coût	Montant lié à l'obésité	Montant lié au surpoids	Montant total
Surcoût pour l'assurance maladie (soins de villes)	2,8	2,7	5,6
Surcoût pour l'assurance maladie (hôpital)	3,7	3,3	7,0
Indemnités journalières (maladie)	0,5	0,3	0,8
Pensions d'invalidité	1,7	1,9	3,6
Dépenses de prévention	0,1	0,0	0,1
Taxes nutritionnelles	-0,2	-0,2	-0,4
Moindres dépenses de pension	-4,0	-3,2	-7,2
<b>Coût pour les finances publiques (G)</b>	<b>4,5</b>	<b>4,9</b>	<b>9,5</b>
Pertes de production dues à l'absentéisme des personnes obèses	1,2	0,9	2,1
Pertes de production dues à l'exclusion des femmes obèses du marché du travail	5,0	0,0	5,0
Dépenses de soins non remboursées (soins de ville)	0,7	0,6	1,3
Dépenses de soins non remboursées (hôpital)	0,4	0,3	0,7
<b>Coûts externes (CE)</b>	<b>7,3</b>	<b>1,8</b>	<b>9,1</b>
<b>Coût social = (1 + α) × G + CE<sup>a</sup></b>	<b>12,8</b>	<b>7,7</b>	<b>20,4</b>
Surcoût total en soins de ville	3,6	3,3	6,9
Surcoût total en soins hospitaliers	4,1	3,6	7,7

a. α = coût d'opportunité de lever des prélèvements obligatoires.

Source : calculs DG Trésor.

## Annexe 2

### Publications relatives aux développement d'outils d'évaluation et de diagnostic

---

#### **Articles originaux :**

- **Fillon, A.**, Miguet, M., O'Malley, G., Mathieu, M.-E., Masurier, J., Julian, V., Cardenoux, C., Pereira, B., Rey, O., Duclos, M., Boirie, Y., & Thivel, D. (in press). *Is the SPARTACUS 15-15 test an accurate proxy for the assessment and tracking of maximal aerobic capacities in adolescents with obesity?*
- Reid, R. E. R., **Fillon, A.**, Thivel, D., Henderson, M., Barnett, T. A., Bigras, J.-L., & Mathieu, M.-E. (2019). Can anthropometry and physical fitness testing explain physical activity levels in children and adolescents with obesity? *Journal of Science and Medicine in Sport*, S1440244019311934. <https://doi.org/10.1016/j.jsams.2019.12.005>
- **Fillon, A.**, Masurier, J., Pereira, B., Miguet, M., Mathieu, M.-E., Drapeau, V., Tremblay, A., Boirie, Y., & Thivel, D. (2019). Usefulness of the satiety quotient in a clinical pediatric obesity context. *European Journal of Clinical Nutrition*. <https://doi.org/10.1038/s41430-019-0540-8>

#### **Revue systématique :**

- **Fillon, A.**, Beaulieu, K., Mathieu, M.-E., Tremblay, A., Boirie, Y., Drapeau, V., & Thivel, D. (under review). *A systematic review of the use of the Satiety Quotient.*

**Is the SPARTACUS 15-15 test an accurate proxy for the assessment and tracking of maximal aerobic capacities in adolescents with obesity?**

**Fillon, A.**, Miguet, M., O'Malley, G., Mathieu, M.-E., Masurier, J., Julian, V., Cardenoux, C., Pereira, B., Rey, O., Duclos, M., Boirie, Y., & Thivel, D.



*In press in Journal of Physical Therapy Science*

Original Article

## Is the SPARTACUS 15-15 test an accurate proxy for the assessment and tracking of maximal aerobic capacities in adolescents with obesity?

ALICIA FILLON<sup>1-3)\*</sup>, MAUD MIGUET<sup>1)</sup>, GRACE O'MALLEY<sup>4)</sup>, MARIE-EVE MATHIEU<sup>5, 6)</sup>, JULIE MASURIER<sup>3)</sup>, VALÉRIE JULIAN<sup>2, 7, 8)</sup>, CHARLOTTE CARDENOUX<sup>9)</sup>, BRUNO PEREIRA<sup>10)</sup>, OLIVIER REY<sup>11)</sup>, MARTINE DUCLOS<sup>2, 7, 8, 12)</sup>, YVES BOIRIE<sup>2, 8, 12, 13)</sup>, DAVID THIVEL<sup>1, 12)</sup>

<sup>1)</sup> Clermont Auvergne University: EA 3533, Laboratory of the Metabolic Adaptations to Exercise under Physiological and Pathological Conditions (AME2P), Clermont-Ferrand, France

<sup>2)</sup> INRA, France

<sup>3)</sup> UGECAM Nutrition Obesity Ambulatory Hospital, France

<sup>4)</sup> School of Physiotherapy, Division of Population Health Sciences, The Royal College of Surgeons in Ireland, Ireland

<sup>5)</sup> School of Kinesiology, University of Montreal, Canada

<sup>6)</sup> Sainte-Justine UHC Research Center, Canada

<sup>7)</sup> Department of Sport Medicine and Functional Explorations, Clermont-Ferrand University Hospital, G. Montpied Hospital, France

<sup>8)</sup> UFR Medicine, University Clermont Auvergne, France

<sup>9)</sup> Pediatric Obesity Department, Children Medical Center, France

<sup>10)</sup> Biostatistics unit (DRCI), Clermont-Ferrand University Hospital, France

<sup>11)</sup> Aix Marseille University, France

<sup>12)</sup> CRNH-Auvergne, France

<sup>13)</sup> Department of Human Nutrition, Clermont-Ferrand University Hospital, G. Montpied Hospital, France

**Abstract.** [Purpose] While there is a need for reliable field tests for the evaluation of physical fitness in pediatric obesity, the present work i) evaluates the validity of the Spartacus 15-15 test in indirectly assessing maximal aerobic capacity in adolescents with obesity and ii) evaluates its sensibility to weight loss. [Participants and Methods] Fifty-five 11–16 year-old adolescents with obesity (Tanner 3–4) were enrolled in a 12-week weight-management intervention. Maximal Aerobic fitness ( $VO_{2peak}$  test + Spartacus test) and body composition (Dual X-ray absorptiometry) were assessed at baseline and after 12 weeks. [Results] Moderate correlations were found at baseline between  $VO_{2peak}$  ( $2,231.90 \pm 465.6$  mL/min) and Spartacus stage ( $6.83 \pm 1.8$  stage,  $r=0.52$ ;  $p \leq 0.05$ ), speed ( $12.85 \pm 1.8$  km/h,  $r=0.52$ ;  $p \leq 0.05$ ) and time ( $20.6 \pm 5.4$  min;  $r=0.50$ ;  $p \leq 0.05$ ). The intervention favored significant improvements for  $VO_{2peak}$ , Spartacus Rate of Perceived Exertion final stage, maximal speed and time. Change over time in  $VO_{2peak}$  and Spartacus variables were not correlated. [Conclusion] The Spartacus test can be used as a proxy for  $VO_{2peak}$  at baseline and can be used to estimate  $VO_{2peak}$  using the proposed equation. The Spartacus 15-15 test might be a better indicator for changes in functional capacity than an indicator of  $VO_{2peak}$  changes in youth with obesity.

**Key words:** Aerobic fitness, Obese adolescents, Field test

(This article was submitted Nov. 1, 2019, and was accepted Jan. 21, 2020)

\*Corresponding author. Alicia Fillon (E-mail: fillonalicia@gmail.com)

©2020 The Society of Physical Therapy Science. Published by IPEC Inc.



This is an open-access article distributed under the terms of the Creative Commons Attribution Non-Commercial No Derivatives (by-nc-nd) License. (CC-BY-NC-ND 4.0: <https://creativecommons.org/licenses/by-nc-nd/4.0/>)



## INTRODUCTION

The alarming prevalence of overweight and obesity among children and adolescents is associated with early psychological, metabolic and functional complications<sup>1-4</sup>. Effective weight management interventions, which employ reliable methods for evaluating health outcomes, are of great importance for the prevention of such co-morbidity and monitoring change over time.

Reliable evaluation methods are particularly necessary for measuring and monitoring change in outcomes related to an individual's physical fitness. While laboratory-based tests are considered as gold standards, access is often limited and testing too costly. This is particularly true when it comes to aerobic fitness where maximal incremental cycling or running tests require direct measurements of oxygen uptake and the supervision of a specialized healthcare staff.

Although indirect, maximal, progressive and continuous field tests are in use, their accuracy remains uncertain, in youth with obesity. Among them, the adapted 20-meter shuttle run test (20-SRT)<sup>5</sup> and the continuous multi-stage track test (MSTT)<sup>6</sup> are often used. Although these provide satisfactory<sup>7</sup> and reproducible<sup>8</sup> tests among lean children and adolescents, their reliability in youth with obesity is questionable<sup>9</sup>. The MSTT consists of a progressive and continuous test, which oftentimes is prematurely stopped in youth with obesity due to a premature and exacerbated fatigue elicited by the back and forth running. Early stoppage may potentially yield inaccurate estimates of maximal aerobic capacity since youth with obesity often prefer intermittent short-term exercise versus longer continuous exercise regardless of intensity<sup>10</sup>. Similarly, the 20-SRT is composed of uninterrupted runs requiring sudden changes in direction which generate high energy costs and musculoskeletal pain and discomfort; all of which lead to premature halting of the test in children with obesity<sup>11</sup>. The impact on musculoskeletal comfort is of particular importance since musculoskeletal and functional limitations are proposed as a main limiting factor during the assessment of aerobic fitness in children and adolescents with overweight and obesity<sup>12</sup>.

The Spartacus 15-15 field test was developed as an intermittent maximal running field test alternating running and rest periods<sup>13</sup>. According to Rey and collaborators, a 20% higher mean maximal speed is observed using the Spartacus compared to the 20-MSTT in adolescents with obesity despite similar maximal heart and perceived exertion rates<sup>14</sup>. Our research group recently showed that the Spartacus 15-15 test was highly reproducible among adolescents with obesity and that higher  $VO_{2peak}$  and  $HR_{peak}$  were obtained using this test compared with other progressive, continuous and maximal test<sup>10</sup>. Although the Spartacus test is a reliable method for assessing maximal aerobic capacity among youth with obesity, it has never been compared with a direct laboratory-based measurement of  $VO_{2peak}$  and it remains unknown whether results obtained using this test are sensible to weight loss. Indeed, while many studies use the above-mentioned indirect field tests when questioning the effect of weight loss interventions on the physical fitness of adolescents with obesity, their validity and reliability rest on cross-sectional studies, and we did not find any work that investigate their sensitivity to weight loss compared with direct measures such as  $VO_{2max}$ .

The first aim of the present study was to test the validity of the Spartacus as an indirect test for assessing maximal aerobic capacities compared with a direct laboratory-based measurement of  $VO_{2peak}$  and, secondly, to investigate its sensibility to weight loss in adolescents with obesity. We hypothesize that the Spartacus is a reliable proxy to estimate  $VO_{2peak}$  in adolescents with obesity and that this intermittent field test shows a significant sensibility to weight loss in this population.

## PARTICIPANTS AND METHODS

Patients attending a specialized pediatric clinic (Pediatric Obesity Department of Romagnat and Tzanou, La Bourboule, France), were eligible to participate in this study. Patients were eligible if they had a Body Mass Index (BMI) above the 90th percentile according to the international reference values<sup>15</sup>, were free of any physical contraindications (i.e. recent fracture, articulation issues, etc.) and did not use any medication that could interfere with the principal outcomes of the study. The adolescents and their legal representatives received information sheets and gave their written consent for participation as requested by the ethical authorities (Committee for Human Protection: CPP Sud Est VI, Clinical Trial: NCT02482220).

Following an initial cardiac test and a medical screen by a pediatrician to ensure the ability of the adolescents to complete the protocol, anthropometric measurements were performed, body composition assessed by dual-energy X-ray absorptiometry (DXA, QDR 4500 Hologic), their maximal aerobic fitness ( $VO_{2peak}$ ) evaluated and they were asked to perform a Spartacus run test. Participants were then enrolled in a 3-month inpatient multidisciplinary intervention designed to induce weight-loss and all measurements were repeated after 12 weeks (T1).

A digital scale (SECA, les Mureaux, France) was used to measure body mass to the nearest 0.1 kg, and height to the nearest 0.5 cm (SECA, les Mureaux, France). Body Mass Index (BMI) was calculated as body mass (kg) divided by height squared ( $m^2$ ). Waist circumference was measured at the level midway between the last rib and the upper iliac crest. Body composition (Fat Mass percentage (FM%) and Fat-Free Mass (kg)) was assessed using Dual X-ray absorptiometry (DXA, QDR 4500A scanner, Hologic, Waltham, MA, USA).

Each  $VO_{2peak}$  was completed under similar conditions at the same time of the day.  $VO_{2peak}$  was measured during a graded exhaustive cycling test<sup>16</sup> that was performed at least one week prior to the Spartacus test, by a specialized medical investigator from the Department of Sports Medicine, Functional and Respiratory Rehabilitation (Clermont-Ferrand University Hospital). The initial power was set at 30 W for 3 min and followed by 15 W increments every 1.5 min. Adolescents were

strongly encouraged by experimenters throughout the test to perform a maximum effort. Criteria for reaching  $VO_{2peak}$  were subjective exhaustion with heart rate above  $195 \text{ beats} \cdot \text{min}^{-1}$  and/or Respiratory Exchange Ratio (RER,  $VCO_2/VO_2$ ) above 1.02 and/or a plateau of  $VO_2$ . An electromagnetically-braked cycle ergometer (Ergoline, Bitz, Germany) was used to perform the test.  $VO_2$  and  $VCO_2$  were measured breath-by-breath through a mask connected to  $O_2$  and  $CO_2$  analyzers (Oxycon Pro-Delta, Jaeger, Hoechberg, Germany). Calibration of gas analyzers was performed with commercial gases of known concentration. Ventilatory parameters were averaged every 30 s. ECG was monitored for the duration of the test.

Each Spartacus test was completed under similar conditions at the same time of the day. As previously described by Rey et al., a rectangle of 750 meters ( $75 \times 10 \text{ m}$ )<sup>2</sup> was created with different marks set at regular intervals, which represent the different speeds (from 7 to 18 km/h)<sup>14</sup>. Each stage lasts three minutes whereby the first stage is set at 7 km/h and each following stage increasing by 1 km/h every three minutes. During the three minutes (for each stage/ speed), participants had 15 sec to reach the corresponding mark and then 15 sec of rest. As such, each stage lasts three minutes and is composed of 90 sec of running and 90 sec of rest. As soon as the participant was not able to complete a whole stage, the test was interrupted and the last completed stage recorded. Participants ran in groups of no more than 5. Figure 1 illustrates the Spartacus protocol. Heart rate was continuously monitored during the test (Polar Electro Inc. RS800CX) and the adolescents' rate of perceived exertion (RPE) was also evaluated at the end of different stage using an adapted version of the Borg Scale (rated from 0 to 10 with 10 representing a maximal effort that cannot be sustained and the need to interrupt the test).

The fifty-five adolescents were enrolled in a 12-week weight management program combining dietary education and physical activity, at the Pediatric Obesity clinical center (Centre Medical Infantile Romagnat & Tzanou, France). Every week, adolescents completed two 60-minute exercise sessions combining resistance and aerobic exercises as well as a third session composed of combined recreative activities and sport games (i.e. ball and racquet games or recreational activities such as trekking or snowshoeing). The adolescents also attended nutritional education classes twice a month led by a dietician and received psychological support through individualized consultation with a professional once a month. During the intervention, the adolescents were submitted to a normo-caloric diet based on their age and gender recommendations<sup>17</sup>.

The statistical analyses were carried out using the statistical software Stata (version 13, StataCorp, College Station, USA). All statistical tests were conducted for a two-sided type I error at 0.05. Continuous variables were described as mean and standard-deviation or median and interquartile range, according to statistical distribution (assumption of normality studied using Shapiro-Wilk test). Paired comparisons were performed using paired Student t-test, or Wilcoxon test when assumptions of t-test were not met. The results were expressed as paired Hedges's effect-sizes. Furthermore, the relationships between quantitative parameters were studied using correlation coefficients (Pearson or Spearman according to the statistical distribution), applying a Sidak's correction to take into account multiple comparisons. Then, to estimate  $VO_{2peak}$ , an equation has been proposed by multiple linear regression model. The covariates were determined according to univariate results and clinical relevance: age, gender and BMI. The normality of residuals was studied using the Shapiro-Wilk test and a logarithmic transformation of dependent variable was proposed to achieve the normality. A particular attention was paid on study of multicollinearity. The results were expressed as regression coefficients and 95% confidence intervals.

## RESULTS

The whole sample was aged  $13.1 \pm 1.2$  years with a body mass of  $92.16 \pm 14.1 \text{ kg}$  and a mean BMI of  $35.06 \pm 4.3 \text{ kg/m}^2$ . The adolescents mean fat mass percentage and fat free mass were  $37.97 \pm 3.9\%$  and  $55.41 \pm 9.0 \text{ kg}$  respectively.

Baseline ( $T_0$ ),  $VO_{2peak}$  ( $2,231.90 \pm 465.6 \text{ mL/min}$ ) was significantly correlated with the  $T_0$  last Spartacus stage ( $6.83 \pm 1.8$

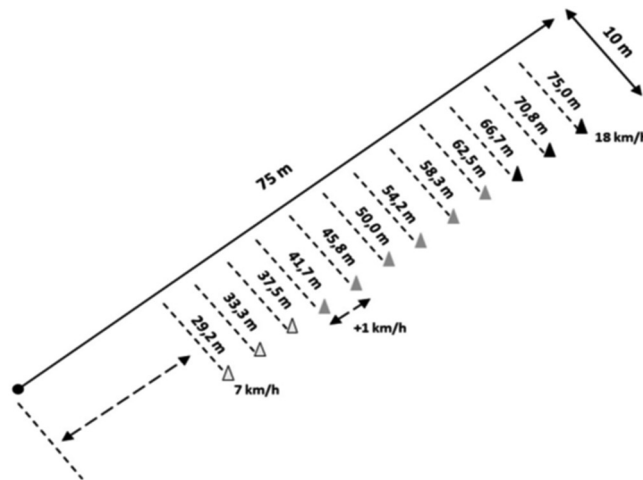

Fig. 1. The Spartacus protocol (adapted from Rey et al., 2013)

stage;  $r=0.52$ ;  $p\leq 0.05$ ); distance ( $53.28 \pm 7.4$  m;  $r=0.52$ ;  $p\leq 0.05$ ), speed ( $12.85 \pm 1.8$  km/h;  $r=0.52$ ;  $p\leq 0.05$ ) and time ( $20.6 \pm 5.4$  min;  $r=0.50$ ;  $p\leq 0.05$ ).

An equation can be proposed to estimate  $VO_{2peak}$  based on the performance obtained during the Spartacus test (Table 1 details the results of the multivariate regression performed to compute this equation). This equation integrates “age”, “gender”, “BMI” and “last SPARTACUS stage validated” ( $r=0.68$ ):

$VO_{2peak}$  estimation equations:

Girl: Last stage \* 153.4433 + BMI \* 58.64534 + age \* -2.701522 - 921.2878

Boy: Last stage \* 153.4433 + 320.1583 + BMI \* 58.64534 + age \* -2.701522 - 921.2878

As described by Table 2, body mass was significantly decreased (ES: 0.38 [-0.2 -0.96];  $p\leq 0.001$ ), as well as BMI (ES: 0.7 [0.11-1.3];  $p\leq 0.001$ ) and fat mass (ES: 0.97 [0.36 -1.58];  $p\leq 0.001$ ), while fat free mass did not change significantly.

Table 3 presents the  $VO_{2peak}$  and Spartacus test results between baseline and T1.  $VO_{2peak}$  was significantly improved by the end of the intervention (ES: -0.43 [-1.01-0.16];  $p<0.05$ ). The Spartacus RPE (ES: -2.29 [-0.89 -0.31];  $p\leq 0.05$ ), last completed stage (-0.84 [-1.45 to -0.23];  $p\leq 0.001$ ), maximal speed (-0.81 [-0.41 to -0.21]), total times (-0.79 [-1.39 to

**Table 1.** Results from the multivariate regression used for the elaboration of the equation

	Coefficient	SD	95%CI	p
Last stage	153.4	30.7	[91.4, 215.4]	***
BMI (kg/m <sup>2</sup> )	58.6	13.3	[31.6, 85.6]	***
Age (years)	-2.7	46.8	[-97.1, 91.7]	0.954
Gender <sup>a</sup>	320.1	97.1	[124.2, 516.0]	***
Constant variable	-921.2	600.4	[-2131.3, 288.7]	0.132

SD: Standard Deviation; CI: Confidence Interval; \*\*\* $p<0.001$ ; <sup>a</sup> when gender is boy.

**Table 2.** Body composition and comparison between T0 and T1

	T0	T1	ES	p
Body mass (kg)	92.16 ± 14.1	85.0 ± 15.7	0.38 [-0.2, 0.96]	***
BMI (kg/m <sup>2</sup> )	35.06 ± 4.3	32.1 ± 4.3	0.7 [0.11, 1.3]	***
Fat mass (%)	37.97 ± 3.9	32.1 ± 4.3	0.97 [0.36, 1.58]	***
Fat free mass (kg)	55.41 ± 9.0	54.3 ± 10.0	-0.006 [0.56, 0.57]	

T0: baseline; T1: end of the intervention; BMI: Body Mass index; ES: Effect Size; \* $p<0.05$ ; \*\* $p<0.01$ .

**Table 3.** Results and comparison between T0 and T1 for the  $VO_{2peak}$  and Spartacus test

	T0	T1	ES [95%CI]	p
Laboratory test				
$VO_{2peak}$ (ml/min)	2,231.9 ± 465.6	2,457.0 ± 396.2	-0.43 [-1.01, 0.16]	*
HR <sub>peak</sub> (bpm)	185.3 ± 8.5	183.5 ± 15.3	0.25 [-0.32, 0.82]	
Spartacus 15-15 test				
RPE <sub>end</sub> (scale 1-10)	8.1 ± 1.7	6.4 ± 2.4	-2.29 [-0.89, 0.31]	*
HR <sub>peak</sub> (bpm)	193.8 ± 9.5	191.1 ± 10.2		
Last stage	6.8 ± 1.8	8.0 ± 2.6	-0.84 [-1.45, -0.23]	***
Maximal distance (m)	53.3 ± 7.4	57.7 ± 11.6	-0.74 [-0.12, 1.35]	**
Maximal speed (km/h)	12.9 ± 1.8	14.1 ± 2.5	-0.81 [-0.41, -0.21]	***
Total time (min)	20.6 ± 5.4	24.2 ± 7.5	-0.79 [-1.39, -1.19]	***
RPE last stage T0	8.2 ± 1.6	3.8 ± 2.1	0.88 [0.30, 1.45]	***
HR last stage T0	176.4 ± 12.5	186.4 ± 36.2	-1.67 [-0.73, 0.39]	***

T0: baseline; T1: end of the intervention; HR: Heart Rate; RPE: Rate of Perceived Exertion; ES: Effect Size; \* $p<0.05$ ; \*\* $p<0.01$ ; \*\*\* $p<0.001$ .

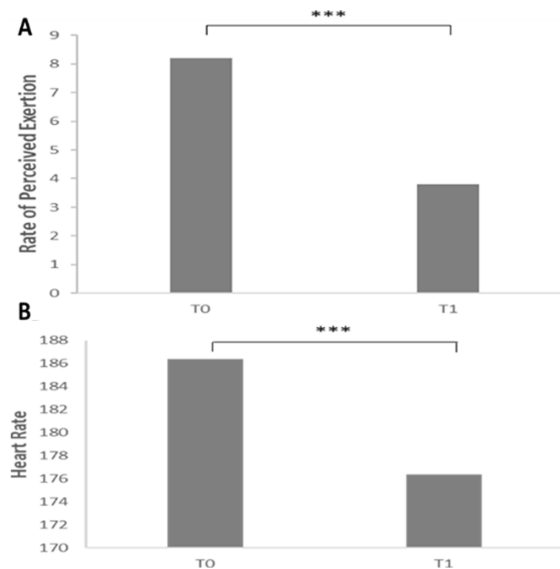

**Fig. 2.** Changes of the adolescents Rate of Perceived Exertion (A) and Peak of Heart Rate (B) recorded at the end of the last stage completed in the Spartacus test.  
T0: baseline; T1: end of the intervention; \*\*\* $p < 0.001$ .

-1.19]) ( $p \leq 0.001$ ) and maximal distance (-0.74 [1.35 to -0.12];  $p \leq 0.01$ ) were significantly improved. Maximal heart rate did not change between baseline and T1 during both the  $VO_{2peak}$  and Spartacus tests.

After the intervention (T1), the adolescents' heart rate and rate of perceived exertion (RPE) recorded at the end of the last stage completed at T0 were both significantly improved ( $p < 0.001$ ) as illustrated by Fig. 2.

There was no significant correlation between the absolute  $VO_{2peak}$  and the Spartacus results at T1 and the  $VO_{2peak}$  and Spartacus results variations (using deltas) were not correlated. None of the Spartacus outcome changes between T0 and T1 was correlated with body weight, BMI, fat mass % and fat free mass changes. The  $VO_{2peak}$  variation was not correlated with body weight and FM% changes but significantly correlated with fat free mass ( $r = 0.48$ ;  $p < 0.05$ ) and BMI ( $r = 0.49$ ;  $p < 0.05$ ) variations.

## DISCUSSION

While it exists many field tests to evaluate aerobic fitness among children and adolescents, their accuracy in youth with overweight or obesity remains debated. The first aim of the present work was to test the validity of the Spartacus as an indirect test assessing maximal aerobic capacities compared with a direct measurement of  $VO_{2peak}$  and, secondarily, to investigate its sensibility to weight loss in adolescents with obesity.

The Spartacus test, as an intermittent progressive and maximal 15-15 test elaborated to indirectly evaluate children and adolescents' aerobic capacities has been previously compared with usually used field tests such as the 20-MSRT or the Leger-Boucher continuous test and has been found to provide satisfactory results in both lean adolescents and youth with obesity<sup>14, 18</sup>. More recently, Thivel and collaborators suggested that this Spartacus 15-15 test could be more appropriate than the other classically used continuous and progressive field ones for assessing functional capacities in adolescents with obesity<sup>19</sup>. Although the authors also found the Spartacus 15-15 test to be highly reproducible, they pointed out the need for direct comparisons with laboratory based  $VO_{2peak}$  measurements<sup>19</sup>. The present work is to our knowledge the first to directly compare the Spartacus performances to a direct laboratory-based measure of maximal aerobic fitness in adolescents with obesity. According to our results, the Spartacus test provides an accurate estimation of  $VO_{2peak}$  in 11 to 16 years old adolescents with obesity. Indeed, our analyses show significant correlations between the different Spartacus outcomes (distance, speed, final stage) and the measured  $VO_{2peak}$ . Importantly, although these correlations are significant and clinically relevant, they remain moderate, suggesting that the Spartacus test might not be an exact direct proxy for  $VO_{2peak}$  but, as previously suggested, might provide a great estimation of the adolescents' aerobic and functional capacities<sup>19</sup>. This is reinforced by the fact that these significant correlations have been obtained at baseline only (despite improvement of both  $VO_{2peak}$  and Spartacus performances as discussed below). Based on these results, we also propose here the use of an equation integrating the adolescents' individual characteristics (age, gender, BMI) and Spartacus performances (last completed stage) to better estimate baseline  $VO_{2peak}$  based on the results obtained during the field test. Since laboratory-based evaluations are rarely available to practitioners and clinicians who rely on indirect field test to assess their patients' capacities<sup>20</sup>) and based on the

practical feasibility of the Spartacus test, such an equation can help these practitioners elaborating and calibrating their interventions (individualizing the exercise intensities and their progression for instance). Although some previously published studies proposed equations based on individual characteristics such as body weight and body composition, anthropometric measurements, gender or age to estimate  $VO_{2peak}$  among children and adolescents<sup>21–23</sup>) we found only few studies that proposed an equation integrating performances issued from a field test<sup>5, 23, 24</sup>).

Although these first results point out a moderate correlation between the performances obtained during the Spartacus test and a direct measure of  $VO_{2peak}$  in adolescents with obesity, we also questioned here whether this field test was sensible to weight loss and whether the improvements observed in response to a multidisciplinary intervention were associated with anthropometric, body composition and  $VO_{2peak}$  changes. Our results show significant correlations between the variations of weight, BMI, fat mass (%) and the improvement of the performances obtained by the adolescents by the end of the intervention, which joins up with previously published studies in the field<sup>24</sup>). However, while both the direct measure of  $VO_{2peak}$  and the Spartacus performances (last completed stage, maximal covered distance, HRmax, maximal speed, RPEend and total duration) showed significant improvements in response to a 3-month intervention; we missed to find any correlation between these changes. Indeed, based on our statistical analysis, the moderate correlations observed between  $VO_{2peak}$  and the Spartacus performances at baseline did not exist anymore at T1, and the progression deltas for  $VO_{2peak}$  and the Spartacus results were not found correlated. Importantly, our concordance analysis also missed to reveal any relationship between these two tests between T0 and T1. Although many studies have used field tests to assess aerobic fitness and its response to weight loss programs in children and adolescents with obesity<sup>25, 26</sup>) we missed to find any already existing analysis of the sensitivity of these tests as potential proxies for  $VO_2$  changes after weight loss in youth with obesity. This sounds of particular importance since most of researchers and practitioners commonly associate these results as indirect measures for aerobic capacities. Even though the Spartacus (certainly such as other equivalent field tests whose sensibility to weight loss remains to be determined) might not be a great indirect tool to estimate  $VO_{2peak}$  changes, our results clearly show significant improvements of its performances in our sample, highlighting its feasibility and potential reliability to assess the adolescents' functional progression after such a multidisciplinary program. These improvements are illustrated by the significant progression of all the results obtained thanks to the Spartacus test at T1 compare with baseline and also interestingly by the significantly lower rate of perceived exertion obtained at T1 after the completion of the final stage completed at baseline.

The present results have to be considered in light of some limitations. Indeed, the number of participants is rather low, with an unequal girl/boy distribution. Moreover, our panel of participants included pre and post-puberty adolescents aged of 11 to 16 years, which could have influenced the responses to both tests due to the metabolic changes occurring during puberty that influence aerobic capacities<sup>27</sup>). Mainly, this work lacks from a direct evaluation of the adolescents oxygen consumption during the Spartacus test. Indeed, the use of a portable calorimeter to assess  $VO_2$  would have provided important results to enrich our comparison with the laboratory measurement of  $VO_{2peak}$ . However, this remained difficult here for practical reasons.

While field tests are mainly used by practitioners, the Spartacus progressive and intermittent maximal 15-15 test proposes a great alternative to laboratory-based evaluation that remains hardly accessible. The present preliminary results add to the actual literature that this Spartacus can be used as an interesting proxy for  $VO_{2peak}$  at baseline and proposes an equation based on its performances to estimate  $VO_{2peak}$  in adolescents with obesity. Such equations are of particular importance since few practitioners have access to direct measurements of aerobic capacities (such as  $VO_{2peak}$ ) that are needed to better calibrate their interventions. It seems however that the improvements observed during a Spartacus test in response to a 3-month multidisciplinary weight loss program cannot be used as proxies for  $VO_{2peak}$  changes in this population but as potential indicators of the adolescents' overall functional capacity improvements.

### *Conflict of interest*

The authors report no conflicts of interest.

## **ACKNOWLEDGEMENT**

The authors want to thank the adolescents who took part in the study and the UGECAM Nutrition Obesity (Tzanou and the ambulatory clinics) Center for its partnership.

## **REFERENCES**

- 1) Ciangura C, Poitou-Bernert C: Complications des obésités. *B Endocrinol-Nutr*, 2010.
- 2) Faucher P, Poitou C: [Physiopathology, causes and complications of obesity]. *Soins*, 2016, 61: 20–25 (in French). [[Medline](#)] [[CrossRef](#)]
- 3) Maggio AB, Martin XE, Saunders Gasser C, et al.: Medical and non-medical complications among children and adolescents with excessive body weight. *BMC Pediatr*, 2014, 14: 232. [[Medline](#)] [[CrossRef](#)]
- 4) Tsiros MD, Olds T, Buckley JD, et al.: Health-related quality of life in obese children and adolescents. *Int J Obes*, 2009, 33: 387–400. [[Medline](#)] [[CrossRef](#)]
- 5) Quinart S, Mougin F, Simon-Rigaud ML, et al.: Evaluation of cardiorespiratory fitness using three field tests in obese adolescents: validity, sensitivity and

prediction of peak VO<sub>2</sub>. *J Sci Med Sport*, 2014, 17: 521–525. [[Medline](#)] [[CrossRef](#)]

- 6) Léger L, Boucher R: An indirect continuous running multistage field test: the Université de Montréal track test. *Can J Appl Sport Sci*, 1980, 5: 77–84. [[Medline](#)]
- 7) Tomkinson GR, Léger LA, Olds TS, et al.: Secular trends in the performance of children and adolescents (1980-2000): an analysis of 55 studies of the 20m shuttle run test in 11 countries. *Sports Med*, 2003, 33: 285–300. [[Medline](#)] [[CrossRef](#)]
- 8) Moran CA, Peccin MS, Bombig MT, et al.: Performance and reproducibility on shuttle run test between obese and non-obese children: a cross-sectional study. *BMC Pediatr*, 2017, 17: 68. [[Medline](#)] [[CrossRef](#)]
- 9) Thivel D, Malina RM, Isacco L, et al.: Metabolic syndrome in obese children and adolescents: dichotomous or continuous? *Metab Syndr Relat Disord*, 2009, 7: 549–555. [[Medline](#)] [[CrossRef](#)]
- 10) Thivel D, Isacco L, O'Malley G, et al.: Pediatric obesity and perceived exertion: difference between weight-bearing and non-weight-bearing exercises performed at different intensities. *J Sports Sci*, 2016, 34: 389–394. [[Medline](#)] [[CrossRef](#)]
- 11) Physical activity and obesity: biomechanical and physiological key concepts. <https://www.hindawi.com/journals/job/2011/650230/> (Accessed Apr. 23, 2018)
- 12) Ratel S, Duché P, Williams CA: Muscle fatigue during high-intensity exercise in children. *Sports Med*, 2006, 36: 1031–1065. [[Medline](#)] [[CrossRef](#)]
- 13) Rossi D, Mauffrey D, Nicol C: Présentation d'un protocole intermittent de test d'aptitude à l'effort aérobie. *Revue Hyper*, 2009, 4–9.
- 14) Rey O, Rossi D, Nicol C, et al.: Évaluation indirecte de la capacité aérobie d'adolescents obèses : intérêt d'un test de course à pied intermittent court, progressif et maximal. *Sci Sports*, 2013, 28: e133–e139. [[CrossRef](#)]
- 15) Cole TJ, Bellizzi MC, Flegal KM, et al.: Establishing a standard definition for child overweight and obesity worldwide: international survey. *BMJ*, 2000, 320: 1240–1243. [[Medline](#)] [[CrossRef](#)]
- 16) Rowland TW: Does peak VO<sub>2</sub> reflect VO<sub>2</sub>max in children?: evidence from supramaximal testing. *Med Sci Sports Exerc*, 1993, 25: 689–693. [[Medline](#)] [[CrossRef](#)]
- 17) Murphy SP, Poos MI: Dietary reference intakes: summary of applications in dietary assessment. *Public Health Nutr*, 2002, 5: 843–849. [[Medline](#)] [[CrossRef](#)]
- 18) Rey O, Maïano C, Nicol C, et al.: Psycho-physiological responses of obese adolescents to an intermittent run test compared with a 20-M shuttle run. *J Sports Sci Med*, 2016, 15: 451–459. [[Medline](#)]
- 19) Thivel D, O'Malley G, Blourdier D, et al.: Reproducibility of the intermittent Spartacus Run Test in obese adolescents. *J Sports Med Phys Fitness*, 2017, 57: 1083–1088. [[Medline](#)]
- 20) O'Malley G, Thivel D: Physical activity and play in children who are obese. M.L. Frelut.
- 21) Saint-Maurice PF, Welk GJ, Finn KJ, et al.: Cross-validation of a PACER prediction equation for assessing aerobic capacity in Hungarian youth. *Res Q Exerc Sport*, 2015, 86: S66–S73. [[Medline](#)] [[CrossRef](#)]
- 22) Chatterjee P, Banerjee AK, Das P: A prediction equation to estimate the maximum oxygen uptake of school-age girls from kolkata, India. *Malays J Med Sci*, 2011, 18: 25–29. [[Medline](#)]
- 23) McMurray RG, Guion WK, Ainsworth BE, et al.: Predicting aerobic power in children. A comparison of two methods. *J Sports Med Phys Fitness*, 1998, 38: 227–233. [[Medline](#)]
- 24) Racil G, Ben Ounis O, Hammouda O, et al.: Effects of high vs. moderate exercise intensity during interval training on lipids and adiponectin levels in obese young females. *Eur J Appl Physiol*, 2013, 113: 2531–2540. [[Medline](#)] [[CrossRef](#)]
- 25) Tjønnå AE, Stølen TO, Bye A, et al.: Aerobic interval training reduces cardiovascular risk factors more than a multitreatment approach in overweight adolescents. *Clin Sci (Lond)*, 2009, 116: 317–326. [[Medline](#)] [[CrossRef](#)]
- 26) Elloumi M, Makni E, Ounis OB, et al.: Six-minute walking test and the assessment of cardiorespiratory responses during weight-loss programmes in obese children. *Physiother Res Int*, 2011, 16: 32–42. [[Medline](#)] [[CrossRef](#)]
- 27) Ratel S, Blazeovich AJ: Are prepubertal children metabolically comparable to well-trained adult endurance athletes? *Sports Med*, 2017, 47: 1477–1485. [[Medline](#)] [[CrossRef](#)]

**Can anthropometry and physical fitness testing explain physical activity  
levels in children and adolescents with obesity?**

Reid, R. E. R., **Fillon, A.**, Thivel, D., Henderson, M., Barnett, T. A., Bigras, J.-L.,  
Mathieu, M.-E.

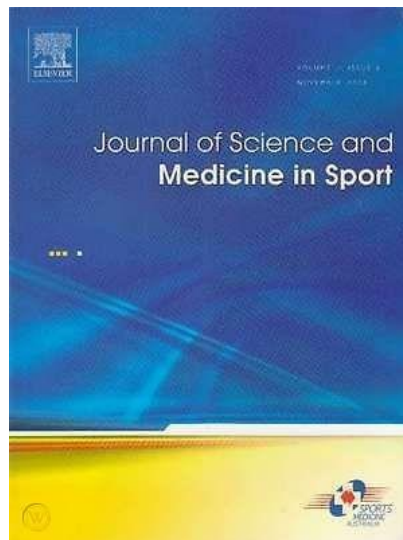

*Accepted in Journal of Science and Medicine in Sport, 2019*



Contents lists available at ScienceDirect

Journal of Science and Medicine in Sport

journal homepage: [www.elsevier.com/locate/jsams](http://www.elsevier.com/locate/jsams)



Original research

## Can anthropometry and physical fitness testing explain physical activity levels in children and adolescents with obesity?

Ryan E.R. Reid<sup>a,b</sup>, Alicia Fillon<sup>c</sup>, David Thivel<sup>c</sup>, Mélanie Henderson<sup>b,d</sup>,  
Tracie A. Barnett<sup>b,e</sup>, Jean-Luc Bigras<sup>b</sup>, Marie-Eve Mathieu<sup>a,b,\*</sup>

<sup>a</sup> School of Kinesiology and Physical Activity Science, Université de Montréal, Canada

<sup>b</sup> Research Center, Sainte-Justine University Hospital Research Center, Canada

<sup>c</sup> Metabolic Adaptation to Exercise Under PhysioPathological Condition Laboratory (AME2P), Center for Human Nutrition Research (CRNH Auvergne), Clermont Auvergne University, France

<sup>d</sup> Department of Pediatrics, Université de Montréal, Canada

<sup>e</sup> Department of Family Medicine, McGill University, Canada

### ARTICLE INFO

#### Article history:

Received 26 August 2019

Received in revised form

29 November 2019

Accepted 5 December 2019

Available online xxx

#### Keywords:

Body mass index

Moderate-to-vigorous physical activity

Body composition

Long jump

Free-living environment

Accelerometry

### ABSTRACT

**Objectives:** As time with patients and resources are increasingly limited, it is important to determine if clinical tests can provide further insight into real-world behaviors linked to clinical outcomes. The purpose of this study was to determine which aspects of anthropometry and physical fitness testing are associated with physical activity (PA) levels among youth with obesity.

**Design:** Cross-sectional study.

**Method:** Anthropometry [height, waist circumference, bodyweight, fat percentage], physical fitness [muscular endurance (partial curl-ups), flexibility (sit-and-reach), lower-body power (long-jump), upper-body strength (grip), speed/agility (5 × 5-m shuttle), cardiorespiratory fitness (VO<sub>2</sub>-max)], and PA [light (LPA), moderate (MPA), vigorous (VPA), MVPA] was assessed in 203 youth with obesity.

**Results:** The sample was stratified by age <12 yrs (children); 12 yrs (adolescents) and sex. Stepwise regression evaluated associations between PA with anthropometry and physical fitness. Children (57% male) and adolescents (45% male) had a BMI Z-score of 3.5(SD:0.94) and 3.1(SD:0.76) respectively. Long-jump explained 19.5% [(Standardized) Beta = 0.44; *p* = 0.001] of variance in VPA for childhood girls and 12.6% (Beta = 0.35; *p* = 0.025) of variance in MPA for adolescent boys. 5 × 5-m shuttle explained 8.4% (Beta = -0.29; *p* = 0.042) of variance in MVPA for childhood girls. Body mass explained 6.3% (Beta = -0.25; *p* = 0.007) of variance in LPA in childhood boys. Fat percentage explained 9.8% (Beta = 0.31; *p* = 0.03) of variance in MPA in adolescent girls.

**Conclusions:** In conclusion, tests of lower body power, body mass and fat percentage provide limited information concerning PA levels in youth with obesity. Activity monitoring should be considered in addition to clinical assessments to more fully understand youth health.

© 2020 Sports Medicine Australia. Published by Elsevier Ltd. All rights reserved.

### Practical implications

- Body mass measurements help to explain time spent in light intensity physical activity.
- Tests of lower body strength help to explain time spent in moderate to vigorous physical activity.
- Overall, anthropometry and fitness tests give limited insight into the physical activity habits of children and adolescents.

- Activity monitoring should be considered in addition to clinical assessments to more fully understand youth health.

### 1. Introduction

Children and adolescents with obesity live at an increased risk of cardiometabolic disease, metabolic syndrome<sup>1,2</sup> and impairments in musculoskeletal fitness.<sup>3,4</sup> As such, the increasing prevalence of childhood and adolescent obesity<sup>5–7</sup> is a primary concern for health care professionals.

Currently, there are anthropometric<sup>8</sup> and physical fitness tests<sup>9</sup> designed to evaluate the overall health and development of children and adolescents that can be used in a clinical setting. Daily

\* Corresponding author.

E-mail address: [me.mathieu@umontreal.ca](mailto:me.mathieu@umontreal.ca) (M.-E. Mathieu).



physical activity (PA) is a key component of maintaining a healthy body weight and composition,<sup>10</sup> as well as aerobic and neuromotor fitness,<sup>11</sup> all of which relate to a healthy cardiovascular disease risk profile.<sup>12</sup> Therefore, understanding daily PA habits would be an ideal addition to any evaluation of overall health in children and adolescents. However, PA habits are an often-under-evaluated component of cardiometabolic risk in a clinical setting, due to two main barriers. Firstly, many clinics and hospitals will not have the resources available to purchase activity monitors or to replace them over time as they are lost or broken.<sup>13</sup> Secondly, explaining how to use the device, reclaiming the device after its use, processing and interpreting the device's output,<sup>14</sup> as well as explaining these results to the patient all take extra time,<sup>13</sup> in addition to the initial visit which is already time-limited.

As professionals' time with their patients should be carefully allocated, and resources for equipment and follow-up are becoming increasingly scarce, it is important to determine if clinical tests can provide insight into PA levels in youth living with an elevated cardiometabolic risk without necessitating the use of PA monitors. The purpose of this study was to explore which aspects of clinical anthropometric and physical fitness testing are the most strongly associated with various intensities of PA for children and adolescents with obesity.

## 2. Methods

The data for this investigation is a convenience sample which comes from the baseline visit of a two-year program focused on increasing PA and reducing sedentary behaviors. Participants are referred to this program by their health care provider. The youth (<18 years old) included in this program exhibited risk factors associated with cardiovascular pathologies, for the purposes of this investigation, primarily obesity. Written informed consent was obtained from all participants and their parents. This project was approved by the ethics review board at the University Hospital Center.

Height was evaluated to the nearest 0.1 cm, in reference position, using a standard wall stadiometer (IBIOM: QC, Canada). Waist circumference was measured to the nearest 0.1 cm, using a tape measure, at mid-height between the last rib (T12) and the upper end of the iliac crest.<sup>15</sup> Body mass and fat percentage were obtained using bioelectric impedance (Tanita BC 418: IL, USA).

Upper-body muscular endurance was assessed using partial curl-ups. Participants lay their back on a floor mat composed of two rough strips parallel to each other and perpendicular to the length of the floor mat. Participants' knees are bent at a 90-degree angle, heels touching the ground, arms alongside their trunk, shoulders relaxed on the ground at the start of the test. The tips of the middle finger on both hands must touch the first band that marks 0 cm to initiate the test. With each sound emitted by a metronome (50 beats per minute), the participant must touch the second rough band on the floor mat (10 cm). The maximum number of repetitions possible for this test is 25.<sup>16</sup>

The sit-and-reach evaluates the degree of flexibility of the lower back and hamstring muscles. Participants begin barefoot, sitting on the ground with their legs extended and the soles of their feet touching the front of the sit-and-reach box (Novel Products: Rockton, IL, USA). The participant then slides their hands (laid over one another) forward as far as possible towards their feet and maintain this maximum position for at least two seconds. The investigator notes the maximum distance reached, as measured at the tips of the participants fingers on two tests to the nearest 0.1 cm.<sup>17</sup>

Standing long jump evaluates the explosive power of the lower-body. Participants perform a maximum push (one jump) forward from a starting line. During the jump, participants can move their

arms. The distance between the starting line and the back of the heel closest to it is measured at the end of each jump. The participant has three tries and the longest distance is recorded to the nearest centimeter.<sup>18</sup>

The handgrip dynamometer (Model 78,010: Lafayette Instruments, Lafayette, LA, USA) measures the maximum isometric force of the muscles in the hand and forearm (grip strength) and is an indicator of upper-body strength. The participant stands upright with elbows in full extension and arms abducted (45°). Two tests are performed on each hand (alternating between left and right). The best result is retained by the investigator, with an accuracy within 1 kg.<sup>19</sup>

The five-X-five shuttle (5 × 5-m shuttle) evaluates speed and agility. Two lines 5 m apart from each other are clearly marked on the ground. Participants run 5 consecutive times between these 2 lines, for a total of 25 m, as quickly as possible. Participants must completely cross each line at every lap for the attempt to be valid. The duration of the participants' singular attempt was recorded to within 0.1 s.<sup>20</sup>

A stress test was performed on a cycle ergometer to assess cardiorespiratory fitness (VO<sub>2</sub> max). Initial resistance and incremental increases in pedalling resistance are calculated from each participant's anthropometric data. After a warm-up of 3 min at 20% of the targeted maximum power, the load is increased every two minutes so that the increase in energy cost corresponds to 1 MET (increase of 0–1 km/h and/or 0%–2% of slope) to reach the maximum power within 12-to-15 min. During this test, heart rate (measured using a Polar, Kempele, Finland), and gas exchange (Quark PFT, COSMED, St. Paul, MN, USA) are all measured continuously. The maximum oxygen consumption (VO<sub>2</sub> max) is defined as the highest value of VO<sub>2</sub> averaged over 30 s during the test.<sup>21</sup>

Physical activity was assessed with an ActiGraph accelerometer (GT3X+, Actigraph LLC, Pensacola, FL, USA) for seven-consecutive days. Participants wore the accelerometer on the right hip. The accelerometer was removed for bathing, aquatic activities, and sleep. A valid day was defined as ≥10 h of wear-time; and a valid wear period was ≥4 wear-days.<sup>22</sup> Non-wear time was defined as at least 60-consecutive minutes of zero counts, with allowance for 1-to-2 min of counts between 0 and 100 and were removed from the 24 h/day recordings.<sup>22</sup> Activity was defined as time (min/day) spent at various levels of movement intensity using activity counts per min. Intensity thresholds of each minute were defined as follows: sedentary, 0–100 counts per min (CPM); light-intensity PA (LPA), 101–2295 CPM; moderate-intensity PA (MPA), 2296–4011 CPM; vigorous PA (VPA), ≥4012 CPM; and moderate-to-vigorous PA (MVPA), ≥2296 CPM.<sup>23</sup>

Data are separated by age [Children (<12 years old) and adolescents (≥12 years old)] and sex (boys and girls) to be representative of the normative values associated with these fitness test are depicted in a similar fashion. Descriptive values are reported as Mean (Standard Deviation). One-way ANOVA's were employed to evaluate possible differences between children and adolescents on anthropometry, physical fitness, and PA. Pearson correlations were used to evaluate linear relationships between anthropometry and physical fitness with PA. Stepwise multiple linear regression was used to evaluate the predictive power of anthropometry and measures of physical fitness on measures of PA reported using a standardized Beta. All statistical tests were performed using version 25 of IBM's SPSS statistical software (IBM Corp. Armonk, NY).

## 3. Results

This study included a total of 203 participants, stratified by age into 115 children and 88 adolescents. Children (57% male) and adolescents (45% male) had an average age of 9.9(1.8) and 14.5(1.5)

**Table 1**  
 Participants' anthropometry, physical fitness tests and physical activity stratified by age and sex.

	Childhood Boys (n = 65)	Adolescent Boys (n = 40)	Childhood Girls (n = 50)	Adolescent Girls (n = 48)
Height (cm)	148.6(12.0)	165.8(10.0)**	147.8(14.5)	161.1(8.0)**
Body weight (kg)	66.2(17.6)	94.2(24.7)**	66.7(20.6)	93.7(16.5)**
Body fat (%)	38.9(5.5)	39.1(6.5)*	40.3(6.1)	43.7(4.4)**
Waist circumference (cm)	92.3(12.3)	105.7(12.3)**	92.4(15.8)	101.9(10.5)**
Partial Curl-ups (#)	15.5(10.6)	21.9(10.9)*	15.9(12.2)	20.3(8.8)*
Flexibility (cm)	21.9(6.1)	21.7(7.9)	27.5(7.8)	26.3(8.6)
Long jump (cm)	106.7(22.1)	123.9(32.4)*	100.1(20.1)	104.1(19.1)
Grip strength (kg)	22.3(5.9)	32.1(9.9)**	21.1(6.3)	29.1(6.5)**
5 × 5-m shuttle (sec)	12.3(1.8)	11.7(1.8)	12.9(1.6)	12.6(2.2)
VO <sub>2</sub> max (mL/min/kg)	28.0(5.8)	28.0(6.1)	26.7(6.2)	23.6(3.9)*
Light physical activity (min)	326.4(82.5)	289.6(90.0)	322.4(80.3)	307.6(90.8)
Moderate physical activity (min)	24.9(11.5)	26.6(16.9)	21.7(12.1)	24.3(12.4)
Vigorous physical activity (min)	4.1(4.5)	7.2(6.8)*	5.2(5.3)	5.7(5.2)
MVPA (min)	28.9(14.2)	33.8(21.3)*	26.9(15.9)	30.0(15.8)

Data are shown as Mean(SD); MVPA: Moderate-to-vigorous physical activity.

\*  $p \leq 0.05$ .

\*\*  $p \leq 0.001$  Adolescents different from children of the same sex.

years respectively. All participants had obesity according to World Health Organization criteria ( $BMIz \geq 2$  SD) and the average BMI Z-scores were 3.5(0.94) for children and 3.12(0.76) for adolescents. Mean differences between children and adolescents concerning anthropometry, physical fitness, and PA are detailed in Table 1.

For the full sample of children, body mass was negatively associated with LPA, and explained 6.3% of its variance ( $F(1, 113) = 7.55, p = 0.007$ ; Table 2). For childhood boys, body mass was negatively associated with LPA, and explained 10.2% of its variance ( $F(1, 63) = 7.15, p = 0.010$ ; Table 2). For childhood girls, there were no significant predictors of LPA. For the full sample of children, or for boys and girls separately, there were no significant predictors of MPA. For the full sample of children, standing long jump was positively associated with VPA, and accounted for 6.2% of its variance ( $F(1, 113) = 7.47, p = 0.007$ ; Table 2). For childhood boys, there were no significant predictors of VPA. For childhood girls, the standing long jump was positively associated with VPA, and explained 19.5% of its variance ( $F(1, 48) = 11.65, p = 0.001$ ; Table 2). For the full sample of children, standing long jump was positively associated with MVPA, and accounted for 3.8% of its variance ( $F(1, 113) = 4.43, p = 0.038$ ; Table 2). For childhood boys, there were no significant predictors of MVPA. For childhood girls, the 5 × 5-m shuttle run was negatively associated with MVPA, and accounted for 8.4% of its variance ( $F(1, 48) = 4.38, p = 0.042$ ; Table 2).

There were no significant predictors of LPA for the full sample of adolescents, or for adolescent boys and girls separately. For the full sample of adolescents, standing long jump ( $Beta = 0.38, t(86) = 3.36, p = 0.001$ ) and body fat percentage ( $Beta = 0.24, t(86) = 2.11, p = 0.037$ ) were positively associated with MPA, and accounted for 12.2% of its variance ( $F(2, 85) = 5.88, p = 0.004$ ; Table 2). For adolescent boys, standing long jump was positively associated with MPA, and accounted for 12.6% of its variance ( $F(1, 38) = 5.46, p = 0.025$ ; Table 2). For adolescent girls, body fat percentage was positively associated with MPA, and accounted for 9.8% of its variance ( $F(1, 46) = 5.01, p = 0.003$ ; Table 2). There were no significant predictors of VPA for the full sample of adolescents, or for adolescent boys and girls separately. For the full sample of adolescents, standing long jump ( $Beta = 0.38, t(86) = 3.36, p = 0.001$ ) and body fat percentage ( $Beta = 0.24, t(86) = 2.11, p = 0.037$ ) were positively associated with MVPA and accounted for 12.2% of its variance ( $F(2, 85) = 5.88, p = 0.004$ ; Table 2). There were no significant predictors of MVPA for adolescent boys or girls separately.

Additional information concerning all associations between PA, fitness tests, and anthropometric variables stratified by age and sex can be found in Table 3 and Supplemental Table S1.

#### 4. Discussion

To the best of our knowledge, this is the first research study to evaluate which aspects of anthropometric and physical fitness testing are the most closely associated with time spent in various intensities of PA for children and adolescents with obesity in a free-living environment. Overall, fitness tests which explained significant variance in MPA and VPA are centered around lower body explosive power as well as speed and agility. Conversely, anthropometric evaluations including body weight help explain LPA in youth with obesity.

The standing long jump explained significant variance in VPA for children overall (boys and girls), however, once divided by sex, it was only found to be significant for the group of childhood girls. Moreover, standing long jump explained significant variance in MPA in adolescents overall (boys and girls); however, once divided by sex, it was only found to be significant for the group of adolescent boys. Relationships concerning standing long jump with MPA and VPA were positive, indicating that the better the score participants achieved on the standing long jump, the more MPA and VPA they participated in. Although Deforche et al. found that youth with obesity had inferior performance on fitness tests requiring propulsion or lifting of their body mass compared to youth without obesity,<sup>24</sup> fitness tests involving lower body strength and power may still be important predictors of PA for youth with obesity. Hulens et al. found that individuals with obesity have higher absolute knee extension strength compared to their normal weight counterparts.<sup>25</sup> Hulens et al. hypothesized this finding to be a result of greater absolute muscle mass from the training effect of weight bearing and support of a larger body mass.<sup>25</sup> A study by Castro-Pinero et al. showed that the standing long jump can be considered a general index of muscular fitness in youth, being strongly associated with other lower and upper body muscular strength tests.<sup>18</sup> However, Hulens et al. showed that the training effect of weight bearing that is seen in the lower body is not replicated in upper body tasks,<sup>25</sup> severely limiting the performance of youth with obesity on fitness assessments that favor the upper body. As muscles of the lower body are the primary movers associated with MPA and VPA, the standing long jump is an appropriate predictor of these higher intensities of PA in youth with obesity.<sup>26</sup> Furthermore, from a clinical perspective, the standing long jump is a practical, time efficient, and low-cost test of fitness which has limited equipment requirements.<sup>18</sup> Therefore, the standing long jump is a worthwhile addition to the evaluation of physical fitness and PA for children and adolescents with obesity.

**Table 2**  
Strength of associations between physical activity with anthropometry and fitness tests stratified by age and sex.

Outcome	Children (<12 years old; n = 115)				Adolescents (≥12 years old; n = 88)			
	Predictor	β (95% CI)	R <sup>2</sup>	P-value	Predictor	β (95% CI)	R <sup>2</sup>	P-value
Light physical activity	Body mass	-0.25 (-1.83, -0.30)	6.3%	0.007	-	-	-	-
Moderate physical activity	-	-	-	-	Long jump	0.38 (0.08, 0.32)	7.5%	-
					Body fat (%)	0.24 (0.04, 1.15)	4.8%	-
					Model Summary		12.2%	0.004
Vigorous physical activity	Long jump	0.25 (0.02, 0.10)	6.2%	0.007	-	-	-	-
MVPA	Long jump	0.19 (0.01, 0.26)	3.8%	0.038	Long jump	0.25 (0.03, 0.31)	6.3%	0.019
					Boys (n = 65)		Boys (n = 40)	
Light physical activity	Body mass	-0.32 (-2.61, -0.38)	10.2%	0.01	-	-	-	-
Moderate physical activity	-	-	-	-	Long jump	0.35 (0.03, 0.35)	12.6%	0.025
Vigorous physical activity	-	-	-	-	-	-	-	-
MVPA	-	-	-	-	-	-	-	-
					Girls (n = 50)		Girls (n = 48)	
Light physical activity	-	-	-	-	-	-	-	-
Moderate physical activity	-	-	-	-	Body fat (%)	0.31 (0.09, 1.67)	9.8%	0.03
Vigorous	Long Jump	0.44 (0.05, 0.19)	19.5%	0.001	-	-	-	-
MVPA	5 X 5 m Shuttle	-0.29 (-5.77, -0.11)	8.4%	0.042	-	-	-	-

MVPA: Moderate-to-vigorous physical activity.

**Table 3**  
Bivariate correlations between predictor and outcomes variables stratified by age and sex.

	Height (cm)	Body mass (kg)	Body fat (%)	Waist circumference (cm)	Partial curl-ups (#)	Flexibility (cm)	Long jump (cm)	Grip strength (kg)	5 × 5-m shuttle (sec)	VO2 max (mL/min/kg)
Children (n = 115)										
Light	-0.219*	-0.250**	-0.099	-0.163	-0.091	-0.108	-0.084	-0.250**	-0.021	0.134
Moderate	0.031	-0.001	-0.083	0.030	0.130	-0.054	0.142	0.046	-0.104	0.081
Vigorous	0.044	-0.037	-0.059	-0.073	0.170	0.101	0.249**	-0.014	-0.148	0.024
MVPA	0.039	-0.013	-0.085	0.000	0.159	-0.010	0.194*	0.032	-0.131	0.072
Boys Child (n = 65)										
Light	-0.241	-0.319**	-0.154	-0.229	0.002	-0.136	-0.089	-0.245*	-0.036	0.194
Moderate	0.070	0.094	0.022	0.227	0.181	-0.216	0.109	0.068	0.006	0.090
Vigorous	0.117	0.122	0.157	0.150	0.093	-0.198	0.135	-0.011	-0.009	-0.087
MVPA	0.094	0.115	0.068	0.231	0.176	-0.238	0.131	0.051	0.002	0.045
Girls Child (n = 50)										
Light	-0.200	-0.173	-0.028	-0.098	-0.200	-0.078	-0.087	-0.264	0.012	0.055
Moderate	-0.018	-0.097	-0.170	-0.158	0.082	0.197	0.146	-0.006	-0.211	0.042
Vigorous	-0.015	-0.192	-0.301*	-0.267	0.243	0.291*	0.442**	0.005	-0.381**	0.165
MVPA	-0.019	-0.139	-0.231	-0.211	0.145	0.248	0.261	-0.003	-0.289*	0.087
Adolescents (n = 88)										
Light	0.039	0.022	0.065	0.006	0.019	-0.131	0.093	0.011	-0.016	0.061
Moderate	0.141	0.102	0.071	0.034	0.153	0.119	0.275**	0.114	-0.116	0.072
Vigorous	0.005	0.081	0.048	0.078	0.193	0.080	0.103	0.073	-0.058	-0.011
MVPA	0.113	0.107	0.072	0.052	0.183	0.120	0.250*	0.114	-0.110	0.053
Boys Adolescent (n = 40)										
Light	0.068	-0.043	0.005	0.020	0.043	-0.263	0.194	0.030	-0.274	0.075
Moderate	0.194	0.067	-0.010	-0.047	0.179	0.174	0.354*	0.177	-0.328*	0.138
Vigorous	0.071	0.176	0.179	0.124	0.244	0.166	-0.016	0.150	-0.037	-0.079
MVPA	0.176	0.109	0.050	0.002	0.220	0.191	0.276	0.188	-0.272	0.084
Girls adolescent (n = 48)										
Light	0.069	0.107	0.059	0.027	0.011	-0.090	0.072	0.030	0.123	0.165
Moderate	0.029	0.161	0.313*	0.111	0.104	0.123	0.097	-0.026	0.113	-0.122
Vigorous	-0.166	-0.074	-0.011	-0.026	0.105	0.075	0.209	-0.113	-0.025	-0.053
MVPA	-0.032	0.102	0.243	0.079	0.116	0.121	0.145	-0.058	0.081	-0.113

Results in bold indicate statistically significant associations, MVPA: Moderate-to-vigorous physical activity.

\* p ≤ 0.05.  
\*\* p ≤ 0.001.

The 5 × 5-m shuttle explained significant variance in MVPA for childhood girls. The association between the 5 × 5-m shuttle and MVPA was negative, meaning that those participants that scored well (i.e. lower time to complete the test) on the 5 × 5-m shuttle also engaged in more MVPA. The 5 × 5-m shuttle measures the ability to repeatedly produce power from a stopped position.<sup>20</sup> For the durations measured in this study, the 5 × 5-m shuttle tested the participants' anaerobic metabolism.<sup>27</sup> Moreover, the 5 × 5-m shuttle relies mostly on the muscle groups of the lower body,<sup>28</sup> reinforcing the findings associated with the aforementioned standing long jump. The anaerobic metabolism is primarily used to provide energy for short duration and high intensity movement.<sup>29</sup>

Praagh et al. indicated that short-duration high-intensity exercise lasting only a few seconds is a natural pattern of movement during childhood as activities are highly transitory and intermittent.<sup>29</sup> As such, the increased number of minutes of MVPA associated with a better score on the 5 × 5-m shuttle may be explained by an accumulation of several high intensity very short-duration bouts of MVPA. Moreover, this study specifically only included participants with obesity and therefore, the absolute low levels of MVPA observed are not surprising.

Body mass explained significant variance in LPA in children overall (boys and girls); however, once divided by sex, it was only found to be significant for the group of childhood boys. There was

a negative relationship between body mass and LPA. As PA directly results in an expenditure of energy,<sup>30</sup> daily PA is a key component of weight loss and weight management.<sup>31</sup> As the majority of daily PA (minutes of PA) occurred at a light intensity, it is not surprising that having a lower body mass may be associated with engaging in more PA.

Body fat percentage explained significant variance in MPA in adolescents overall (boys and girls); however, once divided by sex, it was only found to be significant for the group of adolescent girls. In this case, there was a positive relationship between MPA and body fat percentage. Studies investigating the relationship between MPA and body fat percentage are relatively inconsistent in the literature. Martinez-Gomez et al. have shown that body fat percentage is negatively associated with MPA in European adolescents, but that the strength of this association is reduced in adolescents with obesity compared to their normal weight peers.<sup>32</sup> Moreover, other studies have found that participation in MPA is not associated with body fat percentage in American adolescents<sup>33</sup> or Swedish children.<sup>34</sup> Our results suggest that further studies are required to determine the relationship of MPA on body fat percentage in youth. Future research should consider investigating this association considering normal weight and obesity as well as sex differences.

A strength of our study was the number of relevant tests of physical fitness which we evaluated. In total, six tests of physical fitness were evaluated including measures of flexibility, strength, power, and endurance. It is rare to see such a thorough clinical evaluation of these measures for children and adolescents living with obesity. Moreover, kinesiologists were employed to carry out all evaluations. Physical activity was assessed objectively using a wearable accelerometer rather than a questionnaire. Additionally, the sample size of 203 youth allowed us to specify our results for both boys and girls as well as children and adolescents separately, identifying group differences in the process, allowing knowledge users to better tailor how they will evaluate youth with obesity.

We would like to acknowledge certain limitations of this study. No information concerning diet or sleep were controlled for in our analysis, each of which can affect daily PA. A control group of normal weight children was not included in this study as our purpose was to evaluate these associations in youth with obesity specifically. Accelerometry only provides a snap-shot of PA levels, since monitoring was over one week and thus not necessarily representative for that subject. Non-compliance can also be an issue with accelerometry in the real-world environment. Analyses were not adjusted for sociodemographics.

In conclusion, fitness tests which explained significant variance in MPA and VPA are centered around lower body strength, a factor which is highly expressed in youth with obesity. For both children and adolescents with obesity, the standing long jump and body mass assessments seem to explain the most variance in PA. Given the percentage of variance explained, tests of physical fitness and anthropometric assessments give us limited clinical insight concerning PA for children and adolescents with obesity. For children and adolescents with obesity, PA monitoring should be considered in addition to regular clinical assessments to verify that youth are indeed meeting both PA guidelines as well as goals associated with anthropometry and physical fitness. Future studies should evaluate these associations longitudinally, following children through adolescence, to confirm these cross-sectional findings.

## Acknowledgments

The program described in this study is supported by donations to the Hospital Foundation where the program takes place. Marie-Eve Mathieu holds a Research scholar (Junior 1), Mélanie Henderson a Junior 2 and Tracie A. Barnett a senior research scholar from the

*Fonds de la recherche du Québec – Santé*. Ryan E.R. Reid has a postdoctoral scholarship from the Fondation associated with the University Hospital Center.

The author wish to thank the team of kinesiologists and researchers working at the Centre CIRCUIT as well as all the participants who gave their time to this research project.

## Appendix A. Supplementary data

Supplementary material related to this article can be found, in the online version, at doi:<https://doi.org/10.1016/j.jsams.2019.12.005>.

## References

1. Thivel D, Malina RM, Isacco L et al. Metabolic syndrome in obese children and adolescents: dichotomous or continuous? *Metab Syndr Relat Disord* 2009; 7(6):549–555.
2. Wicklow BA, Becker A, Chateau D et al. Comparison of anthropometric measurements in children to predict metabolic syndrome in adolescence: analysis of prospective cohort data. *Int J Obesity* 2015; 39(7):1070–1078 (2005).
3. O'Malley G, Hussey J, Roche E. A pilot study to profile the lower limb musculoskeletal health in children with obesity. *Pediatr Phys Ther* 2012; 24(3):292–298.
4. Thivel D, Ring-Dimitriou S, Weghuber D et al. Muscle strength and fitness in pediatric obesity: a systematic review from the European Childhood Obesity Group. *Obes Facts* 2016; 9(1):52–63.
5. Faucher P, Poitou C. Physiopathology, causes and complications of obesity. *Soins* 2016; 61(811):20–25.
6. Maggio ABRMKEG CS, Gal-Duding C, Beghetti M et al. Medical and non-medical complications among children and adolescents with excessive body weight. *BMC Pediatr* 2014; 14(232):1–9.
7. Tsiros MD, Olds T, Buckley JD et al. Health-related quality of life in obese children and adolescents. *Int J Obesity* 2009; 33(4):387–400 (2005).
8. Shelley Kirk MZ, Randal Clayton, Megan Santangelo et al. The relationship of health outcomes to improvement in BMI in children and adolescents. *Obes Res* 2005; 13(5):876–882.
9. Valentini NC. Validity and reliability of the TGMD-2 for Brazilian children. *J Mot Behav* 2012; 44(4):275–280.
10. Andersen RE, Crespo CJ, Bartlett SJ et al. Relationship of physical activity and television watching with body weight and level of fatness among children results from the Third National Health and Nutrition Examination Survey. *JAMA* 1998; 279(12):938–942.
11. Dencker M, Thorsson O, Karlsson MK et al. Daily physical activity and its relation to aerobic fitness in children aged 8–11 years. *Eur J Appl Physiol* 2006; 96(5):587–592.
12. Twisk JW, Kemper HC, van Mechelen W. Tracking of activity and fitness and the relationship with cardiovascular disease risk factors. *Med Sci Sports Exercise* 2000; 32(8):1455–1461.
13. Reid RER, Andersen RE. Affordable activity monitors can improve post-surgical care in bariatric surgery patients. *Anaplastol* 2015; 4.
14. Migueles JH, Cadenas-Sanchez C, Ekelund U et al. Accelerometer data collection and processing criteria to assess physical activity and other outcomes: a systematic review and practical considerations. *Sports Med* 2017; 47(9):1821–1845.
15. McCarthy HD, Jarrett KV, Crawley HF. The development of waist circumference percentiles in British children aged 5.0–16.9 y. *Eur J Clin Nutr* 2001; 55(10):902–907.
16. Tremblay MS, Shields M Fau, Laviolette M et al. Fitness of Canadian children and youth: results from the 2007–2009 Canadian Health Measures Survey. *Health Rep* 2010; 21(1):7–20.
17. Hartman JG, Looney M. Norm-referenced and criterion-referenced reliability and validity of the back-saver sit-and-reach. *Meas Phys Educ Exercise Sci* 2003; 7(2):71–87.
18. Castro-Pinero JO FB, Artero EG, Girela-Rejon MJ et al. Assessing muscular strength in youth: usefulness of standing long jump as a general index of muscular fitness. *J Strength Conditioning Res* 2010; 24(7):1810–1817.
19. Ortega FB, Artero EG, Ruiz JR et al. Reliability of health-related physical fitness tests in European adolescents. The HELENA study. *Int J Obesity* 2008; 32(Suppl. 5):S49–S57 (2005).
20. Boddington MK, Lambert MI, Waldeck MR. Validity of a 5-meter multiple shuttle run test for assessing fitness of women field hockey players. *J Strength Conditioning Res* 2004; 18(1):97–100.
21. Gunning GR, Everatt D, Hastman L. Bruce treadmill test in children: normal values in a clinic population. *Am J Cardiol* 1978; 41(1):69–75.
22. Troiano RP, Berrigan D, Dodd KW et al. Physical activity in the United States measured by accelerometer. *Med Science in Sports Exercise* 2008; 40(1):181–188.
23. Evenson KR, Catellier DJ, Gill K et al. Calibration of two objective measures of physical activity for children. *J Sports Sci* 2008; 26(14):1557–1565.
24. Deforche B, Lefevre J, De Bourdeaudhuij I et al. Physical fitness and physical activity in obese and nonobese Flemish youth. *Obes Res* 2003; 11(3):434–441.

25. Hulens M, Vansant G, Lysens R et al. Study of differences in peripheral muscle strength of lean versus obese women: an allometric approach. *Int J Obesity Relat Metab Disord* 2001; 25(5):676–681.
26. Novacheck TF. The biomechanics of running. *Gait Posture* 1998; 7(1):77–95.
27. Spencer M, Bishop D, Dawson B et al. Physiological and metabolic responses of repeated-sprint activities. *Sports Med* 2005; 35(12):1025–1044.
28. Ebben WP, Suchomel TJ. Analysis of male and female athletes' muscle activation patterns during running, cutting, and jumping, in *ACL Injuries in the Female Athlete: Causes, Impacts, and Conditioning Programs*, Noyes FR, Barber-Westin S, editors, Berlin, Heidelberg, Springer Berlin Heidelberg, 2018, p. 167–187.
29. Praagh E. Anaerobic fitness tests: what are we measuring? *Med Sport Sci* 2007; 50:26–45.
30. Ainsworth BE, Haskell WL, Herrmann SD et al. Compendium of Physical Activities: a second update of codes and MET values. *Med Sci Sports Exercise* 2011; 43(8):1575–1581, 2011.
31. Mead E, Brown T, Rees K et al. Diet, physical activity and behavioural interventions for the treatment of overweight or obese children from the age of 6 to 11 years. *Cochrane Database Syst Rev* 2017; 6:CD012651.
32. Martinez-Gomez D, Ruiz JR, Ortega FB et al. Recommended levels of physical activity to avoid an excess of body fat in European adolescents: the HELENA study. *Am J Preventive Med* 2010; 39(3):203–211.
33. Gutin B, Yin Z, Humphries MC et al. Relations of moderate and vigorous physical activity to fitness and fatness in adolescents. *Am J Clin Nutr* 2005; 81(4):746–750.
34. Dencker M, Thorsson O, Karlsson MK et al. Daily physical activity related to aerobic fitness and body fat in an urban sample of children. *Scand J Med Sci Sports* 2008; 18(6):728–735.

**Usefulness of the satiety quotient in a clinical pediatric obesity context.**

**Fillon, A.**, Masurier, J., Pereira, B., Miguet, M., Mathieu, M.-E., Drapeau, V., Tremblay, A., Boirie, Y., & Thivel, D.



*Accepted in European Journal of Clinical Nutrition, November 2019*



Body composition, energy expenditure, and physical activity

# Usefulness of the satiety quotient in a clinical pediatric obesity context

Alicia Fillon<sup>1,2</sup> · Julie Masurier<sup>2</sup> · Bruno Pereira<sup>3</sup> · Maud Miguet<sup>1</sup>  · Marie-Eve Mathieu<sup>4</sup> · Vicky Drapeau<sup>5</sup> · Angelo Tremblay<sup>5</sup> · Yves Boirie<sup>6,7,8,9</sup> · David Thivel<sup>1,6</sup>

Received: 5 October 2019 / Revised: 19 November 2019 / Accepted: 21 November 2019  
© The Author(s), under exclusive licence to Springer Nature Limited 2019

## Abstract

**Background** While the satiety quotient (SQ) is increasingly used in pediatric populations, the present study assessed its reliability and reproducibility in adolescents with obesity.

**Methods** Sixty-eight adolescents with obesity were enrolled. Anthropometric measurements and body composition (DXA) were assessed. They randomly completed two experimental sessions: (i) condition with a standardized breakfast used to calculate SQ (C1); (ii) condition with the same breakfast and ad libitum lunch and dinner buffet meals (C2). Appetite feelings were assessed at regular interval (visual analog scales).

**Results** SQ for hunger (SQH), satiety (SQS), prospective food consumption (SQP), and desire to eat (SQD) were calculated using the breakfast. SQH, SQD, and SQ mean did not differ between conditions ( $p = 0.41, 0.57,$  and  $0.74,$  respectively) whereas SQS and SQP were significantly different between conditions ( $p = 0.007$  and  $0.005$ ). None of the SQ was correlated with body weight (BW), BMI, or FM. There was no significant correlation between the SQ and the adolescent's ad libitum energy intake (lunch, dinner, and total). No differences were observed between adolescents with a low and high phenotype for BW, BMI, and FM% ( $p = 0.26, 0.30,$  and  $0.83$ ); total energy ( $p = 0.21$ ); total protein intake ( $p = 0.28$ ); total fat intake ( $p = 0.24$ ) and total carbohydrate intake ( $p = 0.44$ ). Thirty percent of the adolescents showed different satiety phenotype (low vs. high) between C1 and C2.

**Conclusions** While the SQ is a reliable indicator in adults, it must be used with caution in adolescents with obesity due to its lack of association with anthropometric measurements, body composition, and energy and macronutrient intakes in this population.

## Introduction

The alarming prevalence of overweight, obesity, and their associated metabolic complications in adolescents highlights the importance of better understanding the

mechanisms involved in order to develop innovative and effective preventive and treatment strategies. In this context, the control and regulation of energy balance plays a central role [1, 2]. The metabolic and physiological processes involved in the control of energy intake have been widely

✉ Alicia Fillon  
fillonalicia@gmail.com

<sup>1</sup> Laboratory of the Metabolic Adaptations to Exercise under Physiological and Pathological Conditions (AME2P), EA 3533, Clermont Auvergne University, Clermont-Ferrand, France

<sup>2</sup> UGECAM Nutrition Obesity Ambulatory Hospital, Clermont-Ferrand, France

<sup>3</sup> Biostatistics unit (DRCI), Clermont-Ferrand University Hospital, Clermont-Ferrand, France

<sup>4</sup> School of kinesiology and physical activity sciences, Université de

Montréal, Montréal, QC, Canada

<sup>5</sup> Institute of Nutrition and Functional Foods (INAF), Université Laval, Quebec City, QC, Canada

<sup>6</sup> CRNH-Auvergne, Clermont-Ferrand, France

<sup>7</sup> INRA, UMR 1019, Clermont-Ferrand, France

<sup>8</sup> Department of Human Nutrition, Clermont-Ferrand University Hospital, G. Montpied Hospital, Clermont-Ferrand, France

<sup>9</sup> University Clermont Auvergne, UFR Medicine, Clermont-Ferrand, France

explored and discussed in recent years [3], highlighting a major role of hunger and overall appetite perceptions. In 1997, Green et al. developed an indicator of the satiating effect of food, known as the satiety quotient (SQ), that considers in its calculation both the caloric quantity of food ingested during a meal and the associated appetite perceptions [4].

The SQ has been adopted widely among adults since its development by Green et al., in both acute studies [5–10] and chronic experiments [11–15]. According to these studies, the SQ is associated with an individuals' food intake and body composition and is a reliable predictor for weight loss success. Based on this quotient, some authors have stratified individuals into a low or high satiety phenotype, with a low phenotype characterizing individuals who report difficulties in appropriately recognizing their appetite sensations before or after a meal [12]. In a clinical context, this low phenotype might be observed in about 10% of patients with obesity who report being unable to detect changes in their appetite, report a weak satiety response to a meal and even an increase in appetite after a meal [16]. Altogether, these results suggest the SQ may be a useful clinical tool that can help to identify more vulnerable individuals, those at risk of overeating and thus at risk of weight gain. It could also help to design more tailored interventions such as a highly satiating diet which can significantly improve satiety in those with a low SQ [11].

The SQ has been shown to have good reliability [12] and described as an accurate and valid indicator by Dalton et al. when used in standardized conditions (in the fasting state, using a standardized calibrated meal at the participants' usual meal time, etc.) among men [12] and women [17]. However, recent studies have used the SQ among adolescents with a healthy weight [18] and adolescents with obesity [19, 20] often without following standardized conditions (for example, the SQ calculated in response to ad libitum meals provided at different times). Based on this growing interest for the SQ in pediatric populations, and in order to avoid any misinterpretation and misuse of the obtained results, the aim of the present study was to assess the reliability and reproducibility of the SQ in adolescents with obesity.

## Materials and methods

### Participants

Seventy-five 11–16-year-old adolescents with obesity (26 boys and 42 girls, Tanner stages 3–4) were approached through clinical pediatric consultation (the Pediatric Obesity Department of Romagnat and SSR La Bourboule, France). Out of the 75 adolescents who initially volunteered, 7 were

excluded due to their high level of cognitive restriction (as detailed below) and were excluded resulting in 65 adolescents being included in the study. These adolescents had to present a body mass index (BMI) above the 90th percentile according to the international reference values [21] and were free of any physical contraindication and of any medication that could interfere with the principal outcomes of the study. The adolescents and their legal representatives received information sheets and gave their written consent (as requested by the ethical authorities, CPP Sud Est VI).

### Design

After a preliminary medical inclusion visit by a pediatrician to determine eligibility for study participation, body composition was assessed by Dual-energy X-ray Absorptiometry (DXA) and participants were asked to complete a food preference questionnaire and the Three-Factor Eating Questionnaire R17 [22] in order to exclude adolescents with high cognitive restraint. Afterwards, adolescents randomly completed two experimental sessions (1 week apart): (i) one condition with a standardized breakfast used to calculate the SQ (Condition 1: C1); and (ii) one condition with the same calibrated breakfast and ad libitum lunch and dinner buffet meals (Condition 2: C2). On the two occasions, participants received a standardized breakfast (08:30) and were asked to fill in visual analog scales (VAS) to assess their appetite feelings before the breakfast and then immediately, 30 and 60 min post breakfast. During C2, the adolescents received ad libitum lunch and dinner buffet meals and filled in the VAS at regular intervals. SQ was calculated in both C1 and C2 based on the calibrated breakfasts only. The associations between SQ and ad libitum energy intake, anthropometric variables and body composition, as well as the comparison between adolescents with low and high satiety phenotypes, were explored using the SQ calculated using the breakfast of C2.

Outside the experimental conditions and between the two ad libitum test meals, the adolescents were requested not to engage in any moderate to vigorous physical activity and mainly completed sedentary activities such as reading, homework, or board games. The study protocol is illustrated in Fig. 1.

### Anthropometric measurements and body composition

A digital scale was used to measure body mass to the nearest 0.1 kg, and height to the nearest 0.5 cm. The BMI was calculated as body mass (kg) divided by height squared ( $m^2$ ) and interpreted according to the international reference values [21]. Waist circumference was measured at the level



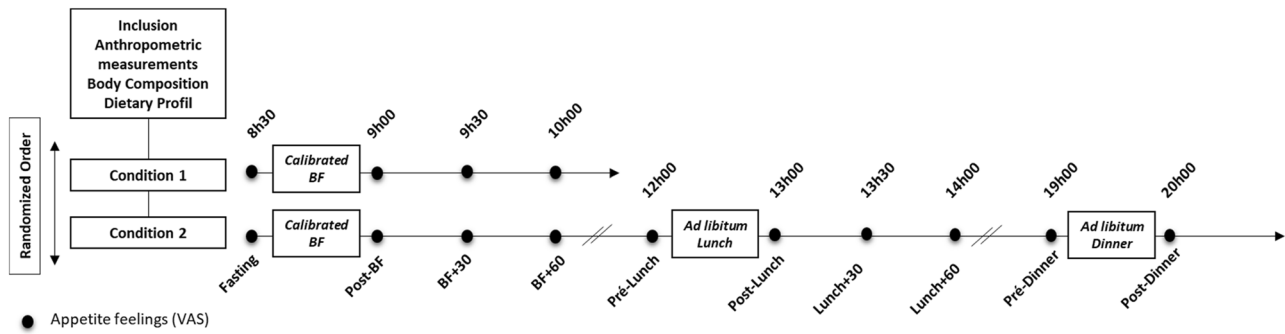

**Fig. 1 Design of the study.** BF Breakfast, VAS visual analog scale.

midway between the last rib and the upper iliac crest. Fat mass (FM) and fat-free mass (FFM) were assessed by DXA following standardized procedures (QDR4500A scanner, Hologic, Waltham, MA, USA). These measurements were obtained during the preliminary visit by a trained technician.

### Three-Factor Eating Questionnaire (CTFEQ-R17)

The Three-Factor Eating Questionnaire R17 for Children (CTFEQ-r17) was administered during the initial visit to determine the adolescents' individual eating behavior traits. The questionnaire measures characteristics that are relatively stable, but that might be affected during weight-loss, for example [22]. This is a 17-item questionnaire assessing three main attitudes to food: (1) chronic dietary restraint, which describes strategic dieting behavior, attitude to self-regulation, etc.; (2) disinhibition, which describes the vulnerability to lose control and over-consume and the responsiveness to the sight and smell of food; and (3) susceptibility to hunger, which describes internal and external loci of hunger [23]. This pediatric version of the CTFEQ-r17 has been validated recently [22, 24].

### Energy intake assessment

At 8:00 a.m., the adolescents consumed a standardized calibrated breakfast (500 kcal). This breakfast was composed according to the adolescent's usual breakfast habits using the information provided by the dietician of the structure (bread or rusk, milk or natural yogurt, fruit or fruit juice, butter, jam), respecting the recommendations for their age. Lunch and dinner meals were served ad libitum using a buffet-type meal. The content of the buffets was determined based on the adolescent's food preferences and eating habits. Top rated items, disliked items and items liked but not usually consumed were excluded to avoid over-, under-, and occasional consumption. The lunch menu was beef steak, pasta, mustard, cheese, yogurt, compote, fruits, and

bread. The dinner menu was ham/turkey, beans, mashed potato, cheese, yogurt, compote, fruits, and bread. Adolescents were told to eat until feeling comfortably satiated. Food items were presented in abundance. Lunch, dinner, and total (lunch + dinner) food intake was weighted by the experimenters and the adolescents were not informed that their energy intake was weighted. The energy ingested as well as the macronutrients distribution (proportion of fat, carbohydrate, and protein) were calculated using the software Bilnut 4.0. This methodology has been previously validated and published [25].

### Subjective appetite sensations

Appetite sensations (hunger, satiety, desire to eat, and prospective food consumption) were measured at regular intervals throughout the day using VAS ranging from "not at all" to "extremely" (150 mm scales). During the two experimental conditions, the adolescents were asked to fill in the VAS before the calibrated breakfast, immediately after, 30 min after, and 60 min after the breakfast. During C2 they were also asked to complete the scales immediately before, immediately after, 30 min after and 60 min after the lunch meal as well as immediately before and after dinner. In 1997, Green et al. proposed an equation to measure the satiating effect of food, called the SQ, using the energy content of the ingested meal as well as these appetite feelings [4]. The basic SQ equation has been lately actualized by Drapeau et al. such as the SQ is calculated by subtracting the average appetite response at the postmeal VAS from the fasting response and dividing it by the caloric content of the ingested meal (kcal), which is then multiplied by 100 (see below) [7]. The mean SQ for the four different appetite sensations (SQ mean) was calculated and used to classify the participants according to their individual satiety efficiency (high versus low). The adolescents were then divided into two equal subgroups in both C1 and C2 based on this SQ mean: (i) high satiety phenotype (50% of the sample with the highest SQ mean) and; (ii) low satiety phenotype

**Table 1** Satiety quotients measured during the two experimental conditions.

	Condition 1 Mean ± SD	Condition 2 Mean ± SD	<i>p</i>	Lin [95% CI]	ICC [95% CI]
SQ Hunger (mm)	13.2 ± 7.1	12.4 ± 6.4	0.41	0.58 [0.36; 0.79]	0.58 [0.37; 0.76]
SQ Satiety (mm)	−11.7 ± 8.3	−8.1 ± 8.9	0.007	0.50 [0.27; 0.72]	0.54 [0.32; 0.74]
SQ DTE (mm)	11.4 ± 5.9	12.1 ± 6.7	0.57	0.34 [0.05; 0.62]	0.34 [0.13; 0.64]
SQ PFC (mm)	0.21 ± 3.4	−1.4 ± 2.9	0.005	0.32 [0.07; 0.58]	0.37 [0.15; 0.65]
SQ mean (mm)	3.55 ± 6.2	3.24 ± 3.0	0.74	0.15 [−0.06; 0.38]	0.15 [0.02; 0.60]

SQ satiety quotient, *p* level of significance from the mean comparison, CI confidence interval, ICC intraclass coefficient, DTE desire to eat, PFC prospective food consumption

(50% of the sample with lowest SQ mean).

$$[\text{SQ}](\text{mm}/\text{Kcal}) = \frac{(\text{fasting AS} - \text{mean 60 min post meal AS})}{(\text{energy content of the test meal (Kcal)})} \times 100$$

## Statistical analysis

All statistical analyses were performed using Stata software (version 13, StataCorp, College Station, US) for a two-sided Type I error of 5%. The sample size was determined to enable sufficient statistical power for the two main objectives of this work. Indeed, to highlight a correlation greater than 0.35 (which correspond to low rule-of-thumb), it was necessary to include more than 62 patients for a type I error at 5% and a statistical power at 80%. Furthermore, since 0.70 is usually recommended as a minimum standard for reproducibility, a sample size of at least 50 patients is required to show intraclass correlation coefficients at least 0.70. Continuous data were expressed as mean ± standard deviation (SD). The assumption of normality was assessed using the Shapiro–Wilk test. To measure the test–retest reproducibility, the concordance has been studied using Lin’s concordance coefficient and Bland and Altman plots. These analyses were completed by random-effects models to evaluate (1) the statistical difference between test and retest measures and (2) the intraclass correlation coefficient which has been expressed with 95% confidence interval. The normality of residuals obtained from these random-effects was studied by the Shapiro–Wilk test. When appropriate, a logarithmic transformation was proposed to assess the normality of dependent outcome. Unpaired *t*-tests were used to compare means between the low and high satiety phenotypes. Finally, the relationships between quantitative variables (SQ and anthropometric measurements, body composition, and energy intake) were assessed using correlation coefficients (Pearson or Spearman, according to statistical distribution). Due to the multiple comparisons, a Sidak’s correction of the type I error was applied.

## Results

The enrolled adolescents were 13.2 ± 1.1 years old. The mean body weight was 95.0 ± 17.5 with a mean BMI of 35.3 ± 5.1 kg/m<sup>2</sup> (*z*-BMI: 2.33 ± 0.2). The mean percentage of FM (FM%) was 37.8 ± 4% and the absolute FM was 36.1 ± 8.9 kg. Mean FFM was 56.7 ± 9.8 kg. The mean ad libitum energy intake at the lunch, dinner, and total were 1203 ± 300 kcal, 914 ± 224 kcal, and 2117 ± 466 kcal, respectively.

Table 1 details the test–retest results for the four SQ. While SQ for Hunger (SQH), SQ for desire to eat (SQD), and SQ mean did not differ between conditions (*p* = 0.41, 0.57, and 0.74, respectively), SQ for Satiety (SQS) and SQ for prospective food consumption (SQP) were significantly different between conditions (*p* = 0.007 and 0.005, respectively). The Lin coefficient and ICC are also presented in Table 1. The Bland–Altman graphical representations illustrate relatively good agreement between the two sessions for SQH and SQS (Fig. 2).

None of the four SQ measured during C2 were significantly correlated with body weight, BMI, or FM (expressed in percentage and kilograms). Similarly, there was no significant correlation between the SQ and the adolescent’s subsequent ad libitum energy intake (lunch, dinner, and total). Figure 2 presents a graphical representation of the correlation coefficients obtained between the SQ and the body composition variables (Fig. 3a) and with energy intake (Fig. 3B). Absolute and relative macronutrient intakes at the lunch, dinner, and total were not significantly correlated with any of the SQ (data not shown).

No difference was observed between adolescents with a low and high phenotype calculated on C2 for body weight (97.7 ± 18 vs. 91.9 ± 15 kg, respectively; *p* = 0.26); BMI (35.7 ± 4 vs. 34.2 ± 5 kg/m<sup>2</sup>, respectively; *p* = 0.30); FM% (37.7 ± 3.3 vs. 37.4 ± 4.2%, respectively; *p* = 0.83); total energy intake (2605 ± 364 vs. 2780 ± 558 kcal, respectively; *p* = 0.21); total protein intake (120 ± 28 vs. 112 ± 20 g, respectively; *p* = 0.28); total fat intake (80 ± 26 vs. 72 ± 18 g, respectively; *p* = 0.24), and total carbohydrate intake (250 ± 72 vs. 235 ± 53 g, respectively; *p* = 0.44). Similarly,

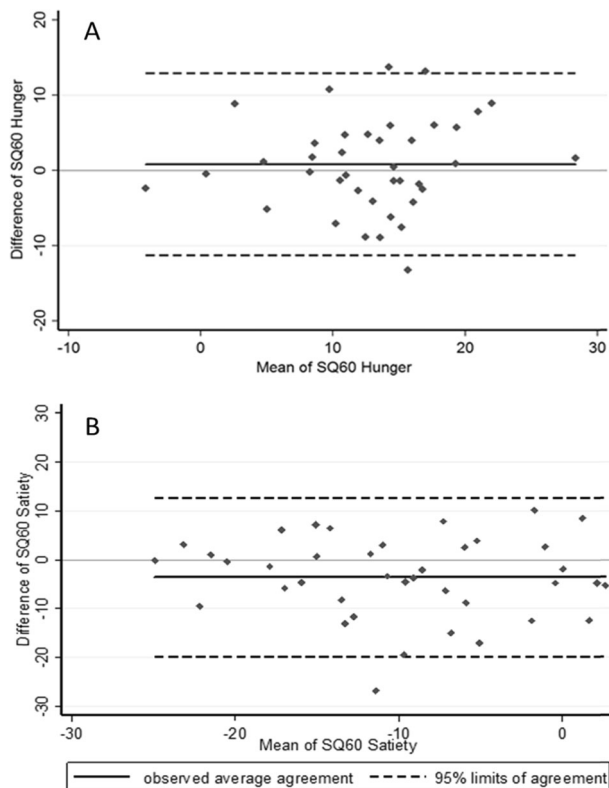

**Fig. 2** Bland and Altman graphical diagram presenting individual variations differences between Condition 1 and Condition 2. **a** the SQ Hunger and **b** SQ Satiety.

none of the appetite sensations (fasting, pre meal, and daily AUC) were different between adolescents with a low or high satiety phenotype (as calculated using the breakfast consumed on C2). Thirty percent of the adolescents showed a different satiety phenotype (low vs. high) between C1 and C2.

## Discussion

Since its development by Green et al. about twenty years ago [4], the SQ, as an indicator of the satiating effect of food, has been widely used in adults. It represents a reliable and reproducible predictor of food consumption and a good indicator to identify individuals at risk of overeating and obesity [7, 12, 14, 17]. In recent years, the SQ has been used among children and adolescents [18–20] but its validity remains unknown in this population. In this context, the present work aimed at evaluating the validity and reproducibility of the SQ in adolescents with obesity. According to our results, SQ (for Appetite, Hunger, DTE, and PFC), when calculated at a fixed breakfast, were not associated with anthropometric measurements and body composition or with measured ad libitum energy and macronutrient intake in this population. Importantly, when used in the present clinical

conditions, none of the calculated SQ showed a high level of reproducibility in our sample, with low-to-moderate reproducibility observed for SQH and SQS only.

By questioning for the first time the validity of the SQ among adolescents with obesity, our results failed to find any significant relationship between the calculated SQ and the adolescents' body weight, BMI, or FM (in percentage or absolute). This contrasts several previous studies in adults that found relationships between SQ and anthropometric measurements or body composition. Drapeau et al., for example, found significant correlations between SQD and SQP and body weight in overweight women as well as correlations between BMI and SQP and SQ fullness in adult women and men with overweight, respectively [7]. Similarly, Salma et al. showed significant correlations between both waist circumference and FM% with SQ fullness in healthy normal weight adults [10]. Likewise, while significant relationships have been found in adults between SQ and their subsequent measured [7, 8], and reported energy intake [14] the present results did not show any relationship between the SQ for the individual appetite constructs (as well as SQ mean) and subsequent ad libitum energy and macronutrient consumption in adolescents with obesity. Since the buffet meal used in our study has been shown to be accurate and reproducible in this population [25], this questions the validity of the SQ in adolescents with obesity.

In adults, Drapeau et al. obtained moderate intraclass coefficients (ranging from 0.52 to 0.67) for the different SQ studied when calculated on two different occasions in men with obesity [12]. With both low ICC and Lin coefficients, our results clearly point to the lack of reproducibility of the SQ in adolescents with obesity, particularly for SQD, SQP, and mean SQ. While the results presented here are for the 68 adolescents who completed the test–retest conditions (C1 and C2), a subsample of 14 adolescents also performed a third condition which also resulted in a low ICC (<0.5; data not shown) and reinforces the lack of reproducibility of this measurement in this population.

Based on the calculation of SQ mean, some studies conducted in adults have stratified individuals as having either a low or high satiety phenotype [12, 16] with a low phenotype characterizing people who report difficulties in appropriately recognizing their appetite feelings before or in response to a meal [12]. The determination of this phenotype has been shown as an accurate indicator of eating behaviors in adults, with people showing a low phenotype reporting higher measured and reported energy intakes [7, 14], a weak satiety response to a meal, a potential postmeal rise in appetite as well as difficulty in detecting changes in their appetite feelings throughout the day [12, 26]. Here again, our results do not support this phenotype in adolescents with obesity. Indeed, while we did not find any differences between adolescents determined

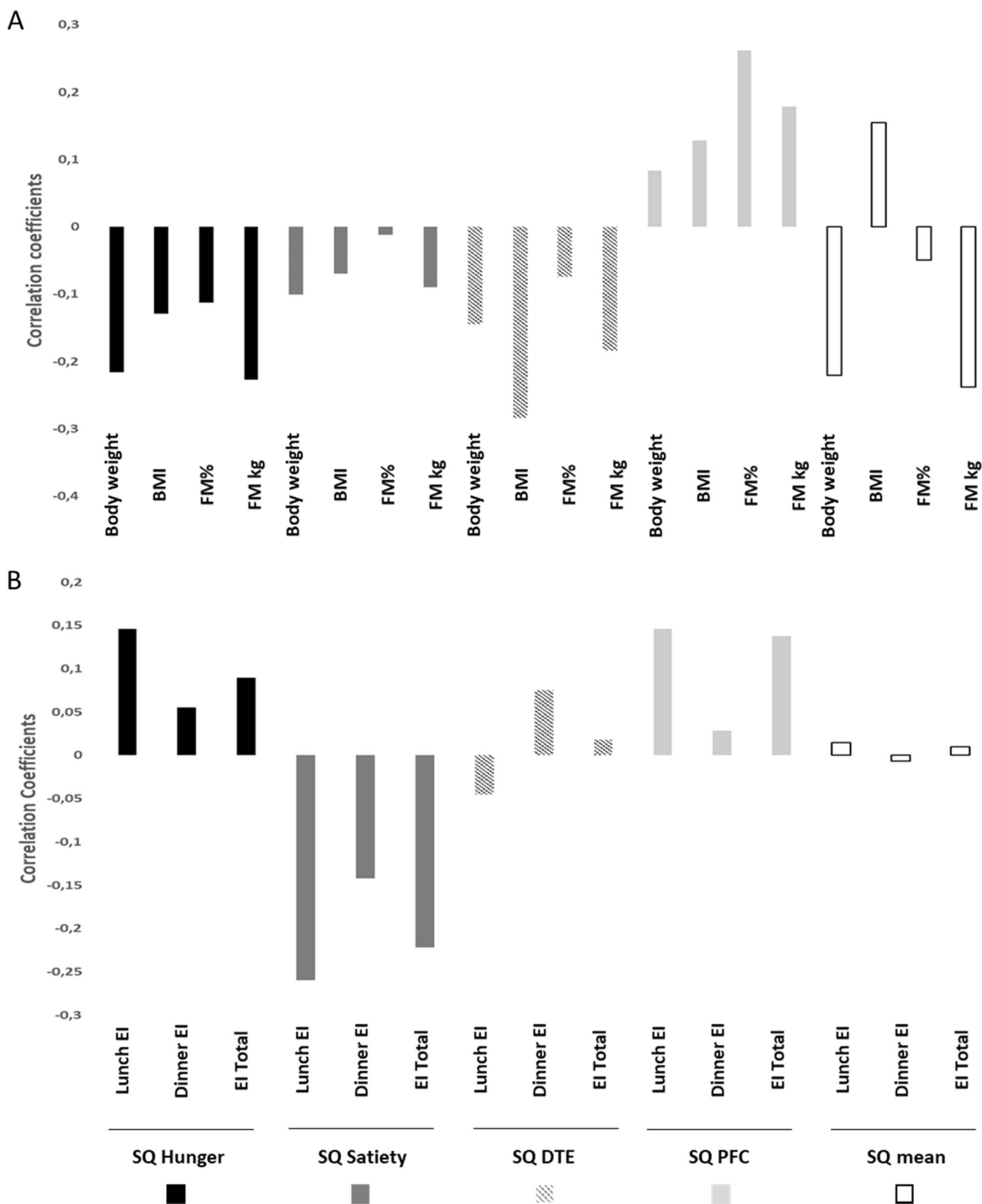

**Fig. 3 Correlation coefficients obtained between the SQ and anthropometric measures, body composition and energy intake. a** Body weight, body mass index, and fat mass (expressed in kilograms and percentage) and **b** energy intake (lunch, dinner, and total).

EI energy intake, SQ satiety quotient, DTE desire to eat, PFC prospective food consumption, FM% percentage of fat mass, FM fat mass, BMI body mass index.

with a low or high satiety responsiveness for body weight, BMI, FM% as well as for total energy and macronutrient intake, 30% of our sample was differently characterized with a low or high profile on C1 and C2. This lack of consistency reinforces the lack of consistency and reproducibility of the SQ in this specific population.

Although the large sample size as well as the highly controlled methods used in the present study represent clear strengths of this work, the results must be considered in light of some limitations. First, although we made sure that the adolescents were habitual breakfast consumers, the standardization (500 kcal) of the breakfast might be considered as a limitation. Moreover, the laboratory setting of our study and the ad libitum nature of the lunch and dinner meals may have impacted the adolescent's food consumption. The inclusion of a third condition in the full sample recruited would have improved the reproducibility analysis but this was not feasible due to practical reasons.

Altogether, our results seem to indicate that, as opposed to what is known in adults, using the SQ and related satiety phenotypes in adolescents with obesity should be implemented with caution. Further work is required to propose a reliable indicator of satiety responsiveness in this population. The calculation of the SQ using a calibrated meal (500 kcal) equivalent to what has been previously used in adults, might not be sufficient to induce changes in appetite that are perceptible enough in adolescents with obesity. Moreover, the SQ rests on the use of self-report appetite feelings using visual analog scales. While these scales have been shown to provide satisfactory results in this population and appear sensitive to meal intake or exercise [25, 27], adolescents might experience difficulty in consistently reporting their hunger, fullness, prospective food consumption, or desire to eat either on separate occasions or in response to the same meal, which might contribute to our results. This should encourage further explorations regarding the use of such scales among adolescents as well as the development of better methods to track such appetite feelings in youth.

To conclude, our results suggest that while the SQ is a reliable indicator in adults, it must be used with caution in adolescents with obesity due to its lack of association with anthropometric measurements, body composition, and energy and macronutrient intakes in this population. Further studies must be conducted to better evaluate the satiety responsiveness to a meal in adolescents with obesity, in order to improve our knowledge regarding appetite control in young people and thus improve our weight loss strategies.

**Acknowledgements** The authors are grateful to all of the adolescents that participated in the program, and to the Nutrition Obesity Ambulatory Hospital (UGECAM) that provided their generous support.

**Funding** This research has been funded through the 2018 award of the French Nutrition Society (SFN) and the support of the UGECAM Nutrition Obesity center.

## Compliance with ethical standards

**Conflict of interest** The authors declare that they have no conflict of interest.

**Publisher's note** Springer Nature remains neutral with regard to jurisdictional claims in published maps and institutional affiliations.

## References

- Blundell JE, Gibbons C, Caudwell P, Finlayson G, Hopkins M. Appetite control and energy balance: impact of exercise. *Obes Rev.* 2015;16:67–76.
- Hopkins M, Duarte C, Beaulieu K, Finlayson G, Gibbons C, Johnstone AM, et al. Activity energy expenditure is an independent predictor of energy intake in humans. *Int J Obes.* 2019. <https://doi.org/10.1038/s41366-018-0308-6>.
- Harris RBS, editor. *Appetite and food intake: central control*. 2nd ed. Boca Raton, FL: CRC Press/Taylor & Francis; 2017. <http://www.ncbi.nlm.nih.gov/books/NBK453148/>. Accessed 21 May 2019.
- Green SM, Delargy HJ, Joanes D, Blundell JE. A satiety quotient: a formulation to assess the satiating effect of food. *Appetite.* 1997;29:291–304.
- Arguin H, Gagnon-Sweeney M, Pigeon É, Tremblay A. Functional food and satiety. Impact of a satiating context effect on appetite control of non-obese men. *Appetite.* 2012;58:354–363.
- Beaulieu K, Hopkins M, Blundell J, Finlayson G. Impact of physical activity level and dietary fat content on passive overconsumption of energy in non-obese adults. *Int J Behav Nutr Phys Act.* 2017;14:14.
- Drapeau V, Blundell J, Therrien F, Lawton C, Richard D, Tremblay A. Appetite sensations as a marker of overall intake. *Br J Nutr.* 2005;93:273–280.
- Dubé M-C, Tremblay A, Lavoie C, John Weisnagel S. Effect of exercise on food consumption and appetite sensations in subjects with diabetes. *Appetite.* 2013;71:403–410.
- McNeil J, Forest G, Hintze LJ, Brunet J-F, Finlayson G, Blundell JE, et al. The effects of partial sleep restriction and altered sleep timing on appetite and food reward. *Appetite.* 2017;109:48–56.
- Salama M, Drapeau V, Tremblay A, Pérusse-Lachance É. The impact of a mental work on food preferences, eating behavior traits and satiety efficiency. *Physiol Behav.* 2016;154:191–195.
- Arguin H, Tremblay A, Blundell JE, Després J-P, Richard D, Lamarche B, et al. Impact of a non-restrictive satiating diet on anthropometrics, satiety responsiveness and eating behaviour traits in obese men displaying a high or a low satiety phenotype. *Br J Nutr.* 2017;118:750–760.
- Drapeau V, Blundell J, Gallant AR, Arguin H, Després J-P, Lamarche B, et al. Behavioural and metabolic characterisation of the low satiety phenotype. *Appetite.* 2013;70:67–72.
- Drapeau V, Jacob R, Panahi S, Tremblay A. Effect of energy restriction on eating behavior traits and psychobehavioral factors in the low satiety phenotype. *Nutrients.* 2019; 11. <https://doi.org/10.3390/nu11020245>.

14. Drapeau V, King N, Hetherington M, Doucet E, Blundell J, Tremblay A. Appetite sensations and satiety quotient: predictors of energy intake and weight loss. *Appetite*. 2007;48:159–166.
15. McNeil J, Prud'homme D, Strychar I, Rabasa-Lhoret R, Brochu M, Lavoie J-M, et al. Satiety quotient linked to food intake and changes in anthropometry during menopause: a MONET Study. *Climacteric J Int Menopause Soc*. 2014;17:449–455.
16. Drapeau V, Hetherington M, Tremblay A. Impact of eating and lifestyle behaviors on body weight: beyond energy value. In: Preedy VR, Watson RR, Martin CR, editors. *Handbook of behavior, food and nutrition*. New York, NY: Springer New York; 2011, p. 693–706.
17. Dalton M, Hollingworth S, Blundell J, Finlayson G. Weak satiety responsiveness is a reliable trait associated with hedonic risk factors for overeating among women. *Nutrients*. 2015;7:7421–7436.
18. Albert M-H, Drapeau V, Mathieu M-E. Timing of moderate-to-vigorous exercise and its impact on subsequent energy intake in young males. *Physiol Behav*. 2015;151:557–562.
19. Fillon A, Mathieu M-E, Masurier J, Roche J, Miguet M, Khammassi M et al. Effect of exercise-meal timing on energy intake, appetite and food reward in adolescents with obesity: the TIMEX study. Under revision.
20. Thivel D, Roche J, Miguet M, Fillon A, Khammassi M, Finlayson G, et al. Post-exercise energy replacement does not reduce subsequent appetite and energy intake in adolescents with obesity. *Obes Facts*. 2019;12:120–122.
21. Cole TJ, Bellizzi MC, Flegal KM, Dietz WH. Establishing a standard definition for child overweight and obesity worldwide: international survey. *Brit Med J*. 2000;320:1240.
22. Bryant EJ, Thivel D, Chaput J-P, Drapeau V, Blundell JE, King NA. Development and validation of the Child Three-Factor Eating Questionnaire (CTFEQr17). *Public Health Nutr*. 2018;21:2558–2567.
23. Stunkard AJ, Messick S. The Three-factor Eating Questionnaire to measure dietary restraint, disinhibition and hunger. *J Psychosom Res*. 1985;29:71–83.
24. Yabsley J-L, Gunnell KE, Bryant EJ, Drapeau V, Thivel D, Adamo KB et al. Validation of a child version of the Three-Factor Eating Questionnaire in a Canadian sample: a psychometric tool for the evaluation of eating behaviour. *Public Health Nutr*. 2018;27:1–13.
25. Thivel D, Genin PM, Mathieu M-E, Pereira B, Metz L. Reproducibility of an in-laboratory test meal to assess ad libitum energy intake in adolescents with obesity. *Appetite*. 2016;105:129–133.
26. Barkeling B, King NA, Näslund E, Blundell JE. Characterization of obese individuals who claim to detect no relationship between their eating pattern and sensations of hunger or fullness. *Int J Obes*. 2007;31:435–439.
27. Tamam S, Bellissimo N, Patel BP, Thomas SG, Anderson GH. Overweight and obese boys reduce food intake in response to a glucose drink but fail to increase intake in response to exercise of short duration. *Appl Physiol Nutr Metab*. 2012;37:520–529.

**A systematic review of the use of the Satiety Quotient.**

**Fillon, A.**, Beaulieu, K., Mathieu, M.-E., Tremblay, A., Boirie, Y., Drapeau, V., & Thivel, D.



*Under review in British Journal of Clinical Nutrition*

## A systematic review of the use of the Satiety Quotient

Fillon A<sup>1,2</sup>, Beaulieu K<sup>3</sup>, Mathieu ME<sup>4</sup>, Tremblay A<sup>5</sup>, Boirie Y<sup>6,7,8,9</sup>, Drapeau V<sup>5</sup>, Thivel D<sup>1,6</sup>.

<sup>1</sup>Clermont Auvergne University, EA 3533, Laboratory of the Metabolic Adaptations to Exercise under Physiological and Pathological Conditions (AME2P), Clermont-Ferrand, France

<sup>2</sup>UGECAM Nutrition Obesity Ambulatory Hospital, Clermont-Ferrand, France

<sup>3</sup>School of Psychology, Faculty of Medicine and Health, University of Leeds, Leeds, LS2 9JT, UK

<sup>4</sup>School of kinesiology and physical activity sciences, Université de Montréal, Montréal, Québec, Canada.

<sup>5</sup>Institute of Nutrition and Functional Foods (INAF), Université Laval, Quebec City, Canada

<sup>6</sup>CRNH-Auvergne, Clermont-Ferrand, France

<sup>7</sup>INRA, UMR 1019, Clermont-Ferrand, France

<sup>8</sup>Department of Human Nutrition, Clermont-Ferrand University Hospital, G. Montpied Hospital, Clermont-Ferrand, France

<sup>9</sup>University Clermont Auvergne, UFR Medicine, Clermont-Ferrand, France

**Key words.** Satiety Quotient, Appetite, Hunger, Fullness, Energy Intake, Desire to Eat, Prospective Food Consumption

**Running head:** Use of the Satiety Quotient

**Corresponding Author :**

Melle FILLON Alicia

Clermont University, EA 3533, Laboratory of the Metabolic Adaptations to Exercise under Physiological and Pathological Conditions (AME2P), BP 80026, F-63171 Aubière cedex, France

[fillonalicia@gmail.com](mailto:fillonalicia@gmail.com)

Phone and fax/ 0033 4 73 40 76 79



32 **Abstract**

33 The satiating efficiency of food has been increasingly quantified using the Satiety Quotient  
34 (SQ). The SQ integrates both the energy content of food ingested during a meal and the  
35 associated change in appetite sensations. This systematic review examines the available  
36 evidence regarding its methodological use and clinical utility. A literature search was conducted  
37 in 6 databases considering studies from 1900 to February 2019 that used SQ in adults,  
38 adolescents and children. All study designs were included. From the initial 492 references  
39 found, 50 were included. Of the studies included, 32 were acute studies (29 in adults and 3 in  
40 adolescents) and 18 were longitudinal studies in adults. A high methodological heterogeneity  
41 in the application of the SQ was observed between studies. Five main utilizations of the SQ  
42 were identified: its association with i) energy intake; ii) anthropometric variables; iii) energy  
43 expenditure/physical activity; iv) sleep quality and quantity; as well as v) to classify individuals  
44 by their satiety responsiveness (i.e. low and high satiety phenotypes). Altogether, the studies  
45 demonstrate that the SQ is a reliable clinical tool regarding the satiety responsiveness to a meal  
46 and its changes in responses to weight loss in adults. The SQ is a reliable clinical indicator in  
47 adults when it comes to both preventive strategies and interventions. There is a need for more  
48 standardized use of the SQ in addition to further studies to investigate its validity in different  
49 contexts and populations, especially among children and adolescents.  
50 Prospero number : CRD42019136442.

51 **Abbreviations**

52 SQ: Satiety Quotient

53 SQ<sub>H</sub>: Satiety Quotient for hunger

54 SQ<sub>D</sub>: Satiety Quotient for desire to eat

55 SQ<sub>S</sub>: Satiety Quotient for satiety

56 SQ<sub>P</sub>: Satiety Quotient for prospective food consumption

57 SQ<sub>F</sub>: Satiety Quotient for fullness

58 BF: Breakfast

59 VAS: Visual analogue scale

60 T2D : Type 2 diabetes

61 T1D : Type 1 diabetes

62 EI: Energy Intake

63 BW: Body Weight

64

65

66 **Introduction**

67 According to the World Health Organization, 39% of adults were overweight and 13% had  
68 obesity in 2016 (1) with pediatric data being just as concerning with 340 million children from  
69 5 to 19 years old classified with overweight and obesity world-wide (1). This alarming  
70 prevalence of overweight, obesity and their associated metabolic complications call for a better  
71 understanding of the mechanisms involved to propose innovative and effective weight loss  
72 strategies. Among them, the regulation of energy balance (2,3) and the pathways involved in  
73 the control of appetite and energy intake (EI) have been of particular interest over the last years  
74 (4). Both homeostatic and hedonic mechanisms influence the motivation to eat (hunger), meal  
75 size (satiety) and post-meal suppression of hunger (satiety) (5).

76 Indeed, a number of objective and subjective methods have been developed for the  
77 quantification and evaluation of both food intake (e.g. *ad libitum* test meals, food diaries) and  
78 appetite sensations (e.g. visual analogue scales; VAS). Integrating both the energy content of  
79 food ingested during a meal and the associated change in appetite sensations, Green and  
80 collaborators developed a Satiety Quotient (SQ) as an indicator of the satiating efficiency of  
81 food (6). The SQ is calculated by dividing the change in subjective appetite sensations in  
82 response to a meal by the energy content of the meal.

83 Since its development, there has been an increasing use of the SQ. While initially created as an  
84 indicator for the satiating efficiency of a meal or food, the SQ has been associated with food  
85 intake (7–10) and body weight (BW) and composition (9,11,12) or used as a tool to classify  
86 individuals by their satiety responsiveness (13–15). However, the extent to which the SQ has  
87 been applied in research and its scientific and clinical relevance has yet to be examined.  
88 Therefore, the aim of this systematic review is to review the available evidence of the different  
89 contexts in which the SQ has been utilized in research, the methodologies used to calculate the  
90 SQ, and to examine its clinical utility.

91

92 **Methods**

93 This review is registered in the PROSPERO database as CRD42019136442. The PRISMA  
94 guidelines were followed for the preparation of this paper (16) .

95

96 *Database search*

97 The following electronic bibliographic databases were searched: PubMed, Embase, Scopus,  
98 Web of Science, CAB Abstract Core Collection and Google Scholar. The literature search  
99 considered studies from year 1900 to February 2019. Keyword searches were performed for  
100 “Satiation”, “Satiety response”, “Appetite”, “Hunger”, “Humans”, “Fullness”, “Prospective  
101 Food Consumption”, “Desire To Eat”, “Motivation To Eat” and “Satiety Quotient”. The search  
102 strategy for each of the databases are detailed in Table 1. The search strategies were developed  
103 based on an analysis of the literature and were open-ended according to the nature of each  
104 database. The reference lists of the articles included were also examined to complete the search.

#### 105 *Study eligibility*

106 *Inclusion criteria.* To be included in the review, studies had to use SQ. There was no exclusion  
107 criterion for the study design (cross-sectional, observational, longitudinal or interventional),  
108 population (no limit for age, weight status and associated complications and both genders were  
109 included), meal type (standardized or ad libitum). Published peer-reviewed studies, conference  
110 proceedings and posters (when data and design properly described), theses and dissertations  
111 were eligible.

112 *Exclusion criteria.* When data were presented in a graphical form without mean or standard  
113 deviation (SD) indicated, the corresponding author of the work was contacted to obtain  
114 complementary data. If the corresponding author did not answer or declined the query, studies  
115 were excluded. When the full text was not found and the corresponding author was unreachable  
116 or did not respond, the article was excluded.

117 *Study selection.* Titles and abstracts of potentially relevant studies were screened in duplicate  
118 for inclusion in the review and any discrepancies were collectively discussed by the authors.  
119 The same procedure was followed for the full texts. Any disagreement regarding eligibility for  
120 inclusion was discussed and a consensus made among co-authors.

#### 121 *Data extraction*

122 For every included study, the following data were extracted: sample size and characteristics  
123 (sex, age, BMI), study design and aim, VAS characteristics (specific appetite sensations  
124 assessed and timing), meal characteristics, SQ equation and main SQ results.

125 *Risk of Bias*

126 Risk of bias was independently evaluated by two authors (AF, DT) using the Cochrane risk of  
127 bias tool (17). Risk of bias was assessed for: selection bias; performance bias; detection bias;  
128 attrition bias; reporting bias. Any discrepancies in bias coding were resolved by a third  
129 reviewer. Studies were not excluded on the basis of risk of bias.

130 **Results**

131 The flow diagram presented in Figure 1 illustrates the selection/inclusion/exclusion process.  
132 The initial database search identified 1281 studies and 7 additional studies were also identified.  
133 Following the removal of duplicate studies, 493 studies were identified. After review of titles  
134 and abstracts, 162 studies were excluded and 83 full-text were screened, leaving 50 included  
135 studies. Table 2 details the risk of bias analysis. Of the 50 studies included, 31 were acute  
136 studies (6–8,11,13–15,18–41) and 19 were longitudinal studies (9,10,12,42–57).

137 .....Figure 1.....

138

139 **Acute studies**

140 Of the 32 acute studies, 29 were conducted in adults (6–8,11,13–15,18–36,38,41,42) and 3 in  
141 adolescents (37,39,40).

142 **Adult acute studies (n=29)**

143 **Main aim, population and design**

144 Of the 29 acute studies selected in the analysis (Table 3), 83% (n=24) evaluated SQ in response  
145 to different conditions (food/meals, sleep duration, drug/food supplements, physical  
146 activity/exercise). Some studies also used SQ to categorize their population (14,15,41). It was  
147 a secondary outcome in 17% of the studies (n=5). As shown in Table 3, 59% (n=17) included  
148 both men and women (6–8,11,18–20,22,23,25,30–32,34,36,38,42), while 24% (n=7) included  
149 only men (13,21,24,26,29,33,41) and 17% (n=5) only women (14,15,27,28,35). Among the  
150 studies, 21 enrolled medically healthy and non-obese adults (6,11,14,15,18,20–23,25,27,30–  
151 36,38,41,42), 5 included adults with overweight or obesity (8,13,19,24,29), 1 had adults with

152 diabetes (T1D and T2D) (7), 1 had people with obesity with or without T2D (26) and 1 had  
153 premenopausal women (28).

154

## 155 **Methods**

### 156 *Topics*

157 Of the 29 studies, 90% (n=26) compared SQ in response to a stimulus (meal, exercise, sleep),  
158 the remaining studies (8,13,14) used SQ to categorize their population (high or low satiety  
159 phenotype). Fifty-nine percent of the included studies (n=17) compared the SQ response to  
160 meals of different composition. Of these 17 studies, 2 used liquid meals (28,33), 14 solid meals  
161 (6,14,15,18,19,21,22,25,27,30,34–36,38,41) and 1 study compared solid *versus* liquid meals  
162 (32). Of these studies, 3 examined the effect of meals differing in energy content (14,28,33)  
163 and 5 studies compared the effect of meals differing in macronutrient composition  
164 (6,15,18,19,25). Martini et al (27) compared the effect of meals differing in fiber and protein,  
165 and Au-Yeung (30) compared the effect of different amounts protein intake via konjac  
166 glucomannan capsules and one study examined the combined effects of a modification in  
167 macronutrients, unsaturated fats, fiber and calcium (41). In a slightly different way, Felix et al.  
168 (32) compared the effect of different kinds of rice and Finlayson et al. (35) the effect of different  
169 tastes on appetite sensations. Defries et al. (22) compared the different satiating effects of meals  
170 made from buckwheat flour or rice flour, while Felix et al. (36) compared the different satiating  
171 effects of white rice or brown rice using 4 different types of rice and Kendall et al. (34) the  
172 effect of different resistant starch compositions using beverages. Finally, in their study, Bligh  
173 et al. (21) investigated the satiating effect of two different types of Paleolithic meals compared  
174 to a reference meal.

175 Three of the studies investigated the influence of sleep on SQ (20,29,31): one examined  
176 the effect of sleep duration (20), while another examined the timing (31) and a last one assessed  
177 the influence of the duration, quality and timing of sleep (29). Two of the 28 studies investigated  
178 acute medication interventions (23,26) and 1 assessed the effect of hormone infusions (24).  
179 Among the acute studies, 2 included acute exercise in their protocol and compared appetite  
180 sensations after the same exercise performed at different blood glucose levels (7) and the other

181 compared different intensities of exercise (38) or different activity related energy expenditure  
182 (42). One study investigated the effect of mental work (11), and another compared the appetite  
183 sensation response of men and women (8). Finally, Drapeau et al. (13) characterized the  
184 biopsychobehavioural profiles of men with low satiety phenotype at the start of a weight loss  
185 intervention.

186 VAS

187 Regarding the type of VAS used, 79% (n=23) of acute studies used the pen and paper method  
188 (6–8,11,13,14,20,22,24,26–36,38,41,42), 10% (n=3) used electronic VAS (18,21,23) and 3  
189 studies did not specify the type of scale used (15,19,25). Of the 23 studies using pen and paper  
190 scales, 15 used 100-mm scales (6,14,20,22,24,26,27,30–36,42), while 8 used 150-mm scales  
191 (7,8,11,13,28,29,38,41). For studies that used electronic VAS, 1 used 100-mm scales (18), one  
192 used 60-mm scales (21) and one did not specify the length of the scale used (23). The 3 studies  
193 that did not specify the type of scale used also did not specify the length of the scale (15,19,25).

194 Out of the 29 studies, 15 had VAS assessing "Fullness", "Prospective Food Consumption",  
195 "Desire To Eat" and "Hunger" (7,8,11,13,14,22,28–31,34,36,38,41,42), 4 measured "Hunger"  
196 only (6,19,32,35), 2 studies included "Hunger", "Satiety", "Fullness", "Prospective Food  
197 Consumption" (20,24), 2 assessed "Hunger" and "Fullness" (25,26), 1 study measured "Satiety"  
198 "Fullness", "Prospective Food Consumption", "Desire To Eat" and "Hunger" (18), 2 studies  
199 assessed "Hunger", "Fullness" and "Desire To Eat" (21,23), another "Satiety", "Fullness" and  
200 " " (27). In his article, a study indicates results for Desire To Eat, Hunger and Prospective Food  
201 Consumption(15). Finally a last one evaluated "Satisfaction", "Hunger", "Fullness" and  
202 "Prospective Food Consumption" (33). In addition to these usually assessed appetite sensations,  
203 other sensations were interrogated via the VAS. Thirst was investigated (20,23) as well as  
204 nausea (23,24). Schmit et al. (24) also examined the "Desire To Eat sweet and fatty food".

205 *Calculation of SQ*

206 Of the 29 acute studies included, 8 used the initial equation proposed by Green et al. (1997)  
207 (6,22,24,30,33–35,42): (appetite sensation pre-meal - appetite sensation post meal) / EI of  
208 eating episode. This equation was slightly reworked by Drapeau et al. (2007), who used this  
209 equation but multiplied the result by 100. Fifteen studies used the equation proposed by

210 Drapeau et al. (7,8,13,14,18–20,25,28,29,31,32,36,38,41). While previous studies have used  
211 similar equations, others have calculated the SQ slightly differently. Chapman et al. (26)  
212 calculated two SQ: a prandial SQ that considered in its calculation both pre- and post-meal  
213 appetite sensations, and a post-prandial SQ only considering post-meal sensations. In their  
214 study, Martini et al. (27) calculated three different SQ: 1) the same equation as Drapeau et al.  
215 using the pre- and post-lunch appetite sensations and energy content of lunch; 2) (appetite  
216 sensation before lunch – appetite sensation before snack) /energy content of lunch \* 100; and  
217 3) (appetite sensation before lunch – appetite sensation after snack) / (energy content of lunch  
218 + snack) \* 100. More specifically, Au Yeung et al. used the Green equation for SQ<sub>H</sub>, SQ<sub>D</sub> and  
219 SQ<sub>P</sub>. For SQ<sub>F</sub>, they subtracted fullness post-eating from fullness fasting. Salama et al. (11) also  
220 reversed the order of subtraction between appetite sensations contrary to what was done by  
221 Drapeau, subtracting pre-meal sensations from post-meal sensations. Two studies did not  
222 specify the type of equation used (15,21). Finally, Thomas et al. used an adapted version of the  
223 equation proposed by Green and calculated “satiety quotient” per quartile, reflecting the  
224 satiety capacity of a food as eaten ((quartile initial hunger – quartile ending hunger  
225 rating)/calorie consumed during quartile) (23).

226 For the SQ calculation, out of the 29 studies, 23 chose to define as "pre-meal sensations"  
227 the sensations recorded immediately before the tested meal (7,8,11,13,14,18–20,22,25,27–  
228 34,36,38,41,42). The remaining 6 studies assessed pre-lunch sensations 1 hour before the meal  
229 (26), 20 minutes before the meal (21) or 5 minutes before the meal (24). Three studies did not  
230 specify the timing of the VAS (15,23,35). Two studies also assessed appetite feelings during  
231 the meal (23,24). Regarding the use of post-meal appetite sensations for calculating SQ, 8  
232 studies evaluated them up to 60 minutes after the end of food intake (7,8,13,23,28,29,33,38), 5  
233 studies up to 120 minutes after the end of food intake (20,27,32,34,36), 4 up to 180 minutes  
234 after the end of food intake (18,22,25,31) and 3 up to 240 minutes after the end of food intake  
235 (6,11,41). Hopkins et al. reported appetite sensations every hour after the end of the meal until  
236 the next meal (19) while Chapman et al. assessed appetite sensations up to 5 hours after the end  
237 of the meal (26). Green et al. measured appetite sensations up to 75 minutes after food intake  
238 (6), Schmidt et al. reported post-meal appetite sensations up to 25 minutes after the meal (24)  
239 and finally, Harrington et al. reported post-meal appetite sensations immediately after the end  
240 of the meal (42). The study from Blight et al. reported appetite sensations up to 175 minutes



241 after the start of food intake, while Dalton et al. reported these sensations up to 90 minutes after  
242 the start of the meal. The timing of VAS are summarized in detail in Table 3.

243 Although we have previously detailed the different appetite sensations assessed in the  
244 included studies, SQ have not been calculated in each of these studies using all the assessed  
245 sensations. Thirteen of the acute studies (7,8,11,13,28,29,31,34,36,38,41,42) calculated a SQ  
246 for each of the following appetite sensations: "Hunger", "Fullness", " Desire To Eat ",  
247 "Prospective Food Consumption" while 9 of the 29 studies calculated a SQ<sub>H</sub> only  
248 (6,14,19,22,23,25,26,32,35). Drapeau et al. calculated the SQ related to the four appetite  
249 sensations assessed but also calculated a mean SQ (13). Two studies calculated a SQ<sub>H</sub> (SQ for  
250 Hunger), SQ<sub>S</sub> (SQ for Satiety) , SQ<sub>F</sub> (SQ for Fullness), SQ<sub>P</sub> (SQ for Prospective Food  
251 Consumption) independently (20,24). Hansen et al. (18) calculated a composite SQ (with  
252 Hunger, Satiety, Fullness, Prospective Food Consumption and Desire To Eat). Blight et al. (21)  
253 proposed SQ<sub>H</sub>, SQ<sub>F</sub>, SQ<sub>D</sub> (SQ for Desire To Eat) while Martini et al. (27) used a different SQ  
254 for each of the following sensations: Fullness, Desire To Eat and Satiety. Finally, Au-Yeung et  
255 al. (30) calculated a different SQ<sub>H</sub>, SQ<sub>D</sub> and SQ<sub>P</sub>. In contrast, Gonzalez et al. (33) produced a  
256 composite SQ, whose equation is however not detailed. In their work, Hollingworth et al. (15)  
257 did not detail which appetite sensations have been used to calculate the SQ.

258 Finally SQ was also calculated in response to different meals. Among the included acute  
259 studies, 15 used a standardized fixed meal to calculate SQ (7,8,14,21,22,28,29,31–36,38), while  
260 7 used an *ad libitum* meal (13,20,23–26,30,42) including one that offered only an *ad libitum*  
261 dessert (30). Six studies calculated the SQ on both types of meals: fixed and *ad libitum*  
262 (6,11,18,19,27,41). One study did not specify the type of meal used to calculate the SQ (15).  
263 Table 3 details the different meals used in the included studies.

264

## 265 **Acute studies conducted in children and adolescents**

### 266 **Main aim, population and design**

267 Of the three acute studies included, two were randomized controlled studies (37,40) and one  
268 was a randomized crossover study (39) aimed to assess the effect of different exercise

269 conditions on satiety responsiveness. The satiating effect of food assessed via the SQ was  
270 among the main outcome studied in all of them.

271 In their work, Albert et al. (39) and Fillon et al. (40) investigated the effect of the delay  
272 between an acute exercise and the meal on food intake and appetite sensations, while Thivel  
273 and colleagues (37) assessed the effect of post-exercise energy replacement on subsequent food  
274 intake.

275 Among these three studies, two enrolled both boys and girls (37,40), while one enrolled  
276 boys only (39). Albert et al.'s study (39) was conducted among lean adolescents (~17 years)  
277 while Thivel et al. (37) and Fillon et al. (40) enrolled adolescents with obesity (~13 years)  
278 (Table 4).

## 279 **Methods**

280 All of the included studies used pen and paper VAS (37,39,40), with 2 using 150-mm scales  
281 (37,40) and Albert et al. using 100-mm scales (39). In their study, Albert and colleagues (39)  
282 assessed “Desire To Eat”, “Hunger”, “Fullness”, “Anticipated Food Consumption”, “Desire  
283 for specific food types”, “Palatability”, “Appreciation” and “Visual appeal”. Thivel et al. (37)  
284 and Fillon et al. (40) assessed “Desire To Eat”, “Hunger”, “Fullness” and “Satiety”.

285 Regarding the calculation of SQ, all of the included studies used the equation proposed  
286 by Drapeau et al. (2007) (appetite sensation pre-meal - appetite sensation post-meal) / EI of  
287 eating episode \* 100. While Albert et al. only used the immediate post-meal sensation in the  
288 equation (39), the two other studies used a the mean of sensations assessed up to 60 minutes  
289 post-meal (immediately post-meal, 30 minutes and 60 minutes post-meal) (37,40).

290 Although Albert et al. (39) assessed different appetite sensations, they only calculated  
291 the SQH while the two other studies calculated the SQ for each of the appetite sensations  
292 assessed: Desire To Eat, Hunger, Fullness and Satiety (37,40). All studies calculated their SQ  
293 using an *ad libitum* lunch meal.

294

## 295 **Chronic studies conducted in adults**

### 296 **Design and aim**

297 Of the 18 studies, 2 were observational (9,10) while the remaining were interventional. Out of  
298 the 18 included studies, 2 used the SQ as a secondary outcome (46,55).

299 Of the chronic studies using SQ as a main outcome, 13 evaluated the changes in SQ in response  
300 to an intervention (specific meal or meal context, different drug or food supplements, different  
301 exercise training interventions), and 3 utilized the SQ to categorize the population in their study  
302 (i.e. low or high satiety phenotype) (12,52,57) .

303

#### 304 **Population**

305 Of the 18 chronic studies included, 7 enrolled both men and women (10,48–50,52,54,55), while  
306 7 studies enrolled women only (9,44,47,51,53,55,57) and 4 men only (12,45,46,54). Seventy-  
307 two percent of the chronic studies enrolled individuals with overweight or obesity  
308 (10,12,44,46,47,49–53,55–57), and one study included healthy adults only (45), one study was  
309 in menopausal women (9), one in patients with ischemic heart disease and impaired glucose  
310 tolerance or T2D (43), one in T2D patients (54) and one in men and premenopausal women  
311 with overweight (48) (Table 5).

312

#### 313 **Methods**

##### 314 *Topics*

315 Eighty-three percent of the included chronic studies investigated the SQ in response to lifestyle  
316 changes (e.g. changing from inactive to active) or physiological modifications (e.g. pre- vs.  
317 post-menopause in women) (9,10,43–51,53–56) while 3 of these 18 studies used SQ as a tool  
318 to classify the population as low and high satiety phenotype (12,52,57).

319 Two observational studies were included and examined the association between SQ and the  
320 change of EI, BW and body composition over time (9,10).

321 Among the included interventional studies, 6 assessed the effect of different dietary  
322 prescriptions on SQ (12,43–45,54,57) while 2 assessed the effect of different physical activity  
323 prescriptions on SQ (49,56). One study investigated the effect of a prescription combining

324 physical activity and dietary interventions on SQ (46). One assessed the effect of weight change  
325 on SQ (47) and two others more specifically on the effect of different energy restrictions on SQ  
326 change (52,53). Bédard and colleagues investigated the effect of sex on SQ (48) and  
327 Carbonneau et al. the effect of different nutritional labelling (51). Finally, the effect of probiotic  
328 (50) or pharmaceutical (55) compounds on the change of SQ was also tested.

### 329 VAS

330 Fourteen studies used pen and paper VAS (9,10,12,44–48,50–53,55,57) while the other 4 used  
331 electronic VAS. Of the 14 who used the pen and paper method, 5 used 100-mm scales  
332 (44,45,53,55,57) while the others used 150-mm scales (9,10,12,46–48,50–52). With regards to  
333 electronic VAS, one study used a 7-point scale (43), another used a scale ranging from -3 to 3  
334 (54) and finally 2 studies did not specify the length of the scales used (49,56).

335 Ten of the 18 studies analyzed "Hunger", "Desire To Eat", "Fullness" and "Prospective Food  
336 Consumption" (9,10,12,46–50,52,53). Two studies used a single scale with "Hunger" and  
337 "Fullness" as extremes (43,54) while one study questioned "Hunger" and "Fullness" separately  
338 (51). Two studies evaluated "Hunger" only (44,45) while Caudwell and colleagues (56)  
339 evaluated "Hunger", "Fullness" and "Desire To Eat" sensations and Halford et al. (55) evaluated  
340 the sensation of "Hunger", "Fullness", "Desire To Eat", "Prospective Food Consumption",  
341 "Satisfaction" and "Nausea". Finally, in chronic studies, Buckland et al. are the only one to use  
342 "Fullness" only in their study (57).

### 343 *Calculation of SQ*

344 Seventy-two percent of the included studies used the following equation proposed by Drapeau  
345 et al. (10,13): (appetite sensation pre-meal - appetite sensation post-meal) / EI of eating episode  
346 \* 100 (9,10,12,44,45,47–53,56). Buckland et al. used the same equation, but they subtracted  
347 post-meal sensation from pre-meal sensation, because they evaluated just "Fullness" (57).  
348 Hintze et al. reversed also the order of subtraction between appetite sensations contrary to what  
349 was done by Drapeau, subtracting pre-meal sensations from post-meal sensations, for SQ<sub>F</sub> (53)  
350 . Three studies used the same equation without multiplying the result by 100 (43,46,55) and one  
351 study did not clearly specify the equation used (54).

352 More specifically, all studies considered as "pre-meal appetite sensation" the sensations  
353 given immediately before the meal. With regard to "post-meal appetite sensation", 5 studies  
354 used only the sensations immediately after the meal (44,46–48,51) and 2 studies considered the  
355 post-meal sensations as the sensations recorded 30 minutes after the start of ingestion (43,54).  
356 Others averaged appetite sensations immediately after eating with appetite sensations 1 hour  
357 after eating (56), or every 10 minutes for 1 hour (10,50,52), or every 10 minutes for 1 hour plus  
358 90 minutes and 120 minutes after eating (12). Two studies used the average appetite sensation  
359 immediately after eating with the sensations reported every 30 minutes for 3 hours (9,53) while  
360 Halford et al. (55) and Buckland et al. (57) used the same protocol but with appetite sensation  
361 evaluations every hour for 3 hours and not every 30 minutes. Finally, Goloso-Gubat and  
362 colleagues (45) used the average of appetite sensation at 15, 30, 45, 60, 90, 120, 150, 180, 240  
363 minutes after the meal to calculate "post-meal appetite sensation". One study (49) indicated that  
364 it had integrated in the calculation of the post-meal sensations the sensations of appetite  
365 immediately after the meal as well as sensations assessed periodically between the 2 meals  
366 (Table 5).

367 Several studies did not use all the appetite sensations reported in their protocol to  
368 calculate the corresponding SQ. Indeed, among the 11 studies that assessed "Desire To Eat",  
369 "Hunger", "Fullness" and "Prospective Food Consumption", one calculated the SQ<sub>F</sub> only (48)  
370 and another one the SQ<sub>H</sub> only (49). In the same way, the study by Caudwell et al. (56) measured  
371 "Desire To Eat", "Hunger", "Fullness" but only calculated the SQ<sub>H</sub>. The other studies calculated  
372 a SQ for each of the appetite sensation assessed (see Table 5).

373 Out of the 18 included studies, 10 calculated the SQ in response to a standardized fixed  
374 meal (9,10,12,45,47–50,52,57) while 5 used an *ad libitum* meal (43,44,46,51,54) with one study  
375 using both type of meals (55). Caudwell et al. (56) and Hintze et al. (53) calculated the SQ on  
376 an individualized BF.

## 377 **Main Results**

378 By adopting a systematic overview of all the included studies, a large heterogeneity is observed  
379 when it comes to the purpose of using SQ. While all details are presented in Tables 3, 4 and 5,  
380 five main methodological uses of the SQ can be identified: i) the association between SQ and  
381 energy intake (7–9,12,15,15,18,19,21,22,25,27,32,36,41,43–45,48,53,54,57); ii) the

382 association between the SQ and anthropometric variables (8–11,46,47,52); iii) the association  
383 between SQ and energy expenditure/physical activity (7,14,38,42,49,56); iv) the association  
384 between SQ and sleep quality and quantity (20,29,31); v) SQ to classify individuals into low  
385 and high satiety phenotypes (13–15,41,52,57).

386 The following sections presents and categorizes the main results observed in the  
387 included studies. While only the main methodological aspects and results related to the use of  
388 the SQ are details in this section, the Tables 3, 4 and 5 presents the full details of the included  
389 studies.

#### 390 *Association between SQ and energy and macronutrient intake*

391 First, four of the included studies demonstrate that SQ is a predictor of food intake (7–10). The  
392 systematic analysis of these studies shows that SQ<sub>F</sub> (8–10), SQ<sub>H</sub> (7), SQ<sub>P</sub> (9) and mean SQ (9)  
393 predict EI and SQ<sub>F</sub> predicts relative EI too (subtracting resting metabolic rate from total energy  
394 intake) (8). A distinction is made in the studies between objectively measured EI and self-  
395 reported EI using food diaries, with SQ<sub>D</sub>, SQ<sub>H</sub>, SQ<sub>F</sub> (7) and SQ<sub>P</sub> (9) predicting reported EI only.  
396 More specifically, according to these studies, macronutrient intake could be predicted by SQ<sub>F</sub>,  
397 SQ<sub>P</sub> and mean SQ (9) and SQ<sub>F</sub> could also predict CHO intake in food diaries (9).

#### 398 *Association between SQ and anthropometric variables*

399 Four of the included studies show associations between the SQ and anthropometric or body  
400 composition variables (8,9,11,52,57). Concerning BW, we observe that individuals with high  
401 satiety phenotype lost more BW than those with a low satiety phenotype (12,52,57) and we find  
402 the same conclusions regarding waist circumference in women with obesity (57). In fact,  
403 individuals with a high waist circumference had lower satiating effect determined by the SQ<sub>F</sub>  
404 (11) and McNeil et al. showed in their 5-year study that changes in SQ was negatively correlated  
405 with the change in waist circumference (9). With regards to the relationship between SQ and  
406 fat mass, Salama et al. found a positive relationship between % fat mass and SQ<sub>F</sub> (11). In their  
407 longitudinal study, McNeil et al. found a positive correlation between the SQ and fat mass  
408 changes (delta) over the entire study, although they found a negative correlation between year  
409 4 and year 5 (9).

#### 410 *Association between SQ and energy expenditure/physical activity*

411 Three of the included studies show contradictory associations between SQ and exercise or the  
412 level of physical activity (25,42,49,56). Some cross-sectional results suggest a decrease in SQ,  
413 indicating a lower satiety responsiveness, in lean individuals with high activity-related energy  
414 expenditure (42) while others show no effect of habitual physical activity level on SQ in non-  
415 obese individuals (25). In individuals with overweight and obesity, a 12-week exercise  
416 intervention led to increased satiety responsiveness to a fixed meal (49,56).

417 With regard to studies in children, it can be observed that the timing between exercise  
418 and a meal (38,42) or the use of an energy replacement strategy (9) have no effect on SQ and  
419 that no particular association was found with SQ. However, a better satiety responsiveness  
420 (higher SQ) was observed when exercise is performed just before a meal vs. a rest condition  
421 (42).

#### 422 *SQ to classify individuals into low and high satiety phenotypes*

423 Six of the included studies support the SQ as a reliable tool to phenotype individuals based on  
424 their satiety responsiveness (12–15,52,57). Indeed, compared to individuals with a high satiety  
425 phenotype, individuals with a low satiety phenotype have higher EI, greater cravings for sweet  
426 foods, lower craving control, higher disinhibition and fasting Hunger, Desire To Eat and  
427 Prospective Food Consumption and exhibit a higher wanting for high-fat food (14,15,57). The  
428 behavioral and psychological characteristics of the low satiety phenotype are associated with a  
429 greater susceptibility to overconsumption (14,15). These results are also corroborated by  
430 another study, where Drapeau et al. indicate that the higher increase in cognitive restraint and  
431 a lower decrease in disinhibition in response to a weight loss intervention could increase the  
432 susceptibility of these individuals to weight gain (52), these results being in agreement with  
433 another work from Drapeau et al. showing that SQ negatively correlated with the external locus  
434 for Hunger measured by the Three-Factor Eating Questionnaire (13). Moreover, Buckland et  
435 al. found a weaker control over eating and weight loss program adherence in people with a low  
436 satiety phenotype, as well as a lower weight loss compared with people with a high satiety  
437 phenotypes(57) .

#### 438 **Discussion**

439 While there has been a growing use of the SQ in clinical studies since its development by Green  
440 and colleagues in 1997 (6), little attention has been paid regarding its use since then and a high  
441 methodological heterogeneity can be observed between studies. In that context, the present  
442 review aimed to systematically analyze the available evidence regarding the scientific and  
443 clinical use of the SQ. Fifty studies were included after our database search, 32 of them being  
444 cross-sectional/acute (6–8,11,13–15,18–41) and 18 being longitudinal (9,10,12,42–57). The  
445 large majority of the included studies enrolled adults participants with only 3 enrolling children  
446 and adolescents (37,39,40).

447 According to our analysis, acute studies mainly used the SQ to compare the satiating  
448 effect of different kinds of meals varying in texture (liquid and solid)  
449 (6,14,15,18,19,21,22,25,27,28,30,32–36,41), energy content (14,28,33) or composition  
450 (6,15,18,19,21,25,27,30,34,36,41). Some of these acute investigations also assessed the effect  
451 of sleep characteristics (i.e. timing, quality or duration) (20,29,31), exercise (7,38), mental work  
452 (11), gender (8) or pharmaceuticals (23,24,26) on the SQ. Regarding the interventional studies  
453 included in our analysis, they mainly used the SQ to evaluate the effect of different dietary  
454 and/or exercise interventions (12,43–46,49,50,52–54,56) on the SQ. Finally, some studies  
455 (acute and chronic) used the SQ to classify individuals as low or high satiety phenotypes (13–  
456 15,41,52,57).

#### 457 *Clinical utility and reliability of the SQ*

458 Mainly, the present systematic approach supports the use of the SQ as a reliable  
459 predictor of both measured (7–10,57) and reported (7,9,10) energy intake, as well as  
460 macronutrient intake (9). Studies effectively highlight higher food consumption with lower  
461 satiety responsiveness to a meal (lower SQ) in T1D (7), healthy women (15), men and women  
462 with overweight (8), premenopausal women (9) and women with obesity (53,57). This is  
463 reinforced by other results demonstrating negative associations between SQ and BW, waist  
464 circumference as well as fat mass (9,11,52,57). Importantly, Drapeau et al. (52) found a positive  
465 association between SQ and weight loss in response to an energy restriction intervention in men  
466 and women with obesity, like Buckland et al. in women with obesity (57). The SQ has been  
467 used as a clinical tool to categorize people depending on their level of satiety responsiveness to  
468 a standardized fixed meal; a low phenotype characterizing people who report difficulties in



469 appropriately recognizing their appetite sensations before or after a meal (8). These results are  
470 supplemented by those of Buckland et al., which have shown that people with low satiety  
471 phenotype have a weaker control over eating and weight loss program adherence compared to  
472 people with high satiety phenotype (57). Moreover, people with low satiety phenotype prefer  
473 and consume more of high energy density food than people with high satiety phenotype (57).  
474 While most studies use a median split to categorize low and high satiety phenotypes, in a clinical  
475 context, a low satiety phenotype might be observed in about 10% of patients with obesity who  
476 declare themselves as unable to detect changes in their appetite, report a weak satiety response  
477 to a meal and even show an increase in appetite after a meal for some of them (58). Altogether,  
478 these results suggest that the SQ is a reliable clinical indicator to identify adults at risk of  
479 overeating and thus could be used in preventive strategies and weight loss interventions.

480           Interestingly, while the SQ has been studied in the context of nutritional manipulations,  
481 some studies also examined its relationship and response to physical activity and exercise.  
482 According to these studies, moderate physical activity levels in lean individuals and exercise  
483 training in individuals with overweight and obesity are associated with a higher SQ, suggesting  
484 an improved satiety responsiveness (42,49,56). However, this was not the case in studies  
485 measuring SQ at an *ad libitum* meal in lean individuals with very high physical activity levels,  
486 one of which showing lower SQ (42) and another showing similar SQ (25) than their less active  
487 counterparts. Using a different methodology to assess the satiety response to food (preload-test  
488 meal protocol), other studies have shown that physically active individuals have better ability  
489 to adjust subsequent energy intake following preloads differing in energy content (59,60). These  
490 results, whether using the SQ or energy compensation following a preload as an indicator of  
491 satiety responsiveness, illustrate a relationship between physical activity, food intake and  
492 appetite control (61). Here again, it underlines the clinical interest of the SQ as part of  
493 multidisciplinary approaches developed to prevent and treat obesity in adults.

494           According to our systematic approach, only few (n=3 out of 50) studies very recently  
495 used the SQ among children and adolescents, all of them investigating the effect of acute  
496 exercise on the subsequent satiating effect of a meal (37,39,40). While two of these studies did  
497 not observe any effect of an acute exercise bout on the SQ calculated on the following *ad libitum*  
498 meal (37,39), Fillon et al. found increased SQ for Hunger, Prospective Food Consumption and

499 Desire To Eat after acute moderate intensity exercise in adolescents with obesity (40). In  
500 addition to the lack of available evidence regarding the use of the SQ in youth, the absence of  
501 any validation study in his population must be highlighted. Indeed, in opposition to what has  
502 been shown in adults, it remains unknown whether the SQ is a clinically valid and reliable tool  
503 to be used in children and adolescents. Based on the increasing interest in the appetite control  
504 of children and adolescents, particularly in those with obesity, our research group recently  
505 conducted a methodological study assessing the reproducibility of SQ and its validity as an  
506 indicator of body corpulence and composition as well as of EI in adolescents with obesity (62).  
507 Although SQH showed a relatively modest reproducibility, none of the other SQ variables were  
508 found reproducible and no association were found with anthropometric variables, body  
509 composition or EI (62). This clearly calls for caution when interpreting existing results and for  
510 further studies developing reliable tools to measure the satiating effect of food in this  
511 population.

#### 512 *Methodological considerations*

513 Our systematic analysis reveals a high level of heterogeneity regarding the methods used  
514 (equation used, type of meal, timing of the measurements of appetite sensations, etc.). While  
515 the SQ has been found reliable and reproducible in adults, especially men with obesity (ICC for  
516 the SQ mean of 0.67) (13,14), more studies are needed to assess its validity and reproducibility  
517 in various contexts and populations.

518 While 42 out of the 47 adults studies included (6–14,18–20,22–36,38,41–53,55–57)  
519 used the equation initially developed by Green and colleagues (6), others used derived equations  
520 (11,23,26,27) or did not specify the equation used (15,21,54). Similarly, as detailed in the tables  
521 and results section, the VAS used (e.g. 100 vs. 150 mm) and the timing of the measurements of  
522 appetite sensations, with some studies only using the post-meal appetite sensation while others  
523 using the mean of the appetite sensations for up to several hours post-meal, vary between studies  
524 making any comparisons difficult. Importantly, while the SQ has been validated under  
525 standardized conditions and mainly using a fixed meal (8,14), 38% (n=18) of the included  
526 studies used an *ad libitum* meal to calculate the SQ (6,11,18–20,23–27,30,41–43,46,51,54,55).  
527 Gonzalez and collaborators examined the accuracy of the SQ depending on the energy content  
528 of the ingested meal and observed a better reproducibility and reliability of SQ (mean SQ as

529 well as SQ<sub>H</sub>, SQ<sub>F</sub>, SQ<sub>P</sub>, SQ<sub>S</sub>) in response to higher energy content compared to meals of lower  
530 energy content (33). Finally, while the validity of the SQ among men (13) and women (14) was  
531 demonstrated, it has been widely used among specific populations such as individuals with  
532 diabetes (7,26), premenopausal women (9,28), people with different levels of physical activity  
533 (25), people with overweight and obesity (8,10,12,13,19,24,26,29,44,46,56). Once more, this  
534 must lead us to interpret these results with caution and calls for more methodological  
535 validations.

## 536 **Conclusion**

537 While the current systematic review provides evidence regarding the reliability of the SQ in  
538 adults and encourages its use as a reliable clinical tool regarding the satiety responsiveness to a  
539 meal and its changes in responses to weight loss; we also encourage the adoption of a more  
540 standardized use of the SQ as well as the development of additional studies assessing its validity  
541 in several contexts and populations, especially among children and adolescents. Based on the  
542 present systematic analysis, we encourage future studies to assess SQ for Hunger, Fullness,  
543 Desire To Eat and Prospective Food Consumption after an overnight fast in response to a  
544 standardized fixed meal, without intense physical activity, and to consistently use a validated  
545 equation (such as the one initially proposed by Drapeau et al. (10,13)). This would allow for  
546 more reliable outcomes and better comparisons across studies.

547

## 548 **Funding**

549 This research received no specific grant from any funding agency, commercial or not-for-profit  
550 sectors.

551

## 552 **Acknowledgements**

553 We would particularly like to thank Mr Denis Arvisais, documentalist at the University of  
554 Montreal, who helped us during the collection of the studies. We also thank the Mitacs  
555 Globalink grant, who supported this work.

556

557 **Conflict of Interest**

558 The authors have no conflicts of interest to disclose. The authors have no financial relationships  
559 relevant to this article to disclose.

560

561 **Authorship**

562 AF, DT, VD and AT conceived the idea and conceptualized the review. AF and DT  
563 conducted the study selection, data extraction, and methodological quality assessment. AF  
564 drafted the initial manuscript. AF, DT, KB and VD contributed to writing the manuscript. All  
565 authors read and approved the final manuscript.

566

567 **References**

568

- 569 1. Obésité et surpoids [Internet]. [cité 20 mars 2019]. Disponible sur:  
570 <https://www.who.int/fr/news-room/fact-sheets/detail/obesity-and-overweight>
- 571 2. Blundell JE, Gibbons C, Caudwell P, Finlayson G, Hopkins M. Appetite control and  
572 energy balance: impact of exercise. *Obes Rev.* 2015;16(S1):67- 76.
- 573 3. Hopkins M, Duarte C, Beaulieu K, Finlayson G, Gibbons C, Johnstone AM, et al. Activity  
574 energy expenditure is an independent predictor of energy intake in humans. *Int J Obes*  
575 2005. 18 janv 2019;
- 576 4. Harris RBS, éditeur. *Appetite and Food Intake: Central Control* [Internet]. 2nd éd. Boca  
577 Raton (FL): CRC Press/Taylor & Francis; 2017 [cité 21 mai 2019]. Disponible sur:  
578 <http://www.ncbi.nlm.nih.gov/books/NBK453148/>
- 579 5. Blundell J, Finlayson G. Mechanisms and biomarkers of appetite control. In: *Food Texture*  
580 *and Food Intake The role of oral sensory exposure.* *Agro Food Industry Hi-Tech.* p.  
581 18- 20.
- 582 6. Green SM, Delargy HJ, Joanes D, Blundell JE. A satiety quotient: a formulation to assess  
583 the satiating effect of food. *Appetite.* déc 1997;29(3):291- 304.
- 584 7. Dubé M-C, Tremblay A, Lavoie C, John Weisnagel S. Effect of exercise on food  
585 consumption and appetite sensations in subjects with diabetes. *Appetite.* déc  
586 2013;71:403- 10.
- 587 8. Drapeau V, Blundell J, Therrien F, Lawton C, Richard D, Tremblay A. Appetite sensations  
588 as a marker of overall intake. *Br J Nutr.* févr 2005;93(2):273- 80.
- 589 9. McNeil J, Prud'homme D, Strychar I, Rabasa-Lhoret R, Brochu M, Lavoie J-M, et al.  
590 Satiety quotient linked to food intake and changes in anthropometry during menopause: a  
591 MONET Study. *Climacteric J Int Menopause Soc.* août 2014;17(4):449- 55.

- 592 10. Drapeau V, King N, Hetherington M, Doucet E, Blundell J, Tremblay A. Appetite  
593 sensations and satiety quotient: predictors of energy intake and weight loss. *Appetite*. mars  
594 2007;48(2):159- 66.
- 595 11. Salama M, Drapeau V, Tremblay A, Pérusse-Lachance É. The impact of a mental work  
596 on food preferences, eating behavior traits and satiety efficiency. *Physiol Behav*. 1 févr  
597 2016;154:191- 5.
- 598 12. Arguin H, Tremblay A, Blundell JE, Despres JP, Richard D, Lamarche B, et al. Impact of  
599 a non-restrictive satiating diet on anthropometrics, satiety responsiveness and eating  
600 behaviour traits in obese men displaying a high or a low satiety phenotype. *Br J Nutr*. nov  
601 2017;118(9):750- 60.
- 602 13. Drapeau V, Blundell J, Gallant AR, Arguin H, Després J-P, Lamarche B, et al. Behavioural  
603 and metabolic characterisation of the low satiety phenotype. *Appetite*. nov  
604 2013;70:67- 72.
- 605 14. Dalton M, Hollingworth S, Blundell J, Finlayson G. Weak Satiety Responsiveness Is a  
606 Reliable Trait Associated with Hedonic Risk Factors for Overeating among Women.  
607 *Nutrients*. 4 sept 2015;7(9):7421- 36.
- 608 15. Hollingworth S, Dalton M, Blundell J, Finlayson G. Evaluation of the influence of  
609 different snack foods on appetite control in the low satiety phenotype. *Appetite*.  
610 2018;123:458.
- 611 16. Liberati A, Altman DG, Tetzlaff J, Mulrow C, Gøtzsche PC, Ioannidis JPA, et al. The  
612 PRISMA statement for reporting systematic reviews and meta-analyses of studies that  
613 evaluate health care interventions: explanation and elaboration. *J Clin Epidemiol*. 1 oct  
614 2009;62(10):e1- 34.
- 615 17. Higgins J, Green S. *Cochrane handbook for systematic reviews of interventions*. 2008.  
616 (Wiley Online Library).

- 617 18. Hansen TT, Sjodin A, Ritz C, Bonnet S, Korndal SK. Macronutrient manipulations of  
618 cheese resulted in lower energy content without compromising its satiating capacity. *J*  
619 *Nutr Sci.* 2018;7:e7.
- 620 19. Hopkins M, Gibbons C, Caudwell P, Blundell JE, Finlayson G. Differing effects of high-  
621 fat or high-carbohydrate meals on food hedonics in overweight and obese individuals. *Br*  
622 *J Nutr.* 28 mai 2016;115(10):1875- 84.
- 623 20. Polugrudov A, Popov S, Smirnov V, Panev A, Ascheulova E, Kuznetsova E, et al.  
624 Association of social jetlag experienced by young northerners with their appetite after  
625 having breakfast. *Biol Rhythm Res.* 2017;48(6):917- 29.
- 626 21. Bligh HF, Godsland IF, Frost G, Hunter KJ, Murray P, MacAulay K, et al. Plant-rich  
627 mixed meals based on Palaeolithic diet principles have a dramatic impact on incretin,  
628 peptide YY and satiety response, but show little effect on glucose and insulin homeostasis:  
629 an acute-effects randomised study. *Br J Nutr.* 28 févr 2015;113(4):574- 84.
- 630 22. Defries DM, Petkau JC, Gregor T, Blewett H. A randomized, controlled, crossover study  
631 of appetite-related sensations after consuming snacks made from buckwheat. *Appl Physiol*  
632 *Nutr Metab.* 2017;43(2):194- 202.
- 633 23. Thomas JM, Dourish CT, Tomlinson JW, Hassan-Smith Z, Higgs S. Effects of the 5-  
634 HT2C receptor agonist meta- chlorophenylpiperazine on appetite, food intake and  
635 emotional processing in healthy volunteers. *Psychopharmacology (Berl).*  
636 2014;231(12):2449- 59.
- 637 24. Schmidt JB, Gregersen NT, Pedersen SD, Arentoft JL, Ritz C, Schwartz TW, et al. Effects  
638 of PYY3-36 and GLP-1 on energy intake, energy expenditure, and appetite in overweight  
639 men. *Am J Physiol - Endocrinol Metab.* 2014;306(11):E1248- 56.
- 640 25. Beaulieu K, Hopkins M, Blundell J, Finlayson G. Impact of physical activity level and  
641 dietary fat content on passive overconsumption of energy in non-obese adults. *Int J Behav*  
642 *Nutr Phys Act.* 2017;14(1):14.

- 643 26. Chapman I, Parker B, Doran S, Feinle-Bisset C, Wishart J, Strobel S, et al. Effect of  
644 pramlintide on satiety and food intake in obese subjects and subjects with type 2 diabetes.  
645 *Diabetologia*. 2005;48(5):838- 48.
- 646 27. Martini D, Brusamolino A, Del Bo C, Laureati M, Porrini M, Riso P. Effect of fiber and  
647 protein-enriched pasta formulations on satiety-related sensations and afternoon snacking  
648 in Italian healthy female subjects. *Physiol Behav*. 2018;185:61- 9.
- 649 28. Blanchet R, Lemieux S, Couture P, Bouchard L, Vohl M-C, Pérusse L. Effects of  
650 neuromedin- $\beta$  on caloric compensation, eating behaviours and habitual food intake.  
651 *Appetite*. 2011;57(1):21- 7.
- 652 29. McNeil J, Drapeau V, Gallant AR, Tremblay A, Doucet E, Chaput JP. Short sleep duration  
653 is associated with a lower mean satiety quotient in overweight and obese men. *Eur J Clin*  
654 *Nutr*. déc 2013;67(12):1328- 30.
- 655 30. Au-Yeung F, Jovanovski E, Jenkins AL, Zurbau A, Ho HV, Vuksan V. The effects of  
656 gelled konjac glucomannan fibre on appetite and energy intake in healthy individuals: a  
657 randomised cross-over trial. *Br J Nutr*. 2018;119(1):109- 16.
- 658 31. McNeil J, Forest G, Hintze LJ, Brunet J-F, Finlayson G, Blundell JE, et al. The effects of  
659 partial sleep restriction and altered sleep timing on appetite and food reward. *Appetite*. 01  
660 2017;109:48- 56.
- 661 32. Felix AD, Trinidad TP, Tuano APP, Juliano BO. Short-Term Satiety of Cooked Philippine  
662 Rices of Varying Apparent Amylose Content and Glycemic Index. *Philipp Agric Sci*. juin  
663 2013;96(2):179- 86.
- 664 33. Gonzalez JT, Frampton J, Deighton K. Postprandial suppression of appetite is more  
665 reproducible at a group than an individual level: Implications for assessing inter-individual  
666 variability. *Appetite*. 2017;108:375- 82.



- 667 34. Kendall CW, Esfahani A, Sanders LM, Potter SM, Vidgen E. The effect of a pre-load meal  
668 containing resistant starch on spontaneous food intake and glucose and insulin responses.  
669 J Food Technol. 2010;8(2):67- 73.
- 670 35. Finlayson G, Bordes I, Griffioen-Roose S, de Graaf C, Blundell JE. Susceptibility to  
671 Overeating Affects the Impact of Savory or Sweet Drinks on Satiation, Reward, and Food  
672 Intake in Nonobese Women—3. J Nutr. 2011;142(1):125- 30.
- 673 36. Felix AD, Tuano APP, Mallillin AC, Trinidad TP, Juliano BO. Short-term Satiety of  
674 Brown Rice and Milled Rice. Philipp J Crop Sci. avr 2016;41(1):52- 9.
- 675 37. Thivel D, Roche J, Miguet M, Fillon A, Khammassi M, Finlayson G, et al. Post- moderate  
676 intensity exercise energy replacement does not reduce subsequent appetite and energy  
677 intake in adolescents with obesity. Br J Nutr. in press;
- 678 38. Thivel D, Fillon A, Genin PM, Miguet M, Khammassi M, Pereira B, et al. Satiety  
679 Responsiveness but not Food Reward is modified in response to an acute bout of low  
680 versus high intensity exercise in healthy adults. Appetite. févr 2020;145:104500.
- 681 39. Albert M-H, Drapeau V, Mathieu M-E. Timing of moderate-to-vigorous exercise and its  
682 impact on subsequent energy intake in young males. Physiol Behav. 1 nov  
683 2015;151:557- 62.
- 684 40. Fillon A, Mathieu M-E, Masurier J, Roche J, Miguet M, Khammassi M, et al. Effect of  
685 exercise-meal timing on energy intake, appetite and food reward in adolescents with  
686 obesity: the TIMEX study. Appetite. mars 2020;146:104506.
- 687 41. Arguin H, Gagnon-Sweeney M, Pigeon É, Tremblay A. Functional food and satiety.  
688 Impact of a satiating context effect on appetite control of non-obese men. Appetite. févr  
689 2012;58(1):354- 63.
- 690 42. Harrington DM, Martin CK, Ravussin E, Katzmarzyk PT. Activity related energy  
691 expenditure, appetite and energy intake. Potential implications for weight management.  
692 Appetite. août 2013;67:1- 7.

- 693 43. Jönsson T, Granfeldt Y, Erlanson-Albertsson C, Ahrén B, Lindeberg S. A paleolithic diet  
694 is more satiating per calorie than a mediterranean-like diet in individuals with ischemic  
695 heart disease. *Nutr Metab.* 2010;7(1):85.
- 696 44. Rodríguez-Rodríguez E, Aparicio A, Bermejo LM, López-Sobaler AM, Ortega RM.  
697 Changes in the sensation of hunger and well-being before and after meals in  
698 overweight/obese women following two types of hypoenergetic diet. *Public Health Nutr.*  
699 2009;12(1):44- 50.
- 700 45. Goloso-Gubat MJ, Magtibay EVJ, Nacis JS, Udarbe MA, Santos NLC, Timoteo VJA.  
701 Differences in Satiating Effects of White Rice and Brown Rice in Selected Filipino Adults.  
702 *Philipp J Crop Sci.* août 2016;41(2):55- 60.
- 703 46. Chaput JP, Pelletier C, Despres JP, Lemieux S, Tremblay A. Metabolic and behavioral  
704 vulnerability related to weight regain in reduced-obese men might be prevented by an  
705 adequate diet-exercise intervention. *Appetite.* nov 2007;49(3):691- 5.
- 706 47. Gilbert JA, Drapeau V, Astrup A, Tremblay A. Relationship between diet-induced  
707 changes in body fat and appetite sensations in women. *Appetite.* juin 2009;52(3):809- 12.
- 708 48. Bédard A, Hudon A-M, Drapeau V, Corneau L, Dodin S, Lemieux S. Gender differences  
709 in the appetite response to a satiating diet. *J Obes.* 2015;2015.
- 710 49. King NA, Caudwell PP, Hopkins M, Stubbs JR, Naslund E, Blundell JE. Dual-process  
711 action of exercise on appetite control: increase in orexigenic drive but improvement in  
712 meal-induced satiety. *Am J Clin Nutr.* oct 2009;90(4):921- 7.
- 713 50. Sanchez M, Darimont C, Panahi S, Drapeau V, Marette A, Taylor VH, et al. Effects of a  
714 Diet-Based Weight-Reducing Program with Probiotic Supplementation on Satiety  
715 Efficiency, Eating Behaviour Traits, and Psychosocial Behaviours in Obese Individuals.  
716 *Nutrients.* 15 mars 2017;9(3).

- 717 51. Carbonneau E, Perron J, Drapeau V, Lamarche B, Doucet E, Pomerleau S, et al. Impact  
718 of nutritional labelling on 10-d energy intake, appetite perceptions and attitudes towards  
719 food. *Br J Nutr.* déc 2015;114(12):2138- 47.
- 720 52. Drapeau V, Jacob R, Panahi S, Tremblay A. Effect of Energy Restriction on Eating  
721 Behavior Traits and Psychobehavioral Factors in the Low Satiety Phenotype. *Nutrients.*  
722 22 janv 2019;11(2).
- 723 53. Hintze LJ, Goldfield G, Seguin R, Damphousse A, Riopel A, Doucet É. The rate of weight  
724 loss does not affect resting energy expenditure and appetite sensations differently in  
725 women living with overweight and obesity. *Physiol Behav.* 1 févr 2019;199:314- 21.
- 726 54. Jönsson T, Granfeldt Y, Lindeberg S, Hallberg A-C. Subjective satiety and other  
727 experiences of a Paleolithic diet compared to a diabetes diet in patients with type 2  
728 diabetes. *Nutr J.* 2013;12(1):105.
- 729 55. Halford J, Boyland E, Cooper S, Dovey T, Huda M, Dourish C, et al. The effects of  
730 sibutramine on the microstructure of eating behaviour and energy expenditure in obese  
731 women. *J Psychopharmacol (Oxf).* 2010;24(1):99- 109.
- 732 56. Caudwell P, Gibbons C, Hopkins M, King N, Finlayson G, Blundell J. No sex difference  
733 in body fat in response to supervised and measured exercise. *Med Sci Sports Exerc.* févr  
734 2013;45(2):351- 8.
- 735 57. Buckland NJ, Camidge D, Croden F, Myers A, Lavin JH, Stubbs RJ, et al. Women with a  
736 low-satiety phenotype show impaired appetite control and greater resistance to weight  
737 loss. *Br J Nutr.* 28 oct 2019;122(8):951- 9.
- 738 58. Drapeau V, Hetherington M, Tremblay A. Impact of Eating and Lifestyle Behaviors on  
739 Body Weight: Beyond Energy Value. In: Preedy VR, Watson RR, Martin CR, éditeurs.  
740 *Handbook of Behavior, Food and Nutrition* [Internet]. New York, NY: Springer New  
741 York; 2011 [cité 21 mai 2019]. p. 693- 706. Disponible sur: [https://doi.org/10.1007/978-](https://doi.org/10.1007/978-0-387-92271-3_46)  
742 [0-387-92271-3\\_46](https://doi.org/10.1007/978-0-387-92271-3_46)

- 743 59. Beaulieu K, Hopkins M, Blundell J, Finlayson G. Does Habitual Physical Activity  
744 Increase the Sensitivity of the Appetite Control System? A Systematic Review. *Sports*  
745 *Med Auckl NZ.* déc 2016;46(12):1897- 919.
- 746 60. Beaulieu K, Hopkins M, Long C, Blundell J, Finlayson G. High Habitual Physical Activity  
747 Improves Acute Energy Compensation in Nonobese Adults: *Med Sci Sports Exerc.* nov  
748 2017;49(11):2268- 75.
- 749 61. Beaulieu K, Hopkins M, Blundell J, Finlayson G. Homeostatic and non-homeostatic  
750 appetite control along the spectrum of physical activity levels: An updated perspective.  
751 *Physiol Behav.* 01 2018;192:23- 9.
- 752 62. Fillon A, Masurier J, Pereira B, Miguet M, Mathieu M-E, Drapeau V, et al. Usefulness of  
753 Satiety Quotient in a clinical pediatric obesity context. in press;

754

755

756 **Figure Legends**

757 Figure 1 : Flow chart ..... **Erreur ! Signet non défini.**

758

Table 1: Database search strategy details

Data Base	Equation	Filters
Pubmed	((((((((("Satiation"[Majr]) OR "Satiety Response"[Majr]) OR "Appetite"[Majr:NoExp]) OR "Hunger"[Majr:NoExp]) AND Humans[Mesh])) OR (((satiety[Title/Abstract] OR satiation*[Title/Abstract] OR appetite[Title/Abstract] OR fullness[Title/Abstract] OR hunger[Title/Abstract] OR "Prospective food consumption"[Title/Abstract] OR "desire to eat"[Title/Abstract] OR "motivation to eat"[Title/Abstract])) AND Humans[Mesh])) AND Humans[Mesh])) AND quotient[Title/Abstract]	Humans
Embase	(*satiety OR *satiety response OR *appetite OR *hunger OR fullness.mp OR "desire to eat".mp OR "Prospective food consumption".mp OR "motivation to eat".mp OR satiety.mp. OR satiation*.mp. OR hunger.mp. OR appetite.mp. AND (quotient.mp.	Humans
Scopus	( TITLE-ABS-KEY ( satiety OR satiation OR appetite OR fullness OR hunger OR "Prospective food consumption" OR "desire to eat" OR "motivation to eat" ) AND TITLE-ABS-KEY ( quotient ) )	Humans
Web of Science	((Satiety OR satiation OR appetite OR fullness OR hunger OR "Prospective food consumption" OR "desire to eat" OR "motivation to eat") AND (quotient))	Humans
CAB Abstract	((Satiety OR satiation OR appetite OR fullness OR hunger OR "Prospective food consumption" OR "desire to eat" OR "motivation to eat") OR ("hunger" OR "satiety" OR "appetite")) AND (Quotient)	Humans

Core Collection		
Google Scholar	« Satiety Quotient »	

*Mp = title, abstract, heading word, drug trade name, original title, device manufacturer, drug manufacturer, device trade name, keyword, floating subheading word, candidate term word*



Table 2: Risk of bias

<b>Study</b>	<b>Random Sequence Generation (Selection bias)</b>	<b>Allocation concealment (Selection bias)</b>	<b>Blinding participants and personnel (Performance bias)</b>	<b>Blinding of outcome assessment (Detection bias)</b>	<b>Incomplete outcome data (Attrition bias)</b>	<b>Selective reporting (Reporting bias)</b>
Albert et al., 2015 [39]	L	NR	L	M	L	L
Arguin et al., 2012 [41]	H	NR	NR	M	NR	L
Arguin et al., 2017 [12]	L	NR	NR	M	M	L
Au-Yeung et al., 2018 [30]	L	NR	NR	M	NR	L
Beaulieu et al., 2017 [60]	L	NR	NR	M	H	L
Bédard et al., 2015 [48]	H	NR	NR	M	L	L
Blanchet et al., 2011 [28]	L	NR	L	L	NR	L
Bligh et al., 2015 [21]	L	NR	L	M	H	L
Buckland et al., 2019 [57]	L	L	NR	M	L	L
Carbonneau et al., 2015 [51]	L	NR	NR	M	NR	L
Caudwell et al., 2013 [56]	H	NR	NR	M	L	NR
Chapman et al., 2005 [26]	L	L	L	M	L	NR

<b>Chaput et al., 2007 [46]</b>	H	NR	NR	M	L	L
<b>Dalton et al., 2015 [14]</b>	L	NR	NR	M	NR	L
<b>Defries et al., 2017 [22]</b>	L	NR	NR	H	NR	L
<b>Drapeau et al., 2005 [8]</b>	H	NR	L	M	NR	L
<b>Drapeau et al., 2007 [10]</b>	H	NR	M	M	L	L
<b>Drapeau et al., 2013 [13]</b>	H	NR	NR	L	H	NR
<b>Drapeau et al., 2019 [52]</b>	H	NR	NR	M	H	L
<b>Dubé et al., 2013 [7]</b>	L	NR	NR	M	NR	L
<b>Felix et al., 2013 [32]</b>	L	NR	NR	M	NR	NR
<b>Felix et al., 2016 [36]</b>	L	NR	NR	M	NR	NR
<b>Fillon et al., 2019 [40]</b>	L	NR	NR	M	L	L
<b>Finlayson et al., 2011 [35]</b>	L	NR	M	M	M	L
<b>Gilbert et al., 2009 [47]</b>	H	NR	M	M	L	L
<b>Goloso-Gubat et al., 2016 [45]</b>	L	NR	NR	M	L	NR
<b>Gonzalez et al., 2017 [33]</b>	M	NR	NR	M	NR	NR
<b>Green et al., 1997 [6]</b>	H	NR	NR	M	NR	NR
<b>Halford et al., 2010 [55]</b>	M	L	L	M	M	L
<b>Hansen et al., 2018 [18]</b>	L	NR	M	M	NR	L

<b>Harrington et al., 2013 [42]</b>	H	NR	NR	M	L	NR
<b>Hintze et al., 2019 [53]</b>	L	NR	NR	M	H	L
<b>Hollingworth et al., 2018 [15]</b>	L	NR	NR	NR	NR	NR
<b>Hopkins et al., 2016 [19]</b>	L	NR	NR	M	NR	NR
<b>Jönsson et al., 2010 [43]</b>	L	NR	NR	H	H	NR
<b>Jonsson et al., 2013 [54]</b>	L	NR	NR	H	L	L
<b>Kendall et al., 2010 [34]</b>	L	L	L	M	M	NR
<b>King et al., 2009 [49]</b>	H	NR	NR	M	L	NR
<b>Martini et al., 2018 [27]</b>	L	NR	NR	M	H	L
<b>McNeil et al., 2013 [29]</b>	H	NR	NR	M	NR	L
<b>McNeil et al., 2014 [9]</b>	H	NR	NR	H	H	L
<b>McNeil et al., 2017 [31]</b>	L	NR	NR	L	M	L
<b>Polugrudov et al., 2017 [20]</b>	L	NR	NR	M	NR	L
<b>Rodriguez-Rodriguez et al., 2008 [44]</b>	L	NR	H	H	L	NR
<b>Salama et al., 2016 [11]</b>	L	NR	L	M	H	L
<b>Sanchez et al., 2017 [50]</b>	L	L	L	M	H	NR
<b>Schmidt et al., 2014 [24]</b>	L	L	L	M	NR	NR

<b>Thivel et al., 2019 [37]</b>	L	NR	NR	M	NR	L
<b>Thivel et al., 2019 [38]</b>	L	NR	NR	M	L	L
<b>Thomas et al., 2014 [23]</b>	L	NR	L	M	M	L

*L: Low risk, M: Medium risk, H: High risk; NR: Not Reported*

Table 3: Population, design, methods and main results of adult acute studies

Study	Population characteristics	Design	VAS timing	SQ equation	Main results
<b>Green et al., 1997 [6] Study 1</b>	n =18 lean, healthy, dietary unrestrained men Age= NR BMI= NR	Cross-over study <u>Protocol:</u> Standardized lunch, ad libitum snack 4 lunch conditions : - Low energy lunch (2238 kJ)/high CHO snack - Low energy lunch (2238 kJ)/high fat snack - High energy lunch (3962 kJ)/high CHO snack - High energy lunch (3962 kJ)/high fat snack	Pre-lunch, post-lunch, 13:30, 14:00, 14:30, 15:00	SQ <sub>H</sub> (mm/kJ)= (rating pre-eating standardized lunch - rating post-standardized lunch)/energy content of standardized lunch  SQ calculated for each of the 5 post-lunch time points, subtracting the ≠ ratings from pre-meal rating	<b><u>SQ, energy intake and appetite control:</u></b> - No difference between conditions. - Effect of time (p<0.001) indicating that the lunches become less satiating per unit energy as time post-lunch ↑.

<b>Green et al., 1997 [6] Study 2</b>	n=20 (20 lean, healthy women, 10 dietary restrained,10 dietary unrestrained) Age= NR BMI= NR	<u>Cross-over study</u> <u>Protocol:</u> Standardized lunch, ad libitum snack, 4 conditions : - Low energy lunch (2238 kJ men, 1679 kJ women)/high CHO snack - Low energy lunch (2238 kJ men, 1679 kJ women)/high fat snack - High energy lunch (3965 kJ men, 2971 kJ women)/ high CHO snack - High energy lunch (3965 kJ men, 2971 kJ women)/high fat snack	Pre-lunch, post-lunch, 13:30, 14:00, 14:30, 15:00	Same SQ equation as Study 1  SQ calculated for each of the 5 post-meal time points, subtracting the ≠ ratings from pre-meal rating	<b><u>SQ, energy intake and appetite control:</u></b> <u>Unrestrained females:</u> Similar SQ between conditions, a main effect of time only (p<0.001). <u>Restrained females:</u> SQ effect of time (p<0.001) and effect of condition (p<0.05).
---	---	--	--	--	--

<b>Green et al., 1997 [6] Study 3</b>	n =17 lean, healthy men Age= NR BMI= NR	<u>Cross-over study</u> <u>Protocol:</u> Standardized preload, ad libitum meal 3 preload conditions : - High energy high-CHO (3347 kJ) - High energy high fat (3343 kJ) - Low energy high-CHO (1828 kJ)	Pre-preload, post-preload, 15:30, 16:00,16:30, 17:00	Same SQ equation as Study 1 but for standardized preload  SQ calculated for each of the 5 post-meal time points, subtracting the ≠ ratings from pre-meal rating	<b><u>SQ, energy intake and appetite control:</u></b> - Time by condition interaction (p<0.001) (the low-energy/high-CHO SQ was higher when preload immediately following consumption but lower than the two other conditions at 17.00 h.) - Effect of time (p<0.001).
<b>Green et al., 1997 [6] Study 4</b>	n =16 lean, healthy men Age= NR BMI= NR	<u>Cross-over study</u> <u>Protocol:</u> Standardized preload (yoghurt), ad libitum meal 4 preload conditions : - Low energy with aspartame (506 kJ) - Low energy without aspartame (506 kJ) - High energy with sucrose	Pre-preload, 10, 20, 30, 40, 50, 60 min post-preload	Same SQ equation as Study 1 but for standardized preload  SQ calculated for each of the 6 post-meal time points, subtracting the ≠ ratings from pre-meal rating	<b><u>SQ, energy intake and appetite control:</u></b> - SQ was higher with lower energy preloads initially than the higher energy preloads, but this effect was reversed 60 min post preload. - Effect of time (p<0.001)

(1247 kJ)  
 - High energy with maltodextrin  
 (1167 kJ)

<b>Green et al., 1997 [6] Study 5</b>	n =10 men, 9 women Age= NR BMI= NR	<u>Cross-over study</u> <u>Protocol</u> : Standardized BF, ad libitum lunch 4 ad libitum lunch conditions : - Low fat and sweet - Low fat and no sweet - High fat and sweet - High fat and no sweet	Pre-lunch, post-lunch, 30, 45, 60, 120, 180 and 240 min post-lunch	Same SQ equation as Study 1 but for ad libitum lunch SQ calculated for each of the 7 post-meal time points, subtracting the ≠ ratings from pre-meal rating	<u><b>SQ, energy intake and appetite control:</b></u> - Macronutrient by time interaction (p<0.001) (SQ was initially lower for high fat food than high CHO foods but after the first hour there was little difference between macronutrient types in their effects on SQ). - Main effects of condition up to an hour post-lunch (p=0.01).
<b>Chapman et al., 2005 [26]</b>	<u>T2D:</u> n=11 men Age=60.2±8.5 yr BMI=28.9±4.8 kg/m <sup>2</sup>	Randomized, double-blind, placebo-controlled cross-over study <u>Protocol</u> : Drug/placebo injection, standardized preload	1h before, immediately before and after buffet, and 5h after the	1. Prandial SQ <sub>H</sub> = [rating 1h before buffet - rating immediately after] / EI at the buffet meal.	<u><b>Other:</b></u> - <u>Prandial SQ:</u> Pramlintide > placebo (by 26% in the T2D group (p=0.21) and by 58% in the obese without diabetes group (p=0.03))



	<u>Obese without diabetes:</u> n=15 men, Age=41±21yr BMI= 34.4±4.5 kg/m <sup>2</sup>	meal (189kcal), ad libitum buffet lunch 2 conditions per group: - Pramlintide - Placebo	beginning of the ad libitum buffet	2. Postprandial SQ <sub>H</sub> = [rating 5h after buffet – rating immediately after] / EI at the buffet meal.	- <u>Postprandial SQ:</u> Pramlintide < placebo (by 100% in the T2D group (p=0.03) and by 120% in the obese without diabetes group (p=0.07))
<b>Drapeau et al., 2005 [8]</b>	<u>Men:</u> n=28 Age= 37.4±7.4 yr BMI=27.9±5.3 kg/m <sup>2</sup> <u>Women:</u> n=23 Age= 38.2±7.2 yr BMI= 27.4±5.3 kg/m <sup>2</sup>	Observational study <u>Protocol:</u> Standardized BF (733 kcal men, 599 kcal women), ad libitum lunch and dinner, TFEQ, body composition, metabolic rate 2 groups: 1. Men 2. Women	Before and immediately after BF, and every 10 min for a 1-h period after BF	SQ <sub>H</sub> , SQ <sub>F</sub> , SQ <sub>DTE</sub> , SQ <sub>PFC</sub> (mm/kcal)=[fasting rating-60 min post-BF]/energy content of BF *100.	- SQ men = SQ women. <b><u>SQ, energy intake and appetite control:</u></b> - SQ <sub>F</sub> correlated with total EI (strength of the associations decreased if adjustment for BW and BMI) - SQ <sub>F</sub> correlated with fullness 1h AUC (r≥0.40, p<0.0001). - SQ <sub>F</sub> not related with any TFEQ score. - In women, SQ <sub>F</sub> correlated with % fat intake (r= -0.60, p=0.002). <b><u>SQ and anthropometrics variables:</u></b> - No consistent correlation between SQ and

BW, BMI, percentage body fat and metabolic rate (for the whole sample or for each sex separately).

- In women, BW correlated with  $SQ_{DTE}$  ( $r = -0.46$ ,  $p = 0.03$ ) and  $SQ_{PFC}$  ( $r = -0.49$ ,  $p = 0.02$ ).

- In women, BMI correlated with  $SQ_{PFC}$  ( $r = -0.49$ ,  $p = 0.02$ ).

- In men, BMI correlated with  $SQS$  ( $r = 0.44$ ,  $p = 0.02$ ).

**Other:**

- Metabolic rate correlated with  $SQ_{DTE}$  ( $r = -0.64$ ,  $p = 0.002$ ) and  $SQ_{PFC}$  ( $r = -0.69$ ,  $p = 0.0005$ ).

<b>Kendall et al., 2010 [34]</b>	n =22 healthy subjects (13 men, 9 women) Age=26±4 yr BMI=23.7±2.4 kg/m <sup>2</sup>	Randomized cross-over controlled study <u>Protocol</u> : standardized cereal bar and beverage snack varying in dose of resistant starch (RS), ad libitum lunch 5 beverage conditions : - 0g RS (control) - 0g RS (control) - 5g RS - 10g RS - 25g RS	Before and at 15, 30, 45, 60, 90 120 min after consuming snack	SQ <sub>H</sub> , SQ <sub>F</sub> , SQ <sub>DTE</sub> , SQ <sub>PFC</sub> (mm/kcal)= (rating pre-snack - rating post-snack)/energy content of snack	<b><i>Other:</i></b> - SQ <sub>F</sub> 5g RS > SQ <sub>F</sub> control 60-min after the test meal (p<0.04). - For overall appetite score at 15, 30 and 45: SQ 25g RS meal>control (p=0.1, 0.08 and 0.04, respectively). - 25g RS meal : the average appetite SQ over the 2 h post meal time period was greater than control although this only approached significance (p=0.14)
<b>Blanchet et al., 2011 [28]</b>	n = 153 premenopausal women <u>P73T genotype (mutation in neuromedin-β gene)</u> : n=61	Randomized single-blind cross-over design <u>Protocol</u> : standardized dinner (day before), standardized BF, milkshake preloads at 10:00, ad libitum cold buffet 2 milkshake conditions per	Before and immediately, 30 and 60 min after BF, before and immediately, 10, 20, 30, 40,	SQ <sub>H</sub> , SQ <sub>F</sub> , SQ <sub>DTE</sub> , SQ <sub>PFC</sub> (mm/kcal)= [fasting rating -mean post-meal rating]/energy content of meal*100.	<b><i>Other:</i></b> - No effect of genotype, meal (BF or preload) or interaction, for any of SQ.

Age= 33.4±9.9yr	group:	50, 60 min	SQ calculated for
BMI= 23.1±2.5	- Low energy (261 Kcal)	after milkshake	standardized BF and
kg/m <sup>2</sup>	- High energy (625 Kcal)	and after buffet	preloads.
<u>P73P genotype</u>		meal.	
<u>(without</u>			
<u>mutation):</u> n=85			
Age=33.3±10.4			
yr			
BMI= 22.7±2.7			
kg/m <sup>2</sup>			
<u>T73T genotype</u>			
<u>(with mutation):</u>			
n=7			
Age= 30.1±9.5yr			
BMI= 22.5±1.2			
kg/m <sup>2</sup>			

<b>Finlayson et al., 2011 [35]</b>	n = 30 healthy women, Age=21.9±0,5 yr BMI=22.7±0.4 kg/m <sup>2</sup>	Randomized cross-over study <u>Protocol</u> : standardized preload (~710-1050 kJ), ad libitum lunch (30 min after), TFEQ 3 preload conditions: - Sweet taste - Savory taste - Bland taste	Not specified	SQ <sub>H</sub> (mm/kcal) = [rating pre-preload - rating post-preload] energy content of preload	<b><u>SQ, energy intake and appetite control:</u></b> - Preloads on SQ scores: increase in satiation after consumption followed by a partial return to baseline (p<0.01). - No difference in SQ according to preload taste. - Effect of disinhibition on SQ of the preloads (p<0.05) and a disinhibition by time interaction (p<0.05). - Higher disinhibition scores associated with weaker satiation and a more rapid return to baseline SQ levels compared to lower scores.
------------------------------------	--	--	---------------	--	---

<b>Arguin et al., 2012 [41]</b>	n = 18 men, Age= 31.0±10.4 yr BMI= 23.8 ± 2.9 kg/m <sup>2</sup>	Controlled study <u>Protocol</u> : standardized BF (733 Kcal), ad libitum lunch 3 lunch conditions : - Control : Ad libitum control macaroni + chocolate cake - Satiating: Ad libitum macaroni containing more proteins, unsaturated fats, fibers and calcium than the control macaroni despite similar energy density, appearance and palatability + chocolate cake - Context effect: Ad libitum control macaroni but participants believed they were eating “a highly satiating macaroni”+ chocolate cake’	Before and at 0, 10, 20, 30, 40, 50, 60 min after BF, immediately before and after lunch, immediately before and after the dessert and 10, 20, 30, 40, 50, 60, 120, 180 and 240 min later	SQ <sub>H</sub> , SQ <sub>F</sub> , SQ <sub>DTE</sub> , SQ <sub>PFC</sub> (mm/kcal) =(fasting rating - mean of the 60-min post-BF ratings)/ energy content of BF)*100 SQ <sub>-25min</sub> (mm/kcal)=(pre-lunch rating – rating immediately after macaroni)/EI at lunch*100 SQ <sub>0-240min</sub> (mm/kcal)=(pre-lunch rating - rating 0-240 min after lunch)/ EI at the meal (macaroni + dessert)*100	<u><b>SQ, energy intake and appetite control:</b></u> - No condition difference for SQ <sub>-25 min</sub> DTE, H, S and PFC - SQD <sub>0-240</sub> and SQH <sub>0-240</sub> , SQS <sub>120-240</sub> , SQP <sub>20-240</sub> : context effect meal > control and the satiating meals (p<0.05). - At baseline, the SQ of the context effect meal was significantly greater from 120 to 240 min in the low satiety signals group (all ASs), and at 120 and 240 min in the high satiety signals group (hunger only) (all p<0.05). - Dietary restraint subgroups SQ (mean SQ <sub>-25min</sub> ) of the context effect macaroni > SQ of the control macaroni for the high restrained individuals (significant interaction between test meals and level of dietary restraint; p=0.03). - High restrained individuals SQ
---------------------------------	---	---	--	--	---

(SQ<sub>0\_240min</sub>) of the context effect meal > SQ control and the satiating meal (SQD<sub>0-240</sub>, SQH<sub>0-240</sub>, SQP<sub>0-240</sub> and SQS<sub>120-240</sub>) (all p≤0.05).

- Low restrained individuals SQ : context effect meal > SQ satiating meal (SQP<sub>180</sub>, SQH<sub>240</sub>, SQP<sub>240</sub>) (all p<0.05)

<b>Drapeau et al., 2013 [13]</b>	n=69 men Age=41.4±5.7 yr BMI=33.6±3.0 kg/m <sup>2</sup>	Observational study <u>Protocol:</u> standardized BF (733 kcal), TFEQ, body composition 2 experimental visits: - Baseline - 2-4 weeks after	Before, immediately after, and every 10 min for a 1-h period after BF. The two last VAS were performed 90 and 120 min	SQ <sub>H</sub> , SQ <sub>F</sub> , SQ <sub>DTE</sub> , SQ <sub>PFC</sub> and mean SQ (mm/kcal) = (fasting rating - mean of the 60 min post-BF ratings)/energy content of BF*100	- Individual SQ ICC r=0.5-0.6 and mean SQ r=0.7 <b><u>SQ, energy intake and appetite control:</u></b> - Mean SQ tended to be correlated with TFEQ external locus for hunger (p=0.06), anxiety scores (present state p=0.09) and night eating symptoms scores (p=0.07). - All SQ, attention to self-regulation, external locus for hunger and night eating
----------------------------------	---	---	---	--	--

---

after the BF.	<u>Low satiety phenotype</u> (LSP) : mean SQ<8mm/100 kcal  <u>High satiety phenotype :</u> mean SQ≥8mm/100 kcal	symptoms were correlated with the SQ <sub>DTE</sub> (r=0.27, 0.28 and 0.28, respectively, p<0.05).  <b><u>SO and satiety phenotype :</u></b> - Lower individual SQ and mean SQ (p<0.0001) and weaker changes in AS responses to the test-meal (p<0.0001) in LSP.  <b><u>Other:</u></b> - A model including present state anxiety and external hunger was borderline significant (p=0.08) but explained just 28% of the variability in SQ. - Present state anxiety was related to SQ <sub>PFC</sub> (r=0.26, p<0.05). - Overall blunted cortisol response to the test-meal (p<0.05), which persisted after controlling for waist circumference (p=0.04) in LSP.
------------------	---	--

---



<b>Dubé et al., 2013 [7 ]</b>	n=16, <u>With T1D</u> : n=12 (6 men, 6 women) Age= 39.4±6.6 yr BMI=24.0±1.4 kg/m <sup>2</sup> <u>With T2D</u> : n=4 (3 men, 1 women) Age= 53.3±2.8 yr BMI=25.5±1.4 kg/m <sup>2</sup>	Randomized cross-over controlled study <u>Protocol</u> : standardized BF (700 kcal men, 600 kcal women), exercise/rest, ad libitum lunch, self-reported 3-day energy intake (1-2 weeks before exercise) 3 conditions: - Control: rest period 60 min - Exercise free (F): exercise 60 min on cycle ergometer at 50% VO <sub>2peak</sub> with free blood glucose decrease - Exercise maintained (M) : exercise 60 min on cycle ergometer at 50% VO <sub>2peak</sub> with blood glucose maintained above 4 mmol/L	Before, immediately after, and every 10 min for a 1- h period after BF	SQ <sub>H</sub> , SQ <sub>F</sub> , SQ <sub>DTE</sub> , SQ <sub>PFC</sub> (mm/kcal) = (fasting rating -mean 60-min post-BF ratings) / (energy content of BF)*100	- Corrected for body weight, SQ T1D = SQ T2D <u><b>SQ, energy intake and appetite control:</b></u> - Correlation between SQ <sub>H</sub> and ad libitum EI (p≤0.05) in T1D - Correlations between SQ <sub>D</sub> , SQ <sub>H</sub> , SQ <sub>F</sub> and reported EI in T1D (p≤0.01-0.05) <u><b>Other:</b></u> - SQ <sub>D</sub> and SQ <sub>H</sub> in control ≠ to F (p<0.05) - SQ <sub>D</sub> and SQ <sub>PFC</sub> in control ≠ to M (p<0.05)
-----------------------------------	--	--	---	---	--

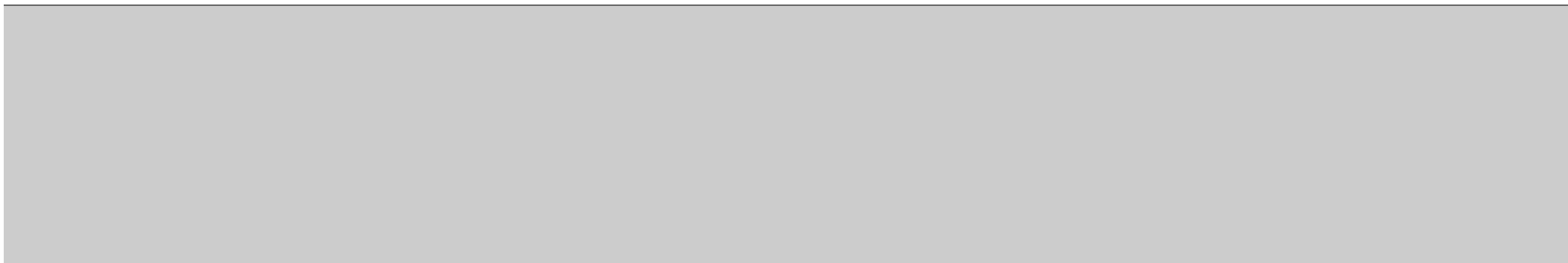

<b>Felix et al., 2013 [32]</b>	n=10 (5 men,5 women) healthy adults Age range=27–55 yr BMI range= 20–25 kg/m <sup>2</sup>	Randomized cross-over study <u>Protocol</u> : Standardized BF, ad libitum lunch 8 BF preload conditions (7 cooked rice varieties with 50 g available carbohydrate): - Improved Malagkit Sungsong 2 - Sinandomeng (low amylose content) - NSIC Rc160 (low amylose content)	Before BF and every 15 min during the 1st hour and every 30 min during the 2nd hour after BF	$SQ_H$ (mm/kJ) = (fasting rating - mean 120 min post-BF rating)/ energy content of BF*100	<b><i>Other:</i></b> - $SQ_H$ was highest for the PSB Rc10 and lowest for the Improved Malagkit Sungsong 2, but the differences across rice types were not significant. - The short-term satiating capacity of rice was independent of its amylose content and glycemic index.
--------------------------------	---	--	--	---	--

- PSB Rc18 (intermediate amylose content), - IR64 (intermediate amylose content) and - - PSB Rc12 (intermediate amylose content)  
 - PSB Rc10 (high amylose content)  
 - 240-mL standard glucose drink (reference food)

<b>Harrington et al., 2013 [42]</b>	n=82, <u>Men</u> : n=40 Age= 26.4±4.0 yr BMI= 23.5±2.5 kg/m <sup>2</sup> <u>Women</u> : n=42	Observational study <u>Protocol</u> :_Ad libitum lunch 3 groups (tertiles of activity-related energy expenditure; AREE): - Low AREE - Middle AREE - High AREE	Before and after ad libitum lunch	SQ <sub>H</sub> , SQ <sub>F</sub> , SQ <sub>DTE</sub> and SQ <sub>PFC</sub> (mm/kcal) = (rating pre-lunch - rating post-lunch)/ EI at lunch	<b><u>SQ, physical activity and energy expenditure:</u></b> Men: - EI middle AREE tertile < high tertile (p=0.001). - SQ <sub>DTE</sub> high AREE < low and middle AREE (p<0.05).
-------------------------------------	--	--	-----------------------------------	---	--

Age= 26.9±4.7  
yr  
BMI= 22.4±2.0  
kg/m<sup>2</sup>

- SQ<sub>H</sub> (p<0.05) and SQ<sub>PFC</sub> (p<0.001) high  
AREE < middle AREE.  
- SQ<sub>F</sub> high AREE > middle AERR  
(p<0.05).

<b>McNeil et al., 2013 [29]</b>	<p>n= 75 overweight/ obese men <i>Group 1 (Sleep duration)</i> <u>&lt;7h/night</u>: n=34 Age= 41.6±6.6 yr BMI= 33.5±2.9 kg/m<sup>2</sup> <u>≥7h/night</u>: n=41</p>	<p>Observational study <u>Protocol</u> : Standardized BF (3066 kJ), ad libitum lunch, 3 groups : - Sleep duration - Sleep quality - Sleep timing</p>	<p>Before, immediately after, and every 10 min for 1h after the standardized BF</p>	<p>SQ<sub>H</sub>, SQ<sub>F</sub>, SQ<sub>DTE</sub>, SQ<sub>PFC</sub> (mm/kcal) = [fasting rating -60 min post-BF] /energy content of BF*100.</p>	<p><b><u>SQ and sleep quality and quantity:</u></b> - No difference in SQ<sub>H</sub>, SQ<sub>F</sub>, SQ<sub>DTE</sub>, SQ<sub>PFC</sub> between groups. - Short-duration sleepers (&lt;7h/night) SQ &lt; sleepers with recommended sleep duration (≥7h/night) - Mean SQ sleep quality = mean SQ sleep timing.</p>
-------------------------------------	---	--	---	---	---

---

Age= 40.4±4.6

yr

BMI= 33.8±3.0

kg/m<sup>2</sup>

*Group 2 (Sleep  
quality)*

PSQI score ≥5:

n=33

Age= 41.0±6.4

yr

BMI= 33.4±2.9

kg/m<sup>2</sup>

PSQI score <5:

n=42

Age= 40.9±5yr

BMI= 33.9±3.1

kg/m<sup>2</sup>

*Group 3 (Sleep  
timing)*

---

Midpoint of

sleep > 02:30:

n=37

Age= 39.3±5.7

yr

BMI= 33.8±2.9

kg/m<sup>2</sup>

Midpoint of

sleep ≤ 02:30:

n=38

Age= 41.8±5.0

yr

BMI= 33.8±3.2

kg/m<sup>2</sup>

<b>Schmidt et al., 2014 [24]</b>	n= 25 healthy males Age= 33±9 yr	Randomized, double-blinded, placebo-controlled, four-arm cross-over study <u>Protocol</u> : standardized dinner day before, no BF, infusion, ad	5 min pre-infusion, and 25, 55, 85, 115 and 145 min after the	SQ <sub>H</sub> , SQ <sub>F</sub> , SQ <sub>S</sub> , SQ <sub>PFC</sub> (mm/mJ) = [rating pre-lunch - rating post-lunch]/EI at lunch	<b><i>Other:</i></b> - SQ <sub>PFC</sub> treatments < placebo (p<0.05) (↓ PFC) - SQ <sub>S</sub> treatments < placebo (p<0.01) (↑Satiety)
----------------------------------	-------------------------------------	--	---	--	---

	BMI= 29±3 kg/m <sup>2</sup>	libitum lunch 4 infusions : - GLP-1 - PYY <sub>3-36</sub> - GLP-1 + PYY <sub>3-36</sub> - Placebo  lunch ad lib (standardized dinner the day before and no BF)	beginning of the infusion) Ad libitum meal : 120 min after the beginning of the infusion	Note: The authors define SQ as “Appetite Quotient”	
<b>Thomas et al., 2014 [23]</b>	<u>Men</u> : n=24 <u>Placebo</u> : n=8 Age=20.8 ±0.4 yr BMI=23.8±0.7 <u>15 mg</u> : n=8 Age=21.9±0.8 yr BMI=22.1±0.7 <u>30 mg</u> : n=8 Age=20.4±0.5 yr	Randomized, double-blind, placebo controlled study <u>Protocol</u> : Typical BF, test dose (2h before lunch), ad libitum lunch 3 test doses: - Placebo - 5-HT <sub>2C</sub> receptor agonist meta- chlorophenylpiperazine (mCPP)	4h pre-lunch, 2h pre-lunch and every 30 minutes, during lunch, post- lunch, 1h post lunch.	SQ <sub>H</sub> = ((quartile initial rating –quartile ending rating)/calories consumed at ad libitum lunch during quartile)  Note: The authors define SQ as “Satiation Quotient”	<u>Other</u> : - Effect of quartile (p<0.001) and gender (p<0.05), a two-way interaction between gender and condition (p<0.01), and a three- way interaction between quartile, gender and condition (p<0.05).  <u>Men</u> : - Effect of quartile (p<0.01) and condition (p<0.05). - SQ 30-mg mCPP < placebo (p<0.05)

BMI=22.8±0.8 15 mg  
Women: n=23 - mCPP 30 mg  
Placebo: n=8  
 Age=22.4 ±1.0 yr  
 BMI=21.5±0.7  
15 mg: n=8  
 Age=20.4±0.5 yr  
 BMI=22.0±0.8  
30 mg: n=8  
 Age=19.9±0.7 yr  
 BMI=22.4±0.9

- ↑ SQ from quartile 2 to 3 (p<0.05).

Women:

- Effect of quartile (p<0.01), condition (p<0.05) and interaction between quartile and condition (p<0.05).

Quartile 1: SQ 30-mg mCPP > placebo (p<0.05)

Quartile 2: SQ 15-mg and 30-mg mCPP > placebo (p<0.01; p<0.05 respectively)

<b>Bligh et al., 2015 [21]</b>	n= 21 healthy males <u>Paleolithic-type meal 1</u> : n=17 Age= 27.9±13.2 yr	Randomized cross-over study 3 standardized lunch conditions: - Paleolithic-type meal 1 (2326 kJ) (range ratios for protein; no cereals or dairy products) - Paleolithic-type meal 2 (1606 kJ) identical plant-based	20 min before lunch, and 10, 25, 40, 55, 85, 115, 175 after the start of meal	SQ <sub>H</sub> , SQ <sub>F</sub> , SQ <sub>DTE</sub> = NR	<b><u>SQ, energy intake and appetite control:</u></b> - SQ <sub>H</sub> , SQ <sub>F</sub> , SQ <sub>DTE</sub> similarly increased in response to both Paleolithic meals.
--------------------------------	---	--	---	--	---



BMI= 23.4±2.7 kg/m<sup>2</sup>  
Paleolithic-type meal 2: n=19  
 Age= 27.5±12.7 yr  
 BMI= 23.4±2.6 kg/m<sup>2</sup>  
Reference meal: n=19  
 Age= 27.5±12.7 yr  
 BMI= 23.4±2.6 kg/m<sup>2</sup>

ingredients to PAL1, but normalised to the REF for fat, protein and energy in addition to available carbohydrates, by changing the fish, nut and strawberry content.  
 - Reference meal (1602 kJ) macronutrient proportions, and contained protein, fruit and vegetables as well as cereals.

<b>Dalton et al., 2015 [14]</b>	n = 30 women Age= 28.0±10.6 yr	Randomized cross-over study <u>Protocol</u> : Calibrated BF, ad libitum lunch, 4 BF conditions : - Calibrated to 20% resting	Before BF and 15,45,75 min post-BF	SQ <sub>H</sub> (mm/kcal) = (rating before BF - mean of the 75 min post-BF ratings)/energy content of BF*100	<b><u>SQ, energy intake and appetite control:</u></b> - Average SQ across all RMR conditions was associated with RMR (r=0.38, p<0.05), a greater implicit wanting fat bias (r=0.49,
---------------------------------	-----------------------------------	---	------------------------------------	--	--

<p>BMI= 23.1±2.9 kg/m<sup>2</sup></p>	<p>metabolic rate (RMR)</p> <ul style="list-style-type: none"> <li>- Calibrated to 25% RMR</li> <li>- Calibrated to 30% RMR</li> <li>- Calibrated to 35% RMR</li> </ul>	<p>p&lt;0.01) and TFEQ disinhibition (r= 0.42, p&lt;0.05).</p> <p>The low satiety phenotypes were identified as those who had a low SQ at least 3 out of 4 conditions (n = 9) whereas the high satiety phenotypes were identified as those who had a high SQ at least 3 out of 4 conditions (n = 9).</p>
---------------------------------------	---	--

**SQ and satiety phenotype:**

- Low satiety phenotype had a lower average SQ across conditions compared to the high satiety phenotype (p<0.001).

<p><b>Felix et al., 2016 [36]</b></p>	<p>n=12 healthy subjects (7 men, 5 women) Age range= 20-50 yr BMI range= 20-25 kg/m<sup>2</sup></p>	<p>Randomized, cross-over study <u>Protocol</u> : Preload, ad libitum lunch 9 preload conditions : - Milled rice : IMS2 - Milled rice : NSIC Rc160 - Milled rice : IR64</p>	<p>Before preload and every 15 min during the 1st hour and every 30 min during the 2nd</p>	<p>SQ<sub>H</sub>, SQ<sub>F</sub>, SQ<sub>DTE</sub>, SQ<sub>PFC</sub> (mm/kJ)= (fasting rating - mean 120 min post-preload rating)/ energy content of preload * 100</p>	<p><b><u>Other:</u></b> <b><u>Short term:</u></b> - SQ glucose beverage &lt; milled and brown rice (liquid foods elicit weaker satiety signals than solid foods). - Among milled samples, SQ<sub>H</sub> was similar across rice varieties, confirming earlier</p>
---------------------------------------	---	---	--	---	--

<ul style="list-style-type: none"> <li>- Milled rice : PSB Rc10</li> <li>- Brown rice : IMS2</li> <li>- Brown rice : NSIC Rc160</li> <li>- Brown rice : IR64</li> <li>- Brown rice : PSB Rc10</li> <li>- Reference food: 240mL standard glucose drink</li> </ul>	<p>hour after preload</p>	<p>results.</p> <ul style="list-style-type: none"> <li>- SQ<sub>F</sub>, SQ<sub>DTE</sub> and SQ<sub>PFC</sub> comparable across rice types. The same trend was noted for brown rice.</li> <li>-SQ<sub>H</sub> and post-meal cooked rice intake were independent of milled rice amylose content and glycemic index.</li> </ul> <p><u>2h post-meal:</u></p> <ul style="list-style-type: none"> <li>- The higher SQ for brown rice than milled rice was not translated into lower common cooked rice intake.</li> </ul>
--	-------------------------------	---

<p><b>Hopkins et al., 2016 [19]</b></p>	<p>n=65 (26 men, 39 women) Age= 41.3±8.7 yr BMI= 30.90±3.8 kg/m<sup>2</sup></p>	<p>Randomized cross-over study <u>Protocol</u> : Ad libitum BF, standardized lunch (800kcal), ad libitum dinner, ad libitum snack box 2 meal conditions : - HFLC day: high-fat/low-carbohydrate for all meals</p>	<p>Immediately before and after a meal, and at hourly intervals throughout the day (from 08:00 to 18:00).</p>	<p>SQ<sub>H</sub> (mm/Kcal) = (rating pre-eating episode - rating post-eating episode)/intake of eating episode*100  SQ calculated for BF and lunch.</p>	<p><b><u>SQ, energy intake and appetite control:</u></b> SQ LFHC &gt; SQ HFLC after BF and lunch (P =0.006 and P=0.001, respectively).</p>
---	---	---	---	--	--

- LFHC day : low-fat/high-carbohydrate for all meals

<b>Salama et al., 2016 [11]</b>	<p>n=35 healthy adults</p> <p><u>Men</u>: n=18</p> <p>Age= 25.4±3.6yr</p> <p>BMI=23.6±2.1 kg/m<sup>2</sup></p> <p><u>Women</u> : n=13</p> <p>Age= 22.6±3.3yr</p> <p>BMI=22.5±2.1 kg/m<sup>2</sup></p>	<p>Randomized cross-over study</p> <p><u>Protocol</u> : Standardized BF (men: 715 Kcal, women: 599Kcal) mental work/control, ad libitum buffet lunch, waist circumference, body composition</p> <p>2 conditions (during 45 minutes):</p> <ul style="list-style-type: none"> <li>- Mental work (reading a text and writing a summary of 350 words)</li> <li>- Control (relaxed in a seated position)</li> </ul>	<p>Before BF, at the end of the two conditions, before and after the buffet, and every hour during the following 4 hours</p>	<p>SQ<sub>H</sub>, SQ<sub>F</sub>, SQ<sub>DTE</sub>, SQ<sub>PFC</sub> (mm/kcal) = (Post-meal rating (T<sub>0</sub>)-Pre-meal rating (T-15)) / energy content of the meal *100.</p> <p>SQ calculated at BF and lunch</p>	<p><b><u>SQ and anthropometrics variables:</u></b></p> <ul style="list-style-type: none"> <li>- A high waist circumference was correlated with lower SQ<sub>F</sub> after mental work.</li> <li>- Positive relationship between % fat mass and SQ<sub>F</sub> (r=0.44, p&lt;0.05).</li> </ul>
---------------------------------	---	--	--	---	---

<b>Beaulieu et al., 2017 [60]</b>	<p>n=39 non-obese adults</p> <p><u>High levels of physical activity:</u></p> <p>n=20 (10 men, 10 women), Age= 29.9±9.6 yr BMI= 22.6±1.9 kg/m<sup>2</sup></p> <p><u>Low levels of physical activity:</u></p> <p>n=19 (8 men, 11 women), Age= 30.4±9.3 yr BMI=23.1±2.7 kg/m<sup>2</sup></p>	<p>Randomized cross-over study</p> <p><u>Protocol</u> : Individualized BF (ad libitum on first test day standardized to quantities consumed on second test day), ad libitum lunch</p> <p>2 lunch conditions</p> <p>- HFAT : high-fat ad libitum lunch</p> <p>- HCHO : high-carbohydrate ad libitum lunch</p>	<p>Pre and post-BF, 60, 120, 180 min post-BF, pre and post-lunch</p>	<p>SQ<sub>H</sub> (mm/kcal) = (rating before lunch - rating after lunch)/EI at lunch*100</p>	<p><b><u>SQ, energy intake and appetite control:</u></b></p> <p>- SQ at lunch: effect of condition (p&lt;0.001), SQ HCHO &gt; SQ HFAT.</p>
-----------------------------------	---	--	--	--	--

<b>Defries et al., 2017</b>	n=38 (10 men, 28 women)	Single-site, randomized, controlled, cross-over study	At 30-min intervals up to 180 min after the first bite of the snack.	SQ <sub>H</sub> (mm/kcal)= (rating before snack – rating after snack)/ energy content of the snack	<b><u>SQ, energy intake and appetite control:</u></b> - Effect of time for SQ buckwheat groats (p < 0.0001).
<b>Seed study [22]</b>	Age = 37.7 yr (range 20-67) BMI= 24.8 kg/m <sup>2</sup> (range 18.7-30.4)	<u>Protocol:</u> Typical BF (replicated on subsequent test days), snack food, ad libitum lunch, food diary remainder of day 2 snack conditions (140 kcal): - Roasted buckwheat groats - Corn nuts (reference food)			
<b>Defries et al., 2017</b>	n=38 (11 men, 27 women)	Single-site, randomized, controlled, cross-over study	At 30-min intervals up to 180 min after the first bite of the snack.	SQ <sub>H</sub> (mm/kcal)= (rating before snack – rating after snack)/ energy content of the snack	<b><u>SQ, energy intake and appetite control:</u></b> - Effect of time (p<0.0001) and snack (p=0.0002) for the SQ buckwheat pita (SQ buckwheat pita > SQ rice bread).
<b>Pita study [22]</b>	Age= 33.5 yr (range 20-67) BMI= 24.4 kg/m <sup>2</sup> (range 18.7-30.4)	<u>Protocol:</u> individualized BF, snack food, ad libitum lunch, food diary remainder of day 2 snack conditions (~135 kcal): - Gluten-free pita bread made from buckwheat and pinto bean flour			

- Gluten-free rice bread  
(reference food)

<b>Gonzalez et al., 2017 [33]</b>	<u>Experiment 1:</u> n=10 non-obese men, Age= 22±1 yr BMI= 24.8±1.6 kg/m <sup>2</sup>	Randomized, double blind, cross-over study (data from 2 experiments pooled for analyses) <u>Protocol</u> : Liquid meal Experiment 1: 2 liquid meal conditions (repeated twice)	Within 5 min before liquid meal, and every 15 min over 60 min post-meal	Composite SQ (μm/kJ)= (baseline appetite - postprandial appetite AUC)/energy content of meal	<b><u>SQ, energy intake and appetite control:</u></b> The reproducibility of the SQ is better in response to the ingestion of meals of higher energy content compared to lower energy meals.
	<u>Experiment 2:</u> n=10 non-obese men, Age=21±4 yr BMI=24.2±2.3 kg/m <sup>2</sup>	- Low energy: 579 kJ - Moderate energy: 1776 kJ Experiment 2 : 2 liquid meal conditions (repeated twice) - Low energy: 828 kJ - High energy: 4188 kJ		Composite SQ calculated with (hunger, (100-fullness), satisfaction and PFC)/4.	

<b>McNeil et al., 2017 [31]</b>	n = 18 (12 men, 6 women) Age=23±4 yr BMI=22.7±2.7 kg/m <sup>2</sup>	Randomized cross-over study <u>Protocol</u> : Individualized BF (ad libitum on preliminary session and standardized to quantities consumed on subsequent sessions), ad libitum lunch 3 conditions: - Control (habitual bed- and wake-time) - 50% sleep restriction with an usual bedtime and advanced wake-time - 50% sleep restriction with a delayed bedtime and habitual wake-time	Before BF and 0, 30, 60, 90, 120, 150, 180 min post-BF.	SQ <sub>H</sub> , SQ <sub>F</sub> , SQ <sub>DTE</sub> , SQ <sub>PFC</sub> (mm/kcal) = [fasting rating - mean post-meal rating] /energy content of BF *100.	<b><u>SQ and sleep quality and quantity:</u></b> - No difference in SQ between sessions. - No correlations between changes in sleep stage durations with mean SQ between sessions.
---------------------------------	---	--	---	--	--



<b>Polugrudov et al., 2017 [20]</b>	n=66 <u>Social JetLag (SJL) ≤1h</u> : n=17 (3 men, 14 women), Age=23.7±2.9 yr BMI=21.2±2.5 kg/m <sup>2</sup> <u>SJL 1h to ≤2h</u> : n=28 (10 men, 18 women) Age=22.8±3.2 yrs BMI= 22.2±3.2 kg/m <sup>2</sup> <u>SJL&gt;2h</u> : n=21 (6 men, 15 women)	Randomized Trial <u>Protocol</u> : Ad libitum BF 3 groups : - SJL ≤1 h - SJL 1h to ≤ 2 h - SJL> 2 h	Before BF and at 30, 60, 90, and 120 min after	SQ <sub>H</sub> , SQ <sub>F</sub> , SQ <sub>S</sub> , SQ <sub>PFC</sub> (mm/kcal)= [fasting rating - mean post-meal rating]/EI at BF*100.	<b><u>Other:</u></b> - Mean SQ (mean value of SQ <sub>H</sub> , SQ <sub>F</sub> , SQ <sub>S</sub> , SQ <sub>PFC</sub> ) in SJL 1-2h and SJL >2h groups lower than SJL ≤ 1h group (p<0.01).
-------------------------------------	---	--	---	--	---

Age= 23.2±4.1  
 yr  
 BMI= 23.4±4.6  
 kg/m<sup>2</sup>

<b>Au-Yeung et al., 2018 [30]</b>	n= 16 (4 men, 12 women) Age=26±19 yr (range 18–62), BMI=23.1 ±3.2 kg/m <sup>2</sup>	Randomized, single-blind, controlled, dose-response cross-over study <u>Protocol:</u> preload, ad libitum dessert 3 preload conditions : - Control: all pasta with no Konjac Glucomannan (KGM)-gel (1849 kJ) - 50-KGM: half pasta and half KGM-gel (1084 kJ) - 100-KGM: no pasta and all KGM-gel (322 kJ)	Baseline (before preload), 15, 30, 45, 60, 75 and 90 min after the first bite of the preload.	SQ <sub>H</sub> , SQ <sub>DTE</sub> , SQ <sub>PFC</sub> (mm/kJ)= (baseline rating - postprandial rating)/ energy content of preload  SQ <sub>F</sub> (mm/kJ)= (postprandial rating – baseline rating)/ energy content of preload  Composite SQ calculated with (hunger,	<u><b>SQ, energy intake and appetite control:</b></u> SQ <sub>H</sub> , SQ <sub>F</sub> , SQ <sub>DTE</sub> , SQ <sub>PFC</sub> and composite SQ were significantly increased in response to 100-KGM ingestion compared with 50-KGM and control with no difference between 50-KGM and control.
-----------------------------------	---	--	---	---	---

(100-fullness), DTE and PFC)/4.

<p><b>Hansen et al., 2018 [18]</b></p>	<p>n=39 (11 men, 28 women) Age=26.3 ± 10.9 yr BMI= 24.4 ± 3.1 kg/m<sup>2</sup></p>	<p>Double-blind randomized cross-over study <u>Protocol</u> : BF, ad libitum meal 3 BF conditions (including 80 g cheese) : - HP/LF: high-protein/low-fat hard cheese (1721 kJ) - HP/HF: high-protein/high-fat hard cheese (2000 kJ) - LP/HF : low-protein/high-fat cream cheese (1796 kJ)</p>	<p>Before and 15 min after the BF and at 30-min intervals after BF during 180 min and before and after ad libitum test meal</p>	<p>Composite SQ (mm/kJ) = (pre-meal rating–post-meal rating)×100/ EI of the food consumed  Composite SQ calculated with (satiety + fullness + (100-hunger) + (100-DTE) + (100-PFC)/5</p>	<p><b><u>SQ, energy intake and appetite control:</u></b> - ↑ feeling of satiety from the HP/LF cheese tended to lower EI compared with the LP/HF cheese - HP cheese content ↑ satiety and ↓ EI when included as part of a diet.</p>
--	--	--	---	--	---

Note: The authors  
define SQ as “Appetite  
Quotient”

<b>Hollingworth et al., 2018 [15]</b>	n= 42 females Age=26.0 ±7.9 yr BMI=22.0 ±2.0 kg/m <sup>2</sup>	Randomized cross-over study Protocol : mid-morning snack, ad libitum EI 3 snack conditions: - Raw almonds - Savory crackers - Water	NR	SQ = NR	<p><b><u>SQ, energy intake and appetite control:</u></b></p> <ul style="list-style-type: none"> <li>- Consumed energy, reported craving for sweet foods : low SQ &gt; high SQ</li> <li>- Levels of hunger, desire to eat and prospective consumption : low SQ &gt; high SQ</li> <li>- Satiating efficiency in low SQ : almonds &gt; snack (crackers)</li> <li>- Low SQ = behavioral and psychological characteristics associated with risk for overconsumption (but substitution of certain snack foods may improve the satiety responsiveness of these individuals)</li> </ul>
---------------------------------------	--	---	----	---------	---

<b>Martini et al., 2018 [27]</b>	n= 20 females Age= NR BMI= <25 kg/m <sup>2</sup>	Randomized cross-over study <u>Protocol</u> : Own low-fiber BF, standardized lunch, ad libitum snack 5 pasta lunch conditions: - High fiber - High fiber + high protein - High protein (soy protein) - High protein (egg white) - Control (standard commercial pasta)	Before and after lunch, every 30 min for 2 h until snack, before and after snack	SQ <sub>F</sub> , SQ <sub>DTE</sub> , SQ <sub>S</sub> SQ 1 (cm/kcal)=(rating before lunch-rating after lunch)/ Energy content of lunch*100 SQ 2 (cm/kcal)=(rating before lunch-rating before snack)/ Energy content of lunch*100 SQ 3 (cm/kcal)=(rating before lunch-rating after snack)/ (Energy content of lunch + snack)*100	<b><u>SQ, energy intake and appetite control:</u></b> - SQ <sub>F</sub> for all formulations > SQ <sub>F</sub> control pasta immediately after lunch and over the subsequent 2 h. - SQ <sub>DTE</sub> for High fiber + high protein pasta < SQ <sub>DTE</sub> for control pasta after lunch and after snack consumption - Only high fiber pasta showed a higher SQ <sub>S</sub> compared to control.
----------------------------------	--	--	--	---	---

<b>Thivel et al., 2019 [37]</b>	n=19 normal weight (10 men, 9 women) Age= 21 ± 1 yr BMI= 22.3±2.9 kg/m <sup>2</sup>	Randomized controlled cross-over study <u>Protocol</u> : Standardized BF (500 kcal), exercise/control, standardized lunch (women: 750 kcal, men: 900 kcal) 3 conditions: - CON: rest during 45 min - Low intensity exercise (LIE): 45 min cycling at 50% VO <sub>2max</sub> - High intensity exercise (HIE): 30 min cycling at 75% VO <sub>2max</sub>	Before and after BF, before and after exercise/rest, before and after lunch, and 30 min and 60 min after the test meal	SQ <sub>H</sub> , SQ <sub>F</sub> , SQ <sub>DTE</sub> , SQ <sub>PFC</sub> (mm/kcal) = (pre meal rating – mean 60 min post-meal rating) / energy content of lunch*100.	<b><u>SQ, physical activity and energy expenditure:</u></b> - No difference in SQ <sub>F</sub> across conditions. - SQ <sub>H</sub> CON > LIE and HIE (p≤0.05) (no difference between LIE and HIE) - SQ <sub>DTE</sub> CON > HIE (p≤0.01) (no difference between CON and LIE, and between LIE and HIE) - SQ <sub>PFC</sub> HIE < CON (p=0.02) (no difference between CON and LIE, and LIE and HIE)
---------------------------------	---	--	--	---	--

Protocol are detailed only the relevant of SQ; values are presented as means ± SD (standard deviation); AS: appetite sensation; EI: energy intake; BF: Breakfast; BW: Body Weight, NR: Not Reported. DTE: Desire To Eat; F: Fullness; H: Hunger, PFC: Prospective Food Consumption; S: Satiety; SQ: Satiety Quotient.

Table 4: Data detailed for adolescents acute studies

Study	Population characteristics	Design	VAS timing	SQ equation	Main results
Albert et al., 2015 [39]	n = 12 boys Age= 17±1,6 yr BMI= 23.1±3.1 kg/m <sup>2</sup>	Randomized cross-over study <u>Protocol</u> : Standardized BF, exercise (70% VO <sub>2max</sub> ), ad libitum lunch (12:00 pm), ad libitum dinner (17:00) 2 conditions : -ExMeal: Exercise at 11:15 meal 12:00 -Ex <sub>delay</sub> Meal: Exercise 09:00 meal 12:00	Before and after lunch and dinner	SQ <sub>H</sub> (mm/kJ) = (pre-lunch rating–post-lunch rating) /EI at lunch*100	<b><u>SQ, physical activity and energy expenditure:</u></b> - No difference SQ between conditions at lunch and dinner.

<b>Fillon et al., 2019 [40]</b>	n=15 (6 boys and 9 girls) Age=13.1±1.4 yr BMI=34.7±6.0 kg/m <sup>2</sup> (z-BMI 2.3±0.3)	Randomized controlled study <u>Protocol</u> : Standardized BF, exercise/rest condition, ad libitum lunch (12:00), ad libitum dinner (18:00) 3 conditions: - rest condition (CON) - 30-min exercise (65% VO <sub>2max</sub> ) 180 min before lunch (EX-180) - 30-min exercise (65% VO <sub>2max</sub> ) 30 min before lunch (EX-30)	Before meal, post-meal, 30 and 60 min after meal for ad libitum lunch and dinner	SQ <sub>H</sub> , SQ <sub>S</sub> , SQ <sub>DTE</sub> and SQ <sub>PFC</sub> (mm/kcal) = (pre-lunch rating – mean post-lunch and 60 min post-lunch rating) / EI at lunch*100	<b><u>SQ, physical activity and energy expenditure:</u></b> - SQ <sub>H</sub> CON < SQ <sub>H</sub> EX180 and EX30 - SQ <sub>PFC</sub> CON < SQ <sub>PFC</sub> EX180 and EX30 - SQ <sub>DTE</sub> CON < SQ <sub>DTE</sub> EX180 and EX30
<b>Thivel et al., 2019 [38]</b>	n= 14 (6 boys, 8 girls) Age= 12.8±0.9 yr BMI=34.8±5.7 kg/m <sup>2</sup> (z-BMI 2.3±0.4)	Randomized controlled study <u>Protocol</u> : Standardized BF, exercise/rest condition, ad libitum lunch (12:00), ad libitum dinner (18:00) 3 conditions: - rest condition (CON) - 30-min exercise (65% VO <sub>2max</sub> ;	Before meal, post-meal, 30 and 60 min after meal for ad libitum lunch and dinner	SQ <sub>H</sub> , SQ <sub>S</sub> , SQ <sub>DTE</sub> and SQ <sub>PFC</sub> (mm/kcal) = (pre-lunch rating – mean post-lunch and 60 min post-lunch rating) / EI at lunch*100	<b><u>SQ, physical activity and energy expenditure:</u></b> - No difference between conditions for SQ <sub>H</sub> , SQ <sub>S</sub> , SQ <sub>DTE</sub> and SQ <sub>PFC</sub>



EX)

- 30-min exercise (65%  $VO_{2max}$ )

+ energy replacement (ER+R).

**Values are means  $\pm$  SD; EI : energy intake; VAS : Visual Analogue Scale; DTE : Desire To Eat; F : Fullness; H : Hunger, PFC : Prospective Food Consumption; S : Satiety ; BF: Breakfast. SQ: Satiety Quotient.**

Table 5: Population, design, methods and main results of adult chronic studies

Study	Population characteristics at baseline	Design	VAS Timing	SQ Equation	Main Results
Chaput et al., 2007 [46]	n= 11 men, Age= 38±16.6 yr BMI= 33.4±3 kg/m <sup>2</sup>	Interventional study <u>Duration:</u> after a 10±1 kg BW loss was achieved <u>Intervention:</u> Diet and exercise <u>Assessment frequency:</u> baseline, after 5±1 kg BW loss (Phase 1) and after 10±1 kg BW loss (Phase 2). <u>Assessments protocol:</u> Anthropometric measurements, standardized BF (kcal), ad libitum lunch	Before and after lunch	SQ <sub>H</sub> , SQ <sub>F</sub> , SQ <sub>DTE</sub> and SQ <sub>PFC</sub> = (rating pre-lunch - rating post-lunch)/EI at lunch	<u>SQ and anthropometrics variables:</u> - No difference in SQ between phases

<b>Drapeau et al., 2007</b> [10]	n=253 <u>Men</u> : n= 142 Age= 42.7±7.15 yr BMI= 32.5±3.6 kg/m <sup>2</sup> <u>Women</u> : n = 111 Age= 41.3±7.4 yr BMI= 33.7±3.2 kg/m <sup>2</sup>	Observational study Subjects were selected from different weight loss studies (data pooled for analyses) <b>Study 1</b> : <u>Duration</u> : 1 year, <u>Intervention</u> : Topiramate <b>Study 2</b> : <u>Duration</u> : 4 weeks, <u>Intervention</u> : Rimonabant <b>Study 3</b> : <u>Duration</u> : 15 weeks, <u>Intervention</u> : Diet + Fenfluramine/placebo <b>Study 4</b> : <u>Duration</u> : 30 weeks, <u>Intervention</u> : Diet + Physical activity <b>Study 5</b> : <u>Duration</u> : 15 weeks, <u>Intervention</u> : Diet + calcium and vit. D/placebo <b>Study 6</b> : <u>Duration</u> : 15 weeks, <u>Intervention</u> : Diet +	Before, immediately after, and every 10 min for 1-h after BF	SQ <sub>H</sub> , SQ <sub>F</sub> , SQ <sub>DTE</sub> and SQ <sub>PFC</sub> (mm/kcal)= (fasting rating - mean 60 min post-meal rating)/energy content of BF*100	<u>Baseline data</u> : <b><u>SQ, energy intake and appetite</u></b> <b><u>control</u></b> : - SQ <sub>F</sub> was correlated with ad libitum EI (p<0.05) (just in women (p<0.01)). <b><u>Other</u></b> : - Men SQ was lower compared with women (p<0.0001). <u>Longitudinal data</u> : <b><u>SQ and anthropometrics variables</u></b> : - ↑ SQ <sub>DTE</sub> (p<0.0001), SQ <sub>H</sub> (p<0.001), SQ <sub>PFC</sub> (p<0.0001) in men after weight loss, but not in women. - Changes in SQ <sub>DTE</sub> were related with changes in BW (r= -0.14, p<0.01).
-------------------------------------	---	--	--	---	---

micronutrient  
supplementation/placebo  
Assessment frequency :  
Baseline and post-  
intervention  
Assessment protocol :  
Anthropometrics,  
standardized BF (men 733  
kcal, women 599 kcal), ad  
libitum lunch, self-reported  
energy intake

<b>Rodriguez- Rodriguez et al., 2008 [44]</b>	n=57 women, Age=27.8±4.7 yr  Diet V: n=28 BMI=27.6±2.5 kg/m <sup>2</sup>  Diet C: n=29	Randomized study  <u>Duration</u> : 6 weeks <u>Intervention</u> : 2 hypoenergetic diet groups - Diet V: Consumption of vegetables increased - Diet C: Consumption of cereals (especially BF	Before and after meals	SQ <sub>H</sub> (cm/kcal) =(fasting rating post-meal rating)/energy consumed at a meal*100	<b><u>SQ, energy intake and appetite</u></b>  <b><u>control:</u></b> - At baseline, lunch SQ diet C < diet V, but not post-intervention because SQ diet C ↑. Post-intervention, SQ ↑ with lunch and dinner, as did the mean SQ (for all meals taken as a whole).
---	---	---	---------------------------	---	---

	BMI=28.3±3.4 kg/m <sup>2</sup>	cereals) increased <u>Assessment frequency:</u> Baseline and post- intervention <u>Assessment protocol:</u> Anthropometrics, standardized BF, lunch, dinner, snack, self-reported of food intake			- Post-intervention : mean SQ diet C > diet V
<b>Gilbert et al., 2009 [47]</b>	n=54 women Age= 39.9±7.5 yr BMI= 32.9±3.5 kg/m <sup>2</sup>	Interventional study <u>Duration</u> : 4 or 6 months <u>Intervention</u> : energy restriction program (2900 kJ/day) <u>Assessment frequency</u> : baseline and post-intervention <u>Assessments protocol</u> : Anthropometrics, standardized BF (2504 kJ)	Before and after BF, 1h after BF	SQ <sub>H</sub> , SQ <sub>F</sub> , SQ <sub>DTE</sub> and SQ <sub>PFC</sub> (mm/kJ)=(fasting rating -60 min post- meal rating)/energy content of BF*100	<b><u>Other:</u></b> - SQD (p=0,03) was the only significant change among the SQ and AUC values.

<b>King et al., 2009 [49]</b>	n= 58 (19 men, 39 women) Age=39.6±9.8 yr BMI= 31.8±4.5 kg/m <sup>2</sup>	Interventional Study <u>Duration:</u> 12 weeks <u>Intervention:</u> Exercise program (500 kcal per session, 70% of individual's maximum heart rate 5 days/week) <u>Assessment frequency:</u> baseline and post-intervention <u>Assessments protocol:</u> Anthropometrics, standardized BF (ad libitum at baseline and quantities replicated post-intervention; 406±5 kcal), ad libitum lunch and dinner, evening snack box	Immediately before, after, and periodically in between meals	SQ <sub>H</sub> (mm/kcal)= (rating before the eating episode -rating after the eating episode)/energy content of BF *100	<u><i>SQ, physical activity and energy expenditure:</i></u> SQ of the standardized BF ↑ over the 12-week period of exercise. This effect was maintained for 4 h after the meal.
-----------------------------------	--	--	--	--	--

<b>Halford et al., 2010 [55]</b>	n= 30 women Age=46.0±12.9 yr BMI= 34.6±3.3 kg/m <sup>2</sup>	<p>Double blind, placebo controlled crossover study</p> <p><u>Duration:</u> 7 days</p> <p><u>Intervention:</u> 3 conditions :</p> <ul style="list-style-type: none"> <li>- Sibutramine 10 mg a day</li> <li>- Sibutramine 15 mg a day</li> <li>- Placebo</li> </ul> <p><u>Assessment frequency :</u> before and after drug administration (7 days)</p> <p><u>Assessment protocol :</u> standardized BF (2173 kJ), ad libitum lunch</p>	<p>Before and after BF, 10:00, 11:00, 12:00, before and after lunch at 13:00, 15:00, 16:00, 17:00</p>	<p>SQ<sub>H</sub> (mm/kJ)= (pre-lunch rating - post-lunch rating) /EI at lunch</p>	<p><b><u>Other:</u></b></p> <ul style="list-style-type: none"> <li>- SQ in the 10 mg group &gt; placebo (p=0.03).</li> <li>- SQ in 15 mg = SQ to placebo (smaller change in hunger rating pre- to post-test meal because of a proportionally greater reduction in food intake in this condition).</li> </ul>
----------------------------------	--	--	---	--	--

<b>Jönsson et al., 2010 [43]</b>	n=29 men ischemic heart disease patients with impaired glucose tolerance or T2D, and waist circumference >94 cm Age= NR BMI= NR	Interventional randomized study <u>Duration:</u> 12 weeks <u>Intervention:</u> 2 diet groups - Paleolithic diet (n=14): based on lean meat, fish, fruit, vegetables, root vegetables, eggs, and nuts - Mediterranean diet (n=15): whole-grain cereals, low-fat dairy products, potatoes, legumes, vegetables, fruit, fatty fish, refined fats rich in monounsaturated fatty acids and alpha-linolenic acid. <u>Assessment frequency:</u> measured once at 15 ± 5 days <u>Assessment protocol:</u> 4-day food record, appetite	At meal initiation and 30 min after meal initiation (free-living measurements)	SQs for energy (rating/MJ) and weight (rating/kg) = (rating pre-eating episode - rating post-eating episode)/food intake of eating episode  Satiety measured with 7-point scale anchored at -3 (very hungry) to +3 (very full)	<u><b>SQ, energy intake and appetite control:</b></u> - SQ for energy Paleolithic group > Mediterranean group (p=0.057) and without the outlier becomes significant (p=0.02). - Correlation between SQ for energy and EI (r= 0.54, p=0.004), absolute intake of CHO (r=0.50, p=0.007), glycemic load (r=0.50, p=0.007), saturated fatty acids (r=0.41, p =0.03) and sodium (r=0.51, p =0.007).
----------------------------------	--	---	--	--	--



sensation, anthropometrics,  
BW

<p><b>Caudwell et al., 2013 [56]</b></p>	<p>n=107 adults with overweight/obesity <u>Men</u>: n=35 Age=41.3±8.6 yr BMI= 30.5±8.6 kg/m<sup>2</sup> <u>Premenopausal women</u>: n=72 Age= 40.6±9.5 yr BMI= 31.8±4.3 kg/m<sup>2</sup></p>	<p>Interventional study <u>Duration</u> : 12 weeks <u>Intervention</u> : Aerobic exercise (500 kcal per session, 70% of individual's maximum heart rate 5 days/week) <u>Assessment frequency</u>: Baseline and post-intervention <u>Assessment protocol</u> : Anthropometric</p>	<p>Immediately before and after each meal, and at hourly intervals between</p>	<p>SQ<sub>H</sub> (mm/kcal)=(rating before BF-rating after BF)/EI of the BF *100</p>	<p><b><u>SQ, physical activity and energy expenditure:</u></b> - Exercise program ↑ SQ in males and females (p&lt;0.0001). - There was a difference in sex (p=0.014); SQ females &gt; SQ males at baseline and post-intervention.</p>
--	--	--	--	--	---

measurements, individualized standardized-energy BF, standardized lunch and ad libitum dinner, evening snack box

<p><b>Jonsson et al., 2013</b> [54]</p>	<p>n= 13 (10 men, 3 women) T2D Age= NR BMI= NR</p>	<p>Randomized cross-over study <u>Duration:</u> 3 months <u>Intervention:</u> 2 conditions : - Diabetes diet (current guidelines) - Paleolithic diet <u>Assessment frequency:</u> baseline and after 3 (in-between crossover) and 6 month <u>Assessments protocol:</u> 4-day weighed food record at 6 weeks</p>	<p>At meal initiation and 30 min after meal initiation (free-living measurements)</p>	<p>SQs for energy (rating/MJ), weight (rating/kg), energy density (rating*g/kJ), glycemic load (rating/kg) and glycemic index (RS) = (rating pre-eating episode - rating post-eating episode)/food intake of eating episode</p>	<p><u><i>SQ, energy intake and appetite control:</i></u> - SQ for energy Paleolithic diet &gt; diabetes diet (p=0.004). - No differences between the diets in SQ for weight per meal and GI per meal. - SQ for energy per meal correlated with triglyceride levels and vitamin B6 intake (r=0.60 and 0.64, p=0.03 and 0.02, respectively). - SQ for energy density correlated with water from food (r=0.71, p =0.01), and</p>
---	--	---	---	---	---

				Satiety measured with 7-point scale anchored at -3 (very hungry) to +3 (very full)	SQ for glycemic load correlated with BMI and spirits ( $r = -0.84$ and $0.59$ , $p = 0.0003$ and $0.03$ , respectively).
<b>McNeil et al., 2014 [9]</b>	n=102 premenopausal women, Age= $49.9 \pm 1.9$ yr BMI= $23.3 \pm 2.2$ kg/m <sup>2</sup>	Observational study <u>Duration</u> : 5 years <u>Assessment frequency</u> : baseline and every 1 year <u>Assessment protocol</u> : Anthropometric measurements, standardized BF (575 kcal), ad libitum lunch, 7-day food diary	VAS: Before, immediately after and every 30 min for 3h post-BF consumption. SQ: 60 and 180 min post-BF consumption.	SQ <sub>H</sub> , SQ <sub>F</sub> , SQ <sub>DTE</sub> and SQ <sub>PFC</sub> (mm/kcal)=[fasting rating - mean post-meal rating]/energy content of the test meal *100	<b><u>Other:</u></b> - No difference in SQ between menopausal status groups (premenopausal, menopausal transition and postmenopausal) at years 2 – 5.  <b><u>SQ, energy intake and appetite control:</u></b> SQ <sub>F</sub> , SQ <sub>PFC</sub> , mean SQ explained 5 to 14% of the variance in ad libitum energy and macronutrient intake at lunch at 1, 3-5 years.

---

-  $SQ_F$ ,  $SQ_{PFC}$  explained 8 and 14% of the variance in daily (7-day food diary) energy and carbohydrate intakes at year 4.

***SQ and anthropometrics variables:***

- year 1 : BW women with a lower mean  $SQ <$  higher mean  $SQ$  ( $p=0.02$ ).

- Changes in BW correlated with delta  $SQ_F$  at 60( $r=0.34$ ;  $p=0.004$ ) and 180 ( $r=0.30$ ;  $p=0.01$ ) min between years 1 and 5.

- Changes in FM correlated with delta  $SQ_F$  at 60 min between years 1 and 5 ( $r=0.24$ ;  $p=0.04$ ).

- Delta FM correlated with i) delta  $SQ_H$  at 60 ( $r=-0.34$ ;  $p=0.02$ ) and 180 min ( $r=-0.34$ ;  $p=0.02$ ), ii) delta  $SQ_{PFC}$  at 60 ( $r=-0.33$ ;  $p=0.02$ ) and 180 ( $r=-0.32$ ;  $p=0.02$ ) min, between years 4 and 5.

---

- Changes in waist circumference associated with delta SQ<sub>DTE</sub> at 60 min (r=-0.31; p=0.02), delta SQ<sub>H</sub> at 60 min (r=-0.32; p=0.02), delta SQ<sub>F</sub> at 60 (r=-0.31; p=0.02) and 180 min (r=-0.29; p=0.03), and delta mean SQ at 60 min (r=-0.32; p=0.02) between years 3 and 4.

<b>Bédard et al., 2015 [48]</b>	n=70 <u>Men:</u> n=38 Age=42.6±7.4 yr BMI= 29.0±3.1 kg/m <sup>2</sup> <u>Premenopausal women:</u> n=32 Age=41.2±7.4 yr BMI= 29.6±5.6 kg/m <sup>2</sup>	Interventional study <u>Duration:</u> 16 weeks <u>Intervention:</u> isoenergetic MedDiet standardized and personalized menu <u>(Assessment frequency:</u> Every wednesday from week 1 to 4. <u>Assessments protocol:</u> Standardized BF, lunch and dinner (2500 kcal/d)	Before and immediately after each meal	SQ <sub>F</sub> (mm/kcal) = (post-meal rating – pre-meal rating)/energy content of the test meal*100	<u>Other:</u> - No change in SQ from first to fourth week for both men and women.
---------------------------------	--	--	--	--	--

<b>Carbonneau et al., 2015 [51]</b>	<p>n=141</p> <p><u>Low-fat label</u></p> <p><u>normal weight:</u></p> <p>n=23</p> <p>Age=43.5±10.8 yr</p> <p>BMI=22.4±1.6 kg/m<sup>2</sup></p> <p><u>Low-fat label</u></p> <p><u>obese:</u></p> <p>n=23</p> <p>Age=52.3±11.5 yrs</p> <p>BMI= 34.7±3.9 kg/m<sup>2</sup></p> <p><u>Energy label</u></p> <p><u>normal weight:</u></p> <p>n=25</p> <p>Age= 37.7±12.6 yr</p>	<p>Randomized, controlled trial</p> <p><u>Duration:</u> 10 days</p> <p><u>Intervention:</u> 3 meals per day under ad libitum conditions</p> <p>3 groups:</p> <ul style="list-style-type: none"> <li>- Low-fat label posted on lunch meal main course</li> <li>- Energy label (energy content of main course and average daily needs)</li> <li>- No label (control)</li> </ul> <p><u>Assessment frequency:</u> Daily</p> <p><u>Assessments protocol:</u> BF, lunch and dinner ad libitum</p>	<p>Before and immediately after meal</p>	<p>SQ<sub>H</sub> and SQ<sub>F</sub> (mm/kcal) = (fasting rating - post-meal rating)/energy content of the meal*100</p>	<p><b><u>Other:</u></b></p> <ul style="list-style-type: none"> <li>- No difference between groups on 10-d mean for SQ<sub>H</sub> and SQ<sub>F</sub>.</li> <li>- Significant labelling group by time interaction was observed for the 3-d mean SQ<sub>H</sub> (p= 0.046). SQ<sub>H</sub> in the energy label group at days 8 – 10 &lt; days 1 – 3 (no difference between low-fat and no-label groups).</li> </ul>
-------------------------------------	---	---	--	---	---

---

BMI= 21.8±1.9

kg/m<sup>2</sup>

Energy label

obese: n=23

Age= 46.0±14.3 yr

BMI= 34.5±4.9

kg/m<sup>2</sup>

No label normal

weight: n=22

Age= 42.6±12.4 yr

BMI= 22.8±1.5

kg/m<sup>2</sup>

No label obese:

n=25 Age=

53.0±11.0 yr

BMI= 32.6±2.3

kg/m<sup>2</sup>

---

<b>Goloso-Gubat et al., 2016 [45]</b>	n=34 healthy male adults Age=27.7±6.2 yr BMI= 22.1±1.9 kg/m <sup>2</sup>	Randomized crossover study <u>Duration:</u> 6 weeks <u>Intervention:</u> 3 conditions: - BF with brown rice - BF with white rice - Control <u>Assessment frequency:</u> Before and after each condition <u>Assessment protocol :</u> Standardized BF (500 Kcal kcal; including 160 g cooked rice)	Before, and 15, 30, 45, 60, 90, 120, 150, 180, 240 min after meals	SQ <sub>H</sub> (mm/kcal)=(mean fasting ratings - mean 240 min post-prandial ratings)/energy content of BF*100.	<u><i>SQ, energy intake and appetite control:</i></u> - Mean SQ of brown rice > white rice (p=0.045).
---------------------------------------	--	--	--	---	--



<b>Arguin et al., 2017</b> [12]	<p>n=69 men</p> <p><u>Control Diet Low Satiety Phenotype (LSP):</u> n=15 Age= 41.0±6.3 yr BMI= 34.1±3.5 kg/m<sup>2</sup></p> <p><u>Control Diet High Satiety Phenotype (HSP):</u> n=19 Age= 41.9±5.5 yr BMI= 33.9±2.8 kg/m<sup>2</sup></p> <p><u>Satiating Diet LSP:</u> n=17 Age= 40.4±6.2 yr BMI= 33.6±3.0 kg/m<sup>2</sup></p>	<p>Randomized controlled trial</p> <p><u>Duration:</u> 16 weeks</p> <p><u>Intervention:</u> Diet intervention</p> <p>2 groups:</p> <p>- Control: 10–15% protein, 55–60% carbohydrate and 30% fat</p> <p>- Satiating: 20–25% protein, 45–50% carbohydrate and 30–35% fat</p> <p><u>Assessment frequency:</u> Baseline and post-intervention</p> <p><u>Assessments protocol:</u> Anthropometrics, standardized BF (733 kcal), TFEQ</p>	<p>Before, immediately after and at 10 min intervals until 1h then 90 and 120 min after BF.</p>	<p>SQ<sub>H</sub>, SQ<sub>F</sub>, SQ<sub>DTE</sub> and SQ<sub>PFC</sub> (mm/kcal) = (fasting rating - mean of the 60-min post-meal rating/energy content of BF) *100</p> <p><u>Low satiety phenotype</u> : mean SQ&lt;8mm/100 kcal</p> <p><u>High satiety phenotype</u> : mean SQ≥8mm/100 kcal</p>	<p><u><b>SQ and satiety phenotype:</b></u></p> <p>- ↑ all SQ for LSP in the satiating diet (all p&lt;0.01).</p> <p>- SQ<sub>H</sub> ↑ for HSP in the satiating diet (p&lt;0.05).</p> <p>- SQ<sub>PFC</sub> tended to ↓ in the HSP-control subgroup (p=0.05).</p> <p>- After adjustment for baseline variables: significant effect of diet for the changes in SQ<sub>H</sub>, SQ<sub>F</sub>, SQ<sub>PFC</sub> and mean SQ (all p&lt;0.05), with greater increases in SQ for the satiating diet.</p>
------------------------------------	---	--	---	---	---

---

Satiating Diet

HSP: n=18

Age= 42.55±5.0 yr

BMI= 32.9±2.9

kg/m<sup>2</sup>

<b>Sanchez et al., 2017 [50]</b>	n=125 <u>Probiotic group</u> : n=62 Age=35.0±10.0 yr BMI= 33.8±3.3 kg/m <sup>2</sup> <u>Placebo</u> : n=63 Age= 37.0±10.0 yr BMI= 33.3±3.2 kg/m <sup>2</sup>	Double-blind, randomized, placebo controlled study <u>Duration</u> : 24 weeks <u>Intervention</u> : 12-week moderate energy restriction including 2 daily capsules of probiotic/placebo (Phase 1), followed by 12 weeks of weight maintenance (Phase 2) <u>Assessment frequency</u> : baseline, week 12, week 24	Before, immediately after, and every 10 min for 1 h after the standardized BF	SQ <sub>H</sub> , SQ <sub>F</sub> , SQ <sub>DTE</sub> and SQ <sub>PFC</sub> (mm/kcal) = (fasting rating - mean of the 60-min post-meal ratings) /energy content of test meal) *100	<b><u>Other</u></b> : - Final sample: n=93, Probiotic: n=45, Placebo: n=48 - For women and men, the SQ <sub>DTE</sub> probiotic group at lunch > placebo group after Phase 1 (men p = 0.03; women p = 0.02). The same trend was observed for the changes in SQ <sub>DTE</sub> at BF but not significantly.
----------------------------------	--	---	---	--	--

		<u>Assessments protocol:</u> Anthropometrics, standardized BF (men 733 kcal, women 599 kcal), ad libitum lunch, TFEQ			
<b>Buckland et al., 2019 [57]</b>	n=52 women Age= 41.2±12.5 yr BMI= 34.0±3.6 kg/m <sup>2</sup>	Randomized controlled trial <u>Duration:</u> 14 weeks <u>Intervention:</u> Weight loss program with low energy density meal and high energy density meal at week 3 and 12. <u>Assessment frequency:</u> week 3 and 12. <u>Assessments protocol:</u> Anthropometric measurements, TFEQ, craving control, food reward, low energy density (LED)	Before and after each meal and at hourly intervals	SQ <sub>F</sub> (mm/kcal) = (mean of the 180-min post-meal rating - fasting rating/energy content of BF)*100  <u>Low satiety phenotype</u> : SQ<4.5mm/100 kcal  <u>High satiety</u> <u>phenotype</u> : SQ≥8.5mm/100 kcal	<u><i>SQ, energy intake and appetite</i></u>  <u><i>control:</i></u> - Preference (explicit liking and implicit wanting) for and consumption of HED food: LSP > HSP  <u><i>SQ and anthropometrics variables:</i></u> - ↓ BW and ↓ waist circumference : LSP < HSP  <u><i>Other:</i></u> - Control over eating and weight loss program adherence: LSP < HSP

and high energy density  
 (HED) test days: standardized  
 BF and lunch, ad libitum  
 dinner and evening snack box

<p><b>Drapeau et al., 2019 [52]</b></p>	<p>n=100  <u>Low Satiety Responsiveness</u>  <u>(LSR)</u>: n=50 (23 men, 27 women)          Age=37.8±9.5 yr          BMI= 33.7±3.9 kg/m<sup>2</sup>  <u>High Satiety Responsiveness</u>  <u>(HSR)</u>: n=50 (6 men, 44 women)          Age= 39.6±7.8 yr</p>	<p>Observational study          Subjects were selected from different weight loss studies          Study 1 &amp; 2: <u>Duration</u>: 15 weeks, <u>Intervention</u> : caloric restriction (-700 kcal/day)          Study 3: <u>Duration</u>: 12 weeks, <u>Intervention</u> : caloric restriction (-500 kcal/day)  <u>Assessment frequency</u> : Baseline and post-intervention  <u>Assessment protocol</u> : Anthropometrics, standardized BF (men 733</p>	<p>Before, immediately after, and 10, 20, 30, 40, 50, and 60 min after BF</p>	<p>SQ<sub>H</sub>, SQ<sub>F</sub>, SQ<sub>DTE</sub> and SQ<sub>PFC</sub> (mm/kcal)= (fasting rating - mean of the 60-min post-meal rating) /energy content of BF*100   <u>Low satiety phenotype</u> : mean SQ&lt;8mm/100 kcal   <u>High satiety phenotype</u> : mean SQ≥8mm/100 kcal</p>	<p><u>Baseline:</u>  <u><i>SQ, energy intake and appetite</i></u>  <u>control:</u>          - Level of external locus for hunger: LSP &gt; HSP  <u><i>SQ and satiety phenotype:</i></u>          - Mean SQ and for each rating: LSP &lt; HSP.  <u><i>SQ and sleep quality and quantity:</i></u>          - Level of PSQI total score: LSP &gt; HSP(indicating lower sleep quality compared to the HSP group)  <u><i>Other:</i></u>          - Present-state anxiety associated with SQ (r = -0.38, p = 0.008).</p>
---	---	---	---	--	--

	BMI= 32.6±3.3 kg/m <sup>2</sup>	kcal, women 599 kcal), ad libitum lunch, TFEQ, State-Trait Anxiety Inventory			- Present-state anxiety score: LSP > HSP <u>After weight-loss program:</u> <b><u>SQ and anthropometrics variables:</u></b> - BW loss : LSP = HSP (-3.5 ± 3.2 vs. -3.8 ± 2.8 kg) <b><u>SQ and satiety phenotype:</u></b> Changes in satiety efficiency : LSP = HSP (LSP pre 6.0 ± 2.6 vs. post 8.0 ± 5.4; HSP group pre 14.8 ± 3.5 vs. post 15.2 ± 4.4)
<b>Hintze et al., 2019 [53]</b>	n=36 <u>Slow weight loss:</u> n=17 Age=30.2±9.3 yr BMI= 32.1±3.1 kg/m <sup>2</sup> <u>Fast weight loss:</u> n=19	Randomized trial <u>Intervention and duration:</u> 2 groups: - Slow weight loss (-500 kcal/day) during 20 weeks - Rapid weight loss (-1000 kcal/day) during 10 weeks <u>Assessment frequency:</u>	Fasting, at 0, 30,60,90,120,180 after standardized BF	SQ <sub>H</sub> , SQ <sub>DTE</sub> and SQ <sub>PFC</sub> (mm/kcal)= (fasting rating - mean 60-min post-meal rating) /energy content of BF*100	Final sample: n=30, Slow weight loss: n=14, Fast weight loss: n=16 <b><u>Other:</u></b> - SQ <sub>DTE</sub> , SQ <sub>H</sub> and SQ <sub>PFC</sub> at 60 and 180 min ↑ after the intervention.

---

Age= 33.1±9.3 yr	baseline, 5-7 days after	SQ <sub>F</sub> (mm/kcal)=
BMI= 34.0±4.4	starting and post-intervention.	(mean of the 60-min
kg/m <sup>2</sup>	<u>Assessments protocol:</u>	post-meal rating –
	standardized and personalized	fasting rating) /energy
	BF (ad libitum in preliminary	content of BF*100
	session and replicated on	
	subsequent sessions), ad	
	libitum lunch	

---

**Protocol are detailed only the relevant of SQ; values are presented as means ± SD (standard deviation); AS: appetite sensation; EI: energy intake; BF: Breakfast; BW: Body Weight, NR: Not Reported. DTE: Desire To Eat; F: Fullness; H: Hunger, PFC: Prospective Food Consumption; S: Satiety; SQ: Satiety Quotient; LSP: Low Satiety Phenotype; HSP: High Satiety Phenotype.**

## Annexe 3

### Publications relatives au projet de recherche

---

#### **Articles originaux :**

- **Fillon, A.**, Mathieu, M.-E., Masurier, J., Roche, J., Miguet, M., Khammassi, M., Finlayson, G., Beaulieu, K., Pereira, B., Duclos, M., Boirie, Y., & Thivel, D. (2020). Effect of exercise-meal timing on energy intake, appetite and food reward in adolescents with obesity: the TIMEX study. *Appetite*, 146, 104506.
- **Fillon, A.**, Beaulieu, K., Miguet, M., Bailly, M., Finlayson, G., Julian, V., Masurier, J., Pereira, B., Duclos, M., Boirie, Y., & Thivel, D. (under review). *Delayed meal timing after exercise is associated with reduced appetite and energy intake in adolescents with obesity.*
- **Fillon, A.**, Beaulieu, K., Miguet, M., Bailly, M., Finlayson, G., Julian, V., Masurier, J., Mathieu, M.-E., Pereira, B., Duclos, M., Boirie, Y., & Thivel, D. (under review). *Does exercising before or after a meal affect energy balance in adolescents with obesity?*

#### **Commentaire :**

- **Fillon, A.**, Mathieu, M. E., Boirie, Y., & Thivel, D. (2020). Appetite control and exercise: Does the timing of exercise play a role? *Physiology & Behavior*, 218, 112733.  
<https://doi.org/10.1016/j.physbeh.2019.112733>

**Effect of exercise-meal timing on energy intake, appetite  
and food reward in adolescents with obesity:  
the TIMEX study**

**Fillon A.**, Mathieu M-E, Masurier J., Roche J., Miguet M., Khammassi M., Finlayson G., Beaulieu K., Pereira B., Duclos M., Boirie Y., Thivel D.



*Accepted in Appetite, Volume 146, Mars 2020*





## Effect of exercise-meal timing on energy intake, appetite and food reward in adolescents with obesity: The TIMEX study

A. Fillon<sup>a,b,c,\*</sup>, M.E. Mathieu<sup>d,e</sup>, J. Masurier<sup>c</sup>, J. Roche<sup>a</sup>, M. Miguet<sup>a</sup>, M. Khammassi<sup>a</sup>, G. Finlayson<sup>f</sup>, K. Beaulieu<sup>f</sup>, B. Pereira<sup>g</sup>, M. Duclos<sup>b,h,i,j</sup>, Y. Boirie<sup>b,i,j,k</sup>, D. Thivel<sup>a,j</sup>

<sup>a</sup> Clermont Auvergne University, EA 3533, Laboratory of the Metabolic Adaptations to Exercise Under Physiological and Pathological Conditions (AME2P), Clermont-Ferrand, France

<sup>b</sup> INRA, UMR, 1019, Clermont-Ferrand, France

<sup>c</sup> UGECAM Nutrition Obesity Ambulatory Hospital, Clermont-Ferrand, France

<sup>d</sup> Department of Kinesiology, University of Montreal, 2100 Edouard-Montpetit, Montreal, H3C 3J7, Canada

<sup>e</sup> Sainte-Justine UHC Research Center, 5757 Decelles, Montreal, H3T 1C5, Canada

<sup>f</sup> School of Psychology, Faculty of Medicine and Health, University of Leeds, Leeds, LS2 9JT, UK

<sup>g</sup> Clermont-Ferrand University Hospital, Biostatistics Unit (DRCI), Clermont-Ferrand, France

<sup>h</sup> Department of Sport Medicine and Functional Explorations, Clermont-Ferrand University Hospital, G. Montpied Hospital, Clermont-Ferrand, France

<sup>i</sup> University Clermont Auvergne, UFR Medicine, Clermont-Ferrand, France

<sup>j</sup> CRNH-Auvergne, Clermont-Ferrand, France

<sup>k</sup> Department of Human Nutrition, Clermont-Ferrand University Hospital, G. Montpied Hospital, Clermont-Ferrand, France

### ARTICLE INFO

#### Keywords:

Exercise timing  
Appetite  
Energy intake  
Food reward  
Obesity  
Adolescent

### ABSTRACT

The present study manipulated the delay between exercise and test meal to investigate its effect on energy intake, appetite sensations and food reward in adolescents with obesity.

Fifteen adolescents with obesity randomly completed 3 experimental sessions: i) rest without exercise (CON); ii) 30 min of exercise 180 min before lunch (EX-180); iii) 30 min of exercise 60 min before lunch (EX-60). *Ad libitum* energy intake was assessed at lunch and dinner, and food reward (LFPQ) assessed before and after lunch. Appetite sensations were assessed at regular intervals.

Absolute energy intake was not different between conditions despite a 14.4% lower intake in EX-60 relative to CON. Lunch relative energy intake (REI: energy intake – exercise-induced energy expenditure) was higher in CON compared with EX-60 ( $p < 0.001$ ). Lunch fat intake was lower in EX-60 compared with CON ( $p = 0.01$ ) and EX-180 ( $p = 0.02$ ). Pre-lunch hunger in CON was lower than EX-180 ( $p = 0.02$ ). Pre-lunch prospective food consumption and desire to eat were lower in CON compared with both exercise conditions ( $p = 0.001$ ). A significant condition effect was found for explicit liking for high-fat relative to low-fat foods before lunch ( $p = 0.03$ ) with EX-60 being significantly lower than EX-180 ( $p = 0.001$ ). The nutritional and food reward adaptations to exercise might be dependent on the timing of exercise, which is of importance to optimize its effect on energy balance in adolescents with obesity.

*Clinical trial reference:* NCT03807609.

### 1. Introduction

- Exercising close to lunch decreases relative energy intake.
- Lipids and proteins intake at lunch are decreased at after EX-60.
- The timing of exercise might not impact appetite sensations.

The rise of pediatric overweight, obesity and their metabolic complications calls for the development of innovative, effective and integrative weight management strategies. Physical exercise is an

\* Corresponding author. Clermont University, EA 3533, Laboratory of the Metabolic Adaptations to Exercise under Physiological and Pathological Conditions (AME2P), BP 80026, F-63171, Aubière cedex, France.

E-mail addresses: [alicia.fillon@etu.uca.fr](mailto:alicia.fillon@etu.uca.fr) (A. Fillon), [me.mathieu@umontreal.ca](mailto:me.mathieu@umontreal.ca) (M.E. Mathieu), [julie.masurier@ugecam.assurance-maladie.fr](mailto:julie.masurier@ugecam.assurance-maladie.fr) (J. Masurier), [johanna.roche@uca.fr](mailto:johanna.roche@uca.fr) (J. Roche), [maud.miguet@gmail.com](mailto:maud.miguet@gmail.com) (M. Miguet), [khammassimarwa.issep@hotmail.com](mailto:khammassimarwa.issep@hotmail.com) (M. Khammassi), [G.S.Finlayson@leeds.ac.uk](mailto:G.S.Finlayson@leeds.ac.uk) (G. Finlayson), [K.Beaulieu@leeds.ac.uk](mailto:K.Beaulieu@leeds.ac.uk) (K. Beaulieu), [bpereira@chu-clermontferrand.fr](mailto:bpereira@chu-clermontferrand.fr) (B. Pereira), [mduclos@chu-clermontferrand.fr](mailto:mduclos@chu-clermontferrand.fr) (M. Duclos), [yves.boirie@inra.fr](mailto:yves.boirie@inra.fr) (Y. Boirie), [thiveldavid@hotmail.com](mailto:thiveldavid@hotmail.com) (D. Thivel).

<https://doi.org/10.1016/j.appet.2019.104506>

Received 11 July 2019; Received in revised form 19 September 2019; Accepted 30 October 2019

Available online 31 October 2019

0195-6663/ © 2019 Published by Elsevier Ltd.

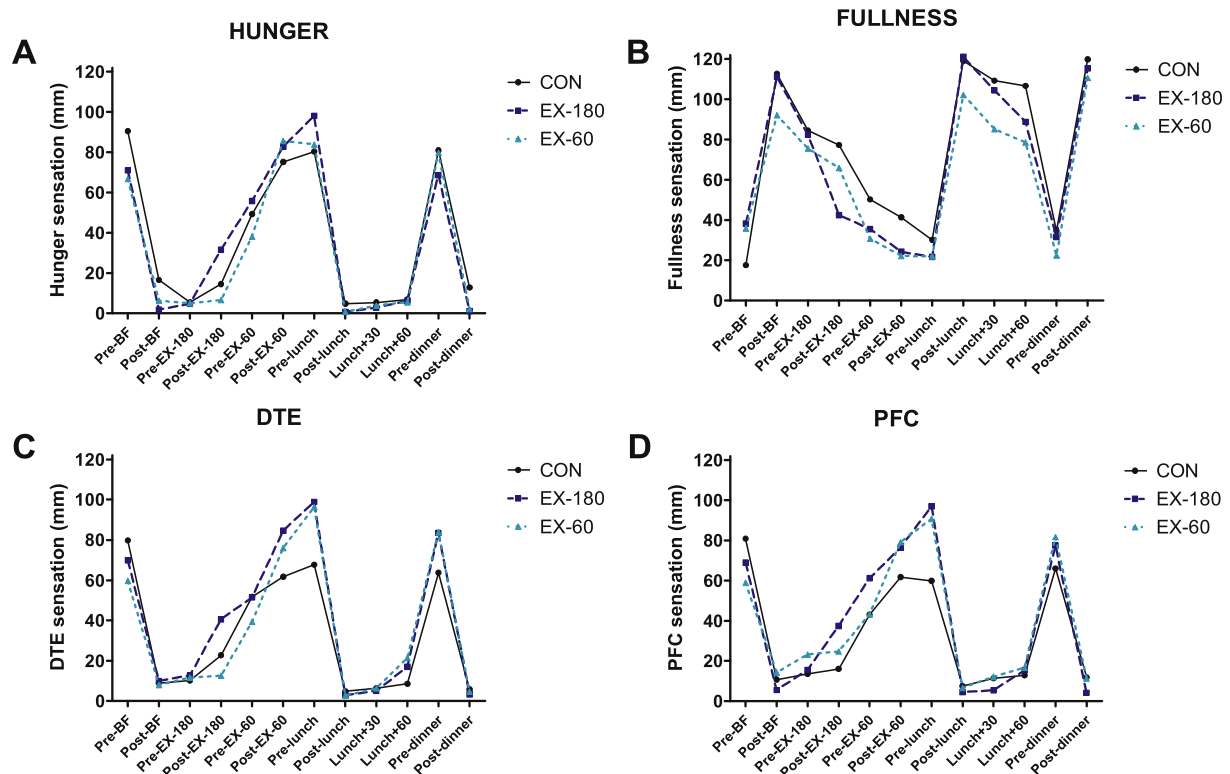

Fig. 1. Daily appetite sensations.

Fig. 1. Daily Hunger (A); Fullness (B); DTE (C) and PFC (D) during the CON (black line), EX-180 (blue line) and EX-30 (light-blue line). DTE; Desire to Eat; PFC; Prospective Food Consumption; BF; Breakfast; CON; rest condition; EX-60; Exercise 60 min before test meal; EX-180; Exercise 180 min before test meal; AUC EX-180 and AUC EX-60 > AUC CON for DTE ( $p < 0.01$ ).

essential component of multidisciplinary weight loss interventions that is no longer considered as a simple source of additional energy expenditure but is now recognized for its potential effects on energy intake (EI) and appetite control in adults (Blundell, Gibbons, Caudwell, Finlayson, & Hopkins, 2015; Donnelly et al., 2014; Hall et al., 2012; Schubert, Desbrow, Sabapathy, & Leveritt, 2013) and youth with obesity (Carnier et al., 2013; Nemet, Arieli, Meckel, & Eliakim, 2010; Thivel et al., 2011). Both homeostatic and neurocognitive pathways have been implicated in the nutritional responses to exercise, as recently reviewed and synthesized (Thivel, Finlayson, & Blundell, 2019a). Physiological responses to exercise such as gastro-intestinal peptide responses have been proposed to explain the anorexigenic effect of intensive exercise observed in adolescents with obesity (Hunschede, Kubant, Akilen, & Anderson, 2017; Prado et al., 2014) as well as some neurocognitive and hedonic mechanisms (Fearnbach et al., 2017; Miguet et al., 2018).

While most of the studies available so far have focused on the role of exercise characteristics on subsequent nutritional responses, such as its intensity (Thivel et al., 2011, 2012, 2014) or duration (Masurier et al., 2018; Tamam, Bellissimo, Patel, Thomas, & Anderson, 2012), only few have questioned its timing in relation to meals. Mathieu et al. recently examined whether exercising immediately before or after a lunch meal could differently affect short term energy balance in children and adolescents (Mathieu, Lebkowski, Laplante, Drapeau, & Thivel, 2018). They observed a lower energy balance when children exercised immediately before their meal, especially when the exercise was performed at moderate-to-vigorous intensity (Mathieu et al., 2018). Additionally, Albert, Drapeau, and Mathieu (2015) investigated the timing between exercise and the following meal on EI and subjective appetite sensations in healthy young males. In their study, 15- to 20-year-old lean boys consumed a standardized breakfast, then performed a 30-min exercise session of moderate-to-vigorous intensity either 135 min or

immediately before an *ad libitum* buffet-type meal (Albert et al., 2015). While they did not observe any difference in hunger between conditions, the authors observed a significant reduction in overall energy intake (11%) mainly explained by a lower energy ingested from lipids (-23%), when exercise was performed immediately before the meal compared with the delayed condition. Although the afternoon snack and dinner intakes were not different between conditions, this demonstrates an absence of compensation for the observed acute reduction in food consumption.

Although later results confirmed the potential benefits of a shorter delay between exercise and meal on energy intake and overall energy balance in lean children this remains to be elucidated in children and adolescents with obesity in order to improve our physical activity prescriptions and then optimize our weight loss strategies (Reid, Thivel, & Mathieu, 2019). Moreover, while recent studies have highlighted the role of food reward in post-exercise energy intake in adolescents with obesity (Miguet et al., 2018; Thivel et al., 2019b), the effect of exercise-meal timing on food reward is unknown. Food reward, as a hedonic pathway, has been effectively recently shown to be an essential actor in the control of energy intake in youth with obesity, potentially overpassing the influence of some physiological signals, especially in response to exercise (Thivel et al., 2019b). It seems then today essential to consider food reward when questioning the effect of acute exercise, in that context depending on its timing, on subsequent energy intake and appetite.

Therefore, the aim of the present study (TIMEX for Timing Intake and Exercise) was to assess the effect of the delay between exercise and subsequent meal on energy intake, appetite sensations and food reward in adolescents with obesity.

## 2. Methods

### 2.1. Population

Fifteen adolescents with obesity (according to (Cole, Bellizzi, Flegal, & Dietz, 2000)) aged 12–15 years (Tanner stage 3–4) participated in this study (6 boys ( $14 \pm 0.7$  years old); and 9 girls ( $12.6 \pm 1.6$  years old)). The adolescents were recruited through the local Pediatric Obesity Center (Tza Nou, La Bourboule, France). To be included in the study, participants had to be free of any medication known to influence appetite or metabolism, not present any contraindication to physical activity, and to be classified as physically inactive, taking part in less than 2 h of physical activity per week (according to the International Physical Activity Questionnaire –IPAQ (Craig et al., 2003)). This study was conducted in accordance with the Helsinki declaration and all the adolescents and their legal representative received information sheets and signed consent forms as requested by the local ethical authorities (Human Ethical Committee authorization reference: 2018 A02161 54; Clinical Trial reference: NCT03807609).

### 2.2. Design

After a preliminary medical inclusion visit made by a pediatrician to control for the ability of the adolescents to complete the study, they were asked to perform a maximal aerobic test and their body composition was assessed by dual-energy x-ray absorptiometry (DXA). The adolescents were then asked to complete a food preference questionnaire and the Three Factor Eating Questionnaire r17 (Bryant et al., 2018) in order to exclude children with high cognitive restraint (none of the volunteers was excluded based on their TFEQR17 results). Afterwards, adolescents randomly completed the three following experimental sessions (one week apart): i) a rest condition without exercise (CON); ii) an exercise session set 180 min before lunch (EX-180); iii) an exercise session set 60 min before lunch (EX-60). On the three occasions, participants received a standardized breakfast (08:00am) and were asked to remain at rest (CON) or to cycle for 30 min either 180 (on EX-180) or 60 (on EX-60) minutes before being served with an *ad libitum* lunch meal at 12:30pm. The adolescents were asked to complete the Leeds Food Preference Questionnaire (LFPQ) (Finlayson, King, & Blundell, 2008) before and after the lunch meal. Dinner energy intake was also assessed using an *ad libitum* buffet-style meal. Appetite sensations were assessed at regular intervals through the day. Outside the experimental conditions and between the two *ad libitum* test meals, the adolescents stayed in the laboratory, devoid of any food cues, and were requested not to engage in any moderate-to-vigorous physical activity and mainly completed sedentary activities such as reading, homework or board games.

### 2.3. Anthropometric characteristics and body composition

Body Mass and height were measured wearing light clothing while bare-footed, using a digital scale and a standard wall-mounted stadiometer, respectively. Body mass index (BMI) was calculated as body mass (kg) divided by height squared ( $m^2$ ). Afterwards, BMI was calculated in the sex and age dependent French reference curves to obtain the BMI percentile (WHO Multicentre Growth Reference Study Group, 2006). Fat mass (FM) and fat-free mass (FFM) were assessed by dual-energy X-ray absorptiometry (DXA) following standardized procedures (QDR4500A scanner, Hologic, Waltham, MA, USA). These measurements were obtained during the preliminary visit by a trained technician.

### 2.4. Peak oxygen uptake test ( $\dot{V}O_{2peak}$ ) and resting metabolic rate

First the resting metabolic rate of each subject was measured while they were lying down for 20 min, using indirect calorimetry (K4b2

COSMED, Neuve-Church, Italy). Then, each subject performed a  $\dot{V}O_{2peak}$  test on a traditional concentric ergometer (Rowland, 1993). The initial power was set at 30W during 3 min, followed by a 15W increment every minute until exhaustion. The adolescents were strongly encouraged by the experimenters throughout the test to perform their maximal effort. Maximal criteria were: heart rate  $> 90\%$  of the theoretical maximum heart rate ( $210 - 0.65 \times \text{age}$ ), respiratory exchange ratio ( $RER = \dot{V}CO_2/\dot{V}O_2$ )  $> 1.1$  and/or  $\dot{V}O_2$  plateau. Cardiac electrical activity (Ultima Series<sup>TM</sup>, Saint Paul, MN) and heart rate (Polar V800) were monitored and the test was coupled with a measurement of breath-by-breath gas exchanges (BreezeSuite Software, Saint Paul, MN), that determined  $\dot{V}O_2$  and  $\dot{V}CO_2$ . Volumes and gases were calibrated before each test. The  $\dot{V}O_{2peak}$  was defined as the average of the last 30 s of exercise before exhaustion.

### 2.5. Experimental conditions

**Rest condition (CON):** During this condition, the adolescents were asked to remain quiet and were not allowed to engage in any physical activity. They were asked to stay seated on a comfortable chair (30 min) between 10:00am and 10:30am, not being allowed to talk, read, watch TV or to complete any intellectual tasks. The 30-minute rest energy expenditure was calculated based on the results obtained assessment of the adolescents' resting metabolic rate.

**Exercise condition 180 min before lunch (EX-180):** Between 09:00am and 09:30 am, the participants performed a moderate intensity exercise bout ( $65\% \dot{V}O_{2peak}$ ) on an ergo-cycle, for a total duration of 30 min. The intensity was controlled by heart rate records (Polar V800) using the results from the maximal aerobic capacity testing. Exercise-induced energy expenditure was calculated based on the results obtained during the maximal oxygen uptake evaluation.

**Exercise condition 60 min before lunch (EX-60):** The adolescents performed the same exercise bout as on EX-180, but 60 min before the *ad libitum* lunch meal (between 11:00am and 11:30 am).

### 2.6. Energy intake

At 08:00am, the adolescents consumed a standardized calibrated breakfast (500 kcal) respecting the recommendations for their age (composition: bread (50 g), butter (10 g), marmalade (15g), yoghurt (125 g) or semi-skimmed milk (20 cl), fruit or fruit juice (20 cl)). Lunch and dinner meals were served *ad libitum* using a buffet-type meal. The content of the buffets was determined using a food preference and habits questionnaire filled in by the adolescents during the inclusion visit (as previously described (Thivel, Genin, Mathieu, Pereira, & Metz, 2016a)). Top rated items as well as disliked ones and items liked but not usually consumed were excluded to avoid over-, under- and occasional consumption. Lunch menu was beef steak, pasta, mustard, cheese, yogurt, compote, fruits and bread. Dinner menu was ham/turkey, beans, mashed potato, cheese, yogurt, compote, fruits and bread. Adolescents were told to eat until sensations comfortably satiated ("You can eat until feeling comfortably fed"). Food items were presented in abundance. Adolescents made their choices and composed their trays individually before joining their habitual table (5 adolescents per table). They had lunch in a quiet environment without being disturbed by music, cell-phones or television. The experimenters weighed the food items before and after each meal. Energy intake in kcal and macronutrient composition (proportion of fat, carbohydrate and protein) were calculated using the software Bilnut 4.0. This methodology has been previously validated and published (Thivel et al., 2016a). Lunch and total relative energy intake (REI) were calculated such as: energy intake – exercise-induced energy expenditure.

### 2.7. Subjective appetite sensations

Appetite sensations were collected throughout the day using visual

analogue scales (150 mm scales) (Flint, Raben, Blundell, & Astrup, 2000). Adolescents had to report their hunger, fullness, desire to eat and prospective food consumption at regular intervals (before and immediately after breakfast, prior and after (CON) or exercise (EX-180 and EX-60), before and immediately after lunch, 30 min and 60 min after lunch, before and immediately after dinner). The questions were: i) "How hungry do you feel?" (hunger), ii) "How full do you feel?" (fullness), iii) "How strong is your desire to eat?" (desire to eat; DTE), iv) "How much do you think you can eat?" (prospective food consumption' PFC).

The satiety quotients (SQ) for hunger, fullness, PFC and DTE have been calculated as follows (Drapeau et al., 2007):

$$\text{Satiety quotient mm/kcal} = [(pre\ meal\ AS\ mm) - (mean\ post\ meal\ and\ 60\ min\ post\ meal\ AS\ mm)] / \text{energy\ content\ of\ the\ meal\ (kcal)} * 100$$

## 2.8. Food liking and wanting

The Leeds Food Preference Questionnaire (described in greater methodological detail by Dalton and Finlayson (Dalton & Finlayson, 2014) provided measures of food preference and food reward. Participants were presented with an array of pictures of individual food items common in the diet. Foods in the array were chosen by the local research team from a validated database to be either predominantly high (> 50% energy) or low (< 20% energy) in fat but similar in familiarity, protein content, palatability and suitable for the study population. The LFPQ has been deployed in a range of research (Dalton & Finlayson, 2014) including a recent exercise/appetite trial in young French males (Thivel et al., 2018).

Explicit liking and explicit wanting were measured by participants rating the extent to which they like each food ("How pleasant would it be to taste this food now?") and want each food ("How much do you want to eat this food now?"). The food images were presented individually, in a randomized order and participants make their ratings using a 100-mm VAS. Implicit wanting and relative food preference were assessed using a forced choice methodology in which the food images were paired so that every image from each of the four food types was compared to every other type over 96 trials (food pairs). Participants were instructed to respond as quickly and accurately as they could to indicate the food they want to eat the most at that time ("Which food do you most want to eat now?"). To measure implicit wanting, reaction times for all responses were covertly recorded and used to compute mean response times for each food type after adjusting for frequency of selection. To measure food choice as a marker of food preference, the mean frequency of selection for each food type was recorded.

Responses on the LFPQ were used to compute mean scores for high-fat, low-fat, sweet or savoury food types (and different fat-taste combinations). Fat bias scores were calculated as the difference between the high-fat scores and the low-fat scores, with positive values indicating

greater liking, wanting or choice for high-fat relative to low-fat foods and negative values indicating greater liking, wanting or choice for low-fat relative to high-fat foods. Sweet bias scores were calculated as the difference between the sweet and savoury scores, with positive values indicating greater liking or wanting for sweet relative to savoury foods and negative values indicating greater liking or wanting for savoury relative to sweet foods.

## 2.9. Statistical analysis

Statistical analyses were performed using Stata software, Version 13 (StataCorp, College Station, TX, US). The sample size estimation was determined according to (i) CONSORT 2010 statement, extension to randomised pilot and feasibility trials (Eldridge et al. CONSORT 2010 statement: extension to randomised pilot and feasibility trials. Pilot and Feasibility Studies (2016) 2:64) and (ii) Cohen's recommendations (Cohen, 1988) who has defined effect-size bounds as: small (ES: 0.2), medium (ES: 0.5) and large (ES: 0.8), "grossly perceptible and therefore large"). So, with 15 patients by condition, an effect-size around 1 can be highlighted for a two-sided type I error at 1.7% (correction due to multiple comparisons), a statistical power greater than 80% and an intra-class correlation coefficient at 0.5 to take into account between and within participant variability. All tests were two-sided, with a Type I error set at 0.05. Continuous data was expressed as mean  $\pm$  standard deviation (SD) or median [interquartile range] according to statistical distribution. The assumption of normality was assessed by using the Shapiro-Wilk test. Daily (total) and 60 min post meal Area Under the Curves (AUC) have been calculated using the trapezoidal methods. Random-effects models for repeated data were performed to compare three conditions (i) considering the following fixed effects: time, condition and time  $\times$  condition interaction, and (ii) taking into account between and within participant variability (subject as random-effect). A Sidak's type I error correction was applied to perform multiple comparisons. As proposed by some statisticians (Feise, 2002; Rothman & Greenland, 1998) a particular focus will be also given to the magnitude of differences, in addition to inferential statistical tests expressed using p-values. The normality of residuals from these models was studied using the Shapiro-Wilk test. When appropriate, a logarithmic transformation was proposed to achieve the normality of dependent outcome.

## 3. Results

Fifteen adolescents with obesity participated in this study. Their mean age was  $13.1 \pm 1.4$  years, body weight was  $98.0 \pm 25.8$  kg, with a BMI of  $34.7 \pm 6.0$  (z-BMI  $2.3 \pm 0.3$ ), a percentage body fat mass of  $36.5 \pm 4.4\%$  and a FFM of  $54.6 \pm 14.7$  kg.

The adolescents had a  $\dot{V}O_{2peak}$  of  $21.6 \pm 5.7$  ml/min/kg. Energy expenditure induced by the exercise (total duration 30 min) was significantly higher compared to the 30-min resting energy expenditure ( $186 \pm 52$  kcal and  $57 \pm 4$  kcal, respectively;  $p < 0.001$ ).

**Table 1**  
Absolute and Relative Energy Intake in response the three conditions.

	CON	EX-180	EX-60	p	ES		
	Mean (SD)	Mean (SD)	Mean (SD)		CON vs. EX-180	CON vs. EX-60	EX-180 vs. EX-60
Energy Intake (kcal)							
Lunch	1204 (288)	1146 (288)	1031 (308)	0.13	-0.14[-0.65-0.36]	-0.54[-1.05- -0.04]	-0.41[-0.91-0.10]
Dinner	801 (183)	802 (259)	790 (210)	0.89	0.06[-0.45-0.56]	-0.02[-0.53-0.48]	-0.08[-0.58-0.43]
Total	2004 (430)	1948 (416)	1820 (459)	0.32	-0.07[-0.57-0.44]	-0.36[-0.87-0.14]	-0.30[-0.81-0.20]
Relative Energy Intake (kcal)							
Lunch	1146 (285)	976 (211)	855 (315) <sup>a</sup>	0.01	-0.51[-1.02-0.00]	-0.91[-1.41- -0.40]	-0.41[-0.91-0.10]
Total	1947 (428)	1779 (382)	1644 (446)	0.12	-0.31[-0.82-0.19]	-0.61[-1.12- -0.11]	-0.31[-0.81-0.20]

<sup>a</sup>  $p < 0.001$  EX-60 versus CON; CON: control condition; EX-60: Exercise 60 min before test meal; EX-180: Exercise 180 min before test meal; SD: Standard Deviation.

**Table 2**  
Macronutrient Intake in response the three conditions.

	CON	EX-180	EX-60	p	ES		
	Mean (SD)	Mean (SD)	Mean (SD)		CON vs. EX-180	CON vs. EX-60	EX-180 vs. EX-60
Proteins (g)							
Lunch	68 (18)	70 (19)	59 (19) <sup>a</sup>	0.07	0.10[-0.40-0.61]	-0.53[-1.03- -0.02]	0.64[-1.14- -0.13]
Dinner	43 (14)	48 (20)	47 (12)	0.19	0.45[-0.06-0.96]	0.36[-0.14-0.87]	-0.08[-0.59-0.42]
Total	111 (30)	117 (30)	105 (24)	0.15	0.38[-0.13-0.89]	-0.16[-0.67-0.34]	-0.55[-1.05- -0.04]
Proteins (%)							
Lunch	22.6 (1.5)	24.1 (3.5)	22.7 (2.9)	0.35	0.42[-0.09-0.92]	-0.01[-0.52-0.49]	-0.43[-0.94-0.08]
Dinner	21.2 (5.0)	23.8 (6.1)	24.6 (7.1) <sup>*</sup>	0.04	0.44[0.07-0.94]	0.54[0.03-1.04]	0.11[-0.40-0.61]
Total	22.0 (2.5)	24.1 (3.7)	23.5 (3.7) <sup>*</sup>	0.06	0.52[0.02-1.03]	0.37[0.14-0.88]	0.15[-0.66-0.35]
Lipids (g)							
Lunch	42 (16)	39 (13)	29 (11) <sup>**a</sup>	0.02	-0.13[-0.64-0.37]	-0.81[-1.31- -0.30]	-0.68[-1.19- -0.18]
Dinner	28 (13)	21 (12)	27 (18)	0.40	-0.40[-0.91-0.11]	-0.06[-0.57-0.44]	0.34[-0.17-0.84]
Total	70 (23)	60 (22)	56 (25)	0.30	-0.34[-0.84-0.17]	-0.51[-1.02- -0.01]	-0.18[-0.69-0.32]
Lipids (%)							
Lunch	30.6 (5.9)	30.1 (7.3)	24.6 (4.2) <sup>**b</sup>	0.05	-0.07[-0.57-0.44]	-0.77[-1.28- -0.26]	-0.71[-1.21- -0.20]
Dinner	30.8 (8.4)	22.4 (9.8)	29.2 (15.4)	0.21	-0.55[-1.06- -0.04]	-0.10[-0.61-0.40]	0.45[-0.06- 0.95]
Total	30.8 (4.8)	27.1 (7.0)	26.7 (8.1)	0.27	-0.43[-0.93-0.08]	-0.48[-0.99-0.02]	-0.06[-0.57-0.45]
CHO (g)							
Lunch	136 (30)	127 (26)	131 (43)	0.76	-0.19[-0.69-0.32]	-0.12[-0.63-0.38]	0.06[-0.44-0.57]
Dinner	94 (18)	106 (33)	90 (38)	0.13	0.37[-0.14-0.87]	-0.14[-0.64-0.37]	-0.51[-1.01-0.00]
Total	230 (38)	234 (49)	221 (65)	0.31	0.07[-0.43-0.58]	-0.15[-0.66-0.36]	-0.22[-0.73-0.28]
CHO (%)							
Lunch	45.8 (6.6)	45.3 (9.4)	50.5 (9.7)	0.35	-0.06[-0.57-0.44]	0.45[-0.05-0.96]	0.52[0.01-1.03]
Dinner	48.5 (9.7)	54.3 (11.5)	46.6 (16.2)	0.10	0.40[0.11-0.91]	-0.24[-0.75-0.26]	-0.65[-1.15- -0.14]
Total	46.9 (6.4)	48.7 (8.9)	49.0 (10.5)	0.78	0.16[-0.34-0.67]	-0.21 [-0.30-0.71]	0.05[-0.46-0.55]

EX-60: Exercise 60 min before test meal; EX-180: Exercise 180 min before test meal; SD: Standard Deviations; \*p < 0.05 versus CON; \*\*p < 0.01 versus CON; \*\*\*p < 0.001 versus CON; <sup>a</sup>p < 0.05 EX-60 vs EX-180; <sup>b</sup>p < 0.01 EX-60 vs EX-180; <sup>c</sup>p < 0.001 EX-60 vs EX-180.

Table 1 details the results related to absolute and relative energy intake. Lunch, dinner and total daily absolute *ad libitum* energy intake were not significantly different between conditions. Lunch REI was significantly higher in CON compared with EX-60 (p < 0.001). Total REI was not different between conditions.

As shown in Table 2, while the dinner and total absolute (in g) ingestion of protein did not differ significantly between conditions, the ANOVA showed a tendency at lunch (p = 0.07) with a lower ingestion on EX-60 compared with EX-180 (p = 0.027). The relative energy ingested from proteins at lunch was not different between conditions with however a lower relative intake of proteins at dinner on CON compared with EX-60 (p = 0.02). There was a tendency for the percentage of energy ingested from proteins to be different between conditions (p = 0.06) with CON lower than EX-180 (p = 0.04) and EX-60 (p = 0.04). The absolute consumption of fat was significantly lower on EX-60 compared with both CON (p = 0.01) and EX-180 (p = 0.02) at lunch. Dinner and total fat intake was not different between conditions. While there was no difference between the three experimental sessions for dinner and total relative intake of fat, it was significantly lower on EX-60 compared with CON (p = 0.02) and EX-180 (p = 0.05) at lunch. The absolute and relative intake of carbohydrates (CHO in g and %) did not differ significantly between conditions.

Table 3 details the results related to appetite sensations. Fasting hunger, 60-minute post-meal AUC and total daily hunger AUC were not different between conditions. However, there was a tendency for pre-lunch hunger to be different between conditions (p = 0.08) with CON lower than EX-180 (p = 0.02). Similarly there was a tendency for SQ hunger to differ between conditions (p = 0.06) with CON lower than EX-180 (p = 0.03) and EX-60 (p = 0.04). None of the fullness variables were significantly different between conditions. Fasting, 60-min post-meal AUC and total daily AUC for PFC were not different between conditions. Pre-lunch PFC was significantly lower in CON compared with both EX-180 (p = 0.003) and EX-60 (p = 0.01). SQ for PFC was significantly lower in CON compared with both EX-180 (p = 0.006) and EX-60 (p = 0.003). Fasting and 60-min post-meal AUC for DTE were not different between conditions. Pre-lunch DTE was significantly lower in CON compared with EX-180 (p = 0.001) and EX-60 (p = 0.004). SQ

for DTE was significantly lower in CON compared with EX-180 (p = 0.01) and EX-60 (p = 0.001). Total daily AUC for DTE was significantly lower in CON compared with EX-180 (p = 0.003) and EX-60 (p = 0.008).

As detailed in Table 4, there were no main effects of condition or time (pre-to post-meal) on preference (choice, liking or wanting) for high fat relative to low fat or sweet relative to savoury foods. We found a significant time × condition interaction between CON and EX-180 for Implicit (p = 0.01) and Explicit Wanting (p = 0.05) Taste bias. Post hoc analyses revealed a decrease in liking for high fat food in response to the test meal in EX-180 while there was an increase in EX-60. A significant condition effect was found for explicit liking for high fat food before the test meal (p = 0.03) with liking for high-fat foods in EX-60 being significantly lower than EX-180 (p = 0.001). A significant condition effect was also observed for explicit liking for sweet food post-meal (p = 0.005), with CON having significantly lower liking for sweet compared to EX-180 (p = 0.002). Explicit liking for sweet was also significantly reduced after the *ad libitum* test meal in CON (p = 0.001).

#### 4. Discussion

Based on the increasing prevalence of pediatric obesity, there is a growing interest and need for the development of effective weight management strategies and interventions. This requires a clear understanding of the regulation of energy balance and control over appetite in adolescents with obesity. The current literature provides growing evidence regarding the effect of the intensity (Prado et al., 2015; Thivel et al., 2011, 2012, 2014), duration (Hintze et al., 2019; Masurier et al., 2018; Schippers, Adam, Smolenski, Wong, & de Wit, 2017; Tamam et al., 2012) and modality (Julian et al., 2019; Thivel et al., 2016b) of exercise as important considerations in weight loss interventions. Although recently proposed as an essential component to consider to improve interventions, the timing of exercise in relation to meals remains poorly explored (Reid, Thivel, & Mathieu, 2019). In that context, the present work questioned the effect of the delay between exercise and the following meal on energy intake, appetite sensations and food reward in adolescents with obesity.

**Table 3**  
Appetite sensation and satiety quotient results.

	CON	EX-180	EX-60	p	ES		
	Mean (SD)	Mean (SD)	Mean (SD)		CON vs. EX-180	CON vs. EX-60	EX-180 vs. EX-60
<b>Hunger</b>							
SQ (mm/kcal)	6.5 (3.4)	8.5 (4.3)*	8.0 (5.0)*	0.06	0.74[0.23–1.25]	0.73[0.22–1.23]	0.03[-0.48-0.54]
AUC 60min post lunch (mm <sup>2</sup> )	336 (292)	185 (177)	208 (349)	0.12	-0.61[-1.12- -0.10]	-0.04[-0.86-0.15]	0.23[-0.27-0.74]
Total AUC (mm <sup>2</sup> )	29279 (12259)	28637 (14108)	27559 (15246)	0.52	0.08[-0.42-0.59]	0.24[-0.27-0.74]	0.17[-0.34-0.67]
<b>Fullness</b>							
SQ (mm/kcal)	-6.5 (4.3)	-7.4 (4.7)	-6.6 (3.8)	0.35	-0.14[-0.65-0.36]	-0.02[-0.53-0.48]	0.12[-0.39-0.62]
AUC 60min post lunch (mm <sup>2</sup> )	6661 (2820)	6280 (2820)	5265 (3207)	0.24	-0.11[-0.62-0.39]	-0.36[-0.87-0.14]	-0.25[-0.76-0.25]
Total AUC (mm <sup>2</sup> )	50993 (26460)	43929 (26341)	39070 (22711)	0.15	-0.37[-0.88-0.13]	-0.53[-1.04- -0.03]	-0.18[-0.69-0.32]
<b>PFC</b>							
SQ (mm/kcal)	4.2 (2.9)	7.6 (3.3)**	7.8 (3.3)**	0.006	0.86[0.35–1.37]	0.94[0.43–1.44]	0.10[-0.40-0.61]
AUC 60min post lunch (mm <sup>2</sup> )	645 (848)	458 (524)	711 (1162)	0.35	-0.18[-0.68-0.33]	0.10[-0.40-0.61]	0.27[-0.23-0.78]
Total AUC (mm <sup>2</sup> )	25864 (15508)	32451 (16219)	32169 (16941)	0.10	0.56[0.06–1.07]	0.69[0.19–1.20]	0.16[-0.35-0.67]
<b>DTE</b>							
SQ (mm/kcal)	5.1 (2.9)	7.8 (3.5)*	8.8 (3.7)**	0.004	0.81[0.31–1.32]	1.11[0.60–1.62]	0.34[-0.16-0.85]
AUC 60min post lunch (mm <sup>2</sup> )	391 (407)	445 (450)	553 (713)	0.45	0.09[-0.41-0.60]	0.28[-0.23-0.78]	0.19[-0.32-0.70]
Total AUC (mm <sup>2</sup> )	25490 (13109)	33632 (16315)**	31381 (17162)**	0.0063	0.86[0.35–1.36]	0.83[0.33–1.34]	0.02[-0.48-0.53]

CON: rest condition; EX-60: Exercise 60 min before test meal; EX-180: Exercise 180 min before test meal; SD: Standard Deviations; SQ: Satiety Quotient; AUC: Area Under the Curve; PFC: Prospective Food Consumption; DTE: Desire To Eat; \*p < 0.05 versus CON; \*\*p < 0.01 versus CON; \*\*\*p < 0.001 versus CON; <sup>a</sup>p < 0.05 EX-60 vs EX-180; <sup>b</sup>p < 0.01 EX-60 vs EX-180; <sup>c</sup>p < 0.001 EX-60 vs EX-180.

**Table 4**  
Pre- and Post-test meal food reward on the three experimental conditions.

	CON	EX-180	EX-60	p	Interaction time x condition		
	Mean (SD)	Mean (SD)	Mean (SD)		CON vs. EX-180	CON vs. EX-60	EX-180 vs. EX-60
<b>Choice</b>							
<b>Fat Bias</b>							
Before meal	4.0 (7.1)	4.4 (10.4)	1.6 (9.0)	0.38	0.91	0.80	0.77
After meal	3.0 (8.1)	4.2 (10.2)	1.4 (6.5)	0.36			
<i>p before vs. after meal</i>	0.64	0.83	0.92		0.03[-0.48-0.54]	0.06[-0.44- 0.57]	0.07[-0.43-0.58]
<b>Taste Bias</b>							
Before meal	0.6 (11.6)	1.8 (12.1)	2.3 (16.2)	0.96	0.94	0.73	0.95
After meal	-0.2 (11.3)	0.2 (13.4)	0.4 (12.5)	0.88			
<i>p before vs. after meal</i>	0.49	0.37	0.47		-0.02[-0.53-0.48]	-0.09[-0.59-0.42]	0.01[-0.49-0.52]
<b>Implicit Wanting</b>							
<b>Fat Bias</b>							
Before meal	8.3 (20.8)	17.0 (30.2)	-1.2 (32.8)	0.19	0.44	0.74	0.09
After meal	6.7 (44.5)	1.7 (30.8)	3.7 (17.5)	0.93			
<i>p before vs. after meal</i>	0.89	0.03	0.90		-0.20[-0.70-0.31]	0.09[-0.42-0.59]	-0.43[-0.94-0.07]
<b>Taste Bias</b>							
Before meal	-2.9 (26.7)	8.4 (32.5)	-0.9 (42.7)	0.40	0.01	0.27	0.40
After meal	12.0 (34.6)	-4.7 (27.2)	-0.8 (39.1)	0.23			
<i>p before vs. after meal</i>	0.01	0.13	0.99		-0.62[-1.13- -0.11]	-0.28[-0.79-0.22]	-0.22[-0.72-0.29]
<b>Explicit Wanting</b>							
<b>Fat Bias</b>							
Before meal	18.2 (16.2)	13.7 (11.2)	14.1 (10.7)	0.46	0.53	0.86	0.42
After meal	13.5 (9.6)	12.4 (8.7)	8.1 (9.9)	0.41			
<i>p before vs. after meal</i>	0.06	0.77	0.07		0.16[-0.35-0.67]	0.04[-0.46-0.55]	0.21[-0.30-0.71]
<b>Taste Bias</b>							
Before meal	22.8 (23.3)	16.5 (8.4)	22.5 (23.0)	0.40	0.05	0.09	0.98
After meal	7.6 (8.3)	16.5 (21.7)	7.7 (6.2)	0.16			
<i>p before vs. after meal</i>	0.01	0.13	0.99		0.51[0.00–1.01]	0.44[-0.07-0.94]	0.01[-0.50-0.51]
<b>Explicit Liking</b>							
<b>Fat Bias</b>							
Before meal	11.7 (13.2)	15.3 (12.3)	8.4 (6.9) <sup>c</sup>	0.03	0.62	0.09	0.01
After meal	9.5 (7.5)	11.0 (10.7)	15.8 (15.4)	0.41			
<i>p before vs. after meal</i>	0.62	0.30	0.02		-0.13[-0.63-0.38]	0.43[-0.08-0.94]	-0.63[-1.13- -0.12]
<b>Taste Bias</b>							
Before meal	17.4 (12.1)	13.8 (10.9)	19.2 (16.1)	0.47	0.52	0.25	0.07
After meal	4.0 (3.9)	12.9 (20.5)**	10.4 (6.3)	0.005			
<i>p before vs. after meal</i>	0.001	0.9	0.25		0.16[-0.34-0.67]	0.30[-0.21-0.80]	0.46[-0.05-0.96]

CON: rest condition; EX-60: Exercise 60 min before test meal; EX-180: Exercise 180 min before test meal; SD: Standard Deviations; \*p < 0.05 versus CON; \*\*p < 0.01 versus CON; \*\*\*p < 0.001 versus CON; <sup>a</sup>p < 0.05 EX-60 vs EX-180; <sup>b</sup>p < 0.01 EX-60 vs EX-180; <sup>c</sup>p < 0.001 EX-60 vs EX-180.

Although our results did not show any significant difference in absolute energy intake between conditions (CON vs. exercise set 60 or 180 min before lunch), a mean reduction of approximately 170 kcal was observed when the exercise was performed closer to lunch (EX-60), which might be of clinical interest. Indeed, lunch and total food consumption were reduced by 14.4% and 9.2% respectively in EX-60 compared with the CON, which could be of importance for weight loss. This reduction of 170 kcal of the adolescents' energy intake, combined with the 186 kcal of energy expended on average during the exercise, can propose a reduction of their daily energy balance of about 350 kcal, which can definitely favor weight loss if repeated over time (the chronic effect remaining to be further studied). Our results are in line with previously published studies showing reduced energy intake 30 min after an acute exercise bout (Miguet et al., 2018; Prado et al., 2014; Thivel et al., 2012, 2014) while early-morning and mid-morning exercise bouts were not found to impact subsequent food intake in adolescents with obesity (Fearnbach et al., 2016; Tamam et al., 2012; Thivel et al., 2019b). The moderate intensity of our exercise (65%  $VO_{2peak}$ ) that has been selected based on the adolescents low fitness and physical activity level, might explain why the observed decrease in EI did not reach statistical significance since the anorexigenic effect of acute exercise has been mainly described after intensive exercise (Prado et al., 2014; Thivel et al., 2012, 2016b). However, our results reinforced that moderate-to-high intensity exercise could also have a beneficial, also suppressive, effect on subsequent food consumption in adolescents with obesity, as previously proposed by Fearnbach et al. (Fearnbach et al., 2016, 2017). Importantly, lunch REI was significantly lower in the EX-60 compared with CON, underlying the importance of the observed decrease in energy intake that allows a negative energy balance when combined with the energy expenditure induced by exercise, contrary to what is observed in response to EX-180. We found only one study that examined the effect of the timing of exercise on subsequent nutritional responses in lean adolescents (Albert et al., 2015). In their work, adolescents cycled for 30 min either 135 min or immediately before a lunch test meal. Their results corroborate the present study showing lower food intake at lunch when exercise is performed immediately before the test meal compared with after a delay (Albert et al., 2015). Similarly, they did not observe any compensation at the dinner test meal, which is also in line with our results.

While most of the studies conducted in the field have used specific buffet meals composed of single items (such as pizzas or yogurts for instance), the present work used a balanced buffet meal offering several items selected to avoid any over-, under- or occasional-consumption (as previously validated, (Thivel et al., 2016a)). This provides the opportunity to also assess the repartition of the macronutrient intake. According to our results, the relative and absolute consumption of lipids was significantly reduced at lunch during the EX-60 condition compared with both CON and EX-180. This is similar to the 23% and 12% reductions observed by Albert et al. for the absolute and relative ingestion of lipids, respectively, when the exercise is performed immediately before the meal compared to 135 min before (Albert et al., 2015). Also in accordance with Albert et al., the consumption of carbohydrates (relative and absolute) was not different between conditions. Although the consumption of proteins remained unchanged in normal-weight adolescents regardless of the timing between exercise and the test meal (Albert et al., 2015), in the current study, absolute intake decreased at lunch in EX-60 compared to EX-180 in adolescents with obesity. Moreover, the daily (total) relative energy ingested through proteins appeared reduced after exercise independently from its timing (EX-60 or EX-180) compared to control. This lower protein consumption is in line with previous studies investigating the effect of an acute exercise bout performed 30 min before an *ad libitum* lunch meal in similar populations (Miguet et al., 2018; Prado et al., 2014). Despite an increasing number of studies assessing the nutritional responses to acute exercise in children and adolescents, as only a few have used buffet meals to allow for the differentiation of macronutrient

consumption, this makes it difficult to draw any firm conclusions.

Regarding appetite sensations, despite PFC and DTE being higher immediately before lunch in both exercise conditions (EX-180 and EX-60), hunger sensations were increased in EX-180 only. Interestingly, this higher hunger sensation after EX-180 was not accompanied by increased energy intake and similarly, the higher PFC and DTE observed after EX-60 appear contradictory with the reduction in food intake. Such results strengthen once more the conclusions of previous studies suggesting an uncoupling effect of exercise on subsequent subjective appetite and effective energy intake in children and adolescents (for review see (Thivel & Chaput, 2014)).

In addition to an effect on appetite sensations, some recent studies also examined the effect of exercise on the satiating effect of food by calculating SQ. This indicator of the satiating effect of food integrates in its calculation both the caloric quantity of food ingested during a meal and the associated change in appetite (Green, Delargy, Joanes, & Blundell, 1997). In adolescents with obesity, SQ has been found to be unchanged in response to acute exercise (with or without post-exercise energy replacement strategy) (Thivel et al., 2019b). Interestingly, in their study also investigating the effect of exercise timing, Albert and colleagues also did not find any changes in SQ at their lunch meal, regardless of the delay from exercise (30 vs. 135 min) in lean adolescents (Albert et al., 2015). Contradictory, we found significant differences in SQ for hunger, PFC and DTE between both exercise sessions *versus* CON. This difference in SQ might suggest that, regardless of the timing, exercise could have an effect on the satiating effect of food in this population. While it has been shown that SQ can be a predictor of subsequent energy intake (Drapeau et al., 2007), we did not find any energy intake differences at dinner. The SQ results in the current study should be interpreted with caution as they were calculated at an *ad libitum* meal and their validity and reproducibility remain to be clarified, especially in adolescents with obesity.

Interestingly, the present study also examined the potential effect of exercise and its timing on food reward. Using the Leeds Food Preference Questionnaire (LFPQ), our results mainly show a significantly lower pre-meal explicit liking for high-fat relative to low-fat foods in EX-60 compared to EX-180 that seems to be in line with the observed reduced energy intake in EX-60 and not EX-180. Moreover, we observed a significant time (pre-post meal) x condition interaction for explicit liking for high-fat foods. There was a decrease in liking in response to the test meal in EX-180 while there was an increase in EX-60 leading to similar post-meal values, which might contribute to the observed similar energy intake at dinner between conditions. These results are in line with recent studies showing reduced explicit liking for high-fat foods only in response to acute exercise in adolescents with obesity (Thivel et al., 2019b). The present results are however contradictory with those from Miguet and colleagues who observed reduced relative preference for fat and sweet taste, and implicit wanting for high-fat foods (also using the LFPQ) in response to an *ad libitum* meal set 30 min after a 16-minute cycling high intensity interval exercise in a similar population (Miguet et al., 2018). Although these studies seem to indicate a potential effect of acute exercise on food reward in adolescents with obesity, evidence remains limited in this population and further investigations are required.

The present work is the first, to our knowledge, to examine the nutritional response to exercise by varying the delay between exercise and the subsequent meal in adolescents with obesity. The well-controlled nature of the present design and the use of an objective measurement of energy intake are the two main strengths of the present study. However, the results must be interpreted in light of some limitations. Mainly, these include the lack of a direct measurement of energy expenditure during exercise, using indirect calorimetry, as well as the lack of a lean control group to examine a potential weight status effect. Similarly, the IPAQ questionnaire has been used to assess the adolescents' initial physical activity level while its validity remains uncertain in this population. Importantly, the fact that are sample

excluded adolescents presenting a high level of cognitive restriction must also be underlined. Indeed, further studies should compare the appetite and energy intake responses to acute exercise between children and adolescents with low of high level of cognitive restriction that might affect their responses, as recently suggested (Miguet et al., 2019a; 2019b). It would have been also interesting to extend the evaluation of energy intake over the following 24–48 h (Thivel et al., 2012), which was not possible for practical reasons. The laboratory-based nature of this study might also have affected our results compared to free-living conditions, such as the school setting, as previously suggested by Mathieu and collaborators in healthy lean adolescents (Mathieu et al., 2018).

## 5. Conclusion

To conclude, the present study highlights the importance of the exercise-meal timing to optimize its effect on energy balance, showing a reduced energy balance (because of a sufficient, while not significant, decrease in absolute energy intake and significantly reduced REI) when exercise is performed close to a meal (compared with a longer delay). While food reward seems to be implicated, further studies are needed in this field, comparing for instance different timings, the potential synergic effect of the exercise-timing and intensity or considering this meal-exercise delay with the breakfast or dinner; in order to improve future exercise prescriptions and implement efficient weight loss strategies.

## Funding

This research did not receive any specific grant from funding agencies in the public, commercial, or not-for-profit sectors.

## Declaration of competing interest

None.

## Acknowledgements

The authors are grateful to all of the adolescents that participated in the program, and to the Nutrition Obesity Ambulatory Hospital (UGEAM) that provided their generous support.

## References

- Albert, M.-H., Drapeau, V., & Mathieu, M.-E. (2015). Timing of moderate-to-vigorous exercise and its impact on subsequent energy intake in young males. *Physiology & Behavior*, *151*, 557–562.
- Blundell, J. E., Gibbons, C., Caudwell, P., Finlayson, G., & Hopkins, M. (2015). Appetite control and energy balance: Impact of exercise. *Obesity Reviews*, *16*, 67–76.
- Bryant, E. J., Thivel, D., Chaput, J.-P., Drapeau, V., Blundell, J. E., & King, N. A. (2018). Development and validation of the child three-factor eating questionnaire (CTFEQr17). *Public Health Nutrition*, *21*, 2558–2567.
- Carnier, J., Mello, M. T. de, Ackel-DElia, C., Corgosinho, F. C., da Silveira Campos, R. M., de Lima Sanches, P., et al. (2013). Aerobic training (AT) is more effective than aerobic plus resistance training (AT + RT) to improve anorexigenic/orexigenic factors in obese adolescents. *Appetite*, *69*, 168–173.
- Cohen, J. (1988). *Statistical power analysis for the behavioral sciences* (2nd ed.). (New Jersey).
- Cole, T. J., Bellizzi, M. C., Flegal, K. M., & Dietz, W. H. (2000). Establishing a standard definition for child overweight and obesity worldwide: International survey. *BMJ*, *320*, 1240.
- Craig, C. L., Marshall, A. L., Sjöström, M., Bauman, A. E., Booth, M. L., Ainsworth, B. E., et al. (2003). International physical activity questionnaire: 12-country reliability and validity. *Medicine & Science in Sports & Exercise*, *35*, 1381–1395.
- Dalton, M., & Finlayson, G. (2014). Psychobiological examination of liking and wanting for fat and sweet taste in trait binge eating females. *Physiology & Behavior*, *136*, 128–134.
- Donnelly, J. E., Herrmann, S. D., Lambourne, K., Szabo, A. N., Honas, J. J., & Washburn, R. A. (2014). Does increased exercise or physical activity alter ad-libitum daily energy intake or macronutrient composition in healthy adults? A systematic review. *PLoS One*, *9*, e83498.
- Drapeau, V., King, N., Hetherington, M., Doucet, E., Blundell, J., & Tremblay, A. (2007). Appetite sensations and satiety quotient: Predictors of energy intake and weight loss. *Appetite*, *48*, 159–166.
- Fearnbach, S. N., Silvert, L., Keller, K. L., Genin, P. M., Morio, B., Pereira, B., et al. (2016). Reduced neural response to food cues following exercise is accompanied by decreased energy intake in obese adolescents. *International Journal of Obesity*, *40*, 77–83 2005.
- Fearnbach, S. N., Silvert, L., Pereira, B., Boirie, Y., Duclos, M., Keller, K. L., et al. (2017). Reduced neural responses to food cues might contribute to the anorexigenic effect of acute exercise observed in obese but not lean adolescents. *Nutr. Res. N. Y. N.*, *44*, 76–84.
- Feise, R. J. (2002). Do multiple outcome measures require p-value adjustment? *BMC Medical Research Methodology*, *2*, 8.
- Finlayson, G., King, N., & Blundell, J. (2008). The role of implicit wanting in relation to explicit liking and wanting for food: Implications for appetite control. *Appetite*, *50*, 120–127.
- Flint, A., Raben, A., Blundell, J. E., & Astrup, A. (2000). Reproducibility, power and validity of visual analogue scales in assessment of appetite sensations in single test meal studies. *Int. J. Obes. Relat. Metab. Disord. J. Int. Assoc. Study Obes.*, *24*, 38–48.
- Green, S. M., Delargy, H. J., Joanes, D., & Blundell, J. E. (1997). A satiety quotient: A formulation to assess the satiating effect of food. *Appetite*, *29*, 291–304.
- Hall, K. D., Heymsfield, S. B., Kemnitz, J. W., Klein, S., Schoeller, D. A., & Speakman, J. R. (2012). Energy balance and its components: Implications for body weight regulation. *American Journal of Clinical Nutrition*, *95*, 989–994.
- Hintze, L. J., Goldfield, G., Seguin, R., Damphousse, A., Riopel, A., & Doucet, É. (2019). The rate of weight loss does not affect resting energy expenditure and appetite sensations differently in women living with overweight and obesity. *Physiology & Behavior*, *199*, 314–321.
- Hunschede, S., Kubant, R., Akilen, R., & Anderson, G. H. (2017). *The role of IL-6 in appetite suppression after high-intensity 1 exercise in normal-weight 2 and obese boys.*
- Julian, V., Thivel, D., Miguet, M., Pereira, B., Costes, F., Coudeyre, E., et al. (2019). Eccentric cycling is more efficient in reducing fat mass than concentric cycling in adolescents with obesity. *Scandinavian Journal of Medicine & Science in Sports*, *29*, 4–15.
- Masurier, J., Mathieu, M.-E., Fearnbach, S. N., Cardenoux, C., Julian, V., Lambert, C., et al. (2018). Effect of exercise duration on subsequent appetite and energy intake in obese adolescent girls. *International Journal of Sport Nutrition and Exercise Metabolism*, *28*, 593–601.
- Mathieu, M.-E., Lebkowski, A., Laplante, E., Drapeau, V., & Thivel, D. (2018). Optimal timing of exercise for influencing energy intake in children during school lunch. *Appetite*, *120*, 416–422.
- Miguet, M., Fearnbach, S., Khammassi, M., Julian, V., & Cardenoux, C. (2019b). Effect of HIIT versus MICT on body composition and energy intake in dietary restrained and unrestrained adolescents with obesity. *Applied Physiology Nutrition and Metabolism* (in press).
- Miguet, M., Fillon, A., Khammassi, M., Masurier, J., Julian, V., Pereira, B., et al. (2018). Appetite, energy intake and food reward responses to an acute High Intensity Interval Exercise in adolescents with obesity. *Physiology & Behavior*, *195*, 90–97.
- Miguet, M., Masurier, J., Chaput, J.-P., Pereira, B., Lambert, C., Dâmaso, A. R., et al. (2019a). Cognitive restriction accentuates the increased energy intake response to a 10-month multidisciplinary weight loss program in adolescents with obesity. *Appetite*, *1*, 125–134.
- Nemet, D., Arieli, R., Meckel, Y., & Eliakim, A. (2010). Immediate post-exercise energy intake and macronutrient preferences in normal weight and overweight pre-pubertal children. *Int. J. Pediatr. Obes. LIPO Off. J. Int. Assoc. Study Obes.*, *5*, 221–229.
- Prado, W. L., Balagopal, P. B., Lofrano-Prado, M. C., Oyama, L. M., Tenório, T. R., Botero, J. P., et al. (2014). Effect of aerobic exercise on hunger feelings and satiety regulating hormones in obese teenage girls. *Pediatric Exercise Science*, *26*, 463–469.
- Prado, W. L., Lofrano-Prado, M. C., Oyama, L. M., Cardel, M., Gomes, P. P., Andrade, M. L. S. S., et al. (2015). Effect of a 12-week low vs. High intensity aerobic exercise training on appetite-regulating hormones in obese adolescents: A randomized exercise intervention study. *Pediatric Exercise Science*, *27*, 510–517.
- Reid, R. E. R., Thivel, D., & Mathieu, M.-E. (2019). Understanding the potential contribution of a third “T” to FITT exercise prescription: The case of timing in exercise for obesity and cardiometabolic management in children. *Appl. Physiol. Nutr. Metab. Physiol. Appl. Nutr. Metab.*, *44*, 911–914.
- Rothman, K., & Greenland, S. (1998). *Modern epidemiology*. Philadelphia: Lippencott-Raven.
- Rowland, T. W. (1993). Does peak VO<sub>2</sub> reflect VO<sub>2</sub>max in children?: Evidence from supramaximal testing. *Medicine & Science in Sports & Exercise*, *25*, 689–693.
- Schippers, M., Adam, P. C. G., Smolenski, D. J., Wong, H. T. H., & de Wit, J. B. F. (2017). A meta-analysis of overall effects of weight loss interventions delivered via mobile phones and effect size differences according to delivery mode, personal contact, and intervention intensity and duration. *Obesity .Reviews.Official.Journal.International.Association.Study. Obesity*, *18*, 450–459.
- Schubert, M. M., Desbrow, B., Sabapathy, S., & Leveritt, M. (2013). Acute exercise and subsequent energy intake. A meta-analysis. *Appetite*, *63*, 92–104.
- Tamam, S., Bellissimo, N., Patel, B. P., Thomas, S. G., & Anderson, G. H. (2012). Overweight and obese boys reduce food intake in response to a glucose drink but fail to increase intake in response to exercise of short duration. *Applied Physiology Nutrition and Metabolism*, *37*, 520–529.
- Thivel, D., & Chaput, J.-P. (2014). Are post-exercise appetite sensations and energy intake coupled in children and adolescents? *Sports Medicine*, *44*, 735–741.
- Thivel, D., Finlayson, G., & Blundell, J. E. (2019a). Homeostatic and neurocognitive control of energy intake in response to exercise in pediatric obesity: A psychobiological framework. *Obesity .Reviews.Official.Journal.International.Association.Study. Obesity*, *20*, 316–324.



- Thivel, D., Finlayson, G., Miguet, M., Pereira, B., Duclos, M., Boirie, Y., et al. (2018). Energy depletion by 24-h fast leads to compensatory appetite responses compared with matched energy depletion by exercise in healthy young males. *British Journal of Nutrition*, *120*, 583–592.
- Thivel, D., Genin, P. M., Mathieu, M.-E., Pereira, B., & Metz, L. (2016a). Reproducibility of an in-laboratory test meal to assess ad libitum energy intake in adolescents with obesity. *Appetite*, *105*, 129–133.
- Thivel, D., Isacco, L., Montaurier, C., Boirie, Y., Duché, P., & Morio, B. (2012). The 24-h energy intake of obese adolescents is spontaneously reduced after intensive exercise: A randomized controlled trial in calorimetric chambers. *PLoS One*, *7*.
- Thivel, D., Isacco, L., Rousset, S., Boirie, Y., Morio, B., & Duché, P. (2011). Intensive exercise: A remedy for childhood obesity? *Physiology & Behavior*, *102*, 132–136.
- Thivel, D., Metz, L., Julien, A., Morio, B., & Duché, P. (2014). Obese but not lean adolescents spontaneously decrease energy intake after intensive exercise. *Physiology & Behavior*, *123*, 41–46.
- Thivel, D., Roche, J., Miguet, M., Fillon, A., Khammassi, M., Finlayson, G., et al. (2019b). Post-exercise energy replacement does not reduce subsequent appetite and energy intake in adolescents with obesity. *Obesity.Facts*, *12*, 120–122.
- Thivel, D., Rumbold, P. L., King, N. A., Pereira, B., Blundell, J. E., & Mathieu, M.-E. (2016b). Acute post-exercise energy and macronutrient intake in lean and obese youth: A systematic review and meta-analysis. *International Journal of Obesity*, *40*, 1469–1479 2005.
- WHO Multicentre Growth Reference Study Group (2006). WHO Child Growth Standards based on length/height, weight and age. *Acta Paediatr. Oslo Nor.* *450*, 76–85 1992 Suppl.

**Delayed meal timing after exercise is associated with reduced appetite and energy intake in adolescents with obesity.**

**Fillon, A.**, Beaulieu, K., Miguet, M., Bailly, M., Finlayson, G., Julian, V., Masurier, J., Pereira, B., Duclos, M., Boirie, Y., & Thivel, D.



*Under review in Pediatric Obesity*

# **Delayed meal timing after exercise is associated with reduced appetite and energy intake in adolescents with obesity**

Fillon Alicia<sup>1,2</sup>, Beaulieu Kristine<sup>3</sup>, Miguet Maud<sup>1</sup>, Bailly Mélina<sup>1</sup>, Finlayson Graham<sup>3</sup>, Julian Valérie<sup>4</sup>, Masurier Julie<sup>2</sup>, Pereira Bruno<sup>5</sup>, Duclos Martine<sup>1,4</sup>, Boirie Yves<sup>1,4</sup>, Thivel David<sup>1,3</sup>.

<sup>1</sup>Clermont Auvergne University, EA 3533, Laboratory of the Metabolic Adaptations to Exercise under Physiological and Pathological Conditions (AME2P), Clermont-Ferrand, France.

<sup>2</sup>UGECAM Nutrition Obesity Ambulatory Hospital, Clermont-Ferrand, France.

<sup>3</sup>School of Psychology, Faculty of Medicine and Health, University of Leeds, Leeds, LS2 9JT, UK

<sup>4</sup>CHU Clermont-Ferrand, Clermont-Ferrand, France.

<sup>5</sup>Clermont-Ferrand University hospital, Biostatistics unit (DRCI), Clermont-Ferrand, France.

**Key words :** Exercise Timing, Appetite, Energy Intake, Obesity, Adolescent, Food reward

**Running title :** Exercise-meal timing in adolescents with obesity

## **Corresponding Author :**

Melle FILLON Alicia

Clermont University, EA 3533, Laboratory of the Metabolic Adaptations to Exercise under Physiological and Pathological Conditions (AME2P), BP 80026, F-63171 Aubière cedex, France

[fillonalicia@gmail.com](mailto:fillonalicia@gmail.com)

Phone and fax/ 0033 4 73 40 76 79

## **Abstract**

**Background.** While the beneficial effects of exercise on appetite might depend on its timing during the day or relative to a meal, this remains poorly explored in youth.

**Objectives.** To examine the importance of meal timing (+30vs.+90minutes) after performing exercise on energy intake, appetite and food reward in adolescents with obesity.

**Methods.** Eighteen adolescents with obesity randomly completed 3 conditions: i) lunch (12:00pm) set 30min after a rest session (11:00am); ii) lunch (12:00pm) set 30min after an exercise session (11:00 am)(MEAL-30); iii) lunch (01:00pm) set 90min after an exercise session (11:00am)(MEAL-90). Lunch and dinner ad libitum energy intake was assessed, food reward (LFPQ) assessed before and after lunch, and before dinner, appetite sensations were assessed at regular intervals.

**Results.** Energy intake was lower at MEAL-90 than MEAL-30 and CON at lunch ( $p<0.05$  and  $p<0.01$ , respectively) and lunch+dinner combined( $p<0.001$ ). A decrease in intake (g) of protein, fat and carbohydrate was observed. Post-exercise hunger was lower on MEAL-90 compared with CON. No condition effects were found at lunch for food reward.

**Conclusions.** Delaying the timing of the meal after exercise might help affect energy balance by decreasing ad libitum energy intake without increasing hunger and by improving satiety in adolescents with obesity.

**Key words.** Exercise Timing, Appetite, Energy Intake, Obesity, Adolescent, Food reward

**CT reference:** NCT03968458

## **Introduction**

While practitioners and clinicians constantly work on the improvement of their weight loss interventions, trying to identify the best exercise characteristics (modality, intensity, duration, etc) to prescribe, the need to also consider the timing of exercise has been recently suggested (Reid, Thivel, et al., 2019b). Recent studies effectively show that the beneficial effects of exercise might also depend on its timing during the day or its delay/position regarding a meal (Reid, Thivel, et al., 2019b). Some studies for instance showed that performing acute exercise one to three hours after a meal could enhance the glycemic response in patients with type II diabetes (Borror et al., 2018; Chacko, 2016; Haxhi et al., 2013; Teo et al., 2018) while others showed a better postprandial lipemia response when exercise was performed immediately before the meal (Petitt & Cureton, 2003; Zhang et al., 1998, 2004). Interestingly, it has also been showed that regularly exercising before a meal improves body weight regulation in adults with overweight and obesity (Alizadeh et al., 2017; Willis et al., 2019).

Looking at the alarming progression of overweight and obesity among children and adolescents, it seems necessary to deepen our understanding on the effects of exercise on overall energy balance, in order to optimize our weight loss strategies. It is now clear that physical exercise does not only impact energy expenditure, it also affects energy intake and appetite control in youth and adolescents with obesity (Thivel, Finlayson, et al., 2019). The current literature mainly investigated the effect of exercise duration (Masurier et al., 2018; Tamam et al., 2012), intensity (Thivel et al., 2011, 2012, 2014) or modality (Laan et al., 2010) on subsequent food intake, appetite sensations or food reward, while the potential role played by the timing of exercise remains poorly explored (Fillon et al., 2019).

In 2017, Mathieu and collaborators assessed the effects of exercising immediately before or after a lunch meal in primary school children on overall energy balance (Mathieu et al., 2018). Although they did not observe any difference on energy intake between conditions (before or after the meal), their results highlight the beneficial effect of performing pre-meal moderate-to-vigorous over low-intensity exercise on subsequent energy intake (Mathieu et al., 2018). More recently, similar results were obtained among adolescents with obesity whose energy intake and food reward remained unchanged whether the adolescents performed 30 min of cycling exercise ( $65\% \text{VO}_{2\text{peak}}$ ) immediately before or after their lunch meal (Fillon, Miguet, et al., 2019).

Interestingly, others investigated the potential effect of the delay between an acute exercise bout and the following meal on energy intake and appetite. In their work, Albert and colleagues compared the effects of exercising (treadmill running at 70%  $\text{VO}_{2\text{max}}$ ) 45 min or 180 min before lunch, in normal weight adolescents (Albert et al., 2015). The authors observed an 11% reduction of the adolescents' *ad libitum* energy intake and a 23% decrease in fat intake when the exercise was performed 45 min before lunch, compared to 180 min. Moreover, there were no difference in terms of appetite sensations and no energy compensation at the following snack or dinner. Our research group recently examined the effect of the exercise-meal delay on energy intake, appetite and food reward among adolescents with obesity (Fillon et al., 2020). According to our results, a 30-min cycling exercise bout (65%  $\text{VO}_{2\text{max}}$ ) performed 60 min before lunch favored a 14% reduction of *ad libitum* energy intake while the same exercise performed 180 min before lunch did not affect the adolescents' energy intake. While appetite sensations (hunger, fullness, prospective food consumption and desire to eat) did not differ between conditions, our results also showed a significantly lower pre-meal explicit liking for high-fat relative to low-fat foods when the exercise was set close to the meal, suggesting the implication of the food reward system (Fillon et al., 2020). Altogether, these results seem to show a beneficial effect of exercising close to a meal on overall energy balance in adolescents.

Although these studies compared exercises of similar characteristics (e.g. duration, modality, intensity), their metabolic demand might have been different due to their divergent delay from breakfast, which might have important implications when it comes to subsequent energy intake. Indeed, it has been shown that the metabolic activity during exercise, particularly the contribution of the energy substrates, is different depending on the delay between a breakfast and this exercise (Aucouturier et al., 2011). The substrate oxidation during exercise, especially the rate of carbohydrate oxidation has been associated with subsequent energy intake (Hopkins et al., 2011), particularly in adults with obesity (Burton et al., 2010; Hopkins et al., 2014). Investigating the effect of the timing of exercise on appetite and energy intake needs to consider not only its delay with the following meal but also the time interval between exercise and the previous food intake.

In that context, the aim was to examine the importance of meal timing (+30 or +90 minutes) after performing exercise on energy intake, appetite and food reward in adolescents with obesity.

## **Materials and methods**

### ***Participants***

Eighteen adolescents with obesity (according to (Cole et al., 2000b)) aged 12-15 years (Tanner stage 3-4) were enrolled in this study (12 boys ( $12.6 \pm 1.2$  years) and 6 girls ( $13.0 \pm 1.6$  years)). They were recruited through the local Pediatric Obesity Center (Tza Nou, La Bourboule, France), based on the following main inclusion criteria: i) to be free of any medication known to influence appetite or metabolism; ii) to be free of any contraindication to physical activity; iii) to be classified as physically inactive (taking part in less than 2 hours of physical activity per week as assessed using the International Physical Activity Questionnaire –IPAQ (Craig et al., 2003)). This study was conducted in accordance with the Helsinki declaration and all the adolescents and their legal representative received information sheets and signed consent forms as requested by the local ethical authorities (Human Ethical Committee authorization reference: 2019-A00530-57; Clinical Trial reference: NCT03968458).

### ***1.1. Design***

After a preliminary medical inclusion visit performed by a pediatrician to control for the ability of the adolescents to complete the study, they were asked to perform a maximal aerobic test and their body composition was assessed by dual-energy x-ray absorptiometry (DXA). The adolescents thereafter completed the three following experimental sessions (one week apart) in randomized order: i) lunch (at 12:00pm) set 30 min after a rest session (at 11:00 am) ii) lunch (at 12:00pm) set 30 min after an exercise session (at 11:00am; MEAL-30); iii) lunch (at 1:00pm) set 90 min after an exercise session (at 11:00am; MEAL-90). On the three occasions, participants received a standardized breakfast (08:00am) and were asked to remain at rest (CON) or to cycle for 30 min at 11:00am and eat either 30 min (on MEAL-30; lunch at 12:00pm) or 90 min (on MEAL-90; lunch at 1:00pm) after exercise. Dinner was provided to the adolescents at 6:30pm. They were asked to complete the Leeds Food Preference Questionnaire (LFPQ) (Finlayson et al., 2008) before and after the lunch meal and before dinner. Lunch and dinner energy intake were assessed via *ad libitum* buffet-style meals. Appetite sensations were measured at regular intervals throughout the day. Outside the experimental conditions and between the two *ad libitum* test meals, the adolescents stayed in the laboratory, devoid of any food cues, and were requested not to engage in any moderate-to-vigorous physical activity and mainly

completed sedentary activities such as reading, homework or board games. Figure 1 details the whole design of the study.

### 1.2. Anthropometric characteristics and body composition

Body mass and height were measured wearing light clothing while bare-footed, using a digital scale and a standard wall-mounted stadiometer, respectively. Body mass index (BMI) was calculated as body mass (kg) divided by height squared (m<sup>2</sup>) and the sex and age dependent French reference curves were used to obtain the BMI percentile 30. Fat mass (FM) and fat-free mass (FFM) were assessed by dual-energy X-ray absorptiometry (DXA) following standardized procedures (QDR4500A scanner, Hologic, Waltham, MA, USA). These measurements were obtained during the preliminary visit by a trained technician.

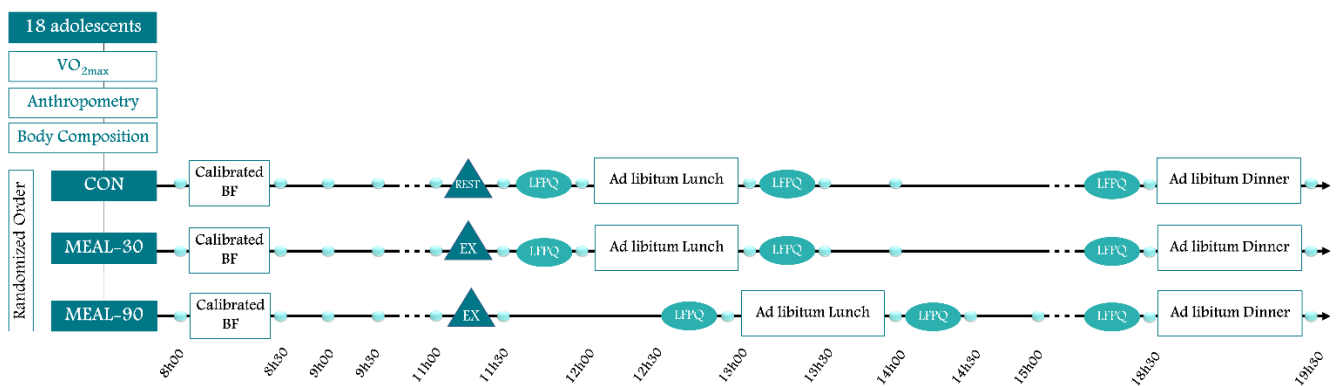

**Figure 1.** Study design. CON: Control Condition; MEAL-30: Test meal 30 min after exercise; MEAL-90: Test meal 90 min after exercise; BF: Breakfast; VAS: Visual Analog Scale; EX: Exercise; LFPQ: Leeds Food Preference Questionnaire;

### 1.3 Peak oxygen uptake test ( $\dot{V}O_{2peak}$ )

Each adolescent performed a  $\dot{V}O_{2peak}$  test on a traditional ergometer (Rowland, 1993). The initial power was set at 30W during 3 minutes, followed by a 15W increment every minute until exhaustion. The adolescents were strongly encouraged by the experimenters throughout the test to perform their maximal effort. Maximal criteria were: heart rate >90% of the theoretical maximum heart rate ( $210 - 0.65 \times \text{age}$ ), respiratory exchange ratio ( $RER = \dot{V}CO_2/\dot{V}O_2$ ) > 1.1 and/or  $\dot{V}O_2$  plateau. Cardiac electrical activity (Ultima Series<sup>TM</sup>, Saint Paul, MN) and heart rate (Polar V800) were monitored and the test was coupled with a measurement of breath-by-breath gas exchanges (BreezeSuite Software, Saint Paul, MN), that determined  $\dot{V}O_2$  and  $\dot{V}CO_2$ . Volumes and



gases were calibrated before each test.  $\dot{V}O_{2peak}$  was defined as the average of the last 30 s of exercise before exhaustion.

#### ***1.4. Experimental conditions***

*Rest condition (CON):* During this condition, the adolescents were asked to remain quiet and were not allowed to engage in any physical activity. They were asked to stay seated on a comfortable chair (30 min) between 11:00am and 11:30am, not being allowed to talk, read, watch TV or to complete any intellectual tasks. Energy expenditure was assessed during the 30-min rest period using portable indirect calorimetry (K4b<sup>2</sup>, COSMED Inc., Rome, Italy).

*Lunch condition 30 min after exercise (MEAL-30):* Between 11:00am and 11:30am, the participants performed a 30-min moderate-intensity exercise bout (65%  $\dot{V}O_{2peak}$ ) on a cycle ergometer. The intensity was controlled by heart rate records (Polar V800) using the results from the maximal aerobic capacity testing. Exercise-induced energy expenditure was calculated based on the results obtained during the maximal oxygen uptake test.

*Lunch condition 90 min after exercise (MEAL-90):* The adolescents performed the same exercise bout as MEAL-30 and at the same time, but the *ad libitum* lunch meal was served at 1:00pm (90 min after the end of the exercise).

#### ***1.5. Energy intake***

At 08:00am, the adolescents consumed a standardized calibrated breakfast (500 kcal) respecting the recommendations for their age (composition: bread (50 g), butter (10 g), marmalade (15 g), yoghurt (125 g) or semi-skimmed milk (20 cl), fruit or fruit juice (20 cl)). Lunch and dinner meals were served *ad libitum* using a buffet-type meal. The content of the buffets was determined using a food preference and habits questionnaire filled in by the adolescents during the inclusion visit, as previously described (Thivel, Genin, et al., 2016b). Top rated items as well as disliked items and items liked but not usually consumed were excluded to avoid over-, under- and occasional consumption. The lunch menu was beef steak, pasta, mustard, cheese, yoghurt, compote, fruits and bread. The dinner menu was ham/turkey, beans, mashed potato, cheese, yoghurt, compote, fruits and bread. Food items were presented in abundance and the adolescents were told to eat until comfortably

full. Adolescents made their choices and composed their trays individually before joining their habitual table (5 adolescents per table). Lunch and dinner were served in a quiet environment free of music, cellphones or television. Food items were weighed by the experimenters before and after each meal. Energy intake and macronutrient composition (proportion of fat, carbohydrate and protein) were calculated using the software Bilnut 4.0. This methodology has been previously validated and published (Thivel, Genin, et al., 2016b). Lunch and total relative energy intake (REI) were calculated such as: energy intake – exercise-induced energy expenditure.

### ***1.6. Subjective appetite sensations***

Appetite sensations were collected at regular intervals throughout the day using visual analogue scales (150-mm scales) (Flint et al., 2000). Adolescents had to report their hunger, fullness, desire to eat (DTE) and prospective food consumption (PFC) before and immediately after breakfast, prior and after rest (CON) or exercise (MEAL-30 and MEAL-90), before and immediately after lunch, 30 min and 60 min after lunch, before and immediately after dinner.

### ***1.7. Food liking and wanting***

The Leeds Food Preference Questionnaire, described in greater methodological detail by Dalton and Finlayson (Michelle Dalton & Finlayson, 2014), provided measures of food preference and food reward. The adolescents were presented with a culturally (food items and language) adapted version of the LFPQ following the recent recommendations from Oustric and collaborators (Oustric et al., 2020). Participants were presented with an array of pictures of individual food items common in the diet. Foods were chosen by the local research team from a validated database to be either predominantly high (>50% energy) or low (<20% energy) in fat but similar in familiarity, protein content, palatability and suitable for the study population. The LFPQ has been deployed in a range of research (Dalton & Finlayson, 2014) including a recent exercise/appetite trial in young French males (Thivel et al., 2018) and adolescents (Fillon et al., 2020; Miguët et al., 2018; Thivel, Roche, et al., 2019).

Explicit liking was measured by participants rating the extent to which they like each food (“How pleasant would it be to taste this food now?”). The food images were presented individually, in a randomized order and participants made their ratings using a 100-mm VAS. Implicit wanting was assessed using a forced choice

methodology in which the food images were paired so that every image from each of the four food types was compared to every other type over 96 trials (food pairs). Participants were instructed to respond as quickly and accurately as they could to indicate the food they want to eat the most at that time (“Which food do you most want to eat now?”). Reaction times for all responses were covertly recorded and used to compute mean response times for each food type after adjusting for frequency of selection.

Responses on the LFPQ were used to compute mean scores for high-fat, low-fat, sweet or savoury food types (and different fat-taste combinations). Fat bias scores were calculated as the difference between the high-fat scores and the low-fat scores, with positive values indicating greater liking or wanting for high-fat relative to low-fat foods and negative values indicating greater liking or wanting for low-fat relative to high-fat foods. Sweet bias scores were calculated as the difference between the sweet and savoury scores, with positive values indicating greater liking or wanting for sweet relative to savoury foods and negative values indicating greater liking or wanting for savoury relative to sweet foods.

### **1.8. Statistical analysis**

Statistical analyses were performed using Stata software, Version 13 (StataCorp, College Station, TX, US). The sample size estimation was determined according to (i) CONSORT 2010 statement, extension to randomised pilot and feasibility trials (Eldridge et al. CONSORT 2010 statement: extension to randomised pilot and feasibility trials. *Pilot and Feasibility Studies* (2016) 2:64) and (ii) Cohen’s recommendations (Cohen, 1988) who has defined effect-size bounds as : small (ES: 0.2), medium (ES: 0.5) and large (ES: 0.8, “grossly perceptible and therefore large”). So, with 15 patients by condition, an effect-size around 1 can be highlighted for a two-sided type I error at 1.7% (correction due to multiple comparisons), a statistical power greater than 80% and an intra-class correlation coefficient at 0.5 to take into account between and within participant variability. All tests were two-sided, with a Type I error set at 0.05. Continuous data was expressed as mean  $\pm$  standard deviation (SD) or median [interquartile range] according to statistical distribution. The assumption of normality was assessed by using the Shapiro-Wilk test. Daily (total) area under the curve (AUC) were calculated using the trapezoidal method. Random-effects models for repeated data were performed to compare three conditions (i) considering the following fixed effects: time, condition and time x condition interaction, and (ii) taking into account between and within participant variability (subject as random-effect). A Sidak’s

type I error correction was applied to perform multiple comparisons. As proposed by some statisticians (Feise, 2002; Rothman & Greenland, 1998) a particular focus will be also given to the magnitude of differences, in addition to inferential statistical tests expressed using p-values. The normality of residuals from these models was studied using the Shapiro-Wilk test. When appropriate, a logarithmic transformation was proposed to achieve the normality of dependent outcome.

## 2. Results

Eighteen adolescents with obesity participated in this study. Their mean age was  $12.7 \pm 1.3$  years, body weight was  $88.9 \pm 23.6$  kg (with a BMI of  $33.3 \pm 6.5$  kg/m<sup>2</sup> (z-BMI  $2.2 \pm 0.4$ ), with a percentage of body fat mass of  $37.6 \pm 5.0$  % and a FFM of  $53.1 \pm 12.5$  kg.

The adolescents had a  $\dot{V}O_{2\text{peak}}$  of  $21.8 \pm 4.6$  ml/min/kg. Energy expenditure induced by the exercise (total duration 30 min) was significantly higher compared to the 30-min resting energy expenditure ( $168.8 \pm 43.6$  kcal and  $46.9 \pm 14.9$  kcal, respectively;  $p < 0.001$ ).

Table 1 details the results related to absolute and relative energy intake. At lunch, absolute *ad libitum* energy intake was significantly lower in MEAL-90 than MEAL-30 and CON ( $p < 0.05$  and  $p < 0.01$ , respectively) and in MEAL-30 than CON ( $p < 0.05$ ). Dinner *ad libitum* energy intake was significantly lower in MEAL-90 compared with MEAL-30 ( $p < 0.01$ ) with no difference between the exercise conditions and CON. Total daily absolute *ad libitum* energy intake was significantly lower in MEAL-90 compared with both CON and MEAL-30 ( $p < 0.001$ ).

REI at lunch was significantly higher in CON compared with MEAL-30 and MEAL-90 ( $p < 0.05$  and  $p < 0.001$ , respectively) and total REI was significantly higher in CON compared with MEAL-90 ( $p < 0.001$ ). Both lunch ( $p < 0.05$ ) and total REI ( $p < 0.001$ ) were significantly lower in MEAL-90 than MEAL-30.

**Table 1:** Absolute and Relative Energy Intake in response the three conditions.

	CON			MEAL-30	MEAL-90	p	ES		
	Mean (SD)	Mean (SD)	Mean (SD)	Mean (SD)	CON vs. MEAL-30		CON vs. MEAL-90	MEAL-30 vs. MEAL-90	
<i>EI(kcal)</i>	Lunch	1380 (185)	1347 (313)*	1168 (234)** <sup>a</sup>	0.0143	-0.12[-0.60, 0.35]	-0.71[-1.19, -0.24]	0.59[0.11, 1.06]	
	Dinner	796 (294)	931 (260)	748 (245) <sup>b</sup>	0.0363	0.48[0.00, 0.96]	-0.20[-0.67, 0.28]	0.68[0.20, 1.15]	
	Total	2175 (330)	2277 (476)	1925 (360)** <sup>c</sup>	0.0001	0.27[-0.21, 0.74]	-0.80[-1.28, -0.33]	1.07[0.59, 1.54]	
<i>REI(kcal)</i>	Lunch	1337 (188)	1172 (313)*	1006 (246)** <sup>a</sup>	0.0003	-0.56[-1.03, -0.08]	-1.08[-1.56, -0.61]	0.52[0.04, 1.00]	
	Total	2119 (332)	2110 (489)	1755 (366)** <sup>c</sup>	<0.0001	-0.11[-0.58, 0.37]	-1.16[-1.63, -0.68]	1.06[0.59, 1.54]	

CON: control condition; MEAL-30: Test meal 30 min after exercise; MEAL-90: Test meal 90 min after exercise; SD: Standard Deviation; ES: Effect Size; EI: Energy Intake; REI: Relative Energy Intake; \*p<0.05 vs. CON ; \*\*p<0.01 vs. CON ; \*\*\*p<0.001 vs. CON ; <sup>a</sup>p<0.05 MEAL-30 vs. MEAL-90 ; <sup>b</sup>p<0.01 MEAL-30 vs. MEAL-90 ; <sup>c</sup>p<0.001 MEAL-30 vs. MEAL-90; ES: post hoc effect size

The lunch and total absolute intake of protein, fat were significantly lower in MEAL-90 compared with both CON (p<0.01 and p<0.05, respectively) and MEAL-30 (p<0.01 and p<0.05, respectively) while their intake at dinner was significantly lower in MEAL-90 compared with MEAL-30 (p<0.05). The absolute intake of CHO was significantly lower in MEAL-90 compared with CON at lunch (p<0.05) and significantly higher in MEAL-30 compared with CON at dinner (p<0.05). Total absolute CHO intake was only significantly lower in MEAL-90 compared with CON (p<0.05). No significant difference was observed between conditions regarding the relative intake of each macronutrient. Table 2 details these results. Figure 2 presents the results related to appetite sensations. Fasting hunger, fullness, PFC and DTE did not differ between conditions. After the standardized breakfast, significant differences between conditions were found: hunger and DTE were higher in MEAL-30 than MEAL-90 (p=0.003 and p=0.02), respectively) and CON (p=0.010 and p=0.016, respectively), while PFC was greater in MEAL-30 than MEAL-90 only (p=0.021). Before exercise, hunger was significantly lower during both exercise conditions than during CON (p<0.001 for both). After exercise, this difference remained significant only between CON and MEAL-90 (p=0.004). Immediately before lunch, hunger and PFC were significantly lower in MEAL-30 compared with CON (p=0.036 and p=0.041, respectively). Post-lunch sensations were similar between conditions.

**Table 2:** Macronutrient Intake in response the three conditions.

		CON	MEAL-30	MEAL-90	p	ES		
		Mean (SD)	Mean (SD)	Mean (SD)		CON vs. MEAL-30	CON vs. MEAL-90	MEAL-30 vs. MEAL-90
Proteins (g)	Lunch	73.8 (11.5)	71.9 (17.2)	60.7 (13.9)**b	0.0059	-0.13[-0.61, 0.34]	-0.76[-1.24, -0.29]	0.63[0.15, 1.10]
	Dinner	42.0 (18.4)	46.8 (14.4)	37.2 (13.2) <sup>a</sup>	0.1811	0.25[-0.22, 0.73]	-0.30[-0.78, 0.17]	0.56[0.08, 1.03]
	Total	115.9 (22.6)	118.7 (23.8)	98.8 (19.4)**c	0.0007	0.08[-0.40, 0.55]	-0.85[-1.32, -0.37]	0.93[0.45, 1.40]
Proteins (%)	Lunch	21.5 (2.3)	21.4 (3.0)	20.8 (2.3)	0.5108	0.05[-0.42, 0.53]	-0.07[-0.55, 0.40]	0.23[-0.25, 0.70]
	Dinner	20.8 (5.2)	19.9 (3.1)	20.1 (3.6)	0.8811	0.17[-0.31, 0.64]	0.01[-0.46, 0.49]	-0.06[-0.53, 0.42]
	Total	21.3 (2.5)	21.0 (2.0)	20.6 (2.3)	0.6248	0.10[-0.38, 0.58]	-0.05[-0.53, 0.42]	0.14[-0.33, 0.62]
Lipids (g)	Lunch	45.4 (9.6)	45.0 (14.2)	38.1 (12.5)* <sup>a</sup>	0.0146	-0.06[-0.53, 0.42]	-0.54[-1.01, -0.06]	0.48[0.06, 1.01]
	Dinner	28.8 (19.0)	33.8 (15.1)	26.1 (14.3) <sup>a</sup>	0.0642	0.33[-0.15, 0.80]	-0.18[-0.66, 0.30]	0.51[0.03, 0.98]
	Total	74.3 (18.0)	78.8 (19.9)	65.8 (19.1)* <sup>b</sup>	0.0123	0.25[-0.23, 0.72]	-0.54[-1.01, -0.06]	0.79[0.31, 1.26]
Lipids (%)	Lunch	29.8 (5.8)	30.3 (8.0)	29.2 (7.3)	0.1910	0.05[-0.42, 0.53]	-0.07[-0.55, 0.40]	0.13[-0.35, 0.60]
	Dinner	30.0 (12.9)	31.3 (10.6)	29.7 (9.8)	0.0277	0.17[-0.31, 0.64]	0.01[-0.46, 0.49]	0.15[-0.32, 0.63]
	Total	30.7 (5.8)	31.2 (4.8)	30.5 (5.7)	0.9655	0.10[-0.38, 0.58]	-0.05[-0.53, 0.42]	0.15[-0.32, 0.63]
CHO (g)	Lunch	166.7 (39.4)	160.8 (52.8)	144.2 (34.6)*	0.1649	-0.14[-0.62, 0.33]	-0.52[-0.99, -0.04]	0.37[-0.10, 0.85]
	Dinner	92.8 (31.5)	109.9 (31.5)*	91.9 (29.4) <sup>a</sup>	0.0269	0.52[0.04, 0.99]	-0.036[-0.54, 0.41]	0.58[0.11, 1.06]
	Total	259.5 (56.1)	270.7 (70.0)	233.9 (49.7) <sup>a</sup>	0.0751	0.17[-0.31, 0.64]	-0.45[-0.92, 0.03]	0.61[0.14, 1.09]
CHO (%)	Lunch	48.0 (7.6)	47.5 (10.5)	49.5 (9.1)	0.2149	0.06[-0.53, 0.42]	0.15[-0.33, 0.62]	-0.20[-0.68, 0.27]
	Dinner	49.7 (15.6)	48.9 (12.4)	50.7 (10.7)	0.0840	-0.01[-0.48, 0.47]	0.13[-0.34, 0.61]	-0.14[-0.61, 0.34]
	Total	47.8 (7.4)	47.4 (6.1)	48.7 (7.3)	0.9547	-0.05[-0.53, 0.42]	0.14[-0.34, 0.61]	-0.19[-0.67, 0.28]

CON: control condition; MEAL-30: Test meal 30 minutes after exercise; MEAL-90: Test meal 90 minutes after exercise; SD: Standard Deviation; \*p<0.05 vs. CON ; \*\*p<0.01 vs. CON ; \*\*\*p<0.001 vs. CON ; <sup>a</sup>p<0.05 MEAL-30 vs. MEAL-90 ; <sup>b</sup>p<0.01 MEAL-30 vs. MEAL-90 ; <sup>c</sup>p<0.001 MEAL-30 vs. MEAL-90; ES: Effect Size; CHO: Carbohydrates; ES: post hoc effect size.

Pre-dinner hunger was lower during both exercise conditions compared with CON (p=0.006 for MEAL-30 and p=0.003 for MEAL-90). Pre-dinner fullness was greater in MEAL-30 and MEAL-90 compared with CON (p=0.006 and p=0.003, respectively). Regarding pre-dinner DTE and PFC, only MEAL-90 was significantly lower than CON (p=0.006 and p=0.005, respectively). Concerning the daily AUC (Figure 2), relative to CON, hunger and DTE were significantly lower in MEAL-30 (p=0.019 and p=0.05, respectively) and MEAL-90 (p=0.034 and p=0.031, respectively). As detailed in Table 3, there was a significant condition effect for pre-dinner explicit liking fat bias (p=0.004), with explicit liking for high-fat foods being lower in MEAL-90

compared with both CON ( $p=0.001$ ) and MEAL-30 ( $p=0.004$ ). While explicit liking taste bias significantly decreased in response to the lunch meal during the CON condition ( $p<0.001$ ), this significant meal effect disappeared during both exercise conditions, without a meal x condition interaction. Implicit wanting taste bias significantly increased in response to the lunch test meal during MEAL-90 ( $p=0.04$ ), and no meal effect was observed in CON and MEAL-30.

**Table 3:** Pre- and Post-test meal food reward on the three experimental conditions

	CON	MEAL-30	MEAL-90	p	Interaction time x condition		
	Mean (SD)	Mean (SD)	Mean (SD)		CON vs. MEAL-30	CON vs. MEAL-90	MEAL-30 vs. MEAL-90
<b>Implicit Wanting</b>							
<i>Fat Bias</i>							
Before lunch	22.32 (31.15)	19.96 (33.15)	22.80 (31.68)	0.78			
After lunch	20.21 (45.58)	17.63 (48.49)	12.61 (29.50)	0.46	0.99	0.58	0.56
<i>p before vs. after lunch</i>	0.88	0.80	0.90		0.00[-0.48-0.48]	-0.13[-0.61-0.34]	-0.14[-0.62-0.33]
Before dinner	4.37 (64.45)	20.74 (19.89)	14.99 (26.63)	0.49			
<i>Taste Bias</i>							
Before lunch	31.60 (33.67)	34.17 (41.81)	24.90 (32.49)	0.76			
After lunch	25.60 (54.02)	27.00 (67.00)	43.59 (30.79)	0.59	0.93	0.14	0.26
<i>p before vs. after lunch</i>	0.69	0.85	0.04		0.02[-0.45-0.50]	0.36[-0.11-0.84]	0.27[-0.20-0.75]
Before dinner	38.24 (37.81)	40.40 (40.11)	42.30 (28.12)	0.98			
<b>Explicit Liking</b>							
<i>Fat Bias</i>							
Before lunch	10.02 (19.71)	12.52 (16.35)	10.53 (19.64)	0.34			
After lunch	5.29 (9.39)	5.14 (10.66)	4.08 (9.25)	0.94	0.57	0.77	0.86
<i>p before vs. after lunch</i>	0.27	0.03	0.11		-0.14[-0.61-0.34]	-0.07[-0.55-0.40]	0.04[-0.43-0.52]
Before dinner	11.35 (19.83)	9.04 (16.34)	2.44 (13.00) <sup>***b</sup>	<0.001			
<i>Taste Bias</i>							
Before lunch	26.18 (20.37)	21.95 (23.03)	20.31 (22.89)	0.82			
After lunch	12.78 (19.10)	18.08 (25.78)	14.47 (27.62)	0.73	0.10	0.25	0.74
<i>p before vs. after lunch</i>	<0.001	0.38	0.19		0.40[-0.07-0.88]	0.28[-0.19-0.76]	-0.08[-0.56-0.40]
Before dinner	24.00 (24.58)	21.40 (26.08)	20.76 (28.74)	0.99			

CON: control condition; MEAL-30: Test meal 30 min after exercise; MEAL-90: Test meal 90 min after exercise; SD: Standard Deviation; \*\*\* $p<0.001$  vs. CON; <sup>b</sup> $p<0.01$  MEAL-30 vs. MEAL-90 ; P values and Effect Size are presented for interactions.

## Discussion

The timing of exercise relative to a meal has been recently highlighted for its influence on energy intake and appetite control (Fillon et al., 2019; Reid, Thivel, et al., 2019b), with some recent studies suggesting a better effect of acute exercise performed close to a meal on energy intake and appetite in both adolescents who are lean (Albert et al., 2015) and adolescents with obesity (Fillon et al., 2020). However these studies did not consider the potential impact of the delay between the exercise and the previous breakfast intake. It has been shown that this delay will impact the metabolic nature of exercise such as the substrates used (Aucouturier et al., 2011), which might, in turn, differently affect subsequent energy intake (Burton et al., 2010; Hopkins et

al., 2011, 2014). In that context, the aim of the present study was to investigate the effect of exercise performed at the same delay from breakfast on energy intake, appetite sensations and food reward at the following lunch set either 30 or 90 min after exercise in adolescents with obesity.

According to our results, both exercise conditions (MEAL-30 and MEAL-90) led to significantly lower absolute energy intake at lunch compared to CON. This is in line with previous studies in similar populations showing reduced subsequent intake in response to acute exercise set at the same time of the morning (Nicole Fearnbach et al., 2016; Fillon et al., 2020; Thivel et al., 2012, 2014). Interestingly, absolute energy intake was also significantly lower in MEAL-90 compared with MEAL-30, suggesting a greater anorexigenic effect when exercise does not immediately precede the meal. Additionally, total and dinner absolute energy intake were lower during MEAL-90 only, with total daily energy intake reduced by 12% (250 kcal/day) and 16% (352 kcal/day) compared with CON and MEAL-30, respectively. These results are reinforced by a lower lunch relative energy intake after MEAL-30 compared with CON and lower lunch and total REI during MEAL-90 compared with both MEAL-30 and CON. Importantly, while most of the available evidence supports the anorexigenic effect of intensive exercise (Miguet et al., 2018; Prado et al., 2015; Thivel et al., 2011; Thivel, Rumbold, et al., 2016), our results reinforce more recent work also observing reduced food intake in response to moderate-to-vigorous exercise in adolescents and children with obesity (Fearnbach et al., 2016, 2016).

While available evidence indicates the beneficial effect of exercising close to a meal on subsequent energy intake (Albert et al., 2015; Fillon et al., 2020), our results seem to suggest that more than the exercise-meal delay itself, the interval between the exercise and the following eating episode is of importance.

A balanced buffet meal offering several items selected to avoid any over-, under- or occasional-consumption (as previously validated, (Thivel, Genin, et al., 2016b)) was offered to adolescents which provided the opportunity to also assess their macronutrient intake. While none of the relative intake of fat, protein and carbohydrate were found different between conditions, their absolute consumption at lunch was reduced only in MEAL-90 compared with CON, and compared with MEAL-30 for protein and lipid. Interestingly, the absolute intake of carbohydrate at dinner increased in MEAL-30 compared with the two other conditions. The macronutrient responses observed in MEAL-90 seem in line with Albert et al. in lean adolescents (Albert et al., 2015) and with our previous study in adolescents with obesity (Fillon et al., 2020), showing reduced



absolute macronutrient intake after moderate exercise set at the end of the morning. The current study however missed to find similar results in MEAL-30, suggesting here the potential importance of the delay between the exercise and the previous eating episode (breakfast). Indeed, in these previous studies, the appetitive responses to exercise set at different times of the morning, and then at different delays from breakfast, were compared, meaning that despite similar duration, modality and intensity, the exercise was not of similar metabolic and energetic load (Aucouturier et al., 2011), which might explain our results. Unfortunately, it was not possible in the present study to measure the substrate oxidation during exercise and at rest. Furthermore, it remains difficult to reach a consensus regarding the effect of acute exercise on macronutrient intake in lean adolescents and in adolescents with obesity based on the available evidence (Thivel, Rumbold, et al., 2016).

Regarding the adolescents' subjective appetite sensations, our results show a lower daily (AUC) hunger and desire to eat in both exercise conditions compared with CON. Although pre-lunch hunger and PFC were significantly lower in MEAL-30 compared with CON, which could have contributed to the lower observed *ad libitum* energy intake, they remained unchanged in MEAL-90 while the decreased food consumption was even more pronounced. This inconsistency between appetite sensations and energy intake reinforce the previously described uncoupling effect of exercise between these sensations and food consumption (Thivel & Chaput, 2014). Interestingly however, post-lunch sensations were identical between exercise conditions, suggesting a similar satiating effect of lunch meals despite lower intakes in MEAL-30 and particularly in MEAL-90, limiting any potential subsequent compensatory responses. This is even reinforced by the significantly reduced food intake observed at dinner in MEAL-90. This is of particular importance since energy deficits, especially when induced by reduced energy intake, have been shown to generate a subsequent compensatory rise in food intake, with physical exercise limiting or avoiding such a compensation (Thivel, Doucet, et al., 2017; Thivel et al., 2018).

Some recent studies have highlighted the importance of considering the effect of exercise on food reward to better understand its impact on subsequent energy intake in adolescents with obesity (Miguet et al., 2018). We also assessed whether the liking and wanting for food could be impacted by the delay between eating episodes and exercise in this population. In 2018, Miguet and colleagues observed reduced relative preference for fat and sweet taste, and implicit wanting for high-fat foods (also using the LFPQ) in response to an *ad libitum*

meal set 30 minutes after a 16-minute cycling high intensity interval exercise in a similar population (Miguet et al., 2018). According to the present results, none of the pre or post lunch components of liking and wanting were different between conditions. These results are contradictory with those from Miguet et al. (2018), especially regarding our MEAL-30 condition that had the same delay between the exercise and the meal. However, the exercise intensities were different (high intensity intermittent exercise vs. moderate intensity continuous exercise), reinforcing once more the importance of the exercise intensity in the subsequent control of energy intake. Interestingly, we can see here a significantly lower explicit liking for high-fat food immediately before dinner in MEAL-90 compared with the two others, which might contribute to the observed reduced dinner *ad libitum* food intake. Our results are however also in contradiction with some recently published from our group, showing different food reward responses depending on exercise-meal timing in adolescents with obesity (Fillon et al., 2020). A lower pre-meal explicit liking for high-fat relative to low-fat foods was observed when the adolescents performed 30 min of moderate intensity cycling 60 min before lunch compared with the same exercise performed 180 min before lunch (Fillon et al., 2020). The different LFPQ timing between MEAL-90 and the two other conditions must be considered when interpreting our results. Indeed, food reward was assessed pre- and post- lunch meaning that its delay from exercise was different, which might have affected the results. Although there is a growing interest in the effect of exercise on food reward in this population, evidence remains too limited to draw any conclusion and further studies using standardized designs are needed.

The present results must be interpreted in light of some limitations. First, as for the other published studies examining the timing of exercise relative to a meal (Albert et al., 2015; Fillon et al., 2019; Fillon et al., 2020; Mathieu et al., 2018), the lack of direct evaluation of the adolescents' oxygen consumption and substrate oxidation using indirect calorimeters, as well as the lack of a lean control group to examine the potential weight status effect, are the two main limitations. Although the laboratory-based nature of this work constitutes a strength as it allows a better control of the adolescents' activity and intake, it might also not be representative of their habitual daily free-living setting, such as the school setting for instance, as previously underlined by Mathieu et al. in healthy adolescents (Mathieu et al., 2018). Finally, the lack of tracking of the adolescents' food intake over 24 to 48 hours for practical reasons also limits the interpretation of our results (Thivel et al., 2012).

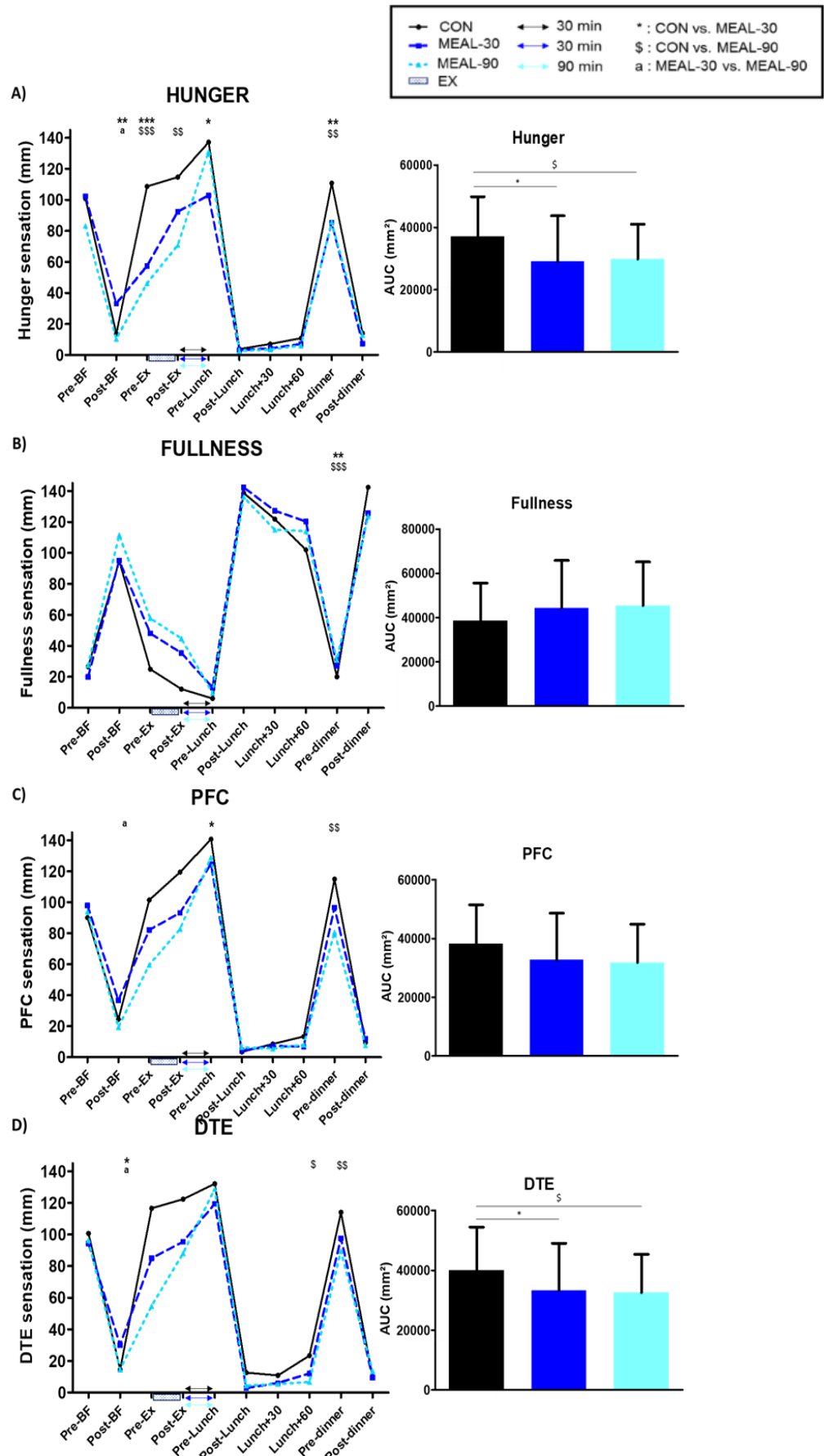

Figure 2 : Daily appetite sensations and AUC for hunger, fullness, prospective food consumption and desire to eat

## **Conclusion**

To conclude, the present study reinforces the interest in the timing of exercise relative to a meal to affect overall energy balance in youth with obesity; highlighting the importance of the time interval between both the exercise and the previous eating episode, and the exercise and the following meal. According to these results, delaying the timing of the meal after exercise might help reduce energy balance by decreasing *ad libitum* energy intake without increasing hunger and by improving satiety in adolescents with obesity. Future studies should question the importance of the exercise-meal timing on the longer term. While further acute and chronic studies are needed, these results contribute to the current limited body of evidence in the area and seem important in order to optimize weight loss strategies.

## **Conflicts of interest statement**

None and this research did not receive any specific grant from funding agencies in the public, commercial, or not-for-profit sectors.

## **Author contributions**

AF and DT conceived experiments. AF, MM and MB carried out experiments, AF and DT analysed data. KB was involved in writing the paper and all authors had final approval of the submitted and published versions.

## **Acknowledgements**

The authors are grateful to all of the adolescents that participated in the program, and to the Nutrition Obesity Ambulatory Hospital (UGECAM) that provided their generous support.

## References

1. Reid RER, Thivel D, Mathieu M-E. Understanding the potential contribution of a third “T” to FITT exercise prescription: the case of timing in exercise for obesity and cardiometabolic management in children. *Appl Physiol Nutr Metab.* 2019;44(8):911-914. doi:10.1139/apnm-2018-0462
2. Borrer A, Zieff G, Battaglini C, Stoner L. The Effects of Postprandial Exercise on Glucose Control in Individuals with Type 2 Diabetes: A Systematic Review. *Sports Med Auckl NZ.* 2018;48(6):1479-1491. doi:10.1007/s40279-018-0864-x
3. Chacko E. Exercising Tactically for Taming Postmeal Glucose Surges. *Scientifica.* 2016;2016:4045717. doi:10.1155/2016/4045717
4. Haxhi J, Scotto di Palumbo A, Sacchetti M. Exercising for Metabolic Control: Is Timing Important. *Ann Nutr Metab.* 2013;62(1):14-25. doi:10.1159/000343788
5. Teo SYM, Kanaley JA, Guelfi KJ, et al. Exercise Timing in Type 2 Diabetes Mellitus: A Systematic Review. *Med Sci Sports Exerc.* 2018;50(12):2387-2397. doi:10.1249/MSS.0000000000001732
6. Petitt DS, Cureton KJ. Effects of prior exercise on postprandial lipemia: A quantitative review. *Metabolism.* 2003;52(4):418-424. doi:10.1053/meta.2003.50071
7. Zhang JQ, Ji LL, Nunez G, Feathers S, Hart CL, Yao WX. Effect of exercise timing on postprandial lipemia in hypertriglyceridemic men. *Can J Appl Physiol Rev Can Physiol Appl.* 2004;29(5):590-603.
8. Zhang JQ, Thomas TR, Ball SD. Effect of exercise timing on postprandial lipemia and HDL cholesterol subfractions. *J Appl Physiol.* 1998;85(4):1516-1522. doi:10.1152/jappl.1998.85.4.1516
9. Alizadeh Z, Younespour S, Rajabian Tabesh M, Haghavan S. Comparison between the effect of 6 weeks of morning or evening aerobic exercise on appetite and anthropometric indices: a randomized controlled trial. *Clin Obes.* 2017;7(3):157-165. doi:10.1111/cob.12187
10. Willis EA, Creasy SA, Honas JJ, Melanson EL, Donnelly JE. The effects of exercise session timing on weight loss and components of energy balance: midwest exercise trial 2. *Int J Obes* 2005. July 2019. doi:10.1038/s41366-019-0409-x
11. Thivel D, Finlayson G, Blundell JE. Homeostatic and neurocognitive control of energy intake in response to exercise in pediatric obesity: a psychobiological framework. *Obes Rev Off J Int Assoc Study Obes.* 2019;20(2):316-324. doi:10.1111/obr.12782
12. Masurier J, Mathieu M-E, Fearnbach SN, et al. Effect of Exercise Duration on Subsequent Appetite and Energy Intake in Obese Adolescent Girls. *Int J Sport Nutr Exerc Metab.* August 2018. doi:10.1123/ijsnem.2017-0352

13. Tamam S, Bellissimo N, Patel BP, Thomas SG, Anderson GH. Overweight and obese boys reduce food intake in response to a glucose drink but fail to increase intake in response to exercise of short duration. *Appl Physiol Nutr Metab*. 2012;37(3):520-529. doi:10.1139/h2012-038
14. Thivel D, Isacco L, Montaurier C, Boirie Y, Duché P, Morio B. The 24-h Energy Intake of Obese Adolescents Is Spontaneously Reduced after Intensive Exercise: A Randomized Controlled Trial in Calorimetric Chambers. *PLoS ONE*. 2012;7(1). doi:10.1371/journal.pone.0029840
15. Thivel D, Isacco L, Rousset S, Boirie Y, Morio B, Duché P. Intensive exercise: A remedy for childhood obesity? *Physiol Behav*. 2011;102(2):132-136. doi:10.1016/j.physbeh.2010.10.011
16. Thivel D, Metz L, Julien A, Morio B, Duché P. Obese but not lean adolescents spontaneously decrease energy intake after intensive exercise. *Physiol Behav*. 2014;123:41-46. doi:10.1016/j.physbeh.2013.09.018
17. Laan DJ, Leidy HJ, Lim E, Campbell WW. Effects and reproducibility of aerobic and resistance exercise on appetite and energy intake in young, physically active adults. *Appl Physiol Nutr Metab Physiol Appl Nutr Metab*. 2010;35(6):842-847. doi:10.1139/H10-072
18. Fillon A, Mathieu ME, Boirie Y, Thivel D. Appetite control and exercise: Does the timing of exercise play a role? *Physiol Behav*. November 2019:112733. doi:10.1016/j.physbeh.2019.112733
19. Mathieu M-E, Lebkowski A, Laplante E, Drapeau V, Thivel D. Optimal timing of exercise for influencing energy intake in children during school lunch. *Appetite*. 2018;120:416-422. doi:10.1016/j.appet.2017.09.011
20. Fillon A, Miguet M, Bailly M, et al. Does exercising before or after a meal optimize overall energy balance in adolescents with obesity? In: *Katowice: Annals of Nutrition and Metabolism*.; 2019:in press.
21. Albert M-H, Drapeau V, Mathieu M-E. Timing of moderate-to-vigorous exercise and its impact on subsequent energy intake in young males. *Physiol Behav*. 2015;151:557-562. doi:10.1016/j.physbeh.2015.08.030
22. Fillon A, Mathieu M-E, Masurier J, et al. Effect of exercise-meal timing on energy intake, appetite and food reward in adolescents with obesity: the TIMEX study. *Appetite*. 2020;146:104506.
23. Aucouturier J, Isacco L, Thivel D, et al. Effect of time interval between food intake and exercise on substrate oxidation during exercise in obese and lean children. *Clin Nutr Edinb Scotl*. 2011;30(6):780-785. doi:10.1016/j.clnu.2011.03.011
24. Hopkins M, Jeukendrup A, King NA, Blundell JE. The Relationship between Substrate Metabolism, Exercise and Appetite Control: Does Glycogen Availability Influence the Motivation to Eat, Energy Intake or Food Choice? *Sports Med*. 2011;41(6):507-521. doi:10.2165/11588780-000000000-00000
25. Burton FL, Malkova D, Caslake MJ, Gill JMR. Substrate metabolism, appetite and feeding behaviour under low and high energy turnover conditions in overweight women. *Br J Nutr*. 2010;104(8):1249-1259. doi:10.1017/S0007114510002023

26. Hopkins M, Blundell JE, King NA. Individual variability in compensatory eating following acute exercise in overweight and obese women. *Br J Sports Med.* 2014;48(20):1472-1476. doi:10.1136/bjsports-2012-091721
27. Cole TJ, Bellizzi MC, Flegal KM, Dietz WH. Establishing a standard definition for child overweight and obesity worldwide: international survey. *BMJ.* 2000;320(7244):1240.
28. Craig CL, Marshall AL, Sjöström M, et al. International physical activity questionnaire: 12-country reliability and validity. *Med Sci Sports Exerc.* 2003;35(8):1381-1395. doi:10.1249/01.MSS.0000078924.61453.FB
29. Finlayson G, King N, Blundell J. The role of implicit wanting in relation to explicit liking and wanting for food: implications for appetite control. *Appetite.* 2008;50(1):120-127. doi:10.1016/j.appet.2007.06.007
30. WHO Multicentre Growth Reference Study Group. WHO Child Growth Standards based on length/height, weight and age. *Acta Paediatr Oslo Nor 1992 Suppl.* 2006;450:76-85.
31. Rowland TW. Does peak VO<sub>2</sub> reflect VO<sub>2</sub>max in children?: evidence from supramaximal testing. *Med Sci Sports Exerc.* 1993;25(6):689-693.
32. Thivel D, Genin PM, Mathieu M-E, Pereira B, Metz L. Reproducibility of an in-laboratory test meal to assess ad libitum energy intake in adolescents with obesity. *Appetite.* 2016;105:129-133. doi:10.1016/j.appet.2016.05.028
33. Flint A, Raben A, Blundell JE, Astrup A. Reproducibility, power and validity of visual analogue scales in assessment of appetite sensations in single test meal studies. *Int J Obes Relat Metab Disord J Int Assoc Study Obes.* 2000;24(1):38-48.
34. Dalton M, Finlayson G. Psychobiological examination of liking and wanting for fat and sweet taste in trait binge eating females. *Physiol Behav.* 2014;136:128-134. doi:10.1016/j.physbeh.2014.03.019
35. Oustric P, Thivel D, Dalton M, et al. Measuring food preference and reward: application and cross-cultural adaptation of the Leeds Food Preference Questionnaire in human experimental research. Oustric P, Thivel D, Dalton M, Beaulieu K, Gibbons C, Hopkins M, Blundell J, Finlayson G.. *Food Qual Pref.* 2020; 80: 103824. doi: 10.1016/j.foodqual.2019.103824. *Food Qual Pref.* 2020;80. doi:doi: 10.1016/j.foodqual.2019.103824
36. Thivel D, Finlayson G, Miguet M, et al. Energy depletion by 24-h fast leads to compensatory appetite responses compared with matched energy depletion by exercise in healthy young males. *Br J Nutr.* 2018;120(5):583-592. doi:10.1017/S0007114518001873
37. Miguet M, Fillon A, Khammassi M, et al. Appetite, energy intake and food reward responses to an acute High Intensity Interval Exercise in adolescents with obesity. *Physiol Behav.* 2018;195:90-97. doi:10.1016/j.physbeh.2018.07.018
38. Thivel D, Roche J, Miguet M, et al. Post- moderate intensity exercise energy replacement does not reduce subsequent appetite and energy intake in adolescents with obesity. *Br J Nutr.* in press.

39. Cohen J. *Statistical Power Analysis for the Behavioral Sciences* (2nd Ed.). Lawrence Erlbaum. New Jersey; 1988.
40. Feise RJ. Do multiple outcome measures require p-value adjustment? *BMC Med Res Methodol.* 2002;2:8. doi:10.1186/1471-2288-2-8
41. Rothman K, Greenland S. *Modern Epidemiology*. 2nd edn. Philadelphia: Lippencott-Raven; 1998.
42. Fearnbach SN, Masterson TD, Schlechter HA, et al. Impact of imposed exercise on energy intake in children at risk for overweight. *Nutr J.* 2016;15(1):92. doi:10.1186/s12937-016-0206-5
43. Prado WL, Lofrano-Prado MC, Oyama LM, et al. Effect of a 12-Week Low vs. High Intensity Aerobic Exercise Training on Appetite-Regulating Hormones in Obese Adolescents: A Randomized Exercise Intervention Study. *Pediatr Exerc Sci.* 2015;27(4):510-517. doi:10.1123/pes.2015-0018
44. Thivel D, Rumbold PL, King NA, Pereira B, Blundell JE, Mathieu M-E. Acute post-exercise energy and macronutrient intake in lean and obese youth: a systematic review and meta-analysis. *Int J Obes* 2005. 2016;40(10):1469-1479. doi:10.1038/ijo.2016.122
45. Thivel D, Chaput J-P. Are Post-Exercise Appetite Sensations and Energy Intake Coupled in Children and Adolescents? *Sports Med.* 2014;44(6):735-741. doi:10.1007/s40279-014-0160-3
46. Thivel D, Doucet E, Julian V, Cardenoux C, Boirie Y, Duclos M. Nutritional compensation to exercise- vs. diet-induced acute energy deficit in adolescents with obesity. *Physiol Behav.* 2017;176:159-164. doi:10.1016/j.physbeh.2016.10.022



**Does exercising before or after a meal affect energy balance in adolescents  
with obesity?**

**Fillon A.**, Beaulieu K., Miguet M., Bailly M., Finlayson G., Julian V., Masurier J., Mathieu ME., Pereira B., Duclos M., Boirie Y., Thivel D.

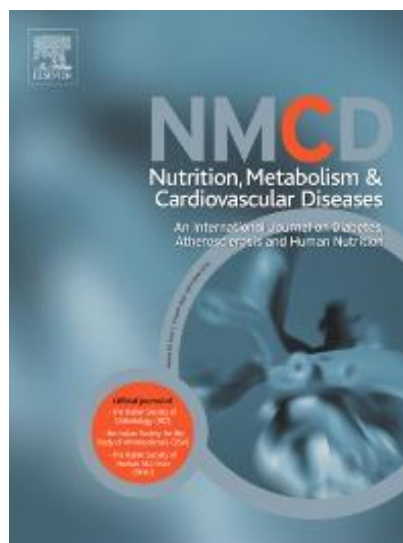

*Under review in Nutrition, Metabolism & Cardiovascular Diseases*

## **Does exercising before or after a meal affect energy balance in adolescents with obesity?**

Fillon Alicia<sup>a, b, \*</sup>, Beaulieu Kristine<sup>c</sup>, Miguet Maud<sup>a</sup>, Bailly Mélina<sup>a</sup>, Finlayson Graham<sup>c</sup>, Julian Valérie<sup>d</sup>, Masurier Julie<sup>b</sup>, Mathieu Marie-Eve<sup>e, f</sup>, Pereira Bruno<sup>g</sup>, Duclos Martine<sup>a, d</sup>, Boirie Yves<sup>a, d</sup>, Thivel David<sup>a, c</sup>.

<sup>a</sup>Clermont University, Laboratory of the Metabolic Adaptations to Exercise under Physiological and Pathological Conditions (AME2P), Clermont-Ferrand, France.

<sup>b</sup>UGECAM Obesity Hospital, Clermont-Ferrand, France.

<sup>c</sup>School of Psychology, University of Leeds, Leeds, UK

<sup>d</sup>CHU, Clermont-Ferrand, France.

<sup>e</sup>Department of Kinesiology, University of Montreal, 2100 Edouard-Montpetit, Montreal H3C 3J7, Canada.

<sup>f</sup>Sainte-Justine UHC Research Center, 5757 Decelles, Montreal H3T 1C5, Canada.

<sup>g</sup>CHU, Biostatistics unit, Clermont-Ferrand, France

### **Corresponding Author :**

FILLON Alicia

AME2P, Clermont-Ferrand, France

[fillonalicia@gmail.com](mailto:fillonalicia@gmail.com) /0033473407679

Competing Interests: None of the authors have a conflict of interest.

Clinical Trial : NCT03967782

Abstract: 195 words

Text: 1487 words

References: 20

Figures: 1

Tables: 2

## **Abstract**

**Background and aim.** While exercise has been suggested to affect appetite and energy intake depending on its timing during the day, the aim of this study was to examine the impact of exercising immediately before or after a meal on energy intake, appetite sensations and food reward in adolescents with obesity.

**Methods and results.** Seventeen adolescents with obesity randomly completed 3 experimental sessions: i) rest without exercise then lunch (CON); ii) exercise before lunch (EX-MEAL); iii) exercise after lunch (MEAL-EX). Outcomes included *ad libitum* energy intake (weighed lunch and dinner), food reward (Leeds Food Preference Questionnaire pre- and post- a combination of exercise or rest and lunch, and pre-dinner) and appetite sensations (visual analogue scales at regular intervals). Lunch and daily intake were not different between conditions. Relative energy intake at lunch was lower in exercise conditions compared with CON (EX-MEAL  $p<0.05$  and MEAL-EX  $p<0.01$ ) and daily only in MEAL-EX compared with CON ( $p<0.01$ ). Postprandial fullness was higher in EX-MEAL compared to CON without modification of food reward.

**Conclusions.** These preliminary results suggest that exercising immediately before or after a meal produce few differences in appetite and have similar effects on overall energy balance in adolescents with obesity.

**Clinical trials.** NCT03967782

**Key Words.** Exercise Timing, Appetite, Energy Intake, Food reward, Obesity, Adolescent

## **Introduction**

It is now recognized that physical exercise not only increases energy expenditure but it can also affect appetite and energy intake (EI) in adolescents with obesity, depending on its duration (Masurier et al., 2018; Tamam et al., 2012), intensity (Thivel et al., 2011, 2012), induced-energy expenditure (Thivel et al., 2013) or as more recently suggested, its timing during the day (A. Fillon et al., 2019; Reid et al., 2019).

Albert and collaborators indeed showed in lean adolescents that EI could be reduced by 11% (with a 23% decrease in fat intake) in response to acute exercise (30min at 65-70%  $VO_{2peak}$ ) performed immediately before lunch compared with the same exercise set 3 hours before lunch (Albert et al., 2015). Similar results have been recently observed in adolescents with obesity who decreased their food intake by 115 kcal 30 minutes but not 180 minutes after similar acute exercise (Alicia Fillon et al., 2020).

While these studies assessed the effect of the delay between exercise and the following meal on EI and appetite; Mathieu et al. recently investigated whether different meal-exercise patterns (exercise then meal or meal then exercise) could differently affect overall energy balance in normal-weight children (Mathieu et al., 2018). Although the authors did not find any differences between conditions (Mathieu et al., 2018), this remains unexplored among children and adolescents with obesity who have shown different appetitive responses to exercise (Thivel et al., 2019).

The aim of the present study was to compare the effect of exercising immediately before or after a meal on EI, appetite sensations and food reward (FR) in adolescents with obesity.

## **Methods**

Seventeen adolescents with obesity (Cole et al., 2000) from the local Pediatric Obesity Center (La Bourboule, France) participated in this study. Adolescents were inactive (IPAQ (Craig et al., 2003)) with no contraindication to physical activity or medication that could influence their nutritional response and metabolism. Anthropometric measurements, body composition (Dual-energy X-ray absorptiometry,

QDR4500A Hologic, Waltham, MA, USA) and maximal aerobic capacity ( $\dot{V}O_{2\text{peak}}$ ) (Rowland, 1993) were assessed as previously described (Miguet et al., 2019). Adolescents randomly completed three experimental sessions (one week apart): i) CON: no exercise and 30-min rest before lunch; ii) EX-MEAL: 30-min cycling exercise ( $65\% \dot{V}O_{2\text{peak}}$ ) between 12:00pm and 12:30pm followed by lunch between 12:30pm and 01:30pm; iii) MEAL-EX: lunch between 12:30pm and 01:30pm followed by 30-min cycling exercise ( $65\% \dot{V}O_{2\text{peak}}$ ) between 01:30pm and 02:00pm. Exercise intensity was controlled by the mechanical load imposed to the cycle ergometer and verified using heart rate recording (Polar V800). Energy expenditure was estimated based on the maximal oxygen uptake evaluation. The experimenters weighed the food items before and after each meal. EI in kcal and macronutrient composition (proportion of fat, carbohydrate and protein) were calculated using the software Bilnut 4.0. Relative energy intake (REI) was obtained by subtracting exercise-induced energy expenditure from EI. Hunger, fullness, desire to eat and prospective food consumption were assessed at regular intervals throughout the day using visual analogue scales (Flint et al., 2000). Pre- and post combination of exercise or rest and lunch, as well as pre-dinner FR (liking and wanting for high-fat relative to low-fat food (fat bias) and sweet relative to savoury food (taste bias)) was assessed using the Leeds Food Preference Questionnaire (Finlayson et al., 2008) as previously described (Miguet et al., 2019). This study was approved by the appropriate ethical institutions (2019-A00507-50) and registered as a clinical trial (NCT03967782).

The sample size was determined according to CONSORT 2010 statement extension to randomized pilot and feasibility trials and Cohen's recommendations. Area under the curve (AUC) was calculated using the trapezoidal method. Random-effects models for repeated data were performed. A particular focus was also given to the magnitude of differences, in addition to inferential statistical tests expressed using p-values (two-sided Type I error set at 0.05 and Sidak's type I error correction applied to multiple comparisons).

## Results

Seventeen adolescents (9 boys) with obesity participated in this study. Their mean age was  $12.8 \pm 1.4$  years, body weight was  $88.0 \pm 15.4$  kg, with a body mass index of  $33.4 \pm 5.7$  kg/m<sup>2</sup> (z-BMI  $2.2 \pm 0.4$ ), a body fat mass of  $38.0 \pm 4.2$  %, a fat-free mass of  $52.5 \pm 9.2$  kg and a  $\dot{V}O_{2\text{peak}}$  of  $21.8 \pm 5.9$  ml/min/kg.

Lunch, dinner and daily EI were not different between conditions (Table 1). REI at lunch was lower in EX-MEAL and MEAL-EX compared to CON ( $p < 0.05$  and  $p < 0.01$ , respectively). Daily REI was lower in MEAL-EX compared with CON ( $p < 0.01$ ). Results are detailed in Table 1. Macronutrient intake at lunch, dinner and daily (in g and %) were not different between conditions.

**Table 1. Absolute and Relative Energy Intake in response the three conditions.**

	CON	EX-MEAL	MEAL-EX	p	ES [95% CI]		
					Mean (SD)	Mean (SD)	Mean (SD)
<b>Energy Intake (kcal)</b>							
Lunch	1244.7 (372.4)	1162.9 (288.9)	1149.5 (314.1)	0.49	-0.14 [-0.62,0.33]	0.26 [-0.73,0.22]	0.12 [-0.36,0.59]
Dinner	751.9 (278.6)	775.9 (302.4)	732.2 (261.5)	0.69	0.15 [-0.33,0.62]	-0.07 [-0.54,0.41]	0.21 [-0.27,0.68]
Total	1996.7 (513.5)	1938.8 (500.7)	1881.7 (488.0)	0.36	-0.04 [-0.51,0.44]	-0.31 [-0.79,0.16]	0.27 [-0.21,0.74]
<b>Relative Energy Intake (kcal)</b>							
Lunch	1205.9 (383.3)	988.7 (285.8)*	988.8 (300.4)**	0.03	-0.76 [-1.24,-0.29]	-0.86 [-1.34,-0.39]	0.10 [-0.38,0.57]
Total	1929.2 (520.3)	1786.2 (511.1)	1720.9 (476.7)*	0.08	-0.42 [-0.90,0.05]	-0.69 [-1.17,-0.22]	0.27 [-0.21,0.74]

CON: control condition; EX-MEAL: Exercise before test meal; MEAL-EX: Exercise after test meal; SD: Standard Deviation

Hunger was significantly lower at 12:00pm in EX-MEAL compared with CON and MEAL-EX ( $p = 0.003$  and  $p = 0.0003$ , respectively). Fullness was significantly higher post-lunch and 30 minutes post-lunch in EX-MEAL compared with CON ( $p = 0.01$  and  $p = 0.04$ , respectively) (Figure 1). Concerning the daily AUC, no differences were found between conditions.

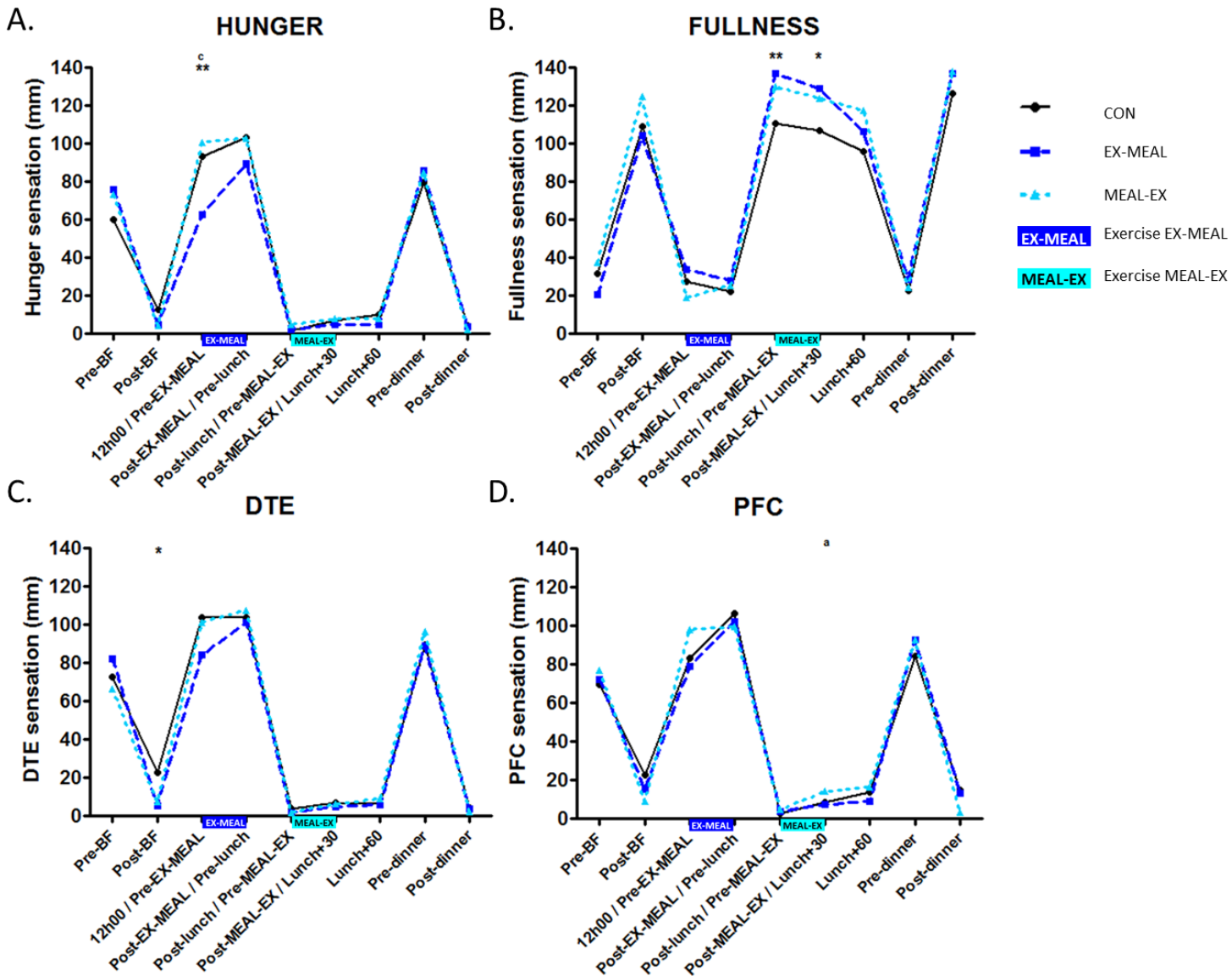

**Figure 1. Daily Hunger(A); Fullness(B); Desire to Eat(DTE;C) and Prospective Food Consumption(PFC;D); BF: Breakfast; CON: rest condition; EX-MEAL: Exercise before test meal; MEAL-EX: Exercise after test meal; \*: CON vs. EX-MEAL  $p < 0.05$ ; \*\*: CON vs. EX-MEAL  $p < 0.01$ ; a: EX-MEAL vs. MEAL-EX  $p < 0.05$ ; c: EX-MEAL vs. MEAL-EX  $p < 0.001$ .**

Pre and post combination of exercise or rest and lunch, and pre-dinner implicit wanting and explicit liking for fat and savory foods did not differ between conditions (Table 2). In response to a combination of rest then lunch, implicit wanting for sweet foods increased (in CON only,  $p = 0.04$ ). Explicit liking for fat foods decreased between before and after a combination of exercise then lunch (EX-MEAL)

( $p < 0.001$ ) and between before and after a combination lunch then exercise (MEAL-EX) ( $p = 0.03$ ). Explicit liking for sweet foods increased only between before and after a combination of exercise then lunch (EX-MEAL) ( $p = 0.05$ ).

Table 2. Pre- and Post-combination food reward on the three experimental conditions

	CON	EX-MEAL	MEAL-EX	P	Interaction time x condition		
	Mean (SD)	Mean (SD)	Mean (SD)		CON vs. EX-MEAL	CON vs. MEAL-EX	EX-MEAL vs. MEAL-EX
<b><u>Implicit Wanting</u></b>							
<b>Fat Bias</b>							
<b>Before comb.</b>	20.7 (31.3)	24.6 (32.6)	26.3 (38.5)	0.24	0.97	0.89	0.95
<b>After comb.</b>	18.8 (34.9)	21.1 (42.8)	15.5 (34.0)	0.38			
<i>p before vs. after</i>	0.32	0.72	0.33				
<b>Before dinner</b>	14.0 (33.4)	2.3 (27.8)	25.5 (50.2)	0.40			
<b>Taste Bias</b>							
<b>Before comb.</b>	13.3 (21.6)	4.5 (33.9)	-0.1 (48.2)	0.38	0.54	0.79	0.54
<b>After comb.</b>	30.0 (30.5)	12.8 (41.0)	22.2 (55.9)	0.57			
<i>p before vs. after</i>	<b>0.04</b>	0.48	0.25				
<b>Before dinner</b>	12.1 (44.8)	11.9 (44.8)	20.2 (36.0)	0.78			
<b><u>Explicit Liking</u></b>							
<b>Fat Bias</b>							
<b>Before comb.</b>	3.3 (17.8)	2.6 (18.5)	5.5 (14.0)	0.33	0.50	0.93	0.53
<b>After comb.</b>	3.6 (15.4)	-0.4 (13.0)	3.4 (15.9)	0.61			
<i>p before vs. after</i>	0.94	<b><math>p &lt; 0.001</math></b>	<b>0.03</b>				
<b>Before dinner</b>	5.7 (14.0)	4.1 (16.5)	5.0 (20.5)	0.23			
<b>Taste Bias</b>							
<b>Before comb.</b>	9.2 (12.8)	7.6 (23.6)	9.3 (25.6)	0.85	0.80	0.96	0.81
<b>After comb.</b>	15.6 (23.1)	15.9 (16.5)	5.4 (17.3)	0.31			
<i>p before vs. after</i>	0.23	<b>0.05</b>	0.50				
<b>Before dinner</b>	7.6 (22.8)	13.7 (30.0)	7.1 (26.4)	0.32			

CON : rest condition ; EX-MEAL: Exercise before lunch; MEAL-EX: Exercise after lunch; SD: Standard Deviations ; comb. : combination of rest or exercise and lunch.



## **Discussion**

This study investigated the effect of exercising immediately before or after lunch on EI, appetite sensations, FR and overall energy balance in adolescents with obesity. While lunch and daily absolute EI did not differ between conditions, consumption at lunch was reduced by 58 kcal(3%) and 115 kcal(6%) on EX-MEAL and MEAL-EX respectively. Furthermore, our results indicated that both exercise conditions favorably affected overall energy balance compared with CON.

This is in line with Mathieu et al. who also did not observe any differences in EI but a reduced REI in lean children who performed an acute moderate-to-vigorous exercise in two different meal-exercise patterns (exercise then meal or meal then exercise) in a school setting (Mathieu et al., 2018). Their results suggest that further studies should be conducted to assess whether exercising at high intensity immediately before or after a meal can differently affect EI in youth.

While hunger, DTE and PFC did not differ between conditions, exercising before lunch seems to favor a higher postprandial fullness compared with the control condition, suggesting a potential effect of pre-meal exercise not only on EI but also on satiety signaling. Indeed, exercise before EI appears to increase postprandial fat oxidation (Wallis & Gonzalez, 2019) and may improve glucose tolerance (Gonzalez & Stevenson, 2012) which offer potential mechanisms to explore in the impact of meal-exercise timing on appetite control. Although Mathieu and colleagues did not assess appetite sensations in their study, our finding is in line with a study in adolescents with obesity showing increased satiety quotient when acute exercise is performed before eating (Alicia Fillon et al., 2020).

Importantly, our results suggest that exercising immediately after a meal does not lead to any perceived-discomfort that could discourage adolescents to exercise or decrease their compliance to physical activity.

Regarding FR, it does not seem to be impacted by the realization of an acute exercise before the meal (EX-MEAL) compare to the condition without exercise (CON). However our results suggest that exercising before a meal (EX-MEAL) attenuates the increased in wanting for sweet food and reduces the explicit liking for fat.

While similar results are observed when the same exercise is performed after the meal (MEAL-EX), it must be noticed that both the pre- and post-condition LFPQ have been realized with a 30-minute delay compared with the two other conditions, in order to keep the lunch meal at the same time of the day, which might have impacted these results and must be considered. It would have been indeed great to implement a fourth condition with Meal-Rest that would have followed the same time and architecture that MEAL-EX to provide better comparison.

An anticipatory effect on subjective appetite may have occurred as differences in hunger and fullness were observed prior to the exercise in EX-MEAL and MEAL-EX, respectively. Further studies are needed to clarify the acute cognitive and metabolic effects of meal-exercise timing on FR.

To conclude, our results suggest that exercising at moderate intensity both immediately before or after a meal have small beneficial effects on overall energy balance in adolescents with obesity. Pre-meal exercise resulted in increased postprandial sensations of fullness. These findings have implications for practitioners who are constrained by adolescents' daily schedules either in the school or clinical setting.

**Acknowledgements.** The authors are grateful to all of the adolescents that participated in the program, and to UGECAM that provided their generous support.

**Financial support.** This research did not receive any specific grant from funding agencies in the public, commercial, or not-for-profit sectors.

**Conflict of interest.** None of the authors have a conflict of interest.

## References

- Albert, M.-H., Drapeau, V., & Mathieu, M.-E. (2015). Timing of moderate-to-vigorous exercise and its impact on subsequent energy intake in young males. *Physiology & Behavior, 151*, 557-562.  
<https://doi.org/10.1016/j.physbeh.2015.08.030>
- Cole, T. J., Bellizzi, M. C., Flegal, K. M., & Dietz, W. H. (2000). Establishing a standard definition for child overweight and obesity worldwide : International survey. *BMJ : British Medical Journal, 320*(7244), 1240.

- Craig, C. L., Marshall, A. L., Sjöström, M., Bauman, A. E., Booth, M. L., Ainsworth, B. E., Pratt, M., Ekelund, U., Yngve, A., Sallis, J. F., & Oja, P. (2003). International physical activity questionnaire : 12-country reliability and validity. *Medicine and Science in Sports and Exercise*, 35(8), 1381-1395. <https://doi.org/10.1249/01.MSS.0000078924.61453.FB>
- Fillon, A., Mathieu, M. E., Boirie, Y., & Thivel, D. (2019). Appetite control and exercise : Does the timing of exercise play a role? *Physiology & Behavior*, 112733. <https://doi.org/10.1016/j.physbeh.2019.112733>
- Fillon, Alicia, Mathieu, M.-E., Masurier, J., Roche, J., Miguet, M., Khammassi, M., Finlayson, G., Beaulieu, K., Pereira, B., Duclos, M., Boirie, Y., & Thivel, D. (2020). Effect of exercise-meal timing on energy intake, appetite and food reward in adolescents with obesity : The TIMEX study. *Appetite*, 146, 104506.
- Finlayson, G., King, N., & Blundell, J. (2008). The role of implicit wanting in relation to explicit liking and wanting for food : Implications for appetite control. *Appetite*, 50(1), 120-127. <https://doi.org/10.1016/j.appet.2007.06.007>
- Finlayson, G., King, N., & Blundell, J. E. (2007). Liking vs. wanting food : Importance for human appetite control and weight regulation. *Neuroscience and Biobehavioral Reviews*, 31(7), 987-1002. <https://doi.org/10.1016/j.neubiorev.2007.03.004>
- Flint, A., Raben, A., Blundell, J. E., & Astrup, A. (2000). Reproducibility, power and validity of visual analogue scales in assessment of appetite sensations in single test meal studies. *International Journal of Obesity and Related Metabolic Disorders: Journal of the International Association for the Study of Obesity*, 24(1), 38-48.
- Gonzalez, J. T., & Stevenson, E. J. (2012). New perspectives on nutritional interventions to augment lipid utilisation during exercise. *The British Journal of Nutrition*, 107(3), 339-349. <https://doi.org/10.1017/S0007114511006684>
- Masurier, J., Mathieu, M.-E., Fearnbach, S. N., Cardenoux, C., Julian, V., Lambert, C., Pereira, B., Duclos, M., Boirie, Y., & Thivel, D. (2018). Effect of Exercise Duration on Subsequent Appetite

- and Energy Intake in Obese Adolescent Girls. *International Journal of Sport Nutrition and Exercise Metabolism*. <https://doi.org/10.1123/ijsnem.2017-0352>
- Mathieu, M.-E., Lebkowski, A., Laplante, E., Drapeau, V., & Thivel, D. (2018). Optimal timing of exercise for influencing energy intake in children during school lunch. *Appetite*, *120*, 416-422. <https://doi.org/10.1016/j.appet.2017.09.011>
- Miguet, M., Fearnbach, S., Khammassi, M., Julian, V., & Cardenoux, C. (2019). Effect of HIIT versus MICT on body composition and energy intake in dietary restrained and unrestrained adolescents with obesity. *Applied Physiology, Nutrition, and Metabolism*, (in press).
- Reid, R. E. R., Thivel, D., & Mathieu, M.-E. (2019). Understanding the potential contribution of a third “T” to FITT exercise prescription : The case of timing in exercise for obesity and cardiometabolic management in children. *Applied Physiology, Nutrition, and Metabolism*, *44*(8), 911-914. <https://doi.org/10.1139/apnm-2018-0462>
- Rowland, T. W. (1993). Does peak VO<sub>2</sub> reflect VO<sub>2</sub>max in children? : Evidence from supramaximal testing. *Medicine and Science in Sports and Exercise*, *25*(6), 689-693.
- Tamam, S., Bellissimo, N., Patel, B. P., Thomas, S. G., & Anderson, G. H. (2012). Overweight and obese boys reduce food intake in response to a glucose drink but fail to increase intake in response to exercise of short duration. *Applied Physiology, Nutrition, and Metabolism*, *37*(3), 520-529. <https://doi.org/10.1139/h2012-038>
- Thivel, D., Aucouturier, J., Doucet, É., Saunders, T. J., & Chaput, J.-P. (2013). Daily energy balance in children and adolescents. Does energy expenditure predict subsequent energy intake? *Appetite*, *60*(1), 58-64. <https://doi.org/10.1016/j.appet.2012.09.022>
- Thivel, D., Finlayson, G., & Blundell, J. E. (2019). Homeostatic and neurocognitive control of energy intake in response to exercise in pediatric obesity : A psychobiological framework. *Obesity Reviews: An Official Journal of the International Association for the Study of Obesity*, *20*(2), 316-324. <https://doi.org/10.1111/obr.12782>

Thivel, D., Isacco, L., Montaurier, C., Boirie, Y., Duché, P., & Morio, B. (2012). The 24-h Energy Intake of Obese Adolescents Is Spontaneously Reduced after Intensive Exercise : A Randomized Controlled Trial in Calorimetric Chambers. *PLoS ONE*, 7(1). <https://doi.org/10.1371/journal.pone.0029840>

Thivel, D., Isacco, L., Rousset, S., Boirie, Y., Morio, B., & Duché, P. (2011). Intensive exercise : A remedy for childhood obesity? *Physiology & Behavior*, 102(2), 132-136. <https://doi.org/10.1016/j.physbeh.2010.10.011>

Wallis, G. A., & Gonzalez, J. T. (2019). Is exercise best served on an empty stomach? *The Proceedings of the Nutrition Society*, 78(1), 110-117. <https://doi.org/10.1017/S0029665118002574>

## Tables Legends

**Table 1.** Absolute and Relative Energy Intake in response the three conditions.

**Table 2.** Pre- and Post-combination food reward on the three experimental conditions

## Figure Legends

**Figure 1.** Daily Hunger (A); Fullness (B); Desire to Eat (DTE; C) and Prospective Food Consumption (PFC; D); BF: Breakfast; CON: rest condition; EX-MEAL: Exercise before test meal; MEAL-EX: Exercise after test meal; \*: CON vs EX-MEAL  $p < 0.05$ ; \*\*: CON vs EX-MEAL  $p < 0.01$ ; a: EX-MEAL vs. MEAL-EX  $p < 0.05$ ; c: EX-MEAL vs. MEAL-EX  $p < 0.001$ .

**Appetite control and exercise:**

**Does the timing of exercise play a role ?**

**Fillon A.**, Beaulieu K., Miguet M., Bailly M., Finlayson G., Julian V., Masurier J., Mathieu ME., Pereira B., Duclos M., Boirie Y., Thivel D.



*Accepted in Physiology and Behavior, Volume 2018, May 2020*



## Appetite control and exercise: Does the timing of exercise play a role?



### ARTICLE INFO

**Keyword:**  
Exercise  
Timing  
Appetite control

### ABSTRACT

The prevention and management of chronic diseases, particularly overweight and obesity, relies on multi-disciplinary strategies mainly combining dietary approaches with physical activity. Recently, the timing of exercise (time of the day as well as delay/position relative to a meal) has been suggested as an important parameter to consider when prescribing physical activity. Some studies have for instance shown the interest of the timing of exercise on the glycemia, sleep and body composition regulation. However, the impact of exercise-timing on appetite control and energy intake remains unclear. This is why, the present paper questions whether physical exercise, depending on its timing during the day and related to a meal, can affect energy intake, appetite sensations and food reward. Although evidences remain actually limited, exercising during the morning; and particularly close to lunch, might have a better impact on overall energy balance through reduced subsequent energy intake, without leading to compensatory intakes at the following meals. Importantly, dealing with the timing of exercise to optimize energy balance (and affect energy intake and appetite) does not only require to consider its time during the day (morning vs. afternoon or evening), but also and maybe mainly its order/position (pre vs. post) and delay regarding meals. While the actual literature remains limited in this area, the present paper tends to highlight the importance of considering the timing of exercise to optimize our impact on the overall energy balance, and to encourage the elaboration of further studies to better understand and determine the potential effect of this timing of exercise, in order to find the best combination between the different exercise characteristics, intensity, duration, modality, to empower these effects.

### 1. Introduction

Physical activity programs are nowadays recognized as a core component of multidisciplinary weight loss strategies. Physical activity interventions are elaborated through the selection of the best and adapted exercise's intensity, duration, modality or frequency, among others, in order to optimize their effects. Recently, the timing of exercise (time of the day as well as delay/position relative to a meal) has been suggested as an important parameter to consider when prescribing physical activity [1]. Some studies have for instance shown a better glycemic control when exercise is performed within one to three hours after food intake in patients with type II diabetes [2–5]. However, a better lipemia response to a meal has been shown when exercise is performed before the meal compared with after [6–8]. Other studies have questioned the interest of the timing of exercise on sleep [9–11], with an evening exercise allowing a better subjective feeling of sleep quality [11], a decrease in daytime sleepiness [11], a relevant sleep phase progression [9] and a better sympathetic regulation (HR and body temperature) [10]. The exercise-meal timing was also investigated in relation to body composition, with regular pre-meal exercise favoring greater weight loss [12,13], decreased BMI and abdominal circumference [12] and then reducing obesity risks [14].

While the effects of exercise, depending on its duration [15,16], intensity [17–19], modality [20–22] or induced-energy expenditure [23] on the control and regulation of appetite and energy intake have received a lot of attention for the last decade, the impact of exercise-timing remains unclear. Since we recently suggested “Timing” as a third “T” to the FITT exercise prescription method (Frequency, Intensity, Time (duration), and Type of exercise) [1], it seems important to

further question the potential effects of the timing of exercise on appetite control to optimize the impact of our interventions on both sides of the energy balance (expenditures and intake). In that context, the present commentary tends to highlight the available evidence regarding the potential effects of the exercise timing on appetite control.

### 2. Time of the day

Although Maraki et al. were among the first to specifically question the appetitive responses to exercise (1 h of aerobic + muscle conditioning exercises) depending on its timing during the day (morning vs. afternoon) [24], their results failed to show any effect of both exercise conditions on self-reported energy intake, with a similar increase in hunger and PFC as well as a similar fullness and satiety decline, compared with their non-exercise group, among healthy normal weight women. To date, we found only two studies whose main aim was to compare the acute effect of morning *versus* afternoon exercises on appetite and energy intake [25,26]. In their work, Alizadeh and collaborators asked adult women with overweight to perform a 30-min acute bout of exercise (treadmill running) set at their individually determined ventilatory threshold, whether between 08:00 and 10:00 am (morning condition) or 02:00 and 04:00 pm (afternoon condition). Although the authors did not observe any difference between conditions for the subsequent energy intake, they used self-reported dietary recalls whose sensitivity might not be enough to detect significant changes, and that have been also shown to favor under-reporting [25]. Interestingly, the authors found a greater level of satiety in response to the morning session [25], suggesting once more the potential beneficial effect of exercising during the morning when it comes to the control of appetite

<https://doi.org/10.1016/j.physbeh.2019.112733>

Received 16 September 2019; Received in revised form 6 November 2019; Accepted 6 November 2019

Available online 07 November 2019

0031-9384/ © 2019 Elsevier Inc. All rights reserved.

and energy intake. Moreover, Larsen et al. recently observed a higher ghrelin concentration in inactive men after a 30-min acute high intensity intermittent cycling exercise performed during the afternoon compared to the same exercise performed in the morning or evening, while perceived hunger and fullness as well as self-reported energy intake appeared unaffected by the timing of the exercise [26].

In their chronic study, Alizadeth et al. (2017) found reduced dietary intake in women with overweight, including carbohydrate and fat consumption in response to a 6-week intervention when exercise (30 min treadmill running at the ventilatory threshold, three-times a week) was performed in the morning but not in the afternoon, despite unchanged appetite feelings [12]. These results have been reinforced by later studies who failed to find any energy intake modifications in response to a 12-week program where adolescents girls performed 30 min exercise sessions (composed of various activities such as running, cycling, team games, dancing, etc.) between 03:30 pm and 04:30 pm, three times a week [27]. Some authors even observed a 80–230 Kcal/day increase in food consumption in response to an afternoon exercise intervention (walking/running on a treadmill), but not when the exercise was set during the morning, in adults with overweight and obesity (noting that these differences did not reach significance) [13]. Such an increase in energy intake after exercise is of main importance to consider since it might decrease the amount of energy expended during the exercise and, in the long term, if the energy expended is overcompensated, this could favor counterproductive results such as weight gain. Importantly, future studies comparing the effect of morning vs. afternoon exercise should also consider the potential existence of different eating patterns between lunch and dinner, with individuals who might be susceptible to overeat at dinner compare to lunch, independently of exercise.

### 3. Exercising before or after a meal?

In 2016, Heden and colleagues questioned for the first time the importance of exercising just before or 45 min after a meal, to improve appetite control [28]. They then asked patients with type II diabetes to perform resistance exercise (45-min session) prior or 45-min following dinner. According to their results, exercising right before a meal favored increased pre-meal perceived fullness, reduced hunger and reduced acylated ghrelin concentrations compared with their post-meal exercise session and control condition [28]. These results are in line with those from Cheng et al. who also obtained decreased appetite, despite increased plasma ghrelin concentrations, when healthy adult males cycled before a meal (50 min at 60% of their maximal capacities) compared with after [29]. Interestingly these studies also suggest the interest of exercising after a meal as a way to potentially extend the suppressive effects of meal consumption on appetite [28,29], which definitely warrants further investigations.

In 2017, Mathieu et al. published a well-controlled free-living study designed to compare the effect of two different lunchtime organizations: i) exercise then meal or ii) meal then exercise, on overall energy balance, also considering the importance of the intensity of exercise [30]. Twenty-one primary school children were then asked to exercise for 40 min (ball games as well as running and chasing games) right before their lunch meal either at low or moderate-to-high intensity; or to perform the 40-min moderate-to-high intensity exercise right after their lunch, on three separate occasions. While their results confirm the interest of prescribing higher intensity exercises to benefit from a subsequent transient anorexigenic effect (with a significantly higher energy intake after the low intensity exercise compared with the moderate-to-high intensity one), they failed to observe any difference in energy intake when exercise was performed before or right after the meal [30]. More recently, similar results were obtained among adolescents with obesity whose energy intake and food reward remained unchanged whether the adolescents performed a 30-min cycling exercise (65%VO<sub>2peak</sub>) right before or after their lunch meal [31]. Pre-

and post-meal hunger feelings were however found reduced when the exercise was performed right before the meal [31]. To our knowledge, only one chronic study questioned the effect of exercising right before or after meals among patients with overweight and obesity. In this study, participants were asked to exercise twice a day for 15 min at high intensity for 4 consecutive weeks [32]. According to their results, the authors failed to find any effect on energy intake, except a slight increase in the percentage of protein intake when exercise was performed just before meal [32].

Interestingly, Gustafson et al. (2018) highlighted the importance of the cognitive and hedonic control of energy intake that must be considered when comparing pre and post meal exercise [33]. They indeed pointed out that individuals' free food selection differs in quality when realized before or after an acute exercise. According to their study, people show a 33.5% higher probability of choosing healthy food items when the choice is made before exercising; while they are about 39% more likely to select "unhealthy" items after exercise [33]. Although the participants of this later study were proposed apples or brownies only, which certainly composes its main limitation; such hedonic compensatory responses to exercise have to be considered when prescribing exercise before or after a meal in order to avoid any compensatory consumption that might attenuate the beneficial effects of exercise.

### 4. The exercise-meal delay

While not specially designed and focused on the effect of the exercise-timing, results from studies using similar exercises and conducted among similar populations tend to suggest potentially different energy intake responses depending on the delay between exercise and the subsequent meal. In their work, Fearnbach et al. for instance showed reduced *ad libitum* energy intake in 12–15 years old adolescents with obesity 30 min after an acute bout of moderate intensity cycling exercise [34,35] while others failed to observe any food consumption modification in a similar population when the same exercise is performed 60 min before lunch [36].

Some studies have been specifically conducted to compare some nutritional outcomes in response to exercise depending on its delay with a meal. In their work, Josaphat and collaborators asked healthy men to perform an acute 30-min exercise set at 70% of their maximal aerobic capacities either 90 min or right before a lunch test meal [37]. According to their results, there was no difference between the two conditions regarding total *ad libitum* energy intake, appetite feelings and the taste or smell sensations [37]. Interestingly, using a similar design, Albert et al. observed a reduction of 11% of the post-exercise energy intake (with a 23% decrease in ingested fat) when the exercise (30 min treadmill running at 70% VO<sub>2max</sub>) is performed just before the meal compared with 165 min before, with no difference regarding appetite feelings, in normal-weight adolescents [38]. This reduced food intake was moreover not compensated for by an increase of the following snack or dinner intake [38]. Our team recently obtained similar results in adolescents with obesity who show a decrease of their relative energy intake after an acute bout of moderate intensity cycling exercise (65% VO<sub>2peak</sub>) set 30 min before lunch compared with 180 min before, without any compensation at the following meal (dinner) [39]. This was accompanied by a significantly reduced intake of proteins and lipids after the control session (rest) or both the control and exercise + 180 min sessions respectively [39]. Interestingly, none of the appetite feelings (hunger, fullness, desire to eat and prospective food consumption) were found different between conditions, suggesting an optimized effect on overall energy balance when exercise is realized close to a meal, without creating any food frustration or hunger. These results are in line with those from Panissa et al. (2019) who recently showed that intermittent high intensity exercise performed one hour before an *ad libitum* meal reduces appetite and energy intake in overweight inactive men [40]. Moreover, Fillon et al. showed a significantly



lower pre-meal explicit liking for high-fat relative to low-fat foods when the exercise is close to the meal [39]. Importantly, all the studies conducted so far questioned the potential effect of the exercise-meal delay implementing exercises between 30 and 150 min after the breakfast and testing the energy intake response at a fixed meal (usually 12:00 pm). However, by doing so, these studies compared the appetitive responses to exercise of different metabolic load and activities. Indeed, it has been showed that performing the same exercise, in terms of duration and intensity, 60 or 180 min after a standardized breakfast, leads to different substrate use in children, which in turns can differently affect subsequent energy intake and appetite [41]. In that sense, *ad libitum* energy intake has been compared at a test meal settled 30 or 90 min after an acute exercise (30 min cycling at 65%  $VO_{2peak}$ ) fixed 150 min after a standardized breakfast on both conditions (modifying then the timing of the lunch meal) [42]. Interestingly, energy intake was found lower on both exercise conditions compared to the control one, with a greater decrease when the lunch was consumed 90 min after the exercise, without any difference in terms of food reward [42].

## 5. Conclusion

Although the actual literature remains limited to date, available results seems to encourage the consideration of the timing of exercise when prescribing physical activity, as an interesting way to empower energy balance by affecting both energy expenditure and energy intake. The available literature discussed in the present work seems to indicate that regularly exercising during the morning would have beneficial effects on subsequent energy intake when compared to afternoon interventions. While it remains difficult to draw any conclusion regarding the effect of exercising right before or after a meal (due to the reduced and heterogeneous evidences); available results suggest that the closer to the lunch is the exercise, the greater might be the impact on overall energy balance through reduced subsequent energy intake, without leading to compensatory intakes at the following meals, which remains obviously to be confirmed. Importantly, dealing with the timing of exercise to optimize energy balance (and affect energy intake and appetite) does not only require to consider its time during the day (morning vs. afternoon or evening), but also and maybe mainly its order/position (pre vs. post) and delay regarding meals. These results remain however to be confirmed since the actual body of literature rests on studies that present a high level of methodological heterogeneity, suggesting the need for a more consensual and standardized method to facilitate our actual understanding and help future exercise prescriptions. Similarly, this high degree of methodological disparity limits any interpretation regarding the potential effect of the exercise timing on food preference and macronutrients intake, which should be better considered in future studies. While the present work highlights the importance of considering the timing of exercise to optimize our impact on the overall energy balance, further studies are needed to find the best combination between the different exercise characteristics, intensity, duration, modality, to empower these effects. Further studies questioning the effect of the timing of exercise on food reward are also required since the few available results come from the same research group and were obtained in adolescents with obesity only. Not only the appetitive and behavioral responses to exercise, depending on its timing, should be further explored, future studies should also investigate the potentially involved physiological and neurocognitive mechanisms, including the potential role of some eating traits such as the eating profile (cognitive restriction, disinhibition, food craving, etc.). Indeed, the beneficial effects (and their extent) of the exercise timing might also depend on these parameters (certainly mainly its intensity). Although encouraging results exist in both lean and children with overweight/and obesity, further long-term investigations and especially free-living school-based studies are required. Indeed, while the elaboration of daily schedules that respect the chronobiology of children has created a lots of debate for the last couple of years,

especially regarding the introduction and organization of physical education and physical activities, there is a clear need to better explore and understand the exact effects and interests of the exercise-meal timing to improve both our public health prevention strategies and treatment programs.

## Declaration of Competing Interest

None.

## References

- [1] R.E.R. Reid, D. Thivel, M.-E. Mathieu, Understanding the potential contribution of a third "T" to FITT exercise prescription: the case of timing in exercise for obesity and cardiometabolic management in children, *Appl. Physiol. Nutr. Metab.* 44 (2019) 911–914, <https://doi.org/10.1139/apnm-2018-0462>.
- [2] A. Borrer, G. Zieff, C. Battaglini, L. Stoner, The effects of postprandial exercise on glucose control in individuals with type 2 diabetes: a systematic review, *Sports Med.* 48 (2018) 1479–1491, <https://doi.org/10.1007/s40279-018-0864-x>.
- [3] E. Chacko, Exercising tactically for taming postmeal glucose surges, *Scientifica* 2016 (2016) 4045717, <https://doi.org/10.1155/2016/4045717>.
- [4] J. Haxhi, A. Scotto di Palumbo, M. Sacchetti, Exercising for metabolic control: is timing important, *Ann. Nutr. Metab.* 62 (2013) 14–25, <https://doi.org/10.1159/000343788>.
- [5] S.Y.M. Teo, J.A. Kanaley, K.J. Guelfi, S.B. Cook, J.J. Hebert, M.R.L. Forrest, T.J. Fairchild, Exercise timing in type 2 diabetes mellitus: a systematic review, *Med. Sci. Sports Exerc.* 50 (2018) 2387–2397, <https://doi.org/10.1249/MSS.0000000000001732>.
- [6] D.S. Pettitt, K.J. Cureton, Effects of prior exercise on postprandial lipemia: a quantitative review, *Metabolism* 52 (2003) 418–424, <https://doi.org/10.1053/meta.2003.50071>.
- [7] J.Q. Zhang, L.L. Ji, G. Nunez, S. Feathers, C.L. Hart, W.X. Yao, Effect of exercise timing on postprandial lipemia in hypertriglyceridemic men, *Can. J. Appl. Physiol.* 29 (2004) 590–603.
- [8] J.Q. Zhang, T.R. Thomas, S.D. Ball, Effect of exercise timing on postprandial lipemia and HDL cholesterol subfractions, *J. Appl. Physiol.* 85 (1998) 1516–1522, <https://doi.org/10.1152/jappl.1998.85.4.1516>.
- [9] O.M. Buxton, C.W. Lee, M. L'Hermite-Baleriaux, F.W. Turek, E. Van Cauter, Exercise elicits phase shifts and acute alterations of melatonin that vary with circadian phase, *Am. J. Physiol. Regul. Integr. Comp. Physiol.* 284 (2003) R714–R724, <https://doi.org/10.1152/ajpregu.00355.2002>.
- [10] Y. Yamanaka, S. Hashimoto, N.N. Takasu, Y. Tanahashi, S.-Y. Nishide, S. Honma, K.-I. Honma, Morning and evening physical exercise differentially regulate the autonomic nervous system during nocturnal sleep in humans, *Am. J. Physiol. Regul. Integr. Comp. Physiol.* 309 (2015) R1112–R1121, <https://doi.org/10.1152/ajpregu.00127.2015>.
- [11] H. Yoshida, T. Ishikawa, F. Shiraishi, T. Kobayashi, Effects of the timing of exercise on the night sleep, *Psychiatry Clin. Neurosci.* 52 (1998) 139–140, <https://doi.org/10.1111/j.1440-1819.1998.tb00994.x>.
- [12] Z. Alizadeh, S. Younespour, M. Rajabian Tabesh, S. Haghvran, Comparison between the effect of 6 weeks of morning or evening aerobic exercise on appetite and anthropometric indices: a randomized controlled trial, *Clin. Obes.* 7 (2017) 157–165, <https://doi.org/10.1111/cob.12187>.
- [13] E.A. Willis, S.A. Creasy, J.J. Honas, E.L. Melanson, J.E. Donnelly, The effects of exercise session timing on weight loss and components of energy balance: midwest exercise trial 2, *Int. J. Obes.* (2019), <https://doi.org/10.1038/s41366-019-0409-x>.
- [14] A.K. Chomistek, E.J. Shiroma, I.-M. Lee, The relationship between time of day of physical activity and obesity in older women, *J. Phys. Act. Health* 13 (2016) 416–418, <https://doi.org/10.1123/jpah.2015-0152>.
- [15] J. Masurier, M.-E. Mathieu, S.N. Fearnbach, C. Cardenoux, V. Julian, C. Lambert, B. Pereira, M. Duclos, Y. Boirie, D. Thivel, Effect of exercise duration on subsequent appetite and energy intake in obese adolescent girls, *Int. J. Sport Nutr. Exerc. Metab.* (2018), <https://doi.org/10.1123/ijsem.2017-0352>.
- [16] S. Tamam, N. Bellissimo, B.P. Patel, S.G. Thomas, G.H. Anderson, Overweight and obese boys reduce food intake in response to a glucose drink but fail to increase intake in response to exercise of short duration, *Appl. Physiol. Nutr. Metab.* 37 (2012) 520–529, <https://doi.org/10.1139/h2012-038>.
- [17] D. Thivel, L. Isacco, C. Montaurier, Y. Boirie, P. Duché, B. Morio, The 24-h energy intake of obese adolescents is spontaneously reduced after intensive exercise: a randomized controlled trial in calorimetric chambers, *PLoS One* (2012) 7, <https://doi.org/10.1371/journal.pone.0029840>.
- [18] D. Thivel, L. Isacco, S. Rousset, Y. Boirie, B. Morio, P. Duché, I. exercise, A remedy for childhood obesity? *Physiol. Behav.* 102 (2011) 132–136, <https://doi.org/10.1016/j.physbeh.2010.10.011>.
- [19] D. Thivel, L. Metz, A. Julien, B. Morio, P. Duché, Obese but not lean adolescents spontaneously decrease energy intake after intensive exercise, *Physiol. Behav.* 123 (2014) 41–46, <https://doi.org/10.1016/j.physbeh.2013.09.018>.
- [20] L. Balaguera-Cortes, K.E. Wallman, T.J. Fairchild, K.J. Guelfi, Energy intake and appetite-related hormones following acute aerobic and resistance exercise, *Appl. Physiol. Nutr. Metab.* 36 (2011) 958–966, <https://doi.org/10.1139/h11-121>.
- [21] D.R. Broom, R.L. Batterham, J.A. King, D.J. Stensel, Influence of resistance and aerobic exercise on hunger, circulating levels of acylated ghrelin, and peptide YY in

- healthy males, *Am. J. Physiol. Regul. Integr. Comp. Physiol.* 296 (2009) R29–R35, <https://doi.org/10.1152/ajpregu.90706.2008>.
- [22] D.J. Laan, H.J. Leidy, E. Lim, W.W. Campbell, Effects and reproducibility of aerobic and resistance exercise on appetite and energy intake in young, physically active adults, *Appl. Physiol. Nutr. Metab.* 35 (2010) 842–847, <https://doi.org/10.1139/H10-072>.
- [23] D. Thivel, J. Aucouturier, É. Doucet, T.J. Saunders, J.-P. Chaput, Daily energy balance in children and adolescents. Does energy expenditure predict subsequent energy intake? *Appetite* 60 (2013) 58–64, <https://doi.org/10.1016/j.appet.2012.09.022>.
- [24] M. Maraki, F. Tsofliou, Y.P. Pitsiladis, D. Malkova, N. Mutrie, S. Higgins, Acute effects of a single exercise class on appetite, energy intake and mood. Is there a time of day effect? *Appetite* 45 (2005) 272–278, <https://doi.org/10.1016/j.appet.2005.07.005>.
- [25] Z. Alizadeh, M. Mostafaei, R. Mazaheri, S. Younespour, Acute effect of morning and afternoon aerobic exercise on appetite of overweight women, *Asian J. Sports Med.* 6 (2015) e24222, [https://doi.org/10.5812/asjms.6\(2\)20156.24222](https://doi.org/10.5812/asjms.6(2)20156.24222).
- [26] P. Larsen, F. Marino, K. Melehan, K.J. Guelfi, R. Duffield, M. Skein, Evening high-intensity interval exercise does not disrupt sleep or alter energy intake despite changes in acylated ghrelin in middle-aged men, *Exp. Physiol.* 104 (2019) 826–836, <https://doi.org/10.1113/EP087455>.
- [27] R. Massie, J. Smallcombe, K. Tolfrey, Effects of a 12-week exercise intervention on subsequent compensatory behaviors in adolescent girls: an exploratory study, *Pediatr. Exerc. Sci.* (2019) 1–10, <https://doi.org/10.1123/pes.2019-0012>.
- [28] T.D. Heden, Y. Liu, J.A. Kanaley, Impact of exercise timing on appetite regulation in individuals with type 2 diabetes, *Med. Sci. Sports Exerc.* 48 (2016) 182–189, <https://doi.org/10.1249/MSS.0000000000000755>.
- [29] M.H.-Y. Cheng, D. Bushnell, D.T. Cannon, M. Kern, Appetite regulation via exercise prior or subsequent to high-fat meal consumption, *Appetite* 52 (2009) 193–198, <https://doi.org/10.1016/j.appet.2008.09.015>.
- [30] M.-E. Mathieu, A. Lebkowski, E. Laplante, V. Drapeau, D. Thivel, Optimal timing of exercise for influencing energy intake in children during school lunch, *Appetite* 120 (2018) 416–422, <https://doi.org/10.1016/j.appet.2017.09.011>.
- [31] A. Fillon, M. Miguët, M. Bailly, V. Julian, B. Pereira, J. Masurier, K. Beaulieu, G. Finlayson, M. Duclos, Y. Boirie, D. Thivel, Does exercising before or after a meal optimize overall energy balance in adolescents with obesity? *Ann. Nutr. Metab.* (2019) Katowice. in press.
- [32] M.-E. Damour, R.E.R. Reid, V. Drapeau, M.-E. Labonte, M.-E. Mathieu, Exercise training in the free-living environment and its impact on energy intake and anthropometric outcomes: a pilot study on exercise timing around meals, *Biol. Exerc.* (2019) 15.
- [33] C.R. Gustafson, N. Rakhmatullaeva, S.E. Beckford, A. Ammachathram, A. Cristobal, K. Koehler, Exercise and the timing of snack choice: healthy snack choice is reduced in the post-exercise state, *Nutrients* (2018) 10, <https://doi.org/10.3390/nu10121941>.
- [34] S.N. Fearnbach, L. Silvert, K.L. Keller, P.M. Genin, B. Morio, B. Pereira, M. Duclos, Y. Boirie, D. Thivel, Reduced neural response to food cues following exercise is accompanied by decreased energy intake in obese adolescents, *Int. J. Obes.* 40 (2016) 77–83, <https://doi.org/10.1038/ijo.2015.215>.
- [35] S.N. Fearnbach, T.D. Masterson, H.A. Schlechter, A.J. Ross, M.J. Rykaczewski, E. Loken, D.S. Downs, D. Thivel, K.L. Keller, Impact of imposed exercise on energy intake in children at risk for overweight, *Nutr. J.* 15 (2016) 92, <https://doi.org/10.1186/s12937-016-0206-5>.
- [36] D. Thivel, P.L. Rumbold, N.A. King, B. Pereira, J.E. Blundell, M.-E. Mathieu, Acute post-exercise energy and macronutrient intake in lean and obese youth: a systematic review and meta-analysis, *Int. J. Obes.* 40 (2016) 1469–1479, <https://doi.org/10.1038/ijo.2016.122>.
- [37] K.J. Josaphat, V. Drapeau, D. Thivel, M.-E. Mathieu, Impact of exercise timing on chemosensory response, appetite and energy intake in lean males, . . (under review).
- [38] M.-H. Albert, V. Drapeau, M.-E. Mathieu, Timing of moderate-to-vigorous exercise and its impact on subsequent energy intake in young males, *Physiol. Behav.* 151 (2015) 557–562, <https://doi.org/10.1016/j.physbeh.2015.08.030>.
- [39] A. Fillon, M.-E. Mathieu, J. Masurier, J. Roche, M. Miguët, M. Khammassi, G. Finlayson, K. Beaulieu, B. Pereira, M. Duclos, Y. Boirie, D. Thivel, Effect of exercise-meal timing on energy intake, appetite and food reward in adolescents with obesity: the TIMEX study, (under revision).
- [40] V.L.G. Panissa, U.F. Julio, D.H. St-Pierre, A. Tavares da Silva Gomes, R.S. Caldeira, F.S. Lira, M.Y. Takito, E. Franchini, Timing of high-intensity intermittent exercise affects ad libitum energy intake in overweight inactive men, *Appetite* 143 (2019) 104443, <https://doi.org/10.1016/j.appet.2019.104443>.
- [41] J. Aucouturier, L. Isacco, D. Thivel, N. Fellmann, J.-M. Chardigny, M. Duclos, P. Duché, Effect of time interval between food intake and exercise on substrate oxidation during exercise in obese and lean children, *Clin. Nutr.* 30 (2011) 780–785, <https://doi.org/10.1016/j.clnu.2011.03.011>.
- [42] A. Fillon, M. Miguët, M. Bailly, V. Julian, B. Pereira, J. Masurier, K. Beaulieu, G. Finlayson, M. Duclos, Y. Boirie, D. Thivel, Effect of the exercise timing on energy intake and appetite sensations in adolescents with obesity, *Annals of Nutrition and Metabolism*, Katowice, 2019.

A. Fillon<sup>a,b,c,\*</sup>, M.E. Mathieu<sup>d,e</sup>, Y. Boirie<sup>b,f,g</sup>, D. Thivel<sup>a,f</sup>

<sup>a</sup> Clermont Auvergne University, EA 3533, Laboratory of the Metabolic Adaptations to Exercise under Physiological and Pathological Conditions (AME2P), Clermont-Ferrand, France

<sup>b</sup> University Clermont Auvergne, INRA, Unité de Nutrition Humaine, 63000 Clermont-Ferrand, France

<sup>c</sup> UGECAM Nutrition Obesity Ambulatory Hostipal, Clermont-Ferrand, France

<sup>d</sup> School of Kinesiology and physical activity sciences, University of Montreal, 2100 Edouard-Montpetit, Montreal H3C 3J7, Canada

<sup>e</sup> Sainte-Justine UHC Research Center, 5757 Decelles, Montreal H3T 1C5, Canada

<sup>f</sup> University Clermont Auvergne, CRNH Auvergne, 63000 Clermont-Ferrand, France

<sup>g</sup> CHU Clermont-Ferrand, Service de Nutrition Clinique, CSO CALORIS, 63003 Clermont-Ferrand, France

E-mail addresses: [fillonalia@gmail.com](mailto:fillonalia@gmail.com) (A. Fillon), [me.mathieu@umontreal.ca](mailto:me.mathieu@umontreal.ca) (M.E. Mathieu), [yves.boirie@inra.fr](mailto:yves.boirie@inra.fr) (Y. Boirie), [thiveldavid@hotmail.com](mailto:thiveldavid@hotmail.com) (D. Thivel).

\* Corresponding author at: Clermont University, EA 3533, Laboratory of the Metabolic Adaptations to Exercise under Physiological and Pathological Conditions (AME2P), BP 80026, F-63171 Aubière cedex, France

## Annexe 4

### Publications non relatives aux questions de recherche

---

#### Articles originaux :

- Aubert, S., Aucouturier, J., Ganière, C., **Fillon, A.**, Genin, P., Schipman, J., Larras, B., Praznoczy, C., Duclos, M., & Thivel, D. (2018). Results from France's 2018 Report Card on Physical Activity for Children and Youth. *Journal of Physical Activity and Health*, 15(s2), S360-S362. <https://doi.org/10.1123/jpah.2018-0511>
- Aubert, S., Aucouturier, J., Vanhelst, J., **Fillon, A.**, Genin, P. M., Ganière, C., Praznoczy, C., Larras, B., Schipman, J., Duclos, M., & Thivel, D. (2020). France's 2018 Report Card on Physical Activity for Children and Youth: Results and International Comparisons. *Journal of Physical Activity and Health*, 17, 270-277. <https://doi.org/10.1123/jpah.2019-0241>
- Khammassi, M., Miguet, M., O'Malley, G., **Fillon, A.**, Masurier, J., Damaso, A. R., Pereira, B., Lambert, C., Duclos, M., Courteix, D., Boirie, Y., & Thivel, D. (2019). Health-related quality of life and perceived health status of adolescents with obesity are improved by a 10-month multidisciplinary intervention. *Physiology & Behavior*, 210, 112549. <https://doi.org/10.1016/j.physbeh.2019.05.010>

- Miguet, M., **Fillon, A.**, Khammassi, M., Masurier, J., Julian, V., Pereira, B., Lambert, C., Boirie, Y., Duclos, M., Blundell, J. E., Finlayson, G., & Thivel, D. (2018). Appetite, energy intake and food reward responses to an acute High Intensity Interval Exercise in adolescents with obesity. *Physiology & Behavior*, 195, 90-97. <https://doi.org/10.1016/j.physbeh.2018.07.018>
  
- Roche, J., Corgosinho, F. C., Dâmaso, A. R., Isacco, L., Miguet, M., **Fillon, A.**, Guyon, A., Moreira, G. A., Pradella-Hallinan, M., Tufik, S., Túlio de Mello, M., Gillet, V., Pereira, B., Duclos, M., Boirie, Y., Masurier, J., Franco, P., Thivel, D., & Mougin, F. (2019). Sleep-disordered breathing in adolescents with obesity: When does it start to affect cardiometabolic health? *Nutrition, Metabolism and Cardiovascular Diseases*, S0939475319304508. <https://doi.org/10.1016/j.numecd.2019.12.003>
  
- Thivel, D., Roche, J., Miguet, M., **Fillon, A.**, Khammassi, M., Beaulieu, K., Finlayson, G., Pereira, B., Miyashita, M., Thackray, A. E., Masurier, J., Duclos, M., & Boirie, Y. (2020). Post-moderate-intensity exercise energy replacement does not reduce subsequent appetite and energy intake in adolescents with obesity. *British Journal of Nutrition*, 123(5), 592-600. <https://doi.org/10.1017/S0007114519003106>
  
- Thivel, D., **Fillon, A.**, Genin, P. M., Miguet, M., Khammassi, M., Pereira, B., Boirie, Y., Duclos, M., Drapeau, V., Blundell, J., Tremblay, A., Finlayson, G., Mathieu, M.-E., & Metz, L. (2020). Satiety Responsiveness but not Food Reward is modified in response to an acute bout of low versus high intensity exercise in healthy adults. *Appetite*, 145, 104500.

# Results from France's 2018 Report Card on Physical Activity for Children and Youth

Aubert, S., Aucouturier, J., Ganière, C., **Fillon, A.**, Genin, P., Schipman, J., Larras, B., Praznoczy, C., Duclos, M., & Thivel, D.

Journal of  
Physical Activity & Health

Volume 15, Issue 1, January 2018



ISPAH

HUMAN KINETICS  
<http://journal.humanKinetics.com/journal/PAH>  
ISSN 1543-3080

*Accepted in Journal of Physical Activity and Health, Volume 15, January 2018*

# Results from France's 2018 Report Card on Physical Activity for Children and Youth

Salomé Aubert, Julien Aucouturier, Caroline Ganière, Alicia Fillon, Pauline Genin, Julien Schipman, Benjamin Larras, Corinne Praznocy, Martine Duclos, and David Thivel

## Introduction

The French Government officially recognises the health benefits of physical activity for children and youth and has supported the development and promotion of national physical activity guidelines since 2002, and their recent renewal in 2016.<sup>1</sup> France's first Report Card of grades on Physical Activity for Children and Adolescents was developed in 2016 with an incomplete grade for the Overall Physical Activity indicator given a lack of recent nationally representative data.<sup>2</sup> The purpose of this paper is to summarize the results of the 2018 France Report Card that includes new data from two national surveys.

## Methods

The 2018 France Report Card synthesized available evidence for 10 indicators of physical activity: Overall Physical Activity Levels, Organized Sport Participation, Active Transportation, Active Play, Sedentary Behaviours, Physical Fitness, Family and Peers, School, Community and Environment and Government. Two French national surveys were used to inform the Overall Physical Activity, the Active transportation and the Sedentary Behavior indicators: the National Study of Individual Nutritional Consumption 3 (INCA 3 2014-2015) and the Health Study of the Environment, Biosurveillance, Physical Activity, and Nutrition (ESTEBAN 2014-2016). To measure child and youth physical activity and its characteristics, both of these surveys used a modified version of the French Surveillance and Nutritional Epidemiology Unit (USEN) questionnaire for the 6-10 year-olds (reported by a parent); and a modified version of the Youth Risk Behaviour Surveillance System questionnaire for the 11-17 year-olds (self-reported). The other indicators were informed by national statistics, reports and scientific studies. The French Report Card Group, composed of national experts discussed and assigned the grades to each indicator, using standardized benchmarks and the same grading scheme (from A+ = excellent, to F = failing), taking into account the nature and origin

of the data sources, the sample size, the age range of participants, the year of publication, and the quality of the available data.

## Results and Discussion

The cover of the 2018 France Report Card is presented in Figure 1, and the grades and rationales for each indicator are presented in Table 1. There is still a lack of large, good quality, national surveys



Figure 1 — France's 2018 Report Card cover.

Aubert is with the Healthy Active Living and Obesity Research Group, Children's Hospital of Eastern Ontario Research Institute, Ottawa, Ontario, Canada. Aucouturier is with A7369, Unité de Recherche Pluridisciplinaire Sport, Santé, Société (URePSSS), Equipe "Activité Physique, Muscle, Santé", Université de Lille, France. Ganière is with the Laboratoire du Centre d'Etude des Transformations des Activités Physiques et Sportives (CETAPS), Rouen, France. Fillon is with the Laboratory of metabolic adaptations to exercise under physiological and pathological conditions (AME2P), the Research Center for Human Nutrition (CRNH Auvergne); and the Clermont Auvergne University, UGECAM, Clermont-Ferrand, Auvergne, France. Genin is with the Laboratory of metabolic adaptations to exercise under physiological and pathological conditions (AME2P) and Research Center for Human Nutrition (CRNH Auvergne), Clermont-Ferrand, France. Schipman is with IRMES (Institute for biomedical and epidemiological research in sport), INSEP, Paris, France. Larras and Praznocy are with the French National Observatory for Physical Activity and Sedentary Behaviours (ONAPS), Clermont-Ferrand, France. Duclos is with the Department of Sport Medicine and Functional Exploration, University Hospital CHU G.Montpied, INRA, UMR 1019, UNH, the Research Center for Human Nutrition (CRNH Auvergne), University of Auvergne; and the French National Observatory for Physical Activity and Sedentary Behaviours (ONAPS), F-63000 Clermont-Ferrand, France. Thivel is with the Laboratory of metabolic adaptations to exercise under physiological and pathological conditions (AME2P), the Research Center for Human Nutrition (CRNH Auvergne), Clermont Auvergne University; and the French National Observatory for Physical Activity and Sedentary Behaviours (ONAPS), Clermont-Ferrand, France. Aubert ([saubert@cheo.on.fr](mailto:saubert@cheo.on.fr)) is corresponding author.

**Table 1 Grades and rationales for France's 2018 Report Card**

Indicator	Grade	Rationale
Overall Physical Activity	D	In the two national surveys, a “high level of physical activity” corresponded to five or more days a week of physical activity and the regular use of active transportation (reported by the parents) for the 6-10 years old; and to practicing a moderate to vigorous physical activity at least 5 days a week (self-reported for the 11-17 years old). Only 24% of the 7-10 years old were reported to have a high level of physical activity; 38% of the 11-14 years old reported a high level of physical activity; 24% of the 15-17 years old reported a high level of physical activity. <sup>3</sup> And only 23% of the 6-17 years old were estimated to have a high level of physical activity in ESTEBAN 2015. <sup>4</sup>
Organized Sport Participation	C-	The proportion of children and youth enrolled in sport federations in 2016 (not including the school sport federations) was 33% for the 0-9 year-olds, 60% for the 10-14 year-olds, and 34% for the 15-19 year-olds. <sup>5</sup>
Active Play	INC	Among the 6-10 year-olds, 38% of the boys and 39% of the girls reported playing outside every school day of the week; and 32% of the boys and 33% of the girls reported playing outside every day on day with reduced or no school time. <sup>4</sup>
Active Transportation	C-	It was estimated in INCA3 2014-2015 that 44% of the 3-10 year-olds and 43% of the 11-14 year-olds use active transportation to go to school. <sup>3</sup> And 41% of the 6-10 year-olds report using active transportation to go to school in ESTEBAN 2015. <sup>4</sup>
Sedentary Behaviours	D-	On average, children and youth spend 3 to 4 hours daily in front of a screen. This estimate varies depending on the data source, the age, and the sex. <sup>3,4</sup> Only 35% of 6-10 year-olds, 17% of 11-14 year-olds, and 8% of 15-17 year-olds spend less than 2 hours in front of a screen daily. <sup>4</sup> Screen time may be overestimated because parents or children were asked to report the time for each type of screen (ie, TV, phone, etc.) and then these times were added. It is a possible that some of these screen times occurred simultaneously.
Physical Fitness	B-	On average, 10-14.9 year-old French adolescents (n=10,631) are at the 68th percentile for cardiorespiratory fitness (VO <sub>2</sub> max estimated from the 20m-shuttle-run test) <sup>6</sup> based on age- and sex-specific international normative data from 24 countries. <sup>7</sup> On average, 10-14.9 year-old French adolescents (n=10,776) are at the 58th percentile for flexibility (measured with the test sit-and-reach) <sup>6</sup> based on age- and sex-specific international normative data from 27 countries. <sup>7</sup>
Family and Peers	INC	A cross sectional study that surveyed 1713 boys and 1724 girls (all 12 years old) in Bas-Rhin found that 46% of fathers and 42% of the mothers “engaged regularly in physical activities”. <sup>8</sup> 46% of 2385 adolescents (11-18 years old) reported that at least one of their parents “is regularly active” in a cross-sectional survey realised in Aquitaine in 2005. <sup>9</sup>
School	B	In primary school (6-10 years old), 3 hours are dedicated to physical education (PE) but only 2 hours and 15 minutes on average were reported, <sup>10</sup> and these classes do not have to be taught by a physical education specialist. In middle school (11-14 years old) and high school (15-17 years old), PE is mandatory for all the students (except proved medical condition), and PE time is fixed and mandatory for 100% of the public educational institutions. Middle school must provide 4 hours of PE weekly the first year, and then 3 hours weekly for the next 3 years. As for high school, 2 hours of physical education weekly is mandatory. Those classes must be taught by a PE teacher (an expert trained for 5 years). Any institution caught not respecting these rules could face disciplinary procedures. In 2016, 22% of all students in middle school or high school were enrolled with the scholar sport federations (National Statistics), <sup>11</sup> which means that they were potentially practicing 1 to 3 additional hours of sport per week but we do not have data to confirm the actual attendance of those enrolled.
Community and Environment	INC	In 2016, 60 territorial communities were enrolled in the “Cycling Cities and Territories Club” (9 with <50,000 inhabitants, 11 between 50,000 and 100,000 inhabitants, 26 between 100,000 and 250,000 inhabitants, and 14 with > 250,000 inhabitants). Among these communities, 26% of the roadway is equipped with cycling path. <sup>12</sup> In addition, 63% of the territorial communities have a budget dedicated to cycling promotion, and the average annual budget is 7.7 euros/year/ inhabitant (vs 5.8 euros/year/ inhabitant in 2013). <sup>12</sup>
Government	C	We decided to assign a grade of C to this indicator because the importance of physical activity is officially acknowledged by the government in official texts, but this acknowledgement is more translated into promotional campaigns (i.e. physical activity and sedentary behaviours guidelines) and local action such as the intervention based on the ICAPS randomized control trial <sup>13</sup> in small population. However, several forms of financial help exist to support the registration of children and adolescent from medium- and low-income families to sport federations. In addition, financial support is also provided to sport clubs annually. This help increases if the clubs are hosting activities after school time, if there are many children or youths or girls or women enrolled, if they are welcoming people with disabilities, and/ or if they are situated in poor, rural or critical areas. This help does not exceed 1,500 euros in 65% of the cases, but 100% of the clubs receive it annually.

assessing physical activity and sedentary behavior characteristics in France. The two national surveys presented here have a relatively small sample size (ie, 3,117 6-17 years children in total), and they are not using commonly used, validated questionnaires. In addition, the way the data were treated potentially led to an

underestimation of the physical activity in the 6-10 years age category, and to a potential overestimation of the screen time. Moreover, there is a lack of data to inform grades for the Active Play, Family and Peers, and the Community and Environment indicators.

## Conclusion

While findings from two national surveys show that French children and youth are spending too much time in front of a screen, and that only a small part of the pediatric population is meeting the physical activity guidelines, these negative outcomes might be exaggerated because of the method used in these surveys. In contrast, French pre-adolescents (10-14 years old) show a good level of physical fitness that can potentially be explained by the good level of organized sport participation in this age group and the mandatory time devoted to PE.

## References

1. Santé Publique France. Synthèse pour les professionnels des recommandations de l'Anses de février 2016 sur l'activité physique et la sédentarité. *Actualisation des repères du PNNS*. 2016;34. <http://www.santepubliquefrance.fr>.
2. Aucouturier J, Ganière C, Aubert S, et al. Results from the first French Report Card on physical activity for children and adolescents. *J Phys Act Heal*. 2017;14(8):660–663. doi:10.1123/jpah.2017-0046
3. Anses. Étude individuelle nationale des consommations alimentaires 3. 2017. <https://www.anses.fr/fr/system/files/NUT2014SA0234Ra.pdf>. Accessed June 8, 2018.
4. Équipe de surveillance et d'épidémiologie nutritionnelle (Esen). *Étude de santé sur l'environnement, la biosurveillance, l'activité physique et la nutrition (Esteban) 2014–2016. Volet nutrition. Chapitre Activité physique et sédentarité*. Saint Maurice, Switzerland: Santé Publique France, 2017:58. [www.santepubliquefrance.fr](http://www.santepubliquefrance.fr).
5. Mission des Études de l'Observation et des Statistiques (MceEOS - INJEP). Recensement Annuel Des Licences et Clubs Auprès Des Fédérations Sportives Agréées Par Le Ministère Des Sports (2016); 2017.
6. Vanhelst J, Labreuche J, Béghin L, et al. Physical Fitness Reference Standards in French Youth. *J Strength Cond Res*. 2017;31(6):1709–1718. doi:10.1519/JSC.0000000000001640
7. Tomkinson GR, Carver KD, Atkinson F, et al. European normative values for physical fitness in children and adolescents aged 9-17 years: results from 2 779 165 Eurofit performances representing 30 countries [published online ahead of print November30, 2017]. *Br J Sports Med*. doi:10.1136/bjsports-2017-098253
8. Wagner A, Klein-Platat C, Arveiler D, Haan MC, Schlienger JL, Simon C. Parent-child physical activity relationships in 12-year old French students do not depend on family socioeconomic status. *Diabetes Metab*. 2004;30(4):359–366. doi:10.1016/S1262-3636(07)70129-5
9. Thibault H, Contrand B, Saubusse E, Baine M, Maurice-Tison S. Risk factors for overweight and obesity in French adolescents: Physical activity, sedentary behavior and parental characteristics. *Nutrition*. 2010;26(2):192–200. doi:10.1016/J.NUT.2009.03.015
10. Ministère Jeunesse Education et Recherche. L'éducation Physique et Sportive Dans Le Premier Degré En 2002-2003. 2004. [http://www.snefsu.net/ftp2/peda/enquete\\_men\\_prim.pdf](http://www.snefsu.net/ftp2/peda/enquete_men_prim.pdf). Accessed June 13, 2018.
11. Union Nationale du Sport Scolaire. Rapport Général 2015/2016. 2017. <http://unss.org/blog/consulter-le-rapport-general/>. Accessed June 13, 2018.
12. Observatoire des Mobilités Actives. Les Politiques En Faveur Des Piétons et Des Cyclistes Dans Les Villes Françaises - Résultats Synthétiques de l'enquête Nationale 2015/2016. Paris. 2016. [https://www.gart.org/wp-content/uploads/2017/02/cvte\\_enquete\\_nationale\\_2016\\_resultats\\_synthetiques.pdf](https://www.gart.org/wp-content/uploads/2017/02/cvte_enquete_nationale_2016_resultats_synthetiques.pdf). Accessed May 2, 2018.
13. Lanckriet S, Brissieux E, Borys J-M, et al. Assessment of the Impact of a Sports Kit on Physical Activity in Children 8 to 11 Years of Age. *J Phys Act Res*. 2017;2(1):50–60. doi:10.12691/jpar-2-1-9



# France's 2018 Report Card on Physical Activity for Children and Youth: Results and International Comparisons.

Aubert, S., Aucouturier, J., Vanhelst, J., **Fillon, A.**, Genin, P. M., Ganière, C., Praznocy, C., Larras, B., Schipman, J., Duclos, M., & Thivel, D.



*Accepted in Journal of Physical Activity and Health, Volume 17, 2020*

# France's 2018 Report Card on Physical Activity for Children and Youth: Results and International Comparisons

Salomé Aubert, Julien Aucouturier, Jeremy Vanhelst, Alicia Fillon, Pauline Genin, Caroline Ganière, Corinne Praznocy, Benjamin Larras, Julien Schipman, Martine Duclos, and David Thivel

**Background:** Insufficient levels of physical activity and increasing sedentary time among children and youth are being observed internationally. The purpose of this paper is to summarize findings from France's 2018 Report Card on physical activity for children and youth, and to make comparisons with its 2016 predecessor and with the Report Cards of other countries engaged in the Global Matrix 3.0. **Methods:** The France's 2018 Report Card was developed following the standardized methodology established for the Global Matrix 3.0 by grading 10 common physical activity indicators using best available data. Grades were informed by national surveys, peer-reviewed literature, government and nongovernment reports, and online information. **Results:** The expert panel awarded the following grades: overall physical activity, D; organized sport participation and physical activity, C-; active play, INC; active transportation, C-; sedentary behaviors, D-; physical fitness, B-; family and peers, INC; school, B; community and the built environment, INC; and government, C. **Conclusions:** Very concerning levels of physical activity and sedentary behaviors among French children and youth were observed, highlighting the urgent need for well-designed national actions addressing the presented physical inactivity crisis. The top 3 strategies that should be implemented in priority to improve the lifestyle of French children and youth are provided.

**Keywords:** adolescents, sedentary behaviors, active transportation, physical activity promotion

Despite concerted efforts to promote physical activity and the development of strategies to reduce sedentary time, scientific data continue to reveal insufficient levels of physical activity<sup>1-5</sup> and increasing time devoted to sedentary behaviors<sup>1,4,6-8</sup> among children and youth internationally. This decline in healthy active lifestyles among children and youth is particularly worrying, as

physical, psychological, social, and cognitive health have been found to be associated with physical activity levels in school-aged children,<sup>9,10</sup> with physical inactivity (defined as not meeting physical activity recommendations) favoring adverse health effects.<sup>9-12</sup> The World Health Organization (WHO) recommends that 5- to 17-year-old children and youth accumulate at least 60 minutes of moderate- to vigorous-intensity physical activity per day with no more than 2 hours of recreational screen time.<sup>13</sup> These guidelines have been broadcasted and promoted by national agencies throughout the world.

In 2005, Canada launched the first Report Card initiative, which gathered and synthesized the best available national data on the physical activity and sedentary behaviors of Canadian children and youth.<sup>14</sup> This annual report was recognized as a highly useful and informative tool, and it quickly influenced national policy, practice, and research orientations.<sup>15</sup> In 2014, based on this Canadian approach, and in order to develop a better understanding of childhood physical activity and inactivity across nations, 15 countries replicated the Report Card process, which constituted the Global Matrix 1.0.<sup>16</sup> The Global Matrix 1.0 aimed to use a harmonized process for data gathering, assessing, and assigning grades for 9 physical activity indicators.<sup>16</sup> Taking advantage of the creation of the National French Observatory for Physical Activity and Sedentary Behaviors (ONAPS), the first French Report Card for physical activity and sedentary behaviors in children and adolescents was launched in 2016,<sup>17</sup> independently of the Global Matrix 2.0, which involved the participation of 38 countries.<sup>18</sup> This French 2016 Report Card adopted and adapted the Global Matrix 2.0 harmonized process to provide the first national grades for each of the common physical activity indicators: overall physical activity, organized sport participation, active transportation, sedentary behaviors, family and peers, school implications, community and built environment, government strategies and investments, and active play (grades detailed in Table 1). This

---

Aubert is with Healthy Active Living and Obesity Research Group, Children's Hospital of Eastern Ontario Research Institute, Ottawa, ON, Canada. Aucouturier is with the University of Lille, Lille, France; University of Artois, Arras, France; Université du Littoral Côte d'Opale, Dunkerque, France; and EA 7369, Unité de Recherche Pluridisciplinaire Sport Santé Société (URePSSS), Lille, France. Vanhelst is with Inserm, CHU Lille, U995, Lille Inflammation Research International Center (LIRIC), Centre d'Investigation Clinique, Université Lille, Lille, France. Fillon is with Laboratoire AME2P (UE3533), SSR Tzanou-SSR Nutrition Obésité, UGECAM, Université Clermont Auvergne, Clermont-Ferrand, France. Genin and Praznocy are with the Laboratoire de physiologie et de biologie du sport, UFR de Médecine et des Professions Paramédicales, Observatoire National de l'Activité Physique et de la Sédentarité, Clermont-Ferrand, France. Ganière is with the Laboratoire CETAPS (Centre d'Etudes des Transformations des Activités Physiques et Sportives), EA 3832, Université de Rouen Normandie, France. Larras is with the Observatoire National de l'Activité Physique et de la Sédentarité (ONAPS), Clermont-Ferrand, France. Schipman is with the Institut de Recherche bio-Médicale et d'Épidémiologie du Sport (IRMES), EA7329, Institut National du Sport, de l'Expertise et de la Performance (INSEP), Paris Descartes, Université Sorbonne Paris Cité, Paris, France. Duclos is with the Department of Sport Medicine and Functional Explorations, University-Hospital (CHU), G. Montpied Hospital, Clermont-Ferrand, France; INRA, UMR 1019, UNH, CRNH Auvergne, Clermont-Ferrand, France; Université Clermont Auvergne, Clermont-Ferrand, France; and Observatoire National de l'Activité Physique et de la Sédentarité (ONAPS), Clermont-Ferrand, France. Thivel is with Laboratoire AME2P (UE3533), Université Clermont Auvergne, Clermont-Ferrand, France; CRNH Auvergne, Clermont-Ferrand, France; and Observatoire National de l'Activité Physique et de la Sédentarité (ONAPS), Clermont-Ferrand, France. Aubert ([salome.aubert.sa@gmail.com](mailto:salome.aubert.sa@gmail.com)) is corresponding author.

**Table 1 Evolution of the French Report Card Grades From 2016 to 2018 for Each Physical Activity Indicator**

Indicator	2016	2018
Overall physical activity	INC	D
Organized sport and physical activity	D	C–
Active play	NA	INC
Active transportation	D	C–
Sedentary behaviors	D	D–
Physical fitness	NA	B–
Family and peers	INC	INC
School	B	B
Community and environment	INC	INC
Government	INC	C
Average	D	C–

Abbreviations: INC, incomplete grade; NA, not assigned.

2016 Report Card concluded by emphasizing the need to implement national physical activity promotion programs and the need for larger scale studies to fill knowledge gaps regarding the physical activity levels and habits of French children and adolescents.<sup>17</sup>

As part of the 2018 Global Matrix 3.0 initiative,<sup>19</sup> our national expert panel carried out an updated evaluation of these physical activity indicators, which is briefly summarized in a recently published condensed article.<sup>20</sup> The purpose of this paper is to present the detailed findings from the France's 2018 Report Card on physical activity for children and youth, to highlight its evolution compared with its 2016 edition, and to discuss these results in comparison with the 48 other countries that participated in the Global Matrix 3.0.<sup>19</sup>

## Methods

Following the standardized methodology established for the Global Matrix 3.0 on physical activity for children and youth previously detailed,<sup>19</sup> the France's 2018 Report Card was prepared and redacted with the collective work of an expert panel composed of members of the French National ONAPS ([www.onaps.fr](http://www.onaps.fr)) and external and academic experts, and with the guidance of the Active Healthy Kids Global Alliance (AHKGA, [www.activehealthykids.org](http://www.activehealthykids.org)). The expert panel leader was responsible for integrating each expert's contribution and for writing the Report Card main document. All members reviewed the whole document and contributed to the grade assignment process for each indicator. All of the authors contributed to identifying key data sources and synthesized the evidence from a range of national surveys. The Report Card was realized thanks to a close collaboration with the ONAPS, whose main role was to gather and synthesize national database results and surveys.

The expert panel evaluated 10 physical activity indicators: overall physical activity levels, organized sport and physical activity, active play, active transportation, sedentary behaviors, physical fitness, family and peers, school, community and environment, and government. These indicators are consistent with the common indicators assessed by all countries participating in the Global Matrix 3.0. Overall physical activity, active transportation, and sedentary behavior indicators were informed by 2 national surveys: National Study of Individual Nutritional Consumption 3

(INCA 3 2014–2015)<sup>21</sup> and the Health Study of the Environment, Biosurveillance, Physical Activity, and Nutrition (ESTEBAN 2014–2016).<sup>22</sup> The remaining indicators were informed by national statistics, official reports, and scientific studies.

The expert panel first connected in December 2017, and indicators were assigned to specific members of the panel according to their area of interest and expertise. Experts were asked to compile the best available evidence for 5- to 17-year-olds and to write a brief chapter for each indicator they were assigned. Based on this compiled information, final grades were collectively discussed and assigned in May 2018 using the standardized benchmarks and grading scheme provided by the AHKGA<sup>19</sup> presented in [Supplementary Material](#) (available online). Nature and origin of the data sources, sample size, age range of participants, and year of publication were considered to establish the quality of the available data. An incomplete grade (INC) was assigned where insufficient data were available or due to the absence of a suitable benchmark.

The data from the Global Matrix 3.0 were used to perform comparisons between France and the 48 other participating countries. Letter grades were converted into interval values using the standardized corresponding numbers presented in the Global Matrix 3.0 grading scheme<sup>19</sup> to calculate averages, which were floored before being converted back to letter grades. Finally, in order to create Table 2, the Global Matrix 3.0 grades were regrouped in cluster grades as follows: "A" including "A–," "A," and "A+"; "B" including "B–," "B," and "B+"; "C" including "C–," "C," and "C+"; "D" including "D–," "D," and "D+"; and "F" and INC remained unchanged.

## Results and Discussion

### France's 2018 Report Card Findings and Comparison With the 2016 Report Card

The grades assigned for each indicator composing the 2018 and 2016 French Report Cards are presented in Table 1. Insufficient evidence was available for active play, family and peers, and community and environment; therefore, these indicators were graded INC. In comparison with the 2016 France's Report Card, 3 more indicators were attributed a letter grade in the France's 2018 Report Card: overall physical activity, physical fitness, and government. On average, the physical activity indicators were graded "C–" in 2018, which was slightly higher than in 2016 ("D"). The available evidence synthesized for the France's 2018 Report Card is presented and discussed by indicators in this part.

**Overall Physical Activity: D.** The 2 national surveys informing this indicator (INCA 3 and ESTEBAN 2014–2016) used the same modified version of the French Surveillance and Nutritional Epidemiology Unit questionnaire for 6- to 10-year-olds (ESTEBAN 2014–2016) and for 3- to 10-year-olds (INCA 3) that was reported by a parent or legal guardian, and a modified French version of the Youth Risk Behavior Surveillance System questionnaire for 11- to 17-year-olds that was self-reported. For the analysis of these 2 surveys, 3 categories of physical activity level were created (low, medium, and high), where a high level of physical activity was estimated to meet the WHO's physical activity guidelines.<sup>13</sup> For children aged below 10 years, a high level of physical activity corresponded to practicing physical activity (including physical education, outdoor active play, and sport participation outside of school) 5 or more days a week and regularly using active transportation; while, for 11- to 17-year-olds, a high level of physical

**Table 2** Number and Proportion (in Percentage) of Countries Involved in the Global Matrix 3.0 per Clustered Grade for Each Indicator

Indicator	A	B	C	D	F	INC	NA	2018 France's letter grade
Overall physical activity	1 (2.0)	0 (0.0)	9 (18.4)	31 (63.3)	6 (12.2)	2 (4.1)	0 (0.0)	D
Organized sport and physical activity	1 (2.0)	13 (26.5)	18 (36.7)	8 (16.3)	2 (4.1)	7 (14.3)	0 (0.0)	C–
Active play	0 (0.0)	3 (6.1)	7 (14.3)	8 (16.3)	2 (4.1)	29 (59.2)	0 (0.0)	INC
Active transportation	3 (6.1)	11 (22.4)	24 (49.0)	8 (16.3)	1 (2.0)	1 (2.0)	1 (2.0)	C–
Sedentary behaviors	1 (2.0)	6 (12.2)	16 (32.7)	18 (36.7)	5 (10.2)	3 (6.1)	0 (0.0)	D–
Physical fitness	2 (4.1)	2 (4.1)	8 (16.3)	9 (18.4)	1 (2.0)	27 (55.1)	0 (0.0)	B–
Family and peers	1 (2.0)	4 (8.2)	11 (22.4)	7 (14.3)	4 (8.2)	22 (44.9)	0 (0.0)	INC
School	4 (8.2)	13 (26.5)	13 (26.5)	11 (22.4)	0 (0.0)	8 (16.3)	0 (0.0)	B
Community and environment	2 (4.1)	17 (34.7)	9 (18.4)	6 (12.2)	2 (4.1)	13 (26.5)	0 (0.0)	INC
Government	3 (6.1)	13 (26.5)	14 (28.6)	9 (18.4)	2 (4.1)	8 (16.3)	0 (0.0)	C

Abbreviations: INC, incomplete grade; NA, not assigned. Note: The proportion that includes France is shadowed for each indicator.

activity corresponded only to practicing moderate to vigorous physical activity at least 5 days a week.<sup>21,22</sup>

Data from INCA 3 indicated that 20.9% of girls and 27.7% of boys aged 7–10 years, 30.1% of girls and 45.6% of boys aged 11–14 years, and 20.0% of girls and 28.3% of boys aged 15–17 years are meeting the WHO's physical activity guidelines.<sup>21</sup> Based on the ESTEBAN 2014–2016 survey, it was estimated that 17.8% of 6- to 10-year-olds (same proportion for boys and girls), 20.2% of girls and 33.7% of boys aged 11–14 years, and 15.4% of girls and 40.1% of boys aged 15–17 years are meeting the WHO's physical activity guidelines.<sup>22</sup> For both surveys, the differences observed between sexes were not significant for children aged 10 years and below, but these differences were statistically significant for 11- to 14-year-olds and 15- to 17-year-olds.<sup>21,22</sup>

In the 2016 France's Report Card, the overall physical activity indicator was graded INC, as the only national data available were nearly 10 years old. Therefore, the availability of data from these 2 surveys (INCA 3 and ESTEBAN 2014–2016) is a positive outcome, in particular because both surveys used similar measurement methods, which allowed for their comparison. Despite this, there are still methodological issues that must be highlighted. The main issue is that there have been no studies on the validity of the 2 questionnaires used in these 2 surveys. As such, we cannot anticipate if the obtained proportions are being overestimated or underestimated. The rationale behind the creation of low, medium, and high categories of physical activity level was not provided. In addition, we can expect that the physical activity levels for the 6- to 10-year-olds is underestimated, as all children not using active transportation, regardless of their frequency of physical activity, could not be classified in the high level of physical activity category. Objective measurement methods and validated questionnaires that are utilized internationally are required to improve the quality of physical activity surveillance in France.

Beyond the aforementioned methodological issues, based on these data, it is estimated that, overall, only 20% to 30% of the children and youth in France are meeting the physical activity guidelines. This situation is very alarming, especially with regard to girls who had a significantly lower level of physical activity than their male counterparts. These findings suggest that the support and development of effective physical activity promotion programs and actions targeting children and youth are urgently needed in France.

**Organized Sport and Physical Activity: C–.** Participation in organized sports was assessed based on the number of sports licenses delivered by French sports federations after registration in sports clubs for children and youth. Licenses delivered for school-based organized sports were excluded from this inventory. In 2016, the proportion of children and youth enrolled in sports federations was 33% of 0- to 9-year-olds, 60% of 10- to 14-year-olds, and 34% of 15- to 19-year-olds.<sup>23</sup> In both boys and girls, a decrease of more than one third of memberships is observed between 10- and 14-year-olds, most poignantly among girls.

In the 2016 France's Report Card, a grade of "D" was attributed to this indicator based on the prevalence of people aged 0–24 years engaged in a sports club.<sup>17</sup> Having access to data that are more specific in terms of targeting different age groups of children and youth is an encouraging progression with regard to the surveillance of organized sport participation. In addition, the lower proportion of girls enrolled in sports federations is consistent with the findings for the overall physical activity indicator. However, these data do not provide any information concerning the dose of physical activity associated with the practice of sport among these children and youth enrolled with sports federations. This represents a research gap in the French surveillance system that should be addressed in the future. Additional research is also needed to identify what the potential barriers to the access to organized sport and physical activity for French children and youth are, and if there is equal opportunity for participation in affordable and appealing activities in terms of territory (rural vs urban), gender, socioeconomic level, and sporting ability.

**Active Play: INC.** The active play indicator was not evaluated in the 2016 France's Report Card. Active play corresponds to a form of gross motor or total body movement in which young children exert energy in a freely chosen, fun, and unstructured manner.<sup>24</sup> The standardized benchmarks proposed by the AHKGA for active play included “% of children and youth who engage in unstructured/unorganized active play at any intensity for more than 2 h a day” and “% of children and youth who report being outdoors for more than 2 h a day.”<sup>19</sup> According to the ESTEBAN 2014–2016 study, among 6- to 10-year-olds, 38% of boys and 39.3% of girls reported engaging in outdoor active play every school day, and 32.2% of boys and 33.2% of girls also reported playing outdoors on nonschool days.<sup>22</sup>

There is still a need for an international consensus on the definition of active play, and this is an obstacle for the development of tools measuring this behavior. The available evidence remains insufficient to grade this indicator in the France's 2018 Report Card, as there is no indication of duration of the engagement in outdoor activities; however, it does suggest that not enough French children spend time outside on a regular basis. Access to active play in the outdoors and in nature, with its risks, is considered essential for healthy child development<sup>25</sup>; therefore, our expert panel calls for the better consideration of active outdoor time for public health messages. Families and schools, in particular, are encouraged to facilitate and create opportunities for children to freely engage in active play outside.

**Active Transportation: C–.** According to the INCA3 survey, 44% of 3- to 10-year-olds and 43% of 11- to 14-year-olds report traveling to school using a mode of active transportation.<sup>21</sup> Similarly, according to the ESTEBAN 2014–2016 survey, 41% of 6- to 10-year-olds use active transportation to go to school.<sup>22</sup> Moreover, among all transportation modes, 6- to 9-year-olds use walking for 37.2% and biking for 4.3% of their trips.<sup>21</sup> For 10- to 14-year-olds, it is 36.6% and 6.7%, respectively, and for 15- to 18-year-olds, it is 26.7% and 5.6%, respectively.<sup>21</sup> The difference of engagement in active transportation by sex among the 6- to 10-year-olds was reported in the ESTBAN 2014–2016 report: 35.6% of the boys and 44.9% of the girls report using active transportation.<sup>22</sup>

In comparison with the results from the 2016 Report Card, based on data from 2006 to 2008, a small increase in the proportion of children and youth who report using active transportation is observed (40% of the 3- to 10-year-olds and 30% of the 11- to 14-year-olds were using active transportation to go to school).<sup>17</sup> Overall, the use of active transportation by children and youth is unsatisfactory, and the France's 2018 Report Card highlights the need for better promotion of cycling and walking to and from school. More research and surveillance are needed to identify the characteristics of the active transportation of children and youth (frequency, mode, and distance covered) and to identify the potential barriers to this in order to develop an effective promotion program.

**Sedentary Behaviors: D–.** On average, French children and youth are estimated to spend 3 to 4 hours per day in front of screens.<sup>21,22</sup> This estimation varies depending on the age, sex, and data source. Custom analysis from ESTEBAN 2014–2016 indicates that only 34.6% of 6- to 10-year-olds, 17% of 11- to 14-year-olds, and 8.4% of 15- to 17-year-olds spend <2 hours per day in front of a screen.<sup>22</sup> In comparison with data from 2006 that were reported in the 2016 France's Report Card, a significant increase in screen time was observed on average in boys (+1 h 17;  $P < .001$ ) and girls (+50 min;  $P < .001$ ) among 6- to 17-year-olds.<sup>22</sup> According to ESTEBAN 2014–2016, this increase is more likely associated with greater time spent in front of a computer, smartphone, and tablet, and not linked to increased TV time.

The increased time that children and youth spend in front of screens is a potential barrier to active behaviors, such as active play. In addition, screen time in children and youth is negatively associated with numerous health indicators, including adiposity, aerobic fitness, quality of life, self-esteem, prosocial behavior, academic achievement, depression, and anxiety.<sup>26</sup> These findings highlight a clear need for the development of policies that are aimed at decreasing recreational screen time among children and youth to prevent the hazardous health consequences associated with this behavior.<sup>27</sup>

**Physical Fitness: B–.** Physical fitness is a new indicator that was recently added in the Global Matrix process and was not evaluated

in the 2016 France's Report Card. Good quality data were available for the cardiorespiratory fitness ( $n = 10,631$ ), muscular endurance ( $n = 10,293$ ), speed ( $n = 10,308$ ), and the flexibility ( $n = 10,776$ ) of French 10- to 14.9-year-olds.<sup>28</sup> These data were collected between 2009 and 2013, in 101 schools from 16 regions of France. On average, French youths were in the 68th percentile for cardiorespiratory fitness (using  $VO_2$ max estimated with by performance on the 20-m shuttle run test) and in the 58th percentile for flexibility (measured with the sit-and-reach test) based on age- and sex-specific international normative data from 27 countries.<sup>29</sup> In addition, boys performed an average of 34.4 repetitions and girls an average of 27.7 repetitions on the curl-up test (indicator of muscular endurance); and boys ran the 50-m sprint test (an indicator of speed) in an average of 9.0 seconds and girls in an average of 9.5 seconds.

These findings indicate that French youths had a moderately good physical fitness level. Cardiorespiratory fitness is recognized as an important indicator of current and future health among school-aged children and youth, and it is critical to develop the continuous surveillance of this indicator,<sup>30</sup> in combination with the surveillance of the other physical fitness health-related components using standardized measurements methods. This surveillance system needs to be implemented at the regional and national levels, and covers all 5- to 17-year-old children and youth.

**Family and Peers: INC.** A regional cross-sectional study that surveyed French 12-year-old boys ( $n = 1713$ ) and girls ( $n = 1724$ ) in 2004 found that 46% of the fathers and 42% of the mothers were regularly engaged in physical activity.<sup>31</sup> In addition, in another regional cross-sectional survey, 46% of 11- to 18-year-olds ( $n = 2385$ ) reported that at least one of their parents "is regularly active."<sup>32</sup> Similarly to the 2016 France's Report Card, the available evidence is not complete enough to attribute a letter grade to the family and peers indicator. More research is needed to develop validated tools to assess the support from family and friends for children and youth's physical activity. It may also be insightful to pair parents with their children in future national surveys assessing the physical activity levels of the French population.

**School: B.** As previously detailed in the 2016 France's Report Card, 3 hours per week of physical education are recommended nationally for children attending primary schools (6–10 y old); however, an official report from the Ministry of Education revealed that only 2 hours and 15 minutes were actually being implemented on average in 2002–2003.<sup>33</sup> In secondary schools (11–14 y old), physical education covers 3 to 4 hours per week, depending on the school grade, and 2 hours per week in high school (15–18 y old). Gender differences were also observed concerning the physical activity of children and youth in school settings. Among the 21.9% of school children and youth involved in school-based extracurricular physical activity, girls represented 40.9% of the enrolled students (compared with 59.2% of boys).<sup>34</sup> The grade attributed to this indicator is stable compared with the 2016 Report Card ("B").

Even though a relatively good grade was obtained for this indicator, our expert panel wants to highlight the potential of the school environment to promote physical activity. In fact, allocating more time to physical activity by decreasing the time dedicated to other subjects can improve the time children spend engaging in moderate to vigorous physical activity without altering academic achievement.<sup>35</sup> This is why developing new school policies that would increase the physical activity opportunities to at least 1 hour daily would ensure that a greater proportion of children and youth, ideally all of those attending public schools, would meet the

WHO's physical activity guidelines. Regarding the difference of participation to school-based extracurricular physical activity by sex, the National Plan for the Development of French School Sport 2016–2020 specifically targets an official strategic objective to increase the proportion of girls to obtain a 50%/50% ratio between boys and girl by 2020.<sup>36</sup>

**Community and Environment: INC.** According to the French Active Mobility Observatory, the number of walking and cycling pathways has increased between 2013 and 2016 (+26% of cycling and +18% of walking pathways);<sup>37</sup> data are missing, however, for 2016 onward. In addition, in 2016, 63% of French territorial communities had a budget dedicated to cycling promotion, which totaled an average of 7.7 euros/year/inhabitant (compared with 5.8 euros/year/inhabitant in 2013).<sup>37</sup> Similarly to the 2016 France's Report Card, there remains not enough evidence available to assign a letter grade to the community and environment indicator for the France's 2018 Report Card. This finding underlines the need for more research and surveillance regarding the availability and quality of active facilities, in addition to the perceived quality, safety, and attractiveness of these infrastructures to French parents and children and youth.

**Government: C.** French Ministries responsible for health, sports, and transport have officially acknowledged the promotion of physical activity and the reduction of sedentary behaviors, although this has yet to translate into concrete actions at the national level. This indicator was graded INC in the 2016 France's Report Card. Despite the absence of data allowing us to quantify the level of leadership and commitment in providing physical activity opportunities for all children and youth from the French government, we decided to grade this indicator as "C" to acknowledge the various forms of funding available to support the physical activity of children and youth from French public institutions. Indeed, sports clubs and leagues can apply for grants funding the building and repair of sports infrastructure and equipment,<sup>38</sup> or for grants financing specific projects that target, among others, girls, people with disabilities, and low-income areas.<sup>39</sup> In addition, low- and middle-income families can also access several financial aids for the payment of the registration of children and youth to sports clubs or federations, and for the purchase of their sports equipment.<sup>40,41</sup> It is hoped that the nomination of Paris as the future host of the 2024 Summer Olympic Games will create a real dynamic to facilitate the promotion of physical activity and sports participation for French people, especially children and youths.

Overall, the evidence compiled in the 2018 France's Report Card shows that French children and youth are not active enough and are too sedentary. Girls are particularly more affected, as a smaller proportion of girls are meeting the WHO's physical activity guidelines, and similar findings were observed for the organized sport and physical activity and school indicators. The small increase in the average grade from "D" to "C–" within the 2 years since the 2016 Report Card cannot be interpreted accurately because 4 indicators that were not previously graded obtained a letter grade in 2018, and because the standardized grading scheme and benchmarks provided by the AHKGA were modified between 2016 and 2018.

## International Comparisons

France's participation in the Global Matrix 3.0 has opened the door to international comparisons with the other participating countries to gain perspective on how France is doing and what can be learned

from it. The present section gives an overview of the main findings and discussions generated by this comparison.

The distribution of the percentages of the 49 countries participating in the Global Matrix 3.0 by clustered grade for each indicator is detailed in Table 2, where the cells with the proportion of countries, including France, are shaded. Overall, a total of 121 INC grades were obtained by the 49 countries participating in the Global Matrix 3.0, for an average of 2.5 INC per country,<sup>19</sup> and a total of 67 INC grades were obtained by the 30 participating very high human development index countries, for an average of 2.2 INC grades per country.<sup>42</sup> With 3 INC grades, France is slightly above the 2 mentioned averages; however, its INC grades concerned 3 of the 4 indicators that had the highest number of INC across the 49 countries: active play (n = 29), family and peers (n = 22), and community and environment (n = 13).<sup>19</sup> This finding shows that the lack of good quality data and approved standardized methods of measurements for these 3 indicators is not just a national but a global research issue. International collaborations are needed for the development of clear consensus definitions and standardized measurement methods for these indicators.<sup>19</sup>

Concerning France's letter grades, the only indicator that stands out in comparison with the 48 other countries participating in Global Matrix 3.0 were physical fitness and school. A "B–" was assigned to France for physical fitness, which places France among the top 10% of the most successful countries for this indicator. Another study that compared the physical fitness of children and youth by means of the 20-m shuttle run across 50 countries ranked France 11th using less recent data.<sup>43</sup> More research is necessary to confirm if French children and youth have a higher level of physical fitness and to identify the factors explaining this success. Concerning the school indicator, obtaining a "B" put France among the top 35% of the 49 Global Matrix 3.0 countries, which is consistent with other data showing that France remains one of the European countries offering the highest number of physical education lessons per week in secondary school.<sup>44</sup> All of the other letter grades that were assigned fell in the cluster categories with the highest proportions of countries.

While the physical activity profile of French children and youth was following the average pattern of the 49 Global Matrix 3.0 countries, performing comparisons focusing only on the 20 European countries showed a different story. Table 3 presents the country letter grades organized by descending order and the average letter grades for each indicator among Global Matrix 3.0 European countries. Overall, France was less successful than the majority of the other countries. Among the 7 indicators with a letter grade, France's grades were below the average for 5 of the indicators (organized sport and physical activity, active transportation, sedentary behaviors, and government), equal to the average for physical activity, and above the average for 2 indicators (physical fitness and school). The average grades for France and the Global Matrix 3.0 European countries were the same ("C–"); however, this ranks France in the bottom half of these 20 countries.

The findings presented in this paper suggest that organized sport and physical activity and active transportation are 2 indicators that could potentially be targeted to increase the overall level of physical activity among children and youth in France. In Denmark, 83% of 7- to 15-year-olds participate in organized sports<sup>45</sup>; and 75% of 11- to 15-year-olds participate in organized sport 2 times per week in Sweden.<sup>46</sup> Similarly, high rates of children and youth using active transportation were observed in Denmark and Finland. These data show that increasing participation in organized sports

**Table 3 Country Letter Grades Organized by Descending Order and Average Letter Grades for Each Indicator Among the 20 Global Matrix 3.0 European Countries**

PA		SP		AP		AT		SB		PF	
AVG	D	AVG	C+	AVG	D+	AVG	C	AVG	D+	AVG	C
Slovenia	A-	Denmark	A-	The Netherlands	B	Denmark	B+	Slovenia	B+	Slovenia	A-
The Netherlands	C	Sweden	B+	Bulgaria	C+	Finland	B+	Spain	B+	France	B-
England	C-	Flanders	B	Finland	C	Bulgaria	B-	Sweden	C+	Czech Republic	C+
Lithuania	C-	Germany	B	Spain	C-	The Netherlands	B-	Flanders	C	Lithuania	C+
Bulgaria	D+	The Netherlands	B	Wales	C-	Spain	B-	Guernsey	C	Finland	C
Sweden	D+	Scotland	B	Slovenia	D	Flanders	C+	Jersey	C	Portugal	C
Wales	D+	Spain	B	Czech Republic	D-	Czech Republic	C+	Lithuania	C-	England	C-
Czech Republic	D	Czech Republic	B-	Germany	D-	Poland	C	The Netherlands	C-	Poland	C-
Finland	D	Portugal	B-	Estonia	F	Scotland	C	Portugal	C-	Jersey	D
France	D	Bulgaria	C+	Flanders	INC	Slovenia	C	Denmark	D+	Flanders	INC
Guernsey	D	Finland	C+	Denmark	INC	Sweden	C	England	D+	Bulgaria	INC
Portugal	D	Guernsey	C+	England	INC	England	C-	Bulgaria	D	Denmark	INC
Spain	D	Slovenia	C+	France	INC	France	C-	Poland	D	Estonia	INC
Denmark	D-	Wales	C+	Guernsey	INC	Germany	C-	Czech Republic	D-	Germany	INC
Estonia	D-	Estonia	C	Jersey	INC	Lithuania	C-	Finland	D-	Guernsey	INC
Germany	D-	Lithuania	C	Lithuania	INC	Portugal	C-	France	D-	The Netherlands	INC
Jersey	D-	France	C-	Poland	INC	Jersey	D+	Germany	D-	Scotland	INC
Poland	D-	England	D+	Portugal	INC	Wales	D+	Estonia	F	Spain	INC
Flanders	F	Poland	D	Scotland	INC	Estonia	D	Scotland	F	Sweden	INC
Scotland	F	Jersey	INC	Sweden	INC	Guernsey	D	Wales	F	Wales	INC
FAM		SCH		COM		GOV		AVG		AVG	
AVG	C-	AVG	B-	AVG	B-	AVG	C+	AVG	C-	AVG	C-
Slovenia	B+	Finland	A	Sweden	A	Slovenia	A	Slovenia	B		
Finland	B-	Portugal	A	Denmark	B+	Denmark	A-	Denmark	B-		
Germany	B-	Slovenia	A	Finland	B+	Finland	A-	Finland	C+		
Flanders	C+	Denmark	A-	Germany	B+	Flanders	B	The Netherlands	C+		
Czech Republic	C+	France	B	Flanders	B	Estonia	B	Portugal	C+		
Jersey	C	Poland	B	Czech Republic	B	Portugal	B	Spain	C+		
Portugal	C	Czech Republic	B+	Estonia	B	Sweden	B	Sweden	C+		
Poland	C-	England	B+	Portugal	B	Czech Republic	C+	Flanders	C		
Bulgaria	D	Germany	B+	Slovenia	B	Poland	C+	Czech Republic	C		
Estonia	D	Flanders	B-	Scotland	B-	Wales	C+	Germany	C		
Lithuania	D	Jersey	B-	Bulgaria	C	France	C	Bulgaria	C-		
Wales	D	Estonia	C+	England	C	Lithuania	C	England	C-		
Denmark	INC	Lithuania	C+	Jersey	C	Scotland	C	France	C-		
England	INC	Spain	C+	Lithuania	C	Guernsey	D	Lithuania	C-		
France	INC	Sweden	C+	Poland	C	Jersey	D	Poland	C-		
Guernsey	INC	Bulgaria	C	France	INC	Bulgaria	INC	Estonia	D+		
The Netherlands	INC	The Netherlands	C	Guernsey	INC	England	INC	Guernsey	D+		
Scotland	INC	Guernsey	INC	The Netherlands	INC	Germany	INC	Jersey	D+		
Spain	INC	Scotland	INC	Spain	INC	The Netherlands	INC	Scotland	D+		
Sweden	INC	Wales	INC	Wales	INC	Spain	INC	Wales	D+		

Abbreviations: AP, active play; AT, active transportation; AVG, average; COM, community and environment; FAM, family and peers; GOV, government; INC, incomplete grade; PA, physical activity; PF, physical fitness; SB, sedentary behaviors; SCH, school; SP, organized sport and physical activity. Cells presenting France's 2018 Report Card grades are shaded in gray.

and the use of active transportation among children and youth in France should be conceivable with well-planned strategies. The successful policies and strategies implemented in Denmark,

Finland, and Sweden to promote participation in organized sports and/or active transportation among children and youth should be studied to facilitate their adaptation to a French context.

Based on the presented findings for France, and their comparison to the rest of the world, the France's 2018 Report Card expert panel has identified the top 3 priorities to improve grades and promote an active healthy lifestyle among children and youth:

- (1) Development and implementation of a consistent national surveillance system of physical activity and related indicators (organized sport and physical activity, active play, active transportation, sedentary behavior, physical fitness, family and peers, and community and environment) among children and youth, including children and youth with disability. The collection of objective physical activity and sedentary behavior data at the population level is recommended as well.
- (2) Development and implementation of specific interventions targeting the reduction of screen time among all children and youth.
- (3) Identify the barriers to the engagement in active behaviors, in particular, among girls and other specific populations, to increase the offer of attractive and accessible organized sport opportunities, physical play structures, and active transportation structures for children of all ages, cultures, and abilities.

## Conclusions

The France's 2018 Report Card expert panel proposes an update to the first 2016 Report Card here, officially joining the 48 other countries composing the Global Matrix 3.0.<sup>19</sup> While insufficient data were available to grade 3 indicators (active play, family and peers, and community and environment), the results show very concerning levels of physical activity and sedentary behaviors among French children and youth, and gender differences were observed. French national survey analysis issues and research gaps were identified in this article. When compared with the other 48 countries from 6 continents that participated in the Global Matrix 3.0, it was observed that, overall, France was performing similarly to the majority of the countries for each indicator, except for the physical fitness and school indicators, where France was among the top 10% and 35%, respectively. But when compared uniquely to the 20 European countries that participated in the Global Matrix 3.0 (all classified in the very high human development index category except Bulgaria),<sup>42</sup> France is behind the majority of these countries, especially in terms of the organized sport and physical activity, active transportation, and sedentary behavior indicators. These findings highlight the urgent need for well-designed actions at the national level to address the presented physical inactivity crisis, and the France's Report Card expert panel has identified the top 3 strategies that should be implemented in priority to improve the lifestyles of French children and youth. In light of the 2024 Olympic Games in Paris, Ministries in charge of education, sports, and agriculture launched a call for tenders to encourage the development of educative projects promoting the physical activity of children and youths, including children and youth with disabilities.<sup>47</sup> It is hopeful that this will generate a real national dynamic in terms of financial and political support for the promotion of physical activity and the reduction of screen time for French people, especially children and youth.

## Acknowledgments

The authors want to particularly thank Mr Evan Turner for the proof review of this paper, as well as Dr Benoit Salanave from Université Paris 13 who performed a custom analysis on the screen time data from the survey ESTEBAN 2014–2016. The authors also want to thank Mr Anthony Constantin and Miss Maelle Bernard for their technical support. The

expert panel of this France's 2018 Report Card wants to thank the Matmut insurance company for their generous financial support to this project.

## References

1. Brodersen NH, Steptoe A, Boniface DR, Wardle J. Trends in physical activity and sedentary behaviour in adolescence: ethnic and socio-economic differences. *Br J Sports Med.* 2007;41(3):140–144. PubMed ID: [17178773](#) doi:[10.1136/bjism.2006.031138](#)
2. Kalman M, Inchley J, Sigmundova D, et al. Secular trends in moderate-to-vigorous physical activity in 32 countries from 2002 to 2010: a cross-national perspective. *Eur J Public Health.* 2015;25-(suppl 2):37–40. PubMed ID: [25805785](#) doi:[10.1093/eurpub/ckv024](#)
3. Booth VM, Rowlands AV, Dollman J. Physical activity temporal trends among children and adolescents. *J Sci Med Sport.* 2015;18(4): 418–425. PubMed ID: [25041963](#) doi:[10.1016/j.jsams.2014.06.002](#)
4. Dollman J, Norton K, Norton L. Evidence for secular trends in children's physical activity behaviour. *Br J Sports Med.* 2005;39(12): 892–897. PubMed ID: [16306494](#) doi:[10.1136/bjism.2004.016675](#)
5. Guthold R, Stevens GA, Riley LM, Bull FC. Worldwide trends in insufficient physical activity from 2001 to 2016: a pooled analysis of 358 population-based surveys with 1.9 million participants. *Lancet Glob Health.* 2018;6(10):e1077–e1086. doi:[10.1016/S2214-109X\(18\)30357-7](#)
6. Sigmund E, Sigmundová D, Badura P, Kalman M, Hamrik Z, Pavelka J. Temporal trends in overweight and obesity, physical activity and screen time among Czech adolescents from 2002 to 2014: a National Health Behaviour in School-Aged Children Study. *Int J Environ Res Public Health.* 2015;12(9):11848–11868. PubMed ID: [26393638](#) doi:[10.3390/ijerph120911848](#)
7. Bucksch J, Sigmundova D, Hamrik Z, et al. International trends in adolescent screen-time behaviors from 2002 to 2010. *J Adolesc Health.* 2016;58(4):417–425. doi:[10.1016/j.jadohealth.2015.11.014](#)
8. Corder K, Sharp SJ, Atkin AJ, et al. Change in objectively measured physical activity during the transition to adolescence. *Br J Sports Med.* 2015;49(11):730–736. PubMed ID: [24273308](#) doi:[10.1136/bjsports-2013-093190](#)
9. Poitras VJ, Gray CE, Borghese MM, et al. Systematic review of the relationships between objectively measured physical activity and health indicators in school-aged children and youth. *Appl Physiol Nutr Metab.* 2016;41(6)(suppl 3):S197–S239. doi:[10.1139/apnm-2015-0663](#)
10. Janssen I, LeBlanc AG. Systematic review of the health benefits of physical activity and fitness in school-aged children and youth. *Int J Behav Nutr Phys Act.* 2010;7(1):40. doi:[10.1186/1479-5868-7-40](#)
11. Kremer P, Elshaug C, Leslie E, Toumbourou JW, Patton GC, Williams J. Physical activity, leisure-time screen use and depression among children and young adolescents. *J Sci Med Sport.* 2014;17(2):183–187. PubMed ID: [23648221](#) doi:[10.1016/j.jsams.2013.03.012](#)
12. McMahon EM, Corcoran P, O'Regan G, et al. Physical activity in European adolescents and associations with anxiety, depression and well-being. *Eur Child Adolesc Psychiatry.* 2017;26(1):111–122. PubMed ID: [27277894](#) doi:[10.1007/s00787-016-0875-9](#)
13. World Health Organization. Global recommendation on physical activity for health. 2010. [http://www.who.int/dietphysicalactivity/factsheet\\_recommendations/en/](http://www.who.int/dietphysicalactivity/factsheet_recommendations/en/). Accessed January 11, 2018.
14. Colley RC, Brownrigg M, Tremblay MS. A model of knowledge translation in health. *Health Promot Pract.* 2012;13(3):320–330. PubMed ID: [22447666](#) doi:[10.1177/1524839911432929](#)
15. Tremblay MS, Barnes JD, Bonne JC. Impact of the Active Healthy Kids Canada report card: a 10-year analysis. *J Phys Act Health.* 2014;11(suppl 1):S3–S20. doi:[10.1123/jpah.2014-0167](#)



16. Tremblay MS, Gray CE, Akinroye K, et al. Physical activity of children: a global matrix of grades comparing 15 countries. *J Phys Act Health*. 2014;11(suppl 1):S113–S125. doi:10.1123/jpah.2014-0177
17. Aucouturier J, Ganière C, Aubert S, et al. Results from the first French report card on physical activity for children and adolescents. *J Phys Act Health*. 2017;14(8):660–663. doi:10.1123/jpah.2017-0046
18. Tremblay MS, Barnes JD, González SA, et al. Global matrix 2.0: report card grades on the physical activity of children and youth comparing 38 countries. *J Phys Act Health*. 2016;13(11)(suppl 2):S343–S366. doi:10.1123/jpah.2016-0594
19. Aubert S, Barnes JD, Abdeta C, et al. Global matrix 3.0 physical activity report card grades for children and youth: results and analysis from 49 countries. *J Phys Act Health*. 2018;15(suppl 2):S251–S273. doi:10.1123/jpah.2018-0472
20. Aubert S, Aucouturier J, Ganière C, et al. Results from France's 2018 report card on physical activity for children and youth. *J Phys Act Health*. 2018;15(suppl 2):S360–S362. doi:10.1123/jpah.2018-0511
21. ANSES. Étude individuelle nationale des consommations alimentaires 3. 2017. <https://www.anses.fr/fr/system/files/NUT2014SAO234Ra.pdf>. Accessed June 8, 2018.
22. Équipe de Surveillance et d'épidémiologie Nutritionnelle (ESEN). Étude de santé sur l'environnement, la biosurveillance, l'activité physique et la nutrition (ESTEBAN) 2014–2016. Volet nutrition. Chapitre Activité physique et sédentarité. 2017;58. <https://www.santepubliquefrance.fr/determinants-de-sante/nutrition-et-activite-physique/documents/rapport-synthese/etude-de-sante-sur-l-environnement-la-biosurveillance-l-activite-physique-et-la-nutrition-esteban-2014-2016--chapitre-activite-physique-et-sede>
23. Institution National de la Jeunesse et de L'Education Populaire (INJEP). Tableaux statistiques relatifs au recensement des licences sportives de 2017. 2017. <https://injep.fr/donnee/tableaux-statistiques-relatifs-au-recensement-des-licences-sportives-de-2017/>. Accessed January 2, 2019.
24. Truelove S, Vanderloo LM, Tucker P. Defining and measuring active play among young children: a systematic review. *J Phys Act Health*. 2017;14(2):155–166. doi:10.1123/jpah.2016-0195
25. Tremblay MS, Gray C, Babcock S, et al. Position statement on active outdoor play. *Int J Environ Res Public Health*. 2015;12(6):6475–6505. PubMed ID: 26062040 doi:10.3390/ijerph120606475
26. Saunders TJ, Vallance JK. Screen time and health indicators among children and youth: current evidence, limitations and future directions. *Appl Health Econ Health Policy*. 2017;15(3):323–331. PubMed ID: 27798796 doi:10.1007/s40258-016-0289-3
27. Poitras VJ, Gray CE, Janssen X, et al. Systematic review of the relationships between sedentary behaviour and health indicators in the early years (0–4 years). *BMC Public Health*. 2017;17(suppl 5):868.
28. Vanhelst J, Labreuche J, Béghin L, et al. Physical fitness reference standards in French youth. *J Strength Cond Res*. 2017;31(6):1709–1718. PubMed ID: 28538324 doi:10.1519/JSC.0000000000001640
29. Tomkinson GR, Carver KD, Atkinson F, et al. European normative values for physical fitness in children and adolescents aged 9–17 years: results from 2 779 165 Eurofit performances representing 30 countries. *Br J Sports Med*. 2018;52(22):1445–1456.
30. Lang JJ, Tomkinson GR, Janssen I, et al. Making a case for cardiorespiratory fitness surveillance among children and youth. *Exerc Sport Sci Rev*. 2018;46(2):66–75.
31. Wagner A, Klein-Platat C, Arveiler D, Haan MC, Schlienger JL, Simon C. Parent-child physical activity relationships in 12-year old French students do not depend on family socioeconomic status. *Diabetes Metab*. 2004;30(4):359–366. PubMed ID: 15525880 doi:10.1016/S1262-3636(07)70129-5
32. Thibault H, Contrand B, Saubusse E, Baine M, Maurice-Tison S. Risk factors for overweight and obesity in French adolescents: physical activity, sedentary behavior and parental characteristics. *Nutrition*. 2010;26(2):192–200. PubMed ID: 19577429 doi:10.1016/j.nut.2009.03.015
33. Ministère Jeunesse Education et Recherche. L'éducation physique et sportive dans le premier degré en 2002-2003. 2004. [http://www.snefsu.net/ftp2/peda/enquete\\_men\\_prim.pdf](http://www.snefsu.net/ftp2/peda/enquete_men_prim.pdf). Accessed June 13, 2018.
34. Union Nationale du Sport Scolaire. Rapport général 2015/2016. 2017. <http://unss.org/blog/consulter-le-rapport-general/>. Accessed June 13, 2018.
35. Trudeau F, Shephard RJ. Physical education, school physical activity, school sports and academic performance. *Int J Behav Nutr Phys Act*. 2008;5(1):10. doi:10.1186/1479-5868-5-10
36. Union Nationale du Sport Scolaire. *Plan National de Développement Du Sport Scolaire 2016–2020*. Paris, France: UNSS AIR; 2016. <https://unss.org/wp-content/uploads/2018/02/UNSS-PDNSS-2016-2020.pdf>.
37. Observatoire des Mobilités Actives. *Les Politiques En Faveur Des Piétons et Des Cyclistes Dans Les Villes Françaises—Résultats Synthétiques de l'enquête Nationale 2015/2016*. Paris, France: Club des villes et territoires cyclables; 2016. [https://www.gart.org/wp-content/uploads/2017/02/cvctc\\_enquete\\_nationale\\_2016\\_resultats\\_synthetiques.pdf](https://www.gart.org/wp-content/uploads/2017/02/cvctc_enquete_nationale_2016_resultats_synthetiques.pdf). Accessed May 2, 2018.
38. Centre National Pour le Développement du Sport. Subventions équipements—comment ça marche? 2018. <http://www.cn.ds.sports.gouv.fr/Comment-ca-marche-12>. Accessed January 17, 2019.
39. Centre National Pour le Développement du Sport. Subventions associations—comment ça marche? 2018. <http://www.cn.ds.sports.gouv.fr/Comment-ca-marche>. Accessed January 17, 2019.
40. Caisse d'Allocations Familiales. Tickets loisirs. 2019. <http://www.caf.fr/allocataires/caf-du-gard/offre-de-service/enfance-et-jeunesse/tickets-loisirs>. Accessed January 17, 2019.
41. Caisse d'Allocations Familiales. Activité sportive ou culturelle. 2018. <http://www.caf.fr/allocataires/caf-de-la-charente-maritime/offre-de-service/enfance-et-jeunesse/activite-sportive-ou-culturelle#>. Accessed January 17, 2019.
42. Aubert S, Barnes JD, Aguilar-Farias N, Tremblay MS. Report card grades on the physical activity of children and youth comparing 30 very high human development index countries. *J Phys Act Health*. 2018;15(suppl 2):S298–S314. doi:10.1123/jpah.2018-0431
43. Lang JJ, Tremblay MS, Léger L, Olds T, Tomkinson GR. International variability in 20 m shuttle run performance in children and youth: who are the fittest from a 50-country comparison? A systematic literature review with pooling of aggregate results. *Br J Sports Med*. 2018;52(4):276. PubMed ID: 27650256 doi:10.1136/bjsports-2016-096224
44. World Health Organization. Physical activity factsheets for the 28 European Union Member States of the WHO European Region. Copenhagen, Denmark; 2018. <http://www.euro.who.int/pubrequest>. Accessed January 18, 2019.
45. Nørager Johansen DL, Neerfeldt Christensen BF, Fester M, et al. Results from Denmark's 2018 report card on physical activity for children and youth. *J Phys Act Health*. 2018;15(suppl 2):S341–S343. doi:10.1123/jpah.2018-0509
46. Delisle Nyström C, Larsson C, Alexandrou C, et al. Results from Sweden's 2018 report card on physical activity for children and youth. *J Phys Act Health*. 2018;15(suppl 2):S413–S414. doi:10.1123/jpah.2018-0519
47. Ministère de l'Education National et de la Jeunesse. Génération 2024—dispositif national et accompagnement local. 2019. <https://eduscol.education.fr/cid131926/dispositif-national-et-accompagnement-local.html?fbclid=IwAR0JowIo0vvBPubDxsuCDA5yPLiRppygY6bcsYH1Vk5JxLJEE1d62mriB9U>. Accessed August 25, 2019.

**Health-related quality of life and perceived health status of adolescents with obesity are improved by a 10-month multidisciplinary intervention.**

Khammassi, M., Miguet, M., O'Malley, G., Fillon, A., Masurier, J., Damaso, A. R., Pereira, B., Lambert, C., Duclos, M., Courteix, D., Boirie, Y., & Thivel, D.



*Accepted in Physiology & Behavior, Volume 210, 2019*



## Health-related quality of life and perceived health status of adolescents with obesity are improved by a 10-month multidisciplinary intervention

Marwa Khammassi<sup>a,b,c,\*</sup>, Maud Miguet<sup>a</sup>, Grace O'Malley<sup>d</sup>, Alicia Fillon<sup>a,e</sup>, Julie Masurier<sup>f</sup>, Ana R. Damaso<sup>g</sup>, Bruno Pereira<sup>l</sup>, Céline Lambert<sup>l</sup>, Martine Duclos<sup>e,h,i,j</sup>, Daniel Courteix<sup>a,i</sup>, Yves Boirie<sup>e,i,j,k</sup>, David Thivel<sup>a,i</sup>

<sup>a</sup> Clermont Auvergne University, Laboratory of the Metabolic Adaptations to Exercise under Physiological and Pathological Conditions (AME2P), Clermont-Ferrand EA 3533, France

<sup>b</sup> Research Unit, Sportive Performance and Physical Rehabilitation, High Institute of Sports and Physical Education of Kef, University of Jendouba, Kef, Tunisia

<sup>c</sup> Faculty of Science of Bizerte, University of Carthage, 7021 Zarzouna, Bizerte, Tunisia

<sup>d</sup> Division of Population Health Sciences, Royal College of Surgeons of Ireland, Childhood Obesity Service, Temple Street Children's University Hospital, Dublin 1, Ireland

<sup>e</sup> INRA, UMR 1019, Clermont-Ferrand, France

<sup>f</sup> UGECAM Nutrition Obesity Ambulatory Hospital, Clermont-Ferrand, France

<sup>g</sup> Program of Nutrition, Paulista Medicine School, Universidade Federal de São Paulo (UNIFESP), Rua Botucatu, 862-Vila Clementino, São Paulo, SP 04020-050, Brazil

<sup>h</sup> Department of Sport Medicine and Functional Explorations, Clermont-Ferrand University Hospital, G. Montpied Hospital, Clermont-Ferrand, France

<sup>i</sup> CRNH-Auvergne, Clermont-Ferrand, France

<sup>j</sup> University Clermont 1, UFR Medicine, Clermont-Ferrand, France

<sup>k</sup> Department of Human Nutrition, Clermont-Ferrand University Hospital, G. Montpied Hospital, Clermont-Ferrand, France

<sup>l</sup> Clermont-Ferrand University Hospital, Biostatistics unit (DRCI), Clermont-Ferrand, France

### ARTICLE INFO

#### Keywords:

Adolescents with obesity  
Body composition  
HRQOL  
Health perception  
Weight-loss  
Multidisciplinary intervention

### ABSTRACT

**Background:** Although multidisciplinary weight management interventions have been shown effective in improving body composition and cardio-respiratory fitness, their effects on HRQOL and perceived health status remain uncertain in adolescents with obesity.

**Objective:** To assess the impact of a 10-month multidisciplinary weight management intervention on HRQOL and health perception in adolescents with obesity, exploring whether these changes were associated with changes in body weight and body composition.

**Methods:** Thirty-six adolescents with obesity (28 girls and 8 boys; mean age:  $13 \pm 1.32$  years) enrolled in a multidisciplinary weight management intervention composed of nutritional counseling, physical activity and health-related therapeutic education. Validated self-report questionnaires were used to assess HRQOL (SF-36) and health perception (HP questionnaire) at baseline (T0) after 5 months (T1) and after 10 months of intervention (T2). In addition, anthropometric parameters and body composition (DXA) were measured at T0, T1 and T2.

**Results:** Items of the SF-36 significantly improved at T1 and T2, such as physical functioning ( $P < .01$ ), general health ( $P < .01$ ), physical ( $P < .001$ ) and mental score (T1:  $P < .05$ , T2:  $P < .01$ ). Dimensions of health perception improved significantly such as physical condition ( $P < .01$  at T2), adiposity ( $P < .001$  at T1 and T2), healthy balanced diet ( $P < .01$  at T1 and  $P < .001$  at T2), general health ( $P < .05$ ), and perceived general health (T1:  $P < .01$ , T2:  $P < .001$ ). Body weight, BMI, and fat mass (in Kg and in %) were significantly decreased ( $P < .001$ ) at T1 and T2. No relationship was observed between variations of weight, BMI and Fat mass and variations of HRQOL and health perception.

**Conclusion:** A 10-month multidisciplinary weight-management intervention was associated with positive changes in HRQOL and perceived health status, which might not be explained by body weight and adiposity improvements.

\* Corresponding author at: Clermont Auvergne University, Laboratory of the Metabolic Adaptations to Exercise under Physiological and Pathological Conditions (AME2P), BP 80026, F-63171 Aubière cedex, EA 3533, France.

E-mail address: [khammassimarwa.issep@hotmail.com](mailto:khammassimarwa.issep@hotmail.com) (M. Khammassi).

<https://doi.org/10.1016/j.physbeh.2019.05.010>

Received 10 October 2018; Received in revised form 9 April 2019

Available online 11 May 2019

0031-9384/ © 2019 Elsevier Inc. All rights reserved.

## 1. Introduction

The prevalence of obesity has increased worldwide and early prevention and intervention strategies are needed since pediatric obesity has been shown to persist into adulthood [1,2]. Indeed 79% of children with obesity aged between 10 and 14 years old are at risk of becoming adults with obesity, regardless of their parents' weight status [3]. The increasing prevalence of pediatric obesity has been associated with the early development of several physical comorbidities including metabolic complications, cardiovascular dysfunctions, functional limitations and pulmonary disease like asthma or obstructive sleep apnea among others [4–7]. Alongside these physical and physiological complications, psychosocial and cognitive impairments have been observed in children and adolescents with obesity such as altered self-esteem, lower social integration, poor academic performances and increased anxiety among others [8–10]. Altogether these complications affect the child or adolescent's well-being and health-related quality of life as well as perceived health status. According to Jeffrey et al., the likelihood of a child or adolescent with obesity with impaired health-related quality of life (HRQL) is 5.5 times greater compared to lean peers and is similar to that of children or adolescents diagnosed with cancer [11]. Importantly, these physiological and psychological complications are associated with the degree of obesity [5,12]. Although the beneficial effect of weight management interventions on obesity indicators (weight, Body Mass Index, body composition, etc.), metabolic comorbidities and functional capacities have been widely demonstrated, fewer studies described the effects on health-related quality of life (HRQL) and perceived health status [13–16], especially in severe obesity [17]. In their work, Rank and collaborators assessed the effects of a 4- to 6-week multidisciplinary weight management intervention among 7 to 20 years old youth with overweight or obesity [14]. According to their results overall HRQL as well as all its subdomains (especially self-esteem) were significantly improved (using the KINDL questionnaire), independent of change in body composition [14]. More recently, Hoedjes and colleagues examined the effect of a 1-year inpatient lifestyle treatment on HRQL in 8 to 19 year old children and adolescents with severe obesity, including a 1-year follow-up reevaluation [15]. Their results indicate that overall HRQL and each specific domain were significantly improved post intervention, and this improvement was maintained 12 months after treatment despite partial weight regain [15]. Importantly, Murray and collaborators recently conducted a meta-analysis questioning the effect of multicomponent weight management interventions on quality of life among adolescents with overweight or obesity [55]. Although the authors pointed out limited available evidence (eight studies only could be included into their analysis), they clearly underlined the absence of correlation between the induced-weight loss and the improvement in health-related quality of life in this population [55]. Based on their analysis, Murray and colleagues suggested that rather than weight loss itself, quality of life improvements might be related to the behavioral and psychological components of such multidisciplinary interventions [55].

It appears then that the evidence examining the positive effect of weight management on HRQL independent of change in anthropometry is sparse and warrants additional study since such positive outcomes are vital for youth psycho-emotional health and well-being.

Similarly, changes in HRQL and the relationship with changes in anthropometry and body composition are important to explore and understand. This is particularly important since several weight management phases have been described during classical multidisciplinary treatments. According to recent studies using intermediary evaluations, weight loss and body composition improvements are significantly greater during the first months of intervention while lower or unchanged during the last months of intervention in adolescents with obesity [18–20].

The aim of the present study was to examine the impact of a 10-month multidisciplinary weight management intervention on Health-Related Quality of Life and Perceived Health Status in adolescents with obesity, exploring whether observed changes were associated with changes in body weight and body composition.

## 2. Subjects and methods

### 2.1. Population

A total of 36 adolescents with obesity (BMI:  $33.15 \pm 4.36 \text{ Kg/m}^2$ ) including 28 girls and 8 boys, aged 11–15 years, were screened for the study (the characteristics of the population are shown in Table 1). The main inclusion criteria were: i) being aged between 11 and 15 years; ii) being obese according to the national reference curves; iii) pubertal stage: Tanner 3–4 and; iv) no preexisting medical condition that would restrict participants from engaging in regular exercise; iv) not being engage in > 2 h of structured physical activity per week. The adolescents were recruited from an inpatient weight management intervention based in a Pediatric Obesity Center (TzaNou, La Bourboule, France). Adolescents and their legal representative were given study information sheets and signed consent forms. The study protocol was approved by the local ethical committee (CPP Sud Est VI: 2015–33; Clinical Trial NCT02626273).

### 2.2. Study design

All prospective adolescents were screened by a pediatrician to ensure appropriate recruitment. Once recruited, all participants completed baseline (T0) anthropometric measurements and body composition evaluation (Dual X-ray Absorptiometry -DXA). The adolescents then joined the local Pediatric Obesity Center (TzaNou, La Bourboule, France) for a 10-month inpatient multidisciplinary weight-management program combining nutritional counseling, physical activity and health-related therapeutic education. The adolescents' Health related Quality of Life (HRQL) and Health Perception were then evaluated using self-reported questionnaire (SF-36 and the Health Perception Questionnaire respectively) at their entrance in the institution. All

**Table 1**  
Pre- and post-intervention body composition in adolescents with obesity.

	T0	T1	T2	Mixed-model	Post-hoc		
					T0 vs T1	T0 vs T2	T1 vs T2
Weight (Kg)	86.97 ± 15.49	82.47 ± 15.25	79.03 ± 11.10	< 0.0001	< 0.0001	< 0.0001	0.0130
BMI (Kg/m <sup>2</sup> )	33.15 ± 4.36	29.93 ± 5.08	29.22 ± 2.97	< 0.0001	< 0.0001	< 0.0001	0.6638
Android fat mass	43.02 ± 5.16	38.14 ± 4.86	34.46 ± 6.39	< 0.0001	< 0.0001	< 0.0001	0.0660
FM (Kg)	35.51 ± 8.68	30.31 ± 8.24	26.35 ± 6.60	< 0.0001	< 0.0001	< 0.0001	0.0126
FM (%)	40.07 ± 5.04	36.37 ± 4.58	32.72 ± 5.16	< 0.0001	< 0.0001	< 0.0001	0.0056
FFM (Kg)	49.39 ± 7.84	50.04 ± 8.15	51 ± 6.66	0.6539	0.6191	0.3605	0.6735

Values are presented as mean ± standard deviation. Bonferroni's post hoc test for significant analysis of variance; T0, before the intervention; T1, after 5 month of intervention; T2: after 10 month of intervention; BMI, body mass index; FM, fat mass; FFM: fat free mass.

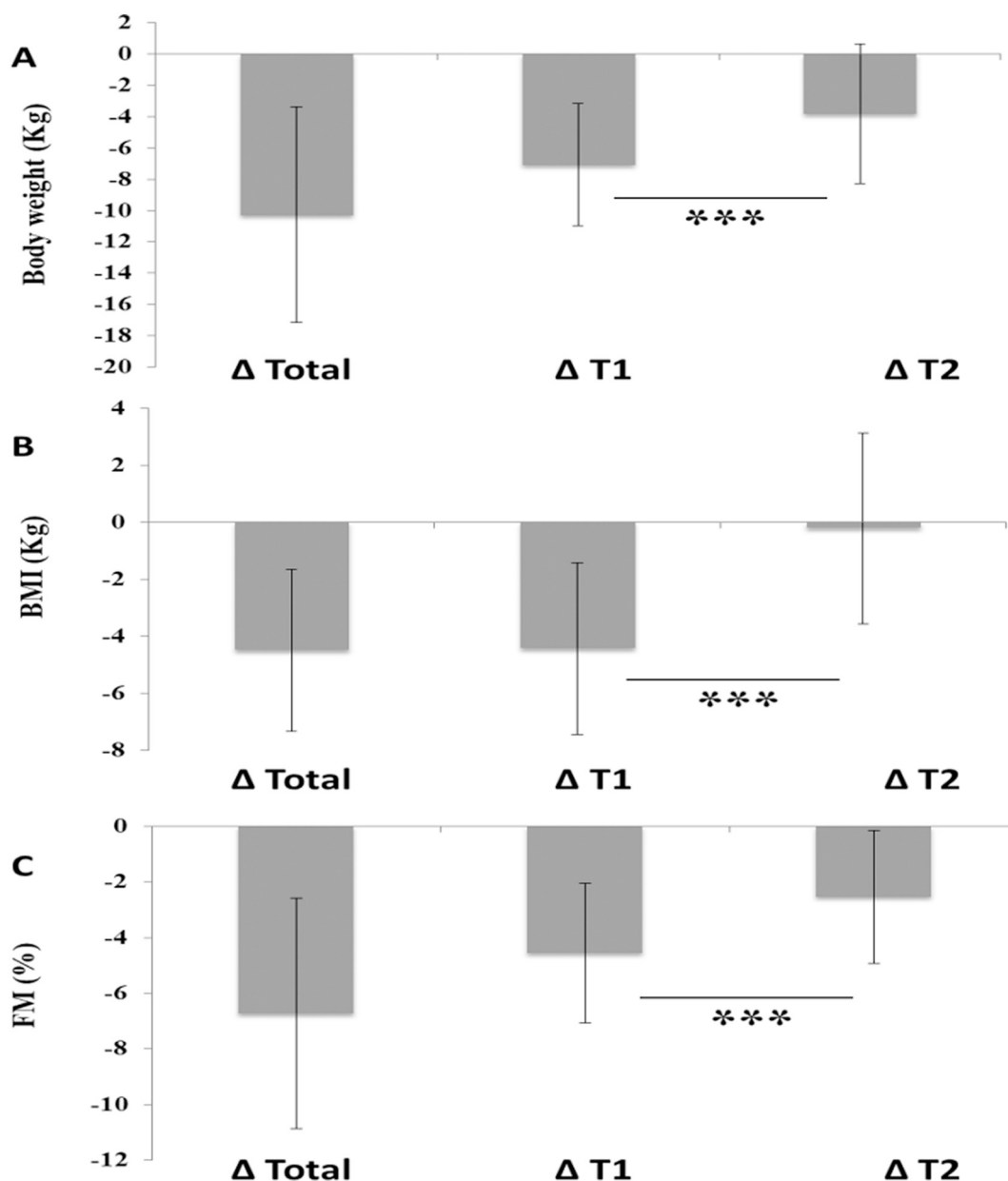

Fig. 1. Body Weight (A), BMI (B) and Fat Mass percentage (C) variations from baseline to the end of the intervention ( $\Delta$  TOTAL); baseline to T1 ( $\Delta$ 1) and from T1 to T2 ( $\Delta$ 2). \*\*\*P < .001; BMI: Body Mass index; FM: Fat Mass.

measurements were performed before (T0), after 5 months (T1) and at the end of the program (T2).

### 2.3. Anthropometry and body composition

Height and weight were measured according to the recommended procedure in indoor clothing and without shoes. Height was measured (at the nearest 0.5 cm) using a standard wall-mounted stadiometer (SECA, Les Mureaux, France). Weight in kilograms was obtained using a reliable digital scale (SECA, Les Mureaux, France). BMI was obtained by the following formula:  $BMI (kg/m^2) = Weight (kg) / Height^2 (m^2)$ ; and reported on appropriate growth curves. Fat mass (FM) and fat-free mass (FFM) were obtained using dual-energy X-ray absorptiometry (DXA) following standardized procedures (QDR4500A scanner, Hologic, Waltham, MA, USA).

### 2.4. Health-related quality of life (HRQL)

The adolescent's Health-Related Quality of Life (HRQL) was assessed using the SF-36 [21,22]. Based on 36 items, this questionnaire contains eight subscales: general health, physical functioning, physical role, pain, vitality, social functioning, role-emotional and mental health. A physical component scale (PCS) and mental component scale (MCS) can be calculated [23].

### 2.5. Health perception (health perception scale)

The participants were also asked to complete a short self-administered questionnaire specifically designed to explore their perception of their own health ("health perception scale"). Six criteria were investigated: (1) perceived physical fitness, (2) perceived ideal weight, (3) perceived healthy balanced diet, (4) perceived sleep quality, (5)

perceived stress level, and (6) perceived general health. A10-point scale from 1 (not at all) to 10 (very much) was used to assess each item. The six individual scores were computed to obtain a global score for health perception. This questionnaire has been previously validated [24,25].

## 2.6. Statistical procedures

The statistical analyses were carried out using the statistical software Stata (version 13, StataCorp, College Station, US). All statistical tests were conducted for a two-sided type I error at 0.05. Continuous variables were described as mean and standard-deviation, according to statistical distribution (assumption of normality studied using Shapiro-Wilk test). Repeated correlated data were analyzed using random-effects models to study time effect taking into account between and within subject variability (as random-effect). A Sidak's type I error correction was applied to take into account the multiple comparisons. When appropriate, the normality of residuals was studied using Shapiro-Wilk test. If necessary, a logarithmic transformation was proposed to achieve the normality of dependent outcome. The results were expressed as Hedges' *g* effect sizes (ES) and forest-plots were used to represent graphically these results. Furthermore, to determine if the changes of quality of life and health perception were associated with variations of anthropometric and body composition, multivariable random-effects models were performed to study their interaction with time. Bayesian Information Criterion (BIC) was estimated to determine the most appropriate model, notably concerning the covariance structure for the random-effects due to repeated measures across the time and consequently to the autocorrelation. These analyses were completed by the study of relationships between changes using Spearman correlation coefficients (according to statistical distribution). As proposed for mixed-models, a Sidak's type I error correction was applied to take into account the multiple comparisons. The results were represented graphically with a color-coded heatmap.

## 3. Results

### 3.1. Body composition

Body weight, BMI, and total fat mass (in Kg and in %) were all significantly reduced at both T1 and T2 compared with baseline ( $P < .0001$ ), while Fat-Free Mass remains stable (Table 1). These improvements were more significant between baseline and T1 compared with T1 and T2: body weight ( $-7.07 \pm 3.88$  vs.  $-3.81 \pm 4.47$ ,  $P < .001$ ), BMI ( $-4.44 \pm 3.02$  vs.  $-0.21 \pm 3.35$ ,  $P < .001$ ), Fat mass (%) ( $-4.56 \pm 2.52$  vs.  $-2.54 \pm 2.40$ ,  $P < .001$ ) and Fat mass (Kg) ( $-6.90 \pm 3.39$  vs.  $-3.18 \pm 3.04$ ,  $P < .001$ ) (Fig. 1).

**Table 2**

Pre- and post- intervention HRQL measures in adolescents with obesity.

	T0	T1	T2	Mixed-model	Post-hoc		
					T0 vs T1	T0 vs T2	T1 vs T2
Physical functioning	77.97 ± 21.73	83.71 ± 26.92	89.60 ± 21.50	0.0065	0.0035	0.0092	0.7166
Physical limitations	58.59 ± 27.39	69.35 ± 30.08	66.35 ± 33.87	0.2366	0.1687	0.8618	0.1227
Bodily pain	79.73 ± 15.88	86.61 ± 12.27	78.56 ± 16.84	0.0587	0.0627	0.6974	0.0263
General health	55.99 ± 16.12	65.19 ± 15.94	68.27 ± 13.29	0.0072	0.0136	0.0033	0.5860
PCS	44.45 ± 35.62	67.74 ± 25.10	75.75 ± 14.49	< 0.0001	0.0013	< 0.0001	0.2500
Social functioning	73.44 ± 23.06	75 ± 19.63	73.56 ± 22.17	0.3252	0.2982	0.1478	0.6755
Emotional limitations	64.58 ± 33.80	70.97 ± 35.22	65.38 ± 41.61	0.6974	0.4251	0.5228	0.8728
Vitality	56.02 ± 13.50	57.74 ± 13.89	51.92 ± 14.15	0.3110	0.6787	0.2845	0.1409
Mental health	55.38 ± 14.97	52.0 ± 14.79	55.08 ± 14.94	0.6610	0.4077	0.9221	0.4646
MCS	41.18 ± 33.81	58.32 ± 22.09	61.49 ± 19.23	0.0102	0.0281	0.0036	0.4287

Values are presented as mean ± standard deviation. Bonferroni's post hoc test for significant analysis of variance; T0, before the intervention; T1, after 5 month of intervention; T2: after 10 month of intervention; PCS: Physical Component Score; MCS: Mental Component Score.

### 3.2. Health related quality of life

Data related to changes in Health related quality of life during the 10 month intervention are summarized in Table 2. Significant improvements were observed in the dimensions of HRQOL at T1 and T2, such as physical functioning ( $P < .01$ , at T1 and T2), general health ( $P < .01$ , at T1 and T2), physical ( $P < .001$  at T1 and T2) and mental score ( $P < .05$  at T1 and  $P < .01$  at T2). Changes from baseline (T0) to T1 for the SF-36 were significantly greater compared with those from T1 to T2 for physical functioning ( $12.68 \pm 25.98$  vs  $6.52 \pm 28.18$ ,  $P < .01$ ), general health ( $9.08 \pm 15.21$  vs  $3.83 \pm 15.67$ ,  $P < .01$ ), physical component score ( $23.30 \pm 36.08$  vs  $8.15 \pm 31.08$ ,  $P < .01$ ) and mental component score ( $17.15 \pm 36.65$  vs  $5.62 \pm 29.64$ ,  $P < .05$ ) (Fig. 2). When incorporating body weight, BMI, total and android fat mass and fat free mass in our mixed model, none of the interactions at T1 and T2 were found statistically significant for each components and scores of HRQOL.

### 3.3. Health perception

Changes from pre-intervention to 5 and 10 month post-intervention for the health perception are shown in Table 3. Perceived physical condition ( $P < .01$  at T2), adiposity ( $P < .0001$  at T1 and T2), healthy balanced diet ( $P < .01$  at T1 and  $P < .0001$  at T2), general health ( $P < .05$ ), and general health perceived ( $P < .01$  at T1 and  $P < .0001$  at T2) were all significantly improved.

The improvements were significantly greater from baseline to T1 compared with T1 to T2 for perceived adiposity ( $1.67 \pm 2.27$  vs  $0.88 \pm 2.03$ ,  $P < .01$ ), healthy balanced diet ( $1.30 \pm 2.95$  vs  $1.28 \pm 2.05$ ,  $P < .05$ ), and for perceived general health ( $0.85 \pm 1.43$  vs  $-2.05 \pm 1.28$ ,  $P < .05$ ). Perceived physical condition was significantly more improved between the second phase of the intervention (T1 to T2) compared with the first one (baseline to T1) ( $0.96 \pm 2.26$  vs  $0.70 \pm 1.96$ , respectively,  $P < .05$ ) (Fig. 2). As for HRQOL, no significant interaction at both T1 and T2 was found when body weight, BMI, total and android fat mass and fat free mass are incorporated in our mixed model (for each component of health perception as well as for the general score).

### 3.4. Correlations between anthropometric and body composition variables with HRQOL and health perception

No significant relationship was found between HRQL changes (items and dimensions) and the anthropometric and body composition modifications during the whole intervention (baseline to T2) or during phase 1 (baseline to T1) and phase 2 (T1 to T2). Similarly, none of the Health Perception questionnaire items nor the total score were significantly associated with the anthropometric and body composition

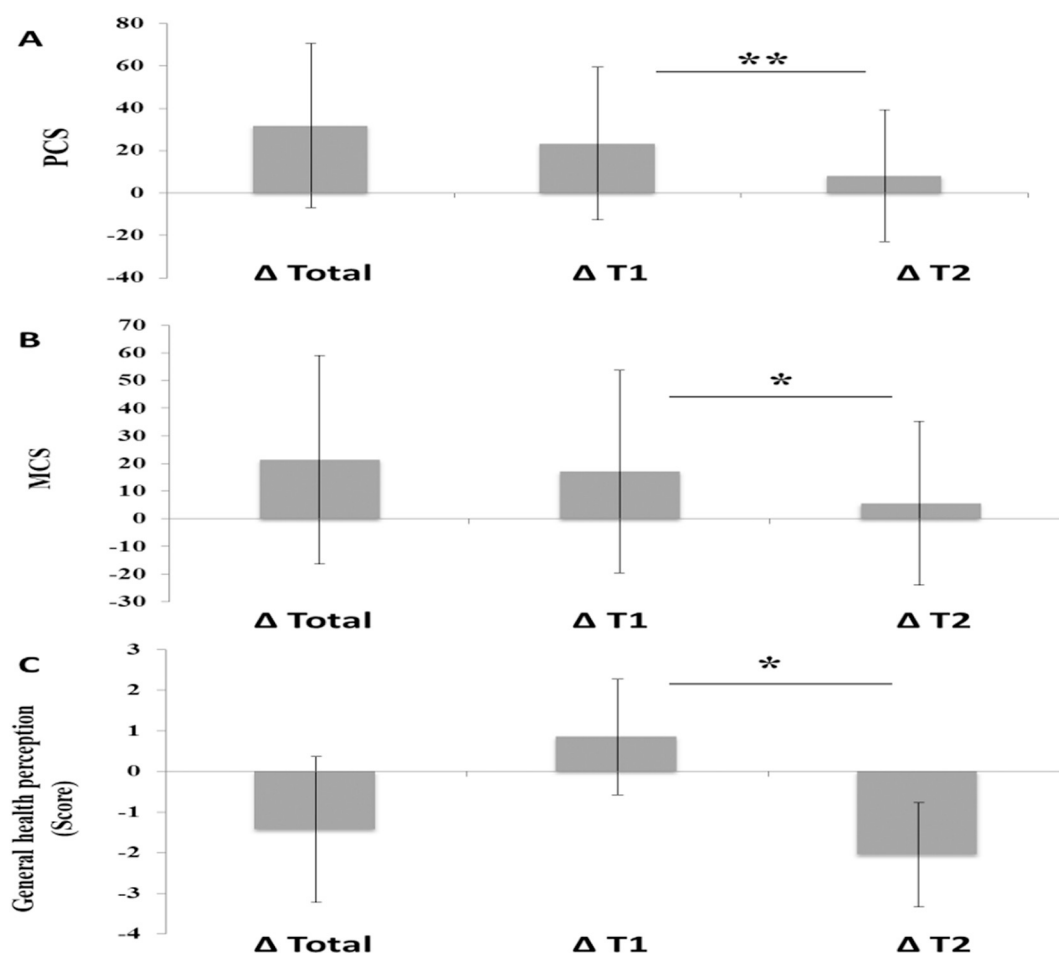

Fig. 2. Physical (A), Mental (B) component scores (SF-36) and General health Perception (C) variations from baseline to the end of the intervention (Δ TOTAL); baseline to T1 (Δ1) and from T1 to T2 (Δ2). \*\*P < .01; \*P < .05, PCS: Physical Component Score; MCS: Mental Component Score.

Table 3  
Pre- and post-intervention health perception measures in adolescents with obesity.

	T0	T1	T2	Mixed-model	Post-hoc		
					T0 vs T1	T0 vs T2	T1 vs T2
Physical condition	5.13 ± 2.13	5.77 ± 2.35	6.81 ± 1.58	0.0115	0.0998	0.0030	0.1482
Adiposity	2.19 ± 1.11	3.65 ± 2.03	4.36 ± 1.25	< 0.0001	0.0008	< 0.0001	0.0692
Healthy balanced diet	4.45 ± 2.87	6.00 ± 2.25	7.50 ± 2.42	0.0003	0.0111	< 0.0001	0.0836
Sleep	5.10 ± 2.72	5.35 ± 2.67	5.54 ± 2.97	0.8489	0.6221	0.6221	0.63
Stress	5 ± 2.99	6.23 ± 2.51	5.92 ± 2.64	0.5848	0.3303	0.8448	0.4351
General health	6.19 ± 2.41	6.55 ± 2.08	7.62 ± 1.42	0.044	0.2010	0.2010	0.0130
General perceived health	4.81 ± 1.45	5.74 ± 1.41	3.62 ± 1.07	< 0.0001	0.0344	< 0.0001	< 0.0001

Values are presented as mean ± standard deviation. ANOVA, analysis of variance; Bonferroni's post hoc test for significant analysis of variance; T0, before the intervention; T1, after 5 month of intervention; T2: after 10 month of intervention.

modifications during the whole intervention (baseline to T2) or during phase 1(baseline to T1) and phase 2 (T1 to T2). The heatmaps (Figs. 3 and 4) propose a graphical presentation of these correlations coefficients for HRQOL (A) and Health Perception (B) between T0-T2 (Fig. 5). Importantly, the lack of significant correlation despite high coefficient correlations can be explained by the use of a Sidak's type I error correction to take into account the multiple comparisons.

#### 4. Discussion

The aim of the present study was to examine the effect of a 10-month multidisciplinary weight loss intervention on Health-Related Quality of Life and Health Perception in adolescents with obesity.

According to our results, the intervention favored improvements in overall health-related quality of life and self-perceived health both after 5 and 10 months of intervention. Although associated, these improvements might not be explained by changes in anthropometry and body composition. Our participants showed marked improvement on body composition, adiposity and health perception, which may in turn have led to improvements in perceived physical condition, diet and general health. Both physical and mental composite scores were improved and reflect an improvement in perceived physical functioning, bodily pain and general health.

While several cross-sectional studies have reported moderate to strong associations between the degree of obesity and well-being or quality of life among children and adolescents [12]; Fallon et al.

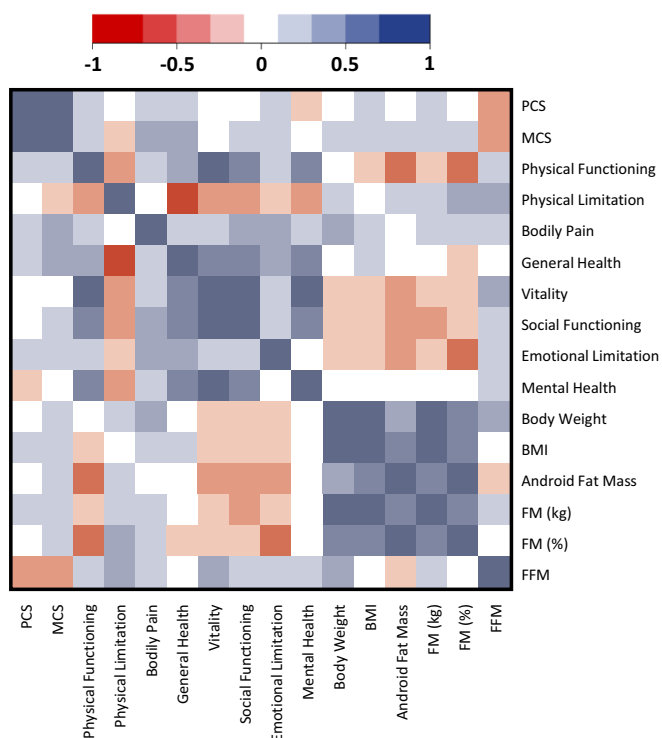

**Fig. 3.** Heatmap representation of the correlations between items and scores for HRQOL, between each items and each dimensions, and between each items and dimensions and anthropometric and body composition variables, between T0 and T2. The darkest is the box and the higher is the correlation. PCS: Physical Component Score; MCS: Mental Component Score; BMI: Body Mass Index; FM: Fat Mass (% et kg); FFM: Fat Free Mass (kg).

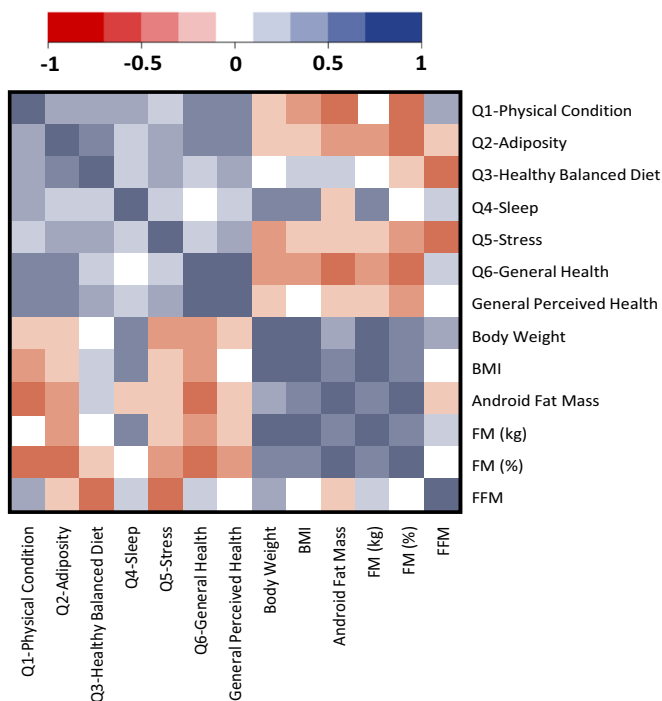

**Fig. 4.** Heatmap representation of the correlations between items and scores for Health Perception, between each items and each dimensions, and between each items and dimensions and anthropometric and body composition variables, between T0 and T2. The darkest is the box and the higher is the correlation. BMI: Body Mass Index; FM: Fat Mass (% et kg); FFM: Fat Free Mass (kg).

[26–31], less is known regarding the effect of weight loss on HRQL in this population [14,16,32]. A limited number of studies have evaluated the changes that occur in HRQL after weight loss. On the whole, most of the data from the literature suggest that a small reduction in weight is associated with an improvement in HRQL [33,34]. Results remain however divergent with some researches that have shown improved physical rather than psychological dimension of HRQL in response to weight loss [20,35,36], while others have observed improvements of both dimensions. [33,37–41]. The present results are in line with these latter studies by showing improvements in both physical and mental dimensions of our adolescents' quality of life after the multidisciplinary intervention. In fact; Rank et al. observed that an inpatient weight-loss program was associated with an improvement of all domain of HRQL, with particular improvements in self-esteem among overweight and obese children and adolescents [14]. Bischoff et al. have demonstrated that a 52-week weight loss program induces improvements of all the parameters composing the physical and psychological aspects of HRQL in 325 participants with obesity. Even three years after their intervention, most of these parameters, such as, physical functioning, general health, vitality and mental health, still indicate significant ameliorations compared with baseline values [42]. Likewise, the study of Kolotkin et al. concurs with our results showing better scores for the physical and psychological aspects of HRQL after their weight reduction program [43].

While HRQL and well-being are widely studied, some recent studies also suggest the evaluation of patients' self-perceived health (HP), which has not yet been described in adolescents with obesity. Health Perception refers to “how people consider their own health” [44,45] and is, according to some recent studies, associated with overall health indicators and physical fitness in those with obesity [24,25,46]. According to our results, the adolescents' general health perception (General score) has been significantly improved after the intervention. When considered separately, the sub-items for Adiposity, Healthy Balanced Diet, General health and Physical Condition were also significantly improved, while Stress and Sleep were not modified. Although these results are to our knowledge the first described in adolescents with obesity, they are in line with previously published studies questioning the effect of interventions in both lean individuals [25,46] and sedentary postmenopausal women with obesity [24].

The pattern of change in HRQL variables was also of interest to us as usually body mass and body composition change at different rates over time in response to intervention whereby, the biggest impacts are observed during the first weeks of intervention with a less marked response during maintenance phases [24,47,48]. We aimed to examine whether changes in HRQL and HP changes would follow a similar pattern of change at 5-months and 10-months, According to our analysis, adiposity, healthy balanced diet and general health perception scores were more improved during the first 5 months of the intervention compared with after 10 months, while perceived physical condition improved more in phase two. Regarding HRQL, both the physical and mental components showed greater changes in phase one. Such results are interesting since body weight and body composition indicators show significantly greater changes on phase one, questioning then their relationship with HRQL and HP.

Although some studies have questioned the effect of weight loss interventions on HRQL, the potential associations between the induced body weight and body composition improvements with the observed quality of life changes remain under-explored. While there is a large body of literature describing negative associations between general HRQL (and its subdomains) and obesity indicators at a single point in time (body weight, BMI, fat mass percentage) in youth [13,49,50], it is not clear whether it improved with intervention due to improved body composition or whether there are other factors influencing improved HRQL. A number of studies describe an inverse association between HRQL and BMI changes in response to weight loss intervention in



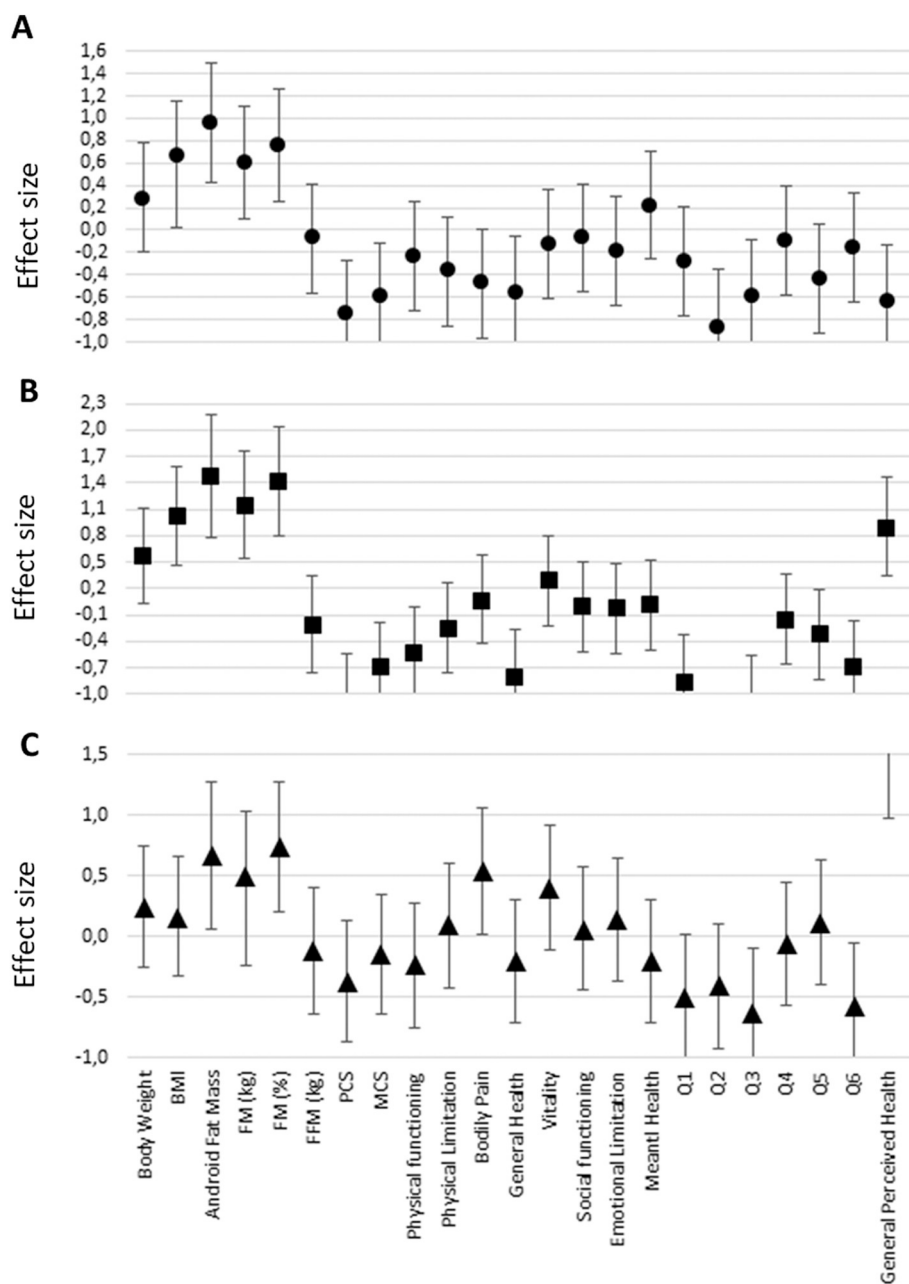

Fig. 5. Graphical representation of the effect sizes regarding the T0-T1 (A), T0-T2 (B) and T1-T2 (C) analysis.

children and adolescents with obesity [13,51,52]. Others however have not observed any relationship between BMI and HRQL variations after inpatient multidisciplinary intervention for children and adolescents with obesity [14]. This absence of relationship between body composition and HRQL changes might explain the commonly observed maintained HRQL improvement several months after weight loss interventions despite weight regain in similar populations [15,37,54].

Our results are in line with those from Rank and colleagues, in that we did not observe any significant relationship between the variations of anthropometric and body composition measurements and HRQL or HP. These results are also in line with another recently published study that questioned the role of both body composition and physical fitness on HRQL improvements in children with obesity [53]. According to their analysis, physical fitness but not body composition or body mass changes mediates HRQL modifications in response to weight loss in this population [53]. Unfortunately, physical fitness was not assessed in the present study. Importantly, despite the lack of significant relationship

between the observed obesity indicators changes (anthropometric measurements and body composition) and HRQL and HP variations, and the lack of significant effect and interaction when these obesity indicator changes are considered in our mixed model; our colored heatmaps suggest high correlation coefficients between these variations and our results show similar trends through the interventions. It seems then that, even though the improvements observed for HRQL and HP might not be explained by the improved anthropometric measurements and body composition, they remain associated.

Not only the adolescents' real corpulence, body weight or fitness changes could be advanced to explain their improved Quality of Life or Perceived Health, but also their physical self-perception. Quality of Life and Health Perception might be highly influenced by psychological and subjective dimensions such as the Physical Self Perception, independently of physical parameters [56,57]. In their study, Daley and colleagues for instance reported significant improvements of physical self-worth and global self-esteem in response to a 8-week physical

activity intervention in adolescents with obesity, despite unchanged BMI [57]. Similarly, Rey and collaborators showed improved physical self-perception after a 5-week physical activity program in adolescent girls with obesity despite unchanged physical fitness while the adolescent boys showed improved fitness but unchanged physical-self-perception [56]. These results suggest a potential uncoupling between subjective and psychological dimensions and the real physical responses to weight loss interventions, which might reinforce the present results.

Some limitations have to be considered when interpreting the present results, such as the relatively reduced sample size as well as the unequal gender repartition. Importantly, it must also be noticed that the adolescents enrolled in this study were volunteers to complete the weight loss program, showing then a high level of motivation, which might have affected their answers to the questionnaire and perception of health. Although it would have been also interesting to objectively assess the adolescents' physical activity level as an important factor affecting the quality of life, all of them showed a level of activity of < 2 h per week before inclusion and followed the same program during the inpatient intervention.

## 5. Conclusion

Although the present results must be considered and interpreted in light of some limitations such as the absence of follow-up or physical fitness evaluation, it provides important and innovative insights regarding the effect of weight loss on HRQL and HP. According to our results, a 10-month multidisciplinary intervention favors both HRQL and HP improvements in adolescents with obesity, which might not be explained by body weight and adiposity improvements. Further studies are required to better understand the exact parameters favoring quality of life and health perception improvements in pediatric obesity.

## Declarations of conflicting interests

The authors have no conflict to declare.

## Funding

This research did not receive any specific grant from funding agencies in the public, commercial, or not-for-profit sectors.

## Acknowledgements

None.

## References

- [1] M. Bastien, P. Poirier, I. Lemieux, J.P. Després, Overview of epidemiology and contribution of obesity to cardiovascular disease, *Prog. Cardiovasc. Dis.* 56 (2014) 369–381.
- [2] J.F. Wu, Childhood obesity: a growing global health hazard extending to adulthood, *Pediatr. Neonatol.* 54 (2013) 71–72.
- [3] R.C. Whitaker, J.A. Wright, M.S. Pepe, K.D. Seidel, W.H. Dietz, Predicting obesity in young adulthood from childhood and parental obesity, *N. Engl. J. Med.* 337 (1997) 869–873.
- [4] D. Thivel, R.M. Malina, L. Isacco, J. Aucouturier, M. Meyer, P. Duché, Metabolic syndrome in obese children and adolescents: dichotomous or continuous? *Metab. Syndr. Relat. Disord.* 7 (2009) 549–855.
- [5] L. Isacco, J. Roche, S. Quinart, D. Thivel, V. Gillet, V. Nègre, F. Mouglin, Cardiometabolic risk is associated with the severity of sleep-disordered breathing in children with obesity, *Physiol. Behav.* 170 (2017) 62–67.
- [6] S.R. Daniels, The consequences of childhood overweight and obesity, *Future Child.* 16 (2006) 47–67.
- [7] A.C. Skinner, J.A. Skelton, Prevalence and trends in obesity and severe obesity among children in the United States, 1999–2012, *JAMA Pediatr.* 168 (2014) 561–566.
- [8] R. Sagar, T. Gupta, Psychological aspects of obesity in children and adolescents, *Indian J. Pediatr.* 85 (2018) 554–559.
- [9] H. Taras, W. Potts-Datema, Obesity and student performance at school, *J. Sch. Health.* 75 (2005) 291–295.
- [10] X.D. Keating, D. Castelli, S.F. Ayers, Association of weekly strength exercise frequency and academic performance among students at a large university in the United States, *J. Strength Cond. Res.* 27 (2013) 1988–1993.
- [11] R.W. Jeffery, R.R. Wing, N.E. Sherwood, D.F. Tate, Physical activity and weight loss: does prescribing higher physical activity goals improve outcome? *Am. J. Clin. Nutr.* 78 (2003) 684–689.
- [12] B.N. Whitaker, P.L. Fisher, S. Jambhekar, G. Com, S. Razzaq, J.E. Thompson, T.G. Nick, W.L. Ward, Impact of degree of obesity on sleep, quality of life, and depression in youth, *J. Pediatr. Health Care* 32 (2018) e37–e44.
- [13] M.D. Tsiros, T. Olds, J.D. Buckley, P. Grimshaw, L. Brennan, J. Walkley, A.P. Hills, P.R. Howe, A.M. Coates, Health-related quality of life in obese children and adolescents, *Int. J. Obes. (Lond.)* 33 (2009) 387–400.
- [14] M. Rank, D.C. Wilks, L. Foley, Y. Jiang, H. Langhof, M. Siegrist, M. Halle, Health-related quality of life and physical activity in children and adolescents 2 years after an inpatient weight-loss program, *J. Pediatr.* 165 (2014) 732–737.
- [15] M. Hoedjes, S. Makkes, J. Halberstadt, H. Noordam, C.M. Renders, J.E. Bosmans, O.H. van der Baan-Slootweg, J.C. Seidell, Health-related quality of life in children and adolescents with severe obesity after intensive lifestyle treatment and at 1-year follow-up, *Obes. Facts* 11 (2018) 116–128.
- [16] C.E. Fonvig, S.A. Hamann, T.R.H. Nielsen, M.Ø. Johansen, H.N. Grønbaek, P.M. Mollerup, J.C. Holm, Subjective evaluation of psychosocial well-being in children and youths with overweight or obesity: the impact of multidisciplinary obesity treatment, *Qual. Life Res.* 26 (2017) 3279–3288.
- [17] A.S. Kelly, S.E. Barlow, G. Rao, T.H. Inge, L.L. Hayman, J. Steinberger, E.M. Urbina, L.J. Ewing, S.R. Daniels, American Heart Association Atherosclerosis, Hypertension, and Obesity in the Young Committee of the Council on Cardiovascular Disease in the Young, Council on Nutrition, Physical Activity and Metabolism, and Council on Clinical Cardiology, Severe obesity in children and adolescents: identification, associated health risks, and treatment approaches: a scientific statement from the American Heart Association, *Circulation* 128 (2013) 1689–1712.
- [18] J. Carnier, M.T. de Mello, C. Ackel-DElia, F.C. Corgosinho, R.M. Campos, L. Sanches, D.C. Masquio, Bueno CR Jr., A.P. Ganen, A.C. Martins, D.A. Caranti, L. Tock, A.P. Clemente, S. Tufik, A.R. Dâmaso, Aerobic training (AT) is more effective than aerobic plus resistance training (AT+RT) to improve anorexigenic/orexigenic factors in obese adolescents, *Appetite.* 69 (2013) 168–173.
- [19] M. Miguet, J. Masurier, V. Julian, L. Metz, E. Chaplais, C. Cardenoux, Y. Boirie, M. Duclos, D. Thivel, Moderate versus high intensity interval exercise trainings on energy intake and appetite feelings in adolescents with obesity, *Obes. Facts.* 10 (2017) 1–274.
- [20] J. Masurier, M. Miguet, D. Courteix, Y. Boirie, M. Duclos, D. Thivel, Effect of a 10-month multidisciplinary weight loss program on quality of life and health perception in adolescents with obesity, *ECO 2017, 24. European Congress on Obesity, Porto, Portugal, May 2017*.
- [21] J.E. Jr Ware, C.D. Sherbourne, The MOS 36-item short-form health survey (SF-36).I. Conceptual framework and item selection, *Med. Care* 30 (1992) 473–483.
- [22] Ware JE Jr., M. Kosinski, B. Gandek, SF-36 Health Survey: Manual and Interpretation Guide, Quality Metric Inc, Lincoln, RI, 2002.
- [23] C. Taft, J. Karlsson, M. Sullivan, Do SF-36 summary component scores accurately summarize subscale scores? *Qual. Life Res.* 10 (2001) 395–404.
- [24] S. Garnier, I. Gaubert, S. Joffroy, G. Auneau, P. Mauriège, Impact of brisk walking on perceived health evaluated by a novel short questionnaire in sedentary and moderately obese postmenopausal women, *Menopause* 20 (2013) 804–812.
- [25] P.M. Genin, F. Degoutte, J. Finaud, B. Pereira, D. Thivel, M. Duclos, Effect of a 5-month worksite physical activity program on tertiary employees overall health and fitness, *J. Occup. Environ. Med.* 59 (2017) e3–e10.
- [26] E.M. Fallon, M. Tanofsky-Kraff, A.C. Norman, J.R. McDuffie, E.D. Taylor, M.L. Cohen, D. Young-Hyman, M. Keil, R.L. Kolotkin, J.A. Yanovski, Health-related quality of life in overweight and non overweight black and white adolescents, *J. Pediatr.* 147 (2005) 443–450.
- [27] J.B. Schwimmer, T.M. Burwinkle, J.W. Varni, Health-related quality of life of severely obese children and adolescents, *JAMA* 289 (2003) 1813–1819.
- [28] M. de Beer, G.H. Hofsteenge, H.M. Koot, R.A. Hirasing, H.A. Delemarre-van de Waal, R.J. Gemke, Health-related-quality-of-life in obese adolescents is decreased and inversely related to BMI, *Acta Paediatr.* 96 (2007) 710–714.
- [29] O. Pinhas-Hamiel, S. Singer, N. Pilpel, A. Fradkin, D. Modan, B. Reichman, Health-related quality of life among children and adolescents: associations with obesity, *Int. J. Obes.* 30 (2006) 267–272.
- [30] M.H. Zeller, A.C. Modi, Predictors of health-related quality of life in obese youth, *Obesity (Silver Spring)* 14 (2006) 122–130.
- [31] V. Ottova, M. Erhart, L. Rajmil, L. Dettenborn-Betz, U. Ravens-Sieberer, Overweight and its impact on the health-related quality of life in children and adolescents: results from the European KIDSCREEN survey, *Qual. Life Res.* 21 (2012) 59–69.
- [32] A.A. Fenner, E.K. Howie, M.C. Davis, L.M. Straker, Relationships between psychosocial outcomes in adolescents who are obese and their parents during a multidisciplinary family-based healthy life style intervention: one-year follow-up of a waitlist controlled trial (Curtin University's Activity, Food and Attitudes Program), *Health Qual. Life Outcomes* 14 (2016) 100.
- [33] J.M. Rippe, J.M. Price, S.A. Hess, G. Kline, K.A. DeMers, S. Damitz, I. Kreidieh, P. Freedson, Improved psychological well being, quality of life, and health practices in moderately overweight women participating in a 12-week structured weight loss program, *Obes. Res.* 6 (1998) 208–218.
- [34] K.R. Fontaine, I. Barofsky, R.E. Andersen, S.J. Bartlett, L. Wiersma, L.J. Cheskin, S.C. Franckowiak, Impact of weight loss on health-related quality of life, *Qual. Life Res.* 8 (1999) 275–277.
- [35] L.M. Warkentin, D. Das, S.R. Majumdar, J.A. Johnson, R.S. Padwal, The effect of weight loss on health-related quality of life: systematic review and meta-analysis of

- randomized trials, *Obes. Rev.* 15 (2014) 169–182.
- [36] J.T. Fine, G.A. Colditz, E.H. Coakley, G. Moseley, J.E. Manson, W.C. Willett, I. Kawachi, A prospective study of weight change and health-related quality of life in women, *JAMA* 282 (1999) 2136–2142.
- [37] B. Blissmer, D. Riebe, G. Dye, L. Ruggiero, G. Greene, M. Caldwell, Health-related quality of life following a clinical weight loss intervention among overweight and obese adults: intervention and 24 month follow-up effects, *Health Qual. Life Outcomes* 4 (2006) 1–10.
- [38] U. Ravens-Sieberer, M. Bullinger, Assessing health-related quality of life in chronically ill children with the German KINDL: first psychometric and content analytical results, *Qual. Life Res.* 7 (1998) 399–407.
- [39] B.H. Knöpfli, T. Radtke, M. Lehmann, B. Schätzle, J. Eisenblätter, A. Gachnang, P. Wiederkehr, J. Hammer, J. Brooks-Wildhaber, Effects of a multidisciplinary inpatient intervention on body composition, aerobic fitness, and quality of life in severely obese girls and boys, *J. Adolesc. Health* 42 (2008) 119–127.
- [40] C.J. Lavie, R.V. Milani, Effects of cardiac rehabilitation, exercise training, and weight reduction on exercise capacity, coronary risk factors, behavioral characteristics, and quality of life in obese coronary patients, *Am. J. Cardiol.* 79 (1997) 397–401.
- [41] G.P. Samsa, R.L. Kolotkin, G.R. Williams, M.H. Nguyen, C.M. Mendel, Effect of moderate weight loss on health-related quality-of life: an analysis of combined data from four randomized trials of sibutramine versus placebo, *Am. J. Managed. Care* 7 (2001) 21–29.
- [42] S.C. Bischoff, A. Damms-Machado, C. Betz, S. Herpertz, T. Legenbauer, T. Löw, J.G. Wechsler, G. Bischoff, A. Austel, T. Ellrott, Multicenter evaluation of an interdisciplinary 52-week weight loss program for obesity with regard to body weight, comorbidities and quality of life - a prospective study, *Int. J. Obes. (Lond.)* 36 (2012) 614–624.
- [43] R.L. Kolotkin, R.D. Crosby, G.R. Williams, G.G. Hartley, S. Nicol, The relationship between health-related quality of life and weight loss, *Obes. Res.* 9 (2001) 564–571.
- [44] S.M. Hunt, S.P. McKenna, J. McEwen, E.M. Backett, J. Williams, E. Papp, A quantitative approach to perceived health status: a validation study, *J. Epidemiol. Community Health* 34 (1980) 281–286.
- [45] G.A. Kaplan, T. Camacho, Perceived health and mortality: a nine-year follow-up of the human population laboratory cohort, *Am. J. Epidemiol.* 117 (1983) 292–304.
- [46] P.M. Genin, P. Dessenne, J. Finaud, B. Pereira, D. Thivel, M. Duclos, Health and fitness benefits but low adherence rate: effect of a 10-month onsite physical activity program among tertiary employees, *J. Occup. Environ. Med.* 60 (2018) e455–e462, <https://doi.org/10.1097/JOM.0000000000001394> (Epub ahead of print).
- [47] J. Masurier, M.E. Mathieu, S.N. Fearnbach, C. Cardenoux, V. Julian, C. Lambert, B. Pereira, M. Duclos, Y. Boirie, D. Thivel, Effect of exercise duration on subsequent appetite and energy intake in obese adolescent girls, *Int. J. Sport Nutr. Exerc. Metab.* 1 (2018) 1–9, <https://doi.org/10.1123/ijnsnem.2017-0352> (Epub ahead of print).
- [48] M. Miguet, A. Fillon, M. Khammassi, J. Masurier, V. Julian, B. Pereira, C. Lambert, Y. Boirie, M. Duclos, J.E. Blundell, G. Finlayson, D. Thivel, Appetite, energy intake and food reward responses to an acute high intensity interval exercise in adolescents with obesity, *Physiol. Behav.* 195 (2018) 90–97.
- [49] S. Halasi, J. Lepeš, A. Stajer, M. Cvetković, Relationship between body composition and HRQOL in primary school children, Croatia, *J. Educ.* 19 (2017) 125–133.
- [50] K.M. Morrison, S. Shin, M. Tarnopolsky, V.H. Taylor, Association of depression & health related quality of life with body composition in children and youth with obesity, *J. Affect. Disord.* 172 (2015) 18–23.
- [51] H.A. Doll, S.E. Petersen, S.L. Stewart-Brown, Obesity and physical and emotional well-being: associations between body mass index, chronic illness, and the physical and mental components of the SF-36 questionnaire, *Obes. Res.* 8 (2000) 160–170.
- [52] M. Bruno, R. Touger-Decker, L. Byham-Gray, R. Denmark, Workplace weight loss program: impact on quality of life, *J. Occup. Environ. Med.* 53 (2011) 1396–1403.
- [53] S. Evaristo, C. Moreira, R. Santos, L. Lopes, S. Abreu, C. Agostinis-Sobrinho, J. Oliveira-Santos, J. Mota, Associations between health-related quality of life and body mass index in Portuguese adolescents: lab Med physical activity study, *Int. J. Adolesc. Med. Health* (2018), <https://doi.org/10.1515/ijamh-2017-0066> (Epub ahead of print).
- [54] K.R. Fontaine, I. Barofsky, Obesity and health-related quality of life, *Obes. Rev.* 2 (2001) 173–182.
- [55] M. Murray, J.L. Pearson, A.L. Dordevic, M.P. Bonham, The impact of multi-component weight management interventions on quality of life in adolescents affected by overweight or obesity: a meta-analysis of randomized controlled trials, *Obes. Rev.* 20 (2018) 278–289.
- [56] O. Rey, J.M. Vallier, C. Nicol, C.S. Mercier, C. Maïano, Effects of combined vigorous interval training program and diet on body composition, physical fitness, and physical self-perceptions among obese adolescent boys and girls, *Pediatr. Exerc. Sci.* 29 (1) (2017) 73–83.
- [57] A.J. Daley, R.J. Copeland, N.P. Wright, A. Roalfe, J.K. Wales, Exercise therapy as a treatment for psychopathologic conditions in obese and morbidly obese adolescents: a randomized, controlled trial, *Pediatrics* 118 (5) (2006) 2126–2134.

**Appetite, energy intake and food reward responses to an acute  
High Intensity Interval Exercise in adolescents with obesity.**

Miguet, M., **Fillon, A.**, Khammassi, M., Masurier, J., Julian, V., Pereira, B., Lambert, C., Boirie, Y., Duclos, M., Blundell, J. E., Finlayson, G., & Thivel, D.



*Accepted in Physiology & Behavior, Volume 195, 2018*



## Appetite, energy intake and food reward responses to an acute High Intensity Interval Exercise in adolescents with obesity



Maud Miguet<sup>a,\*</sup>, Alicia Fillon<sup>a</sup>, Marwa Khammassi<sup>a</sup>, Julie Masurier<sup>b</sup>, Valérie Julian<sup>c,d</sup>, Bruno Pereira<sup>e</sup>, Céline Lambert<sup>e</sup>, Yves Boirie<sup>d,f,g,h</sup>, Martine Duclos<sup>c,d,g,h</sup>, John Edward Blundell<sup>i</sup>, Graham Finlayson<sup>i</sup>, David Thivel<sup>a,h</sup>

<sup>a</sup> Clermont Auvergne University, Laboratory of the Metabolic Adaptations to Exercise under Physiological and Pathological Conditions (AME2P), EA 3533, Clermont-Ferrand, France

<sup>b</sup> UGECAM Nutrition Obesity Ambulatory Hospital, Clermont-Ferrand, France

<sup>c</sup> Department of Sport Medicine and Functional Explorations, Clermont-Ferrand University Hospital, G. Montpied Hospital, Clermont-Ferrand, France

<sup>d</sup> University Clermont 1, UFR Medicine, Clermont-Ferrand, France

<sup>e</sup> Clermont-Ferrand University Hospital, Biostatistics Unit (DRCI), Clermont-Ferrand, France

<sup>f</sup> Department of Human Nutrition, Clermont-Ferrand University Hospital, G. Montpied Hospital, Clermont-Ferrand, France

<sup>g</sup> INRA, UMR 1019, Clermont-Ferrand, France

<sup>h</sup> CRNH-Auvergne, Clermont-Ferrand, France

<sup>i</sup> School of Psychology, Faculty of Medicine and Health, University of Leeds, Leeds LS2 9JT, UK

### ARTICLE INFO

#### Keywords:

High Intensity Interval Exercise  
Appetite  
Energy Intake, Pediatric Obesity

### ABSTRACT

**Background:** High Intensity Interval Exercise (HIIE) is currently advocated for its beneficial effect on body composition and cardio-metabolic health in children and adolescents with obesity; however its impact on appetite control and food intake remains unknown. The aim of the present study was to examine the effect of a single HIIE session on subsequent energy intake, appetite feelings and food reward in adolescents with obesity. **Methods:** Using a randomized cross-over design, *ad libitum* energy intake, subjective appetite, and food reward were examined in 33 adolescents with obesity (13.0 (± 0.9) years) following an acute high-intensity interval exercise (HIIE) versus a rest condition (CON). Absolute and relative energy intakes were measured from an *ad libitum* lunch meal 30 min after exercise or rest. Food reward was assessed using the Leeds Food Preference Questionnaire before and after the test meal. Appetite feelings were assessed using visual analogue scales at regular intervals throughout the day.

**Results:** *Ad libitum* food intake was significantly reduced after HIIE (lunch meal:  $-7$  (± 23.7)%;  $p = .014$  and whole day:  $-4$  (± 14.7)%;  $p = .044$ ), despite unchanged appetite feelings. HIIE was also found to decrease *ad libitum* meal food reward in adolescents with obesity: fat relative preference (from 3.3 (± 9.5) to 0.1 (± 8.0);  $p = .03$ ), sweet taste relative preference (from  $-0.8$  (± 13.9) to  $-5.0$  (± 11.8);  $p = .02$ ) and fat implicit wanting (from 22.3 (± 55.7) to  $-13.2$  (± 58.5);  $p = .01$ ) were significantly decreased in response to the *ad libitum* meal on HIIE. When considering the degree of obesity, it appears that the adolescents with higher BMI and higher fat mass percentage showed greater food intake reductions in response to HIIE ( $-21$  (± 15)% for the third BMI tertile versus  $+8$  (± 30)% for the first BMI tertile  $p = .004$ ;  $-15$  (± 21)% for the third fat mass tertile versus  $+8$  (± 28)% for the first fat mass tertile  $p = .017$ ).

**Conclusion:** A single HIIE session resulted in reduced subsequent energy intake and food reward in adolescents with obesity. Our results also seem to indicate that these nutritional responses depend on the adolescents' degree of obesity with a greater anorexigenic effect observed with higher obesity.

### 1. Introduction

There is an alarming progression of pediatric obesity with one out of

four children concerned in European countries [1]. This obesity pandemic results in part from an energy imbalance between energy intake and expenditure, favored by the increasing availability of palatable

\* Corresponding author at: Clermont University, Blaise Pascal University, EA 3533, Laboratory of the Metabolic Adaptations to Exercise under Physiological and Pathological Conditions (AME2P), BP 80026, F-63171 Aubière Cedex, France.

E-mail address: [Maud.MIGUET@uca.fr](mailto:Maud.MIGUET@uca.fr) (M. Miguet).

<https://doi.org/10.1016/j.physbeh.2018.07.018>

Received 9 April 2018; Received in revised form 20 July 2018; Accepted 21 July 2018

Available online 23 July 2018

0031-9384/ © 2018 Elsevier Inc. All rights reserved.

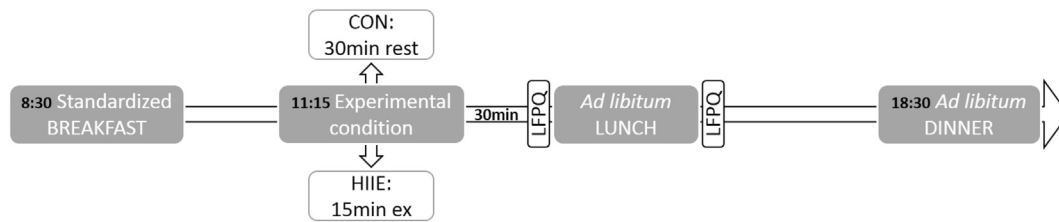

Fig. 1. Design of the experimental days. CON: rest condition; HIIE: high intensity interval exercise; LFPQ: Leeds Foes Preferences Questionnaire.

high-fat food, concomitantly with a clear decline in children's physical activity and progression of the time they spend sedentary [2]. Anti-obesity strategies that consider both sides of energy balance are therefore needed.

Evidence has shown that exercise energy expenditure and energy intake are loosely coupled variables, therefore we need a better understanding of their interactions [3]. Since the 1950s, many works have attempted to assess the role of daily activity-induced energy expenditure (from vigorous physical activity to sedentary behaviors) on energy intake in adults [4]. A recent systematic review in adults revealed there to be a better control of energy intake in active compared to inactive people, while individuals with very low levels of physical activity and high rates of sedentary behavior seem to suffer from a non-regulated control of food intake [5].

Although this relationship between exercise and energy intake has been mainly studied in adults for the last couple of decades, more attention has been recently paid to this question among children and adolescents, lean or obese [6–8]. According to the available evidence, while an acute bout of exercise does not seem to alter subsequent food consumption in lean children and adolescents [9, 10], an acute bout of intensive exercise (above 70% of the adolescent's maximal capacities) has been shown to significantly decrease food intake at the following meal in those with obesity [11]. This effect has been attributed to higher post-exercise anorexigenic gastrointestinal peptide concentrations [12] (such as peptide YY, glucagon-like peptide-1, and pancreatic polypeptide) and lower neurocognitive responses to food cues [13].

High-Intensity Interval Exercise (HIIE) has recently been described as an efficient exercise modality in adolescents with obesity, producing a lower perceived exertion and being at least as effective as moderate-continuous training to improve their body composition and metabolic profile [14]. Recent studies conducted in overweight adults also suggest that HIIE has similar effects on appetite sensations and hedonic liking and wanting for food than moderate intensity interval training [15]. Thus, HIIE does not appear to lead to a reward-induced increase in food intake [15]. The same team also found that a 4-week HIIE intervention was able to reduce hunger and the desire to eat, as well as to limit food compensation compared to a moderate-intensity program that tended to increase the preference for high fat food in overweight adults [16]. To our knowledge, there is so far no study that has examined the effect of HIIE on subsequent energy intake and appetite feelings in children and adolescents with obesity. Morris and collaborators recently examined the effect of a 22-min HIIE session composed of 30-s sprints on subsequent food intake in 10-year-old lean children [17]. According to their results, food intake and macronutrient preferences at the following meal were not affected, which is consistent with previous results from our teams showing that only overweight and obese youth modify their food consumption after an intensive bout of exercise [7].

The aim of the present study was to examine the effect of a single HIIE session on subsequent energy intake, macronutrient consumption, appetite sensations and food reward in adolescents with obesity. Secondly, we questioned whether these post-exercise nutritional adaptations could be influenced by the degree of obesity in adolescents.

## 2. Methods

### 2.1. Population

Thirty three adolescents with obesity (according to Cole et al. [18]) aged 12–15 years old (Tanner stage 3–4) participated in this study (12 boys and 21 girls). The adolescents were recruited through the local Pediatric Obesity Center (Tza Nou, La Bourboule, France). The adolescents and their parents were proposed to participate by the pediatrician during their regular medical visit in the center. To be included in the study, participants had to be free of any medication that could interact with the protocol (e.g. diabetic or blood pressure medications), should not present any contraindications to physical activity, and had to take part in < 2 h of physical activity per week (according to the International Physical Activity Questionnaire –IPAQ [19]). This study was conducted in accordance with the Helsinki declaration and all the adolescents and their legal representative received information sheets and signed up consent forms as requested by the local ethical authorities (Human Ethical Committee (CPP Sud Est VI) authorization reference: AU 1178 2015).

### 2.2. Design

After a preliminary medical inclusion visit made by a pediatrician to control for the ability of the adolescents to complete the study, they were asked to perform a maximal aerobic test and their body composition was assessed by Dual-energy X-ray Absorptiometry (DXA). The adolescents were then asked to complete a food preference questionnaire and the Three-Factor-Eating-Questionnaire R21 [20] in order to exclude children with high cognitive restraint. Afterward, adolescents were randomly assigned to one of two experimental sessions (see Fig. 1) performed one week apart: i) a rest condition without exercise (CON); ii) a High Intensity Interval Exercise condition (HIIE). On the two occasions, participants received a standardized breakfast (08:30) and started one of the two experimental conditions at 11:15 am (rest or exercise). Thirty minutes after the end of the experimental conditions (rest or exercise), participants had to complete the Leeds Food Preference Questionnaire (LFPQ) [21] before being served with an *ad libitum* buffet-style meal. They had to complete the LFPQ once more after the meal. Dinner energy intake was also assessed using an *ad libitum* buffet-style meal. Their appetite sensations were assessed at regular intervals through the day. Outside the experimental conditions and between the two *ad libitum* test meals, the adolescents were requested not to engage in any moderate to vigorous physical activity and mainly completed sedentary activities such as reading, homework or board games.

### 2.3. Anthropometric characteristics and body composition

Adolescents were weighed and had height measured wearing light clothing while bare-footed, using respectively a digital scale and a standard wall-mounted stadiometer. Body Mass Index (BMI) was calculated as weight (kg) divided by height squared ( $m^2$ ). Afterwards, BMI was calculated in the sex and age dependent French reference curves to obtain the BMI percentile [22]. Fat mass (FM) and fat-free mass (FFM)

were assessed by dual-energy X-ray absorptiometry (DXA) following standardized procedures (QDR4500A scanner, Hologic, Waltham, MA, USA). These measurements were obtained during the preliminary visit by a trained technician.

#### 2.4. Maximal oxygen uptake test (VO<sub>2</sub>)

Each subject performed a  $\dot{V}O_{2peak}$  test on a traditional concentric ergometer [23]. The initial power was set at 30 W during 3 min, followed by a 15 W increment every minute until exhaustion. The adolescents were strongly encouraged by the experimenters throughout the test to perform their maximal effort. Maximal criteria were: heart rate > 90% of the theoretical maximum heart rate ( $210 - 0.65 \times \text{age}$ ), Respiratory Exchange Ratio ( $RER = \dot{V}CO_2/\dot{V}O_2$ ) > 1.1 and/or  $\dot{V}O_2$  plateau. Cardiac electrical activity (Ultima Series™, Saint Paul, MN) and heart rate (Polar V800) were monitored and the test was coupled with a measurement of gas exchanges breath by breath (BreezeSuite Software, Saint Paul, MN), that determined  $\dot{V}O_2$  and CO<sub>2</sub> (Carbon Dioxide) production ( $\dot{V}CO_2$ ). Volumes and gases were calibrated before each test. The  $\dot{V}O_{2peak}$  was defined as the average of the last 30 s of exercise before exhaustion.

#### 2.5. Experimental conditions

##### 2.5.1. Rest condition (CON)

Between 11:15 to 11:45 am, the participants remained seated on a comfortable chair (30 min). They were not allowed to talk, read, watch TV or to complete any intellectual tasks.

##### 2.5.2. Exercise condition (HIIE)

Between 11:15 to 11:45 am, the participants were invited to perform a High Intensity Interval Exercise on an ergo-cycle, for a total duration of 15 min. Warming-up began at 60% of Maximal Heart Rate (HR<sub>max</sub>) for 3 min. Then, adolescents had to perform 5 times the same pattern: 2 min intense bouts interspersed by active 30 s low intensity cycling. The intensity of the steps was as follows: 70%, 75%, 80%, 85%, and 90% HR<sub>max</sub>. The intensity was controlled by heart rate records (Polar V800) using the results from the maximal aerobic capacity testing. Exercise induced energy expenditure was estimated afterwards based on the results obtained during the maximal oxygen uptake evaluation.

#### 2.6. Perceived exertion

Immediately after exercise (HIIE session), the adolescents were asked to rate their perceived exertion using the Children's Effort Rating Table (CERT) from Williams et al. [24]. This scale was elaborated using a range of items from 1 to 10, the number 1 corresponding to an extremely easy exercise, while an effort leading the subject to interrupt the test because of its hard difficulty is indicated by 10.

#### 2.7. Energy intake

At 08:00 am, the adolescents consumed a standardized calibrated breakfast (500 kcal) respecting the recommendations for their age (composition: bread, butter, marmalade, yogurt or semi-skimmed milk, fruit or fruit juice). Lunch and dinner meals were served *ad libitum* using a buffet-type meal. The content of the buffets was determined based on the adolescent's food preferences and eating habits. Top rated items as well as disliked ones and items liked but not usually consumed were excluded to avoid over-, under- and occasional consumption. Lunch menu was beef steak, pasta, mustard, cheese, yogurt, compote, fruits and bread. Dinner menu was ham/turkey, beans, mashed potato, cheese, yogurt, compote, fruits and bread. Adolescents were told to eat until feeling comfortably satiated. Food items were presented in abundance. Food intake was weighted by the experimenters and the

macro nutritive distribution (proportion of fat, carbohydrate and protein) as well as the total energy consumption in kcal were calculated using the software Bilnut 4.0. This methodology has been previously validated and published [25].

#### 2.8. Subjective appetite sensations

Appetite sensations were collected throughout the day using visual analogue scales (150 mm scales) [26]. Adolescents had to report their hunger, fullness, desire to eat and prospective food consumption at 12 time points (before and immediately after breakfast, 30 min and 60 min after breakfast, prior and after the experimental condition (CON or HIIE), before and immediately after lunch, 30 min and 60 min after lunch, before and right after dinner). The questions were i) "How hungry do you feel?", ii) "How full do you feel?", iii) "Would you like to eat something?", iv) "How much do you think you can eat?".

#### 2.9. Food liking and wanting

The Leeds Food Preference Questionnaire (described in greater methodological detail by Dalton and Finlayson [27]) provided measures of food preference and food reward. Participants were presented with an array of pictures of individual food items common in the diet. Foods in the array were chosen by the local research team from a validated database to be either predominantly high (> 50% energy) or low (< 20% energy) in fat but similar in familiarity, protein content, palatability and suitable for the study population. The LFPQ has been deployed in a range of research [27] including a recent exercise/appetite trial in young French males [28]. Explicit liking and explicit wanting were measured by participants rating the extent to which they like each food ("How pleasant would it be to taste this food now?") and want each food ("How much do you want to eat this food now?"). The food images were presented individually, in a randomized order and participants make their ratings using a 100-mm VAS. Implicit wanting and relative food preference were assessed using a forced choice methodology in which the food images were paired so that every image from each of the four food types was compared to every other type over 96 trials (food pairs). Participants were instructed to respond as quickly and accurately as they could to indicate the food they want to eat the most at that time ("Which food do you most want to eat now?"). To measure implicit wanting, reaction times for all responses were covertly recorded and used to compute mean response times for each food type after adjusting for frequency of selection. Responses on the LFPQ were used to compute mean scores for high fat, low fat, sweet or savory food types (and different fat-taste combinations).

#### 2.10. Statistical analysis

Sample size was determined according to previous works reported in literature [11] and to an estimation based on effect-size difference > 0.6, for a two-sided type I error at 5%, a statistical power at 90% and a correlation coefficient at 0.5 (two conditions for a same subject). For these assumptions, 32 subjects were enough to detect such true difference between the two conditions where our recruitment enrolled 33 subjects. Statistical analysis was performed using Stata software (version 13; StataCorp, College Station, Texas, USA) and Statview (version 4 for Windows). Continuous data were expressed as mean ( $\pm$  standard deviation (SD)). All tests were two-sided, with a Type I error set at 0.05. The normality of the data was checked using the Smirnov-Kolmogorov test. Adapted paired *t*-tests were used to compare absolute and relative energy intake, macronutrient preferences and energy expenditure between conditions (CON and HIIE). For appetite sensations, area under the curves (AUC, based on the trapezoid methods) were calculated and compared between CON and HIIE using *t*-test. To measure the *ad libitum* meal effect on relative preference, implicit wanting, explicit wanting and explicit liking, statistical analysis

was conducted with linear mixed models to take into account the repeated measurements per subject. Interaction between time (before and after meal) and condition (CON and HIIE) was tested before performing subgroup analyzes. Our sub-analysis, questioning the effect of degree of obesity, children were classified in tertiles (based on weight, BMI, FM% and FFM kg as the main anthropometric and body composition indicators used in the literature to characterize obesity). One-way ANOVA were used to compare lunch energy intake, macronutrient preferences, and appetite sensations AUC on CON and HIIE between tertiles. Bonferroni post-hoc test were used when appropriate.).

### 3. Results

#### 3.1. Characteristics of the participants

Thirty-three healthy adolescents with obesity were recruited for this study (11 boys, 21 girls). Participants had an average ( $\pm$  SD) age of 13.3 ( $\pm$  0.9) years; weight: 93.2 ( $\pm$  13.0) kg; BMI: 35.0 ( $\pm$  4.3) kg/m<sup>2</sup>; z-BMI: 2.3 ( $\pm$  0.2); fat mass: 37.6 ( $\pm$  3.5)%; fat free mass: 55.9 ( $\pm$  7.3) kg and VO2peak: 23.5 ( $\pm$  4.3) ml/min/kg.

#### 3.2. Characteristics of HIIE and CON condition

Energy expenditure (EE) induced by exercise (total duration 15 min) was significantly higher compared to the 30-min resting energy expenditure (respectively 102 ( $\pm$  21) kcal; and 52 ( $\pm$  10) kcal;  $p < .001$ ). The rate of perceived exertion by the end of the HIIE was 5.8 ( $\pm$  2.0).

#### 3.3. Energy intake

Absolute energy intake (EI) at lunch (HIIE: 1102 ( $\pm$  276) kcal and CON: 1222 ( $\pm$  310) kcal;  $p = .014$ ; which represents a difference of 7%), as well as the total energy intake over the day (HIIE: 2062 ( $\pm$  460) kcal and CON: 2177 ( $\pm$  471) kcal;  $p = .044$ ; which represents 4% difference) were significantly lower on HIIE compared with CON. Moreover, relative energy intake after lunchtime (REI = EI-EE) was also lower on HIIE compared with CON (1005 ( $\pm$  274) kcal and 1172 ( $\pm$  306) kcal respectively;  $p = .001$ ) (Table 1).

#### 3.4. Macronutrient consumption

The macronutrient intake expressed as both absolute intake (grams) and percentage of the total ingested energy, is shown in Table 2. On HIIE, the adolescents consumed significantly less protein and fat (in grams) at lunch compared to CON ( $p = .008$  and  $p = .022$ ). This difference is still significant regarding the total protein and fat content of the food consumed all day ( $p = .020$  and  $p = .033$ ). The carbohydrate consumption at lunch tended to decrease on HIIE compared with CON ( $p = .058$ ).

**Table 1**

Energy expenditure, energy intake and relative energy intake, in response to high intensity interval exercise (HIIE condition) or rest (CON condition), in obese adolescents.

	CON	HIIE	<i>p</i> value
	Mean ( $\pm$ SD)	Mean ( $\pm$ SD)	
Lunch EI (kcal)	1222 ( $\pm$ 310)	1102 ( $\pm$ 276)	0.014
Lunch REI (kcal)	1172 ( $\pm$ 306)	1005 ( $\pm$ 274)	0.001
Dinner EI (kcal)	955 ( $\pm$ 228)	960 ( $\pm$ 246)	0.877
Total EI (kcal)	2177 ( $\pm$ 471)	2062 ( $\pm$ 460)	0.044

CON: control condition; HIIE: high intensity interval exercise; EI: energy intake; REI: relative energy intake (EI-EE); SD: Standard Deviation; \*:  $p < .05$ ; \*\*:  $p < .01$ ; \*\*\*:  $p < .001$ , NS: not significant.

#### 3.5. Subjective appetite sensations

Overall daily hunger, satiety, desire to eat and prospective food consumption were not different between conditions as illustrated by Fig. 2.

#### 3.6. Food reward

Our results show a significant meal  $\times$  condition interaction for taste implicit wanting ( $p = .046$ ) with sweet taste implicit wanting increasing after the *ad libitum* meal on CON while decreasing on HIIE (see Table 3: a positive score for fat and/or taste bias indicates a preference for high fat and/or sweet food; a negative score for fat and/or taste bias indicates a preference for low fat and/or savory food). The before meal LFPQ results were not different after the rest or the HIIE condition. However, whereas no meal effect on CON was observed; fat relative preference, sweet taste relative preference and fat implicit wanting significantly decrease in response to the *ad libitum* meal on HIIE ( $p = .026$ ,  $p = .013$  and  $p = .010$  respectively).

#### 3.7. Effects of the degree of obesity

As detailed in the statistical analysis section, adolescents were classified in tertiles, depending on their degree obesity, according to four categories: weight, BMI, FM% and FFM (Table 4).

Regarding lunch energy intake depending of the degree of obesity, the delta between HIIE and CON was significantly different between the first and third BMI tertiles (ANOVA  $p = .013$ ; post-hoc T1 vs T3  $p = .004$ ): a 21% lower energy intake ( $-287 (\pm 242)$  kcal) was observed after HIIE compared with CON in adolescents within the third BMI tertile, while those in the first one (then with a lower BMI) increased their food consumption at the lunch test meal by 8% ( $+33 (\pm 284)$  kcal) in response to HIIE. Similar results were observed when using FM% tertiles (ANOVA  $p = .033$ ), where lunch food intake was lower in response to the HIIE session in the adolescents of the second and third FM% tertiles only ( $-15\% (-219 (\pm 283)$  kcal) for the third FM% tertile and  $-14\% (-189 (\pm 222)$  kcal) for the second FM% tertile), while an 8% ( $+45 (\pm 225)$  kcal) increase was observed in the first FM% tertile (T1 vs T2:  $p = .033$ ; T1 vs. T3:  $p = .017$ ). The results are illustrated in Fig. 3.

The macronutrient consumption depending on the tertiles of obesity showed a significant BMI tertiles  $\times$  conditions interaction on carbohydrate consumption (in grams) ( $p = .015$ ): while the first BMI tertile (lower BMI) increased CHO consumption after HIIE compared to CON ( $+8$  g), the second and the third BMI tertiles decreased their intake of CHO ( $-13.2$  g and  $-41.4$  g). For the sensations of appetite, we did not find either any difference between tertiles.

### 4. Discussion

While HIIE is largely promoted as an efficient anti-obesity strategy thanks to its beneficial effects on body composition and cardio-metabolic health [14], less is known regarding its potential nutritional impacts. The present study examined for the first time the effect of a single HIIE session on subsequent energy intake, macronutrient consumption, appetite sensations and food reward in adolescents with obesity. According to our main result, an acute HIIE session reduced subsequent *ad libitum* food intake (at the following test meal and whole day), despite unchanged appetite feelings in 12–15 years old patients with obesity. HIIE was also found to decrease post *ad libitum* meal food reward in adolescents with obesity. Interestingly these nutritional responses seem to depend on the adolescents' degree of obesity.

Recently, Morris and collaborators explored for the first time the effects of HIIE on food consumption and appetite sensations in children [17]. Contrary to our results, their 22-minutes HIIE session composed of 30-second sprints did not affect subsequent food intake in lean children



**Table 2**  
Absolute (grams) and relative (percentages) macronutrient consumption between meals during each experimental condition.

	CON		HIIE		p value	
	Grams Mean ( ± SD)	% Mean ( ± SD)	Grams Mean ( ± SD)	% Mean ( ± SD)	Grams	%
Lunch protein	64.3 ( ± 13.0)	21.4 ( ± 2.3)	58.6 ( ± 13.0)	21.5 ( ± 2.5)	0.008	0.801
Dinner protein	57.1 ( ± 15.8)	24.3 ( ± 6.2)	56.5 ( ± 14.5)	24.3 ( ± 6.2)	0.782	0.948
Total protein	121.4 ( ± 22.9)	22.6 ( ± 3.4)	115.1 ( ± 23.1)	22.7 ( ± 3.3)	0.020	0.994
Lunch fat	45.60 ( ± 9.6)	34.7 ( ± 8.6)	41.6 ( ± 9.8)	34.6 ( ± 6.0)	0.022	0.947
Dinner fat	33.5 ( ± 18.7)	30.2 ( ± 12.1)	32.0 ( ± 17.8)	28.3 ( ± 11.0)	0.430	0.120
Total fat	79.5 ( ± 22.5)	32.7 ( ± 6.1)	73.6 ( ± 22.7)	31.9 ( ± 5.9)	0.033	0.384
Lunch CHO	139.6 ( ± 54.8)	44.5 ( ± 8.0)	124.7 ( ± 47.5)	44.4 ( ± 8.9)	0.058	0.947
Dinner CHO	107.9 ( ± 29.4)	46.2 ( ± 11.7)	113.0 ( ± 29.9)	48.0 ( ± 9.9)	0.376	0.265
Total CHO	247.5 ( ± 70.7)	45.3 ( ± 7.1)	237.8 ( ± 66.7)	46.1 ( ± 7.03)	0.308	0.499

CON: control condition; HIIE: high intensity interval exercise; CHO: Carbohydrate; NS: not significant; SD: Standard Deviation.

[17]. Altogether, Morris et al. and our results confirm the actual literature clearly showing that intensive acute exercise can favor reduced energy intake in overweight and obese but not lean children and adolescents [7, 11, 29, 30]. These results add to the available evidence and suggest that HIIE might not only have beneficial effects on body composition, physical and cardio-metabolic fitness, but can also favor a transient negative energy balance, as illustrated by the significantly lower REI observed in the present work, as compared with a rest session. Importantly, this is accompanied by a low rate of perceived exertion, highlighting the acceptability and feasibility of such exercise modality in youth with obesity. While further chronic studies are needed to test the nutritional responses to long term High Intensity Interval Training, the observed transient anorexigenic effect of HIIE can be explained by some physiological and neurocognitive responses. Indeed, as already expressed in the literature, HIIE affects the concentrations of some of the main appetite-related peptides in adolescents with obesity, favoring increased PYY<sub>3–36</sub> [31] and decreased active ghrelin [29]. Recent data suggest that post-intensive exercise energy intake modifications can also be explained by the response to exercise of some neural networks involved in the cognitive processing of food-related cues. In their work, Fearnbach et al. recently questioned the potential role played by such cognitive processing of food-related cues in the nutritional response to exercise in children and adolescents [13, 32]. Their results showed that the neural response reflecting the cognitive effort engaged in response to food stimuli is significantly reduced compared to non-food ones after a 45-minute cycling exercise set at moderate-to-high intensity in obese, but not lean adolescent boys [13, 32]. Importantly, this reduced neural activation was accompanied by a significant decreased energy intake at the following meal compared to a rest condition [32].

While all the previously published studies in the field have considered weight status, the present analysis also questioned whether the degree of obesity may influence the adolescents' post-exercise energy intake. According to this sub-analysis, the transient anorexigenic effect of exercise seems to be stronger in adolescents with higher BMI and higher fat mass percentage. Indeed, a 21% decreased energy intake was observed after HIIE compared with CON in adolescents within the third BMI tertile, while those in the first one (with a lower BMI) increased their food consumption at the test meal by 8% in response to HIIE. Similar results were observed when using FM% tertiles, where food intake was reduced in response to the HIIE session in the adolescents of the second and third tertiles only (−15% for the third tertile and −14% for the second one), while a 8% increase was observed in the first tertile. These results are consistent with previous works done by Fearnbach et al. who found body composition specific post-exercise neural responses to food cues [13, 33]. According to their results, body weight, BMI and FM are inversely correlated with the neural response to food stimuli following exercising [13]. In other words, they found that a higher index of adiposity was associated with lower brain responsiveness to food stimuli following 45 min-cycling exercise (at 65%

VO<sub>2</sub>max). Thus, our results indicating a body composition specific nutritional post-exercise response may be explained by different cognitive processing of food stimuli: the greater post-exercise reduced energy intake in adolescents with the highest degree of obesity could be explained by a reduced neural response to food cues. Our results however failed to show any significant difference between FFM tertiles, which seems contradictory with the actual literature pointing a strong association between lean mass and daily energy intake in both adults and adolescents [34, 35] with Fearnbach et al. moreover showing a positive association between fat-free mass index and post-exercise intake in children at risk for obesity [36].

Interestingly, the reduced food consumption observed in the present work is not due to a particular effect on one specific macronutrient. Indeed, absolute protein, fat and CHO intakes at the test meal were all reduced (tendency for CHO) with no change of their respective contribution to the total energy ingested. Although the literature remains quite divergent regarding the macronutrient response to acute exercise, these results are in line with a recent systematic review suggesting that children and adolescents with obesity do not alter their relative macronutrient composition in response to acute exercise and calling for further specific researches [7]. Our secondary analysis however showed a significant BMI tertiles x CHO consumption interaction, with a higher CHO intake by the adolescents with lower BMI after HIIE while the adolescents of the second and the third BMI tertiles decreased their CHO consumption. More studies are needed regarding the potential effect of body composition on post-exercise macronutrient consumption.

Importantly, the observed post-exercise reduction in energy intake was not accompanied by any change in subjective appetite sensations (feelings of hunger, satiety, prospective food consumption or desire to eat); suggesting that this effect occurs without any food frustration in adolescents. This result is in line with previous works that have already highlighted this uncoupling effect of exercise on energy intake and appetite sensations in children and adolescents [37].

Elsewhere, evidence indicates that exercise may be link to food intake through its potential effect on food reward. If previous works have demonstrated the effect of exercise on explicit and implicit hedonic process in adults [15, 16, 38, 39], the present work is the first to question the effect of acute exercise on food reward in adolescents with obesity. According to our results, implicit wanting for sweet taste decreased in response to the *ad libitum* meal during the HIIE condition, while it increased after the CON condition. Furthermore, the preferences for high fat foods and sweet foods (relative to low fat foods and savory foods) were significantly reduced in response to our *ad libitum* test meal after the acute HIIE condition but not during the rest condition. Similarly, HIIE favored a reduced fat implicit wanting after the *ad libitum* meal compared to the rest condition. Altogether, these results suggest that an acute bout of HIIE might favor reduced reward for fat and sweet foods. These results are in line with previous works that demonstrated that food reward is altered by both aerobic and resistance

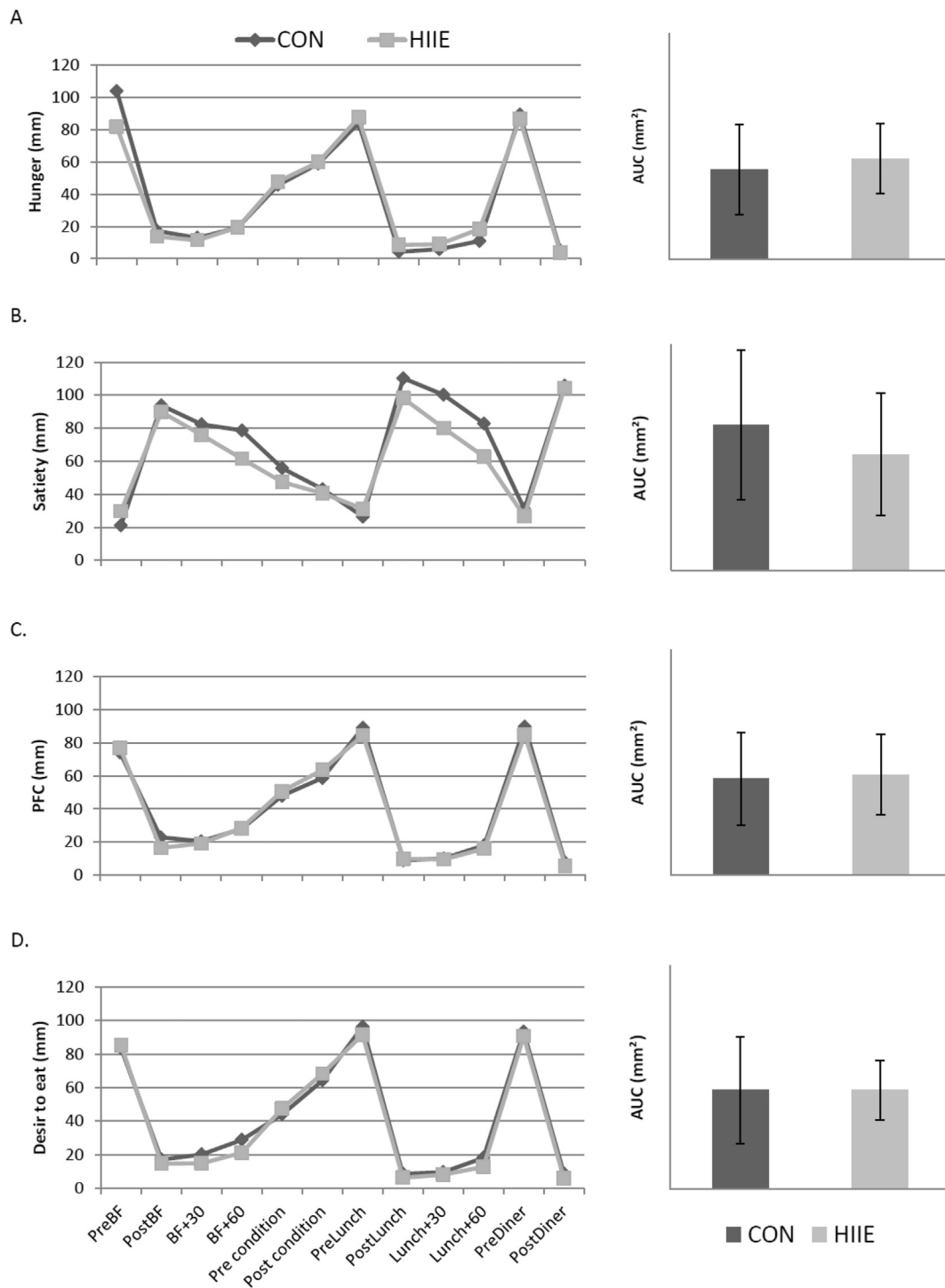

**Fig. 2.** Subjective Hunger (A), Satiety (B), Prospective Food Consumption (C) and Desire to Eat (D) kinetics (left side) and Area Under the Curve (AUC, right side). CON: rest condition; HIIE: high intensity interval exercise; AUC: area under the curves.

acute exercises [40]. Indeed, McNeil et al. found greater relative preference for high fat as well as greater explicit wanting for high fat during their CON condition compared to both (aerobic and resistance) exercises. However, Finlayson et al. highlighted high inter-individual food hedonic responses to exercise showing that while some individuals decreased their desire to eat after exercising others increased their implicit wanting [39]. Further studies considering and questioning the inter-individual variability regarding post-exercise food reward are needed in both adults and youth.

The present results have to be interpreted in light of some

limitations. First, although our results provide new interesting insights regarding the post-exercise energetic and behavioral adaptations of appetite control, physiological and neurocognitive investigations are missing to provide some potential explanatory mechanisms. Moreover, while acute exercises, particularly intensive ones, have been shown to impact energy balance (intake and expenditure) for up to 72 h, it would have been useful to assess energy expenditure and intake for the following days. Although the fact that the rest and the exercise conditions are not of exact same duration could be considered as a limitation of the study, the standardization of the timing between the end of both

**Table 3**  
Relative preference, implicit wanting, explicit wanting and explicit liking for high vs low fat foods and sweet vs savory foods, between rest and exercise condition.

			CON Mean ( ± SD)	Time	HIIIE Mean ( ± SD)	Time	Condition	Interaction time * condition
Relative preference	Fat biases	Before	4.1 ( ± 9.7)	0.101	3.3 ( ± 9.5)	0.026	0.729	0.814
		After	1.2 ( ± 8.2)		0.1 ( ± 8.0)			
	Taste biases	Before	-3.9 ( ± 13.3)	0.839	-0.8 ( ± 13.9)	0.013	0.217	0.092
		After	-3.2 ( ± 10.9)		-5.0 ( ± 11.8)			
Implicit wanting	Fat biases	Before	7.7 ( ± 28.3)	0.535	22.3 ( ± 55.7)	0.010	0.157	0.093
		After	1.2 ( ± 51.2)		-13.2 ( ± 58.5)			
	Taste biases	Before	-15.0 ( ± 42.9)	0.076	-5.7 ( ± 70.6)	0.203	0.660	0.046
		After	5.1 ( ± 60.8)		-22.6 ( ± 50.3)			
Explicit wanting	Fat biases	Before	6.2 ( ± 12.1)	0.238	3.5 ( ± 15.5)	0.932	0.245	0.461
		After	3.2 ( ± 9.7)		3.1 ( ± 12.3)			
	Taste biases	Before	-4.1 ( ± 12.8)	0.688	-1.7 ( ± 16.4)	0.304	0.472	0.693
		After	-5.4 ( ± 14.7)		-4.8 ( ± 11.1)			
Explicit liking	Fat biases	Before	5.0 ( ± 12.6)	0.104	4.7 ( ± 14.7)	0.569	0.863	0.472
		After	1.4 ( ± 10.3)		3.5 ( ± 12.5)			
	Taste biases	Before	-6.3 ( ± 12.0)	0.857	-2.2 ( ± 13.6)	0.174	0.070	0.288
		After	-5.5 ( ± 15.4)		-5.5 ( ± 11.8)			

CON: control session; HIIIE: high intensity interval exercise; NS: not significant; SD: Standard Deviation.

**Table 4**  
Description of the obesity tertiles.

	T1 Mean ( ± SD)	T2 Mean ( ± SD)	T3 Mean ( ± SD)	ANOVA	Post-hoc
Weight tertiles	81.00 ( ± 3.63)	90.48 ( ± 3.12)	107.13 ( ± 12.53)	< 0.001	T1 < T2*; T1 < T3***; T2 < T3***
BMI tertiles	30.69 ( ± 1.52)	34.78 ( ± 0.66)	39.42 ( ± 3.95)	< 0.001	T1 < T2 < T3***
FM % tertiles	33.65 ( ± 1.79)	38.01 ( ± 1.16)	41.13 ( ± 2.10)	< 0.001	T1 < T2 < T3***
FFM kg tertiles	48.84 ( ± 2.11)	54.75 ( ± 1.73)	64.26 ( ± 5.42)	< 0.001	T1 < T2 < T3***

T1: first tertile; T2: second tertile; T3: third tertile; BMI: Body Mass Index; FM: Fat Mass; FFM; Fat Free Mass; SD: Standard Deviation; \*: p = .015; \*\*\*: p < .001.

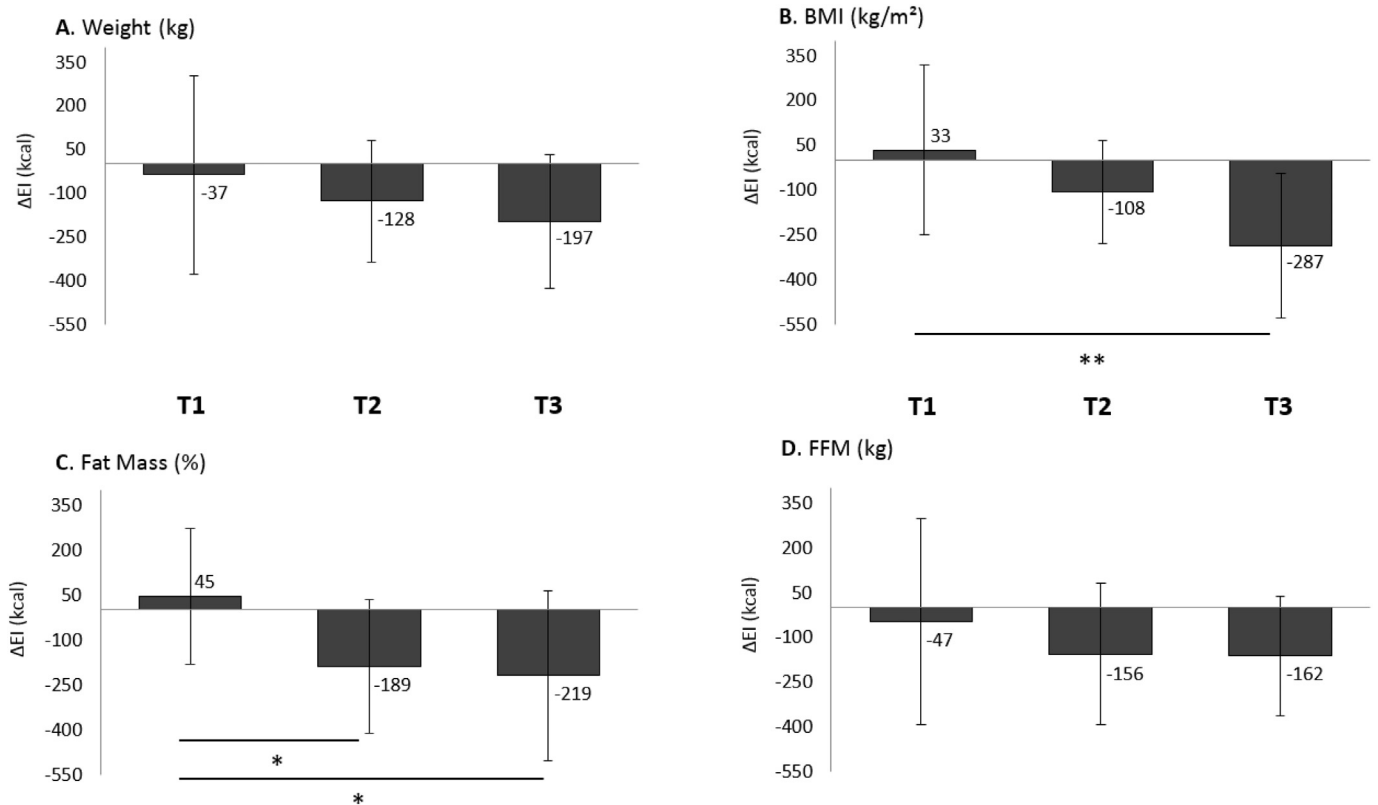

**Fig. 3.** Lunch energy intake differences (ΔEI) in response to high intensity interval exercise compare to control session, related to weight (A), body mass index (B), fat mass (C) and fat free mass (D) tertiles. ΔEI: Energy intake difference between control and high intensity interval exercise session; T1: first tertile; T2: second tertile; T3: third tertile; BMI: Body Mass Index; FM: Fat Mass; FFM; Fat Free Mass; SD: Standard Deviation; \*: p < .05; \*\*: p < .01.

experimental conditions and the LFPQ and *ad libitum* meal (30 min after both) has to be highlighted (so that the delay between the experimental conditions and the nutritional evaluations was the same). Furthermore, these results relate to the acute effect of HIIE on appetite control in adolescents with obesity; however, longitudinal investigations should be conducted, since it has been suggested in adults with obesity that four weeks of high intensity interval training might minimize the enhancement of food reward compared with a moderate intensity interval training [16]. Similarly, it must be underlined that our secondary analysis, questioning the effect of the degree of obesity using tertiles, might have been influenced by the fact that all the adolescents received the same breakfast independently of their level of obesity and then basal energy needs, which might have influenced energy intake at the test meal. Importantly, our analysis did not show gender differences, which is in line with previously published studies that have already pointed this absence of gender effect regarding post-exercise energy intake and appetite feelings in adolescents with obesity [40].

## 5. Conclusion

In conclusion, the present study found that an acute session of HIIE favors reduced subsequent energy intake and food reward despite unchanged appetite feelings in adolescents with obesity. Although this joins up with the actual literature regarding the effect of intensive exercise on subsequent nutritional responses in obese youth, our results seem to indicate for the first time that these nutritional responses depend on the adolescents' degree of obesity with a greater anorexigenic effect observed with higher obesity. Further studies are needed regarding the effects of HIIE on appetite and energy intake in such a population and to better understand this potential role played by the degree of obesity in adolescents.

## Acknowledgements

The authors are grateful to all of the adolescents that participated in the program, and to the Nutrition Obesity Ambulatory Hospital (UGEAM) that provided their generous support.

## Funding

This research did not receive any specific grant from funding agencies in the public, commercial, or not-for-profit sectors.

## References

- [1] WHO European Childhood Obesity Surveillance Initiative, 9th Meeting of the WHO European Childhood Obesity Surveillance Initiative (COSI). Meeting Report (2016), [Online]. Available: <http://www.euro.who.int/en/health-topics/disease-prevention/nutrition/publications/meeting-reports/technical-meetings-and-workshops/9th-meeting-of-the-who-european-childhood-obesity-surveillance-initiative-cosi-meeting-report-2016>, (2017), Accessed date: 4 April 2018.
- [2] P. Husu, H. Vähä-Yppä, T. Vasankari, Objectively measured sedentary behavior and physical activity of Finnish 7- to 14-year-old children- associations with perceived health status: a cross-sectional study, *BMC Public Health* 16 (Apr. 2016) 338.
- [3] J.-P. Chaput, A.M. Sharma, Is physical activity in weight management more about "calories in" than "calories out"? *Br. J. Nutr.* 106 (11) (Dec. 2011) 1768–1769.
- [4] J. Mayer, P. Roy, K.P. Mitra, Relation between caloric intake, body weight, and physical work: studies in an industrial male population in West Bengal, *Am. J. Clin. Nutr.* 4 (2) (Apr. 1956) 169–175.
- [5] K. Beaulieu, M. Hopkins, J. Blundell, G. Finlayson, Homeostatic and non-homeostatic appetite control along the spectrum of physical activity levels: an updated perspective, *Physiol. Behav.* 192 (2017) 23–29.
- [6] C. Schwartz, N.A. King, B. Pereira, J.E. Blundell, D. Thivel, A systematic review and meta-analysis of energy and macronutrient intake responses to physical activity interventions in children and adolescents with obesity: food intake and exercise in obese youth, *Pediatr. Obes.* 12 (3) (Jun. 2017) 179–194.
- [7] D. Thivel, P.L. Rumbold, N.A. King, B. Pereira, J.E. Blundell, M.-E. Mathieu, Acute post-exercise energy and macronutrient intake in lean and obese youth: a systematic review and meta-analysis, *Int. J. Obes* 40 (10) (2005) 1469–1479.
- [8] S.N. Fearnbach, et al., Impact of imposed exercise on energy intake in children at risk for overweight, *Nutr. J.* 15 (1) (Dec. 2016).
- [9] S. Hunschede, R. Kubant, R. Akilen, S. Thomas, H. Anderson, Decreased appetite following high intensity exercise correlates with increased plasma IL-6 in normal-weight and overweight/obese boys, *Curr. Dev. Nutr.* 1 (3) (2017) Feb.
- [10] D. Thivel, L. Metz, A. Julien, B. Morio, P. Duché, Obese but not lean adolescents spontaneously decrease energy intake after intensive exercise, *Physiol. Behav.* 123 (Jan. 2014) 41–46.
- [11] D. Thivel, L. Isacco, C. Montaurier, Y. Boirie, P. Duché, B. Morio, The 24-h energy intake of obese adolescents is spontaneously reduced after intensive exercise: a randomized controlled trial in calorimetric chambers, *PLoS ONE* 7 (1) (Jan. 2012) e29840.
- [12] T.J. Hazell, H. Islam, L.K. Townsend, M.S. Schmale, J.L. Copeland, Effects of exercise intensity on plasma concentrations of appetite-regulating hormones: potential mechanisms, *Appetite* 98 (Mar. 2016) 80–88.
- [13] S.N. Fearnbach, et al., Reduced neural responses to food cues might contribute to the anorexigenic effect of acute exercise observed in obese but not lean adolescents, *Nutr. Res.* 44 (Aug. 2017) 76–84.
- [14] A. García-Hermoso, A.J. Cerrillo-Urbina, T. Herrera-Valenzuela, C. Cristi-Montero, J.M. Saavedra, V. Martínez-Vizcaino, Is high-intensity interval training more effective on improving cardiometabolic risk and aerobic capacity than other forms of exercise in overweight and obese youth? A meta-analysis, *Obes. Rev. Off. J. Int. Assoc. Study Obes.* 17 (6) (2016) 531–540.
- [15] S.A. Alkahtani, N.M. Byrne, A.P. Hills, N.A. King, Acute interval exercise intensity does not affect appetite and nutrient preferences in overweight and obese males, *Asia Pac. J. Clin. Nutr.* 23 (2) (2013) 232–238.
- [16] S.A. Alkahtani, N.M. Byrne, A.P. Hills, N.A. King, Interval training intensity affects energy intake compensation in obese men, *Int. J. Sport Nutr. Exerc. Metab.* 24 (6) (Dec. 2014) 595–604.
- [17] A. Morris, R. Cramb, C.J. Dodd-Reynolds, Food intake and appetite following school-based high-intensity interval training in 9–11-year-old children, *J. Sports Sci.* 36 (3) (Feb. 2018) 286–292.
- [18] T.J. Cole, M.C. Bellizzi, K.M. Flegal, W.H. Dietz, Establishing a standard definition for child overweight and obesity worldwide: international survey, *BMJ* 320 (7244) (May 2000) 1240–1243.
- [19] C.L. Craig, et al., International physical activity questionnaire: 12-country reliability and validity, *Med. Sci. Sports Exerc.* 35 (8) (Aug. 2003) 1381–1395.
- [20] Bryant, Thivel, Chaput, Drapeau, Blundell, and King, 2018 Development and validation of the child three factor eating questionnaire (CTFEQr21), *Public Health Nutr.*, (In press).
- [21] G. Finlayson, N. King, J. Blundell, The role of implicit wanting in relation to explicit liking and wanting for food: implications for appetite control, *Appetite* 50 (1) (Jan. 2008) 120–127.
- [22] WHO Multicentre Growth Reference Study Group, WHO Child Growth Standards based on length/height, weight and age, *Acta Paediatr. Oslo Nor.* 450 (Suppl) (1992) 76–85 (Apr. 2006).
- [23] T.W. Rowland, Does peak VO<sub>2</sub> reflect VO<sub>2</sub>max in children?: evidence from supramaximal testing, *Med. Sci. Sports Exerc.* 25 (6) (Jun. 1993) 689–693.
- [24] J.G. Williams, R. Eston, B. Furlong, CERT: a perceived exertion scale for young children, *Percept. Mot. Skills* 79 (3 Pt 2) (Dec. 1994) 1451–1458.
- [25] D. Thivel, P.M. Genin, M.-E. Mathieu, B. Pereira, L. Metz, Reproducibility of an in-laboratory test meal to assess ad libitum energy intake in adolescents with obesity, *Appetite* 105 (2016) 129–133.
- [26] A. Flint, A. Raben, J.E. Blundell, A. Astrup, Reproducibility, power and validity of visual analogue scales in assessment of appetite sensations in single test meal studies, *Int. J. Obes. Relat. Metab. Disord. J. Int. Assoc. Study Obes.* 24 (1) (Jan. 2000) 38–48.
- [27] M. Dalton, G. Finlayson, Psychobiological examination of liking and wanting for fat and sweet taste in trait binge eating females, *Physiol. Behav.* 136 (Supplement C) (Sep. 2014) 128–134.
- [28] D. Thivel, et al., Energy depletion by 24-hr fast leads to compensatory appetite responses compared to matched energy depletion by exercise in healthy young males, *Br. J. Nutr.* (2018) (In press).
- [29] S. Hunschede, R. Kubant, R. Akilen, S. Thomas, H. Anderson, Decreased Appetite Following High Intensity Exercise Correlates with Increased Plasma IL-6 in Normal-weight and Overweight/Obese boys, *Curr. Dev. Nutr.* (2017) cdn.116.000398, Jan.
- [30] A.Y. Sim, K.E. Wallman, T.J. Fairchild, K.J. Guelfi, High-intensity intermittent exercise attenuates ad-libitum energy intake, *Int. J. Obes* 38 (3) (2005) 417–422.
- [31] W.L. Prado, et al., Effect of aerobic exercise on hunger feelings and satiety regulating hormones in obese teenage girls, *Pediatr. Exerc. Sci.* 26 (4) (Nov. 2014) 463–469.
- [32] S.N. Fearnbach, et al., Reduced neural response to food cues following exercise is accompanied by decreased energy intake in obese adolescents, *Int. J. Obes.* 40 (1) (2005) 77–83.
- [33] S.N. Fearnbach, et al., Brain response to images of food varying in energy density is associated with body composition in 7- to 10-year-old children: results of an exploratory study, *Physiol. Behav.* 162 (Aug. 2016) 3–9.
- [34] J.E. Blundell, G. Finlayson, C. Gibbons, P. Caudwell, M. Hopkins, The biology of appetite control: Do resting metabolic rate and fat-free mass drive energy intake? *Physiol. Behav.* 152 (Pt B) (Dec. 2015) 473–478.
- [35] J.D. Cameron, et al., Body composition and energy intake - skeletal muscle mass is the strongest predictor of food intake in obese adolescents: the HEARTY trial, *Appl. Physiol. Nutr. Metab. Physiol. Appl. Nutr. Metab.* 41 (6) (Jun. 2016) 611–617.
- [36] S.N. Fearnbach, D. Thivel, K. Meyerermann, K.L. Keller, Intake at a single, palatable buffet test meal is associated with total body fat and regional fat distribution in children, *Appetite* 92 (Sep. 2015) 233–239.
- [37] D. Thivel, J.-P. Chaput, Are post-exercise appetite sensations and energy intake coupled in children and adolescents? *Sports Med. Auckl. NZ* 44 (6) (Jun. 2014) 735–741.
- [38] G. Finlayson, E. Bryant, J.E. Blundell, N.A. King, Acute compensatory eating following exercise is associated with implicit hedonic wanting for food, *Physiol. Behav.* 97 (1) (2009) 62–67.
- [39] J. McNeil, S. Cadieux, G. Finlayson, J.E. Blundell, É. Doucet, The effects of a single bout of aerobic or resistance exercise on food reward, *Appetite* 84 (Jan. 2015) 264–270.
- [40] D. Thivel, et al., Gender effect on exercise-induced energy intake modification among obese adolescents, *Appetite* 56 (3) (Jun. 2011) 658–661.

# Sleep-disordered breathing in adolescents with obesity: When does it start to affect cardiometabolic health?

Roche, J., Corgosinho, F. C., Dâmaso, A. R., Isacco, L., Miguet, M., **Fillon, A.**, Guyon, A., Moreira, G. A., Pradella-Hallinan, M., Tufik, S., Túlio de Mello, M., Gillet, V., Pereira, B., Duclos, M., Boirie, Y., Masurier, J., Franco, P., Thivel, D., & Mougín, F.

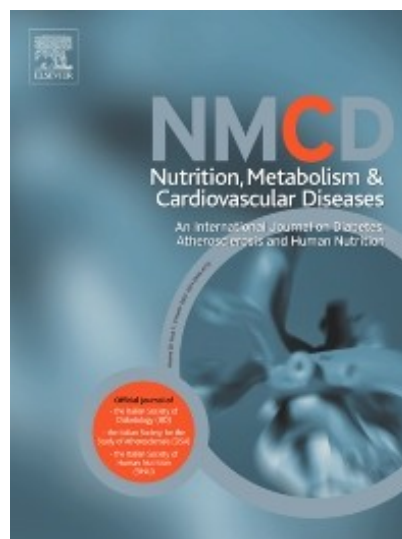

Available online at [www.sciencedirect.com](http://www.sciencedirect.com)

## Nutrition, Metabolism &amp; Cardiovascular Diseases

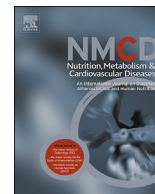
journal homepage: [www.elsevier.com/locate/nmcd](http://www.elsevier.com/locate/nmcd)

## Sleep-disordered breathing in adolescents with obesity: When does it start to affect cardiometabolic health?

Johanna Roche <sup>a,b,c,d,\*</sup>, Flavia C. Corgosinho <sup>e</sup>, Ana R. Dâmaso <sup>f</sup>, Laurie Isacco <sup>a</sup>, Maud Miguët <sup>c</sup>, Alicia Fillon <sup>c</sup>, Aurore Guyon <sup>g,h</sup>, Gustavo A. Moreira <sup>f,i</sup>, Marcia Pradella-Hallinan <sup>f,i</sup>, Sergio Tufik <sup>i</sup>, Marco Túlio de Mello <sup>j</sup>, Valérie Gillet <sup>b</sup>, Bruno Pereira <sup>k</sup>, Martine Duclos <sup>l,m,n,o</sup>, Yves Boirie <sup>l,m,n,p</sup>, Julie Masurier <sup>q</sup>, Patricia Franco <sup>g,h</sup>, David Thivel <sup>c,n</sup>, Fabienne Mougin <sup>a</sup>

<sup>a</sup> EA3920, Exercise Performance Health Innovation platform, University of Franche-Comte, Besançon, France<sup>b</sup> Sleep and Health Medicine Center Ellipse, Franois, France<sup>c</sup> Laboratory of the Metabolic Adaptations to Exercise under Physiological and Pathological Conditions (AME2P), UE3533, Clermont Auvergne University, Clermont-Ferrand, France<sup>d</sup> Wits Sleep Laboratory, Brain Function Research Group, School of Physiology, Faculty of Health Sciences, University of the Witwatersrand, Johannesburg, South Africa<sup>e</sup> Universidade Federal de Goiás – Faculdade de Nutrição - Programa de Pós-Graduação em Nutrição, Sao Paulo, Brazil<sup>f</sup> Universidade Federal de São Paulo - Escola Paulista de Medicina, Programa de Pós-Graduação em Nutrição, Sao Paulo, Brazil<sup>g</sup> Sleep Pediatric Unit, Woman Mother Child Hospital, Hospices Civils de Lyon, Lyon1 University, F-69500, France<sup>h</sup> Physiology of Brain Arousal System Research Laboratory, CRNL, INSERM-U1028, CNRS UMR5292, Lyon1 University, Lyon, France<sup>i</sup> Universidade Federal de São Paulo – Escola Paulista de Medicina – Departamento de Psicobiologia, Sao Paulo, Brazil<sup>j</sup> Universidade Federal de Minas Gerais – Programa de Pós-Graduação em Educação Física – Minas Gerais, Brazil<sup>k</sup> Clermont-Ferrand University Hospital, Biostatistics Unit (DRCI), Clermont-Ferrand, France<sup>l</sup> University Clermont 1, UFR Medicine, Clermont-Ferrand, France<sup>m</sup> INRA, UMR, 1019, Clermont-Ferrand, France<sup>n</sup> CRNH-Auvergne, Clermont-Ferrand, France<sup>o</sup> Department of Sport Medicine and Functional Explorations, Clermont-Ferrand University Hospital, G. Montpied Hospital, Clermont-Ferrand, France<sup>p</sup> Department of Human Nutrition, Clermont-Ferrand University Hospital, G. Montpied Hospital, Clermont-Ferrand, France<sup>q</sup> UGECAM Nutrition Obesity Ambulatory Hospital, Clermont-Ferrand, France

Received 29 July 2019; received in revised form 29 October 2019; accepted 3 December 2019

Handling Editor: A. Campanozzi

Available online ■ ■ ■

**KEYWORDS**

Pediatric obesity;  
Sleep-disordered  
breathing;  
Sleep apnea;  
Polysomnography;  
MetScore;  
Metabolic syndrome;  
Cardiometabolic risk

**Abstract** *Background and aims:* Pediatric obesity and sleep-disordered breathing (SDB) are associated with cardiometabolic risk (CMR), but the degree of severity at which SDB affects cardiometabolic health is unknown. We assessed the relationship between the CMR and the apnea-hypopnea index (AHI), to identify a threshold of AHI from which an increase in the CMR is observed, in adolescents with obesity. We also compared the clinical, cardiometabolic and sleep characteristics between adolescents presenting a high (CMR+) and low CMR (CMR-), according to the threshold of AHI.

*Methods and results:* 114 adolescents with obesity were recruited from three institutions specialized in obesity management. Sleep and SDB as assessed by polysomnography, anthropometric parameters, fat mass (FM), glucose and lipid profiles, and blood pressure (BP) were measured at admission. Continuous (MetScore<sub>FM</sub>) and dichotomous (metabolic syndrome, MetS) CMR were determined. Associations between MetScore<sub>FM</sub> and AHI adjusted for BMI, sex and age were assessed by multivariable analyses.

Data of 82 adolescents were analyzed. Multivariable analyses enabled us to identify a threshold of AHI = 2 above which we observed a strong and significant association between CMR and AHI (Cohen's d effect-size = 0.57 [0.11; 1.02] p = 0.02). Adolescents with CMR+

\* Corresponding author. Wits Sleep Laboratory, Brain Function Research Group, School of Physiology, Faculty of Health Sciences, University of the Witwatersrand, 7 York Road, Parktown, Johannesburg 2193, Gauteng, South Africa.

E-mail address: [johanna.roche@wits.ac.za](mailto:johanna.roche@wits.ac.za) (J. Roche).

<https://doi.org/10.1016/j.numecd.2019.12.003>

0939-4753/© 2019 The Italian Society of Diabetology, the Italian Society for the Study of Atherosclerosis, the Italian Society of Human Nutrition, and the Department of Clinical Medicine and Surgery, Federico II University. Published by Elsevier B.V. All rights reserved.

Please cite this article as: Roche J et al., Sleep-disordered breathing in adolescents with obesity: When does it start to affect cardiometabolic health?, Nutrition, Metabolism & Cardiovascular Diseases, <https://doi.org/10.1016/j.numecd.2019.12.003>

exhibited higher MetScore<sub>FM</sub> ( $p < 0.05$ ), insulin resistance ( $p < 0.05$ ), systolic BP ( $p < 0.001$ ), sleep fragmentation ( $p < 0.01$ ) and intermittent hypoxia than CMR- group ( $p < 0.0001$ ). MetS was found in 90.9% of adolescents with CMR+, versus 69.4% in the CMR- group ( $p < 0.05$ ).

**Conclusions:** The identification of a threshold of AHI  $\geq 2$  corresponding to the cardiometabolic alterations highlights the need for the early management of SDB and obesity in adolescents, to prevent cardiometabolic diseases.

**Clinical trials:** NCT03466359, NCT02588469 and NCT01358773

© 2019 The Italian Society of Diabetology, the Italian Society for the Study of Atherosclerosis, the Italian Society of Human Nutrition, and the Department of Clinical Medicine and Surgery, Federico II University. Published by Elsevier B.V. All rights reserved.

## Introduction

The prevalence of pediatric overweight and obesity has been increasing over the last few decades, and is now reaching alarming proportions [1]. Pediatric obesity is accompanied by many complications and comorbidities, such as metabolic disorders, amongst others [2]. It is also closely associated with sleep-disordered breathing (SDB) which is observed in 33–61% of obese youths [2–4] versus 1–3% in the general pediatric population [5]. Obesity and SDB are both known as independent pro-inflammatory factors [6,7], promoting endothelial and metabolic dysfunctions [7,8] and favoring cardiovascular mortality [6]. Indeed, breathing disorders during sleep are associated with sleep fragmentation [9] and intermittent hypoxia [10], leading to sympathetic over-activity [11] and over-production of radical oxygen species [12]. This inflammatory cascade is involved in the development of numerous cardiometabolic disorders [13]. Concomitantly, adipose tissue dysfunction, observed in pediatric obesity, has been incriminated in the development of insulin resistance [14] which, in turn, has a major impact on the metabolism of triglyceride-rich lipoproteins and free-fatty acids, favoring a pro-atherogenic state [15].

While several studies reported contradictory results regarding the effects of SDB on the development of dyslipidemia [16–18] and insulin resistance [19,20] in youth with obesity, a recent meta-analysis showed that SDB favors increased metabolic impairments in adolescents independently of the effects of obesity [21]. SDB has indeed been shown to be associated with higher systolic blood pressure (SBP), higher triglyceride (TG) and insulin concentrations, as well as reduced levels of high-density lipoprotein-cholesterol (HDL-C) in adolescents with obesity. These variables correspond to the parameters currently retained for the diagnosis of metabolic syndrome (MetS) [22], and there is a body of evidence suggesting a positive association between MetS and the presence of SDB in youth with obesity [17,23].

As a substitute for the MetS, a continuous metabolic score named MetScore [24,25] can be used to overcome the limits of dichotomous definitions. Indeed, in 2009, Thivel and colleagues [26] assessed CMR in children and adolescents with obesity comparing the use of a classical MetS diagnosis based on cut-offs [27], and the MetScore.

According to these authors [26], the standard dichotomous definition of the MetS did not adequately diagnose patients at risk of metabolic disorders, and the MetScore could propose a better and accurate alternative. Mostly, our group [28] recently reported an association between this MetScore and the severity of SDB in children with obesity, despite the absence of any significant difference in the rate of children diagnosed with MetS as per the classical definition, confirming its limited clinical significance.

Finally, if it is recognized that SDB has deleterious effects on cardiometabolic health in adolescents with obesity [21], the degree of severity at which SDB affects cardiometabolic health is unknown.

In that context, the objectives of the present study were, first, to assess the relationship between the MetScore<sub>FM</sub> and the apnea-hypopnea index (AHI) in order to identify a threshold of AHI from which an increase in the severity of the CMR is observed, in a population of adolescents with obesity. Second, we compared the clinical, cardiometabolic and sleep characteristics between adolescents presenting a high (CMR+) and low CMR (CMR-), according to the threshold of AHI. We hypothesized that participants with CMR+ would exhibit greater fat mass (FM) and waist circumference (WC), along with higher dyslipidemia, insulin resistance and SBP, as well as greater nocturnal intermittent hypoxia and fragmented sleep, compared to participants with CMR-.

## Methods

### Participants

One-hundred fourteen adolescents (69 girls and 45 boys) with obesity were recruited from three institutions specialized in the management of adolescent obesity; 39 adolescents were recruited through the pediatric obesity center of Clermont-Ferrand, France, 29 adolescents from the pediatric obesity center of Besançon, France, and 46 adolescents were recruited from the institution of São Paulo, Brazil. Obesity was defined as age-specific BMI greater than the IOTF-30 according to the International Obesity Task Force (IOTF) references [29].

The flow chart of the study is presented in Fig. 1.

### Protocol overview

The present analyses were performed as part of a collaborative project focusing on sleep and cardiometabolic health in adolescents with obesity, combining identical data from Clermont-Ferrand (ethical agreement of the University Hospital of Clermont-Ferrand, France: 2017-A00817-46, registered with ClinicalTrials. Gov under the identifier NCT03466359), Besançon (ethical agreement of the University Hospital of Besançon, France: 2015-A00763-46, registered with ClinicalTrials. Gov under the identifier NCT02588469), and São Paulo (ethical agreement of the Universidade Federal of São Paulo, Brazil: #0135/04, registered with ClinicalTrials. Gov under the identifier NCT01358773). Any potential experimental center effects have been tested on the outcome studies by comparing data between the three experimental sites. Since no effect was observed, pooling of the data from all three centers was possible.

The studies were performed in accordance with the Declaration of Helsinki. All participants and their parents or legal guardians were fully informed of the experimental procedures and provided written informed consent before enrollment in the study.

### Experimental procedures

At enrollment in the institutions, clinical evaluation, blood pressure measurement, nocturnal recordings and fasting blood sample collection the following day were performed for all participants.

### Clinical evaluations

Body weight was measured to the nearest 0.1 kg using a calibrated scale and height was determined to the nearest 0.01 m using a standing stadiometer for each child. BMI was calculated as body mass divided by height in meters squared ( $\text{kg}\cdot\text{m}^{-2}$ ). Waist circumference (WC) was measured to the nearest 0.5 cm in a standing position with a standard non-elastic tape that was applied horizontally midway between the last rib and the superior iliac crest.

BMI z-score was calculated for age and sex reference values adapted to the international pediatric population [30]. Body composition was assessed by three different techniques depending on the center: In Clermont-Ferrand, body composition was assessed by dual-energy X-ray absorptiometry (DXA) following standardized procedures (QDR4500A scanner, Hologic, Waltham, MA, USA). In Besançon, body fat mass (FM)

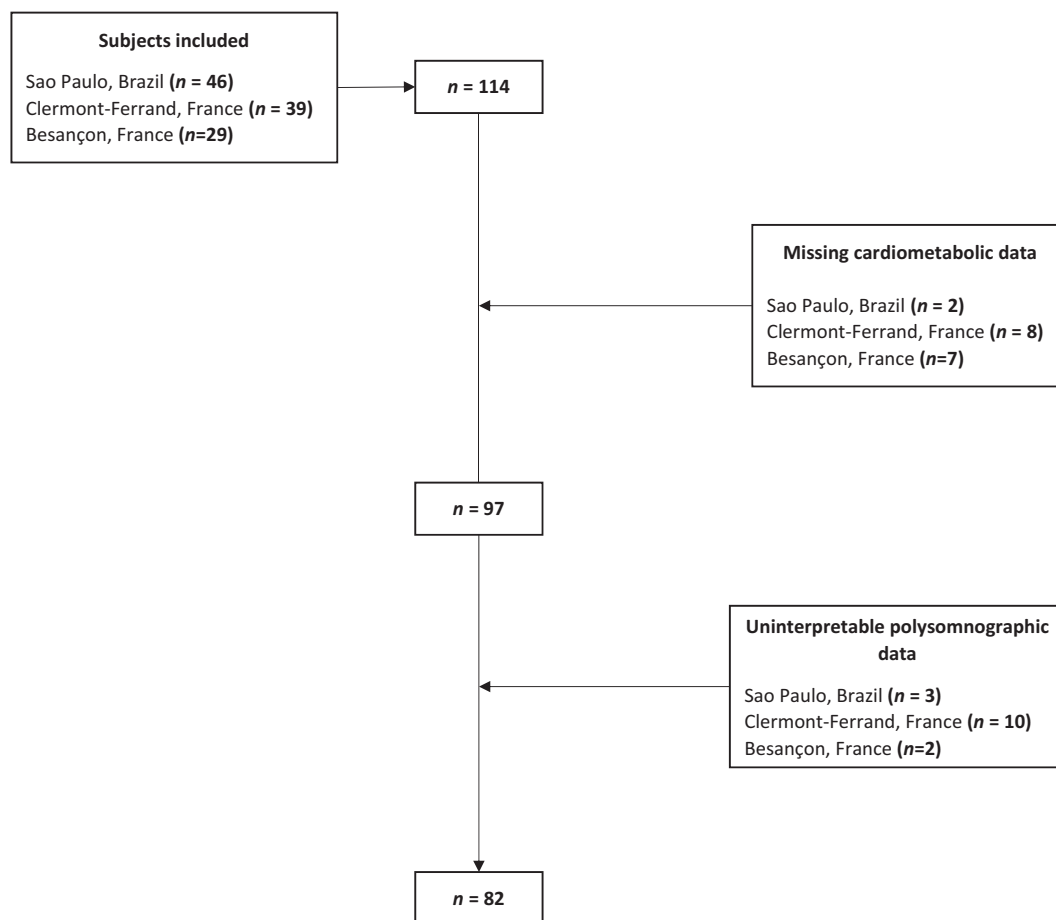

**Figure 1** Flow chart of the study population.



and fat-free mass (FFM) were measured by multi-frequency bioelectrical impedance analysis (MF-BIA, SFB7 model, Impedimed Limited, Pinkenba, Queensland, Australia) using four body surface electrodes in the supine position. BIA was performed in a fasting state after voiding the bladder. Finally, in São Paulo, body composition was measured by plethysmography in a BOD POD body composition system (version 1.68; Life Measurement Instruments, Concord, CA, USA).

Both multi-frequency bioelectrical impedance analysis and air plethysmography have shown good agreement with DXA for body composition assessment in children and adolescents [31–34].

### Blood pressure measurement

Systolic and diastolic blood pressures (SBP and DBP, respectively) were measured in a seated position after 20 min resting using an auditory stethoscope with a blood pressure cuff adapted to the arm circumference (Column Trimline graduated in mmHg, blood pressure cuff Welch Allyn).

### Nocturnal recordings

All participants underwent a standard polysomnography (PSG) on a weekday and during the school period, under the same conditions. Recordings were performed in the specialized residential nursing institution with an ambulatory polysomnograph (Morpheus, Micromed, Italy and Medatec, DREAM, Belgium) or in the sleep laboratory following an adaptation night (EMBLA S7000, Embla Systems Inc., Broomfield, CO., USA). Sleep was assessed with standard PSG techniques using the 10–20 system [35] and the following variables were also continuously measured and recorded for at least 6 h: Fz, Cz, F4-M1, C4-M1, O2-M1, F3-M2, C3-M2 and O1-M2, left and right electrooculogram, chin electromyogram, left and right anterior tibialis electromyogram and electrocardiogram.

Respiratory efforts were studied by thoracic and abdominal inductance plethysmography. Airflow was measured with a thermistor and nasal pressure cannula. Peripheral oxygen saturation (SpO<sub>2</sub>) and heart rate were both recorded by pulse oximetry (Nonin medical, Inc. Plymouth, Minnesota, USA).

The electroencephalogram (EEG) recordings were visually scored in 30-s periods by an experienced board-certified sleep physician using the American Academy of Sleep Medicine's standard rules to obtain the overnight pattern of sleep stages [36].

The following sleep parameters were recorded: sleep latency (time from lights out to sleep onset, defined as the first epoch of any sleep stage, min), total sleep time (TST, min), arousal index (number of arousals/TST, %), percentage of stage 1 sleep in TST (N1, %), percentage of stage 2 sleep in TST (N2, %), percentage of stage 3 sleep in TST (N3, %) and percentage of rapid-eye movement sleep stage in TST (REM, %).

Respiratory events, were scored in 3-min periods for airflow, according to the pediatric criteria, by an experienced board-certified sleep physician according to the

criteria of the American Academy of Sleep Medicine [37]. Apnea was defined as  $\geq 90\%$  reduction in airflow for a duration of at least 2 breaths, associated with the presence of respiratory effort for obstructive apnea (OA), or associated with absent respiratory effort during one portion of the event and the presence of inspiratory effort in another portion for mixed apnea (MA). Central apnea (CA) was defined as  $\geq 90\%$  reduction in airflow, for at least 20 s with absent inspiratory effort throughout the entire event, or for at least the duration of 2 breaths associated with  $\geq 3\%$  fall in oxygen saturation and/or arousal. Hypopnea was defined as  $\geq 30\%$  reduction in airflow for at least 2 breaths associated with  $\geq 3\%$  fall in oxygen saturation and/or arousal. Respiratory Effort-Related Arousal (RERA) was defined as increasing respiratory effort for at least 2 breaths, characterized by a flattening of the inspiratory portion of the nasal pressure, and leading to arousal from sleep [37]. Apnea, obstructive apnea, central apnea, mixed apnea, hypopnea and RERA index (AI, OAI, CAI, MAI, HI and RERA-I, respectively; events per hour) were determined by dividing the number of apnea, obstructive apnea, central apnea, mixed apnea, hypopnea and RERA events, respectively, by hours of sleep. Obstructive apnea-hypopnea index (OAHl; events per hour) was determined by dividing the number of obstructive apnea plus mixed apnea and hypopnea events by hours of sleep. Apnea-hypopnea index (AHI; events per hour) was determined by dividing the number of apneas plus hypopneas by hours of sleep. Respiratory Disturbance Index (RDI) was defined by the sum of AHI and RERA-I indices. Oxygen Desaturation Index (ODI) was determined by dividing the number of oxygen desaturation  $\geq 3\%$  by hours of sleep.

### Blood sample collection

Blood was collected via an antecubital vein after an overnight fast (12-h). Samples were centrifuged (4000 g for 10 min at 4 °C) and plasma was transferred into plastic tubes and kept at  $-80$  °C until analysis. Plasma glucose, total cholesterol, HDL-C, low-density lipoprotein cholesterol (LDL-C) and TG concentrations were determined by enzymatic methods. Plasma insulin concentrations were measured by chemoluminescence. Homeostatic model assessment for insulin resistance (HOMA<sub>IR</sub>) was calculated using the following formula: fasting insulin (mIU/L) \*fasting glucose (mmol/L)/22.5 [38]. The intra-assay coefficients of glucose, HDL-C, LDL-C, TG and insulin were 1.8%, 0.8%, 1.0%, 1.0% and 2.3%, respectively.

### Metabolic syndrome detection

The presence or absence of MetS was based on the criteria of Chen et al. using thresholds adapted to the pediatric population [39,40]. MetS was considered to be present when a child presented at least 3 of the following criteria: (1) BMI  $\geq$  IOTF-30 [29]; (2) SBP or DBP  $\geq$  90th percentile [41]; (3) HDL-C  $\leq$  0.4 g L<sup>-1</sup> [40]; (4) TG  $\geq$  1.3 g L<sup>-1</sup> [40] and (5) HOMA<sub>IR</sub>  $\geq$  75th percentile [42].

### Cardiometabolic risk scores

In the absence of site differences, a continuous CMR score (MetScore<sub>FM</sub>) [24,25] was calculated in the whole sample, according to previous studies [26,28,43]. Z-scores of the 6 following variables were calculated: fasting insulin and glucose, TG, HDL-C, FM<sub>kg</sub>, and SBP and DBP average. Each z-score was obtained by subtracting the sample mean from the individual value divided by the standard deviation (SD) of the sample mean:  $z\text{-score} = (\text{individual value} - \text{sample mean})/\text{SD}$ .

The 6 z-scores were then summed, except for HDL-C z-score which was deducted because of its decreased health risk with higher values, and then divided by 6 to create a continuous CMR score; MetScore<sub>FM</sub>.

### Statistical analysis

Statistical analysis was performed using STATA software (version 13, StataCorp, College Station, Texas, USA). The statistical tests were two-sided, with type I error at 0.05. Data are presented as mean  $\pm$  standard deviation (SD) and as median (25–75% ranges). The Kolmogorov-Smirnov test was used to test the assumption of distribution normality for quantitative parameters.

First, a sensitivity analysis was conducted to determine the best threshold of AHI from which CMR is increased using (i) Hedges' effect size (ES) for univariate analysis and (ii) regression coefficients ( $\beta$ ) for multivariable analysis. More precisely, for each value of AHI between 1 and 3, MetScore<sub>FM</sub> was compared among  $<$  or  $\geq$  of each value of AHI. The results were expressed as ES and 95% confidence interval (95%CI), and were interpreted according to Cohen's rules of thumb which defined effect-size bounds as: small (ES: 0.2), medium (ES: 0.5) and large (ES: 0.8: grossly perceptible and therefore large). Multivariable analysis was then performed to take into account possible cofounders covariates as sex, age and BMI. Results were expressed as  $\beta$  coefficients and 95%CI. The range fixed for the sensitivity analysis (AHI between 1 and 3) was determined according to statistical AHI distribution.

Finally, unpaired t test, Welch's test or Chi<sup>2</sup> test were performed as appropriate, to compare data between participants exhibiting CMR+ and CMR-

## Results

### Characteristics of the population

One-hundred fourteen adolescents (69 girls and 45 boys) were eligible at admission. Seventeen participants (12 girls, 5 boys) were excluded because they did not undergo blood sample collections or blood pressure assessments, and 15 (8 girls, 7 boys) because they presented poor quality of polysomnographic data.

In total, 82 participants (49 girls, 33 boys) with a mean age ( $\pm$ SD) of  $15.03 \pm 1.68$  years were then considered for analysis. Participants presented a median BMI (25–75% range) of 35.43 (33.45–42.11). MetS was observed in 64

participants (78%). Overall, AHI ranged from 0 to 22.9 events per hour, with a median AHI (25–75% range) of 1.40 (0.40–3.23). Results are presented in Table 1.

### Sensitivity analysis to determine the threshold of AHI from which CMR is increased

As presented in the statistical analysis section, for each value of AHI between 1 and 3, MetScore<sub>FM</sub> was compared among  $<$  or  $\geq$  of each value of AHI. Results are presented in Fig. 2, with effect sizes and 95% CI for univariate analyses, and with regression coefficients and 95% CI for multivariable analyses adjusted for age, BMI and sex. For AHI between 1.50 and 2.40, MetScore<sub>FM</sub> was statistically associated with AHI. Specifically, for AHI = 2, ES = 0.57 [0.11; 1.02] ( $p = 0.02$ ) and  $\beta = 0.25$  [0.04; 0.47] ( $p = 0.02$ ).

### Comparison of participants of the CMR+ group (AHI $\geq 2$ ) and the CMR- group (AHI $< 2$ )

Accordingly, the 33 participants who exhibited an AHI  $\geq 2$  were allocated to the CMR+ group (40.2%), while the 49 participants with an AHI  $< 2$  were allocated to the CMR- group (59.8%).

### Clinical characteristics

Adolescents with CMR+ and CMR- presented similar age, body weight, height, BMI and body composition, while a greater waist circumference was observed in the CMR+ group ( $p < 0.05$ , Table 1).

### Cardiometabolic data

Total cholesterol, LDL-C, HDL-C and TG concentrations were similar between the two groups, despite a trend towards lower HDL-C in participants with CMR+ ( $p = 0.08$ ). Insulin concentrations and HOMA<sub>IR</sub> were significantly higher in the CMR+ group ( $p < 0.05$ ) with no difference in glucose concentrations. SBP was higher in the CMR+ group ( $p < 0.001$ ) while DBP was not different between groups.

As expected, MetScore<sub>FM</sub> was higher in the group of participants with CMR+ ( $p < 0.05$ ). A higher prevalence of MetS was found in participants with CMR+ compared to participants with CMR- (90.9% vs 69.4%,  $p < 0.05$ , Table 1).

### Sleep data

TST and sleep latency were similar between the two groups. Regarding sleep architecture, only N1% was found in higher proportions in participants with CMR+ ( $p < 0.05$ ) and N2%, N3% and REM% were similar between groups.

Arousal index was greater in the CMR+ group ( $p < 0.01$ ). Regarding the respiratory events, AHI, AI, OAI, CAI, OAH and HI were higher in the CMR+ group ( $p < 0.001$ ), while MAI did not differ between groups. RERA and RDI were greater in the group of CMR+ participants ( $p < 0.01$  and  $p < 0.0001$ , respectively). Finally, both nadir SpO<sub>2</sub> and ODI were higher in the group of participants with CMR+ (respectively;  $p < 0.001$  and  $p < 0.0001$ , Table 1).

**Table 1** Clinical, cardiometabolic and sleep characteristics of participants with CMR- and CMR+, depending of the AHI threshold (AHI < or ≥ 2).

	Whole population	CMR- (AHI < 2)	CMR+ (AHI ≥ 2)	<i>p</i>
<i>n</i> (%)	82 (100)	49 (59.8)	33 (40.2)	
<i>Clinical characteristics</i>				
Boys/Girls	33/49	15/34	18/15	<b>&lt;0.05</b>
Age (yrs)	15.03 ± 1.68	15.18 ± 1.72	14.79 ± 1.61	0.30
Body weight (kg)	101.30 (91.51–118.00)	100.60 (89.77–111.40)	104.50 (93.27–122.50)	0.21
Height (cm)	1.67 ± 0.07	1.67 ± 0.07	1.67 ± 0.07	0.65
BMI (kg/m <sup>2</sup> )	35.43 (33.45–42.11)	35.34 (33.02–40.40)	36.45 (33.65–42.75)	0.27
BMI z-score	2.39 ± 0.32	2.34 ± 0.28	2.47 ± 0.36	0.07
Waist Circumference (cm)	102.00 (94.63–112.00)	100.00 (93.00–109.80)	103.50 (96.00–123.00)	<b>&lt;0.05</b>
Fat mass (%)	42.43 ± 6.26	43.10 ± 6.25	41.43 ± 6.23	0.25
Fat mass (kg)	41.25 (35.15–54.95)	41.25 (35.27–54.95)	41.43 (35.08–55.06)	0.99
Fat-free mass (kg)	57.65 (52.56–64.77)	56.34 (52.05–62.90)	59.11 (53.44–69.41)	0.06
<i>Cardiometabolic data</i>				
Total Cholesterol (g/L)	1.45 (1.26–1.77)	1.45 (1.32–1.73)	1.44 (1.17–1.88)	0.97
LDL-C (g/L)	0.89 ± 0.30	0.90 ± 0.28	0.88 ± 0.34	0.81
HDL-C (g/L)	0.43 ± 0.09	0.45 ± 0.09	0.41 ± 0.08	0.08
Triglycerides (g/L)	0.92 (0.67–1.13)	0.88 (0.66–1.11)	0.95 (0.69–1.27)	0.42
Glucose (g/L)	0.86 (0.80–0.90)	0.86 (0.81–0.90)	0.85 (0.80–0.88)	0.70
Insulin (μUI/mL)	17.40 (13.20–23.43)	16.2 (12.4–22.45)	20.6 (15.2–26.2)	<b>&lt;0.05</b>
HOMA <sub>IR</sub>	3.80 (2.72–4.86)	3.60 (2.50–4.50)	4.40 (3.27–4.93)	<b>&lt;0.05</b>
Systolic blood pressure (mmHg)	120 (110–130)	120 (110–120)	130 (120–130)	<b>&lt;0.001</b>
Diastolic blood pressure (mmHg)	70 (70–80)	70 (70–80)	70 (65–80)	0.9
MetScore <sub>FM</sub>	−0.01 (−0.35–0.22)	−0.13 (−0.45–0.15)	0.05 (−0.19–0.40)	<b>&lt;0.05</b>
Metabolic syndrome <i>n</i> (%)	64 (78.0)	34 (69.4)	30 (90.9)	<b>&lt;0.05</b>
<i>Sleep data</i>				
Total sleep time (min)	433 (401.9–465.3)	437 (400.5–474.3)	428 (406.5–461.5)	0.58
Sleep latency (min)	14.50 (8.30–28.00)	14.20 (9.00–27.50)	14.80 (6.15–30.05)	0.93
Stage N1 (% TST)	6.65 ± 3.59	5.99 ± 2.94	7.63 ± 4.24	<b>&lt;0.05</b>
Stage N2 (% TST)	50.56 ± 6.97	51.15 ± 7.44	49.67 ± 6.20	0.35
Stage N3 (% TST)	24.37 ± 6.67	24.59 ± 7.32	24.03 ± 5.67	0.70
REM (% TST)	18.40 ± 4.95	18.23 ± 5.07	18.64 ± 4.85	0.72
Arousal index (nb/h)	7.40 (5.05–9.65)	6.20 (4.45–8.60)	8.40 (6.30–11.90)	<b>&lt;0.01</b>
AHI (nb/h)	1.40 (0.40–3.23)	0.50 (0.10–1.10)	4.30 (2.65–7.40)	<b>&lt;0.0001</b>
AI (nb/h)	0.10 (0.00–0.53)	0.00 (0.00–0.20)	0.60 (0.20–1.45)	<b>&lt;0.0001</b>
OAI (nb/h)	0.00 (0.00–0.40)	0.00 (0.00–0.00)	0.30 (0.00–0.85)	<b>&lt;0.0001</b>
MAI (nb/h)	0.00 (0.00–0.00)	0.00 (0.00–0.00)	0.00 (0.00–0.00)	0.08
CAI (nb/h)	0.00 (0.00–0.93)	0.00 (0.00–0.01)	0.10 (0.00–0.65)	<b>&lt;0.001</b>
OAHI (nb/h)	1.25 (0.30–3.53)	0.40 (0.05–1.00)	3.80 (2.55–6.85)	<b>&lt;0.0001</b>
HI (nb/h)	1.10 (0.30–2.50)	0.40 (0.00–0.90)	3.60 (2.15–5.40)	<b>&lt;0.0001</b>
RERA-I (nb/h)	1.10 (0.00–5.85)	0.00 (0.00–4.25)	5.00 (0.00–8.35)	<b>&lt;0.01</b>
RDI (nb/h)	5.20 (0.50–10.13)	1.00 (0.25–4.30)	10.40 (7.40–12.35)	<b>&lt;0.0001</b>
Nadir SpO <sub>2</sub> (%)	90.00 (85.00–92.00)	91.00 (87.70–93.00)	87.50 (80.75–90.00)	<b>&lt;0.001</b>
ODI ≥3% (nb/h)	2.40 (0.80–4.50)	1.85 (1.10–2.83)	4.35 (2.75–5.68)	<b>&lt;0.0001</b>

Values are presented as mean ± sd and as median (25–75% range). Comparison between groups with CMR- (AHI < 2) and CMR+ (AHI ≥ 2); Unpaired *t* test for parametric data, Welch's test for non-parametric data. Chi<sup>2</sup> for qualitative data. AHI = apnea-hypopnea index; AI = apnea index; BMI = body mass index; CAI = central apnea index; CMR = cardiometabolic risk; HDL-C = high-density lipoprotein cholesterol; HOMA<sub>IR</sub> = homeostatic model assessment for insulin resistance; LDL-C = low-density lipoprotein cholesterol; MAI = mixed apnea index; OAHI = obstructive apnea-hypopnea index; OAI = obstructive apnea index; ODI = oxygen desaturation index; RDI = respiratory disturbance index; REM = rapid-eye movements sleep; RERA-I = respiratory-related arousal index; SpO<sub>2</sub> = peripheral oxygen saturation.

## Discussion

The prevalence of pediatric obesity continues to grow worldwide [1], associated with an alarming prevalence of SDB [2–4], promoting systemic inflammation [6,7] and increased risks for cardiovascular and metabolic diseases [6]. If the management of SDB in adolescents with obesity is challenging [2,4], its relationship with cardiometabolic health deserves to be clarified, and it remains especially unclear when SDB starts affecting cardiometabolic health. Then, the main objective of the present study was to assess the relationship between the MetScore<sub>FM</sub> and the AHI, in

order to identify a threshold of AHI from which an increase in the severity of the CMR is observed, in a population of adolescents with obesity. Second, we aimed to assess the differences, in terms of clinical, cardiometabolic and sleep parameters, between the adolescents identified with high (CMR+) and low CMR (CMR-), according to the threshold of AHI.

In our population of adolescents with severe obesity, AHI ranged from 0 to 22.9 events/hour, and we found an alarming rate of MetS at around 78%. This prevalence, although high, is consistent with that previously reported by our research group in children with obesity [28] and

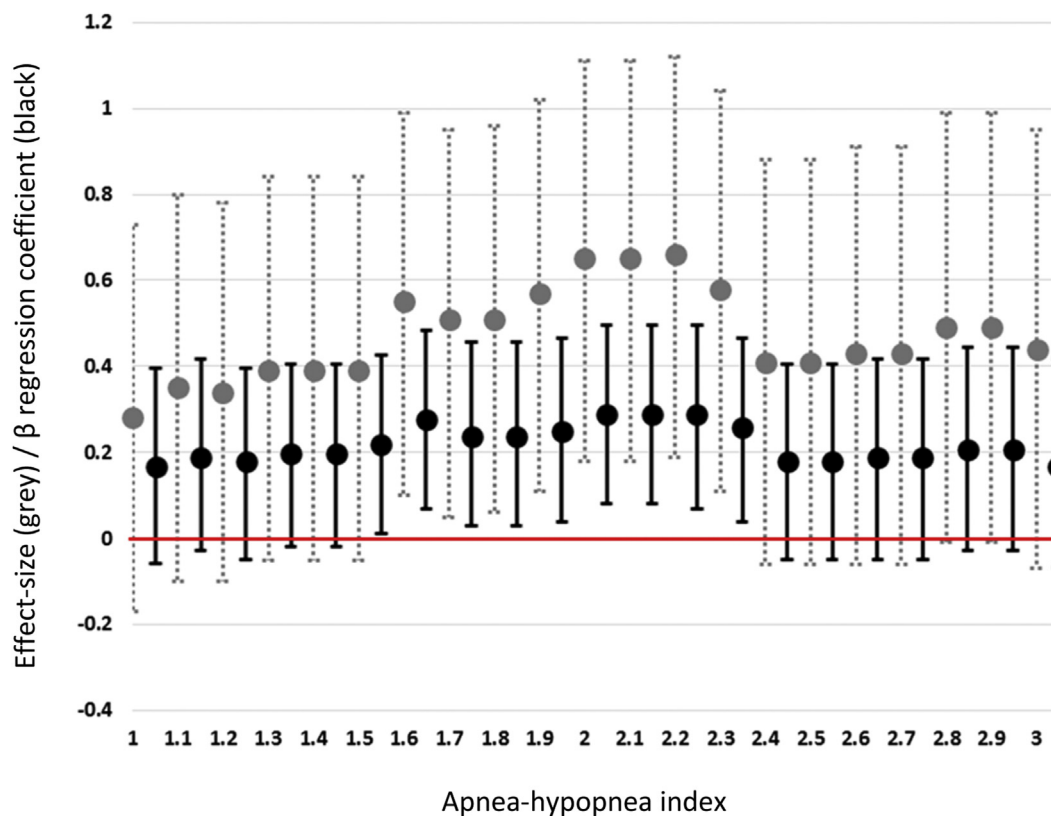

**Figure 2** Sensitivity analysis studying the relationship between  $\text{MetScore}_{\text{FM}}$  and AHI. Grey: Effect-size and 95% CI (univariate analysis), Black:  $\beta$  regression coefficient from linear regression and 95% CI (multivariable analysis).

emphasizes the deleterious effects of obesity and SDB on cardiometabolic health. The detection of MetS, although commonly used to identify patients at risk for cardiovascular disease [44], is based on a dichotomous approach that presents several limitations [26], also leading us to investigate the association between CMR and SDB using continuous score ( $\text{MetScore}_{\text{FM}}$ ).

Multivariable analyses adjusted for BMI, sex and age enabled us to identify a range of thresholds of AHI above which we observed a strong and significant association with CMR. Indeed, significant associations were found between  $1.5 \leq \text{AHI} < 2.4$ . Beyond the threshold of  $\text{AHI} = 2.4$ , the thresholds were less sensitive to discriminate participants who exhibited  $\text{CMR}^+$  from those exhibiting  $\text{CMR}^-$  (i.e. there was no significant association between CMR status and SDB status as defined by an AHI above a certain threshold). Importantly, the strongest association between the  $\text{MetScore}_{\text{FM}}$  and AHI was observed around a clinically useable threshold of  $\text{AHI} = 2$ . This threshold corresponds to the one commonly used, arbitrarily, to determine SDB in the adolescents with obesity [45], and the present result seems then to confirm its clinical relevance. To the best of our knowledge, this study is the first to propose a threshold of SDB from which CMR seems to be significantly increased in adolescents with obesity.

Based on our analysis, adolescents in the present study were then classified as  $\text{CMR}^+$  ( $\text{AHI} \geq 2$ ) or  $\text{CMR}^-$  ( $\text{AHI} < 2$ ), enabling us to report an alarming prevalence of MetS in

adolescents with  $\text{CMR}^+$  (90.9%) as compared with participants with  $\text{CMR}^-$  (69.4%). Additionally, the classification according to an  $\text{AHI} \geq 2$  allowed us to report a prevalence of SDB of 40.2% in our sample, which is consistent with the current literature [2–4].

Despite similar age, BMI, BMI z-score and percentage of fat mass and fat-free mass, the adolescents with  $\text{CMR}^+$  showed higher WC, indicating greater abdominal obesity, compared with participants with  $\text{CMR}^-$ . In the literature, inconsistent results regarding the relation between SDB and abdominal obesity assessed by WC in adolescents are reported [4,28]. For instance, Verhulst and colleagues [46], in a study assessing 104 youths with overweight or obesity, reported that SDB was independent of WC. In 2011, Canapari and colleagues [47] however showed that visceral adiposity, as measured by magnetic resonance imaging (MRI) at L4, was a significant predictor of the SDB severity in adolescents with obesity independently of BMI. Our results seem to be in line with those of Canapari et al. [47], noting however that simple WC assessment does not make it possible to distinguish between visceral and subcutaneous abdominal fat mass. On the other hand, the same authors [47] reported that AHI was associated with insulin resistance.

In the current study, we reported higher levels of insulin and greater  $\text{HOMA}_{\text{IR}}$  for similar glucose levels, along with greater SBP, and a trend for lower concentrations of HDL-C in the group of adolescents with  $\text{CMR}^+$ , compared to adolescents with  $\text{CMR}^-$ . These three parameters of

cardiometabolic health seem to be the first affected by SDB in this population.

Indeed, the association between insulin resistance, which is characterized by elevated levels of insulin and high HOMA<sub>IR</sub>, and SDB, is well documented in the literature [20,47] and may be explained through numerous pathways. Among others, sympathetic overactivity induced by intermittent hypoxia and sleep fragmentation leads to the release of catecholamines which, in turn, decrease the peripheral absorption of glucose by insulin and increase insulin resistance [48]. Also, gluconeogenesis, induced by sympathetic overactivity would contribute to high fasting glycemia, promoting type 2 diabetes [49]. Moreover, intermittent hypoxia may attenuate the glucose-induced secretion from pancreatic  $\beta$ -cells through the downregulation of the CD38 gene that is implicated in insulin release [50]. In 2012, Lesser and colleagues [20] reported that sleep fragmentation and intermittent hypoxia were associated with decreased insulin sensitivity in a population of obese adolescent males. As expected, in our study, we observed substantial sleep fragmentation and intermittent hypoxia in adolescents with CMR+ compared to their counterparts with CMR-, and these alterations might have promoted the observed insulin resistance.

Moreover, higher SBP was observed in adolescents with CMR+ while no difference in DBP was found. Similar results have recently been reported by Horne and colleagues [51] in a population of adolescents with SDB compared to their counterparts without SDB and to normal-weight adolescents with SDB. In their study, Horne et al. reported that obese youth with SDB exhibited impaired autonomic control in addition to elevated BP. As for insulin resistance, high SBP may be explained by recurrent nocturnal sympathetic overactivity. Additionally, intermittent hypoxia may lead to over-reactivity of peripheral chemoreceptors, leading to diurnal hypertension [11,52].

Although we did not report any difference in TG and LDL-C concentrations between our two groups, we found a trend towards lower HDL-C concentrations in the CMR+ group, as already reported in similar groups of subjects [21,53]. HDL-C has anti-atherogenic and antioxidant properties [54] which might be disturbed by SDB. Tan and colleagues reported in a controlled study focusing on adults with SDB that, despite having similar concentrations of TG, LDL-C and HDL-C to controls, subjects with SDB had a greater degree of HDL-C dysfunction [55]. In fact, HDL-C was dysfunctional in preventing the formation and inactivation of oxidized lipids. Interestingly, the authors [55] outlined that HDL-C dysfunction was strongly associated with markers of oxidative stress, itself induced by intermittent hypoxia [56]. Additionally, Li and colleagues, in an animal study assessing the effects of moderate and severe chronic intermittent hypoxia on lipid metabolism, reported that even mild to moderate SDB might increase lipid peroxidation, a consequence of oxidative stress, promoting atherosclerosis [57].

Insulin resistance, elevated BP and low HDL-C concentrations are among the criteria for MetS. The association

between MetS and SDB in adolescents with obesity remains controversial [16,58–60]. There are at least probable explanations for this: firstly, discrepancies regarding the retained parameters, and their thresholds, for MetS definition and secondly, discrepancies regarding the retained cut-off for SDB diagnosis, making it difficult to compare results between studies. In 2015, Erdim and colleagues [59] investigated this relationship and failed to observe any difference in MetS prevalence between adolescents with and without SDB, the latter being diagnosed as AHI  $\geq 1$ . By contrast, Redline and colleagues [60] reported a prevalence of MetS of 59% in adolescents with SDB, using a cut-off of AHI  $\geq 5$ , while it reached 16% in adolescents without SDB. In the present study, we proposed to assess the relationship between the CMR severity and the AHI, in order to identify a threshold of AHI from which we observe an increase in the severity of the CMR. Following this method, we found that cardiometabolic health was affected from AHI = 2 and we reported an alarming prevalence of MetS in adolescents with CMR+ (90.9%) as compared with participants with CMR- (69.4%). The high rates of MetS reported in our overall population (78%), compared to the previously cited studies, might be explained by the severity of obesity of our population.

In light of these results, the identification of a threshold of AHI corresponding to the cardiometabolic alterations in adolescents with obesity seems of major importance since it highlights the need for the early management of both SDB and obesity in this population.

This study has some limitations that deserve to be underlined. First, body composition was assessed using three different methods, and this potentially introduced bias in comparing participants. Despite the fact that both multi-frequency bioelectrical impedance analysis and air plethysmography have shown good agreement with DXA for body composition assessment in children and adolescents [31–34], it would have been preferable to use a single method, ideally DXA. This was unfortunately not possible due to the availability of different facilities between sites. Obviously, the use of MRI would have been relevant in order to assess visceral fat mass in our population. Second, it would have been relevant to propose a MetScore including a measure of central obesity, since this parameter has been found to be associated with SDB. While the measurement of WC was part of our clinical evaluation, this remains a multi-center study, and different experimentators assessed WC, increasing the potential inter-experimentator variability of its measure, which explains why we did not prefer to include WC in the calculation of the MetScore.

Third, despite insulin, glucose and lipid profiles were measured following the same methodology, different kits were used among the sites, and the analyses were performed at different time and by different experimentators. As such, we cannot ignore the inter-assay variability, which must be taken into account when interpreting the present findings.

Fourth, the present study exclusively included participants with obesity, and so, at risk for metabolic abnormalities. As such, the present findings cannot be generalized to populations that include normal-weight individuals.

Finally, two out of three centers proposed an adaptation night before the recording used for analysis. Nevertheless, as we did not discuss sleep stages in the present study and since respiratory events were presented in the form of indices, the lack of an adaptation night does not reduce the significance of our results. Finally, the measurement of carbon dioxide concentrations by capnometry during the night would have been interesting for the assessment of the obesity hypoventilation syndrome, as often found in individuals with obesity, but it was not possible for practical reasons.

In conclusion, this study is, to the best of our knowledge, the first to propose a threshold of SDB from which affected CMR is found. Multivariable analyses adjusted for BMI, sex and age enabled us to identify a threshold of AHI = 2 above which we observed a strong and significant association between CMR and AHI. Secondary, we were able to compare the clinical and cardiometabolic parameters of participants identified with CMR+ and CMR-.

According to this classification, we reported that adolescents with CMR+ and AHI  $\geq 2$ , presented substantial insulin resistance and high SBP, certainly mediated through sleep fragmentation, intermittent hypoxia and sympathetic overactivity. An alarming prevalence of MetS was found in our overall population (78%), and more specifically, in the participants identified to have AHI  $\geq 2$  (90.9%), emphasizing the additive deleterious effects of SDB on cardiometabolic health in adolescents with obesity.

In the current context of the continued increase in pediatric obesity worldwide, the identification of a threshold of AHI  $\geq 2$  corresponding to the cardiometabolic alterations in adolescents with obesity seems of major importance since it highlights the need for the early diagnosis and management of SDB, even when considered as mild, and of obesity in adolescents, in order to prevent cardiometabolic diseases. The results of this study provide new insights, and further studies in larger samples of participants are warranted to better explore the relationships between CMR and SDB in adolescents with severe obesity.

## Funding

The study was supported by a grant from “Le Don Du Souffle” to Johanna Roche and by The FAPESP (2008/53069-0, 2006/00684-3, 2011/50356-0, 2011/50414-0, 2013/04136-4 and CEPID/Sleep #9814303-3 S T), CAPES (AUX-PE-PNPD 2566/2011), AFIP, CNPq, CAPES, CENESP, UNIFESP-EPM, CENSA, and CEPE to the center of Sao Paulo, Brazil.

## Acknowledgements

The authors are grateful to the Sleep Medicine Center “Ellipse” for technical support, Dr Karine Spiegel and Dr

Karine Scheuermaier for scientific output, Fanny Capellier for sleep scoring and technical advices and Fiona Ecartot for editorial assistance. The authors are grateful to Dr Frédéric Perret, the staff of “Tzanou”, La Beline” and “The Interdisciplinary Obesity Program” of São Paulo for technical assistance. The authors would like to address particular words of thanks to the study participants and their parents.

## References

- [1] Han JC, Lawlor DA, Kimm SY. Childhood obesity. *The Lancet* 2010; 375:1737–48. [https://doi.org/10.1016/S0140-6736\(10\)60171-7](https://doi.org/10.1016/S0140-6736(10)60171-7).
- [2] Roche J, Isacco L, Perret F, et al. Beneficial effects of a lifestyle intervention program on C-reactive protein: impact of cardiorespiratory fitness in obese adolescents with sleep disturbances. *Am J Physiol Regul Integr Comp Physiol* 2019;316:R376–86. <https://doi.org/10.1152/ajpregu.00309.2018>.
- [3] Kalra M, Inge T, Garcia V, et al. Obstructive sleep apnea in extremely overweight adolescents undergoing bariatric surgery. *Obes Res* 2005;13:1175–9. <https://doi.org/10.1038/oby.2005.139>.
- [4] Roche J, Gillet V, Perret F, Mougou F. Obstructive sleep apnea and sleep architecture in adolescents with severe obesity: effects of a 9-month lifestyle modification program based on regular exercise and a balanced diet. *J Clin Sleep Med* 2018;14:967–76.
- [5] Brunetti L, Rana S, Lospalluti ML, et al. Prevalence of obstructive sleep apnea syndrome in a cohort of 1,207 children of southern Italy. *Chest* 2001;120:1930–5.
- [6] Unnikrishnan D, Jun J, Polotsky V. Inflammation in sleep apnea: an update. *Rev Endocr Metab Disord* 2015;16:25–34. <https://doi.org/10.1007/s11154-014-9304-x>.
- [7] DeBoer MD. Obesity, systemic inflammation, and increased risk for cardiovascular disease and diabetes among adolescents: a need for screening tools to target interventions. *Nutrition* 2013;29:379–86. <https://doi.org/10.1016/j.nut.2012.07.003>.
- [8] Kheirandish-Gozal L, Philby MF, Qiao Z, et al. Endothelial dysfunction in children with obstructive sleep apnea is associated with elevated lipoprotein-associated phospholipase A2 plasma activity levels. *J Am Heart Assoc* 2017;6. <https://doi.org/10.1161/JAHA.116.004923>.
- [9] Kimoff RJ. Sleep fragmentation in obstructive sleep apnea. *Sleep* 1996;19:S61–6.
- [10] Chiang AA. Obstructive sleep apnea and chronic intermittent hypoxia: a review. *Chin J Physiol* 2006;49:234–43.
- [11] Chouchou F, Pichot V, Pépin JL, et al. Sympathetic overactivity due to sleep fragmentation is associated with elevated diurnal systolic blood pressure in healthy elderly subjects: the PROOF-SYNAPSE study. *Eur Heart J* 2013;34:2122–31. <https://doi.org/10.1093/eurheartj/ehz208.2131a>.
- [12] Lavie L. Intermittent hypoxia: the culprit of oxidative stress, vascular inflammation and dyslipidemia in obstructive sleep apnea. *Expert Rev Respir Med* 2008;2:75–84. <https://doi.org/10.1586/17476348.2.1.75>.
- [13] Drager LF, Togeiro SM, Polotsky VY, Lorenzi-Filho G. Obstructive sleep apnea: a cardiometabolic risk in obesity and the metabolic syndrome. *J Am Coll Cardiol* 2013;62:569–76. <https://doi.org/10.1016/j.jacc.2013.05.045>.
- [14] Enriori PJ, Evans AE, Sinnayah P, Cowley MA. Leptin resistance and obesity. *Obesity* 2006;14(Suppl 5):254S–8S. <https://doi.org/10.1038/oby.2006.319>.
- [15] Klop B, Elte JWF, Castro Cabezas M. Dyslipidemia in obesity: mechanisms and potential targets. *Nutrients* 2013;5:1218–40. <https://doi.org/10.3390/nu5041218>.
- [16] Watson SE, Li Z, Tu W, et al. Obstructive sleep apnoea in obese adolescents and cardiometabolic risk markers. *Pediatr Obes* 2014;9:471–7. <https://doi.org/10.1111/j.2047-6310.2013.00198.x>.
- [17] Bhushan B, Ayub B, Loghmanee DA, Billings KR. Metabolic alterations in adolescents with obstructive sleep apnea. *Int J Pediatr Otorhinolaryngol* 2015;79:2368–73. <https://doi.org/10.1016/j.ijporl.2015.10.046>.

- [18] Hannon TS, Lee S, Chakravorty S, et al. Sleep-disordered breathing in obese adolescents is associated with visceral adiposity and markers of insulin resistance. *Int J Pediatr Obes* 2011;6:157–60. <https://doi.org/10.3109/17477166.2010.482156>.
- [19] Tauman R, O'Brien LM, Ivanenko A, Gozal D. Obesity rather than severity of sleep-disordered breathing as the major determinant of insulin resistance and altered lipidemia in snoring children. *Pediatrics* 2005;116:e66–73. <https://doi.org/10.1542/peds.2004-2527>.
- [20] Lesser DJ, Bhatia R, Tran WH, et al. Sleep fragmentation and intermittent hypoxemia are associated with decreased insulin sensitivity in obese adolescent Latino males. *Pediatr Res* 2012;72:293–8. <https://doi.org/10.1038/pr.2012.73>.
- [21] Patinkin ZW, Feinn R, Santos M. Metabolic consequences of obstructive sleep apnea in adolescents with obesity: a systematic literature review and meta-analysis. *Child Obes* 2017;13:102–10. <https://doi.org/10.1089/chi.2016.0248>.
- [22] Weiss R, Dziura J, Burgert TS, et al. Obesity and the metabolic syndrome in children and adolescents. *N Engl J Med* 2004;350:2362–74. <https://doi.org/10.1056/NEJMoa031049>.
- [23] Qu X-X, Esangbedo IC, Zhang X-J, et al. Obstructive sleep apnea syndrome is associated with metabolic syndrome among adolescents and youth in Beijing: data from Beijing child and adolescent metabolic syndrome study. *Chin Med J* 2015;128:2278–83. <https://doi.org/10.4103/0366-6999.163394>.
- [24] Franks PW, Ekelund U, Brage S, et al. Does the association of habitual physical activity with the metabolic syndrome differ by level of cardiorespiratory fitness? *Diabetes Care* 2004;27:1187–93.
- [25] Brage S, Wedderkopp N, Ekelund U, et al. Features of the metabolic syndrome are associated with objectively measured physical activity and fitness in Danish children the European youth heart study (EYHS). *Diabetes Care* 2004;27:2141–8. <https://doi.org/10.2337/diacare.27.9.2141>.
- [26] Thivel D, Malina RM, Isacco L, et al. Metabolic syndrome in obese children and adolescents: dichotomous or continuous? *Metab Syndrom Relat Disord* 2009;7:549–55. <https://doi.org/10.1089/met.2008.0085>.
- [27] Chen AK, Roberts CK, Barnard RJ. Effect of a short-term diet and exercise intervention on metabolic syndrome in overweight children. *Metab Clin Exp* 2006;55:871–8. <https://doi.org/10.1016/j.metabol.2006.03.001>.
- [28] Isacco L, Roche J, Quinart S, et al. Cardiometabolic risk is associated with the severity of sleep-disordered breathing in children with obesity. *Physiol Behav* 2017;170:62–7. <https://doi.org/10.1016/j.physbeh.2016.12.018>.
- [29] Cole TJ, Lobstein T. Extended international (IOTF) body mass index cut-offs for thinness, overweight and obesity. *Pediatr Obes* 2012;7:284–94. <https://doi.org/10.1111/j.2047-6310.2012.00064.x>.
- [30] Flegal KM, Cole TJ. Construction of LMS parameters for the centers for disease control and prevention 2000 growth charts. *Natl Health Stat Rep* 2013;1–3.
- [31] Lockner DW, Heyward VH, Baumgartner RN, Jenkins KA. Comparison of air-displacement plethysmography, hydrodensitometry, and dual X-ray absorptiometry for assessing body composition of children 10 to 18 years of age. *Ann N Y Acad Sci* 2000;904:72–8.
- [32] Thomson R, Brinkworth GD, Buckley JD, et al. Good agreement between bioelectrical impedance and dual-energy X-ray absorptiometry for estimating changes in body composition during weight loss in overweight young women. *Clin Nutr* 2007;26:771–7. <https://doi.org/10.1016/j.clnu.2007.08.003>.
- [33] Yu O-K, Rhee Y-K, Park T-S, Cha Y-S. Comparisons of obesity assessments in over-weight elementary students using anthropometry, BIA, CT and DEXA. *Nutr Res Pract* 2010;4:128–35. <https://doi.org/10.4162/nrp.2010.4.2.128>.
- [34] Seo Y-G, Kim JH, Kim Y, et al. Validation of body composition using bioelectrical impedance analysis in children according to the degree of obesity. *Scand J Med Sci Sport* 2018;28:2207–15. <https://doi.org/10.1111/sms.13248>.
- [35] JASPER HH. The ten twenty electrode system of the international federation. *Electroencephalogr Clin Neurophysiol* 1958;10:371–5.
- [36] Berry RB, Gamaldo CE, Harding SM, et al. AASM scoring manual version 2.2 updates: new chapters for scoring infant sleep staging and home sleep apnea testing. *J Clin Sleep Med* 2015;11:1253–4. <https://doi.org/10.5664/jcsm.5176>.
- [37] Berry RB, Budhiraja R, Gottlieb DJ, et al. Rules for scoring respiratory events in sleep: update of the 2007 AASM manual for the scoring of sleep and associated events. Deliberations of the sleep apnea definitions Task Force of the American Academy of sleep medicine. *J Clin Sleep Med* 2012;8:597–619. <https://doi.org/10.5664/jcsm.2172>.
- [38] Matthews DR, Hosker JP, Rudenski AS, et al. Homeostasis model assessment: insulin resistance and beta-cell function from fasting plasma glucose and insulin concentrations in man. *Diabetologia* 1985;28:412–9.
- [39] Mellerio H, Alberti C, Druet C, et al. Novel modeling of reference values of cardiovascular risk factors in children aged 7 to 20 years. *Pediatrics* 2012;129:e1020–9. <https://doi.org/10.1542/peds.2011-0449>.
- [40] Girardet J-P. Management of children with hypercholesterolemia. *Arch Pediatr* 2006;13:104–10. <https://doi.org/10.1016/j.arcped.2005.09.020>.
- [41] National High Blood Pressure Education Program Working Group on High Blood Pressure in Children and Adolescents. The fourth report on the diagnosis, evaluation, and treatment of high blood pressure in children and adolescents. *Pediatrics* 2004;114:555–76.
- [42] Allard P, Delvin EE, Paradis G, et al. Distribution of fasting plasma insulin, free fatty acids, and glucose concentrations and of homeostasis model assessment of insulin resistance in a representative sample of Quebec children and adolescents. *Clin Chem* 2003;49:644–9.
- [43] Eisenmann JC. On the use of a continuous metabolic syndrome score in pediatric research. *Cardiovasc Diabetol* 2008;7:17. <https://doi.org/10.1186/1475-2840-7-17>.
- [44] Grundy SM. Does a diagnosis of metabolic syndrome have value in clinical practice? *Am J Clin Nutr* 2006;83:1248–51. <https://doi.org/10.1093/ajcn/83.6.1248>.
- [45] Verhulst SL, Franckx H, Van Gaal L, et al. The effect of weight loss on sleep-disordered breathing in obese teenagers. *Obesity* 2009;17:1178–83. <https://doi.org/10.1038/oby.2008.673>.
- [46] Verhulst SL, Schrauwen N, Haentjens D, et al. Sleep-disordered breathing and the metabolic syndrome in overweight and obese children and adolescents. *J Pediatr* 2007;150:608–12. <https://doi.org/10.1016/j.jpeds.2007.01.051>.
- [47] Canapari CA, Hoppin AG, Kinane TB, et al. Relationship between sleep apnea, fat distribution, and insulin resistance in obese children. *J Clin Sleep Med* 2011;7:268–73. <https://doi.org/10.5664/JCSM.1068>.
- [48] Deibert DC, DeFronzo RA. Epinephrine-induced insulin resistance in man. *J Clin Invest* 1980;65:717–21. <https://doi.org/10.1172/JCI109718>.
- [49] Polak J, Shimoda LA, Drager LF, et al. Intermittent hypoxia impairs glucose homeostasis in C57BL/6J mice: partial improvement with cessation of the exposure. *Sleep* 2013;36:1483–90. <https://doi.org/10.5665/sleep.3040>. 1490A-1490B.
- [50] Ota H, Tamaki S, Itaya-Hironaka A, et al. Attenuation of glucose-induced insulin secretion by intermittent hypoxia via down-regulation of CD38. *Life Sci* 2012;90:206–11. <https://doi.org/10.1016/j.lfs.2011.11.011>.
- [51] Horne RSC, Shandler G, Tamanyan K, et al. The impact of sleep disordered breathing on cardiovascular health in overweight children. *Sleep Med* 2018;41:58–68. <https://doi.org/10.1016/j.sleep.2017.09.012>.
- [52] Tamisier R, Pépin JL, Rémy J, et al. 14 nights of intermittent hypoxia elevate daytime blood pressure and sympathetic activity in healthy humans. *Eur Respir J* 2011;37:119–28. <https://doi.org/10.1183/09031936.00204209>.
- [53] Nandalike K, Agarwal C, Strauss T, et al. Sleep and cardiometabolic function in obese adolescent girls with polycystic ovary syndrome. *Sleep Med* 2012;13:1307–12. <https://doi.org/10.1016/j.sleep.2012.07.002>.
- [54] Soran H, Schofield JD, Durrington PN. Antioxidant properties of HDL. *Front Pharmacol* 2015;6. <https://doi.org/10.3389/fphar.2015.00222>.
- [55] Tan KCB, Chow W-S, Lam JCM, et al. HDL dysfunction in obstructive sleep apnea. *Atherosclerosis* 2006;184:377–82. <https://doi.org/10.1016/j.atherosclerosis.2005.04.024>.

- [56] Lavie L. Oxidative stress in obstructive sleep apnea and intermittent hypoxia – revisited – the bad ugly and good: implications to the heart and brain. *Sleep Med Rev* 2015;20:27–45. <https://doi.org/10.1016/j.smr.2014.07.003>.
- [57] Li J, Savransky V, Nanayakkara A, et al. Hyperlipidemia and lipid peroxidation are dependent on the severity of chronic intermittent hypoxia. *J Appl Physiol* 2007;102:557–63. <https://doi.org/10.1152/jappphysiol.01081.2006>.
- [58] Corgosinho FC, Ackel-D'Elia C, Tufik S, et al. Beneficial effects of a multifaceted 1-year lifestyle intervention on metabolic abnormalities in obese adolescents with and without sleep-disordered breathing. *Metab Syndrome Relat Disord* 2015;13:110–8. <https://doi.org/10.1089/met.2014.0110>.
- [59] Erdim I, Akcay T, Yilmazer R, et al. Is metabolic syndrome associated with obstructive sleep apnea in obese adolescents? *J Clin Sleep Med* 2015;11:1371–6. <https://doi.org/10.5664/jcsm.5266>.
- [60] Redline S, Storfer-Isser A, Rosen CL, et al. Association between metabolic syndrome and sleep-disordered breathing in adolescents. *Am J Respir Crit Care Med* 2007;176:401–8. <https://doi.org/10.1164/rccm.200703-375OC>.



**Post-moderate-intensity exercise energy replacement does not  
reduce subsequent appetite and energy intake in adolescents  
with obesity.**

Thivel, D., Roche, J., Miguet, M., **Fillon, A.**, Khammassi, M., Beaulieu, K., Finlayson, G., Pereira, B., Miyashita, M., Thackray, A. E., Masurier, J., Duclos, M., & Boirie, Y.



*Accepted in British Journal of Nutrition, Volume 123, 2020*

## Post- moderate intensity exercise energy replacement does not reduce subsequent appetite and energy intake in adolescents with obesity

Thivel D<sup>1,2,4</sup>, Roche J<sup>1</sup>, Miguet M, Fillon A<sup>1,3</sup>, Khammassi M<sup>1</sup>, Beaulieu K<sup>4</sup>, Finlayson G<sup>4</sup>, Pereira B<sup>5</sup>, Miyashita M<sup>6</sup>, Thackray AE<sup>7</sup>, Masurier J<sup>3</sup>, Duclos M<sup>2,8,9,10</sup>, Boirie Y.<sup>2,8,10,11</sup>

<sup>1</sup>Clermont Auvergne University, EA 3533, Laboratory of the Metabolic Adaptations to Exercise under Physiological and Pathological Conditions (AME2P), Clermont-Ferrand, France.

<sup>2</sup>CRNH-Auvergne, Clermont-Ferrand, France.

<sup>3</sup>UGECAM Nutrition Obesity Ambulatory Hospital, Clermont-Ferrand, France.

<sup>4</sup>School of Psychology, Faculty of Medicine and Health, University of Leeds, Leeds, LS2 9JT, UK

<sup>5</sup>Clermont-Ferrand University hospital, Biostatistics unit (DRCI), Clermont-Ferrand, France.

<sup>6</sup>Faculty of Sport Sciences, Waseda University, Saitama 169-8050, Japan.

<sup>7</sup>National Centre for Sport and Exercise Medicine, School of Sport, Exercise and Health Sciences, Loughborough University, Leicestershire LE11 3TU, UK.

<sup>8</sup>INRA, UMR 1019, Clermont-Ferrand, France.

<sup>9</sup>Department of Sport Medicine and Functional Explorations, Clermont-Ferrand University Hospital, G. Montpied Hospital, Clermont-Ferrand, France.

<sup>10</sup>University Clermont Auvergne, UFR Medicine, Clermont-Ferrand, France.

<sup>11</sup>Department of Human Nutrition, Clermont-Ferrand University Hospital, G. Montpied Hospital, Clermont-Ferrand, France

**Running head:** Post-exercise energy replacement and appetite

### Corresponding Author:

Thivel David (PhD, HDR)

Clermont University, EA 3533, Laboratory of the Metabolic Adaptations to Exercise under Physiological and Pathological Conditions (AME2P), BP 80026, F-63171 Aubière cedex, France

[David.thivel@uca.fr](mailto:David.thivel@uca.fr)

Phone and fax/ 0033 4 73 40 76 79

**Conflict of Interest:** No conflict of interest.

**Funding:** This study was funded by the French University Institute (IUF) and the UGECAM Nutrition Obesity Clinic.

**Key words.** Exercise; Energy Replacement; Appetite; Adolescents; Obesity

This peer-reviewed article has been accepted for publication but not yet copyedited or typeset, and so may be subject to change during the production process. The article is considered published and may be cited using its DOI

10.1017/S0007114519003106

The British Journal of Nutrition is published by Cambridge University Press on behalf of The Nutrition Society

**Abstract**

Exercise modifies energy intake in adolescents with obesity, but whether this is mediated by the exercise-induced energy deficit remains unknown. The present study examined the effect of exercise with and without dietary replacement of the exercise energy expenditure on appetite, energy intake and food reward in adolescents with obesity. Fourteen 12-15 years adolescents with obesity (8girls; Tanner3-4; BMI  $34.8\pm 5.7\text{kg/m}^2$ ; BMI-z score  $2.3\pm 0.4$ ) randomly completed 3 experimental conditions: i) rest control (CON); ii) 30-min cycling (EX); iii) 30-min cycling with dietary energy replacement (EX+R). *Ad libitum* energy intake (EI) was assessed at lunch and dinner, and food reward (Leeds Food Preference Questionnaire) before and after lunch. Appetite was assessed at regular intervals. Lunch, evening and total EI (excluding the post-exercise snack in EX-R) were similar across conditions. Lunch and total EI including the post-exercise snack in EX+R were higher in EX-R than CON and EX; EX and CON were similar. Total relative EI was lower in EX ( $1502\pm 488$  kcal) compared with CON ( $1713\pm 530$ ;  $p<0.05$ ) and higher in EX+R ( $1849\pm 486$  kcal) compared with CON ( $p<0.001$ ). Appetite and satiety quotients did not differ across conditions ( $p\geq 0.10$ ). Pre-meal explicit liking for fat was lower in EX compared to CON and EX+R ( $p=0.05$ ). There was time by condition interaction between EX and CON for explicit wanting and liking for fat ( $p=0.01$ ). Despite similar appetite and energy intake, adolescents with obesity do not adapt their post-exercise food intake to account for immediate dietary replacement of the exercise-induced energy deficit, favoring a short-term positive energy balance.

## Introduction

The prevalence of pediatric overweight and obesity represents a continuing global public health challenge <sup>(1)</sup> and arises as a consequence of a chronic surplus of energy intake above energy expenditure <sup>(2)</sup>. Evidence supports a role for exercise in the control of body weight due to its ability to increase energy expenditure and induce a negative energy deficit in the absence of compensatory changes in energy intake <sup>(3)</sup>. The interplay between exercise, energy intake and appetite control in young people has attracted increasing scientific attention given the direct implications for energy homeostasis and body weight control.

It is well established that adults respond to acute moderate-to-high intensity exercise with a transient suppression in appetite and do not exhibit compensatory increases in appetite or *ad libitum* energy intake on the day of exercise <sup>(4;5)</sup>. Single bouts of moderate-to-high intensity exercise have been shown to reduce *ad libitum* energy intake on the same day in children and adolescents with overweight or obesity but this effect has not been observed in healthy weight young people <sup>(6; 7; 8)</sup>. A recent review suggests that energy intake responses to acute exercise in young people may be modulated by physiological, neurocognitive and hedonic pathways <sup>(9)</sup>. Furthermore, it has been demonstrated recently that the exercise-induced reduction in *ad libitum* energy intake observed in adolescents with obesity appears to coincide with a reduction in food reward, evidenced by a reduction in the preference for high fat and sweet foods after exercise <sup>(10)</sup>. However, research examining hedonic responses to acute exercise stimuli in young people is sparse and further studies are required to enhance understanding of the interaction between exercise, appetite and energy intake in this population.

A handful of studies have examined the impact of energy intake manipulations in the immediate pre- or post-exercise periods on subsequent energy intake and appetite responses in young people. Specifically, it has been demonstrated that ingestion of a glucose solution immediately after 15 min of rest or moderate-to-vigorous intensity exercise reduced *ad libitum* energy intake independent of exercise in boys who were lean or overweight <sup>(11)</sup>. Similarly, a reduction in *ad libitum* energy intake

has also been observed after a glucose preload was ingested before 40 min of rest or exercise in normal weight boys and men, but the effect was augmented when combined with the exercise bout <sup>(12)</sup>. A recent study in adolescent boys and girls aged 12 to 14 years demonstrated that *ad libitum* energy intake was not altered in response to a mid-morning snack and an isoenergetic bout of cycling completed alone or in combination <sup>(13)</sup>. However, it is possible that the provision of a highly palatable pizza meal consumed in small peer groups may have influenced their *ad libitum* energy intake in the snack and exercise conditions <sup>(14)</sup>. The authors also reported that appetite was suppressed after snack intake but returned to control values before the *ad libitum* meal and were not influenced by exercise <sup>(13)</sup>. However, it is not known whether replacement of the exercise-induced energy deficit immediately after exercise alters subsequent appetite, energy intake and food reward responses in adolescents with obesity.

Therefore, the aim of this study was to compare the effects of acute exercise with and without immediate replacement of the exercise-induced energy deficit on *ad libitum* energy intake, appetite perceptions and food reward in adolescents with obesity. We formulate the hypothesis that the adolescents will not reduce their *ad libitum* energy intake in presence of an energy replacement snack after exercise, favoring then a higher overall energy balance.

## Methods

### *Population*

Fourteen adolescents with obesity (according to Cole et al <sup>(15)</sup>) aged 12 to 15 years (Tanner stage 3-4) were recruited through the local Pediatric Obesity Centre (Tza Nou, La Bourboule, France) to participate in this study (6 boys, 8 girls). This study was conducted in accordance with the Declaration of Helsinki, approved by the local ethics authorities (Human Ethical Committee: CPP ILE DE FRANCE III; authorization reference: 2018-A02160-55) and registered with ClinicalTrials.gov (trial identifier: NCT03742622). All participants and their parent or legal guardian provided written informed assent or consent, respectively, before the study commenced. Participants were not taking any medications that could interact with the study outcomes, were engaging in less than 2 h of moderate physical activity per week (according to the IPAQ short-form questionnaire)<sup>(16)</sup>, and did not exhibit high cognitive restraint (as assessed using the Child Three-Factor Eating Questionnaire (CTFEQr17))<sup>(17)</sup>.

### ***Preliminary measures***

After a preliminary medical screening visit with a clinical pediatrician to confirm eligibility, preliminary measurements were conducted to assess anthropometry and to determine peak oxygen uptake (peak  $\dot{V}O_2$ ). Height and body mass were determined using a standard wall-mounted stadiometer and digital scale (SECA, Les Mureaux, France), respectively. Body Mass Index (BMI) was calculated as body mass (kg) divided by height squared ( $m^2$ ), and BMI percentile was calculated using age- and sex-specific French reference curves<sup>(18)</sup>. Fat mass (FM) and fat-free mass (FFM) were assessed by dual-energy X-ray absorptiometry (DXA) (QDR4500A scanner, Hologic, Waltham, MA, USA).

### ***Peak oxygen uptake ( $\dot{V}O_2$ ) test***

Participants performed a peak  $\dot{V}O_2$  test on a traditional concentric cycle ergometer<sup>(19)</sup>. The initial power was set at 30 W for 3 minutes, and was increased in 15 W increments every minute until volitional exhaustion. Maximal criteria were: heart rate  $>90\%$  of the age-predicted maximum heart rate ( $210 - 0.65 \times \text{age}$ ), respiratory exchange ratio (RER)  $> 1.1$  and/or  $\dot{V}O_2$  plateau. Heart rate was monitored continuously using short-range telemetry (Polar V800, Polar Inc.) and 12-lead electrocardiography monitoring was conducted (Ultima Series<sup>TM</sup>, Saint Paul, MN). Oxygen consumption and carbon dioxide production were determined using an online breath-by-breath gas analysis system (BreezeSuite Software, Saint Paul, MN). Peak  $\dot{V}O_2$  was defined as the average of the last 30 s of exercise before exhaustion.

### ***Main trials***

Participants completed 3, 12 h trials (08:00am–08:00pm) in a random crossover design separated by one week: (1) rest control (CON); (2) exercise with energy deficit (EX); and (3) exercise with energy replacement (EX+R). Participants arrived at the laboratory at 08:00am on the morning of the trials after a 12 h overnight fast. The adolescents were requested not to engage in any moderate-to-vigorous physical activity during the two days that preceded each trial. Similarly, the adolescents were asked to avoid any food overconsumption and to record their intake on the day the preceded their first trial. They were asked to maintain a similar food consumption on the day before their two other trials.

During CON, participants were required to remain quiet and not to engage in any physical activity. During the exercise trials, participants cycled for 30 min (09:45am-10:15am) at 65% of their peak  $\dot{V}O_2$  and then rested in the laboratory. Heart rate was monitored continuously and the exercise-induced energy expenditure was estimated using data from the peak  $\dot{V}O_2$  test. Immediately after the exercise session in EX-R, participants consumed an individually calibrated snack composed of bread, nuts, fruits and chocolate within 20 minutes to replace the estimated exercise-induced energy deficit ( $177 \pm 39$  kcal, respecting recommendations for age<sup>(20)</sup>).

### ***Standardized and ad libitum meals***

At 08:00am, participants consumed a standardised breakfast respecting the nutritional recommendation for age and consisting of white bread, butter, marmalade, yoghurt or semi-skimmed

milk and fruit or fruit juice which provided 500 kcal. Participants were provided with an *ad libitum* buffet meal for lunch (12:00pm) and evening meal (07:00pm). Lunch consisted of beef steak, pasta (Lustucru, Grenoble Isère; France), mustard (Auchan brand, Croix, France), cheese (Camembert Auchan brand, Croix, France), yoghurt (plain yoghurt, Auchan Brand, Croix, France), compote (apple compote Andros, Biars-sur-Cère, France), fruits and bread (white bread), and the evening meal consisted of ham or turkey, beans, mashed potato, cheese (Camembert Auchan brand, Croix, France), yoghurt (plain yoghurt, Auchan Brand, Croix, France), compote (apple compote Andros, Biars-sur-Cère, France), fruit and bread (white bread). Food items were provided in excess of expected consumption and participants were instructed to eat until “comfortably satiated”. The adolescents made their choices and composed their trays individually. Their food selection was weighted by the investigators who served the adolescents. Importantly the adolescents were not aware that their plates were weighted and did not have any indication regarding the quantity of calories served. The weighted difference of food items was measured before and after the meal and intakes of energy and macronutrients were calculated using dietary analysis software (Bilnut v4.0 for Windows, La Fressinouze, France). Relative energy intake (REI) for the *ad libitum* lunch meal and total (*ad libitum* lunch and evening meals combined) were calculated as the energy intake *minus* the net energy expenditure of exercise.

### ***Subjective appetite ratings***

Appetite ratings were assessed throughout the day using visual analogue scales (150 millimeters scales) at baseline (fasted – 08:00 am), immediately after breakfast (08:30am), and then immediately before (09:45am) and after (10:15am) exercise, before (12:00pm) and after (01:00pm) lunch and before (07:00pm) and after (08:00pm) evening meal. Additional measurements were also obtained 30 and 60 min after lunch<sup>(21)</sup>. Specifically, the questions i) “how hungry do you feel?”, ii) “how full do you feel?”, iii) “would you like to eat something?”, and iv) “how much do you think you can eat?” provided an assessment of perceived hunger, fullness, drive to eat (DTE) and prospective food consumption (PFC), respectively. Total daily Area Under the Curves (AUC) for each appetite sensation were calculated as well as AUC for the 60 minutes post lunch. The satiety quotient (SQ) for hunger, fullness, PFC and DTE were calculated as follows<sup>(22)</sup>:

$$\text{Satiety quotient (mm/kcal)} = \frac{\text{pre-lunch appetite (mm)} - \text{mean 60 min post-lunch appetite (mm/h)}}{\text{energy content of lunch (kcal)}} \times 100$$

### ***Food liking and wanting***

The Leeds Food Preference Questionnaire (LFPQ; described in detail by Dalton and Finlayson<sup>(23)</sup>) provided a measure of food preference and food reward. Participants were presented with an array of pictures of individual food items common in the diet. Foods in the array were chosen by the local research team from a validated database to be either predominantly high (>50% energy) or low (<20% energy) in fat but similar in familiarity, protein content, palatability and suitable for the study population. The LFPQ has been deployed in a range of research studies<sup>(23)</sup> including a recent exercise and appetite trial in young French boys<sup>(10)</sup>. Explicit liking and explicit wanting were measured by participants using 100 mm visual analogue scales to rate the extent they like each food (“How pleasant would it be to taste this food now?”) and want each food (“How much do you want to eat this food now?”). The food images were presented individually, in a randomized order. Implicit wanting and relative food preference were assessed using a forced choice methodology in which the food images

were paired so that every image from each of the four food types was compared to every other type over 96 trials (food pairs). Participants were instructed to respond as quickly and accurately as they could to indicate the food they wanted to eat the most at that time (“Which food do you most want to eat now?”). To measure implicit wanting, reaction times for all responses were covertly recorded and used to compute mean response times for each food type after adjusting for frequency of selection. Responses on the LFPQ were used to compute mean scores for high fat, low fat, sweet or savoury food types (and different fat-taste combinations). Fat bias scores were calculated as the difference between the high-fat scores and the low-fat scores, with positive values indicating greater liking, wanting or choice for high-fat relative to low-fat foods and negative values indicating greater liking, wanting or choice for low-fat relative to high-fat foods. Sweet bias scores were calculated as the difference between the sweet and savoury scores, with positive values indicating greater liking or wanting for sweet relative to savoury foods and negative values indicating greater liking or wanting for savoury relative to sweet foods.

### ***Statistical analyses***

Statistical analyses were performed using Stata software, Version 13 (StataCorp, College Station, TX, US). The sample size estimation was determined according to (i) CONSORT 2010 statement, extension to randomized pilot and feasibility trials (Eldridge et al., 2016) and (ii) Cohen’s recommendations (Cohen, 1988) who has defined effect-size bounds as : small (ES: 0.2), medium (ES: 0.5) and large (ES: 0.8, “grossly perceptible and therefore large”). So, with 12 patients by condition, an effect-size around 1 can be highlighted for a two-sided type I error at 1.7% (correction due to multiple comparisons), a statistical power greater than 80% and an intra-class correlation coefficient at 0.5 to take into account between and within participant variability. Continuous data was expressed as mean  $\pm$  standard deviation (SD) or median [interquartile range] according to statistical distribution. The assumption of normality was assessed using the Shapiro-Wilk test. Random-effects models for repeated data were performed with condition and time included as fixed factors and including a random effect for each participant. A Sidak’s type I error correction was applied to perform multiple comparisons. As proposed by some statisticians <sup>(24; 25)</sup> a particular focus was also given to the magnitude of differences, in addition to inferential statistical tests expressed using p-values. The normality of residuals from these models was studied using the Shapiro-Wilk test. Although no gender difference was observed (certainly due to the relatively reduced sample size and then respective number of boys and girls), all statistical analyses were adjusted for gender.

### **Results**

Fourteen  $12.8 \pm 0.9$  years old adolescents with obesity participated in this study. Their mean body mass was  $95.3 \pm 16.1$  kg, with a BMI of  $34.8 \pm 5.7$  kg/m<sup>2</sup> (z-BMI  $2.3 \pm 0.4$ ), percentage of body fat mass of  $37.7 \pm 4.2$  % and FFM of  $57.4 \pm 8.2$  kg. The adolescents had a  $\dot{V}O_{2\text{peak}}$  of  $22.25 \pm 4.22$  ml/min/kg. Energy expenditure induced by exercise (total duration 30min) was higher compared to the 30-min resting energy expenditure ( $177 \pm 39$  kcal and  $56 \pm 6$  kcal, respectively;  $p < 0.001$ ).



### ***Absolute and relative energy intake***

Table 1 displays the absolute and relative energy intake excluding the energy content of the post-exercise snack in EX-R. Lunch, evening and total daily absolute *ad libitum* energy intakes were not different across the conditions (main effect of condition  $P = 0.09$ ).

Absolute lunch and total energy intake including the energy content of the post-exercise snack in EX-R were different across conditions (main effect of condition  $p=0.008$  and  $p=0.0013$ , respectively) (Figure 1A). Both lunch and total energy intake were higher in EX-R compared with CON and EX but no difference was seen between EX and CON (Figure 1A).

Lunch REI (including the post-exercise snack in EX-R; main effect of condition was higher in EX+R ( $1040 \pm 329$  kcal) compared with both CON ( $931 \pm 315$  kcal) and EX ( $826 \pm 279$  kcal) ( $p<0.001$ ). Lunch REI had a tendency to be lower in EX versus CON ( $p=0.08$ ). Total REI (including the post-exercise snack in EX-R; main effect of condition was lower in EX ( $1502 \pm 488$  kcal) compared with CON ( $1713 \pm 530$ ) ( $p<0.05$ ) and higher in EX+R ( $1849 \pm 486$  kcal) compared with CON ( $p<0.001$ ). A tendency was found for total REI to be lower in EX compared with CON ( $p=0.07$ ).

This Figure 2 illustrates the inter-individual variability of the lunch and total absolute and relative energy intake variations between the three experimental conditions (Figure 2).

### ***Macronutrient intake***

Absolute protein consumption at the evening meal was different across conditions (main effect of condition  $p=$ ), with intakes lower in EX ( $39.6 \pm 16.9$  g) compared with CON ( $58.6 \pm 25.8$  g,  $p=0.009$ ) and EX+R ( $51.1 \pm 16.8$  g,  $p=0.0253$ ). No differences were observed in absolute protein intake at lunch or overall, or in absolute carbohydrate and fat intake at lunch, evening meal or overall.

The percentage of energy ingested from protein and CHO was not different across conditions at lunch, evening meal or overall. At the evening meal, the percentage of energy ingested through fat was lower in CON ( $21.9 \pm 10.8$  %) compared with both EX ( $31.3 \pm 9.7$  %,  $p=0.043$ ) and EX+R ( $32.1 \pm 7.8$  %,  $p=0.023$ ). In total (lunch and evening meal combined), the percentage of energy ingested from fat was higher in EX+R ( $30.8 \pm 4.5$  %) compared with CON ( $26.8 \pm 5.6$  %,  $p=0.0363$ ), and was marginally higher in EX-R than EX ( $27.5 \pm 3.8$  %) ( $p=0.063$ ).

### ***Appetite ratings***

As detailed in Table 2, none of the fasting, pre-lunch or total AUC values for hunger, fullness, PFC and DTE were different across conditions (all main effects of condition  $p \geq 0.10$ ). The AUC 60 minutes post lunch and satiety quotients, as satiating indicators, did not differ across conditions for any of the appetite ratings (all main effects of condition  $P=0.11$ ).

### ***Food reward***

As detailed in Table 3, no condition (exercise versus control), time (pre versus post meal) or interaction (time x condition) effects were found for Choice Taste Bias, Implicit Wanting Taste and Fat Bias, and Explicit Liking Taste Bias. Choice Fat Bias did not show any condition or interaction effect. Explicit Wanting Fat Bias was significantly reduced in response to the test meal in CON only ( $p=0.001$ ) and a time x condition interaction was observed between CON and EX ( $p=0.017$ ). Explicit Wanting Taste Bias only showed a significant reduction in response to the *ad libitum* test meal in CON ( $p=0.03$ ). Pre-meal Explicit Liking Fat Bias showed a significant condition effect ( $p=0.05$ ) with EX being significantly lower than both CON ( $p=0.016$ ) and EX+R ( $p=0.01$ ). Explicit Liking Fat Bias also showed a condition x time interaction between CON and EX ( $p=0.026$ ).

### **Discussion**

In accordance with our initial hypothesis, the primary finding of the present study was that 30-minutes of moderate-intensity cycling did not alter subsequent *ad libitum* energy intake or appetite in adolescents with obesity, irrespective of whether the exercise-induced energy deficit was replaced immediately after exercise. The absence of adjustments in post-exercise energy intake suggests that maintenance of the exercise-induced energy deficit may be required to prevent the promotion of a positive energy balance on the same day of exercise.

Absolute energy intake at the *ad libitum* lunch and evening meals were similar between conditions resulting in higher energy intake in EX+R when accounting for the energy content of the post-exercise snack. This resulted in a lower REI when the energy deficit was maintained after exercise, but REI was higher in EX+R than CON indicative of a positive energy balance on the day of exercise when the exercise-induced energy deficit was replaced. The lack of modification in post-exercise absolute energy intake might be explained by the moderate intensity of the exercise bout. Indeed, while our results are in line with some studies using similar exercise intensities<sup>(26; 27)</sup>, other studies conducted in similar populations reported reduced energy intake after single bouts of vigorous-intensity exercise (>70% of maximal capacity)<sup>(10; 28; 29)</sup>. This anorexigenic effect of vigorous-intensity exercise in adolescents with obesity has been confirmed in a recent systematic review and meta-analysis<sup>(8)</sup>. It is

also possible that the absence of energy intake modification after exercise with an energy deficit in the present study may reflect the delay between the exercise bout and the *ad libitum* lunch meal. Previous studies have typically provided an *ad libitum* test meal approximately 30 minutes after exercise cessation <sup>(26; 29)</sup> whereas the *ad libitum* lunch meal was provided 2 h after exercise in the current investigation. In this regard, Albert et al. reported lower food intake after moderate-intensity exercise completed 30 minutes, but not 130 minutes, before a test meal in healthy weight adolescent boys <sup>(30)</sup>. Our study was not designed to investigate the importance of energy intake timing in the post-exercise period; therefore, further research is required before recommendations can be made.

The effect of immediate replacement of the exercise-evoked energy expenditure on subsequent energy intake responses in young people is restricted to one previous investigation in 12 to 14 year-old adolescents <sup>(13)</sup>. In accord with our findings, Varley-Campbell et al. did not find any differences in energy intake after acute exercise regardless of whether the exercise energy expenditure was replaced, resulting in a lower relative energy intake when the energy deficit was maintained <sup>(13)</sup>. Importantly, the authors employed a pizza buffet meal, which may have reduced the sensitivity to detect differences in energy intake due to the high palatability of the meal <sup>(14)</sup>. Consequently, the present work adopted a balanced buffet meal that was designed to provide familiar foods without promoting over-, under- or occasional/opportunistic consumption (as previously validated <sup>(31)</sup>). Furthermore, the buffet meals adopted in this study allowed the exploration of specific macronutrient intakes. While we did not find any modification in the absolute consumption of fats, proteins and carbohydrates at lunch, absolute protein intake was lower at the evening meal after EX but not after EX+R. Interestingly, the total daily percentage of energy derived from fat was higher in EX+R compared to CON and EX. The reason underpinning these findings is unclear, with previous evidence examining the effect of exercise on macronutrient intake in young people yielded largely conflicting findings <sup>(8)</sup>. Nevertheless, the findings of the present study contribute to the extant literature examining energy and macronutrient intake responses to acute exercise in adolescents.

It has been shown previously in healthy weight boys and girls that ingestion of a mid-morning snack, both before acute exercise and an equivalent period or rest, suppressed hunger and PFC and elevated

fullness compared to exercise and rest conditions with no snack provision<sup>(13)</sup>. The present study in adolescents with obesity observed no differences in any of the fasting, pre-meal or total daily appetite sensations after exercise inducing an energy deficit, supporting previous studies in adolescents with obesity<sup>(26; 32)</sup>. Our findings extend the current evidence base by demonstrating that subjective appetite is not altered in adolescents with obesity when the energy expenditure induced by exercise is replaced, contrasting the previously discussed findings in healthy weight boys and girls<sup>(13)</sup>. Clearly, the effect of acute exercise on appetite ratings and the interplay between subjective appetite sensations and energy intake requires further attention in this population, particularly given the largely contradictory results evident in the present literature (for review see<sup>(33)</sup>).

The Leeds Food Preference Questionnaire was adopted in this study to assess the adolescents' food reward immediately before and in response to an *ad libitum* lunch meal. Evidence examining the effect of acute exercise on food reward are relatively sparse<sup>(34; 35; 36)</sup>, especially in children and adolescents. Nevertheless, it has been reported recently that the preference for high-fat vs. low-fat foods was reduced in response to single bouts of aerobic and resistance exercise in healthy adult women using the LFPQ<sup>(36)</sup>. Furthermore, the hedonic "liking" of high-fat foods was lower after resistance, but not after aerobic exercise, suggesting a potential role for exercise modality<sup>(36)</sup>. In adolescents with obesity, Miguet and colleagues showed recently that 16-minutes of high-intensity interval cycling decreased the relative preference for both fat and sweet taste, and implicit wanting for high-fat foods (using the LFPQ) in response to an *ad libitum* meal<sup>(10)</sup>. The present results also seem to suggest a potential effect of acute exercise on food reward in this population with a reduced pre-meal explicit liking for fat compared to the control condition which was not altered in the presence of post-exercise energy replacement (EX+R). Explicit Wanting for fat showed a significant interaction between CON and EX with a lower reduction in response to the test meal on EX compared with CON, whereas no time x condition interaction was observed between CON and EX+R. A significant interaction was also observed between CON and EX for Explicit Liking for fat that increased in response to the test meal in EX and decreased in CON. This suggests that an exercise-induced energy deficit may influence food reward in adolescents with obesity, while these effects are diminished after immediate replacement of

the energy expenditure induced by exercise. Further work is required to confirm these findings and to determine the relevance in relation to exercise, appetite and energy balance in young people.

The present study is limited by the absence of a direct measurement of energy expenditure during the exercise bouts which may have under- or over-estimated the exercise-induced energy deficit. Longer exercise and/or performed at higher intensities might be considered to favor greater energy deficits, which might lead to divergent results. Other limitations like the absence of hormonal indicators (mainly those involved in the control of energy intake), the lack of control of the level of hydration of the adolescents and the relatively reduced sample size have to be considered when interpreting our results. Nevertheless, this study is the first to investigate the effect of post-exercise energy replacement on the subsequent appetite and energy intake responses in adolescents with obesity, a population where weight control strategies are likely to provoke the most clinical relevance.

In conclusion, adolescents with obesity do not alter their post-exercise *ad libitum* energy intake after immediate dietary replacement of the exercise-induced energy deficit. This results in a short-term positive energy balance which, if sustained over the long term, may have important implications for weight control in this population. Further work is required to confirm the clinical relevance of these findings, but cautious adoption of post-exercise energy replacement practices may be required in adolescents with obesity to optimize the beneficial effects of exercise.

#### **Authors' contribution**

TD, MJ, DM, TA and YB designed the study. RJ, MM, FA, KM performed the data collection. KB, MM, GF, TD PB analyzed and interpreted the data. TD, YB, DM, AT and MM wrote and revised the paper.

## References

1. (2017) Worldwide trends in body-mass index, underweight, overweight, and obesity from 1975 to 2016: a pooled analysis of 2416 population-based measurement studies in 128.9 million children, adolescents, and adults. *Lancet* **390**, 2627-2642.
2. Swinburn BA, Sacks G, Hall KD *et al.* (2011) The global obesity pandemic: shaped by global drivers and local environments. *Lancet* **378**, 804-814.
3. Donnelly JE, Blair SN, Jakicic JM *et al.* (2009) American College of Sports Medicine Position Stand. Appropriate physical activity intervention strategies for weight loss and prevention of weight regain for adults. *Med Sci Sports Exerc* **41**, 459-471.
4. Deighton K, Stensel DJ (2014) Creating an acute energy deficit without stimulating compensatory increases in appetite: is there an optimal exercise protocol? *Proc Nutr Soc* **73**, 352-358.
5. Schubert MM, Desbrow B, Sabapathy S *et al.* (2013) Acute exercise and subsequent energy intake. A meta-analysis. *Appetite* **63**, 92-104.
6. Thivel D, Metz L, Julien A *et al.* (2014) Obese but not lean adolescents spontaneously decrease energy intake after intensive exercise. *Physiol Behav* **123**, 41-46.
7. Fearnbach SN, Silvert L, Pereira B *et al.* (2017) Reduced neural responses to food cues might contribute to the anorexigenic effect of acute exercise observed in obese but not lean adolescents. *Nutr Res* **44**, 76-84.
8. Thivel D, Rumbold PL, King NA *et al.* (2016) Acute post-exercise energy and macronutrient intake in lean and obese youth: a systematic review and meta-analysis. *Int J Obes* **40**, 1469-1479.
9. Thivel D, Finlayson G, Blundell JE (2019) Homeostatic and neurocognitive control of energy intake in response to exercise in pediatric obesity: a psychobiological framework. *Obes Rev* **20**, 316-324.
10. Miguet M, Fillon A, Khammassi M *et al.* (2018) Appetite, energy intake and food reward responses to an acute High Intensity Interval Exercise in adolescents with obesity. *Physiol Behav* **195**, 90-97.
11. Tamam S, Bellissimo N, Patel BP *et al.* (2012) Overweight and obese boys reduce food intake in response to a glucose drink but fail to increase intake in response to exercise of short duration. *Appl Physiol Nutr Metab* **37**, 520-529.
12. Hunschede S, Kubant R, Akilen R *et al.* (2017) The Role of IL-6 in Appetite Suppression after High-Intensity Exercise in Normal-weight and Obese Boys. *Current Developments in Nutrition* **1**, e000398.
13. Varley-Campbell JL, Moore MS, Williams CA (2017) The effects of a mid-morning snack and moderate-intensity exercise on acute appetite and energy intake in 12-14-year-old adolescents. *Br J Nutr* **117**, 602-610.
14. Thivel D, Duché P, Morio B (2012) Discussion of "overweight and obese boys reduce food intake in response to a glucose drink but fail to increase intake in response to exercise of short duration". *Appl Physiol Nutr Metab* **37**, 1014-1015; discussion 1016-1017.
15. Cole TJ, Bellizzi MC, Flegal KM *et al.* (2000) Establishing a standard definition for child overweight and obesity worldwide: international survey. *BMJ* **320**, 1240-1243.
16. Craig CL, Marshall AL, Sjostrom M *et al.* (2003) International physical activity questionnaire: 12-country reliability and validity. *Med Sci Sports Exerc* **35**, 1381-1395.
17. Bryant EJ, Thivel D, Chaput JP *et al.* (2018) Development and validation of the Child Three-Factor Eating Questionnaire (CTFEQr17). *Public Health Nutr* **21**, 2558-2567.
18. (2006) WHO Child Growth Standards based on length/height, weight and age. *Acta Paediatr Suppl* **450**, 76-85.
19. Rowland TW (1996) *Developmental Exercise Physiology*. Human Kinetics ed ed. Champaign, IL.

20. Murphy SP, Poos MI (2002) Dietary Reference Intakes: summary of applications in dietary assessment. *Public Health Nutr* **5**, 843-849.
21. Flint A, Raben A, Blundell JE *et al.* (2000) Reproducibility, power and validity of visual analogue scales in assessment of appetite sensations in single test meal studies. *Int J Obes Relat Metab Disord* **24**, 38-48.
22. Drapeau V, King N, Hetherington M *et al.* (2007) Appetite sensations and satiety quotient: predictors of energy intake and weight loss. *Appetite* **48**, 159-166.
23. Dalton M, Finlayson G (2014) Psychobiological examination of liking and wanting for fat and sweet taste in trait binge eating females. *Physiol Behav* **136**, 128-134.
24. Feise RJ (2002) Do multiple outcome measures require p-value adjustment? *BMC Med Res Methodol* **2**, 8.
25. Rothman, Greenland (1998) *Modern epidemiology*. 2nd ed. Philadelphia, PA: Lippencott-Raven Publishers.
26. Masurier J, Mathieu ME, Fearnbach SN *et al.* (2018) Effect of exercise duration on subsequent appetite and energy intake in obese adolescent girls. *Int J Sport Nutr Exerc Metab* **28**, 593-601.
27. Thivel D, Doucet E, Julian V *et al.* (2017) Nutritional compensation to exercise- vs. diet-induced acute energy deficit in adolescents with obesity. *Physiol Behav* **176**, 159-164.
28. Prado WL, Balagopal PB, Lofrano-Prado MC *et al.* (2015) Effect of aerobic exercise on hunger feelings and satiety regulating hormones in obese teenage girls. *Pediatr Exerc Sci* **26**, 463-469.
29. Thivel D, Isacco L, Montaurier C *et al.* (2012) The 24-h Energy Intake of Obese Adolescents Is Spontaneously Reduced after Intensive Exercise: A Randomized Controlled Trial in Calorimetric Chambers. *PLoS One* **7**, e29840.
30. Albert MH, Drapeau V, Mathieu ME (2015) Timing of moderate-to-vigorous exercise and its impact on subsequent energy intake in young males. *Physiol Behav* **151**, 557-562.
31. Thivel D, Genin PM, Mathieu ME *et al.* (2016) Reproducibility of an in-laboratory test meal to assess ad libitum energy intake in adolescents with obesity. *Appetite* **105**, 129-133.
32. Fearnbach SN, Silvert L, Keller KL *et al.* (2016) Reduced neural response to food cues following exercise is accompanied by decreased energy intake in obese adolescents. *Int J Obes (Lond)* **40**, 77-83.
33. Thivel D, Chaput JP (2014) Are post-exercise appetite sensations and energy intake coupled in children and adolescents? *Sports Med* **44**, 735-741.
34. Finlayson G, Bryant E, Blundell JE *et al.* (2009) Acute compensatory eating following exercise is associated with implicit hedonic wanting for food. *Physiol Behav* **97**, 62-67.
35. Farah NM, Brunstrom JM, Gill JM (2012) Using a novel computer-based approach to assess the acute effects of exercise on appetite-related measures. *Appetite* **58**, 196-204.
36. McNeil J, Cadieux S, Finlayson G *et al.* (2015) The effects of a single bout of aerobic or resistance exercise on food reward. *Appetite* **84**, 264-270.

## Figures' list

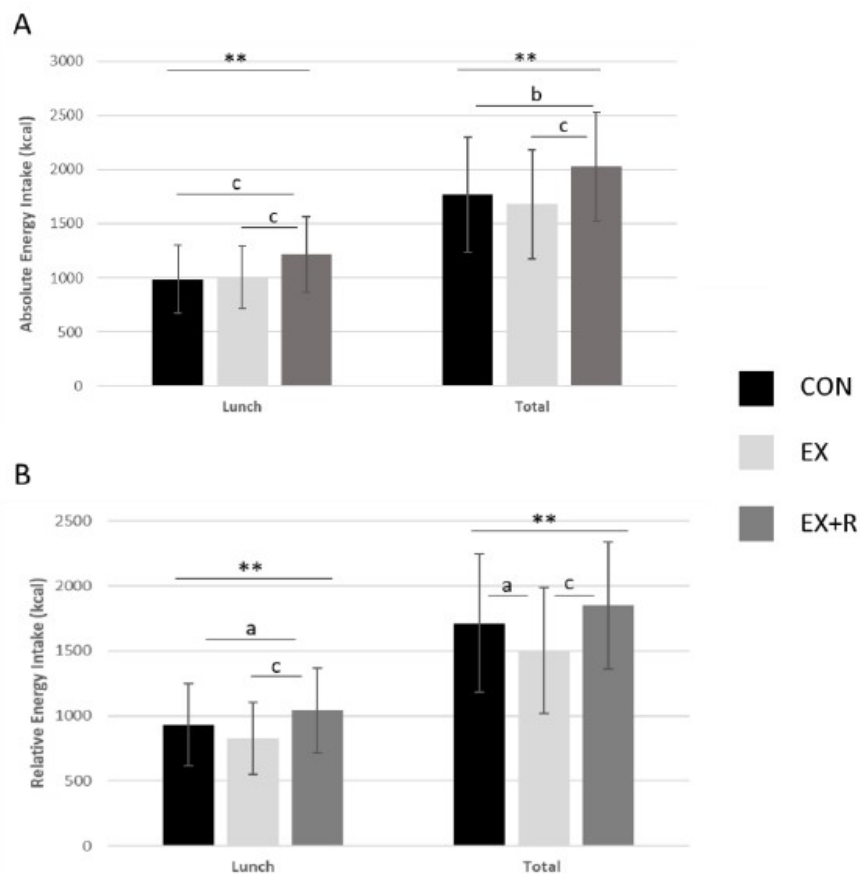

**Figure 1.** Absolute (A) and relative (B) energy intake in the control (CON), exercise with energy deficit (EX) and exercise with energy replacement (EX+R) conditions. Values are mean (SD) for  $n = 14$ . Values for EX-R include the energy content of the post-exercise snack. (\*\* $p < 0.05$  for the main effect of condition; a:  $p < 0.05$  versus control; c:  $p < 0.001$  versus Exercise).



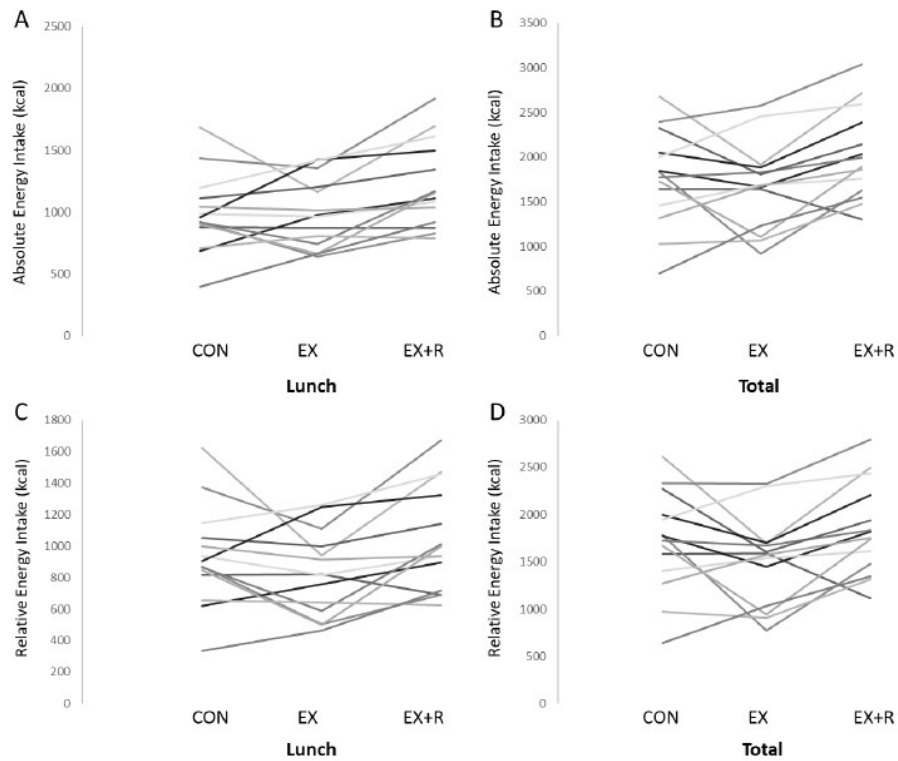

**Figure 2.** Individual variation of absolute energy intake at lunch (A) and total (B) and of relative energy intake at lunch (C) and total (D) in the control (CON), exercise with energy deficit (EX) and exercise with energy replacement (EX+R) conditions. Values are mean (SD) for  $n = 14$ . Values for EX+R include the energy content of the post-exercise snack.

## Tables

**Table 1.** Absolute and relative *ad libitum* energy intake in the control, exercise with energy deficit (EX) and exercise with energy replacement (EX+R) conditions.

	CON		EX		EX+R		P
	Mean	SD	Mean	SD	Mean	SD	
<b><i>Absolute Energy Intake (kcal)</i></b>							
Lunch	987	315	1003	289	1040	329	0.44
Evening	782	319	676	295	809	177	0.17
Total	1769	532	1678	501	1849	486	0.09
<b><i>Relative Energy Intake (kcal)</i></b>							
Lunch	931	315	826	279	1040	329 <sup>*.C</sup>	0.0032
Total	1713	530	1502	488 <sup>*</sup>	1849	486 <sup>C</sup>	0.0020

Values are mean (SD) for n = 14 and are exclusive of the post-exercise snack consumed in EX-R. <sup>\*</sup>p<0.05 versus CON.

<sup>C</sup>p<0.001 versus EX; P values represent the main effect of condition.

**Table 2.** Fasting, total area under the curve and satiety quotients for each appetite rating in the control (CON), exercise with energy deficit (EX) and exercise with energy replacement (EX+R) conditions.

	CON		EX		EX+R		P
	Mean	SD	Mean	SD	Mean	SD	
<b><i>Hunger</i></b>							
Fasting (mm)	68	48	81	48	97	38	0.10
Pre-lunch (mm)	91	36	83	45	87	37	0.76
SQ (mm/kcal)	8,7	3,5	7,5	4,3	8,1	5,1	0.59
AUC 60min post lunch (mm)	570	681	633	997	665	1061	0.82
Total AUC (mm)	9243	3747	9526	4703	9841	4304	0.51
<b><i>Fullness</i></b>							
Fasting (mm)	33	55	21	33	9	9	0.20
Pre lunch meal (mm)	22	25	27	40	23	30	0.97
SQ (mm/kcal)	-10,1	4,6	-5,4	9,8	-8,1	5,2	0.26
AUC 60min post lunch (mm)	7139	2037	4953	3442	5987	2746	0.11
Total AUC (mm)	23180	6988	17837	8877	19881	7918	0.17
<b><i>PFC</i></b>							
Fasting (mm)	71	43	80	44	85	40	0.69
Pre lunch meal (mm)	97	26	94	42	89	38	0.82
SQ (mm/kcal)	9,1	3,8	8,6	5,9	7,6	4,3	0.62
AUC 60min post lunch (mm)	888	1141	869	1095	905	1267	0.94
Total AUC (mm)	10253	5005	11297	5106	10574	5444	0.84
<b><i>DTE</i></b>							
Fasting (mm)	74	48	87	48	96	42	0.30
Pre lunch meal (mm)	100	36	96	44	89	39	0.63
SQ (mm/kcal)	9,6	3,9	8,3	3,8	7,8	4,6	0.31
AUC 60min post lunch (mm)	659	960	662	777	763	1145	0.79
Total AUC (mm)	10576	4922	11106	6076	9701	4826	0.42

Values are mean (SD) for n =14. SQ: Satiety Quotient; DTE: Desire To Eat; PFC: Prospective Food Consumption; AUC; Area Under the Curve; SD: Standard Deviation. P values represent the main effect of condition.

**Table 3.** Pre- and post-lunch meal food reward in the control (CON), exercise with energy deficit (EX) and exercise with energy replacement (EX-R) conditions.

Choice	CON		EX		EX+R		p	Interaction time x condition		
	Mean	SD	Mean	SD	Mean	SD		CON vs. EX	CON vs. EX+R	EX vs. EX+R
<b>Choice</b>										
<i>Fat Bias</i>										
Before meal	6,4	10,4	5,6	10,0	4,8	7,2	0,71	0,97	0,76	0,75
After meal	8,29	10,1	7,6	8,8	6,5	6,3	0,42			
<i>p before vs. after meal</i>	0,01		0,22		0,26					
<i>Taste Bias</i>										
Before meal	5,5	12,3	2,15	13,0	4,4	11,8	0,49	0,21	0,35	0,74
After meal	5,7	12,4	5,54	11,8	7,4	13,2	0,68			
<i>p before vs. after meal</i>	0,88		0,11		0,06					
<b>Implicit Wanting</b>										
<i>Fat Bias</i>										
Before meal	4,6	40,3	16,29	25,9	2,6	27,9	0,22	0,06	0,24	0,16
After meal	28,3	47,1	12,51	13,7	24,4	82,9	0,18			
<i>p before vs. after meal</i>	0,10		0,29		0,12					
<i>Taste Bias</i>										
Before meal	18,5	39,8	-0,26	42,0	15,5	30,3	0,78	0,57	0,99	0,32
After meal	20,7	34,6	17,51	29,4	18,7	36,1	0,73			
<i>p before vs. after meal</i>	0,93		0,18		0,60					
<b>Explicit Wanting</b>										
<i>Fat Bias</i>										
Before meal	15,5	7,5	11,90	7,5	15,1	14,7	0,80	0,017	0,84	0,26
After meal	4,7	6,1	10,74	9,0	5,7	10,4	0,32			
<i>p before vs. after meal</i>	0,001		0,92		0,08					
<i>Taste Bias</i>										
Before meal	17,2	12,2	16,10	12,0	17,6	20,8	0,87	0,94	0,78	0,84
After meal	9,3	9,4	8,60	10,6	11,8	11,6	0,64			
<i>p before vs. after meal</i>	0,03		0,12		0,26					
<b>Explicit Liking</b>										
<i>Fat Bias</i>										
Before meal	14,4	7,4**	1,60	12,9	9,0	16,4**	0,05	0,026	0,50	0,25
After meal	7,9	9,7	8,08	8,2	7,3	8,1	0,97			
<i>p before vs. after meal</i>	0,09		0,21		0,72					
<i>Taste Bias</i>										
Before meal	17,7	12,0	8,90	18,1	15,0	18,5	0,23	0,22	0,17	0,76
After meal	9,2	10,3	7,46	9,4	18,6	15,9	0,15			
<i>p before vs. after meal</i>	0,06		0,91		0,65					

Values are mean (SD) for n =14. CON: control condition; EX: Exercise condition; EX+R: Exercise + Energy Replacement condition; SD: Standard Deviation, \*\*p<0.01 versus EX

**Satiety Responsiveness but not Food Reward is modified in response to an acute bout of low versus high intensity exercise in healthy adults.**

Thivel, D., **Fillon, A.**, Genin, P. M., Miguet, M., Khammassi, M., Pereira, B., Boirie, Y., Duclos, M., Drapeau, V., Blundell, J., Tremblay, A., Finlayson, G., Mathieu, M.-E., & Metz, L.

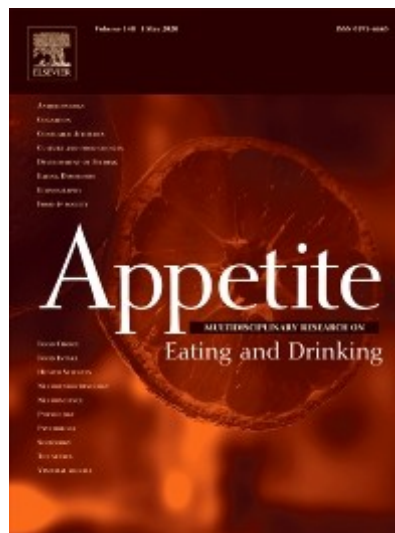

*Accepted in Appetite, Volume 145, 2020*



## Satiety responsiveness but not food reward is modified in response to an acute bout of low *versus* high intensity exercise in healthy adults

D. Thivel<sup>a,b,c,\*</sup>, A. Fillon<sup>a,d,e</sup>, P.M. Genin<sup>a,d</sup>, M. Miguet<sup>a</sup>, M. Khammassi<sup>a</sup>, B. Pereira<sup>f</sup>, Y. Boirie<sup>b,d,g,h</sup>, M. Duclos<sup>b,d,h,i</sup>, V. Drapeau<sup>j</sup>, J.E. Blundell<sup>c</sup>, A. Tremblay<sup>j</sup>, G. Finlayson<sup>c</sup>, M.E. Mathieu<sup>k</sup>, L. Metz<sup>a,b</sup>

<sup>a</sup> Clermont Auvergne University, Laboratory of the Metabolic Adaptations to Exercise under Physiological and Pathological Conditions (AME2P), Clermont-Ferrand, EA, 3533, France

<sup>b</sup> CRNH-Auvergne, Clermont-Ferrand, France

<sup>c</sup> Appetite Control and Energy Balance Research Group, University of Leeds, Leeds, UK

<sup>d</sup> INRA, UMR, 1019, Clermont-Ferrand, France

<sup>e</sup> UGECAM Nutrition Obesity Ambulatory Hospital, Clermont-Ferrand, France

<sup>f</sup> Clermont-Ferrand University Hospital, Biostatistics unit (DRCI), Clermont-Ferrand, France

<sup>g</sup> Department of Human Nutrition, Clermont-Ferrand University Hospital, G. Montpied Hospital, Clermont-Ferrand, France

<sup>h</sup> University Clermont Auvergne, UFR Medicine, Clermont-Ferrand, France

<sup>i</sup> Department of Sport Medicine and Functional Explorations, Clermont-Ferrand University Hospital, G. Montpied Hospital, Clermont-Ferrand, France

<sup>j</sup> Institute of Nutrition and Functional Foods (INAF), Université Laval, Québec City, Canada

<sup>k</sup> School of Kinesiology and Physical Activity Sciences, Université de Montréal, Montréal, Québec, Canada

### ARTICLE INFO

#### Keywords:

Satiety quotient  
Appetite  
Exercise  
Energy intake  
Intensity  
Food reward

### ABSTRACT

To compare the effect of iso-caloric low and high intensity exercises on Satiety Quotient and Food Reward in response to a fixed meal in healthy young adults. Anthropometric measurements, body composition (BIA), aerobic capacity (VO<sub>2</sub> max) and food preferences were assessed in 19 healthy normal-weight young adults (21 ± 0.5 years old, 10 men). They randomly completed 3 experimental sessions: i) control session without exercise (CON); ii) High Intensity exercise session (HIE); iii) Low intensity exercise session (LIE). Thirty minutes after exercise or rest, then received a fixed lunch. Food reward (Leeds Food Preference Questionnaire) was assessed before and after the meal. Appetite sensations were assessed at regular intervals, SQ was calculated from the lunch meal and self-reported food intake was collected for the rest of the day. Mean body weight was 66.7 ± 9.2 kg, body mass index was 22.3 ± 2.9 kg/m<sup>2</sup> and FM% was 18.7 ± 6.8%. Appetite feelings did not differ between conditions and were not affected by exercise. SQ for satiety was not different between conditions. SQ hunger on CON was significantly higher than on LIE and HIE ( $p \leq 0.05$ ) with no difference between exercise conditions. SQ for desire to eat was significantly higher on CON *versus* HIE ( $p \leq 0.01$ ) with no differences between CON and LIE and between exercise sessions. SQ PFC was significantly lower on HIE compared with CON ( $p = 0.02$ ) with no differences between LIE and CON and between LIE and HIE. Food reward was not significantly different between the three condition as well as self-reported total food and macronutrient intake for the rest of the days. Acute exercise, depending on its intensity, might affect the satiating response to food intake in healthy adults, without altering food reward.

### 1. Introduction

Appetite sensations are an accurate method for measuring subjective states of motivation to eat before and in response to meals (Flint, Raben, Blundell, & Astrup, 2000). Measured before and after a meal in laboratory conditions, appetite feelings can also provide information

about the satiating capacity of food, which can be expressed as Satiety Quotient (SQ). First introduced by Kissileff in 1984, the satiating efficiency of food aims at measuring the extent to which an energy preload could reduce subjective appetite sensations per unit of intake (e.g. kcal, kJ) (Kissileff, 1984). This concept has been later extended by Green and collaborators who considered the temporal effect of foods and

\* Corresponding author. Clermont Auvergne University, EA 3533, Laboratory of the Metabolic Adaptations to Exercise under Physiological and Pathological Conditions (AME2P), BP 80026, F-63171, Aubière cedex, France.

E-mail address: [thivel.david@uca.fr](mailto:thivel.david@uca.fr) (D. Thivel).

<https://doi.org/10.1016/j.appet.2019.104500>

Received 11 June 2019; Received in revised form 3 October 2019; Accepted 22 October 2019

Available online 23 October 2019

0195-6663/ © 2019 Published by Elsevier Ltd.

suggested calculation of the SQ for each appetite sensations measured over time (Green, Delargy, Joanes, & Blundell, 1997). Not only this SQ provides information regarding individuals' satiety responsiveness to a test meal, it has also been identified as a predictor of energy intake in men and women of different weight status (Drapeau et al., 2005).

Although the role of physical exercise on energy balance is usually associated with its direct effects on energy expenditure, it has also been shown to indirectly affect energy intake and appetite, which suggests its potential dual effect on energy balance (Blundell, Gibbons, Caudwell, Finlayson, & Hopkins, 2015). Yet the effects of exercise on the main physiological (i.e. gastro-peptides, insulin and the main adipokines) and neurocognitive (i.e. neural activation in response to food stimuli) signals involved in the control of energy intake have been widely studied so far (Hanlon, Larson, Bailey, & LeCheminant, 2012; Ueda, Yoshikawa, Katsura, Usui, & Fujimoto, 2009), it remains to our knowledge unknown whether exercise can also affect the individuals' satiating capacity of food. Indeed, while it has been clearly shown that subjective feelings of appetite are transiently suppressed in response to intensive exercise (above 60% maximal capacities), returning to resting control values within 30–60 min after exercise cessation, without impacting subsequent energy and macronutrient intake (Blundell, Stubbs, Hughes, Whybrow, & King, 2003; Dorling et al., 2018), data are missing regarding the satiating response to a fixed meal after acute exercise.

Similarly, human energy intake has been shown to be under the control of some hedonic pathways with "Liking" and "Wanting" being strongly implicated (Finlayson, King, & Blundell, 2008). Yet the literature remains quite limited regarding the effect of acute exercise on food reward (Farah, Brunstrom, & Gill, 2012; Finlayson, Bryant, Blundell, & King, 2009; McNeil, Cadieux, Finlayson, Blundell, & Doucet, 2015), Farah et al. failed to observe any food "liking" rating differences in response to a 60-min aerobic exercise compared with a rest condition (Farah et al., 2012). McNeil and colleagues recently found decreased relative preference for high fat vs. low fat foods in response to a single bout of both aerobic or resistance exercise in healthy women (McNeil et al., 2015). Interestingly, the hedonic "liking" of high fat foods was found to be reduced after their resistance exercise but not after the aerobic session (as compared with a resting session), suggesting a potential role for exercise modality (McNeil et al., 2015). Although intensity has been identified as the main exercise characteristic involved in subsequent energy intake and appetite responses (Donnelly et al., 2014; Schubert, Desbrow, Sabapathy, & Leveritt, 2013; Thivel et al., 2016; Ueda et al., 2009), it remains unknown whether food reward might respond differently to exercise depending on its intensity.

The aim of the current study was to compare the effect of iso-energetic low and high intensity exercises on the satiety responsiveness (using the Satiety Quotient) and Food Reward in response to a fixed meal in healthy young adults.

## 2. Methods

### 2.1. Population

Nineteen healthy normal-weight young adults ( $21 \pm 0.5$  years old, 10 men and 9 women) were recruited among university students to participate in this randomized study. To be included in the study they had to be free of any illnesses or medications that could interfere with the study outcomes. The participants also had to show a moderate physical activity level, being engaged in regular physical activity between 150 and 240 min per week (being then above the international recommendation for physical activity), including intensive activities, as assessed using the International Physical Activity Questionnaire – IPAQ). Importantly, the participants had to be used to consuming breakfast in their daily life to be included. This study was conducted according to the guidelines laid down in the Declaration of Helsinki, written informed consents were obtained from all subjects as requested by our local Research Ethics Committee (CPP Sud Est VI).

### 2.2. Design

After a medical inclusion conducted by a physician to confirm the ability of each candidate to perform the whole protocol, anthropometric measurements, body composition (BIA), aerobic capacity (VO<sub>2</sub> max) and food preferences were assessed for all the participants. The dietary status of the participant was checked with the use of the TFEQ. They had to then complete 3 experimental sessions in a randomized order (block randomized using Stata software): i) a control session without exercise (CON); ii) a High Intensity exercise session (HIE); iii) a low intensity exercise session (LIE). For each session (detailed below) the participants were asked to join the laboratory at 08:00 a.m. fasted. After a calibrated breakfast they were asked to remain sedentary until 11:00 a.m. when they were asked to complete a cycling exercise (on HIE and LIE conditions) or to remain at rest until lunch time (CON). 30 min after the exercises or rest, they received a fixed meal. 15 min before and 15 min after the meal, the participants had to perform the computer based Leeds Food Preference Questionnaire (LFPQ). Food intake after lunch was also assessed using self-reported food diaries for the rest of the days. Appetite feelings were assessed using Visual Analogue Scales at regular intervals throughout the sessions.

### 2.3. Experimental conditions

**Control condition (CON).** From 08:00am to 12:00pm, the participants were asked to remain sedentary, restricted from any physical exercise. They had access to books and magazines as well as to movies. From 11:00am to 11:45am they were particularly asked to remain seated without any intensive cognitive and intellectually demanding task (music and entertaining magazines were available). 30 min later they received a calibrated test meal that they were asked to entirely consume. 15 min before and after the test meal they were asked to perform the computerized LFPQ questionnaire. Appetite feelings have been assessed at regular intervals until the end of the experimental session. The participants were then asked to self-report their free-living intake for the rest of each experimental days (snack and dinner).

**High Intensity Exercise session (HIE).** This session was similar to the CON one except that the participants were asked to cycle for 30 min at 75% of their maximal aerobic capacities on an ergocycle. The VO<sub>2</sub>max tests previously performed provided for each participant the linear relationship between oxygen uptake and the mechanical workload (in Watt) imposed on the ergocycle at each stage of the test (see description of the test below). Thanks to this individual linear relationship, the workload corresponding to 75% of the measured VO<sub>2</sub>max was identified (the corresponding heart rate was also used as a double indicator of the targeted intensity) and then imposed to the ergocycle.

**Low Intensity Exercise session (LIE).** This session was similar to the HIE one except that the participants were asked to cycle for 45 min at 50% of the VO<sub>2</sub>max.

### 2.4. Anthropometric measurements and body composition assessment

A digital scale was used to measure body mass to the nearest 0.1 kg, and barefoot standing height was assessed to the nearest 0.1 cm by using a wall-mounted stadiometer. The Body Mass Index (BMI) was calculated as body mass (kg) divided by height squared (m<sup>2</sup>). Body composition was assessed on the same occasion using impedance analysis (Tanita MC 780). This Tanita MC780 device has been recently validated in young adults of various physical activity levels (Verney, Schwartz, Amiche, Pereira, & Thivel, 2015).

### 2.5. Aerobic capacities

VO<sub>2</sub>max was measured during a graded exhaustive cycling test that was performed during a preliminary session at least one week prior to the first experimental session (test performed under medical

supervision). The initial power was set at 30 W for 3 min and followed by 15 W increments every 3 min. Participants were strongly encouraged by experimenters throughout the test to perform a maximum effort. Criteria for reaching  $\dot{V}O_{2\max}$  were subjective exhaustion with heart rate above 195  $\text{beats}\cdot\text{min}^{-1}$  and/or Respiratory Exchange Ratio (RER,  $\dot{V}CO_2/\dot{V}O_2$ ) above 1.02 and/or a plateau of  $\dot{V}O_2$  (Rowland, 1996). An electromagnetically-braked cycle ergometer (Ergoline, Bitz, Germany) was used to perform the test.  $\dot{V}O_2$  and  $\dot{V}CO_2$  were measured breath-by-breath through a mask connected to  $O_2$  and  $CO_2$  analyzers (Oxycon Pro-Delta, Jaeger, Hoechberg, Germany). Calibration of gas analysers was performed with commercial gases of known concentration. Ventilatory parameters were averaged every 30 s. ECG was monitored for the duration of the test.

## 2.6. Energy intake

On each experimental day both males and females received a calibrated breakfast of 500 kcal (according to the eating habits and food preference questionnaire the participants filled in during their inclusion, both males and females were used to consume a regular breakfast of about 500 kcal, which explains why they received a similar breakfast). The lunch test meal was identical for the 3 experimental conditions and was also composed according to the participants food preference questionnaire and consisted in: turkey, pasta, green beans, yogurt, stewed apple, butter, bread and sugar. The content of the lunch meal was 750 kcal for women and 900 kcal for men, maintaining the macronutrient proportions. Similarly, the energy content of the meal was calibrated in regard to the participants eating habits. The participants were asked to consume the entire served meal. The participants were asked to self-report their intake for the rest of the experimental days assisted by the SUVIMAX methods that consists in an instruction manual for coding food portions, which included validated photographs of more than 250 foods represented in three different portion sizes. The self-reported diary were analyzed by an experienced dietician and the participants' energy intake and the proportion of the total energy intake derived from fat, carbohydrate and protein were calculated using the Nutralog software (Nutralog Inc., Marans, France).

## 2.7. Subjective appetite sensations (AS)

At regular intervals throughout the experimental sessions (before and after breakfast, before and after exercise or rest, before the test meal, after the test meal, 30 min and 60 min after the test meal), participants were asked to rate their hunger, fullness, desire to eat (DTE) and prospective food consumption (PFC) using visual analogue scales (VAS of 150 mm) whose reliability has been previously reported (Flint et al., 2000). The satiety quotients (SQ) for hunger, fullness, PFC and DTE were calculated on the lunch meal as follows (Drapeau et al., 2007):

Satiety quotient  $\text{mm}/\text{kcal} = [(\text{pre meal AS mm}) - (\text{mean 60 min post meal AS mm})] / \text{energy content of the meal (kcal)} * 100$

## 2.8. Food reward: the Leeds Food Preference Questionnaire (LFPQ)

The participants were asked to complete a validated computer-based procedure to measure food reward (Leeds Food Preference Questionnaire; LFPQ) (Finlayson et al., 2008) prior to and immediately following the calibrated lunch test. Briefly, the LFPQ provides measures of the wanting and liking for an array of food images, varying in both fat content and taste. A total of 16 different foods, divided into four categories (high-fat savoury, low-fat savoury, high-fat sweet and low-fat sweet) were used. Table 1 details the nutritional characteristics for food images and food categories used (Table 1). During the forced choice part of the test, each food image was presented with every other

**Table 1**

Nutritional characteristics of the food items used in the Leeds Food Preference Questionnaire.

Food items	Kcal/ serving	% CHO	% Protein	% Fat
<b>HFLC</b>				
Salted peanuts	364	6.5	18	73.8
Crisps	336	37.9	3.6	58.4
Swiss cheese	250	0.1	24.4	75.5
Chips	361	48	4	48
Milk chocolate with nuts (Galaxy)	469	32.5	5.2	62.3
Jam doughnut	380	44.9	6.6	48.5
Cream cake	198	42.1	6.1	49.7
Shortbread	102	47.1	6.1	47.7
<b>LFHC</b>				
Savoury biscuits	480	64.2	12.4	19.4
Pilau rice	145	86.6	10.3	3.1
New Potatoes	150	90.8	8.4	0.8
Bread roll	265	73.0	14.0	13.0
Marshmallows	384	94.1	4.9	0.7
Popcorn	390	89.0	3.0	7.0
Jelly babies	344	91.0	6.7	2.0
Fruit salad	130	84.0	4.0	12.0
<b>Mean HFLC</b>	<b>307</b>	<b>32.4</b>	<b>9.1</b>	<b>58.0</b>
<b>Mean LFHC</b>	<b>286</b>	<b>84.1</b>	<b>84.1</b>	<b>7.3</b>

CHO, carbohydrate; HFLC, high fat/low carbohydrate; LFHC, low fat/high carbohydrate.

image in turn. The participants were instructed to select the food they "most want to eat now" during each trial. A standardized implicit wanting score for each food category was calculated as a function of the reaction time in selecting a certain food adjusted for the frequency of choice for each category (Dalton & Finlayson, 2014). To measure the explicit liking and explicit wanting, participants were asked to rate the extent to which they "liked" or "wanted" each randomly presented food item with a 100-mm visual analogue scale. The questions and scoring methods used to assess the implicit wanting, explicit wanting and explicit liking during this task are described elsewhere (Dalton & Finlayson, 2014). For all food reward measurements, bias scores for fat (liking/wanting for high-fat relative to low-fat food) content and taste (liking/wanting for sweet relative to savoury food) were computed by subtracting the mean low fat scores from the mean high fat scores, and the mean savoury scores from the mean sweet scores, respectively. Positive values indicate a preference for high fat or sweet foods, negative values indicate a preference for low fat or savoury foods, and a score of 0 indicates an equal preference between fat content and taste categories.

## 2.9. Statistical analysis

Statistical analyses were performed using Stata software, Version 13 (StataCorp, College Station, TX, US). All tests were two-sided, with a Type I error set at 0.05. The sample size estimation was determined according to (i) CONSORT 2010 statement, extension to randomized pilot and feasibility trials and (ii) Cohen's recommendations who has defined effect-size bounds as: small (ES: 0.2), medium (ES: 0.5) and large (ES: 0.8, "grossly perceptible and therefore large"). So, with 19 participants (by condition), an effect-size around 0.8 can be highlighted for a two-sided type I error at 1.8% (correction due to multiple comparisons), a statistical power greater than 80% and an intra-class correlation coefficient at 0.5 to take into account between and within participant variability. Continuous data were expressed as mean  $\pm$  standard deviation (SD) or median [interquartile range] according to statistical distribution. The assumption of normality was assessed by using the Shapiro-Wilk test. Random-effects models for repeated data were performed to compare three conditions (i) considering the following fixed effects: time, condition and time  $\times$  condition interaction,



and (ii) taking into account between and within participant variability (subject as random-effect). Furthermore, due to cross-over randomized design, period, order of conditions and carry-over were considered as covariates. A Sidak's type I error correction was applied to perform multiple comparisons. As proposed by some statisticians (Feise, 2002; Ra, 1998) a particular focus has been also given to the magnitude of differences, in addition to inferential statistical tests expressed using p-values. The normality of residuals from these models was studied using the Shapiro-Wilk test. When appropriate, a logarithmic transformation was proposed to achieve the normality of dependent outcome.

### 3. Results

The participants showed a mean body weight of  $66.7 \pm 9.2$  kg and body mass index (BMI) of  $22.3 \pm 2.9$  kg/m<sup>2</sup>. The mean Fat Mass percentage of the sample was  $18.7 \pm 6.8\%$  with a Fat-Free Mass of  $51.5 \pm 8.8$  kg. The participants had VO<sub>2</sub>max of  $44.5 \pm 1.2$  ml min<sup>-1</sup>.kg<sup>-1</sup> and  $37.3 \pm 1.7$  ml min<sup>-1</sup>.kg<sup>-1</sup> in boys and girls respectively. The exercise conditions (HIE and LIE) generated a mean energy expenditure of  $401 \pm 141$  kcal.

#### 3.1. Appetite sensations and satiety quotient

Table 2 details the appetite and satiety quotient results. Fasting hunger, satiety, prospective food consumption and desire to eat were not different between conditions. Similarly, none of the appetite sensations was different between conditions when assessed immediately before the lunch meal. Our general mixed model also did not show any differences between conditions regarding the 60-min post meal hunger, satiety, desire to eat and prospective food consumption Areas Under the Curves (AUC).

The Satiety SQ did not differ between the three experimental conditions. The mixed model showed a significant difference between conditions for the Hunger SQ ( $p \leq 0.05$ ), with SQ hunger on CON being

significantly higher than on LIE and HIE ( $p \leq 0.05$ ) with no difference between the two exercise conditions. The SQ for desire to eat was found to be significantly higher on CON versus HIE ( $p \leq 0.01$ ) with no differences between CON and LIE and between exercise sessions. While the mixed model regarding the SQ for prospective food consumption showed a tendency ( $p = 0.06$ ). SQ PFC was found to be significantly lower on HIE compared with CON ( $p = 0.02$ ) with no differences between LIE and CON and between LIE and HIE.

#### 3.2. Food reward

As detailed in Table 3, none of the metrics for preference of high fat relative to low fat foods (Choice, Implicit Wanting, Explicit Wanting and Explicit Liking) was found to be different between conditions or in response to the fixed meal within conditions. Sweet taste relative to savoury bias for food choice, implicit wanting, explicit wanting and explicit liking was significantly increased in response to the fixed meal on the three conditions ( $p < 0.0001$ ) with pre meal sweet vs savoury food choice being significantly decreased on LIE and HIE compared with CON ( $p < 0.05$ ) without differences between LIE and HIE. Similarly, pre meal sweet vs savoury implicit wanting was found significantly decreased on LIE compared with CON ( $p < 0.05$ ).

#### 3.3. Self-reported energy intake

The energy ingested on the rest of the experimental days did not differ between conditions (CON:  $729 \pm 388$  kcal; LIE:  $900 \pm 598$  kcal; HIE:  $752 \pm 356$  kcal). None of the absolute (in grams) and relative (in percentage of the total energy ingested) protein, fat and carbohydrates intakes were found significantly different between conditions.

### 4. Discussion

While the effect of acute exercise on appetite and subsequent ad

**Table 2**  
Appetite sensations and satiety responsiveness.

	CON	LIE	HIE	p	CON vs LIE	CON vs HIE	LIE vs HIE
	Mean $\pm$ SD	Mean $\pm$ SD	Mean $\pm$ SD				
<b>Hunger</b>							
Fasting (mm)	74 $\pm$ 41	72 $\pm$ 47	75 $\pm$ 47	0.93	0.75	0.99	0.74
Before lunch (mm)	114 $\pm$ 37	103 $\pm$ 45	103 $\pm$ 49	0.54	0.33	0.35	0.96
Post lunch (mm)	7 $\pm$ 9	13 $\pm$ 25	10 $\pm$ 20	0.51	0.24	0.51	0.61
AUC	568.4 $\pm$ 665.6	1072.1 $\pm$ 1555.9	1160.5 $\pm$ 1444.3	0.13	0.15	0.06	0.63
SQ	12.9 $\pm$ 5.0	10.4 $\pm$ 5.0	10.1 $\pm$ 6.0	<b>0.05</b>	<b>0.05</b>	<b>0.02</b>	0.81
<b>Satiety</b>							
Fasting (mm)	46 $\pm$ 40	47 $\pm$ 40	51 $\pm$ 49	0.89	0.96	0.66	0.69
Before lunch (mm)	29 $\pm$ 33	20 $\pm$ 22	28 $\pm$ 35	0.44	0.23	0.81	0.33
Post lunch (mm)	139 $\pm$ 11	133 $\pm$ 28	133 $\pm$ 29	0.48	0.28	0.31	0.95
AUC	8046.3 $\pm$ 933.6	7162.1 $\pm$ 2000.8	7499.2 $\pm$ 1843.6	0.15	0.06	0.15	0.65
SQ	-12.9 $\pm$ 4.7	-12.2 $\pm$ 4.5	-11.7 $\pm$ 5.7	0.62	0.60	0.33	0.65
<b>Desire to eat</b>							
Fasting (mm)	77 $\pm$ 47	80 $\pm$ 46	79 $\pm$ 50	0.96	0.79	0.85	0.93
Before lunch (mm)	119 $\pm$ 36	110 $\pm$ 43	102 $\pm$ 50	0.22	0.38	0.08	0.39
Post lunch (mm)	8 $\pm$ 11	15 $\pm$ 30	17 $\pm$ 29	0.39	0.30	0.20	0.81
AUC	683.7 $\pm$ 756.5	1297.9 $\pm$ 1889.1	1151.8 $\pm$ 1701.4	0.10	0.04	0.53	0.15
SQ	13.2 $\pm$ 4.5	10.9 $\pm$ 5.2	9.8 $\pm$ 6.4	<b>0.04</b>	0.09	<b>0.01</b>	0.40
<b>PFC</b>							
Fasting (mm)	82 $\pm$ 47	88 $\pm$ 38	86 $\pm$ 44	0.80	0.52	0.65	0.84
Before lunch (mm)	121 $\pm$ 24	109 $\pm$ 35	108 $\pm$ 42	0.26	0.17	0.14	0.92
Post lunch (mm)	20 $\pm$ 22	21 $\pm$ 30	24 $\pm$ 34	0.81	0.91	0.55	0.62
AUC	1344.5 $\pm$ 1225.5	1632.6 $\pm$ 1896.9	1811.8 $\pm$ 2151.4	0.65	0.66	0.35	0.62
SQ	12.1 $\pm$ 4.0	10.1 $\pm$ 4.4	9.4 $\pm$ 5.6	0.06	0.09	<b>0.02</b>	0.54

CON: Control Condition; LIE: Low Intensity Condition; HIE: High Intensity Condition; SD: Standard Deviation; AUC: Area Under the Curve; SQ: Satiety Quotient; PFC: Prospective Food Consumption.

**Table 3**  
Pre and post fixed lunch food reward analysis.

	CON	LIE	HIE	p	Interaction time x group		
	Mean $\pm$ SD	Mean $\pm$ SD	Mean $\pm$ SD		CON vs. LIE	CON vs. HIE	LIE vs. HIE
<b>Choice</b>							
<i>Fat Bias</i>							
Before meal	5.6 $\pm$ 10.6	2.9 $\pm$ 10.8	4.5 $\pm$ 7.7	0.17	0.24	0.69	0.33
After meal	5.1 $\pm$ 6.1	5.3 $\pm$ 8.7	4.6 $\pm$ 6.4	0.86			
<i>p</i> before vs. after meal	0.78	0.17	0.91				
<i>Taste Bias</i>							
Before meal	-5.6 $\pm$ 13.3	-10.2 $\pm$ 11.3*	-9.8 $\pm$ 13.1*	<b>0.04</b>	0.33	0.52	0.82
After meal	20.1 $\pm$ 9.2	19.8 $\pm$ 9.8	19.1 $\pm$ 11.2	0.84			
<i>p</i> before vs. after meal	< 0.0001	< 0.0001	< 0.0001				
<b>Implicit Wanting</b>							
<i>Fat Bias</i>							
Before meal	13.5 $\pm$ 29.7	7.2 $\pm$ 30.0	10.5 $\pm$ 19.7	0.29	0.50	0.94	0.45
After meal	15.0 $\pm$ 16.7	13.2 $\pm$ 21.1	12.1 $\pm$ 16.9	0.6			
<i>p</i> before vs. after meal	0.78	0.22	0.58				
<i>Taste Bias</i>							
Before meal	-13.9 $\pm$ 36.7	-27.0 $\pm$ 33.3*	-24.1 $\pm$ 34.0	<b>0.04</b>	0.34	0.67	0.65
After meal	56.0 $\pm$ 21.8	54.4 $\pm$ 24.0	51.4 $\pm$ 29.3	0.55			
<i>p</i> before vs. after meal	< 0.0001	< 0.0001	< 0.0001				
<b>Explicit Wanting</b>							
<i>Fat Bias</i>							
Before meal	1.5 $\pm$ 13.6	2.0 $\pm$ 14.4	2.0 $\pm$ 12.1	0.98	0.41	0.55	0.71
After meal	2.7 $\pm$ 6.8	0.0 $\pm$ 7.6	1.1 $\pm$ 7.3	0.19			
<i>p</i> before vs. after meal	0.7	0.5	0.7				
<i>Taste Bias</i>							
Before meal	-10.0 $\pm$ 18.8	-13.9 $\pm$ 21.2	-11.2 $\pm$ 16.6	0.24	0.95	0.93	0.88
After meal	14.8 $\pm$ 16.6	11.3 $\pm$ 13.2	12.9 $\pm$ 16.0	0.55			
<i>p</i> before vs. after meal	< 0.0001	< 0.0001	< 0.0001				
<b>Explicit Liking</b>							
<i>Fat Bias</i>							
Before meal	5.7 $\pm$ 14.4	3.9 $\pm$ 15.0	4.0 $\pm$ 12.6	0.78	0.87	0.80	0.68
After meal	3.2 $\pm$ 5.8	0.8 $\pm$ 7.7	2.3 $\pm$ 9.9	0.23			
<i>p</i> before vs. after meal	0.42	0.23	0.58				
<i>Taste Bias</i>							
Before meal	-8.3 $\pm$ 19.0	-13.3 $\pm$ 20.1	-9.9 $\pm$ 15.2	0.16	0.30	0.83	0.37
After meal	16.4 $\pm$ 18.3	20.4 $\pm$ 20.8	16.4 $\pm$ 16.6	0.52			
<i>p</i> before vs. after meal	< 0.0001	< 0.0001	< 0.0001				

CON: Control Condition; LIE: Low Intensity Condition; HIE: High Intensity Condition; SD: Standard Deviation.

*libitum* food intake have been widely studied, it remained to our knowledge unexplored whether other indicators involved in the control of energy intake such as food reward and the satiating capacity of food are modified after acute exercise. In that context, the main aim of the present study was to question the effects of low versus high intensity cycling exercises (isocaloric) on the food reward and satiating responses to a fixed meal in healthy young adults as well as on their following energy intake.

While a transient anorexigenic effect of intensive exercise has been widely described (Blundell et al., 2015; Dorling et al., 2018), none of the pre-lunch appetite feelings assessed in the present work (hunger, satiety, prospective food consumption and desire to eat) were different after both exercises compared with resting values. Although this is consistent with previously published studies also failing to find any modification of appetite sensation after intensive exercise (Finlayson et al., 2009) or after both aerobic and resistance exercises (McNeil et al., 2015) in similar populations, this could also be explained by the moderately active profile of our participants that are healthy recreational exercisers. In line with this absence of sensation differences, the participants' self-reported energy intake (total energy ingested as well as absolute and relative macronutrient consumption) for the rest of the experimental days (afternoon snacks and diner) did not differ between

conditions. This reveals an absence of short-term energy compensation in response to an acute exercise of various intensity, suggesting a positive effect on overall energy balance as previously pointed out (Imbeault, Saint-Pierre, Almeras, & Tremblay, 1997).

This is to our knowledge the first study evaluating the satiating capacity of food in response to acute exercises of various intensities. According to our results, while none of the 60-min post-meal appetite feelings' AUC were different between conditions, both low and high intensity exercises favored reduced satiety quotients for hunger, with the intensive condition also leading to lower SQ for desire to eat and prospective food consumption compared with the resting session. SQ for fullness was not affected by acute exercise. Although SQ has been studied in responses to meals of various calorie content (Felix, Trinidad, Arvin, Tuña, & Bienvenido, 2013; Gonzalez, Frampton, & Deighton, 2017) and composition (Hansen, Sjodin, Ritz, Bonnet, & Korndal, 2018; Hopkins, Gibbons, Caudwell, Blundell, & Finlayson, 2016), comparison studies are lacking regarding their response to acute exercise. Dubé and collaborators are to our knowledge the first who assessed SQ after an acute exercise in patients with type one or type two diabetes (Dubé, Tremblay, Lavoie, & John Weisnagel, 2013). According to their results, both Type 1 and Type 2 diabetic patients report increased SQ for hunger, Desire to Eat and Prospective Food Consumption after a 60-min

moderate cycling exercise (50% of their maximal aerobic capacities) independently of their blood glucose level and variation (Dube et al., 2013). Importantly, the SQ were calculated in response to an *ad libitum* buffet meal, which might have influenced the results. Although the authors failed to find any statistically significant difference between the control and exercise sessions for total energy intake as well as for the proportion of lipids and carbohydrates ingested; the consumption of proteins significantly varied between conditions which might have influenced the SQ. The use of an *ad libitum* meal might indeed impose a limitation when comparing SQs between various experimental conditions. We found only one other study that calculated SQ in response to different exercise conditions, comparing the effect of an acute moderate-to-vigorous exercise set either 135 min before or immediately before a meal, in normal-weight adolescents (Albert, Drapeau, & Mathieu, 2015). According to their results, none of the SQs under study (hunger, fullness, desire to eat and PFC) were affected by the 30-min exercise, whatever its timing (Albert et al., 2015). Once more, it must be underlined that this last study used *ad libitum* buffet meals to calculate their SQ, thereby introducing a potential additional variable into their analysis. The absence of significant subsequent energy intake change despite lower SQ for Hunger, DTE and PFC observed in the present work might suggest, as for appetite feelings, an uncoupling effect of acute exercise on food intake and SQ. It must be however underlined that these lower SQ after the intensive exercise only might also contribute to the absence of subsequent energy compensation as compared with the LIE condition where the self-reported energy intake was raised from about 150 kcal compared to both HIE and CON, even though it did not reach statistical significance. This potential effect of the intensive exercise over the low-intensity one is also comforted by the lower PFC observed after HIE only compared with the control session. Further studies are then needed to better understand the effect of acute exercise on the satiating capacity of food.

The present study also seems to be the first to provide results regarding the effect of acute isoenergetic exercises of different intensities on food reward, importantly using identical isocaloric test meals. Indeed, as pointed out earlier, the use of *ad libitum* meals might affect food reward itself, masking the potential effect of exercise. In a recent study work, McNeil and collaborators compared exercise of different modalities on the following food reward in healthy young men and women, also using the Leeds Food Preference Questionnaire (McNeil et al., 2015). The authors found decreased relative preference for high fat vs. low fat foods in response to both aerobic or resistance acute exercises, with a reduced hedonic “liking” for high fat foods after resistance exercise only (McNeil et al., 2015). Interestingly, as in the present study, they did not observe any sex difference. Although food reward was measured in response to an *ad libitum* test meal, they did not observe any total energy intake nor macronutrient consumption difference between conditions (McNeil et al., 2015). According to the authors, their results could suggest the potential role played by the exercise modality on food reward in this population (McNeil et al., 2015). Also using the LFPQ, Miguet and collaborators recently assessed food reward in response to an acute High Intensity Interval Exercise (HIIE) session in adolescents with obesity (Miguet et al., 2018). While their 16-min cycling HIIE favored reduced *ad libitum* energy intake at the following meal, it was also found to decrease fat relative preference, sweet taste relative preference and fat implicit wanting in response to this *ad libitum* meal (Miguet et al., 2018). In contrast, our results failed to show any food reward difference between conditions. Although post-meal taste bias was increased after both rest and exercise conditions, no difference was obtained for the other dimensions of food reward between conditions. These results seem to be consistent with those from Farah and colleagues who failed to find any food liking difference in response to a 60-min aerobic exercise (compared with a rest condition) in healthy men and women (Farah et al., 2012). The recreationally active profile of our population could once more explain our results. Indeed, while McNeil and colleagues found modified food reward after

their two exercise modalities, their participants were all inactive (while Farah et al. did not report their sample physical activity level) (McNeil et al., 2015). Although it has been previously suggested that the energy expenditure induced by acute exercise might not be associated with subsequent energy intake (Thivel & Chaput, 2014), this might require deeper investigations when it comes to food reward. Indeed, McNeil and colleagues found modified post-exercise food reward in healthy adults after exercises inducing expenditures of  $278 \pm 51$  kcal (aerobic) an  $274 \pm 56$  kcal (resistance), while no difference was seen after exercises of higher expenditure, such as in Farah et al.’s study ( $443 \pm 79$  kcal) and in the present work ( $401 \pm 141$  kcal). Taken together, these results highlight the need for a better understanding of the effect of exercise on the hedonic control of energy intake in order to avoid any compensatory responses that could undermine the beneficial energetic effect of exercise.

Although this study is the first one to our knowledge to examine the effect of acute isoenergetic exercises of various intensities on the satiating and food reward response to a fixed meal, its results must be interpreted in light of some limitations. The somehow reduced sample size, the lack of objectively measured energy intake on the days that followed each sessions, the lack of a direct measure of exercise-induced energy expenditure using indirect calorimeter for instance, or the use of a subjective self-reported questionnaire to assess the participants’ physical activity level (IPAQ) compose the main limitations of this work. The fact that both males and females received the same breakfast but lunches of different energy contents in order to match with their eating habits, must also be considered when interpreting our results. While most of the previously conducted studies used *ad libitum* meals to question the effect of exercise on subsequent energy intake, the present study deliberately used a fixed meal in order to properly compare the satiating and rewarding responses to the same energy stimulus, after exercises of different intensities. Based on our results, it seems that acute exercise, depending on its intensity, can influence satiating responsiveness, while food reward does not seem to be affected in healthy moderately active adults. Importantly, these results must be considered in light of the characteristics of the exercises used, such as its modality (cycling, while other modalities might induce different results) or timing (some recent evidence showing effectively different nutritional responses to the same exercise depending on its timing during the day or delay with the meal), or the characteristics of population (moderately active healthy young adults). Further studies are required to confirm these results and question these effects in populations confronted to appetite control impairments such as patients with overweight and obesity.

## Acknowledgements

The authors want to thank all the participants who took part in this work and the National French University Institute (IUF) for its financial support.

## Appendix A. Supplementary data

Supplementary data to this article can be found online at <https://doi.org/10.1016/j.appet.2019.104500>.

## References

- Albert, M. H., Drapeau, V., & Mathieu, M. E. (2015). Timing of moderate-to-vigorous exercise and its impact on subsequent energy intake in young males. *Physiology & Behavior*, *151*, 557–562.
- Blundell, J. E., Gibbons, C., Caudwell, P., Finlayson, G., & Hopkins, M. (2015). Appetite control and energy balance: Impact of exercise. *Obesity Reviews*, *16*(Suppl 1), 67–76.
- Blundell, J. E., Stubbs, R. J., Hughes, D. A., Whybrow, S., & King, N. A. (2003). Cross talk between physical activity and appetite control: Does physical activity stimulate appetite? *Proceedings of the Nutrition Society*, *62*(3), 651–661.
- Dalton, M., & Finlayson, G. (2014). Psychobiological examination of liking and wanting for fat and sweet taste in trait binge eating females. *Physiology & Behavior*, *136*,

- 128–134.
- Donnelly, J. E., Herrmann, S. D., Lambourne, K., Szabo, A. N., Honas, J. J., & Washburn, R. A. (2014). Does increased exercise or physical activity alter ad-libitum daily energy intake or macronutrient composition in healthy adults? A systematic review. *PLoS One*, *9*(1), e83498.
- Dorling, J., Broom, D. R., Burns, S. F., Clayton, D. J., Deighton, K., James, L. J., et al. (2018). Acute and chronic effects of exercise on appetite, energy intake, and appetite-related hormones: The modulating effect of adiposity, sex, and habitual physical activity. *Nutrients*, *10*(9).
- Drapeau, V., Blundell, J., Therrien, F., Lawton, C., Richard, D., & Tremblay, A. (2005). Appetite sensations as a marker of overall intake. *British Journal of Nutrition*, *93*(2), 273–280.
- Drapeau, V., King, N., Hetherington, M., Doucet, E., Blundell, J., & Tremblay, A. (2007). Appetite sensations and satiety quotient: Predictors of energy intake and weight loss. *Appetite*, *48*(2), 159–166.
- Dube, M. C., Tremblay, A., Lavoie, C., & John Weisnagel, S. (2013). Effect of exercise on food consumption and appetite sensations in subjects with diabetes. *Appetite*, *71*, 403–410.
- Farah, N. M., Brunstrom, J. M., & Gill, J. M. (2012). Using a novel computer-based approach to assess the acute effects of exercise on appetite-related measures. *Appetite*, *58*(1), 196–204.
- Feise, R. J. (2002). Do multiple outcome measures require p-value adjustment? *BMC Medical Research Methodology*, *2*, 8.
- Felix, A., Trinidad, P., Arvin, P., Tũaño, P., & Bienvenido, O. J. (2013). Short-term satiety of cooked philippine rices of varying apparent amylose content and glycemic index. *The Philippine Agricultural Scientist*, *96*(2), 179–186.
- Finlayson, G., Bryant, E., Blundell, J. E., & King, N. A. (2009). Acute compensatory eating following exercise is associated with implicit hedonic wanting for food. *Physiology & Behavior*, *97*(1), 62–67.
- Finlayson, G., King, N., & Blundell, J. (2008). The role of implicit wanting in relation to explicit liking and wanting for food: Implications for appetite control. *Appetite*, *50*(1), 120–127.
- Flint, A., Raben, A., Blundell, J. E., & Astrup, A. (2000). Reproducibility, power and validity of visual analogue scales in assessment of appetite sensations in single test meal studies. *International Journal of Obesity and Related Metabolic Disorders*, *24*(1), 38–48.
- Gonzalez, J. T., Frampton, J., & Deighton, K. (2017). Postprandial suppression of appetite is more reproducible at a group than an individual level: Implications for assessing inter-individual variability. *Appetite*, *108*, 375–382.
- Green, S. M., Delargy, H. J., Joanes, D., & Blundell, J. E. (1997). A satiety quotient: A formulation to assess the satiating effect of food. *Appetite*, *29*(3), 291–304.
- Hanlon, B., Larson, M. J., Bailey, B. W., & LeCheminant, J. D. (2012). Neural response to pictures of food after exercise in normal-weight and obese women. *Medicine & Science in Sports & Exercise*, *44*(10), 1864–1870.
- Hansen, T. T., Sjodin, A., Ritz, C., Bonnet, S., & Korndal, S. K. (2018). Macronutrient manipulations of cheese resulted in lower energy content without compromising its satiating capacity. *Journal of Nutrition Sciences*, *7*, e7.
- Hopkins, M., Gibbons, C., Caudwell, P., Blundell, J. E., & Finlayson, G. (2016). Differing effects of high-fat or high-carbohydrate meals on food hedonics in overweight and obese individuals. *British Journal of Nutrition*, *115*(10), 1875–1884.
- Imbeault, P., Saint-Pierre, S., Almeras, N., & Tremblay, A. (1997). Acute effects of exercise on energy intake and feeding behaviour. *British Journal of Nutrition*, *77*(4), 511–521.
- Kissileff, H. R. (1984). Satiating efficiency and a strategy for conducting food loading experiments. *Neuroscience & Biobehavioral Reviews*, *8*(1), 129–135.
- McNeil, J., Cadieux, S., Finlayson, G., Blundell, J. E., & Doucet, E. (2015). The effects of a single bout of aerobic or resistance exercise on food reward. *Appetite*, *84*, 264–270.
- Miguet, M., Fillon, A., Khammassi, M., Masurier, J., Julian, V., Pereira, B., et al. (2018). Appetite, energy intake and food reward responses to an acute High Intensity Interval Exercise in adolescents with obesity. *Physiology & Behavior*, *195*, 90–97.
- Ra, G. (1998). *Modern epidemiology* (2nd ed.). Philadelphia, PA: Lippencott-Raven Publishers.
- Rowland, T. W. (1996). *Developmental exercise physiology. Human kinetics ed. Champaign, IL.*
- Schubert, M. M., Desbrow, B., Sabapathy, S., & Leveritt, M. (2013). Acute exercise and subsequent energy intake. A meta-analysis. *Appetite*, *63*, 92–104.
- Thivel, D., & Chaput, J. P. (2014). Are post-exercise appetite sensations and energy intake coupled in children and adolescents? *Sports Medicine*, *44*(6), 735–741.
- Thivel, D., Rumbold, P. L., King, N. A., Pereira, B., Blundell, J. E., & Mathieu, M. E. (2016). Acute post-exercise energy and macronutrient intake in lean and obese youth: A systematic review and meta-analysis. *International Journal of Obesity*, *40*(10), 1469–1479.
- Ueda, S. Y., Yoshikawa, T., Katsura, Y., Usui, T., & Fujimoto, S. (2009). Comparable effects of moderate intensity exercise on changes in anorectic gut hormone levels and energy intake to high intensity exercise. *Journal of Endocrinology*, *203*(3), 357–364.
- Verney, J., Schwartz, C., Amiche, S., Pereira, B., & Thivel, D. (2015). Comparisons of a multi-frequency bioelectrical impedance analysis to the dual-energy X-ray absorptiometry scan in healthy young adults depending on their physical activity level. *Journal of Human Kinetics*, *47*, 73–80.

## Annexe 5

### Autres productions

---

#### Chapitre d'ouvrage :

- **Fillon, A.**, Duclos, M., & Thivel, D. (2020). Mesure de l'activité physique et de la sédentarité en obésité. In Traité de l'Obésité. (JM Lecerf. Elsevier Masson).
- Aucouturier, J., **Fillon, A.**, Masurier, J., & Thivel, D. (2017). Intervention en activité physique chez les enfants et les adolescents en surpoids/obèses : entraînement en endurance et/ou en résistance ? In Le livre électronique (eBook) de l'ECOG sur l'obésité des enfants et des adolescents. (M.L. Frelut (Ed.))
- Thivel, D., **Fillon, A.**, Masurier, J., & Aucouturier, J. (2017). Évaluation des aptitudes cardiorespiratoires en obésité pédiatrique. In Le livre électronique (eBook) de l'ECOG sur l'obésité des enfants et des adolescents. (M.L. Frelut (Ed.)).

**Mesure de l'activité physique et de la sédentarité en  
obésité.**

**Fillon, A.**, Duclos, M., Thivel, D.

*Dans Traité de l'Obésité. (JM Lecerf. Elsevier Masson), 2020*

# Mesure de l'activité physique et de la sédentarité

Fillon A.<sup>1</sup>, Duclos M.<sup>2,3</sup>, Thivel D.<sup>1,3</sup>

<sup>1</sup> Laboratoire des Adaptations Métaboliques à l'Exercice en conditions Physiologiques et Pathologiques (AME2P, EA3533), Université Clermont Auvergne ; Centre de Recherche en Nutrition Humaine (CRNH Auvergne).

<sup>2</sup> Service de Médecine du Sport et des Explorations Fonctionnelles et Respiratoires, CHU Clermont-Ferrand ; Faculté de Médecine, Université Clermont Auvergne ; Unité de Nutrition Humaine (UMR 1019 INRA) ; Centre de Recherche en Nutrition Humaine (CRNH Auvergne).

<sup>3</sup> Observatoire National de l'Activité Physique et de la Sédentarité (ONAPS), Clermont-Ferrand.

Bien qu'assimilée la plupart du temps à la pratique sportive exclusive par la population générale, l'activité physique concerne l'ensemble des activités humaines quotidiennes, des tâches domestiques aux transports actifs, en passant par les activités professionnelles ou de loisirs. Dès 1985, Caspersen et al. définissent l'activité physique comme l'ensemble des mouvements corporels produits par la mise en action des muscles squelettiques et entraînant une dépense énergétique au-dessus du métabolisme de repos (1). Définition encore récemment rappelée par l'OMS (2) et l'expertise collective INSERM (3). Le niveau d'activité physique se définit et se caractérise par sa modalité, sa durée, sa fréquence, son intensité et son contexte de réalisation. La sédentarité, souvent confondue avec l'inactivité physique (non atteinte des recommandations en activité physique pour la santé physique (4,5), représente les comportements requérant une très faible dépense d'énergie, en situation d'éveil, généralement en dessous de 1,5 Mets (équivalent métabolique), et est le plus souvent mesurée à travers le temps passé assis et/ou devant un écran (4).

Les implications respectives de l'activité physique, de l'inactivité physique et des comportements sédentaires sont aujourd'hui clairement décrites, notamment en ce qui concerne les risques de développer un surpoids ou une obésité ainsi que leur impact sur le développement de complications associées pour les patients déjà concernés par une obésité. La prise en compte du niveau et des habitudes d'activité physique et de sédentarité des patients est aujourd'hui un élément clé du diagnostic et de la prise en charge du traitement de l'obésité.

L'objectif de ce chapitre n'est pas de décrire ces implications et la nécessité de considérer l'activité physique et la sédentarité dans la prévention et la prise en charge du surpoids et de l'obésité (sujet traité au sein d'autres chapitres de cet ouvrage), mais d'en présenter les principales méthodes d'évaluation (sans en élaborer un catalogue), et de proposer certains critères permettant une optimisation du choix et de l'utilisation de ces méthodes.

### ***Quelles méthodes de mesure de l'activité physique et de la sédentarité ?***

Bien que l'évaluation du niveau d'activité physique et des comportements sédentaires soit d'une importance particulière dans le cadre du surpoids et de l'obésité de manière à mieux déterminer et comprendre le bilan énergétique des patients, les méthodes de mesure disponibles ne sont pas spécifiques à cette population. En effet, qu'ils soient directs ou indirects, déclaratifs ou objectifs, ce sont les résultats issus de la mesure et leur interprétation, plus que la méthode utilisée, qui devront prendre en compte le statut pondéral de la population étudiée ou du patient concerné et non pas l'inverse. Il sera néanmoins indispensable d'interpréter les résultats obtenus au regard des avantages et limitations spécifiques à la méthode utilisée.

*Mais alors quelle méthode utiliser ?* Le choix de la méthode d'évaluation du niveau d'activité physique et de sédentarité va donc déterminer la nature des informations recueillies. Ce choix doit se faire en fonction des moyens à disposition (les coûts et techniques d'analyse peuvent être plus ou moins élevés et complexes en fonction de la méthode choisie), de la nature de l'information recherchée, mais aussi, et peut-être principalement, du contexte de la mesure : scientifique ou de pratique clinique. Certains auteurs ont en ce sens proposé un modèle illustrant les divers paramètres qui semblent déterminants dans le choix des outils et méthodes d'évaluation du niveau d'activité physique et de sédentarité (6). D'après ce modèle, en fonction des caractéristiques des sujets concernés par la mesure, du contexte de cette mesure, des moyens disponibles et de la nature de l'information recherchée, il semble possible d'identifier le, ou les, outils à utiliser pour une évaluation cohérente et adaptée. Bien que leur



modèle soit intéressant, il reste centré sur la mesure du niveau d'activité physique et des comportements sédentaires dans un contexte principalement scientifique. La Figure 1, inspirée du modèle proposé par Pettee-Gabriel et al., offre un aperçu des principales méthodes disponibles pour l'évaluation du niveau d'activité physique et de sédentarité en fonction de la nature de la méthode (directe ou indirecte) mais aussi de l'information recueillie. Ce modèle est un support d'accompagnement pour un choix adapté de la méthode et de l'outil à utiliser par le professionnel dans un contexte de recherche mais aussi de prise en charge clinique.

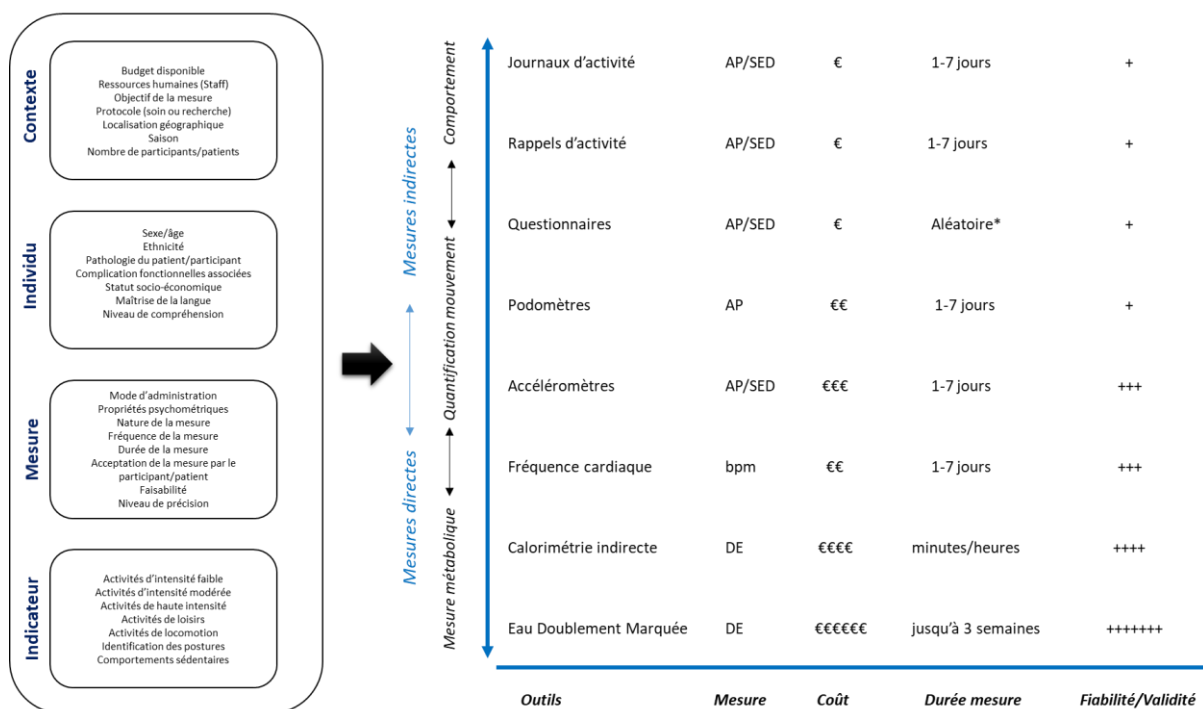

**Figure 1.** Modèle décisionnel orientant le choix des méthodes d'évaluation de l'activité physique et de la sédentarité. AP : Activité Physique ; DE : Dépense Energétique ; SED : Sédentarité ; bpm : battements par minute.

### Approches déclaratives

Le plus souvent utilisées, les mesures déclaratives reposent sur un recueil d'informations directement auprès des participants ou patients. Si les *journaux d'activité* ou *rappels d'activité* sont très souvent employés et permettent souvent l'identification d'habitudes précises, leur fiabilité reste soumise à la compliance des sujets, à leur mémoire, mais aussi au degré de subjectivité (le plus souvent

inconsciente) inhérent aux informations auto-rapportées. Lors des vingt dernières années, un nombre important de *questionnaires* ont vu le jour, permettant l'évaluation à la fois du niveau d'activité physique, des domaines de l'activité physique réalisée (comme les transports actifs ; les activités quotidiennes, occupationnelles ou encore les activités de loisirs ou sportives), et pour certains d'entre eux, du temps consacré à des comportements sédentaires (temps passé devant un écran, assis, etc.). L'International Physical Activity Questionnaire (IPAQ) (7) ou encore le GPAQ (Global Physical Activity Questionnaire) (8) sont parmi les principaux questionnaires utilisés, permettant une évaluation du niveau d'activité physique et de sédentarité des sujets. Si la littérature met en avant que les versions françaises de ces questionnaires permettent l'obtention de résultats intéressants et met en avant leur validité (9), la nature auto-rapportée et subjective des informations recueillies ne doit pas être occultée.

Certains questionnaires spécifiques à l'évaluation du niveau de sédentarité ont été développés (9-11), mais leur fiabilité reste discutable lorsqu'ils sont comparés à des mesures objectives par accéléromètre (12). Il apparaît néanmoins important de souligner que questionnaires et accéléromètres n'apportent pas les mêmes informations, plutôt qualitatives pour les premiers alors que les accéléromètres proposent une mesure quantitative, importance de taille quand il est question de sédentarité.

Les informations recueillies grâce à ces méthodes déclaratives doivent donc être considérées avec prudence, notamment chez les patients souffrant de surpoids ou d'obésité. En effet ces derniers ont tendance à surestimer leurs déclarations d'engagement dans des comportements sains (comme l'activité physique) et à l'inverse, de sous-estimer leurs comportements sédentaires. En revanche, l'accessibilité méthodologique et la faisabilité pratique et clinique de ces approches en font des méthodes de choix. De manière à accroître la fiabilité des résultats obtenus, il est recommandé qu'un professionnel revienne en direct avec le participant et/ou patient sur les réponses apportées par ce dernier, de manière à vérifier la compréhension des questions (qui ont obligatoirement été détaillées et expliquées une première fois avant la distribution du questionnaire) et ainsi la cohérence des

réponses apportées. Les informations qualitatives apportées restent néanmoins précieuses et une recommandation pourrait être, dans la mesure du possible, de coupler ces approches avec une mesure plus objective et quantitative des activités quotidiennes des participants et/ou patients.

### **Approches objectives**

Les **podomètres** et **accéléromètres** sont les deux méthodes les plus utilisées aujourd'hui, reposant sur une approche quantitative du mouvement humain. Le podomètre permet une approche simple de la comptabilité du nombre de pas réalisé. Aujourd'hui accessible à tous en raison de son faible coût, et basé sur une activité simple qu'est la marche, le podomètre reste, malgré une fiabilité de mesure plutôt faible, un outil de quantification informationnelle intéressant sur le plan clinique. En revanche, le podomètre ne permet pas l'obtention d'informations relatives à la sédentarité. Si sur le plan scientifique il est préférable d'utiliser des podomètres ne permettant pas une visualisation en direct du nombre de pas effectués (de manière à ne pas modifier le comportement du participant), sur le plan interventionnel et clinique, le podomètre peut, au-delà de son utilité comme outil de mesure, servir d'outil de sensibilisation et d'incitation à la marche. Il a en effet été mis en avant que le simple fait de porter ce type de capteur permet de spontanément augmenter le nombre de pas des sujets (13). Plus sophistiqués que les podomètres, le développement des accéléromètres, d'abord uni-axiaux puis bi- et triaxiaux, permet une quantification plus complexe mais aussi plus complète des mouvements humains, comprenant à la fois le niveau d'activité physique et de sédentarité. Bien que le coût d'acquisition de ces accéléromètres s'abaisse avec le temps (il s'agit ici d'accéléromètres de laboratoire et non pas d'outils grand public dont la fiabilité reste à confirmer), leur achat représente encore un poste important de dépense et les résultats obtenus, bien qu'objectifs, vont dépendre de la compliance des participants/patients, à porter ces appareils au poignet ou à la ceinture. Les accéléromètres présentent l'avantage de mesurer de manière relativement précise et détaillée, à la fois la fréquence, la durée, l'intensité et le style d'activité, et ce sur une période pouvant couvrir

plusieurs jours. Bien que de nombreux travaux ont proposé des équations et méthodes d'analyse des données issues d'enregistrements d'accéléromètres permettant de déterminer le temps passé à des activités physiques en fonction de leur intensité, voire même d'obtenir à partir de ces derniers une estimation de la dépense énergétique, ces équations sont la plupart du temps développées à partir d'études réalisées auprès de sujets sains, normo-pondéraux. Quelques récents travaux proposent néanmoins des équations adaptées aux patients souffrant d'obésité (14) ou d'obésité sévère (15). Ces équations proposent également une quantification du temps dévoué à des comportements sédentaires (tout comme dans certains cas du temps consacré au sommeil), la sensibilité de la mesure reste ici encore insuffisante et il est recommandé de coupler ces accéléromètres avec des méthodes de mesure des changements posturaux, telles que les inclinomètres. En effet, le couplage d'un accéléromètre et d'un inclinomètre semble être une alternative de choix de manière à détecter et à quantifier les changements de postures et particulièrement les passages de la station assise à debout et les transitions entre ces postures, caractérisant parfaitement les temps de sédentarité et leurs ruptures (16). Jusqu'alors, peu d'inclinomètres semblent proposer une sensibilité suffisante : la technologie ActivPal offre aujourd'hui la mesure la plus satisfaisante en la matière (17).

Bien que les accéléromètres proposent une estimation de la dépense énergétique engendrée, cette dernière reste indicative. Il est néanmoins possible d'affiner cette mesure de la dépense énergétique en couplant à l'utilisation de ces capteurs une évaluation plus physiologique, comme la fréquence cardiaque. La fréquence cardiaque est aujourd'hui la mesure physiologique directe la plus utilisée en condition naturelle de vie (hors laboratoire). Il existe une relation linéaire forte entre la fréquence cardiaque et la dépense énergétique lors d'activités d'intensités modérées à vigoureuses, relation plus modeste voire très faible à des intensités plus faibles (17). Certains outils de quantification et de mesure de l'activité humaine comme les ActiHearts (CamNtech Ltd, Cambridge, UK) reposent précisément sur le couplage entre l'accélérométrie et une mesure de la fréquence cardiaque. D'autres technologies comme les Armband Senswear (BodyMedia Inc., Fresno, CA) ou encore les Zephyr (Zephyr Technology Corp., Annapolis, MD), combinant accélérométrie et mesure de la fréquence cardiaque,

proposent des estimations de la dépense énergétique. S'éloignant de la quantification du mouvement en elle-même mais permettant une mesure plus précise de la dépense énergétique, la *calorimétrie* ne semble adaptée et accessible que dans un contexte expérimental de laboratoire. La calorimétrie directe, qui repose sur la mesure de la chaleur produite par l'utilisation de l'énergie, nécessite une évaluation corps entier (rares sont les équipements disponibles) qui plus est à un coût très élevé. Lorsqu'elle est indirecte la calorimétrie repose sur l'analyse des échanges gazeux, permettant ainsi une estimation de la dépense d'énergie générée. Les chambres métaboliques permettent une approche calorimétrique indirecte corps entier (lourde méthodologiquement et coûteuse), cependant aujourd'hui des équipements portatifs sont disponibles, mais encore coûteux et, ne permettant qu'une mesure de quelques heures. Enfin, *l'eau doublement marquée*, considérée aujourd'hui comme la mesure de référence, permet une mesure de la dépense énergétique en condition naturelle de vie. Cette méthode isotopique, hautement sophistiquée et onéreuse, repose sur l'évaluation du taux d'élimination de l'oxygène 18 et du deutérium et est à l'heure actuelle uniquement utilisée dans des conditions expérimentales.

Considérer l'ensemble de ces méthodes de manière appropriée pour en sélectionner la ou les plus adaptées à nos besoins est extrêmement important pour la mise en place de réponses adaptées par les professionnels. Il apparaît néanmoins aujourd'hui intéressant, dans l'optique d'une mise en mouvement pérenne, d'intégrer les nouvelles technologies à cette approche, principalement lors de la phase d'autonomisation du patient, comme présenté en Box 1.

### **BOX-1**

#### ***Quid des nouvelles technologies dans la mesure de l'activité physique et de la sédentarité?***

Applications mobiles, montres et bracelets connectés : nous connaissons actuellement une démocratisation de ces outils de quantification de l'activité quotidienne et un accroissement de leur popularité. Mais quel est l'intérêt de ces outils pour nos patients et nos prises en charge ?

Très largement plébiscitées et de plus en plus utilisées dans notre société, ces nouvelles technologies semblent proposer une appréciation du niveau d'activité physique et de sédentarité (voire du sommeil pour certaines d'entre elles) satisfaisante ; elles souffrent néanmoins d'une grande variabilité d'un modèle à l'autre (18,19). Bien qu'encore relativement faible, la littérature actuelle souligne leur intérêt comme indicateurs du niveau d'activité des individus (20, 21). De manière intéressante, que ce soit chez le sujet sain, normo-pondéré ou concerné par un surpoids ou une obésité, ces nouvelles technologies semblent agir comme de réels outils motivationnels à la pratique. En effet, plusieurs études et revues systématiques mettent en avant que l'utilisation de ces *trackers* conduit à une progression du niveau d'activité physique et une réduction des comportements sédentaires (22). Il reste néanmoins important de souligner que cet effet ne s'inscrit pas dans le temps et s'estompe au bout de quelques semaines, leur utilisation et considération par le sujet s'atténuant au cours du temps (22). Quelques récents travaux encouragent tout de même l'utilisation des nouvelles technologies dans le cadre de programmes de prise en charge de l'obésité, et soulignent des bénéfices en termes de compliance au programme et d'adhésion des patients (23).

#### ***Conclusions et recommandations***

La prévention et la prise en charge de l'obésité passent par une pleine considération et compréhension du niveau d'activité physique, des comportements sédentaires et de leurs implications. Il est donc impératif de mettre en place une évaluation diagnostique du niveau d'activité physique et de sédentarité, de manière à i) cibler les habitudes et besoins des patients ; ii) établir des objectifs adaptés et individualisés; iii) en évaluer l'atteinte ; iv) mais aussi identifier les barrières et freins à cette pratique. Le choix du ou des outils/méthodes utilisés doit reposer sur une pleine considération de la fiabilité et du contexte de la mesure, mais aussi des caractéristiques du patient et de l'information recherchée. Il apparaît essentiel également de garantir le respect des protocoles d'utilisation de ces méthodes d'évaluation, ce qui est primordial pour obtenir des résultats fiables. Il semble intéressant de privilégier le couplage entre une méthode objective et une approche déclarative, de manière à appréhender au mieux à la fois les dimensions quantitatives et comportementales de l'activité physique et de la sédentarité. Il apparaît aussi nécessaire de mettre en place un retour en face-à-face

avec le patient sur les résultats obtenus de manière à en garantir la cohérence, et de permettre le partage des résultats pour une prise en charge concertée (patients-soignants).

## Références

1. Caspersen, C. J., K. E. Powell, et al. (1985). "Physical activity, exercise, and physical fitness: definitions and distinctions for health-related research." *Public Health Rep* 100(2): 126-131.
2. Organisation Mondiale de la Santé (2018). "Activité physique." Organisation mondiale de la santé. PAG (2018). "Plan d'action gouvernemental - Habitudes de vie et prévention des maladies chroniques."
3. "Inserm (dir.). *Activité physique : contextes et effets sur la santé. Rapport.* Paris : Les éditions Inserm, 2008, XII - 811 p. - (Expertise collective). - <http://hdl.handle.net/10608/97>"
4. Tremblay MS, Colley RC, Saunders TJ, Healy GN, Owen N. (2010). Physiological and health implications of a sedentary lifestyle. *Appl Physiol Nutr Metab* 35(6): 725-740.
5. Tremblay MS, Aubert S, Barnes JD, Saunders TJ, Carson V, Latimer-Cheung AE, Chastin SFM, Altenburg TM, Chinapaw MJM; SBRN Terminology Consensus Project Participants. (2017). Sedentary Behavior Research Network (SBRN) - Terminology Consensus Project process and outcome. *Int J Behav Nutr Phys Act*; 14(1): 75.
6. Pettee Gabriel KK1, Morrow JR Jr, Woolsey AL. (2012) Framework for physical activity as a complex and multidimensional behavior. *J Phys Act Health*; 9 Suppl 1:S11-8.
7. Rosenberg DE, Bull FC, Marshall AL, Sallis JF, Bauman AE. (2008) Assessment of sedentary behavior with the International Physical Activity Questionnaire. *J Phys Act Health*; 5 Suppl 1:S30-44.
8. Armstrong T, Bull F. (2006) Development of the World Health Organization Global Physical Activity Questionnaire (GPAQ). *J Public Health*; 14(2):66–70
9. Rosenberg DE, Norman GJ, Wagner N, Patrick K, Calfas KJ, Sallis JF. (2010) Reliability and validity of the Sedentary Behavior Questionnaire (SBQ) for adults. *J Phys Act Health*; 7(6):697-705
10. Marshall AL, Miller YD, Burton NW, Brown WJ. (2010) Measuring total and domain-specific sitting: a study of reliability and validity. *Med Sci Sports Exerc*; 42(6):1094-102
11. Mielke GI, Crochemore M da Silva I, Gomersall SR, Owen N, Hallal PC. (2019) Reliability of a multi-domain sedentary behaviour questionnaire and comparability to an overall sitting time estimate. *J Sports Sci*; 9:1-6.
12. Clark BK, Sugiyama T, Healy GN, Salmon J, Dunstan DW, Owen N. (2009) Validity and reliability of measures of television viewing time and other non-occupational sedentary behaviour of adults: a review. *Obes Rev*; 10(1):7-16.

13. Joseph-Shehu EM, Ncama BP, Mooi N, Mashamba-Thompson TP. (2019) The use of information and communication technologies to promote healthy lifestyle behaviour: a systematic scoping review. *BMJ Open*; 9(10):e029872.
14. Howe CCF, Hannah JM, Easton C. (2019) Classification of Physical Activity cut-points and the estimation of energy expenditure during walking using the GT3X+ accelerometer in overweight and obese adults. *Measurement in Physical education and Exercise Science*; ISSN 1091-367X.
15. Diniz-Sousa F, Veras L, Ribeiro JC, Boppre G, Devezas V, Santos-Sousa H, Preto J, Machado L, Vilas-Boas JP, Oliveira J, Fonseca H. (2019) Accelerometry calibration in people with class II-III obesity: Energy expenditure prediction and physical activity intensity identification. *Gait Posture*; 76:104-109.
16. Ainsworth B, Cahalin L, Buman M, Ross R. (2015) The current state of physical activity assessment tools. *Prog Cardiovasc Dis*; 57(4):387-95.
17. Kozey-Keadle S, Libertine A, Lyden K, Staudenmayer J, Freedson PS. (2011) Validation of wearable monitors for assessing sedentary behavior. *Med Sci Sports Exerc*; 43(8):1561-7
18. Breteler MJ, Janssen JH, Spiering W, Kalkman CJ, van Solinge WW, Dohmen DA. (2019) Measuring Free-Living Physical Activity With Three Commercially Available Activity Monitors for Telemonitoring Purposes: Validation Study. *JMIR Form Res*; 3(2):e11489.
19. Böhm B, Karwiese SD, Böhm H, Oberhoffer R. (2019) Effects of Mobile Health Including Wearable Activity Trackers to Increase Physical Activity Outcomes Among Healthy Children and Adolescents: Systematic Review. *JMIR Mhealth Uhealth*; 7(4):e8298.
21. Chaplais E, Naughton G, Thivel D, Courteix D, Greene D. (2015) Smartphone Interventions for Weight Treatment and Behavioral Change in Pediatric Obesity: A Systematic Review. *Telemed J E Health*; 21(10):822-30.
22. Feehan LM, Geldman J, Sayre EC, Park C, Ezzat AM, Yoo JY, Hamilton CB, Li LC. (2018) Accuracy of Fitbit Devices: Systematic Review and Narrative Syntheses of Quantitative Data. *JMIR Mhealth Uhealth*; 6(8):e10527.
23. Jo A, Coronel BD, Coakes CE, Mainous AG 3rd. (2019) Is There a Benefit to Patients Using Wearable Devices Such as Fitbit or Health Apps on Mobiles? A Systematic Review. *Am J Med*; 132(12):1394-1400.e1.
24. Cheatham SW, Stull KR, Fantigrassi M, Motel I. (2018) The efficacy of wearable activity tracking technology as part of a weight loss program: a systematic review. *J Sports Med Phys Fitness*; 58(4):534-548.



# Évaluation des aptitudes cardiorespiratoires en obésité pédiatrique

Thivel, D., Fillon, A., Masurier J., Aucouturier J.



*Dans ECOG E-Book, 2017*

# Évaluation des aptitudes cardiorespiratoires en obésité pédiatrique

[ebook.ecog-obesity.eu/fr/depense-energetique-activite-physique/evaluation-des-aptitudes-cardiorespiratoires-en-obesite-pediatrique/](http://ebook.ecog-obesity.eu/fr/depense-energetique-activite-physique/evaluation-des-aptitudes-cardiorespiratoires-en-obesite-pediatrique/)



## **David Thivel**

Université Clermont Auvergne, EA 3533, Laboratoire des adaptations métaboliques à l'exercice en conditions physiologiques et pathologiques (AME2P), BP 80026, F-63171 Aubière cedex, France

## **Alicia Fillon**

Université Clermont Auvergne, EA 3533, Laboratoire des adaptations métaboliques à l'exercice en conditions physiologiques et pathologiques (AME2P), BP 80026, F-63171 Aubière cedex, France

SSR Nutrition Obésité UGECAM, Clermont-Ferrand, France

## **Julie Masurier**

SSR Nutrition Obésité UGECAM, Clermont-Ferrand, France

## **Julien Aucouturier**

Université Droit et Santé Lille 2, EA 4488 "Activité Physique, Muscle, Santé", Faculté des Sciences du Sport et de l'Éducation Physique, 59790 Ronchin, France

## **Correspondance:**

THIVEL David

Laboratoire des Adaptations Métaboliques à l'Exercice en conditions Physiologiques et Pathologiques (AME2P), BP 80026, F-63171 Aubière cedex, France

[David.Thivel@univ-bpclermont.fr](mailto:David.Thivel@univ-bpclermont.fr)

## **Aptitude cardio-respiratoire des enfants et adolescents obèses.**

Les enfants et les adolescents obèses présentent en règle générale des capacités physiques globales, et plus particulièrement une aptitude cardiorespiratoire, plus faibles que celles de leurs homologues de poids normaux. L'effort accru requis pour déplacer une masse corporelle importante et une quantité excessive de masse grasse (MG) en sont les principales explications<sup>1</sup>. Chez les enfants souffrant d'une obésité sévère, cette faible aptitude cardiorespiratoire peut, en partie, résulter d'une insuffisance respiratoire, par diminution du volume de réserve expiratoire (VRE) et des capacités résiduelles fonctionnelles, notamment en raison d'une plus faible compliance pulmonaire.

He et al. n'ont observé aucune différence de fonctions pulmonaires entre des enfants minces et obèses, malgré une prévalence plus élevée de symptômes respiratoires chez les jeunes obèses, pouvant occasionnellement affecter leur capacité cardiorespiratoire<sup>6</sup>. En effet, les performances cardiorespiratoires des enfants et adolescents obèses sont inférieures lorsqu'elles sont ajustées à la masse corporelle mais, similaires voire plus élevées que celles des enfants et adolescents minces une fois exprimées en valeurs absolues. De plus, ces différences disparaissent lorsque les performances sont ajustées à la masse maigre (MM), suggérant que la capacité oxydative maximale musculaire n'est pas altérée par l'obésité chez les plus jeunes<sup>7,8</sup>. Par exemple, Lazzer et al. ont rapporté une consommation maximale d'oxygène ( $VO_{2max}$ ), exprimée en valeur absolue (L.min-1), supérieure d'environ 27% chez les jeunes obèses de 12 à 16 ans. En revanche, une fois ajusté à la MM, aucune différence ne persiste entre les adolescents obèses et les enfants de poids normaux, comme illustré par la Figure 1<sup>9</sup>.

A partir d'un test incrémental sur tapis roulant, réalisé jusqu'à épuisement, Watanabe et al. ont observé une relation significative inverse entre l'aptitude cardiorespiratoire des adolescents obèses de 12 à 15 ans et leur masse grasse (MG) corporelle<sup>7</sup>. Des méthodes de mesure indirectes ont été développées lorsque la  $VO_{2max}$  ne peut pas être évaluée directement, permettant d'obtenir des résultats corrélés à ceux issus d'une mesure directe (Queen's college step test)<sup>10</sup>. L'excès de graisse corporelle semble aussi contribuer à l'intolérance à l'effort et à une faible aptitude cardiorespiratoire chez les jeunes obèses<sup>7</sup>. Certaines études suggèrent de plus une disparité entre les effets de l'obésité entre filles et garçons. Mota et al. n'ont pas observé de différence entre les aptitudes cardiorespiratoires de garçons minces, en surpoids ou obèses à l'âge de 8 ans, alors que des filles obèses et en surpoids présentaient une aptitude aérobie inférieure à celle des filles de poids normal<sup>11</sup>. Ces données concordent avec les résultats d'une étude longitudinale qui montre une association significative entre les aptitudes cardiorespiratoires des filles mais non des garçons et l'incidence du surpoids et de l'obésité<sup>12</sup>.

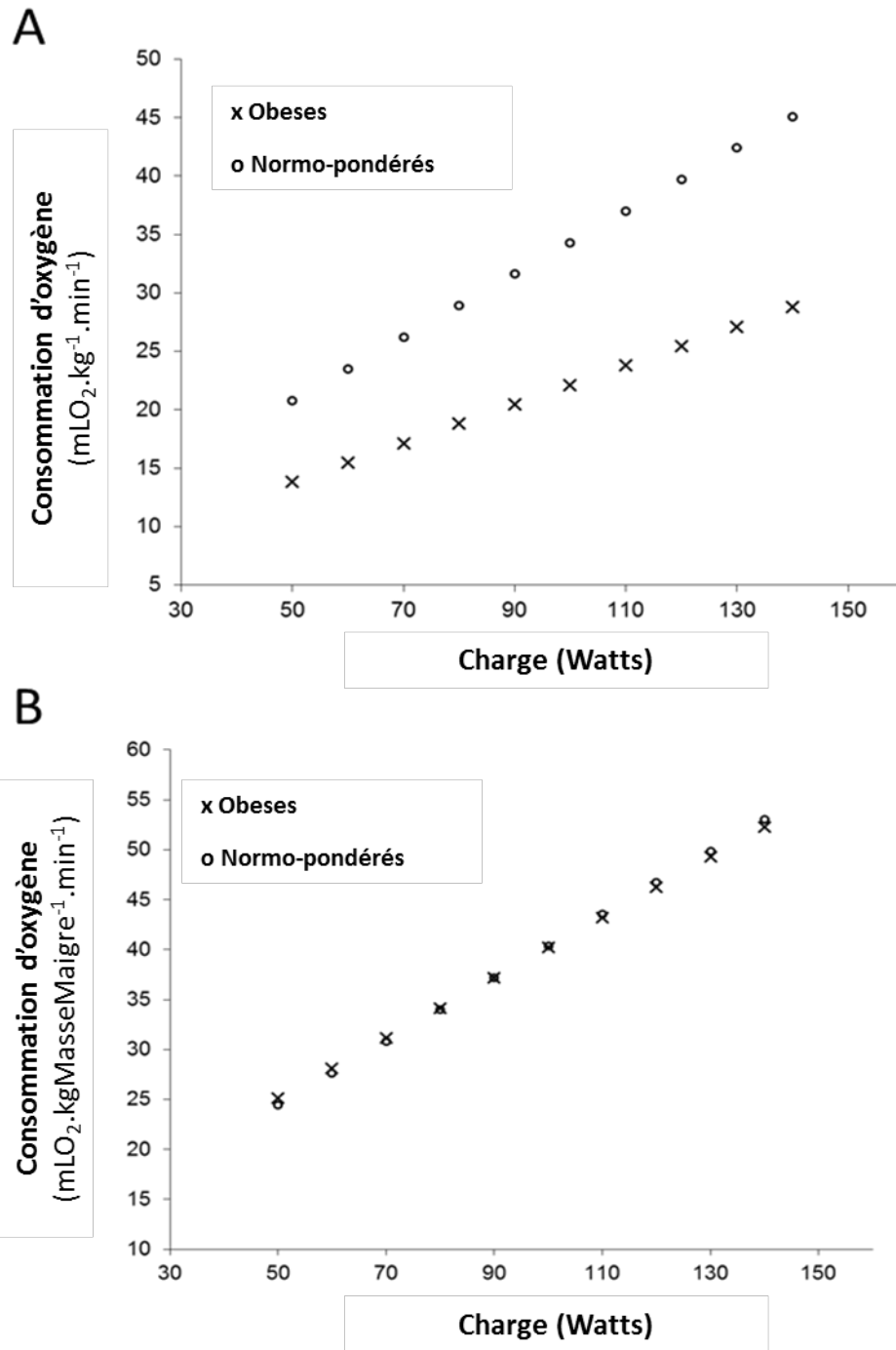

**Figure 1.** Illustration des différences de VO<sub>2</sub> entre enfants/adolescents de poids normaux et obèses en fonction de son expression, au cours d'un test d'effort progressif (par rapport à la masse corporelle (A) ou à la masse maigre (B)).

Bien que l'entraînement régulier soit la meilleure méthode pour améliorer les aptitudes cardiorespiratoires chez les jeunes obèses, leur faible condition physique initiale est un obstacle à leur engagement dans des

activités physiques régulières, expliquant en partie le faible niveau de compliance généralement observé au cours d'interventions en activité physique<sup>13</sup>.

Sur le plan clinique, un des principaux challenges à relever de manière à évaluer les effets des programmes de prise en charge est de mesurer correctement les aptitudes cardiorespiratoires des enfants et adolescents obèses, à l'aide de tests validés et adaptés.

## **Comment mesurer les aptitudes cardiorespiratoires en obésité pédiatrique ?**

*La consommation maximale d'oxygène (VO<sub>2max</sub>): le « gold standard »*

Les tests de laboratoire évaluant la capacité cardiorespiratoire mesurent ou prédisent la consommation d'oxygène (VO<sub>2max</sub>) et sont considérés comme des méthodes de référence<sup>14-17</sup>. La VO<sub>2max</sub> est évaluée dans des conditions de référence lors d'une épreuve maximale de pédalage ou de course conduite jusqu'à épuisement, avec une charge de travail croissante, exprimée en Watt lorsqu'elle est effectuée sur un ergocycle, ou via la vitesse et/ou l'inclinaison lors de la pratique sur un tapis roulant. Que ce soit sur un ergocycle ou un tapis roulant, la durée de chaque palier à une même charge de travail ou vitesse varie entre 1 et 3 minutes. Chez les enfants et les adolescents, les critères d'atteinte de VO<sub>2max</sub> sont l'épuisement subjectif, un rythme cardiaque supérieur à 195 battements.min<sup>-1</sup> et / ou un quotient respiratoire (QR : VCO<sub>2</sub> / VO<sub>2</sub>) supérieur à 1,02 et / ou un plateau de VO<sub>2</sub><sup>18</sup>. Bien que cette méthode soit largement utilisée, la réalisation d'un test d'effort maximal nécessite un fort encouragement de la part de l'investigateur ou de l'équipe médicale et reste difficile à effectuer chez les sujets obèses. Les enfants et les adolescents obèses perçoivent ces tests incrémentaux comme plus difficiles à réaliser (évaluation à l'aide d'échelles de perception de l'effort) que leurs pairs de poids normaux<sup>19</sup>, surtout à cause de la douleur et la fatigue ressenties.

Les enfants rarement engagés dans une activité physique de haute intensité ne parviennent souvent pas à atteindre les critères requis de VO<sub>2max</sub> mentionnés au cours d'un test maximal d'aptitude cardiorespiratoire. Si ces critères ne sont pas satisfaits, la consommation maximale d'oxygène mesurée est appelée VO<sub>2peak</sub> plutôt que VO<sub>2max</sub><sup>20</sup>. La VO<sub>2peak</sub> représente la consommation d'oxygène la plus élevée atteinte par le participant lors d'un protocole maximal, mais avec des critères moins stricts que ceux de l'atteinte de la VO<sub>2max</sub>. A titre d'exemple, Breithaupt et al. rapportent que seuls 18 des 62 enfants obèses étudiés, soumis à un test maximal d'aptitude cardiorespiratoire, ont été en mesure d'atteindre leur VO<sub>2max</sub> sur la base des critères présentés ci-dessus<sup>21</sup>.

Outre VO<sub>2max</sub>, deux seuils ventilatoires (SV1 et SV2) peuvent être déterminés lors d'un test incrémental, chacun étant caractérisé par une augmentation disproportionnée de la ventilation (VE) par rapport à l'augmentation de VO<sub>2</sub>. SV1 et SV2 sont considérés comme de bons indicateurs physiologiques de l'endurance cardiorespiratoire, mais restent difficiles à déterminer avec précision chez les enfants et les adolescents obèses en raison d'une fréquence respiratoire trop irrégulière. Ces seuils seraient pratiquement indétectables chez 20% des enfants et des adolescents<sup>22, 23</sup>. Malgré ces limitations, la détermination des seuils ventilatoires peut être utilisée pour la prescription d'exercice. Ainsi, l'entraînement à une intensité inférieure au SV1 représentera une intensité d'exercice modérée qui favorisera l'oxydation des graisses<sup>24</sup>. L'entraînement alternant des intensités modérées et élevées (entre SV1 et SV2) est associé à une réduction des facteurs de risque cardiovasculaire<sup>25</sup> et l'exercice au SV2 peut réduire la consommation d'énergie post-exercice<sup>26</sup>.

Les tests de laboratoire maximaux avec mesure de l'échange gazeux représentent certes la méthode la plus précise pour évaluer les capacités cardiorespiratoires, mais ils restent coûteux et souvent inaccessibles aux patients ou à de nombreux praticiens. Des tests sous-maximaux ont donc été développés et validés dans la population pédiatrique générale<sup>27</sup>, et sont de mieux en mieux adaptés aux jeunes obèses.

### *Tests sous-maximaux: du laboratoire au terrain*

Les tests d'effort sous-maximaux validés offrent une alternative précieuse et fiable pour estimer la  $VO_{2max}$ . Les mesures sous-maximales n'exigent pas que les participants déploient leurs efforts jusqu'à épuisement, permettant ainsi de surmonter certaines limites inhérentes aux tests maximaux. Ils sont aussi mieux tolérés par les patients présentant certaines limitations à l'effort physique, une fatigue importante ou des douleurs pendant l'exercice<sup>17</sup>.

Généralement, des extrapolations de  $VO_{2max}$  ou de puissance maximale sont réalisées à partir de la fréquence cardiaque maximale théorique (FC) et de la relation linéaire entre la puissance de travail (ou  $VO_2$ ) et la fréquence cardiaque mesurée lors d'épreuves comprenant au moins deux paliers d'intensités sous-maximales<sup>28</sup>. L'estimation des capacités cardiorespiratoires peut aussi être effectuée à l'aide d'autres variables prédictives tels le temps de récupération de la fréquence cardiaque au cours de step-tests<sup>29, 30</sup> ou des équations prédictives validées reposant sur différents paramètres : l'âge, le sexe, le poids corporel, la fréquence cardiaque de repos entre autres<sup>31-33</sup>.

Récemment, Breithaupt et al. ont proposé un nouveau protocole sous-maximal adapté aux jeunes obèses (protocole HALO: protocole de groupe de recherche Healthy Active Living and Obesity) qu'ils ont comparé à un test maximal progressif réalisé jusqu'à épuisement chez 21 adolescents obèses<sup>34</sup>. Ce protocole repose sur un test de marche composé de paliers consécutifs de 4 minutes réalisés à vitesse constante (rapide mais confortable) afin de s'assurer que l'état d'équilibre de la  $VO_2$  et de la FC est atteint. Après un échauffement de 4 minutes, l'inclinaison du tapis roulant est augmentée de 3% à chaque palier. Le test se termine lorsque le participant: i) atteint 85% de sa FC maximale estimée; ii) a accompli 20 minutes d'exercice; iii) indique qu'il ne peut plus continuer. La  $VO_{2peak}$  est alors prédite en extrapolant la relation linéaire FC- $VO_2$  à la  $FC_{max}$  prédite par l'âge. Alors que seul 29% de l'échantillon atteint un plateau de  $VO_2$  pendant le test maximal, tous les participants ont terminé le protocole HALO et ont jugé l'effort moins difficile. Le protocole sous-maximal HALO propose donc une méthode précise et validée pour estimer  $VO_{2peak}$  par rapport à un test maximal classique. En outre, ce test estime mieux le  $VO_{2peak}$  que les méthodes sous-maximales validées jusqu'à présent chez les jeunes obèses<sup>34</sup>.

Un protocole sous-maximal plus court a également été validé chez les adolescents obèses par rapport à une mesure de  $VO_{2max}$  en laboratoire. Nemeth et al. ont demandé à 113 garçons et filles obèses, de 12 ans, de réaliser un exercice de 4 minutes sur tapis roulant<sup>33</sup>. Après un échauffement de 4 minutes à une vitesse de marche de confort choisie par l'adolescent (inclinaison du tapis roulant = 0%); les participants ont été invités à maintenir cette vitesse pendant 4 minutes alors que l'inclinaison du tapis roulant augmentait à 5%. La fréquence cardiaque a été enregistrée au repos et à la fin des 4 minutes et la vitesse de marche notée. S'appuyant sur ces deux variables, les auteurs proposent une équation d'estimation de  $VO_{2max}$  incluant le sexe, le poids (kg) et la taille (cm).

Ces méthodes simples qui ne requièrent que la mesure des FC, prédisent avec précision  $VO_{2max}$  chez les enfants et les adolescents obèses et en surpoids<sup>33</sup> et offrent aux praticiens des méthodes réalisables d'évaluation de la condition cardiorespiratoire. Plusieurs méthodes de terrain peu coûteuses, faciles à mettre en œuvre et reproductibles, initialement validées chez les enfants de poids normaux sont communément utilisées chez les jeunes obèses<sup>17, 35-37</sup>. Les deux principaux tests de terrain utilisés sont le test de marche de six minutes (TM6) et le test navette. Le test de marche de 6 minutes est une méthode précise et pratique pour évaluer la capacité cardiorespiratoire à une intensité sous-maximale chez les enfants<sup>38</sup>. Il est démontré qu'il reflète mieux les activités de la vie quotidienne que tout autre test de marche fonctionnel<sup>39</sup>. Les valeurs de référence établies récemment facilitent l'utilisation du TM6 et permettent de déterminer la qualité de la capacité cardiorespiratoire d'un enfant<sup>40-44</sup>.

Plusieurs études rapportent de façon prévisible des distances parcourues inférieures chez les enfants obèses par rapport aux enfants et adolescents minces lors d'un TM6<sup>45, 46</sup>. Elloumi et al. ont confirmé la validité du TM6 chez les adolescents obèses par comparaison avec un protocole sous-maximal incrémental validé avec des mesures d'échange gazeux<sup>47</sup>. Le TM6 s'avère sensible aux changements de condition physique des adolescents obèses liés à un programme d'activité physique de 2 mois<sup>47, 48</sup>. Le TM6 a également été utilisé pour estimer le point maximal d'oxydation des graisses (Fatmax ou Lipoxmax), lorsque la mesure des échanges gazeux et l'utilisation de la VO<sub>2</sub> et VCO<sub>2</sub> pour calculer le taux d'oxydation des graisses n'est pas disponible (en utilisant la distance effectuée pendant le test comme valeur centrale dans une équation prédictive)<sup>49</sup>.

Le test navette développé par Leger et al. est l'un des tests de terrain les plus utilisés pour évaluer la condition cardiorespiratoire chez les jeunes<sup>50</sup>. Au cours de ce test, les enfants sont invités à courir le plus longtemps possible, entre deux lignes espacées de 20 mètres, à une vitesse croissante imposée par un enregistrement sonore émettant des tonalités à des intervalles donnés. Le test commence à 8 km/h et augmente de 0,5 km / h toutes les minutes. Le test se termine lorsque le participant n'est plus en mesure de terminer un palier. Castro-Pineiro et al. ont montré que les enfants en surpoids et obèses ont des performances plus faibles que les enfants minces à ce test<sup>51</sup>, en raison en particulier d'une vitesse de course trop élevée dès le premier palier (8 km/h). Ceci a conduit au développement d'une version adaptée du test navette : 15 paliers allant de 1,8 à 10,3 km/h sur une distance de 10 mètres<sup>36</sup>. Plus récemment, une autre version adaptée du test navette a été développée pour les enfants et adolescents obèses<sup>52</sup>. Dix paliers ont été ajoutés au début du test navette d'origine afin de réduire la vitesse de départ et la vitesse sur la durée du test<sup>52</sup>. Ensuite, on demande aux participants de débiter l'épreuve à 4 km/h (vitesse de marche) avec un incrément de 0,5 km/h toutes les minutes. La vitesse initiale de 8 km/h est atteinte après 10 minutes. Les auteurs ont montré une forte corrélation entre la vitesse maximale obtenue et la VO<sub>2</sub> maximale évaluée en laboratoire ( $r = 0,81$ ), ce qui suggère la validité de cette version adaptée du test chez les jeunes obèses<sup>52</sup>.

## Conclusions et recommandations

La capacité cardiorespiratoire réduite des enfants et adolescents obèses, constitue l'une des principales raisons de leur pratique réduite des activités physiques. L'évaluation correcte de la capacité cardiorespiratoire dans cette population a un double intérêt. Tout d'abord, elle constitue un paramètre clinique important pour le diagnostic et le suivi de la santé fonctionnelle et métabolique, de ces sujets. Une évaluation directe et maximale devrait donc être encouragée. D'un point de vue plus pratique, la capacité cardiorespiratoire est une information nécessaire à la mise en œuvre de programmes de prise en charge de l'obésité, reposant sur l'activité physique. Disposer des indicateurs de la capacité cardiorespiratoire aidera les praticiens et / ou les éducateurs à prescrire correctement les activités physiques en déterminant les intensités d'exercices appropriées et en contrôlant leur progression durant ces interventions. Lorsque la mesure directe de la VO<sub>2max</sub> n'est pas disponible, les tests sous-maximaux et de terrain sont des alternatives fiables. Grâce à leur faisabilité, ces tests peuvent être répétés plusieurs fois pendant le programme et permettre une éventuelle adaptation de la prescription d'exercices.

## Références

1 Dupuis JM, Vivant JF, Daudet G, Bouvet A, Clement M, Dazord A, *et al.* [Personal sports training in the management of obese boys aged 12 to 16 years]. *Arch Pediatr.* 2000; 7: 1185-93.

- 2 Fung KP, Lau SP, Chow OK, Lee J, Wong TW. Effects of overweight on lung function. *Arch Dis Child*. 1990; 65: 512-15.
- 3 Ferretti A, Giampiccolo P, Cavalli A, Milic-Emili J, Tantucci C. Expiratory flow limitation and orthopnea in massively obese subjects. *Chest*. 2001; 119: 1401-8.
- 4 Zerah F, Harf A, Perlemuter L, Lorino H, Lorino AM, Atlan G. Effects of obesity on respiratory resistance. *Chest*. 1993; 103: 1470-6.
- 5 Ray CS, Sue DY, Bray G, Hansen JE, Wasserman K. Effects of obesity on respiratory function. *Am Rev Respir Dis*. 1983; 128: 501-6.
- 6 He QQ, Wong TW, Du L, Jiang ZQ, Qiu H, Gao Y, *et al*. Respiratory health in overweight and obese Chinese children. *Pediatr Pulmonol*. 2009; 44: 997-1002.
- 7 Watanabe K, Nakadomo F, Maeda K. Relationship between body composition and cardiorespiratory fitness in Japanese junior high school boys and girls. *Ann Physiol Anthropol*. 1994; 13: 167-74.
- 8 Goran MI. Energy metabolism and obesity. *Med Clin North Am*. 2000; 84: 347-62.
- 9 Lazzer S, Boirie Y, Bitar A, Petit I, Meyer M, Vermorel M. Relationship between percentage of VO<sub>2</sub>max and type of physical activity in obese and non-obese adolescents. *J Sports Med Phys Fitness*. 2005; 45: 13-9.
- 10 Chatterjee S, Chatterjee P, Bandyopadhyay A. Validity of Queen's College Step Test for estimation of maximum oxygen uptake in female students. *Indian J Med Res*. 2005; 121: 32-5.
- 11 Mota J, Flores L, Ribeiro JC, Santos MP. Relationship of single measures of cardiorespiratory fitness and obesity in young schoolchildren. *Am J Hum Biol*. 2006; 18: 335-41.
- 12 Kim J, Must A, Fitzmaurice GM, Gillman MW, Chomitz V, Kramer E, *et al*. Relationship of physical fitness to prevalence and incidence of overweight among schoolchildren. *Obes Res*. 2005; 13: 1246-54.
- 13 Quinart S, Mougin-Guillaume F, Simon-Rigaud ML, Bertrand AM, Negre V. [Sports counseling for overweight children]. *Arch Pediatr*. 2010; 17: 894-5.
- 14 Balke B, Ware R. An experimental study of Air Force personnel. *US Armed Forces Med Journal*. 1959; 10: 675-88.
- 15 Bruce RA, Kusumi F, Hosmer D. Maximal oxygen intake and nomographic assessment of functional aerobic impairment in cardiovascular disease. *Am Heart J*. 1973; 85: 546-62.
- 16 Patterson JA, Naughton J, Pietras RJ, Gunnar RM. Treadmill exercise in assessment of the functional capacity of patients with cardiac disease. *Am J Cardiol*. 1972; 30: 757-62.
- 17 Noonan V, Dean E. Submaximal exercise testing: clinical application and interpretation. *Phys Ther*. 2000; 80: 782-807.
- 18 Rowland TW. Developmental Exercise physiology. . Human Kinetics ed edn. Champaign, IL 1996.
- 19 Marinov B, Kostianev S, Turnovska T. Ventilatory efficiency and rate of perceived exertion in obese and non-obese children performing standardized exercise. *Clin Physiol Funct Imaging*. 2002; 22: 254-60.
- 20 Wagner PD. New ideas on limitations to VO<sub>2</sub>max. *Exerc Sport Sci Rev*. 2000; 28: 10-4.
- 21 Breithaupt PG, Colley RC, Adamo KB. Using the oxygen uptake efficiency slope as an indicator of cardiorespiratory fitness in the obese pediatric population. *Pediatr Exerc Sci*. 2012; 24: 357-68.
- 22 Washington RL, van Gundy JC, Cohen C, Sondheimer HM, Wolfe RR. Normal aerobic and anaerobic exercise data for North American school-age children. *J Pediatr*. 1988; 112: 223-33.
- 23 Owens S, Gutin B. Exercise testing of the child with obesity. *Pediatr Cardiol*. 1999; 20: 79-83; discussion 84.
- 24 Lazzer S, Lafortuna C, Busti C, Galli R, Tinozzi T, Agosti F, *et al*. Fat oxidation rate during and after a low- or high-intensity exercise in severely obese Caucasian adolescents. *Eur J Appl Physiol*. 2010; 108: 383-91.



- 25 Tjonna AE, Stolen TO, Bye A, Volden M, Slordahl SA, Odegard R, *et al.* Aerobic interval training reduces cardiovascular risk factors more than a multitreatment approach in overweight adolescents. *Clin Sci (Lond)*. 2009; 116: 317-26.
- 26 Thivel D, Isacco L, Montaurier C, Boirie Y, Duche P, Morio B. The 24-h energy intake of obese adolescents is spontaneously reduced after intensive exercise: a randomized controlled trial in calorimetric chambers. *PLoS One*. 2012; 7: e29840.
- 27 Cottin F, Lepretre PM, Lopes P, Papelier Y, Medigue C, Billat V. Assessment of ventilatory thresholds from heart rate variability in well-trained subjects during cycling. *Int J Sports Med*. 2006; 27: 959-67.
- 28 Astrand I. Aerobic work capacity in men and women with special reference to age. *Acta Physiol Scand Suppl*. 1960; 49: 1-92.
- 29 Weller IM, Thomas SG, Corey PN, Cox MH. Selection of a maximal test protocol to validate the Canadian Aerobic Fitness Test. *Can J Sport Sci*. 1992; 17: 114-9.
- 30 Weller IM, Thomas SG, Cox MH, Corey PN. A study to validate the Canadian Aerobic Fitness Test. *Can J Public Health*. 1992; 83: 120-4.
- 31 Dolgener FA, Hensley LD, Marsh JJ, Fjelstul JK. Validation of the Rockport Fitness Walking Test in college males and females. *Res Q Exerc Sport*. 1994; 65: 152-8.
- 32 Ebbeling CB, Ward A, Puleo EM, Widrick J, Rippe JM. Development of a single-stage submaximal treadmill walking test. *Med Sci Sports Exerc*. 1991; 23: 966-73.
- 33 Nemeth BA, Carrel AL, Eickhoff J, Clark RR, Peterson SE, Allen DB. Submaximal treadmill test predicts VO<sub>2</sub>max in overweight children. *J Pediatr*. 2009; 154: 677-81.
- 34 Breithaupt P, Adamo KB, Colley RC. The HALO submaximal treadmill protocol to measure cardiorespiratory fitness in obese children and youth: a proof of principle study. *Appl Physiol Nutr Metab*. 2012; 37: 308-14.
- 35 Drinkard B, McDuffie J, McCann S, Uwaifo GI, Nicholson J, Yanovski JA. Relationships between walk/run performance and cardiorespiratory fitness in adolescents who are overweight. *Phys Ther*. 2001; 81: 1889-96.
- 36 Klijn PH, van der Baan-Slootweg OH, van Stel HF. Aerobic exercise in adolescents with obesity: preliminary evaluation of a modular training program and the modified shuttle test. *BMC Pediatr*. 2007; 7: 19.
- 37 Wallman KE, Campbell L. Test-retest reliability of the Aerobic Power Index submaximal exercise test in an obese population. *J Sci Med Sport*. 2007; 10: 141-6.
- 38 Nixon PA, Joswiak ML, Fricker FJ. A six-minute walk test for assessing exercise tolerance in severely ill children. *J Pediatr*. 1996; 129: 362-6.
- 39 Solway S, Brooks D, Lacasse Y, Thomas S. A qualitative systematic overview of the measurement properties of functional walk tests used in the cardiorespiratory domain. *Chest*. 2001; 119: 256-70.
- 40 Li AM, Yin J, Au JT, So HK, Tsang T, Wong E, *et al.* Standard reference for the six-minute-walk test in healthy children aged 7 to 16 years. *Am J Respir Crit Care Med*. 2007; 176: 174-80.
- 41 Geiger R, Strasak A, Treml B, Gasser K, Kleinsasser A, Fischer V, *et al.* Six-minute walk test in children and adolescents. *J Pediatr*. 2007; 150: 395-9, 99 e1-2.
- 42 Gulmans VA, van Veldhoven NH, de Meer K, Helders PJ. The six-minute walking test in children with cystic fibrosis: reliability and validity. *Pediatr Pulmonol*. 1996; 22: 85-9.
- 43 Larsson UE, Reynisdottir S. The six-minute walk test in outpatients with obesity: reproducibility and known group validity. *Physiother Res Int*. 2008; 13: 84-93.
- 44 Li AM, Yin J, Yu CC, Tsang T, So HK, Wong E, *et al.* The six-minute walk test in healthy children: reliability and validity. *Eur Respir J*. 2005; 25: 1057-60.
- 45 Calders P, Deforche B, Verschelde S, Bouckaert J, Chevalier F, Bassle E, *et al.* Predictors of 6-minute walk test and 12-minute walk/run test in obese children and adolescents. *Eur J Pediatr*. 2008; 167: 563-8.

- 46 Morinder G, Mattsson E, Sollander C, Marcus C, Larsson UE. Six-minute walk test in obese children and adolescents: reproducibility and validity. *Physiother Res Int*. 2009; 14: 91-104.
- 47 Elloumi M, Makni E, Ounis OB, Moalla W, Zbidi A, Zaoueli M, *et al*. Six-minute walking test and the assessment of cardiorespiratory responses during weight-loss programmes in obese children. *Physiother Res Int*. 2011; 16: 32-42.
- 48 Geiger R, Willeit J, Rummel M, Hogler W, Stubing K, Strasak A, *et al*. Six-minute walk distance in overweight children and adolescents: effects of a weight-reducing program. *J Pediatr*. 2011; 158: 447-51.
- 49 Makni E, Moalla W, Trabelsi Y, Lac G, Brun JF, Tabka Z, *et al*. Six-minute walking test predicts maximal fat oxidation in obese children. *Int J Obes (Lond)*. 2012; 36: 908-13.
- 50 Leger L, Mercier D, Gadoury C, Lambert J. The multistage 20 metre shuttle run test for aerobic fitness. *Journal of Sports Science*. 1988; 6: 93-101.
- 51 Castro-Pinero J, Padilla-Moledo C, Ortega FB, Moliner-Urdiales D, Keating X, Ruiz JR. Cardiorespiratory fitness and fatness are associated with health complaints and health risk behaviors in youth. *J Phys Act Health*. 2011; 9: 642-9.
- 52 Quinart S, Mougin F, Simon-Rigaud ML, Nicolet-Guenat M, Negre V, Regnard J. Evaluation of cardiorespiratory fitness using three field tests in obese adolescents: Validity, sensitivity and prediction of peak V O<sub>2</sub>. *J Sci Med Sport*. 2013; 17: 521-5.
- 53 Health GW. Behavioral approaches to physical activity promotion. In: Ehrman JK, Gordon PM, Visich PS, Keteyian SJ (eds.). *Clinical Exercise Physiology*. Human Kinetics: Champaign IL 2008; 18-19.
- 54 Visich PS, Ehrman JK. Graded exercise testing and exercise prescription. In: Ehrman JK, Gordon PM, Visich PS, Keteyian SJ (eds.). *Clinical Exercise Physiology*. Human Kinetics: Champaign IL 2008; 95.
- 55 Tsiros MD, Buckley JD, Howe PR, Walkley J, Hills AP, Coates AM. Musculoskeletal pain in obese compared with healthy-weight children. *Clin J Pain*. 2014; 30: 583-8.
- 56 Smith SM, Sumar B, Dixon KA. Musculoskeletal pain in overweight and obese children. *Int J Obes (Lond)*. 2014; 38: 11-5.
- 57 Krul M, van der Wouden JC, Schellevis FG, van Suijlekom-Smit LW, Koes BW. Musculoskeletal problems in overweight and obese children. *Ann Fam Med*. 2009; 7: 352-6.
- 58 Parameswaran K, Todd DC, Soth M. Altered respiratory physiology in obesity. *Can Respir J*. 2006; 13: 203-10.
- 59 Schiel R, Beltschikow W, Kramer G, Stein G. Overweight, obesity and elevated blood pressure in children and adolescents. *Eur J Med Res*. 2006; 11: 97-101.
- 60 Sinha R, Fisch G, Teague B, Tamborlane WV, Banyas B, Allen K, *et al*. Prevalence of impaired glucose tolerance among children and adolescents with marked obesity. *N Engl J Med*. 2002; 346: 802-10.
- 61 Wang LY, Cerny FJ. Ventilatory response to exercise in simulated obesity by chest loading. *Med Sci Sports Exerc*. 2004; 36: 780-6.
- 62 Chlif M, Keochkerian D, Feki Y, Vaidie A, Choquet D, Ahmaidi S. Inspiratory muscle activity during incremental exercise in obese men. *Int J Obes (Lond)*. 2007; 31: 1456-63.
- 63 Cooper DM, Kaplan MR, Baumgarten L, Weiler-Ravell D, Whipp BJ, Wasserman K. Coupling of ventilation and CO<sub>2</sub> production during exercise in children. *Pediatr Res*. 1987; 21: 568-72.
- 64 Rowland TW, Cunningham LN. Development of ventilatory responses to exercise in normal white children. A longitudinal study. *Chest*. 1997; 111: 327-32.
- 65 Mead J. Dyanapsis in normal lungs assessed by the relationship between maximal flow, static recoil, and vital capacity. *Am Rev Respir Dis*. 1980; 121: 339-42.
- 66 Gibson N, Johnston K, Bear N, Stick S, Logie K, Hall GL. Expiratory flow limitation and breathing strategies in overweight adolescents during submaximal exercise. *Int J Obes (Lond)*. 2014; 38: 22-6.

- 67 Belanger K, Breithaupt P, Ferraro ZM, Barrowman N, Rutherford J, Hadjiyannakis S, *et al.* Do obese children perceive submaximal and maximal exertion differently? *Clin Med Insights Pediatr.* 2013; 7: 35-40.
- 68 Ward DS, Bar-Or O. Usefulness of Borg scale in exercise prescription for overweight youth. . *Canadian Journal of Sport Science.* 1990; 15: 120-25.

### ENCADRE 1

**L'aptitude cardio-respiratoire**, ou capacité aérobie, décrit la capacité du corps à réaliser des activités d'intensités élevées ou sur une période prolongée sans stress physique ou fatigue excessive. Une aptitude cardiorespiratoire élevée permet de supporter les activités de la vie quotidienne et les activités de loisir plus facilement et avec une efficacité supérieure<sup>53</sup>.

L'**endurance cardio-respiratoire** est la capacité du système cardiorespiratoire à fournir de l'oxygène aux muscles actifs lors d'efforts prolongés sous-maximaux<sup>54</sup>.

### ENCADRE 2

#### **Facteurs limitant l'évaluation des capacités cardio-respiratoires chez le jeune obèse.**

**Douleur.** L'excès de poids inhérent au surpoids et à l'obésité est responsable d'une augmentation des douleurs musculaires, limitant l'engagement dans des activités physiques<sup>55</sup>. Dans une récente revue de la littérature, Smith et al. ont souligné le rôle joué par l'obésité chez les plus jeunes sur l'accroissement des dysfonctions et douleurs musculo-squelettiques et ostéo-articulaires<sup>56</sup>. Les enfants et adolescents en surpoids et obèses ont davantage de problèmes articulaires au niveau des genoux, poignets ou encore chevilles par rapport à leur homologues minces<sup>57</sup>. Tout ceci constitue une limite importante à la réalisation de tests physiques et favorise un arrêt prématuré des épreuves, qu'elles soient maximales ou sous-maximales.

**Limitations respiratoires.** L'obésité s'accompagne de nombreuses complications métaboliques qui limitent l'adhésion des jeunes en surpoids et obèses à des tests physiques ou programmes d'activité physique. La réduction de la compliance thoracique, ou encore l'augmentation de la résistance respiratoire à de faibles volumes respiratoires ont été entre autres identifiées<sup>58-60</sup> et contribuent à la contrainte ventilatoire<sup>61</sup>, à l'augmentation de la fatigue des muscles respiratoires<sup>62</sup>, puis à une dyspnée. Cette réponse ventilatoire à l'exercice excessive chez les plus jeunes par rapport à la demande métabolique, favorise la contrainte ventilatoire chez les enfants et adolescents obèses<sup>63, 64</sup>. Une taille de poumons inférieure<sup>65</sup> chez les jeunes obèses serait à l'origine d'une réduction du débit expiratoire défavorable à la compliance à des épreuves maximales et sous-maximales<sup>66</sup>.

**Perception de l'effort (RPE).** Bien que peu de données soient disponibles sur la perception de l'effort lors d'une épreuve incrémentale chez l'enfant obèse, il semble que sa perception de la difficulté lors d'un test d'évaluation des aptitudes cardio-respiratoires soit exacerbée par rapport à celle des enfants minces<sup>19</sup>. Belanger et al. ont également mis en exergue une perception de l'effort plus élevée chez des adolescents obèses lors d'une épreuve maximale par rapport à une épreuve sous-maximale<sup>67</sup>. D'après Ward & Bar-Or, l'excès de poids et la capacité physique moindre induits par l'obésité, augmentent la perception des difficultés induites par l'exercice, et s'avère l'une des principales limitations à ces activités<sup>68</sup>. Cette perception exacerbée de la difficulté à l'effort favorise très certainement l'arrêt prématuré des tests physiques et peut donc générer une sous-estimation des aptitudes aérobies.

~ Les auteurs ~

## **David Thivel**



Université Clermont Auvergne, EA 3533, Laboratoire des adaptations métaboliques à l'exercice en conditions physiologiques et pathologiques (AME2P), BP 80026, F-63171 Aubière cedex, France

## **Alicia Fillon**

Université Clermont Auvergne, EA 3533, Laboratoire des adaptations métaboliques à l'exercice en conditions physiologiques et pathologiques (AME2P), BP 80026, F-63171 Aubière cedex, France

SSR Nutrition Obésité UGECAM, Clermont-Ferrand, France

## **Julie Masurier**

SSR Nutrition Obésité UGECAM, Clermont-Ferrand, France

## **Julien Aucouturier**



Université Droit et Santé Lille 2, EA 4488 "Activité Physique, Muscle, Santé", Faculté des Sciences du Sport et de l'Éducation Physique, 59790 Ronchin, France

**~ Comment utiliser cet article ~**

Vous êtes autorisé(e) à utiliser, partager et copier cet article en le citant comme suit :

*David Thivel, Fillon A, Masurier J, Aucouturier J (2017). Évaluation des aptitudes cardiorespiratoires en obésité pédiatrique. Dans M.L. Frelut (Ed.), Le livre électronique (eBook) de l'ECOG sur l'obésité des enfants et des adolescents. Téléchargé sur [ebook.ecog-obesity.eu](http://ebook.ecog-obesity.eu).*

Assurez-vous également de donner de créditer de façon appropriée ce contenu lors de son utilisation. Visitez [ebook.ecog-obesity.eu/fr/conditions-utilisation/sommaire/](http://ebook.ecog-obesity.eu/fr/conditions-utilisation/sommaire/) pour plus d'informations.

**~ Mot final ~**

Merci pour votre intérêt dans cet article. Si vous pensez que cela que quelqu'un d'autre peut être intéressé n'hésitez pas à le partager ! Enfin rendez-vous sur [ebook.ecog-obesity.eu](http://ebook.ecog-obesity.eu) pour découvrir d'autres articles.

**Intervention en activité physique chez les enfants et les adolescents en surpoids/obèses : entraînement en endurance et/ou en résistance ?**

Aucouturier J., Fillon, A., Masurier J., Thivel, D.



*Dans ECOG E-Book, 2017*

# **Intervention en activité physique chez les enfants et les adolescents en surpoids/obèses : entraînement en endurance et/ou en résistance ?**

[ebook.ecog-obesity.eu/fr/depense-energetique-activite-physique/intervention-en-activite-physique-chez-les-enfants-et-les-adolescents-en-surpoids-obeses-entrainement-en-endurance-et-ou-en-resistance](http://ebook.ecog-obesity.eu/fr/depense-energetique-activite-physique/intervention-en-activite-physique-chez-les-enfants-et-les-adolescents-en-surpoids-obeses-entrainement-en-endurance-et-ou-en-resistance)



## **Julien Aucouturier**

Université Droit et Santé Lille 2, EA 4488 "Activité Physique, Muscle, Santé", Faculté des Sciences du Sport et de l'Education Physique, 59790 Ronchin, France

## **Alicia Fillon**

Université Clermont Auvergne, EA 3533, Laboratoire des Adaptations Métaboliques à l'Exercice en conditions Physiologiques et Pathologiques (AME2P), BP 80026, F-63171 Aubière cedex, France

SSR Nutrition Obésité UGECAM, Clermont-Ferrand, France

## **Julie Masurier**

SSR Nutrition Obésité UGECAM, Clermont-Ferrand, France

## **David Thivel**

Université Clermont Auvergne, EA 3533, Laboratoire des Adaptations Métaboliques à l'Exercice en conditions Physiologiques et Pathologiques (AME2P), BP 80026, F-63171 Aubière cedex, France

## **Correspondance:**

THIVEL David

Laboratoire des Adaptations Métaboliques à l'Exercice en conditions Physiologiques et Pathologiques (AME2P), BP 80026, F-63171 Aubière cedex, France

[David.Thivel@univ-bpclermont.fr](mailto:David.Thivel@univ-bpclermont.fr)



## Introduction

L'obésité infantile et ses complications métaboliques sont associées à une activité physique insuffisante, à une sédentarité excessive ainsi qu'à de mauvaises habitudes alimentaires, tous ces facteurs constituant un mode de vie délétère<sup>1, 2</sup>. Les programmes de prévention primaire promeuvent les bienfaits de l'activité physique régulière et de saines habitudes alimentaires. Des interventions éducatives en milieu scolaire plébiscitent un mode de vie sain, la plupart du temps associé à des séances d'activité physique (au moins deux fois par semaine)<sup>3, 4</sup>. Ces interventions ciblant la population générale constituent une prévention efficace de l'accumulation excessive de graisse corporelle et améliorent la condition physique chez les enfants et les adolescents<sup>3, 4</sup>.

Cependant, les jeunes souffrant d'obésité ont souvent besoin de programmes plus structurés. La plupart des études ont jusqu'à présent suggéré que l'augmentation du niveau d'activité physique combinée à une diminution de l'apport énergétique pouvait améliorer la composition corporelle et la santé en général chez les enfants et les adolescents en surpoids ou obèses<sup>5</sup>. Les interventions en activité physique reposaient principalement et jusqu'à une période récente sur des exercices d'endurance, combinés ou non à des interventions alimentaires. L'entraînement en résistance n'a gagné en intérêt que récemment.

L'exercice en endurance ou exercice aérobie, correspond à un effort prolongé, réalisé à une intensité faible à modérée et s'appuyant principalement sur le métabolisme aérobie<sup>6</sup>.

L'exercice en résistance implique la force musculaire et se compose principalement d'exercices isométriques, isotoniques ou isocinétiques. L'entraînement en résistance est conçu pour permettre une plus grande opposition afin de développer la force musculaire et l'endurance anaérobie. L'exercice en résistance a longtemps été proscrit chez les enfants et les adolescents, en raison d'un risque supposé accru de blessures musculo-squelettiques ou d'effets négatifs sur le processus de maturation de par les contraintes mécaniques induites. Dans le cas de l'obésité, l'entraînement en résistance n'était pas conseillé compte tenu de la faible dépense énergétique qui en résulte et donc du peu d'effet sur l'adiposité<sup>7</sup>.

De nombreuses études récentes ont montré que l'entraînement en résistance pouvait être réalisé en toute sécurité et de façon bénéfique pour les jeunes obèses lorsqu'ils sont encadrés correctement et avec prudence par des professionnels, selon les directives établies<sup>8-10</sup>. Puisqu'il est particulièrement difficile pour les jeunes obèses d'effectuer une activité physique<sup>11</sup>, il est nécessaire de mettre au point une prescription d'exercice favorisant leur adhésion, l'entraînement en résistance pouvant alors prouver son efficacité. Le but de ce chapitre est de fournir un aperçu des connaissances actuelles sur l'efficacité de l'endurance et / ou des exercices en résistance dans le but de perdre du poids chez les enfants et les adolescents en surpoids et obèses.

## Des interventions en endurance ou en résistance ?

L'Organisation Mondiale de la Santé recommande actuellement au moins 60 minutes d'activité physique modérée à vigoureuse, avec des exercices qui renforcent les muscles et les os au moins 3 jours par semaine, de nombreuses études utilisent ce type de programmes avec des volumes d'exercice similaires. Les programmes d'exercices aérobies structurés avec des séances de 3 à 5 fois par semaine, d'intensité modérée jusqu'à 60 minutes, sont les interventions de perte de poids les plus couramment mises en œuvre chez les enfants et les adolescents<sup>12, 13</sup>. Elles se sont révélées efficaces pour améliorer à court terme l'indice de masse corporelle (IMC), la masse grasse (MG), la pression artérielle (PA) ou encore la concentration plasmatique en triglycérides<sup>14</sup>.

L'entraînement aérobie est habituellement proposé aux jeunes obèses mais leur faible compliance à ce type d'exercice demeure une limitation importante<sup>15</sup>. La pénibilité moins importante de l'exercice en résistance peut offrir une forme mieux acceptée d'activité physique chez ces enfants et adolescents<sup>16</sup>. En

effet, les exercices d'endurance ne sont souvent pas bien tolérés dans cette population en raison de la masse corporelle supplémentaire à mobiliser par rapport à leurs pairs de poids normal<sup>17</sup>. Comme décrit par McGuigan et al., les programmes d'exercices aérobies peuvent ne pas être bien tolérés par les personnes obèses / en surpoids en raison de leur poids corporel important qui augmente l'intensité des activités à poids porté, exacerbe la perception de la difficulté et ainsi favorise l'abandon de l'effort<sup>18</sup>. De plus, le faible niveau de condition physique aérobie des jeunes obèses<sup>19</sup> limite l'intensité de l'exercice d'endurance, contrairement aux exercices de résistance pour lesquels leur masse musculaire élevée constitue un avantage plutôt qu'un inconvénient<sup>20</sup>. L'entraînement en résistance peut donc représenter une bonne option pour améliorer leur adhésion à l'activité physique<sup>16</sup>. Cet entraînement à longterm a été évité chez les enfants et les adolescents par crainte de blessures musculo-squelettiques<sup>21</sup>. Il est maintenant clair qu'ils peuvent le réaliser en toute sécurité<sup>22, 24</sup>, d'où un intérêt croissant pour ce type d'exercice chez les jeunes obèses<sup>16, 25-28</sup>.

Les enfants et adolescents obèses sont fréquemment présentés comme ayant une masse musculaire plus élevée que leurs homologues de poids normaux, et par conséquent, comme capables de meilleures performances lors d'exercices impliquant force et puissance. Ils peuvent ainsi adhérer davantage aux programmes d'exercices en résistance, avec pour conséquence des effets favorables sur la confiance et l'estime de soi<sup>16</sup>. Les avantages de ce type d'exercice, un programme d'intensité modérée et de résistance progressive de 10 semaines (avec un suivi d'un an) chez les enfants obèses âgés de 7 à 12 ans se sont révélés comparables à ceux observés chez des adultes<sup>26</sup>. Bien que l'entraînement en résistance puisse offrir une excellente alternative pour augmenter le taux d'adhérence aux programmes d'exercices, ses effets exacts sur la composition corporelle, la condition physique et l'état métabolique des enfants et des adolescents obèses restent à clarifier et à comparer à ceux induits par l'entraînement en endurance.

### ***Effets sur la composition corporelle***

De nombreux travaux attestent que l'entraînement en endurance permet une réduction du poids corporel, de l'IMC, du tour de taille et de la MG chez les enfants et adolescents obèses<sup>29-34</sup>. Les intensités favorisant l'oxydation des graisses sont mises en exergue pour diminuer le stockage des lipides et augmenter la perte de MG. Fondée sur le modèle du Fatmax ou du Lipox max (voir encadré 2) proposé par Brooks et Mercier<sup>35</sup>, l'efficacité de l'entraînement au Lipox max a été testée chez les jeunes obèses<sup>29</sup>. Des résultats favorables ont été observés sur le poids corporel et la composition corporelle : un entraînement aérobie de 2 mois (45 minutes par jour) au Lipox max (individuellement calibré) combiné à un régime hypocalorique de -300 kcal s'est montré efficace pour améliorer l'intensité du Lipox max de 12,5% et le cross-over de 17% (voir encadré 2)<sup>29</sup>.

Ces résultats mettent en évidence la pertinence de telles interventions pour améliorer la capacité d'oxydation des graisses pendant l'exercice chez les jeunes obèses. Ben Ounis et al. ont également souligné une capacité accrue à oxyder les graisses lors de l'exercice chez les enfants obèses, après une intervention de 2 mois fixée au Lipox max avec 90 minutes d'exercice par jour, 4 jours par semaine<sup>34</sup>. Dernièrement, Lee et al. ont comparé l'effet sur l'adiposité d'un programme d'activité physique de 3 mois composé d'exercices aérobies ou d'exercices de résistance, 180 minutes par semaine, chez des filles de 12 à 18 ans. Ces auteurs ont montré que malgré l'absence de perte de masse corporelle dans les deux groupes, le programme d'endurance a induit en soi une diminution significative du tissu adipeux viscéral ( $-15,68 \pm 7,64 \text{ cm}^2$ ) et des lipides intra-hépatiques ( $-1,70 \pm 0,74\%$ )<sup>36</sup>.

En revanche, la MG, le tissu adipeux intramusculaire et viscéral ainsi que les lipides intrahépatiques n'ont diminué que de façon non significative avec l'entraînement en résistance<sup>36</sup>. Après un programme en résistance de 12 semaines (2 séances d'une heure par semaine), Van der Heijden et al. ont rapporté une augmentation du poids corporel chez des adolescentes en surpoids/obèses de 15 ans mais 80% de cette augmentation était due à une augmentation de la masse maigre (MM) (de 55,7 à 57,9 kg)<sup>37</sup>, confirmant

ainsi les résultats précédents qui montraient une augmentation de la MM après un entraînement en résistance de 6 semaines chez les enfants obèses<sup>28</sup>. Van der Heijden et al. n'ont pas observé de diminution de la graisse viscérale, hépatique ni intramyocellulaire<sup>38</sup>.

En revanche, avec le même volume d'activité physique, mais avec un seul exercice aérobie, les MG totales, viscérales et hépatiques ont diminué de façon significative et la sensibilité à l'insuline périphérique et hépatique a augmenté<sup>37,39</sup>. Sur la base de programmes de durée similaire, Van der Heijden et ses collègues ont montré qu'une séance aérobie par semaine n'affecte pas la teneur en lipides intramusculaires alors que la quantité de lipides hépatiques a diminué de  $8,9 \pm 3,2$  à  $5,6 \pm 1,8\%$  et la graisse viscérale de  $54,7 \pm 6,0$  à  $49,6 \pm 5,5 \text{ cm}^2$ <sup>37</sup>.

Sgro et al. ont exploré l'effet de la durée de l'entraînement en résistance sur la composition corporelle chez des enfants de 7 à 12 ans, s'entraînant 3 fois par semaine, pendant 8, 16 ou 24 semaines. Leur composition corporelle après 8 semaines de programme est améliorée avec une réduction de 5 à 7% de la graisse corporelle et de 8,1% après 16 semaines d'intervention<sup>17</sup>. Les résultats précédents montrant une amélioration significative de la composition corporelle par 8 semaines de programme en résistance (3 séances par semaine) sont ainsi confirmés<sup>18</sup>. De même, 8 semaines d'entraînement en résistance (3 jours par semaine) montrent une réduction de la MG chez les enfants en surpoids et obèses<sup>18, 25</sup>. D'autres auteurs rapportent des résultats légèrement différents chez les enfants prépubères après 12 semaines d'entraînement en résistance à intensité modérée (2 séances de 75 min / semaine) : le poids corporel, la MM et l'IMC ont augmenté, sans modification du pourcentage de MG<sup>40</sup>.

Sur la base d'une analyse systématique, Dietz et al. soulignent que l'entraînement en résistance chez les jeunes obèses est associé à une augmentation de l'IMC et du poids corporel, sans aucune modification de la MG totale<sup>20</sup>. Treuth et al. ont même observé une augmentation de la MG après une intervention en résistance mais c'est à notre connaissance le seul travail ayant observé de tels résultats<sup>27</sup>. Au regard des données disponibles, l'entraînement en résistance ne favorise une diminution de la MG qu'en association à une restriction énergétique<sup>7,16,28</sup>. Alors que les restrictions alimentaires font partie des stratégies de perte de poids chez les enfants et les adolescents en surpoids et obèses, les programmes axés sur la résistance offrent une excellente possibilité de contrecarrer la réduction du métabolisme de base et de la MM, associées à la perte de poids ainsi induite<sup>5</sup>. En plus de ses effets sur la MG et la MM, l'exercice de résistance a également des effets bénéfiques sur l'os<sup>41,42</sup>. Une augmentation du contenu minéral osseux a été observée après un entraînement en résistance de 6 semaines avec des exercices effectués à 70-85% de la Répétition Maximale (RM) des individus, alors que le pourcentage de MG restait inchangé<sup>43</sup>.

Plusieurs études récentes ont comparé l'effet de l'entraînement aérobie seul à des programmes combinant des exercices d'endurance et de résistance. Campos et al. ont demandé à 42 adolescents obèses de suivre un programme de perte de poids avec suivi psychologique, restriction alimentaire et soit des exercices d'endurance, soit une combinaison d'exercices de résistance et d'endurance. Bien que les deux programmes aient entraîné une diminution de l'IMC, de la graisse viscérale et sous-cutanée, de la concentration d'insuline à jeun et de l'indice de résistance à l'insuline (indice HOMA), seule la combinaison d'exercices aérobies et de résistance a permis d'améliorer le contenu minéral osseux, la concentration en adiponectine et la MM<sup>44</sup>. Selon ces auteurs, la combinaison des deux modalités (endurance et résistance) joue un rôle protecteur pour l'os, combiné à l'amélioration des productions d'adipokines, réduisant l'état inflammatoire induit par l'excès d'adiposité<sup>44</sup>.

Bien que l'entraînement en résistance contribue à l'augmentation de la masse musculaire, les preuves des effets sur la graisse corporelle restent encore limitées<sup>25, 45</sup>, alors que la diminution des MG totale et surtout MG centrale sont déterminantes dans l'amélioration de la condition physique et du profil métabolique des jeunes obèses (tableau 1).

**Tableau 1.** Résumé des effets de programmes d'endurance vs. résistance sur la composition corporelle des enfants et adolescents obèses.

	Poids	IMC	MG	MM	MG viscérale	Graisse intramusculaire	Lipides hépatiques	Intra-
Endurance	↓	↓	↓	↓	↓	↓	↓	
Résistance	↑	↑	↔	↑	↔	↔	↔	

IMC : Indice de Masse Corporelle ; MG : Masse Grasse ; MM : Masse Maigre

## Effets sur les aptitudes cardiorespiratoires et musculo-squelettiques

L'aptitude cardiorespiratoire, également appelée aptitude ou capacité aérobie, décrit la capacité des systèmes respiratoires et circulatoires à fonctionner ensemble pour fournir une quantité suffisante d'oxygène afin d'apporter au corps l'énergie nécessaire pour maintenir un exercice dynamique <sup>46</sup>. L'entraînement en endurance est considéré comme le plus bénéfique pour le maintien et développement cardio-respiratoire. La condition musculo-squelettique décrit la capacité des systèmes musculaires et squelettiques à soutenir le travail physique sans fatigue excessive <sup>46</sup>. L'entraînement en résistance est la forme la plus efficace d'exercice pour améliorer le système musculo-squelettique grâce à l'amélioration de la force musculaire et de la puissance chez les jeunes obèses <sup>47</sup>. En bref, l'entraînement en résistance améliore la force et l'hypertrophie musculaire chez les adolescents <sup>48, 49</sup>, y compris chez les adolescents obèses <sup>17, 18, 50</sup>.

Mc Guigan et al. ont observé une augmentation de la puissance musculaire et de la force musculaire après un entraînement en résistance de 8 semaines composé de 3 séances par semaine chez les jeunes obèses <sup>18</sup>. Alberga et al. ont montré qu'un programme de résistance de 12 semaines, avec un nombre élevé de répétitions effectuées à une intensité modérée, à raison de 2 séances de 75 minutes par semaine, a conduit à une amélioration de la force des membres inférieurs et supérieurs <sup>40</sup>. Bien que Sgro et al. n'aient pas observé d'amélioration de la condition physique après 8 semaines d'entraînement en résistance (3 fois par semaine), leurs résultats ont montré que 16 ou 24 semaines d'intervention ont pu induire une amélioration significative des capacités anaérobies des enfants (+10,5% minimum, en utilisant un test de saut statique) <sup>17</sup>. Selon Van der Heijden et al., un entraînement en résistance de 12 semaines (2x1h / semaine chez les adolescents obèses de 15 ans) favorise un gain de force significatif dans les groupes musculaires inférieurs et supérieurs <sup>37</sup>. Cette équipe a rapporté dans une autre étude qu'un entraînement en aérobie de 12 semaines (4x30min / semaine au moins à 70% VO<sub>2</sub>peak) a permis d'augmenter de 13 ± 2% la condition physique aérobie d'enfants obèses pré-pubères <sup>37</sup>.

Alors que Sung et al. ont décrit l'entraînement en résistance comme une alternative sûre et efficace pour induire une perte de poids chez les jeunes afin de réduire la gravité des facteurs de risques cardiorespiratoires associés à l'obésité <sup>7</sup>, leur capacité à améliorer les aptitudes cardio-respiratoires est peu documentée. <sup>5, 43, 51, 52</sup>. Dans une revue de la littérature, Alberga et al. ont conclu que, pour améliorer la condition cardiorespiratoire des jeunes obèses, les programmes d'exercices doivent inclure l'entraînement aérobie <sup>50</sup>.

### Quid du profil métabolique?

Bien que la perte de MG soit un des objectifs principaux des programmes de prise en charge de l'obésité infantile, il semble aujourd'hui nécessaire de cibler avant tout les complications métaboliques associées à l'excès de poids, variante pédiatrique du syndrome métabolique <sup>1, 2</sup>. La littérature actuelle présente surtout des résultats sur l'impact de l'entraînement en endurance sur le profil métabolique des enfants obèses et en surpoids.

Dans une récente revue systématique des effets de l'entraînement sur le profil lipidique chez les jeunes obèses et en surpoids <sup>53</sup> seuls les programmes basés sur un entraînement aérobie montraient une

amélioration du profil lipidique, avec des effets modérés sur les lipoprotéines de faible densité transportant le cholestérol (LDL-C) et des effets importants sur les triglycérides (TG), pour une quantité d'exercice moyenne de 3 séances de 60 min par semaine et une intensité maximale de 75% de la fréquence cardiaque maximale. Dans une série d'études basées sur la prescription de l'exercice à l'intensité correspondante au Fatmax (ou Lipoxmax), Ben Ounis et al. ont montré l'effet positif des interventions aérobies sur le HOMA-IR, les TG, les LDL-C et le cholestérol total, sur la concentration en adiponectine, les marqueurs de l'inflammation, le facteur de croissance IGF-1 et sa protéine de liaison IGFBP-3<sup>30-32</sup>. L'entraînement aérobie a aussi des effets bénéfiques sur le métabolisme du glucose. Nassis et al. ont montré que 12 semaines d'entraînement aérobie, à raison de 3 séances par semaine, ont permis d'améliorer la sensibilité à l'insuline de filles en surpoids ou obèses âgées de  $13.1 \pm 1.8$  ans<sup>54</sup>, malgré l'absence de modification significative de la masse corporelle, de la MG totale, des concentrations d'adipokines ou des marqueurs de l'inflammations<sup>54</sup>.

Une méta-analyse récente souligne que l'exercice aérobie (pendant au moins 60 minutes trois fois par semaine) est capable de réduire les concentrations de LDL-C et de TG, et que la combinaison d'entraînements aérobies et en résistance offre des avantages supplémentaires, telle l'augmentation du HDL-C<sup>53</sup>. Lorsque les exercices en résistance et aérobies sont combinés, les programmes peuvent avoir un effet positif sur le HDL-C si la session dure au moins 60 minutes pour une intensité minimale de 75% des capacités aérobies maximales<sup>53</sup>. Suh et al. ont montré que l'entraînement en endurance ou en résistance améliore de la même manière qu'une restriction alimentaire seule, l'indice de sensibilité à l'insuline chez des adolescents asiatiques en surpoids<sup>53, 55</sup>. Cependant, chez les adultes, l'entraînement en aérobie améliorerait davantage la sensibilité à l'insuline que l'entraînement en résistance<sup>56, 57</sup>. La comparaison d'un entraînement en endurance combiné à un entraînement en résistance, associant des séances de résistance et des séances aérobies pendant 1 an, par rapport à un entraînement en endurance seul, a été effectuée par De Piano et al. Chez les adolescents obèses atteints d'une stéatose hépatique non alcoolique (NAFLD), ce programme améliorerait davantage l'indice HOMA, l'adiponectine et de la leptine et favorisait une diminution plus prononcée de la concentration de mélanine (MCH) que l'endurance seule<sup>58</sup>.

L'entraînement en résistance seul s'avère efficace pour réduire la résistance à l'insuline et pour améliorer le contrôle glycémique chez les jeunes obèses<sup>59</sup> indépendamment des changements de poids corporel<sup>59</sup>. D'autres auteurs ont rapporté des effets bénéfiques de l'entraînement en résistance, comme la diminution du rythme cardiaque au repos, de la pression artérielle systolique, des concentrations de TG et d'insuline et l'augmentation de celle de HDL-C après un programme en résistance de 6 semaines chez les enfants obèses (3 fois par semaine fixé à 70 à 85% des capacités maximales des enfants)<sup>43</sup>. Comme dans le cas de l'entraînement aérobie, l'amélioration de la sensibilité à l'insuline, de la sensibilité hépatique à l'insuline (+  $24 \pm 9\%$ ) et du contrôle métabolique de la glyco-génolyse ne sont pas liées au changement de l'adiposité ou de la quantité de graisse viscérale, hépatique et de lipides intramyocellulaires après un programme en résistance de 12 semaines chez les jeunes obèses<sup>38</sup>. Le Tableau 2 résume les effets de deux modalités d'entraînements sur le profil métabolique de jeunes obèses.

**Tableau 2.** Impact des programmes d'endurance versus résistance sur le profil métabolique chez les jeunes obèses

	Sensibilité à l'insuline	LDL-C	HDL-C	Triglycérides	Cholestérol Total	Pression artérielle
<b>Endurance</b>	↑	↓	↔	↓	↓	↓
<b>Resistance</b>	↑	-	↑	↓	-	↓

## Discussion et recommandations

Il est maintenant établi que l'exercice en résistance peut être inclus dans les programmes de prise en charge de l'obésité chez les enfants et les adolescents. L'Organisation Mondiale de la Santé et de nombreuses organisations nationales et internationales se concentrant sur la condition physique, comme l'Association Nationale Américaine de Renforcement et de Remise en Condition (NSCA)<sup>60</sup> ou les recommandations américaines en activité physique pour les enfants<sup>61</sup>, recommandent l'utilisation de l'entraînement en résistance chez les enfants et les adolescents. Ce type d'exercice devrait impliquer une activité du corps entier et être exécuté à des intensités modérées à sous-maximales de 2 à 3 séries répétées de 8 à 20 fois sur une période d'au moins 8 semaines<sup>10, 20, 21, 62</sup>. Avec ce type d'exercice, le niveau de compliance est élevé (environ 84%) et un faible taux de blessures chez les enfants et les adolescents est à déplorer<sup>20</sup>. Il convient toutefois de noter qu'un taux de compliance similaire de 80 à 100% peut être atteint par les entraînements aérobies<sup>13</sup>.

Les entraînements en endurance et en résistance offrent des effets bénéfiques sur la santé des enfants et des adolescents obèses et en surpoids. En regardant leurs avantages respectifs, nous recommandons une combinaison d'exercices en résistance et aérobie, pour optimiser les effets bénéfiques combinés, plutôt que le travail en résistance ou l'exercice aérobie seul<sup>63</sup>. Les praticiens sont encouragés à suivre les recommandations générales classiques pour les exercices prescrits chez les enfants et les adolescents, soit 60 minutes ou plus d'activité physique tous les jours pour l'essentiel à une intensité modérée à vigoureuse, complétées par des séances de travail musculo-squelettique environ 3 fois par semaine.

## Références

- 1 Aguilar-Salinas CA, Rojas R, Gomez-Perez FJ, Franco A, Olaiz G, Rull JA, *et al.* [The metabolic syndrome: a concept in evolution]. *Gac Med Mex.* 2004; 140 Suppl 2: S41-8.
- 2 Thivel D, Malina RM, Isacco L, Aucouturier J, Meyer M, Duche P. Metabolic syndrome in obese children and adolescents: dichotomous or continuous? *Metab Syndr Relat Disord.* 2009; 7: 549-55.
- 3 Lazaar N, Aucouturier J, Ratel S, Rance M, Meyer M, Duche P. Effect of physical activity intervention on body composition in young children: influence of body mass index status and gender. *Acta Paediatr.* 2007; 96: 1315-20.
- 4 Thivel D, Isacco L, Lazaar N, Aucouturier J, Ratel S, Dore E, *et al.* Effect of a 6-month school-based physical activity program on body composition and physical fitness in lean and obese schoolchildren. *Eur J Pediatr.* 2011; 170: 1435-43.
- 5 Watts K, Jones TW, Davis EA, Green D. Exercise training in obese children and adolescents: current concepts. *Sports Med.* 2005; 35: 375-92.
- 6 Plowman SA, Smith DL. *Exercise Physiology for Health, Fitness, and Performance 2007.*
- 7 Sung RY, Yu CW, Chang SK, Mo SW, Woo KS, Lam CW. Effects of dietary intervention and strength training on blood lipid level in obese children. *Arch Dis Child.* 2002; 86: 407-10.
- 8 Faigenbaum AD, Kraemer WJ, Blimkie CJ, Jeffreys I, Micheli LJ, Nitka M, *et al.* Youth resistance training: updated position statement paper from the national strength and conditioning association. *J Strength Cond Res* 1996; 23: 60-79.
- 9 Falk B, Tenenbaum G. The effectiveness of resistance training in children. A meta-analysis. *Sports Med.* 1996; 22: 176-86.
- 10 American Academy of Pediatrics COMmittee on Sports Medicine and Fitness. Strength training by children and adolescents. *Pediatrics.* 2001; 107: 1470-2.
- 11 Faith MS, Leone MA, Ayers TS, Heo M, Pietrobelli A. Weight criticism during physical activity, coping skills, and reported physical activity in children. *Pediatrics.* 2002; 110: e23.
- 12 Daniels SR, Arnett DK, Eckel RH, Gidding SS, Hayman LL, Kumanyika S, *et al.* Overweight in children and adolescents: pathophysiology, consequences, prevention, and treatment. *Circulation.* 2005; 111: 1999-2012.

- 13 Kelley GA, Kelley KS. Effects of aerobic exercise on non-high-density lipoprotein cholesterol in children and adolescents: a meta-analysis of randomized controlled trials. *Prog Cardiovasc Nurs*. 2008; 23: 128-32.
- 14 Balas-Nakash M, Benitez-Arciniega A, Perichart-Perera O, Valdes-Ramos R, Vadillo-Ortega F. The effect of exercise on cardiovascular risk markers in Mexican school-aged children: comparison between two structured group routines. *Salud Publica Mex*. 2010; 52: 398-405.
- 15 Martin JE, Dubbert PM, Katell AD, Thompson JK, Raczynski JR, Lake M, *et al*. Behavioral control of exercise in sedentary adults: studies 1 through 6. *J Consult Clin Psychol*. 1984; 52: 795-811.
- 16 Sothorn MS, Loftin JM, Udall JN, Suskind RM, Ewing TL, Tang SC, *et al*. Safety, feasibility, and efficacy of a resistance training program in preadolescent obese children. *Am J Med Sci*. 2000; 319: 370-5.
- 17 Sgro M, McGuigan MR, Pettigrew S, Newton RU. The effect of duration of resistance training interventions in children who are overweight or obese. *J Strength Cond Res*. 2009; 23: 1263-70.
- 18 McGuigan MR, Tataschiere M, Newton RU, Pettigrew S. Eight weeks of resistance training can significantly alter body composition in children who are overweight or obese. *J Strength Cond Res*. 2009; 23: 80-5.
- 19 Owen CG, Nightingale CM, Rudnicka AR, Sattar N, Cook DG, Ekelund U, *et al*. Physical activity, obesity and cardiometabolic risk factors in 9- to 10-year-old UK children of white European, South Asian and black African-Caribbean origin: the Child Heart And health Study in England (CHASE). *Diabetologia*. 2010; 53: 1620-30.
- 20 Dietz P, Hoffmann S, Lachtermann E, Simon P. Influence of exclusive resistance training on body composition and cardiovascular risk factors in overweight or obese children: a systematic review. *Obes Facts*. 2012; 5: 546-60.
- 21 Faigenbaum AD. Strength training for children and adolescents. *Clin Sports Med*. 2000; 19: 593-619.
- 22 Faigenbaum AD, Loud RL, O'Connell J, Glover S, Westcott WL. Effects of different resistance training protocols on upper-body strength and endurance development in children. *J Strength Cond Res*. 2001; 15: 459-65.
- 23 Faigenbaum AD, Milliken LA, Westcott WL. Maximal strength testing in healthy children. *J Strength Cond Res*. 2003; 17: 162-6.
- 24 Faigenbaum AD, Westcott WL, Loud RL, Long C. The effects of different resistance training protocols on muscular strength and endurance development in children. *Pediatrics*. 1999; 104: e5.
- 25 Benson AC, Torode ME, Fiatarone Singh MA. The effect of high-intensity progressive resistance training on adiposity in children: a randomized controlled trial. *Int J Obes (Lond)*. 2008; 32: 1016-27.
- 26 Sothorn MS, Loftin JM, Udall JN, Suskind RM, Ewing TL, Tang SC, *et al*. Inclusion of resistance exercise in a multidisciplinary outpatient treatment program for preadolescent obese children. *South Med J*. 1999; 92: 585-92.
- 27 Treuth MS, Hunter GR, Figueroa-Colon R, Goran MI. Effects of strength training on intra-abdominal adipose tissue in obese prepubertal girls. *Med Sci Sports Exerc*. 1998; 30: 1738-43.
- 28 Yu CC, Sung RY, So RC, Lui KC, Lau W, Lam PK, *et al*. Effects of strength training on body composition and bone mineral content in children who are obese. *J Strength Cond Res*. 2005; 19: 667-72.
- 29 Brandou F, Dumortier M, Garandeu P, Mercier J, Brun JF. Effects of a two-month rehabilitation program on substrate utilization during exercise in obese adolescents. *Diabetes Metab*. 2003; 29: 20-7.
- 30 Ben Ounis O, Elloumi M, Amri M, Zbidi A, Tabka Z, Lac G. Impact of diet, exercise and diet combined with exercise programs on plasma lipoprotein and adiponectin levels in obese girls. *J Sports Sci Med*. 2008; 7: 437-45.
- 31 Ben Ounis O, Elloumi M, Ben Chiekh I, Zbidi A, Amri M, Lac G, *et al*. Effects of two-month physical-endurance and diet-restriction programmes on lipid profiles and insulin resistance in obese adolescent boys. *Diabetes Metab*. 2008; 34: 595-600.

- 32 Ben Ounis O, Elloumi M, Lac G, Makni E, Van Praagh E, Zouhal H, *et al.* Two-month effects of individualized exercise training with or without caloric restriction on plasma adipocytokine levels in obese female adolescents. *Ann Endocrinol (Paris)*. 2009; 70: 235-41.
- 33 Ben Ounis O, Elloumi M, Zouhal H, Makni E, Denguezli M, Amri M, *et al.* Effect of individualized exercise training combined with diet restriction on inflammatory markers and IGF-1/IGFBP-3 in obese children. *Ann Nutr Metab*. 2010; 56: 260-6.
- 34 Ben Ounis O, Elloumi M, Zouhal H, Makni E, Lac G, Tabka Z, *et al.* Effect of an individualized physical training program on resting cortisol and growth hormone levels and fat oxidation during exercise in obese children. *Ann Endocrinol (Paris)*. 2011; 72: 34-41.
- 35 Brooks GA, Mercier J. Balance of carbohydrate and lipid utilization during exercise: the "crossover" concept. *J Appl Physiol (1985)*. 1994; 76: 2253-61.
- 36 Lee S, Deldin AR, White D, Kim Y, Libman I, Rivera-Vega M, *et al.* Aerobic exercise but not resistance exercise reduces intrahepatic lipid content and visceral fat and improves insulin sensitivity in obese adolescent girls: a randomized controlled trial. *Am J Physiol Endocrinol Metab*. 2013; 305: E1222-9.
- 37 van der Heijden GJ, Wang ZJ, Chu ZD, Sauer PJ, Haymond MW, Rodriguez LM, *et al.* A 12-week aerobic exercise program reduces hepatic fat accumulation and insulin resistance in obese, Hispanic adolescents. *Obesity (Silver Spring)*. 2010; 18: 384-90.
- 38 Van Der Heijden GJ, Wang ZJ, Chu Z, Toffolo G, Manesso E, Sauer PJ, *et al.* Strength exercise improves muscle mass and hepatic insulin sensitivity in obese youth. *Med Sci Sports Exerc*. 2010; 42: 1973-80.
- 39 van der Heijden GJ, Toffolo G, Manesso E, Sauer PJ, Sunehag AL. Aerobic exercise increases peripheral and hepatic insulin sensitivity in sedentary adolescents. *J Clin Endocrinol Metab*. 2009; 94: 4292-9.
- 40 Alberga AS, Farnesi BC, Lafleche A, Legault L, Komorowski J. The effects of resistance exercise training on body composition and strength in obese prepubertal children. *Phys Sportsmed*. 2013; 41: 103-9.
- 41 Heinonen A, Sievanen H, Kannus P, Oja P, Pasanen M, Vuori I. High-impact exercise and bones of growing girls: a 9-month controlled trial. *Osteoporos Int*. 2000; 11: 1010-7.
- 42 Morris FL, Naughton GA, Gibbs JL, Carlson JS, Wark JD. Prospective ten-month exercise intervention in premenarcheal girls: positive effects on bone and lean mass. *J Bone Miner Res*. 1997; 12: 1453-62.
- 43 Lau P, YU C, Lee A, Sung R. The physiological and psychological effects of resistance training on chinese obese adolescents. *Journal of Exercise Science and Fitness*. 2004; 2: 115-20.
- 44 Campos RM, de Mello MT, Tock L, da Silva PL, Corgosinho FC, Carnier J, *et al.* Interaction of bone mineral density, adipokines and hormones in obese adolescents girls submitted in an interdisciplinary therapy. *J Pediatr Endocrinol Metab*. 2013; 26: 663-8.
- 45 Falk B, Eliakim A. Resistance training, skeletal muscle and growth. *Pediatr Endocrinol Rev*. 2003; 1: 120-7.
- 46 Heyward VH. Advanced fitness assessment and exercise prescription. 4th edn. Champaign, IL 2002.
- 47 Maffiuletti NA, Ratel S, Sartorio A, Martin V. The impact of obesity on in vivo human skeletal muscle function. *Curr Obes Rep*. 2013; 2: 251-60.
- 48 Kraemer WJ, Fry AC, Frykman PM, Conroy B, Hoffman J. Resistance training and youth. *Ped Exe Science*. 1989: 336-50.
- 49 Webb DR. Strength training in children and adolescents. *Pediatr Clin North Am*. 1990; 37: 1187-210.
- 50 Alberga AS, Sigal RJ, Kenny GP. A review of resistance exercise training in obese adolescents. *Phys Sportsmed*. 2011; 39: 50-63.
- 51 Maziekas MT, LeMura LM, Stoddard NM, Kaercher S, Martucci T. Follow up exercise studies in paediatric obesity: implications for long term effectiveness. *Br J Sports Med*. 2003; 37: 425-9.



- 52 Davis JN, Tung A, Chak SS, Ventura EE, Byrd-Williams CE, Alexander KE, *et al.* Aerobic and strength training reduces adiposity in overweight Latina adolescents. *Med Sci Sports Exerc.* 2009; 41: 1494-503.
- 53 Escalante Y, Saavedra JM, Garcia-Hermoso A, Dominguez AM. Improvement of the lipid profile with exercise in obese children: a systematic review. *Prev Med.* 2012; 54: 293-301.
- 54 Nassis GP, Papantakou K, Skenderi K, Triandafillopoulou M, Kavouras SA, Yannakoulia M, *et al.* Aerobic exercise training improves insulin sensitivity without changes in body weight, body fat, adiponectin, and inflammatory markers in overweight and obese girls. *Metabolism.* 2005; 54: 1472-9.
- 55 Suh S, Jeong I, Kim MY, Kim YS, Shin S, Kim SS, *et al.* Effects of Resistance Training and Aerobic Exercise on Insulin Sensitivity in Overweight Korean Adolescents: A Controlled Randomized Trial. *Diabetes Metab J.* 2011; 35: 418-26.
- 56 Poehlman ET, Dvorak RV, DeNino WF, Brochu M, Ades PA. Effects of resistance training and endurance training on insulin sensitivity in nonobese, young women: a controlled randomized trial. *J Clin Endocrinol Metab.* 2000; 85: 2463-8.
- 57 Davidson LE, Hudson R, Kilpatrick K, Kuk JL, McMillan K, Janiszewski PM, *et al.* Effects of exercise modality on insulin resistance and functional limitation in older adults: a randomized controlled trial. *Arch Intern Med.* 2009; 169: 122-31.
- 58 de Piano A, de Mello MT, Sanches Pde L, da Silva PL, Campos RM, Carnier J, *et al.* Long-term effects of aerobic plus resistance training on the adipokines and neuropeptides in nonalcoholic fatty liver disease obese adolescents. *Eur J Gastroenterol Hepatol.* 2012; 24: 1313-24.
- 59 Shaibi GQ, Cruz ML, Ball GD, Weigensberg MJ, Salem GJ, Crespo NC, *et al.* Effects of resistance training on insulin sensitivity in overweight Latino adolescent males. *Med Sci Sports Exerc.* 2006; 38: 1208-15.
- 60 Faigenbaum AD, Kraemer WJ, Blimkie CJ, Jeffreys I, Micheli LJ, Nitka M, *et al.* Youth resistance training: updated position statement paper from the national strength and conditioning association. *J Strength Cond Res.* 2009; 23: S60-79.
- 61 Neumark-Sztainer D, Story M, Hannan PJ, Rex J. New Moves: a school-based obesity prevention program for adolescent girls. *Prev Med.* 2003; 37: 41-51.
- 62 Stratton G, Jones M, Fox KR, Tolfrey K, Harris J, Maffulli N, *et al.* BASES position statement on guidelines for resistance exercise in young people. *J Sports Sci.* 2004; 22: 383-90.
- 63 LeMura LM, Maziakas MT. Factors that alter body fat, body mass, and fat-free mass in pediatric obesity. *Med Sci Sports Exerc.* 2002; 34: 487-96.
- 64 Cooper DM, Kaplan MR, Baumgarten L, Weiler-Ravell D, Whipp BJ, Wasserman K. Coupling of ventilation and CO<sub>2</sub> production during exercise in children. *Pediatr Res.* 1987; 21: 568-72.
- 65 Aucouturier J, Rance M, Meyer M, Isacco L, Thivel D, Fellmann N, *et al.* Determination of the maximal fat oxidation point in obese children and adolescents: validity of methods to assess maximal aerobic power. *Eur J Appl Physiol.* 2009; 105: 325-31.
- 66 Perez-Martin A, Dumortier M, Raynaud E, Brun JF, Fedou C, Bringer J, *et al.* Balance of substrate oxidation during submaximal exercise in lean and obese people. *Diabetes Metab.* 2001; 27: 466-74.

## ENCADRE 1

### **Entraînement en endurance**

L'entraînement en endurance (aussi appelé aérobie ou cardio-training) repose sur des programmes d'exercices d'intensité faible à modérée recourant principalement au le métabolisme aérobie. Le terme aérobie signifiant littéralement « vivre dans l'air », on comprend aisément que le travail aérobie repose sur l'utilisation de l'oxygène pour assurer la production nécessaire d'énergie lors de la réalisation d'un exercice, grâce au métabolisme aérobie <sup>64</sup>.

### **Entraînement en résistance**

Aussi appelé renforcement musculaire ou musculation, l'entraînement en résistance implique l'utilisation de la force musculaire pour travailler contre une force de résistance ou pour déplacer du poids. Il consiste principalement en des exercices isométriques, isotoniques ou isocinétiques élaborés pour progressivement développer une meilleure résistance ou force, endurance aérobie ainsi que le capital musculaire.

## ENCADRE 2

### **Lipox max (ou Fat max)**

Le Fatmax ou Lipoxmax représente l'intensité d'exercice à laquelle l'utilisation des lipides est maximale. Chez les enfants et adolescents obèses, il se situe habituellement vers  $53.3 \pm 12.2\%$  du  $VO_2\max$  <sup>65</sup>.

### **Le "Cross-over point"**

Lors d'un exercice incrémental, l'oxydation des hydrates de carbone augmente progressivement alors que celle des lipides décline jusqu'à arriver à un point de croisement où l'oxydation des glucides représente 70% de la fourniture d'énergie alors que celle des lipides couvre les 30% restant. Ce point de croisement est appelé le « cross-over point ». Des études conduites chez des adultes obèses ont montré que le point de cross-over se situe à des intensités plus faibles chez eux que des adultes minces, soulignant une moindre capacité du muscle à utiliser les graisses <sup>66</sup>. De nombreuses études ont montré que le point de cross-over peut être déplacé à des intensités supérieures par un entraînement sous-maximal chez de jeunes obèses, témoignant ainsi d'une amélioration de la capacité des muscles à oxyder les lipides <sup>29</sup>.

~ Les Auteurs ~

**Julien Aucouturier**



Université Droit et Santé Lille 2, EA 4488 "Activité Physique, Muscle, Santé", Faculté des Sciences du Sport et de l'Education Physique, 59790 Ronchin, France

**Alicia Fillon**

Université Clermont Auvergne, EA 3533, Laboratoire des Adaptations Métaboliques à l'Exercice en conditions Physiologiques et Pathologiques (AME2P), BP 80026, F-63171 Aubière cedex, France

SSR Nutrition Obésité UGECAM, Clermont-Ferrand, France

**Julie Masurier**

SSR Nutrition Obésité UGECAM, Clermont-Ferrand, France

**David Thivel**



Université Clermont Auvergne, EA 3533, Laboratoire des Adaptations Métaboliques à l'Exercice en conditions Physiologiques et Pathologiques (AME2P), BP 80026, F-63171 Aubière cedex, France

**Correspondance :**

THIVEL David

Laboratoire des Adaptations Métaboliques à l'Exercice en conditions Physiologiques et Pathologiques (AME2P), BP 80026, F-63171 Aubière cedex, France

[David.Thivel@univ-bpclermont.fr](mailto:David.Thivel@univ-bpclermont.fr)

**~ Comment utiliser cet article ~**

Vous êtes autorisé(e) à utiliser, partager et copier cet article en le citant comme suit :

*Julien Aucouturier J, Fillon A, Masurier J, Thivel D (2017). Intervention en activité physique chez les enfants et les adolescents en surpoids/obèses : entraînement en endurance et/ou en résistance ? Dans M.L. Frelut (Ed.), Le livre électronique (eBook) de l'ECOG sur l'obésité des enfants et des adolescents. Téléchargé sur [ebook.ecog-obesity.eu](http://ebook.ecog-obesity.eu).*

Assurez-vous également de donner de créditer de façon appropriée ce content lors de son utilisation. Visitez [ebook.ecog-obesity.eu/fr/conditions-utilisation/sommaire/](http://ebook.ecog-obesity.eu/fr/conditions-utilisation/sommaire/) pour plus d'informations.

**~ Mot final ~**

Merci pour votre intérêt dans cet article. Si vous pensez que cela que quelqu'un d'autre peut être intéressé n'hésitez pas à le partager ! Enfin rendez-vous sur [ebook.ecog-obesity.eu](http://ebook.ecog-obesity.eu) pour découvrir d'autres articles.

## Annexe 6

### Communications affichées

---

#### Relative à la thèse :

- **Fillon, A.**, Mathieu, M.-E., Masurier, J., Roche, J., Miguet, M., Khammassi, M., Finlayson, G., Beaulieu, K., Pereira, B., Duclos, M., Boirie, Y., & Thivel, D. (2019). *Effet du délai entre l'exercice et le déjeuner sur la prise alimentaire, les sensations d'appétit et le système de la récompense alimentaire chez des adolescents en situation d'obésité : L'étude TIMEX*. JFN, Rennes.
- **Fillon, A.**, Mathieu, M.-E., Masurier, J., Roche, J., Miguet, M., Khammassi, M., Finlayson, G., Beaulieu, K., Pereira, B., Duclos, M., Boirie, Y., & Thivel, D. (2019b). *Effet du délai entre l'exercice et le déjeuner sur la prise alimentaire, les sensations d'appétit et le système de la récompense alimentaire chez des adolescents en situation d'obésité : L'étude TIMEX*. JED, Clermont-Ferrand.
- **Fillon, A.**, Miguet, M., Bailly, M., Julian, V., Pereira, B., Masurier, J., Beaulieu, K., Finlayson, G., Duclos, M., Boirie, Y., & Thivel, D. (2019). *Does exercising before or after a meal optimize overall energy balance in adolescents with obesity?* ECOG Workshop, Katowice.
- **Fillon, A.**, Miguet, M., Khammassi, M., Duclos, M., Boirie, Y., Tremblay, A., Drapeau, V., Mathieu, M.-E., & Thivel, D. (2018). *Quotient de satiété : une méthode reproductible et prédictive de la prise alimentaire chez des adolescents obèses ?* JFN, Nice.

#### Non relative à la thèse :

- **Fillon, A.**, Metz, L., Genin, P. M., Miguet, M., Khammassi, M., Pereira, B., Duclos, M., Boirie, Y., Blundell, J., Tremblay, A., Drapeau, V., Finlayson, G., Mathieu, M.-E., & Thivel, D. (2018). *Satiety Quotients but not appetite feelings are reduced after acute exercise in healthy adults*. EGEA, Lyon.

**Effet du délai entre l'exercice et le déjeuner sur la prise alimentaire, les sensations d'appétit et le système de la récompense alimentaire chez des adolescents en situation d'obésité : L'étude TIMEX.**

**Fillon A.**, Mathieu M-E, Masurier J., Roche J., Miguet M., Khammassi M., Finlayson G., Beaulieu K., Pereira B., Duclos M., Boirie Y., Thivel D.



*Journées Francophones de Nutrition, Rennes, 2019*

*Journées de l'Ecole Doctorale, 2019*

# Effet du délai entre l'exercice et le déjeuner sur la prise alimentaire, les sensations d'appétit et le système de la récompense alimentaire chez des adolescents en situation d'obésité : L'étude TIMEX.



*Fillon A, Mathieu ME, Masurier J, Roche J, Miguët M, Khammassi M, Finlayson G, Beaulieu K, Pereira B, Duclos M, Boirie Y, Thivel D.*

## Introduction

Alors que le rôle des voies homéostatiques et neurocognitives impliquées dans les réponses nutritionnelles à l'exercice a été identifié en fonction de l'intensité, de la modalité ou encore de la durée d'exercice (Thivel, 2018) ; seuls Albert et al. (2015) ont questionné le rôle du délai entre l'exercice et le repas sur l'apport énergétique (AE) et les sensations d'appétit (SA) chez de jeunes hommes sains (15-20 ans). Cette thématique reste non questionnée à l'heure d'aujourd'hui chez les enfants et les adolescents obèses, ce qui pourrait avoir une grande importance pour améliorer nos stratégies de perte de poids dans cette population.

## Méthode

**Le but de la présente étude est d'évaluer l'effet du délai entre l'exercice et le repas sur l'AE, les SA et le système de la récompense chez des adolescents en situation d'obésité.**

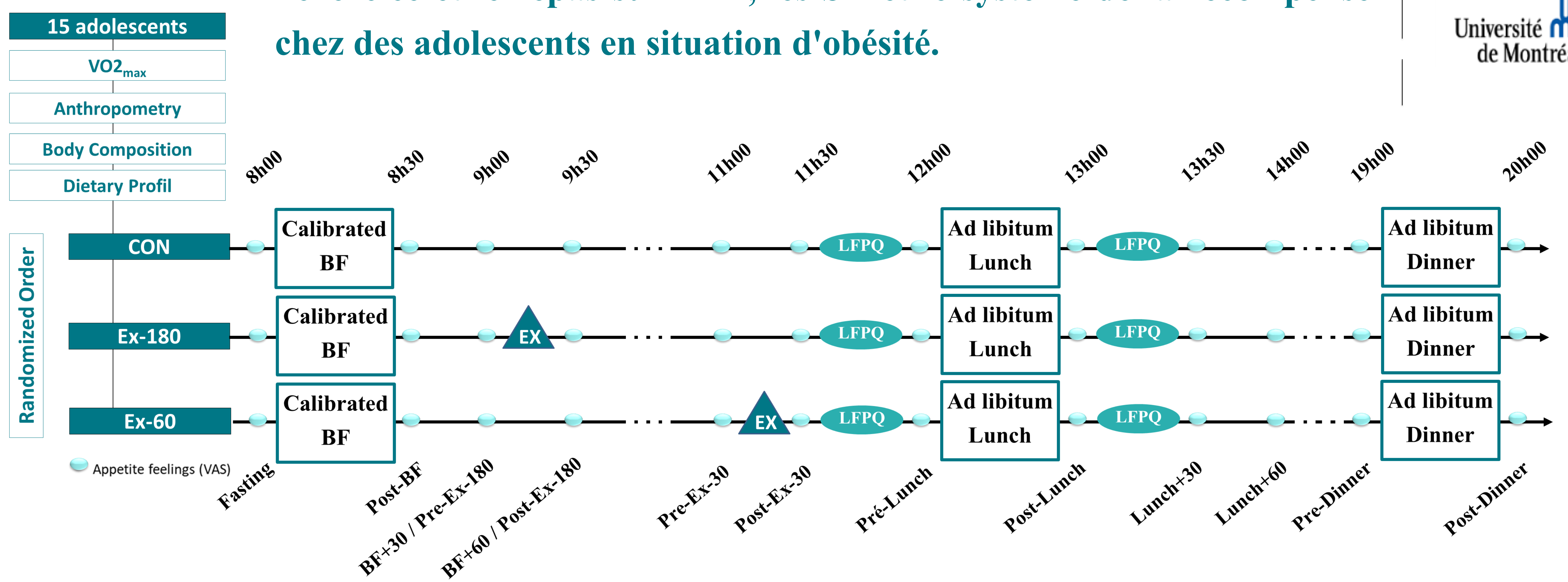

## Résultats

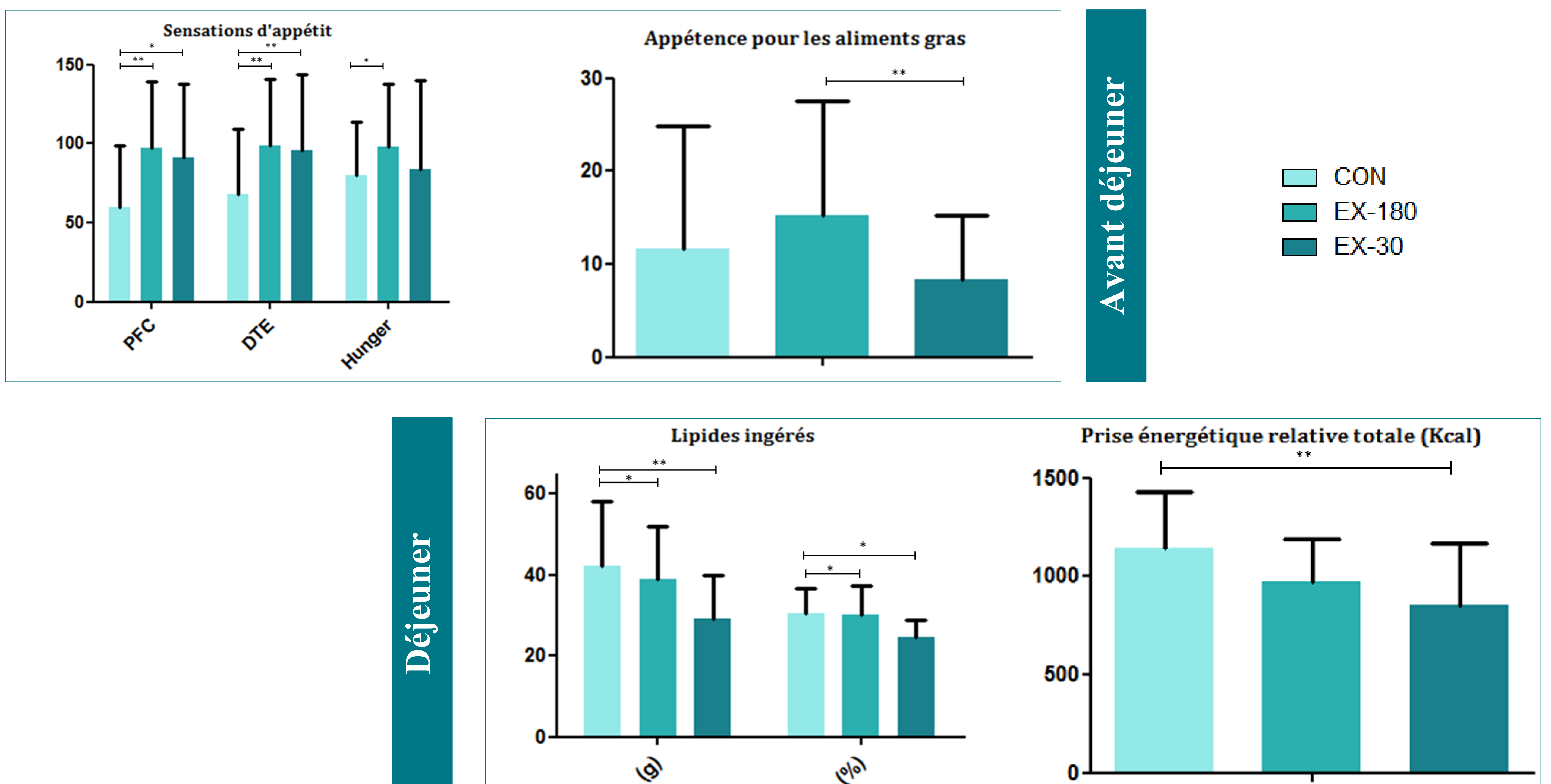

## Conclusion

**Exercice effectué juste avant le repas du midi :**

- ✓ Adaptations nutritionnelles
- ✓ Adaptations du système de la récompense alimentaire



**Optimisation de la balance énergétique chez les adolescents en situation d'obésité**



**Does exercising before or after a meal optimize overall energy balance in adolescents with obesity?**

**Fillon, A.**, Miguet, M., Bailly, M., Julian, V., Pereira, B., Masurier, J., Beaulieu, K., Finlayson, G., Duclos, M., Boirie, Y., & Thivel, D.





# Does exercising before or after a meal optimize overall energy balance in adolescents with obesity?



Fillon A., Miguet M., Bailly M., Julian V., Pereira B., Masurier J., Beaulieu K., Finlayson G., Duclos M., Boirie Y., Thivel D.



Introduction

The rise of pediatric overweight, obesity and their metabolic complications calls for the development of innovative, effective and integrative weight management strategies. In that sense, physical exercise is no longer considered as a simple source of additional energy expenditure but is now recognized for its potential effects on energy intake (EI) and appetite control in youth with obesity (Carnier et al., 2013; Nemet et al., 2010; Thivel et al., 2011). Recently, the timing of exercise (time of the day as well as delay/position relative to a meal) has been suggested as an important parameter to consider when prescribing physical activity. Albert et al. (2015), in lean young adults, and Fillon et al. (2019) in adolescents with obesity, showed that on acute exercise performed 30 minutes before a meal could optimize energy balance. Mathieu et al. (2018) failed to observe any difference in energy intake when the exercise was performed before or right after the meal (in the same period for lunch and exercise) in primary school children.

Methods

- 17 adolescents
- VO<sub>2max</sub>
- Anthropometry
- Body Composition

In order to optimize our weight management strategies, the aim of this study was to determine if it is actually more efficient to exercise just before eating, or if similar effects are found when exercise is performed just after eating.

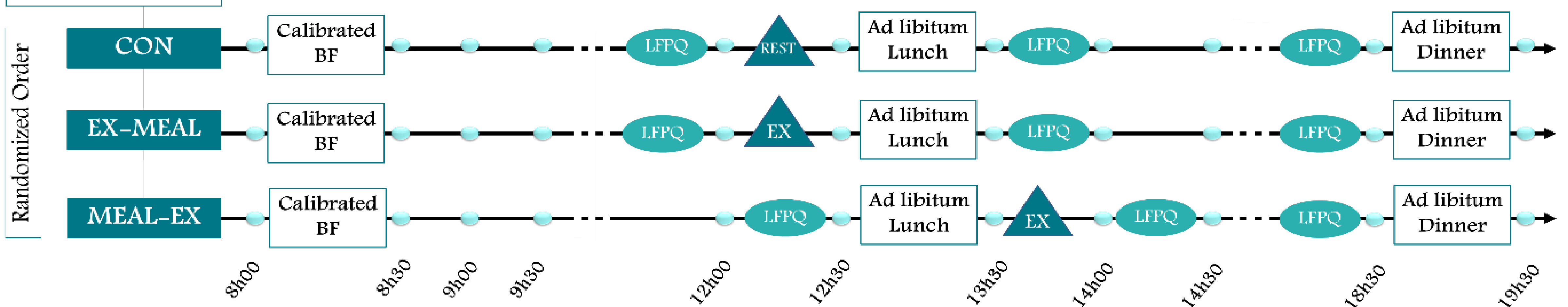

Results

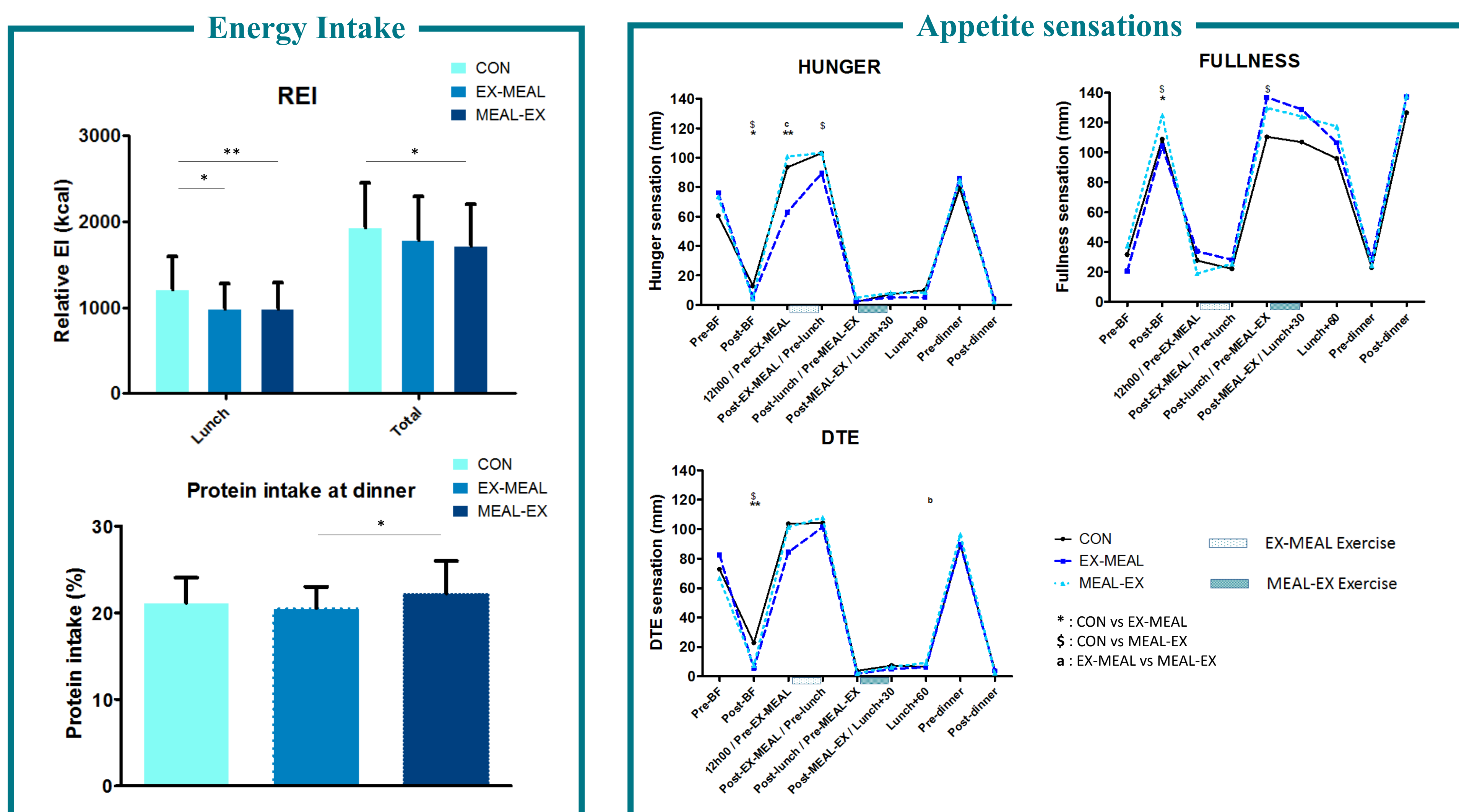

The others results not differ significantly.

Conclusion

- Potentiation of the energy balance whether the exercise is performed just before or after the meal
- Pre and post-meal hunger sensations are reduced when exercise is performed before the the meal
- Exercising after a meal improves the satiety response to the meal

# Quotient de satiété : une méthode reproductible et prédictive de la prise alimentaire chez des adolescents obèses ?

**Fillon, A.**, Miguet, M., Khammassi, M., Duclos, M., Boirie, Y., Tremblay, A., Drapeau, V., Mathieu, M.-E., & Thivel, D.



*Journées Francophones de Nutrition, Nice, 2018*

# Quotient de satiété : une méthode reproductible et prédictive de la prise alimentaire chez des adolescents obèses ?

FILLON A, MIGUET M, KHAMMASSI M, DUCLOS M, BOIRIE Y,  
TREMBLAY A, DRAPEAU V, MATHIEU ME, THIVEL D.

L'évolution de ces sensations d'appétit en réponse à une prise énergétique permet de renseigner sur la capacité satiétogène de cette dernière, à travers le calcul du Quotient de Satiété (QS). Couramment utilisé chez l'adulte sain et en situation d'obésité, notamment comme un prédicteur fiable de la prise alimentaire (PA) et de la perte de poids, la validité du QS reste incertaine en pédiatrie.

L'**objectif** est ici d'évaluer la reproductibilité de ce QS chez l'adolescent obèse et de questionner sa capacité à prédire sa prise alimentaire subséquente.

Introduction

Méthode

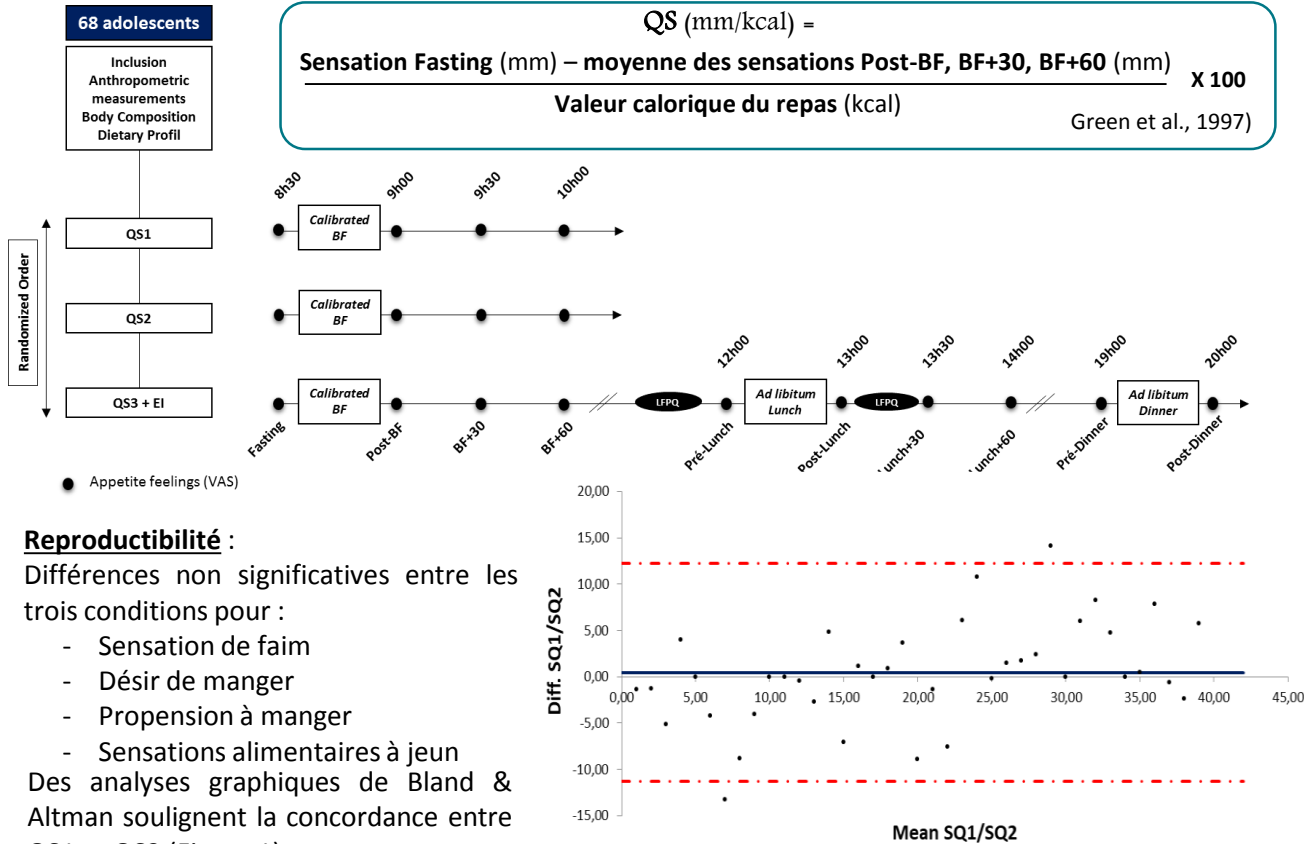

Résultats

**Prédiction PA :** Le QS de faim est corrélé avec la prise alimentaire au repas du soir ( $p < 0,05$ ,  $r = 0,353$ ) et la prise alimentaire totale sur la journée ( $p < 0,05$ ,  $r = 0,379$ ). En revanche, les QS ne sont pas corrélés avec les sensations alimentaires post-déjeuner.

Conclusion

- Reproductibilité chez l'adolescent obèse
- Prédicteur de la PA chez l'adolescent obèse
- Prédicteur de la perte de poids chez l'adolescent obèse

**Satiety Quotients but not appetite feelings are reduced  
after acute exercise in healthy adults.**

**Fillon, A.**, Metz, L., Genin, P. M., Miguet, M., Khammassi, M., Pereira, B., Duclos, M., Boirie, Y., Blundell, J., Tremblay, A., Drapeau, V., Finlayson, G., Mathieu, M.-E., & Thivel, D.



# Satiety Quotients but not appetite feelings are reduced after acute exercise in healthy adults

Fillon A, Metz L, Genin PM, Miguet M, Khammassi M, Pereira B, Duclos M, Boirie Y, Blundell JE, Tremblay A, Drapeau V, Finlayson G, Mathieu ME, Thivel D

**Introduction.** Appetite sensations are an accurate method of measuring subjective states of motivation to eat before and in response to meals. Measured before and after a meal, appetite feelings can also provide information about the satiating capacity of food, which can be expressed as Satiety Quotient (SQ). Yet exercise has been found to affect subsequent ad libitum energy intake, it remains to our knowledge unknown whether exercise can also affect the individuals' satiating capacity. The aim of the current study was to compare the effect of iso-caloric low and high intensity exercises on the Satiety Quotients in response to a fixed meal in healthy adults.

## Methods.

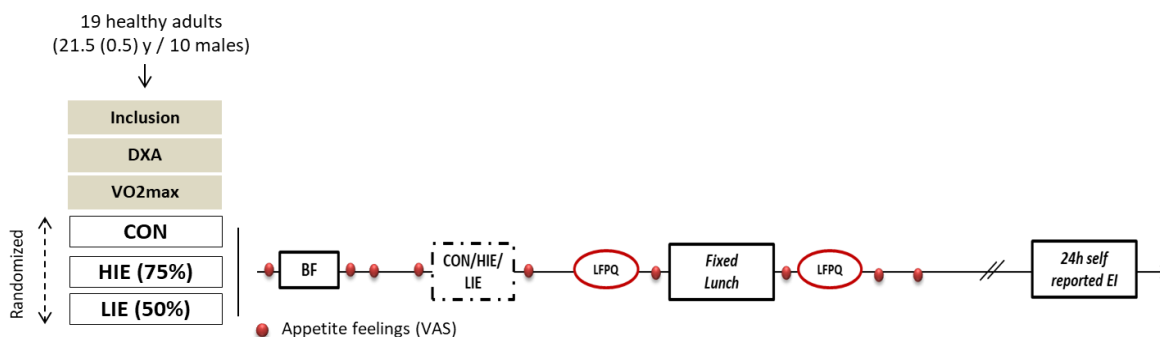

**Results.** Fasting, pre-meal and post meal AUC for Hunger, Fullness, Prospective Food Consumption and Desire to Eat were not different between conditions. SQ for hunger was significantly higher on CON ( $12.8 \pm 5.0$ ) than HIE ( $10.4 \pm 4.5$ ) and LIE ( $10.1 \pm 5.9$ ) ( $p < 0.05$ ) and SQ for DTE was significantly higher on CON ( $13.2 \pm 9.7$ ) than HIE ( $4.5 \pm 6.4$ ) ( $p < 0.05$ ). Pre-meal Choice for sweet food was higher on CON vs. LIE and HIE and the Implicit wanting for sweet was higher on CON vs. LIE ( $p < 0.05$ ).

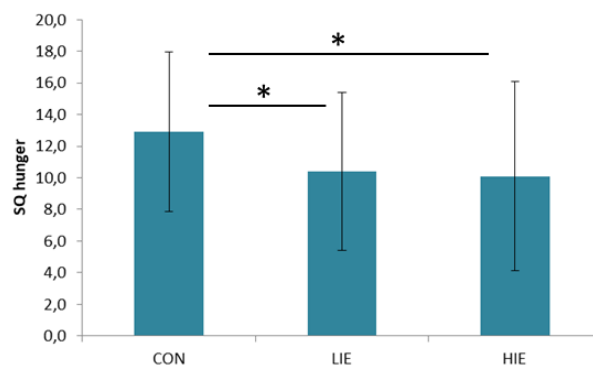

**Conclusion.** These preliminary findings suggest that the satiating capacity of food might be affected by acute exercise in healthy adults. Further analyses are needed to assess whether this might be accompanied by subsequent nutritional compensations.