



HAL
open science

Optical network design considering fault tolerance to any set of link failures

Nicolás Jara

► **To cite this version:**

Nicolás Jara. Optical network design considering fault tolerance to any set of link failures. Networking and Internet Architecture [cs.NI]. Université de Rennes; Universidad técnica Federico Santa María (Valparaiso, Chili), 2018. English. NNT : 2018REN1S111 . tel-03232722

HAL Id: tel-03232722

<https://theses.hal.science/tel-03232722>

Submitted on 22 May 2021

HAL is a multi-disciplinary open access archive for the deposit and dissemination of scientific research documents, whether they are published or not. The documents may come from teaching and research institutions in France or abroad, or from public or private research centers.

L'archive ouverte pluridisciplinaire **HAL**, est destinée au dépôt et à la diffusion de documents scientifiques de niveau recherche, publiés ou non, émanant des établissements d'enseignement et de recherche français ou étrangers, des laboratoires publics ou privés.

THESE DE DOCTORAT DE NICOLAS JARA

L'UNIVERSITE DE RENNES 1
COMUE UNIVERSITE BRETAGNE LOIRE

EN COTUTELLE INTERNATIONALE AVEC
UNIVERSIDAD TECNICA FEDERICO SANTA MARIA, CHILI

ECOLE DOCTORALE N° 601
*Mathématiques et Sciences et Technologies
de l'Information et de la Communication*
Spécialité : *informatique*

Conception de réseaux optiques en tenant compte de la tolérance aux fautes d'un ensemble quelconque de liens

Thèse présentée et soutenue à Valparaíso, Chili, le 20 Juillet 2018

Unité de recherche : IRISA (UMR 6074)

Thèse N° :

Rapporteurs avant soutenance :

Hector CANCELA	Professeur, UDELAR, Uruguay
Helio WALDMAN	Professeur, UNICAMP, Bresil

Composition du Jury :

Ricardo OLIVARES	Professeur, UTFSM, Chili
Hector CANCELA	Professeur, UDELAR, Uruguay
Helio WALDMAN	Professeur, UNICAMP, Bresil
Marta BARRÍA	Professeur, U. de Valparaíso, Chili
Reinaldo VALLEJOS	Professeur, UTFSM, Chili
Co-directeur de thèse	
Gerardo RUBINO	Directeur de recherche, DIONYSOS,
INRIA Rennes	
Directeur de thèse	

I would like to dedicate this thesis to my loving wife and family.

Declaration

I hereby declare that except where specific reference is made to the work of others, the contents of this dissertation are original and have not been submitted in whole or in part for consideration for any other degree or qualification in this, or any other university. This dissertation is my own work and contains nothing which is the outcome of work done in collaboration with others, except as specified in the text and Acknowledgements. This dissertation contains fewer than 20,000 words including appendices, bibliography, footnotes, tables and equations and has fewer than 30 figures.

Nicolás Jara Carvallo
December 2018

Acknowledgements

This work received financial support from FONDEF ID14I10129, Stic/Amsud-Conicyt project “DAT”, USM PIIC Project, CONICYT PhD and CONICYT PhD internship scholarships. These projects and institutions are then gratefully acknowledged.

Additionally, i would like to acknowledge both my supervisors, Dr. Reinaldo Vallejos and Dr. Gerardo Rubino for their great interest on my work, and my personal welfare during this amazing experience.

Abstract

The rapid increase in demand for bandwidth from existing networks has caused a growth in the use of technologies based on WDM optical networks. Nevertheless, this decade researchers have recognized a “Capacity Crunch” on optical networks, i.e. transmission capacity limit on optical fiber is close to be reached in the near future. This situation claims to evolve the current WDM optical networks architectures in order to satisfy the relentless exponential growth in bandwidth demand.

Currently, this type of network has two main technological features defining the network architecture. First, the optical nodes have not wavelength conversion capabilities. This imply that an end-to-end communication between any pair of nodes in the network, the path connecting them must use the same wavelength on each link on its route (known as wavelength continuity constraint).

The second property is optical networks are operated statically. However, the current operation is inefficient in the usage of network resources, and with the upcoming capacity crunch in optical networks, it is of pressing matter to upgrade our networks.

To solve the impending capacity crunch, several proposals have been addressed and researched so far, such as Elastic optical network, Spatial-division multiplexing and Dynamic optical networks, etc. Among these solutions, *Dynamic optical networks* is the one close to be implemented, since the technology is already available, and it has not been implemented due to the fact that the network cost savings are not enough to convince communication enterprises to incorporate this operation scheme in present networks. Consequently, we focused this thesis on dynamic optical networks.

The design of dynamic optical networks decomposes into different tasks, where the engineers must basically organize the way the main system’s resources are used, minimizing the design and operation costs and respecting critical performance constraints. All of these

tasks, have to guarantee certain level of quality of service pre-established on the Service Level Agreement. Then, in order to provide a proper quality of service measurement, we propose a new fast and accurate analytical method to evaluate the *blocking probability* (burst loss probability) in dynamic WDM networks without wavelength conversion.

This evaluation allows network designers to quickly solve higher order problems. More specifically, network operators face the challenge of solving: which wavelength is going to be used by each user (known as *Wavelength Assignment*), the number of wavelengths needed on each network link (called as *Wavelength Dimensioning*), the set of paths enabling each network user to transmit (known as *Routing*) and how to deal with link failures when the network is operating (called as *Fault Tolerance capacity*).

The different tasks before mentioned are usually solved separately, or in some cases by pairs, leading to solutions that are not necessarily close to optimal ones. This thesis proposes progressively 3 novel methods to *simultaneously* solve them. First, to jointly solve the wavelength assignment and wavelength dimensioning problems. Next, the routing problem is added to the previous solution, solving them together. Finally, all the problems are simultaneously solve, including fault tolerance to any possible link failure scenario.

The complete method allows to obtain: a) all the primary routes by which each connection normally transmits its information, b) the additional routes, called secondary routes, used to keep each user connected in cases where one or more simultaneous failures occur, and c) the wavelength assignment strategy to be used during the network operation d) the number of wavelengths available at each link of the network, calculated such that the blocking probability of each connection is lower than a pre-determined threshold (which is a network design parameter), despite the occurrence of simultaneous link failures.

The solution obtained by the new algorithm is significantly more efficient than current methods, its implementation is notably simple and its on-line operation is very fast. We believe that the results obtained in this thesis may provide sufficient network cost savings to foster telecommunications companies to migrate from the current static operation to a dynamic one.

Résumé de la thèse

Introduction

La demande croissante en bande passante dans les réseaux actuels a provoqué une forte augmentation de l'utilisation des réseaux optiques de type WDM pour les cœurs des architectures de communication. Mais en même temps, les chercheurs ont identifié un risque majeur dans le domaine, appelé "Capacity Crunch", c'est-à-dire, crash de capacité. Il se traduit par le fait que la capacité de transmission dans les réseaux optiques se rapproche dangereusement de leurs limites technologiques [1–4]. Cette situation entraîne la nécessité de faire évoluer l'architecture actuelle des réseaux WDM pour pouvoir satisfaire cette demande croissante en ressources.

Actuellement, l'architecture de ce type de réseau a deux caractéristiques majeures. Premièrement, les nœuds optiques n'ont pas la capacité de changer de longueur d'onde (capacité dite de conversion) des différents liens transportant les données d'une même connexion. Ceci implique que la communication entre deux nœuds quelconques du réseau doit utiliser la même longueur d'onde sur tous les liens de la route suivie par les données. Ceci est habituellement appelé "contrainte de continuité" des longueurs d'onde. Deuxièmement, ces réseaux sont opérés de façon statique, ce qui signifie que les longueurs d'onde sur les liens composant la route sont allouées à la connexion avant de transmettre et restent allouées en permanence à cette connexion. Ce mode d'opération est inefficace dans l'utilisation de la ressource principale du réseau, car les longueurs d'onde restent allouées même si la connexion ne transmet pas, et ce problème est exacerbé par le risque de Capacity Crunch.

Plusieurs idées ont été proposées pour faire face à ces difficultés, et parmi elles, le mode d'opération dynamique est celle qui se présente comme la plus probable à être mise

en œuvre. La raison est que la technologie est déjà disponible. Le mode d'opération dynamique consiste à allouer les ressources seulement lorsqu'elles sont nécessaires, en faisant de sorte que le réseau s'adapte dynamiquement à la demande. Ce mode d'opération n'est pas encore déployé car les industriels veulent être convaincus que les gains en performances seront suffisants pour justifier les investissements.

La conception de réseaux optiques se décompose en différentes tâches, dans lesquelles les ingénieurs doivent organiser le partage des ressources principales du système, tout en minimisant les coûts d'opération et en respectant des contraintes sur les performances. Ces tâches doivent assurer un certain niveau de Qualité de Service (QoS) qui a été fixé dans le Service Level Agreement. Ceci signifie qu'il est aussi très important d'être capable d'évaluer cette QoS, en particulier par utilisateur du réseau. Dans le contexte de ce travail, la principale métrique de QoS est la probabilité de blocage (ou probabilité de perte) du réseau, de chaque connexion et de chaque lien. Une méthode efficace de faire cette évaluation permet au concepteur du réseau de résoudre également de façon efficace d'autres problèmes de "niveau supérieur". Plus concrètement, les principaux sont les suivants :

- (i) quelle longueur d'onde va être utilisée par chaque utilisateur, i.e., par chaque connexion ? il s'agit du problème de l'assignation des longueurs d'onde (en Anglais, Wavelength Assignment (WA)) ;
- (ii) combien de longueurs d'onde devront être disponibles sur chacun des liens ? problème du dimensionnement des longueurs d'onde (en Anglais, Wavelength Dimensioning (WD)) ;
- (iii) quel chemin devra être suivi par les données de chacune des connexions ? c'est le problème du routage ;
- (iv) comment faire face aux possibles défaillances des liens du réseau lorsque celui-ci se trouve en opération ? il s'agit du problème de la tolérance aux fautes (en Anglais, Fault Tolerance (FT)).

Cette thèse a deux objectifs principaux :

1. offrir une méthodologie rapide, simple et précise pour évaluer les probabilités de blocage associées à un réseau de type WDM avec la restriction de continuité satisfaite

par les longueurs d'onde (i.e., pour les réseaux sans conversion des longueurs d'onde dans les nœuds, la technologie actuellement déployée),

2. en utilisant la méthodologie précédente, résoudre simultanément les quatre problèmes précédemment définies, notés collectivement RWAD+FT.

La structure de la thèse est la suivante. Dans le Chapitre 2, on présente un modèle analytique pour évaluer les probabilités de blocage. Le Chapitre 3 propose une nouvelle méthode pour résoudre en même temps les problèmes (i) et (ii), i.e., l'assignation et le dimensionnement des longueurs d'onde, tout en garantissant un niveau minimal de QoS. Elle est basée, entre autre, sur les résultats décrits dans le chapitre précédent. Dans le Chapitre 4 on décrit une nouvelle technique pour résoudre simultanément les trois premiers problèmes, i.e. l'assignation et le dimensionnement des longueurs d'onde plus le routage, toujours en assurant un niveau minimal de QoS (i.e., une probabilité de blocage maximale). Dans le Chapitre 5 on y présente une procédure qui ajoute à la solution précédente la possibilité d'offrir une tolérance aux fautes associées à des sous-ensembles arbitraires de liens du réseau. Enfin, des conclusions font l'objet du Chapitre 6.

Étant donné le fait qu'aujourd'hui il n'y a pas assez de gains dans l'utilisation des ressources pour compenser la complexité de l'opération dynamique des réseaux optiques [5], nous espérons contribuer à améliorer l'état de l'art technologique dans le domaine pour améliorer ce gain, et motiver les compagnies de télécommunications à migrer leurs systèmes vers ce mode d'opération. Ceci permettra d'améliorer l'utilisation des ressources sans transformer en profondeur les infrastructures déjà installées.

À continuation, nous allons décrire les résultats et les contributions présentées dans les différents chapitres de la thèse.

Évaluation des probabilités de blocage (Chapitre 2)

En général, les probabilités de blocage sont estimées par simulation [6, 7, 5]. La raison de cet état de fait est que le calcul numérique exact de ces probabilités est la plupart du temps inaccessible à cause du coût de calcul associé. Ceci étant, la simulation, tout en étant plus rapide, nécessite également des longs temps de calcul pour permettre les estimations. De manière générale, l'idéal est alors de disposer d'une technique de type

analytique qui approche les valeurs exactes de près. Lorsque ceci est possible, ce type d'approche est beaucoup plus rapide que l'exécution d'un programme de simulation [8]. La vitesse d'évaluation est un paramètre très pertinent, car lorsque l'on doit attaquer les problèmes de plus haut niveau notés (i), (ii), etc. précédemment, il est nécessaire de solliciter le calcul des probabilités de blocage un grand nombre de fois. Donc, une méthode de type analytique, rapide et précise, est extrêmement utile pour le problème de conception traité dans ce travail.

Dans le Chapitre 2, nous présentons une approche avec les caractéristiques préalablement décrites. Elle permet donc d'évaluer les probabilités de blocage ou de perte dans les réseaux WDM dynamiques, sans conversion des longueurs d'onde, avec du trafic hétérogène (chaque connexion peut avoir ses propres caractéristiques). Nous avons appelé LIPBE notre méthode (de l'Anglais, Layered Iterative Blocking Probability Evaluation). Ses résultats ont été comparés à ceux obtenus par simulation, ainsi qu'aux résultats d'une autre technique couramment employée. Nous montrons que LIPBE est suffisamment précise pour nos objectifs de conception, affirmation fondée sur la comparaison avec les simulations, et, comme conséquence de la nature analytique des procédures, très rapide, fournissant ses résultats dans une fraction de seconde, plusieurs ordres de magnitude plus rapidement qu'avec un simulateur.

Assignment et dimensionnement des longueurs d'onde (Chapitre 3)

Le problème de l'assignation des longueurs d'onde (WA) [9, 7, 10] a été largement couvert par des travaux précédents [9, 7, 10–16]. Parmi les différentes propositions faites dans la littérature, celle appelée First Fit (FF) [16, 17, 12] est la plus utilisée ainsi que celle nécessitant le plus court temps d'exécution.

Pour attaquer ce problème, il faut connaître combien de longueurs d'onde seront associées à chacun des liens du réseau (problème du dimensionnement, avec acronyme WD [9]). Ce nombre a un fort impact sur les performances du réseau, et il est l'élément central dans le coût global de ce dernier, car il est proportionnel à la partie la plus important de l'investissement en ressources associé [18].

Donc, pour obtenir un dimensionnement efficace de ces réseaux dynamiques, deux objectifs contradictoires doivent être adressés : d'un côté, le réseau doit être conçu de façon à offrir à ses utilisateurs des probabilités de blocages faibles ; de l'autre côté, le coût total du système, donc, le nombre total de longueurs d'onde utilisées doit être aussi faible que possible. Parmi les différentes approches utilisées dans la pratique pour atteindre ces objectifs, la plus fréquemment rencontrée dans les réseaux actuels est celle dite du dimensionnement homogène [12, 19–27].

Ce chapitre décrit une nouvelle méthode, que nous appelons Fair-HED, pour attribuer une longueur d'onde à chaque connexion, et en même temps pour calculer le nombre de longueurs d'onde portées par chaque lien. Ceci est fait de façon telle que la probabilité de blocage de chaque connexion ne dépasse pas une valeur de tolérance prédéfinie. Notre approche a deux différences principales avec les techniques existantes. D'abord, le nombre de longueurs d'onde d'un lien peut être différent de celui d'un autre lien (on appelle ceci dimensionnement hétérogène). Ensuite, la méthode comprend une nouvelle procédure d'attribution de longueurs d'onde appelée "Politique d'Équité" (Fairness Policy). Cette approche permet que la probabilité de blocage de chaque connexion soit aussi proche que possible du seuil défini dans le SLA (qui peut être différent pour chaque utilisateur). Ceci permet de réduire la quantité totale de longueurs d'onde du réseau.

Dans le chapitre, nous étudions les performances de notre méthode et la comparons avec la référence dans le domaine, la procédure First-Fit WA and Homogeneous WD, que nous notons FF-HD, nous l'évaluons dans divers scénarios et sur plusieurs topologies. Nous montrons que notre méthode a de bien meilleures performances que FF-HD. Dans tous les configurations analysées, Fair-HED nécessite entre 25% et 30% moins de longueurs d'onde que FF-HD, avec une charge dans le réseau de 0.3, une valeur de référence [28].

Routage (Chapitre 4)

Pour résoudre le problème du routage, plusieurs approches ont été suivies dans la littérature. Zang et al. [10] proposent une revue claire dans le domaine. Les méthodes Shortest Path First-Fit et K -Shortest Path First-Fit sont les plus utilisées dans les réseaux optiques actuels et celles offrant les meilleures performances. Elles sont donc les meilleures alternatives à comparer avec la proposition que fait l'objet du Chapitre 4. Nous présentons une technique qui trouve simultanément une solution aux trois premiers

problèmes : l'attribution et le dimensionnement des longueurs d'onde, et le routage. Nous l'appelons CPL (pour Cheapest Path by Layers, en Anglais). Elle attribue à chaque source-destination définissant une connexion la route la moins chère, dans un certain sens, tout en essayant d'équilibrer la charge arrivant sur chaque lien, et s'appuie sur la procédure d'attribution et de dimensionnement des longueurs d'onde présentée dans le Chapitre 2.

Pour évaluer les performances des différentes méthodes, les programmes correspondants furent exécutés sur divers scénarios et topologies de réseaux existants. Notre technique CPL propose de meilleures solutions que SP-FF. Dans nos expériences, cette dernière a eu, en moyenne, besoin de 45% plus de longueurs d'onde que CPL. Les procédures K-SP-FF et CPL ont des performances similaires, mais dans la plupart des cas, CPL est légèrement meilleure en termes de performance. En fait, K-SP-FF a besoin, en moyenne, de 7% plus de longueurs d'onde que notre méthode. En taille mémoire et en complexité temporelle, CPL est aussi simple que n'importe quelle technique à routage fixe, en conservant seulement un chemin pour connecter chaque utilisateur (chaque paire source-destination) ; la procédure K-SP-FF demande K entrées dans les tables de routage, en imposant un délai supplémentaire chaque fois qu'un utilisateur essaie de transmettre sur une route.

Il est important de noter que notre proposition obtient, en moyenne, 20% moins de longueurs d'onde que dans le cas d'un scénario d'opération statique. Ces résultats pourraient fournir des raisons suffisantes pour migrer du mode statique d'opération au mode dynamique.

Tolérance aux fautes (Chapitre 5)

Jusqu'ici, nous avons ignoré la possibilité d'avoir des défaillances dans le réseau, qui est donc vu comme opérant de façon parfaite : seulement la performance du service de transmission optique est considéré. Maintenant, la fréquence observée des défaillances essentiellement dans les lignes du réseau est souvent significative. Par exemple, [29, 30] signalent des mesures réalisées dans des structures optiques installées et en opération, qui donnent un temps moyen entre défaillances dans les lignes d'environ 376 ans/km. Ceci signifie que les défaillances des lignes peuvent aussi avoir un impact significatif sur les performances du réseau, et qu'il faut donc les intégrer dans un processus complet

de conception de ces systèmes. À ceci s'ajoute le fait qu'on a observé que la défaillance simultanée de plusieurs lignes du réseau se produit avec une fréquence suffisamment élevée faisant qu'une bonne méthodologie de conception doit aussi en tenir compte [30].

Dans le Chapitre 5 nous proposons une nouvelle procédure de conception capable de résoudre de façon conjointe (i.e. simultanée) de tous les problèmes décrits au début, (i), (ii), (iii) et (iv), c'est-à-dire, l'attribution et le dimensionnement des longueurs d'onde, et le routage, en tenant compte aussi de la possibilité de défaillances d'une ou de plusieurs lignes dans le réseau. Nous avons baptisé "Cheapest Path By Layers with Fault Tolerance" notre procédure, avec l'acronyme CPLFT. Elle produit toutes les routes primaires et secondaires (celles à utiliser en remplacement des premières en cas de défaillance) associées aux connexions. Comme dit précédemment, notre méthode tient compte du cas d'un ensemble arbitraire de liens qui simultanément ont une défaillance, dont le cardinal peut donc être absolument quelconque. CPLFT calcule aussi le nombre de longueurs d'onde par lien, s'assurant que la probabilité de blocage de chaque connexion soit toujours en dessous du seuil (de la QoS) spécifiée à l'avance, même en cas de défaillances. La technique s'appuie sur les résultats de la technique d'attribution de longueurs d'onde et de leur dimensionnement présentée dans le Chapitre 2.

Il y a plusieurs types d'algorithmes de tolérance aux fautes dans le domaine, tels que Shared Path Protection (SP-FF), p -cycle et "1+1". Pour nos analyses, nous avons trouvé que les plus appropriés pour être comparés avec notre technique sont SP-FF pour la génération des routes primaires et "1+1" pour les mécanismes de tolérance aux fautes. Cette combinaison est appelée SPFF1+1 dans le chapitre. Nous faisons nos comparaisons en considérant différents scénarios sur plusieurs topologies de réseaux existants. Dans le cas de la tolérance à des défaillances isolées, la procédure CPLFT dépasse clairement SPFF1+1. Dans tous les cas étudiés, SPFF1+1 demande en général 30% plus de longueurs d'onde que notre méthode. Lorsqu'on considère la défaillance de deux liens simultanément, SPFF1+1 nécessite à peu près 160% plus de longueurs d'onde que CPLFT.

Conclusions

Dans cette thèse, nous avons abordé cinq problèmes majeurs dans la conception de réseaux optiques WDM dynamiques, dans le cas actuel où les nœuds n'ont pas la capacité de

changer les longueurs d'onde des connexions entrantes vers des longueurs d'onde différents en sortie : l'évaluation rapide et précise de la probabilité de blocage, l'assignation des longueurs d'onde, le dimensionnement des longueurs d'onde, le routage et la tolérance aux fautes.

Concernant le premier problème de cette liste, les probabilités de blocage dans le réseau sont habituellement estimées en utilisant la simulation d'événements discrets. La raison est la très élevée complexité temporelle de type exponentielle du calcul exact, qui fait que sauf pour des topologies petites, ce calcul est dans les cas des réseaux réels impossible. Cette estimation est toutefois un processus très lent et, en pratique, elle se limite à quelques scénarios. Or, une solution efficace aux quatre problèmes restants dans la conception des réseaux (ou dans leur maintenance, extension, etc.) nécessite d'évaluer ces probabilités dans de très nombreux cas. La raison est que dans ces quatre problèmes dans lesquels se décompose la conception d'un réseau optique, il faut garantir des niveaux spécifiques de qualité de service, qui se traduisent pas des niveaux maximaux de probabilités de blocage.

Dans la mesure où la méthodologie suivie pour évaluer les probabilités de blocage est la simulation, ce qui entraîne la contrainte de se limiter à faire ces évaluations dans un nombre limité de cas, dans la littérature les problèmes de conception mentionnés sont en général résolus séparément, car il est couramment admis que les solutions simultanées de plusieurs de ces problèmes est trop complexe. De plus, les techniques actuellement employées utilisent diverses heuristiques pour limiter encore plus les espaces de recherche de solutions.

Notre approche démarre par le développement d'une technique de calcul des probabilités de blocage rapide et précise. Ensuite, en s'appuyant sur cet outil, nous abordons les problèmes restants de conception en tenant compte de plusieurs problèmes en même temps, de façon progressive, en ajoutant un problème après l'autre pour finir par une méthode de conception les abordant tous d'une manière intégrée.

Dans ce qui suit, nous discutons quelques points qui développent et justifient l'intérêt de notre approche et des résultats obtenus.

- Dans la mesure où nous basons nos contributions dans la solution de type analytique de l'évaluation des probabilités de blocage (Chapitre 2), notre proposition de solution globale aux problèmes de conception de réseaux optiques consiste en une méthode

de solution conjointe de toutes les sous-tâches du problème que nous avons noté R&WAD+FT. En tenant en compte en même temps de tous les aspects du réseau liés à ces sous-tâches, nous obtenons une procédure plus efficace que celles existantes qui attaquent les sous-problèmes du problème global séparément.

- Notre procédure pour la partie dimensionnement attribue un nombre de longueurs d’onde à un lien a priori différent de celui attribué à un autre lien. On appelle ceci “dimensionnement hétérogène”. Ceci exploite le fait que les réseaux considérés sont en pratique très peu symétriques, ce qui explique les meilleurs résultats obtenus par notre méthodologie.
- De plus, nous avons défini une méthode d’attribution des longueurs d’onde appelée “Fairness Policy” qui permet que chaque connexion utilise seulement le nombre de longueurs d’onde nécessaire pour satisfaire son propre critère de Qualité de Service, ce qui contribue à obtenir un nombre inférieur de longueurs d’onde que celui obtenu par les techniques concurrentes.
- Notre politique de dimensionnement de longueurs d’onde ne différencie pas les routes primaires des routes secondaires. De cette manière, nous exploitons mieux le multiplexage statistique entre toutes les demandes de connexion/déconnexion, et, en définitive, nous obtenons un bon partage des ressources du réseau.
- Nous dimensionnons toujours pour les cas fréquents et pas pour ceux qui ne se produisent pas en pratique. Par exemple, lorsque nous considérons un cas spécifique de défaillance, nous ne tenons pas compte de la charge des routes primaires affectées par les défaillances en question. Même si l’idée semble une banalité, ceci ne se fait pas dans la méthode dite “1+1”.
- Toujours du point de vue de la tolérance aux fautes, rappelons que nos procédures peuvent gérer la défaillance de n’importe quel sous-ensemble de liens, donc, de tenir compte de n’importe quel cas de défaillances dites multiples (i.e., simultanées).
- L’opération on-line de notre méthode finale est rapide et simple. L’information de re-routage est enregistrée dans des tables qui contiennent aussi les routes secondaires associées à chaque possible scénario de défaillance considéré par les concepteurs. Ceci signifie qu’en cas de défaillance, le mécanisme de tolérance est activé très rapidement.

- Du côté du traitement off-line, notre solution demande seulement quelques secondes de CPU, avec une machine Windows standard (Windows 10 64 bits, Intel Core i7 2.60GHz, 8GB de RAM).

Comme mentionné dans l'introduction de cette thèse, il est d'une grande importance de faire un "surclassement" de la méthode actuelle d'opération de nos infrastructures optiques, en passant du mode statique au mode dynamique, pour gérer la demande croissante de communications. Plusieurs solutions ont été proposées pour faire face à ce problème, et parmi elles, celle d'utiliser ces réseaux optiques de façon dynamique est techniquement disponible pour être intégrée aux infrastructures existantes. Le problème est de convaincre les opérateurs de procéder à cette migration, c'est-à-dire, de mettre en évidence des gains suffisants qui justifient les investissements associés.

L'objectif de ce travail de thèse est d'offrir des éléments de conception qui puissent contribuer à ce dernier objectif. Par exemple, dans certains de nos tests, en considérant une charge de trafic standard, dans des cas sans un service de tolérance aux fautes, nous obtenons des gains de l'ordre de 20% par rapport au coût d'un système avec les mêmes objectifs de qualité de service mais opérant de façon statique (voir le Chapitre 4). Nous espérons qu'en ajoutant nos contributions aussi en tolérance aux fautes, nous pourrions aider à convaincre les opérateurs (et les constructeurs d'équipements) de commencer à migrer vers le mode d'opération dynamique de ces réseaux.

Table of contents

List of figures	xxvii
List of tables	xxxiii
1 Introduction	1
2 Blocking Evaluation of Dynamic WDM Networks	11
2.1 Introduction	11
2.2 Blocking Evaluation Strategy	14
2.2.1 Auxiliary sequence of networks	15
2.2.2 Network analytical model when $W = 1$	16
2.2.3 Networks interaction	18
2.2.4 Network blocking evaluation	22
2.3 Numerical Illustrations	23
2.3.1 Analysis of the results	26
2.4 Summary and example of application	29
2.4.1 Summary of the chapter's proposal	29
2.4.2 Wavelength Dimensioning	30
2.5 Conclusions	32

3	Wavelength assignment and dimensioning	35
3.1	Introduction	35
3.2	Wavelength Assignment and Dimensioning	40
3.2.1	Model and assumptions	40
3.2.2	WA&D Procedure	41
3.3	Numerical Results	44
3.3.1	Heterogeneous QoS requirements	48
3.3.2	Analysis and summary of the method	54
3.4	Conclusions	57
4	Routing, Wavelength Assignment and Dimensioning	61
4.1	Introduction	61
4.2	Routing and Wavelength Dimensioning	64
4.2.1	Model and assumptions	64
4.2.2	Sub-procedures needed by our CPL method	65
4.2.3	R&WAD Procedure	67
4.3	Numerical Examples	71
4.3.1	Network Cost	74
4.3.2	Memory size and time access	76
4.3.3	Level of routing unbalance	77
4.3.4	Analysis and summary of the method	80
4.4	Conclusions	83
5	Fault Tolerance	85
5.1	Introduction	85
5.2	Fault tolerance strategy	88
5.2.1	Model and assumptions	88

5.2.2	Sub-procedures needed by our CPLFT method	90
5.2.3	R&WAD+FT procedure	92
5.3	Numerical Examples	96
5.3.1	Extra number of wavelengths	102
5.3.2	Memory size and routing delay	103
5.3.3	Analysis and summary of the method	107
5.4	Conclusions	109
6	Conclusions	111
6.1	General Conclusions	111
6.1.1	Blocking probability	113
6.1.2	Wavelength assignment and dimensioning	114
6.1.3	Routing, Wavelength Assignment and Dimensioning	115
6.1.4	Fault Tolerance	116
6.1.5	Final Words	117
	References	119

List of figures

1.1	Diagram presenting the capacity crunch main possible solutions.	2
1.2	Diagram presenting some of the main problems in Optical Network Design.	5
2.1	Markov chain modeling the occupation of a given link in a network where all links have only one wavelength. There are T_ℓ connections using the link. State c means that connection c is using the link, $c = 1, 2, \dots, T_\ell$. State 0 means that the single wavelength of the link is available. Arrival rate of a burst of connection c : $\lambda_c = 1/t_{OFFc}$. Service rate (by the link) of a burst of connection c : $\mu_c = 1/t_{ONc}$	17
2.2	Time Equivalence Diagram. This figure shows every possible scenario where the user 1 can be accepted or blocked when making a connection request. The network has 4 users and a link's capacity of 3 wavelengths. The upper half (above the dotted line) corresponds to each one of the 3 wavelengths showing the real t_{OFF1} and t_{ON1} seen on each wavelength by the user 1 and the lower part (bellow the dotted line) shows how the user 1 times are taking place.	19
2.3	Mesh networks evaluated. Each edge on the networks are bidirectional, so the number of links L refers to unidirectional arcs on each graph. The parameter d is a measure of density: if the graph has L arcs (the picture shows $L/2$ edges) and N nodes, then $d = L/(N(N - 1))$	25

2.4	Network blocking probability B_{net} , for Eurocore, NSFNet, EON and UKNet real mesh network topologies and different numbers of wavelengths for each topology, for different connection traffic loads. Observe that for each considered configuration, the curves go visually “in pairs”, the simulated output and the analytically evaluated result, showing that they are pretty close to each other.	27
2.5	Network blocking probability B_{net} obtained to compare LIBPE, Overflow method and Simulation technique, for Eurocore, NSFNet, EON and UKNet real mesh network topologies and different numbers of wavelengths for each topology, for different connection traffic loads.	28
3.1	Dimensioning and wavelength assignment: using a first-fit wavelength assignment scheme with a fairness policy, this procedure assigns a number W_ℓ of wavelengths to the link ℓ , for each ℓ , such that the blocking probability of connection c is less than the beforehand specified bound β_c , for each c	43
3.2	Mesh networks evaluated. The number of links refers to the number of bidirectional arcs. Observe that in the picture we see the edges (for instance, the picture shows the EON topology with 39 edges, which corresponds to 78 arcs). The parameter d is a measure of density: if the graph has a arcs (twice the number of edges) and n nodes, $d = a/(n(n - 1))$	45
3.3	The total number of wavelengths C_{net} obtained with our method (FairHED) and with FF-HD on Eurocore, EON, UKNet and Eurolarge real mesh network topologies, for different connection traffic loads, with an homogeneous maximum acceptable blocking probability $\beta_c = 10^{-6}$	46
3.4	The total number of wavelengths C_{net} obtained with our method (FairHED) and with FF-HD on Eurocore, EON, UKNet and Eurolarge real mesh network topologies, for different connection traffic loads, with an homogeneous maximum acceptable blocking probability $\beta_c = 10^{-3}$	47

3.5	The total number of wavelengths C_{net} obtained with our method (Fair-HED) and with FF-HD on Eurocore, EON, UKNet and Eurolarge real mesh network topologies, for different connection traffic loads, with an heterogeneous maximum acceptable blocking probability β_c . The values of β_c are chosen between 10^{-6} and 10^{-3} in an arbitrary form.	50
3.6	Decision process to assign the QoS constrains in \mathcal{Z} to each connection in \mathcal{X}_h , with $h = 1, 2, \dots, H$. The criteria used to make the assignment of the β_c correspond to the idea of longer the connections the stricter the QoS requirements (ascending heterogeneous QoS constrains criteria) . . .	52
3.7	The total number of wavelengths C_{net} obtained with our method (Fair-HED) and with FF-HD on Eurocore, EON, UKNet and Eurolarge real mesh network topologies, for different connection traffic loads, with an heterogeneous maximum acceptable blocking probability β_c . The values of β_c are chosen between 10^{-3} and 10^{-6} in an ascending order, proportionally to the connections route lengths.	53
3.8	The total number of wavelengths C_{net} obtained with our method (Fair-HED) and with FF-HD on Eurocore, EON, UKNet and Eurolarge real mesh network topologies, for different connection traffic loads, with an heterogeneous maximum acceptable blocking probability β_c . The values of β_c are chosen between 10^{-6} and 10^{-3} in an descending order, proportionally to the connections route lengths.	55
4.1	Diagram showing the inputs required to run the CPL method, the condition to be guarantee by the method, and the outputs delivered by the method, to solve the routing and wavelength dimensioning problem.	68
4.2	function CPL() proposed on this thesis chapter to solve the $R\&WAD$ problem, denoted as “Cheapest Path By Layers”.	69
4.3	Mesh networks evaluated. The number of links refers to the number of bidirectional arcs. Observe that in the picture we see the edges (for instance, the picture shows the Eurocore topology with 25 edges, which corresponds to 50 arcs). The parameter d is a measure of density: if the graph has a arcs (twice the number of edges) and n nodes, $d = a/(n(n-1))$.	73

4.4	The total number of wavelengths C_{net} obtained with our method (CPL), SP-FF and 3-SP-FF on Eurocore, EON, UKNet and Arpanet real mesh network topologies, for different connection traffic loads with a maximum acceptable blocking probability $\beta_c = 10^{-3}$	75
5.1	Diagram showing the inputs required to run the CPLFT method, the condition to be guarantee by the method, and the outputs delivered by the method, to solve the routing and wavelength dimensioning problem. .	93
5.2	Algorithm for solving the R&WAD problem, providing alternative routes if the links of one specific subset of links fail (all together) belonging to a list of possible subsets of links that can fail.	95
5.3	Mesh networks evaluated. The number of links refers to the number of bidirectional arcs. Observe that in the picture we see the edges (for instance, the picture shows the Eurocore topology with 25 edges, which corresponds to 50 arcs). The parameter d is a measure of density: if the graph has a arcs (twice the number of edges) and n nodes, $d = a/(n(n-1))$. 99	
5.4	The total number of wavelengths C_{net} obtained with our method (CPLFT) and SPFF1+1 on Eurocore, NSFNet, EON and UKNet real mesh network topologies, for different connection traffic loads with a blocking probability threshold β_c equal to 10^{-3} , in the single fault tolerance case.	100
5.5	The total number of wavelengths C_{net} obtained with our method (CPLFT) and SPFF1+1 on Eurocore, NSFNet, EON and UKNet real mesh network topologies, for different connection traffic loads with a blocking probability threshold β_c equal to 10^{-3} , in the simultaneous double fault tolerance case. 101	
5.6	The extra percentaje of wavelengths $EX(A)$ obtained with our method (CPLFT) and SPFF1+1 on Eurocore, NSFNet, EON and UKNet real mesh network topologies, for different connection traffic loads with a blocking probability threshold β_c equal to 10^{-3} , in the single fault tolerance case. .	104

5.7	The extra porcentaje of wavelengths $EX(A)$ obtained with our method (CPLFT) and SPFF1+1 on Eurocore, NSFNet, EON and UKNet real mesh network topologies, for different connection traffic loads with a blocking probability threshold β_c equal to 10^{-3} , in the simultaneous double fault tolerance case.	105
-----	--	-----

-
- 4.2 Total number of wavelengths C_{net} required by the CPL, SP-FF and 3-SP-FF methods and their respective coefficient of variation in accordance with number of wavelength $CV_W(A)$ and links traffic load $CV_\rho(A)$, for Eurocore, EON, UKNet and Arpanet networks, considering a maximum blocking probability of 10^{-3} and a mean traffic load of 0.3. 80
- 5.1 Total number of wavelengths required by the CPLFT and SPFF1+1 methods: no fault tolerance (C_{net} no FT), single fault (C_{net} Single FT), and simultaneous double fault (C_{net} Double FT), for Eurocore, NSFNET, ARPANET, UKNet and Eurolarge networks, considering a maximum blocking probability of 10^{-3} and a load of traffic 0.3. Additionally, the extra percentage of wavelength (with respect to the no failure case), needed to achieve single and double fault tolerance by each method, respectively, denoted as $EX(A)$ is presented. 107

Chapter 1

Introduction

The numerous new Internet applications arriving nowadays require to transmit very large volumes of information. Think of Social networks, IPTV, HD Streaming, Video on Demand, Online Gaming, Cloud Computing, Internet of Things, Smart Cities, etc. This has caused a considerable increase in the demand for bandwidth to the communication infrastructure, leading to a significant rise in the use of optical networks based on WDM technologies, due to the fact that they can transmit at terabits per second [Tb/s] per fiber [28]. Nevertheless, the relentless exponential growth in bandwidth demand claims to evolve the current WDM optical networks architectures in order to satisfy such increasing traffic requirements.

The precedent means that any progress in the optical network performance leads to meaningful social and economic improvements. This is the reason why optical network design is a topic with great research and development activity.

Currently, this type of network has two main technological features defining the network architecture. One of them is the wavelength conversion capacity on the optical nodes. This means that if a node receives an incoming signal on a determined wavelength, then the node can (or not) transmit the signal on any exit channel, but using a different wavelength. Nevertheless, this technology is not commercially available yet, but solely developed on little experimental prototypes on laboratories. Therefore, the actual optical networks have a wavelength continuity constraint, i.e., when performing an end-to-end communication between any pair of nodes, the path connecting them must use the same wavelength on each route link.

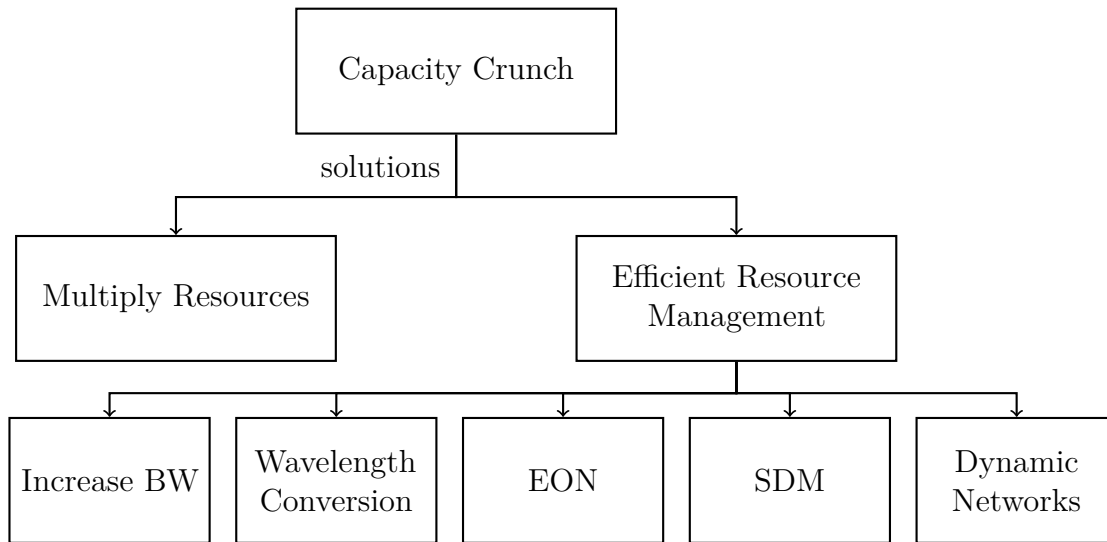

Fig. 1.1 Diagram presenting the capacity crunch main possible solutions.

The second technological characteristic is that current optical networks are operated statically [28], i.e., the route assigned to each user (connection) is permanently assigned from source to destination, regardless of the percentage of time it is used. This operation mode is inefficient in the usage of network resources, especially for low traffic loads, which is the most common situation. Even more, at the start of the decade, researchers encounter that there is an upcoming “Capacity Crunch” in communication networks. This means that transmission capacity limit on optical fiber is close to be reached in the near future due to the increasing traffic demand [1–4], thus researchers should focus their works to solve this major problem.

There are two possible solutions to the capacity crunch problem. First, once the maximum fiber capacity is reached, the worldwide optical network will have to increase the resources installed. For instance, by multiplying the fiber cables and everything related to their performance. Second, to improve the traffic management in order to efficiently use the resources already installed on the optical networks (and of course the ones to come).

To solve the impending capacity crunch, several proposals have been addressed and researched so far. Next are listed the more important ones:

- *Bandwidth Increase*[3, 4]. To increase the bandwidth on the networks by allowing complex modulation formats is a possible solution. Nevertheless, this process has

limitations, since the modulation formats require a bigger bandwidth to properly transmit and optical networks have a limited bandwidth capacity due the capacity crunch. Therefore, this is not a realistic solution.

- *Wavelength Conversion* [31, 32]. This technology can help to overcome the capacity crunch by adding more dynamism on the resource allocation, although it requires a dynamic resource allocation (with a static operation is pointless). Nevertheless, it is not yet commercially available, and it will not be on the near future.
- *Elastic Optical Networks* [33–36]. This new paradigm allows to flexibly use the frequency spectrum in order to attend different traffic needs adaptively, by giving only the necessary bandwidth to each user (no more, no less). In order to achieve this, first the frequency spectrum is divided on several frequency slots units (called FSU) and, later, the FSU can be grouped to fulfill the bandwidth required to transmit each application. This has been an important topic of investigation nowadays, but still requires some research and development to be implemented.
- *Space Division Multiplexing* [37, 38, 4]. This approach, use in both mobile and fiber networks, proposes to divide the channels physically. In optical network it will mean to create different optical fibers, in order to reduce the energy consumption. For instance, fibers with more than one core, or annular fiber cores. etc. This is approach is still in development, and requires some research to be available in the near future.
- *Dynamic Optical Networks* [5, 39]. Another way to help overcome the inefficiencies of static networks consists of allocating the resources required by each user only when there is enough data to transmit. The possible lack of resources to successfully transmit a piece of information can happen because dynamic networks are designed based on a statistical commitment: from one side, for economy reasons dynamic networks are designed with the minimum possible amount of resources; on the other side, for effectiveness they are designed to avoid (or, more generally, to minimize) the occurrence of information losses due to lack of resources when needed (blocking).

From these possible solutions, dynamic optical networks is the one closer to be implemented, since the technology to migrate current networks is already available. Consequently, this thesis addressed this type of networks.

On dynamic networks, to achieve a balance between the previously mentioned two opposite goals (network savings, and quality of service), the network must be designed so that the blocking probability of any connection is less than or equal to a given threshold or bound, seen as a parameter of network design, which is usually a value close to 0. This can be refined by looking for a design where each connection c must have a blocking probability BP_c less than a given bound β_c , so, a specific restriction for each connection. In this way, we can give more or less importance (or priority) to some of the connections.

The network cost definition can be addressed as an economic and commercial point of view. For example, representing the cost of how many optical fibers are needed on the network, taking into account how many wavelengths each fiber can handle. However, this approach is highly volatile, since it quickly changes overtime, due the fast technology growth and commercial strategies. Hence, to measure the network cost in a stable and representative way, we choose to use the number of wavelengths on the network, in a similar way as in most works in literature [9, 5, 40, 41]. This is because the cost of many components in an optical network is strongly affected by this parameter. In fact, it determines how many infrastructure resources are needed on the network to achieve the network operation. Moreover, if the number of wavelengths required increases by any reason, the cost of the network components may be maintained or must be increased. This means that the economic network cost is a non-decreasing function of the network cost measured as the number of network wavelength.

To design dynamic optical networks is necessary to solve several technical problems. Figure 1.2 presents the most important problems that need to be solved in order to design dynamic WDM networks taking into account the main services they must provide. Notice that each problem is dependent of the previous problem (in the figure, the one below), and the complete solution of all the problem can be address as the Routing, Wavelength Assignment and Wavelength Dimensioning problem considering Fault Tolerance (**R&WD+FT problem**), while guaranteeing a maximum blocking probability predefine in the Service Level Agreement. Let us now describe each one of them.

Blocking Probability This measures the chance that any user can not transmit over the network due to the lack of resources [10, 9]. As previously mentioned, dynamic optical network designers must achieve a balance between two contradictory objectives. On one side, to minimize the network resources required, and on the other side, to guarantee a

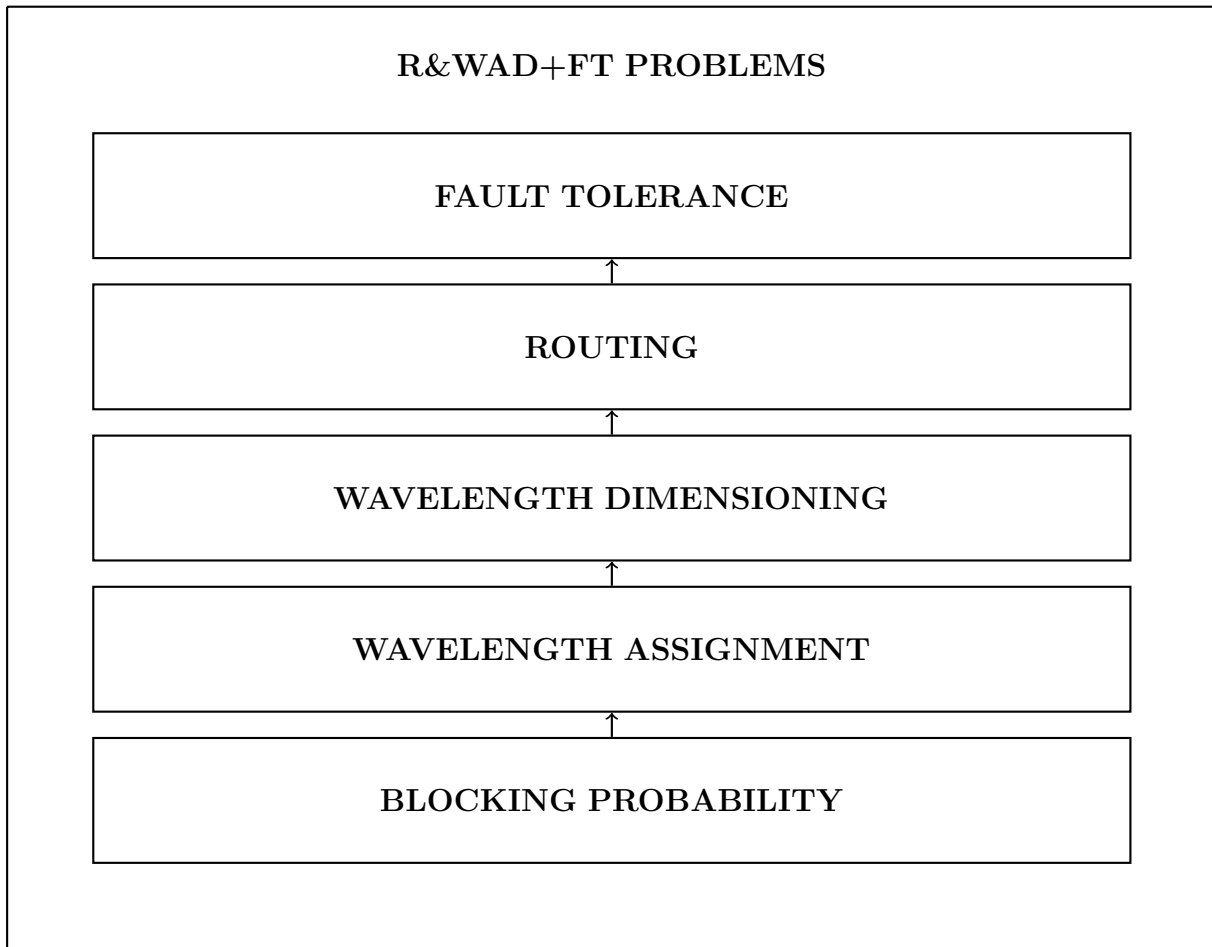

Fig. 1.2 Diagram presenting some of the main problems in Optical Network Design.

quality of service threshold to each user. In this context, the quality of service is measured as the blocking probability. In consequence, the blocking probability is an important parameter used to design (and evaluate) dynamic WDM optical networks.

Wavelength Assignment (WA) This means to define a wavelength to each user in order to successfully communicate each source destination pair of nodes [10, 7, 9]. This problem changes on static and dynamic networks. A static operation requires only one wavelength assignment previous network operation, since then do not change over time. However, on dynamic networks this problem has to be solved each time a user wants to transmit, due to the system operation. By solving this problem on a network with

wavelength continuity constraint becomes even harder to solve, due to the fact than the wavelength chosen has to be available in all the links belonging to the users path.

Wavelength Dimensioning (WD) It must also be determined how many wavelengths should be assigned to each link of the network, in order to achieve the compromise between efficiency and cost previously described [9, 18]. As many works on the literature, we assumed each connection needs one wavelength at each link it uses, in order to transport its content.

Routing (R) This is a basic component of the network operation: every connection is defined by a pair of nodes in the network, the source and the destination, and for each such pair the designer must assign a route to be followed by the data to be transmitted [10, 7, 9].

Fault Tolerance (FT) A major problem to be addressed is to ensure that the network is still able to provide its transmission service after the failure of one or more of its links [42, 30, 43]. The solution to this problem consists of allowing the necessary infrastructure to rapidly re-establish communication between all source-destination pairs of nodes affected by these link failures. In addition, it is desirable that the method takes into account any possible fault tolerance scenario in the network.

The recently described problems have a major economic, technique and scientific importance, since any improvement will change the optical network infrastructure. This situation opens an opportunity to provide a meaningful contribution in actual networks, enabling to migrate from static to dynamic network operation. In practical terms, this will allow to highly increase the network capacity, in the sense of traffic demands, but with a very low investment.

In consequence, this thesis has two main objectives:

1. First, to provide a fast, simple and accurate analytical model to measure each user blocking probability in WDM optical networks with wavelength continuity constraints.
2. Next, thanks to the previous model, to jointly solve the most important technological problems in dynamic optical networks presented in Figure 1.2. These are Routing, Wavelength Assignment, Wavelength Dimensioning, and Fault Tolerance.

The remainder of this thesis is as follows:

- In Chapter 2 we present an analytical model to evaluate the blocking probability in dynamic WDM optical networks with wavelength continuity constraint taking into account heterogeneous traffic.
- Chapter 3 contains a novel method to jointly calculate the number of wavelengths needed on each network link (Wavelength Dimensioning) when providing a novel wavelength assignment strategy called “Fairness Policy”, so that the blocking probability of each user is lower than a certain pre-specified threshold (which is a design parameter of the network).
- Next, in Chapter 4 we propose a new technique to simultaneously determine: the set of routes enabling each network user to transmit; the wavelength assignment strategy to be used; and the wavelength dimensioning necessary on each network link, while, again, guaranteeing a predetermined minimum quality of service.
- Chapter 5 includes a fault tolerance capacity on the previous solution, thus presenting a novel methodology to jointly solve the Routing, Wavelength Assignment, Wavelength Dimensioning and adding fault tolerance to the network to any set of links failure scenario.
- Finally, the conclusions of this thesis are given in Chapter 6.

Due to the fact that nowadays there is not enough resource savings to compensate the complexity introduced to the network when operating dynamically [5], we hope to achieve a progress on the state of art that will finally enable the telecommunication companies to migrate optical networks from the current static operation, to a dynamic one. In this way, the enterprises using this technology will offer a significantly major number of user, with basically the same infrastructure installed.

Publications

In summary, the publications made during this thesis period are:

Journals

- [41] R. Vallejos and N. Jara. Join routing and dimensioning heuristic for dynamic WDM optical mesh networks with wavelength conversion. *Optical Fiber Technology*, 20(3), 2014.
- [53] R. Vallejos, J. Olavarría, and N. Jara. Blocking evaluation and analysis of dynamic WDM networks under heterogeneous ON/OFF traffic. *Optical Switching and Networking*, 20, 2016.
- [81] Nicolás Jara, Reinaldo Vallejos, and Gerardo Rubino. Blocking Evaluation and Wavelength Dimensioning of Dynamic WDM Networks Without Wavelength Conversion. *Journal of Optical Communications and Networking*, 9(8):625, 2017.
- [117] Nicolás Jara, Reinaldo Vallejos, and Gerardo Rubino. A method for joint routing, wavelength dimensioning and fault tolerance for any set of simultaneous failures on dynamic WDM optical networks. *Optical Fiber Technology*, 38:30–40, 2017.

Conference

- [82] N Jara, R Vallejos, and G Rubino. Blocking evaluation of dynamic WDM networks without wavelength conversion. In *2016 21st European Conference on Networks and Optical Communications (NOC)*, pages 141–146, 2016.
- [83] Reinaldo Jara, Nicolas; Rubino, Gerardo; Vallejos. Blocking Evaluation of dynamic WDM networks without wavelength conversion. In *11ème Atelier en Evaluation de Performances*, Toulouse, France, 2016.
- [87] C Meza, N Jara, V M Albornoz, and R Vallejos. Routing and spectrum assignment for elastic, static, and without conversion optical networks with ring topology. In *2016 35th International Conference of the Chilean Computer Science Society (SCCC)*, pages 1–8, oct 2016.
- [118] N. Jara, G. Rubino, and R. Vallejos. Alternate paths for multiple fault tolerance on Dynamic WDM Optical Networks. In *IEEE International Conference on High Performance Switching and Routing, HPSR*, volume 2017-June, 2017.

Chapter 2

Blocking Evaluation of Dynamic WDM Networks

2.1 Introduction

The rapid increase in demand for bandwidth on existing networks has caused a growth in the use of technologies based on WDM optical infrastructures [28, 44]. Currently, this type of network is operated statically [28], i.e., the resources used by a connection (user) is permanently assigned from source to destination. This type of operation is inefficient in the usage of network assets, specially for low traffic loads, which is the most common case.

One way to help overcome these inefficiencies is to migrate these communication infrastructures to networks working dynamically. This operation mode consists in allocating the resources required only when the user has data to transmit. A possible lack of resources to successfully transmit can then happen, because dynamic networks are designed to save costs using the less possible amount of resources, and simultaneously to be effective (low burst losses). To achieve a tradeoff between these two contradictory aspects, the network must be designed such that the connection blocking probability is less than or equal to a design parameter β . The evaluation of the real blocking probability achieved allows to determine whether or not each network user (each connection) is being treated with the required quality of service. As a result, the blocking probability is one of

the main parameters that has been used to evaluate the performance of dynamic WDM optical networks [9].

In general, the blocking probability is evaluated through simulation [6, 7, 5]. The reason is that the exact (numerically speaking) computation of this metric is most of the time out of reach, because of the complexity of the analysis, the combinatorial explosion problem, etc. Nevertheless, simulations are in general very slow compared with the solution obtained following a mathematical approach [8]. The evaluation speed is relevant, because when solving problems of higher order (e.g. concerning routing or fault tolerant mechanisms), it is in general necessary to calculate the blocking probability a large number of times. Thus, a fast and accurate mathematical computational method is extremely useful. However, to obtain a mathematical procedure with such characteristics is a difficult task, due to important aspects to take into account while modeling, such as: traffic load, wavelengths capacity, wavelength continuity constraint (because the network operates without wavelength conversion), network topology, etc. Therefore, several hypotheses are typically introduced to simplify the model in order to facilitate its analysis.

One of these hypotheses is the homogeneous load assumption. Many works assume that the traffic load offered by each connection to the network is statistically the same [45–52]. This hypothesis strongly simplifies the modeling, but it does not adequately represent the operation of optical networks (or computer networks in general), because the offered traffic is usually very heterogeneous. This is relevant since replacing each of the sources by the average of all of them can significantly modify the performance metrics of the system [53]. This underlines the interest in including the traffic load heterogeneity on the network mathematical models used. In [54] a model based on the Erlang-B formula is proposed with the purpose of evaluating the link blocking probability. This model allows different traffic loads on each network link, but since it is based on the Erlang-B formula, the individual loads don't appear in the solutions (only their sums do), and thus, it suffers from the same limitations as when the homogeneous assumption is used.

Another commonly used hypothesis is the Poisson traffic assumption, shared by the majority of papers published so far [55, 45–47, 54, 48, 49, 56, 50–52], which greatly simplifies the mathematical evaluation. However, a Poisson process is not representative of the real traffic in optical networks, for several reasons. For instance, the rate of the offered traffic in a given link varies significantly over time, because it is sensitive to the

number of connections that are not currently transmitting. Another way of using the Poisson modeling was proposed in [50, 46, 45] where the network is split into several layers (one for each wavelength). The blocked traffic in one layer is overflowed to the next. This overflowed traffic is not Poisson (it is bursty), therefore the authors use the Fredericks and Hayward's approximation [57, 58] to transform the bursty overflowed traffic (non-Poisson) into a Poisson flow. The solving procedure then applies the Erlang-B formula separately at each layer to evaluate its blocking probability. This formula can be used on queuing systems where the arrival rate does not change with time, which happens when there is a huge number of connections. However, in an optical network the total number of users that can share a network link is low, and the arrival rate (on any instant and any network link) depends on the number of active connections passing through the link. Then, the arrival rate changes significantly over time, making this model inadequate.

In this chapter we propose a new approach to evaluate the blocking probability (of burst losses) in dynamic WDM optical networks without considering wavelength conversion and with heterogeneous traffic. The method is called Layered Iterative Blocking Probability Evaluation, LIBPE in the text. It takes into account the bursty nature of the offered traffic, by modeling the sources with ON-OFF processes. Our technique obtains very accurate results in comparison to those achieved by simulation, with computational speed orders of magnitude faster.

We illustrate the use of our technique for calculating the number of wavelengths on every network link, that is, for dimensioning the WDM network. The final network dimensioning results show that the proposed method obtains the same results as the ones obtained by simulation (which in general are based on the sequential execution of simulation experiments), but much faster (e.g. between 10^3 and 10^4 times faster).

The remainder of this chapter is as follows: In Section 2.2 we use a layer-based strategy to evaluate the blocking probability. Section 2.3 presents some numerical examples. Then, Section 2.4 presents the dimensioning method and the obtained results. Finally, conclusions are given in Section 2.5.

2.2 Blocking evaluation strategy

The network is represented by a directed graph $\mathcal{G} = (\mathcal{N}, \mathcal{L})$, where \mathcal{N} is the set of network nodes and \mathcal{L} is the set of unidirectional links (the graph's arcs), with respective cardinalities N and L . The set of connections (or users) $\mathcal{C} \subseteq \mathcal{N}^2$, with cardinality C , is composed by all the source-destination pairs with communication between them, together with the route followed by the data.

To represent the traffic between a given source-destination pair an ON-OFF model is used. In works such as [59], it has been demonstrated that the blocking probability on dynamic networks is mainly affected by the mean times t_{ON} y t_{OFF} , and is practically insensitive to the specific distribution of such times. In fact, in [60], the sensitivity of the blocking probability in dynamic networks on the blocking probability was studied in such networks. That work concluded that, for practical purposes, we can consider this probability as insensitive to the specific distribution of t_{ON} y t_{OFF} . Consequently, to represent the times of formation and transmission of bursts, our work uses only the mean values of those times.

Consider connection c . During any of its ON periods, whose average length is t_{ONc} , the source transmits at a constant transmission rate. During an OFF period, with average length t_{OFFc} , the source refrains from transmitting data. We use the notation $\tau_c = t_{ONc} + t_{OFFc}$, and call it the average length of a *cycle* for connection c . For a given user, we assume that the lengths of ON (respectively OFF) periods are i.i.d. random variables, and that both sequences are independent of each other.

When traffic sources are ON, they all transmit at the same rate, determined by the used technology, that to simplify the presentation will be our rate unity. Consequently, the traffic load for connection c , denoted by ϱ_c , given by the following expression,

$$\varrho_c = \frac{t_{ONc}}{t_{ONc} + t_{OFFc}}, \quad (2.1)$$

is also the mean traffic offered by connection c .

Let $\mathcal{R} = \{r_c \mid c \in \mathcal{C}\}$ be the set of routes that enable communication among the different users, where r_c is the route associated with connection $c \in \mathcal{C}$. To simplify the explanation, we assume for the moment that every link $\ell \in \mathcal{L}$ has a same number W of

wavelengths associated with, but keep in mind that our method allows different number of wavelengths on each network link (see at the end of Section II, paragraph *a*).

Let the W available wavelengths be numbered $1, 2, \dots, W$. The network basically operates as follows. Upon the arrival of a connection request to destination d , say by user c , the source s will attempt to transmit on the first wavelength $w = 1$ on the predetermined fixed path from node s to node d , by assuming a “first fit” wavelength allocation method. The request is accepted if wavelength 1 is available on all the links belonging to the predetermined fixed path (wavelength continuity constraint), that is, on route r_c . Otherwise, the same request is offered to the next wavelength ($w = 2$). The process continues in the same way, until there is some wavelength available on all the links of the path, or until the W wavelengths have been considered and none was available along the path. In the first case, the node s transmits its information to d through the available wavelength, and in the last case, the request is blocked (lost).

Given the complexity of the exact evaluation of the blocking probability considering all the aspects described before, we developed a strategy to obtain an accurate while light cost approximate computational scheme. Note that one of the most important aspects to consider is the wavelength continuity problem, because there is no wavelength conversion capability. This means that when a connection transmits, it must use the same wavelength on each link that belongs to its route. We explain below the different steps of the LIBPE procedure.

2.2.1 Auxiliary sequence of networks

Observe that, from the vocabulary point of view, we can consider that the network is actually composed of W networks operating “in parallel”, with the same topology as the original one, which we denoted by \mathcal{G} , but where each link has a single wavelength associated with (that is, a capacity equal to 1). We will see this set of networks as a sequence $\langle \mathcal{G}_1, \mathcal{G}_2, \dots, \mathcal{G}_W \rangle$ and say that these auxiliary networks are different “layers” of \mathcal{G} . Moreover, the single wavelength associated with each link in \mathcal{G}_w is precisely the one having number w . Then, an arriving connection will look for room in layer 1 first, that is, in network \mathcal{G}_1 , if this fails, in \mathcal{G}_2 , and so on, until it finds available capacity in one of the W layers, or until all of them block it.

The technique proposed in this work will then follow a decomposition approach: each layer will be analyzed in isolation, but its parameters will depend on what happens on the other layers. The heuristic mentioned in the abstract appears in the way these two elements (solving for a layer and using the dependencies between them) are treated.

To take into account the interaction between the W auxiliary networks we will establish a dependency between the mean lengths of the OFF periods associated with the sources. That is, the traffic offered to the different layers in the analysis process will (naturally) be different for each one, and its calculation will take into account the different ways where what happens with a wavelength impacts the traffic that will arrive to another one.

In the following, we describe the procedure in detail, which constitutes the main contribution of the chapter.

2.2.2 Network analytical model when $W = 1$

Since the network is divided into a sequence of W networks/layers where each link has now capacity 1, we consider first the case of $W = 1$. With this, we have a method to solve any of the \mathcal{G}_w networks generated on the network division with link capacity equals to 1. Fix a link in the network, say link ℓ . Some connections (at least one) use this link in their routes, some don't. Denote by T_ℓ the number of connections using ℓ , and assume that, once ℓ fixed, we renumber the connections so that those using link ℓ are $1, 2, \dots, T_\ell$. Observe that link ℓ can be either free, or busy transmitting a burst from connection c , $c = 1, 2, \dots, T_\ell$.

Assume the system is in equilibrium, and denote by $BL_{c,\ell}$ the blocking probability of connection c at link ℓ , that is, the probability that a burst of connection c arriving at link ℓ finds it busy. To evaluate it, assume Markovian conditions, that is, Exponentially distributed burst generation times and Exponentially distributed burst transmission times, with respective rates λ_c and μ_c , with the usual independence conditions. The service rate μ_c is simply $\mu_c = 1/t_{ONc}$. For the arrival rate, observe first that when the link ends transmitting a burst, all the T_ℓ connections (including the one that just transmitted) are in the OFF part of their cycles (this is because we are dealing with a loss system). So, when entering state 0, we have T_ℓ exponential clocks competing, the c -th one with an exponentially distributed time length having parameter $1/t_{OFFc}$. So, $\lambda_c = 1/t_{OFFc}$. The continuous time stochastic process $Z = \{Z(t), t \geq 0\}$ on the state space $\{0, 1, 2, \dots, T_\ell\}$,

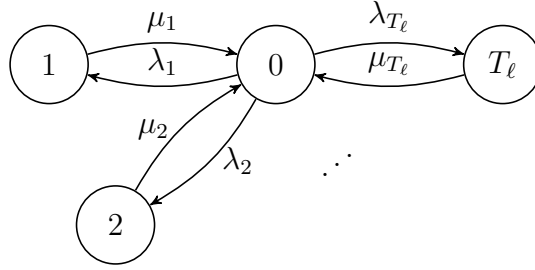

Fig. 2.1 Markov chain modeling the occupation of a given link in a network where all links have only one wavelength. There are T_ℓ connections using the link. State c means that connection c is using the link, $c = 1, 2, \dots, T_\ell$. State 0 means that the single wavelength of the link is available. Arrival rate of a burst of connection c : $\lambda_c = 1/t_{OFFc}$. Service rate (by the link) of a burst of connection c : $\mu_c = 1/t_{ONc}$.

representing the state of the link at time t , where $Z(t) = 0$ if link is idle at t , is then Markov (see Figure 2.1). A straightforward analysis of this Markov chain gives its steady state distribution $(\pi_0, \pi_1, \dots, \pi_{T_\ell})$. The equilibrium equation of state $c \in \{1, 2, \dots, T_\ell\}$ is

$$\pi_c \cdot \mu_c = \pi_0 \cdot \lambda_c. \quad (2.2)$$

This immediately leads to

$$\pi_c = \frac{\phi_c}{1 + \phi}, \quad c = 1, 2, \dots, T_\ell, \quad \pi_0 = \frac{1}{1 + \phi}, \quad (2.3)$$

where ϕ_c is the ratio $\phi_c = \lambda_c/\mu_c = t_{ONc}/t_{OFFc}$ and ϕ is the sum $\phi = \phi_1 + \dots + \phi_{T_\ell}$. Observe that, in terms of loads, we have $\phi_c = \rho_c/(1 - \rho_c)$, since $\rho_c = \lambda_c/(\lambda_c + \mu_c)$.

It is immediate to see that the equilibrium distribution (2.3) doesn't depend on the distribution of ON periods, that is, it doesn't change if the ON periods have any other distribution with finite expectation if this expectation is equal to $1/\mu_c$ for user c . The reason is that any state $i \neq 0$ has only one successor (state 0), so, the model's stationary distribution doesn't change if we set the distribution of any of these holding times to another distribution with the same mean (see, for instance, [61, Prop. 4.8.1] on semi-Markov processes). Here, for simplicity in the presentation, we assume Exponential ON times.

The blocking probability $BL_{c,\ell}$ is the ratio between the probability of a connection c request being blocked for lack of resources and the probability of the union of all possible

scenarios when connection c wants to transmit. It can also be derived marking connection c arrivals and analyzing the chain embedded at the marked transition epochs. The result is

$$BL_{c,\ell} = \frac{1 - \pi_0 - \pi_c}{1 - \pi_c} = \frac{\phi - \phi_c}{1 + \phi - \phi_c}. \quad (2.4)$$

Since we are considering this evaluation on any of the \mathcal{G}_w networks, we can conclude that the link blocking probability on the w -th network $BL_{c,\ell}^w$ is equal to the one obtained on equation (2.4) considering the \mathcal{G}_w network values t_{ON} and t_{OFF} .

The blocking probability of connection c , with $c \in \mathcal{C}$, on network \mathcal{G}_w , that is, the probability that a burst of connection c arriving at \mathcal{G}_w finds at least one link busy in its route, can be then approximated by means of the typical link independence assumption, that is, by assuming that the states of the links in the network (or just in the route) are independent of each other. This gives

$$BC_c^w = 1 - \prod_{\ell \in r_c} (1 - BL_{c,\ell}^w). \quad (2.5)$$

This independence assumption is not realistic in this highly competitive context where many connections can be often trying to access simultaneously the same resources (this is called ‘‘Streamline Effect’’ in [62]). Moreover, remember that in the first \mathcal{G}_w networks, with w close to 1, we are considering the border case where resources are really scarce (there is only one wavelength per link, and several users trying to use it). To improve the quality of the approximation, we use the fixed point method proposed by Kelly [63]: once BC_c , for all connections c , is computed, we modify the arrival rate λ_c by replacing it with the value $\lambda'_c = \lambda_c(1 - BC_c)$. Then, we recompute a new blocking probability BC'_c for all c , and we repeat the process until an appropriate convergence criteria is satisfied.

2.2.3 Networks interaction

Now that every layer performance can be evaluated using the scheme described in 2.2.2, we need to take also into account the interaction between the W networks $\mathcal{G}_1, \dots, \mathcal{G}_W$. This interaction will be captured through new values characterizing the ON-OFF arrival processes of the different connections on each network \mathcal{G}_w . For this purpose, let us denote by $t_{ON_{c,w}}$ and $t_{OFF_{c,w}}$ the average values of ON and OFF periods for connection c in network \mathcal{G}_w . Regarding $t_{ON_{c,w}}$, since it is the time used by source c to transmit, it will be

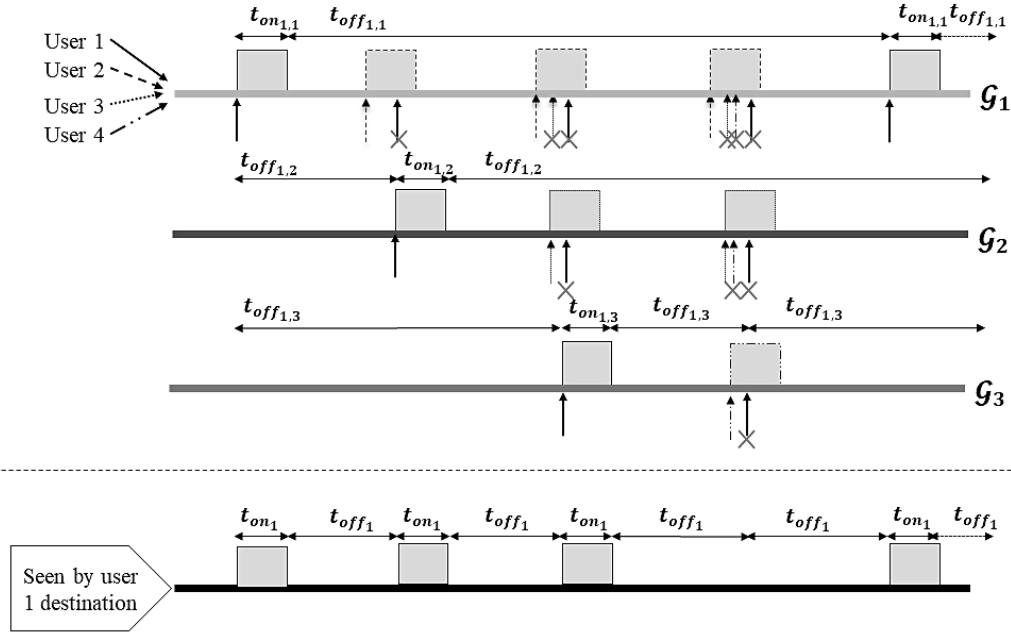

Fig. 2.2 Time Equivalence Diagram. This figure shows every possible scenario where the user 1 can be accepted or blocked when making a connection request. The network has 4 users and a link's capacity of 3 wavelengths. The upper half (above the dotted line) corresponds to each one of the 3 wavelengths showing the real t_{OFF1} and t_{ON1} seen on each wavelength by the user 1 and the lower part (below the dotted line) shows how the user 1 times are taking place.

kept equal to the initial data t_{ON_c} . In other words, the dependencies between layers will be captured only by the $t_{OFF_{c,w}}$ values and for all source c and wavelength w , $t_{ON_{c,w}} = t_{ON_c}$.

As an example, Figure 2.2 shows the time system diagram seen by user 1 when there are 4 users and a link network capacity of 3 wavelengths (we have 3 auxiliary networks named \mathcal{G}_1 , \mathcal{G}_2 and \mathcal{G}_3). The upper part (first 3 horizontal lines of the figure), shows how the connections use the wavelengths resources, and how user 1 sees them work on any wavelengths separately in different scenarios, represented by its t_{ON} and t_{OFF} . The lower part (under the dotted horizontal line) shows how user 1 destination node "sees" the overall transmission time. Every arrival is marked with a vertical arrow. If the connection request is blocked on a wavelength, then an X appears at the bottom of the arrow, and if the connection is accepted a block corresponding a transmission time (t_{ON}) appears. As mentioned before, wavelength allocation is First Fit as can be seen on the diagram.

The heart of our procedure concentrates then on those dependencies between layers, which are of three types, informally described below and represented on the Time Equivalence Diagram shown on figure 2.2. The precise way in which these interactions will be taken into account in the equations will be explicitly presented.

- **Sequential dependency:** when a request from connection c is accepted at layer \mathcal{G}_w , the next layers will not receive it. In other words, a wavelength in the sequence receives a request from connection c only if it is blocked in every previous wavelengths in the sequence. Therefore, $t_{OFF_{c,w'}}$ will grow by the quantity $\tau_c = t_{OFF_c} + t_{ON_c}$ in every $w' > 1$, for each request transmitted on the wavelengths previous to w' . This can be seen on figure 2.2, where the second wavelength will receive a request only when the same connection request is blocked on the first wavelength..
- **Backward dependency:** After connection c is blocked on network \mathcal{G}_1 and accepted in any of the next wavelengths, the next transmission request (in \mathcal{G}_1) of connection c will occur after one transmission period -because the first request was accepted- and one idle period (mean length t_{OFF_c}) to collect new data to transmit. Therefore, all blocked connections in network \mathcal{G}_1 , but accepted on any of the next networks \mathcal{G}_w , $w > 1$, make $t_{OFF_{c,1}}$ grow by τ_c . Notice that this does not only affects only on the first layer \mathcal{G}_1 , but every layer in the network. But it is enough to consider this dependency only on \mathcal{G}_1 , because the sequential dependency will spread this effect. This can be seen on figure 2.2, where user 1 next request time on the first wavelength increases every time user 1 is accepted on any other wavelength but the first.
- **General blocking dependency:** This considers the scenario when a connection c request is blocked on every wavelength (every network \mathcal{G}_w , for all w). In this case, connection c start again to collect new data to transmit (OFF period). Therefore, all blocked connections in the final network \mathcal{G}_W make the $t_{OFF_{c,1}}$ value increase by t_{OFF_c} . This can be seen in fig. 2.2 when the user 1 is blocked on every wavelength.

Let us go now through the details concerning the evaluation of $t_{OFF_{c,w}}$ for all w s, considering the dependencies just introduced. For this purpose, we will denote by BC_c^w the blocking probability of connection c at layer \mathcal{G}_w .

- First Wavelength ($w = 1$). On the first wavelength, that is, on the first layer \mathcal{G}_1 , we take into account the last 2 dependencies. First, when connection c is blocked

on \mathcal{G}_1 and accepted in any of the next layers, it will have to wait an additional delay τ_c until trying to transmit again on \mathcal{G}_1 (*Backward* dependency). Second, if the connection is blocked in every following wavelength, that is, in every layer, then the connection starts again an OFF period (*General blocking* dependency). These facts translates into the following relationship, by considering every possible scenario in a probabilistic way:

$$\begin{aligned}
t_{OFF_{c,1}} &= t_{OFF_c} \\
&+ 0 \cdot (1 - BC_c^1) \\
&+ \tau_c BC_c^1 (1 - BC_c^2) \\
&+ \tau_c BC_c^1 BC_c^2 (1 - BC_c^3) \\
&+ \dots \\
&+ \tau_c \left(\prod_{k=1}^{W-1} BC_c^k \right) (1 - BC_c^W) \\
&+ t_{OFF_c} \left(\prod_{k=1}^W BC_c^k \right).
\end{aligned} \tag{2.6}$$

The first term in (2.6) considers the source t_{OFF_c} of the connection c . The second term represents the probability of being accepted on the first wavelength, in which case the value of $t_{OFF_{c,1}}$ remains unchanged. The next terms correspond to the cases of connection c accepted at the next layers ($w > 1$), in which case the *Backward* dependency applies. The very last term handles the case where the connection is blocked on every possible wavelength; in that case, the *General blocking* dependency. Now, (2.6) can be simplified into

$$t_{OFF_{c,1}} = t_{OFF_c} \left(1 + \prod_{k=1}^W BC_c^k \right) + \tau_c \sum_{1 \leq i \leq W-1} (1 - BC_c^{i+1}) \prod_{k=1}^i BC_c^k. \tag{2.7}$$

The last term in previous equation has a telescopic sum inside. This allows a further simplification:

$$t_{OFF_{c,1}} = t_{OFF_c} + \tau_c BC_c^1 - t_{ON_c} \prod_{k=1}^W BC_c^k. \tag{2.8}$$

- Next wavelengths now. Observe first that layer \mathcal{G}_w , for $w > 1$, will not have a connection request from user c until this user is blocked on all previous layers. So,

connection c mean OFF period length increases by a mean cycle length τ_c for every time the user c was accepted on any of the previous layers.

Consider BC_c^m , with $m < w$, the blocking probability of connection c on \mathcal{G}_m . Notice that the periods between consecutive successful transmissions on \mathcal{G}_m , are statistically equivalent. Then, the probability that a sequence of transmission request are successful, is given by a sequence of i.i.d. Bernoulli random variables, with success parameter equal to $1 - BC_c^m$. This implies that the mean number of connection c request in network \mathcal{G}_m until the first one is blocked is $1/BC_c^m$. Therefore, the mean number of user c successful transmissions on network \mathcal{G}_m is equal to $\frac{1}{BC_c^m} - 1$. This happens on each previous network previous to \mathcal{G}_w ; therefore, we must consider all of them.

The mean length of the OFF period corresponding to connection c for wavelength $w > 1$ is then

$$t_{OFF_{c,w}} = t_{OFF_{c,w-1}} + \tau_c \sum_{m=1}^{w-1} \left(\frac{1}{BC_c^m} - 1 \right). \quad (2.9)$$

This equation shows how the mean time $t_{OFF_{c,w}}$ seen on the \mathcal{G}_w network captures the sequential overflow traffic of every connection c .

2.2.4 Network blocking evaluation

The total network blocking probability of a dynamic WDM network (that is, the blocking probability of an arriving burst, without considering to which connection it belongs), B_{net} , will be measured by the total blocked burst rate divided by the total burst rate arriving at the network, i.e.,

$$B_{net} = \frac{\sum_{c \in \mathcal{C}} \rho_c BC_c}{\sum_{c \in \mathcal{C}} \rho_c}, \quad (2.10)$$

where BC_c is the overall blocking probability of connection c , calculated by

$$BC_c = \prod_{\text{all } w} BC_c^w. \quad (2.11)$$

It is important to note that the evaluation of the BC_c^w , for all \mathcal{G}_w , requires the values of $t_{OFF_{c,w}}$ for all w . On the other hand, according to the relationships (2.8) and (2.9), the

value of every $t_{OFF_{c,w}}$ requires the values of BC_c^w , for all \mathcal{G}_w . This problem can then be solved with an iterative fixed point method, where BC_c^w , for all \mathcal{G}_w , is initially set to 0.

The corresponding pseudo-code of the entire strategy is summarized in Algorithm 1. In this pseudo-code five functions are used.

- **Initialize(c):** This function assigns the respective values of t_{ON_c} and t_{OFF_c} to connection c , for all $c \in \mathcal{C}$.
- **LinkBP(ℓ):** For a given network \mathcal{G}_w , this function evaluates the link blocking probability of every connection c passing through link ℓ , using Equations (2.3) and (2.4).
- **ConnectionBP(c):** For a given network \mathcal{G}_w , this function evaluates the connection c end-to-end blocking probability using Equation (2.5).
- **NetworkBP():** This function evaluates the global network blocking probability using Equation (2.10).
- **Update(t_{OFF_c}, w, j):** This function updates the mean time OFF “seen” by network \mathcal{G}_w on iteration j , i.e. $t_{OFF_{c,w}}$, as explained before (Equations (2.8) and (2.9)).

Case of different numbers of wavelengths in different links. Assume now that link ℓ of \mathcal{G} has capacity \mathcal{W}_ℓ , that is, that it can work with wavelengths $1, 2, \dots, \mathcal{W}_\ell$, where the \mathcal{W}_ℓ s are not necessarily the same on each link. To handle this general case, we divide the network into \mathcal{W}_{\max} layers, where $\mathcal{W}_{\max} = \max_{\ell \in \mathcal{L}} \{\mathcal{W}_\ell\}$. As before, all links in each layer have a single (and the same) wavelength associated with. If link $\ell \in \mathcal{L}$ has capacity $\mathcal{W}_\ell < \mathcal{W}_{\max}$, then in any layer \mathcal{G}_w where $w > \mathcal{W}_\ell$, link ℓ simply doesn't appear.

2.3 Numerical Illustrations

In this section we illustrate the accuracy of the approximation scheme of LIBPE, by comparing its output with the overflow traffic-based method proposed in [50] (denominated as “Overflow” method) and to the result of simulation.

Algorithm 1 Layered Iterative Blocking Probability Evaluation

```

1: procedure LIBPE
2:   for each  $c \in \mathcal{C}$  do
3:      $\langle t_{ON_c}, t_{OFF_c} \rangle \leftarrow \text{Initialize}(c)$ 
4:   end for
5:    $j \leftarrow 1$ 
6:   repeat
7:     for  $w \leftarrow 1$  to  $W_{max}$  do
8:       for each  $c \in \mathcal{C}$  do
9:          $t_{OFF_{c,w}}(j) \leftarrow \text{Update}(t_{OFF_c}, w, j)$ 
10:      end for
11:      for each  $\ell \in \mathcal{L}$  do
12:         $\{BL_{\ell,w}^i(j) : \text{for all } i\} \leftarrow \text{LinkBP}(\ell)$ 
13:      end for
14:      for each  $c \in \mathcal{C}$  do
15:         $BC_c^{w-1}(j) \leftarrow \text{ConnectionBP}(c)$ 
16:      end for
17:    end for
18:     $j \leftarrow j + 1$ 
19:  until  $(BC_c^w(j), \forall c \in \mathcal{C} \text{ converges})$ 
20:   $B_{net} \leftarrow \text{NetworkBP}()$ 
21: end procedure

```

The simulation results were obtained by an event based Monte Carlo simulation. The simulation was made to represent how dynamic optical networks perform, i.e. it does not use a layer based approach to operate, it emulates the network work without wavelength conversion. Since we wanted to have a good idea about the accuracy of the approximation, we stopped the simulation when we had a statistical relative error on the targets (the global network blocking probabilities) less than 5%, a pretty stressing objective. We are considering here a typical network performance evaluation process where the systems are considered in equilibrium, so, the simulation results were obtained by removing the initial transient phase, that is, using the concept of *warm-up time*. For each simulation, enough bursts were generated in order to accomplish a 95% interval confidence.

In real optical infrastructures, the lengths of ON periods are proportional to the burst size, which depends on the burst aggregation mechanism [64, 65]. These bursts have a maximum size and in this context where resources are scarce, the maximum burst

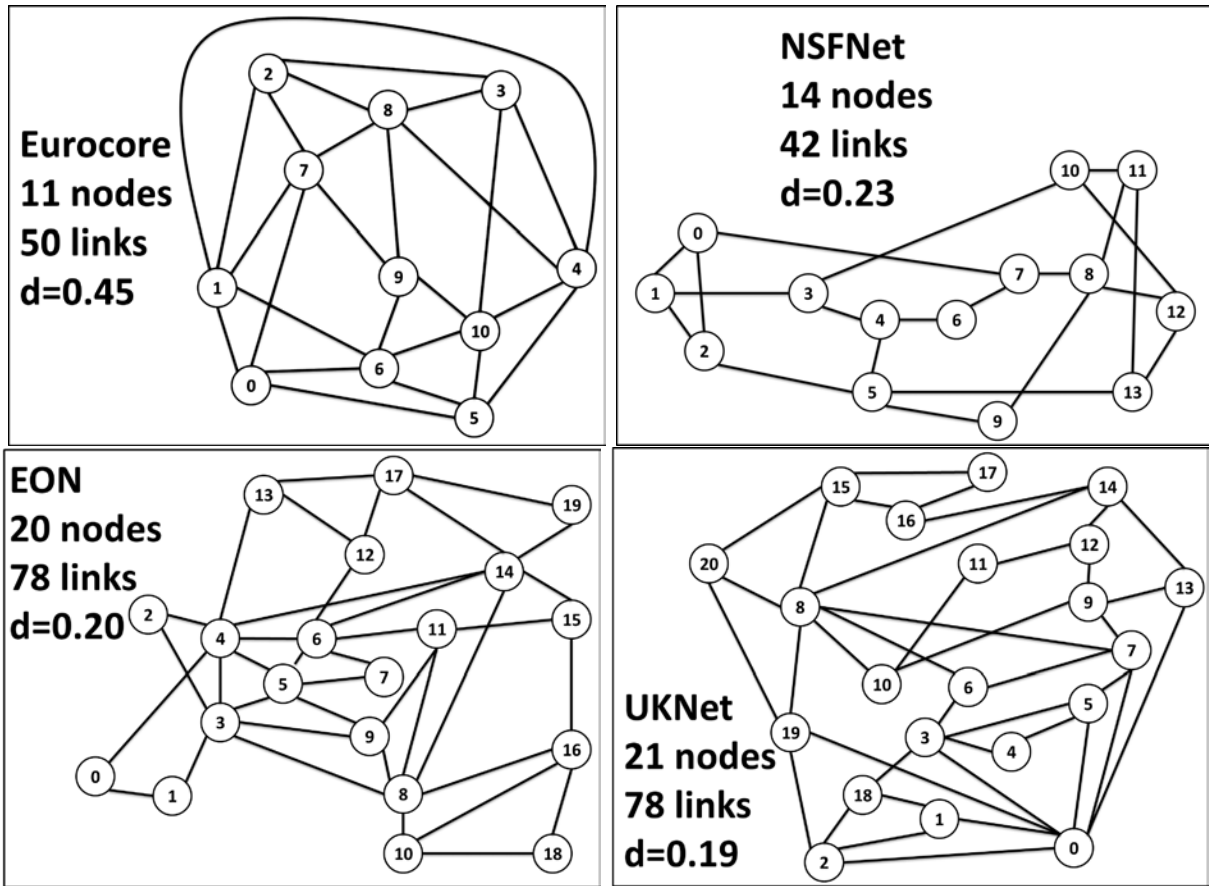

Fig. 2.3 Mesh networks evaluated. Each edge on the networks are bidirectional, so the number of links L refers to unidirectional arcs on each graph. The parameter d is a measure of density: if the graph has L arcs (the picture shows $L/2$ edges) and N nodes, then $d = L / (N(N - 1))$.

size will in general be reached. This suggests that a constant length ON period is much more realistic than an Exponentially distributed one. Thus, we used the same data but changed the length in time of the ON periods of every connection, from random and Exponentially distributed to deterministic, that is constant ones.

In the experiments we compared the outputs of LIBPE method with simulation results using four different real mesh topologies. Figure 2.3 shows these topologies and some of their parameters: number N of nodes, number L of links (the arcs of the graph, that is, twice the number of edges that are drawn in the picture) and network density $d = L / (N(N - 1))$.

Figure 2.4 shows the results for the different graphs. The parameter t_{ON} was set to 10 ms and t_{OFF} was varied, in order to obtain different values for the traffic load, ρ , in the range [0.1...0.9].

Regarding the Overflow method [50], as explained on Section 2.1, it is based by the overflow traffic analysis used on ITU's teletraffic engineering [57]. In this case, the network is split into several layers (one for each wavelength) where the blocked traffic in one layer is overflowed to the next, and uses the Fredericks and Hayward's approximation [57, 58] to transform the bursty overflowed traffic (non-Poisson) into a Poisson flow. Then, to solve each layer blocking probability applies the Erlang-B formula.

To compare our method with the Overflow method, we compared the outputs of LIBPE and the Overflow method with simulation results using four different real mesh topologies presented in Figure 2.3.

2.3.1 Analysis of the results

In the experiments, our method always gave results very close to those coming from simulations, as illustrated in the examples used in the chapter. We see that our heuristic procedure LIBPE is extremely accurate, and the results reported show that LIBPE is very robust with respect to the model assumptions concerning the length of ON periods at the sources, the mechanism in which we capture the overflow between network layers, the blocking probability evaluation method at each layer, and using Kelly's technique to consider the Streamline effect. Our results also show that LIBPE outperforms significantly the standard Overflow method.

If we compare the LIBPE and Simulation sets of curves composing Figure 2.5, it's hard to see any difference between them (in a logarithmic scale, as shown on Figure 2.5). Then, to make a zoom on this aspect of the work, consider the case of the UKNet topology with 10 wavelengths per network link, when the load of all connections is 0.3. In this case we observed the largest differences between LIBPE and simulation. Our method obtains a global network blocking probability of $9.56 \cdot 10^{-2}$, and using simulation, the estimation was equal to $5.78 \cdot 10^{-2}$. At an opposite situation, consider the Eurocore network topology with 3 wavelengths per link and, again, a traffic load of 0.3. LIBPE obtains $B_{net} = 4.56 \cdot 10^{-2}$; and simulation led to a global blocking probability of $4.41 \cdot 10^{-2}$. As a supplementary and positive comment, we always observed that LIBPE evaluates the

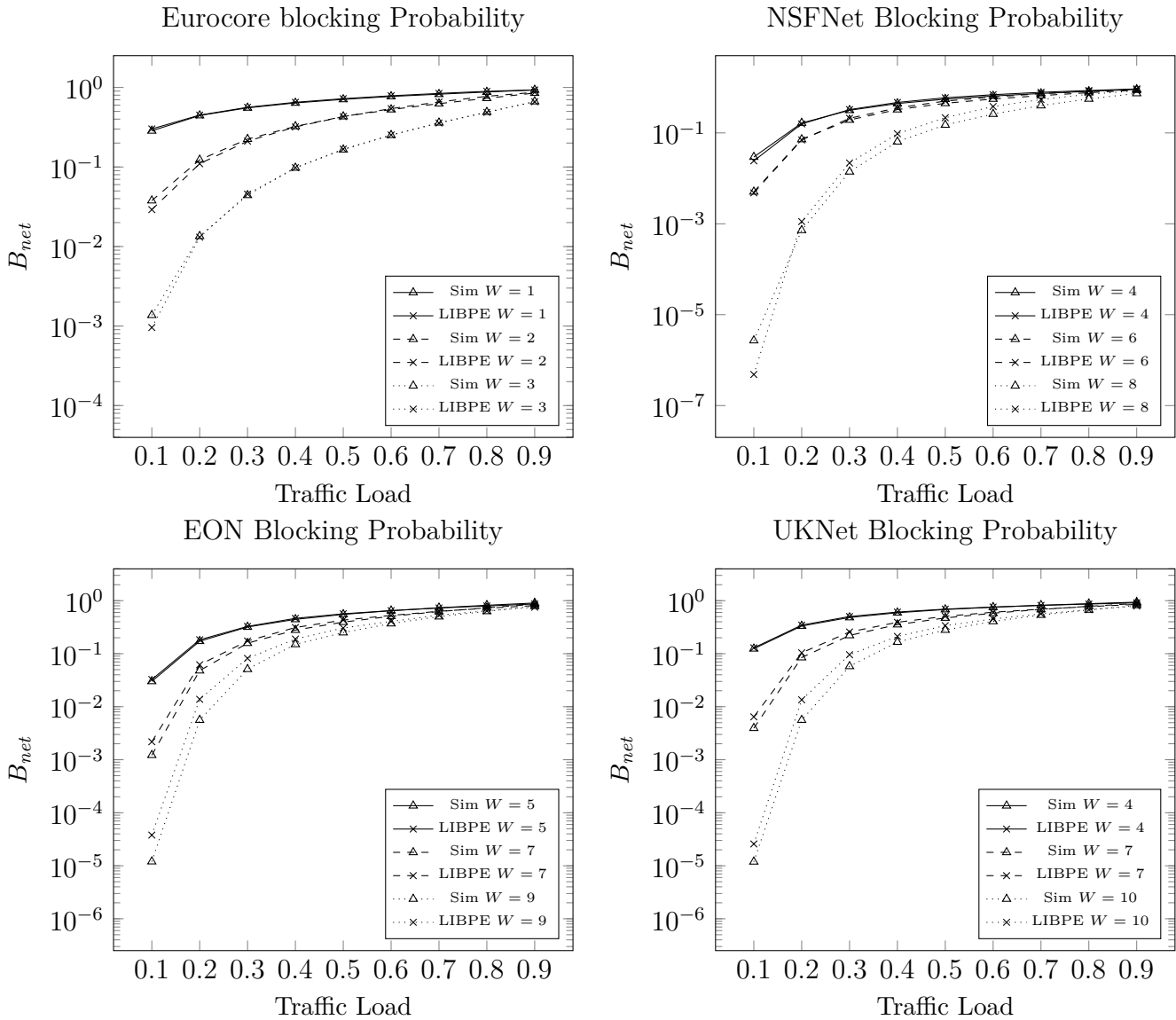

Fig. 2.4 Network blocking probability B_{net} , for Eurocore, NSFNet, EON and UKNet real mesh network topologies and different numbers of wavelengths for each topology, for different connection traffic loads. Observe that for each considered configuration, the curves go visually “in pairs”, the simulated output and the analytically evaluated result, showing that they are pretty close to each other.

global blocking probability pessimistically, that is, it provides values slightly higher than those coming from simulating the network. This is a good feature (when guaranteeing

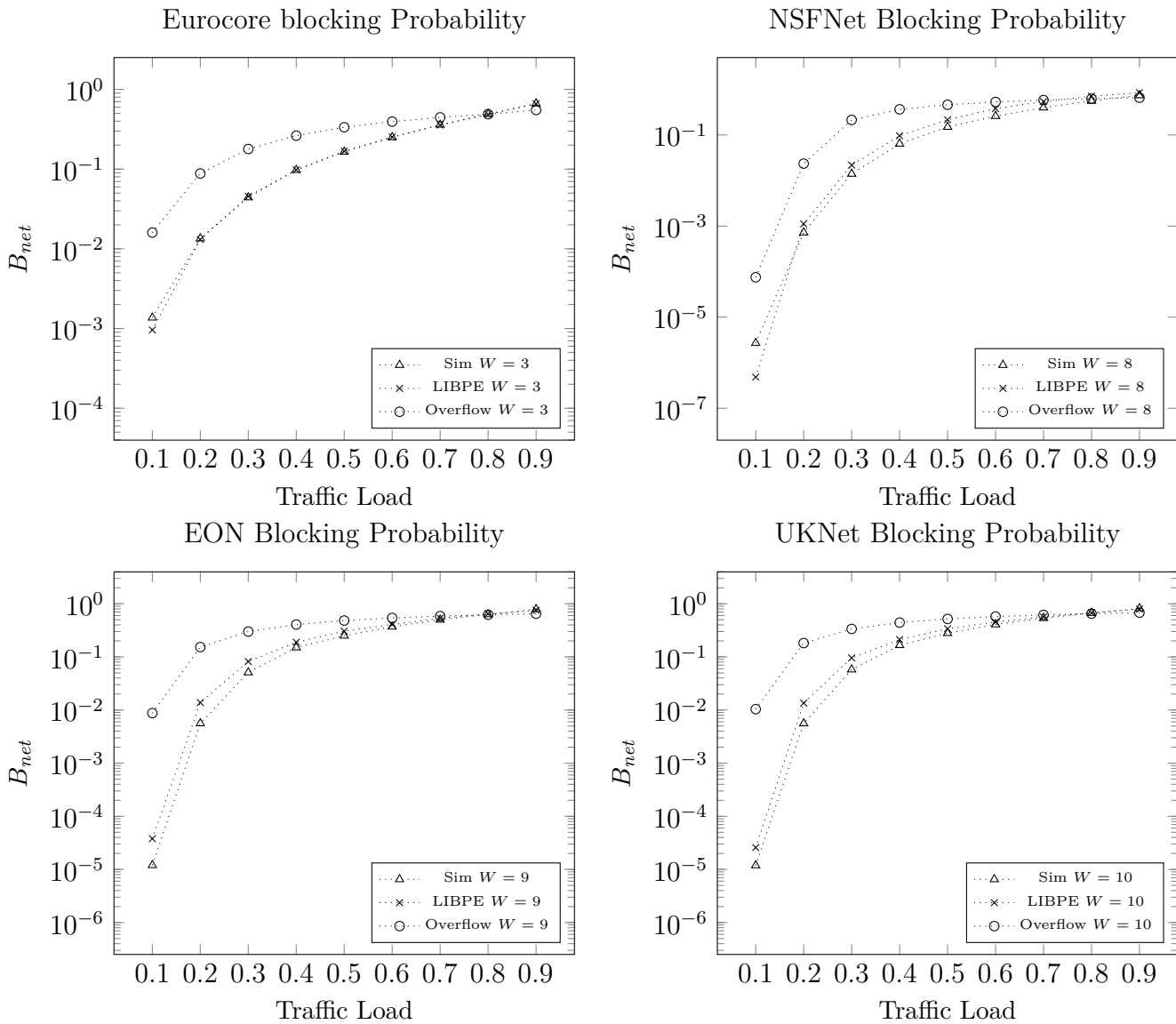

Fig. 2.5 Network blocking probability B_{net} obtained to compare LIBPE, Overflow method and Simulation technique, for Eurocore, NSFNet, EON and UKNet real mesh network topologies and different numbers of wavelengths for each topology, for different connection traffic loads.

QoS when solving real size problems), even if for the moment we don't see what is the reason explaining this fact.

The main difference between LIBPE and simulation is the time required to obtain the network blocking probability. For example, to generate the curves for the UKNet network, the mathematical method took less than a second, while the simulation procedures needed about 6 hours in the same computer. The practical implication of this is that our method can be used as an engine internal to a real time decision system, or to assess network performance under different scenarios as a part of an optimization process.

2.4 Summary and example of application

2.4.1 Summary of the chapter's proposal

In qualitative terms, the main characteristics of our approach are the following ones:

- Our method divides the network into W separated networks $\mathcal{G}_1, \dots, \mathcal{G}_W$, that we call *layers*, to handle the wavelength continuity problem. This allows designing an evaluation technique that decomposes the problem into two different procedures: one for analyzing each layer in isolation, and the other one to interconnect what happens in the different networks. This approach leads to a significant simplification of the evaluation, compared to the effort in computing exactly the blocking probabilities, out of reach even for small networks because of the combinatorial explosion problem.
- To consider the overflowed traffic from a layer to the next, we modify the mean OFF time period for each connection (user) “seen” on each layer, considering the existent dependencies between them.
- The Markov chain proposed to evaluate every link blocking probability on each \mathcal{G}_w network considers an ON-OFF traffic, taking into account the mean OFF and ON time periods “seen” on each network.
- Our method takes into account the fact that the blocking probability of a link depends on what happens with other links in the network (“Streamline Effect”). The majority of the connections pass through more than one link, which means that if a connection request is blocked in one of the first links of its route, the request does not reach the following links of the route (the “downstream” links).

This phenomenon affects the load perceived by downstream links and therefore their blocking probabilities.

- The model allows to take into account heterogeneous traffic. This is important because it represents reality more accurately than the usual homogeneous traffic assumption.
- Our methodology allows to obtain very accurate results in, say, less than a second for real mesh topologies.

2.4.2 Wavelength Dimensioning

We illustrate the use of the procedure proposed in this thesis to dimension the number of wavelengths required on every network link, as a function of the offered traffic and a performance objective. The latter typically consists in finding the capacity of the links such that the blocking probability BC_c of each connection c does not exceed a predefined maximum tolerance value (typically agreed in the Service Level Agreement between carriers and customers). The number of wavelengths impacts significantly the network cost, therefore an efficient dimensioning of every link in an optical network is of paramount importance. Usually, the dimensioning of these networks has been done based on simulation. The calculation speed is important, so the network designers may solve higher order problems faster.

For different reasons, the usual dimensioning procedures consider homogeneity in the links' capacities, that is, they look for a capacity W , the same on all links, such that the performance objective is reached; see for example [24, 66, 22, 23, 20]. Solving this procedure with different links' capacities leads to a state space that grows exponentially in size. This means that solving this problem by simulation becomes hard. We will then follow here the same approach, because this can facilitate further comparisons with existing methods. The idea is simple: we are given the network topology and the offered traffic, and our tolerance value for the blocking probability of connection c , BC_c^{TARGET} . We then initialize the network capacity W by value 1 and we evaluate the blocking probabilities per connection BC_1, \dots, BC_C in two different ways, using simulation and by means of our analytical procedure (in order to be able to compare their respective dimensioning and execution times); then, we check the condition “for all connection $c \in \mathcal{C}$,

Network Topology	BC_c^{TARGET}	Method	C_{net}	Execution Time(s)
Eurocore	10^{-6}	AnHD	400	$3.20 \cdot 10^{-2}$
	10^{-6}	SimHD	400	$3.98 \cdot 10^2$
	10^{-3}	AnHD	300	$1.60 \cdot 10^{-2}$
	10^{-3}	SimHD	300	$2.28 \cdot 10^2$
NSFNet	10^{-6}	AnHD	672	$2.34 \cdot 10^{-1}$
	10^{-6}	SimHD	672	$1.21 \cdot 10^3$
	10^{-3}	AnHD	546	$1.72 \cdot 10^{-1}$
	10^{-3}	SimHD	546	$7.25 \cdot 10^2$
EON	10^{-6}	AnHD	1716	$1.25 \cdot 10^0$
	10^{-6}	SimHD	1716	$2.06 \cdot 10^3$
	10^{-3}	AnHD	1404	$8.90 \cdot 10^{-1}$
	10^{-3}	SimHD	1404	$1.82 \cdot 10^3$
UKNet	10^{-6}	AnHD	1872	$1.62 \cdot 10^0$
	10^{-6}	SimHD	1872	$2.37 \cdot 10^3$
	10^{-3}	AnHD	1560	$1.03 \cdot 10^0$
	10^{-3}	SimHD	1560	$2.11 \cdot 10^3$

Table 2.1 Computational time required to calculate the total number of wavelengths C_{net} with the homogeneous dimensioning method based on simulation (SimHD) and the proposed analytical procedure (AnHD). Both dimensioning algorithms considers the maximum connection blocking probability BC_c^{TARGET} with values equal to 10^{-3} and 10^{-6} , and are applied to Eurocore, NSFNet, EON and UKNet real mesh network topologies for a mean traffic load equal to 0.3. HD stands for Homogeneous Dimensioning, meaning that all links have the same number of wavelengths associated with.

$BC_c \leq BC_c^{TARGET}$. If the condition is satisfied, we stop the algorithm. If not, we increase W by 1 and we repeat the procedure.

Let us denote by **AnHD** the dimensioning procedure using our mathematical approach for evaluating the blocking probabilities, as in Analytical Homogeneous Dimensioning;

and by **SimHD** the analogous method using simulation for the same evaluations, as in Simulation-based Homogeneous Dimensioning. Our goal is to verify the robustness of the approach by checking that both algorithms will produce the similar values for W , and the corresponding execution times.

The two dimensioning algorithms, **AnHD** and **SimHD**, were applied to different real mesh network topologies. Both algorithms were used in a PC Intel Core I7 with 16GB of RAM and Windows 8 OS. Table 2.1 shows the computational time required to calculate the total network cost $C_{net} = LW$, where W is the capacity per link calculated by each algorithm applied to mesh network topologies, for values of BC_c^{TARGET} equal to 10^{-3} and 10^{-6} , for a mean connection traffic load equal to 0.3.

In Table 2.1 it is clear that our method is very accurate. Indeed, in all scenarios evaluated the dimensioning procedure gave roughly the same results as the simulation method. Moreover, it is clear that **AnHD** has a very low execution time, which is between 3 and 4 orders of magnitude smaller than the execution time of **SimHD**. For example, on the network EON **AnHD** is 1648 and 2044 times faster than **SimHD**, when we consider a maximum blocking probability of 10^{-3} and 10^{-6} respectively.

2.5 Conclusions

In this chapter a new layer-based mathematical method called LIBPE for blocking probability evaluation of dynamic WDM optical networks without considering wavelength conversion and taking into account heterogeneous traffic is presented. Another feature of our technique is that it considers that the sources are modeled by *ON-OFF* processes. This allows to take into account the non-uniform (bursty) nature of the traffic offered to the links. The link blocking dependency is handled by means of the Kelly's Reduced Load method. By dividing the network into several layers, the wavelength continuity constraint can be efficiently taken into account. The interactions between layers is considered through the mean *OFF* periods seen on every network layer.

The results obtained have been compared with simulation and with another commonly used method. The results of the proposed technique are accurate enough to closely match those obtained by simulation. By its analytical nature, our method allows to obtain the

blocking probability of the network in a fraction of a second. This is usually several orders of magnitude faster than using simulation.

As an illustration of the calculating procedure, we report its use for wavelength dimensioning providing a QoS guarantee on the connections' blocking probability. By using our method, we can solve this problem 4 orders of magnitude faster than simulation on the scenarios presented. This is relevant, because allows the network designer to solve problems of higher order several times, to adjust and improve the network designing procedures, to further optimize costs or benefits with respect to other parameters, etc.

As in several procedures of this type, some mathematical aspects have not been considered, namely the existence and unicity of fixed points, or the validity of the convergence tests in the fixed point calculations. In future work we will explore these issues, for instance by analyzing the potential use of Brouwer theorem and extensions for the analysis of the fixed points, or the capabilities of different convergence tests. Our only claim here is the fact that in a large set of experiments, some of which are reported here, we never found any problem with these mathematical issues.

Chapter 3

Wavelength assignment and dimensioning

3.1 Introduction

A central issue in WDM optical networks is to choose which wavelength is going to be used by each connection (also called “user”) every time they want to transmit, denoted as the “Wavelength Assignment” (*WA*) problem [9, 7, 10]. The solution of this problem on dynamic WDM optical networks is specially tricky when the network has not wavelength conversion capabilities. This lack of wavelength conversion means when a connection wants to transmit, the same wavelength has to be available on every link belonging to the given connection route (end-to-end). In other words, there is a wavelength continuity constraint. Notice that the chosen wavelength changes over time, since every time the user request resources to send data the *WA* method searches an available wavelength on the user route links. This problem has been vastly covered by previous work [9, 7, 10–16]. Next we present some of the most common heuristics proposed in the literature to solve the *WA* problem:

- First Fit (FF) [16, 17, 12]. This is the most common and fastest method used to date. In this scheme the wavelengths are considered as a sequence. When searching for an available wavelength upon the arrival of a connection request, the search starts on the first wavelength in the sequence. The request is accepted if the first

wavelength is available on all the links belonging to the predetermined user fixed path. Otherwise, the same request is sent to the next wavelength on the sequence. The process continues on the same way, until there is some wavelength available on all the links of the path, or until all the wavelengths have been checked and none was available along the path. This scheme performs well in terms of blocking probability, and is preferred in practice because of its small computational overhead and low complexity. Additionally, it does not introduce any communication overhead because no global knowledge is required.

- Random Fit (RF) [10, 11]. This technique searches through every possible wavelength along the path as the previous scheme, but it selects the wavelength sequence randomly, using any probability distribution (usually an uniform one). It will continue doing so until there is a wavelength available to transmit on each link along the user's route, or until every wavelength has been checked and none of them is available. This method does not require further information from the network status, hence does not introduce any communication overhead as well.
- Most-Used (MU) [12, 11, 10, 67]. Also known as PACK, the MU scheme chooses the wavelength that is most-used in the network. The performance of MU slightly outperforms FF [10, 14], doing a better job of packing connections into fewer wavelengths and conserving the spare capacity of less-used wavelengths; by doing so it maximizes the wavelengths usage. In order to obtain a solution it requires global information to compute the most-used wavelength; therefore, it introduces additional communication overhead.
- Least-Used (LU) [11, 68, 10]. Also known as SPREAD, this method selects the wavelength that is the least used in the network. By choosing the least-used wavelength it seeks to balance the load among all the wavelengths. The performance of LU is worse than Random and the communication overhead; storage and computation cost are all similar to those in MU [14, 10].

To solve the WA problem, it is required to previously know how many wavelengths were assigned to the network links. Finding the number of wavelengths of the links is called the "Wavelength Dimensioning" (*WD*) problem [9]. The number of wavelengths impacts significantly the network cost, since it determines how many infrastructure resources are needed in the network to achieve the network operation [18]. Additionally,

it greatly influences the network performance. Therefore an efficient dimensioning of every link in an optical network is of paramount importance.

To achieve an efficient Wavelength Dimensioning on dynamic networks, two contradictory objectives must be satisfied. On the one hand, it is necessary to diminish the cost in infrastructure, thus the network cost; on the other hand, it is necessary to guarantee a certain level of quality of service to the network users, measured by the user blocking probability. In other words, the network is designed to offer a very low blocking probability to the users (a value close to 0) and to simultaneously save meaningful network resources.

To solve the Wavelength Dimensioning problem on dynamic networks without wavelength conversion, several studies have been proposed so far. They can be classified in two different categories, as shown next:

- Approximations [69–72, 9]. These approaches provide an analytical insight of how many wavelengths should be assigned to each network link. They allow to analyze the wavelength dimensioning by providing a theoretical lower limit on the number of wavelengths required [69, 70, 72]. Additionally, in Ramaswami (2009) [9] an analytical lower bound is proposed, in which the dimensioning must be less than the static case scenario. The article also proposes an heuristic method to dimension each link capacity based on graph coloring, considering the maximum load scenario. This proposal does not take into account the quality of service given to the network users.
- Statistical method [12, 9]. This method calculates the number of wavelengths on each link taking into account the quality of service given to each network connection, measured as the user blocking probability. To dimension the network, the procedure is carried out for a given value of the traffic load. The main goal of this technique is to calculate the minimum amount of wavelengths necessary to communicate all source-destination pair of nodes, while guaranteeing a maximum blocking probability to each network user (close to 0). A standard procedure for assessing this problem has been to assign the same number of wavelengths to each network link; see for example [12, 19, 21, 25]. We call this procedure “Homogeneous Dimensioning”. In this case, initially the network links are allocated with 1 wavelength each (this allocation results in a very high blocking probability); next, this value is sequentially

increased by one at each network link, until the network blocking probability reaches a pre-established threshold value, typically evaluated by means of simulation [5, 16].

The Homogeneous Dimensioning is the most common method used to date [12, 19–27]. However, these studies have failed to recognize that this procedure over-dimensions the network. The homogeneous dimensioning is suitable for those networks where the routing algorithm balances the traffic load across the links (i.e. all the network links have very similar levels of utilization). As this balanced-load routing is very much used (e.g.[73, 74, 25]), this dimensioning technique would be appropriate for many cases. Nevertheless, it is not entirely possible to completely balance the network, due, in general, to the fact that the topologies are not symmetric and the traffic load is usually asymmetric.

Notice that, since the wavelength dimensioning has been usually solved by simulation, the time-consuming task involved does not allowed to explore every possible solution on the dimensioning. For instance, to solve the dimensioning problem with different links' capacities, the number of different scenarios to be evaluated grows exponentially. Then, to solve this problem by simulation becomes even harder to obtain.

A long standing issue in optical networks has been to provide a certain quality of communication to the network connections, despite the existence of different classes of users. This multi-class traffic occurs due to the existence of different priority users (or QoS requirements) [75, 76], or of some mechanisms to intentionally drop non-compliant bursts in order to improve the network performance [77]. In spite of these observations, the usual wavelength assignment and dimensioning approach (First-Fit wavelength assignment with an homogeneous dimensioning procedure) does not take into account these issues. For instance, the first fit wavelength assignment scheme fails to consider classes of users, since it merely searches an available wavelength sequentially, without making any class distinction. On the other hand, in the homogeneous dimensioning, the number of wavelengths assigned to the network links is usually defined by the user class with the strictest QoS requirement, thus providing to the classes with a lower priority, a better quality of service than the one requested on the SLA. In the context of OBS networks, several works [78–80] address a mechanism to provide an absolute differentiated service to each user class, improving the network performance. The mechanism is based on a dynamic wavelength assignment, in which a wavelength sharing policy is proposed. This policy allows to provide a strict end-to-end QoS for each network user. The authors consider a single link, and by using linear programming they calculate different thresholds

to each connection passing through the link. These thresholds define a limited set of wavelengths that the connections can use while attempting to transmit, according to their QoS requirements. The method relies on previous dimensioning of the network, thus it requires a proper dimensioning procedure to satisfy each connection QoS. Additionally, the OBS network context simplifies the problem, due there is not wavelength continuity constrains allowing to address the problem on each link separately.

This chapter presents a new method to jointly define a policy to assign the wavelengths to each network connection, and to calculate the number of wavelengths in Dynamic WDM Optical Networks without wavelength conversion. To solve this problem, the method contemplates that each network connection has a fixed route to transmit, defined previous to the network operation. This new approach has two main differences with previous strategies. First, it assigns a different number of wavelengths to each network link (denoted as “Heterogeneous Dimensioning”), such that the blocking probability of each connection does not exceed a predefined maximum tolerance value (typically agreed in the Service Level Agreement between carriers and customers). Second, it proposes a new wavelength assignment policy called “Fairness Policy”. This policy provides to each network user a quality of service (blocking probability) as close as possible to the one required in the SLA, since each connection may have different quality of service requirements. By doing so, the fairness policy allows to reduce the amount of wavelengths required in the network.

Numerical results presented at the end of the chapter (Section 3.3) show that the proposed algorithm no only enjoys advantages of low complexity and ease of implementation, but that it is also able to achieve much better performance (measured as the total number of wavelengths required on the network) than the homogeneous wavelength dimensioning approach with a regular wavelength assignment scheme such as first-fit.

The remainder of this chapter is as follows: In Section 3.2 we present the Fair Heterogeneous Wavelength Dimensioning method. Section 3.3 contains some results obtained by the proposed algorithm, which are compared with those obtained with the current best methods in a set of different scenarios. Finally, the conclusions of the study are given in Section 3.4.

3.2 Wavelength Assignment and Dimensioning

This section contains the main contribution of the chapter. We present first the model used and the associated assumptions. Then, we present the algorithm we found to solve the problem of Wavelength Assignment and Dimensioning (*WALD*).

3.2.1 Model and assumptions

The network topology is represented by a graph $\mathcal{G} = (\mathcal{N}, \mathcal{L})$, where \mathcal{N} is the set of network nodes or vertices and \mathcal{L} is the set of unidirectional links (the arcs in \mathcal{G}), with respective cardinalities $|\mathcal{N}| = N$ and $|\mathcal{L}| = L$. The set of connections $\mathcal{X} \subseteq \mathcal{N}^2$, with cardinality $|\mathcal{X}| = X$, is composed by all the source-destination pairs with communication between them. These connections are also called “users” in the text.

To represent the traffic between a given source-destination pair, an ON-OFF model is used. Consider connection c . During any of its ON periods, whose average length is t_{ONc} , the source transmits at a constant rate (which is the rate associated with the wavelength). During an OFF period, with average length t_{OFFc} , the source refrains from transmitting data.

The constant transmission rate during the ON periods is determined by the used technology, and to simplify the presentation it will be our rate unity. Consequently, the traffic load of connection c , denoted by ρ_c , is given by the following expression:

$$\rho_c = \frac{t_{ONc}}{t_{ONc} + t_{OFFc}}. \quad (3.1)$$

Observe that we address here the general case where the load can be different for each connection, the so-called *heterogeneous* situation.

Let $\mathcal{R} = \{r_c \mid c \in \mathcal{X}\}$ be the set of routes that enable communications among the different users, where r_c is the route associated with connection $c \in \mathcal{X}$. The routes \mathcal{R} are fixed and can be obtained by any algorithm available in the literature (e.g. Dijkstra Algorithm), previous to the network operation (in the next chapter we propose a new routing algorithm compatible with our method).

Let $\mathcal{W} = \{W_\ell \mid \ell \in \mathcal{L}\}$ be the set containing the number of wavelengths associated with each unidirectional network link, where W_ℓ , $\ell \in \mathcal{L}$, is the number of wavelengths on link ℓ .

The value W_ℓ , for every $\ell \in \mathcal{L}$, will be evaluated so that the blocking probability BP_c of each connection $c \in \mathcal{X}$ be less than or equal to a given pre-specified threshold β_c , and the total number of available network wavelengths is as small as possible. Observe that the pre-defined threshold value β_c can be different for each network connection, allowing the method to solve these problems when there are classes of users with different service level agreements.

The chosen number of wavelengths per link varies significantly if the optical switches in the network have or have not the ability of wavelength conversion. When the network nodes are not capable of wavelength conversion, the order in which the wavelengths are used on each link is important, since the total number of wavelengths required by the network is affected by it [5]. Thus, to correctly dimension the network considering the wavelength continuity constraint, the blocking probability evaluation method chosen must consider this restriction. Therefore, to evaluate the connections blocking probability required on the dimensioning procedure, we use the method proposed on Chapter 2, a very fast, simple and accurate procedure to evaluate the blocking probability considering the wavelength continuity constraint [81–83].

3.2.2 WA&D Procedure

The wavelength assignment and dimensioning (*WA&D*) problem consists in finding, for each link $\ell \in \mathcal{L}$, a capacity W_ℓ , such that the end-to-end blocking probability BP_c of every user $c \in \mathcal{X}$ passing through the link ℓ is less than the given threshold or upper bound β_c , taking into account some wavelength assignment scheme (assuming a given fixed routing method). The procedure considers the First-Fit wavelength assignment approach, since it is simple and performs well in terms of blocking probability, with a small computational overhead and low complexity execution, due to the fact that it does not require any global network information.

Let the wavelengths be numbered sequentially (i.e. $1, 2, \dots, W_\ell$).

As previously explained, the routes \mathcal{R} are fixed and are obtained previous to the network operation by any method available on the literature (e.g. by means of the Dijkstra Algorithm).

To put in simple algorithmic form, this method can be written as shown in Figure 3.1. We call this procedure “Fair Assignment-based Heterogeneous Wavelength Dimensioning” (**Fair-HED**).

In the pseudo-code given in Figure 3.1, there are some sub-procedures required to fully explain the method.

- The sub-procedure $ConnectionBP(\mathcal{G}, \mathcal{X}, \mathcal{R})$ refers to the procedure described in [81] (Chapter 2), used to calculate the connection’s blocking probability.
- The sub-procedure $LinkQoS(\ell)$ is the procedure that checks if all the connections passing through link ℓ have their QoS constraints satisfied (i.e. $BP_c \leq \beta_c$, for all $c \in \mathcal{X}$).

We define the set $\mathcal{Q} = \{c \mid c \in \mathcal{X}\}$ as the set of connections with their QoS constraint satisfied (maximum acceptable blocking probability) during the iterative procedure, and $\mathcal{U} = \{u_c \mid c \in \mathcal{X}\}$ as the set containing the maximum available wavelength to each user c .

Symbolically, the execution of the whole dimensioning procedure will be written $\{\mathcal{W}, \mathcal{U}\} := \mathbf{Fair-HED}(\mathcal{R})$, since its output is the set of wavelengths and the set of available wavelengths to each connection.

First, the set \mathcal{Q} starts empty, since no connection has yet been checked about the fact that it satisfies its QoS requirement, and each network link ℓ has W_ℓ value equal to 1. (Line 1 to 3 on fig. 3.1). The main idea of the procedure is to keep incrementing iteratively the value W_ℓ on each link $\ell \in \mathcal{L}$ until the network connections have satisfied their service level agreements β_c .

Then, the iterative procedure begins (line 4). Each connection c blocking probability BP_c , with $c \in \mathcal{X}$, is evaluated by the sub-procedure $ConnectionBP(\mathcal{G}, \mathcal{X}, \mathcal{R})$.

Later, on lines 6 to 9, we check if the network connections have accomplished the threshold β_c with the current network links dimensioning. To do so, it checks only the connections that have not yet satisfied the inequality $BP_c \leq \beta_c$, thus for each $c \notin \mathcal{Q}$. If connection c reaches its threshold requirement, then it is included in the \mathcal{Q} set (line 8) and the current wavelength dimensioning of the links belonging to the route of connection c , is stored as the maximum available wavelength to that connection ($u_c = W_\ell$, with $\ell \in r_c$). This allows to provide the Fairness policy. In other words, based on a first-fit scheme,

```

function Fair-HED( $\mathcal{R}$ )
// --- input: the graph  $\mathcal{G}$  (the network), the connections
//           and the bounds on the blocking probabilities  $\beta_c$ ,
//           all seen as global variables
//           and a set  $\mathcal{R}$  of routes
// --- output: a set  $\mathcal{W}$  of wavelengths per link
//           satisfying the QoS constraints and
//           the set of available wavelengths per connection  $\mathcal{U}$ 

1   $\mathcal{Q} := \phi$ ; // --- starts empty.
   // --- start with capacity equal to 1
2  for all link  $\ell$ 
3      $W_\ell := 1$ ;

   // --- increase  $W_\ell$  until QoS constraint accomplished
4  do
5      $BP_c := \text{ConnectionBP}(\mathcal{G}, \mathcal{X}, \mathcal{R})$ ;

   // --- check if connection QoS constrain is accomplished
6     for all connection  $c$ 
7         if ( $c \notin \mathcal{Q}$  and  $\beta_c \leq BP_c$ )
8              $\mathcal{Q} := \mathcal{Q} \cup \{c\}$ ;
9              $u_c := W_\ell$ ;

   // --- check if all link connections accomplished QoS.
10    for all link  $\ell$ 
11        if (not  $\text{LinkQoS}(\ell)$ )
12             $W_\ell := W_\ell + 1$ ;
13    until ( $\mathcal{Q} \equiv \mathcal{X}$ )
14 return  $\mathcal{W}, \mathcal{U}$ 

```

Fig. 3.1 Dimensioning and wavelength assignment: using a first-fit wavelength assignment scheme with a fairness policy, this procedure assigns a number W_ℓ of wavelengths to the link ℓ , for each ℓ , such that the blocking probability of connection c is less than the beforehand specified bound β_c , for each c .

each connection will be able to use a different number of wavelengths, calculated in

the procedure, and they will solely use the wavelengths from the first one to the u_c -th wavelength.

Afterward, in lines 10 to 12 on Figure 3.1, the procedure checks, on each link $\ell \in \mathcal{L}$, if every connection c using link ℓ has satisfied its QoS constraint ($BP_c \leq \beta_c$). To do so, the sub-procedure $LinkQoS(\ell)$ is evaluated. If any connection using link ℓ does not succeed in satisfying its threshold, then the number of wavelengths on the link is augmented by 1. Otherwise, W_ℓ is the final wavelength dimensioning of link ℓ . Notice that each link inspection is completely independent, leading to an heterogeneous wavelength dimensioning.

Finally, the procedure is finished if every link has their connections QoS fulfilled, thus the set \mathcal{Q} has the same connections than the set \mathcal{X} (line 13).

3.3 Numerical Results

To compare different methods, it is necessary to evaluate their performances with respect to relevant metrics that enable to assess the advantages/disadvantages of each of them. Given that the network fulfilled the SLA requirements (due to the fact that the methods provide solutions that satisfy the users QoS constrains), the remaining most important metric for the wavelength dimensioning is the cost of the network.

To the best of our knowledge, the only algorithm used to dimension the network is the homogeneous wavelength dimensioning one, since the other methods based on approximations (see this chapter's introduction, 3.1) do not give a proper answer of how many wavelengths to use. On the other hand, to solve the wavelength assignment problem, the First-Fit scheme is mostly used and referenced, because it is the fastest and simplest method with a good performance. Consequently, the method chosen for our comparisons, is the Homogeneous wavelength dimensioning with a First-Fit wavelength assignment scheme [20, 22, 23, 66, 24–27], called from now on **FF-HD**.

To obtain the corresponding blocking probabilities, it can be evaluated by means of simulation or with a validated analytical model, as the one presented in Chapter 2. Due to the fact that the analytical method proposed on the previous chapter was properly validated, and that it is orders of magnitude faster than simulation (see numerical results

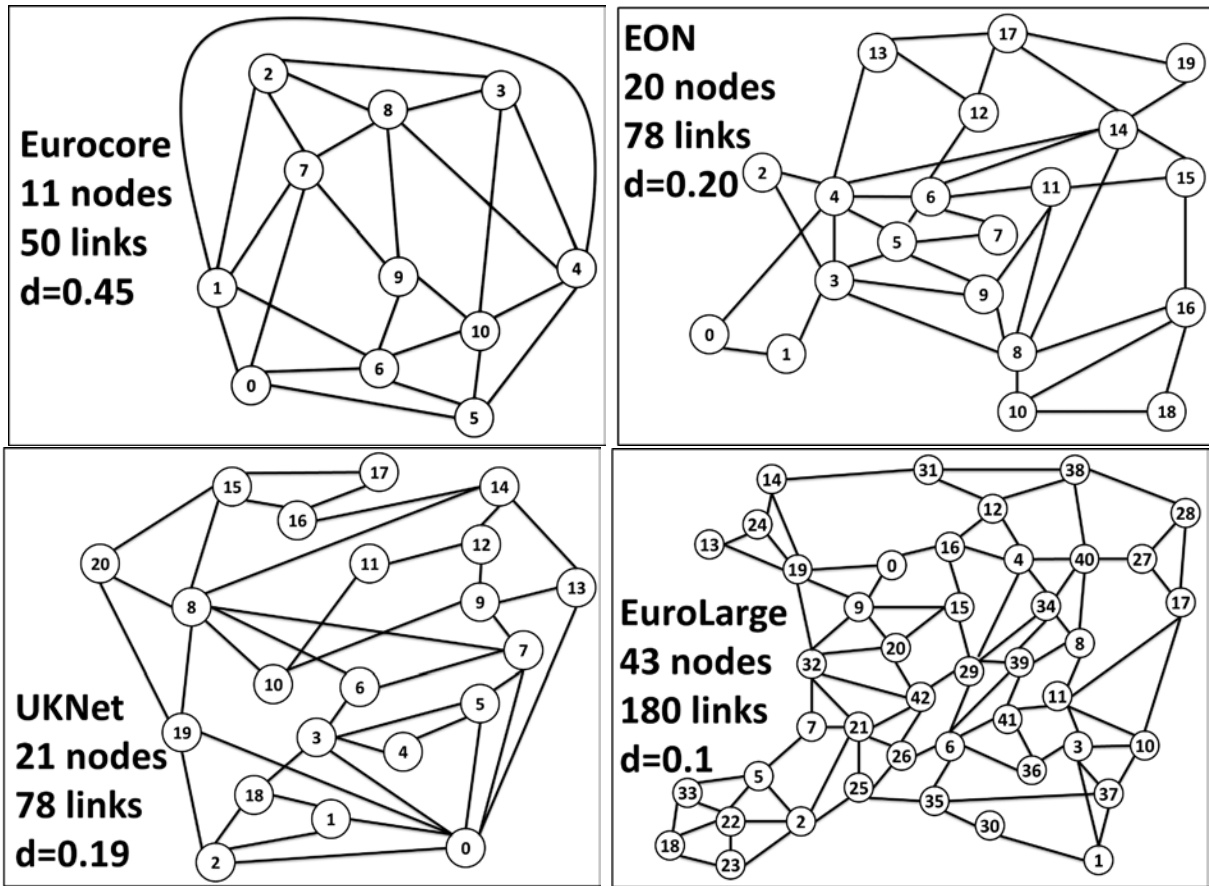

Fig. 3.2 Mesh networks evaluated. The number of links refers to the number of bidirectional arcs. Observe that in the picture we see the edges (for instance, the picture shows the EON topology with 39 edges, which corresponds to 78 arcs). The parameter d is a measure of density: if the graph has a arcs (twice the number of edges) and n nodes, $d = a / (n(n-1))$.

of chapter 2.3), the mathematical method proposed in Chapter 2 [81], called LIBPE, was used in both FF-HD and Fair-HED.

To evaluate the performance of the methods under different scenarios, the algorithms were executed for different real network topologies, having different sizes and different degrees of connection d , where d is the average number of neighbors of a node in the network. Some of the selected topologies and their respective parameters N , L and d are shown in Figure 3.2. Additionally, both procedures consider a fixed routing shortest path one (calculated by Dijkstra's algorithm).

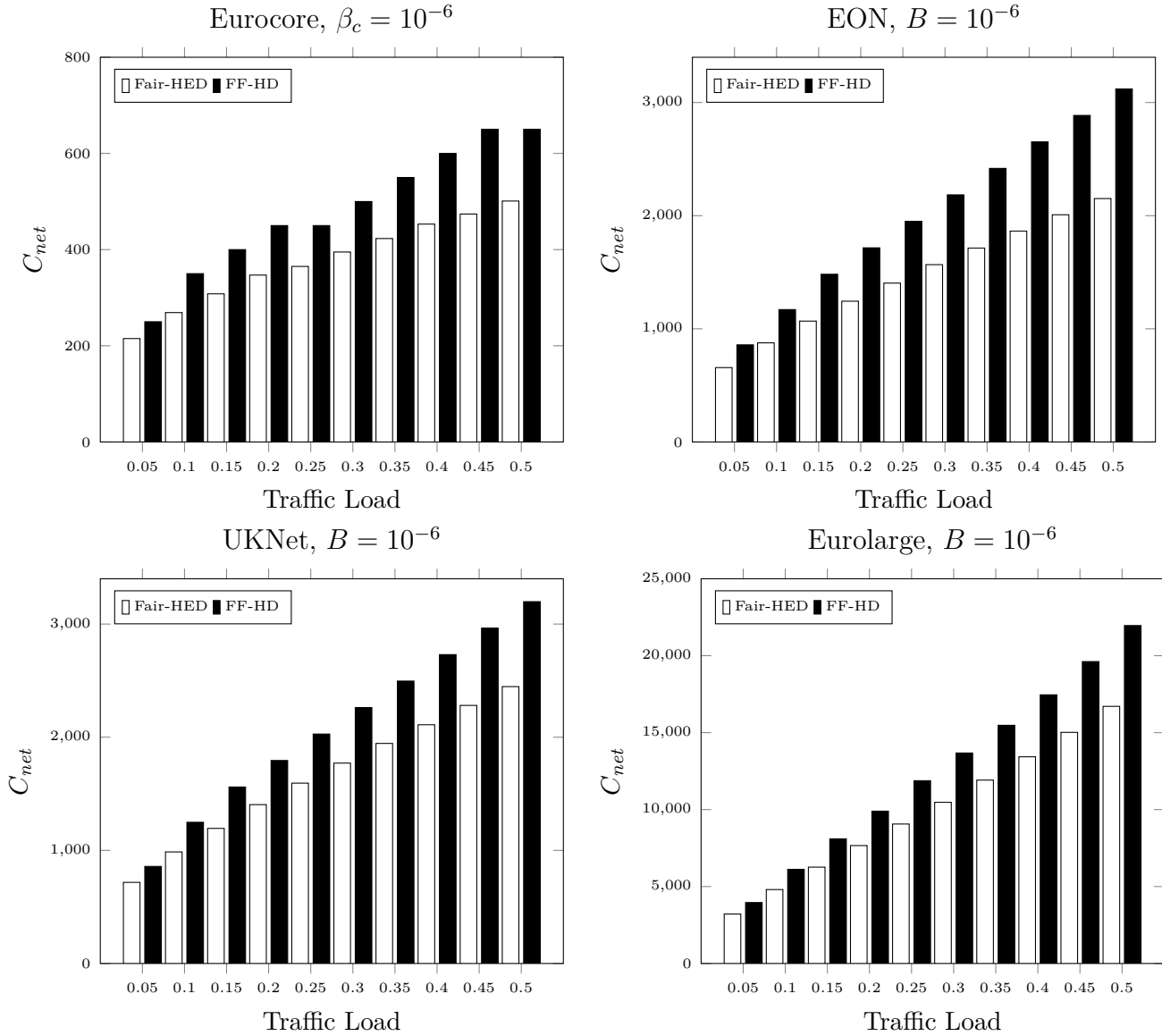

Fig. 3.3 The total number of wavelengths C_{net} obtained with our method (Fair-HED) and with FF-HD on Eurocore, EON, UKNet and Eurolarge real mesh network topologies, for different connection traffic loads, with an homogeneous maximum acceptable blocking probability $\beta_c = 10^{-6}$.

As in [9, 5, 41], in this work the total network cost C_{net} is defined as the sum of all wavelengths of all network links, that is, $C_{net} = \sum_{\ell \in \mathcal{L}} W_{\ell}$. This is because the cost of many components in an optical network is strongly affected by this parameter. In

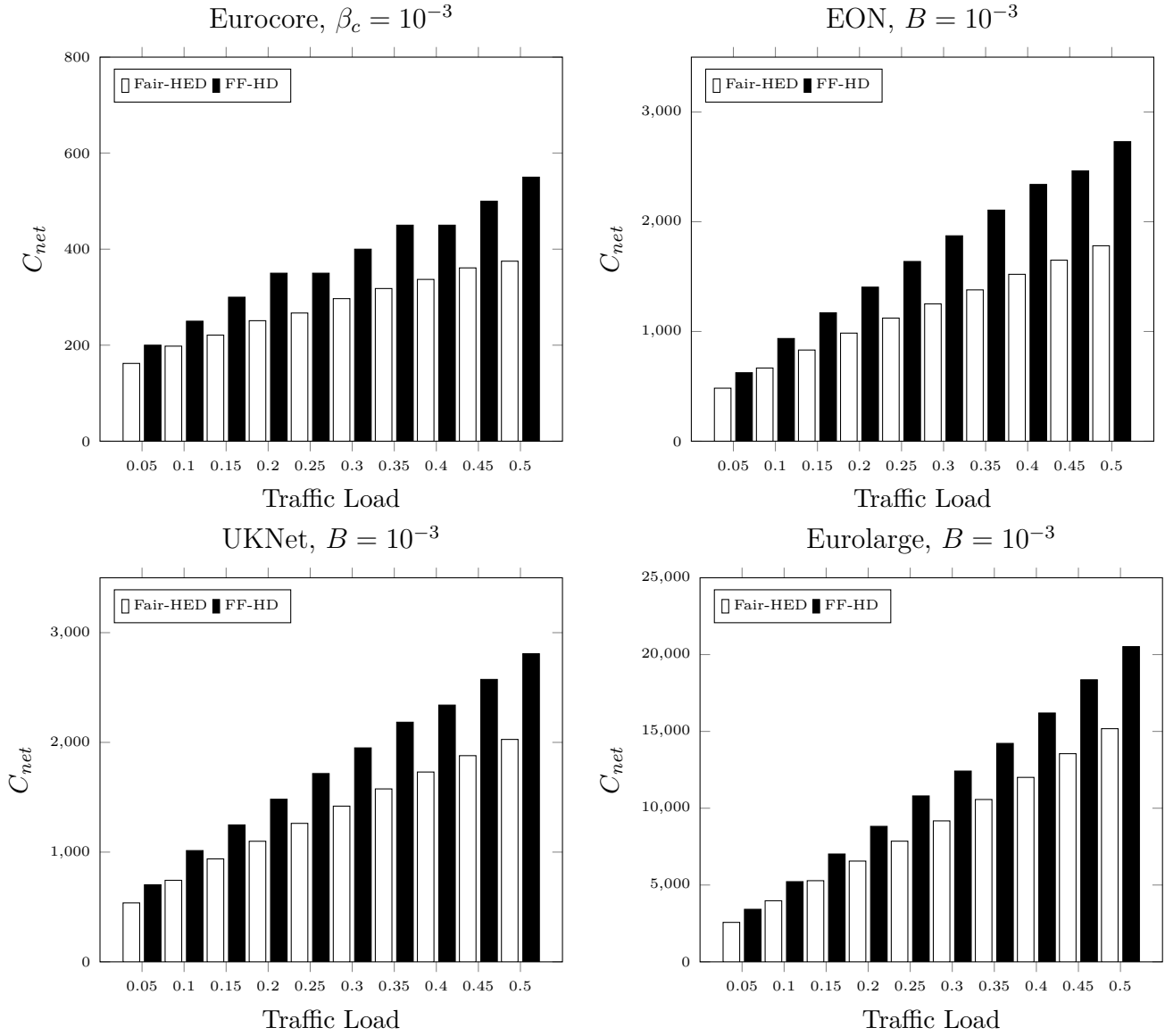

Fig. 3.4 The total number of wavelengths C_{net} obtained with our method (Fair-HED) and with FF-HD on Eurocore, EON, UKNet and Eurolarge real mesh network topologies, for different connection traffic loads, with an homogeneous maximum acceptable blocking probability $\beta_c = 10^{-3}$.

fact, it determines how many infrastructure resources are needed to achieve the network operation.

On the first set of experiments, we analyze the homogeneous QoS constraint case, which means that every network connection has the same maximum acceptable blocking probability $\beta_c = \beta$. In Figure 3.4 we show the total cost C_{net} obtained by the FF-HD and Fair-HED methods for the case when all the connections have the same maximum acceptable blocking probability of 10^{-6} ($\beta_c = 10^{-6}$, for all $c \in \mathcal{X}$), as a function of the traffic load, for different network topologies. Additionally, Figure 3.3 shows the C_{net} value for the same methods, but considering a threshold of $\beta_c = 10^{-3}$, for all $c \in \mathcal{X}$.

As it can be seen in Figure 3.4, in the case of homogeneous QoS constraints, our proposal (Fair-HED) performs clearly better. In fact, for all the scenarios evaluated in our experiments, the method proposed here requires in general 25% less wavelengths (for $\rho = 0.3$ which is a representative network load [28]) than the cost of the FF-HD method, considering a threshold of $\beta_c = 10^{-6}$. In the case of a maximum blocking probability equal to 10^{-3} (Figure 3.3), the Fair-HED method also significantly outperforms the FF-HD technique. In this last case, the Fair-HED method requires in the order of 30% less wavelengths (always for $\rho = 0.3$ [28]) than FF-HD. Notice that each scenario presented here achieves to connect the same users (connections) with the same QoS requirements (maximum acceptable blocking probability), but our proposal requires less resources than FF-HD to do so.

3.3.1 Heterogeneous QoS requirements

Now, as mentioned in the introduction of this chapter, different end-to-end quality of services per user on WDM optical networks considering multi-class traffic is of paramount importance [75–77, 84, 79, 80]. Thus, to assess this kind of scenario, we evaluate both methods (FF-HD and Fair-HED) considering heterogeneous QoS constraints. This means that each connection has a different quality of service requirement, measured by the maximum acceptable blocking probability (β_c).

First, let \mathcal{Z} be a set containing different values of quality of service constrains. Then, we predefine a set of different possible values to be assigned to β_c , and store them in \mathcal{Z} (For example: $\mathcal{Z} = \{10^{-3}, 10^{-4}, 10^{-5}, 10^{-6}\}$).

Next, we assign to each network connection c their maximum blocking probability β_c . To make this assignment, we define 3 different criteria to set β_c from the values stored on \mathcal{Z} , in order to obtain heterogeneous QoS constrains.

Arbitrary heterogeneous QoS

In this scenario, the assignment of each connection c maximum blocking probability β_c will be made arbitrarily with the function shown next:

$$\beta_c = (\mathcal{I}(c, source) + \mathcal{I}(c, destination) \bmod |\mathcal{Z}|) + 1, \quad (3.2)$$

where $\mathcal{I}(c, source)$ and $\mathcal{I}(c, destination)$ are the connection c source and destination node identifier, respectively.

To illustrate our method in this multi-class context, we perform a set of experiments to evaluate both wavelength assignment and dimensioning methods (FF-HD and Fair-HED) with an heterogeneous QoS requirements per connection. To assign each connection maximum blocking probability, we use the QoS assignment function defined in (3.2), on both methods.

The values on \mathcal{Z} were chosen between 10^{-3} and 10^{-6} , with 4 different values according to different magnitude orders (i.e. $\mathcal{Z} = \{10^{-3}, 10^{-4}, 10^{-5}, 10^{-6}\}$).

To evaluate the performance of the methods under different scenarios, as shown in the previous experiments, the algorithms were executed for the same network topologies presented in Figure 3.2. In general, the experiments' conditions were the same as in the initial experiments of this section, but with heterogeneous QoS constraints.

In Figure 3.7 we show the total cost C_{net} obtained by the FF-HD and Fair-HED methods for the case when each connection have different maximum acceptable blocking probability in a arbitrary assignment, as a function of the traffic load, for different network topologies.

As it can be seen in Figure 3.5, in the case of arbitrary QoS constraints, our proposal (Fair-HED) also outperforms FF-HD. In fact, for all the scenarios evaluated in our experiments, the method propose herein requires, on average, 28% less wavelengths (for $\rho = 0.3$) than the cost of the FF-HD method.

Ascending heterogeneous QoS

On the previous experiments an arbitrary assignment of the β_c values was shown. But, the different priorities given to each user are not necessarily arbitrary. Thus, to show the

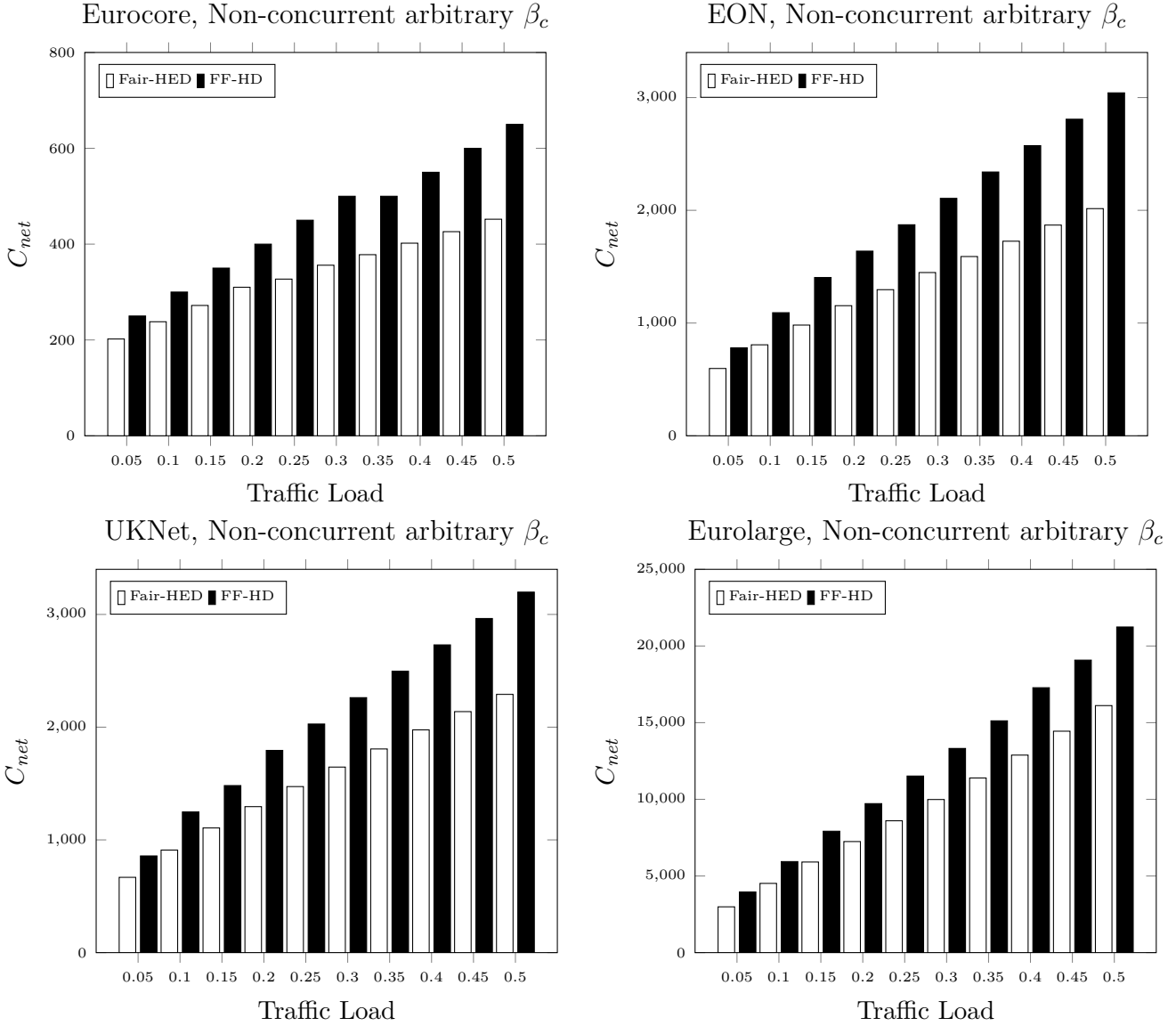

Fig. 3.5 The total number of wavelengths C_{net} obtained with our method (Fair-HED) and with FF-HD on Eurocore, EON, UKNet and Eurolarge real mesh network topologies, for different connection traffic loads, with an heterogeneous maximum acceptable blocking probability β_c . The values of β_c are chosen between 10^{-6} and 10^{-3} in an arbitrary form.

robustness of our method, we present a different set of experiments using a non-arbitrary criteria to set each β_c heterogeneously.

The value of each connection β_c is assigned according to each connection route length (measured by its number of hops). In this case, the value assigned to β_c increases with the connection c route length.

To this end, we classify each connection $c \in \mathcal{X}$ depending on its length in number of hops (i.e. $|r_c|$). Thus, the connections with the same length will be stored on \mathcal{X}_h , where $h = |r_c|$. Let H be the length of the longest connection route on the network. This means that we have H sets of connections \mathcal{X}_h . This procedure, allows us to define the same QoS requirement, given by β_h , for each connection in \mathcal{X}_h . This means $\beta_c = \beta_h$, when $c \in \mathcal{X}_h$.

The values on set \mathcal{Z} are ordered from easier to harder to satisfy (e.g. a QoS constraint of 10^{-3} is easier to fulfill than 10^{-6} , so it will go first).

It remains to choose the values of each β_h , with $h = 1, 2, \dots, H$. The idea is to assign a value within the elements on the set \mathcal{Z} , to each β_h . To this purpose, we classify the H sets of connection \mathcal{X}_h in $|\mathcal{Z}|$ categories. These categories are going to be chosen according to the connections length h . Thus we assign to β_h , with $h = 1, 2, \dots, H$, the z -th value on \mathcal{Z} (with $1 \leq z \leq |\mathcal{Z}|$), if the route lengths h are in the range $[1 + (z - 1) \cdot T, 1 + z \cdot T]$. The parameter T is:

$$T = \frac{H - 1}{|\mathcal{Z}|}. \quad (3.3)$$

This method assigns to each connection c in \mathcal{X} a maximum blocking probability according to the connection length in an ascending order, thus, the longer the connections the stricter the QoS requirements.

We called this procedure ‘‘AQOSassignment’’.

In algorithmic form the procedure is presented in 3.6.

As presented in the previous scenarios, we perform the same set of experiments to evaluate both wavelength assignment and dimensioning methods (FF-HD and Fair-HED) using the same network topologies. To assign each β_c value, we use the QoS assignment procedure given in 3.6, on both methods. Figure 3.7 presents the total cost C_{net} obtained by the FF-HD and Fair-HED methods.

The values stored in \mathcal{Z} were defined from easier to stricter to fulfill, between 10^{-3} and 10^{-6} , thus $\mathcal{Z} = \{10^{-3}, 10^{-4}, 10^{-5}, 10^{-6}\}$.

Once again, our proposal (Fair-HED) obtains much better results than FF-HD, using on average 30% less wavelengths (for $\rho = 0.3$) than needed by the FF-HD method.

```

function AQOSassignment
// --- input: the graph  $\mathcal{G}$  (the network), the connections
//         and the different bounds on the blocking probabilities in  $\mathcal{Z}$ 
//         ordered from easier to harder to satisfy,
//         all seen as global variables,
//         and the set  $\mathcal{R}$  of predefined routes
// --- output: the values of  $\beta_c$  per connection

// --- obtain the longest route, and create H sets of connections.
1 H=longest( $\mathcal{R}$ );
2 for  $h = \{1, \dots, H\}$ 
3      $\mathcal{X}_h := \phi$ ;

// --- store each connection on their respective  $\mathcal{X}_h$  set.
4 for all connection  $c$ 
5     if ( $c = h$ )
6          $\mathcal{X}_h := \mathcal{X}_h \cup c$ ;

// --- evaluate the threshold to make the QoS assignment.
7  $T = \frac{H-1}{|\mathcal{Z}|}$ 

// --- sets  $\beta_c$  to each connection following the ascending criteria.
8 for  $h = \{1, \dots, H\}$ 
9     for  $z = \{0, \dots, |\mathcal{Z}| - 1\}$ 
10        if  $(1 + (z - 1) \cdot T) \leq h < (1 + z \cdot T)$ 
11             $\beta_h := \mathcal{Z}(z)$ ;
12            break;
13    for connection  $c \in \mathcal{X}_h$ 
14         $\beta_c := \beta_h$ ;

return ( $\beta_c$ , forall  $c \in \mathcal{X}$ )

```

Fig. 3.6 Decision process to assign the QoS constrains in \mathcal{Z} to each connection in \mathcal{X}_h , with $h = 1, 2, \dots, H$. The criteria used to make the assignment of the β_c correspond to the idea of longer the connections the stricter the QoS requirements (ascending heterogeneous QoS constrains criteria)

Descending heterogeneous QoS

The previous experiments have shown the performance of our method in non-arbitrary QoS constrains. Following the same line of thought, we present a final set of experiments to prove the robustness of our method, no matter the scenario chosen.

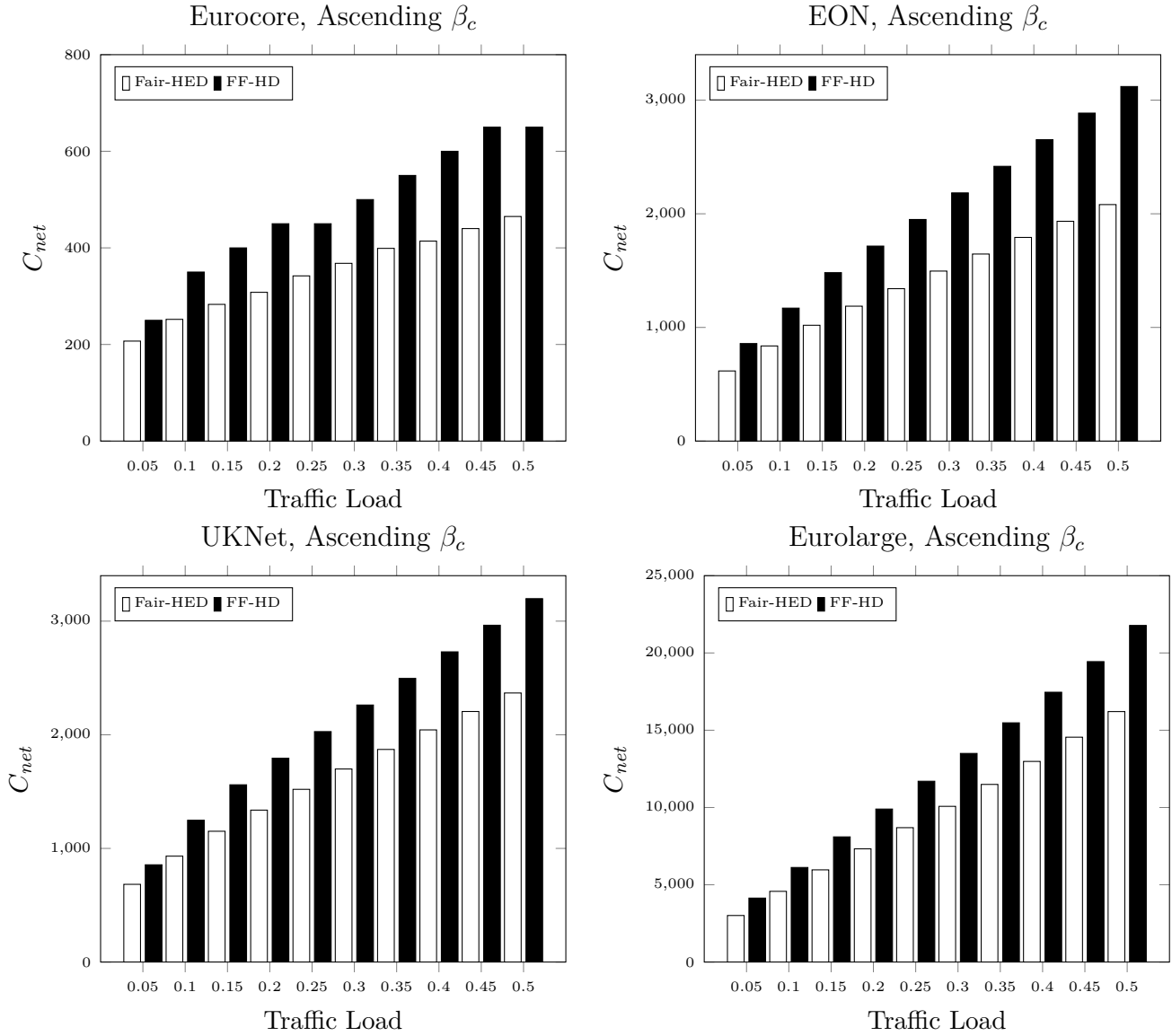

Fig. 3.7 The total number of wavelengths C_{net} obtained with our method (Fair-HED) and with FF-HD on Eurocore, EON, UKNet and Eurolarge real mesh network topologies, for different connection traffic loads, with an heterogeneous maximum acceptable blocking probability β_c . The values of β_c are chosen between 10^{-3} and 10^{-6} in an ascending order, proportionally to the connections route lengths.

In this case, the value of each β_c is also assigned according to the number of hops of each connection, but decreasing with the route length. To do this, we follow the same

procedure than in Subsection 3.3.1. However, due to the fact that now we want to make a decreasing QoS assignment, the decision processes to assign the values in \mathcal{Z} , to each connection belonging to the sets \mathcal{X}_h , with $h = 1, 2, \dots, H$, changes. We set the z -th value on \mathcal{Z} to β_h , if the route lengths h are in the range $[1 + (H - z) \cdot T, 1 + (H - z + 1) \cdot T]$. This criteria assigns the β_c values in a descending order, this means the shorter the connections the stricter the QoS requirements assigned. This new criteria is easily changeable on the pseudo-code in 3.6 (change line 10 on Figure 3.6).

Once again, as shown on the previous experiments, we illustrate the performance of our method in this scenario evaluating the FF-HD and Fair-HED techniques. The values on \mathcal{Z} were defined exactly as in the ascending order scenario; this means $\mathcal{Z} = \{10^{-3}, 10^{-4}, 10^{-5}, 10^{-6}\}$.

Figure 3.8 shows the value of C_{net} obtained by both methods on different traffic loads and topologies. Once again, Fair-HED obtains better results, getting a 25% less wavelengths than FF-HD method for $\rho = 0.3$, on average.

3.3.2 Analysis and summary of the method

In the experiments, our method (Fair-HED) always gave much better results than those coming from the FF-HD technique to dimension and assign the wavelengths, as illustrated in the examples used in the chapter (Figures 3.4, 3.3, 3.5, 3.7 and 3.8). Therefore, we claim that our method is robust performing on different network topologies, connections traffic loads and QoS requirements.

To illustrate in a more detailed way such differences, in Table 3.1, the total cost C_{net} is shown for the following cases: homogeneous QoS constrains with $\beta_c = 10^{-3}$ and $\beta_c = 10^{-6}$, arbitrary heterogeneous QoS constrains, ascending heterogeneous QoS constrains, and descending heterogeneous QoS constrains. The results shown were obtained for the same network topologies as in Figure 3.2, for a traffic load of 0.3.

In Table 3.1 it is clear that the method proposed herein performs much better than FF-HD. By taking a closer look at the results with homogeneous QoS constraints, we can see a notable consequence. Our method achieves a QoS requirement of 10^{-6} with the same (or even less) resources than the ones required using the FF-HD method to

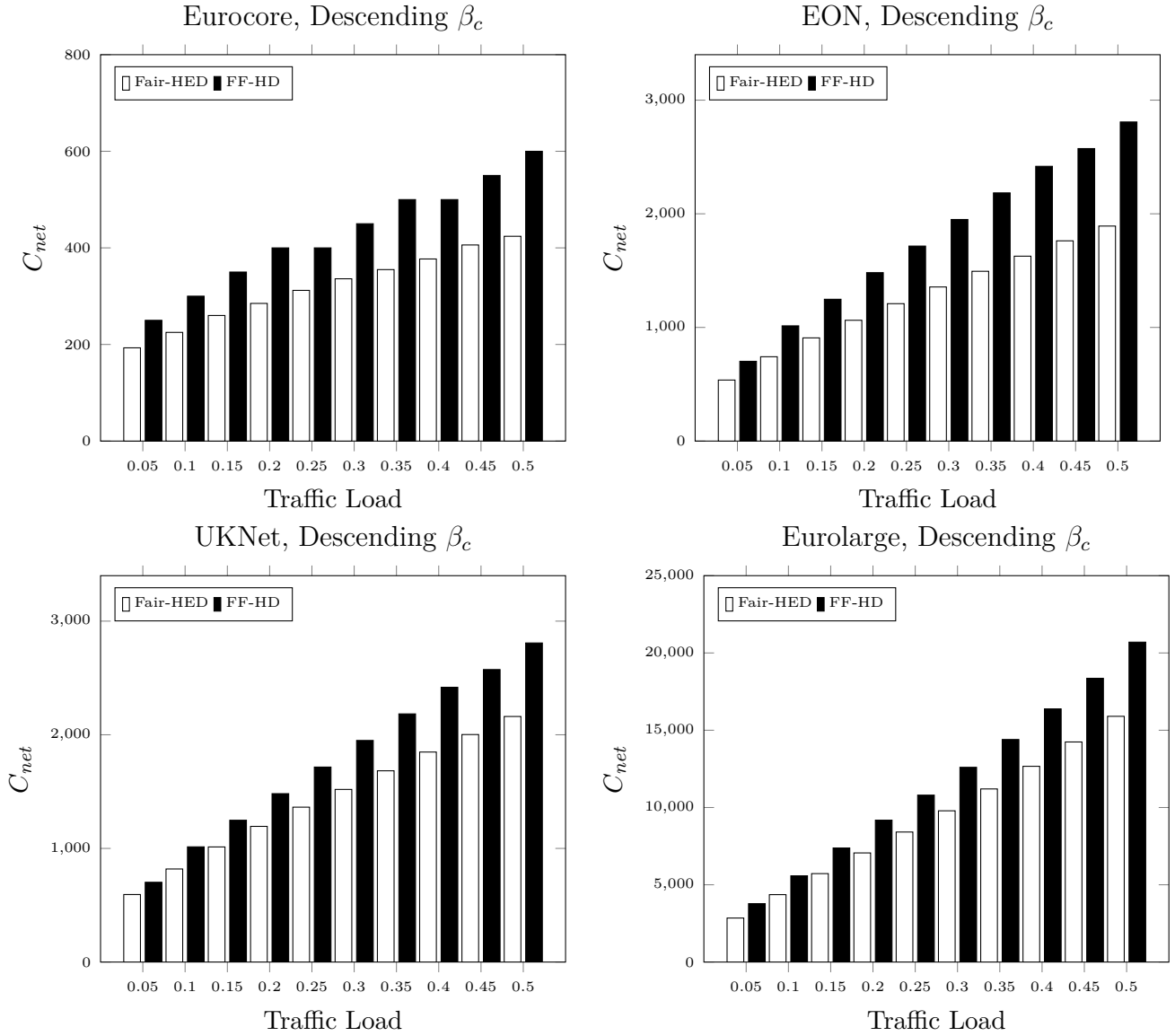

Fig. 3.8 The total number of wavelengths C_{net} obtained with our method (Fair-HED) and with FF-HD on Eurocore, EON, UKNet and Eurolarge real mesh network topologies, for different connection traffic loads, with an heterogeneous maximum acceptable blocking probability β_c . The values of β_c are chosen between 10^{-6} and 10^{-3} in an descending order, proportionally to the connections route lengths.

satisfy a β_c value equal to 10^{-3} . This clearly illustrate that the FF-HD over-dimensions the network links.

It is also interesting to analyze the results obtained with Heterogeneous QoS requirements. By considering the ascending QoS constraints scenario, the FF-HD method requires basically the same amount of wavelengths than considering an homogeneous QoS equal to 10^{-6} . This comparison verifies that the FF-HD dimensioning is strongly influenced by the worst case scenario, because of the stricter blocking probability requirement. This situation makes the FF-HD method assign more wavelengths than needed to the connections with lower QoS requirement levels. This situation is not observed on the Fair-HED method, since the number of wavelengths in the case of homogeneous QoS requirements is higher than any heterogeneous QoS constraints (ascending and descending scenarios), thus providing a closer gap between the QoS required and the actual QoS offered to each network connection. The latter shows how important is to consider the different QoS requirements in the wavelength assignment and dimensioning problem on multi-class optical networks.

In addition, the results shown by the heterogeneous ascending and decreasing QoS requirements are clearly different. On the first hand, the ascending QoS scenario can be considered as a worst case, where the longer routes require a tough QoS demand to satisfy. On the other hand, the descending QoS scenario can be reckon as a best case one, where the longer the route, the looser the QoS demand. First, no matter the scenario our method performs better than the commonly used FF-HD. Second, this examples shows that the definition of multiple classes of services affect the network performance. Therefore, this examples provide an insight on how we can take advantage of the classes of user to have more efficient networks. For instance, by defining a policy as the descending heterogeneous QoS constraints requires less network resources than an any other QoS assignment criteria presented on this work.

Let us discuss here some qualitative reasons that justify the better results of Fair-HED over FF-HD:

- Our method assigns a different number of wavelengths to each network link (this is called Heterogeneous Dimensioning), such that the blocking probability of each connection does not exceed a predefined maximum blocking probability. This takes advantage of the fact that real networks are hardly symmetric, making difficult to balance the traffic loads offered to the different links. Therefore, each network link capacity can be dimensioned differently, since they have a different amount of users assigned to.

- Our technique proposes a new wavelength assignment policy called “Fairness Policy”. This policy consists of providing to each network user a quality of service (blocking probability) as close as possible to the one required in the SLA, since each user may have different quality of service requirements. This way the method diminishes the wavelength dimensioning since each connection uses only the wavelengths needed to satisfy their QoS demand.
- The usual blocking probability evaluation technology is based on simulation, which is a slow procedure. Consequently, the evaluation process is limited to only a few restricted scenarios. So, to find the best possible solution, researchers apply some criteria to restrict the solutions search (heuristics), for example, making choices as homogeneous wavelength dimensioning and using plain first-fit wavelength assignment. The method we proposed is able to outperform these methodologies, so we can conclude that such heuristic solutions are not using good assumptions and taking appropriate decisions.
- Our method can solve the problem of wavelength assignment and dimensioning using any method available to evaluate the connection’s blocking probability. For instance, it can rely on simulation or on any analytical method from the literature. Thus, the time require to solve both problems strongly depends on the chosen method to evaluate the QoS, since it requires several evaluations of the connections blocking probability. At this point, we suggest using the fast, simple and very accurate method proposed in Chapter 2, which allows to dimension the network in a very short time (less than a second, say).

3.4 Conclusions

This chapter presents a novel method to jointly calculate the number of wavelengths needed on each network link, and to define a strategy to approach the wavelength assignment procedure during the network operation based on the well known First-fit scheme, in Dynamic WDM Optical Networks without wavelength conversion. This joint solution allows us to obtain a global solution to these problems, which in general is better than to obtain them separately.

The methodology differs considerably from those published so far. It assigns a different number of wavelengths to each network link, so that the blocking probability of each user is lower than a certain pre-specified threshold (which is a design parameter of the network). Additionally, the technique proposes a fair wavelength assignment policy, offering to each network user a quality of service as close as possible to the one defined in the SLA, since each user may have different quality of service requirements (multi-class networks).

Our proposal relies on the blocking probability method proposed in Chapter 2, thus it requires less than a second to solve both problems. Nevertheless, observe that it can be used calling any other procedure to evaluate the blocking probability (e.g. by means of simulation or another method available). This means that the time required to solve the wavelength assignment and dimensioning strongly depends on the method used to calculate this blocking probability.

Parameters Topology	Homogeneous $\beta_c = 10^{-3}$		Homogeneous $\beta_c = 10^{-6}$		Arbitrary Heterogeneous β_c		Ascending Heterogeneous β_c		Descending Heterogeneous β_c	
	Fair-HED	FF-HD	Fair-HED	FF-HD	Fair-HED	FF-HD	Fair-HED	FF-HD	Fair-HED	FF-HD
Eurocore	297	400	395	500	358	500	368	500	336	450
EON	1251	1872	1567	2184	1448	2106	1496	2184	1356	1950
UKNet	1419	1950	1771	2262	1646	2262	1699	2262	1519	1950
Eurolarge	9175	12420	10474	13680	9987	13320	10075	13500	9787	12600

Table 3.1 Total number of wavelengths required by the Fair-HED and FF-HD methods with: homogeneous QoS constrains (Homogeneous $\beta_c = 10^{-3}$ and $\beta_c = 10^{-6}$), non-concurrent arbitrary heterogeneous QoS constrains (Arbitrary Heterogeneous β_c), ascending heterogeneous QoS constrains (Ascending Heterogeneous β_c), and descending heterogeneous QoS constrains (Descending Heterogeneous β_c), for Eurocore, EON, UKNet and Eurolarge network topologies, considering a connection mean traffic load of 0.3.

Chapter 4

Routing, Wavelength Assignment and Dimensioning

4.1 Introduction

“Routing” is a basic component of the network operation: every connection is defined by a pair of nodes in the network, the source and the destination, and for each pair, the designer must assign a route to be followed by the data to be transmitted. Then, the routing problem consist in to assign to each connection a specific route. To solve the routing problem, various approaches has been proposed, Zang et al. [10] provides a comprehensive survey on these routing algorithms, which are summarized next:

- *Fixed Routing*: Considered as the most straightforward approach, this scheme always assigns to each user the same fixed route to connect from the source to destination. This route is defined previous to the network operation and it does not change over time. Shortest Path—First Fit (SP-FF) [16, 85, 9, 86, 12, 11] is the most common fixed routing approach. SP-FF has shown to be the fastest algorithm available to date, since it uses pre-established routes and the a simple wavelength allocation algorithm (Fist-fit). Be that as it may, it has been known to have, in general, a higher blocking probability than the next 2 approaches, due the lack of alternative paths to connect any source-destination pair of nodes in case of blocking.

- *Fixed-Alternate Routing:* This approach assigns to each network user a set of alternative paths (more than one) to offer a connection from source to destination node [10, 85, 9, 12, 11]. These paths are typically disjoint between them (i.e. they do not share any resources). As fixed routing approach, the paths are stored in routing tables prior to the network operation, to be addressed on demand. Thus, to communicate the source node to destination, each user attempts to connect by the first route in the set. If there is any blocking among the path links, then it tries with the next path until it finds an available path in the set to make the transmissions or blocked in all of them. K-Alternate Paths using Shortest Path-First Fit (K-SP-FF) is the most common approach in literature, usually with $k=3$. It is known to perform a good compromise between computational complexity and performance, and it is expected to have a better performance than fixed routing without a global knowledge of the network state [12].
- *Adaptive Routing:* This methodology chooses the route from a source node to destination on demand, depending on the network state, hence it requires a constant knowledge of the network situation [9, 12, 11]. Adaptive Unconstrained Routing—Exhaustive (AUR-E) as shown to be the best adaptive routing method [6]. This approach has shown to have the lowest blocking probability to date due to the online execution of Dijkstra algorithm per transmission request [10]. In fact, it has been reported that AUR-E requires on average a 15% less wavelengths than 3-SP-FF to achieve the same blocking probability requirements [5]. Nevertheless, this operation scheme performs a huge overhead on the network, thus a slow network operation [8].

Among the different routing algorithms proposed to date, fixed routing is the most studied and typically used for real world networks [87, 26, 27, 25, 85, 88, 5, 9, 86, 11].

The Wavelength dimensioning (WD) problem, as explained in chapter 3, determines how many wavelengths should be assigned to each link of the network in order to achieve a compromise between efficiency and the network infrastructure cost. The usual procedure to solve the WD problem has been to assign the same number of wavelengths to each network link (called Homogeneous Dimensioning). This procedure has been generally solved by means of simulation, thus it does not allow to explore every possible solution due to the time-consuming task involved.

The Wavelength assignment (WA) problem assesses the problem to choose which wavelength is going to be used by each user, taking into account the wavelength continuity constraint on networks without wavelength conversion. First-fit has been the most common and fastest method used to date, and is preferred in practice because of its small computational overhead and low complexity.

These problems are solved while aiming to simultaneously minimize the network cost, while guaranteeing that the network performance meets the level established in the Service Level Agreement (SLA). Then, we call these problems together as the Routing, and Wavelength Assignment and dimensioning (R&WAD) problem.

This problem has been extensively studied in the literature, because of their great impact on network cost (CapEx) and on network performance. These tasks are usually solved separately [10, 11]. This happens due to the fact that solving them simultaneously have a great complexity associated. Then, to diminish this constraint, a traditional solution has been as follows: first the routes are calculated; later, the wavelength assignment is chosen and the number of wavelengths for each network link are dimensioned accordingly, while satisfying some pre-established performance restrictions.

By solving separately the Routing, the Wavelength Assignment and the Wavelength Dimensioning, it is possible to achieve good local solutions to both problems. Since the wavelength dimensioning has been usually solved by simulation, the time-consuming task involved does not allow to explore every possible solution, requiring to divide the R&WD problem. However, the approach misses the opportunity to find a good global solution found when solving them simultaneously. One way to overcome this problem is to solve the dimensioning by using heuristics, but they should be validated extensively, as we did in chapter 3 proposal. Recently in [41], an exhaustively validated heuristic strategy, called CPR (Cheapest Path Routing) was applied, solving both routing and wavelength dimensioning jointly, in the context of WDM optical networks with wavelength conversion capabilities. Its performance was better than local strategies approaches.

In this chapter we propose a novel procedure to simultaneously solve the routing, wavelength assignment and wavelength dimensioning (which we call the Cheapest Path by Layers *CPL* method). The method assigns to each source-destination pair of nodes the cheapest route while attempting to balance the traffic load offered to each link. The method also evaluates the number of wavelengths W_ℓ for each link ℓ of the network, ensuring

that the blocking probability of any connection request will be lower than the predefined threshold β_c . The method relies on a wavelength assignment and dimensioning completely different than the ones proposed to date. It introduces 2 new characteristics: the number of wavelengths (in general) are different on each link (heterogeneous dimensioning), while satisfying a predefined quality of service threshold; and the wavelength assignment used introduces a Fairness Policy to each network user providing a quality of service as close as possible as the one defined on the SLA.

The remainder of this paper is as follows: Section 4.2 presents the new algorithm. Section 4.3 contains some results obtained by the proposed algorithm, which are compared with those obtained with the current best methods in a set of different scenarios. Finally, the conclusions of the study are given in Section 4.4.

4.2 Routing and Wavelength Dimensioning Strategy

This section contains the main contribution of the paper. We present first the model used and the related assumptions. Then, we describe the main sub-procedures necessary to our technique. Last, we present the algorithm.

4.2.1 Model and assumptions

We define the same model and assumptions than previous chapters. Thus, if you are already familiar with it, you are welcome to skip this subsection (continue in 4.2.2).

The network topology is represented by a graph $\mathcal{G} = (\mathcal{N}, \mathcal{L})$, where \mathcal{N} is the set of network nodes or vertices and \mathcal{L} is the set of unidirectional links (the arcs in \mathcal{G}), with respective cardinalities $|\mathcal{N}| = N$ and $|\mathcal{L}| = L$. The set of connections $\mathcal{X} \subseteq \mathcal{N}^2$, with cardinality $|\mathcal{X}| = X$, is composed by all the source-destination pairs with communication between them, also called “users” in the text.

To represent the traffic between a given source-destination pair, an ON-OFF model is used. Consider connection c . During any of its ON periods, whose average length is t_{ONc} , the source transmits at a constant rate (which is the rate associated to the wavelength). During an OFF period, with average length t_{OFFc} , the source refrains from transmitting data.

To simplify the presentation, the constant transmission rate during the ON periods is determined by the used technology, that will be our rate unity. Consequently, the traffic load of connection c , denoted by ϱ_c , is given by the following expression:

$$\varrho_c = \frac{t_{ONc}}{t_{ONc} + t_{OFFc}}. \quad (4.1)$$

Observe that we address here the general case where the load can be different for each connection, the so-called *heterogeneous* situation, instead of the usual homogeneous case where the load is assumed to be the same for all users.

Let $\mathcal{R} = \{r_c \mid c \in \mathcal{X}\}$ be the set of routes that enable communications among the different users, where r_c is the route associated with connection $c \in \mathcal{X}$. The set \mathcal{R} is also denominated set of *primary* routes, because this set alone does not offer any fault tolerance to the possible failure of network links.

Let $\mathcal{W} = \{W_\ell \mid \ell \in \mathcal{L}\}$ be the set containing the number of wavelengths associated with the unidirectional network links, where W_ℓ , $\ell \in \mathcal{L}$, is the number of wavelengths on link ℓ . The value W_ℓ , for every $\ell \in \mathcal{L}$, will be evaluated so that the blocking probability BP_c , of each connection $c \in \mathcal{X}$ be less than or equal to a given pre-specified threshold β_c and the total number of available network wavelengths be as small as possible. Remark that the pre-defined threshold value β_c can be different for each network connection, allowing the method to solve these problems when there are classes of users with different priorities.

As in [5, 9, 41], in this work the total network cost C_{net} is defined as the sum of all wavelengths of all network links, that is, $C_{net} = \sum_{\ell \in \mathcal{L}} W_\ell$.

4.2.2 Sub-procedures needed by our CPL method

The method needs a few sub-procedures to work. They are described now. Since the given graph and the set of connections (or users) are fixed data that never change, as well as the upper bounds β_c of the blocking connection probabilities, we will omit them in the list of the parameters of the procedures. Also, when we refer to the network cost, we will write simply C_{net} because we must in general change many times during the computational process the capacities of the links.

***InitialRoutes()*: initial computation of the shortest routes** Our method starts by computing an initial set of routes. For each connection (s, t) we look for the shortest route from s to t in the graph, implicitly assuming that the capacity of all involved links (that is, the number of wavelengths available at each arc of the graph) is infinite. Let us symbolically write $\mathcal{R} := \text{InitialRoutes}()$ to represent the execution of this sub-procedure.

***CandidateRoutes(δ, c)*: evaluation of δ shortest routes** Our procedure requires to compute an initial set of routes to each connection $c \in \mathcal{X}$. This routes will be considered as candidates to be use as the definitive route. This can be done by any available technique (e.g. Yen’s algorithm [89]). The number of routes in the set is defined by the parameter δ . Then, for each connection c we look for a set of δ shortest routes from source to destination in the graph \mathcal{G} , denoted as \mathcal{H}_c , again assuming that the capacity of all involved links is infinite. Let us algorithmically write $\{\mathcal{H}_c\} := \text{CandidateRoutes}(\delta, c)$ to represent the evaluation of this sub-procedure.

***BestOf()*: given the possible routes provided by function *CandidateRoutes(δ, c)*, find the best of them** The idea is to choose which one of the routes defined by the function *CandidateRoutes(δ, c)* stored on \mathcal{H}_c , has the smallest cost (given by routes assigned at the moment, considering each connection traffic load), that is, the sum of all the link ℓ relative costs \mathcal{C}_ℓ . The route cost is denoted as $\sigma(i)$, as the i -th route cost in \mathcal{H}_c , updated on the procedure. The one with the smallest cost is called the “best” of them all, storing it on r_c . Symbolically, we write $r_c := \text{BestOf}(\mathcal{H}_c)$.

***WavelengthAD()*: given the routes and the thresholds β_c , compute the capacities and the wavelength assignment policy** We call *WavelengthAD* this sub-procedure. The problem consists in finding, for each link $\ell \in \mathcal{L}$, a capacity W_ℓ such that the end-to-end blocking probability BP_c of every user $c \in \mathcal{X}$ passing through the link ℓ is less than the given threshold or upper bound, denoted as β_c , while choosing which wavelength is going to be used by each connection. The routes \mathcal{R} are considered fixed and calculated before the evaluation of this sub-procedure.

The wavelength assignment method is based on the First-Fit method, due it is the fastest and simplest method with a good performance in terms of blocking probability,

but will be modified to a better match between the QoS offered and the QoS actually obtained on the network.

To dimension the wavelengths on each network link and to define a proper wavelength assignment strategy, we use the method proposed on the chapter 3. The method was called **Fair-HED**. First, Fair-HED method introduces a “Fairness Policy” to solve the wavelength assignment. This policy is based on the First-fit approach, but the number of wavelengths available to each connection are different (defined on the method itself and stored in the set $\mathcal{U} = \{u_c \mid c \in \mathcal{X}\}$). This Fairness policy allows a tighter difference between the quality of service offered to each user and the QoS requested on the SLA. Second, the dimensioning procedure assigns a different number of wavelengths on each link, called “Heterogeneous Dimensioning”, while satisfying a predefined maximum blocking probability given on the SLA β_c .

For additional information about this sub-procedure, chapter 3 addresses the wavelength assignment and dimensioning technique used in this procedure.

Let us symbolically write $\{\mathcal{W}, \mathcal{U}\} = \text{WavelengthAD}(\mathcal{R})$ to represent the evaluation of this sub-procedure.

4.2.3 R&WAD Procedure

The routing, wavelength assignment and dimensioning (*R&WAD*) problem consists in finding, for each connection a route to be followed by the data to be transmitted, and at the same time, to find, for each link $\ell \in \mathcal{L}$, a capacity W_ℓ , such that the end-to-end blocking probability BP_c of every user $c \in \mathcal{X}$ passing through the link ℓ is less than the given threshold or upper bound β_c , while taking account some wavelength assignment scheme. All of this, with the smallest cost possible.

Figure 4.1 shows a diagram presenting the inputs required by the CPL method, the condition to be guarantee by the method and the outputs obtained by the method execution. The inputs are: the graph $\mathcal{G} = (\mathcal{N}, \mathcal{L})$ (the network topology), which can be any network topology; each user traffic load ϱ_c , for all $c \in \mathcal{X}$, offered to the network. Notice that, the value ϱ_c of each user c can be different, we called this “Heterogeneous traffic load”. The requirement to be satisfied by the method is to guarantee a maximum blocking probability to each network user β_c , predefined on the Service Level Agreement (SLA).

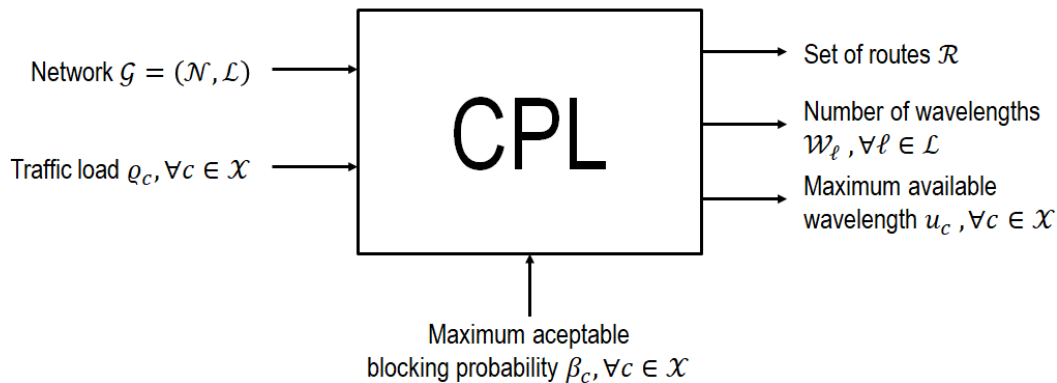

Fig. 4.1 Diagram showing the inputs required to run the CPL method, the condition to be guaranteed by the method, and the outputs delivered by the method, to solve the routing and wavelength dimensioning problem.

Finally, the method's outputs are the set of routes \mathcal{R} allowing to provide communication to each network connection c , for all $c \in \mathcal{X}$, and the amount of wavelength W_ℓ necessary on each network link ℓ , for all $\ell \in \mathcal{L}$.

Let the wavelengths be numbered sequentially (i.e. $1, 2, \dots, W_\ell$).

As mentioned on the dimensioning sub-procedure the method uses a First-Fit wavelength assignment approach, and during the method's execution, the fairness policy is obtained to complete the wavelength assignment strategy.

It remains to specify the procedure used to compute the connection blocking probabilities, necessary to evaluate the quality of service offered to each connection c . For this purpose, we use the method proposed in the previous chapter 2 [81], a fast and simple numerical evaluation considering heterogeneous traffic loads on each network connection on optical networks with wavelength continuity constraints.

In algorithmic form, the procedure can be written as shown in Figure 4.2.

Symbolically, the execution of the whole routing and wavelength dimensioning procedure will be written $\{\mathcal{R}, \mathcal{W}\} := \text{CPL}()$, since its output is the set of wavelengths and the set of all the connections route.

First, we compute a set of candidate paths to each connection $c \in \mathcal{X}$ (see line 1 to 4). These paths are candidates to be the final connection route. The amount of routes is set

```

function CPL()
// --- input: the graph (the network), the connections
//         and the bounds on the blocking probabilities  $\beta_c$ ,
//         all seen as global variables
// --- output: the routes  $\mathcal{R}$  and the wavelengths per link  $\mathcal{W}$ .

// --- calculate the set of candidate paths
1   $\mathcal{R}' := \text{InitialRoutes}()$ ; // shortest paths
2  for all connection  $c$ 
3       $\delta := \text{Length}(\mathcal{R}')$ ; // shortest route length
4       $\mathcal{H}_c := \text{CandidateRoutes}(\delta, c)$ ;

// --- start computing connections path and set them operational
5   $\mathcal{X} := \text{Sort}(\mathcal{X}, \mathcal{R}')$  // sort connections by route's length
6   $\mathcal{P} := \emptyset$ ; // no operational connections
7   $c := 0$ ;
   // --- define 1 hop length connections path
8  while connection  $c$  length equals to 1
9       $r_c := \mathcal{H}_c(0)$  // set the only possible route
10      $\mathcal{P} := \mathcal{P} \cup \{c\}$ ; // connection  $c$  is operational
11      $c++$ ;
   // --- compute next connections, choosing the best path in  $\mathcal{H}_c$ 
12 do
13     for  $i := 1$  to  $\text{Length}(\mathcal{H}_c)$ 
14          $\varrho_i := \sum_{c \in \mathcal{X} \setminus \mathcal{X}_{\mathcal{F}} \wedge \ell \in r_c} \varrho_c$ ; // operational + candidate route
15          $\bar{\varrho} := \frac{\sum_{\ell \in \mathcal{L}} \varrho_\ell}{L}$ ;
16          $\mathcal{C}_\ell := e^{\varrho_\ell - \bar{\varrho}}$ ;
17          $\sigma(i) := \sum_{\ell \in r_c} \mathcal{C}_\ell$ ; // i-th path cost
18          $r_c := \text{BestOf}(\mathcal{H}_c)$ ; // the best route is chosen
19          $\mathcal{P} := \mathcal{P} \cup \{c\}$ ; // connection  $c$  is operational
20          $c++$ ;
21 until ( $\mathcal{P} \equiv \mathcal{X}$ )
22  $\mathcal{W} := \text{WavelengthAD}(\mathcal{R})$ ; // --- with  $\mathcal{W}$ , QoS is satisfied
23  $C_{net} := \text{Cost}(\mathcal{W})$ ; // ---  $C_{net} = W_1 + \dots + W_L$ 
24 return ( $\mathcal{R}, \mathcal{W}$ )

```

Fig. 4.2 function CPL() proposed on this thesis chapter to solve the $R\&WAD$ problem, denoted as “Cheapest Path By Layers”.

by the parameter δ , evaluated as the connection shortest path length. This allows us to narrow the number of candidates path. In the case that there is not possible to achieve δ candidate paths, then those paths obtained are the candidates, and if there are more than δ possible candidates routes, the δ shortest ones are taken into account.

The main idea of this algorithm's section is to define one by one the connections path (line 5 to 21). With this in mind, we define a connection as "operational", as a connection with a definitive route to transmit. Thus, in the algorithm, an operational connection will be considered using the route links. To this end, let us define the set $\mathcal{P} = \{c \mid c \in \mathcal{X}\}$ as the set of all the operational connections on the network. To the contrary, a non-operational connection has not yet defined its definitive route, hence on the algorithm, it will not be considered as using its resources until its state changes to operational.

To chose the definitive path to each user among their candidate routes, we sort the connections in \mathcal{X} in terms of their shortest path length, from shorter to larger path (line 5). Additionally, the set \mathcal{P} starts empty (line 6).

Later, the connections with a route length equals to 1 hop define their unique option as their connection path (the only link connection source with destination node). In addition, this connection changed their state to operational, this means, they are added to the set \mathcal{P} . This procedure is executed from line 8 to 11.

Afterward, all the remaining connections define their routes following the previously defined connections order on line 5. To this end, from line 13 to 17, the algorithm checks on every candidate path in \mathcal{H}_c one by one, defining a route relative cost $\sigma(i)$ to each candidate path in \mathcal{H}_c , where i is the i -th candidate path in \mathcal{H}_c . Let us define ρ_ℓ as the link ℓ traffic load offered by the operational connections using link ℓ plus the traffic load offered by the candidate path connection, and $\bar{\rho}$ as the mean traffic load on the network. Then, the link ℓ relative cost \mathcal{C}_ℓ is evaluated as $\mathcal{C}_\ell = e^{\rho_\ell - \bar{\rho}}$. Based on the \mathcal{C}_ℓ values, the path relative cost $\sigma(i)$ is evaluated.

After computing every $\sigma(i)$ value, with $i = \{1, 2, \dots, |\mathcal{H}_c|\}$, the "best" candidate path is chosen. That is the cheapest candidate path is defined as the connection c definitive route, obtained by function *BestOf()* on line 18. This allows to change the connection c state to operational (line 19).

Finally, after setting all the network connections operational (this means every connection has a definitive primary route), the network is dimensioned, the wavelength

assignment fairness policy is obtained by the procedure defined on chapter 3 (line 20), and the network cost is computed on line 21.

Notice that CPL method provides only one fixed route r_c to each connection c . This solution is based on our hypothesis that a fixed routing can perform as good as fixed alternate routing (or even better). This can be possible if we pre-compute proper routes to each network connection, and dimension the network simultaneously with the route selection. This joint solution allow us to take advantage of statistical decisions, by exploring a bigger solution space to find the best possible solution. To do this, we rely on the analytical blocking probability evaluation [81], since it quickly and accurately solves each connection quality of service (measured as blocking probability), allowing us to make better decisions than other heuristic solutions based on simulation techniques.

4.3 Numerical Examples

To compare our proposal with other methodologies, it is necessary to evaluate their performances with regard to relevant metrics that let us compare the advantages/disadvantages of each method available. The most important metrics for the routing, wavelength assignment and wavelength dimensioning problem are: the cost of the network and the delay in the routing procedure. However, in our approach this delay is negligible since the computations are done off-line. Nevertheless, both metrics are going to be considered on the method evaluation.

Ideally, to quantify the quality of the solution obtained by the CPL method, it should be compared with the optimal solution. However, it is known that the R&WAD problem is an NP-complete problem [9, 90]. Consequently, for real network topologies (dozens or hundreds of nodes) R&WAD cannot be solved optimally. Given this situation, our best alternative was to compare the CPL method with the most frequently referenced methods considered as the most competitive at this moment.

First, as we mention on section 4.1, the Routing, Wavelength Assignment and Wavelength Dimensioning problem has been usually solved separately. Thus, when reviewing the current methods of Routing, we can find 3 different types of solution. Next we discuss the pertinence in comparing CPL with each of these different types of algorithms.

Fixed routing : This strategy provides connectivity to each user with only one route, computed before the network operations and stored on routing tables. Thus, each user uses the same path every time he attempts to transmit, even if their links path are already congested (causing a blocking situation). Among this strategy solutions, SP-FF (Shortest Path - First Fit) is the algorithm most commonly referenced today. It has shown to be the simplest and fastest algorithm to date with a very good performance measured as blocking probability.

Fixed alternate routing : This strategy computes a set of disjoint routes to allow each user to transmit. It is similar to fixed routing in the sense it calculates the routes set previous the network operation, but during the network operation it provides several alternatives to achieve communication between the source and destination node. This paths are stored on routing tables (as the fixed routing approach). The standard most referenced algorithm, and considered the best so far is the K-SP-FF (K-Shortest Path-First Fit), due to the fact it has a good compromise between operation complexity and performance, and it performs better than SP-FF.

Adaptive routing : This method computes each user path on demand, this means, each time a user attempts to transmit on the network. Adaptive Unconstrained Routing—Exhaustive (AUR-E) is known to be the best adaptive routing method. As previously mentioned, this strategy usually has a lower blocking probability than the previous approaches, but it causes a huge overhead on the network since it requires to execute the routing algorithm per request. Evidently, this on-line strategy causes a slow re-routing. Then, this type of method does not represent a practical mechanism to solve the routing problem. Therefore, the AUR-E method was not considered for comparison with the method proposed in this chapter.

Consequently, SP-FF and K-SP-FF methods are the most appropriate routing method to be compared with our algorithm. For instance, the value of K on the K-SP-FF technique was chosen equal to 3, since a higher number does not achieves a better performance in terms of wavelength requirements [5].

With regard to the dimensioning problem, as mentioned on the wavelength dimensioning chapter (Ch.3) the Homogeneous Wavelength Dimensioning has proven to be the most

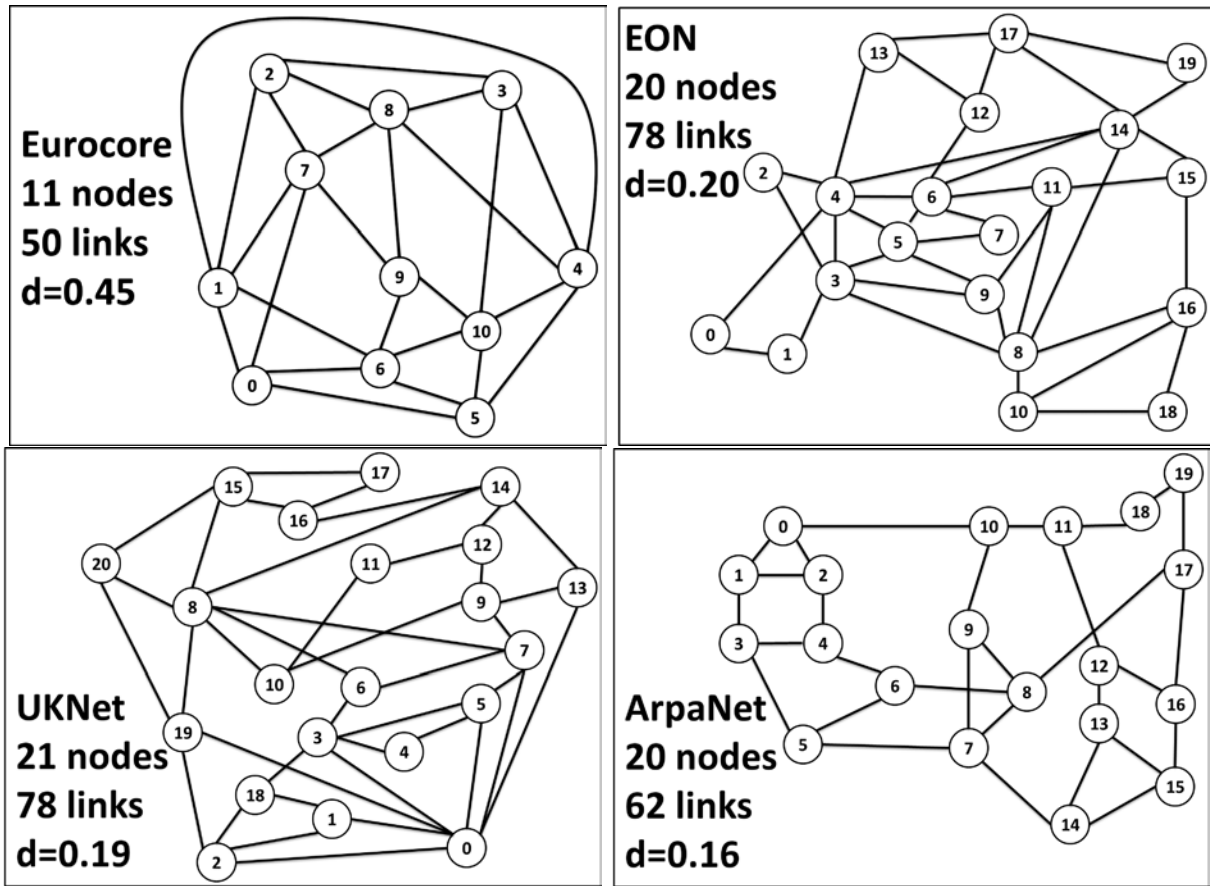

Fig. 4.3 Mesh networks evaluated. The number of links refers to the number of bidirectional arcs. Observe that in the picture we see the edges (for instance, the picture shows the Eurocore topology with 25 edges, which corresponds to 50 arcs). The parameter d is a measure of density: if the graph has a arcs (twice the number of edges) and n nodes, $d = a / (n(n - 1))$.

frequently used and referenced, thus this method will be used to solve the dimensioning problem.

Accordingly, SP-FF and K-SP-FF routing methods with an Homogeneous wavelength dimensioning are the most suitable R&WD methods to compare with.

One of the main objectives of the R&WAD method is to satisfy the quality of service requirements of each user, predefined on the SLA. Then CPL, SP-FF and K-SP-FF methods are going to be computed in order to guarantee a maximum connection blocking probability. Thus, to evaluate the corresponding blocking probabilities, the mathematical

method proposed in chapter 2 was used on each SP-FF, and CPL methods. But, due to the fact that K-SP-FF method uses a fixed alternate routing method and the mathematical method performs only with fixed routing, a simulation technique was necessary to evaluate its blocking probability.

To evaluate the performance of the methods under different scenarios, the algorithms were executed for different real network topologies, having different sizes (different amount of nodes and links) and different degrees of connection d , where d is the average number of neighbors of a node in the network. Hence, allowing us to execute the methods on different scenarios. Some of the selected topologies and their respective parameters N , L and d are shown in Figure 4.3.

4.3.1 Network Cost

First, let us compare the cost of the network C_{net} obtained by the contenders execution.

In Figure 4.4 we show the total cost C_{net} obtained by the SP-FF, K-SP-FF (with $k = 3$) and CPL methods, as a function of the traffic load, for different network topologies, and for a maximum acceptable blocking connection $\beta_c = 10^{-3}$. In addition, we included on the Figure the wavelength dimensioning needed on the static operation, as a reference of the results.

As it can be seen in Figure 4.4, our method clearly gets better results than SP-FF method. In fact, for all the scenarios evaluated in our experiments, SP-FF required on average a 45% more wavelengths (for $\rho = 0.3$ which is a representative network load [28]) than the cost of the method proposed herein. On the other hand, when comparing K-SP-FF and CPL methods the results obtained are similar, but in most cases our method is slightly better than K-SP-FF. As a matter of fact, K-SP-FF requires on average a 7% more wavelengths than our proposal. Notice that each scenario presented herein achieves to connect the same users (connections) with the same QoS constraints, but our proposal always requires less resources than SP-FF (and most of the times than 3-SP-FF) to do so.

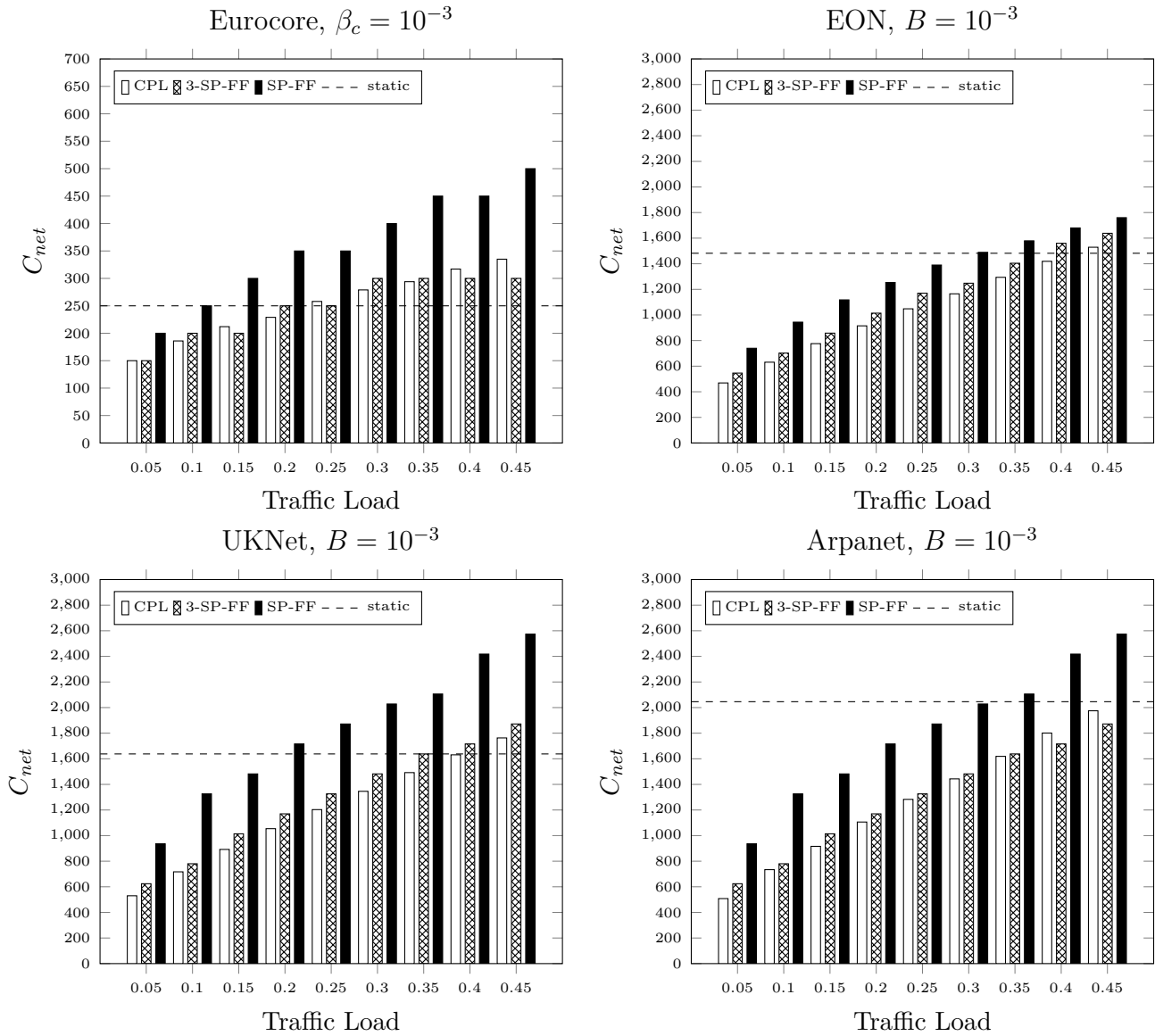

Fig. 4.4 The total number of wavelengths C_{net} obtained with our method (CPL), SP-FF and 3-SP-FF on Eurocore, EON, UKNet and Arpanet real mesh network topologies, for different connection traffic loads with a maximum acceptable blocking probability $\beta_c = 10^{-3}$.

4.3.2 Memory size and time access

Another aspects that influence the network performance are: the storage size used by the routing tables, and the delay imposed by the routing procedure when gaining access at the routing tables.

The routing tables storage size depends on how many routes are computed to each user by the R&WD procedure. In the case of fixed routing algorithms, such as CPL and SP-FF methods, the number of entries of the routing table assuming a centralized management is equal to the number of connections in \mathcal{X} . In the case of distributed management, the routing tables size are in the order of $O(\overline{X}_n)$, where \overline{X}_n is the average number of connections passing through a given n -th node of the network, i.e. $\overline{X}_n = N(N-1)\overline{H}/N$, and \overline{H} is the connection average number of hops. On the other hand, with a fixed alternate routing algorithms such as K-SP-FF, the number of entries of the routing table is $k \cdot \mathcal{X}$ assuming a centralized control, and $O(\overline{X}_n) = O(KN(N-1)\overline{H}/N)$ with a distributed management. The storage size is mostly important on a distributed management scheme. On this scheme the routing tables are stored directly on each optical switch, where the memory available to store information is usually limited. Thus, a k times larger routing table when routing by the K-SP-FF (comparing to our proposal) can be a remarkable issue.

The delay in the routing procedure means how much time it takes to access the connection routes on the routing tables. Let us define T as the time needed to access the routing table, which can be considered as a constant, and let τ be the mean time required to access the routing table by any attempt of transmission, in order to successfully achieve communication or to be blocked on any user possible path. This means, that $\tau(A)$ measures the routing delay obtained by how many times it is required to access the routing tables to have a successful communication or to be blocked, using the routing scheme obtained by the method A .

As mention before, the fixed routing methods only use one route per user, thus the delay $\tau(A)$ is equal to the time it takes to request information on the routing tables, this means:

$$\tau(CPL) = \tau(SP - FF) = T. \quad (4.2)$$

This strategy (fixed routing) performs the shortest delay possible to access the routes information on the network.

On the other hand, K-SP-FF requires to access the routing tables several times, since it checks on every route available for each user sequentially until it succeeds to transmit or is blocked on every alternate route. As an example, again choosing the k value equal to 3, we obtained:

$$\tau = a_1 \cdot T + a_2 \cdot T + a_3 \cdot T, \quad (4.3)$$

where a_i is the probability that a given transmission request is served by the i -th routing memory access in 3-SP-FF, with $1 \leq i \leq 3$. This means, the given connection transmits on the i -th route stored in the routing tables. Remember that a_3 also includes the cases where the users requests are blocked. On the experiments made in EON network topology with the same dimensioning obtained in figure 4.4 with the ρ_c values equals to 0.3, we got $a_1 = 1$, $a_2 = 0.23$ and $a_3 = 0.02$. Then, τ is as follows:

$$\tau = 1 \cdot T + 0.23 \cdot T + 0.02 \cdot T = 1.25T. \quad (4.4)$$

This shows us, than on average 3-SP-FF requires to read the routing tables an extra 25% times than any fixed routing algorithm. Additionally, we can conclude that each connection transmits, on average, 23% of the time by the second route and 2% of the time by the 3rd route.

4.3.3 Level of routing unbalance

We try to explain the reasons under the diverse performance obtained by the method compared herein. To this end, first we define some metrics, and then we use those metrics to compare the methods' performance.

Let $W_\ell(A)$ be the number of wavelengths computed to link ℓ by algorithm A , and $\overline{W}(A)$ be the mean number of wavelengths per link in a network when the R&WAD algorithm A is applied. By the mean value definition, $\overline{W}(A)$ is given by:

$$\overline{W}(A) = \frac{\sum_{\ell: \ell \in \mathcal{L}} W_\ell(A)}{L}. \quad (4.5)$$

Let $\sigma_W(A)$ be the standard deviation of the number of wavelengths per link in a network when R&WD algorithm A is applied. That is:

$$\sigma_W(A) = \sqrt{\frac{\sum_{\ell: \ell \in \mathcal{L}} [W_\ell(A) - \bar{W}(A)]^2}{L}}. \quad (4.6)$$

Now, to provide a measure of dispersion of the wavelength dimensioning, let us define $CV_W(A)$ as the coefficient of variation (also known as relative standard deviation) of the number of wavelengths per link in the network when the A technique is executed. That is:

$$CV_W(A) = \frac{\sigma_W(A)}{\bar{W}(A)}. \quad (4.7)$$

Additionally, let us define the same dispersion measurement, but according to the traffic load offered by the users to each network link, computed by all methods analyzed herein. Let $\varrho_\ell(A)$ be the traffic load offered to the link ℓ obtained by the path calculated on method A , and $\bar{\varrho}(A)$ be the mean traffic load on the network links. That is:

$$\bar{\varrho}(A) = \frac{\sum_{\ell: \ell \in \mathcal{L}} \varrho_\ell(A)}{L}. \quad (4.8)$$

Then, let $\sigma_\varrho(A)$ be the standard deviation of traffic load assigned to the links in a network when the algorithm A is applied, and let $CV_\varrho(A)$ be the coefficient of variation obtained. The $\sigma_\varrho(A)$ and $CV_\varrho(A)$ values are obtained as follows:

$$\sigma_\varrho(A) = \sqrt{\frac{\sum_{\ell: \ell \in \mathcal{L}} [\varrho_\ell(A) - \bar{\varrho}(A)]^2}{L}}. \quad (4.9)$$

$$CV_\varrho(A) = \frac{\sigma_\varrho(A)}{\bar{\varrho}(A)}. \quad (4.10)$$

Remember that a perfectly balanced network would achieve $CV_W(A) = 0$ and $CV_\varrho(A) = 0$. However, in real topologies -especially in mesh networks- a perfectly balanced routing is difficult to achieve (due to the fact that real networks are hardly symmetric), leading to $CV_W(A)$ and $CV_\varrho(A)$ values greater than zero. This means that both coefficient of variation quantifies how unbalanced the network is due the evaluation of the A algorithm.

Parameter	$CV_W(\mathbf{A})$			$CV_\rho(\mathbf{A})$		
	CPL	SP-FF	K-SP-FF	CPL	SP-FF	3-SP-FF
Eurocore	0.124	0	0	0.2453	0.4534	0.2106
EON	0.141	0	0	0.3957	0.6861	0.3643
UKNet	0.057	0	0	0.3868	0.7121	0.3180
Arpanet	0.051	0	0	0.4853	0.5109	0.3485

Table 4.1 Coefficient of Variation $CV_W(A)$ and $CV_\rho(A)$ of the number of wavelengths and link's traffic load, respectively. This values were obtained by the CPL, SP-FF and 3-SP-FF methods for Eurocore, EON, UKNet and Arpanet networks, considering a maximum blocking probability of 10^{-3} and a mean traffic load of 0.3.

As an example, Table 4.1 shows the Coefficient of Variation of the number of wavelengths per link ($CV_W(A)$) and each link traffic load ($CV_\rho(A)$), obtained by the CPL, SP-FF and K-SP-FF techniques, for different mesh topologies with an specific blocking probability requirement of 10^{-3} and a mean traffic load of 0.3 for each connection.

From this Table, it can be seen that, in terms of wavelength dimensioning both SP-FF and 3-SP-FF procedures obtained a completely balanced solution. Obviously, this happens due to the fact that both method use a homogeneous dimensioning. Hence, they “artificially” balance the number of wavelength on the networks link. However, if we see the traffic load coefficient of variation, is clear that SP-FF actually highly unbalance the traffic load compared with our proposal and 3-SP-FF technique. This measurement shows that in reality no method achieves a perfectly balanced routing solution, which is due to the irregular geometry of mesh networks.

Moreover, in Table 4.1 can be observed that the methods with a better performance (CPL and 3-SP-FF) in terms of network cost have a more balance traffic load. This observation lets us to conclude that balancing the traffic load is a key issue to achieve a lower cost on optical networks with a wavelength continuity constraints.

Parameter	CPL			SP-FF			3-SP-FF		
Topology	C_{net}	$CV_W(\text{CPL})$	$CV_\ell(\text{CPL})$	C_{net}	$CV_W(\text{SP-FF})$	$CV_\ell(\text{SP-FF})$	C_{net}	$CV_W(\text{K-SP-FF})$	$CV_\ell(\text{K-SP-FF})$
Eurocore	279	0.124	0.245	450	0	0.453	300	0	0.210
EON	1165	0.141	0.395	1489	0	0.686	1248	0	0.364
UKNet	1346	0.057	0.386	2028	0	0.712	1482	0	0.318
Arpanet	1443	0.051	0.485	2028	0	0.510	1482	0	0.348

Table 4.2 Total number of wavelengths C_{net} required by the CPL, SP-FF and 3-SP-FF methods and their respective coefficient of variation in accordance with number of wavelength $CV_W(A)$ and links traffic load $CV_\ell(A)$, for Eurocore, EON, UKNet and Arpanet networks, considering a maximum blocking probability of 10^{-3} and a mean traffic load of 0.3.

4.3.4 Analysis and summary of the method

In the experiments, our method (CPL) always gave better results than those coming from the SP-FF technique as illustrated in the examples used in the chapter (Figures 4.4) and perform closely and usually better than K-SP-FF procedure.

To better exemplify each method differences, in Table 4.2, the total cost C_{net} obtained by the method proposed herein (CPL), SP-FF and 3-SP-FF methods is shown. The results presented were obtained for the same network topologies as in Figure 4.3, and considering a maximum blocking probability of 10^{-3} and a mean traffic load of 0.3. Additionally, each method coefficient of variation in terms of each link wavelength dimensioning $CV_W(A)$ and each link traffic load $CV_\ell(A)$ is presented.

First, let us compare in details SP-FF and CPL techniques. In Table 4.2 it is clear that our method performs much better than SP-FF, using the same fixed routing technique. The difference lie in the wavelength assignment and dimensioning procedure used, and the choice to balance the traffic load on the network. On the one hand, we proved on Chapter 2 that an heterogeneous dimensioning together with a Fairness Policy on the wavelength assignment procedure greatly diminishes the number of wavelengths required to successfully guarantee the users QoS constrains. On the other hand, we exemplify that in this wavelength continuity environment, balancing the network load seems to obtains better results than concentrating the traffic load. In this point, as shown on Table 4.1, our method seeks to balance the network, contrary to the SP-FF method which concentrates the traffic load on the network.

Next, let's compare K-SP-FF and our method. As presented on the figure 4.4 and Table 4.2 CPL obtains slightly better results than K-SP-FF, in accordance with the C_{net} value obtained, but using a simpler routing scheme. Both algorithm achieves a much more balance solution than SP-FF, reinforcing us the idea that a balance solution obtains a better performance in terms of network cost. On top of this, as previously explained, K-SP-FF technique uses a fixed alternate routing scheme, thus it provides connectivity using K alternate routes to transmit, contrary to the CPL method which uses only one path to communicate each user. This means, that our technique performs similar than a more complex technique on several points (as mention on subsection 4.3.2). First, K-SP-FF requires K times memory size to store the routing tables, since it requires to store K routes per network user. Additionally, the delay induced by the routing procedure is bigger than our method, due to the fact that it requires to read the routing table more times per connection attempt to transmit on any alternate route available.

Let us discuss here some qualitative reasons that justify the better results of CPL over SP-FF and K-SP-FF:

- By simultaneously solving the 2 problems (routing, and wavelengths dimensioning), a global solution is obtained, which is a more efficient strategy than to solve these problems separately.
- The routing strategy is based on fixed routing, defining one path to each user previous the network operation and stored in routing tables. This solution is based on our hypothesis that a fixed routing can perform as good as fixed alternate routing (or even better). This can be possible if we pre-compute proper routes to each network connection, and dimension the network simultaneously with the route selection. This joint solution allow us to take advantage of statistical decisions, by exploring a bigger solution space to find the best possible solution. To do this, we rely on the fast and accurate analytical blocking probability evaluation proposed in Chapter 2, allowing us to make better decisions than other heuristic solutions based on simulation techniques.
- The dimensioning procedure assigns a different number of wavelengths to each network link (called Heterogeneous Dimensioning), such that the blocking probability of each connection does not exceed a predefined maximum blocking probability.

This takes advantage that real network are hardly symmetric, thus hard to balance the connections traffic load within.

- Additionally, the dimensioning procedure uses a wavelength assignment policy called “Fair Policy”. This policy consists in to offer a maximum blocking probability to each network user as close as possible to the one defined in the SLA, since each user may have different quality of service requirements. This way the method diminishes the wavelength dimensioning since each connection uses only the wavelengths needed to satisfy their QoS demand.
- The usual blocking probability evaluation technology is based on simulation, which is a slow procedure. Consequently, the evaluation process is limited to only a few restricted scenarios. So, to find the best possible solution, researchers apply some criteria to restrict the solutions search (heuristics), for example, making choices as the shortest path. CPL obtains better results, so we can conclude that such heuristic solutions are not using good assumptions and taking appropriate decisions.
- The routing method balances the traffic load on the network. This is due to the relative cost function defined to decide each user path. As mentioned on the numerical results, we conclude that this characteristic is a key aspect to achieve a lower cost in terms of wavelength dimensioning, while satisfying the quality of service predefined on the SLA at the same time.

In addition to the increased efficiency compared to existing methods, the CPL method has other desirable attributes:

- The on-line operation (during network operation) of the method is very fast and simple. This is due to the fact that our proposal uses a fixed routing scheme, and the routing information is stored in routing tables, which contain each connection’s path. This means that the routing mechanism is as short as possible.
- The off-line execution time of the CPL method takes only a few seconds using a standard current PC (Windows 10 64 bits, Intel Core i7 2.60GHz processor and 8GB RAM).

4.4 Conclusions

A new method was proposed to jointly solve three of the main problems in optical network design: it determines the set of routes enabling each network user to transmit, it defines an efficient wavelength assignment scheme in order to choose a wavelength to transmit on each communication request, and it evaluates the minimum number of wavelengths necessary on each network link while guaranteeing certain blocking probability threshold to each user (which is a design parameter of the network).

The technique proposed is considerably different from those published so far. It computes a global solution, which often obtains a better solution than solving the problems separately. In fact, it obtains better results in terms of number of wavelengths assigned to the links (specially than the fixed routing method known as SP-FF), with less entries on the routing tables than any fixed alternate routing method. Hence, CPL requires less memory to store the paths on the routing tables, and it involves a smaller delay to route each user each time it attempts to transmit.

It is important to notice that the proposal obtains on average 20% less wavelength than required on the static operation scenario. This results may provide enough reasons to migrate from static to dynamic operation.

Due to the fact that our methods use the procedure proposed on chapter 3, the method assigns different number of wavelengths on each link (heterogeneous wavelength dimensioning), and defines a Fairness policy in the First-Fit Wavelength Assignment, in order to offer a quality of service to each user as close as the one requested on the Service Level Agreement.

The method is executed previous the network operation requiring a few seconds to simultaneously solve the R&WAD problem. Additionally, the network operation based on our approach is simple and fast, due to the fact that the paths are stored in routing tables and addressed on demand.

Chapter 5

Fault Tolerance

5.1 Introduction

Another issue to be solved in order to design WDM optical networks is to ensure that the network will still be able to provide its transmission service after the failure of one or more of its links. The solution to this problem consists in providing the necessary infrastructure to rapidly re-establish communications between all source-destination pair of nodes affected by these link failures. This type of mechanism is known as “Fault Tolerance”.

The frequency of link failures’ occurrences is often significant. For instance, [29, 30] reports measures of the mean time between failures of about 367 year/km. This explains why failures on links may significantly impact the performance of the networks. For example, in a 26,000 km-long network such as NSFNet [91], there is an average of one fiber cut every 5 days. Moreover, it has been found that the frequency with which two simultaneous network failures occur is high enough to be taken into account in the design process. For example, in [30] it has been reported that the probability of two simultaneous failures occurring in a network like NSFNet is approximately 0.0027 (a downtime of about 24 hours per year on average), which in addition to the high transmission rate of this kind of networks, implies an unacceptable loss for the operator if the event happens.

The previous elements justify the need to provide an efficient methodology for multiple fault tolerance, which should ensure (with a certain probabilistic guarantee) successful

communications among all network users, despite the occurrence of failures in some of the links, and at the lowest possible cost regarding the network infrastructure.

The fault tolerance methods proposed so far generally have been devoted to finding alternative paths considering single link failure. This means, one bidirectional link fails, affecting the connections with routes passing through the failed link in both directions (uplink and downlink). Then, the number of wavelengths in the network is dimensioned to tolerate this situation [30, 92, 93]. However, as already noted, the probability of occurrence of two or more simultaneous failures is often high enough, making that it is useful to consider this event in the design of the network. Some studies have focused on this scenario [94–97], which are described next. Also, some studies have considered special cases of failure, such as Disaster risk constrains and Shared-Risk-Group scenarios. Disaster risk constrains [98, 99] considers the possible service disruptions in case of a natural disaster or a targeted attack. On the other hand, Shared-Risk-Group (SRG) [100] considers the possibility that some fibers are placed physically together, even if they are connecting different optical nodes. This scenario makes them all liable to physical cuts, since they can be cut together at the same time.

Let us briefly list next the most common methods currently used to provide fault tolerance. One of the most frequent ways considered to address simple and double fault tolerance, called “1+1”, can be found in [101, 43, 102, 103, 92, 104]. In this technique, a secondary route is associated with each primary one (with the restriction that they don’t share any link) and the information is transmitted simultaneously through both of them. To dimension the number of wavelengths of each link (task usually done by simulation), each secondary route is considered as just another network route with a load equal to the corresponding primary one. The 1+1 method is also scalable to provide tolerance to $K \geq 1$ simultaneous failures. In this case, for each connection, $K + 1$ supplementary disjoint routes must be found, one to be designed as the primary route and the remaining K as secondary routes. Observe that a necessary and sufficient condition (allowing this scheme to work) is that the graph defined by the set of nodes and links is $(K + 1)$ -connected.

Another strategy is described in [105], where a routing technique is proposed to provide fault tolerance while sharing the resources of the network. This method is known as “*Shared Path Protection*” (SPP) [106, 105, 107]. In this method the extra resources (wavelengths) assigned to the secondary routes can be shared by different connections,

and are assigned only when a fault occurs. It can be executed in two different ways. The first one consists of running the algorithm off-line, where the routes are calculated prior to the operation of the network (off-line SPP). The second way is the on-line implementation (on-line SPP). In this last case, the method is executed every time there is a network link failure. In the SPP online mode, the primary routes are specified before the network is operating, but in order to find new routes to the affected connections it must be executed again every time that one or more simultaneous failures occur. For this reason, we say that this is a proactive and a reactive approach at the same time.

Finally, in [108–110, 94–96] a method of fault tolerance called “*p-cycle*” is used, allowing sharing resources through fixed secondary routes which have a cyclic form. These routes are shared between several primary routes. One problem with this approach is that the applicability of the idea is very dependent on the size of the network, introducing excessive additional delay for a connection in protection state on large networks. Also, to perform multiple fault tolerance, this method requires a large amount of cycles (e.g. hundreds of cycles for the 11 nodes pan-European COST 239 network [109]), which is impractical from various points of view.

In this chapter we propose a new procedure for simultaneously solve the routing, wavelength assignment, wavelength dimensioning and multiple fault tolerance problems (which we call the “Cheapest Path By Layers with Fault Tolerance” method- *CPLFT*). This new approach obtains all primary and secondary routes assigned to each possible connection. Secondary routes replace the primary ones when the latter are affected by at least one failure, thus keeping users connected as long as the network itself remains connected; that is, for every connection (user) there is at least one path with operational links to reach their destination nodes. In our approach we go one step further, and we take into account the case of an arbitrary set of simultaneous failures. The method also evaluates the number of wavelengths W_ℓ for each link ℓ of the network, ensuring that the blocking probability of any connection request will be lower than the predefined threshold β_c previously mentioned, despite the possible occurrence of those simultaneous link failures. The technique relies on a wavelength assignment and dimensioning completely different than the ones proposed to date. It introduces 2 new features: the number of wavelengths (in general) are different on each link (heterogeneous dimensioning); and the wavelength assignment used introduces a Fairness Policy to each network user providing a quality of service as close as possible as the one defined on the SLA.

The remainder of this chapter is as follows: Section 5.2 presents the new algorithm. Section 5.3 contains some results obtained by the proposed algorithm, which are compared with those obtained with the current best methods in a set of different scenarios. Finally, the conclusions of the study are given in Section 5.4.

5.2 Fault tolerance strategy

This section contains the main contribution of the chapter. We present first the model used and the related assumptions. Then, we describe the main sub-procedures necessary to our technique. Last, we present the fault tolerance algorithm.

5.2.1 Model and assumptions

We define the same model and assumptions than previous chapters. Thus, if you are already familiar with it, you are welcome to skip this sub-section and continue in Fault Tolerance definitions 5.2.1.

The network topology is represented by a graph $\mathcal{G} = (\mathcal{N}, \mathcal{L})$, where \mathcal{N} is the set of network nodes or vertices and \mathcal{L} is the set of unidirectional links (the arcs in \mathcal{G}), with respective cardinalities $|\mathcal{N}| = N$ and $|\mathcal{L}| = L$. The set of connections $\mathcal{X} \subseteq \mathcal{N}^2$, with cardinality $|\mathcal{X}| = X$, is composed by all the source-destination pairs with communication between them. These connections are also called “users” in the text.

To represent the traffic between a given source-destination pair, an ON-OFF model is used. Consider connection c . During any of its ON periods, whose average length is t_{ONc} , the source transmits at a constant rate (which is the rate associated to the wavelength). During an OFF period, with average length t_{OFFc} , the source refrains from transmitting data.

To simplify the presentation, the constant transmission rate during the ON periods is determined by the used technology, that will be our rate unity. Consequently, the traffic load of connection c , denoted by ρ_c , is given by the following expression:

$$\rho_c = \frac{t_{ONc}}{t_{ONc} + t_{OFFc}}. \quad (5.1)$$

Observe that we address here the general case where the load can be different for each connection, the so-called *heterogeneous* situation, instead of the usual homogeneous case where the load is assumed to be the same for all users [74, 111–113, 95, 114, 96, 115–117].

Let $\mathcal{R} = \{r_c \mid c \in \mathcal{X}\}$ be the set of routes that enable communications among the different users, where r_c is the route associated with connection $c \in \mathcal{X}$. The set \mathcal{R} is also denominated set of *primary* routes, because this set alone does not offer any fault tolerance to the possible failure of network links.

Let $\mathcal{W} = \{W_\ell \mid \ell \in \mathcal{L}\}$ be the set containing the number of wavelengths associated with each unidirectional network link, where W_ℓ , $\ell \in \mathcal{L}$, is the number of wavelengths on link ℓ . The value W_ℓ , for every $\ell \in \mathcal{L}$, will be evaluated so that the blocking probability BP_c of each connection $c \in \mathcal{X}$ is less than or equal to a given pre-specified threshold β_c and the total number of available network wavelengths is as small as possible. Remark that the pre-defined threshold value β_c can be different for each network connection, allowing the method to solve these problems when there are classes of users with different priorities.

As in previous chapters, in this work the total network cost C_{net} is defined as the sum of all wavelengths of all network links, that is, $C_{net} = \sum_{\ell \in \mathcal{L}} W_\ell$. As we are considering fault tolerance capabilities, this includes all the extra wavelengths needed to provide tolerance to multiple link failures.

Fault tolerance definitions

Consider a set of every possible failure scenarios Ω on the network to be considered. Each of these scenarios is a subset of failed network links \mathcal{F} , where $\mathcal{F} \subset \mathcal{L}$. This subset \mathcal{F} corresponds to a failure scenario, where every links belonging to \mathcal{F} is non-operational (failed). Therefore, this method can be applied to any possible case of failures in the network, e.g.: every possible single failure scenario ($|\mathcal{F}| = 1$) which corresponds to the case of single link failure; every possible double failure scenario ($|\mathcal{F}| = 2$); node failure (corresponding to a special case of multiple failure, where all the links connected to that node are non-operational); Disaster risk constrains [98, 99] can be considered in our method by including in the failure scenario \mathcal{F} all the links where the disaster has taken place; also, Shared-Risk-Group (SRG) [100] can be considered also as a special case of multiple link failures, where \mathcal{F} is composed by every link that can be affected by the same physical cut.

Assume some failure scenario \mathcal{F} is also given (or observed), that is, assume that the links in \mathcal{F} are failed, and those that don't belong to \mathcal{F} work (are operational). Some additional definitions required for this method are presented in the following list:

- $\mathcal{G}_{-\mathcal{F}} = (\mathcal{N}, \mathcal{L} \setminus \mathcal{F})$, is the partial graph of \mathcal{G} (same nodes, part of the edges), containing only the non-failed links;
- $\mathcal{X}_{\mathcal{F}} = \{c \in \mathcal{X} \mid \text{there exists } \ell \in \mathcal{F} \text{ with } \ell \in r_c\}$, is the set of all network connections whose routes pass through at least one failed link;
- $\mathcal{A}_{\mathcal{F}} = \{r_c \in \mathcal{R} \mid \text{there exists } \ell \in \mathcal{F} \text{ with } \ell \in r_c\}$, is the set of routes that are affected when all links in \mathcal{F} fail; that is, $\mathcal{A}_{\mathcal{F}}$ is the subset of the routes in \mathcal{R} that are associated with the connections in $\mathcal{X}_{\mathcal{F}}$;
- $\mathcal{R}_{\mathcal{F}}$ is a set of routes that replace those in $\mathcal{A}_{\mathcal{F}}$ when all links in \mathcal{F} are failed; for each of these routes, the corresponding blocking probability must be less than or equal to the corresponding given upper bound;
- $\mathcal{S}_{\mathcal{F}}$ is the total set of routes guaranteeing fault tolerance to the failure event “all links in \mathcal{F} fail”, that is, the set defined by $\mathcal{S}_{\mathcal{F}} = (\mathcal{R} \setminus \mathcal{A}_{\mathcal{F}}) \cup \mathcal{R}_{\mathcal{F}}$.
- $\mathcal{C}_{\mathcal{F}} = \{C_{\ell} \mid \text{for all } \ell \in \mathcal{L} \setminus \mathcal{F}\}$ is the total set of costs of each link non-affected by a failure.

5.2.2 Sub-procedures needed by our CPLFT method

The method needs a few sub-procedures to work. They are described next. Since the given graph and the set of connections (or users) are fixed data that never change, as well as the upper bounds β_c of the blocking connection probabilities, we will omit them in the list of the parameters of the procedures. Also, when we refer to the network cost, we will write simply C_{net} because we must in general change many times during the computational process the capacities of the links.

PrimaryRoutes(): **initial computation of primary routes** Our method starts by computing an initial set of routes and the corresponding wavelength dimensioning. This are the primary routes by which each connection normally transmits its information. This

can be done by any available technique. Nevertheless, for each connection (s, t) we look for the cheapest routes from nodes s to t in the graph, using the algorithm propose on chapter 4. The algorithm, called CPL, propose a novel technique to simultaneously solve the routing, wavelength assignment and wavelength dimensioning. The method assigns to each source-destination pair of nodes the cheapest path while trying to balance the traffic load on each network link. The method also evaluates the number of wavelengths W_ℓ for each link ℓ of the network, ensuring that the blocking probability of any connection request will be lower than the predefined threshold β_c , and introduces a Fairness Policy on the wavelength assignment solution, defining a scheme to assign on demand a wavelength to transmit on each attempt of communication.

Let us symbolically write $\{\mathcal{R}, \mathcal{W}\} := PrimaryRoutes()$ to represent the execution of this sub-procedure.

SecondaryRoutes(): **given the set of link failures, find new routes** The problem is the following: we have a set of failure links \mathcal{F} , the set of costs $\mathcal{C}_\mathcal{F}$ and a set of users $\mathcal{X}_\mathcal{F}$ affected by the failure of the links in \mathcal{F} . We would like to find a new set of routes allowing to connect each user in $\mathcal{X}_\mathcal{F}$ in case of the failure scenario \mathcal{F} , while still satisfying the QoS required by each connection.

The search for new routes is then done as follows. We run Dijkstra's algorithms looking, for each user $c \in \mathcal{X}$, for the cheapest route where the link costs are now given by the link costs in $\mathcal{C}_\mathcal{F}$ (explained on the algorithm). This produces a new set of routes that we denote $\mathcal{R}_\mathcal{F}$.

Symbolically, we execute the call $\mathcal{R}_\mathcal{F} := SecondaryRoutes(\mathcal{X}_\mathcal{F}, \mathcal{F}, \mathcal{C}_\mathcal{F})$.

WavelengthAD(): **given the routes and the thresholds β_c , compute the capacities** We call *WavelengthAD* this sub-procedure ("Wavelength Assignment and Dimensioning"). The problem consists in finding, for each link $\ell \in \mathcal{L}$, a capacity W_ℓ such that the end-to-end blocking probability BP_c of every user $c \in \mathcal{X}$ passing through the link ℓ is less than the given threshold or upper bound, denoted as β_c , while at the same time, providing a wavelength assignment scheme to use during the network operation. The routes \mathcal{R} are considered fixed and calculated before the evaluation of this sub-procedure.

The wavelength assignment method is based on the First-Fit method, due it is the fastest and simplest method with a good performance in terms of blocking probability, but will be modified to a better match between the QoS offered and the QoS actually obtained on the network.

To dimension the wavelengths on each network link, and to define a proper wavelength assignment strategy, we use the method proposed on the chapter 3. The method was called **Fair-HED**. First, Fair-HED method introduces a “Fairness Policy” to solve the wavelength assignment. This policy is based on the First-fit approach, but the number of wavelengths available to each connection are different (defined on the method itself and stored in the set $\mathcal{U} = \{u_c \mid c \in \mathcal{X}\}$). This Fairness policy allows a tighter difference between the quality of service offered to each user and the QoS requested on the SLA. Second, the dimensioning procedure assigns a different number of wavelengths on each link, called “Heterogeneous Dimensioning”, while satisfying a predefined maximum blocking probability given on the SLA β_c .

For additional information about this sub-procedure, chapter 3 addresses the wavelength assignment and dimensioning technique used in this procedure.

Let us symbolically write $\{\mathcal{W}, \mathcal{U}\} = \text{WavelengthAD}(\mathcal{L}, \mathcal{R})$ to represent the evaluation of this sub-procedure.

5.2.3 R&WAD+FT procedure

The routing, wavelength assignment, wavelength dimensioning and fault tolerance (**R&WAD+FT**) problems consists in finding, for each connection a primary route to be followed by the data to be transmitted, additional routes (also called secondary route) used to keep each user connected in cases where one or more simultaneous failures occur, and at the same time, to find, for each link $\ell \in \mathcal{L}$, a strategy to assign on demand each user wavelength to communication and a capacity W_ℓ , such that the end-to-end blocking probability BP_c of every user $c \in \mathcal{X}$ passing through the link ℓ is less than the given threshold or upper bound β_c , despite the occurrence of link failures.

These tasks are usually solved separately [10]. This happens due to the fact that solving them simultaneously have a great complexity associated. By solving separately the Routing, the Wavelength Assignment, Wavelength Dimensioning and Fault tolerance

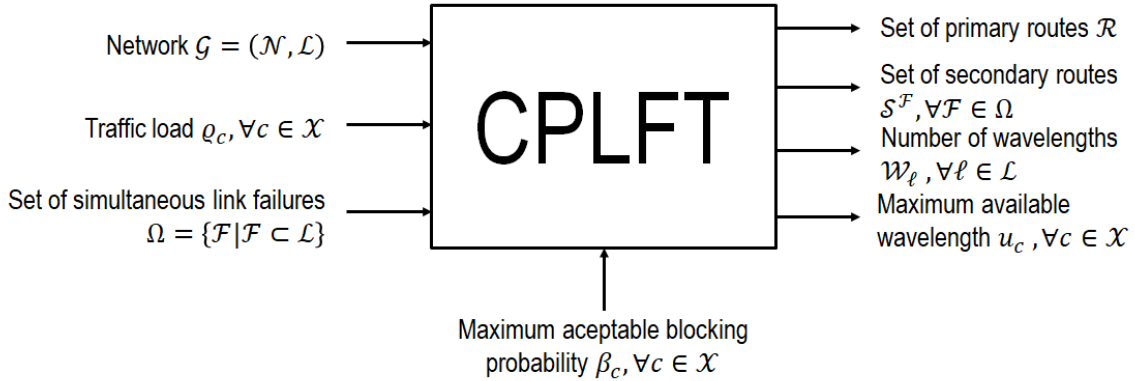

Fig. 5.1 Diagram showing the inputs required to run the CPLFT method, the condition to be guaranteed by the method, and the outputs delivered by the method, to solve the routing and wavelength dimensioning problem.

is possible to achieve good local solutions to each problem. As shown on previous chapters, we strongly believe that to provide a joint solution of the R&WAD+FT problem may achieve a good global solution. As a matter of fact, recently in [118, 119], an exhaustively validated heuristic strategy, called Joint3 was applied, solving jointly the routing, wavelength dimensioning and fault tolerance problems, in the context of WDM optical networks with wavelength conversion capabilities. Its performance was better than local strategies approaches.

We named the method proposed herein “Cheapest Path by Layers considering Fault Tolerance” (CPLFT).

Figure 5.1 presents a diagram presenting the inputs required by the method, the condition to be guaranteed by the method and the outputs obtained by the method execution. In figure 5.1 the inputs are: the network topology $\mathcal{G} = (\mathcal{N}, \mathcal{L})$, which can be any network topology; each user traffic load ϱ_c , for all connections in \mathcal{X} , offered to the network. Notice that, the value ϱ_c of each user c can be different, we called this “Heterogeneous traffic load”; and the set $\Omega = \{\mathcal{F} | \mathcal{F} \subset \mathcal{L}\}$ composed by all the link failure scenarios to be considered by the method execution. The requirement to be satisfied by the method is to guarantee a maximum blocking probability to each network user β_c , predefined on the Service Level Agreement (SLA). Finally, the method’s outputs are the set of routes \mathcal{R} allowing to provide communication to each network connection c , for all

$c \in \mathcal{X}$; the set of alternative routes $\mathcal{S}_{\mathcal{F}}$, for all $\mathcal{F} \in \Omega$, which allow to communicate in spite of the links in \mathcal{F} fail; and the amount of wavelength W_{ℓ} necessary on each network link ℓ , for all $\ell \in \mathcal{L}$ considering every possible failure scenario in Ω .

Once again, let the wavelengths be numbered sequentially (i.e. $1, 2, \dots, W_{\ell}$).

As mentioned on the wavelength assignment and dimensioning sub-procedure the method uses a First-Fit wavelength assignment approach, and during the method's execution, the fairness policy is obtained to complete the wavelength assignment strategy.

The procedure used to compute the connection blocking probabilities, necessary to evaluate the quality of service offered to each connection c , is the method proposed in chapter 2. As explained on [81], this is an accurate, fast and simple to evaluate each user blocking probability with continuity constraints. This important due to the fact that our method requires to execute the blocking probability time an time again in all failure cases considered in the set Ω , while executing the dimensioning procedure. Therefore, it is not possible to evaluate this measure by means of simulation due to the time-consuming task involved.

In algorithmic form, the routing, wavelength dimensioning and fault tolerance procedure is presented in Figure 5.2.

In **line 1**, we first use the algorithm proposed in chapter 4 to obtain a set of primary routes \mathcal{R} and a set of capacities \mathcal{W} compatible with the QoS constraints β_c , $c \in \mathcal{X}$, assuming no failures, executed by the sub-procedure *PrimaryRoutes*.

Then in **line 2**, we consider that we have a set of every possible failure scenarios Ω , where each of these scenarios is a subset of failed network links \mathcal{F} that can have up any set of simultaneous link failures. To explain how the procedure works, just assume that the only possible failure event is the simultaneous failures of all links in a specific subset \mathcal{F} of \mathcal{L} .

In **lines 4 to 7**, we first start by finding replacement routes in case of the failure of all links in a single subset of links \mathcal{F} . If a route r_c doesn't use any link of \mathcal{F} , it is not changed. But for all connections c whose route $r_c \in \mathcal{R}$ uses at least one link of \mathcal{F} (that is, for all $c \in \mathcal{X}_{\mathcal{F}}$), we must find a new route that avoids the links of \mathcal{F} . As in previous subsection, for every link $\ell \in \mathcal{L} \setminus \mathcal{F}$, we define its cost \mathcal{C}_{ℓ} using the traffic load offered to each link by the expression:

$$\mathcal{C}_{\ell} = e^{\theta_{\ell} - \bar{\theta}}, \quad (5.2)$$

```

function CPLFT()
// --- input: the graph (the network), the connections,
//           the bounds on the blocking probabilities,
//           and the set  $\Omega$  of links failure scenarios,
//           where at most one of the events ‘all links in  $\mathcal{F}$ 
//           fail simultaneously’ occurs, all seen as global variables
// --- output: the primary routes, the secondary routes
//           and the wavelengths per link

// first compute primary routes and corresponding dimensioning
1   $(\mathcal{R}, \mathcal{W}) := \text{PrimaryRoutes}()$ ;

// calculates secondary paths in all failure scenarios.
2  foreach  $\mathcal{F}$  in  $\Omega$ 
3    for all links  $\ell \in \mathcal{L} \setminus \mathcal{F}$ 
4       $q_\ell := \sum_{c \in \mathcal{X} \setminus \mathcal{X}_\mathcal{F} \wedge \ell \in r_c} q_c$ ; // non-affected routes
5       $\bar{q} := \frac{\sum_{\ell \in \mathcal{L} \setminus \mathcal{F}} q_\ell}{|\mathcal{L} \setminus \mathcal{F}|}$ ;
6       $\mathcal{C}_\ell := e^{q_\ell - \bar{q}}$ ;
7       $\mathcal{R}_\mathcal{F} := \text{SecondaryRoutes}(\mathcal{X}_\mathcal{F}, \mathcal{F}, \mathcal{C}_\mathcal{F})$ ; // compute alternative routes
8       $\mathcal{S}_\mathcal{F} := (\mathcal{R} \setminus \mathcal{A}_\mathcal{F}) \cup \mathcal{R}_\mathcal{F}$ ;
9       $\mathcal{W}_\mathcal{F} := \text{WavelengthAD}(\mathcal{L} \setminus \mathcal{F}, \mathcal{S}_\mathcal{F})$ ;

// Decide the final wavelength dimensioning
10 for all links  $\ell \in \mathcal{L}$ 
11    $W_\ell := \text{Max}(W_\ell, \mathcal{W}_{1,\ell}, \dots, \mathcal{W}_{|\Omega|,\ell})$ 
12 return  $(\mathcal{R}, \mathcal{S}, \mathcal{W})$ 

```

Fig. 5.2 Algorithm for solving the R&WAD problem, providing alternative routes if the links of one specific subset of links fail (all together) belonging to a list of possible subsets of links that can fail.

where q_ℓ is the traffic load offered to the link ℓ by the connections non-affected by the failed links, and \bar{q} is the mean traffic load on the operational links $\mathcal{L} \setminus \mathcal{F}$. Then, with these \mathcal{C}_ℓ s as weights, we run Dijkstra’s algorithm to find the cheapest route for each connection $c \in \mathcal{X}_\mathcal{F}$. The set of all these routes will be denoted by $\mathcal{R}_\mathcal{F}$. Symbolically, we execute the call $\mathcal{R}_\mathcal{F} := \text{SecondaryRoutes}(\mathcal{X}_\mathcal{F}, \mathcal{F}, \mathcal{C}_\mathcal{F})$.

Then, **line 8** defines the set of routes $\mathcal{S}_{\mathcal{F}}$:

$$\mathcal{S}_{\mathcal{F}} = (\mathcal{R} \setminus \mathcal{A}_{\mathcal{F}}) \cup \mathcal{R}_{\mathcal{F}}.$$

In words, $\mathcal{S}_{\mathcal{F}}$ is the set of routes to use when all links in \mathcal{F} are failed. Now, we must dimension again the links because we must always respect the QoS constraints. For this purpose, we restrict the analysis to the graph $\mathcal{G}^{-\mathcal{F}}$, that is, we remove the links in \mathcal{F} from \mathcal{L} , and in **line 9** we run a dimensioning phase. In pseudo-algorithmic form, we execute the function call $\mathcal{W}_{\mathcal{F}} := \text{Dimensioning}(\mathcal{L} \setminus \mathcal{F}, \mathcal{S}_{\mathcal{F}})$.

To finish this process in **lines 10 to 11**, since we obtain now new capacities for the links $\mathcal{W}_{\mathcal{F},\ell}$, for every possible failure scenario in Ω , we compare each $W_{\mathcal{F},\ell}$ (and the W_{ℓ} obtained in the no failure scenario), for all $\ell \in \mathcal{L}$, and the final capacity of the link will be the maximum between them. Formally, we add a procedure $Max()$ that performs this task, and we symbolically write $W_{\ell} := Max(W_{\ell}, \mathcal{W}_{1,\ell}, \dots, \mathcal{W}_{|\Omega|,\ell})$. Finally, putting together each final link capacity W_{ℓ} , $\ell \in \mathcal{L}$ will conform the final dimensioning set \mathcal{W} .

The complexity of the fault tolerance procedure presented on Fig 5.2 is proportional to the number of link failures scenarios in Ω , the complexity of Dijkstra's algorithm ($O(N^2)$) to find the cheapest routes for every connection in $\mathcal{X}_{\mathcal{F}}$ and the algorithmic cost to execute the dimensioning procedure (define as $O(W)$). The set $\mathcal{X}_{\mathcal{F}}$ cardinality is given by X the total number of network connections, multiplied by the mean number of hops of each connection route, which is denoted by \bar{r} , divided by the total number of network links L . Then, the procedure complexity is order $O(|\Omega|N^2X \cdot \bar{r}/LW)$. For example, in the case of single link failure (in this case the number of link failures scenarios $|\Omega|$ is given by the L possible single link failure) the complexity of the proposed method is order $O(LN^2X \cdot \bar{r}/LW)$. On the other hand, if the algorithm is used to solve the problem of double link failures, the link failure scenarios are $|\Omega| = L^2$; therefore the algorithm complexity is order $O(L^2N^2X \cdot \bar{r}/LW)$.

5.3 Numerical Examples

To quantify the quality of the solution obtained by the CPLFT method, it should be compared against the optimal solution. However, it is known that the R&WAD problem is an NP-complete problem [90]. Those who have been dedicated to solve this problem

optimally only have been able to achieve it to very small networks (with less than 10 nodes). Consequently, for real network topologies (dozens to hundreds nodes) the fault tolerance problem cannot be optimally solved. Given this situation, our best alternative was to compare the CPLFT method with those methods considered as the most competitive at this moment.

Then, it is necessary to make the comparison using metrics that enable to assess the advantages/disadvantages of each fault tolerance method. The most important metrics for the routing, wavelength assignment, wavelength dimensioning and fault tolerance methods are: the cost of the network and the delay in the restoration procedure in case of the occurrence of failures, when this is relevant (in our approach this delay is comparable to the time needed to access the primary routes on the routing tables since the computations are done off-line).

When reviewing the current methods of Routing and Wavelength Assignment, it was noted that the algorithms most commonly referenced today, and considered the best so far, use the shortest path (both fixed and fixed alternate routing strategy) together with a First Fit wavelength assignment scheme. These are SP-FF and K-SP-FF [16, 10, 88, 85, 5, 9, 86, 11, 12] (see Chapter 4 Section 4.1). It is interesting to consider that the K-SP-FF technique is a fixed alternate routing method, thus it uses several disjoint alternative routes to provide communication. By itself, it provides certain level of fault tolerance, thanks to the alternative routes, but it does not guarantee fault tolerance. This occurs due to the fact that K-SP-FF requires to define a restoration procedure together with a dimensioning procedure which calculates the extra resources needed to guarantee fault tolerance on diverse scenarios. Nevertheless, if we adjust the K-SP-FF to provide fault tolerance satisfying the QoS restrictions, then the result would be the same as to add fault tolerance to the SP-FF method. Consequently, SP-FF was the routing method chosen for comparison.

Additionally, as it was explained on Chapter 3 and 4, the Wavelength Dimensioning method most commonly used is the homogeneous dimensioning. Consequently, we will consider an homogeneous dimensioning with the SP-FF method.

There are several types of fault tolerance algorithms proposed so far, such as Shared Path Protection, p -cycle and 1+1. In the sequel we discuss the pertinence in comparing CPLFT with each of these different types of algorithms.

Shared Path Protection (SPP) Method This strategy provides tolerance to multiple network links failure. There are two methods for implementing this algorithm (SPP on-line and SPP off-line). Both methods require between 40 to 80% of additional wavelengths (compared to the case without fault tolerance) to provide single link fault tolerance capability [105]. Another aspect that must be considered is that the SPP off-line method has the additional weakness that the percentage of restorability obtained (percentage of connections that remain connected in case of link failure) is very low (80% to 90% [105]). Therefore, it is not comparable to the method proposed in this work, which ensures that the blocking probability pre-established by the network designer (i.e. 10^{-6}) is satisfied. On the other hand, the implementation of the SPP-online method requires to run on demand a route search algorithm (whenever one or more links fail) in order to find an alternative route to each affected connection. Evidently, this on-line strategy causes a slow re-routing, which added to the fact that many of the applications that use computer networks require very fast on-line responses in case of failures [28], make that this type of method does not represent a practical fault tolerant mechanism for many practical applications. Due to the facts just commented, the SPP method was not considered for comparison with the method proposed in this paper.

The p -cycle Method To provide tolerance to multiple failures, this method requires a large quantity of cycles (which implies a high cost when defining secondary routes), so it is not scalable for multiple faults. Given the fact that in this paper we consider the multiple fault tolerant case, it is unreasonable to compare our method with the p -cycle one.

Method 1+1 This method provides tolerance to multiple failures, using as many disjoint routes as simultaneous link failures it can tolerate. It solves the problem of primary and secondary routes prior to the network dimensioning (off-line) sub-task. Then, the number of wavelengths is computed, having as a constraint to provide enough resources to all routes, and guaranteeing sufficient information to re-route each connection in case of failure. Consequently, 1+1 is the most suitable fault tolerance method to compare with our algorithm.

In summary, the most appropriate methods for comparison are SP-FF in order to generate the primary routes and then, 1+1 for the fault tolerance mechanism. These two

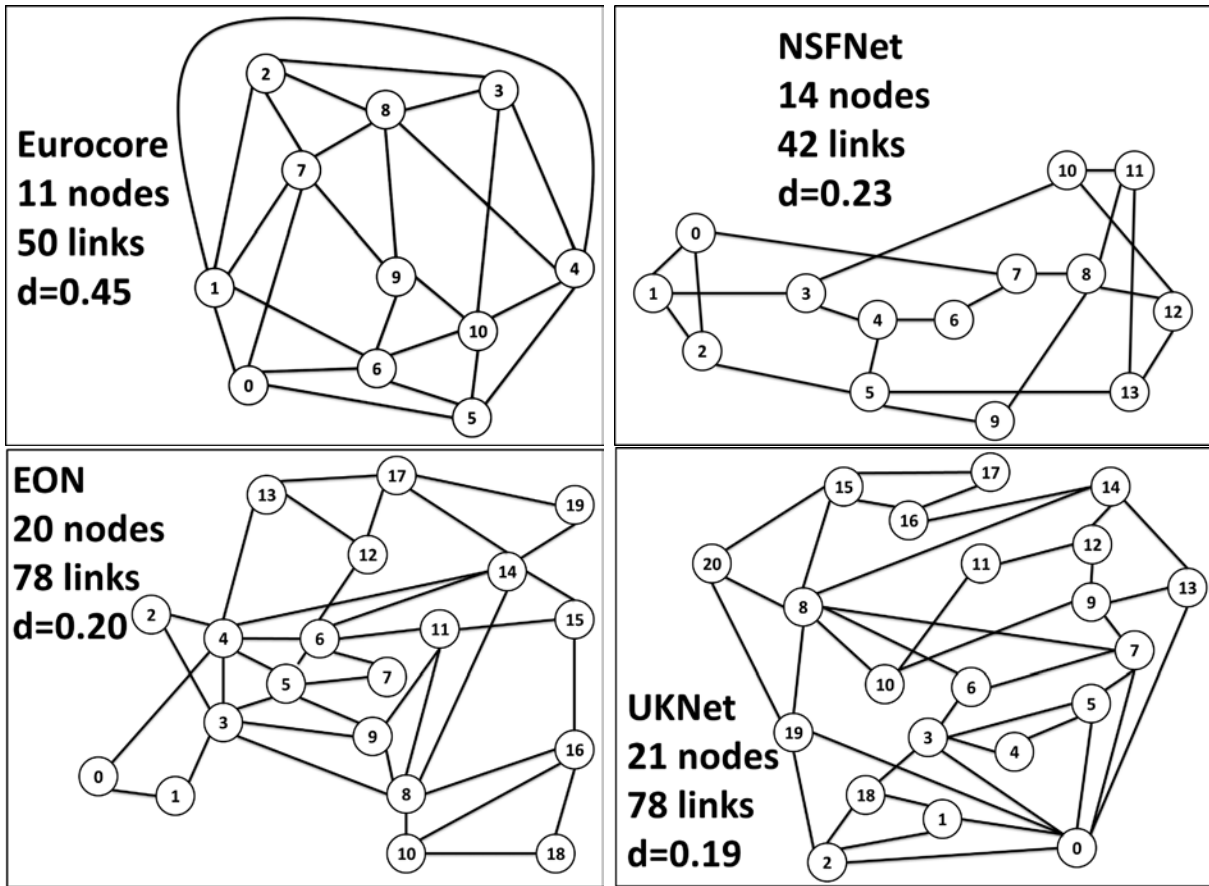

Fig. 5.3 Mesh networks evaluated. The number of links refers to the number of bidirectional arcs. Observe that in the picture we see the edges (for instance, the picture shows the Eurocore topology with 25 edges, which corresponds to 50 arcs). The parameter d is a measure of density: if the graph has a arcs (twice the number of edges) and n nodes, $d = a / (n(n-1))$.

methods together are denoted SPFF1+1 in the chapter. To evaluate the corresponding blocking probabilities, the mathematical method proposed in chapter 2 was used in both SPFF1+1 and CPLFT.

To evaluate the performance of the methods under different scenarios, the algorithms were executed for different real network topologies, having different sizes and different degrees of connection d , where d is the average number of neighbors of a node in the network. Some of the selected topologies and their respective parameters N , L and d are shown in Figure 5.3.

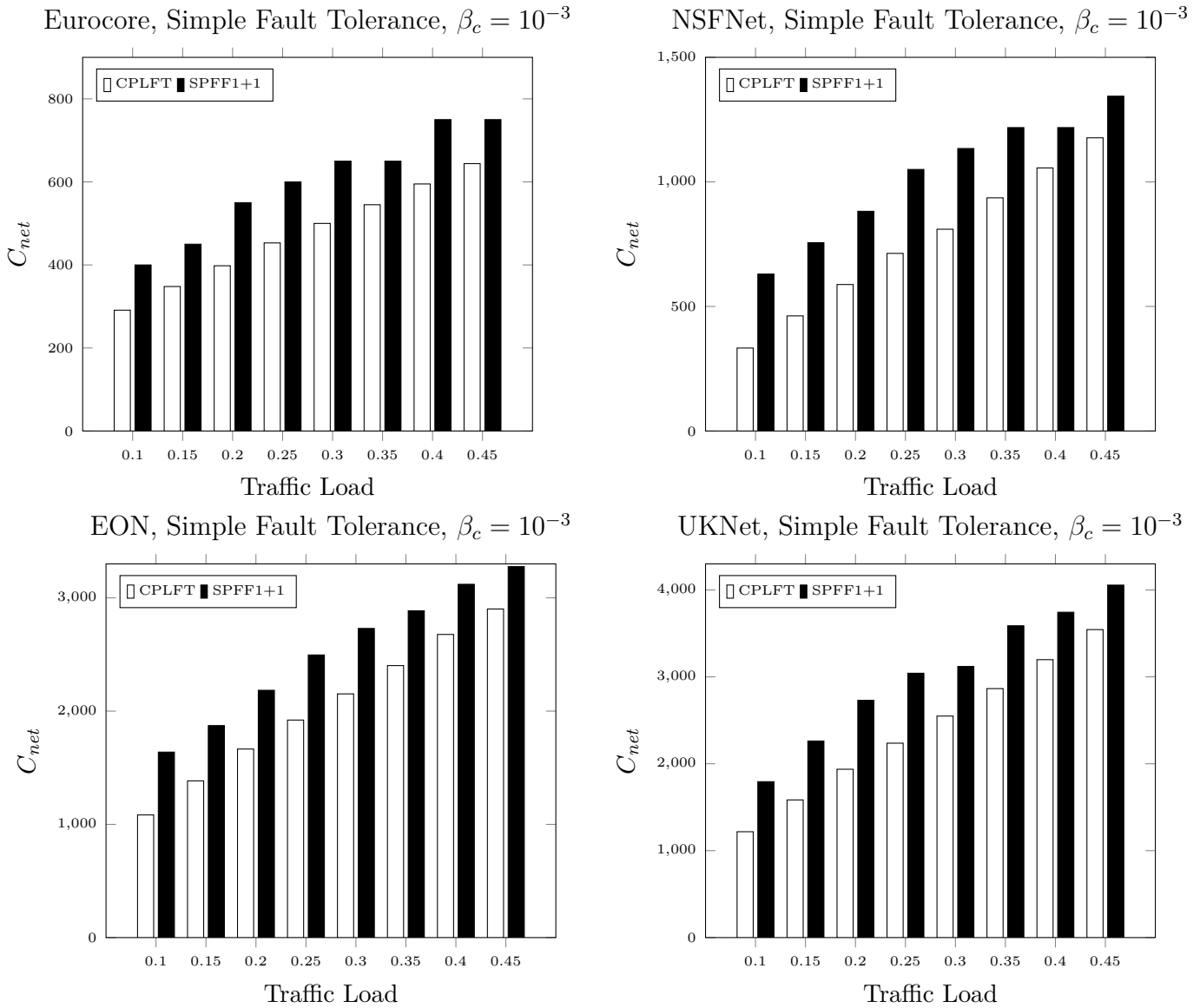

Fig. 5.4 The total number of wavelengths C_{net} obtained with our method (CPLFT) and SPFF1+1 on Eurocore, NSFNet, EON and UKNet real mesh network topologies, for different connection traffic loads with a blocking probability threshold β_c equal to 10^{-3} , in the single fault tolerance case.

In Figure 5.4 we show the total cost C_{net} obtained by the CPLFT and SPFF1+1 methods for the case of a single link failure, as a function of the traffic load, for different network topologies, and for a maximum acceptable blocking connection of 10^{-3} . Ad-

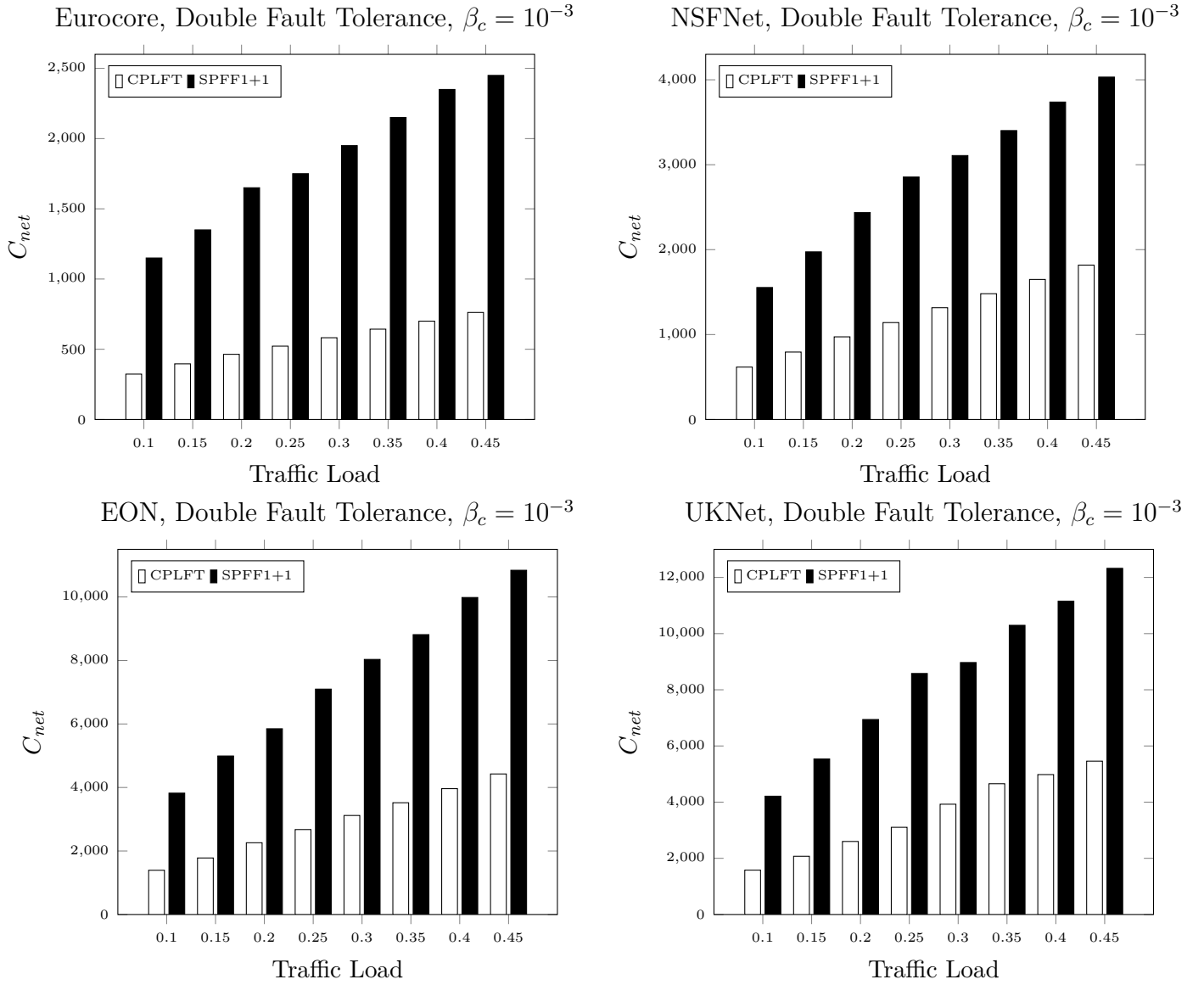

Fig. 5.5 The total number of wavelengths C_{net} obtained with our method (CPLFT) and SPFF1+1 on Eurocore, NSFNet, EON and UKNet real mesh network topologies, for different connection traffic loads with a blocking probability threshold β_c equal to 10^{-3} , in the simultaneous double fault tolerance case.

ditionally, Figure 5.5 shows the C_{net} value for the same methods, but for double link failures (i.e. any pair of simultaneous link failure possible). Note that the total cost C_{net} is given by the total number of wavelengths necessary to perform in both cases, with or

without fault tolerance capability, that is, including the primary and secondary routes of every connection c (but only taking into account the actual traffic that can transmit each possible scenario). Also, it is important to notice that in this section only single and double link failure scenarios are shown. This is because to represent another kind of failures scenarios, such as SRG and Disaster Risk constrains, any subset selection could be arbitrary (not representative of a general type of failure situation). However, the algorithm developed can easily evaluate any type of fault tolerance case.

As it can be seen in Figure 5.4, in the case of tolerance to a single failure, the CPLFT method performs clearly better. In fact, for all the scenarios evaluated in our experiments, the SPFF1+1 method requires in general 30% more wavelengths (for $\rho = 0.3$ which is a representative network load [28]) than the cost of the method proposed herein. In the case of tolerance to two simultaneous failures of links (Figure 5.5), the CPLFT method also significantly outperforms the SPFF1+1 technique. In this last case, the SPFF1+1 method requires in the order of 160% more wavelengths (always for $\rho = 0.3$ [28]) than our proposal. Notice that each scenario presented herein achieves to connect the same users (connections) with the same QoS requirements (maximum acceptable blocking probability), but our proposal requires less resources than SPFF1+1 to do so.

Now, to provide a deeper discussion of the results obtained by CPLFT, next we present some in details analysis about: the fault tolerance methodology used (Sub-Section5.3.1); our method memory size used and the time required to access the memory during the network operation (Sub-Section5.3.2); and, finally, a general review of CPLFT method, remarking qualitative reasons that justify the better results, and some desirable features included (Sub-Section5.3.3).

5.3.1 Extra number of wavelengths

The previous analysis provides an insight of the performance of our joint solution, solving together four of the most important problem in optical networks. Nevertheless, we want to properly measure the efficiency of the solely fault tolerance procedure.

Let us define $EX(A)$ as the extra percentage of wavelength (with respect to the no failure case) needed to achieve fault tolerance by algorithm A . This will measure how many extra resources are needed to provide any fault tolerance scenario, taking into

account each algorithm solution. The $EX(A)$ value can be obtained as follows:

$$EX(A) = 100 \cdot \frac{C_{net}(A) - C_{nft}(A)}{C_{nft}(A)}, \quad (5.3)$$

where $C_{nft}(A)$ is the total network cost obtained in the no failure case by the A algorithm (i.e. dimensioning the wavelengths considering only the primary routes), and C_{net} as the total network cost evaluated by the A method on the fault tolerance case considered on the evaluation.

In order to be fair between both methods, we define the same primary paths and wavelength dimensioning in both methods no failure case, i.e. $C_{nft}(CPLFT) \equiv C_{nft}(SPFF1 + 1)$. Then, to analyze each fault tolerance mechanism, Figure 5.6 contains the $EX(A)$ value achieved by the CPLFT and SPFF1+1 method to provide single fault tolerance on the same network topologies presented in Figure 5.3, with different mean users traffic load for a blocking probability threshold value $\beta_c = 10^{-3}$. Similarly, Figure 5.7 shows the $EX(A)$ value on the double fault tolerance case.

The results obtained in single and double fault tolerance case shows our method requires to install lesser resources (wavelengths, and any equipment related to) than SPFF1+1 solution. We strongly believe that this occurs based on two situations. First, the 1+1 mechanism guarantee certain level of fault tolerance by transmitting in parallel the data by more than one path. This means, that on the dimensioning procedure the primary and secondary routes are considered operational. This definitely rises the traffic on the network, leading to a bigger dimensioning than needed. Second, the homogeneous dimensioning procedure strongly relies on balancing the traffic on the network. However, as mention on chapter 4, rarely the network topologies are symmetrical, thus the network are hard to completely balance. Therefore, the homogeneous dimensioning depends on the link more loaded, achieving a bigger dimensioning than our heterogeneous dimensioning proposal.

5.3.2 Memory size and routing delay

Another aspects that influence the network performance are: the storage size used by the routing tables, and the delay imposed by the routing procedure when each user attempts to transmit over a path.

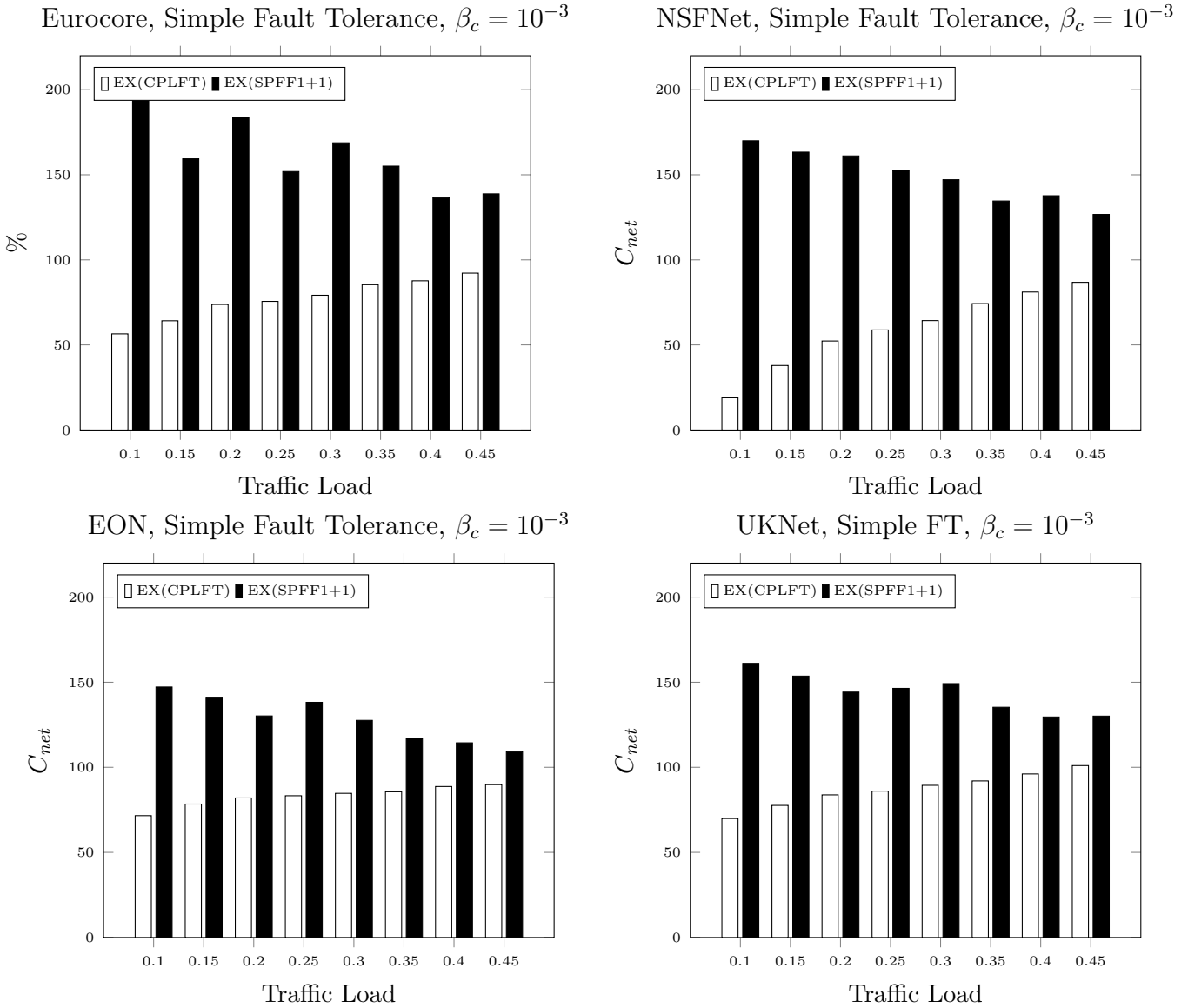

Fig. 5.6 The extra percentage of wavelengths $EX(A)$ obtained with our method (CPLFT) and SPFF1+1 on Eurocore, NSFNet, EON and UKNet real mesh network topologies, for different connection traffic loads with a blocking probability threshold β_c equal to 10^{-3} , in the single fault tolerance case.

The routing tables storage size depends on how many routes are computed to each user by the R&WAD+FT procedure. On the 1+1 fault tolerance method, the paths obtained depends solely on the fault tolerance case computing several disjoint alternative

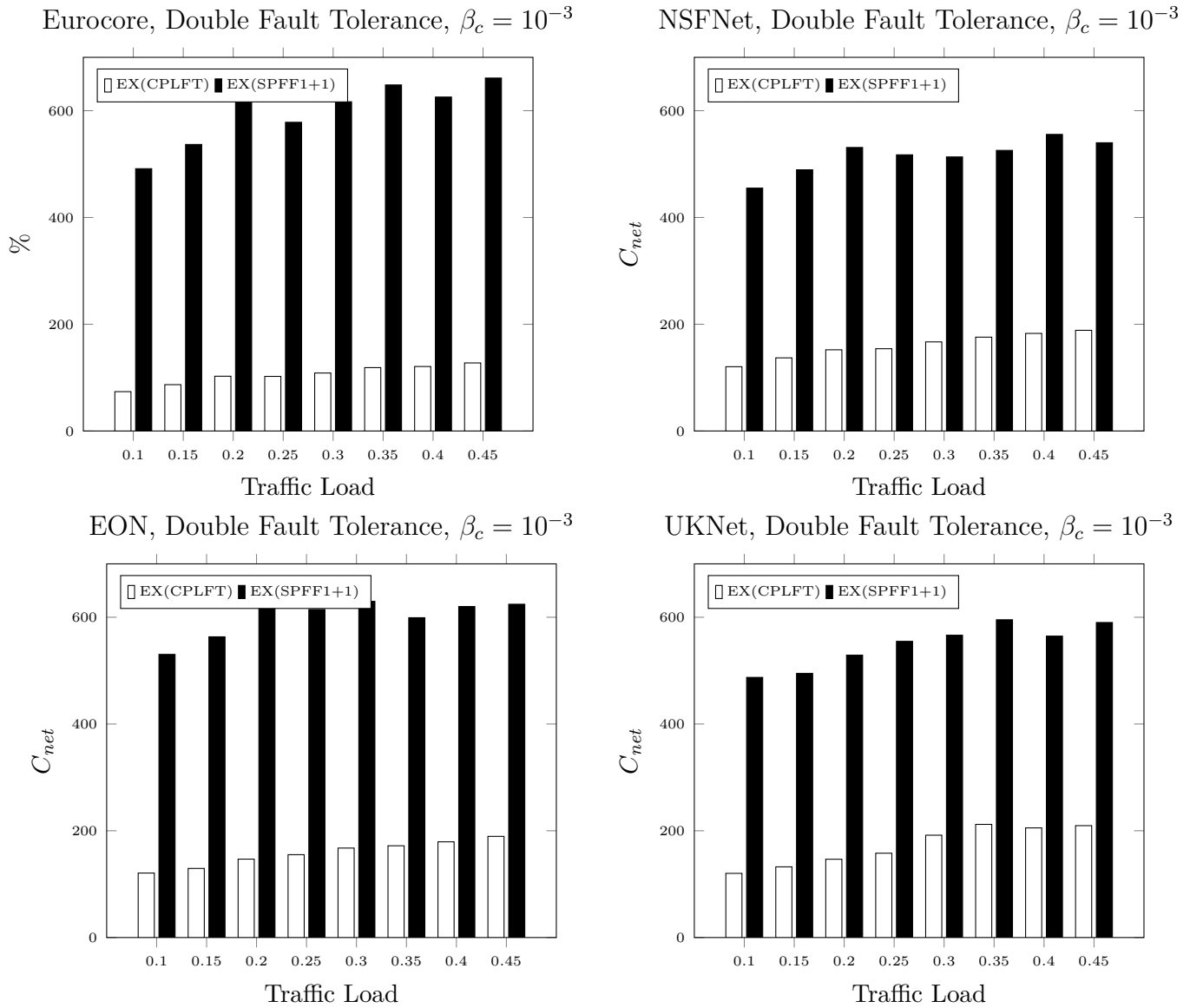

Fig. 5.7 The extra percentage of wavelengths $EX(A)$ obtained with our method (CPLFT) and SPFF1+1 on Eurocore, NSFNet, EON and UKNet real mesh network topologies, for different connection traffic loads with a blocking probability threshold β_c equal to 10^{-3} , in the simultaneous double fault tolerance case.

routes. This means, that to provide fault tolerance to a single link failure, the method computes one secondary path. Likewise, to offer fault tolerance to simultaneous double link failure, the 1+1 technique provides two secondary routes. Therefore, the number of

entries stored on the routing tables are two and three times the number of connections in \mathcal{X} to provide single fault tolerance and double fault tolerance, respectively (with a centralized management).

On our method, the number of paths computed changes over the different scenarios of link failure and the network topology (size and node degree) evaluated. This is due to the fact that on each failure case, our method searches for a new route to each connection affected by the failed links, computing the best possible route on that scenario. Then, this will provide, in general, a little more paths than the 1+1 fault tolerance method. Despite this observation, our method requires a similar number of alternate paths to provide single and fault tolerance than 1+1. On the Eurocore network topology to provide single and fault tolerance, our methods computes the same number of alternate paths than 1+1. Moreover, on a bigger network such as Arpanet, our methods require on average three and four paths to provide single and double fault tolerance, respectively.

During the network operation, there is a delay incurred by the routing procedure, defined as the time that each connection requires to find a path over the network and to successfully transmit by it, or to be finally blocked. We will define this delay as $\tau(A)$, where A is the algorithm considered (SPFF1+1 or CPLFT methods). Due to the fact that both methods compared in this chapter use predefine routes, then the this delay is mainly compose by the time needed to access the routing table. This value can be considered as a constant T . Then, in this context $\tau(A)$ measures the routing delay obtained by how many times it is required to access the routing tables to have a successful communication or to be blocked, using the routing scheme obtained by the method A .

Both methods, store the alternate paths in routing tables, but the technique to route each user on every communication request differs. The 1+1 fault tolerance scheme, sends the information on each alternate path every time the user attempts to transmit, thus the access to routing tables requires to read each the entries including all the alternate path, thus two routes per connection on single fault tolerance, and three routes per user on simultaneous double fault tolerance. On the other hand, our method has only one route per link failure case, thus CPLFT requires to read only one entry on the routing table on each attempt of transmission.

In summary, the $\tau(A)$ value per method is:

- $\tau(SPFF1 + 1) = 2 \cdot T$, considering tolerance to single link faulure.

Parameters	C_{net} no FT		C_{net} Single FT				C_{net} Double FT			
	CPLFT	SPFF1+1	CPLFT	$EX(CPLFT)$	SPFF1+1	$EX(SPFF1+1)$	CPLFT	$EX(CPLFT)$	SPFF1+1	$EX(SPFF1+1)$
Eurocore	279	400	500	79%	750	168%	582	108%	2000	616%
NSFNet	493	588	810	64%	1281	147%	1316	166%	3024	513%
EON	1165	1489	2152	84%	2652	127%	3118	167%	8502	629%
UKNet	1346	2028	2549	89%	3354	149%	3926	191%	8970	566%

Table 5.1 Total number of wavelengths required by the CPLFT and SPFF1+1 methods: no fault tolerance (C_{net} no FT), single fault (C_{net} Single FT), and simultaneous double fault (C_{net} Double FT), for Eurocore, NSFNET, ARPANET, UKNet and Eurolarge networks, considering a maximum blocking probability of 10^{-3} and a load of traffic 0.3. Additionally, the extra percentage of wavelength (with respect to the no failure case), needed to achieve single and double fault tolerance by each method, respectively, denoted as $EX(A)$ is presented.

- $\tau(SPFF1 + 1) = 3 \cdot T$, considering tolerance to simultaneous double link failure.
- $\tau(CPLFT) = T$, tolerating any link failure scenario.

5.3.3 Analysis and summary of the method

To better exemplify such differences, in Table 5.1, the total cost C_{net} is shown for the following cases: without fault tolerance (C_{net} no FT); single link failure (C_{net} Simple FT); and simultaneous double link failure (C_{net} Double FT). The results shown were obtained for the same network topologies as in Figure 5.4 and 5.5, and considering a maximum blocking probability of 10^{-3} for a traffic load of 0.3. Additionally, the single and double fault tolerance cases include the extra percentage of wavelength (with respect to the no failure case) needed to achieve single and double fault tolerance by each method, respectively, denoted as $EX(A)$ (being A the algorithm name).

In Table 5.1 it is clear that our method performs much better than SPFF1+1. For example, to achieve the same users and QoS requirements, the CPLFT method requires only on average 80% extra number of wavelengths than the no fault tolerance case, to provide single fault tolerance; meanwhile, the SPFF1+1 requires from 147% more wavelengths than the no fault tolerance scenario. On the other hand, in the double link failure case, our proposal requires between 158% extra wavelengths, in contrast to the SPFF1+1 method which requires over 500% more wavelengths than the no fault tolerance

scenario requires. A notable consequence of this performance is that our method achieves double fault tolerance capacity with similar resources than the ones required using the SPFF1+1 method to provide just single fault tolerance.

Let us discuss here some qualitative reasons that justify the better results of CPLFT over SPFF1+1:

- By simultaneously solving the four problems (primary and secondary routing, wavelength assignment, wavelengths dimensioning and fault tolerance), a global solution is obtained, which is a more efficient strategy than to solve these problems separately.
- Our proposal allows to share the resources between the primary and secondary routes, just like the shared path protection, while guaranteeing certain level of quality of service (defined on the SLA) despite the existence of any set of link failure, as long as the network remains connected. The latter is a characteristics not seen on previous methods in the literature.
- CPLFT uses a wavelength dimensioning policy without distinction between primary and secondary routes. Therefore, it better exploits statistical multiplexing among all requests for connection/disconnection.
- Our technique never dimensions the cases that will never happened. For example, when dimensioning a determined failure case, it does not consider the load of the primary routes affected by the link failures. Although this fact may seem trivial, this is not considered by the 1+1 method.
- The dimensioning procedure assigns a different number of wavelengths to each network link (called Heterogeneous Dimensioning), such that the blocking probability of each connection does not exceed a predefined maximum blocking probability. This takes advantage that real network are hardly symmetric, thus hard to balance the connections traffic load within.
- Additionally, the dimensioning procedure uses a wavelength assignment policy called “Fair Policy”. This policy consists in to offer a maximum blocking probability to each network user as close as possible to the one defined in the SLA, since each user may have different quality of service requirements. This way the method diminishes the

wavelength dimensioning since each connection uses only the wavelengths needed to satisfy their QoS demand.

- The usual blocking probability evaluation is based on simulation techniques, which is a slow procedure. Consequently, the evaluation process is limited to only a few restricted scenarios. So, to find the best possible solution, researchers apply some criteria to restrict the solutions search (heuristics). For example, using SPF to select the primary routes, and similar criteria to find secondary routes. However, CPLFT was able to outperform these methodologies, so we can conclude that such heuristic solutions are not using completely accurate assumptions and decisions. We think that one of the key aspects why our proposal achieves better solutions is due to the fact that we can quickly explore a bigger solution space to find the best possible solution.

In addition to the increased efficiency compared to existing methods, the CPLFT method has other desirable attributes:

- It is scalable to any set of simultaneous failures, as long as the network remains connected after those multiple failures.
- The on-line operation of the method is very fast and simple. This is due to the fact that the re-routing information is stored in routing tables, which contain the secondary routes for each possible failure scenario. This means that the mechanism of fault tolerance can be executed quickly on demand.
- The off-line execution time of the CPLFT method takes only a few seconds using a standard current PC (Windows 10 64 bits, Intel Core i7 2.60GHz processor and 8GB RAM).

5.4 Conclusions

A novel method was proposed to jointly solve four main problems in dynamic optical network design with wavelength continuity constraint: It determines the set of primary and secondary routes using a fixed routing strategy, it defines a strategy to approach the wavelength assignment on the network operation based on the well known First-fit

scheme, it evaluates the minimum number of wavelengths necessary on each network link so that the blocking probability of each user is lower than a certain pre-specified threshold (which is a design parameter of the network), and it solves the fault tolerance problem on any possible scenario represented as a set of possible link failures. This joint solution allows us to obtain a global solution to these problems, which in general is better than to obtain them separately.

The methodology differs considerably from those published so far, obtaining better results in terms of necessary number of wavelengths. The method only evaluates scenarios that happen during the network operation (for each user, it considers either a primary or a secondary route, not both). In fact, the method allows to share the resources between the secondary routes such as Shared Path Protection methodologies, while guaranteeing a maximum blocking probability to each network connection. Additionally, the dimensioning method does not make any distinction between primary and alternative routes, and it calculates a different number of wavelengths on each link (heterogeneous wavelength dimensioning). Besides, the method introduces a Fairness policy in the First-Fit Wavelength Assignment, in order to offer a quality of service to each user as close as the one requested on the Service Level Agreement.

The fault tolerance technique is scalable to any set of simultaneous link failures, as long as the network topology allows reconnection via the links that remain operating.

The method is executed before the network operation requiring a few seconds to solve the R&WAD subtask. This allows us to quickly solve any link failure scenario and to re-evaluate in case of variations during network operation (for example, traffic load variations). Additionally, the network operation based on our approach is simple and fast, since the routes (both primary and secondary) are stored in routing tables and consulted only on demand.

Chapter 6

Conclusions

6.1 General Conclusions

In this work, five of the most important problems needed to be solved were taken into account in order to design dynamic WDM networks. These concern the:

- *Blocking Probability evaluation.*
- *Routing.*
- *Wavelength Assignment.*
- *Wavelength Dimensioning.*
- *Fault Tolerance Capacity on any set of link failures.*

There are many works in literature that propose different solutions to these problems. Usually they are solved separately, due to the fact that normally it is assumed that a simultaneous solution involves a high complexity. Thus, to diminish this difficulties it is standard to solved them as follows: first the routes are chosen; then the wavelength assignment scheme is chosen and the amount of wavelengths available on each network link is dimensioned; later, once solved the previous problems, the fault tolerance capacities are added (secondary routes and the corresponding wavelength dimensioning).

All of these problems, have to guarantee certain level of quality of service pre-established on the Service Level Agreement, measured as connection blocking probability.

However, the usual blocking probability evaluation is based on simulation techniques, which is a slow procedure. Consequently, the evaluation process is limited to only a few restricted scenarios. So, to find the best possible solution, researchers apply some criteria to restrict the solutions search, using heuristics and solving these problems separately. However, we think that one of the key aspects to solve these problems efficiently is to provide a faster method to measure the network performance in order to quickly explore a bigger solution space to find the best possible solution.

The precedent analysis led us to the first solution of this thesis, presented in **Chapter 2**. A new method to analytically solve the **Blocking Probability** of dynamic WDM optical networks without considering wavelength conversion is presented, taking into account heterogeneous traffic. The results obtained were compared with simulation and with another commonly used method. The results of the proposed technique are accurate enough to closely match those obtained by simulation, but several orders of magnitude faster. This evaluation allowed us to quickly solve the next higher order problems simultaneously, due to the fact that each quality of service evaluation (measured as blocking probability) is solved very fast allowing to explore a (very) higher solution space.

Next, in **Chapter 3** a novel method to jointly evaluate every connections **Wavelengths Assignment**, and to calculate the number of wavelengths needed on each network link, called **Wavelength Dimensioning** problem, in Dynamic WDM Optical Networks without wavelength conversion was presented. The strategy used differs considerably from those published so far. It introduces two new features to do so: it assigns a different number of wavelengths to each network link, so that the end-to-end blocking probability of each user is lower than a certain pre-specified threshold (which is a design parameter of the network); and it proposes a fair wavelength assignment policy, offering to each network user a quality of service as close as possible to the one defined in the SLA, since each user may have different quality of service requirements (multi-class networks). These joint solution allowed us to obtain a global solution, which resulted in a more efficient solution than those coming from solving them separately.

Later, the **Routing** procedure was included in **Chapter 4**. That is, a joint solution of three problems at the same time was proposed: to determine the set of routes enabling each network user to transmit; to define an efficient wavelength assignment scheme to choose a wavelength to transmit on each attempt of communication; and to evaluate the minimum number of wavelengths necessary on each network link, so that the blocking

probability of each user is lower than a certain pre-specified threshold (which is a design parameter of the network).

Finally, the **Fault Tolerance** was added in the procedures on **Chapter 5**, to jointly solve the four technical problems presented. The routing, wavelength assignment, wavelength dimensioning, and fault tolerance capabilities on any set of link failures, while satisfying a predefined quality of service threshold. The method is applicable to any set of simultaneous link failures, as long as the network topology allows reconnection via the links that remain operating.

By relying on our analytical solution of the blocking probability proposed on Chapter 2, our proposal attempts to jointly solve the R&WAD+FT problem (presented on Figure 1.2). By doing this a global solution was obtained, which turned out to be a more efficient solution than those coming from solving them separately.

In order to better understand each one of the solutions proposed on this thesis, next each chapter specific conclusions are presented.

6.1.1 Blocking probability

In Chapter 2 a new layer-based mathematical method called LIBPE for blocking probability evaluation of dynamic WDM optical networks without considering wavelength conversion and taking into account heterogeneous traffic is presented. The results obtained have been compared with simulation and with another commonly used method. The results of the proposed technique are accurate enough to closely match those obtained by simulation.

Its main contributions are the following:

- a) Our technique is that it considers that the sources are modeled by *ON-OFF* processes. This allows to take into account the non-uniform (bursty) nature of the traffic offered to the links.
- b) The link blocking dependency is handled by means of the Kelly's Reduced Load method.

- c) By dividing the network into several layers, the wavelength continuity constraint can be efficiently taken into account. The interactions between layers is considered through the mean *OFF* periods seen on every network layer.
- d) By its analytical nature, our method allows to obtain the blocking probability of the network in a fraction of a second. This is usually several orders of magnitude faster than using simulation.
- e) As an illustration of the calculating procedure, we report its use for wavelength dimensioning providing a QoS guarantee on the connections' blocking probability. By using our method, we can solve this problem 4 orders of magnitude faster than simulation on the scenarios presented. This is relevant, because allows the network designer to solve problems of higher order several times, to adjust and improve the network designing procedures, to further optimize costs or benefits with respect to other parameters, etc.

6.1.2 Wavelength assignment and dimensioning

Chapter 3 presented a novel method to jointly evaluate every connections wavelengths assignment, and to calculate the number of wavelengths needed on each network link in Dynamic WDM Optical Networks without wavelength conversion.

The methodology differs considerably from those published so far. Its main contributions are the following:

- a) it assigns a different number of wavelengths to each network link, so that the blocking probability of each user is lower than a certain pre-specified threshold (which is a design parameter of the network).
- b) it proposes a fair wavelength assignment policy, offering to each network user a quality of service as close as possible to the one defined in the SLA, since each user may have different quality of service requirements (multi-class networks).
- c) By simultaneously solving the wavelength assignment and dimensioning, a global solution can be obtained, which is often more efficient than a solution coming from solving them separately.

- d) By relying on the blocking probability method proposed in Chapter 2, the method requires less than a second to solve both problems. But observe that it can be used calling any other procedure to evaluate the blocking probability (e.g. by means of simulation or another method available). Thus, the time required to solve the wavelength assignment and dimensioning strongly depends on the method used to calculate this blocking probability.

6.1.3 Routing, Wavelength Assignment and Dimensioning

A new method was proposed in Chapter 4 to jointly solve three of the main problems in optical network design. These are routing, wavelength assignment and wavelength dimensioning.

As the previous Chapters, the strategy differs considerably from those published so far. Its main contributions are the following:

- a) Our approach jointly solves three problems at the same time: it determines the set of routes enabling each network user to transmit, it defines an efficient wavelength assignment scheme to choose a wavelength to transmit on each attempt of communication, and it evaluates the minimum number of wavelengths necessary on each network link so that the blocking probability of each user is lower than a certain pre-specified threshold (which is a design parameter of the network).
- b) The features (and the benefits) presented on the previous chapter remains, due to the fact that this proposal uses the solution presented on Chapter 3. These are: the heterogeneous wavelength dimensioning, and the fairness policy included on the wavelength assignment procedure.
- c) By simultaneously attacking the three problems, a global solution can be obtained, which is often more efficient than that obtained when solving them separately. The solution is more efficient than current methods in terms of necessary number of wavelengths.
- d) The method balances the traffic load on the network, since we found out that balancing the network is a key aspect to diminish the amount of wavelengths while still guaranteeing a given level of quality of service.

- e) The main work of the procedure is executed before the network is operating (off-line) and the on-line operation of our procedure is simple and fast, since the routes are stored in routing tables.
- f) It requires a few seconds to solve the problem, so our approach can be adapted to traffic load variations during network operation.

6.1.4 Fault Tolerance

In Chapter 5 a novel method was proposed to jointly solve four main problems in optical network design. These concern routing, wavelength assignment, wavelength dimensioning and fault tolerance capacity on any set of link failures, so that

The methodology differs considerably from those published so far. Its main contributions are the following:

- a) Our approach jointly solves four problems at the same time: it determines the set of primary and secondary routes, it defines a fairness strategy to approach the wavelength assignment on the network operation, it evaluates the minimum number of wavelengths necessary on each network link so that the blocking probability of each user is lower than a certain pre-specified threshold (which is a design parameter of the network), and it solves the fault tolerance problem on any possible scenario represented as a set of possible link failures.
- b) By simultaneously attacking the four problems, a global solution can be obtained, which is often more efficient than that obtained when solving them separately. The solution is more efficient than current methods in terms of necessary number of wavelengths.
- c) The features (and the benefits) presented on Chapter 4 remains again, since this proposal modifies the R&WAD strategy on Chapter 4 to provide fault tolerance capabilities. This are: the fixed routing solution, the heterogeneous wavelength dimensioning, and the fairness policy included on the wavelength assignment procedure.

- d) Our technique dimensions the number of wavelengths without making any distinction between primary and secondary routes. In this way, it better exploits statistical multiplexing among all connection requests.
- e) The method is scalable to any set of simultaneous link failures, as long as the network topology allows reconnection via the links that remain operating.
- f) The main work of the procedure is executed off-line and the on-line operation of our procedure is simple and fast, since the routes (both primary and secondary) are stored in routing tables that are consulted only under demand.
- g) It requires a few seconds to fulfill the routing and the wavelength dimensioning subtasks, so our approach can be adapted to network variations during network operation.

6.1.5 Final Words

As mentioned on this thesis introduction (see Chapter 1), the current static operation of the WDM optical networks is inefficient in the usage of network resources, and with the upcoming capacity crunch in optical networks, it is of pressing matter to upgrade our networks to keep up with the increasing traffic demand over telecommunication networks. Several solutions have appeared over the last years such as: Elastic Optical Networks (EON), Space-Division Multiplexing (SDM), among others. Dynamic Optical Networks is one of them, and the technology is already available to be integrated in current networks, but the network cost savings are not yet convincing enough to migrate the networks to a dynamic operation.

However, this work may provide a strategy to finally achieve sufficient cost savings to properly change the static operation to a dynamic one. For example, the network cost achieved by our proposal without fault tolerance in a standard traffic load ($\rho_c = 0.3$) is on average 20% less than the the number of wavelengths required on static operation (see Chapter 4). To this results, adding the benefits obtained by our fault tolerance proposal, the results may be enough to make the decision to migrate from static to dynamic resource allocation.

References

- [1] Andrew R. Chraplyvy. Plenary paper: The coming capacity crunch. In *2009 35th European Conference on Optical Communication*, page 8007, 2009.
- [2] David J Richardson. Applied physics. Filling the light pipe. *Science (New York, N. Y.)*, 330(6002):327–328, 2010.
- [3] Dirk van den Borne, Mohammad S. Alfiad, and Sander L. Jansen. The Capacity Crunch Challenge: How to Design the Next Generation of Ultra-High Capacity Transmission Systems - OSA Technical Digest (CD). In *SPPCom - Signal Processing in Photonic Communications - OSA Technical Digest*, page SPTuA1, 2010.
- [4] A. D. Ellis, N. Mac Suibhne, D. Saad, and D. N. Payne. Communication networks beyond the capacity crunch. *Philosophical Transactions of the Royal Society A: Mathematical, Physical and Engineering Sciences*, 374(2062):20150191, 2016.
- [5] Alejandra Zapata-Beghelli and Polina Bayvel. Dynamic Versus Static Wavelength-Routed Optical Networks. *Lightwave Technology, Journal of*, 26(20):3403–3415, oct 2008.
- [6] Ahmed Mokhtar and Murat Azizoglu. Adaptive Wavelength Routing in All-optical Networks. *IEEE/ACM Trans. Netw.*, 6(2):197–206, 1998.
- [7] Biswanath Mukherjee. *Optical WDM networks*, volume 26. Springer Science & Business Media, 2006.
- [8] Michael Düser, Alejandra Zapata, and Polina Bayvel. Investigation of the scalability of dynamic wavelength-routed optical networks \[Invited\]. *J. Opt. Netw.*, 3(9):674–693, sep 2004.
- [9] Rajiv Ramaswami, Kumar Sivarajan, and Galen Sasaki. *Optical Networks: A Practical Perspective, 3rd Edition*. Morgan Kaufmann Publishers Inc., San Francisco, CA, USA, 3rd edition, 2009.
- [10] Hui Zang, Jason P Jue, Biswanath Mukherjee, and Others. A review of routing and wavelength assignment approaches for wavelength-routed optical {W}{D}{M} networks. *Optical Networks Magazine*, 1(1):47–60, 2000.

-
- [11] Bijoy Chand Chatterjee, Nityananda Sarma, and Partha Pratim Sahu. Review and Performance Analysis on Routing and Wavelength Assignment Approaches for Optical Networks. *IETE Technical Review*, 30(1):12–23, 2013.
- [12] Ravi Teja Koganti and Deepinder Sidhu. Analysis of routing and wavelength assignment in large WDM networks. In *Procedia Computer Science*, volume 34, pages 71–78, 2014.
- [13] Asuman E. Ozdaglar and Dimitri P. Bertsekas. Routing and wavelength assignment in optical networks. *IEEE/ACM Transactions on Networking*, 11(2):259–272, 2003.
- [14] S Subramaniam and R A Barry. Wavelength assignment in fixed routing WDM networks. *Communications, 1997. ICC 97 Montreal, 'Towards the Knowledge Millennium'. 1997 IEEE International Conference on*, 1:406–410 vol.1, 1997.
- [15] Dhritiman Banerjee and Biswanath Mukherjee. A practical approach for routing and wavelength assignment in large wavelength-routed optical networks. *IEEE Journal on Selected Areas in Communications*, 14(5):903–908, 1996.
- [16] I Chlamtac, A Ganz, and G Karmi. Lightpath communications: an approach to high bandwidth optical WAN's. *Communications, IEEE Transactions on*, 40(7):1171–1182, jul 1992.
- [17] X. Sun, Y. Li, I. Lambadaris, and Y.Q. Zhao. Performance analysis of first-fit wavelength assignment algorithm in optical networks. In *Proceedings of the 7th International Conference on Telecommunications, 2003. ConTEL 2003.*, volume 2, pages 403–409 vol.2, 2003.
- [18] Dhritiman Banerjee and Biswanath Mukherjee. Wavelength-routed optical networks: Linear formulation, resource budgeting tradeoffs, and a reconfiguration study. *IEEE/ACM Transactions on Networking*, 8(5):598–607, 2000.
- [19] Liying Tan, Qinglong Yang, Jing Ma, and Shiqi Jiang. Wavelength Dimensioning of Optical Transport Networks Over Nongeosynchronous Satellite Constellations. *Journal of Optical Communications and Networking*, 2(4):166–174, 2010.
- [20] A L Chiu, G Choudhury, G Clapp, R Doverspike, J W Gannett, J G Klinecicz, G Li, R A Skoog, J Strand, A Von Lehmen, and D Xu. Network Design and Architectures for Highly Dynamic Next-Generation IP-Over-Optical Long Distance Networks. *Journal of Lightwave Technology*, 27(12):1878–1890, 2009.
- [21] Maurice Gagnaire, Mohamed Koubàa, and Nicolas Puech. Network dimensioning under scheduled and random lightpath demands in all-optical WDM networks. *IEEE Journal on Selected Areas in Communications*, 25(9):58–67, 2007.
- [22] Jing Teng and George N Rouskas. Routing path optimization in optical burst switched networks. In *Proc. ONDM*, volume 2005. Citeseer, 2005.

- [23] Jintae Yu, I Yamashita, S Seikai, and K Kitayama. Upgrade design of survivable wavelength-routed networks for increase of traffic loads. In *Conference on Optical Network Design and Modeling, 2005.*, pages 163–174, feb 2005.
- [24] E Kozlovski, M Duser, I De Miguel, and P Bayvel. Analysis of burst scheduling for dynamic wavelength assignment in optical burst-switched networks. In *IEEE, Proc. LEOS*, volume 1, 2001.
- [25] Wouter Van Parys, Bart Van Caenegem, and Piet Demeester. Reduction of blocking in arbitrary meshed WDM networks through a biased routing approach. In *Optical Fiber Communication Conference and Exhibit, 1998. OFC'98., Technical Digest*, page 94. IEEE, 1998.
- [26] Gerald R Ash. *Dynamic Routing in Telecommunications Networks*. McGraw-Hill Professional, 1st edition, 1997.
- [27] Srinivasan Keshav. An engineering approach to computer networking: {A}{T}{M} networks, the {I}nternet, and the telephone network. *Reading MA*, 11997, 1997.
- [28] A A M Saleh and Jane M Simmons. Technology and architecture to enable the explosive growth of the internet. *Communications Magazine, IEEE*, 49(1):126–132, 2011.
- [29] M To and P Neusy. Unavailability analysis of long-haul networks. *Selected Areas in Communications, IEEE Journal on*, 12(1):100–109, 1994.
- [30] D A Schupke, A Autenrieth, and T Fischer. Survivability of Multiple Fiber Duct Failures. In *Third International Workshop on the Design of Reliable Communication Networks (DRCN)*, pages 7–10, 2001.
- [31] S. J B Yoo. Wavelength conversion technologies for WDM network applications. *Journal of Lightwave Technology*, 14(6):955–966, 1996.
- [32] Byrav Ramamurthy and Biswanath Mukherjee. Wavelength conversion in WDM networking. *IEEE Journal on Selected Areas in Communications*, 16(7):1061–1073, 1998.
- [33] Ioannis Tomkos, Marianna Angelou, RamónJ. Durán Barroso, Ignacio de Miguel, RubénM. Lorenzo Toledo, Domenico Siracusa, Elio Salvadori, Andrzej Tymecki, Yabin Ye, and Idelfonso Tafur Monroy. Next Generation Flexible and Cognitive Heterogeneous Optical Networks. In Federico Alvarez, Frances Cleary, Petros Daras, John Domingue, Alex Galis, Ana Garcia, Anastasius Gavras, Stamatis Karnourskos, Srdjan Krco, Man-Sze Li, Volkmar Lotz, Henning Müller, Elio Salvadori, Anne-Marie Sassen, Hans Schaffers, Burkhard Stiller, Georgios Tselentis, Petra Turkama, and Theodore Zahariadis, editors, *The Future Internet*, volume 7281 of *Lecture Notes in Computer Science*, pages 225–236. Springer Berlin Heidelberg, 2012.
- [34] O Gerstel, M Jinno, A Lord, and S J B Yoo. Elastic optical networking: a new dawn for the optical layer? *Communications Magazine, IEEE*, 50(2):s12–s20, 2012.

-
- [35] N Sambo, Piero Castoldi, F Cugini, G Bottari, and P Iovanna. Toward high-rate and flexible optical networks. *Communications Magazine, IEEE*, 50(5):66–72, may 2012.
- [36] I T Monroy, D Zibar, N G Gonzalez, and R Borkowski. Cognitive Heterogeneous Reconfigurable Optical Networks (CHRON): Enabling technologies and techniques. In *Transparent Optical Networks (ICTON), 2011 13th International Conference on*, pages 1–4, 2011.
- [37] D. J. Richardson, J. M. Fini, and L. E. Nelson. Space-division multiplexing in optical fibres. *Nature Photonics*, 7(5):354–362, 2013.
- [38] Dan M. Marom and Miri Blau. Switching solutions for WDM-SDM optical networks. *IEEE Communications Magazine*, 53(2):60–68, 2015.
- [39] M. Jinno, H. Takara, and B. Kozicki. Dynamic optical mesh networks: Drivers, challenges and solutions for the future. *2009 35th European Conference on Optical Communication*, pages 2–5, 2009.
- [40] Reinaldo Vallejos, Alejandra Zapata, and Marco Aravena. Fast and effective dimensioning algorithm for end-to-end optical burst switching networks with $\{O\}\{N\}$ - $\{O\}\{F\}\{F\}$ traffic model. In *Optical Network Design and Modeling*, pages 378–387. Springer, 2007.
- [41] R. Vallejos and N. Jara. Join routing and dimensioning heuristic for dynamic WDM optical mesh networks with wavelength conversion. *Optical Fiber Technology*, 20(3), 2014.
- [42] S. Ramamurthy and Biswanath Mukherjee. Survivable WDM mesh networks, Part I - Protection. In *Proceedings - IEEE INFOCOM*, volume 2, pages 744–751, 1999.
- [43] S. Chalasani and V. Rajaravivarma. Survivability in optical networks. In *System Theory, 2003. Proceedings of the 35th Southeastern Symposium on*, volume 2003-Janua, pages 6–10, 2003.
- [44] A Sano, T Kobayashi, S Yamanaka, A Matsuura, H Kawakami, Y Miyamoto, K Ishihara, and H Masuda. 102.3-Tb/s (224 x 548-Gb/s) C- and extended L-band all-Raman transmission over 240 km using PDM-64QAM single carrier FDM with digital pilot tone. In *Optical Fiber Communication Conference and Exposition (OFC/NFOEC), 2012 and the National Fiber Optic Engineers Conference*, pages 1–3, 2012.
- [45] Anwar Alyatama. Computing blocking probabilities in survivable WDM optical networks. *Photonic Network Communications*, 27(1):34–46, 2014.
- [46] Anwar Alyatama. Wavelength Decomposition Approach for Computing Blocking Probabilities in Multicast WDM Optical Networks. *Opt. Switch. Netw.*, 12:24–33, 2014.

-
- [47] Joan Triay, Cristina Cervelló-Pastor, and Vinod M Vokkarane. Analytical Blocking Probability Model for Hybrid Immediate and Advance Reservations in Optical WDM Networks. *IEEE/ACM Trans. Netw.*, 21(6):1890–1903, 2013.
- [48] V Abramov, Shuo Li, Meiqian Wang, E W M Wong, and M Zukerman. Computation of Blocking Probability for Large Circuit Switched Networks. *Communications Letters, IEEE*, 16(11):1892–1895, 2012.
- [49] Jun He, Maïté Brandt-Pearce, and Suresh Subramaniam. Analysis of Blocking Probability for First-Fit Wavelength Assignment in Transmission-Impaired Optical Networks. *J. Opt. Commun. Netw.*, 3(5):411–425, may 2011.
- [50] Anwar Alyatama. Wavelength decomposition approach for computing blocking probabilities in {WDM} optical networks without wavelength conversions. *Computer Networks*, 49(6):727–742, 2005.
- [51] Kejie Lu, Gaoxi Xiao, and I Chlamtac. Analysis of blocking probability for distributed lightpath establishment in WDM optical networks. *Networking, IEEE/ACM Transactions on*, 13(1):187–197, feb 2005.
- [52] Ashwin Sridharan and K N Sivarajan. Blocking in all-optical networks. *Networking, IEEE/ACM Transactions on*, 12(2):384–397, 2004.
- [53] R. Vallejos, J. Olavarriá, and N. Jara. Blocking evaluation and analysis of dynamic WDM networks under heterogeneous ON/OFF traffic. *Optical Switching and Networking*, 20, 2016.
- [54] Luiz H Bonani and Iguatemi E Fonseca. Estimating the blocking probability in wavelength-routed optical networks. *Optical Switching and Networking*, 10(4):430–438, 2013.
- [55] Yongli Zhao and Jie Zhang. Blocking probability analysis model for flexible spectrum optical networks. *Chin. Opt. Lett.*, 12(7):70601, jul 2014.
- [56] R C Almeida, D R Campelo, H Waldman, and K Guild. Accounting for link load correlation in the estimation of blocking probabilities in arbitrary network topologies. *Communications Letters, IEEE*, 11(7):625–627, 2007.
- [57] B Iversen Villy. *Teletraffic Engineering Handbook*, 2002.
- [58] A A Fredericks. Congestion in Blocking Systems—A Simple Approximation Technique. *Bell System Technical Journal*, 59(6):805–827, 1980.
- [59] Thomas Bonald. The Erlang Model with Non-poisson Call Arrivals. *SIGMETRICS Perform. Eval. Rev.*, 34(1):276–286, 2006.
- [60] Jianan Zhang, Yu Peng, Eric W M Wong, and Moshe Zukerman. Sensitivity of blocking probability in the generalized Engset model for OBS. *Communications Letters, IEEE*, 15(11):1243–1245, 2011.

-
- [61] Sheldon Ross. *Stochastic Processes*. John Wiley & Sons, Inc., 2nd edition, 1996.
- [62] Qian Chen, Gurusamy Mohan, and Kee Chaing Chua. Route optimization in optical burst switched networks considering the streamline effect. *Computer Networks*, 52(10):2033–2044, 2008.
- [63] F P Kelly. Loss Networks. *The Annals of Applied Probability*, 1(3):pp. 319–378, 1991.
- [64] An Ge, Franco Callegati, and Lakshman S Tamil. On optical burst switching and self-similar traffic. *Communications Letters, IEEE*, 4(3):98–100, 2000.
- [65] Yijun Xiong, Marc Vandenhoute, and Hakki C Cankaya. Control architecture in optical burst-switched WDM networks. *Selected Areas in Communications, IEEE Journal on*, 18(10):1838–1851, 2000.
- [66] T K Nayak and K N Sivaraman. A new approach to dimensioning optical networks. *IEEE Journal on Selected Areas in Communications*, 20(1):134–148, 2002.
- [67] I. Chlamtac, A. Ganz, and G. Karmi. Purely optical networks for terabit communication. In *Proceedings - IEEE INFOCOM*, pages 887–896, 1989.
- [68] Jun Zheng and Hussein T. Mouftah. Routing and wavelength assignment for advance reservation in wavelength-routed WDM optical networks. *IEEE International Conference on Communications*, 5:2722–2726, 2002.
- [69] D R Hjelm, A Royset, and B J Slagsvold. How many wavelengths does it take to build a wavelength routed optical network? In *Proceedings of European Conference on Optical Communication*, volume 1, pages 27–30 vol.1, sep 1996.
- [70] Stefano Baroni and Polina Bayvel. Wavelength requirements in arbitrarily connected wavelength-routed optical networks. *Journal of Lightwave Technology*, 15(2):242–251, feb 1997.
- [71] O Gerstel and S Kutten. Dynamic wavelength allocation in all-optical ring networks. In *Communications, 1997. ICC '97 Montreal, Towards the Knowledge Millennium. 1997 IEEE International Conference on*, volume 1, pages 432–436 vol.1, jun 1997.
- [72] Giancarlo Marchis and Roberto Sabella, editors. *Optical Networks: Design and Modelling*. Springer US, Boston, MA, 1 edition, 1999.
- [73] J. Li, G. Mohan, and K.C. Chua. Dynamic load balancing in IP-over-WDM optical burst switching networks. *Computer Networks*, 47(3):393–408, 2005.
- [74] Mauro Brunato, Roberto Battiti, and Elio Salvadori. *Dynamic Load Balancing in WDM Networks*, 2003.
- [75] Wanjiun Liao and Chi Hong Loi. Providing service differentiation for optical-burst-switched networks. *Journal of Lightwave Technology*, 22(7):1651–1660, 2004.

- [76] Chi-Hong Loi Chi-Hong Loi, Wanjiun Liao Wanjiun Liao, and De-Nian Yang De-Nian Yang. Service differentiation in optical burst switched networks. *Global Telecommunications Conference 2002 GLOBECOM 02 IEEE*, 3, 2002.
- [77] Yang Chen Yang Chen, M Hamdi, and D H K Tsang. Proportional QoS over OBS networks. *GLOBECOM01 IEEE Global Telecommunications Conference Cat No01CH37270*, 3:1510–1514 vol.3, 2001.
- [78] Nail Akar, Ezhan Karasan, Kyriakos G. Vlachos, Emmanouel A. Varvarigos, Davide Careglio, Mirosław Klinkowski, and Josep Solé-Pareta. A survey of quality of service differentiation mechanisms for optical burst switching networks, 2010.
- [79] Li Yang and George N. Rouskas. Optimal wavelength sharing policies in OBS networks subject to QoS constraints. *IEEE Journal on Selected Areas in Communications*, 25(9):40–49, 2007.
- [80] Li Yang and George N. Rouskas. Generalized wavelength sharing policies for absolute QoS guarantees in OBS networks. *IEEE Journal on Selected Areas in Communications*, 25(4):93–103, 2007.
- [81] Nicolás Jara, Reinaldo Vallejos, and Gerardo Rubino. Blocking Evaluation and Wavelength Dimensioning of Dynamic WDM Networks Without Wavelength Conversion. *Journal of Optical Communications and Networking*, 9(8):625, 2017.
- [82] N Jara, R Vallejos, and G Rubino. Blocking evaluation of dynamic WDM networks without wavelength conversion. In *2016 21st European Conference on Networks and Optical Communications (NOC)*, pages 141–146, 2016.
- [83] Reinaldo Jara, Nicolas; Rubino, Gerardo; Vallejos. Blocking Evaluation of dynamic WDM networks without wavelength conversion. In *11ème Atelier en Evaluation de Performances*, Toulouse, France, 2016.
- [84] Sungchang Kim, Jin Seek Choi, and Minho Kang. Absolute Differentiated Services for Optical Burst Switching Networks Using Dynamic Wavelength Assignment. In *SPIE Multimedia Computing and Networking*, pages 855–866, 2004.
- [85] Jun Zheng, Baoxian Zhang, and Hussein T. Mouftah. Toward automated provisioning of advance reservation service in next-generation optical Internet. *IEEE Communications Magazine*, 44(12):68–74, 2006.
- [86] Neal Charbonneau and Vinod M. Vokkarane. A survey of advance reservation routing and wavelength assignment in wavelength-routed WDM networks. *IEEE Communications Surveys and Tutorials*, 14(4):1037–1064, 2012.
- [87] C Meza, N Jara, V M Albornoz, and R Vallejos. Routing and spectrum assignment for elastic, static, and without conversion optical networks with ring topology. In *2016 35th International Conference of the Chilean Computer Science Society (SCCC)*, pages 1–8, oct 2016.

- [88] Jing Teng and George Rouskas. Traffic engineering approach to path selection in optical burst switching networks. *J. Opt. Netw.*, 4(11):759–777, nov 2005.
- [89] Jin Y. Yen. Finding the K Shortest Loopless Paths in a Network. *Management Science*, 17(11):712–716, 1971.
- [90] Reinaldo Vallejos, Alejandra Zapata-Beghelli, Víctor Albornoz, and Marco Tarifeño. Joint routing and dimensioning of optical burst switching networks. *Photonic Network Communications*, 17(3):266–276, 2009.
- [91] R Ramaswami and K N Sivarajan. Design of logical topologies for wavelength-routed all-optical networks. In *INFOCOM '95. Fourteenth Annual Joint Conference of the IEEE Computer and Communications Societies. Bringing Information to People. Proceedings. IEEE*, pages 1316–1325 vol.3, 1995.
- [92] Hardeep Singh, Jai Prakash, Dinesh Arora, and Amit Wason. Fault Tolerant Congestion Based Algorithms in $\{O\}\{B\}\{S\}$ Network. *International Journal of Engineering (IJE)*, 5(5), 2011.
- [93] Fernanda Sumika H Souza, Daniel L Guidoni, and Geraldo R Mateus. A column generation-based heuristic for the GRWA with protection and QoS in WDM optical networks. In *Computers and Communications (ISCC), 2013 IEEE Symposium on*, pages 922–927, 2013.
- [94] D S Mukherjee, C Assi, and A Agarwal. Alternate Strategies for Dual Failure Restoration Using p-Cycles. In *Communications, 2006. ICC '06. IEEE International Conference on*, volume 6, pages 2477–2482, 2006.
- [95] Raghav Yadav, RamaShankar Yadav, and HariMohan Singh. Intercycle switching (ICS)-based dynamic reconfiguration of p-cycle for dual-failure survivability of WDM networks. *Photonic Network Communications*, 24(2):160–165, 2012.
- [96] Liangrui Tang, Mingming Cai, Bin Li, and Runze Wu. A novel multi-link fault-tolerant algorithm for survivability in multi-domain optical networks. *Photonic Network Communications*, 24(2):77–85, 2012.
- [97] Dharmendra Singh Yadav, Santosh Rana, and Shashi Prakash. A mixed connection recovery strategy for surviving dual link failure in $\{WDM\}$ networks. *Optical Fiber Technology*, 19(2):154–161, 2013.
- [98] Ferhat Dikbiyik, Abu S Reaz, Marc De Leenheer, and Biswanath Mukherjee. Minimizing the disaster risk in optical telecom networks. In *Optical Fiber Communication Conference*, pages OTh4B—2. Optical Society of America, 2012.
- [99] Sifat Ferdousi, Ferhat Dikhiyik, M Farhan Habib, and Biswanath Mukherjee. Disaster-aware data-center and content placement in cloud networks. In *2013 IEEE International Conference on Advanced Networks and Telecommunications Systems (ANTS)*, pages 1–3. IEEE, 2013.

- [100] Hui Zang, Canhui Ou, and Biswanath Mukherjee. Path-protection routing and wavelength assignment in WDM mesh networks under shared-risk-group constraints. In *Asia-Pacific Optical and Wireless Communications Conference and Exhibit*, pages 49–60. International Society for Optics and Photonics, 2001.
- [101] S Ramamurthy, L Sahasrabudde, and B Mukherjee. Survivable WDM mesh networks. *Lightwave Technology, Journal of*, 21(4):870–883, 2003.
- [102] G Mohan and C S R Murthy. Lightpath restoration in WDM optical networks. *Network, IEEE*, 14(6):24–32, nov 2000.
- [103] P C Srikanth, M V Sathyanarayana, D Balaraju, and T Srinivas. Fault tolerance in survivable WDM optical networks using hybrid scheme: An analytical approach. In *TENCON 2009 - 2009 IEEE Region 10 Conference*, pages 1–6, 2009.
- [104] M Wang, S Li, E W M Wong, and M Zukerman. Performance Analysis of Circuit Switched Multi-Service Multi-Rate Networks With Alternative Routing. *Journal of Lightwave Technology*, 32(2):179–200, 2014.
- [105] Dominic A. Schupke and Robert G. Prinz. Capacity Efficiency and Restorability of Path Protection and Rerouting in WDM Networks Subject to Dual Failures. *Photonic Network Communications*, 8(2):191–207, 2004.
- [106] Jing Zhang and B Mukherjee. A review of fault management in WDM mesh networks: basic concepts and research challenges. *Network, IEEE*, 18(2):41–48, mar 2004.
- [107] Amit Wason and R S Kaler. Fault-tolerant routing and wavelength assignment algorithm for multiple link failures in wavelength-routed all-optical {WDM} networks. *Optik - International Journal for Light and Electron Optics*, 122(2):110–113, 2011.
- [108] D A Schupke, C G Gruber, and A Autenrieth. Optimal Configuration of p-Cycles in WDM Networks. In *In IEEE International Conference on Communications*, pages 2761–2765, 2002.
- [109] D A Schupke. Multiple failure survivability in WDM networks with p-cycles. In *Circuits and Systems, 2003. ISCAS '03. Proceedings of the 2003 International Symposium on*, volume 3, pages III–866–III–869 vol.3, may 2003.
- [110] D A Schupke, W D Grover, and M Clouqueur. Strategies for enhanced dual failure restorability with static or reconfigurable p-cycle networks. In *Communications, 2004 IEEE International Conference on*, volume 3, pages 1628–1633, 2004.
- [111] Mirosław Klinkowski, João Pedro, Davide Careglio, Michał Pióro, João Pires, Paulo Monteiro, and Josep Solé-Pareta. An overview of routing methods in optical burst switching networks. *Optical Switching and Networking*, 7(2):41–53, 2010.
- [112] C Yahaya, Abd Latiff, and A B Mohamed. A review of routing strategies for optical burst switched networks. *International Journal of Communication Systems*, 2011.

-
- [113] Erick Donato, Joaquim Celestino Júnior, Antônio Vieira, and Ahmed Patel. A Proposal of Dynamic RWA Using Ant Colony in Optical Burst Switched Networks. In *ICN 2012, The Eleventh International Conference on Networks*, pages 246–252, 2012.
- [114] Dewiani, K Hirata, Y Higami, and S.-Y. Kobayashi. Dynamic routing and wavelength assignment in multifiber $\{W\}\{D\}\{M\}$ networks with sparse wavelength conversion. In *ICT Convergence (ICTC), 2012 International Conference on*, pages 567–572, 2012.
- [115] Lucile Belgacem, Irène Charon, and Olivier Hudry. A post-optimization method for the routing and wavelength assignment problem applied to scheduled lightpath demands. *European Journal of Operational Research*, 2013.
- [116] Amin Ebrahimzadeh, Akbar Ghaffarpour Rahbar, and Behrooz Alizadeh. Binary quadratic programming formulation for routing and wavelength assignment problem in all-optical $\{W\}\{D\}\{M\}$ networks. *Optical Switching and Networking*, 10(4):354–365, 2013.
- [117] Chia-Chun Hsu, Hsun-Jung Cho, and Shu-Cherng Fang. Routing and Wavelength Assignment in Optical Networks from Maximum Edge-Disjoint Paths. In *Genetic and Evolutionary Computing*, volume 238 of *Advances in Intelligent Systems and Computing*, pages 95–103. Springer International Publishing, 2014.
- [118] Nicolás Jara, Reinaldo Vallejos, and Gerardo Rubino. A method for joint routing, wavelength dimensioning and fault tolerance for any set of simultaneous failures on dynamic WDM optical networks. *Optical Fiber Technology*, 38:30–40, 2017.
- [119] N. Jara, G. Rubino, and R. Vallejos. Alternate paths for multiple fault tolerance on Dynamic WDM Optical Networks. In *IEEE International Conference on High Performance Switching and Routing, HPSR*, volume 2017-June, 2017.

Titre : Conception de réseaux optiques en tenant compte de la tolérance aux fautes d'un ensemble quelconque de liens

Mots clés : réseaux optiques dynamiques, probabilité de blocage, tolérance aux fautes

Résumé : L'augmentation rapide de la demande en bande passante dans les réseaux de télécommunication d'aujourd'hui a provoqué une augmentation correspondante de l'utilisation de technologies basées dans les réseaux optiques de type WDM. Ceci étant, la recherche a identifié une limite forte dans la capacité de croissance de ces infrastructures, du point de la vitesse de transmission, limite qui sera atteinte bientôt. Cette situation conduit à des efforts de recherche pour faire évoluer les architectures courantes vers de nouvelles solutions capables d'absorber cette croissance dans la demande. Par exemple, les réseaux d'aujourd'hui sont opérés de façon statique. Ceci est inefficace dans l'utilisation des ressources, et la nécessité d'améliorer cet état de fait est reconnue par la recherche ainsi que par l'industrie. Plusieurs solutions ont été proposées pour passer à des modes de fonctionnement dynamiques, mais les diminutions des coûts qu'ont été obtenues n'ont pas encore convaincu les industriels.

Cette thèse fait une nouvelle proposition de cette nature, qui inclut une nouvelle et très rapide méthodologie pour évaluer la probabilité de blocage dans ce type de système, qui est le cœur de notre procédure de conception.

Le travail réalisé a conduit à la découverte de solutions pour l'ensemble des problèmes principaux d'une architecture de transmission optique. Il s'agit de décider chemins à utiliser par chaque utilisateur et la longueur d'onde (Wavelength Assignment Problem). Ensuite, il faut choisir le nombre total de longueurs d'onde qui sera nécessaire (Wavelength Dimensioning Problem). Enfin, il faut proposer les procédures à suivre en cas de défaillance d'un ou de plusieurs liens du réseau (Fault Tolerance Problem).

La thèse propose une solution globale à cet ensemble de problèmes, et montre que les gains que l'on peut espérer dans l'opération de ces réseaux sont significativement plus importants qu'avec les autres propositions existantes.

Title : Optical Network Design considering Fault Tolerance to any set of link failures

Keywords : optical networks, blocking probability, fault tolerance

Abstract : The rapid increase in demand for bandwidth from existing networks has caused a growth in the use of technologies based on WDM optical networks. Nevertheless, this decade researchers have recognized a "Capacity Crunch" on optical networks, i.e. transmission capacity limit on optical fiber is close to be reached in the near future. This situation claims to evolve the current WDM optical networks architectures. For example, optical networks are operated statically. This operation is inefficient in the usage of network resources. To solve this problem Dynamic optical networks solve this inefficiencies, but it has not been implemented since network cost savings are not enough to convince enterprises.

The design of dynamic optical networks decomposes into different tasks, where the engineers must organize the way the main system's resources are used.

All of these tasks, have to guarantee certain level of quality of service pre-established on the Service Level Agreement. Then, we propose a new fast and accurate analytical method to evaluate the blocking probability in these systems.

This evaluation allows network designers to quickly solve higher order problems. More specifically, network operators face the challenge of solving: which wavelength is going to be used by each user (known as Wavelength Assignment), the number of wavelengths needed on each network link (called as Wavelength Dimensioning), the set of paths enabling each network user to transmit (known as Routing) and how to deal with link failures when the network is operating (called as Fault Tolerance capacity).

This thesis proposes a joint solution to these problems, and it may provide sufficient network cost savings to foster telecommunications companies to migrate from the current static operation to a dynamic one.