



HAL
open science

New hybrid systems of heat recovery : thermal modeling and optimization

Hassan Jaber

► **To cite this version:**

Hassan Jaber. New hybrid systems of heat recovery : thermal modeling and optimization. Electric power. Université d'Angers, 2019. English. NNT : 2019ANGE0079 . tel-03249321

HAL Id: tel-03249321

<https://theses.hal.science/tel-03249321>

Submitted on 4 Jun 2021

HAL is a multi-disciplinary open access archive for the deposit and dissemination of scientific research documents, whether they are published or not. The documents may come from teaching and research institutions in France or abroad, or from public or private research centers.

L'archive ouverte pluridisciplinaire **HAL**, est destinée au dépôt et à la diffusion de documents scientifiques de niveau recherche, publiés ou non, émanant des établissements d'enseignement et de recherche français ou étrangers, des laboratoires publics ou privés.

THESE DE DOCTORAT DE

L'UNIVERSITE D'ANGERS
COMUE UNIVERSITE BRETAGNE LOIRE

ECOLE DOCTORALE N° 602
Sciences pour l'Ingénieur
Spécialité : Energétique-Thermique-Combustion

Par

M. Hassan JABER

Nouveaux systèmes hybrides de récupération de chaleur : modélisation thermique et optimisation

New hybrid systems of heat recovery: thermal modeling and optimization

Thèse présentée et soutenue à Angers, le 9 Juillet 2019

Unité de recherche : **LARIS EA 7315**

Thèse N° :

JURY

Président :	M. Laurent AUTRIQUE	Professeur, Polytech Angers
Rapporteurs :	M. Daniel BOUGEARD M. Stéphane FOHANNO	Professeur, IMT Lille Douai Professeur, Université de Reims
Directeur de thèse :	M. Thierry LEMENAND	Maître de conférences HDR, Polytech Angers
Co-directeur de thèse :	M. Mahmoud KHALED M. Mohamad RAMADAN	Maître de conférences HDR, LIU University (Liban) Maître de conférences, LIU University (Liban)

Table des matières

Introduction.....	1
Chapitre 1. Etude bibliographique.....	5
1.1 Bref bilan de la récupération de chaleur des gaz d'échappement.....	9
1.2 Revue des techniques de récupération de la chaleur perdue dans les applications domestiques	19
1.3 Revue de la récupération de chaleur des gaz d'échappement : sources, moyens et applications.....	37
1.4 Revue de la récupération de chaleur des gaz d'échappement à l'aide de générateurs thermoélectriques	73
Chapitre 2. Système de Cogénération Thermoélectrique Domestique : analyse d'optimisation, consommation d'énergie et réduction des émissions de CO₂.....	99
Chapitre 3. Système de Cogénération Thermoélectrique Domestique - Analyses paramétriques et études de cas	119
3.1 Effet de la température des gaz d'échappement sur les performances d'un système de récupération de chaleur hybride.....	121
3.2 Systeme de cogeneration thermoelectrique domestique : analyse d'optimisation - effet du changement de volume d'eau	131
3.3 Effet de la charge du générateur sur le système de récupération de chaleur hybride.....	137
3.4 Système de récupération de chaleur hybride appliqué aux gaz d'échappement - Modélisation thermique et étude de cas.....	145
Chapitre 4. Système de séchage et de cogénération thermoélectrique domestique	159
Chapitre 5. Utilisation d'un réservoir multitube pour la récupération de chaleur à partir de gaz d'échappement : analyses d'optimisation.....	177
5.1 Simulation numérique d'échangeur de chaleur à plusieurs tubes: analyse d'optimisation	179
5.2 Étude expérimentale sur la récupération de chaleur à l'aide d'un réservoir multi-tubes: effet de la modification de la forme de la tête.....	191
Chapitre 6. Conclusions et perspectives.....	201
Références	207

Introduction

La Conférence des Nations Unies sur le changement climatique de 2015, la COP 21, qui s'est tenue à Paris, a impliqué 195 pays à légiférer pour mettre en place des conditions permettant d'atténuer l'augmentation de la température mondiale [1]. Le principal objectif de l'accord était de limiter le taux d'augmentation de la température de la Terre à moins de 2°C. Cela impose une réduction importante des émissions de gaz à effet de serre (principalement du dioxyde et du monoxyde de carbone).

La quantité globale de production de dioxyde de carbone est fonction de la population, de la consommation individuelle, de l'énergie par service et de la production de dioxyde de carbone par unité d'énergie. Premièrement, notre population mondiale **augmente** (à un taux de 1,11% en 2017 [2]). Deuxièmement, la consommation individuelle **augmente** en raison de l'évolution du style de vie et des besoins humains. Ces deux premiers paramètres ne peuvent en aucun cas être facilement contrôlés ou réduits, même par des approches technologiques. Il est donc nécessaire de minimiser les deux paramètres restants : l'énergie par service et la production de dioxyde de carbone par énergie. Il est possible de **réduire** l'énergie par service en diminuant l'utilisation des sources d'énergie non renouvelables ou en diminuant les pertes d'énergie. D'autre part, la production de dioxyde de carbone peut être **réduite** en utilisant des sources d'énergie propres ou en réduisant l'énergie dissipée dans l'environnement. Cela implique que la réduction de la quantité de dioxyde de carbone produite dans le monde peut être obtenue par une gestion de l'énergie et/ou l'utilisation de l'énergie alternative.

L'énergie alternative est une énergie non-destructrice de l'environnement qui peut remplacer l'énergie traditionnelle qui repose sur des sources d'énergie fossiles. L'énergie solaire, éolienne, la biomasse, l'énergie des marées, de l'hydroélectricité, de la géothermie et des piles à combustible sont les principaux types d'énergie de remplacement. D'autre part, la gestion de l'énergie peut être obtenue par l'optimisation du système, la récupération d'énergie ou les deux. La récupération d'énergie vise à capter ou chaleur fatale provenant de diverses applications et à l'utiliser à différentes fins. La majeure partie de l'énergie gaspillée est rejetée sous forme d'énergie thermique et principalement par le biais de fluides de refroidissement ou de gaz d'échappement de plusieurs applications telles que les moteurs à combustion interne, les cheminées, les fours, les pompes à chaleur, les refroidisseurs et les générateurs. Typiquement, environ 30% à 40% de l'énergie d'entrée d'un moteur à combustion interne sont dissipés par les gaz d'échappement et le fluide caloporteur, respectivement [3].

La récupération de chaleur [4] à partir de l'énergie thermique dissipée est l'une des principales nouvelles technologies mises en avant pour réduire la consommation d'énergie et maximiser l'utilisation de l'énergie. On estime qu'environ un tiers de l'énergie absorbée est dissipée dans l'environnement sans en tirer parti [5]. Cette énergie thermique libérée pourrait être utilisée afin de diminuer l'apport d'énergie. Il est possible de réduire la consommation de carburant d'environ 10% en récupérant 6% de la chaleur rejetée dans les gaz d'échappement d'un moteur à combustion interne (MCI) [6]. En outre, une réduction de 1% de la consommation de carburant d'une chaudière est obtenue lorsque l'air de combustion est chauffé à 200°C de plus ou lorsque l'eau alimentée par la chaudière est chauffée à 60°C de plus [7]. La chaleur récupérée peut être utilisée directement comme énergie thermique pour chauffer un autre liquide ou gaz (eau ou chauffage), pour être stockée sous forme de chaleur sensible ou latente ou pour produire de l'électricité à l'aide de

générateurs thermoélectriques (GTE) pour une application à basse température ou d'un cycle de Rankine pour les applications à haute température.

Les principaux défis en matière de récupération de chaleur ne sont pas représentés de nos jours par la recherche de nouvelles sources de chaleur perdue. Toutefois, ils peuvent être décrits en proposant de **nouvelles méthodes d'extraction de la chaleur** dissipée ou en suggérant de **nouveaux systèmes hybrides** composés d'étapes de récupérations multiples optimisant l'utilisation de l'énergie et améliorant l'efficacité globale du système.

Sur la base du contexte présenté ci-dessus, l'objet de ces travaux de thèse est de proposer de nouveaux systèmes/concepts de récupération de chaleurs hybrides à partir des gaz d'échappement et de réaliser des études de cas et des analyses paramétriques afin de prédire et d'optimiser les performances thermiques du système.

➤ **Deux systèmes de récupération de chaleur hybrides** sont proposés dans cette thèse et étudiés analytiquement : le Système de Cogénération Thermoélectrique Domestique (SCTD) et le Système de Séchage et de Cogénération Thermoélectrique Domestique (SSCTD). Ces systèmes utilisent des gaz d'échappement pour chauffer de l'eau, générer de l'électricité à l'aide de générateurs thermoélectriques et même chauffer l'air à des fins de séchage, pour le système SSCTD. Des études de cas sont considérées sur les deux systèmes et différents paramètres ont été étudiés pour examiner l'effet de la modification de ces paramètres sur les performances du système de récupération.

➤ **Des analyses d'optimisation** ont été effectuées sur un échangeur de chaleur à récupération de chaleur récemment suggéré par Khaled et al. [8] dénommé Réservoir Multi-Tube (RMT).

➤ **Un nouveau système hybride** est proposé, combinant le RMT avec un échangeur de chaleur à tubes concentriques pour récupérer l'énergie thermique des gaz d'échappement et de l'eau de refroidissement d'un générateur diesel électrique. Un prototype expérimental est construit et différents paramètres sont étudiés expérimentalement pour optimiser les performances du système de récupération.

Afin d'atteindre ces objectifs, une analyse documentaire approfondie sur la récupération de chaleur est effectuée et présentée au **chapitre 1**. Elle couvre les principales sources de gaz d'échappement, les moyens et les objectifs des systèmes de récupération de chaleur. En outre, cette analyse récapitule les travaux antérieurs effectués dans le domaine de la récupération de chaleur des gaz d'échappement. Les générateurs thermoélectriques étant utilisés dans les deux systèmes, une analyse complète de la technologie des générateurs thermoélectriques est également effectuée. Le **chapitre 2** traite du système hybride récemment proposé, appelé Système de Cogénération Thermoélectrique Domestique (SCTD). Le concept du système est défini et une modélisation thermique complète est développée. Une étude de cas est réalisée et l'effet de l'emplacement des générateurs thermoélectriques sur les performances du système est examiné. De plus, une étude économique et environnementale est réalisée sur le système. Cette étude est complétée par une analyse d'optimisation présentée au **chapitre 3**, dans laquelle des études de cas et des analyses paramétriques sont effectuées pour estimer l'effet de la modification de la température des gaz d'échappement, du volume d'eau et de la charge de la génération sur les performances du SCTD. Le Système de Séchage de Cogénération Thermoélectrique Domestique (SSCTD) est présenté au **chapitre 4**. Une fois la conception du système définie, une modélisation thermique complète du système est effectuée. La modélisation thermique couvre chaque étape de récupération pour calculer l'énergie récupérée sur chaque partie du système. Ensuite, une étude de cas est considérée

dans laquelle les gaz d'échappement d'une cheminée sont utilisés pour trois combustibles différents (diesel, charbon et bois). Le **chapitre 5** est consacré à l'optimisation du RMT dans lequel l'effet de la modification du nombre de tubes et de la forme de la tête du système sont testés. Une simulation numérique du système est développée afin de démontrer l'effet de la variation du nombre de tubes sur la température de l'eau, l'énergie récupérée par l'eau et la température des gaz d'échappement à la sortie. Dans le même temps, une étude expérimentale est réalisée pour illustrer l'effet de la modification de la forme de la tête du RMT sur les performances du système. Deux têtes ont été considérées : une tête de forme cylindrique et une autre de forme conique. En outre, une étude théorique est mise en œuvre pour évaluer la différence entre la tête cylindrique et la tête conique du point de vue économique et environnemental. Enfin, le **chapitre 6** reprend les principales conclusions de la thèse et suggère des travaux futurs.

Chapitre 1. Etude bibliographique

Contraint par la deuxième loi de la thermodynamique, tout système d'ingénierie thermique est obligé de libérer dans l'environnement une certaine quantité d'énergie. L'idée de base de la récupération de chaleur perdue est de traiter cette chaleur perdue afin de réduire la consommation d'énergie et les impacts sur l'environnement. Le concept de récupération de chaleur repose sur l'affirmation selon laquelle « la meilleure énergie est celle qui n'est pas consommée ». Il vise à réutiliser directement ou indirectement l'énergie rejetée par tout système d'ingénierie thermique. Il permet également d'augmenter l'efficacité des systèmes de conversion d'énergie conventionnels.

Il a été démontré que 70% de l'énergie générée par la combustion de carburant est rejetée dans l'environnement [9]. La chaleur perdue est générée par les machines, le matériel électrique, les systèmes de génération de chaleur résidentiels et industriels. Dans les principales applications, les systèmes de génération de chaleur dissipent la plus grande quantité d'énergie thermique par les gaz d'échappement et les systèmes de refroidissement. De plus, la récupération de chaleur est la solution la plus prometteuse, en particulier dans les régions où les ressources en énergies renouvelables ne sont pas disponibles ou limitées. Il a été estimé que, pour générer 1 GW d'électricité solaire, environ 100 à 150 km² sont nécessaires pour une centrale électrique et 2 500 km² d'énergie issue de la biomasse [10]. C'est pourquoi la récupération de chaleur a connu une amélioration considérable et a reçu une attention particulière dans les travaux de recherche au cours des dernières années.

Ce chapitre vise à effectuer une revue de la littérature complète sur **la récupération de chaleur** des gaz d'échappement. De plus, un examen de la récupération de chaleur à l'aide de générateurs thermoélectriques (GTE) est ajouté car les GTE sont utilisés dans nos travaux comme étape de la récupération de chaleur et pour montrer leur importance lorsqu'ils sont couplés à des systèmes de récupération de chaleur. Revues bibliographiques ont été mises en place pour la réalisation des objectifs proposés au début de la thèse. Elles sont les suivantes :

➤ **1.1 Bref bilan de la récupération de chaleur des gaz d'échappement** : l'étude vise à classer la technologie de la récupération de chaleur des gaz d'échappement en fonction de différents critères : en fonction de la température des gaz d'échappement et des équipements utilisés. De plus, une nouvelle taxonomie est proposée et expliquée, dont l'avantage est de visualiser les principaux objectifs de la récupération de chaleur et de présenter les principales technologies existantes pour atteindre l'objectif recherché. La chaleur perdue peut être classée en fonction de la température : élevée (supérieure à 650°C), moyenne (entre 230°C et 650°C) ou faible (inférieure à 230°C) (voir **section 2.1**). Dans la **section 2.2**, différents équipements utilisés dans la récupération de chaleur, tels que récupérateurs, régénérateurs, roue thermique, caloduc, échangeurs de chaleur à tubes et calandres, échangeurs de chaleur à plaques, échangeurs à serpentin, pompes à chaleur et économiseurs, sont passés en revue. La troisième taxonomie suggérée est fonction de l'objectif de récupération de chaleur tel que le chauffage, le refroidissement, la production d'électricité ou le stockage, comme indiqué à la **section 2.3**. Cette revue a été présentée à la **TMREES 2016** (*Technologies and Materials for Renewable Energy, Environment and Sustainability*) et publiée dans *l'American Institute of Physics (AIP)*.

➤ **1.2 Revue des techniques de récupération de la chaleur perdue dans les applications domestiques** : d'un point de vue pratique, le concept de récupération de chaleur domestique présente un fort potentiel car il pourrait être appliqué à la plupart des logements de manière très simple. Il étudie essentiellement quatre applications principales : la récupération de chaleur à partir des gaz d'échappement de cheminées, des cuisinières, des générateurs électriques et la récupération de chaleur à partir des eaux usées. La **section 2** présente la technologie de récupération de chaleur appliquée aux applications domestiques. La **section 3** traite de la récupération de chaleur des gaz d'échappement d'une cheminée, d'un poêle et d'un générateur électrique. La **section 4** examine la récupération de chaleur à partir des eaux usées. La **section 5** est consacrée aux avantages actuels et aux obstacles à la récupération de chaleur des applications domestiques, accompagnés de recommandations. Enfin, une conclusion récapitulative est présentée. Cette étude est acceptée pour publication dans le journal « *Energy Sources, Part A : Recovery, Utilization, and Environmental Effects* ».

➤ **1.3 Revue de la récupération de chaleur des gaz d'échappement : sources, moyens et applications** : cette étude fournit les paramètres les plus efficaces qui affectent le processus de récupération (**section 2**). La **section 3** illustre les principales sources industrielles et résidentielles de gaz d'échappement tels que les fours, les moteurs à combustion interne (MCI), les cheminées, les cuisinières et chaudières à vapeur. La technologie de récupération de chaleur peut être appliquée directement en utilisant le gaz d'échappement ou indirectement au moyen d'échangeurs de chaleur ou d'autres équipements de récupération de chaleur. La **section 4** présente les échangeurs de chaleur couplés à des équations thermiques, tandis que la **section 5** expose les applications de la récupération de chaleur. La chaleur perdue peut être utilisée pour chauffer d'autres flux principalement pour la production d'eau chaude sanitaire ou de chauffage ou pour chauffer de l'air à des fins de séchage ou même d'élévation de la température de l'air de combustion. De plus, elle peut être utilisée pour la production d'énergie à l'aide de générateurs thermoélectriques, de cycles organiques de Rankine et de moteurs Stirling. En outre, l'énergie thermique récupérée peut être stockée sous forme de chaleur sensible ou latente (principalement avec des matériaux à changement de phase). La récupération de chaleur peut également être mise en œuvre pour être utilisée à des fins de refroidissement en utilisant des cycles d'absorption et d'adsorption. Afin de mettre en lumière l'importance de la récupération d'énergie et son impact sur le coût de l'énergie produite, il est possible de réaliser des économies en réutilisant l'énergie perdue et en réduisant les émissions de CO₂. Des études économiques et environnementales ont ainsi été réalisées. Il est prévu de soumettre cette revue à « *Renewable and Sustainable Energy Reviews* ».

➤ **1.4 Revue de la récupération de chaleur des gaz d'échappement à l'aide de générateurs thermoélectriques**. Les GTE sont des dispositifs passifs qui génèrent de l'électricité directement lorsqu'ils sont pris en sandwich entre une source de chaleur et des puits de chaleur. Les GTE sont des dispositifs silencieux, simples, fiables et durables, avec un rendement limité (autour de 5%). Ils génèrent de l'électricité à partir de tout gradient de température, ce qui les rend très attrayants pour les systèmes de récupération de la chaleur. La **section 2** traite de la récupération de chaleur à partir des gaz d'échappement, classée en fonction de différentes taxonomies. Les GTE sont ensuite expliqués en détail dans la **section 3** dans laquelle sont présentés le principe, le matériau, la modélisation thermique et électrique. De plus, les étapes nécessaires à la fabrication d'un dispositif thermoélectrique sont illustrées. La technologie GTE est mise en œuvre dans les gaz d'échappement à basse et moyenne température, tandis que les gaz d'échappement à haute température sont utilisés pour générer de l'électricité à l'aide du cycle de Rankine ordinaire. La **section 4** présente les travaux antérieurs réalisés sur la récupération de chaleur des gaz

d'échappement à l'aide de GTE. En outre, des études économiques et environnementales sont réalisées pour mettre en évidence l'importance de l'utilisation des GTE dans les applications de valorisation. Enfin, la **section 5** présente les principales conclusions de l'étude. Il est prévu de soumettre cette revue à « *Energy Conversion and Management* ».

1.1 Bref bilan de la récupération de chaleur des gaz d'échappement

Hassan Jaber, Mahmoud Khaled, Thierry Lemenand et Mohamad Ramadan

Cette revue a été présentée à la TMREES (**Technologies and Materials for Renewable Energy, Environment and Sustainability**) et publiée dans l'**American Institute of Physics** (AIP)

Résumé - La croissance de la demande énergétique amène à proposer de nouvelles solutions efficaces. La récupération de chaleur constitue la solution la plus prometteuse, en particulier dans les régions où les ressources en énergies renouvelables ne sont pas disponibles. C'est pourquoi le domaine de la récupération de chaleur s'est considérablement amélioré au cours des dernières années. D'autre part, peu de travaux ont été consacrés à la récupération de chaleur des gaz d'échappement. Cet article présente une analyse de la récupération de chaleur des gaz d'échappement. Les auteurs proposent de classer les systèmes de récupération de chaleur des gaz d'échappement dans trois catégories différentes : température des gaz d'échappement, équipement utilisé et récupération.

Short Review on Heat Recovery from Exhaust Gas

Hassan Jaber^{1, a)}, Mahmoud Khalid^{1, 2, b)}, Thierry Lemenand^{3, c)} and Mohamad Ramadan^{1, d)}

¹ School of Engineering, Lebanese International University LIU, PO Box 146404 Beirut, Lebanon.

² Univ Paris Diderot, Sorbonne Paris Cité, Interdisciplinary Energy Research Institute (PIERI), Paris, France

³ 2ISTIA and LARIS EA 7315, University of Angers, Angers, France

^a hassan.jaber@liu.edu.lb

^b mahmoud.khaled@liu.edu.lb

^c thierry.lemenand@univ-angers.fr

^d mohamad.ramadan@liu.edu.lb

Abstract. The increasing growth of energy demand leads to propose new efficient solutions. Heat recovery consists the most promising solution especially in regions where renewable energy resources are not available. That is why the domain of heat recovery has shown a tremendous improvement during the recent years. On the other hand few works have been dedicated to review heat recovery from exhaust gas. This paper presents a review on heat recovery from exhaust gas. The authors propose to classify exhaust gas heat recovery systems within three different classifications that are exhaust gas temperature, utilized equipment and recovery purposes.

1. INTRODUCTION

During the last decades energy demand has increased rapidly due to the huge industrial development, which made energy very essential for worldwide economic progress and industrialization. Moreover the environmental impact of this increase in energy demand is very dangerous. That is why governments and scientists have been involved in finding solutions for this crisis. The proposed solutions can be classified into two classes that are the use of renewable energy sources and the reduction of energy consumption by recovering lost energy [1-4]. Typical example of renewable energy sources are solar, wind, wave and biomass [5-7]. Those systems can be employed when there is acceptable availability of such sources. However from a practical point of view the use of these systems is generally limited in time and space. It was estimated that in order to generate 1GW electricity from solar energy about 100 – 150 Km² are required as an area for the power station and 2500 Km² from biomass energy [8]. The concept of heat recovery is to reuse rejected energy from any engineering system directly or indirectly. In some applications the percentage of energy loss may represent one third of the input energy [9]. This heat can be released either by exhaust gases or cooling water. In many applications [10-14], such as boilers, engines, ovens, chimneys, chillers, heat pump... Exhaust gases are released at high temperature which consist a valuable source of energy that can highly reduce the energy consumption. Heat recovery from exhaust gases can be classified according to different criteria. However, this paper will manage to view those criteria and explain two main criteria from them. In addition to that a new taxonomy is proposed and explained. The advantage of the new proposed taxonomy is to view the main purposes of recovering heat and to show the main technologies available in order to achieve the required purpose.

2. HEAT RECOVERY FROM EXHAUST GASES

The domain of heat recovery from exhaust gases can be classified within several subdomains [15-17], as shown in Figure 1. In this paper three different classifications will be presented. In the first classification, HRS (Heat Recovery Systems) are classified with respect to exhaust gas temperature, in the second one the systems are classified with respect to the utilized equipment whereas the third classification presents the systems according to the recovery purposes.

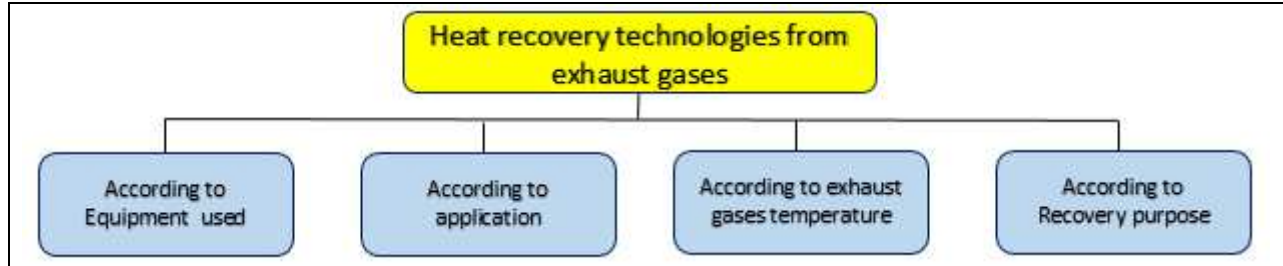

FIGURE 1. Heat recovery classification criteria.

2.1 Classification according to exhaust gas temperature

Categorization with respect to gas temperature [18] is the simplest one, indeed the systems are divided into three different categories, high temperature systems, medium temperature systems and low temperature systems.

Such classification is based on the range of temperature in which exhaust gases having temperature above 650°C are classified as high temperature exhaust gases. Whereas for applications dissipate heat between 230 °C and 650°C the exhaust gases are classified under medium temperature. And finally, lower than 230 °C are taken as low temperature exhaust gases.

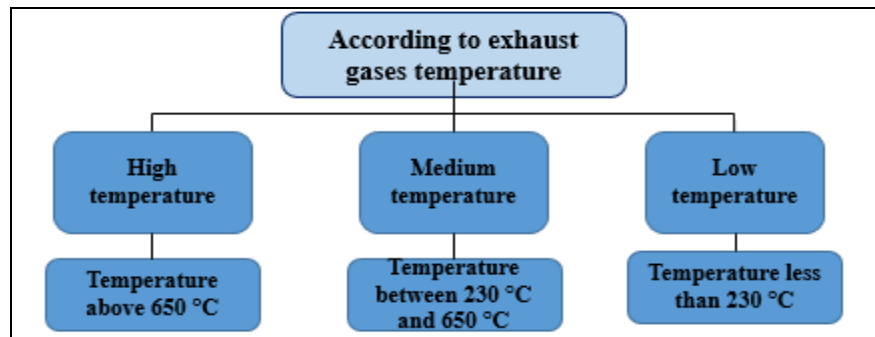

FIGURE 2. Heat recovery classification according to exhaust gas temperature.

2.2 Classification according to the equipment used for heat recovery

The main heat recovery device used in heat recovery systems is the heat exchanger. It is chosen depending on the application. Figure 3 presents the most utilized heat exchanger for heat recovery applications [19].

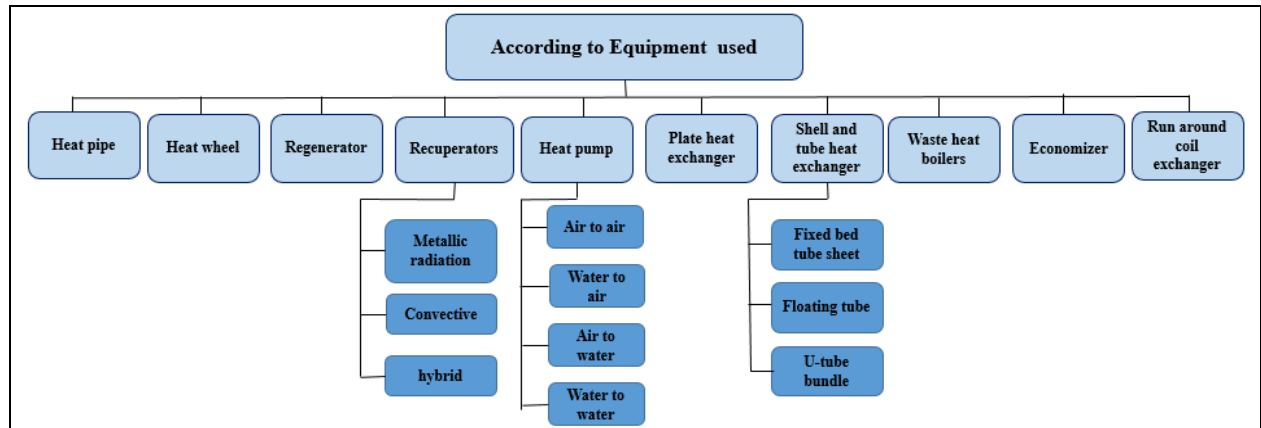

FIGURE 3. Heat recovery equipment classification.

2.1.1 Recuperators

Recuperators are formed of metallic or ceramic material (for high temperature up to 1500 °C). They are typically utilized to increase the temperature of the air in combustion processes which increases the efficiency of combustion and decrease the consumption of fuel. In some applications, about 1% reduction of fuel consumption can be achieved by raising the combustion temperature [16]. Recuperators are of three types radiative, conductive, and combined. Radiative recuperators consist of two concentric ducts in which flue gases pass through the inner duct and combustion air passes through the outer duct. Convective recuperators consist of a large shell with small diameter tubes. The combination of both radiative and convective recuperator forms the combined recuperator which has higher heat transfer effectiveness.

2.1.2 Regenerators

Regenerators or furnace regenerator is composed of two brick chambers in which hot gases and air flow alternately. Waste heat gases pass through the brick chamber in which brick absorbs heat from the gases. Then air is entered to the chamber where it gains heat from the brick. The usage of two chambers is to allow continuous operation, while the first chamber is being heated by exhaust gases the other is releasing its heat to air [20].

2.1.3 Heat wheel

Heat wheel which can be considered one of the most promising equipment and that is why its use is continuously increasing. It consists of a rotary disc containing high heat capacity material installed between two parallel ducts. They are a relatively simple, but efficient [21]. In a typical installation, the rotating wheel is positioned in a duct system such that it is divided into two equal sections. The incoming gas is directed to one side of the spinning perforated thermal wheel, while the outgoing air is directed onto the other side. The two gas flows are kept separate from each other. The gas streams pass through small holes in the wheel and are therefore exposed to a large surface area of the wheel material. The wheel is composed of a material which has high thermal conductivity that can easily absorb heat from one air flow and then immediately release it again in the other flow.

2.1.4 Heat pipe

Heat pipes are passive heat transferring devices. They are utilized to transfer large amount of heat for relatively long distance with minimal resistance. Heat pipes are simple, effective devices, light in weight and compact in size [18]. Heat pipe consist of metallic pipe sealed at both ends and partially filled in liquid at vacuum pressure. It consists of evaporative section, adiabatic section, and condenser section. The evaporative section is installed in the waste heat gases duct which may be finned in order to increase heat transfer area as shown in figure.4 (a) in which heat is absorbed rising the temperature of the liquid until vaporization. The vapor will move through the adiabatic section till it reaches the condenser section where it releases its heat and condense. The condensed vapor will flow

back to the evaporator section and the cycle will repeat itself. Heat pipes can transfer 100 more times thermal energy than best known conductor (copper) [17].

2.1.5 Shell and tube heat exchanger

Shell and tube heat exchangers [22] are used for liquid or vapor to liquid heat recovery. It consists of tubes contained in a shell with baffles to direct the flow of fluid in the shell. Mainly, the low pressure flow circulates through the shell and the higher temperature fluid passes through the tubes. Shell and tube heat exchangers are of three types: fixed bed tube sheet, floating head, and U-tube bundle.

2.1.6 Plate heat exchanger

Plate heat exchangers [23] consist of a number of separate parallel plates forming a thin flow pass. Plates are disconnected from each other by gaskets. The plates are arranged in which the first plate allows hot stream to pass and the second plate allows the cold stream to pass through it. This arrangement allows the heat transfer between the hot and cold plate rising the temperature of the cold stream.

2.1.7 Run around coil exchanger

Run around coil exchangers [24] are mainly used when the hot and cold streams are away from each other. A working fluid that circulates between two coil exchangers (one is installed in hot stream and the other is in the cold stream) by a pump, gains heat from the hot stream and releases it at the cold stream.

2.1.8 Heat pump

Heat pumps [25] are devices utilized to transfer heat from a heat source (waste heat gases) to a heat sink (liquid or gas to be heated) using vapor compression cycle. It consists of an evaporator, condenser, compressor, expansion valve, and a heat transfer fluid (HTF)/ refrigerant as shown in Figure 4 (b). At the evaporator heat is extracted leading to the vaporization of the heat transfer fluid which will be compressed at the compressor to high pressure. This high pressure refrigerant vapor will condense at the condenser releasing its heat then the condensed refrigerant is driven to the expansion valve to reduce its pressure and the cycle repeat itself. The advantage of heat pump is that they can increase heat about twice the energy consumed by the device. The main limitation of such system is maintenance of moving parts (mainly compressor).

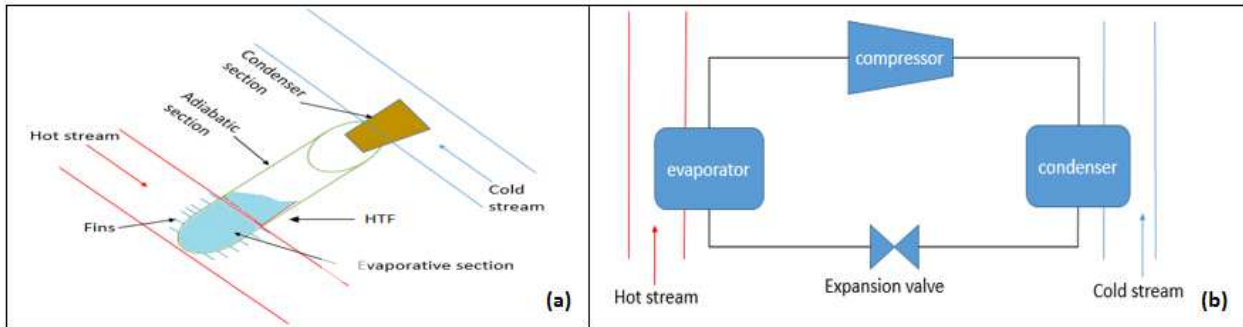

FIGURE 4. Schematic of: (a) heat pipe, (b) heat pump.

2.1.9 Economizer

Economizer [26] is mainly used in boilers in order to preheat supply water of the boiler. It is a finned tube heat exchanger collect heat from wasted exhaust gases which transfer it to supply water rising its temperature.

2.1.10 Waste heat recovery boiler

Such boiler is an ordinary water tube boiler provided with a number of parallel tubes containing water in which flue gases pass over them rising water temperature [27]. The water tubes are finned in order to increase the heat transfer area between exhaust gases and tubes. The water is vaporized and collected at the drum.

2.3 Waste heat recovery purpose

The main goal of heat recovery technology is to reduce energy consumption and maximize the usage of the consumed energy. Starting from this point of view scientist managed to improve this energy usage by either using the dissipated heat again in same application or utilize this dissipated heat in other applications. For same temperature of exhaust gases, energy recovery was employed for different purposes mainly depending on efficiency change, cost of recovery, energy availability, and industry needs. The main available and utilized recovery purposes [28] are summarized in fig 5. It also shows the main available technologies that can be used to recover heat energy from exhaust gases.

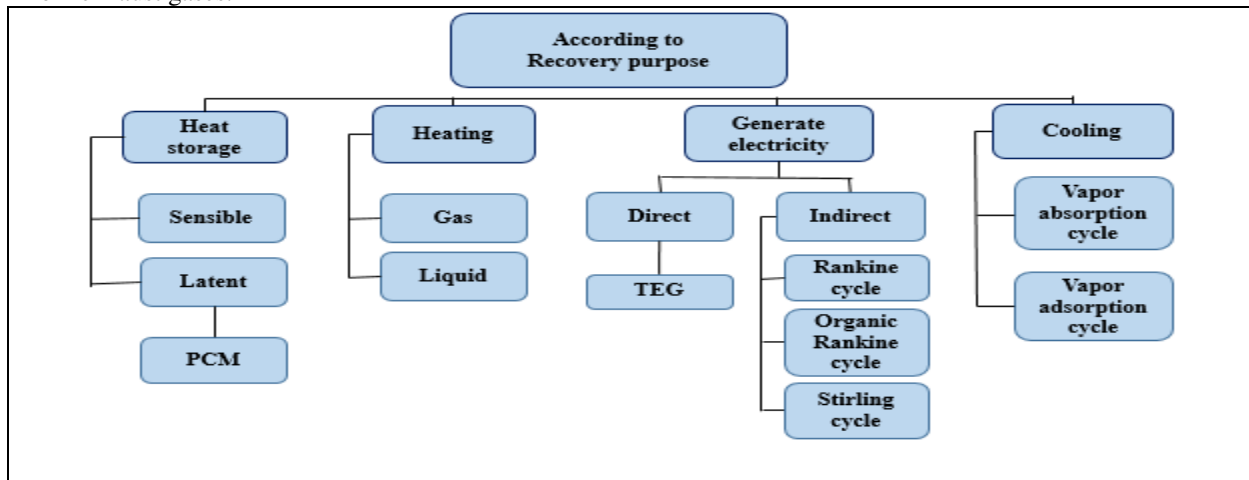

FIGURE 5. Heat recovery classification according to recovery purpose.

2.2.1 Energy storage

Since in some application there is a mismatch between energy availability and energy request, energy storage would be the perfect way to eliminate or decrease the effect of this problem. There are many forms of energy storage but mainly they are sensible and latent heat storage. J.Shon et al [29] did a study to improve heat storage rate for an automobile coolant waste heat recovery system using phase-change material in a fin-tube heat exchanger. A theoretical study was carried for calculating the time needed to melt the Phase change material. He concluded that the warming up of the automobile was shortened about 33%. K.Gopal et al [30] performed energy and exergy analysis for a diesel engine integrated with phase change material. Figure 5 (a) shows a schematic for recovering heat using phase change material. A waste heat recovery heat exchanger transfers heat from exhaust gases to a working fluid. This working fluid is driven by a pump to a PCM storage tank where it releases its heat to the PCM. As a result of this latent heat storage 6.13% of the total energy was saved at full load of 10KW diesel engine. J.Jia and W.Lee [31] did experimental investigations on using phase change material for performance improvement of storage-enhanced heat recovery room air-conditioner. They did two identical sets of experiments in which one of them was without PCM and the other contained graphite/paraffin as PCM. The results show that the overall coefficient of performance was higher in the PCM-set and the water tank kept its heat for a longer time (20% more).

2.2.3 Heating

Khaled et al [32] did a parametric study on HRS from exhaust gases of a 500KVA generator. For the purpose of heating water, a counter flow concentric heat exchanger was introduced to transfer heat from gases to water in which

two flow patterns were employed. The first pattern was water inside tubes and gases in the annulus and the second pattern is the reverse. For a different diameter ratio of the tubes of the heat exchanger and different mass flow rate of water the outlet temperature of water were recorded, thus the heat rate was calculated. The results shows that water inside tubes and gas are in the annulus with diameter ratio of 0.75 is the most efficient configuration with maximum heat captured (26KW). Also wasted heat from chimneys is a good source to produce domestic hot water. In [33] the authors developed an experimental analysis of heating water from waste heat of a chimney. The water tank is filled in water and the exhaust gases passes through those pipes. The tank was above the brazier in which water in tank gain heat by convection and radiation from the brazier and by convection through the pipes. The water temperature increased from 10 °C to 78 °C in one hour at a variable exhaust gas temperature 350 °C at start to 175 °C at the end of the experiment. It was noted that 70% of heat gained was from the convection and radiation part from the brazier. Ramadan et al [34] performs a study on heat recovery from HVAC system to produce domestic hot water from the condenser. A complete thermal modeling for the system was provided as well as a parametric analysis for different mass flow rates of water and air. An iterative code was applied which shows that water can achieve relatively high temperature 70 °C and at a flow rate of 0.01 Kg, water temperature increased 43 °C and the cooling load increase from 3.5 KW to 63 KW.

2.2.2 Generating electricity

As previously mentioned the temperature of the waste gas determine the required process to be used. In some application the wasted heat gases may have very high temperature that can be used for generating electricity by generating steam for an ordinary Rankine cycle as shown in fig 5 (b). The generated steam flows to the turbine where heat energy transfer to mechanical energy in order to be converted to electric energy at the generator. For lower temperature organic Rankine cycle or Stirling cycle is utilized. However for relatively low to medium temperatures thermoelectric generators (TEG) can be utilized. TEG are passive device that convert heat energy to electric energy. The major drawback for thermoelectric generators is the low efficiency (typically 5%). It can also be used for refrigeration using vapor adsorption cycle. In [35] a review on car waste heat recovery systems utilizing thermoelectric generators and heat pipes is presented. In [36] the authors present a review on thermo-electric generators that deals with the manufacturing process, feasibility study and material properties.

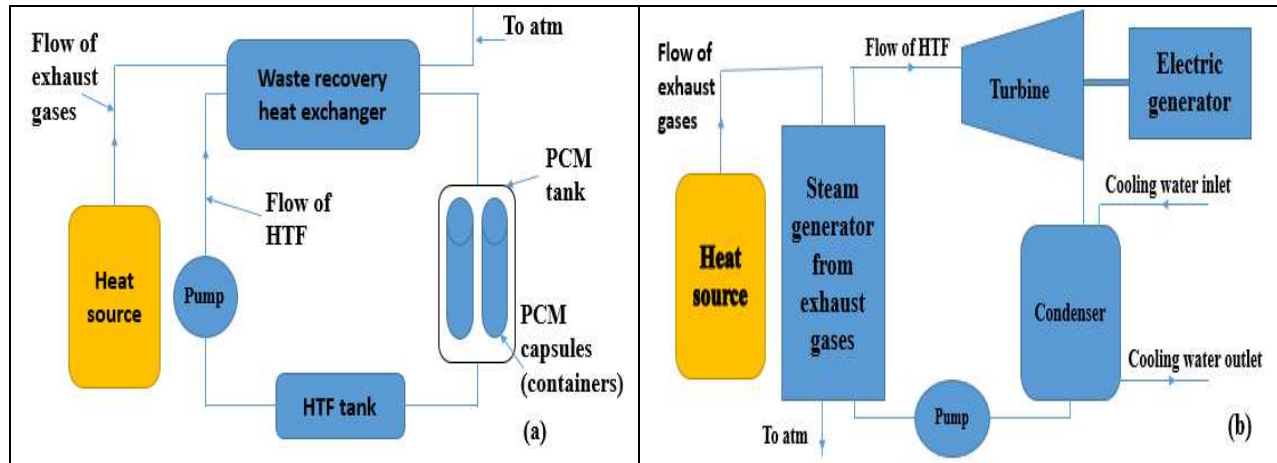

FIGURE 6. Schematic diagram for: (a) heat recovery using PCM; (b) heat recovery using Rankine cycle [37, 38].

2.2.4 Cooling

Vapor absorption cycle can upgrade wasted heat energy with a low electrical energy input [39]. In [40] a performance investigation in an adsorption cycle powered by waste heat for supplying shipboard is presented. A model for the system was constructed and stimulated under different weather conditions. The results show that the system has relatively high coefficient of performance compared to vapor compression cycle.

3. CONCLUSION

Exhaust gas is a huge source of energy that if recovered can highly reduce the energy consumption as well as pollution level. Exhaust gas heat recovery concepts can be classified within several categories. This paper proposes three different classifications for exhaust gas heat recovery systems. The first category is the classification according to the gas temperatures. Three different classes are considered depending on the temperature range, low temperature system, medium temperature systems and high temperature system. The second classification suggests a classification with respect to the utilized heat recovery device. Several devices were presented and the operational mode of each is described. The third category is based on the heat recovery purposes where the systems are classified within three categories that are heating, generating electricity and cooling.

REFERENCES

1. H. Chaudhry, B. Hughes, and S. Ghani, A review of heat pipe systems for heat recovery and renewable energy applications, *Renewable and Sustainable Energy Reviews*, Volume 16, Issue 4, May 2012, Pages 2249-2259
2. R. Baños, F. Agugliaro, F.G. Montoya, C. Gil, A. Alcayde, and J. Gómez, Optimization methods applied to renewable and sustainable energy: A review, *Renewable and Sustainable Energy Reviews*, Volume 15, Issue 4, May 2011, Pages 1753-1766
3. M. Kassai, A developed method for energy saving prediction of heat-and energy recovery units, *Energy Procedia*, volume 85, (2016), 311 – 319
4. M. Kassaia, M. Nasrb, and C. Simonson, A developed procedure to predict annual heating energy by heat- and energy-recovery technologies in different climate European countries, *Energy and Buildings*, volume 109, 15 December 2015, Pages 267–273
5. E. Strantzali, and K. Aravossis, Decision making in renewable energy investments: A review, *Renewable and Sustainable Energy Reviews*, Volume 55, March 2016, Pages 885-898
6. V. Khare, S. Nema, and P. Baredar, Solar–wind hybrid renewable energy system: A review, *Renewable and Sustainable Energy Reviews*, Volume 58, May 2016, Pages 23-33
7. S.K. Sahoo, Renewable and sustainable energy reviews solar photovoltaic energy progress in India: A review, *Renewable and Sustainable Energy Reviews*, Volume 59, June 2016, Pages 927-939
8. L. Szarka and J. Ádám, “A megújuló energiafajták környezeti hatásainak összehasonlíthatóságáról” (in Hungarian), *Környezet és Energia Konferencia*, ISBN 978-963-7064-20-3, p. 7–12 (2009).
9. M. Remeli, L. Tan, A. Date, B. Singh , and A. Akbarzadeh, Simultaneous power generation and heat recovery using a heat pipe assisted thermoelectric generator system, *Energy Conversion and Management*, Vol 91 (2015) 110–119
10. D. ling, H. wei, X. Gang, Y. ping, L. zhen, Efficient waste heat recovery system of power plant boiler, *East China Electric Power*, vol.41, Jan. 2013, pp. 200-400
11. H. Aghaali, , and H. Ångström, A review of turbocompounding as a waste heat recovery system for internal combustion engines, *Renewable and Sustainable Energy Reviews*, Volume 49, September 2015, Pages 813–824
12. J. Liu, Q.Yu, J. Peng, X. Hu, and W. Duan, Thermal energy recovery from high-temperature blast furnace slag particles, *International Communications in Heat and Mass Transfer*, Volume 69, December 2015, Pages 23–28
13. W. Wu, B. Wang, W. Shi, and X. Li, An overview of ammonia-based absorption chillers and heat pumps, *Renewable and Sustainable Energy Reviews*, Volume 31, March 2014, Pages 681–707
14. G. Oluleye, , R. Smith, and M. Jobson, Modelling and screening heat pump options for the exploitation of low grade waste heat in process sites, *Applied Energy*, Volume 169, 1 May 2016, Pages 267–286
15. B.K. Singh, and N. Shrivastava, Exhaust Gas Heat Recovery for C.I Engine-A Review, *International journal of engineering sciences and research technology*, volume 3(11): November, 2014.
16. J. S. Jadhao, and D. G. Thombare, Review on Exhaust Gas Heat Recovery for I.C. Engine, *International Journal of Engineering and Innovative Technology (IJEIT)* Volume 2, Issue 12, June 2013
17. A. J. Chaudhari, V. D. Patel, and R. D. Jilte, Design and Experimental Performance Evaluation of Heat Exchanger Installed to Recover Exhaust Heat from Chimney to Supply Dry and Hot Air Required in a Bread/Biscuit Production Processes, *International Journal of Engineering Research and Applications* 2012
18. M.F Remeli , L. Kiatbodin, B. Singh ,b , K. Verojporn, A. Date, and A. Akbarzadeh, Power generation from waste heat using Heat Pipe and Thermoelectric Generator, *Energy Procedia*, volume 75, (2015), 645 – 650

19. S. Yoon, S. Lee, and G. Go, Evaluation of thermal efficiency in different types of horizontal ground heat exchangers, *Energy and Buildings*, Volume 105, 15 October 2015, Pages 100–105
20. S.M. Sadrameli, Mathematical models for the simulation of thermal regenerators: A state-of-the-art review, *Renewable and Sustainable Energy Reviews*, Volume 58, May 2016, Pages 462–476
21. F. Fathieh, R.W. Besant, R.W. Evitts, and C.J. Simonson, Determination of air-to-air heat wheel sensible effectiveness using temperature step change data, *International Journal of Heat and Mass Transfer*, Volume 87, August 2015, Pages 312–326
22. H. Hajabdollahia, M. Naderib, and S. Adimic, comparative study on the shell and tube and gasket-plate heat exchangers: The economic viewpoint, *Applied Thermal Engineering*, volume 92, 5 January 2016, Pages 271–282
23. O. Giurgiu, A. Pleșa, and L. Socaciu, Plate Heat Exchangers – Flow Analysis through Mini Channels, *Energy Procedia*, Volume 85, January 2016, Pages 244–251
24. T. Lua, X. Lüa, C. Kibertb, and J. Puttonena, The application of linear regression and the power law relationship of air-side heat transfer with field measurements to model the performance of run-around heat recovery systems, *Energy and Buildings*, Volume 110, 1 January 2016, Pages 453–467
25. L. Ni, J. Dong, Y. Yao, C. Shen, D. Qv, and X. Zhang, A review of heat pump systems for heating and cooling of buildings in China in the last decade, *Renewable Energy*, Volume 84, December 2015, Pages 30–45
26. S. Hama, M. Kima, B. Choib, and J. Jeong, Energy saving potential of various air-side economizers in a modular data center, *Applied Energy*, Volume 138, 15 January 2015, Pages 258–275
27. J. Hua, , G. Li, Y. Chen, X. Zhao, and Q. Li, Optimization of thermal parameters of boiler in triple-pressure Kalina cycle for waste heat recovery, *Applied Thermal Engineering*, volume 91, 5 December 2015, Pages 1026–1031
28. S. Brückner, S. Liu, L. Miró, M. Radspieler, L. Cabeza, and E.Lävemann, Industrial waste heat recovery technologies: An economic analysis of heat transformation technologies, *Applied Energy*, Volume 151, (2015), 157–167
29. J. Shon, H. Kim, and K. Lee, Improved heat storage rate for an automobile coolant waste heat recovery system using phase-change material in a fin–tube heat exchanger, *Applied Energy*, volume 113, January 2014, Pages 680–689
30. K.N.Gopal, R. Subbarao, V.Pandiyarajan, and R. Velraj, Thermodynamic Analysis of a Diesel Engine Integrated with a PCM Based Energy Storage System, *Int. Journal of Thermodynamics*, Vol. 13, March 2010, pp. 15–21
31. J. Jia, and W. Lee, Experimental investigations on using phase change material for performance improvement of storage-enhanced heat recovery room air-conditioner, *Energy*, volume 93, Part 2, 15 December 2015, Pages 1394–1403
32. M.Khaled, M. Ramadan, and H. El Hage, Parametric Analysis of Heat Recovery from Exhaust Gases of Generators, the 7th International Conference on Applied Energy (2015).
33. M.Khaled, M.Ramadan, K.Chahine, and A.Assi, Prototype implementation and experimental analysis of water heating using recovered waste heat of chimneys, *Case Studies in Thermal Engineering*, volume 5, (2015) 127–133.
34. M. Ramadan , M. Gad El Rab , M. Khaled, Parametric analysis of air–water heat recovery concept applied to HVAC systems: Effect of mass flow rates, *Case Studies in Thermal Engineering*, volume 6, (2015), 61–68
35. B. Orr , A. Akbarzadeh , M. Mochizuki, and R. Singh, review of car waste heat recovery systems utilizing thermoelectric generators and heat pipes, *Applied Thermal Engineering* (2015)
36. S. LeBlanc, Thermoelectric generators: Linking material properties and systems engineering for waste heat recovery applications, *Sustainable Materials and Technologies*, volume 1–2, (2014), 26–35.
37. M.A. Izquierdo-Barrientos, C. Sobrino, J.A. Almendros-Ibáñez, Experimental heat transfer coefficients between a surface and fixed and fluidized bed with PCM, *Applied Thermal Engineering*, Volume 78, 2015, Pages 373–379.
38. S. Thapa, E. Borquist, A. Baniya, and L. Weiss, Experimental and computational investigation of a MEMS-based boiler for waste heat recovery, *Energy Conversion and Management*, volume 100, 2015, 403–413
39. P. Donnellan, K. Cronin, and E. Byrne, Recycling waste heat energy using vapor absorption heat transformers: A review, *Renewable and Sustainable Energy Reviews*, volume 42, (2015), 1290–1304
40. T. Caoa, H. Leea, Y. Hwanga, R. Radermachera, and H. Chunb, Performance investigation of engine waste heat powered absorption cycle cooling system for shipboard applications, *Applied Thermal Engineering*, Volume 90, 5 November 2015, Pages 820–830

1.2 Revue des techniques de récupération de la chaleur perdue dans les applications domestiques

Hisham Elhage, Mohamad Ramadan, Hassan Jaber, Mahmoud Khaled et Abdul Ghani Olabi

Cette étude est publiée dans « **Energy Sources, Part A : Recovery, Utilization, and Environmental Effects** »

Résumé - La crise énergétique à laquelle nous sommes confrontés aujourd'hui présente plusieurs aspects. En effet, cela ne concerne pas seulement le coût et la réserve de carburant, mais également le niveau de pollution. C'est la raison pour laquelle les trois dernières décennies ont déployé des efforts considérables pour trouver de nouvelles solutions adéquates permettant de surmonter les effets négatifs de cette crise. La situation générale montre que la plupart des solutions s'inscrivent dans le cadre des ressources renouvelables. Cela dit, une autre approche qui attire de plus en plus d'intérêts est la récupération de chaleur. Du point de vue de la stratégie énergétique, la récupération de la chaleur perdue pourrait être considérée comme une solution complémentaire aux systèmes renouvelables. Dans ce cadre, le présent document vise à mettre en évidence le concept de récupération de chaleur appliqué aux systèmes domestiques. Ce document est une brève revue qui examine essentiellement quatre applications principales : la récupération de chaleur des gaz d'échappement des cheminées, la récupération de chaleur des cuisinières, la récupération de chaleur des générateurs électriques et la récupération de la chaleur des eaux usées.



A short review on the techniques of waste heat recovery from domestic applications

Hicham El Hage^{a,b}, Mohamad Ramadan^{a,b,c}, Hassan Jaber^{a,b}, Mahmoud Khaled^{a,b,d}, and Abdul Ghani Olabi^{e,f}

^aSchool of Engineering, International University of Beirut, BIU, Beirut, Lebanon; ^bLebanese International University, LIU, Beirut, Lebanon; ^cAssociate members at FCLAB, CNRS, Univ. Bourgogne Belfort cedex, France; ^dUniv Paris Diderot, Sorbonne Paris Cité, Interdisciplinary Energy Research Institute (PIERI), Paris, France; ^eSustainable and Renewable Energy Engineering, University of Sharjah, Sharjah, UAE; ^fMechanical Engineering and Design, School of Engineering and Applied Science, Aston University, Birmingham, UK

ABSTRACT

The energy crisis we are facing today has several aspects. Indeed, it not only concerns the fuel cost and reserve but also the level of pollution. That is why the last three decades had shown a tremendous effort to come up with new adequate solutions allowing to overcome the negative impact of this crisis. The anatomy of the overall situation shows that most of the solutions fall within the frame of renewable resources. That said, another approach is attracting increasing interests that is heat recovery. From energy strategy stand point, recovering waste heat could be considered as a complementary solution with renewable systems. In this frame, the present paper aims at highlighting the concept of heat recovery applied to domestic systems. The paper is a short review that essentially investigates four main applications, heat recovery from exhaust gas of chimneys, heat recovery from cook stove, heat recovery from electric generators and heat recovery from drain water.

ARTICLE HISTORY

Received 19 October 2018
Revised 10 April 2019
Accepted 29 April 2019

KEYWORDS

Heat Recovery; renewable energy; waste heat; energy management; cogeneration

Introduction

The technological revolution that has occurred in last century especially in the domain of engineering has offered plenty of advantages in all branches of applied science; however, it had initiated an increasing crisis of energy with complicated impact at economic and environmental level. Energy management, energy recovery (Abam et al. 2018; Chahine et al. 2016; Chinnapandian et al. 2015; El Mays et al. 2017a; Jaber et al. 2018a; Krokida and Bisharat 2004; Liu 2018; Mago 2012; Nam-Chol et al. 2018; Ngusale et al. 2017; Ramadan et al. 2017; Ramadan, Khaled, and El Hage 2015; Su et al. 2018; Wei et al. 2011) and renewable energy (Ahmad and Rashid 2010; El Hage et al. 2018; El Mays et al. 2017b; Hachem et al. 2017; Haddad et al. 2016; Herez et al. 2016; Herez, Ramadana, and Khaled 2018; Jaber et al. 2018b; Khaled et al. 2016a; Orosa, García-Bustelo, and Oliveira 2012; Ramadan et al. 2016b; Shen, Wu, and Shi 2015) are the main solutions that can reduce the impact of fossil fuel depletion. On the other hand, heat recovery (Jaber et al. 2017a, 2017b, 2016; Khaled and Ramadan 2017, 2016; Khaled et al. 2015; Khaled, Ramadan, and El Hage 2015; Khaled, Ramadan, and El-Rab 2014; Ramadan, Gad El Rab, and Khaled 2015; Ramadan and Khaled 2014; Ramadan, Lemenand, and Khaled 2016; Ramadan et al. 2016c) is also a promising solution. It is defined as the re-usage of dissipated thermal energy. Power generation, heating, cooling and heat storage systems are among the main applications of heat recovery (Khaled, Ramadan, and El Hage 2016). Such technology can

be implemented using heat exchangers (Khaled et al. 2016b; Kumar, Kumar, and Tyagi 2013; Ramadan et al. 2016a) that are generally selected depending on the nature of the application.

From a practical point of view, the concept domestic heat recovery has high potential because it could be applied to almost each house in very simple methods. In this context, the present paper is devoted to present a short review on heat recovery from domestic applications. The remaining part of this paper is organized as follows. Section 2 presents heat recovery technology applied on domestic applications. Section 3 discusses heat recovery from exhaust gases of a chimney, stove and electric generator. In Section, 4 heat recovery from drain water is examined. Section 5 is dedicated to present advantages and barriers of heat recovery from domestic application coupled with recommendations. Finally concluding remarks are summarized in the conclusion.

Residential heat recovery

Many residential applications dissipate energy in the form of heat captured in exhaust gases or water. Figure 1 shows the main applications or sources of energy lost that can be utilized for recovery process.

Heat dissipated can be in the form of sensible and latent heat contents that can be utilized in recovery process. The sensible (Q_s) and latent (Q_L) amount of heat can be calculated as follows:

$$Q_s = \dot{m}_{ex} \cdot C_p \cdot \Delta T \quad (1)$$

$$Q_L = \dot{m}_{ex} \cdot h_{fg} \quad (2)$$

where \dot{m}_{ex} and C_p are the mass flow rate ($\text{kg}\cdot\text{s}^{-1}$) and specific heat at constant pressure ($\text{J}\cdot\text{kg}^{-1}\cdot\text{K}^{-1}$), respectively, ΔT is the temperature difference (K) and h_{fg} is the latent heat of fusion ($\text{kJ}\cdot\text{kg}^{-1}$). Quality and quantity of energy dissipated directly affect the recovery process. In addition to that thermal conductivity, convection coefficient, allowable pressure drop, density and viscosity play a crucial role in recovery.

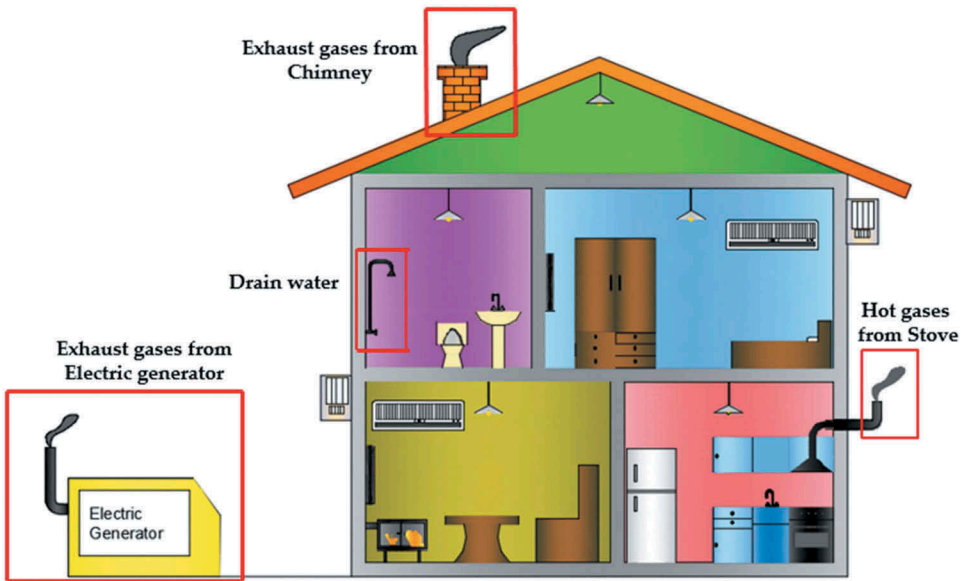

Figure 1. Domestic sources of heat dissipated.

The heat dissipated can be utilized directly or indirectly to heat another fluid or stream. In addition to that, recovery process can be implemented for various purposes. Table 1 summarizes the main sources of heat dissipated, means and purposes of recovery.

Heat recovery from exhaust gases of domestic applications

It is obvious that applications providing exhaust gas (Buczynski et al. 2016b; Kolasinska and Kolasinski 2016) represent the highest potential for heat recovery due to the high temperature at which the combustion occurs. Having said that few are the domestic systems that involve exhaust gas. In general, the main residential applications that could be considered to recover heat from exhaust gas are chimney, cook stoves and electric generators.

Heat recovery from domestic chimney

Two applications are generally applied to recover heat from chimney, heating water or (and) generating electricity using TEGs. Since water heaters are the main residential electric consumer, heating water from dissipated thermal energy is a real benefit. Such heat recovery technology can be applied by means of heat exchangers such as shell and tubes, plate, thermal wheel heat exchangers or even using heat pipe or heat pump. It could be a simple or complicated heat recovery system depending on the temperature and flow rate of exhaust gases. The main problem faces such system is the condensation of some harmful gases carried which would lead to corrosion and decrease the life time of the heat exchanger. Thermoelectric generators are passive devices that directly convert thermal energy to electric energy which is known as solid state energy conversion devices. When a TEG is subjected to a temperature difference, an induced voltage is generated. Thermoelectric generators are composed of P- and N-type semiconductors that are connected electrically in series thermally in parallel between a heat source and heat sink (Figure 2). Such devices are widely studied in heat recovery system since they are reliable, silent and simple. However, they have high cost and low efficiency (typically 5%). TEG's most popular form is made up of bismuth telluride and for high operating temperature thermoelectric generators they are made up of lead telluride and calcium manganese. Ewa and Piotr Kolasinska (Gao et al. 2016) performed a complete review on electroactive polymers for waste heat recovery. Different materials for thermoelectric devices are investigated as well as the heat sources and ways of heat recovery. The development of thermoelectric materials was related to the ZT values which witnessed three generations. The first generation has $ZT = 1$ and 4% to 5% energy conversion efficiency (ECE). The second generation reached $ZT = 1.7$ with ECE ranging between 11% and 15%. While the third generation which is under development achieved $ZT = 1.8$ with predicted ECE of 15% to 20%. In addition to that, the study presents review on inorganic and electroactive polymers material for heat recovery. Electroactive polymers can complement the alloy and oxide-based materials in low-grade heat recovery. The main advantages of electroactive polymers are

Table 1. Domestic sources, means and purposes of recovery.

Sources of dissipated energy	Means	Applications of recovery
<ul style="list-style-type: none"> ● Electric generator ● Diesel or wood ● chimney ● Stove ● Drain water ● Refrigerator ● Air conditioner 	<ul style="list-style-type: none"> ● Heat exchanger: <ul style="list-style-type: none"> ● Shell and tube ● Fixed plate ● Thermal wheel ● Tube fin ● Plate fin ● Heat pump ● Heat pipe 	<ul style="list-style-type: none"> ● Power generation: <ul style="list-style-type: none"> ● TEG ● Power cycle ● Heating: <ul style="list-style-type: none"> ● Fluid (water) ● Gases (air) ● Refrigeration: <ul style="list-style-type: none"> ● Absorption refrigeration ● cycle ● Power generation: <ul style="list-style-type: none"> ● Sensible ● Latent (phase change material)

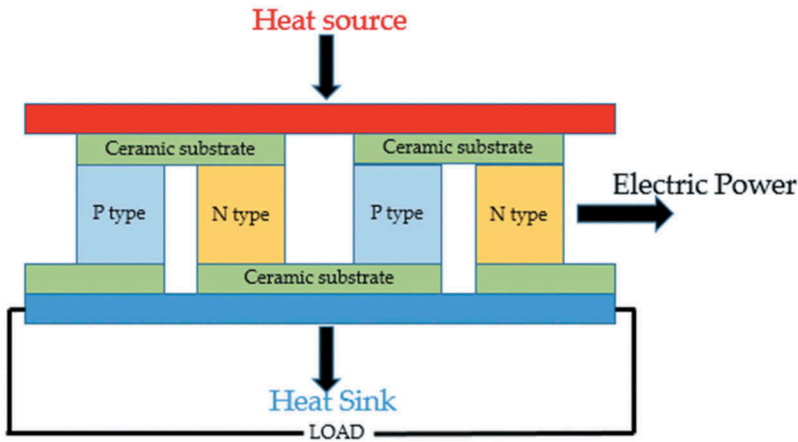

Figure 2. Thermoelectric generator.

summarized by low environmental impact, can be recycled and low cost. Polyaniline-based materials are the most favorable due to their thermal and chemical stability and low cost. Such thermoelectric generators can be used at low temperatures where inorganic materials are partially active. Polyaniline thermoelectric generators can be perfectly used in heat recovery from exhaust gases of domestic applications.

Jaber et al. (Khaled and Ramadan 2017) perform an optimization analysis on a domestic thermoelectric cogeneration system. As shown in Figure 3, the system utilizes exhaust gases of a chimney to generate electricity using TEGs and produce domestic hot water. The effect of changing the location of TEGs on the recovery process has been studied. Six configurations have been considered by which the TEGs are placed on the inner or outer walls of the tank or the pipe (cases 2–5), or on all of them (case 6). A thermal modeling of each case has been performed. Results show that about 200 L of water can be heated up to 76°C with 0.35 W electric power per TEG. In addition to that, it was shown that as the TEGs become nearer to exhaust gases they produce higher power but reduces water temperature. Moreover, a complete economic and environmental study is done showing a 1 year and 8 months as a payback period when the system is utilized 60 times per month and 6 tons of CO₂ gases are reduced yearly.

Khaled et al. (Ramadan and Khaled 2014) perform an experimental study on a heat recovery system from exhaust gas of chimney. A “multi- tube tank” system is utilized. It is composed of a tank and 6 tubes coaxially crossing the tank. Water is located inside the tank and exhaust gases passes through the tubes as shown in Figure 4. Exhaust gases flow through the copper tubes allowing heat transfer from gases to water. Results show that water temperature raises from 10°C to 78°C in 1 h when the exhaust gases are allowed to pass through tubes (enters the tank). However, when the exhaust gases are not allowed to enter the tubes (exhaust gases pass beside the lower part of the tank), heat transfers occur through conduction and radiation from the bottom of the tank to the water which led to an increase in water temperature from 10°C to 48°C in 1 h. Those results show that allowing exhaust gases to flow through pipes inside the tank increases water temperature by 30°C compared to what was obtained when exhaust gases just pass beside the bottom side of the tank.

Heat recovery from domestic cook stove

Cook stove is a rich source of waste heat. Similar to chimneys, its recovered heat is mainly utilized to heat water or generate electricity; however, in cook stove the recovery system is generally near the main heat resource whereas in chimney applications the heat recovery system is generally outside of the heated room. Figure 5 shows a representative schematic of a thermoelectric heat recovery system

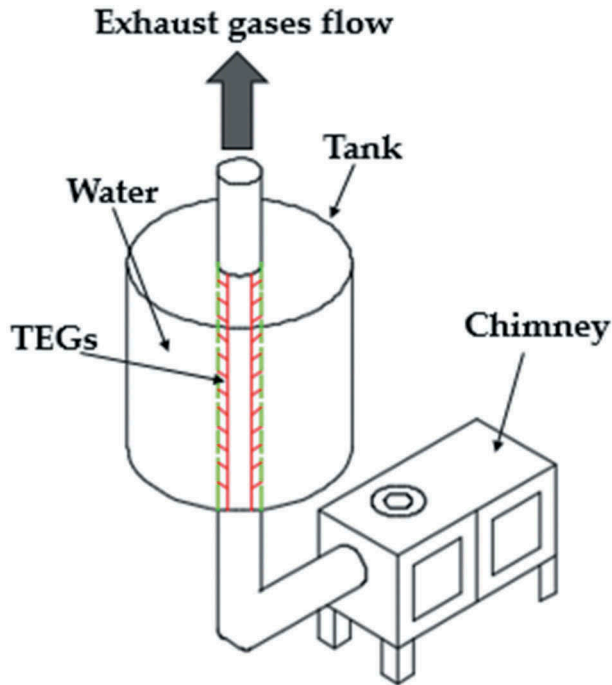

Figure 3. Cogeneration heat recovery system.

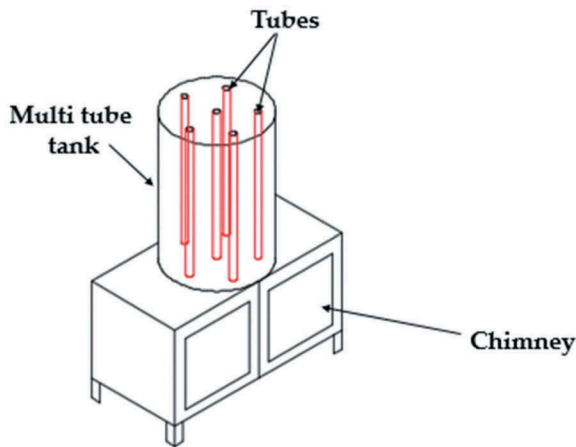

Figure 4. Heat recovery from chimney.

attached to a stove. The system is air cooled. To optimize the recovery process, a fan is placed at the cold side of the TEG to increase the heat transfer rate in order to increase the gradient of temperature trough both side of the TEG, as matter of fact the generated power increases.

Gao et al. (Aranguren et al. 2015) performed a review on heat recovery from stoves using thermoelectric generators. A thermal and electrical modeling of the TEGs is presented. Results show that it requires \$225 more to modify the conventional stove by TEGs and the payback period is 11 years. *Aranguren et al.* (Montecucco, Siviter, and Knox 2017) perform an experimental study on heat recovery from combustion chamber using TEGs. A prototype is constructed and it is capable to

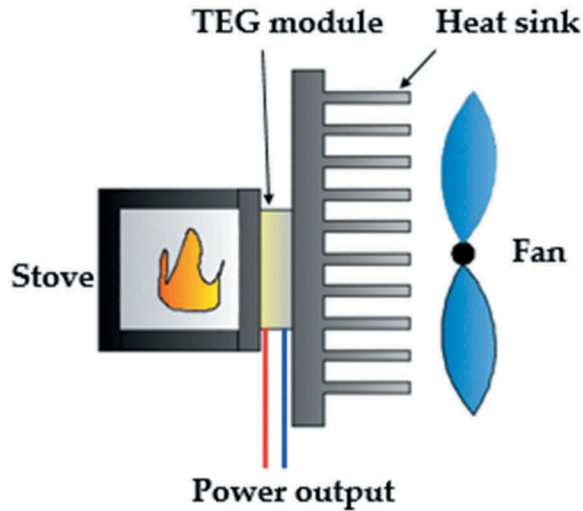

Figure 5. Air forced cooled thermoelectric heat recovery system.

produce 21.56 W as a net power. About 48 thermoelectric generators are attached to the system on a 0.25 m² area. Two heat sinks were developed in which one is a finned dissipater and the other is finned heat pipe. Chen et al. (2012) carried out an experimental study that utilizes exhaust gases of solid-fuel stove to heat water and produce electricity using TEGs to charge a lead-acid battery. A prototype (see Figure 6) has been implemented; the heat sink of the TEGs is water which will be heated and pumped to a water tank.

Four thermoelectric generators are attached to the system which generated about 27 W of electric power with 5% TEG efficiency. Also about 600 W thermal energy is been captured by water. Water temperature was nearly reached 50°C. An experimental study to develop a thermo-acoustic engine (TAE) that operates by waste heat of a cooking stove is conducted in Champier et al. (2011). Champier et al (Georges, Skreiberg, and Novakovic 2014) performed an experimental and theoretical study on thermoelectric generator coupled to wood stove. A thermal and electrical modelling of TEGs was carried. The thermoelectric generators recovery dissipated heat from exhaust gases to generate electricity with a water cooled thermoelectric module. The experimental and theoretical results are compatible. Results show that TEG module can produce up to 9.5 W. The authors report that such system can cost about 258 euro per single unit. The system is shown in Figure 7.

Table 2 shows the main studies done on heat recovery from exhaust gases of residential stoves.

Heat recovery from electric generators

Electric generators are widely utilized in countries that suffer from continuous electric cut off. Mainly about 65% of the energy generated from burning fuel is dissipated through exhaust gases, cooling water, friction, sound and others. About 40% of the dissipated thermal energy are carried by exhaust gases and 35% are carried though cooling fluid. In the last decades, recovering part of this dissipated energy has been a real interest for researchers. Depending on the size of the generator and the load exhaust gases temperature varies. Moreover, studies are carried to utilize the cooling fluid in recovery process (mainly heat water for domestic usage).

Khaled et al. (Amon et al. 2015) presented a parametric study that allows to measure the amount of heat recovered from an electric generator. A heat exchanger is selected by which water flows inside the annulus of the heat exchanger and exhaust gases flow in opposite direction through a concentric pipe passing through the heat exchanger. Thermal modeling of the system is carried and applied in 15 kVA

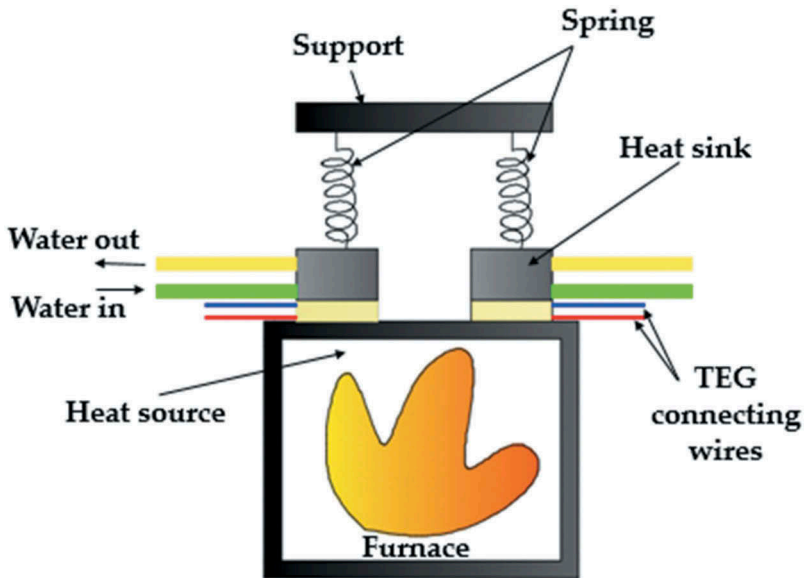

Figure 6. Heat recovery system applied to cook stove for power generation using TEGs.

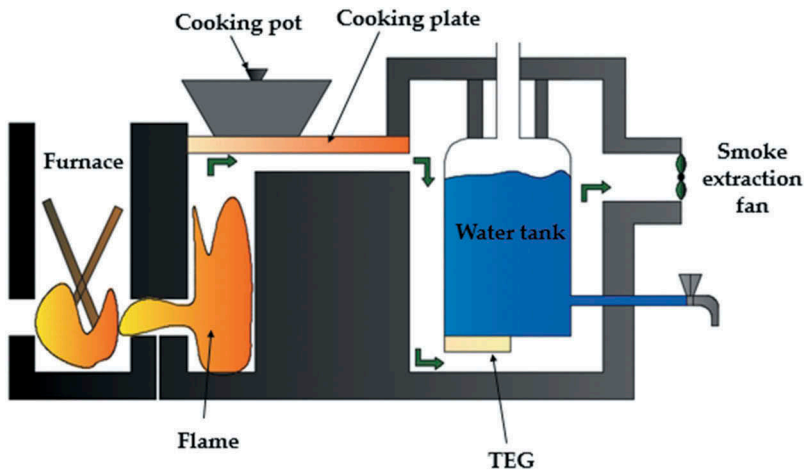

Figure 7. Modified conventional cook stove (hybrid heat recovery system).

electric generator. The flow rate of water is varied and the outlet water temperature is measured. Results show that water reached 50.5°C with 4.3 kW heat recovered. This heat rate is increased to 7.7 kW when the water flow rate is increased from 0.05 kg/s to 0.5 kg/s . In addition to that, the effect of changing the size of the electric generator on the water outlet temperature is studied. 15 kVA , 30 kVA , 60 kVA , and 180 kVA electric generators are studied. At 10°C and 0.4 kg/s inlet water temperature and flow rate, the outlet water temperature increases from 14.6°C for a 15 kVA generator to 39.4°C for a 180 kVA generator. Moreover, the heat rate increased from 7.7 kW to 49.15 kW .

Jaber et al. (Ramadan, Lemenand, and Khaled 2016) performed a study on effect of changing the exhaust gases temperature on the performance of a hybrid heat recovery system. This recovery system is utilized to generate electricity using TEGs and produce domestic hot water. A resistance thermal modeling is presented and the steps are shown in the Figure 8. This modeling is carried to obtain the

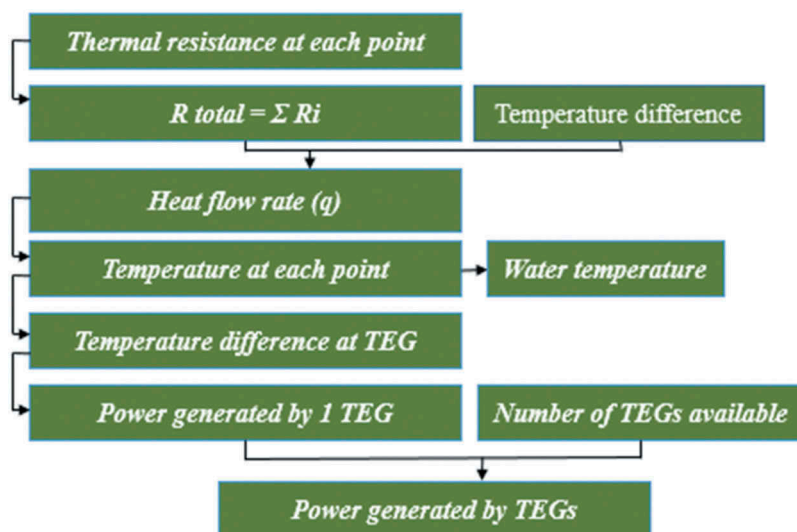

Figure 8. Resistance thermal modeling steps.

Table 2. Studies on heat recovery from exhaust gases of residential stoves.

Reference number	Authors	Title	Year of publication	Journal name	Type of study
(Buczynski et al. 2016b)	Kumar M Kumar S Tyagi SK	Design, development and technological advancement in the biomass cookstoves: A review	2013	Renewable and sustainable energy reviews	Review, modeling and experimental
(Aranguren et al. 2015)	Gao HB Huang GH Li HJ Qu ZG Zhang YJ	Development of stove-powered thermoelectric generators: A review	2015	Applied thermal engineering	Review
(Montecucco, Siviter, and Knox 2017)	Aranguren P Astrain D Rodríguez A Martínez A	Experimental investigation of the applicability of a thermoelectric generator to recover waste heat from a combustion chamber	2015	Applied energy	Experimental
(Chen et al. 2012)	Montecucco A Siviter J Knox AR	Combined heat and power system for stoves with thermoelectric generators	2015	Applied energy	Experimental
(Georges, Skreiberg, and Novakovic 2014)	Champier D Bédécarrats JP Kouksou T Rivaletto M Strub F Pignolet P	Study of a TE (thermoelectric) generator incorporated in a multifunction wood stove	2011	Energy	Modeling and experimental
(Buczynski et al. 2016a)	Georges L Skreiberg Y Novakovic V	On the proper integration of wood stoves in passive houses under cold climates	2013	Energy and buildings	Parametric
(Gogoi and Baruah 2016)	Buczynski R Weber R Kim R Schwoppe P	One-dimensional model of heat-recovery, non-recovery coke ovens. Part III: Upper-oven, down-comers and sole-flues	2016	Fuel	Modeling and parametric
(Raman, Ram, and Murali 2014)	Gogoi B Baruah DC	Steady state heat transfer modeling of solid fuel biomass stove: Part 1	2015	Energy	Modeling
(Khaled et al. 2018)	Raman P Ram NK Murali J	Improved test method for evaluation of bio-mass cook-stoves	2014	Energy	Review and modeling

outlet water temperature and power generated by TEGs. Results obtained show that as the exhaust gas temperature increases, heat rate and temperature at each layer of the heat exchanger increase linearly. In addition to that, the power generated by TEGs increases with the increase in gases temperature.

Heat recovery from drain water

Heat recovery from drain water is among the energy solutions that are being tremendously developed (Alnahhal and Spremberg 2016; Yang, Li, and Svendsen 2016). Particularly, a much and frequent quantity of energy is utilized by residential buildings in which this usage is illustrated excessively in domestic water heating (Culha et al. 2015). A considerable amount of heat is lost down into drains every year through various sources (Slyš and Kordana 2014) such as showers, baths, dishwasher ... That is why the concept of heat recovery could be optimally applied to drain water in residential applications. It can be seen as a smart strategy to increase the energy efficiency of a building, by heating cold water supply using the heat lost through drain water in other terms it is a pre-heating step that allows to decrease the needed amount of energy to reach the required temperature. Drain water heat recovery (DWHR) systems rely on increasing the temperature of cold water flow using a heat exchanger connected to sewages (Nardin et al. 2014). Figure 9 shows a schematic of DWHR system connected to a shower.

Different types of heat exchangers may be installed in DWHR systems in order to attain the best heat transfer rate (Manouchehri, C J, and M R 2015; S S and Maglionico 2014). The most common used configuration is presented in Figure 9. The cold flow circulates inside a spiral copper coil and extracts heat from the main drain pipe carrying the wasted hot water before falling into sewages. The quantity of heat transfer rate is directly affected by the hot and cold flows temperature and flowrates in addition to the heat transfer area (C M and Lubitz 2009). Different DWHR systems applications have been conducted and studied based on different heat exchanger types and installations in which they can be classified into direct and indirect systems and save energy up to 50% in some cases. Direct systems use a heat exchanger installed in order to recover the lost heat to heat water. However, indirect systems are usually coupled with a heat pump to improve recovery system's efficiency.

Direct systems

Direct systems are classified within three types that are vertical systems, horizontal systems and storage tank.

Vertical systems

This type of system uses a vertical heat exchanger installed to a drainage system (see Figure 10). Comparing this system with solar water heat, it was shown that DWHR systems are much effective in cost and energy savings (Beentjes, Manouchehri, and Collins 2014). The main parameters that affect the effectiveness of a vertical DWHR system are the boiler temperature, hot water flow rate, shower length and water consumption (Khaled and Ramadan 2016; McNabola and Shields 2013).

Horizontal systems

Horizontal systems (see Figure 11) use a counter-flow heat exchanger in which hot water exchanges its heat with a cold flow before drawing into sewages (L T, K W, and Guan 2010). As in the case of vertical system, the effectiveness of this configuration is also affected by hot and cold flowrates and temperature, in addition to shower time values (Torrás et al. 2016). It is remarked that this system was rarely used and installed due to its moderate energy saving amounts.

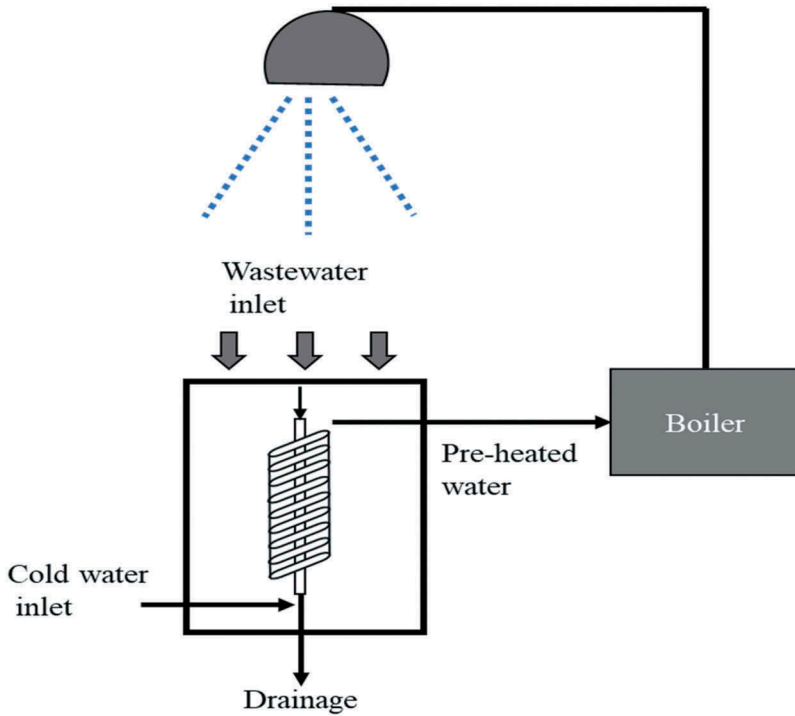

Figure 9. Schematic of DWHR system assisted in a shower.

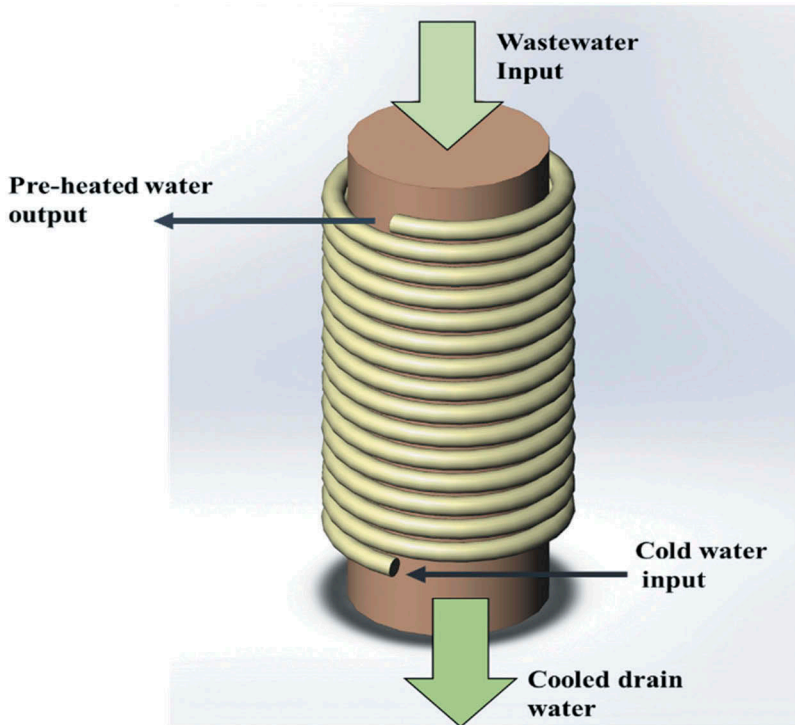

Figure 10. Vertical DWHR system installation.

Storage tank system

Storage tank-based systems store hot wastewater inside a tank for further usage (De Paepe et al. 2003). The cold-water flows inside the coiled heat exchanger extracting heat from hot water tank (Hepbasli et al. 2014; Spur et al. 2006). This system shows a capacity of recovering energy up to 60% from that available in drains. Figure 12 provides an illustration of storage tank system. The main advantage of such system with respect to the vertical and horizontal system is that the heat recovery is not necessarily instantaneous.

Indirect systems

Aside from heat exchanger configurations, DWHR systems could be coupled with a heat pump system (N C, U C, and Yoon 2005). The objective is to increase the COP of the heat pump. Enhancement percentage widely depends on heat source temperature and flowrates. Coupling heat pump and DWHR system shows some promising results in lowering power consumption as well as

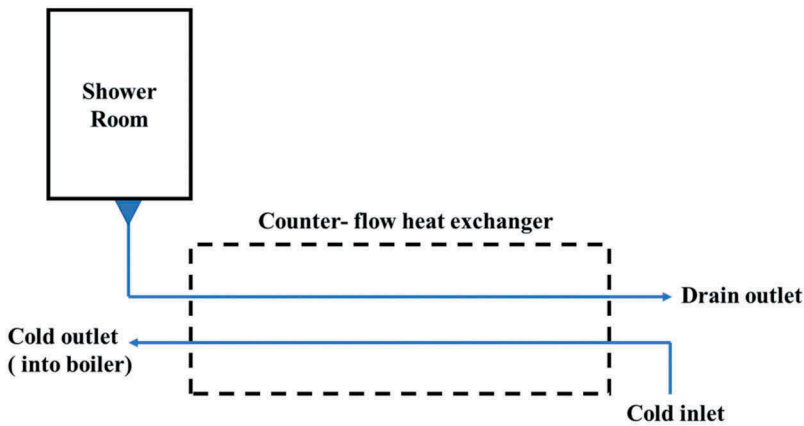

Figure 11. Horizontal DWHR system.

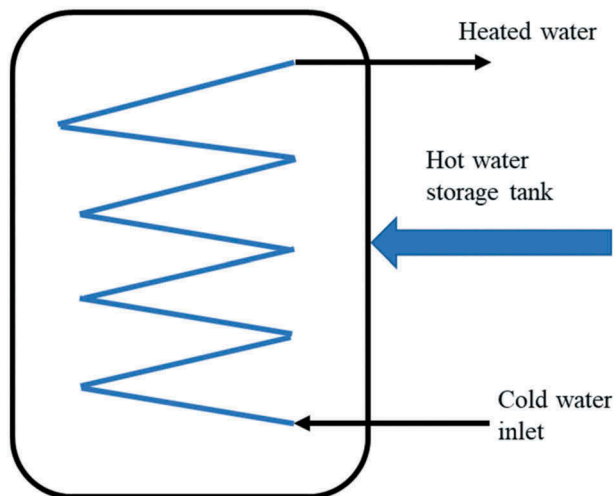

Figure 12. Storage tank-based DWHR system.

improving heat recovery system’s efficiency (Alaswad et al. 2015b; Liu, Fu, and Zhang 2014; Wallin and Claesson 2014). Figure 13 shows the heating and cooling mode of a heat pump assisted with a wastewater heat exchanger.

Discussion

Applying heat recovery concept on domestic applications is very promising. If a gain-loss balance is performed, we can summarize the result as follows:

Adopting heat recovery strategies in domestic applications offers three main advantages

- Reducing the global energy bill due to the fact that a part of the needed energy is covered by the recuperated heat.
- Providing a local source of heat without the need of having electrical source or a combustion process.
- Increasing the efficiency of the system by reducing the percentage of waste energy

On the other hand, applying heat recovery concepts faces several barriers

- Some heat recovery systems are specific and could be applied only in particular conditions. Typical example is heat recovery from exhaust gas of chimneys. Indeed, in many cities and regions electrical heating systems are adopted and thus heat recovery systems could not be installed.
- Recovering heat decreases the temperature of the exhaust gas and as a matter of fact a pressure drop occurs which may affect the flow of the exhaust gas.
- Installing heat recovery systems requires enough space which is not available in many building.
- Decreasing the temperature of exhaust gas may cause deposit of solids particles that require a regular maintenance of the exhaust pipes.

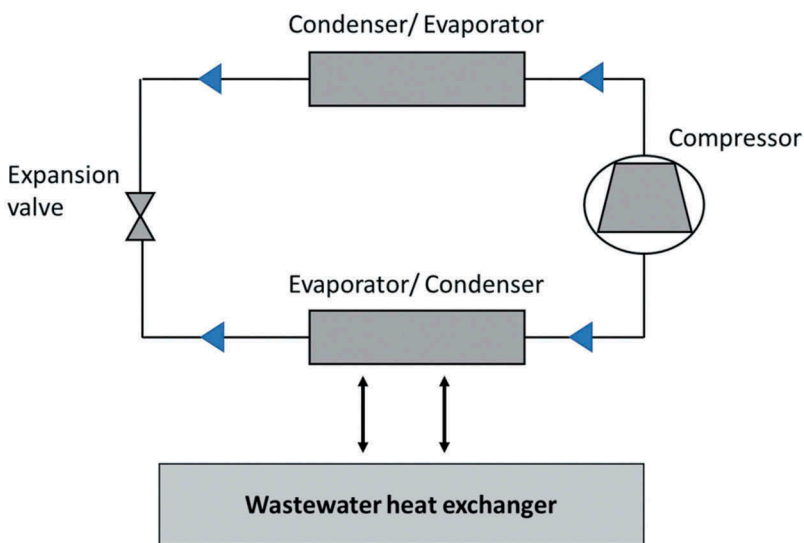

Figure 13. A wastewater source heat pump.

Recommendations

- As it has been discussed through this review, heat recovery can be applied in many engineering systems even in residential building. Indeed, most of the existing research works have been dedicated to investigate specific type of heat recovery; however, to increase the efficiency of heat recovery it is recommended to study hybrid systems combining several heat recovery concepts at the same time.
- An optimal energy strategy could be adopted by combining heat recovery with energy storage system such as fuel cell (Montingelli et al. 2016; Rodriguez et al. 2015; Tedesco, Barroso, and Olabi 2014; Wilberforce et al. 2016).
- It is also recommended to couple renewable sources such as biomass (Alaswad et al. 2015a-82) with heat recovery concepts to reduce the energy consumption.

Conclusion

Heat recovery could be considered as one of the most promising solutions to decrease the negative repercussions of the energy crisis. This paper draws a quick representative illustration of heat recovery concept focused on domestic applications. Three different domestic waste heat sources are examined. Heat recovery from exhaust gas of chimneys is very beneficial due to the huge amount of available energy in the exhaust gas. Recuperated heat is generally used to heat water. That said, heat recovery from stoves is pretty similar to that from chimney. Recovered heat is mostly utilized to generate electricity using TEG in addition to water heating. On the other hand, drain water contains high potential of energy that could be used directly to preheat water where two main configurations are adopted, horizontal and vertical. An indirect approach is also examined where the recovered heat is utilized to enhance the efficiency of heat pumps.

References

- Abam, F. I., T. A. Briggs, E. B. Ekwe, C. G. Kanu, S. O. Effiom, M. C. Ndukwu, S. O. Ohunakin, and M. I. Ofem. 2018. Exergy analysis of a novel low-heat recovery organic Rankine cycle (ORC) for combined cooling and power generation. *Energy Sources, Part A: Recovery, Utilization, and Environmental Effects*. doi:10.1080/15567036.2018.1549140.
- Ahmad, I., and A. Rashid. 2010. Study of geothermal energy resources of pakistan for electric power generation. *Energy Sources, Part A: Recovery, Utilization, and Environmental Effects* 32 (9):826–38. doi:10.1080/15567030802606210.
- Alaswad, A., A. Baroutaji, H. Achour, J. Carton, A. Al Makky, and A. G. Olabi. 2015a. Developments in fuel cell technologies in the transport sector. *International Journal of Hydrogen Energy* 41 (37):16499–508. doi:10.1016/j.ijhydene.2016.03.164.
- Alaswad, A., M. Dassisti, T. Prescott, and A. G. Olabi. 2015b. Technologies and developments of third generation biofuel production. *Renewable and Sustainable Energy Reviews* 51:1446–60. doi:10.1016/j.rser.2015.07.058.
- Alnahhal, S., and E. Spremberg. 2016. Contribution to exemplary in-house wastewater heat recovery in Berlin, Germany. *Procedia CIRP* 40:35–40. doi:10.1016/j.procir.2016.01.046.
- Amon, R., M. Maulhardt, T. Wong, D. Kazama, and C. W. Simmons. 2015. Waste heat and water recovery opportunities in California tomato paste processing. *Applied Thermal Engineering* 78:525–32. doi:10.1016/j.applthermaleng.2014.11.081.
- Aranguren, P., D. Astrain, A. Rodríguez, and A. Martínez. 2015. Experimental investigation of the applicability of a thermoelectric generator to recover waste heat from a combustion chamber. *Applied Energy* 152:121–30. doi:10.1016/j.apenergy.2015.04.077.
- Beentjes, I., R. Manouchehri, and M. R. Collins. 2014. An investigation of drain-side wetting on the performance of falling film drain water heat recovery systems. *Energy Build* 82:660–67. doi:10.1016/j.enbuild.2014.07.069.
- Buczynski, R., R. Weber, R. Kim, and P. Schwoppe. 2016a. One-dimensional model of heat-recovery, non-recovery coke ovens. Part III: Upper-oven, down-comers and sole-flues. *Fuel* 181:1132–50. doi:10.1016/j.fuel.2016.01.087.
- Buczynski, R., R. Weber, R. Kim, and P. Schwöppe. 2016b. One-dimensional model of heat-recovery, non-recovery coke ovens. Part II: Coking-bed sub-model. *Fuel* 181:1115–31. doi:10.1016/j.fuel.2016.01.086.



- C M, L., and W. D. Lubitz. 2009. Comparing domestic water heating technologies. *Technology in Society* 31:244–56. doi:10.1016/j.techsoc.2009.06.005.
- Carton, J. G., and A. G. Olabi. 2015. Representative model and flow characteristics of open pore cellular foam and potential use in proton exchange membrane fuel cells. *International Journal of Hydrogen Energy* 40 (16):5726–38. doi:10.1016/j.ijhydene.2015.02.122.
- Carton, J. G., and A. G. Olabi. 2017. Three-dimensional proton exchange membrane fuel cell model: Comparison of double channel and open pore cellular foam flow plates. *Energy* 136:185–95. doi:10.1016/j.energy.2016.02.010.
- Chahine, K., M. Ramadan, Z. Merhi, H. Jaber, and M. Khaled. 2016. Parametric analysis of temperature gradient across thermoelectric power generators. *Journal of Electrical Systems* 12-3:623–32.
- Champier, D., J. P. Bédécarrats, T. Kouksou, M. Rivaletto, F. Strub, and P. Pignolet. 2011. Study of a TE (thermoelectric) generator incorporated in a multifunction wood stove. *Energy* 36:1518–26. doi:10.1016/j.energy.2011.01.012.
- Chen, B. M., Y. A. Abakr, P. H. Riley, and D. B. Hann. 2012. Development of thermoacoustic engine operating by waste heat from cooking stove. *AIP Conf. Proc* 1440:532–40.
- Chinnapandian, M., V. Pandiyarajan, A. Prabhu, and R. Velraj. 2015. Experimental investigation of a cascaded latent heat storage system for diesel engine waste heat recovery. *Energy Sources, Part A: Recovery, Utilization, and Environmental Effects* 37 (12):1308–17. doi:10.1080/15567036.2011.586974.
- Culha, O., H. Gunerhan, E. Biyik, O. Ekren, and A. Hepbasli. 2015. Heat exchanger applications in wastewater source heat pumps for buildings: A key review. *Energy Build* 104:215–32. doi:10.1016/j.enbuild.2015.07.013.
- De Paepe, M., E. Theuns, S. Lenaers, and J. Van Loon. 2003. Heat recovery system for dishwashers. *Applied Thermal Engineering* 23:743–56. doi:10.1016/S1359-4311(03)00016-4.
- El Hage, H., A. Herez, M. Ramadan, H. Bazzi, and M. Khaled. 2018. An investigation on solar drying: A review with economic and environmental assessment. *Energy* 157:815–29. A. Herez, M. Khaled, R. Murr, A. Haddad, H. Elhage, M. Ramadan. Using Geothermal Energy for cooling - Parametric study. *Energy Procedia*. 119, 2017, 783-791. doi:10.1016/j.energy.2018.05.197.
- El Mays, A., R. Ammar, M. Hawa, M. Abou Akroush, F. Hachem, M. Khaled, and M. Ramadan. 2017a. Using phase change material in under floor heating. *Energy Procedia* 119:806–11. doi:10.1016/j.egypro.2017.07.101.
- El Mays, A., R. Ammar, M. Hawa, M. Abou Akroush, F. Hachem, M. Khaled, and M. Ramadan. 2017b. Improving photovoltaic panel using finned plate of aluminum. *Energy Procedia* 119:812–17. doi:10.1016/j.egypro.2017.07.103.
- Gao, H. B., G. H. Huang, H. J. Li, Z. G. Qu, and Y. J. Zhang. 2016. Development of stove-powered thermoelectric generators: A review. *Applied Thermal Engineering* 96:297–310. doi:10.1016/j.applthermaleng.2015.11.032.
- Georges, L., Y. Skreiberg, and V. Novakovic. 2014. On the proper integration of wood stoves in passive houses under cold climates. *Energy Build* 72:87–95. doi:10.1016/j.enbuild.2013.12.023.
- Gogoi, B., and D. C. Baruah. 2016. Steady state heat transfer modeling of solid fuel biomass stove: Part 1. *Energy* 97:283–95. doi:10.1016/j.energy.2015.12.130.
- Hachem, F., B. Abdulhay, M. Ramadan, H. El Hage, M. Gad El Rab, and M. Khaled. 2017, July. Improving the performance of photovoltaic cells using pure and combined phase change materials – Experiments and transient energy balance. *Renewable Energy* 107:567–75. doi: 10.1016/j.renene.2017.02.032.
- Haddad, A., M. Ramadan, M. Khaled, and K. Chahine. An investigation on coupling fuel cell and photovoltaic systems for power generation,” 2016 3rd International Conference on Advances in Computational Tools for Engineering Applications (ACTEA), Beirut, 2016, pp. 37–42.
- Hepbasli, A., E. Biyik, O. Ekren, H. Gunerhan, and M. Araz. 2014. A key review of waste water source heat pump (WWSHP) systems. *Energy Conversion and Management* 88:700–22. doi:10.1016/j.enconman.2014.08.065.
- Herez, A., M. Ramadan, B. Abdulhay, and M. Khaled. Short review on solar energy systems. *AIP Conference Proceedings* 2016;1758,1: 10.1063/1.4959437.
- Herez, A., M. Ramadan, and M. Khaled. 2018. Review on solar cooker systems: Economic and environmental study for different Lebanese scenarios. *Renewable and Sustainable Energy Reviews* 81:421–32. doi:10.1016/j.rser.2017.08.021.
- Jaber, H., M. Khaled, T. Lemenand, J. Faraj, H. Bazzi, and M. Ramadan. 2017a. Effect of exhaust gases temperature on the performance of a hybrid heat recovery system. *Energy Procedia* 119:775–82. doi:10.1016/j.egypro.2017.07.110.
- Jaber, H., M. Khaled, T. Lemenand, R. Murr, J. Faraj, and M. Ramadan. Triple domestic heat recovery system: Thermal modeling and parametric study. *Proceedings of SEEP2017*, 27-30 June 2017b, Bled, Slovenia.
- Jaber, H., M. Khaled, T. Lemenand, and M. Ramadan. Short review on heat recovery from exhaust gas. *AIP Conference Proceedings* 2016; 1758, Bled, Slovenia 10.1063/1.4959441.
- Jaber, H., M. Khaled, T. Lemenand, and M. Ramadan. Domestic Thermoelectric Cogeneration Drying System: Thermal Modeling, and Case Study, *Energy*, In Press, Accepted Manuscript, 2018a
- Jaber, H., M. Ramadan, T. Lemenand, and M. Khaled. 2018b. Domestic thermoelectric cogeneration system optimization analysis, energy consumption and CO2 emissions reduction. *Applied Thermal Engineering* 130:279–95. doi:10.1016/j.applthermaleng.2017.10.148.

- Khaled, M., H. Beltagy, A. Shaito, H. El Hage, and M. Ramadan. 2016a. Heating residential water using parabolic trough concentrators: Theoretical calculations and analysis. *Progress in Industrial Ecology, an International Journal* 10 (4), 321–333.
- Khaled, M., R. Murr, H. El Hage, M. Ramadan, H. Ramadan, and M. Becherif. An iterative algorithm for simulating heat recovery from exhaust gas – Application on generators. *mathematics and computers in simulation*. In Press, Corrected Proof, Available online 26 April, 2018.
- Khaled, M., and M. Ramadan. 2016, September. Heating fresh air by hot exhaust air of HVAC systems. *Case Studies in Thermal Engineering* 8:398–402. doi: [10.1016/j.csite.2016.10.004](https://doi.org/10.1016/j.csite.2016.10.004).
- Khaled, M., and M. Ramadan. 2017. Study of the thermal behavior of multi concentric tube tank in heat recovery from chimney – Analysis and optimization. *Heat Transfer Engineering Journal* 8:1–11.
- Khaled, M., M. Ramadan, K. Chahine, and A. Assi. 2015. Prototype implementation and experimental analysis of water heating using recovered waste heat of chimneys. *Case Studies in Thermal Engineering* 5:127–33. doi:[10.1016/j.csite.2015.03.004](https://doi.org/10.1016/j.csite.2015.03.004).
- Khaled, M., M. Ramadan, and H. El Hage. 2015. Parametric analysis of heat recovery from exhaust gases of generators. *Energy Procedia* 75:3295–300. doi:[10.1016/j.egypro.2015.07.710](https://doi.org/10.1016/j.egypro.2015.07.710).
- Khaled, M., M. Ramadan, and H. El Hage. 2016, April 25 . Innovative approach of determining the overall heat transfer coefficient of heat exchangers – Application to cross-flow water-air types. *Applied Thermal Engineering* 99: 1086–92. doi:[10.1016/j.applthermaleng.2016.01.145](https://doi.org/10.1016/j.applthermaleng.2016.01.145).
- Khaled, M., M. Ramadan, and M. G. El-Rab. Application of waste heat recovery concepts to generators — Thermal modeling and analysis,” International Conference on Renewable Energies for Developing Countries 2014, Beirut, 2014, pp. 82–88.
- Khaled, M., M. Ramadan, A. Shaito, H. El Hage, F. Harambat, and H. Peerhossaini. 2016b. Parametric analysis of heat exchanger thermal performance in complex geometries – Effect of velocity and temperature distributions. *Heat Transfer Engineering Journal* 37:1027–37. doi:[10.1080/01457632.2015.1104166](https://doi.org/10.1080/01457632.2015.1104166).
- Kolasinska, E., and P. Kolasinski. 2016. A review on electroactive polymers for waste heat recovery. *Materials* 9:485. doi:[10.3390/ma9060485](https://doi.org/10.3390/ma9060485).
- Krokida, M. K., and G. I. Bisharat. 2004. Heat recovery from dryer exhaust air. *Drying Technology* 22 (7):1661–74. doi:[10.1081/DRT-200025626](https://doi.org/10.1081/DRT-200025626).
- Kumar, M., S. Kumar, and S. K. Tyagi. 2013. Design, development and technological advancement in the biomass cookstoves: A review. *Renewable and Sustainable Energy Reviews* 26:265–85. doi:[10.1016/j.rser.2013.05.010](https://doi.org/10.1016/j.rser.2013.05.010).
- L T, W., M. K W, and Y. Guan. 2010. Shower water heat recovery in high-rise residential buildings of Hong Kong. *Applied Energy* 87:703–09. doi:[10.1016/j.apenergy.2009.08.008](https://doi.org/10.1016/j.apenergy.2009.08.008).
- Liu, L., L. Fu, and S. Zhang. 2014. The design and analysis of two exhaust heat recovery systems for public shower facilities. *Applied Energy* 132:267–75. doi:[10.1016/j.apenergy.2014.07.013](https://doi.org/10.1016/j.apenergy.2014.07.013).
- Liu, W. 2018. Optimizing energy recovery level of a Dutch waste incineration facility. *Energy Sources, Part A: Recovery, Utilization, and Environmental Effects* 40 (6):727–33. doi:[10.1080/15567036.2018.1457739](https://doi.org/10.1080/15567036.2018.1457739).
- Mago, P. J. 2012. Exergetic evaluation of an organic rankine cycle using medium-grade waste. *Heat, Energy Sources, Part A: Recovery, Utilization, and Environmental Effects* 34 (19):1768–80. doi:[10.1080/15567036.2010.492382](https://doi.org/10.1080/15567036.2010.492382).
- Manouchehri, R., B. C J, and C. M R. 2015. Impact of small tilt angles on the performance of falling film drainwater heat recovery systems. *Energy Build* 102:181–86. doi:[10.1016/j.enbuild.2015.05.024](https://doi.org/10.1016/j.enbuild.2015.05.024).
- McNabola, A., and K. Shields. 2013. Efficient drain water heat recovery in horizontal domestic shower drains. *Energy Build* 59:44–49. doi:[10.1016/j.enbuild.2012.12.026](https://doi.org/10.1016/j.enbuild.2012.12.026).
- Montecucco, A., J. Siviter, and A. R. Knox. 2017. Combined heat and power system for stoves with thermoelectric generators. *Applied Energy* 185:1336–42. doi:[10.1016/j.apenergy.2015.10.132](https://doi.org/10.1016/j.apenergy.2015.10.132).
- Montingelli, M. E., K. Y. Benyounis, J. Stokes, and A. G. Olabi. 2016. Pretreatment of macroalgal biomass for biogas production. *Energy Conversion and Management* 108:202–09. doi:[10.1016/j.enconman.2015.11.008](https://doi.org/10.1016/j.enconman.2015.11.008).
- N C, B., S. U C, and J. H. Yoon. 2005. A study on the design and analysis of a heat pump heating system using wastewater as a heat source. *Solar Energy* 78:427–40. doi:[10.1016/j.solener.2004.07.009](https://doi.org/10.1016/j.solener.2004.07.009).
- Nam–Chol, O., P. Hyo–Song, S. Yong–Chol, R. Yong–Hyok, and K. Yong–Nam. 2018. A feasibility study of energy recovery of RDF from municipal solid waste. *Energy Sources, Part A: Recovery, Utilization, and Environmental Effects* 40 (24):2914–22. doi:[10.1080/15567036.2018.1514431](https://doi.org/10.1080/15567036.2018.1514431).
- Nardin, G., A. Meneghetti, M. F D, and N. Benedetti. 2014. PCM-based energy recovery from electric arc furnaces. *Applied Energy* 136:947–55. doi:[10.1016/j.apenergy.2014.07.052](https://doi.org/10.1016/j.apenergy.2014.07.052).
- Ngusale, G. K., M. Oloko, S. Agong, and B. Nyakinya. 2017. Energy recovery from municipal solid waste. *Energy Sources, Part A: Recovery, Utilization, and Environmental Effects* 39 (16):1807–14. doi:[10.1080/15567036.2017.1376007](https://doi.org/10.1080/15567036.2017.1376007).
- Orosa, J. A., E. J. García-Bustelo, and A. C. Oliveira. 2012. Realistic solutions for wind power production with climate change. *Energy Sources, Part A: Recovery, Utilization, and Environmental Effects* 34 (10):912–18. doi:[10.1080/15567031003716733](https://doi.org/10.1080/15567031003716733).



- Ramadan, M., S. Ali, H. Bazzi, and M. Khaled. 10 September, 2017. New hybrid system combining TEG, condenser hot air and exhaust airflow of all-air HVAC systems. *Case Studies in Thermal Engineering* 154–60. doi:10.1016/j.csite.2017.05.007.
- Ramadan, M., M. Gad El Rab, and M. Khaled. 2015. Parametric analysis of air-water heat recovery concept applied to HVAC systems: Effect of mass flow rates. *Case Studies in Thermal Engineering* 6:61–68. doi:10.1016/j.csite.2015.06.001.
- Ramadan, M., and M. Khaled. Recovering heat from shower water — Design calculation and prototype. International Conference on Renewable Energies for Developing Countries 2014, Beirut, 2014, pp. 118–21.
- Ramadan, M., M. Khaled, and H. El Hage. 2015. Using speed bump for power generation – Modeling and experimental study. *Energy Procedia* 75:867–72. doi:10.1016/j.egypro.2015.07.192.
- Ramadan, M., M. Khaled, H. El Hage, F. Harambat, and H. Peerhossaini. 2016a. Effect of air temperature non-uniformity on water-air heat exchanger thermal performance – Towards new control approach for energy consumption reduction. *Applied Energy* 173:481–93. doi:10.1016/j.apenergy.2016.04.076.
- Ramadan, M., M. Khaled, H. S. Ramadan, and M. Becherif. 2016b, November 26. Modeling and sizing of combined fuel cell-thermal solar system for energy generation. *International Journal of Hydrogen Energy* 4144: 19929–35. doi: 10.1016/j.ijhydene.2016.08.222
- Ramadan, M., T. Lemenand, and M. Khaled. 2016, September 15 . Recovering heat from hot drain water— Experimental evaluation, parametric analysis and new calculation procedure. *Energy and Buildings* 128: 575–58. doi:10.1016/j.enbuild.2016.07.017.
- Ramadan, M., A. Shaer, A. Haddad, and M. Khaled, An experimental study on recovering heat from domestic drain water, TMREES16 International Conference on Technologies and Materials for Renewable Energy, Environment and Sustainability, AIP Conference Proceedings 1758, 030011 (2016c), Beirut.
- Raman, P., N. K. Ram, and J. Murali. 2014. Improved test method for evaluation of bio-mass cook-stoves. *Energy* 71:479–95. doi:10.1016/j.energy.2014.04.101.
- Rodriguez, C., A. Alaswad, J. Mooney, T. Prescott, and A. G. Olabi. 2015. Pre-treatment techniques used for anaerobic digestion of algae. *Fuel Processing Technology* 138:765–79. doi:10.1016/j.fuproc.2015.06.027.
- S S, C., and M. Maglionico. 2014. Heat recovery from urban wastewater: Analysis of the variability of flow rate and temperature in the sewer of Bologna, Italy. *Energy Procedia* 45:288:297.
- Shen, Y.-Q., Y.-Q. Wu, and S.-H. Shi. 2015. Reserve assessment and potential exploitation of tidal energy in Shanghai’s Sea Area of China. *Energy Sources, Part A: Recovery, Utilization, and Environmental Effects* 37 (9):938–46. doi:10.1080/15567036.2011.576415.
- Slys, D., and S. Kordana. 2014. Financial analysis of the implementation of a drain water heat recovery unit in residential housing. *Energy Build* 71:1–11. doi:10.1016/j.enbuild.2013.11.088.
- Spur, R., D. Fiala, D. Nevrala, and D. Probert. 2006. Performances of modern domestic hot-water stores. *Applied Energy* 83:893–910. doi:10.1016/j.apenergy.2005.10.001.
- Su, H., H. Qi, P. Liu, and J. Li. 2018. Experimental investigation on heat extraction using a two-phase closed thermosiphon for thermoelectric power generation. *Energy Sources, Part A: Recovery, Utilization, and Environmental Effects* 40 (12):1485–90. doi:10.1080/15567036.2018.1477875.
- Tedesco, S., T. M. Barroso, and A. G. Olabi. 2014. Optimization of mechanical pre-treatment of Laminariaceae spp. *Biomass-Derived Biogas. Renewable Energy* 62:527–34.
- Torras, S., C. Oliet, J. Rigola, and A. Oliva. 2016. Drain water heat recovery storage-type unit for residential housing. *Applied Thermal Engineering* 103:670–83. doi:10.1016/j.applthermaleng.2016.04.086.
- Wallin, J., and J. Claesson. 2014. Investigating the efficiency of a vertical inline drain water heatrecovery heat exchanger in a system boosted with a heat pump. *Energy Build* 80:7–16. doi:10.1016/j.enbuild.2014.05.003.
- Wei, L., Y. Zhang, Y. Mu, X. Yang, and X. Chen. 2011. Efficiency improving strategies of low-temperature heat conversion systems using organic rankine cycles: an overview. *Energy Sources, Part A: Recovery, Utilization, and Environmental Effects* 33 (9):869–78. doi:10.1080/15567036.2010.531514.
- Wilberforce, T., A. Alaswad, A. Palumbo, M. Dassisti, and A. G. Olabi. 2016. Advances in stationary and portable fuel cell applications. *International Journal of Hydrogen Energy* 41 (37):16509–22. doi:10.1016/j.ijhydene.2016.02.057.
- Yang, X., H. Li, and S. Svendsen. 2016. Evaluations of different domestic hot water preparing methods with ultra-low-temperature district heating. *Energy* 109:248–59. doi:10.1016/j.energy.2016.04.109.

1.3 Revue de la récupération de chaleur des gaz d'échappement : sources, moyens et applications

Hassan Jaber , Thierry Lemenand , Mohamad Ramadan et Mahmoud Khaled

Il est prévu de soumettre cette revue à « **Renewable and Sustainable Energy Reviews** »

Résumé - Soumis à la deuxième loi de la thermodynamique, tout système d'ingénierie est obligé de restituer à l'environnement une quantité d'énergie considérable. L'idée de base de la récupération de chaleur fatale est de traiter cette chaleur perdue afin de réduire la consommation d'énergie et les impacts sur l'environnement. Ce document constitue une revue complète des sources, moyens et applications de récupération de chaleur. Il fournit également les paramètres efficaces qui affectent le processus de récupération. Les chaudières, les générateurs d'air chaud, les moteurs, les générateurs et les cheminées sont les principales sources de chaleur perdue. La chaleur fatale peut être utilisée dans diverses applications principalement pour la production d'électricité, le chauffage de l'eau ou stockée pour une utilisation ultérieure. De plus, des études économiques et environnementales sont réalisées. Ces études permettent de mettre en lumière l'importance de la récupération de chaleur pour économiser de l'argent, réduire l'épuisement des combustibles fossiles et les émissions de CO₂.

Review on Heat Recovery from Exhaust Gases: Sources, Means and Applications

Hassan Jaber ^{a,b}, Thierry Lemenand ^b, Mohamad Ramadan ^{a,c}, and Mahmoud Khaled ^{a,d,*}

^a School of Engineering, Lebanese International University LIU, PO Box 146404 Beirut, Lebanon.

^b LARIS EA 7315, University of Angers – ISTIA, Angers, France

^c Associate member at FCLAB, CNRS, Univ. Bourgogne Franche-Comte, Belfort cedex, France.

^dUniversty Paris Diderot, Sorbonne Paris Cité, Interdisciplinary Energy Research Institute (PIERI), Paris, France

*Corresponding author: Mahmoud.khaled@liu.edu.lb

Abstract — Constrained by the second law of thermodynamics, any engineering system is obliged to release to the environment a considerable amount of energy. The basic idea underlying waste heat recovery is to deal with this wasted heat in order to decrease energy consumption and environmental impacts. This paper constitutes a complete review on heat recovery sources, means and applications. It provides also the effective parameters that affect the recovery process. Boilers, furnaces, engines, generators, and chimneys are the main sources of wasted heat. The wasted heat can be utilized in a variety of applications mainly for generating electricity, heating water or stored for later usage. In addition, an economic and environmental studies are carried out. These studies permit to shed light on the importance of heat recovery on money saving, fossil fuel depletion reduction and CO₂ emissions reduction.

Keywords: CO₂ emissions reduction - Energy management - Exhaust gases - Heat exchangers - Heat recovery.

1. Introduction

The 2015 United Nations Climate Change Conference, COP 21, held in Paris, had implied 195 countries to legislate terms that serve in mitigating the increasing rate of global temperature. The main conducted point of the agreement is to limit the rate of increase of earth temperature under 2°C. This imposes a severe reduction of greenhouse gas emissions (mainly Carbon dioxide and monoxide).

The global amount of carbon dioxide production is function of the population, service per person, energy per service and carbon dioxide production per unit energy. First, the world population is growing at an average rate of 1.11% in 2017 [1]. Second, the service per person is rising due to the development of life style and human needs. Those two first parameters cannot be easily controlled or reduced in any case by technological approaches. So, it is required to minimize the remaining two parameters: energy per service and carbon dioxide production per energy. Reducing the energy per service can be accomplished by either decreasing the usage of nonrenewable energy sources or decreasing energy losses. Besides, carbon dioxide production can be mitigated by relying on clean energy sources or reducing the energy released to the environment. This implies that, decreasing the amount of carbon dioxide produced globally can be attained by alternative energy and energy recovery.

On the one hand, alternative energy is an environmentally friendly energy which can replace traditional energy that relies on fossil fuel sources. Solar [2–7], wind [8–11], biomass [12–17], tidal [18–22], hydropower [23–25], geothermal [26–32] and fuel cell [33–36] are the main types of alternative energies.

On the other hand, energy recovery deals with the re-utilization of wasted energy [37–42]. Most of the energy wasted is dumped in the form of thermal energy and mainly through exhaust gases. This led scientists to develop high investigations and studies on heat recovery from exhaust gases.

The present manuscript is devoted to a review on heat recovery from exhaust gases. It presents the sources, means and applications of heat recovery systems. Section 2 shows the main parameters that affect the heat recovery process. Section 3 illustrates then the main sources of exhaust gases systems that can be utilized in a heat recovery process. Section 4 deals with the means used in heat recovery systems. Then, the applications of heat recovery are exposed in section 5, while section 6 is concerned with the economic and environmental studies. Finally, section 7 draws the main conclusions of the review performed.

2. Heat recovery from exhaust gases

Constrained by the second law of thermodynamics, systems that utilize fuel or chemical substances to be burned or reacted in order to generate heat energy released considerable amount of energy to the environment without taking advantage of it. Recovering part of this energy “Heat Recovery”. In the aforementioned systems, the released heat is contained in exhaust gases at high temperatures. Figure 1 is a schematic that shows the main sources of exhaust gases and the main advantages of heat recovery technology.

The ability of utilizing heat recovery technology in any application is controlled by crucial parameters that would limit the recovery process. Table 1 shows the main parameters that can

directly affect the heat recovery process and its effectiveness. The quality of the exhaust gases is more important than its quantity [43]. Higher temperature reflects the higher quality of heat recovery and greater cost effective heat recovery process. For the high temperature cases, a cascaded system can be employed in order to maximize the usage of the dissipated heat. It should be noted that the temperature and mass flow rate of the exhaust gases restrict the available applications of heat recovery (purpose of recovery). In addition, exiting temperature of the exhaust gases is limited to a minimum temperature for different reasons mainly to avoid corrosive effect (avoid condensation for exhaust gases that would carry sulfuric and nitric acids). Besides, specific heat, thermal conductivity and fluid properties of the exhaust gases affect the heat exchange process occurring between exhaust gases and the fluid to be heated.

In addition to these parameters, it is very important to carry out an economical study in order to track the efficiency of the recovery process.

The released flue gases contain at the same time sensible and latent heat that can be recovered. In some applications, flue gases would contain vapor that may condensate releasing its latent heat. Equations (1) and (2) show the calculation of the amount of heat that can be recovered [44]:

$$Q_s = \dot{m} \cdot C_p \Delta T \quad (1)$$

$$Q_L = \dot{m} \cdot h_{fg} \quad (2)$$

where Q_s and Q_L are the amount of sensible and latent heat (W), \dot{m}_{ex} is the mass flow rate (kg s^{-1}), C_p is the specific heat of the

released flue gas or cooling water ($\text{J kg}^{-1} \text{K}^{-1}$), ΔT is the temperature difference ($^{\circ}\text{C}$) and h_{fg} is the latent heat of fusion (J kg^{-1}).

Table 1. Main effective parameters on heat recovery process.

Effective Parameter	Symbol
Exhaust gases temperature	T_{ex}
Exhaust gases mass flow rate	\dot{m}_{ex}
Specific heat of exhaust gases	C_p
Exhaust gases viscosity	μ
Exhaust gases density	ρ
Exhaust gases thermal conductivity	k
Allowable pressure drop	$\Delta P_{allowable}$
Required temperature of the heated fluid	$T_{required,out}$
Lower allowable temperature of exhaust gases	$T_{ex,L-all}$

Heat recovery is one of the new main trending technologies raised for mitigating energy consumption and maximizing energy usage. Many studies were done on heat recovery from exhaust gases and published in different journals. Table A1.1 in appendix shows the main reviews on heat recovery from exhaust gases that are published in the “Renewable and Sustainable Energy Reviews” journal. From Table A1.1, it is apparent that heat recovery from exhaust gases is a new growing technology developed on the recent years.

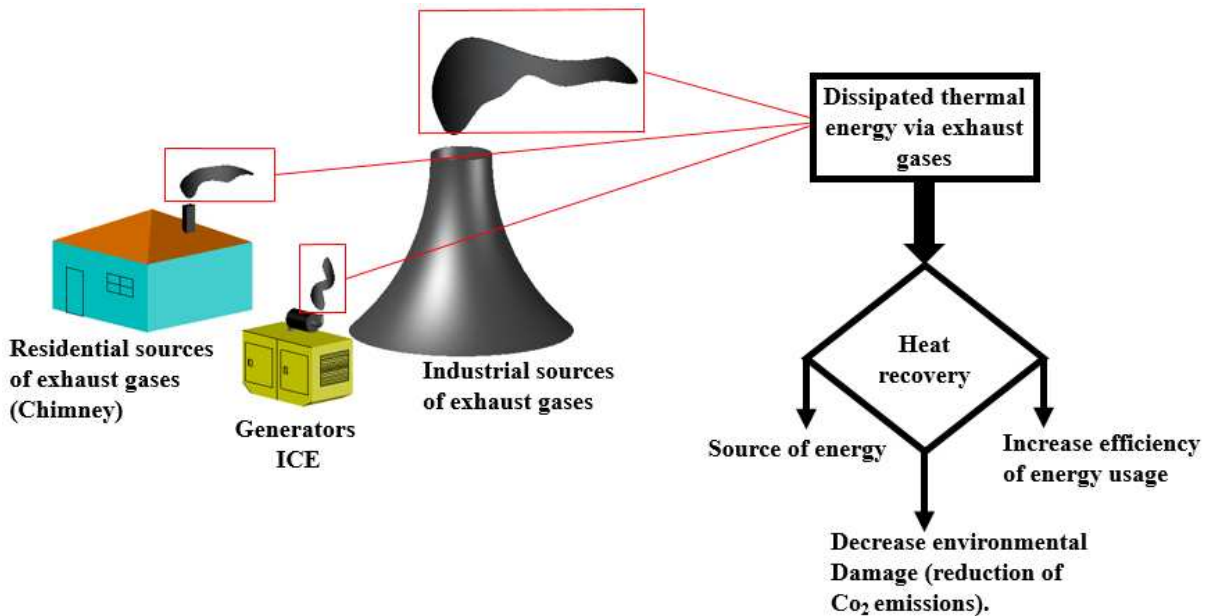

Fig. 1. Sources of exhaust gases and heat recovery technology.

3. Sources for heat recovery systems

Mainly industrial applications produce highest amount of heat that would lead to highest amount of energy recovery. Waste heat recovery systems can be classified according to their temperature as high temperature (above 650°C), medium temperature (between 230°C and 650°C), and low temperature (less than 230°C) [58]. Figure 2 summarizes the main sources of exhaust gases that can be implemented in a heat recovery system. Industrial furnace, cement kilns and hydrogen plants produce high amount of waste heat. Internal combustion engines, steam boilers, gas turbines, and chimneys produce medium waste heat. Finally, low waste heat production sources are as cooling water for condenser, air compressors, pumps, bearings, and welding furnaces.

Heat recovery from internal combustion engines (ICEs) dominates the field of energy recovery from exhaust gases. This domination results from the high quantity and quality of heat that is rejected and lost by exhaust gases. Karvonen et al. [59] published a review on waste heat recovery from exhaust gases of internal combustion engines using thermoelectric generators,

ordinary and organic Rankine cycle. Aghaali and Ångström [53] made a review on turbo-compounding for waste heat recovery (WHR) from internal combustion engines. The turbine efficiency plays a crucial role in recovering waste heat and the change in geometry and rotational speed would offer higher efficiencies. Singh and Shrivastava [60] presented a review on waste heat recovery systems for internal combustion engines. 30-40% of the input energy are released through the exhaust gases at a temperature of 450-600°C. A 10% reduction of primary fuel consumption can be achieved by recovering 6% of the wasted heat [61]. Chintala et al. [45] studied the utilization of organic Rankine cycle for recovering heat from internal combustion engines. A review about the present technologies on heat recovery was carried out and showed that the thermal efficiency of the standalone engine-organic Rankine cycle system is about 10-25%, while the combined overall efficiency is in the range of 60-90%. In addition, R245fa was selected as the best working fluid based on the system performance, availability, economic and environmental concerns.

Table A1.2 provides references dealing with heat recovery from internal combustion engines, each article is detailed by its scientific content.

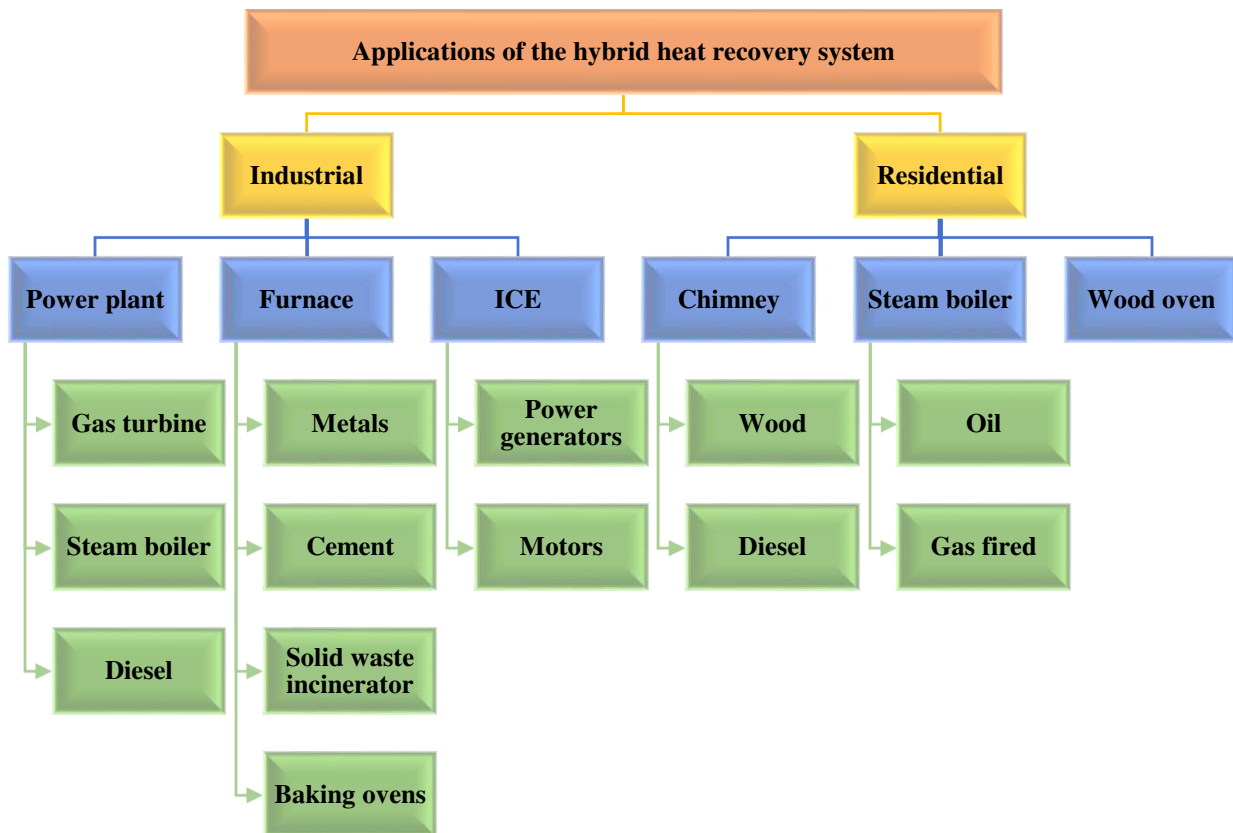

Fig. 2. Main industrial and residential sources of exhaust gases.

Carapellucci and Giordano [96] wrote a review on heat recovery from gas turbine, by which heat recovery can be applied externally or internally. Bottoming steam power plant or combined cycle power plant consists of Bryton cycle followed by Rankine cycle (exhaust gases is used to generate steam for the steam cycle). This configuration is known as external WHR and it can achieve high efficiency of 55%. For the internal type, it could be applied by either using wasted exhaust gases to the outlet of the compressor or by generating steam injected into the combustor which increases the efficiency about 10%. Wei *et al.* [97] performed a study on coal-fired boiler. The generated flue gases contain sulfur particles that would lead for corrosion if the temperature of the exhaust gases is reduced below the dew point. Authors proposed a new system to use the sulfur-reduced flue gas, in which direct contact heat transfer and absorption cycles are utilized to maximize the energy recovery. The main advantage of this system is that it recovers heat and reduces sulfur dioxide in flue gases by desulfurization tower. Results show that the boiler efficiency increased by 3.2% and the outlet flue gas temperature reached 39°C. The cooling treatment removed about 59% of sulfur dioxide and 8.8% of nitrogen dioxide. Such system has a payback period of about four years.

Table A.1.3 shows some references that deal with heat recovery from steam boilers and gas turbines.

Since chimneys are widely used, essentially in rural areas, many studies were carried out in this field. Chimneys are thermal systems that utilize fuel to generate heat, in which part of the generated heat is utilized to heat the surrounding air and part of it is wasted to the environment through exhaust gases. Khaled *et al.* [126] did an experimental analysis of heating water from waste heat of a chimney. A prototype was implemented composed of a water tank installed above a chimney of diameter 40 cm. Inside the tank, multiple tubes were installed wherein was the circulation of exhaust gases, while water was placed in the annulus of the tank. The tank gains heat through convection and radiation from the brazier and through convection from the flue gases in tubes. In one hour, a 65°C temperature increase was obtained with variable exhaust gas temperature (ranging from 350°C to 175°C). It was noted that 70% of heat gained was provided by the convection and radiation part from the brazier.

Table A.1.4 is a table of references for heat recovery studies performed on chimneys and stoves.

Mal *et al.* [137] did a theoretical study for waste heat recovery from biomass cook stove in rural areas using thermoelectric generators. In order to achieve efficient complete combustion sufficient air was provided by a fan that operates from a thermoelectric device. The result shows that the output power becomes 24 W at heat rate of 350 W at a high temperature (600°C) in the stove.

Wang *et al.* [138] did an experimental study for waste heat recovery from adsorption chiller. At a 12.2°C chilled water temperature, 49°C cooling water temperature and 85°C hot water inlet temperature, it shows that recovering waste of four bed chillers can provided 25% improvement in the coefficient of performance (COP).

Varma and Srinivas [139] did a case study for recovering heat from cement factory containing two units. The factory rejects heat at three outlets at temperatures 176°C, 330°C and 420°C. Ordinary Rankine cycle is utilized to generate electricity. The result shows that 12.5 MW of power is generated which is about 83% of the factory power demand.

4. Means of heat recovery

Heat recovery technology can be applied directly by using the exhausted fluid directly or indirectly by a mean of heat exchangers or other heat recovery equipment. Figure 3 shows the main equipment utilized for heat recovery. It shows different types of heat exchangers that can be utilized to recover heat between liquid-liquid, gas-liquid or gas-gas streams. Shell and tubes, plate, concentric tube heat exchangerd are widely utilized in recovery systems. In addition to that, some systems are composed of multiple heat recovery heat exchangers build in within the application such as boilers. Moreover heat pump and incinerators are also utilized in recovery systems depending on the application of heat recovery.

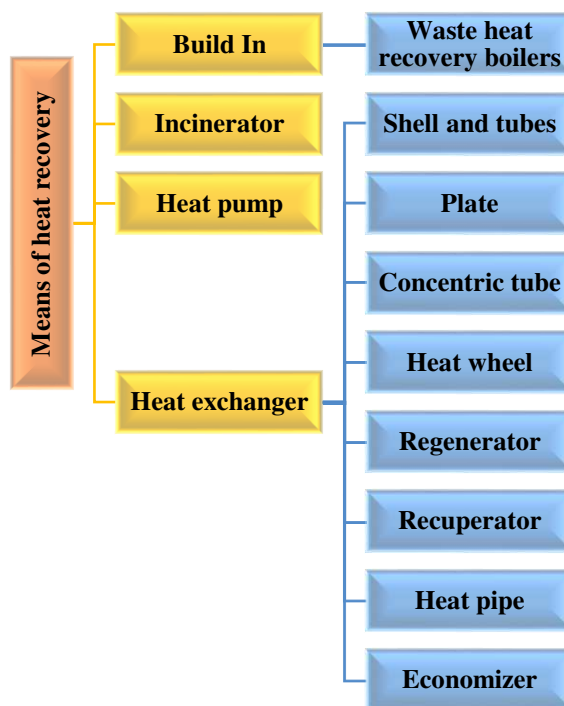

Fig. 3. Main equipment utilized for heat recovery process.

Waste heat boilers [140–146] are ordinary boilers with addition of waste heat recovery equipment as shown in Figure 4. It consists of waste heat recovery evaporator in which exhaust gases hit evaporator tubes rising the temperature of the passing fluid. The fluid evaporates and is collected at the drum where the vapor is delivered to a super-heater then to the turbine. In addition, fed water is preheated by the exhaust gases leaving the evaporator at the economizer system and combustion air is preheated before combustion at the air preheater.

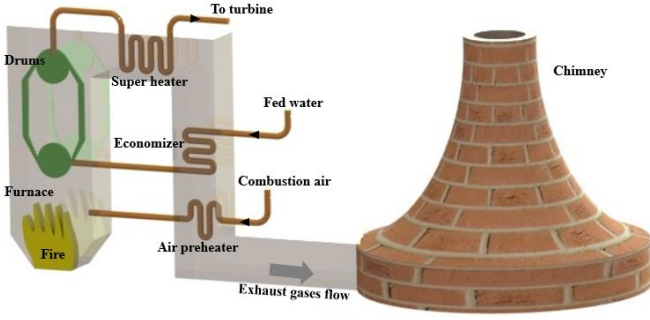

Fig. 4. Waste heat recovery boiler with economizer and air preheater.

The energy balances at the economizer and air preheater are shown in Figure 5 and represented in the following equations [147]:

$$\begin{aligned} Q_{eco} &= \dot{m}_s (h_{w,eco-o} - h_{w,eco-i}) \\ &= \dot{m}_g \cdot Cp_g \cdot (T_{g,eco-o} - T_{g,eco-i}) \end{aligned} \quad (3)$$

$$\begin{aligned} Q_{preheater} &= \dot{m}_a Cp_a \cdot (T_{a,pre-o} - T_{a,pre-i}) \\ &= \dot{m}_g \cdot Cp_g \cdot (T_{g,pre-o} - T_{g,eco-o}) \end{aligned} \quad (4)$$

where Q_{eco} and $Q_{preheater}$ are the heat transfer rate at the economizer and air preheater respectively (W), \dot{m}_s , \dot{m}_g and \dot{m}_a are the mass flow rates of the working steam, flue gases and combustion air (kg/s), $h_{w,eco-o}$ and $h_{w,eco-i}$ are the enthalpies of the steam at the outlet and inlet of the economizer (J/kg), $T_{g,eco-o}$, $T_{g,eco-i}$ and $T_{g,pre-o}$ are the temperatures of the flue gases at the economizer outlet, economizer inlet and preheater outlet, and $T_{a,pre-o}$ and $T_{a,pre-i}$ are the temperatures of combustion air at the outlet and inlet of the air preheater.

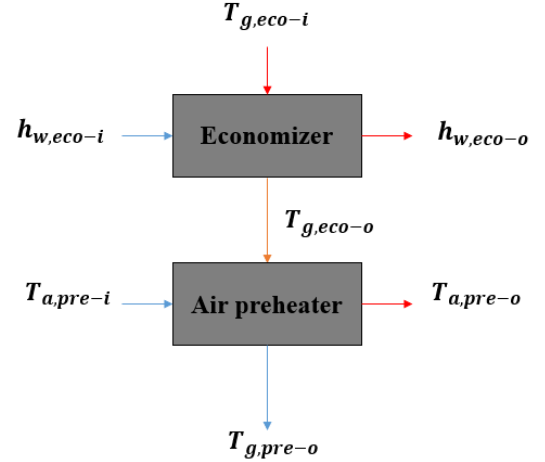
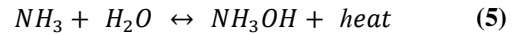

Fig. 5. Energy balance at the economizer and air preheater.

Heat pumps [148–152] are mainly utilized for low grade heat recovery. It is used to upgrade the wasted heat for higher levels in order to be utilized in higher temperature applications. On the one hand, it can be an ordinary heat pump that consists of a heat source (evaporator), heat sink (condenser), compressor, and expansion valve. This type of heat pumps utilize vapor compression cycle by which a refrigerant transfers heat from heat source at low pressure and releases it on the heat sink at higher pressure. On the other hand, another type of heat pumps utilizes absorption cycle. The main characteristic of this type of heat pump is the absence of conventional compressor that is replaced by chemical compressor. Figure 6 shows an absorption heat pump in which the absorbate and absorbent pair would be NH_3/H_2O , $H_2O/LiBr$, or $H_2O/LiCl$. It undergoes a reversible chemical reaction denoted by:



The coefficient of performance (COP) of heat pumps is calculated using the following equation [153]:

$$COP = \frac{Q_e}{Q_G + W_p} \quad (6)$$

where Q_e is the heat energy absorbed at the evaporator and Q_G is the heat energy at the generator and W_p is the work of the pump. In such system, the heat energy gained at the generator is taken from exhaust gases.

The chemical heat pumps are not harmful (no CFC, HCFC nor HFC gases) and include almost no moving parts (circulating pump has a minor work). However, they have high initial cost and their coefficient of performance is greater than one.

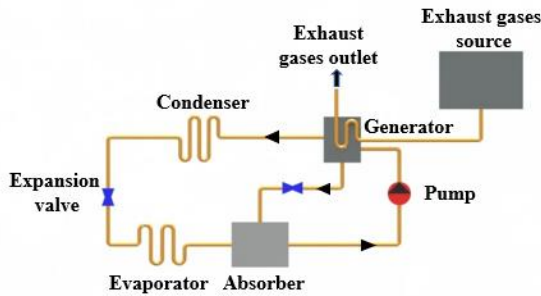

Fig. 6. Open absorption heat pump.

Sun *et al.* [154] did an experimental study on a double evaporation absorption heat pump to recover heat under low driving source. Such type of heat pumps is more efficient when the temperature of both the driving source and waste heat is relatively low. The coefficient of performance of the constructed heat pump was 1.97 with a driving source temperature of 70°C and the maximum concentration of the LiBr solution of 60% (no risk for crystallization). The expected payback period of this heat pump is less than two years compared to the common thermal substation.

Heat exchangers are utilized for any indirect heat recovery. Figure 3 showed the main types of heat exchangers in which heat transfer occurs between gases-liquids, liquids-liquids or gases-gases. Heat exchangers may also be classified according to the flow of fluids: parallel, counter, and cross flow. Either both hot and cold stream are moving in the same direction – beside each other – and the flow is called parallel, either the two streams are moving in opposite direction and the flow is called counter flow. Finally, cross flow heat exchanger normally has two flows perpendicular to each other.

Recuperators heat exchangers [155–160] transfer heat through a separating surface directly from one stream to another without utilizing intermittent flow. However, in regenerator, heat transfer occurs after hot stream releases its heat to a storing medium where this heat is being stored and heat is released when

passing cold stream over it. They are mainly of two types: static and dynamic. In static regenerators, there is a flow switching device directing the entering flow through generator. Hot stream enters through the regenerator where heat is absorbed in a porous medium (pebbles, balls) and released when the cold stream passes over it. Concerning the dynamic part, it has a high surface to volume ratio (6500 m²/m³) with a rotating matrix, and it is utilized for high temperature application (up to 870°C). Suping *et al.* [156] did a numerical investigation and performance analysis of liquid desiccant regenerator coupled with heat recovery heat pipe. Authors performed hybrid heat transfer, mass transfer and heat recovery model analysis and validated the conducted results by experiment. The effect of air flow rate on the regenerating and heat recovery was studied. The maximum theoretical heat recovery ratio when a heat pipe is installed is 26.5%.

Heat pipe is passive heat transfer device in which moving parts and power input are not required [161–170]. It has a very high thermal conductance (more than copper – the best-known heat conductor). Figure 7 shows a schematic of (a) heat pipe connections and (b) its parts and operational principle. Heat pipe consists mainly of three parts: evaporative, adiabatic, and condensing part. A working fluid is partially filled inside the heat pipe that is closed at both sides. Heat is absorbed by the working fluid at the evaporator from the hot stream. Thus, working fluid evaporates and passes through the adiabatic part to the condensing part. At the condensing part, heat is released to the cold stream and the working fluid condensates, returns back to the evaporative part, and the cycle continues. The main limitations of heat pipes are the working temperature range (high temperature leads to high pressure) and heat pipes presents a maximum heat transfer rate [168]. Srimuang and Amatachaya [168] did a literature review on the applications of heat pipe as heat recovery heat exchanger. The review includes study on three types of heat pipes: conventional heat pipe, two phase closed thermosiphon and oscillating heat pipe. The parameters of effectiveness of the three types of heat pipes were given and design information of the heat pipes were provided.

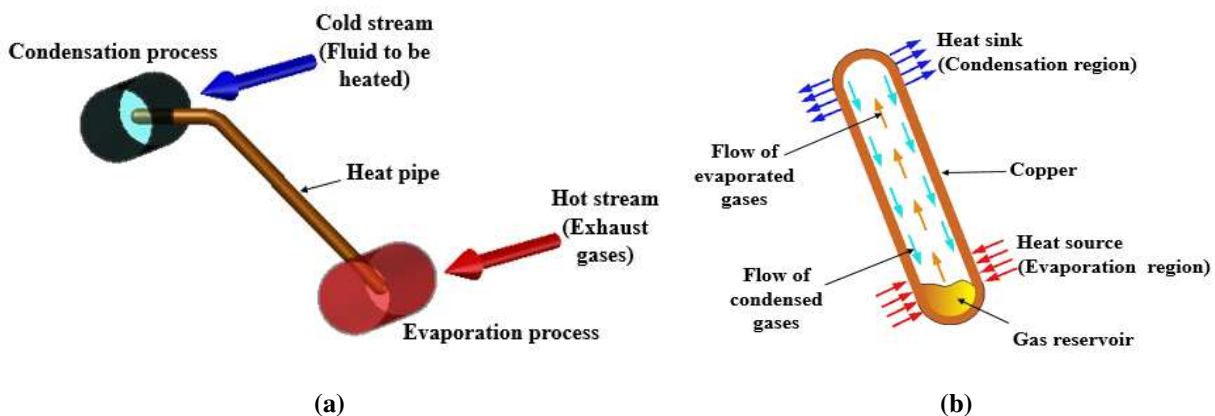

Fig. 7. Schematic of: (a) heat pipe connections and (b) heat pipe operational principle.

Thermal wheel is gas to gas heat recovery exchanger combined with ventilation system design [172–174]. It is utilized to recover heat from exhaust gas and preheat fresh air from this recovered energy (in winter). It consists of a matrix of wheel shape where the frontal area is designed with flow passages of small diameters. Thermal wheel is a disk made up of aluminum (high thermal conductivity) where exhaust fan is located in the middle of two air ducts. Exhaust air pass through one air duct, while fresh air to be heated pass through the other duct. To ensure cleanness of the wheel, filters are installed. Thermal wheel exchanger can recover heat (sensible heat) or heat and moisture (latent heat). Figure 8 shows a thermal wheel connected between two ducts to recover heat from one duct to another. In order to achieve latent heat transfer, a coating of silica gel polymer must be used in the wheel. Such coating absorbs vapor and then releases it when it is heated. The main advantages of thermal wheel are its widely spread usage in industrial ventilation and its utilization for heating or cooling applications. It serves in increasing energy saving and reduces costs of ventilation and humidification [175]. Thermal wheel has a high heat transfer efficiency compared to other air-to-air heat exchangers. Also, energy consumed by the electric motor to rotate the wheel is low compared to the energy saved by it. Whereas, the main disadvantages of thermal wheel are its requirement for a regularly replacement and maintenance of filters since cleaning the wheel is difficult, it requires a large space, and in addition, it may permit cross-leakage between air streams [176]. Fu *et al.* [177] investigated the performance of a heat recovery honeycomb type desiccant wheel for different solid desiccant materials. One dimensional, transient heat and mass transfer model was carried out to estimate the behavior of the desiccant wheels. The effect of the rotary speed, inlet velocities of inlet and exhausted air on the performance of the wheel was studied and compared, to various desiccant materials. Results show that zeolites 5A and 13X have better performance for total heat recovery under high rotary speed (more than 15 rpm).

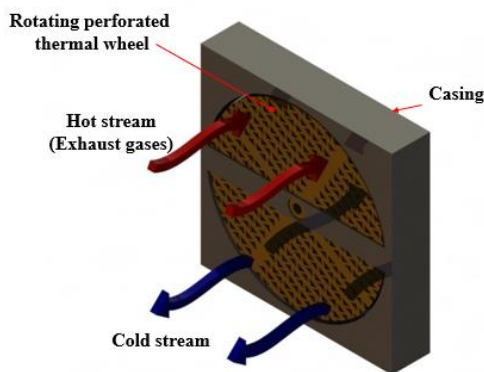

Fig. 8. Schematic of thermal wheel utilized for heat recovery from exhaust gases.

Shell and tube heat exchangers [178–188] (shown in Figure 9) are gas to liquid heat exchangers in which exhaust gases pass through pipes placed in shell where the liquid is flowing. Fixed tube sheet, U-tube, and floating heat are the main types of shell and tube

heat exchangers. The heat exchanged in the heat exchanger can be calculated using the following equation [189].

$$Q = U \cdot A \cdot LMTD \quad (7)$$

where Q is the heat transfer rate of the heat exchanger, U is the overall heat transfer coefficient, A is the exchange area of tubes, and $LMTD$ is the logarithmic mean temperature difference.

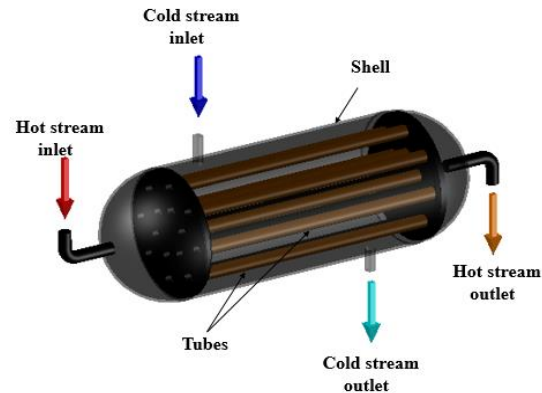

Fig. 9. Shell and tubes heat exchanger.

Plate heat exchangers [190–198] are gas to gas and liquid to liquid heat exchangers. It consists of alternating plates in which hot and cold stream flow alternately through those plates. The plates are formed from metal sheets sandwiched to each other. Figure 10 shows a schematic of plate heat exchanger. The two streams usually flow in a counter flow direction. Such heat exchangers are simple and easy to be cleaned. However, it frequently suffers from gasket maintenance problems. Liquid to liquid type can achieve high heat recovery efficiency (80%) and the maximum pressure drop is 3200 kPa. Fin plate type heat exchangers are gas to gas type which can be utilized for gas temperature lower than 500°C, and such type can obtain heat recovery efficiency of 75% [199].

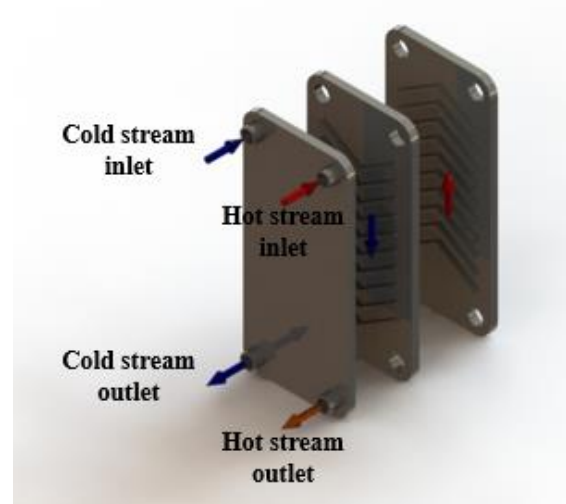

Fig. 10. Plate heat exchanger.

5. Applications of heat recovery

The main purpose of heat recovery is to maximize usage of wasted heat. Wasted thermal energy can be utilized directly (as thermal energy) or transferred to another type of energy mainly electrical energy. Figure 11 shows the main applications for heat recovery summarized by heat storage, heating, electricity generation and cooling.

The wasted heat can be used to heat another streams mainly for producing domestic hot water or space heating or heating air for drying purposes or even rising temperature of combustion air that leads to an increase in system efficiency. Heating combustion air at 200°C would lead for 1% energy saving [61].

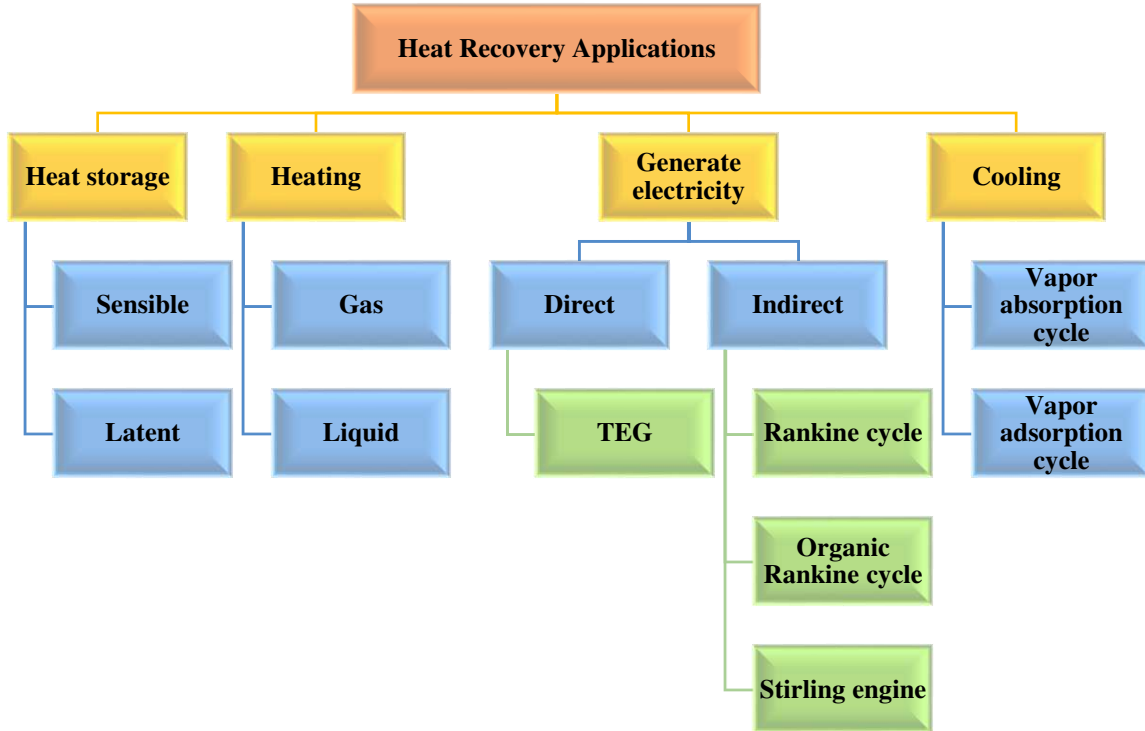

Fig. 11. Main applications of heat recovery.

Domestic hot water can be produced by transferring heat energy using a waste recovery heat exchanger. Naldi *et al.* [200] did a numerical calculation to evaluate performance of a heat pump in addition to producing domestic hot water from condensation heat recovery. Ramadan *et al.* [201] did a study on heating or preheating domestic water from the hot air released at the condenser of an air conditioning system. Hot air was driven to a concentric waste heat recovery heat exchanger in which water retrieves heat from air. The results show that the water temperature can increase from 25°C to 70°C. In addition, a parametric study was carried on the mass flow rate of water and hot air, the results show that high efficient heat recovery system can be obtained by lowering the flow of hot air.

Table A.1.5 shows a group of references that dealt with heat recovery of heating water purposes.

Thermoelectric generators are passive devices used to transfer thermal energy to electric energy [227-229]. They can produce

power from any temperature difference that makes them attractive to be utilized in heat recovery. Thermoelectric generators consist of N and P type semiconductor that are connected, electrically in series and thermally in parallel (Figure 12). The main limitation of thermoelectric generators is their low efficiency (5%) [230]. Thermoelectric generators are sandwiched between a heat source (waste heat) and a heat sink. The temperature difference at both sides of the device induces small voltage resulting from Seebeck effect. Remeli *et al.* [231] introduced a theoretical and experimental study in generating electricity using thermoelectric generators coupled with heat pipe. The obtained results show that 1.345 kW of waste heat is recovered generating 10 W using eight TEG.

The produced electrical energy P_e is calculated using the following equations [231].

$$P_e = \mu \cdot TEG \cdot Q_H \quad (8)$$

$$Q_H = P_e + Q_C \quad (9)$$

where $\mu \cdot TEG$ is the conversion efficiency of the thermoelectric generator, Q_H and Q_C are respectively the hot and cold heat energy that can be calculated as follows [232,233]:

$$Q_H = \dot{m}_H \cdot Cp_H \cdot \Delta T_H \quad (10)$$

$$Q_C = \dot{m}_C \cdot Cp_C \cdot \Delta T_C \quad (11)$$

where \dot{m}_H and \dot{m}_C are the mass flow rates of respectively hot and cold streams, Cp_H and Cp_C are the specific heats of the hot and cold streams, ΔT_H and ΔT_C are the temperature differences at the hot and cold sides.

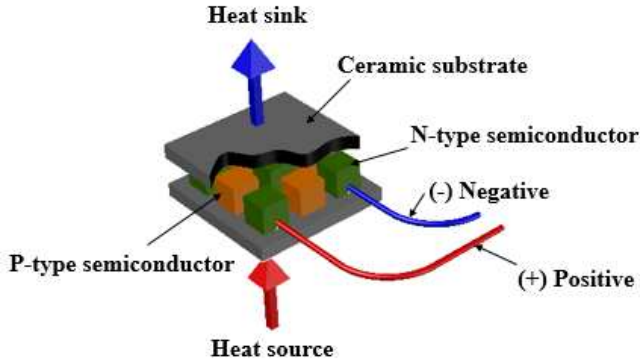

Fig. 12. Thermoelectric generator.

Table A.1.6 in appendix shows some references that dealt with heat recovery using thermoelectric generators.

Thermoelectric generators are used to produce low voltage. However, when there is a high amount of wasted heat with high temperature, higher voltage can be achieved by generating steam (Rankine cycle) or superheating a refrigerant (organic Rankine cycle) or heating a Stirling engine.

Organic Rankine cycles are utilized for relatively low temperature waste heat compared to what ordinary Rankine cycle requires. Song and Gu [275] made energy and exergy analysis on organic Rankine cycle utilized for recovering heat from exhaust gases of an engine. The result shows that the combination of cyclohexane and R141b refrigerant produced the maximum power compared to pure cyclohexane (output power increased about 13%). Figure 13 shows an electric power plant that utilizes wasted heat to generate steam. This type of power plant is called combined power plant and is widely used. Fuel is burned through burners generating high temperature flue gases that enter a gas turbine then flow to a steam boiler where steam is generated.

Energy availability and request mismatch are the direct limitation for heat recovery. Energy storage is applied in order to reduce this mismatch and improve the performance and reliability of energy system. It also provides a security for energy supply and decreases the environmental impact [276]. Sensible and latent heat storage are the main types of energy storage. However, latent heat storage have higher density storage compared to sensible heat storage [277]. Solid-liquid phase change material (PCM) [278] is the most utilized type of latent heat storage mainly due to its low volume change and stability [279]. Sharma *et al.* [280] did a review

on PCM including classification, thermo-physical properties and applications of phase change material. Figure 14 shows a latent storage system coupled to a wasted heat source.

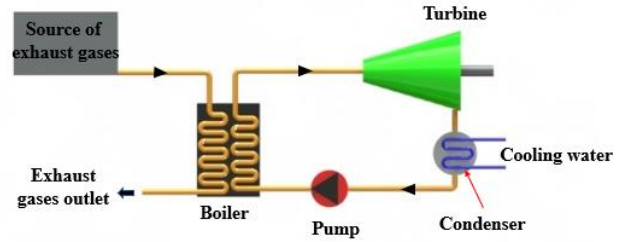

Fig. 13. Electric power plant using heat recovery energy source.

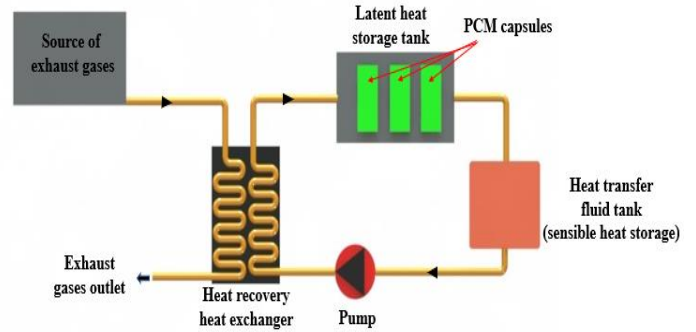

Fig. 14. Combined latent and sensible heat storage system.

The charging rate (Q_c) is the rate of heat absorbed by the latent heat storage (PCM) and the sensible heat hold by the heat transfer fluid [281,282].

$$Q_c = \frac{\dot{m}_{HTF} \cdot Cp_{HTF} \cdot \Delta T + \dot{m}_{PCM} \cdot Cp_{PCM} \cdot \Delta T + \dot{m}_{PCM} \cdot h_{fg}}{t} \quad (12)$$

where \dot{m}_{HTF} and \dot{m}_{PCM} are the mass flow rates of respectively heat transfer fluid and phase change material and t is the time. The efficiency η of the system is the charging rate over heat input (for exhaust gas case):

$$\eta = Q_c Q_g = Q_c m_g Cp_g \cdot \Delta T \quad (13)$$

where \dot{m}_g is the mass flow rate of exhaust gases. The percentage of the energy saved E_s is:

$$E_s = \frac{Q_c}{\dot{m}_f \cdot LCV} \quad (14)$$

where \dot{m}_f is the mass flow rate of fuel, and LCV is the calorific value of fuel.

Table A.1.7 shows some references that detailed heat recovery works using PCM.

Liu *et al.* [297] did an experimental study on recovering heat from superheated vapor and hot refrigerant in the condenser of the heat pump to produce domestic hot water. A parametric study was carried out by changing the flow rate of water (350, 550, 750 L/h). The water temperature was raised to 40°C with an initial temperature of 15.6°C. Results show that hot water absorbs both sensible and latent heat when the temperature of water is lower than the condensation temperature.

6. Economic and environmental concerns

In order to shed light on the importance of energy recovery and its impact on the cost of energy generated, money saved by reusing dissipated energy and amount of CO₂ emissions reduced, an economic and environmental studies are carried out. The studies concern heat recovery from exhaust gases of specific sources and applied on specific type of heat recovery systems. Figure 15 shows the procedure to lead up to the economic and environmental studies in order to estimate the total amount of recovered energy, its equivalent money saving and payback period, and the amount of CO₂ emissions reduced.

Table 2 shows each application with its exhaust gases temperature and flow rate. The sources are distributed into industrial and residential sources of exhaust gases.

It shows high temperature of exhaust gases for industrial applications (diesel power plant and cement industry) with high flow rates (>> 1 kg/s) compared to residential applications.

Table 2. Properties of exhaust gases for different sources.

Source	Reference number	Exhaust gases temperature (°C)	Mass flow rate of exhaust gases (kg/s)
Diesel power plant	[298]	560	124.11
Cement industry	[299]	350	48.34
ICE 40 kW	[300]	598	0.0367
ICE 20 kW diesel	[300]	332	0.0394
Chimney	[301]	112	0.00298
Wood stove	[302]	321	0.00268

Equation (15) shows how to obtain $Q_{dissipated}$, the dissipated heat *via* exhaust gases:

$$Q_{dissipated} (kW) = \dot{m}_g \cdot C_{p_g} \cdot (T_g - T_a) \quad (15)$$

where \dot{m}_g is the mass flow rate (kg/s), C_{p_g} is the specific heat at constant pressure (kJ kg⁻¹ K⁻¹) of exhaust gases, T_g and T_a are respectively the exhaust gases and ambient air temperatures (°C). It should be noted that the specific heat of exhaust gases is equal to 1.259 kJ kg⁻¹ K⁻¹ [303] and the ambient air temperature is assumed to be 20°C. The total amount of the heat energy dissipated per month, $E_{dissipated}$, is calculated as follows:

$$\begin{aligned} E_{dissipated} \left(\frac{kWh}{month} \right) &= Q_{dissipated} (kW) \\ &\times 720 \frac{hours}{month} \end{aligned} \quad (16)$$

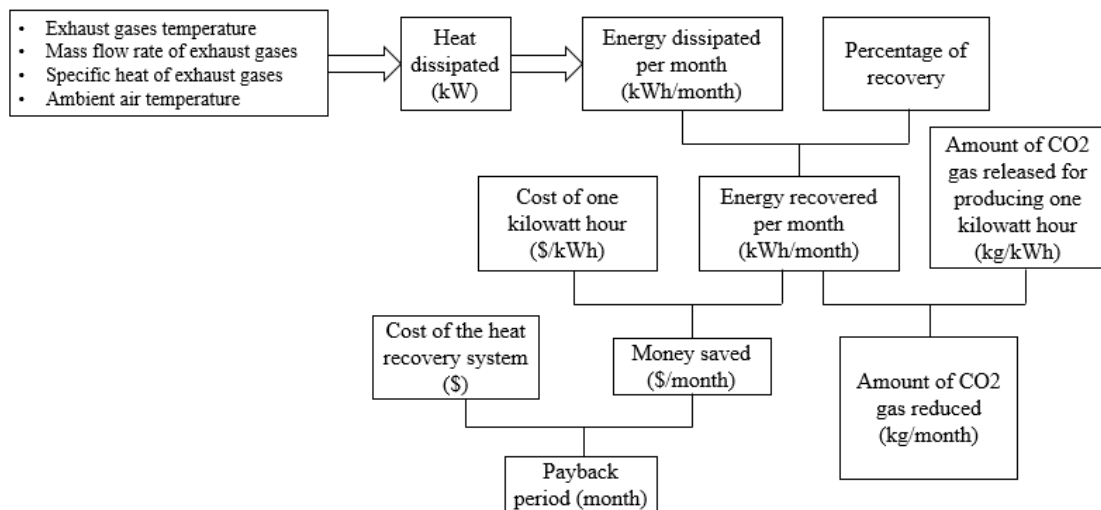

Fig. 15. Economic and environmental studies procedure.

Figure 16 shows the total amount of energy recovered for the different applications at different percentages of energy recovery which can be expressed as:

$$E_{recovered} \left(\frac{kWh}{month} \right) = E_{dissipated} \left(\frac{kWh}{month} \right) \times \% \text{ of recovery} \quad (17)$$

Figure 16 shows that wood stove have the lowest energy dissipated and diesel power plant has the highest amount of energy dissipated compared to others, since the latter has the largest mass flow rate of exhaust gases. It shows that industrial applications reject much higher amount of energy compared to residential. About 557 kWh/month are recovered from a 20 kW diesel generator when 5 % of the energy dissipated is recovered, which increases to 66585 kWh/month when 60 % of the dissipated energy is recovered. Whereas for chimney, about 93 kWh/month are recovered for 5 % energy recovery percentage, and 1492 kWh when 80 % of the energy is dissipated. For cement industry, the system is capable to recover 5.7 GWh/month when 40 % of the dissipated energy is recovered. By comparing the average heat recovered of the industrial and residential applications at same percentage of recovery, results show that in average 4500 times more energy can be recovered from industrial application compared to residential application, which reflects the energy concentration of industrial installations.

The total amount of money saved per month is in function of the amount of energy recovered and the cost of producing one kilowatt-hour.

$$MS \left(\frac{\$}{month} \right) = E_{recovered} \left(\frac{kWh}{month} \right) \times C_{1kWh} \left(\frac{\$}{kWh} \right) \quad (18)$$

where MS is the amount of money saved monthly and C_{1kWh} is the cost of one kilowatt-hour taken at 0.08 \$/kWh [205].

Figure 17 shows the total amount of money saved per month. It shows that wood stove can save 2 \$/month for 5 % energy recovery which rises to 46 \$/month for 80 % energy recovery.

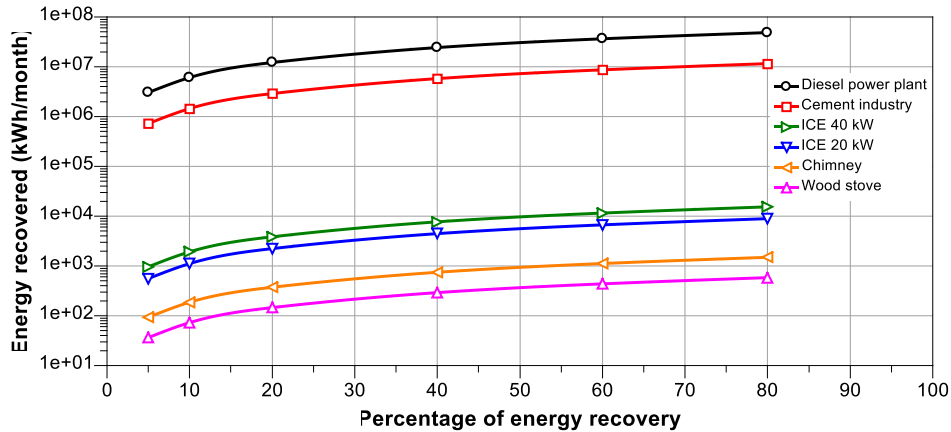

Fig. 16. Energy recovered for each application at different percentages of energy recovery.

While for 40 kW diesel generator, about 76 \$ can be saved monthly for 5 % energy recovery, and 615 \$/month when 40 % of the dissipated energy is recovered. Diesel power plant can recover about 200,000 \$ if only 5 % of the dissipated energy is recovered. This explains why mostly Brayton cycles are coupled with Rankine cycle by which exhaust gases enters a steam heat recovery boiler after exiting the gas turbine. Also for residences that utilize chimneys, it could save 60 \$/month when 40 % of the dissipated energy is recovered which can be achieved by heating water for domestic usage.

Finally, the payback period of each system is estimated by the following equation:

$$PbP \text{ (month)} = \frac{C_{HRS} \text{ ($)}}{MS \left(\frac{\$}{month} \right)} \quad (19)$$

where PbP and C_{HRS} are the payback period and the cost of the heat recovery system required for each application. Table 3 shows each system and its corresponding heat recovery system cost.

Table 3. Cost of heat recovery system for each application.

Source	Cost of HRS (\$)
Diesel power plant	6,332,500
Cement industry	2,466,500
ICE 40 kW	2,500
ICE 20 kW diesel	2,000
Chimney	500
Wood stove	500

The wood stove and chimney has the same heat recovery system cost and for electric generators the cost is about 2000 \$. Whereas, for industrial application the cost of the heat recovery system is much higher compared to residential systems, resulting mainly from the higher exhaust gases flow rate and temperature. Figure 18 shows the payback period of each system for different percentages of energy recovery.

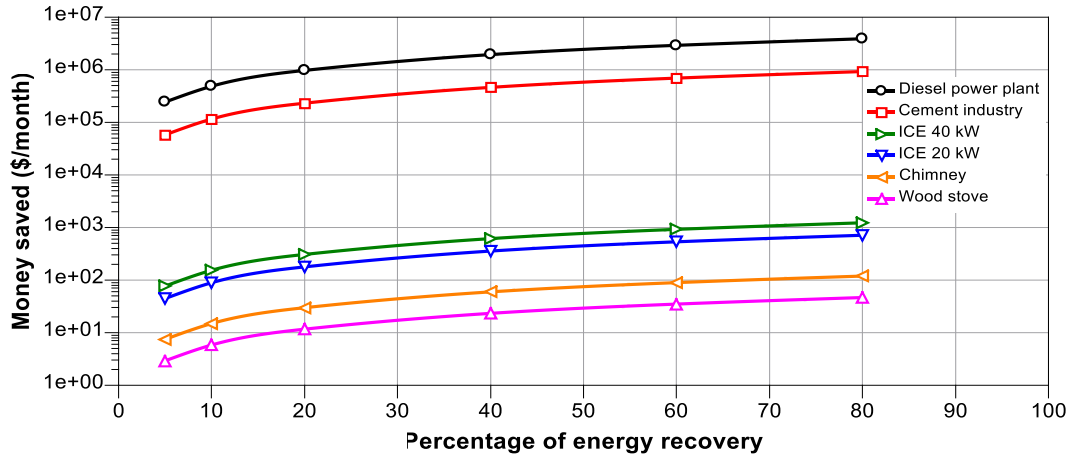

Fig. 17. Money saved per month for each system at different percentages of energy recovery.

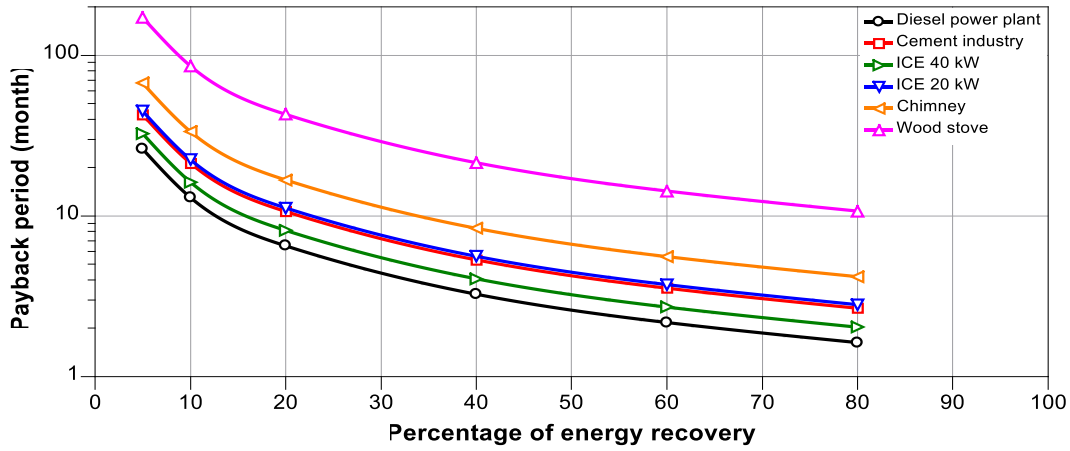

Fig. 18. Payback period of each application.

Results shows that diesel power plant heat recovery system requires about 2 years to payback its cost when 5 % of the dissipated energy is recovered, which decreases to about 6 months when 20 % of the energy lost is recovered. For chimney, it requires 2.75 years to payback the cost of the system at 5 % of recovery, which decreases to 5 months when 80 % of the dissipated energy is recovered. While for 20 kW generator, the payback period is about 3.5 years for 5 % energy recovery system and decreases to 1 year when the system recovers 20 % of the dissipated energy. Almost both generators require relatively same payback period while wood stove requires 10 months as a payback period when 80 % of the energy is dissipated. All these times are short enough to be lower than the theoretical lifetime of the energy recovery systems.

Regarding the environmental study, it is concerned on the CO₂ emissions generated in order to produce the required heat energy.

Then by recovering dissipated energy, heat recovery reduces the CO₂ emissions that are required to generate equivalent energy to the recovered energy. The total amount of CO₂ gas emissions reduced ($GE_{reduced}^{CO_2}$) is the factor of the amount of energy recovered monthly ($E_{recovered}$) and the amount of carbon dioxide generated per kilowatt-hour ($GE_{produced}^{CO_2}$):

$$\begin{aligned}
 GE_{reduced}^{CO_2} \left(\frac{kg}{month} \right) &= E_{recovered} \left(\frac{kWh}{month} \right) \\
 &\times GE_{produced}^{CO_2} \left(\frac{kg}{kWh} \right)
 \end{aligned} \quad (20)$$

Figure 19 shows the amount of carbon dioxide emissions reduced per month for each system.

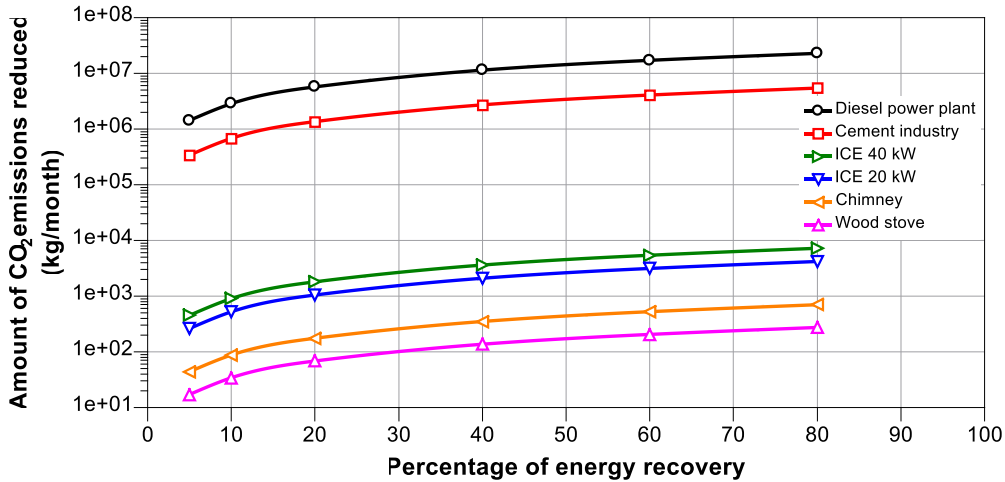

Fig. 19. Amount of CO₂ emissions reduced.

Results show that wood stove can reduce about 17 kg/month of CO₂ gas emissions which rises to half a ton per month when the system recovers respectively 5 % and 80 % of the dissipated energy. For 40 kW diesel generator, by utilizing heat recovery system that is capable to recover 10% of the lost energy, about 1 ton/month CO₂ gas emissions are reduced, and it reaches 5.5 tons/month when the system recovers 60 % of the dissipated energy. From diesel power plant, heat recovery can reduce up to 1430 tons/month when a heat recovery system is allowed to recover 5 % of energy dissipated, it rises to 17,130 tons/month when 60 % of the lost energy is recovered. This explains the high impact of energy recovery on environment by reducing CO₂ gas emissions.

7. Conclusions

Heat recovery technology is widely being employed in new industrial and residential applications. It is the usage of dumped thermal energy to increase the efficiency of the system or to drive another system as a thermal energy source. It plays a crucial role in decreasing the harmful gases emissions thus minimizing environmental damage. Heat recovery improves the system efficiency; however, it is limited by specific conditions. Many parameters control the recovery process that are mainly exhaust gases temperature and flow rate. A review on the sources, means and applications of heat recovery was done.

Internal combustion engines, generators, furnaces, gas turbines, stoves, chimneys are the main sources of exhaust gases that can be associated with a heat recovery system.

Heat recovery heat exchangers are widely used in the heat recovery process. Heat pumps, heat pipes, thermal wheels, regenerators, economizers, recuperators, plate and shell and tube heat exchangers are the main types used.

The purpose of recovery is limited by the working conditions; however, the main heat recovery purposes were illustrated. The dumped thermal energy can be recovered to be stored for later usage, or to heat another fluid (water, air), or to generate electricity or even for cooling by absorption and adsorption refrigeration cycle. Energy availability and request mismatch would limit heat recovery process, this major problem can be minimized by storing this recovered energy using sensible or latent heat storage. Electricity can be generated directly by thermoelectric generators or indirectly by generating steam that can be utilized to drive a steam turbine through an ordinary Rankine cycle.

In addition, this paper presented an economic and environmental study on specific type of heat recovery systems applied to different applications, industrial and residential. The study was done in order to shed light on the impact of energy recovery on the environment, by reducing CO₂ gas emissions, and on economy, by maximizing energy usage that led to decrease of the cost of the energy and fossil fuels.

Many studies have been completed, and many are still under implementation. This field is taking a huge place in scientist studies and will certainly increase, mostly due to two main reasons, depletion of fossil fuel and increase of the cost of energy.

References

- [1] BP. BP Statistical Review of World Energy 2017.
- [2] Shukla DL, Modi K V. A technical review on regeneration of liquid desiccant using solar energy. *Renew Sustain Energy Rev* 2017;78:517–29. doi:10.1016/J.RSER.2017.04.103.
- [3] Herez A, Ramadan M, Abdulhay B, Khaled M. Short review on solar energy systems. *AIP Conf Proc* 2016;1758.
- [4] Hachem F, Abdulhay B, Ramadan M, El Hage H, El Rab MG, Khaled M. Improving the performance of photovoltaic cells using pure and combined phase change materials – Experiments and transient energy balance. *Renew Energy* 2017;107:567–75. doi:10.1016/J.RENENE.2017.02.032.
- [5] Mussard M. Solar energy under cold climatic conditions: A review. *Renew Sustain Energy Rev* 2017;74:733–45. doi:10.1016/J.RSER.2017.03.009.
- [6] El Mays A, Ammar R, Hawa M, Akroush MA, Hachem F, Khaled M, et al. Improving Photovoltaic Panel Using Finned Plate of Aluminum. *Energy Procedia* 2017;119:812–7. doi:10.1016/J.EGYPRO.2017.07.103.
- [7] Wesley H. Solar energy strategies in the U.S. utility market. *Renew Sustain Energy Rev* 2017;55:590–5.
- [8] Tiwari R, Babu NR. Recent developments of control strategies for wind energy conversion system. *Renew Sustain Energy Rev* 2016;66:268–85. doi:10.1016/J.RSER.2016.08.005.
- [9] Loncar D, Milovanovic I, Rakic B, Radjenovic T. Compound real options valuation of renewable energy projects: The case of a wind farm in Serbia. *Renew Sustain Energy Rev* 2017;75:354–67. doi:10.1016/J.RSER.2016.11.001.
- [10] Sedaghat A, Hassanzadeh A, Jamali J, Mostafaiepour A, Chen W-H. Determination of rated wind speed for maximum annual energy production of variable speed wind turbines. *Appl Energy* 2017;205:781–9. doi:10.1016/J.APENERGY.2017.08.079.
- [11] Niesten E, Jolink A, Chappin M. Investments in the Dutch onshore wind energy industry: A review of investor profiles and the impact of renewable energy subsidies. *Renew Sustain Energy Rev* 2018;81:2519–25. doi:10.1016/j.rser.2017.06.056.
- [12] Carcasci C, Mussato L, Neri M. Biomass residues revaluation with energy production in a nursery company. *Ecol Eng* 2017;106:496–506. doi:10.1016/J.ECOLENG.2017.05.006.
- [13] Roni MS, Chowdhury S, Mamun S, Marufuzzaman M, Lein W, Johnson S. Biomass co-firing technology with policies, challenges, and opportunities: A global review. *Renew Sustain Energy Rev* 2017;78:1089–101. doi:10.1016/J.RSER.2017.05.023.
- [14] Toklu E. Biomass energy potential and utilization in Turkey. *Renew Energy* 2017;107:235–44. doi:10.1016/J.RENENE.2017.02.008.
- [15] Al-Hamamre Z, Saidan M, Hararah M, Rawajfeh K, Alkhasawneh HE, Al-Shannag M. Wastes and biomass materials as sustainable-renewable energy resources for Jordan. *Renew Sustain Energy Rev* 2017;67:295–314. doi:10.1016/j.rser.2016.09.035.
- [16] Giwa A, Alabi A, Yusuf A, Olukan T. A comprehensive review on biomass and solar energy for sustainable energy generation in Nigeria. *Renew Sustain Energy Rev* 2017;69:620–41. doi:10.1016/j.rser.2016.11.160.
- [17] Rodríguez-Monroy C, Mármol-Acitores G, Nilsson-Cifuentes G. Electricity generation in Chile using non-conventional renewable energy sources – A focus on biomass. *Renew Sustain Energy Rev* 2018;81:937–45. doi:10.1016/j.rser.2017.08.059.
- [18] Liu Y, Li Y, He F, Wang H. Comparison study of tidal stream and wave energy technology development between China and some Western Countries. *Renew Sustain Energy Rev* 2017;76:701–16. doi:10.1016/J.RSER.2017.03.049.
- [19] Goward Brown AJ, Lewis MJ. Tidal energy extraction in three-dimensional ocean models. *Renew Energy* 2017;114:244–57. doi:10.1016/J.RENENE.2017.04.032.
- [20] Segura E, Morales R, Somolinos JA, López A. Techno-economic challenges of tidal energy conversion systems: Current status and trends. *Renew Sustain Energy Rev* 2017;77:536–50. doi:10.1016/J.RSER.2017.04.054.
- [21] Khojasteh D, Khojasteh D, Kamali R, Beyene A, Iglesias G. Assessment of renewable energy resources in Iran; with a focus on wave and tidal energy. *Renew Sustain Energy Rev* 2018;81:2992–3005. doi:10.1016/j.rser.2017.06.110.
- [22] Nash S, Phoenix A. A review of the current understanding of the hydro-environmental impacts of energy removal by tidal turbines. *Renew Sustain Energy Rev* 2017;80:648–62. doi:10.1016/j.rser.2017.05.289.
- [23] Năstase G, Șerban A, Năstase AF, Dragomir G, Brezeanu AI, Iordan NF. Hydropower development in Romania. A review from its beginnings to the present. *Renew Sustain Energy Rev* 2017;80:297–312. doi:10.1016/J.RSER.2017.05.209.
- [24] Brimmo AT, Sodiq A, Sofela S, Kolo I. Sustainable energy development in Nigeria: Wind, hydropower, geothermal and nuclear (Vol. 1). *Renew Sustain Energy Rev* 2017;74:474–90. doi:10.1016/J.RSER.2016.11.162.
- [25] Bildirici ME, Gökmenoğlu SM. Environmental pollution, hydropower energy consumption and economic growth: Evidence from G7 countries. *Renew Sustain Energy Rev* 2017;75:68–85. doi:10.1016/J.RSER.2016.10.052.
- [26] Melikoglu M. Geothermal energy in Turkey and around the World: A review of the literature and an analysis based on Turkey's Vision 2023 energy targets. *Renew Sustain Energy Rev* 2017;76:485–92. doi:10.1016/J.RSER.2017.03.082.
- [27] Shortall R, Kharrazi A. Cultural factors of sustainable energy development: A case study of geothermal energy in Iceland and Japan. *Renew Sustain Energy Rev* 2017;79:101–9. doi:10.1016/J.RSER.2017.05.029.
- [28] Wang F, Deng S, Zhao J, Zhao J, Yang G, Yan J. Integrating geothermal into coal-fired power plant with carbon capture: A comparative study with solar energy. *Energy Convers Manag* 2017;148:569–82. doi:10.1016/J.ENCONMAN.2017.06.016.
- [29] Miranda-Barbosa E, Sigfússon B, Carlsson J, Tzimas E. Advantages from Combining CCS with Geothermal Energy. *Energy Procedia* 2017;114:6666–76. doi:10.1016/J.EGYPRO.2017.03.1794.
- [30] Herez A, Khaled M, Murr R, Haddad A, Elhage H, Ramadan M. Using Geothermal Energy for cooling - Parametric study. *Energy Procedia* 2017;119:783–91. doi:10.1016/J.EGYPRO.2017.07.111.
- [31] Younas U, Khan B, Ali SM, Arshad CM, Farid U, Zeb K, et al. Pakistan geothermal renewable energy potential for electric power generation: A survey. *Renew Sustain Energy Rev* 2016;63:398–413. doi:10.1016/j.rser.2016.04.038.
- [32] Clauser C, Ewert M. The renewables cost challenge: Levelized cost of geothermal electric energy compared to other sources of primary energy – Review and case study. *Renew Sustain Energy Rev* 2018;82:3683–93. doi:10.1016/j.rser.2017.10.095.
- [33] Caux S, Gaoua Y, Lopez P. A combinatorial optimisation approach to energy management strategy for a hybrid fuel cell vehicle. *Energy* 2017;133:219–30. doi:10.1016/J.ENERGY.2017.05.109.
- [34] Ramadan M, Khaled M, Ramadan HS, Becherif M. An innovative system coupling energy recovery from speed bump and fuel cell. *Int J Hydrogen Energy* 2017. doi:10.1016/J.IJHYDENE.2017.07.160.
- [35] Das HS, Tan CW, Yatim AHM, Lau KY. Feasibility analysis of hybrid photovoltaic/battery/fuel cell energy system for an indigenous residence in East Malaysia. *Renew Sustain Energy Rev*

- 2017;76:1332–47. doi:10.1016/J.RSER.2017.01.174.
- [36] Ramadan M, Khaled M, Ramadan HS, Becherif M. Modeling and sizing of combined fuel cell-thermal solar system for energy generation. *Int J Hydrogen Energy* 2016;41:19929–35.
- [37] O'Connor D, Calautit JKS, Hughes BR. A review of heat recovery technology for passive ventilation applications. *Renew Sustain Energy Rev* 2016;54:1481–93. doi:10.1016/j.rser.2015.10.039.
- [38] Wahlroos M, Pärssinen M, Rinne S, Syri S, Manner J. Future views on waste heat utilization – Case of data centers in Northern Europe. *Renew Sustain Energy Rev* 2018;82:1749–64. doi:10.1016/j.rser.2017.10.058.
- [39] Cuce PM, Riffat S. A comprehensive review of heat recovery systems for building applications. *Renew Sustain Energy Rev* 2015;47:665–82. doi:10.1016/j.rser.2015.03.087.
- [40] Khaled M, Ramadan M, Hage H El. Parametric Analysis of Heat Recovery from Exhaust Gases of Generators. *Energy Procedia* 2015;75:3295–300. doi:10.1016/J.EGYPRO.2015.07.710.
- [41] Khaled M, Ramadan M. Study of the Thermal Behavior of Multi Tube Tank in Heat Recovery from Chimney—Analysis and Optimization. *Heat Transf Eng* 2017;1–11. doi:10.1080/01457632.2017.1312864.
- [42] Ramadan M, lemenand T, Khaled M. Recovering heat from hot drain water—Experimental evaluation, parametric analysis and new calculation procedure. *Energy Build* 2016;128:575–82.
- [43] Dheep GR, Sreekumar A. Phase Change Materials—A Sustainable Way of Solar Thermal Energy Storage. *Energy Sustain Through Green Energy* 2015:217–44. doi:10.1007/978-81-322-2337-5_9.
- [44] Incropera FP, DeWitt DP, Bergman TL, Lavine AS. Fundamentals of heat and mass transfer. Sixth edition. John Wiley; 2007.
- [45] Chintala V, Kumar S, Pandey JK. A technical review on waste heat recovery from compression ignition engines using organic Rankine cycle. *Renew Sustain Energy Rev* 2018;81:493–509.
- [46] Varma GVP, Srinivas T. Power generation from low temperature heat recovery. *Renew Sustain Energy Rev* 2017;75:402–14.
- [47] Feneley AJ, Pesiridis A, Andwari AM. Variable Geometry Turbocharger Technologies for Exhaust Energy Recovery and Boosting—A Review. *Renew Sustain Energy Rev* 2017;71:959–75.
- [48] Ma H, Du N, Zhang Z, Lyu F, Deng N, Li C, et al. Assessment of the optimum operation conditions on a heat pipe heat exchanger for waste heat recovery in steel industry. *Renew Sustain Energy Rev* 2017;79:50–60. doi:10.1016/J.RSER.2017.04.122.
- [49] Lion S, Michos CN, Vlaskos I, Rouaud C, Taccani R. A review of waste heat recovery and Organic Rankine Cycles (ORC) in on-off highway vehicle Heavy Duty Diesel Engine applications. *Renew Sustain Energy Rev* 2017;79:691–708.
- [50] Zhou F, Joshi SN, Rhoté-Vaney R, Dede EM. A review and future application of Rankine Cycle to passenger vehicles for waste heat recovery. *Renew Sustain Energy Rev* 2017;75:1008–21. doi:10.1016/J.RSER.2016.11.080.
- [51] Yan B, Xue S, Li Y, Duan J, Zeng M. Gas-fired combined cooling, heating and power (CCHP) in Beijing: A techno-economic analysis. *Renew Sustain Energy Rev* 2016;63:118–31. doi:10.1016/J.RSER.2016.05.036.
- [52] Tsiliyannis CA. Enhanced waste to energy operability under feedstock uncertainty by synergistic flue gas recirculation and heat recuperation. *Renew Sustain Energy Rev* 2015;50:1320–37.
- [53] Aghaali H, Ångström H-E. A review of turbocompounding as a waste heat recovery system for internal combustion engines. *Renew Sustain Energy Rev* 2015;49:813–24. doi:10.1016/J.RSER.2015.04.144.
- [54] Hatami M, Ganji DD, Gorji-Bandpy M. A review of different heat exchangers designs for increasing the diesel exhaust waste heat recovery. *Renew Sustain Energy Rev* 2014;37:168–81. doi:10.1016/J.RSER.2014.05.004.
- [55] Gewald D, Siokos K, Karellas S, Spliethoff H. Waste heat recovery from a landfill gas-fired power plant. *Renew Sustain Energy Rev* 2012;16:1779–89. doi:10.1016/J.RSER.2012.01.036.
- [56] Saidur R, Rezaei M, Muzammil WK, Hassan MH, Paria S, Hasanuzzaman M. Technologies to recover exhaust heat from internal combustion engines. *Renew Sustain Energy Rev* 2012;16:5649–59. doi:10.1016/J.RSER.2012.05.018.
- [57] Wang T, Zhang Y, Peng Z, Shu G. A review of researches on thermal exhaust heat recovery with Rankine cycle. *Renew Sustain Energy Rev* 2011;15:2862–71. doi:10.1016/J.RSER.2011.03.015.
- [58] Jaber H, Khaled M, Lemenand T, Ramadan M. Short review on heat recovery from exhaust gas, 2016, p. 030045. doi:10.1063/1.4959441.
- [59] Karvonen M, Kapoor R, Uusitalo A, Ojanen V. Technology competition in the internal combustion engine waste heat recovery: a patent landscape analysis. *J Clean Prod* 2016;112:3735–43. doi:10.1016/J.JCLEPRO.2015.06.031.
- [60] Singh B, Shrivastava N. Exhaust Gas Heat Recovery for C.I Engine—A Review. *Int J Eng Sci Res Technol* 2014;3.
- [61] Kumar C, Sonthalia A, Goel R. Experimental study on waste heat recovery from an internal combustion engine using thermoelectric technology. *Therm Sci* 2011;15:1011–22.
- [62] Gabriel-Buenaventura A, Azzopardi B. Energy recovery systems for retrofitting in internal combustion engine vehicles: A review of techniques. *Renew Sustain Energy Rev* 2015;41:955–64. doi:10.1016/j.rser.2014.08.083.
- [63] Shu G, Liang Y, Wei H, Tian H, Zhao J, Liu L. A review of waste heat recovery on two-stroke IC engine aboard ships. *Renew Sustain Energy Rev* 2013;19:385–401. doi:10.1016/j.rser.2012.11.034.
- [64] Hamdy M, Askalany AA, Harby K, Kora N. An overview on adsorption cooling systems powered by waste heat from internal combustion engine. *Renew Sustain Energy Rev* 2015;51:1223–34. doi:10.1016/j.rser.2015.07.056.
- [65] Chae SH, Kim SH, Yoon SG, Park S. Optimization of a waste heat utilization network in an eco-industrial park. *Appl Energy* 2010;87:1978–88. doi:10.1016/j.apenergy.2009.12.003.
- [66] Rahman A, Razzak F, Afroz R, Mohiuddin AKM, Hawlader MNA. Power generation from waste of IC engines. *Renew Sustain Energy Rev* 2015;51:382–95. doi:10.1016/j.rser.2015.05.077.
- [67] Luján JM, Climent H, Dolz V, Moratal A, Borges-Alejo J, Soukeur Z. Potential of exhaust heat recovery for intake charge heating in a diesel engine transient operation at cold conditions. *Appl Therm Eng* 2016;105:501–8. doi:10.1016/j.applthermaleng.2016.03.028.
- [68] Sprouse C, Depcik C. Review of organic Rankine cycles for internal combustion engine exhaust waste heat recovery. *Appl Therm Eng* 2013;51:711–22. doi:10.1016/j.applthermaleng.2012.10.017.
- [69] Dong G, Morgan R, Heikal M. A novel split cycle internal combustion engine with integral waste heat recovery. *Appl Energy* 2015;157:744–53. doi:10.1016/j.apenergy.2015.02.024.
- [70] Yang F, Zhang H, Song S, Bei C, Wang H, Wang E. Thermoeconomic multi-objective optimization of an organic Rankine cycle for exhaust waste heat recovery of a diesel engine. *Energy* 2015;93:2208–28. doi:10.1016/j.energy.2015.10.117.
- [71] Pandiyarajan V, Chinnappandian M, Raghavan V, Velraj R. Second law analysis of a diesel engine waste heat recovery with a combined sensible and latent heat storage system. *Energy Policy* 2011;39:6011–20. doi:10.1016/j.enpol.2011.06.065.
- [72] Yu G, Shu G, Tian H, Wei H, Liu L. Simulation and thermodynamic analysis of a bottoming Organic Rankine Cycle (ORC) of diesel engine (DE). *Energy* 2013;51:281–90.
- [73] Bai S, Lu H, Wu T, Yin X, Shi X, Chen L. Numerical and experimental analysis for exhaust heat exchangers in automobile

- thermoelectric generators. *Case Stud Therm Eng* 2014;4:99–112. doi:10.1016/j.csite.2014.07.003.
- [74] He W, Wang S, Zhang X, Li Y, Lu C. Optimization design method of thermoelectric generator based on exhaust gas parameters for recovery of engine waste heat. *Energy* 2015;91:1–9. doi:10.1016/j.energy.2015.08.022.
- [75] Danel Q, Périlhon C, Lacour S, Punov P, Danlos A. Waste Heat Recovery Applied to a Tractor Engine. *Energy Procedia* 2015;74:331–43. doi:10.1016/j.egypro.2015.07.622.
- [76] Wang JL, Wu JY, Zheng CY. Simulation and evaluation of a CCHP system with exhaust gas deep-recovery and thermoelectric generator. *Energy Convers Manag* 2014;86:992–1000. doi:10.1016/j.enconman.2014.06.036.
- [77] Xie H, Yang C. Dynamic behavior of Rankine cycle system for waste heat recovery of heavy duty diesel engines under driving cycle. *Appl Energy* 2013;112:130–41. doi:10.1016/j.apenergy.2013.05.071.
- [78] Yang MH. Thermal and economic analyses of a compact waste heat recovering system for the marine diesel engine using transcritical Rankine cycle. *Energy Convers Manag* 2015;106:1082–96. doi:10.1016/j.enconman.2015.10.050.
- [79] Amicabile S, Lee JI, Kum D. A comprehensive design methodology of organic Rankine cycles for the waste heat recovery of automotive heavy-duty diesel engines. *Appl Therm Eng* 2015;87:574–85. doi:10.1016/j.applthermaleng.2015.04.034.
- [80] Song J, Gu C wei. Performance analysis of a dual-loop organic Rankine cycle (ORC) system with wet steam expansion for engine waste heat recovery. *Appl Energy* 2015;156:280–9. doi:10.1016/j.apenergy.2015.07.019.
- [81] Kim YM, Shin DG, Kim CG, Cho GB. Single-loop organic Rankine cycles for engine waste heat recovery using both low- and high-temperature heat sources. *Energy* 2016;96:482–94. doi:10.1016/j.energy.2015.12.092.
- [82] Dolz V, Novella R, García A, Sánchez J. HD Diesel engine equipped with a bottoming Rankine cycle as a waste heat recovery system. Part 1: Study and analysis of the waste heat energy. *Appl Therm Eng* 2012;36:269–78. doi:10.1016/j.applthermaleng.2011.10.025.
- [83] Boretti AA. Transient operation of internal combustion engines with Rankine waste heat recovery systems. *Appl Therm Eng* 2012;48:18–23. doi:10.1016/j.applthermaleng.2012.04.043.
- [84] Raznoshinskaia A V. The research of influence characteristics of heat-storage material on thermodynamic process in heat storage, installed in system of wasteheat recovery of internal combustion engines. *Procedia Eng* 2015;129:140–4. doi:10.1016/j.proeng.2015.12.022.
- [85] Lee DH, Park JS, Ryu MR, Park JH. Development of a highly efficient low-emission diesel engine-powered co-generation system and its optimization using Taguchi method. *Appl Therm Eng* 2013;50:491–5. doi:10.1016/j.applthermaleng.2012.06.040.
- [86] Shon J, Kim H, Lee K. Improved heat storage rate for an automobile coolant waste heat recovery system using phase-change material in a fin-tube heat exchanger. *Appl Energy* 2014;113:680–9. doi:10.1016/j.apenergy.2013.07.049.
- [87] Di Battista D, Mauriello M, Cipollone R. Waste heat recovery of an ORC-based power unit in a turbocharged diesel engine propelling a light duty vehicle. *Appl Energy* 2015;152:109–20. doi:10.1016/j.apenergy.2015.04.088.
- [88] Kauranen P, Elonen T, Wikstrom L, Heikkinen J, Laurikko J. Temperature optimisation of a diesel engine using exhaust gas heat recovery and thermal energy storage (diesel engine with thermal energy storage). *Appl Therm Eng* 2010;30:631–8. doi:10.1016/j.applthermaleng.2009.11.008.
- [89] Hatami M, Ganji DD, Gorji-Bandpy M. Numerical study of finned type heat exchangers for ICEs exhaust waste heat recovery. *Case Stud Therm Eng* 2014;4:53–64. doi:10.1016/j.csite.2014.07.002.
- [90] Shu G, Li X, Tian H, Liang X, Wei H, Wang X. Alkanes as working fluids for high-temperature exhaust heat recovery of diesel engine using organic Rankine cycle. *Appl Energy* 2014;119:204–17. doi:10.1016/j.apenergy.2013.12.056.
- [91] Hatami M, Jafaryar M, Ganji DD, Gorji-Bandpy M. Optimization of finned-tube heat exchangers for diesel exhaust waste heat recovery using CFD and CCD techniques. *Int Commun Heat Mass Transf* 2014;57:254–63. doi:10.1016/j.icheatmasstransfer.2014.08.015.
- [92] Du Q, Diao H, Niu Z, Zhang G, Shu G, Jiao K. Effect of cooling design on the characteristics and performance of thermoelectric generator used for internal combustion engine. *Energy Convers Manag* 2015;101:9–18. doi:10.1016/j.enconman.2015.05.036.
- [93] Yang F, Zhang H, Bei C, Song S, Wang E. Parametric optimization and performance analysis of ORC (organic Rankine cycle) for diesel engine waste heat recovery with a fin-and-tube evaporator. *Energy* 2015;91:128–41. doi:10.1016/j.energy.2015.08.034.
- [94] Song J, Gu C wei. Parametric analysis of a dual loop Organic Rankine Cycle (ORC) system for engine waste heat recovery. *Energy Convers Manag* 2015;105:995–1005. doi:10.1016/j.enconman.2015.08.074.
- [95] Wang H, Zhang H, Yang F, Song S, Chang Y, Bei C, et al. Parametric optimization of regenerative organic rankine cycle system for diesel engine based on particle swarm optimization. *Energies* 2015;8:9751–76. doi:10.3390/en8099751.
- [96] Carapellucci R, Giordano L. The Recovery of Exhaust Heat from Gas Turbines. *Effic. Perform. Robustness Gas Turbines, InTech*; 2012. doi:10.5772/37920.
- [97] Wei M, Zhao X, Fu L, Zhang S. Performance study and application of new coal-fired boiler flue gas heat recovery system. *Appl Energy* 2017;188:121–9. doi:10.1016/j.apenergy.2016.11.132.
- [98] Jana K, De S. ENERGY SAVINGS POTENTIAL THROUGH WASTE HEAT RECOVERY FROM FLUE GAS FOR POST COMBUSTION CO₂ CAPTURE 2013;3:435–42.
- [99] Basrawi F, Yamada T, Nakanishi K. Evaluation of the performance of a micro gas turbine cogeneration system in a sewage treatment facility: Optimized configuration of a cogeneration system. *Heat Transf - Asian Res* 2013;42:556–68. doi:10.1002/htj.20389.
- [100] Han X, Liu M, Zhai M, Chong D, Yan J, Xiao F. Investigation on the off-design performances of flue gas pre-dried lignite-fired power system integrated with waste heat recovery at variable external working conditions. *Energy* 2015;90:1743–58.
- [101] Grljušić M, Medica V, Radica G. Calculation of efficiencies of a ship power plant operating with waste heat recovery through combined heat and power production. *Energies* 2015;8:4273–99. doi:10.3390/en8054273.
- [102] Zebian H, Mitsos A. A split concept for HRSG (heat recovery steam generators) with simultaneous area reduction and performance improvement. *Energy* 2014;71:421–31. doi:10.1016/j.energy.2014.04.087.
- [103] Han X, Liu M, Wu K, Chen W, Xiao F, Yan J. Exergy analysis of the flue gas pre-dried lignite-fired power system based on the boiler with open pulverizing system. *Energy* 2016;106:285–300. doi:10.1016/j.energy.2016.03.047.
- [104] Franco A. Analysis of small size combined cycle plants based on the use of supercritical HRSG. *Appl Therm Eng* 2011;31:785–94. doi:10.1016/j.applthermaleng.2010.10.027.
- [105] Tajik Mansouri M, Ahmadi P, Ganjeh Kaviri A, Jaafar MNM. Exergetic and economic evaluation of the effect of HRSG configurations on the performance of combined cycle power plants. *Energy Convers Manag* 2012;58:47–58. doi:10.1016/j.enconman.2011.12.020.

- [106] Najjar YSH, Abubaker AM, El-Khalil AFS. Novel inlet air cooling with gas turbine engines using cascaded waste-heat recovery for green sustainable energy. *Energy* 2015;93:770–85. doi:10.1016/j.energy.2015.09.033.
- [107] Yang Y, Xu C, Xu G, Han Y, Fang Y, Zhang D. A new conceptual cold-end design of boilers for coal-fired power plants with waste heat recovery. *Energy Convers Manag* 2015;89:137–46. doi:10.1016/j.enconman.2014.09.065.
- [108] Li Y, Yan M, Zhang L, Chen G, Cui L, Song Z, et al. Method of flash evaporation and condensation - heat pump for deep cooling of coal-fired power plant flue gas: Latent heat and water recovery. *Appl Energy* 2016;172:107–17. doi:10.1016/j.apenergy.2016.03.017.
- [109] Pitot de la Beaujardiere JFP, Reuter HCR, Klein SA, Reindl DT. Impact of HRSG characteristics on open volumetric receiver CSP plant performance. *Sol Energy* 2016;127:159–74. doi:10.1016/j.solener.2016.01.030.
- [110] Sharma M, Singh O. Exergy analysis of dual pressure HRSG for different dead states and varying steam generation states in gas/steam combined cycle power plant. *Appl Therm Eng* 2016;93:614–22. doi:10.1016/j.applthermaleng.2015.10.012.
- [111] Wang J, Xia K, Chen W, Liu M, Chong D, Liu J, et al. Research on Heat Recovery System of Turbine Exhaust Steam Using Absorption Heat Pump for Heating Supply Based on Heating Load Characteristics. *Energy Procedia* 2015;75:1502–7. doi:10.1016/j.egypro.2015.07.290.
- [112] Lee CE, Yu B, Lee S. An analysis of the thermodynamic efficiency for exhaust gas recirculation-condensed water recirculation-waste heat recovery condensing boilers (EGR-CWR-WHR CB). *Energy* 2015;86:267–75. doi:10.1016/j.energy.2015.04.042.
- [113] Qu M, Abdelaziz O, Yin H. New configurations of a heat recovery absorption heat pump integrated with a natural gas boiler for boiler efficiency improvement. *Energy Convers Manag* 2014;87:175–84. doi:10.1016/j.enconman.2014.06.083.
- [114] Xi X, Zhou Y, Guo C, Yang L, Du X. Characteristics of Organic Rankine Cycles with Zeotropic Mixture for Heat Recovery of Exhaust Gas of Boiler. *Energy Procedia* 2015;75:1093–101. doi:10.1016/j.egypro.2015.07.496.
- [115] Han X, Liu M, Wang J, Yan J, Liu J, Xiao F. Simulation study on lignite-fired power system integrated with flue gas drying and waste heat recovery - Performances under variable power loads coupled with off-design parameters. *Energy* 2014;76:406–18. doi:10.1016/j.energy.2014.08.032.
- [116] Bassily AM. Modeling, analysis, and modifications of different GT cooling techniques for modern commercial combined cycle power plants with reducing the irreversibility of the HRSG. *Appl Therm Eng* 2013;53:131–46. doi:10.1016/j.applthermaleng.2013.01.002.
- [117] Thapa S, Borquist E, Baniya A, Weiss L. Experimental and computational investigation of a MEMS-based boiler for waste heat recovery. *Energy Convers Manag* 2015;100:403–13. doi:10.1016/j.enconman.2015.04.061.
- [118] Liu M, Qin Y, Yan H, Han X, Chong D. Energy and water conservation at lignite-fired power plants using drying and water recovery technologies. *Energy Convers Manag* 2015;105:118–26. doi:10.1016/j.enconman.2015.07.069.
- [119] Nadir M, Ghenaiet A. Thermodynamic optimization of several (heat recovery steam generator) HRSG configurations for a range of exhaust gas temperatures. *Energy* 2015;86:685–95. doi:10.1016/j.energy.2015.04.023.
- [120] Bin Mamat AMI, Martinez-Botas RF, Rajoo S, Romagnoli A, Petrovic S. Waste heat recovery using a novel high performance low pressure turbine for electric turbocompounding in downsized gasoline engines: Experimental and computational analysis. *Energy* 2015;90:218–34. doi:10.1016/j.energy.2015.06.010.
- [121] Wang D, Bao A, Kunc W, Liss W. Coal power plant flue gas waste heat and water recovery. *Appl Energy* 2012;91:341–8. doi:10.1016/j.apenergy.2011.10.003.
- [122] Feng H, Zhong W, Wu Y, Tong S. Thermodynamic performance analysis and algorithm model of multi-pressure heat recovery steam generators (HRSG) based on heat exchangers layout. *Energy Convers Manag* 2014;81:282–9. doi:10.1016/j.enconman.2014.02.060.
- [123] Li C, Zhu Q, Wang H. Parametric Optimization of Brayton /Organic Trans-critical Combined Cycle for Flue Gas Waste Heat Recovery. *Energy Procedia* 2015;75:1590–5. doi:10.1016/j.egypro.2015.07.370.
- [124] Sharma M, Singh O. Parametric Evaluation of Heat Recovery Steam Generator (HRSG). *Heat Transf Res* 2014;43:691–705. doi:10.1002/htj.21106.
- [125] Sharma M, Singh O. Exergy Based Parametric Analysis of a Heat Recovery Steam Generator. *Heat Transf Res* 2016;45:1–14. doi:10.1002/htj.21148.
- [126] Khaled M, Ramadan M, Chahine K, Assi A. Prototype implementation and experimental analysis of water heating using recovered waste heat of chimneys. *Case Stud Therm Eng* 2015;5:127–33. doi:10.1016/j.csite.2015.03.004.
- [127] Raman P, Ram NK, Murali J. Improved test method for evaluation of bio-mass cook-stoves. *Energy* 2014;71:479–95. doi:10.1016/j.energy.2014.04.101.
- [128] Gao HB, Huang GH, Li HJ, Qu ZG, Zhang YJ. Development of stove-powered thermoelectric generators: A review. *Appl Therm Eng* 2016;96:297–310. doi:10.1016/j.applthermaleng.2015.11.032.
- [129] Manoj Kumar, Sachin Kumar, Tyagi SK. Design, development and technological advancement in the biomass cookstoves: A review. *Renew Sustain Energy Rev* 2013;26:265–85.
- [130] Gogoi B, Baruah DC. Steady state heat transfer modeling of solid fuel biomass stove: Part I. *Energy* 2016;97:283–95.
- [131] Champier D, Bédécarrats JP, Kouksou T, Rivaletto M, Strub F, Pignolet P. Study of a TE (thermoelectric) generator incorporated in a multifunction wood stove. *Energy* 2011;36:1518–26.
- [132] Buczynski R, Weber R, Kim R, Schwoppe P. One-dimensional model of heat-recovery, non-recovery coke ovens. Part III: Upper-oven, down-comers and sole-flues. *Fuel* 2016;181:1132–50. doi:10.1016/j.fuel.2016.01.087.
- [133] Montecucco A, Siviter J, Knox AR. Combined heat and power system for stoves with thermoelectric generators. *Appl Energy* 2017;185:1336–42. doi:10.1016/j.apenergy.2015.10.132.
- [134] Chen BM, Abakr YA, Riley PH, Hann DB. Development of thermoacoustic engine operating by waste heat from cooking stove. *AIP Conf Proc* 2012;1440:532–40. doi:10.1063/1.4704259.
- [135] Aranguren P, Astrain D, Rodríguez A, Martínez A. Experimental investigation of the applicability of a thermoelectric generator to recover waste heat from a combustion chamber. *Appl Energy* 2015;152:121–30. doi:10.1016/j.apenergy.2015.04.077.
- [136] Georges L, Skreiberg Y, Novakovic V. On the proper integration of wood stoves in passive houses under cold climates. *Energy Build* 2014;72:87–95. doi:10.1016/j.enbuild.2013.12.023.
- [137] Mal R, Prasad R, Vijay V. Renewable Energy from Biomass Cookstoves for Off Grid Rural Areas. *Int Proc Chem Biol Environ Eng* 2014;64:113–7.
- [138] Ng KC, Wang X, Lim YS, Saha BB, Chakaraborty A, Koyama S, et al. Experimental study on performance improvement of a four-bed adsorption chiller by using heat and mass recovery. *Int J Heat Mass Transf* 2006;49:3343–8. doi:10.1016/J.IJHEATMASSTRANSFER.2006.01.053.
- [139] Pradeep Varma GV, Srinivas T. Design and analysis of a

- cogeneration plant using heat recovery of a cement factory. *Case Stud Therm Eng* 2015;5:24–31. doi:10.1016/J.CSITE.2014.12.002.
- [140] Wang Z, Zhang X, Han J, Li Z. Waste heat and water recovery from natural gas boilers: Parametric analysis and optimization of a flue-gas-driven open absorption system. *Energy Convers Manag* 2017;154:526–37. doi:10.1016/j.enconman.2017.11.042.
- [141] Wang J, Fu L, Zhao X, Zhao J. Mathematical simulation of the flue-gas recovery system for coal-fired boilers based on the direct-contact heat exchanger. *Procedia Eng* 2017;205:321–8. doi:10.1016/j.proeng.2017.09.987.
- [142] Liu X, Gong G, Wu Y, Li H. Thermal performance analysis of Brayton cycle with waste heat recovery boiler for diesel engines of offshore oil production facilities. *Appl Therm Eng* 2016;107:320–8. doi:10.1016/j.applthermaleng.2016.05.066.
- [143] Chen W, Shi W, Wang B, Shang S, Li X. A Deep Heat Recovery Device between Flue Gas and Supply Air of Gas-fired Boiler by Using Non-contact Total Heat Exchanger. *Energy Procedia* 2017;105:4976–82. doi:10.1016/j.egypro.2017.03.994.
- [144] Wei M, Zhao X, Fu L, Zhang S. Performance study and application of new coal-fired boiler flue gas heat recovery system. *Appl Energy* 2017;188:121–9. doi:10.1016/j.apenergy.2016.11.132.
- [145] Thapa S, Borquist E, Weiss L. Thermal energy recovery via integrated small scale boiler and superheater. *Energy* 2018;142:765–72. doi:10.1016/j.energy.2017.10.063.
- [146] Shang S, Li X, Chen W, Wang B, Shi W. A total heat recovery system between the flue gas and oxidizing air of a gas-fired boiler using a non-contact total heat exchanger. *Appl Energy* 2017;207:613–23. doi:10.1016/j.apenergy.2017.05.169.
- [147] Nag PK. *Power plant engineering*. Second edition. Tata McGraw-Hill; 2001.
- [148] Wang JF, Brown C, Cleland DJ. Heat pump heat recovery options for food industry dryers. *Int J Refrig* 2018;86:48–55. doi:10.1016/j.ijrefrig.2017.11.028.
- [149] Thalfeldt M, Kurnitski J, Latšov E. Exhaust air heat pump connection schemes and balanced heat recovery ventilation effect on district heat energy use and return temperature. *Appl Therm Eng* 2018;128:402–14. doi:10.1016/j.applthermaleng.2017.09.033.
- [150] Farshi LG, Khalili S, Mosaffa AH. Thermodynamic analysis of a cascaded compression – Absorption heat pump and comparison with three classes of conventional heat pumps for the waste heat recovery. *Appl Therm Eng* 2018;128:282–96. doi:10.1016/j.applthermaleng.2017.09.032.
- [151] Jabari F, Mohammadi-Ivatloo B, Li G, Mehrjerdi H. Design and performance investigation of a novel absorption ice-making system using waste heat recovery from flue gases of air to air heat pump. *Appl Therm Eng* 2018;130:782–92. doi:10.1016/j.applthermaleng.2017.11.015.
- [152] Buker MS, Riffat SB. Solar assisted heat pump systems for low temperature water heating applications: A systematic review. *Renew Sustain Energy Rev* 2016;55:399–413. doi:10.1016/J.RSER.2015.10.157.
- [153] Pesaran A, Lee H, Hwang Y, Radermacher R, Chun H-H. Review article: Numerical simulation of adsorption heat pumps. *Energy* 2016;100:310–20. doi:10.1016/J.ENERGY.2016.01.103.
- [154] Sun J, Ge Z, Fu L. Investigation on LiBr-H₂O double evaporation-absorption heat pump (DEAHP) for heat recovery under lower driving sources. *Appl Therm Eng* 2017;125:978–85. doi:10.1016/J.APPLTHERMALENG.2017.07.061.
- [155] Maghsoudi P, Sadeghi S, Gorgani HH. Comparative study and multi-objective optimization of plate-fin recuperators applied in 200 kW microturbines based on non-dominated sorting and normalization method considering recuperator effectiveness, exergy efficiency and total cost. *Int J Therm Sci* 2018;124:50–67. doi:10.1016/j.ijthermalsci.2017.10.001.
- [156] Cao Y, Gao Y, Zheng Y, Dai Y. Optimum design and thermodynamic analysis of a gas turbine and ORC combined cycle with recuperators. *Energy Convers Manag* 2016;116:32–41. doi:10.1016/J.ENCONMAN.2016.02.073.
- [157] Serrano IP, Linares JI, Cantizano A, Moratilla BY. Enhanced arrangement for recuperators in supercritical CO₂ Brayton power cycle for energy conversion in fusion reactors. *Fusion Eng Des* 2014;89:1909–12. doi:10.1016/j.fusengdes.2014.03.083.
- [158] Aquaro D, Pieve M. High temperature heat exchangers for power plants: Performance of advanced metallic recuperators. *Appl Therm Eng* 2007;27:389–400. doi:10.1016/j.applthermaleng.2006.07.030.
- [159] Cao Y, Gao Y, Zheng Y, Dai Y. Optimum design and thermodynamic analysis of a gas turbine and ORC combined cycle with recuperators. *Energy Convers Manag* 2016;116:32–41. doi:10.1016/j.enconman.2016.02.073.
- [160] Xiao G, Yang T, Liu H, Ni D, Ferrari ML, Li M, et al. Recuperators for micro gas turbines: A review. *Appl Energy* 2017;197:83–99. doi:10.1016/j.apenergy.2017.03.095.
- [161] Jouhara H, Almahmoud S, Chauhan A, Delpech B, Bianchi G, Tassou SA, et al. Experimental and theoretical investigation of a flat heat pipe heat exchanger for waste heat recovery in the steel industry. *Energy* 2017;141:1928–39. doi:10.1016/j.energy.2017.10.142.
- [162] Zhou F, Duan W, Ma G. Thermal performance of a pump-driven loop heat pipe as an air-to-air energy recovery device. *Energy Build* 2017;151:206–16. doi:10.1016/j.enbuild.2017.06.057.
- [163] Jouhara H, Almahmoud S, Chauhan A, Delpech B, Nannou T, Tassou SA, et al. Experimental investigation on a flat heat pipe heat exchanger for waste heat recovery in steel industry. *Energy Procedia* 2017;123:329–34. doi:10.1016/j.egypro.2017.07.262.
- [164] Diao YH, Liang L, Kang YM, Zhao YH, Wang ZY, Zhu TT. Experimental study on the heat recovery characteristic of a heat exchanger based on a flat micro-heat pipe array for the ventilation of residential buildings. *Energy Build* 2017;152:448–57. doi:10.1016/j.enbuild.2017.07.045.
- [165] Deng Z, Zheng Y, Liu X, Zhu B, Chen Y. Experimental study on thermal performance of an anti-gravity pulsating heat pipe and its application on heat recovery utilization. *Appl Therm Eng* 2017;125:1368–78. doi:10.1016/j.applthermaleng.2017.07.107.
- [166] Mahajan G, Thompson SM, Cho H. Energy and cost savings potential of oscillating heat pipes for waste heat recovery ventilation. *Energy Reports* 2017;3:46–53. doi:10.1016/j.egypr.2016.12.002.
- [167] Ma H, Du N, Zhang Z, Lyu F, Deng N, Li C, et al. Assessment of the optimum operation conditions on a heat pipe heat exchanger for waste heat recovery in steel industry. *Renew Sustain Energy Rev* 2017;79:50–60. doi:10.1016/j.rser.2017.04.122.
- [168] Orr B, Akbarzadeh A, Lappas P. An exhaust heat recovery system utilising thermoelectric generators and heat pipes. *Appl Therm Eng* 2017;126:1185–90. doi:10.1016/j.applthermaleng.2016.11.019.
- [169] Cao Q, Luan W, Wang T. Performance enhancement of heat pipes assisted thermoelectric generator for automobile exhaust heat recovery. *Appl Therm Eng* 2018;130:1472–9. doi:10.1016/j.applthermaleng.2017.09.134.
- [170] Solomon AB, Sekar M, Yang SH. Analytical expression for thermal conductivity of heat pipe. *Appl Therm Eng* 2016;100:462–7. doi:10.1016/J.APPLTHERMALENG.2016.02.042.
- [171] Shen S, Cai W, Wang X, Wu Q, Yon H. Investigation of liquid desiccant regenerator with heat recovery heat pipe system. *Energy Build* 2017;146:353–63. doi:10.1016/J.ENBUILD.2017.04.057.
- [172] Tu R, Hwang Y. Efficient configurations for desiccant wheel cooling systems using different heat sources for regeneration. *Int J Refrig*

- 2018;86:14–27. doi:10.1016/j.ijrefrig.2017.12.001.
- [173] Fu H-X, Yang Q-R, Zhang L-Z. Effects of material properties on heat and mass transfer in honeycomb-type adsorbent wheels for total heat recovery. *Appl Therm Eng* 2017;118:345–56. doi:10.1016/j.applthermaleng.2017.03.006.
- [174] De Antonellis S, Intini M, Joppolo C, Leone C. Design Optimization of Heat Wheels for Energy Recovery in HVAC Systems. *Energies* 2014;7:7348–67. doi:10.3390/en7117348.
- [175] Ge TS, Dai YJ, Wang RZ. Review on solar powered rotary desiccant wheel cooling system. *Renew Sustain Energy Rev* 2014;39:476–97. doi:10.1016/J.RSER.2014.07.121.
- [176] Liu W, Lian Z, Radermacher R, Yao Y. Energy consumption analysis on a dedicated outdoor air system with rotary desiccant wheel. *Energy* 2007;32:1749–60. doi:10.1016/J.ENERGY.2006.11.012.
- [177] Fu H-X, Yang Q-R, Zhang L-Z. Effects of material properties on heat and mass transfer in honeycomb-type adsorbent wheels for total heat recovery. *Appl Therm Eng* 2017;118:345–56. doi:10.1016/J.APPLTHERMALENG.2017.03.006.
- [178] Seddegh S, Tehrani SSM, Wang X, Cao F, Taylor RA. Comparison of heat transfer between cylindrical and conical vertical shell-and-tube latent heat thermal energy storage systems. *Appl Therm Eng* 2018;130:1349–62. doi:10.1016/j.applthermaleng.2017.11.130.
- [179] Seddegh S, Wang X, Joybari MM, Haghghat F. Investigation of the effect of geometric and operating parameters on thermal behavior of vertical shell-and-tube latent heat energy storage systems. *Energy* 2017;137:69–82. doi:10.1016/j.energy.2017.07.014.
- [180] Gasia J, Diriken J, Bourke M, Van Bael J, Cabeza LF. Comparative study of the thermal performance of four different shell-and-tube heat exchangers used as latent heat thermal energy storage systems. *Renew Energy* 2017;114:934–44. doi:10.1016/j.renene.2017.07.114.
- [181] Lei Y, Li Y, Jing S, Song C, Lyu Y, Wang F. Design and performance analysis of the novel shell-and-tube heat exchangers with louver baffles. *Appl Therm Eng* 2017;125:870–9. doi:10.1016/j.applthermaleng.2017.07.081.
- [182] Hajabdollahi H, Hajabdollahi Z. Numerical study on impact behavior of nanoparticle shapes on the performance improvement of shell and tube heat exchanger. *Chem Eng Res Des* 2017;125:449–60. doi:10.1016/j.cherd.2017.05.005.
- [183] Mirzaei M, Hajabdollahi H, Fadakar H. Multi-objective optimization of shell-and-tube heat exchanger by constructal theory. *Appl Therm Eng* 2017;125:9–19. doi:10.1016/j.applthermaleng.2017.06.137.
- [184] Riahi S, Saman WY, Bruno F, Belusko M, Tay NHS. Performance comparison of latent heat storage systems comprising plate fins with different shell and tube configurations. *Appl Energy* 2018;212:1095–106. doi:10.1016/j.apenergy.2017.12.109.
- [185] Khan Z, Khan ZA. An experimental investigation of discharge/solidification cycle of paraffin in novel shell and tube with longitudinal fins based latent heat storage system. *Energy Convers Manag* 2017;154:157–67. doi:10.1016/j.enconman.2017.10.051.
- [186] wen J, Gu X, Wang M, Liu Y, Wang S. Multi-parameter optimization of shell-and-tube heat exchanger with helical baffles based on entransy theory. *Appl Therm Eng* 2018;130:804–13. doi:10.1016/j.applthermaleng.2017.10.164.
- [187] Wang S, Xiao J, Wang J, Jian G, Wen J, Zhang Z. Application of response surface method and multi-objective genetic algorithm to configuration optimization of Shell-and-tube heat exchanger with fold helical baffles. *Appl Therm Eng* 2018;129:512–20. doi:10.1016/j.applthermaleng.2017.10.039.
- [188] Pal E, Kumar I, Joshi JB, Maheshwari NK. CFD simulations of shell-side flow in a shell-and-tube type heat exchanger with and without baffles. *Chem Eng Sci* 2016;143:314–40. doi:10.1016/J.CES.2016.01.011.
- [189] Ebrahimzadeh E, Wilding P, Frankman D, Fazlollahi F, Baxter LL. Theoretical and experimental analysis of dynamic heat exchanger: Retrofit configuration. *Energy* 2016;96:545–60. doi:10.1016/J.ENERGY.2015.12.068.
- [190] Lee D, Kim D, Park S, Lim J, Kim Y. Evaporation heat transfer coefficient and pressure drop of R-1233zd(E) in a brazed plate heat exchanger. *Appl Therm Eng* 2018;130:1147–55. doi:10.1016/j.applthermaleng.2017.11.088.
- [191] Jin B-J, Lee J-P, Park M-H, Yun T-J, Song Y-H, Kim I-S. A Study on Forming for Plate-Type Heat Exchangers of the Ti Material. *Procedia Eng* 2017;174:171–8. doi:10.1016/j.proeng.2017.01.197.
- [192] Kumar B, Soni A, Singh SN. Effect of geometrical parameters on the performance of chevron type plate heat exchanger. *Exp Therm Fluid Sci* 2018;91:126–33. doi:10.1016/j.expthermflusci.2017.09.023.
- [193] Marchionni M, Bianchi G, Karvountzis-Kontakiotis A, Pesiridis A, Tassou SA. Dynamic modeling and optimization of an ORC unit equipped with plate heat exchangers and turbomachines. *Energy Procedia* 2017;129:224–31. doi:10.1016/j.egypro.2017.09.146.
- [194] Eldeeb R, Aute V, Radermacher R. A survey of correlations for heat transfer and pressure drop for evaporation and condensation in plate heat exchangers. *Int J Refrig* 2016;65:12–26. doi:10.1016/j.ijrefrig.2015.11.013.
- [195] Zhang Y, Jiang C, Shou B, Zhou W, Zhang Z, Wang S, et al. A quantitative energy efficiency evaluation and grading of plate heat exchangers. *Energy* 2018;142:228–33. doi:10.1016/j.energy.2017.10.023.
- [196] Hall SM, Hall SM. Chapter 12 – Heat Exchangers. *Rules Thumb Chem. Eng.*, 2018, p. 197–230. doi:10.1016/B978-0-12-811037-9.00012-6.
- [197] Arsenyeva OP, Tovazhnyanskyy LL, Kapustenko PO, Khavin GL, Yuzbashyan AP, Arsenyev PY. Two types of welded plate heat exchangers for efficient heat recovery in industry. *Appl Therm Eng* 2016;105:763–73. doi:10.1016/j.applthermaleng.2016.03.064.
- [198] Zhicheng Y, Lijun W, Zhaokuo Y, Haowen L. Shape optimization of welded plate heat exchangers based on grey correlation theory. *Appl Therm Eng* 2017;123:761–9. doi:10.1016/j.applthermaleng.2017.05.005.
- [199] Goodarzi M, Nouri E. A new double-pass parallel-plate heat exchanger with better wall temperature uniformity under uniform heat flux. *Int J Therm Sci* 2016;102:137–44. doi:10.1016/J.IJTHEMALSCI.2015.11.012.
- [200] Naldi C, Dongellini M, Morini GL. Summer Performances of Reversible Air-to-water Heat Pumps with Heat Recovery for Domestic Hot Water Production. *Energy Procedia* 2015;78:1117–22. doi:10.1016/J.EGYPRO.2015.11.068.
- [201] Ramadan M, El Rab MG, Khaled M. Parametric analysis of air–water heat recovery concept applied to HVAC systems: Effect of mass flow rates. *Case Stud Therm Eng* 2015;6:61–8. doi:10.1016/J.CSITE.2015.06.001.
- [202] Fuentes E, Arce L, Salom J. A review of domestic hot water consumption profiles for application in systems and buildings energy performance analysis. *Renew Sustain Energy Rev* 2017;81:1530–47. doi:10.1016/j.rser.2017.05.229.
- [203] McNabola A, Shields K. Efficient drain water heat recovery in horizontal domestic shower drains. *Energy Build* 2013;59:44–9. doi:10.1016/j.enbuild.2012.12.026.
- [204] Li F, Duanmu L, Fu L, Zhao XL. Research and Application of Flue Gas Waste Heat Recovery in Co-generation Based on Absorption Heat-exchange. *Procedia Eng* 2016;146:594–603. doi:10.1016/j.proeng.2016.06.407.
- [205] Jaber H, Ramadan M, Lemenand T, Khaled M. Domestic thermoelectric cogeneration system optimization analysis, energy

- consumption and CO₂ emissions reduction. *Appl Therm Eng* 2018;130:279–95. doi:10.1016/j.applthermaleng.2017.10.148.
- [206] Martić I, Budimir S, Mitrović N, Maslarević A, Marković M. Application and design of an economizer for waste heat recovery in a cogeneration plant. *Therm Sci* 2016;20:1355–62. doi:10.2298/TSCI141113211M.
- [207] Najjar YSH, Abubaker AM. Thermoeconomic analysis and optimization of a novel inlet air cooling system with gas turbine engines using cascaded waste-heat recovery. *Energy* 2017;128:421–34. doi:10.1016/j.energy.2017.04.029.
- [208] Jia J, Lee WL. Applying storage-enhanced heat recovery room air-conditioner (SEHRAC) for domestic water heating in residential buildings in Hong Kong. *Energy Build* 2014;78:132–42. doi:10.1016/j.enbuild.2014.03.020.
- [209] Elgendy E, Schmidt J. Optimum utilization of recovered heat of a gas engine heat pump used for water heating at low air temperature. *Energy Build* 2014;80:375–83. doi:10.1016/j.enbuild.2014.05.054.
- [210] Todorović MS, Kim JT. In search for sustainable globally cost-effective energy efficient building solar system - Heat recovery assisted building integrated PV powered heat pump for air-conditioning, water heating and water saving. *Energy Build* 2014;85:346–55. doi:10.1016/j.enbuild.2014.08.046.
- [211] Zhang L, Chennells M, Xia X. A power dispatch for a ferrochrome plant heat recovery cogeneration system. *Appl Energy* 2018; 227:180–189. doi.org/10.1016/j.apenergy.2017.08.019.
- [212] Tanha K, Fung AS, Kumar R. Performance of two domestic solar water heaters with drain water heat recovery units: Simulation and experimental investigation. *Appl Therm Eng* 2015;90:444–59. doi:10.1016/j.applthermaleng.2015.07.038.
- [213] Semmari H, LeDenn A, Boudéhen F, Praene J-P, Lucas F, Marc O. Case study for experimental validation of a new presizing tool for solar heating, cooling and domestic hot water closed systems. *Case Stud Therm Eng* 2017;10:272–82. doi:10.1016/j.csite.2017.07.007.
- [214] Pradeep Varma G V., Srinivas T. Design and analysis of a cogeneration plant using heat recovery of a cement factory. *Case Stud Therm Eng* 2015;5:24–31. doi:10.1016/j.csite.2014.12.002.
- [215] Kapil A, Bulatov I, Smith R, Kim JK. Site-wide low-grade heat recovery with a new cogeneration targeting method. *Chem Eng Res Des* 2012;90:677–89. doi:10.1016/j.cherd.2011.09.001.
- [216] Nemati A, Nami H, Ranjbar F, Yari M. A comparative thermodynamic analysis of ORC and Kalina cycles for waste heat recovery: A case study for CGAM cogeneration system. *Case Stud Therm Eng* 2017;9:1–13. doi:10.1016/j.csite.2016.11.003.
- [217] Li W, Zhao J, Fu L, Yuan W, Zheng Z, Li Y. Energy efficiency analysis of condensed waste heat recovery ways in cogeneration plant. *Energy Convers Manag* 2015;101:616–25. doi:http://dx.doi.org/10.1016/j.enconman.2015.06.017.
- [218] Li Y, Mi P, Li W, Zhang S. Full operating conditions optimization study of new co-generation heating system based on waste heat utilization of exhausted steam. *Energy Convers Manag* 2018;155:91–9. doi:10.1016/j.enconman.2017.10.081.
- [219] Lu Y, Wang Y, Bao H, Yuan Y, Wang L, Roskilly AP. Analysis of an optimal resorption cogeneration using mass and heat recovery processes. *Appl Energy* 2015;160:892–901. doi:10.1016/j.apenergy.2015.01.138.
- [220] Jaber H, Khaled M, Lemenand T, Faraj J, Bazzi H, Ramadan M. Effect of Exhaust Gases Temperature on the Performance of a Hybrid Heat Recovery System. *Energy Procedia* 2017;119:775–82. doi:10.1016/j.egypro.2017.07.110.
- [221] Ngendakumana P, Gabriele F, Restivo Y, Sartor K. Energetic and Environmental Performances of a Domestic Hot Water Condensing Boiler Fired by Wood Pellets. *Energy Procedia* 2017;120:270–7. doi:10.1016/j.egypro.2017.07.207.
- [222] Hoshi A, Akazawa T, Wakashima S ichiro, Fujimoto I, Kikuoka Y. Study on waste heat recovery from exhaust smoke in cogeneration system using woody biomass fuels. *Heat Transf - Asian Res* 2012;41:634–48. doi:10.1002/htj.20390.
- [223] Khaled M, Ramadan M, Chahine K, Assi A. Prototype implementation and experimental analysis of water heating using recovered waste heat of chimneys. *Case Stud Therm Eng* 2013;5:127–33.
- [224] Liu F-G, Tian Z-Y, Dong F-J, Yan C, Zhang R, Yan A-B. Experimental study on the performance of a gas engine heat pump for heating and domestic hot water. *Energy Build* 2017;152:273–8. doi:10.1016/j.enbuild.2017.07.051.
- [225] Niemelä T, Manner M, Laitinen A, Sivula T-M, Jokisalo J, Kosonen R. Computational and experimental performance analysis of a novel method for heating of domestic hot water with a ground source heat pump system. *Energy Build* 2018;161:22–40. doi:10.1016/j.enbuild.2017.12.017.
- [226] Yue C, Han D, Pu W, He W. Parametric analysis of a vehicle power and cooling/heating cogeneration system. *Energy* 2016;115:800–10. doi:10.1016/j.energy.2016.09.072.
- [227] Chahine K, Ramadan M, Merhi Z, Jaber H, Khaled M. Parametric analysis of temperature gradient across thermoelectric power generators. *J Electr Syst* 2016;12:623–32.
- [228] Ramadan M, Ali S, Bazzi H, Khaled M. New hybrid system combining TEG, condenser hot air and exhaust airflow of all-air HVAC systems. *Case Stud Therm Eng* 2017;10:154–60. doi:10.1016/J.CSITE.2017.05.007.
- [229] LeBlanc S. Thermoelectric generators: Linking material properties and systems engineering for waste heat recovery applications. *Sustain Mater Technol* 2014;1–2:26–35. doi:10.1016/J.SUSMAT.2014.11.002.
- [230] Orr B, Akbarzadeh A, Mochizuki M, Singh R. A review of car waste heat recovery systems utilising thermoelectric generators and heat pipes. *Appl Therm Eng* 2016;101:490–5. doi:10.1016/J.APPLTHERMALENG.2015.10.081.
- [231] Remeli MF, Tan L, Date A, Singh B, Akbarzadeh A. Simultaneous power generation and heat recovery using a heat pipe assisted thermoelectric generator system. *Energy Convers Manag* 2015;91:110–9. doi:10.1016/J.ENCONMAN.2014.12.001.
- [232] Tian H, Jiang N, Jia Q, Sun X, Shu G, Liang X. Comparison of Segmented and Traditional Thermoelectric Generator for Waste Heat Recovery of Diesel Engine. *Energy Procedia* 2015;75:590–6. doi:10.1016/J.EGYPRO.2015.07.461.
- [233] Tang ZB, Deng YD, Su CQ, Shuai WW, Xie CJ. A research on thermoelectric generator's electrical performance under temperature mismatch conditions for automotive waste heat recovery system. *Case Stud Therm Eng* 2015;5:143–50. doi:10.1016/J.CSITE.2015.03.006.
- [234] Kanno T, Takahashi K, Sakai A, Tamaki H, Kusada H, Yamada Y. Detection of thermal radiation, sensing of heat flux, and recovery of waste heat by the transverse thermoelectric effect. *J Electron Mater* 2014;43:2072–80. doi:10.1007/s11664-013-2959-3.
- [235] Stevens RJ, Weinstein SJ, Koppula KS. Theoretical limits of thermoelectric power generation from exhaust gases. *Appl Energy* 2014;133:80–8. doi:10.1016/j.apenergy.2014.07.075.
- [236] Kristiansen NR, Snyder GJ, Nielsen HK, Rosendahl L. Waste heat recovery from a marine waste incinerator using a thermoelectric generator. *J Electron Mater* 2012;41:1024–9. doi:10.1007/s11664-012-2009-6.
- [237] Klein Altstedde M, Rinderknecht F, Friedrich H. Integrating phase-change materials into automotive thermoelectric generators: An

- experimental examination and analysis of energetic potential through numerical simulation. *J Electron Mater* 2014;43:2134–40. doi:10.1007/s11664-014-2990-z.
- [238] Zhang Y, Cleary M, Wang X, Kempf N, Schoensee L, Yang J, et al. High-temperature and high-power-density nanostructured thermoelectric generator for automotive waste heat recovery. *Energy Convers Manag* 2015;105:946–50. doi:10.1016/j.enconman.2015.08.051.
- [239] He W, Wang S, Lu C, Zhang X, Li Y. Influence of different cooling methods on thermoelectric performance of an engine exhaust gas waste heat recovery system. *Appl Energy* 2016;162:1251–8. doi:10.1016/j.apenergy.2015.03.036.
- [240] Date A, Gauci L, Chan R, Date A. Performance review of a novel combined thermoelectric power generation and water desalination system. *Renew Energy* 2015;83:256–69. doi:10.1016/j.renene.2015.04.024.
- [241] Cao Z, Koukharenko E, Tudor MJ, Torah RN, Beeby SP. Flexible screen printed thermoelectric generator with enhanced processes and materials. *Sensors Actuators, A Phys* 2016;238:196–206. doi:10.1016/j.sna.2015.12.016.
- [242] Barma MC, Riaz M, Saidur R, Long BD. Estimation of thermoelectric power generation by recovering waste heat from Biomass fired thermal oil heater. *Energy Convers Manag* 2015;98:303–13. doi:10.1016/j.enconman.2015.03.103.
- [243] Lu C, Wang S, Chen C, Li Y. Effects of heat enhancement for exhaust heat exchanger on the performance of thermoelectric generator. *Appl Therm Eng* 2015;89:270–9. doi:10.1016/j.applthermaleng.2015.05.086.
- [244] Phillip N, Maganga O, Burnham KJ, Ellis MA, Robinson S, Dunn J, et al. Investigation of maximum power point tracking for thermoelectric generators. *J Electron Mater* 2013;42:1900–6. doi:10.1007/s11664-012-2460-4.
- [245] Korzhuev MA. Conflict between internal combustion engine and thermoelectric generator during waste heat recovery in cars. *Tech Phys Lett* 2011;37:151–3. doi:10.1134/S1063785011020258.
- [246] Yu S, Du Q, Diao H, Shu G, Jiao K. Start-up modes of thermoelectric generator based on vehicle exhaust waste heat recovery. *Appl Energy* 2015;138:276–90. doi:10.1016/j.apenergy.2014.10.062.
- [247] Remeli MF, Date A, Orr B, Ding LC, Singh B, Affandi NDN, et al. Experimental investigation of combined heat recovery and power generation using a heat pipe assisted thermoelectric generator system. *Energy Convers Manag* 2016;111:147–57. doi:10.1016/j.enconman.2015.12.032.
- [248] Navarro-Peris E, Corberan JM, Ancik Z. Evaluation of the potential recovery of compressor heat losses to enhance the efficiency of refrigeration systems by means of thermoelectric generation. *Appl Therm Eng* 2015;89:755–62. doi:10.1016/j.applthermaleng.2015.06.033.
- [249] Remeli MF, Verjoporn K, Singh B, Kiatbodan L, Date A, Akbarzadeh A. Passive Heat Recovery System Using Combination of Heat Pipe and Thermoelectric Generator. *Energy Procedia* 2015;75:608–14. doi:10.1016/j.egypro.2015.07.465.
- [250] Massaguer E, Massaguer A, Montoro L, Gonzalez JR. Modeling analysis of longitudinal thermoelectric energy harvester in low temperature waste heat recovery applications. *Appl Energy* 2015;140:184–95. doi:10.1016/j.apenergy.2014.12.005.
- [251] Elefsiniotis A, Becker T, Schmid U. Thermoelectric energy harvesting using phase change materials (PCMs) in high temperature environments in aircraft. *J Electron Mater* 2014;43:1809–14. doi:10.1007/s11664-013-2880-9.
- [252] KUMAR CR, Sonthalia A, Goel R. Experimental study on waste heat recovery from an internal combustion engine using thermoelectric technology. *Therm Sci* 2011;15:1011–22. doi:10.2298/TSCI100518053K.
- [253] Jang JY, Tsai YC. Optimization of thermoelectric generator module spacing and spreader thickness used in a waste heat recovery system. *Appl Therm Eng* 2013;51:677–89. doi:10.1016/j.applthermaleng.2012.10.024.
- [254] Remeli MF, Tan L, Date A, Singh B, Akbarzadeh A. Simultaneous power generation and heat recovery using a heat pipe assisted thermoelectric generator system. *Energy Convers Manag* 2015;91:110–9. doi:10.1016/j.enconman.2014.12.001.
- [255] Sonthalia A, Reddy S, Kumar CR, Kamani K. Theoretical Investigation of Waste Heat Recovery from an IC Engine Using Vapor Absorption Refrigeration System and Thermoelectric Converter. *Heat Transf - Asian Res* 2015;44:499–514. doi:10.1002/htj.21133.
- [256] Kumar S, Heister SD, Xu X, Salvador JR, Meisner GP. Thermoelectric generators for automotive waste heat recovery systems part II: Parametric evaluation and topological studies. *J Electron Mater* 2013;42:944–55. doi:10.1007/s11664-013-2472-8.
- [257] Hendricks TJ, Karri NK, Hogan TP, Cauchy CJ. New perspectives in thermoelectric energy recovery system design optimization. *J Electron Mater* 2013;42:1725–36. doi:10.1007/s11664-012-2406-x.
- [258] Gao X, Andreasen SJ, Chen M, Kær SK. Numerical model of a thermoelectric generator with compact plate-fin heat exchanger for high temperature PEM fuel cell exhaust heat recovery. *Int J Hydrogen Energy* 2012;37:8490–8. doi:10.1016/j.ijhydene.2012.03.009.
- [259] Yazawa K, Shakouri A. Scalable cost/performance analysis for thermoelectric waste heat recovery systems. *J Electron Mater* 2012;41:1845–50. doi:10.1007/s11664-012-2049-y.
- [260] Niu Z, Diao H, Yu S, Jiao K, Du Q, Shu G. Investigation and design optimization of exhaust-based thermoelectric generator system for internal combustion engine. *Energy Convers Manag* 2014;85:85–101. doi:10.1016/j.enconman.2014.05.061.
- [261] Shu G, Zhao J, Tian H, Liang X, Wei H. Parametric and exergetic analysis of waste heat recovery system based on thermoelectric generator and organic rankine cycle utilizing R123. *Energy* 2012;45:806–16. doi:10.1016/j.energy.2012.07.010.
- [262] Ma H-K, Lin C-P, Wu H-P, Peng C-H, Hsu C-C. Waste heat recovery using a thermoelectric power generation system in a biomass gasifier. *Appl Therm Eng* 2015;88:274–9. doi:10.1016/j.applthermaleng.2014.09.070.
- [263] Hasani M, Rahbar N. Application of the thermoelectric cooler as a power generator in waste heat recovery from a PEM fuel cell - An experimental study. *Int J Hydrogen Energy* 2015;40:15040–51. doi:10.1016/j.ijhydene.2015.09.023.
- [264] Aranguren P, Astrain D, Rodríguez A, Martínez A. Experimental investigation of the applicability of a thermoelectric generator to recover waste heat from a combustion chamber. *Appl Energy* 2015;152:121–30. doi:10.1016/j.apenergy.2015.04.077.
- [265] Jaworski M, Bednarczyk M, Czachor M. Experimental investigation of thermoelectric generator (TEG) with PCM module. *Appl Therm Eng* 2016;96:527–33. doi:10.1016/j.applthermaleng.2015.12.005.
- [266] Orr B, Singh B, Tan L, Akbarzadeh A. Electricity generation from an exhaust heat recovery system utilising thermoelectric cells and heat pipes. *Appl Therm Eng* 2014;73:586–95. doi:10.1016/j.applthermaleng.2014.07.056.
- [267] Liu X, Deng YD, Li Z, Su CQ. Performance analysis of a waste heat recovery thermoelectric generation system for automotive application. *Energy Convers Manag* 2015;90:121–7. doi:10.1016/j.enconman.2014.11.015.
- [268] Hatzikraniotis E. On the recovery of wasted heat using a commercial thermoelectric device. *Acta Phys Pol A* 2012;121:287–9.

- [269] Wang T, Luan W, Wang W, Tu S-T. Waste heat recovery through plate heat exchanger based thermoelectric generator system. *Appl Energy* 2014;136:860–5. doi:10.1016/j.apenergy.2014.07.083.
- [270] Ming T, Wu Y, Peng C, Tao Y. Thermal analysis on a segmented thermoelectric generator. *Energy* 2015;80:388–99. doi:10.1016/j.energy.2014.11.080.
- [271] Huang G-Y, Yao D-J. Two-Dimensional Thermal Resistance Analysis of a Waste Heat Recovery System with Thermoelectric Generators. *J Electron Mater* 2013;42:1982–7. doi:10.1007/s11664-013-2488-0.
- [272] Baker C, Vuppuluri P, Shi L, Hall M. Model of heat exchangers for waste heat recovery from diesel engine exhaust for thermoelectric power generation. *J Electron Mater* 2012;41:1290–7. doi:10.1007/s11664-012-1915-y.
- [273] Tian H, Jiang N, Jia Q, Sun X, Shu G, Liang X. Comparison of Segmented and Traditional Thermoelectric Generator for Waste Heat Recovery of Diesel Engine. *Energy Procedia* 2015;75:590–6. doi:10.1016/j.egypro.2015.07.461.
- [274] Gao X, Andreasen SJ, Kær SK, Rosendahl LA. Optimization of a thermoelectric generator subsystem for high temperature PEM fuel cell exhaust heat recovery. *Int J Hydrogen Energy* 2014;39:6637–45. doi:10.1016/j.ijhydene.2014.01.193.
- [275] Song J, Gu C. Analysis of ORC (Organic Rankine Cycle) systems with pure hydrocarbons and mixtures of hydrocarbon and retardant for engine waste heat recovery. *Appl Therm Eng* 2015;89:693–702. doi:10.1016/j.applthermaleng.2015.06.055.
- [276] Kousksou T, Rhafiki TE, Bruel P, Jamilc A, Zeraouli Y. Energy storage: Applications and challenges. *Sol Energy Mater Sol Cells* 2014;120:59–80. doi:10.1016/J.SOLMAT.2013.08.015.
- [277] Zhou D, Zhao CY, Tian Y. Review on thermal energy storage with phase change materials (PCMs) in building applications. *Appl Energy* 2012;92:593–605. doi:10.1016/J.APENERGY.2011.08.025.
- [278] El Mays A, Ammar R, Hawa M, Akroush MA, Hachem F, Khaled M, et al. Using phase change material in under floor heating. *Energy Procedia* 2017;119:806–11. doi:10.1016/J.EGYPRO.2017.07.101.
- [279] Farid MM, Khudhair AM, Razack SAK, Al-Hallaj S. A review on phase change energy storage: materials and applications. *Energy Convers Manag* 2004;45:1597–615. doi:10.1016/J.ENCONMAN.2003.09.015.
- [280] Sharma SD, Kitano H, Sagara K. Phase Change Materials for Low Temperature Solar Thermal Applications. *Res Rep Fac Eng Mie Univ* 2004;29:31–64.
- [281] Wang Z, Qiu F, Yang W, Zhao X. Applications of solar water heating system with phase change material. *Renew Sustain Energy Rev* 2015;52:645–52. doi:10.1016/J.RSER.2015.07.184.
- [282] Raja SP, Rajavel R, Navaneethakrishnan D. Experimental Investigation Of Heat Recovery From Diesel Engine Exhaust Using Compact Heat Exchanger And Thermal Storage Using Phase Change Material. *Int J Innov Res Sci Eng Technol* 2014;3:2663–70.
- [283] Moreno P, Solé C, Castell A, Cabeza LF. The use of phase change materials in domestic heat pump and air-conditioning systems for short term storage: A review. *Renew Sustain Energy Rev* 2014;39:1–13. doi:10.1016/j.rser.2014.07.062.
- [284] Zhang G, Li J, Chen Y, Xiang H, Ma B, Xu Z, et al. Encapsulation of copper-based phase change materials for high temperature thermal energy storage. *Sol Energy Mater Sol Cells* 2014;128:131–7. doi:10.1016/j.solmat.2014.05.012.
- [285] Fukahori R, Nomura T, Zhu C, Sheng N, Okinaka N, Akiyama T. Macro-encapsulation of metallic phase change material using cylindrical-type ceramic containers for high-temperature thermal energy storage. *Appl Energy* 2016;170:324–8. doi:10.1016/j.apenergy.2016.02.106.
- [286] Rathod MK, Banerjee J. Thermal Performance of a Phase Change Material-Based Latent Heat Thermal Storage Unit. *Heat Transf Res* 2014;43:706–19. doi:10.1002/htj.21120.
- [287] Zhang HL, Baeyens J, Degrève J, Cáceres G, Segal R, Pitié F. Latent heat storage with tubular-encapsulated phase change materials (PCMs). *Energy* 2014;76:66–72. doi:10.1016/j.energy.2014.03.067.
- [288] Warzoha RJ, Fleischer AS. Improved heat recovery from paraffin-based phase change materials due to the presence of percolating graphene networks. *Int J Heat Mass Transf* 2014;79:314–23. doi:10.1016/j.ijheatmasstransfer.2014.08.009.
- [289] Fan LW, Xiao YQ, Zeng Y, Fang X, Wang X, Xu X, et al. Effects of melting temperature and the presence of internal fins on the performance of a phase change material (PCM)-based heat sink. *Int J Therm Sci* 2013;70:114–26. doi:10.1016/j.ijthermalsci.2013.03.015.
- [290] Jia J, Lee WL. Experimental investigations on using phase change material for performance improvement of storage-enhanced heat recovery room air-conditioner. *Energy* 2015;93:1394–403. doi:10.1016/j.energy.2015.10.053.
- [291] Rao Y, Lin G, Luo Y, Chen S, Wang L. Preparation and thermal properties of microencapsulated phase change material for enhancing fluid flow heat transfer. *Heat Transf Res* 2007;36:28–37. doi:10.1002/htj.20138.
- [292] Zhang X, Yu S, Yu M, Lin Y. Experimental research on condensing heat recovery using phase change material. *Appl Therm Eng* 2011;31:3736–40. doi:10.1016/j.applthermaleng.2011.03.040.
- [293] Ben Mâad H, Miled A, Askri F, Ben Nasrallah S. Numerical simulation of absorption-desorption cyclic processes for metal-hydrogen reactor with heat recovery using phase-change material. *Appl Therm Eng* 2016;96:267–76. doi:10.1016/j.applthermaleng.2015.11.093.
- [294] Pitié F, Zhao CY, Baeyens J, Degrève J, Zhang HL. Circulating fluidized bed heat recovery/storage and its potential to use coated phase-change-material (PCM) particles. *Appl Energy* 2013;109:505–13. doi:10.1016/j.apenergy.2012.12.048.
- [295] Shi X, Che D, Agnew B, Gao J. An investigation of the performance of compact heat exchanger for latent heat recovery from exhaust flue gases. *Int J Heat Mass Transf* 2011;54:606–15. doi:10.1016/j.ijheatmasstransfer.2010.09.009.
- [296] Ferreira VJ, Lopez-Sabiron AM, Royo P, Aranda-Uson A, Ferreira G. Integration of environmental indicators in the optimization of industrial energy management using phase change materials. *Energy Convers Manag* 2015;104:67–77. doi:10.1016/j.enconman.2015.05.011.
- [297] Liu Y, Ma J, Zhou G, Wan W. heat pump for heat recovery with superheated vapor. *Therm Sci* 2015;19:1468–9.
- [298] Singh S, Kumar R. Ambient Air Temperature Effect on Power Plant. *Int J Eng Sci Technol* 2012;4:3916–23.
- [299] Fergani Z, Touil D, Morosuk T. Multi-criteria exergy based optimization of an Organic Rankine Cycle for waste heat recovery in the cement industry. *Energy Convers Manag* 2016;112:81–90. doi:10.1016/J.ENCONMAN.2015.12.083.
- [300] Brito CHG, Maia CB, Sodré JR. A Mathematical Model for the Exhaust Gas Temperature Profile of a Diesel Engine. *J Phys Conf Ser* 2015;633:012075. doi:10.1088/1742-6596/633/1/012075.
- [301] Jaber H, Khaled M, Lemenand T, Murr R, Faraj J, Ramadan M. TRIPLE DOMESTIC HEAT RECOVERY SYSTEM : THERMAL MODELING AND PARAMETRIC STUDY. *Proc SEEP* 2017.
- [302] Najjar YSH, Kseibi MM. Heat transfer and performance analysis of thermoelectric stoves. *Appl Therm Eng* 2016;102:1045–58. doi:10.1016/J.APPLTHERMALENG.2016.03.114.
- [303] Hossain SN, Bari S. Waste Heat Recovery from Exhaust of a Diesel Generator Set Using Organic Fluids. *Procedia Eng* 2014;90:439–44.

Appendix A

Table A.1.1. Reviews on heat recovery from exhaust gases published in “Renewable and Sustainable Energy Reviews” journal.

Ref.	Author(s)	Title	Year	Objective(s)
[45]	Chintala V. Kumar S. Pandey J.	A technical review on waste heat recovery from compression ignition engines using organic Rankine cycle	2018	<ul style="list-style-type: none"> Review of the potential of waste heat recovery from exhaust gas, water jackets and intake charge air of CI engines. Investigate the research challenges related to engine-ORC system.
[46]	Varma G. Srinivas T.	Power generation from low temperature heat recovery	2017	<ul style="list-style-type: none"> Discuss the existing technologies and conduct a comparative study to expose the possible configuration that is convenient to low temperature heat recovery, where the R124 fluid is chosen for ORC and OFC.
[47]	Feneley A. Pesiridis A. Andwari A.	Variable Geometry Turbocharger Technologies for Exhaust Energy Recovery and Boosting - A Review	2017	<ul style="list-style-type: none"> Review of the present and short-term future application of variable geometry systems for application in turbocharger compressors and turbines.
[48]	Ma H. Du N. Zhang Z. Lyu F. Deng N. Li C. Yu S.	Assessment of the optimum operation conditions on a heat pipe heat exchanger for waste heat recovery in steel industry	2017	<ul style="list-style-type: none"> Design and build a waste heat recovery system that serves in investigating the properties of a heat pipe heat exchanger utilized for recovering the waste heat in a slag cooling process in steel industry.
[49]	Lion S. Michos C. Vlaskos I. Rouaud C. Taccani R.	A review of waste heat recovery and Organic Rankine Cycles (ORC) in on-off highway vehicle Heavy Duty Diesel Engine applications	2017	<ul style="list-style-type: none"> Present an overview of the Organic Rankine Cycle (ORC) technology to recover wasted thermal energy in Heavy Duty Diesel Engines with special concentration on vehicle applications for on and off highway sectors.
[50]	Zhou F. Joshi S.N. Rhoté-Vaney R. Dede E.M.	A review and future application of Rankine Cycle to passenger vehicles for waste heat recovery	2017	<ul style="list-style-type: none"> Review of the efforts in the past few decades to apply RC to on-road vehicles, mainly passenger cars. Discuss the properties of the waste heat sources existing in vehicles and the restrictions applied on the automotive RC application. Epitomize Rankine cycle architectures, system components and working fluids convenient to distinct applications. Conduct a new concept and case study into the future application of Rankine cycle to vehicle waste heat recovery.
[51]	Yan B. Xue S. Li Y. Duan J. Zeng M.	Gas-fired combined cooling, heating and power (CCHP) in Beijing: A techno-economic analysis	2016	<ul style="list-style-type: none"> Analyze the status, the technology structure and economic advantages of gas-fired CCHP systems in Beijing. Conduct a technical economic assessment framework of gas-fired CCHP. Analyze the economy of the gas-fired CCHP system, the affecting parameters on economic performance. Discuss the energy efficiency sharing model of a cooling, heating and power system that considers the grid enterprises' economic efficiency. Conduct an empirical study on a trigeneration project control center in the Beijing Gas Group.
[52]	Tsiliyannis C.	Enhanced waste to energy operability under feedstock uncertainty by synergistic flue gas recirculation and heat recuperation	2015	<ul style="list-style-type: none"> Investigate the potential of developing operability of WTE facilities by common utilization of FHR and FGR, using multiple waste mixtures with uncertain federates, heating value, or composition.
[53]	Aghaali H. Ångström H.	A review of turbo-compounding as a waste heat recovery system for internal combustion engines	2015	<ul style="list-style-type: none"> Review the recent progress and research on turbocompounding to detect vital parameters and supply ideas into the investigation of a high-efficiency turbocompound engine.
[54]	Hatami M. Ganji D.D. Gorji-Bandpy M.	A review of different heat exchangers designs for increasing the diesel exhaust waste heat recovery	2014	<ul style="list-style-type: none"> Brief review of the waste heat recovery technologies from diesel engines. Short review of the technologies that increase the heat transfer in heat exchangers. Assess the possibility of utilizing heat exchangers in the exhaust of engines. Review of distinct heat exchangers that were designed to rise the exhaust waste heat recovery. Suggest future viewpoints for new heat exchanger designs to maximize heat recovery from exhaust of diesel engines.
[55]	Gewald D. Siokos K. Karellas S. Spliethoff H.	Waste heat recovery from a landfill gas-fired power plant	2012	<ul style="list-style-type: none"> Demonstrate the potential of utilizing large amount of heat in order to rise the electricity generation and efficiency of the Ano Liosia power station. Develop a thermodynamic and economic study of two distinct waste recovery systems (water/steam cycle and Organic Rankine cycle). Compare the benefits and drawbacks of the two systems concerning their maximum thermodynamic efficiency and the minimum power production cost.
[56]	Saidur R. Rezaei M. Muzammil W. Hassan M.	Technologies to recover exhaust heat from internal combustion engines	2012	<ul style="list-style-type: none"> Review the recent progresses and technologies on waste heat recovery of exhaust gas from internal combustion engines such as thermoelectric generators (TEG), organic Rankine cycle (ORC), six-stroke cycle IC engine and new developments on turbocharger technology.

	Paria S. Hasanuzzaman M.			<ul style="list-style-type: none"> • Focus on the possible energy savings and performances of the aforementioned technologies.
[57]	Wang T. Zhang Y. Peng Z. Shu G.	A review of researches on thermal exhaust heat recovery with Rankine cycle	2011	<ul style="list-style-type: none"> • Review on researches that supply an idea to potential system designs, thermodynamic principles to attain high efficiency, and selection of working fluids to preserve necessary system performance. • Investigate system configurations based on Rankine cycle.

Table A.1.2. Table of references for heat recovery from ICEs.

Reference, year, Journal name	Title	Type of study/ Methodology	Main outcomes
Aghaali and Ångström [52], 2015, Renewable and Sustainable Energy Reviews	A review of turbocompounding as a waste heat recovery system for internal combustion engines	➤ Review	<ul style="list-style-type: none"> ➤ Review the recent advancements and research on turbocompounding to detect crucial variables and suggest ideas regarding the implementation of a high-efficiency turbo compound engine. ➤ Turbine design is an important issue in turbocompounding since the recovery of the wasted heat is high affected by turbine efficiency. ➤ Efficiency of turbocompound engines is dependent on the variability in geometry and rotational speed of power turbines. ➤ Turbocompounding is a significant technology that serves in mitigating fuel consumption in the coming decades in both light- and heavy-duty engines.
Saidur et al [56], 2012, Renewable and Sustainable Energy Reviews	Technologies to recover exhaust heat from internal combustion engines	➤ Review	<ul style="list-style-type: none"> ➤ Review the recent advancements and technologies on waste heat recovery of exhaust gas from internal combustion engines including thermoelectric generators (<i>TEG</i>), organic Rankine cycle (<i>ORC</i>), six-stroke cycle <i>IC</i> engine and new improvements on turbocharger technology. ➤ Review the potential energy savings and the performance of the aforementioned technologies.
Buenaventura and Azzopardi [62], 2015, Renewable and Sustainable Energy Reviews	Energy recovery systems for retrofitting in internal combustion engine vehicles: A review of techniques	➤ Review	<ul style="list-style-type: none"> ➤ Offer technical knowledge on the prospect cons that modified ERSs may maintain in reducing carbon emissions. ➤ Propose a research to demonstrate the trade-off between fuel consumption alleviation and the investment cost of the system.
Shu et al [63], 2013, Renewable and Sustainable Energy Reviews	A review of waste heat recovery on two-stroke IC engine aboard ships	➤ Review	<ul style="list-style-type: none"> ➤ Demonstrate distinct types of waste heat recovery technologies from the technical principle and application feasibility perspectives. ➤ Suggest a better understanding of the available choices for waste heat recovery and utilizing different applications onboard ocean-going ships to enhance fuel economy and environmental compliance.
Hamdy et al [64], 2015, Renewable and Sustainable Energy Reviews	An overview on adsorption cooling systems powered by waste heat from internal combustion engine	➤ Review	<ul style="list-style-type: none"> ➤ Overview of research that have been performed on adsorption cooling systems powered by waste heat from automobiles. ➤ Study adsorption pairs including zeolite-water and gel-water. ➤ It was obtained from the results that this technology can serve in raising the overall engine efficiency and minimize the thermal pollution form engines.
Hatami et al [54], 2014, Renewable and Sustainable Energy Reviews	A review of different heat exchangers designs for increasing the diesel exhaust waste heat recovery	➤ Review ➤ Modeling	<ul style="list-style-type: none"> ➤ Short review of the technologies that maximize the heat transfer in heat exchangers and estimate the availability of utilizing them in the exhaust of engines. ➤ Review of various heat exchangers that were previously designed for raising the exhaust waste heat recovery. ➤ Suggest future view points for heat exchangers designs to increase heat recovery from exhaust of diesel engines.
Chae et al [65], 2010, Applied Energy	Optimization of a waste heat utilization network in an eco-industrial park	➤ Review ➤ Modeling	<ul style="list-style-type: none"> ➤ Conduct a mathematical model to synthesize waste heat usage network for nearby companies and communities. ➤ It was obtained from a case study performed on an existing Petro-chemical complex in Yeosu, south Korea that by applying the proposed waste heat utilization networks, the total energy cost and the amount of waste heat of the region can be alleviated by more than 88% and 82% from the present values respectively.
Rahman et al [66], 2015, Renewable and Sustainable Energy Reviews	Power generation from waste of IC engines	➤ Modeling	<ul style="list-style-type: none"> ➤ Present an innovative approach on power production from waste of internal combustion engine based on coolant and exhaust. ➤ It was obtained that the specific fuel consumption of engine has progressed by 3% due to minimization in HC formation into the engine combustion chamber. ➤ The brake power has raised by 7% due to the fuel atomization and vaporization at 70°C engine temperature.
Luján et al [67], 2016, Applied Thermal Engineering	Potential of exhaust heat recovery for intake charge heating in a diesel engine transient operation at cold conditions	➤ Modeling	<ul style="list-style-type: none"> ➤ Suggest an exhaust heat recovery system for automobile diesel engine. ➤ Conduct experiments in transient operation at low ambient temperature. ➤ Compared to standard air–air intercooler, intake air heating results with the heat recovery system reveal a mitigation of 65% in unburned hydrocarbons, 40% in carbon monoxide and 10% in fuel use.
Sprouse and Depcik [68], 2013, Applied Thermal Engineering	Review of organic Rankine cycles for internal combustion engine exhaust waste heat recovery	➤ Modeling	<ul style="list-style-type: none"> ➤ Review the history of internal combustion engine exhaust waste heat recovery considering the Organic Rankine Cycle. ➤ The results show an improvement in potential fuel economy by about 10% with modern refrigerants and advancements in expander technology.
Dong and Heikal [69], 2015, Applied Energy	A novel split cycle internal combustion engine with integral waste heat recovery	➤ Modeling	<ul style="list-style-type: none"> ➤ Propose a novel engine thermodynamic cycle and apply a theoretical analysis to identify its key parameters. ➤ The detailed cycle simulation reveals that compared to the conventional diesel engine, the efficiency improvement that can be expected is 32%.
Yang et al [70], 2015, Energy	Thermoeconomic multi-objective optimization of an organic Rankine cycle for exhaust waste heat recovery of a diesel engine	➤ Modeling	<ul style="list-style-type: none"> ➤ Perform a thermo economic multi-objective optimization of an Organic Rankine Cycle system and sensitivity analysis of the decision variables. ➤ The results indicate that the thermodynamic performance of the ORC system is enhanced at the expense of economic performance.
Pandiyarajan et al [71], 2011, Energy Policy	Second law analysis of a diesel engine waste heat recovery with a combined sensible and latent heat storage system	➤ Modeling ➤ Experimental	<ul style="list-style-type: none"> ➤ Quantify and illustrate the energy and exergy balance for diesel engine waste heat recovery with a combined sensible and latent heat storage system using energy and exergy flow diagrams. ➤ Consider and analyze an illustrative example with two distinct cases to study the discharge process in a thermal storage system.
Yu et al [72], 2013, Energy	Simulation and thermodynamic analysis of a	➤ Modeling ➤ Numerical	<ul style="list-style-type: none"> ➤ Perform a simulation model based on an actual Organic Rankine Cycle bottoming system of a diesel engine.

	bottoming Organic Rankine Cycle (ORC) of diesel engine (DE)		<ul style="list-style-type: none"> ➤ The performance of ORC system is good under the rated engine condition with expansion power up to 14.5 kW, recovery efficiency up to 9.2% and exergy efficiency up to 21.7%. ➤ The thermal efficiency of diesel engine can be raised up to 6.1% when Combining it with bottoming ORC system.
Bai et al [73], 2014, Case Studies in Thermal Engineering	Numerical and experimental analysis for exhaust heat exchangers in automobile thermoelectric generators	<ul style="list-style-type: none"> ➤ Modeling ➤ Numerical 	<ul style="list-style-type: none"> ➤ Design six distinct exhaust heat exchangers within the same shell and conduct their computational fluid dynamics models to compare heat transfer and pressure drop in typical driving cycles for a vehicle within a 1.2 L gasoline engine. ➤ It was shown by the results that the serial plate structure improved heat transfer by 7 baffles, conveyed maximum heat of 1737 W, and generated a maximum pressure drop of 9.7 kPa in a suburban driving cycle.
He et al [74], 2015, Energy	Optimization design method of thermoelectric generator based on exhaust gas parameters for recovery of engine waste heat	<ul style="list-style-type: none"> ➤ Modeling ➤ Numerical 	<ul style="list-style-type: none"> ➤ Present an advanced mathematical model of a thermoelectric generator that includes the effect of the temperature gradient in the flow direction. ➤ Introduce a power deviation analysis method to design the best TEG module area for a high-power output. ➤ The results show that the optimum design areas are 0.22 m² and 0.3 m² for the co-flow and the counter flow respectively.
Danel et al [75], 2015, Energy Procedia	Waste Heat Recovery Applied to a Tractor Engine	<ul style="list-style-type: none"> ➤ Modeling ➤ Numerical 	<ul style="list-style-type: none"> ➤ Represent various heat loss recovery methods by presenting a detailed model of the Rankine-Hirn engine utilized to dimension the future test bench., focusing on the selection of fluid, pressure and temperature as a function of the hot source temperature. ➤ Present an initial assessment of the efficiency increase depending on the variation in the heat source.
Wang et al [76], 2014, Energy Conversion and Management	Simulation and evaluation of a CCHP system with exhaust gas deep-recovery and thermoelectric generator	<ul style="list-style-type: none"> ➤ Modeling ➤ Numerical ➤ Parametric 	<ul style="list-style-type: none"> ➤ Suggest a CCHP system based on internal combustion engine for power generation, refrigeration and domestic hot water production, and integrate exhaust gas deep-recovery and thermoelectric generator to it. ➤ It was obtained that the electric output of TEG changes from 0.231kW to 1.18 kW, total recoverable waste heat raises by 13-16%, ESR, CSR and PEE reached 0.304, 0.417 and 0.944 respectively.
Xie and Yang [77], 2013, Applied Energy	Dynamic behavior of Rankine cycle system for waste heat recovery of heavy-duty diesel engines under driving cycle	<ul style="list-style-type: none"> ➤ Modeling ➤ Numerical ➤ Parametric 	<ul style="list-style-type: none"> ➤ Demonstrate waste heat recovery behavior of the RCS during driving cycle by defining four operating modes to describe its operating process. ➤ It was shown that the dry isentropic fluids are superior to the wet ones due to their less probabilities of droplets formation as a result of their saturated vapor properties. ➤ The effects of the vapor parameters on the Rankine cycle thermal efficiency and power mode percentage are opposite.
Yang et al [78], 2015, Energy Conversion and Management	Thermal and economic analyses of a compact waste heat recovering system for the marine diesel engine using transcritical Rankine cycle	<ul style="list-style-type: none"> ➤ Modeling ➤ Numerical ➤ Parametric 	<ul style="list-style-type: none"> ➤ Discuss the economic performance of a novel compact waste heat recovering system for the marine diesel engine. ➤ Implement optimal analysis and comparison of three models for waste heat recovering. ➤ The compact waste heat recovering system operated in model I has superiority on the payback periods and heavy diesel oil saving over the others.
Amicabile et al [79], 2015, Applied Thermal Engineering	A comprehensive design methodology of organic Rankine cycles for the waste heat recovery of automotive heavy-duty diesel engines	<ul style="list-style-type: none"> ➤ Modeling ➤ Parametric 	<ul style="list-style-type: none"> ➤ Suggest a comprehensive design methodology to enhance the organic Rankine cycles. ➤ The regenerative subcritical cycle with Ethanol provides the best performance. ➤ The subcritical cycle with Ethanol by either recuperator is the solution with the minimal capital cost.
Song and Gu [80], 2015, Applied Energy	Performance analysis of a dual-loop organic Rankine cycle (ORC) system with wet steam expansion for engine waste heat recovery	<ul style="list-style-type: none"> ➤ Modeling ➤ Parametric 	<ul style="list-style-type: none"> ➤ Design a dual-loop organic Rankine cycle to recover the waste heat of a diesel engine. ➤ Assess the impact of the high temperature loop operating conditions on the low temperature loop.
Kim et al [81], 2016, Energy	Single-loop organic Rankine cycles for engine waste heat recovery using both low- and high-temperature heat sources	<ul style="list-style-type: none"> ➤ Modeling ➤ Parametric 	<ul style="list-style-type: none"> ➤ Propose a highly efficient single-loop organic Rankine cycle for engine waste heat recovery from gasoline vehicle. ➤ Perform thermodynamic analysis of the suggested system in comparison to the conventional system. ➤ The power produced by the novel system is greater by about 20% from engine waste heat recovery when operating under the target engine conditions.
Novella and Sánchez [82], 2012, Applied Thermal Engineering	HD Diesel engine equipped with a bottoming Rankine cycle as a waste heat recovery system. Part 1: Study and analysis of the waste heat energy	<ul style="list-style-type: none"> ➤ Modeling ➤ Parametric 	<ul style="list-style-type: none"> ➤ Discuss the study of distinct bottoming Rankine cycles with water-steam and/or ORC configurations in classical and innovative setups ➤ describe the model of the studied heavy-duty diesel (HDD) engine and the available waste energy sources in this HDD Engine. ➤ Analyze additional innovative setups in the HDD engine to fit this engine with ORC cycles.
Boretti [83], 2012, Applied Thermal Engineering	Transient operation of internal combustion engines with Rankine waste heat recovery systems	<ul style="list-style-type: none"> ➤ Experimental 	<ul style="list-style-type: none"> ➤ Combine single Rankine cycle system with the engine design to enhance the fuel economy of vehicles under normal driving conditions.
Raznoshinskaia [84], 2015, Procedia Engineering	The Research of Influence Characteristics of Heat-storage Material on Thermodynamic Process in Heat Storage, Installed in System of Waste-heat Recovery of Internal Combustion Engines	<ul style="list-style-type: none"> ➤ Experimental 	<ul style="list-style-type: none"> ➤ Presents the results of the research of the effective characteristics of heat-storage material on the thermodynamic process in heat storage, integrated in the waste heat recovery system of ICES.
Lee et al [85], 2013, Applied Thermal Engineering	Development of a highly efficient low-emission diesel engine-powered co-generation system and its optimization using Taguchi method	<ul style="list-style-type: none"> ➤ Experimental 	<ul style="list-style-type: none"> ➤ Implement a highly efficient low-emission diesel engine co-generation system. ➤ The efficiency achieved of the developed system is 85.7% which is higher than that of the similar system by 6%.
Shon et al [86], 2014, Applied Energy	Improved heat storage rate for an automobile coolant waste heat recovery system using phase-change material in a fin-tube heat exchanger	<ul style="list-style-type: none"> ➤ Experimental 	<ul style="list-style-type: none"> ➤ Conduct experiments to evaluate the actual heat transfer coefficient of a phase change material in order to enhance the heat storage rate of an automotive coolant waste heat storage system using latent heat of PCM.
Battista et al [87], 2015, Applied Energy	Waste heat recovery of an ORC-based power unit in a turbocharged diesel engine propelling a light duty vehicle	<ul style="list-style-type: none"> ➤ Experimental 	<ul style="list-style-type: none"> ➤ Describe the influence of the pressure losses generated by an ORC based power unit placed on the exhaust line of a turbocharged diesel engine propelling a light duty vehicle.

Kauranen et al [88], 2010, Applied Thermal Engineering	Temperature optimization of a diesel engine using exhaust gas heat recovery and thermal energy storage (diesel engine with thermal energy storage)	➤ Experimental	➤ Replace the additional heater used in automotive diesel engines by a combination of exhaust gas heat recovery system and latent heat accumulator for thermal energy storage and assess the system.
Hatami et al [89], 2014, Case Studies in Thermal Engineering	Numerical study of finned type heat exchangers for ICEs exhaust waste heat recovery	➤ Numerical	➤ Conduct numerical model of two cases of heat exchangers to recover the exhaust waste heat. ➤ Demonstrate the influence of size and number of fins on recovery heat amount in different engine loads and speeds.
Shu et al [90], 2014, Applied Energy	Alkanes as working fluids for high-temperature exhaust heat recovery of diesel engine using organic Rankine cycle	➤ Numerical	➤ Conduct several attempts to choose Alkanes as working fluid due to their excellent thermos-physical and environmental properties. ➤ ORCs based on Alkanes may be more appealing than steam cycle for exhaust heat recovery.
Hatami et al [91], 2014, International Communications in Heat and Mass Transfer	Optimization of finned-tube heat exchangers for diesel exhaust waste heat recovery using CFD and CCD techniques	➤ Numerical	➤ Perform numerical modeling of fifteen heat exchanger cases with distinct fins height, thickness and number based on the central composite design principle. ➤ Achieve optimization to attain the maximum heat recovery amount and minimum of pressure drop along the heat exchanger.
Du et al [92], 2015, Energy Conversion and Management	Effect of cooling design on the characteristics and performance of thermoelectric generator used for internal combustion engine	➤ Numerical	➤ Conduct a 3D model of TEG combined with exhaust and cooling channels. ➤ Demonstrate the effect of cooling type, flow rate, baffle and flow arrangement. ➤ The net output power is higher in liquid cooling while the flow resistance is large for air cooling.
Yang et al [93], 2015, Energy	Parametric optimization and performance analysis of ORC (organic Rankine cycle) for diesel engine waste heat recovery with a fin-and-tube evaporator	➤ Parametric	➤ Implement a parametric optimization and performance analysis of ORC system using genetic algorithm for recovering exhaust waste heat of a diesel engine. ➤ The ORC system can reach maximum net power output per unit heat transfer area of 0.74kW/m ² at engine maximum rated power point.
Song and Gu [94], 2015, Energy Conversion and Management	Parametric analysis of a dual loop Organic Rankine Cycle (ORC) system for engine waste heat recovery	➤ Parametric	➤ Design a dual loop ORC system of low temperature loop and high temperature loop for engine waste heat recovery. ➤ The additional engine power produced by the dual loop ORC system is raised by 11.2% compared to the original power output of the engine.
Wang et al [95], 2015, Energies	Parametric Optimization of Regenerative Organic Rankine Cycle System for Diesel Engine Based on Particle Swarm Optimization	➤ Parametric	➤ Exploit a regenerative ORC system with several working fluids including butane, R124, R416A and R134a to recover the waste heat from a diesel engine exhaust in an efficient way. ➤ At engine speed 2200 r/min and engine torque of 1215 N.m, the net power output of the exploited system using butane is 36.57kW.

Table A.1.3. Table of references for heat recovery from boilers and gas turbines.

Reference, year, Journal name	Title	Type of study/ Methodology	Main outcomes
Wang et al [57], 2011, Renewable and Sustainable Energy Reviews	A review of researches on thermal exhaust heat recovery with Rankine cycle	➤ Review	➤ Review the relevant researches to expose the potential system designs, the thermodynamic principles for achieving high efficiency and the selection of working fluids for achieving the required performance of the system. ➤ Based on several researches, the Rankine cycle is the most preferred basic working cycle for thermodynamic exhaust heat recovery systems.
Jana and De [98], 2013, International Journal of Emerging Technology and Advanced Engineering	Energy savings potential through waste heat recovery from flue gas for post combustion CO ₂ capture	➤ Numerical	➤ Conceptualize several systems to crisp CO ₂ from the flue gas using the waste heat from the flue gas. ➤ Perform simulation using ASPEN Plus to assess the conceptualized schemes energy performance.
Basrawi et al [99], 2013, Heat Transfer-Asian Research	Evaluation of the performance of a micro gas turbine cogeneration system in a sewage treatment facility: Optimized configuration of a cogeneration system	➤ Modeling	➤ Demonstrate the efficient configuration of a biogas-fueled cogeneration system in a sewage treatment facility.
Han et al [100], 2015, Energy	Investigation on the off-design performances of flue gas pre-dried lignite-fired power system integrated with waste heat recovery at variable external working conditions	➤ Review ➤ Modeling	➤ Model a flue gas pre-dried lignite-fired power system combined with waste heat recovery. ➤ The plant thermal efficiency increased by 1.7% and the predicted water saving was 81 t/h.
Grljušić et al [101], 2015, Energies	Calculation of Efficiencies of a Ship Power Plant Operating with Waste Heat Recovery through Combined Heat and Power Production	➤ Review ➤ Modeling ➤ Parametric	➤ Demonstrate a new technique for waste heat recovery in order to mitigate the fuel consumption and the ship propulsion systems emissions. ➤ When the main engine functions at 65% or more of its specified maximum continuous rating, the ship's power plant overall thermal efficiency is predicted to increase by more than 5%.
Zebian and Mitsos [102], 2014, Energy	A split concept for HRSG (heat recovery steam generators) with simultaneous area reduction and performance improvement	➤ Modeling	➤ Propose a split concept for boilers and heat recovery steam generators to minimize the area of the heat exchanger and/or the pressure losses. ➤ The suggested split concept reduces the capital costs, increases the performance and raises the average temperature difference.
Han et al [103], 2016, Energy	Exergy analysis of the flue gas pre-dried lignite-fired power system based on the	➤ Modeling	➤ Conduct exergy analysis model of flue gas pre-dried lignite-fired power system to identify the inefficiencies in the system's components.

	boiler with open pulverizing system			
Franco [104], 2011, Applied Thermal Engineering	Analysis of small size combined cycle plants based on the use of supercritical HRSG	➤ Modeling		➤ Analyze the alternative design of combined cycle power plants with a supercritical Heat Recovery Steam Generators by comparing three different configurations.
Mansouri et al [105], 2012, Energy Conversion and Management	Exergetic and economic evaluation of the effect of HRSG configurations on the performance of combined cycle power plants	➤ Modeling		<ul style="list-style-type: none"> ➤ Discuss the influence of Heat Recovery Steam Generator pressure levels on the exergy efficiency of a combined cycle power plants. ➤ Assess three types of gas turbine combined cycles similar to the gas turbine of the topping cycle. ➤ Model double pressure and two triple pressure Heat Recovery Steam Generators. ➤ The triple pressure reheat combined cycle has the minimum losses due to heat transfer in the HRSG and the exhaust of the flue gas to the stack, compared to the other cases.
Najjar et al [106], 2015, Energy	Novel inlet air cooling with gas turbine engines using cascaded waste-heat recovery for green sustainable energy	➤ Modeling		<ul style="list-style-type: none"> ➤ Investigate novel inlet air cooling and cascade waste-heat recovery to enhance the global power produced from a gas turbine. ➤ Evaluate the net power and the efficiency where both increased by 35% and 50% respectively when the ambient temperature is decreased 15°C.
Yang et al [107], 2015, Energy Conversion and Management	A new conceptual cold-end design of boilers for coal-fired power plants with waste heat recovery	➤ Modeling		<ul style="list-style-type: none"> ➤ Propose a new cold-end design of boilers for coal-fired power plants with waste heat recovery. ➤ The suggested system could generate additional net power output of 13.3 MW, heat rate reduction of 112 kJ/kWh and net benefit of \$85.8 per year.
Li et al [108], 2016, Applied Energy	Method of flash evaporation and condensation – heat pump for deep cooling of coal-fired power plant flue gas: Latent heat and water recovery	➤ Modeling		➤ Conduct a technique for deep cooling of flue gas in coal-fired boilers to recover latent heat and water from flue gas.
Beaujardiere et al [109], 2016, Solar Energy	Impact of HRSG characteristics on open volumetric receiver CSP plant performance	➤ Modeling		➤ Present an assessment of the influence of heat recovery steam generator operating properties on the performance of a 100MW open volumetric solar receiver plant.
Sharma and singh [110], 2016, Applied Thermal Engineering	Exergy analysis of dual pressure HRSG for different dead states and varying steam generation states in gas/steam combined cycle power plant	➤ Modeling		➤ Implement gas model and exergy model for the dual pressure heat recovery steam generator having steam generation at high pressure (HP) and low pressure.
Wang et al [111], 2015, Energy Procedia	Research on Heat Recovery System of Turbine Exhaust Steam Using Absorption Heat Pump for Heating Supply Based on Heating Load Characteristics	➤ Modeling		<ul style="list-style-type: none"> ➤ Present the design thought of heat recovery system of turbine exhaust steam using absorption heat pump for heating supply based on heating load characteristics. ➤ Design the heat recovery system and compute its economic efficiency.
Lee et al [112], 2015, Energy	An analysis of the thermodynamic efficiency for exhaust gas recirculation-condensed water recirculation-waste heat recovery condensing boilers (EGR-CWR-WHR CB)	➤ Modeling		<ul style="list-style-type: none"> ➤ Develop a new boiler which is predicted to have high efficiency and lower emissions compared to existing boilers. ➤ Compute the thermodynamic efficiency of exhaust gas recirculation-condensed water recirculation-waste heat recovery condensing boilers (EGR-CWR-WHR CB). ➤ The efficiency of EGR-CWR-WHR CB is 93.91%, higher than the existing condensing boilers by 7.04%.
Qu et al [113], 2014, Energy Conversion and Management	New configurations of a heat recovery absorption heat pump integrated with a natural gas boiler for boiler efficiency improvement	<ul style="list-style-type: none"> ➤ Modeling ➤ Experimental 		<ul style="list-style-type: none"> ➤ Investigate a new approach to enhance the thermal efficiency of the boiler by combining absorption heat pumps with natural gas boilers for waste heat recovery, where three configurations are defined, discussed and modeled. ➤ Conduct experiments on hot water absorption heat pumps for model validation.
Xi et al [114], 2015, Energy Procedia	Characteristics of Organic Rankine Cycles with Zeotropic Mixture for Heat Recovery of Exhaust Gas of Boiler	<ul style="list-style-type: none"> ➤ Modeling ➤ Numerical ➤ Parametric 		<ul style="list-style-type: none"> ➤ Develop thermodynamic models of ORC with and without internal heat exchangers where zeotropic is the used working fluid. ➤ Calculate the power generating capability per unit heat transfer area, exergy efficiency and work output to evaluate the ORC performance in recovering the waste heat of exhaust gas of boiler.
Han et al [115], 2014, Energy	Simulation study on lignite-fired power system integrated with flue gas drying and waste heat recovery – Performances under variable power loads coupled with off-design parameters	<ul style="list-style-type: none"> ➤ Modeling ➤ Numerical ➤ Parametric 		<ul style="list-style-type: none"> ➤ Propose a pre-dried lignite-fired power system combined with boiler flue gas drying and waste heat recovery. ➤ Pre-drying and waste heat recovery could raise the plant thermal efficiency by 1.51% at benchmark conditions.
Bassily [116], 2013, Applied Thermal Engineering	Modeling, analysis, and modifications of different GT cooling techniques for modern commercial combined cycle power plants with reducing the irreversibility of the HRSG	<ul style="list-style-type: none"> ➤ Modeling ➤ Numerical ➤ Parametric 		<ul style="list-style-type: none"> ➤ Introduce, model and analyze the steam-cooled combustor and the expansions in the gas turbines that use the cooling methods for recent commercial combined cycle power plants. ➤ Define methods to minimize the irreversibility of the HRSG which in its turn leads to crucial enhancement in efficiency and power for all cycles.
Thapa et al [117], 2015, Energy Conversion and Management	Experimental and computational investigation of a MEMS-based boiler for waste heat recovery	<ul style="list-style-type: none"> ➤ Modeling ➤ Parametric 		<ul style="list-style-type: none"> ➤ Present an ORC steam powered micro system whose function is to recover waste heat from distinct sources. ➤ For 1.8 W and 2.7 W power inputs, the peak power absorption efficiency achieved by the boiler through working fluid phase change was about 88% and the maximum operating pressure was 8.5 kPa.
Liu et al [118], 2015, Energy Conversion and Management	Energy and water conservation at lignite-fired power plants using drying and water recovery technologies	<ul style="list-style-type: none"> ➤ Modeling ➤ Case study 		➤ Combine drying and water recovery technologies with lignite-fired power plants for energy and water conservation.
Nadir and Ghenaïet [119], 2015, Energy	Thermodynamic optimization of several (heat recovery steam generator) HRSG configurations for a	<ul style="list-style-type: none"> ➤ Modeling ➤ Parametric 		<ul style="list-style-type: none"> ➤ Perform optimization and thermodynamic comparison between three types of HRSG functioning at exhaust gas temperature from 350°C to 650°C. ➤ Whatever the value of turbine outlet temperature is, higher pressure level leads to improvement in thermodynamic performance, achievement of higher optimal pressures and production of more steam qualities.

	range of exhaust gas temperatures		
Mamat et al [120], 2015, Energy	Waste heat recovery using a novel high-performance low-pressure turbine for electric turbocompounding in downsized gasoline engines: Experimental and computational analysis	<ul style="list-style-type: none"> ➤ Experimental ➤ Numerical ➤ Modeling 	<ul style="list-style-type: none"> ➤ Investigate a novel turbocompounding for highly downsized gasoline engine. ➤ Design a low-pressure turbine of 74% efficiency at pressure ratio of 1.08, where its tested prototype showed 2.6% enhancement in the Brake Specific Fuel Consumption at constant load. ➤ Conduct simulation on NEDC where it revealed that 3.36 kW can be produced by the electric turbocompounding.
Wang et al [121], 2012, Applied Energy	Coal power plant flue gas waste heat and water recovery	<ul style="list-style-type: none"> ➤ Experimental ➤ Parametric 	<ul style="list-style-type: none"> ➤ Implement a developed waste heat and water recovery technology to excavate part of the water vapor and its latent heat from the flue gases. ➤ The recovered energy from water vapor enhances the efficiency of the boiler and saves water. ➤ Establish the technology for coal power plant flue gas applications.
Feng et al [122], 2014, Energy Conversion and Management	Thermodynamic performance analysis and algorithm heat recovery steam generators (HRSG) based on heat exchangers layout	<ul style="list-style-type: none"> ➤ Numerical 	<ul style="list-style-type: none"> ➤ Establish a model of multi-pressure HRSG based on heat exchangers layout. ➤ Enhancement of heat exchangers layout of HRSGs has a vital importance for waste heat recovery and energy conservation.
Li et al [123], 2015, Energy Procedia	Parametric Optimization of Brayton /Organic Trans-critical Combined Cycle for Flue Gas Waste Heat Recovery	<ul style="list-style-type: none"> ➤ Parametric 	<ul style="list-style-type: none"> ➤ Develop air based open Brayton cycle (BC) combined with organic trans-critical cycle (OTC) for power recovery from flue gas of initial temperature around 600°C. ➤ The choice of OTC working fluid and the pressure ratio value of the BC has crucial influence on the system performance, in addition to other parameter such as the initial temperature of air in BC expansion process, the initial pressure and temperature of the organic fluid in OTC expansion process, and the condensing temperature of OTC. ➤ ➤ Benzene, toluene, heptane, acetone and R113 are good choices for OTC working fluid, and benzene attain the maximum net power output of 175.87 kJ/ (kg-flue gas).
Sharma and singh [124], 2014, Heat Transfer	Parametric Evaluation of Heat Recovery Steam Generator (HRSG)	<ul style="list-style-type: none"> ➤ Modeling ➤ Parametric 	<ul style="list-style-type: none"> ➤ Investigate influence of the physical parameters of a HRSG on its design by comparing between existing and optimized plat designs.
Sharma and singh [125], 2016, Heat Transfer	Exergy Based Parametric Analysis of a Heat Recovery Steam Generator	<ul style="list-style-type: none"> ➤ Parametric 	<ul style="list-style-type: none"> ➤ Establish exergy analysis of HRSG to compute the exergy losses, heat transfer and pressure losses for distinct physical components. ➤ Selection of the fin density and height within the examined range and operating conditions, the exergy efficiency raises by 1% for super heater, 0.7% for evaporator and by 2.08% for economizer sections.

Table A.1.4. Table of references for heat recovery from chimneys and stoves.

Reference, year, Journal name	Title	Type of study/ Methodology	Main outcomes
Raman et. al. [127], 2014, Energy	Improved test method for evaluation of bio-mass cook-stoves	<ul style="list-style-type: none"> ➤ Review ➤ Modeling 	<ul style="list-style-type: none"> ➤ Ordinary biomass cook-stoves has a low efficiency which causes health problems and environmental damage ➤ One of the main defiance is to minimize the difference between laboratory studies and actual cases ➤ Proposing an approach to narrow the gap between results conducted and actual cooking conditions ➤ Technical, social and economic parameters are specified
Gao et. al. [128], 2016, Applied Thermal Engineering	Development of stove-powered thermoelectric generators: A review	<ul style="list-style-type: none"> ➤ Review ➤ Modeling 	<ul style="list-style-type: none"> ➤ Demonstration of the basic principles and power efficiency relations of TEGs ➤ Thermal and electrical modeling is provided ➤ Provide different systems based on stove powered TEGs ➤ For proper sections, the heat sink, battery, module and converter are calculated ➤ Economical study for stove powered TEGs for different component (heat sinks)
Kumar et. al. [129], 2013, Renewable and Sustainable Energy Reviews	Design, development and technological advancement in the biomass cookstoves: A review	<ul style="list-style-type: none"> ➤ Review ➤ Modeling ➤ Numerical 	<ul style="list-style-type: none"> ➤ Review on biomass cook stoves ➤ Recent development of cook stoves and technical enhancements (material of construction and combustion air supply) ➤ Mathematical modeling for three types of cook stove (side feed wood-burning, pulverized and wood gas stove) ➤ Impact of inefficient burning on environment and health
Gogoi et. al. [130], 2016, Energy	Steady state heat transfer modeling of solid fuel biomass stove: Part 1	<ul style="list-style-type: none"> ➤ Modeling 	<ul style="list-style-type: none"> ➤ Development of steady state heat transfer model ➤ Study the effect if changing composition, moist in fuel, air flow and ambient conditions on the system ➤ For 3.77×10^{-4} kg/s mass flow rate of fuel and 6.47×10^{-6} m³/s flow rate of air the generated thermal power is 6.58 kW with 1003 flame temperature ➤ The efficiency and the time required to heat 5 L of water of the theoretical model are compatible with the model 24% and 17 minutes respectively
Champier et. al. [131], 2011, Energy	Study of a TE (thermoelectric) generator incorporated in a multifunction wood stove	<ul style="list-style-type: none"> ➤ Review ➤ Modeling ➤ Experimental 	<ul style="list-style-type: none"> ➤ Review on the existing thermoelectric generators is carried ➤ Experimental study is performed in which gas heater simulates the cookstove ➤ The generator setup is illustrated, and the generated power is stored in battery after being regulated using switch voltage regulator ➤ Thermal contact resistance directly affects the performance of the generator ➤ Effect of applying pressure of TEG on the thermal contact resistance is examined ➤ Using TEG and heat transfer equations, the electric power measurements are estimated and compared to the experimental results
Buczynski et. al. [132], 2016, Fuel	One-dimensional model of heat-recovery, non-recovery coke ovens. Part II: Coking-bed sub-mode	<ul style="list-style-type: none"> ➤ Modeling 	<ul style="list-style-type: none"> ➤ Development of 1D thermal modeling for heat recovery and non-heat recovery cookstove ➤ Study on the carbonization process of a coking bed sub model ➤ The sub model treats heat transfer, moisture vaporization and condensation ➤ Modeling the variation of fixed bed properties such as coking pressure
Montecucco et. al. [133], 2017, Applied Energy	Combined heat and power system for stoves with thermoelectric generators	<ul style="list-style-type: none"> ➤ Experimental 	<ul style="list-style-type: none"> ➤ Experimental study on combined heat and power heat recovery system from a stove ➤ Power is generated by TEGs to charge lead-acid battery and heat water

			<ul style="list-style-type: none"> ➤ TEGs acquire heat from the wall of the stove (heat source) and reject heat to water (heat sink) ➤ About 600 W thermal power is generated by heating water ➤ 27 W average electric power generated by TEGs during 2 hours and reached 42 W at the peak ➤ The energy conversion efficiency of TEGs is 5%
Chen et. al. [134], 2012, AIP Conference Proceeding	Development of thermoacoustic engine operating by waste heat from cooking stove	<ul style="list-style-type: none"> ➤ Review ➤ Experimental 	<ul style="list-style-type: none"> ➤ Review of two types of thermoacoustic engine (propane engine and wood burning) that utilizes waste heat from cooking stove ➤ Efficiency of the stove is 25.13% which is acceptable ➤ 3.2% is the efficiency of the thermoacoustic engine which is relatively low ➤ Wood burning thermoacoustic engine is capable to generate 22.7 W
Aranguren et. al. [135], 2015, Applied Energy	Experimental investigation of the applicability of a thermoelectric generator to recover waste heat from a combustion chamber	➤ Experimental	<ul style="list-style-type: none"> ➤ Experimental study on generating electricity using TEGs from waste heat of a combustion chamber ➤ About 21.56 W is generated by 48 TEGs ➤ Two kinds of heat exchanger are studied; finned and heat pipe ➤ Effect of exhaust gases temperature and flow rate is studied ➤ About 43% more power is obtained by using heat pipe instead on finned heat exchanger
Georges et. al. [136], 2014, Energy and Buildings	On the proper integration of wood stoves in passive houses under cold climates	➤ Numerical	<ul style="list-style-type: none"> ➤ Dynamic simulation applied on wood stove to ensure if the thermal energy generated is enough for complete building and overheating ➤ Large power modulation is important to prevent overheating in addition to opening the internal doors ➤ Single stove is not able to supply thermal comfort to whole building ➤ Architectonic properties significantly affect temperature distribution along rooms

Table A.1.5. Table of references on cogenerated heat recovery systems.

Reference, year, Journal name	Title	Type of study/ Methodology	Main outcomes
Fuentes et al [202], 2018, Renewable and Sustainable Energy Reviews	A review of domestic hot water consumption profiles for application in systems and buildings energy performance analysis	➤ Review	<ul style="list-style-type: none"> ➤ Review the latest researches performed on hot water consumption profiles in distinct types of buildings, and the existing information for the precise evaluation of energy consumption resulting from DHW utilization. ➤ Study the affecting parameters on water consumption such as climatic conditions, seasonality, building type and socio-economic factors.
Nabola and Shields [203], 2013, Energy and Buildings	Efficient drain water heat recovery in horizontal domestic shower drains	<ul style="list-style-type: none"> ➤ Experimental ➤ Numerical 	<ul style="list-style-type: none"> ➤ Investigate the improvement and analysis of a horizontal drain water heat recovery system for domestic showers. ➤ Results reveal the possibility of recovering energy from horizontal shower drains by utilizing a drain water heat recovery system. ➤ The system could be economically viable, could reduce energy consumption and CO₂ emissions.
Li et al [204], 2016, Procedia Engineering	Research and application of flue gas waste heat recovery in cogeneration based on absorption heat-exchange	➤ Review	<ul style="list-style-type: none"> ➤ Establish the method of flue gas waste heat recovery in absorption heat-exchange gas cogeneration system. ➤ The system has greater circuit temperature drop compared to the conventional system. ➤ Investigate the advantages of the system including energy saving, environmental and economic benefits of the system.
Jabber et al [205], 2018, Applied Thermal Engineering	Domestic Thermoelectric Cogeneration System Optimization Analysis, Energy Consumption and CO ₂ Emissions Reduction	<ul style="list-style-type: none"> ➤ Review ➤ Modeling ➤ Experimental ➤ Parametric 	<ul style="list-style-type: none"> ➤ Propose a domestic thermoelectric cogeneration system (DCS) which utilizes the lost heat of exhaust gases to simultaneously heat water and generate electricity through thermoelectric generators (TEG). ➤ Using thermal modeling, an optimization analysis is conducted based on the location of the thermoelectric generators within the system. ➤ The power generated by the TEGs is higher and the water temperature is lower when the TEGs are nearer to the exhaust gases. ➤ One TEG in direct contact with the exhaust gas can produce 0.35W and achieve water temperature of 76 power produced by one TEG °C.
Martić et al [206], 2015, Thermal Science	Application and design of an economizer for waste heat recovery in a cogeneration plant	➤ Modeling	<ul style="list-style-type: none"> ➤ Demonstrate technical and economic study of a small cogeneration plant, which is constructed to heat milk products in Serbia. ➤ Investigate the potential of raising energy efficiency by integrating additional heat exchanger to the present cogeneration heat and power plant.
Najjar and Abubaker [207], 2017, Energy	Thermo-economic analysis and optimization of a novel inlet air cooling system with gas turbine engines using cascaded waste-heat recovery	➤ Numerical	<ul style="list-style-type: none"> ➤ Combine the energy and exergy analysis with economic study to conduct thermoeconomic analysis whose aim is to assess the total operating cost using Engineering Equation Solver software (EES). ➤ At the design point, the total cost rate is 2.69 USUS\$/s, the net power of the system is 48.46 MW and the thermal efficiency is 30.38%.
Jia and Li [208], 2014, Energy and Buildings	Applying storage-enhanced heat recovery room air-conditioner (SEHRAC) for domestic water heating in residential buildings in Hong Kong	➤ Modeling	<ul style="list-style-type: none"> ➤ A typical residential estate in Hong Kong was utilized to conduct a study for estimating the amount of recoverable heat. ➤ Utilization of Storage-enhanced heat recovery room air-conditioner (SEHRAC) reveals that the daily cumulative recoverable heat exceeds the daily household water heating demand. ➤ The potential energy, the energy cost savings and the minimized CO₂ emission for wider application of SEHRAC were assessed as 9.3% of the global contribution of the residential sector in Hong Kong.
Elgendy and Schmidt [209], 2014, Energy and Buildings	Optimum utilization of recovered heat of a gas engine heat pump used for water heating at low air temperature	➤ Modeling	<ul style="list-style-type: none"> ➤ Conduct experimental investigation on the performance of a gas engine heat pump combined with heat recovery subsystem for two modes (mode I: evaporating the refrigerant in the refrigerant circuit, mode II: heating the supply water). ➤ The condenser water inlet temperature has more significant influence on the system performance compared to the effect of ambient air temperature and engine speed. ➤ When the recovered engine heat is conveyed to water the peak primary energy ratio is about 1.83, while it is 1.25 when the recovered engine heat is transmitted to refrigerant circuit.
Todorovic and Kim [210], 2014,	In search for sustainable globally cost-effective	➤ Modeling	<ul style="list-style-type: none"> ➤ Establish a new energy efficient multipurpose system. ➤ Conduct dynamic analysis and optimization methodology of the system.

Energy and Buildings	energy efficient building solar system – Heat recovery assisted building integrated PV powered heat pump for air-conditioning, water heating and water saving		
Zhang et al [211], 2018, Applied Energy	A power dispatch model for a ferrochrome plant heat recovery cogeneration system	➤ Modeling	<ul style="list-style-type: none"> ➤ Development of power dispatch modeling ➤ Using the modeling, the owner benefits are planned to increase by exporting power to the grid ➤ Both electrical and cooling power are generated by the cogeneration system ➤ About 1290000\$ can be saved by generating power and 920000\$ by cooling power yearly ➤ About 4.4 MW electrical power is generated by the combined cogeneration system and 11.3 MW cooling power from waste heat recovery
Tanha et al [212], 2015, Applied Thermal Engineering	Performance of two domestic solar water heaters with drain water heat recovery units: Simulation and experimental investigation	<ul style="list-style-type: none"> ➤ Modeling ➤ Experimental ➤ Numerical ➤ Parametric 	<ul style="list-style-type: none"> ➤ Demonstrate the performance of drain water heat recovery (DWHR) system and two solar domestic water heaters (SDWH). ➤ Experimental study revealed that the annual heat recovery of DWHR is 789 kWh and the global effectiveness is 50%. ➤ SDWH that uses flat plate collector and evacuated tube collector generate annual thermal energy output equal to 2038 kWh and 1383 kWh respectively.
Semmari et al [213], 2017, Case Studies in Thermal Engineering	Case study for experimental validation of a new presizing tool for solar heating, cooling and domestic hot water closed systems	➤ Case study	<ul style="list-style-type: none"> ➤ Perform a case study for experimental validation of PISTACHE which is a modern precising device constructed for designers and planners. ➤ The simple cooling mode and the double cooling and heating mode are the two configuration modes that are demonstrated in the experimental study to insure the reliability of the new built tool.
Varma and Srinivas [214], 2015, Case Studies in Thermal Engineering	Design and analysis of a cogeneration plant using heat recovery of a cement factory	<ul style="list-style-type: none"> ➤ Modeling ➤ Case study ➤ Numerical 	<ul style="list-style-type: none"> ➤ Develop a case study, design and thermodynamic analysis of a convenient power plant configuration to investigate the potential heat recovery from cement plant. ➤ The available heat recovery against a 15 MW cement factory demand can generate 12.5 MW power.
Kapil et al [215], 2012, Chemical Engineering Research and Design	Site-wide low-grade heat recovery with a new cogeneration targeting method	➤ Modeling	<ul style="list-style-type: none"> ➤ Implement a new technique to evaluate the cogeneration potential of site utility systems. ➤ Perform systematic optimization of steam levels in the design of site utility configurations. ➤ Develop a techno-economic study to enhance heat recovery of low-grade waste heat in industrial process. ➤ Exploit simulation models to assess the influence of introducing low grade heat usage technology.
Nemati et al [216], 2017, Case Studies in Thermal Engineering	A comparative thermodynamic analysis of ORC and Kalina cycles for waste heat recovery: A case study for CGAM cogeneration system	<ul style="list-style-type: none"> ➤ Modeling ➤ Numerical 	<ul style="list-style-type: none"> ➤ Develop a thermodynamic modeling and optimization to compare the benefits and drawbacks of ORC and Kalina cycle as a bottoming cycle for waste heat recovery from CGAM cogeneration system. ➤ ORC cycle simpler construction, higher net power generated and superheated turbine outlet flow causes a reliable performance of the turbine. ➤ The size parameter of Kalina turbine is lower than that of ORC.
Li et al [217], 2015, Energy Conversion and Management	Energy efficiency analysis of condensed waste heat recovery ways in cogeneration plant	➤ Modeling	<ul style="list-style-type: none"> ➤ Assess the energy efficiencies and applicability of distinct condensed waste heat recovery methods by using the heating equivalent electricity technique. ➤ Establish the main parameters influencing energy efficiencies of the common heating methods by combining with the characteristics of the steam turbines.
Li et al [218], 2018, Energy Conversion and Management	Full operating conditions optimization study of new co-generation heating system based on waste heat utilization of exhausted steam	<ul style="list-style-type: none"> ➤ Modeling ➤ Parametric 	<ul style="list-style-type: none"> ➤ Suggest a new cascade heating system with multi-heat source. ➤ Enhance the integration technique of the new cogeneration heating system. ➤ The comprehensive energy efficiency of the system is improved by 16%.
Lu et al [219], 2015, Applied Energy	Analysis of an optimal resorption cogeneration using mass and heat recovery processes	<ul style="list-style-type: none"> ➤ Modeling ➤ Parametric 	<ul style="list-style-type: none"> ➤ Investigate an optimized resorption cogeneration to generate electricity and refrigeration. ➤ Utilize mass and heat recovery to enhance the performance of a novel resorption cogeneration suggested by Wang et al. ➤ Apply the second law analysis to demonstrate the exergy usage and specify the affecting components. ➤ When the high temperature salt (HTS) was NiCl₂ the coefficient of performance increased by 38%, while when the HTS was MnCl₂ it raises by 35%. ➤ The energy efficiency of electricity increases from 8% to 12% when heat and mass recovery is exploited. ➤ The second law highest efficiency is 41% which is attained by the resorption working pair BaCl₂-MnCl₂ when the heat source temperature is 110°C.
Jaber et al [220], 2017, Energy Procedia	Effect of Exhaust Gases Temperature on the Performance of a Hybrid Heat Recovery System	<ul style="list-style-type: none"> ➤ Modeling ➤ Parametric 	<ul style="list-style-type: none"> ➤ Investigate a hybrid heat recovery system which reutilizes the thermal energy from exhaust gases to generate domestic hot water and produce electric power via thermoelectric generators. ➤ Demonstrate the influence of the gas temperature on the system water temperature and power produced for several residential applications. ➤ The increase in the exhaust gas temperature raises the heat rate, water temperature and power generated.
Ngendakumana et al [221], 2017, Energy Procedia	Energetic and Environmental Performances of a Domestic Hot Water Condensing Boiler Fired by Wood Pellets	➤ Experimental	<ul style="list-style-type: none"> ➤ Study the impact of distinct factors influencing the operation of the boiler, the thermal efficiency and the pollutants emission. ➤ Better performance of the boiler could be achieved when the ON period of the cycle of the burner is raised or if the \off period is repressed.
Hoshi et al [222], 2012, Heat Transfer Asian Research	Study on waste heat recovery from exhaust smoke in cogeneration system using woody biomass fuels	➤ Experimental	<ul style="list-style-type: none"> ➤ Suggest a cogeneration system with the Stirling engine that utilizes woody biomass fuels such as firewood, sawdust and wood pellets. ➤ Present the results of the performance test and experiment for a cogeneration system which integrated the waste heat recovery with power production system.
Khaled et al [223], 2015, Case Studies in Thermal Engineering	Prototype implementation and experimental analysis of water heating using recovered waste heat of chimneys	➤ Experimental	<ul style="list-style-type: none"> ➤ Construct, test and discuss a waste heat recovery system integrated to chimneys for heating water in residential buildings. ➤ The temperature of water in a 95L tank is raised by 68°C in one hour. ➤ The total heat transfer of water is significantly affected by the convection and radiation exchanges at the bottom surface of the tank.
Liu et al [224], 2017, Energy Buildings	Experimental study on the performance of a gas engine heat pump for heating and domestic hot water	➤ Experimental	<ul style="list-style-type: none"> ➤ Establish the performance properties of a gas engine heat pump (GEHP) system including heating and domestic hot water. ➤ Implement a test prototype using R134a as a working fluid.

			<ul style="list-style-type: none"> ➤ Experiments were conducted to study the performance characteristics of the gas engine and GEHP system during the heating mode. ➤ The output efficiency and speed of the gas engine are directly proportional to each other. ➤
Niemelä et al [225], 2018, Energy Buildings	Computational and experimental performance analysis of a novel method for heating of domestic hot water with a ground source heat pump system	<ul style="list-style-type: none"> ➤ Experimental ➤ Numerical 	<ul style="list-style-type: none"> ➤ Investigate a novel technique for heating domestic hot water with a ground source heat pump system. ➤ Computational and experimental analyses were performed to validate the method. ➤ The developed concept enhances the energy efficiency by 45-50%. ➤ When the domestic hot water was heated from 7 °C to 55°C the attained COP was 3.7-3.85.
Yue et al [226], 2016, Energy	Parametric analysis of a vehicle power and cooling/heating cogeneration system	<ul style="list-style-type: none"> ➤ Modeling ➤ Parametric 	<ul style="list-style-type: none"> ➤ Suggest a vehicle power and cooling/heating cogeneration energy supply system. ➤ Implement a calculation model of the cogeneration system via Aspen Plus platform and verify it based on waste heat data of an existing vehicle engine. ➤ Compute the power, cooling/heating and thermal efficiency of the cogeneration system. ➤ Describe the functioning parameters, such as compression ratio and primary solution mass concentration of the bottom cycle, for several working conditions.

Table A.1.6. Table of references for heat recovery using TEG.

Reference, year, Journal name	Title	Type of study/ Methodology	Main outcomes
Kanno et al. [234], 2014, Journal of Electronic Materials	Detection of thermal radiation, sensing of heat flux, and recovery of waste heat by the transverse thermoelectric effect	<ul style="list-style-type: none"> ➤ Review 	<ul style="list-style-type: none"> ➤ Demonstration of the effect of transverse feature to issue promising simple configuration of TEGs ➤ Two-dimensional imaging is illustrated using fabricated sensor array of tilt-oriented Ca_xCoO_2 epitaxial thin film
Gao et al. [128], 2016, Applied Thermal Engineering	Development of stove-powered thermoelectric generators: A review	<ul style="list-style-type: none"> ➤ Review ➤ Modeling 	<ul style="list-style-type: none"> ➤ Demonstration of the basic principles and power efficiency relations of TEGs ➤ Thermal and electrical modeling is provided ➤ Provide different systems based on stove powered TEGs ➤ For proper sections, the heat sink, battery, module and converter are calculated ➤ Economical study for stove powered TEGs for different component (heat sinks)
Stevens et al. [235], 2014, Applied energy	Theoretical limits of thermoelectric power generation from exhaust gases	<ul style="list-style-type: none"> ➤ Review ➤ Modeling 	<ul style="list-style-type: none"> ➤ A complete theoretical model is provided to estimate the limit of power generation which supply optimal electric loading at a specified system configuration ➤ Results shows that the figure of merit is not enough to predict the performance of the system ➤ Any TEG system requires an optimum number of TEGs leg pairs to generate maximum power and raising the number of leg pairs more than the optimum can decrease the performance of the system ➤ Higher power is generated when the thermoelectric legs are connected in series compared to parallel connection
Kristiansen et al. [236], 2012, Journal of Electronic Materials	Waste heat recovery from a marine waste incinerator using a thermoelectric generator	<ul style="list-style-type: none"> ➤ Review ➤ Modeling 	<ul style="list-style-type: none"> ➤ Applying heat recovery system on marine waste incinerator using TEGs ➤ Optimization analyses for the heat exchanger and other crucial parameters using mathematical model. ➤ About 58 kW electric power is generated from 850 kW thermal incinerator at a cost of 6.6 \$/W ➤ About 25 kW electric power is produced from same incinerator at a cost of 2.5 \$/kW ➤ A trade-off between the two targets guide to a combination that gives 38 kW electric power at a cost of 2.7 \$/W
Klein et al. [237], 2014, Journal of Electronic Materials	Integrating phase-change materials into automotive thermoelectric generators: An experimental examination and analysis of energetic potential through numerical simulation	<ul style="list-style-type: none"> ➤ Review ➤ Experimental ➤ Numerical 	<ul style="list-style-type: none"> ➤ Study the effect of integrating latent heat storage on an automotive thermoelectric heat recovery system ➤ The amount of energy stored by PCM is estimated ➤ A considerable increase in electric energy is obtained in the selected test cycle using numerical simulation
Zhang et al. [238], 2015, Energy Conversion and Management	High-temperature and high-power-density nanostructured thermoelectric generator for automotive waste heat recovery	<ul style="list-style-type: none"> ➤ Review ➤ Experimental ➤ Numerical 	<ul style="list-style-type: none"> ➤ Demonstration of a high-performance TEG in order to allow TEG device to operate at higher temperatures. ➤ The TEG is fabricated by combining high-efficiency nanostructured bulk materials with a novel direct metal brazing ➤ At 500 °C temperature difference, a high-power density is achieved using the fabricated TEG (5.26 W/cm) ➤ Experimental study is performed to recover heat from automotive diesel engine ➤ Bases on experimental results, at a 550 °C hot side temperature and 339 °C temperature difference the energy conversion efficiency was 2.1%
He et al. [239], 2016, Applied Energy	Influence of different cooling methods on thermoelectric performance of an engine exhaust gas waste heat recovery system	<ul style="list-style-type: none"> ➤ Review ➤ Numerical 	<ul style="list-style-type: none"> ➤ Mathematical model that utilizes multi-element thermoelectric components connected in series and consider temperature difference along TEG. ➤ Fortran computation program was utilized for the numerical calculations ➤ Study the effect of changing cooling method on the performance of the thermoelectric system ➤ It is crucial in TEG system design to select an optimal module area which is compatible with the mass flow rate of the fluid ➤ No huge difference between co and counter flow methods when water is used as cooling method, while it should be differentiated when using air. ➤ The gas mass flow rate estimates the optimal module area (not the temperature)
Hatami et al. [54], 2014, Renewable and Sustainable energy reviews	A review of different heat exchangers designs for increasing the diesel exhaust waste heat recovery	<ul style="list-style-type: none"> ➤ Review 	<ul style="list-style-type: none"> ➤ Brief review of the waste heat recovery technologies from diesel engines. ➤ Short review of the technologies that increase the heat transfer in heat exchangers ➤ Assess the possibility of utilizing heat exchangers in the exhaust of engines ➤ Review of distinct heat exchangers that were designed to rise the exhaust waste heat recovery ➤ Suggest future viewpoints for new heat exchanger designs to maximize heat recovery from exhaust of diesel engines
Rahman et al. [66], 2015, Renewable and Sustainable energy reviews	Power generation from waste of IC engines	<ul style="list-style-type: none"> ➤ Modeling 	<ul style="list-style-type: none"> ➤ Dual heat recovery system that utilizes exhaust gases and coolant of an ICE ➤ Air is heated to 60-70 °C and fed into the engine using the coolant heat recovery system

			<ul style="list-style-type: none"> ➤ The waste energy recovery system of exhaust system has been advanced with integrating fuzzy intelligent controlled Micro-Faucet emission gas recirculation and thermoelectric generators ➤ About 10% reduction of the load of the alternator is achieved by generating power using TEGs ➤ 3% improvement on the specific fuel consumption ➤ 7% increase in brake power
Date et al. [240], 2015, Renewable energy	Performance review of a novel combined thermoelectric power generation and water desalination system	<ul style="list-style-type: none"> ➤ Modeling ➤ Experimental 	<ul style="list-style-type: none"> ➤ Suggestion of a new thermoelectric power generation and desalination system ➤ Thermal modeling of the system is carried ➤ Four heat pipes are attached to the heat sink side of TEGs by which the condenser of the heat pipe is immersed in the pool ➤ Higher heat flux could be supplied to TEGs at low saturation temperature
Cao et al. [241], 2016, Sensors and Actuators A: Physics	Flexible screen printed thermoelectric generator with enhanced processes and materials	<ul style="list-style-type: none"> ➤ Modeling 	<ul style="list-style-type: none"> ➤ Heat recovery from wireless sensor networks using flexible screen printed TEG ➤ A higher power is generated using TEG with SbTe electrodes compared to TEG with Ag electrodes ➤ Study the contact resistance between thermocouple and Ag electrodes ➤ 200% in power generated when applying epichlorohydrin-polyglycol based epoxy binder
Barma et al. [242], 2015, Energy Conversion and Management	Estimation of thermoelectric power generation by recovering waste heat from Biomass fired thermal oil heater	<ul style="list-style-type: none"> ➤ Modeling 	<ul style="list-style-type: none"> ➤ Study on heat recovery from exhaust gases of biomass thermal oil heater. ➤ Study on the effect of changing thermoelectric material on the power generated ➤ At same operating conditions, the power generated using new module (p-type (Bi, Sb)₂Te₃ and n-type hot forged Bi₂Te₃) is 4.4 W whereas for Bi₂Te₃ commercial module is 3.7 W ➤ Suggested system is capable to generate 181MWh yearly ➤ Thermal efficiency is enhanced by 8.18% based on changing the material ➤ Specifications of heat sink and material of TEGs significantly affect the performance of the thermoelectric generator
Lu et al. [243], 2015, Applied Thermal Engineering	Effects of heat enhancement for exhaust heat exchanger on the performance of thermoelectric generator	<ul style="list-style-type: none"> ➤ Modeling 	<ul style="list-style-type: none"> ➤ Investigation of two types of heat transfer enhancements used on thermoelectric heat recovery system coupled to the exhaust of an automobile on the net power generated ➤ Metal foam and rectangular offset strip fins enhancers are studied ➤ For the rectangular offset strip fin, to generate maximum power is in function of the fin transvers spacing and thickness which should be set at optimal values ➤ Utilizing metal foam with low porosity and small pore density considerable increases, the power generated and energy conversion efficiency
Phillip et al. [244], 2013, Journal of Electronic Materials	Investigation of maximum power point tracking for thermoelectric generators	<ul style="list-style-type: none"> ➤ Modeling ➤ Mathematical 	<ul style="list-style-type: none"> ➤ Demonstration of maximum power point tracking (MPPT) using a thermal model ➤ Investigation on perturb and observe algorithm and extremum seeking control ➤ Cons of utilizing MPPT controller are summarized ➤ Extremum seeking control maximum power point tracking algorithm coupled with buck-boost DC_DC converter is capable to effectively control the power generated by thermoelectric generator
Korzhev [245], 2011, Technical Physics Letters	Conflict between internal combustion engine and thermoelectric generator during waste heat recovery in cars	<ul style="list-style-type: none"> ➤ Modeling 	<ul style="list-style-type: none"> ➤ Study the thermodynamic limitations of the maximum power generated by TEGs in which is related to the conflict of thermal machines ➤ Study the potential for utilizing TEGs located on the exhaust pipe of an internal combustion engine with permitting the conflict between thermal machines ➤ Conflict increases with increasing useful electric power of the thermoelectric generators
Yu et al. [246], 2015, Applied Energy	Start-up modes of thermoelectric generator based on vehicle exhaust waste heat recovery	<ul style="list-style-type: none"> ➤ Experimental ➤ Modeling 	<ul style="list-style-type: none"> ➤ Study the transient behavior of TEG under various start up modes ➤ Constant voltage, constant power, constant current and maximum power mode are investigated ➤ Study the time required to reach the rated power and investigate the effect of vehicle speed and ambient temperature ➤ Time to reach steady state for all modes is almost equal (less than 5% difference) ➤ About 70% difference in the duration to reach 40% of steady state for different start up modes ➤ As velocity of vehicle increased, the performance of TEG is enhanced
Remeli et al. [247], 2016, Energy Conversion and Management	Experimental investigation of combined heat recovery and power generation using a heat pipe assisted thermoelectric generator system	<ul style="list-style-type: none"> ➤ Experimental ➤ Modeling 	<ul style="list-style-type: none"> ➤ Experimental study to recover heat using TEGs and heat pipe. ➤ Heat transfer rate, maximum generated power and heat exchanger effectiveness are studied ➤ At 1.1m/s hot air speed, the heat exchanger effectiveness was maximum (41%) ➤ System is capable to recover 1079 W of dissipated heat ➤ About 7 W electric power is generated by TEGs with 0.7% energy conversion efficiency
Navarro-Peris et al. [248], 2015, Applied Thermal Engineering	Evaluation of the potential recovery of compressor heat losses to enhance the efficiency of refrigeration systems by means of thermoelectric generation	<ul style="list-style-type: none"> ➤ Experimental ➤ Modeling 	<ul style="list-style-type: none"> ➤ Study the potential to apply heat recovery from heat of compressor ➤ TEGs are experimented under different conditions (different temperature gradient) ➤ About 3.5% increase in cooling capacity can be achieved by recovering heat from compressor using TEGs
Remeli et al. [249], 2015, Energy Procedia	Passive Heat Recovery System Using Combination of Heat Pipe and Thermoelectric Generator	<ul style="list-style-type: none"> ➤ Experimental ➤ Modeling 	<ul style="list-style-type: none"> ➤ Experimental study on heat recovery using TEGs and heat pipes ➤ Two heat pipes are installed on the hot and cold side of TEGs ➤ 2kW electric heater is used to generate hot air ➤ Theoretical model is done to predict the heat transfer and effectiveness of the heat exchanger ➤ Effectiveness increased from 67.9% to 72.4% with the increase in air speed
Massaguer et al. [250], 2015, Applied Energy	Modeling analysis of longitudinal thermoelectric energy harvester in low temperature waste heat recovery applications	<ul style="list-style-type: none"> ➤ Modeling ➤ Experimental ➤ Numerical 	<ul style="list-style-type: none"> ➤ A new longitudinal thermoelectric heat recovery system is suggested and studied at transient and steady states ➤ New TRNSYS component is developed and can be used as design tool ➤ About 0.16 W is generated with 0.46% efficiency
Elefsiniotis et al. [251], 2014, Journal of Electronic Materials	Thermoelectric energy harvesting using phase change materials (PCMs) in high temperature environments in aircraft	<ul style="list-style-type: none"> ➤ Modeling ➤ Experimental ➤ Numerical 	<ul style="list-style-type: none"> ➤ Heat recovery from the pylon aft fairing using TEGs and PCM ➤ Different scenarios were considered ➤ About 81.4J are harvested
Kumar et al. [252], 2011, Thermal Science	Experimental study on waste heat recovery from an internal combustion engine using thermoelectric technology	<ul style="list-style-type: none"> ➤ Modeling ➤ Experimental ➤ Numerical 	<ul style="list-style-type: none"> ➤ Summary of the potential of thermoelectric generators ➤ Experimental study on heat from exhaust gases of an ICE using TEGs under various conditions ➤ 18 TEG module are attached to the engine and tested ➤ Different heat exchangers are modeled using numerical software which resulted to select the rectangular shape heat exchanger

Jang et al. [253], 2013, Applied Thermal Engineering	Optimization of thermoelectric generator module spacing and spreader thickness used in a waste heat recovery system	➤ Numerical	<ul style="list-style-type: none"> ➤ 3D numerical model of TEG ➤ Effect of changing the temperature gradient between the hot and cold sides of TEGs on heat transfer rate is studied. ➤ Based on finite element method, the TEG module spacing and spreader thickness are optimized ➤ The convection heat transfer coefficient has a significant effect on the module spacing and spreader thickness
Remeli et al. [254], 2015, Energy Conversion and Management	Simultaneous power generation and heat recovery using a heat pipe assisted thermoelectric generator system	➤ Modeling ➤ Experimental	<ul style="list-style-type: none"> ➤ Suggestion of new method to recover heat using heat pipe assisted thermoelectric generator ➤ Theoretical model is carried to estimate the heat recovered, power generated and energy efficiency ➤ Modeling shows that the system is capable to recover 1.345 kW ➤ About 10.39 W electric power is generated using 8 TEGs
Sonthalia et al., [255], 2015, Heat Transfer – Asian Resource	Theoretical Investigation of Waste Heat Recovery from an IC Engine Using Vapor Absorption Refrigeration System and Thermoelectric Converter	➤ Numerical	<ul style="list-style-type: none"> ➤ Applying heat recovery from exhaust gases generated by single cylinder ICE using TEG coupled to vapor absorption system ➤ Parametric numerical simulation is carried ➤ Study the effect of engine load, speed on the power generated by TEGs and coefficient of performance (COP) of the vapor absorption refrigeration cycle ➤ The pump of the absorption cycle is powered by TEGs ➤ Engine load, speed and air to fuel ratio have significant effect on COP ➤ About 10-15% of dissipated thermal energy through exhaust gases is recovered by the system
Kumar et al. [256], 2013, Journal of Electronic Materials	Thermoelectric generators for automotive waste heat recovery systems part II: Parametric evaluation and topological studies	➤ Numerical	<ul style="list-style-type: none"> ➤ Numerical modeling of heat recovery from automotive application ➤ Optimization study is performed on heat exchanger, geometry and thermoelectric module ➤ Adding fins enhanced heat transfer and improved power generated by 8% for longitudinal configuration
Hendricks et al. [257], 2013, Journal of Electronic Materials	New perspectives in thermoelectric energy recovery system design optimization	➤ Numerical	<ul style="list-style-type: none"> ➤ Study on new TE materials which include nanocomposite materials such as lead-antimony-silver-telluride (LAST) and lead-antimony-silver-tin-telluride (LASTT) compounds ➤ Optimization study is carried on such new material using numerical model ➤ Maximum power generated by TEG can be achieved when the external resistance is slightly greater than TEG internal resistance ➤ Such device is capable to handle 400 °C and reached 7% efficiency theoretically ➤ Maximum power output at full generator power is about 1.4 kW at about 9.0% TE module conversion efficiency
Gao et al. [258], 2012, International Journal of Hydrogen Energy	Numerical model of a thermoelectric generator with compact plate-fin heat exchanger for high temperature PEM fuel cell exhaust heat recovery	➤ Numerical	<ul style="list-style-type: none"> ➤ Numerical study on heat recovery for high temperature polymer electrolyte fuel cell ➤ TEGs are attached to the wall of compact plate-fin heat exchanger ➤ Based on finite element method, fluid properties, heat transfer and TEG performance is calculated
Yazawa et al. [259], 2012, Journal of Electronic Materials	Scalable cost/performance analysis for thermoelectric waste heat recovery systems	➤ Numerical	<ul style="list-style-type: none"> ➤ Study the cost-efficient trade-offs for various ZT and identify applications by which low cost organic TEGs would have high impact ➤ Defining the minimum mass of TEG material and heat sink allows optimization of the system ➤ low-cost lower-efficiency TE materials have the best potential for lightweight remote power applications
Niu et al. [260], 2014, Energy Conversion and Management	Investigation and design optimization of exhaust-based thermoelectric generator system for internal combustion engine	➤ Numerical	<ul style="list-style-type: none"> ➤ 3D numerical model is carried on thermoelectric heat recovery system that utilizes exhaust gases of an ICE ➤ Different transport phenomena are studied taking into consideration the geometry of TEG and exhaust channel ➤ To balance the heat transfer to TEGs and pressure drop along the channel, the exhaust channel should be moderated ➤ The performance of the system can be improved by increasing the number of channels however it will require more spacing and more TEGs (more expensive system) ➤ Baffle angle should be large (for downstream locations) to ensure effective harvesting of dissipated thermal energy
Shu et al. [261], 2012, Energy	Parametric and exergetic analysis of waste heat recovery system based on thermoelectric generator and organic rankine cycle utilizing R123	➤ Modeling	<ul style="list-style-type: none"> ➤ Energetic and exergetic study is carried for the thermoelectric generator and organic Rankine cycle ➤ Study the effect of TEG flow direction, TEG scale, condensation temperature, maximum temperature and the efficiency of heat exchanger on the performance of the system ➤ Under both supercritical and subcritical conditions, the thermodynamic irreversibility is studied at various system component (turbine, pump, evaporator, condenser and heat exchanger) ➤ Most effective operation of the system was at 5.5 MPa evaporator pressure which lead to maximum power (27.01 kW) ➤ System efficiency with TEGs is 45.71% which is greater than the ordinary efficiency of organic Rankine cycle (41%) ➤ Maximum exergy efficiency reached is 46.03% at 0.8 internal heat exchanger efficiency
Ma et al. [262], 2015, Applied Thermal Engineering	Waste heat recovery using a thermoelectric power generation system in a biomass gasifier	➤ Modeling ➤ Experimental	<ul style="list-style-type: none"> ➤ Study the potential of heat recovery using TEGs in a biomass gasifier ➤ 8 Bi₂Te₃ TEGs are placed on the surface of the catalytic reactor ➤ Hot side temperature ranged between 473-633 K ➤ Maximum power generated by TEGs is 29.7 W at 505 K temperature difference between the hot and cold sides of the TEG ➤ Energy conversion efficiency was found to be 10.9% and 2.8% at 505 K and 75 K temperature difference respectively
Hasani et al. [263], 2015, International Journal of Hydrogen Energy	Application of thermoelectric cooler as a power generator in waste heat recovery from a PEM fuel cell - An experimental study	➤ Modeling ➤ Experimental	<ul style="list-style-type: none"> ➤ Experimental study on heat recovery from 5 kW Proton exchange membrane (PEM) fuel cell ➤ Empirical relations are provided to calculate the system voltage using the outlet water temperature of fuel cell ➤ Highest temperature difference reached is 18 °C with outlet water temperature 65 °C ➤ System is capable to recover about 800 W from hot water which is about 10% of the dissipated energy through water (8012 W) ➤ As outlet water temperature increase, overall efficiency decreases which indicate that the overall efficiency is significantly affected by insulation quality
Aranguren et al. [264], 2015, Applied Energy	Experimental investigation of the applicability of a thermoelectric generator to	➤ Experimental	<ul style="list-style-type: none"> ➤ 48 TEGs are located at the exhaust of combustion chamber of ICE with two different types heat exchangers (finned and heat pipe type) ➤ The constructed prototype is capable to generate 21.56 W covering 0.25 m²

	recover waste heat from a combustion chamber		<ul style="list-style-type: none"> ➤ 43% increase in power generated is reached when using heat pipe compared to the conventional finned type ➤ TEGs efficiency was estimated to be 2.2%
Jaworski et al. [265], 2016, Applied Thermal Engineering	Experimental investigation of thermoelectric generator (TEG) with PCM module	➤ Experimental	<ul style="list-style-type: none"> ➤ Solar radiations are used as heat source of TEGs and PCM is attached at the cold side ➤ The main role of PCM is to cool TEG and stabilize the cold side of TEG ➤ Voltage and current are measured at specific time intervals for different electric configurations and heat rate
Orr et al. [266], 2014, Applied Thermal Engineering	Electricity generation from an exhaust heat recovery system utilising thermoelectric cells and heat pipes	➤ Experimental ➤ Modeling	<ul style="list-style-type: none"> ➤ Heat recovery from exhaust gases to generate electricity using TEG and heat pipe ➤ 8 TEGs are attached to the system and generated 6.03 W ➤ Energy conversion efficiency of TEGs is 1.43% ➤ Actual efficiency is about 1/15 Carnot cycle efficiency
Liu et al. [267], 2015, Energy Conversion and Management	Performance analysis of a waste heat recovery thermoelectric generation system for automotive application	➤ Experimental	<ul style="list-style-type: none"> ➤ Design of new heat recovery system called “Four TEGs” and applying in a designed vehicle ➤ 944 W is the maximum power generated by TEGs ➤ TEGs has a promising potential to be utilized in low temperature waste heat recovery vehicles
Hatzikraniotis [268], 2011, ACTA Physica Polonica A	On the recovery of wasted heat using a commercial thermoelectric device	➤ Modeling	<ul style="list-style-type: none"> ➤ Study the power generated by TEGs at different locations of TEGs on the exhaust pipe and different engine loads ➤ Using theoretical model, the natural cooling of TEG seems to be efficient while using an electric fan will reduce the overall efficiency of the TEG system ➤ 1 W per module is generated at a speed of 110 km/h ➤ The TEG efficiency ranged between 2.5 to 3.2 % ➤ 7.1% reduction on the alternator load when TEGs generate 30 W
Wang et al. [269], 2014, Applied Energy	Waste heat recovery through plate heat exchanger based thermoelectric generator system	➤ Experimental ➤ Modeling	<ul style="list-style-type: none"> ➤ Suggestion of new type of heat recovery heat exchanger know as open-cell metal foam filled plate heat exchanger based thermoelectric generator system ➤ This system is utilized in low grade waste heat ➤ Heat exchanger reached maximum efficiency of 83.56% ➤ TEGs are capable to produce 108.1 mV as maximum open circuit voltage ➤ As number of TEGs increase, the open circuit voltage increases linearly
Ming et al. [270], 2015, Energy	Thermal analysis on a segmented thermoelectric generator	➤ Numerical	<ul style="list-style-type: none"> ➤ Derivation of the optimum efficiency of segmented thermoelectric generator that operates between 300 and 780 K ➤ 3D numerical simulation is carried ➤ The segmented thermoelectric generator is capable to steadily generate 1 V or more with TEG maximum efficiency of 11.2%
Huang et al. [271], 2013, Journal of Electronic Materials	Two-Dimensional Thermal Resistance Analysis of a Waste Heat Recovery System with Thermoelectric Generators	➤ Numerical	<ul style="list-style-type: none"> ➤ Prediction of the power generated by TEGs using 2D thermal resistance analysis ➤ 2D model requires less time compared to numerical CFD simulations ➤ 3D numerical results match the 2D results within 10%
Baker et al. [272], 2012, Journal of Electronic Materials	Model of heat exchangers for waste heat recovery from diesel engine exhaust for thermoelectric power generation	➤ Modeling ➤ Numerical	<ul style="list-style-type: none"> ➤ Modeling of moral thermoelectric generator which harvest dissipated heat from exhaust gases of medium duty turbocharged diesel engine ➤ Two finite element models are carried: heat exchanger model and TEG model ➤ Net power generated by single duct without heat transfer enhancement is 320 W ➤ 0.705 mm, 1.03 mm, 834 mΩ, and 2.07% are the optimum n-type to p-type leg area ratio, leg length, load resistance, and fill fraction respectively for a single duct without heat transfer enhancement ➤ Net power generated by single duct with heat transfer enhancement (32 fins) is 975 W ➤ 0.683mm, 0.327 mm, 4.35 Ω, and 2.38% are the optimum n-type to p-type leg area ratio, leg length, load resistance, and fill fraction respectively for a single duct with heat transfer enhancement ➤ Net power generated for the 3 ducts counterflow parallel-plate configuration without heat transfer enhancement is 1.06 kW
Tian et al. [273], 2015, Energy Procedia	Comparison of Segmented and Traditional Thermoelectric Generator for Waste Heat Recovery of Diesel Engine	➤ Numerical	<ul style="list-style-type: none"> ➤ Mathematical model is carried on low and medium temperature segmented thermoelectric generator which are bismuth telluride and Skutterudite respectively ➤ Comparison between ordinary and segmented TEGs under various conditions ➤ Maximum generated power and electric-thermal efficiency of segmented TEG are higher significantly using exhaust of diesel engine (DE) as heat source and coolant as heat sink ➤ The relation between maximum power and efficiency are opposed the increase of thermocouple length ➤ The relation between maximum power and increase of cross section area is linearly proportional while the electric-thermal efficiency is constant
Gao et al. [274], 2014, International Journal of Hydrogen Energy	Optimization of a thermoelectric generator subsystem for high temperature PEM fuel cell exhaust heat recovery	➤ Numerical	<ul style="list-style-type: none"> ➤ 4x12 TEG modules are connected in the subsystem which are electrically separated into 3 branches along the exhaust pipe ➤ “Pin-fin plate-fin, surface PF-4(F)” heat exchanger is installed ➤ Steps of optimizing TEG is clearly shown ➤ Electrical connection style affects the optimal size, reliability and performance of both off and on design

Table A.1.7. Table of references for heat recovery using phase change material.

Reference, year, Journal name	Title	Type of study/ Methodology	Main outcomes
Moreno et al. [283], 2014, Renewable and Sustainable Energy Reviews	The use of phase change materials in domestic heat pump and air-conditioning systems for short term storage: A review	➤ Review	<ul style="list-style-type: none"> ➤ Comprehensive review on thermal energy storage system using phase change material (PCM) coupled with domestic heat pump ➤ Listing of previous works done and the main outcomes conducted from those studies. PCM storage in heat pump for space cooling and heating are presented and hybrid systems are illustrated ➤ PCM have the suitable melting temperature to work with ordinary heat pumps
Zhang et al. [284], 2014, Solar Energy Materials and Solar Cells	Encapsulation of copper-based phase change materials for high temperature thermal energy storage	➤ Experimental	<ul style="list-style-type: none"> ➤ Suggestion of a new metal PCM known as copper capsules coated with refractory metallic shells which is capable to operate at 1000 °C ➤ Using new chromium periodic-barrel electroplating method and nickel barrel-plating method, tiny copper spheres are encapsulated with a thick chromium–nickel bilayer

			<ul style="list-style-type: none"> ➤ The melting temperature and latent heat of fusion of this PCM is 1077 °C 71 J/g respectively ➤ About 1000 cycle of charging and discharging can be handled by this PCM with temperature range 1050 to 1150 °C without leakage
Fukahori et al. [285], 2016, Applied Energy	Macro-encapsulation of metallic phase change material using cylindrical-type ceramic containers for high-temperature thermal energy storage	➤ Experimental	<ul style="list-style-type: none"> ➤ Suggestion of a new macro-encapsulation of metallic PCM (Al–25 wt%Si) using cylindrical-type Al₂O₃ containers ➤ PCM capsule has perfect corrosive resistance ➤ Due to the presence of void in the capsules, this capsule has an excellent durability cycling
Rathod et al. [286], 2014, Heat Transfer-Asian Research	Thermal Performance of a Phase Change Material-Based Latent Heat Thermal Storage Unit	➤ Experimental	<ul style="list-style-type: none"> ➤ Experimental study on latent thermal energy storage which utilizes Paraffin as PCM and water as heat transfer fluid ➤ Effect of changing mass flow rate and inlet temperature of water on the PCM temperature distribution and melting time are examined ➤ Melting front move from top to bottom whereas solidification front moves radially ➤ The melting time required decreases with the increase of mass flow rate and inlet temperature of heat transfer fluid (water)
Zhang et al. [287], 2014, Energy	Latent heat storage with tubular-encapsulated phase change materials (PCMs)	➤ Experimental ➤ Numerical	<ul style="list-style-type: none"> ➤ Experimental study on latent heat storage by encapsulating NaNO₃/KNO₃-PCM in an AISI 321 tube ➤ Metallic foam and metallic sponge inserts are tested in order to increase the thermal conductivity of PCM ➤ Using COMSOL Multiphysics and un-steady conduction equations, experimental cooling results are interpreted ➤ The effective conductivity when foam is added is about 15% greater than both molten salt and solid PCM ➤ The effective conductivity when metallic sponge is inserted is about 32% greater than both molten salt and solid PCM
Warzoha et al. [288], 2014, International Journal of Heat and Mass Transfer	Improved heat recovery from paraffin-based phase change materials due to the presence of percolating graphene networks	➤ Experimental	<ul style="list-style-type: none"> ➤ Study on paraffin based PCM embedded with nanoparticles that would increase the thermal conductivity of PCM (Paraffin-based PCM suffers from low thermal conductivity) ➤ Implementing nanoparticles in PCM can reduce the amount of heat energy that can be harvested by PCM ➤ Amount of heat that can be harnessed from MWCNT, Al or TiO₂ nanocomposite PCMs is about 15–17% less than the base paraffin during its period of solidification ➤ Thermal energy that can be harnessed from paraffin in the presence of graphene nanoparticle networks is about 11% greater than for the base paraffin
Fan et al. [289], 2013, International Journal of Thermal Science	Effects of melting temperature and the presence of internal fins on the performance of a phase change material (PCM)-based heat sink	➤ Experimental	<ul style="list-style-type: none"> ➤ Experimental study on two PCMs with similar thermophysical properties but different melting temperature ➤ Behavior of PCMs for different pulse heat load is examined ➤ PCM with a higher melting temperature can increase time of protection from over-heating ➤ PCM with a lower melting temperature can enable a rapid protection of the device
Jia et al. [290], 2015, Energy	Experimental investigations on using phase change material for performance improvement of storage-enhanced heat recovery room air-conditioner	➤ Experimental	<ul style="list-style-type: none"> ➤ Experimental study on adding PCM to the water tank of “storage-enhanced heat recovery room air-conditioner” ➤ Two experiments were done at similar conditions but with or without PCM ➤ When PCM is added the overall coefficient of performance was 6.9-9.8% greater compared with the system without PCM. ➤ The time required for the water to cool when PCM is added was 21.1% longer when PCM is not presenting
Rao et al. [291], 2007, Heat Transfer-Asian Research	Preparation and thermal properties of microencapsulated phase change material for enhancing fluid flow heat transfer	➤ Experimental	<ul style="list-style-type: none"> ➤ Microencapsulation phase change material (MEPCM) is defined by inserting PCM into solid but flexible shell microcapsule ➤ Experimental study on the preparation of double layered shell MEPCM ➤ n-Docosane (C₂₂H₄₆) are used as core material and melamine as shell material ➤ The efficiency of microencapsulation is inversely proportional to the fraction of the core ➤ Between 0 and 180 °C the thermal stability of MEPCM was relatively good
Zhang et al. [292], 2011, Applied Thermal Engineering	Experimental research on condensing heat recovery using phase change material	➤ Experimental ➤ Parametric	<ul style="list-style-type: none"> ➤ Designing and analyzing a condensing heat recovery with paraffin wax PCM ➤ Study on the charging and discharging rates, and on the effect of temperature rises and flow rate rise. ➤ High flow rate lead to lower temperature rise of cold water during the discharging process ➤ Paraffin wax heat resistance is higher in discharging process
Ben Mâad et al. [293], 2016, Applied Thermal Engineering	Numerical simulation of absorption-desorption cyclic processes for metal-hydrogen reactor with heat recovery using phase-change material	➤ Numerical	<ul style="list-style-type: none"> ➤ 2D numerical model is carried to predict the behavior of coupled heat and mass transfer within a metal-hydrogen reactor filled with a phase change material (MHR- PCM) ➤ Unstructured control volume finite element method is utilized coupled with computer code done on Fortran 90 ➤ When the metal- hydrogen reactor reaches 97% of its maximum capacity of hydrogen storage, about 80% of the hydrogen stored in the reactor can be evacuated by PCM
Pitié et al. [294], 2013, Applied Energy	Circulating fluidized bed heat recovery/storage and its potential to use coated phase-change-material (PCM) particles	➤ Numerical	<ul style="list-style-type: none"> ➤ Study on PCMs that have potential to be used in high temperature energy storage using a circulating fluidized bed ➤ Optimum size range for the applied PCM particles (<400 μm) ➤ Wall-to- bed heat transfer coefficient, is 60 W/m²K at low G values which increases to 350 W/m²K at higher G values
Shi et al. [295], 2011, International Journal of Heat and Mass Transfer	An investigation of the performance of compact heat exchanger for latent heat recovery from exhaust flue gases	➤ Modeling ➤ Experimental	<ul style="list-style-type: none"> ➤ Theoretical and experimental study on the usage of finned tube compact heat exchanger to recover both sensible and latent heat ➤ Heat transfer and pressure drop of the heat exchanger are estimated using the theoretical modeling ➤ Colburn factor and the friction factor for humid air (simulating the exhaust of heat recovery steam generator) are larger than for dry air. ➤ Friction factor difference between humid and dry air decrease as Reynolds number increase
Ferreira et al. [296], 2015, Energy Conversion and Management	Integration of environmental indicators in the optimization of industrial energy management using phase change materials	➤ Theoretical	<ul style="list-style-type: none"> ➤ Study on heat recovery from medium temperature source through PCM ➤ 20 various scenarios were studied in terms of energy and environmental effect with combination of 4 different PCM types and 5 different type of fossil fuel ➤ Case 1 had a considerable effect in terms of the carbon footprint, with a contribution over 80%

1.4 Revue de la récupération de chaleur des gaz d'échappement à l'aide de générateurs thermoélectriques

Hassan Jaber , Mahmoud Khaled , Thierry Lemenand et Mohamad Ramadan

Il est prévu de soumettre cette revue à « **Energy Conversion and Management** »

Résumé - Afin de réduire les émissions de gaz à effet de serre et le prix de l'énergie, les ingénieurs ont tendance à étudier plus en profondeur la valorisation des déchets. Étant donné que 70% de l'énergie générée par la combustion de carburant est rejetée dans l'environnement, la récupération de chaleur à partir des gaz d'échappement devient une solution qui doit faire l'objet d'études supplémentaires. Cela a permis à de nombreuses études de générer de l'électricité à partir d'une source de chaleur perdue à l'aide de générateurs thermoélectriques (GTE). Les appareils thermoélectriques génèrent de l'électricité directement lorsqu'ils sont pris en sandwich entre une source de chaleur et un dissipateur de chaleur. Ils génèrent de l'électricité à partir de tout gradient de température. Cet article présente une analyse de la récupération de chaleur des gaz d'échappement à l'aide de générateurs thermoélectriques. Il présente les principales sources de gaz d'échappement. Le principe de fonctionnement, les matériaux, les avantages et les inconvénients des GTE sont présentés. En plus de cela, la modélisation thermique et électrique est explicitée. En outre, il présente quelques travaux antérieurs réalisés sur ce domaine d'étude. Cet article inclut une étude économique et environnementale sur un système de récupération de chaleur thermoélectrique couplé à différentes applications telles que cheminée, générateur diesel, voitures et chauffage à huile thermique industrielle.

Review on Heat Recovery from Exhaust Gases Using Thermo-Electric Generators

Hassan Jaber^a, Mahmoud Khaled^{a,b}, Thierry Lemenand^c and Mohamad Ramadan^{a,d,*}

^a School of Engineering, Lebanese International University LIU, PO Box 146404 Beirut, Lebanon.

^b Univ Paris Diderot, Sorbonne Paris Cité, Interdisciplinary Energy Research Institute (PIERI), Paris, France

^c LARIS EA 7315, University of Angers – ISTIA, Angers, France

^d Associate member at FCLAB, CNRS, Univ. Bourgogne Franche-Comte, Belfort cedex, France.

*Mohamad.Ramadan@liu.edu.lb

Abstract- Abstract- In order to reduce the greenhouse gas emission and to reduce the price of energy, engineers tend to study waste recovery more deeply. Since 33% of energy generated from burning fuel is exhausted to the environment, heat recovery from exhaust gases became attractive for more investigations and studies. This made generating electricity from a wasted heat source directly using thermoelectric generators (TEGs) a trending technology. Thermoelectric devices generate electricity directly when they are sandwiched between a heat source and heat sink. They generate electricity from any temperature gradient. This paper presents a review on heat recovery from exhaust gases using thermoelectric generators. It presents the main sources of exhaust gases. The principle of working, materials, advantages and disadvantages of TEGs are presented. In addition, thermal and electrical modelling is shown. Also, it presents some previous works that are done on this field of study. Moreover, this paper includes an economic and environmental study on thermoelectric heat recovery system coupled to different applications such as chimney, diesel generator, cars and industrial thermal oil heater.

Keywords: Energy management; Heat recovery; Seebeck effect; Thermoelectric generators;

1. Introduction

Development of green and renewable energy sources can reduce greenhouse emissions and reliance on fossil fuel considerably. Last decades, engineers and scientists shed light on their studies on renewable energy and waste heat recovery for cheaper energy generation. Renewable energy is defined by capturing energy from a naturally renewable source such as solar, wind, biomass, tidal, hydropower [1–4] ... whereas, waste heat recovery is defined by taking advantage of dissipated thermal energy to the environment. It can increase the conventional energy conversion efficiency [5–8]. Waste heat is normally generated by machinery, electrical equipment, residential and industrial heat generating systems [9–15]. At most, heat generating systems dissipate the highest amount of thermal energy through exhaust gases and cooling systems. Heat recovery from exhaust gases is a trend field of study.

Generating electricity from waste heat presents the largest field of studies in recovery systems. It can be produced directly using thermoelectric generators (TEG) [16] or indirectly using power cycles.

Thermoelectric generators are passive devices that directly convert thermal energy to electrical energy. Many studies were associated in the last years on heat recovery systems that utilizes exhaust gases to generate electricity via thermoelectric generators.

This paper presents a review on heat recovery from exhaust gases using thermoelectric generator. Section 1 presents an introduction of the paper. Section 2 deals with heat recovery

from exhaust gases by which it is classified according to different taxonomies. While section 3 explains how TEG works, made up of, advantages and disadvantages. Section 4 exhibits the previous works done on heat recovery from exhaust gases using TEGs. Finally, section 5 is a summarizing conclusion.

2. Heat recovery technologies

Wasted heat is the heat dissipated to the environment without taking advantage of it. It is mainly generated from the combustion of fuel or any chemical substance and released through exhaust gases. Recovering part of this dissipated energy is a real benefit that can reduce the pollution and decrease the cost of energy [17,18]. The released exhaust gases contain sensible and latent heat that can be recovered. Equations (1) and (2) show how to estimate the amount of sensible and latent heat.

$$Q_s = \dot{m} \cdot C_p \Delta T \quad (1)$$

$$Q_L = \dot{m} \cdot h_{fg} \quad (2)$$

where Q_s and Q_L are the amount of sensible and latent heat, \dot{m} is the mass flow rate, C_p is the specific heat of the released flue gas, ΔT is the temperature difference and h_{fg} is the latent heat of fusion. It shows that heat recovery depends in the temperature and mass flow rate of exhaust gases.

Heat recovery technology can be applied on different sources that generate wasted heat at different temperatures in order to either store the captured energy or reuse it directly or indirectly.

Table 1 summarizes the sources, means and applications of heat recovery [19]. The sources can be industrial or residential and may have high, medium or low temperature. Mainly internal combustion engines, generators, boilers, furnaces, chimneys are the sources that generate exhaust gases. The energy captured by exhaust gases is transferred by means of heat exchangers or heat pump. Heat recovery is implemented for many direct and indirect aims which are summarized as heating, cooling, storing and generating electricity.

Singh and Shrivastava [20] and Jadhao and Thombare [21] did reviews on heat recovery from exhaust gases of internal combustion engine. The writers presented that around 30-40% of the energy generated from burning the fuel is converted into useful energy while the remaining is dissipated by exhaust gases, friction and cooling system. Recovering part of the energy dissipated through exhaust gases can significantly reduce secondary energy consumers, reduce equipment size and reduce emissions. It also presents methods of energy recovery mainly from automobiles.

Hossain and Bari [22] did an experimental study on heat recovery from exhaust gases of 40 kW diesel generator. The authors shed light on the importance of heat exchanger and how enhancing it affects the recovery process. Using the experimental results and computer simulation, the heat exchanger was studied in order to be optimized. Results show that the proposed heat exchanger can produce 10%, 9% and 8% additional power using water, ammonia and HFC 134a as the working fluids respectively.

Khaled *et al.* [23] did a parametric analysis study on recovering heat from the wasted flue gases of a 500-kVA electric diesel generator (figure 1) to generate domestic hot water. The recovery process utilizes concentric tube heat exchanger. Thermal modelling of various geometrical configurations was stated. Two flow patterns were studied, by which either exhaust gases pass through the inner tube and water in the annulus or vice versa. In addition, different inner to outer diameter ratios of the concentric tube were studied. Results show that the best inner to outer diameter ratio is 0.75 and about 26 kW were recovered by heating water.

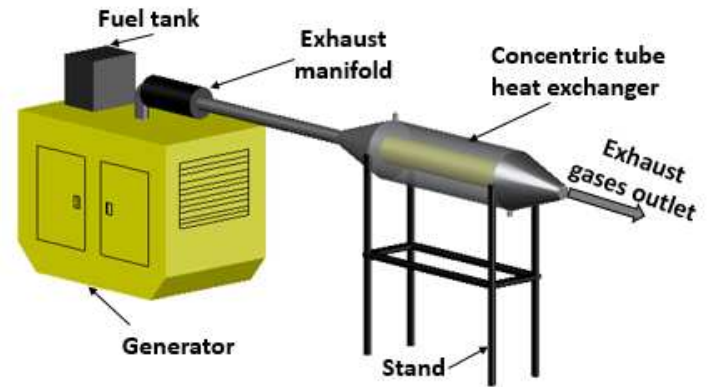

Figure 1. Cogeneration heat recovery system from exhaust gases of electric generator.

Table 1. Heat Recovery classification.

Sources		Means	Applications	
<ul style="list-style-type: none"> • High temperature Above 650 °C 	<ul style="list-style-type: none"> • Nickel /Aluminum /zinc /copper refining furnace • Steel heating furnace • Open hearth furnace • Cement kiln (Dry process) • Glass melting furnace • Hydrogen plants • Solid waste incinerators • Fume incinerators 	<ul style="list-style-type: none"> • Heat pump • Shell and tube heat exchanger • Plate heat exchanger • Thermal wheel heat exchanger • Heat pipe • Economizer • Regenerator • Recuperator 	Heating	<ul style="list-style-type: none"> • Gases • Liquids
			Generating electricity	<ul style="list-style-type: none"> • Thermoelectric generators • Organic Rankine cycle • Ordinary Rankine cycle
<ul style="list-style-type: none"> • Medium temperature Between 200 °C and 650 °C 	<ul style="list-style-type: none"> • Steam boiler exhaust • Gas turbine exhaust • Reciprocating engine exhaust • Reciprocating engine exhaust • Heat treatment furnace • Drying & baking ovens 		Storage	<ul style="list-style-type: none"> • Latent heat storage • Sensible heat storage
<ul style="list-style-type: none"> • Low temperature Below 200 °C 	<ul style="list-style-type: none"> • Process steam condensate • Cooling water from furnace door • Bearings • Welding machines • Injection molding machines • Annealing furnaces 		Cooling	<ul style="list-style-type: none"> • Vapor absorption cycle • Vapor adsorption cycle

Danel *et al.* [24] applied heat recovery technology in tractor engine. Since tractors are utilized for long periods at the high load, they are good source for a heat recovery system. The writer illustrated different technologies for recovery such as Stirling cycle, Ericsson cycle, thermoelectric, thermoacoustics and Rankin-Hirn cycle. A case study was considered on heat recovery using Rankin-Hirn cycle using different working fluids (water, ethanol and R245fa). Thermal modelling of the system was provided. In the case studied, water was shown as the best fluid compared to others at 85% high load.

Raja *et al.* [25] performed an experimental study on recovering heat from diesel engine exhaust using compact shell and tube heat exchanger. The aim of the recovery is to store the recovered thermal energy mainly using thermal latent heat storage tank, where paraffin and ethylene glycol are the phase change material (PCM) used (figure 2). The results show that 14% of the dissipated energy is recovered and stored by PCM and the maximum heat extracted by the heat exchanger is 3.6 kW.

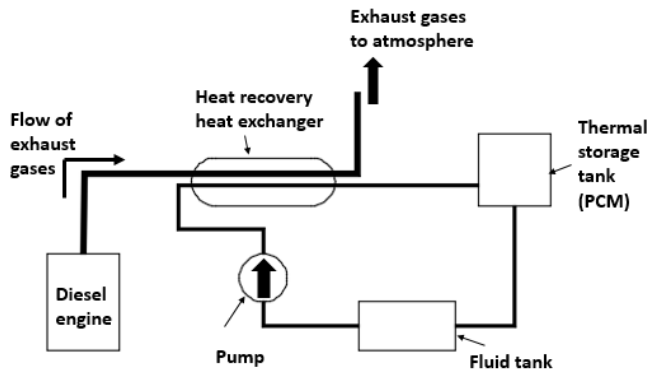

Figure 2. Latent heat storage heat recovery system.

Pradeep Varma and Srinivas [26] performed a case study on cogeneration power plant using heat recovery from cement factory. A detailed thermodynamic methodology is shown in order to solve cogeneration plant to calculate the output power. The results show that the designed power plant can produce up to 12.5 MW of electric output power from waste heat recovery. In addition, changing from industrial to cogeneration mode increases the energy utilization factor from 0.6 to 0.63 respectively

3. Thermoelectric generators

Thermoelectric generator is a technology of direct conversion of thermal energy into electrical energy [27]. They are made up of two dissimilar semiconductors (P and N types) which are connected thermally in parallel and electrically in series. A TEG should be sandwiched between a heat source and heat sink which will develop a temperature difference across the terminals of TEG generating voltage based on Seebeck effect. Thermoelectric generators generate electricity from any temperature gradient, this phenomenon was discovered by

Thomas Johann Seebeck in 1821. Figure 3 shows a thermoelectric generator. When heat transfers through the TEG module, the N-type semiconductor has highly negative charge (excess of electrons) and P-type semiconductor hold positively charged ions (excess of holes) which results electric flow of current. TEGs are popularly made up from Bismuth Telluride (Be₂Te₃). This material has low cost compared to other materials such as lead Telluride (PbTe) which can handle higher temperatures than Be₂Te₃. Some TEGs are made up of Lead Telluride at the hot side and from Bismuth Telluride at the cold side by which this TEG can handle high temperature and have low cost (at the cold side there is no reason for using high pure material that can handle high temperature). TEGs efficiency is limited by Carnot efficiency, which implies that as the temperature gradient increases, efficiency increases. However, TEGs efficiency is typically 5%.



Figure 3. Thermoelectric device.

The main advantages of TEGs that they are passive devices that directly convert thermal energy to electrical energy without moving parts and chemical reactions. This will lead to minimal maintenance requirement. In addition to that TEGs are silent devices, simple, reliable and durable. However, these devices have low efficiency and high initial cost. But as the source of energy is cost free, efficiency become not an important factor [28].

The performance of a thermoelectric device is estimated by a dimensionless number known as “figure of merit” (ZT) and calculated as follows:

$$ZT = \frac{\alpha^2}{\rho \cdot k} T \quad (3)$$

where k is the thermal conductivity, ρ is the electric resistance, and T is the temperature and α is the Seebeck coefficient. The

following equations shows the thermal and electrical modelling of a thermoelectric generator or module.

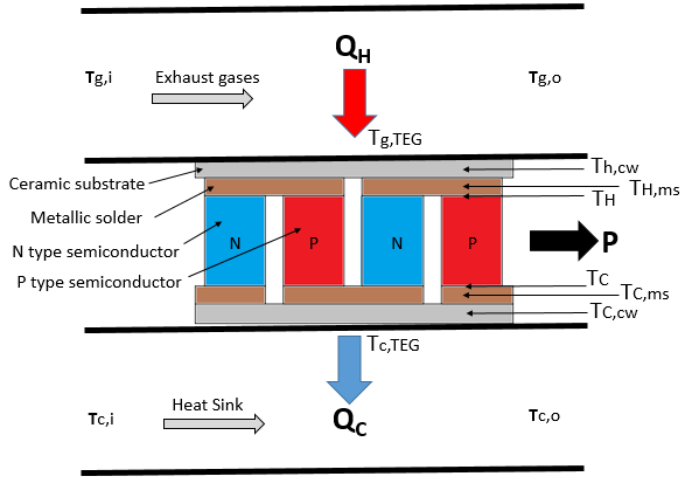

Figure 4. Thermal modeling of TEG.

$$P = Q_H - Q_C \quad (4)$$

$$Q_H = \dot{m}_g \cdot C_{p_g} (T_{g,i} - T_{g,o}) = \frac{T_{g,TEG} - T_H}{R_g + R_{cw} + R_{ms}} \quad (5)$$

$$Q_C = \dot{m}_c \cdot C_{p_c} (T_{c,i} - T_{c,o}) = \frac{T_{c,TEG} - T_C}{R_c + R_{cw} + R_{ms}} \quad (6)$$

where P , Q_H and Q_C are respectively the output power generated, heat rate at hot side and heat rate at cold side. \dot{m}_g , \dot{m}_c and C_{p_g} , C_{p_c} are the mass flow rate and specific heat at constant pressure of the exhaust gases and cooling fluid respectively. $T_{g,i}$, $T_{g,o}$ and $T_{c,o}$, $T_{c,i}$ are the inlet and outlet temperature of exhaust gases and cooling fluid respectively. $T_{g,TEG}$ and $T_{c,TEG}$ are the exhaust gases and cooling fluid temperature at the TEG (Figure 4). R_g is the convection resistance between exhaust gases and TEG while R_c is the convection resistance between TEG and cooling fluid. R_{cw} and R_{ms} are the conduction resistance of ceramic wafer and metallic solder respectively.

The convection and conduction resistances are as follows.

$$R_g = \frac{1}{h_g A} \quad (7)$$

$$R_c = \frac{1}{h_c A} \quad (8)$$

$$R_{cw} = \frac{t_{cw}}{k_{cw} \cdot A_{cw}} \quad (9)$$

$$R_{ms} = \frac{t_{ms}}{k_{ms} \cdot A_{ms}} \quad (10)$$

where h_g and h_c are the convection heat transfer coefficient of exhaust gases and cooling fluid. t_{cw} , k_{cw} , A_{cw} and t_{ms} , k_{ms} , A_{ms} are the thickness, conduction coefficient and area of the ceramic wafer and metallic solder respectively. Then the electrical equations are as follows [29].

$$Q_H = N \left\{ U_{PN} (T_H - T_C) + \alpha \cdot I \cdot T_H - \frac{I \cdot R_i^2}{2} \right\} \quad (11)$$

$$Q_C = N \left\{ U_{PN} (T_H - T_C) + \alpha \cdot I \cdot T_C + \frac{I \cdot R_i^2}{2} \right\} \quad (12)$$

$$P = Q_H - Q_C = N \{ \alpha \cdot I (T_H - T_C) - I \cdot R_i^2 \} \quad (13)$$

$$I = \frac{V_{OC}}{2R_i} = \frac{\alpha (T_H - T_C)}{2R_i} \quad (14)$$

where I is the current, N is the number of semiconductors, R_i is the internal resistance, and U_{PN} is the thermal conductance of TEG (W/K).

The maximum efficiency (η_{max}) of a thermoelectric device sandwiched between hot and cold sides is in function of the figure of merit and the temperature of hot and cold side which is defined as [30]:

$$\eta = \frac{T_H - T_C}{T_H} \frac{\sqrt{1 + ZT} - 1}{\sqrt{1 + ZT} + \frac{T_C}{T_H}} \quad (15)$$

For the energy conversion efficiency (η_c) calculation, it is calculated as the ratio of the generated power over the rate of heat supply.

$$\eta_c = \frac{\text{Power generated}}{\text{Rate of heat in}} = \frac{P}{Q_H} \quad (16)$$

Champier [27] developed a review on thermoelectric generators. It starts by presenting the general principle of TEGs. The present and future materials used for manufacturing the thermoelectric generator are illustrated. In addition, design optimization is viewed. The main applications of the thermoelectric generator were addressed such as space exploration, industrial applications in remote areas, automobiles, aircrafts and helicopters, ships, locomotives, industrial waste heat, sensors, microelectronics and solar systems. The main aim of the writer is to show that whether for industrial or domestic applications, thermoelectricity technology is worth to be studied when a heat moves from heat source to heat sink.

LeBlanc [31] presented a review on TEGs and mainly on thermoelectric materials and material performance that would improve the energy efficiency of TEGs. In order to increase the

efficiency two challenges should be solved which are materials development and system engineering. Those challenges are discussed and a system-level performance way that relies on more than factor is compared to traditional thermoelectric material. Relevant thermo-mechanical and chemical material properties, system components (heat exchangers) and system form factors are studied. In addition, manufacturing steps (shown in figure 5) are provided and the total cost of the system is calculated.

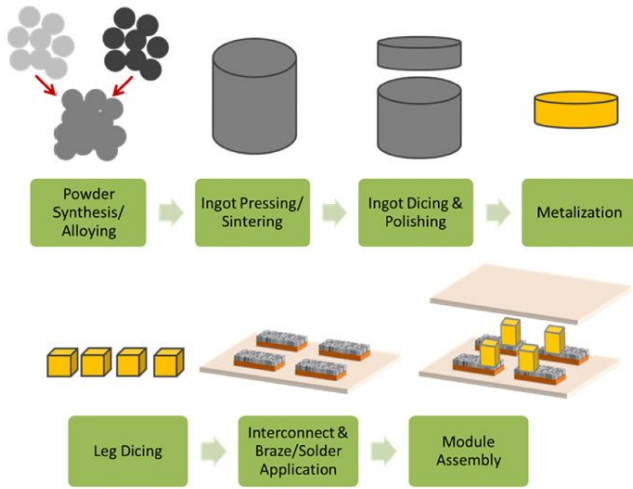
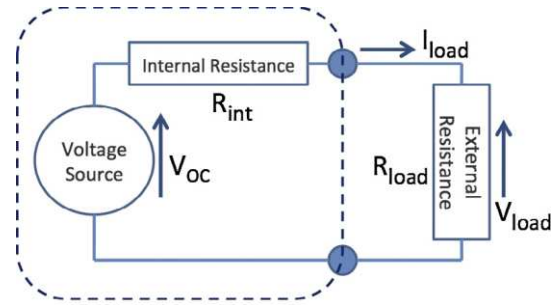

Figure 5. Steps required for manufacturing a standard TEG [31].

Riffat and Ma [32] performed a review on thermoelectrics. The basic knowledge of thermoelectric devices is introduced. Power generation, cooling and thermal energy sensor thermoelectric devices are illustrated. In addition, the applications of these types of thermoelectrics are shown. They can be used in military, aerospace, biology, instruments and industrial or residential applications. Also, TEG technology can be implemented with solar energy known as “solar thermoelectric generation” which combines the solar thermal collector and TEGs.

Montecucco *et al.* [33] conducted experimental and theoretical study on the effect of temperature mismatch across a TEG array electrically connected in series or parallel. When high power is required, several modules of TEG are utilized forming an array. The temperature difference across TEGs varies from one TEG to another on the same TEG array, generating temperature mismatch (thermal imbalance). The way of connecting TEGs are defined by the voltage and current required. Thermoelectric generators can be assembled as a voltage source connected in series with internal resistance (figure 6). The value of the internal resistance and voltage changes as the temperature changes. In order to maximize the power produced by TEGs, the electrical load impedance should be equated with the internal resistance (known as maximum power transfer theorem).



Thermoelectric Generator

Figure 6. Electric assembly of thermoelectric generator [33].

The article presents the ideal and actual conditions when the array is connected in series or parallel (figure 7). Where in ideal cases the modules experience uniform temperature difference and produce same output open circuit voltage. However, in actual conditions for the series connection, the voltage is different between modules (resulted from temperature mismatch) resulting that the open circuit voltage is the summation of the different voltages produced. Then the equations of the voltage and current are as follows.

$$V_{oc} = V_1 + V_2 + V_3 \quad (17)$$

$$I = \frac{V_{oc} - V_s}{R_1 + R_2 + R_3} \quad (18)$$

where V_s is the voltage at the terminals of the array.

Similarly, in actual parallel connection the current generated is different between the modules. Then the equations of the currents are expressed as the following equations.

$$I_1 = \frac{V_1 - V_p}{R_1} \quad (19)$$

$$I_2 = \frac{V_2 - V_p}{R_2} \quad (20)$$

$$I_3 = -I_1 - I_2 \quad (21)$$

where V_p is the voltage at the terminals of the array.

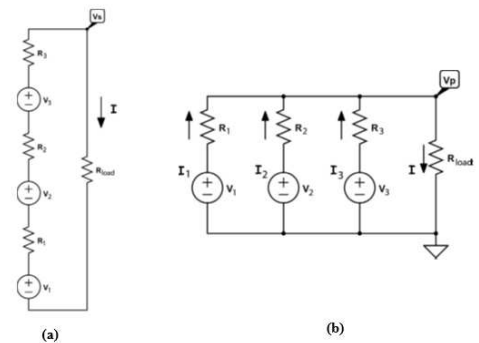

Figure 7. Three TEG electric connections: (a) in parallel; (b) in series [33].

Montecucco *et al.* [34] performed an optimization study in order to increase the power generated, improve the thermodynamic efficiency and minimize the quantity of material used for a limited thermal input power. Analysis for various cases are considered in which the input thermal power is constant and the temperature gradient at the TEG is changed depending on TEG effective thermal resistance. It presents the electrical characteristics for constant heat and studies the relationship between open-circuit voltage and maximum power. In addition, it investigates on the maximum power produced when TEGs with different pellets and size are used. It provides recommendations for optimizing the pellets geometrical parameter.

4. Heat recovery from exhaust gases using TEGs

Power generation by heat recovery from exhaust gases can be obtained directly using thermoelectric generators or indirectly using power cycles. As mentioned above thermoelectric generators provide high advantage by which it can generate electricity from any temperature difference. However, mainly TEG technology is implemented in low and medium temperature exhaust gases while high temperature exhaust gases are driven to generate electricity using ordinary Rankin cycle.

Jaber *et al.* [35] developed a theoretical and experimental studies on heat recovery from exhaust gases of a chimney (figure 8). It aims to study the effect of changing the TEG location on a thermoelectric cogeneration heat recovery system.

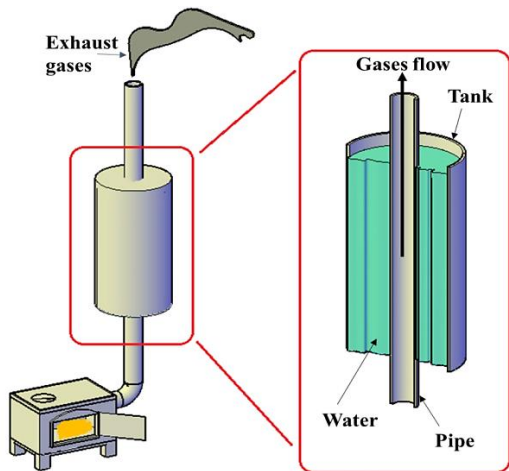

Figure 8. Cogeneration heat recovery system implemented on exhaust gases of a chimney [35].

Six configurations were studied where TEGs are varied from the inner or the outer wall of the tube, the tank or at all walls, or without TEGs as reference. Results show that water can be heated up to 97 °C. In addition, it can generate up to 0.35 W electric power per TEG. Also, it was shown that the system can heat water till 81°C and generate 52 W electric power. An economic and environmental study are carried and shows that

such system can reduce up to 6 tons yearly and the location of TEGs does not highly affect the reduced amount.

Remeli *et al.* [36] performed a theoretical study assisted with experimental results for modelling a heat recovery system that utilizes heated air (to simulate exhaust gases) to generate electricity using thermoelectric generators. Air is forced to flow through a duct using an air blower where it contacts with the condenser part of a heat pipe. Then air is heated using an electric heater to which it passes through the evaporator part of another heat pipe. Between the two heat pipes, thermoelectric modules are connected by which they absorb heat from the condenser part of the second heat pipe and release heat to the evaporator part of the first heat pipe, generating electricity (figure 9). The authors aim to study the theoretical thermal and electrical behavior of the system. Results show that the suggested HP-TEG system can recover about 1.345 kW thermal energy by generating 10.39 W electric power using 8 thermoelectric generators. It was shown that HP-TEG system is an effective heat recovery system aimed for generating electricity.

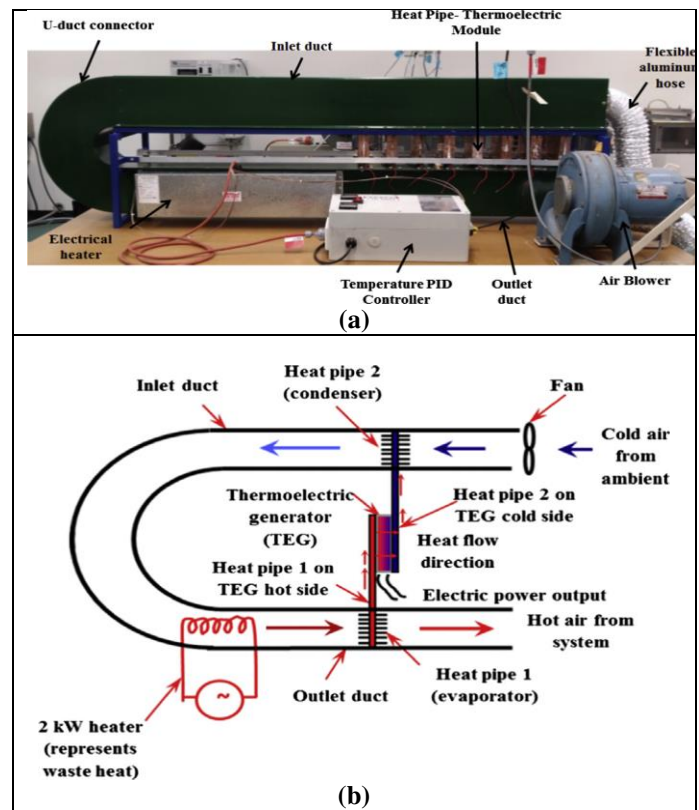

Figure 9. HP-TEG heat recovery system: (a) experimental prototype; (b) schematic [36].

Champier *et al.* [37] did a study of a thermoelectric generator incorporated in a multifunction wood stove. A review on the existing thermoelectric generators coupled with wood stove is presented. A multifunction wood stove is mainly used in rural areas where they suffer lack of electricity. It is used for cooking, heating water for domestic usage and generating electricity (figure 10). Exhaust gases generated from the combustion of

wood are utilized to cook and generate electricity using TEG, knowing that water is utilized as heat sink. The generated electricity can be utilized to charge a phone, light a LED or radio, or run a smoke extraction fan to increase the efficiency of the combustion process by increasing the air to fuel ratio. Experiment is done in order to study the effect of the pressure applied to TEGs on the produced power to show the influence of thermal contact. Results show that a 5-bar compressive load is recommended to minimize thermal losses and increase output power. It was shown that about 9.5 W of electric power is generated with exhaust gases temperature of about 250 °C and 80 °C cold side temperature.

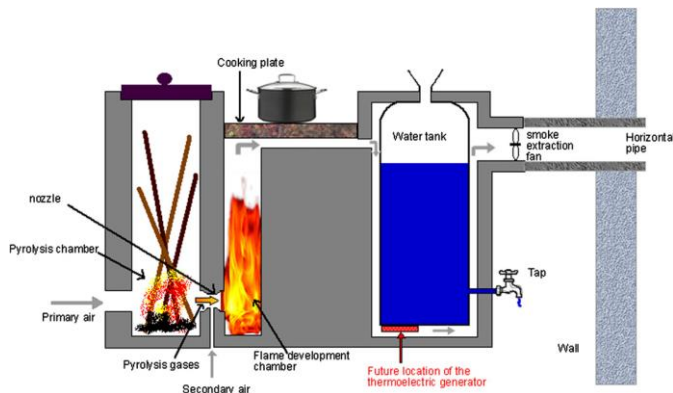

Figure 10. Multifunction wood stove [37].

Orr *et al.* [38] developed a complete review about heat recovery from exhaust gases of the car using thermoelectric generator. It defines the thermoelectric generators and the materials used for TEGs production. In addition, it defines the heat pipe by which it is used to reduce the thermal resistance between TEGs and gases. Also, it may reduce pressure drop and allow for more flexible design. Moreover, heat pipes can be used to regulate the hot side temperature using the “Variable conductance heat pipe (VCHP)” (figure 11). VCHP operates in the same way as typical HP but it maintains steady operation temperature.

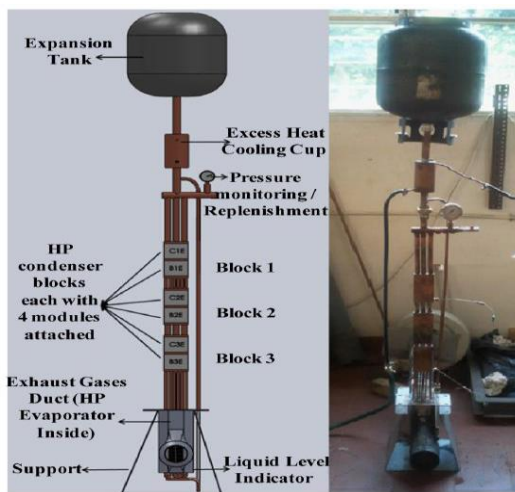

Figure 11. TEG hot side temperature regulator (VCHP) [38].

However, heat pipes are limited to have a maximum rate of heat transfer and working temperature range. Then, the review presents the existing heat recovery systems from exhaust gases of cars using TEGs. Mainly TEGs are located at the exhaust pipe surface and cooled by engine coolant. Figure 12 shows a Honda prototype heat recovery system using TEGs. The recovery system is made up of a simple rectangular box with TEGs located on the top and bottom sides. It consists of 32 TEGs and produce maximum power of 500 W with a 3% fuel consumption reduction.

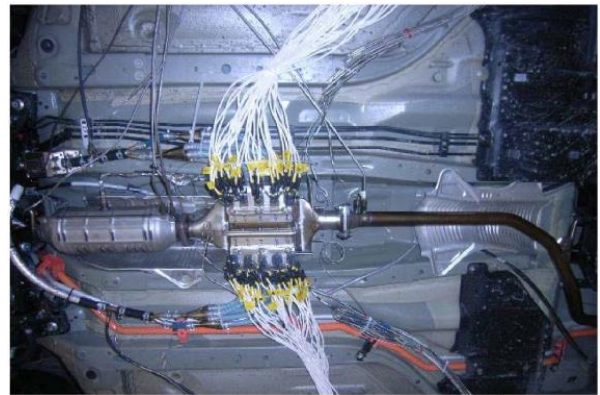

Figure 12. Heat recovery from exhaust gases of a Honda car using TEGs [38].

Orr *et al.* [39] described an experimental study done on combined heat pipe and thermoelectric heat recovery system. Exhaust gases of a 3.0L V6 engine car have been utilized (figure 13). 38 TEGs (62 mm x 62 mm) were connected to recover the dissipated thermal energy. 1541 W of thermal energy is recovered generating 38 W electric power. The TEG efficiency is 2.46%. Moreover, about 1.57% reduction in CO₂ emissions, fuel consumption and fuel cost were achieved.



Figure 13. Prototype of combined HP-TEG heat recovery system [39].

Table 2 shows the main studies carried on heat recovery from exhaust gases using thermoelectric generators and published in Elsevier journals. It shows the main studies conducted in last few years. By presenting the journal name, year of publication and title the papers are described. The type of study is included with the source of exhaust gases, and the main conducted outcomes are summarized.

Table 2. Studies on heat recovery from exhaust gases using TEGs published in Elsevier.

Reference Year Journal name	Title	Type of study	Source	Main outcomes
Champier et al. [37] 2011 Energy	Study of a TE (thermoelectric) generator incorporated in a multifunction wood stove	Experimental Modelling	Wood stove	<ul style="list-style-type: none"> ➤ Review on the existing stove-powered thermoelectric generators ➤ Performance of the generator mainly depends on the heat transfer through the modules and particularly on the thermal contact resistances ➤ Influence of thermal contact is shown ➤ 9.5 W electric power is generated
Gao et al. [40] 2012 International Journal of Hydrogen Energy	Numerical model of a thermoelectric generator with compact plate-fin heat exchanger for high temperature PEM fuel cell exhaust heat recovery	Numerical (Finite element analysis)	PEM fuel cell exhaust heat recovery	<ul style="list-style-type: none"> ➤ Numerical model of an exhaust heat recovery system for a high temperature polymer electrolyte membrane fuel cell stack
Shu et al. [41] 2012 Energy	Parametric and exergetic analysis of waste heat recovery system based on thermoelectric generator and organic Rankine cycle utilizing R123	Parametric Exergy analysis	Internal combustion engines	<ul style="list-style-type: none"> ➤ Theoretical study on combined TEG-ORC heat recovery system applied on exhaust gases of ICE ➤ Marked increase on system performance when TEG and internal heat exchanger are combined with ORC bottoming cycle ➤ TEG can extend the temperature range of heat source and thus enhance the security and fuel economy of engines
Gao et al. [42] 2012 International Journal of Hydrogen Energy	Optimization of a thermoelectric generator subsystem for high temperature PEM fuel cell exhaust heat recovery	Numerical	PEM fuel cell exhaust heat recovery	<ul style="list-style-type: none"> ➤ Optimization of the configuration of the TEG exhaust heat recovery subsystem ➤ Balanced between the subsystem performance and complexity, 3-branch scenario is chosen that increases the subsystem power output by 12.9%.
Jang et al. [43] 2013 Applied Thermal Engineering	Optimization of thermoelectric generator module spacing and spreader thickness used in a waste heat recovery system	Numerical Experimental	Exhaust gases of chimney	<ul style="list-style-type: none"> ➤ 3D numerical model of a TEG module used in a waste heat recovery system ➤ Effects of temperature difference and waste gases heat transfer coefficients on the performance of the recovery process ➤ Investigation on optimizing a TEG module spacing and its spreader thickness
Hatami et al. [44] 2014 Renewable and Sustainable Energy Reviews	A review of different heat exchangers designs for increasing the diesel exhaust waste heat recovery	Review	Diesel engine	<ul style="list-style-type: none"> ➤ Review on waste heat recovery from exhaust gases of engine ➤ Heat exchangers have a crucial role on recovering process ➤ Organic Rankin cycle, thermoelectric generator, turbocharging, exhaust gas recirculation and engine heat exchangers are the main technologies for energy recovery
Bai et al. [45] 2014 Case Studies in Thermal Engineering	Numerical and experimental analysis for exhaust heat exchangers in automobile thermoelectric generators	Numerical Experimental	Automobile exhaust	<ul style="list-style-type: none"> ➤ Development of computational fluid dynamics of six different heat exchangers with same shell in order to compare heat transfer and pressure drop for an ordinary driving cycle with 1.2 liters gasoline engine ➤ Serial plate structure enhanced heat transfer by 7 baffles, transferred the maximum heat of 1737 W and produced a pressure drop of 9.5 kPa ➤ Inclined plate and empty cavity structure experience a 80 kPa pressure drop at maximum power output condition

Orr et al. [46] 2014 Applied Thermal Engineering	Electricity generation from an exhaust heat recovery system utilizing thermoelectric cells and heat pipes	Experimental	Internal combustion engine	<ul style="list-style-type: none"> ➤ 8 TEGs were used and managed to produce 6.03 W when charging the battery ➤ 1.43% energy conversion efficiency of TEG ➤ 6.03 W electric power produced
Wang et al. [47] 2014 Applied Energy	Waste heat recovery through plate heat exchanger based thermoelectric generator system	Experimental	Low grade waste heat source	<ul style="list-style-type: none"> ➤ Experimental study on open-cell metal foam-filled plate heat exchanger based thermoelectric generator system ➤ 83.6% heat exchanger efficiency between heated air and cold water ➤ Maximum temperature difference between two adjacent layers is 13.8 °C ➤ 108.1 mV maximum open circuit voltage generated from 16 thermoelectric generators
Stevens et al. [48] 2014 Applied Energy	Theoretical limits of thermoelectric power generation from exhaust gases	Theoretical modelling	Exhaust gases	<ul style="list-style-type: none"> ➤ Optimization of thermal system using variational method ➤ Comparison between four modelling approaches for thermoelectric optimization
Wang et al. [49] 2014 Energy Conversion and Management	Simulation and evaluation of a CCHP system with exhaust gas deep-recovery and thermoelectric generator	Modelling Parametric	Internal combustion engines	<ul style="list-style-type: none"> ➤ Study on a combined cooling, heating and power system based on internal combustion engine for power generation, refrigeration and domestic hot water production. ➤ Primary energy efficiency of system can reach 0.944 ➤ 0.304 primary energy saving ratio can be reached ➤ 0.417 cost saving ratio can be reached ➤ 11.1% total investment increment
Niu et al. [50] 2014 Energy Conversion and Management	Investigation and design optimization of exhaust-based thermoelectric generator system for internal combustion engine	Numerical Parametric	Internal combustion engines	<ul style="list-style-type: none"> ➤ 3D numerical model for engine exhaust-based thermoelectric generator system is carried ➤ Increasing the number of exhaust channels may improve the performance but the cost and area of the system will increase ➤ Locating bafflers at the channel inlet might increase the heat transfer coefficient for the whole channel ➤ Bafflers angle affect the utilization of exhaust gases, but they increase the pressure drop ➤ Making the number of exhaust channels and baffler angle adjustable (according to engine operating conditions) would enhance the performance
Massaguer et al. [51] 2015 Applied Energy	Modeling analysis of longitudinal thermoelectric energy harvester in low temperature waste heat recovery applications	Modelling Numerical (TRNSYS) Experimental	Low temperature waste heat recovery sources	<ul style="list-style-type: none"> ➤ TRNSYS model of thermoelectric energy harvester ➤ 0.162 W maximum power generated ➤ 0.46% efficiency of TEG ➤ Normalized root mean square errors are 0.67%, 0.5% and 0.894% respectively
Yu et al. [52] 2015 Applied Energy	Start-up modes of thermoelectric generator based on vehicle exhaust waste heat recovery	Modelling Parametric	Vehicles Internal combustion engine	<ul style="list-style-type: none"> ➤ Transient behavior in different start-up modes is studied ➤ For various start-up currents, the durations to achieve steady power are similar
Date et al. [53] 2015 Renewable Energy	Performance review of a novel combined thermoelectric power generation and water desalination system	Modelling	Low grade thermal energy sources	<ul style="list-style-type: none"> ➤ Utilization of low-grade thermal energy to heat thermoelectric generator for electric power generation and water desalination ➤ Heat flux for a TEG with a 250 °C cell failure temperature could be increased by minimizing the pressure in the saline water tank ➤ Specific energy consumption for water distillation is about 1.5 kWh/kg

Aranguren et al. [54] 2015 Applied Energy	Experimental investigation of the applicability of a thermoelectric generator to recover waste heat from a combustion chamber	Experimental Modelling	Simulated combustion chamber	<ul style="list-style-type: none"> ➤ Experimental study of different variables under real conditions of a thermoelectric heat recovery system ➤ 48 thermoelectric generators produced 21.56W of net energy covering 0.25 m² ➤ Heat pipes outperform the conventional finned dissipators by 43% increase in power ➤ 2.2% thermoelectric efficiency
He et al. [55] 2015 Energy	Optimization design method of thermoelectric generator based on exhaust gas parameters for recovery of engine waste heat	Numerical	Internal combustion engine	<ul style="list-style-type: none"> ➤ Mathematical study on the effect of temperature gradient on thermoelectric heat recovery system ➤ Optimum module areas were found to be highly affected by the mass flow rate of the exhaust gas ➤ Study the effect of the fluctuation in exhaust gases parameters on the performances ➤ Results show that optimal design area is 0.22 m² (co-flow) and 0.3 m² (counter-flow) ➤ Optimal area produced a maximum deviation of about 6% for co-flow and 2% for counter flow from the peak power output ➤ Counter flow arrangement is recommended since it keeps a smaller deviation
Barma et al. [56] 2015 Energy Conversion and Management	Estimation of thermoelectric power generation by recovering waste heat from Biomass fired thermal oil heater	Modelling	Industrial thermal oil heater (biomass)	<ul style="list-style-type: none"> ➤ 3.7 W electric power generated using a Bi₂Te₃ TEG module ➤ 4.4 W electric power generated using a p-type (Bi,Sb)₂Te₃ and Bi₂Te₃ n-type TEG ➤ 19% improvement between two cases ➤ 181 kWh/year is estimated to be generated by the proposed TEG ➤ 8.18% enhancement on the thermal efficiency could be achieved based on recent development
Liu et al. [57] 2015 Energy Conversion and Management	Performance analysis of a waste heat recovery thermoelectric generation system for automotive application	Performance analysis Parametric	Automotive applications	<ul style="list-style-type: none"> ➤ Test the performance of Bi₂Te₃-based TEG system ➤ 183 kW maximum electric power is generated at 235 °C temperature difference ➤ System efficiency is improved from 1.28% to 1.85%
Remeli et al. [58] 2015 Energy Conversion and Management	Simultaneous power generation and heat recovery using a heat pipe assisted thermoelectric generator system	Experimental Theoretical modelling	Simulated combustion chamber	<ul style="list-style-type: none"> ➤ 2069 kW maximum output power ➤ 10.93% maximum system efficiency ➤ 58.77% exergy efficiency ➤ 2.824% improvement in propulsion efficiency ➤ 6.06% reduction in the specific fuel oil consumption and specific CO₂ emissions
Lu et al. [59] 2015 Applied Thermal Engineering	Effects of heat enhancement for exhaust heat exchanger on the performance of thermoelectric generator	Numerical Parametric	Vehicles Internal combustion engine	<ul style="list-style-type: none"> ➤ Study the effects of heat transfer enhancement on the TEG net power produced ➤ Foam with low porosity and small pore density can increase the total power output and the efficiency of the TEG ➤ Metal foams produce a high pressure drop and a low net power output which can be solved by utilizing a TEG with catalytic conversion
Zhang et al. [60] 2015 Energy Conversion and Management	High-temperature and high-power-density nanostructured thermoelectric generator for automotive waste heat recovery	Numerical Parametric	Automotive applications	<ul style="list-style-type: none"> ➤ 2.1% energy conversion efficiency with 550 °C hot side temperature and 339 °C temperature difference ➤ Unicouple device produces a high-power density (5.26 W/cm²) with a 500 °C temperature difference ➤ About 1 kW electric power generated by TEGs at 480 g/s of exhaust gases

Ma et al. [61] 2015 Applied Thermal Engineering	Waste heat recovery using a thermoelectric power generation system in a biomass gasifier	Experimental Modelling	Biomass gasifier	<ul style="list-style-type: none"> ➤ Thermoelectric power generation heat recovery system from biomass gasifier ➤ 193.1 W/m² maximum power density can be reached by the system ➤ 6.1 W maximum power produced by TEG ➤ 10.9 % maximum energy conversion efficiency at 505 K temperature difference ➤ 2.8 % minimum conversion efficiency at 75 K temperature difference
Remeli et al [62] 2015 Energy Procedia	Passive heat recovery system using combination of heat pipe and thermoelectric generator	Experimental Theoretical	Simulated combustion chamber	<ul style="list-style-type: none"> ➤ Experimental study on combined heat pipe and thermoelectric generator heat recovery system ➤ Effectiveness of the heat exchanger increased from 67.9% to 72.4% with an increase of air face velocity
Montecucco et al [63] 2015 Applied Energy	Combined heat and power system for stoves with thermoelectric generators	Experimental	Solid fuel stove	<ul style="list-style-type: none"> ➤ Experimental study on solid-fuel stove heat recovery system using TEG to charge a lead-acid battery and transfer heat to water for cogeneration process ➤ 600 W thermal energy is recovered during 2 hours ➤ 27 W average electrical energy generated (42 W at the peak) during 2 hours ➤ 5% TEG efficiency
Rahman et al. [64] 2015 Renewable and Sustainable Energy Reviews	Power generation from waste of IC engines	Review	Internal combustion engines	<ul style="list-style-type: none"> ➤ Innovative approach on power generation from waste of IC engine using coolant and exhaust gases. ➤ Waste energy harvesting system of coolant is used to heat air to about 60–70 °C ➤ Power generated by TEGs could reduce the load of the alternator by 10% ➤ Specific fuel consumption of engine has been improved by 3% ➤ Brake power is increased by 7% resulted from heating air to 70 °C
Arsie et al. [65] 2015 Energy Procedia	Modeling analysis of waste heat recovery via thermo-electric generator and electric turbo-compound for CO ₂ reduction in automotive SI engines	Numerical	Internal combustion engine	<ul style="list-style-type: none"> ➤ Study the integration of TEG and electric turbo-compound systems in a compact car powered by a SI engine ➤ Application of both TEG and ETC can lead to a CO₂ emissions reduction ranging from 5.6 % to 6.6 % for the analyzed standard driving cycles
Tian et al. [66] 2015 Energy Procedia	Comparison of segmented and traditional thermoelectric generator for waste heat recovery of diesel engine	Numerical Parametric	Diesel engine	<ul style="list-style-type: none"> ➤ Comparison using mathematical modelling between Bismuth Telluride (traditional) and Skutterudite (segmented) under different conditions (heat and cold source temperature, heat transfer coefficient, length and cross section area of thermocouple) ➤ Maximum output power and energy conversion efficiency of segmented TEG are higher significantly using exhaust of diesel engine as heat source and coolant as cold source ➤ Trends of maximum output power and conversion efficiency are inversely proportional with increment of thermocouple length ➤ Segmented TEG has a more potential to recover waste heat than tradition TEG

Orr et al. [39] 2015 Applied Thermal Engineering	A review of car waste heat recovery systems utilising thermoelectric generators and heat pipes	Review	Vehicles	<ul style="list-style-type: none"> ➤ Review on heat recovery from exhaust gases of cars using TEGs assisted by heat pipes ➤ TEGs and heat pipes are solid state, passive, silent, scalable and durable ➤ Heat pipes minimize the thermal resistance between the TEG and gases ➤ Heat pipes can be used for temperature regulation of the TEGs (Variable conductance heat pipe) ➤ Heat pipes have disadvantages such as maximum rates of heat transfer and working temperature ranges
Tang et al. [67] 2015 Case Studies in Thermal Engineering	A research on thermoelectric generator's electrical performance under temperature mismatch conditions for automotive waste heat recovery system	Experimental	Automotive	<ul style="list-style-type: none"> ➤ Study on the electrical performance of a TEM under mismatch conditions (limited working temperature and unequal temperature distribution among a series connected module) ➤ Suitable mechanical pressure applied on the module enhances the electrical performance ➤ Significant power loss in series connection modules (11% less than the theoretical maximum power)
Remeli et al. [68] 2015 Energy Procedia	Power generation from waste heat using Heat Pipe and Thermoelectric Generator	Experimental	Industrial heat recovery	<ul style="list-style-type: none"> ➤ Study on power generation using combined heat pipe and thermoelectric heat recovery system ➤ An increase in the ratio of mass flow rate in upper duct to lower duct improves the overall system performance ➤ Higher mass flow rate ratio results in a higher amount of heat transfer and higher power generated
Liu et al. [69] 2015 Journal of the Energy Institute	An experimental study of a novel prototype for two-stage thermoelectric generator from vehicle exhaust	Thermal modelling Experimental	Vehicle	<ul style="list-style-type: none"> ➤ Unfamiliar prototype for two-stage TEG from vehicle exhaust has been suggested. ➤ Maximum power generated by TEGs is 250 W with 473 K hot side temperature ➤ System thermal efficiency reaches 5.35% (improved by 32% compared to single stage TEG system at same conditions) ➤ 4.55 years payback period of the heat recovery system
In et al. [70] 2015 International Journal of Heat and Mass Transfer	The study of a thermoelectric generator with various thermal conditions of exhaust gas from a diesel engine	Thermal modelling Experimental Parametric	Diesel engine	<ul style="list-style-type: none"> ➤ Higher power generated when a rectangular pillar heat sink was used followed by a triangular prism heat sink ➤ 6.2 W electric power generated by TEG from rectangular pillar heat sink ➤ 5.5 W electric power generated by TEG from triangular prism heat sink ➤ Performance of the TEG is improved by increasing the hot side temperature
Gao et al. [71] 2016 Applied Thermal Engineering	Development of stove-powered thermoelectric generators: A review	Review	Stoves	<ul style="list-style-type: none"> ➤ Review on stove-powered thermoelectric generators ➤ Types of cooling systems are summarized (air cooled natural and forced convection and water cooled natural and forced convection systems) ➤ Cooling system design should be coupled with the heating equipment for space heating or hot water ➤ Structure and thermal resistance of the hot side are critical

Remeli et al. [72] 2016 Energy Conversion and Management	Experimental investigation of combined heat recovery and power generation using a heat pipe assisted thermoelectric generator system	Experimental Modelling	Industrial heat recovery (simulated by heating air)	<ul style="list-style-type: none"> ➤ Lab scale bench-top prototype of waste heat recovery and electricity conversion system is designed ➤ Waste gases were simulated by heating air using 2 kW electric heater ➤ Highest heat exchanger effectiveness (41%) is achieved at a 1.1 m/s air speed ➤ System could recover around 1079 W of heat and produce around 7 W of electric power ➤ 0.7% energy conversion efficiency of the TEG
He et al [73] 2016 Applied Energy	Influence of different cooling methods on thermoelectric performance of an engine exhaust gas waste heat recovery system	Numerical	Internal combustion engine	<ul style="list-style-type: none"> ➤ Comparison of different cooling methods for a thermoelectric generator (TEG) ➤ Water cooling do not need to be defined by co-flow and counter-flow methods ➤ Higher power output per module area produced for co-flow compared to counter-flow ➤ Optimal module area is determined by the gas mass flow rate (not the temperature)
Demir et al. [74] 2016 Applied Thermal Engineering	Performance assessment of a thermoelectric generator applied to exhaust waste heat recovery	Numerical	Automobile exhaust	<ul style="list-style-type: none"> ➤ $GdCO_{0.95}Ni_{0.05}O_3$ reflects better thermoelectric performance than $La_{1.98}Sr_{0.02}CuO_4$ ➤ Highest energy and exergy efficiency are 0.61% and 0.9% respectively ➤ An increase by 280% on the efficiency was achieved by utilizing $GdCO_{0.95}Ni_{0.05}O_3$ as p-type thermoelectric material instead of $La_{1.98}Sr_{0.02}CuO_4$
Orr et al. [75] 2016 Applied Thermal Engineering	An exhaust heat recovery system utilizing thermoelectric generators and heat pipes	Experimental	Vehicles	<ul style="list-style-type: none"> ➤ Testing was done on a 3.0 L V6 engine car ➤ Maximum power output generated by 8 TEGs is 38 W ➤ 2.46% TEG efficiency ➤ 1.57% reduction in CO_2 emissions, fuel consumption and fuel cost
Meng et al. [76] 2016 Energy Conversion and Management	Performance investigation and design optimization of a thermoelectric generator applied in automobile exhaust waste heat recovery	Mathematical modelling	Automobile exhaust	<ul style="list-style-type: none"> ➤ Counter flow cooling pattern is recommended (reduces the temperature non-uniformity effectively, which ensures system reliability) ➤ For fixed exhaust channel length, the maximum output power of the system can be enhanced by increasing the thermoelectric unit number
He et al. [77] 2016 Energy Procedia	Optimal heat exchanger dimensional analysis under different automobile exhaust temperatures for thermoelectric generator system	Mathematical modelling	Automobile exhaust	<ul style="list-style-type: none"> ➤ For 300-600 °C exhaust gases temperature, $h_{opt}=4$ mm ➤ The higher the exhaust temperature, the greater the exchanger length and smaller the exchanger width (optimal exchanger height is taken)
Stobart et al. [78] 2016 Applied Thermal Engineering	Comprehensive analysis of thermoelectric generation systems for automotive applications	Numerical (Computational Fluid Dynamics) Experimental	Automotive applications	<ul style="list-style-type: none"> ➤ A baseline, open pipe heat exchange design was represented using a CFD code and tested experimentally ➤ 10% agreement between the experiment and simulation
He et al. [79] 2016 Energy Conversion and Management	Structural size optimization on an exhaust exchanger based on the fluid heat transfer and flow resistance characteristics applied to an automotive thermoelectric generator	Mathematical modelling	Automotive applications	<ul style="list-style-type: none"> ➤ Study on the relationship between the heat exchanger scales, heat transfer and flow resistance characteristics and TEG performance ➤ 0.0056 m² is the optimal cross section area to generate the maximum net power with 0.005 m optimal height and 0.56 m length

Kim et al. [80] 2016 Energy Conversion and Management	Waste heat recovery of a diesel engine using a thermoelectric generator equipped with customized thermoelectric modules	Experimental	Diesel engine	<ul style="list-style-type: none"> ➤ Exhaust gases of six-cylinder diesel engine are used as heat source and water at 293 K temperature of 8 SLPM (flow rate) is utilized as coolant of the TEG ➤ Generated output power increases with the increase on the load and speed of the engine ➤ Maximum output power obtained is 119 W at 2000 rpm ➤ 2.8% conversion efficiency is achieved ➤ Experimental pressure drop was found to be between 0.45 and 1.46 kPa
Temizer et al. [81] 2016 Renewable and Sustainable Energy Reviews	The performance and analysis of the thermoelectric generator system used in diesel engines	Review Mathematical modelling ANSYS Fluent (CFD) Experimental	Diesel engine	<ul style="list-style-type: none"> ➤ Study heat recovery from diesel engine at different speed and load ➤ Maximum current and voltage have been obtained as a result of working under 100 N.m load and 3500 1/min speed ➤ Maximum power generated by TEGs was 157 W
Huang et al. [82] 2016 Energy Conversion and Management	Optimization of a waste heat recovery system with thermoelectric generators by three-dimensional thermal resistance analysis	Thermal modelling (3D thermal resistance) Numerical simulation (FloTHERM) Experimental	Combustion chamber	<ul style="list-style-type: none"> ➤ 3D thermal resistance modelling, numerical simulation and experiment were done to study and optimize TEG heat recovery system ➤ Numerical solution matched the solution of the 3D thermal resistance analysis within 6%
Cao et al. [83] 2017 Applied Thermal Engineering	Performance enhancement of heat pipes assisted thermoelectric generator for automobile exhaust heat recovery	Experimental	Automobile exhaust	<ul style="list-style-type: none"> ➤ Power generated by HP-TEG recommend high exhaust gases temperature, cold water flow rate and mass flow rate ➤ 81.09 V can maximally be achieved as open circuit voltage by 36 TEG ➤ 2.58% optimized thermoelectric power generation efficiency of the HP-TEG
Meng et al. [84] 2017 Energy	Thermoelectric generator for industrial gas phase waste heat recovery	Numerical Parametric	Industrial heat recovery	<ul style="list-style-type: none"> ➤ Exhaust gas inlet temperature and transfer coefficient have significant effects on the optimal thermoelectric element length ➤ At 350 °C of exhaust gases, about 1.47 kW electrical energy can be produced per square meter ➤ 4.5% energy conversion efficiency can be attained ➤ 4 years as a payback period
He et al. [85] 2017 Energy Conversion and Management	Peak power evaluation and optimal dimension design of exhaust heat exchanger for different gas parameters in automobile thermoelectric generator	Numerical (Finite element analysis)	Automobile exhaust	<ul style="list-style-type: none"> ➤ The maximum recovered power per unit mass increases with increasing exhaust temperature ➤ Optimal exchanger plate area increases linearly with increasing exhaust mass flow rate, but not affected by the exhaust temperature
Orr et al. [86] 2017 Energy Procedia	Prospects of waste heat recovery and power generation using thermoelectric generators	Theoretical modelling	Car engine	<ul style="list-style-type: none"> ➤ About 1.4 kW of electricity is generated from a car exhaust heat recovery system if the engine produces 150 kW ➤ About 5.9 MW of electricity is generated from a 500 MW gas turbine power plant waste heat recovery system ➤ In both cases only 0.59% of the waste heat is converted into electricity

Vale et al. [87] 2017 Energy Conversion and Management	Parametric study of a thermoelectric generator system for exhaust gas energy recovery in diesel road freight transportation	Parametric	Diesel vehicles used in road freight transportation	<ul style="list-style-type: none"> ➤ Plain fins are the better choice compared to offset strip fins ➤ Using plain fins, a maximum electrical power of 188 W for the commercial vehicle and 886 W for the heavy-duty vehicle is generated ➤ Best recovery efficiency is 2% for light duty vehicles
Zhao et al. [88] 2017 Energy Procedia	Performance analysis of wet flue-gas thermoelectric generator	Mathematical simulation	Flue gases of natural gases, biomass fuel and domestic water boilers	<ul style="list-style-type: none"> ➤ For a fixed mass flow and gases temperature of 150°C, the maximum output power of the wet flue gas with humidity of 30% is approximately 5.8 times that of the dry flue gas ➤ Maximum output power can be increased with the increase of both the humidity and the flue gas temperature
Lu et al. [89] 2017 Energy Conversion and Management	Experimental investigation on thermoelectric generator with non-uniform hot-side heat exchanger for waste heat recovery	Experimental	Simulated exhaust gases (hot air)	<ul style="list-style-type: none"> ➤ Denser fins are utilized on the hot-side heat exchanger to enhance the uniformity of temperature field which improve total power output performance of thermoelectric generators ➤ Power output of non-uniform heat exchanger under matched load resistance is 46.4% greater than the uniform heat exchanger ➤ Net power output of non-uniform heat exchanger is 55.1% greater than the uniform heat exchanger
Demir et al. [90] 2017 International Journal of Heat and Mass Transfer	Development and heat transfer analysis of a new heat recovery system with thermoelectric generator	Numerical	Passenger car	<ul style="list-style-type: none"> ➤ 90% increase in power generated can be achieved by increasing the temperature and mass flow rate of exhaust gases ➤ The heat transfer rate increased by 33.8% when the TEG size is increased by 66.7% (52.5% decrease on the overall heat transfer coefficient)
Aranguren et al. [91] 2017 Energy Conversion and Management	Thermoelectric generators for waste heat harvesting: A computational and experimental approach	Experimental Computational	Exhaust gases of diesel combustor	<ul style="list-style-type: none"> ➤ Prototype gives a 65% reduction in the generation of the two levels of the thermoelectric generator resulted from the temperature loss of the flue gases ➤ 24.59 W output power generated at 560 °C exhaust gases temperature and 170 kg/h flow rate
Kim et al. [92] 2017 Energy	Assessment of the energy recovery potential of a thermoelectric generator system for passenger vehicles under various drive cycles	Transient simulation	Passenger vehicles	<ul style="list-style-type: none"> ➤ 1D simulation model for 40 TEGs heat recovery system ➤ Depending on the drive cycles, TEG system contributed to power increases ranging from 1.54 to 1.68%
Kim et al. [93] 2017 Energy Conversion and Management	Experimental and numerical study of waste heat recovery characteristics of direct contact thermoelectric generator	Experimental Numerical	Diesel engine	<ul style="list-style-type: none"> ➤ 12-45 W output power generated by TEGs for engine operating conditions at 1700 – 2300 rpm respectively ➤ About 0.25% increase in the energy conversion efficiency is achieved by decreasing the coolant temperature by 10 K ➤ Heat recovery efficiency of TEG system is ranged between 5.7 to 11% ➤ 700 Pa pressure drop generated at 322 kg/h mass flow rate of exhaust gases
Li et al. [94] 2017 Applied Energy	Heat transfer enhancement of a modularised thermoelectric power generator for passenger vehicles	Mathematical modelling	Passenger vehicles	<ul style="list-style-type: none"> ➤ Heat pipe-assisted heat enhancement method enhance the TEG performance ➤ Electric power generated by TEGs is highly dependent on the heat transfer enhancement

Li et al. [95] 2017 Energy Procedia	Experimental study on the influence of the core flow heat transfer enhancement on the performance of thermoelectric generator	Experimental	Automobile exhaust gas	<ul style="list-style-type: none"> ➤ Foam metal increased the convection heat transfer coefficient between exhaust gases and TEG five times from 20 to 100 W/(m²K) ➤ Output power generated is improved by 80% and 140% when the filling ratio of metal foam was 50 and 75% respectively ➤ Pressure drop increases by 3 and 10 times when the filling ratio of metal foam was 50 and 75% respectively
He et al. [96] 2017 Applied Energy	High net power output analysis with changes in exhaust temperature in a thermoelectric generator system	Mathematical modelling	Automotive exhaust gases	<ul style="list-style-type: none"> ➤ Peak net power generated at same optimal height (0.004 m) ➤ At same height, the increase in exhaust gases temperature leads to increase in heat exchanger length, decrease in the optimal exchanger width, decrease in the optimal cross-sectional area, and decrease in the TEG module area
Kim et al. [97] 2017 Energy	Experimental study of energy utilization effectiveness of thermoelectric generator on diesel engine	Experimental	Diesel engine	<ul style="list-style-type: none"> ➤ 10 K decrease in coolant temperature increases the output power by 33.7 % with 34.8% improvement on the energy conversion efficiency ➤ 125 W maximum power was generated at a 3% conversion efficiency ➤ Changing the coolant flow rate has a low influence on the power generated ➤ About 37.4% to 47.1% of exhaust gases energy is lost to environment
Jaber et al. [35] 2018 Applied Thermal Engineering	Domestic thermoelectric cogeneration system optimization analysis, energy consumption and CO ₂ emissions reduction	Theoretical Experimental	Domestic chimney	<ul style="list-style-type: none"> ➤ Domestic thermoelectric cogeneration system is suggested ➤ Optimization analysis is carried out using the thermal modeling ➤ Study the effect of changing the TEG location on the performance of the heat recovery system ➤ When TEGs are located at the pipe inner wall, the concept is the most cost effective ➤ Power generated by one TEG in direct contact with the exhaust gases is 0.35W and the water temperature is 76 °C ➤ When TEGs are located on the inner wall of the pipe, the system has a payback period of 1 year and 8 months with water being heated 60 times per month
Mostafavi et al. [98] 2018 Applied Thermal Engineering	Modeling and fabricating a prototype of a thermoelectric generator system of heat energy recovery from hot exhaust gases and evaluating the effects of important system parameters	Thermal Modelling Experimental	Smokestack	<ul style="list-style-type: none"> ➤ Thermoelectric module with a low thermal conductivity is more effective ➤ System efficiency could be enhanced by using liquids on the cold and hot side of TEG ➤ Thermal conductivity of the heat sinks does not affect the efficiency
Nithyanandam et al. [99] 2018 International Journal of Heat and Mass Transfer	Evaluation of metal foam based thermoelectric generators for automobile waste heat recovery	Numerical	Automobile exhaust	<ul style="list-style-type: none"> ➤ Maximum net electric power generated from exhaust waste heat by metal foam enhanced TEG is 5.7 to 7.8 times higher than that generated by the configuration without metal foam

Lan et al. [100] 2018 Applied Energy	A dynamic model for thermoelectric generator applied to vehicle waste heat recovery	Theoretical Experimental	Vehicles	<ul style="list-style-type: none"> ➤ Steady-state measurement is performed in TEM test rig and both steady-state and transient measurements are conducted on a diesel engine ➤ Power output generated for a TEG with 20 TEMs produces about 170–224 W electric power ➤ 25.8% enhancement on the generated power is achieved by optimizing the thermal contact conductance and the convection heat transfer coefficient on the hot and cold sides of the TEG module
Muralidhar et al. [101] 2018 Energy	Modeling of a hybrid electric heavy duty vehicle to assess energy recovery using a Thermoelectric Generator	Theoretical modelling Matlab /simulink architecture	Heavy duty vehicles	<ul style="list-style-type: none"> ➤ When using Skutterudite and SiGe-based thermoelectric generator a fuel saving of 7.2% and 6.5% can be achieved respectively ➤ Skutterudite-based system has a mean thermal efficiency of 6.99% and a fuel economy of 38.33 L/100km ➤ SiGe-based TEG has a mean thermal efficiency of about 5% and a fuel economy of 38.6 L/100km
Fernandez-Yanez et al. [102] 2018 Journal of Cleaner Production	Evaluating thermoelectric modules in diesel exhaust systems: potential under urban and extra-urban driving conditions	Mathematical simulation	Diesel exhaust systems	<ul style="list-style-type: none"> ➤ Maximum obtainable energy in diesel light-duty engines by utilizing regular engine coolant temperatures is 386 W ➤ Driving cycle conditions, extra power needed in accelerations can increase the generated power to near 50W or 75 W
Chinguwa et al. [103] 2018 Procedia Manufacturing	The design of portable automobile refrigerator powered by exhaust heat using thermoelectric	Numerical	Vehicles	<ul style="list-style-type: none"> ➤ Design of a 20 liters portable automobile refrigerator from exhaust gases using TEGs
Kim et al. [104] 2018 Energy Conversion and Management	Energy harvesting performance of hexagonal shaped thermoelectric generator for passenger vehicle applications: An experimental approach	Experimental	Passenger vehicle applications	<ul style="list-style-type: none"> ➤ The generated power of the hexagonal TEG increases with the increase in engine speed and load (between 21.2 and 98.8 W) ➤ Conversion efficiency of about 1.3–2.6% when 18 TEM are utilized ➤ Maximum pressure drop across the hexagonal TEG is 2.1 kPa
Wang et al [105] 2018 Applied Energy	Performance evaluation of an automotive thermoelectric generator with inserted fins or dimpled-surface hot heat exchanger	Virtual evaluation method (computational fluid dynamics combines with mathematical model)	Automobile exhaust	<ul style="list-style-type: none"> ➤ Backpressure could be minimized by 20.57% in the ATEG with dimpled surface. ➤ Output power of the ATEG with dimpled surface could be enhanced by 173.60% ➤ Efficiency of the ATEG with dimpled surface is 0.68%
Durand et al. [106] 2018 Fuel	Potential of energy recuperation in the exhaust gas of state of the art light duty vehicles with thermoelectric elements	Theoretical modelling Mathematical simulation	Light duty vehicles	<ul style="list-style-type: none"> ➤ Investigation of the installation of Half-Heusler-based thermoelectric generators at the manifold and after the exhaust after-treatment system (ATS) of 4 light duty vehicles ➤ Exhaust gases temperature reaches 800 °C (at the manifold) and 600 °C (ATS) ➤ 100 W electric power is generated at the manifold and 30 W after the ATS

Many studies were performed last decade on heat recovery from exhaust gases using thermoelectric generators by which this technology caught the attention of researchers. It is resulted from the main advantage of thermoelectricity which is the ability of TEG to generate electricity from any temperature gradient. Figure 14 presents the evolution of the number of these studies per year. It shows an increasing development of this studies in the last decade. In 2011, three studies were performed about this subject which increased by years till it reach 21 studies in 2015. This implies that this technology proves its existence on energy recovery field.

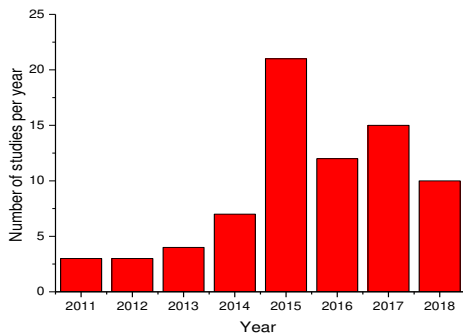

Figure 14. Number of studies done on heat recovery from exhaust gases using TEG published per year.

Figure 15 shows the distribution of this studies along the journals of Elsevier publisher. “Energy Conversion and Management” Journal contains the highest number of publications (17)

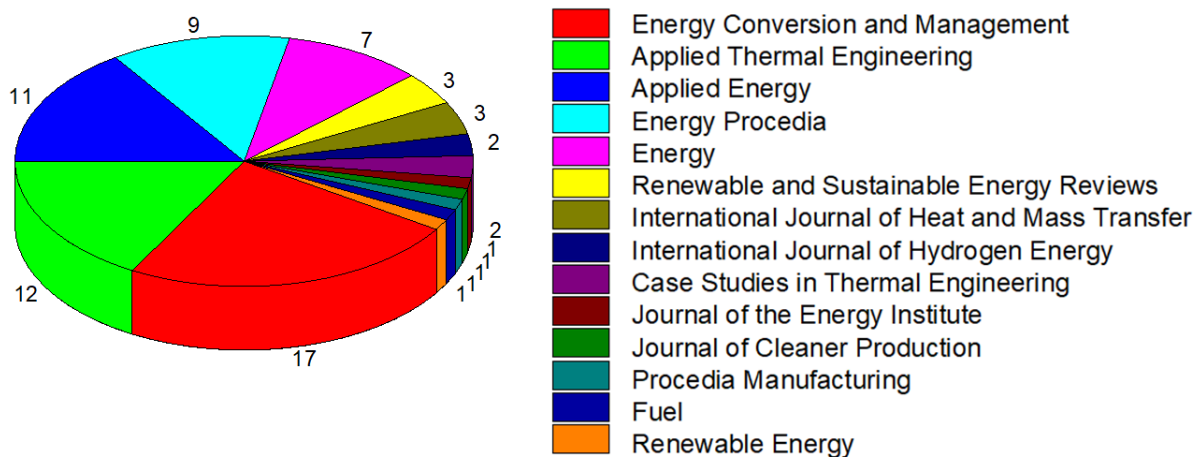

Figure 15. Distribution of studies published along Elsevier journals

publications, i.e. about 24% of the total publications), since TEG is an energy conversion device used for energy management.

Heat recovery from exhaust gases using TEGs has been implemented on many sources of exhaust gases. Figure 16 shows the main sources of exhaust gases. It shows that, heat recovery from exhaust gases of vehicles-ICE has been highly studied (about 51% of the publications). Since industrial applications generate high temperature and flow rate exhaust gases, rare studies were done about it (about 5%). 14% of the studies were carried on heat recovery from diesel engines, and 7% are done on combustion chambers to simulate the exhaust gases temperature in order to perform parametric studies.

Table 2 shows different methodologies in writing the publications which are summarized in Figure 17. It shows the number of studies published for specific types of studies (experimental, theoretical modelling, review and numerical). 38 published papers contain a numerical study on heat recovery from exhaust gases using TEG. Also, 29 papers include experimental results while 5 papers include a review on this technology. Numerical and experimental studies are the main types of studies done on such technology that are mainly performed in order to optimize heat recovery process. Numerical studies are done to reduce time, due to their ability to do parametric analysis and ease to change geometries. Whereas experimental studies are often carried out to validate numerical results which explain the reason that many numerical studies are coupled with experiment results.

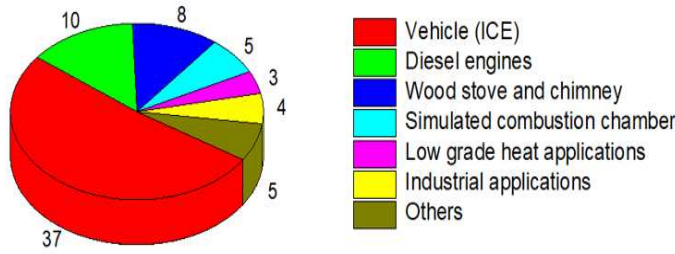

Figure 16. Number of studies done per source of exhaust gases

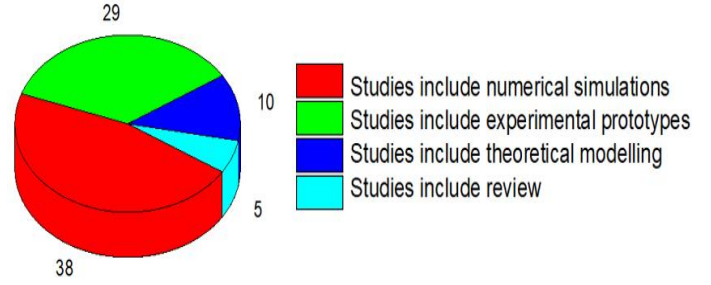

Figure 17. Number of studies published for different manuscripts methodology.

5. Economic and environmental concerns

The main objective of heat recovery is to reduce the environmental impact of releasing high temperature exhaust gases to environment. However, economical study should be taking into consideration to achieve a cost-effective heat recovery system. Knowing that TEG price is high, it is very crucial to conduct an economic study in order to have a cost-effective heat recovery system. Thus, this section will deal with some applications that are coupled to a heat recovery system to measure the payback period and the amount of carbon dioxide gases reduced.

Different industrial and residential sources were selected and examined such as residential wood chimney, passenger car, industrial thermal oil heater and diesel electric generator. Those sources are studied in different journal papers and the total power generated by thermoelectric generators is estimated. Furthermore, the number of thermoelectric modulus is approximated for some applications.

In order to calculate the total price of the heat recovery system the cost of TEGs should be calculated and added to the cost of the heat recovery system (heat exchanger, cooling system, pipes, pumps, sensors, electronic parts and safety devices). Equations (22) and (23) shows how to estimate the total cost C_{total}^{HRS} .

$$C_{total}^{TEG} = N_{TEG} \cdot C_{TEG} \quad (22)$$

$$C_{total}^{HRS} = C_{total}^{TEG} + C_{system} \quad (23)$$

where C_{total}^{TEG} , N_{TEG} and C_{TEG} are the total cost of TEGs, number of TEGs connected and the cost of single TEG module respectively. C_{system} is the cost of the auxiliary devices that complete the recovery system.

Table 3 shows the total cost of each heat recovery system for the selected sources, knowing that the cost of one TEG module is 35\$.

It shows that as the number of TEGs increase the total price of the system increase and it directly affect the cost of the recovery system which will be expected to affect the payback period of the system.

To estimate the payback period, the money saved by the recovery system should be calculated. The TEG recovery system mainly saves money by the generated power. Then, using power generated by TEG, cost of one kilowatt hour and the number of hours the system is running per day, the total energy produced per month is calculated. Equation (24) shows how to estimate the payback period of each system.

$$E_{total}^{monthly} = P_{total}^{TEG} \cdot Nb_{hours} \cdot Nb_{days}^{monthly} \quad (24)$$

where $E_{total}^{monthly}$ is the total electric energy generated per month in “kWh/month” and P_{total}^{TEG} is the total power generated by TEGs (in “W”). Nb_{hours} is the number of hours the exhaust gases are available per day (hours/day). While $Nb_{days}^{monthly}$ is the number of days the system is running per month (days/month).

Table 3. Total cost calculation of the TEG heat recovery system.

Source	Reference number	N_{TEG}	C_{total}^{TEG} (\$)	C_{system} (\$)	C_{total}^{HRS} (\$)
Chimney	[63]	4	140	112	252
Engine of typical passenger car	[46]	8	280	224	504
Industrial thermal oil heater (biomass)	[56]	8	280	500	780
Diesel engine (six cylinders 110 kW)	[80]	40	1400	1120	2520
4 Cylinders diesel engine (Fiat dobro 1.9 multijet)	[81]	40	1400	1120	2520

The money saved (MS) by recovering the dissipated thermal energy using thermoelectric heat recovery system is estimated as follows.

$$MS = E_{total}^{monthly} \cdot C_{1kWh} \quad (25)$$

where C_{1kWh} is the cost of one kilowatt hour per month which is taken at 0.13 \$/kWh which is referenced to the Lebanese cost [107].

Then, the payback period (PBP) of the system is the total cost of the recovery system over the money saved.

$$PBP = \frac{C_{total}^{HRS}}{MS} \quad (26)$$

Table 4 shows the energy generated per month, money saved and payback period of each system. The approximated average number of hours of car engines is 4 hours per day, 24 hours per day for industrial application and diesel electric generator and 18 hours per day for chimneys. Moreover, the source (Car, chimney...) will run daily.

Table 4. Money saved and payback period for each system.

Source	P_{total}^{TEG} (W)	Nb_{hours} (hr/day)	$E_{total}^{monthly}$ (kWh/month)	MS (\$/month)	PBP (Year)
Chimney	27	18	14.6	2	11.0
Engine of typical passenger car	6	4	0.73	1	446.4
Industrial thermal oil heater (biomass)	252	24	181.2	24	2.75
Diesel engine (six cylinders 110 kW)	184	24	133	17.4	12.1
4 Cylinders diesel engine (Fiat doblo 1.9 multijet)	157	4	18	2.4	85.8

Table 4 shows that industrial thermal oil heater has the highest energy generated per month. While the passenger car generates the lowest energy. This is mainly resulted from two reasons which are number of hours the system runs daily and the total power generated by TEGs. Also, results show that car has very high payback period which are not acceptable as a cost-effective system. However, such technology is highly studied in the cars since generating electricity can reduce the electric equipment in car, reduce the size of motor and increase the efficiency of motor by reducing the energy taken from motor to generate electricity. Industrial thermal oil heater has about 2.75 years to return the money paid while for diesel generator it needs about 12 years to pay back its price.

Finally, regarding the environmental concerns, the amount of CO₂ gases reduced ($M_{CO_2}^{reduced}$) is estimated as follows.

$$M_{CO_2}^{reduced} = E_{total}^{monthly} \cdot M_{CO_2}^{generated} \quad (27)$$

where $M_{CO_2}^{generated}$ is the mass of CO₂ gases generated for producing one kilowatt-hour. It is estimated in Lebanon that in order to produce one kilowatt hour, 0.47 kg of CO₂ gases are released [107].

Table 5 shows the amount of CO₂ gases reduced for each system. Results show that, about one ton of CO₂ gases are reduced yearly when applying a thermoelectric heat recovery system in industrial thermal oil with eight TEGs.

Table 5. Amount of CO₂ gases reduced.

Source	$M_{CO_2}^{generated}$ (kg /month)	$M_{CO_2}^{generated}$ (ton /year)
Chimney	6.8526	0.08
Engine of typical passenger car	0.34	0.004
Industrial thermal oil heater (Biomass)	85	1.02
Diesel engine (six cylinders 110 kW)	62.5	0.75
4 Cylinders diesel engine (Fiat doblo 1.9 multijet)	9	0.1

6. Conclusion

Heat recovery from exhaust gases for power generation using thermoelectric generators is a trending technology that is deployed on different industrial and residential application. Thermoelectric generators are energy conversion devices that convert thermal energy to electrical energy directly by applying temperature difference at the sides of the TEG. This paper presents a review on heat recovery from exhaust gases using thermoelectric generators. Starting by the sources of exhaust gases which are distributed between residential and industrial applications such as chimneys, woodstoves, internal combustion engine, boilers and furnaces. The principle of thermoelectric generation is presented coupled with thermal and electrical modelling. In addition, this paper presents some previous works that are done on this field of study. Moreover, an economic and environmental study was produced for different industrial and residential applications.

Even though many studies were carried on heat recovery from exhaust gases using TEGs and mainly on internal combustion engines, it remains scarce when it comes for residential applications such as chimneys and wood stoves. In addition, TEGs remain limited due to their low efficiency and many studies are done to increase their efficiency up to 12% however this dramatically increases their cost, since the material is more purified.

References

- [1] El Mays A, Ammar R, Hawa M, Akroush MA, Hachem F, Khaled M, et al. Improving Photovoltaic Panel Using Finned Plate of Aluminum. *Energy Procedia* 2017;119:812–7. doi:10.1016/J.EGYPRO.2017.07.103.
- [2] Hachem F, Abdulhay B, Ramadan M, El Hage H, El Rab MG, Khaled M. Improving the performance of photovoltaic cells using pure and combined phase change materials – Experiments and transient energy balance. *Renew Energy* 2017;107:567–75. doi:10.1016/J.RENENE.2017.02.032.
- [3] Herez A, Ramadan M, Abdulhay B, Khaled M. Short review on solar energy systems. *AIP Conf Proc* 2016:1758.
- [4] Herez A, Khaled M, Murr R, Haddad A, Elhage H, Ramadan M. Using Geothermal Energy for cooling - Parametric study. *Energy Procedia* 2017;119:783–91. doi:10.1016/J.EGYPRO.2017.07.111.
- [5] Ramadan M, El Rab MG, Khaled M. Parametric analysis of air–water heat recovery concept applied to HVAC systems: Effect of mass flow rates. *Case Stud Therm Eng* 2015;6:61–8. doi:10.1016/J.CSITE.2015.06.001.
- [6] Ramadan M, Khaled M, Ramadan HS, Becherif M. An innovative system coupling energy recovery from speed bump and fuel cell. *Int J Hydrogen Energy* 2017. doi:10.1016/J.IJHYDENE.2017.07.160.
- [7] Ramadan M, Khaled M, Ramadan HS, Becherif M. Modeling and sizing of combined fuel cell-thermal solar system for energy generation. *Int J Hydrogen Energy* 2016;41:19929–35. doi:10.1016/J.IJHYDENE.2016.08.222.
- [8] El Mays A, Ammar R, Hawa M, Akroush MA, Hachem F, Khaled M, et al. Using phase change material in under floor heating. *Energy Procedia* 2017;119:806–11. doi:10.1016/J.EGYPRO.2017.07.101.
- [9] Jaber H, Khaled M, Lemenand T, Faraj J, Bazzi H, Ramadan M. Effect of Exhaust Gases Temperature on the Performance of a Hybrid Heat Recovery System. *Energy Procedia* 2017;119:775–82. doi:10.1016/j.egypro.2017.07.110.
- [10] Khaled M, Ramadan M, El H. Parametric Analysis of Heat Recovery from Exhaust Gases of Generators. *Energy Procedia* 2015;00:1–7. doi:10.1016/j.egypro.2015.07.710.
- [11] Khaled M, Ramadan M, Chahine K, Assi A. Prototype implementation and experimental analysis of water heating using recovered waste heat of chimneys. *Case Stud Therm Eng* 2013;5:127–33.
- [12] Ramadan M, Lemenand T, Khaled M. Recovering heat from hot drain water—Experimental evaluation, parametric analysis and new calculation procedure. *Energy Build* 2016;128:575–82. doi:10.1016/J.ENBUILD.2016.07.017.
- [13] Ramadan M, Ali S, Bazzi H, Khaled M. New hybrid system combining TEG, condenser hot air and exhaust airflow of all-air HVAC systems. *Case Stud Therm Eng* 2017;10:154–60. doi:10.1016/J.CSITE.2017.05.007.
- [14] Khaled M, Ramadan M, Chahine K, Assi A. Prototype implementation and experimental analysis of water heating using recovered waste heat of chimneys. *Case Stud Therm Eng* 2015;5:127–33. doi:10.1016/j.csite.2015.03.004.
- [15] Khaled M, Ramadan M. Study of the Thermal Behavior of Multi Tube Tank in Heat Recovery from Chimney—Analysis and Optimization. *Heat Transf Eng* 2017:1–11. doi:10.1080/01457632.2017.1312864.
- [16] Chahine K, Ramadan M, Merhi Z, Jaber H, Khaled M. Parametric analysis of temperature gradient across thermoelectric power generators. *J Electr Syst* 2016;12:623–32.
- [17] Yeşiller N, Hanson JL, Yee EH. Waste heat generation: A comprehensive review. *Waste Manag* 2015;42:166–79. doi:10.1016/j.wasman.2015.04.004.
- [18] Brückner S, Liu S, Miró L, Radspieler M, Cabeza LF, Lävemann E. Industrial waste heat recovery technologies: An economic analysis of heat transformation technologies. *Appl Energy* 2015;151:157–67. doi:10.1016/j.apenergy.2015.01.147.
- [19] Jaber H, Khaled M, Lemenand T, Ramadan M. Short review on heat recovery from exhaust gas, 2016, p. 030045. doi:10.1063/1.4959441.
- [20] Singh BK, Shrivastava N. Exhaust Gas Heat Recovery for C.I Engine-A Review. *Int J Eng Sci Res Technol* 2014;3:125–9.
- [21] Jadhao JS, Thombare DG. Review on Exhaust Gas Heat Recovery for I. C. Engine. *Int J Eng Innov Technol* 2013;2:93–100.
- [22] Hossain SN, Bari S. Waste Heat Recovery from Exhaust of a Diesel Generator Set Using Organic Fluids. *Procedia Eng* 2014;90:439–44. doi:10.1016/J.PROENG.2014.11.753.
- [23] Khaled M, Ramadan M, Hage H El. Parametric Analysis of Heat Recovery from Exhaust Gases of Generators. *Energy Procedia* 2015;75:3295–300. doi:10.1016/J.EGYPRO.2015.07.710.
- [24] Danel Q, Périllon C, Lacour S, Punov P, Danlos A. Waste Heat Recovery Applied to a Tractor Engine. *Energy Procedia* 2015;74:331–43. doi:10.1016/j.egypro.2015.07.622.
- [25] Raja SP, Rajavel R, Navaneethakrishnan D. Experimental Investigation Of Heat Recovery From Diesel Engine Exhaust Using Compact Heat Exchanger And Thermal Storage Using Phase Change Material. *Int J Innov Res Sci Eng Technol* 2014;3:2663–70.
- [26] Pradeep Varma GV, Srinivas T. Design and analysis of a cogeneration plant using heat recovery of a cement factory. *Case Stud Therm Eng* 2015;5:24–31.

- doi:10.1016/J.CSITE.2014.12.002.
- [27] Champier D. Thermoelectric generators: A review of applications. *Energy Convers Manag* 2017;140:167–81. doi:10.1016/j.enconman.2017.02.070.
- [28] Ringler J, Seifert M, Guyotot V, Hübner W. Rankine Cycle for Waste Heat Recovery of IC Engines. *SAE Int J Engines* 2009;2:67–76.
- [29] Cao Z, Koukharenko E, Tudor MJ, Torah RN, Beeby SP. Flexible screen printed thermoelectric generator with enhanced processes and materials. *Sensors Actuators, A Phys* 2016;238:196–206. doi:10.1016/j.sna.2015.12.016.
- [30] Ming T, Wu Y, Peng C, Tao Y. Thermal analysis on a segmented thermoelectric generator. *Energy* 2015;80:388–99. doi:10.1016/j.energy.2014.11.080.
- [31] LeBlanc S. Thermoelectric generators: Linking material properties and systems engineering for waste heat recovery applications. *Sustain Mater Technol* 2014;1:26–35. doi:10.1016/j.susmat.2014.11.002.
- [32] Riffat SB, Ma X. Thermoelectrics: A review of present and potential applications. *Appl Therm Eng* 2003;23:913–35. doi:10.1016/S1359-4311(03)00012-7.
- [33] Montecucco A, Siviter J, Knox AR. The effect of temperature mismatch on thermoelectric generators electrically connected in series and parallel. *Appl Energy* 2014;123:47–54. doi:10.1016/j.apenergy.2014.02.030.
- [34] Montecucco A, Siviter J, Knox AR. Constant heat characterisation and geometrical optimisation of thermoelectric generators. *Appl Energy* 2015;149:248–58. doi:10.1016/j.apenergy.2015.03.120.
- [35] Jaber H, Ramadan M, Iemenand T, Khaled M. Domestic thermoelectric cogeneration system optimization analysis, energy consumption and CO2 emissions reduction. *Appl Therm Eng* 2018;130:279–95. doi:10.1016/j.applthermaleng.2017.10.148.
- [36] Remeli MF, Tan L, Date A, Singh B, Akbarzadeh A. Simultaneous power generation and heat recovery using a heat pipe assisted thermoelectric generator system. *Energy Convers Manag* 2015;91:110–9. doi:10.1016/J.ENCONMAN.2014.12.001.
- [37] Champier D, Bédécarrats JP, Kouskou T, Rivaletto M, Strub F, Pignolet P. Study of a TE (thermoelectric) generator incorporated in a multifunction wood stove. *Energy* 2011;36:1518–26. doi:10.1016/j.energy.2011.01.012.
- [38] Orr B, Akbarzadeh A, Mochizuki M, Singh R. A review of car waste heat recovery systems utilising thermoelectric generators and heat pipes. *Appl Therm Eng* 2016;101:490–5. doi:10.1016/j.applthermaleng.2015.10.081.
- [39] Orr B, Akbarzadeh A, Mochizuki M, Singh R. A review of car waste heat recovery systems utilising thermoelectric generators and heat pipes. *Appl Therm Eng* 2016;101:490–5. doi:10.1016/J.APPLTHERMALENG.2015.10.081.
- [40] Gao X, Andreasen SJ, Chen M, Kær SK. Numerical model of a thermoelectric generator with compact plate-fin heat exchanger for high temperature PEM fuel cell exhaust heat recovery. *Int J Hydrogen Energy* 2012;37:8490–8. doi:10.1016/j.ijhydene.2012.03.009.
- [41] Shu G, Zhao J, Tian H, Liang X, Wei H. Parametric and exergetic analysis of waste heat recovery system based on thermoelectric generator and organic rankine cycle utilizing R123. *Energy* 2012;45:806–16. doi:10.1016/j.energy.2012.07.010.
- [42] Gao X, Andreasen SJ, Kær SK, Rosendahl LA. Optimization of a thermoelectric generator subsystem for high temperature PEM fuel cell exhaust heat recovery. *Int J Hydrogen Energy* 2014;39:6637–45. doi:10.1016/j.ijhydene.2014.01.193.
- [43] Jang JY, Tsai YC. Optimization of thermoelectric generator module spacing and spreader thickness used in a waste heat recovery system. *Appl Therm Eng* 2013;51:677–89. doi:10.1016/j.applthermaleng.2012.10.024.
- [44] Hatami M, Ganji DD, Gorji-Bandpy M. A review of different heat exchangers designs for increasing the diesel exhaust waste heat recovery. *Renew Sustain Energy Rev* 2014;37:168–81. doi:10.1016/J.RSER.2014.05.004.
- [45] Bai S, Lu H, Wu T, Yin X, Shi X, Chen L. Numerical and experimental analysis for exhaust heat exchangers in automobile thermoelectric generators. *Case Stud Therm Eng* 2014;4:99–112. doi:10.1016/j.csite.2014.07.003.
- [46] Orr B, Singh B, Tan L, Akbarzadeh A. Electricity generation from an exhaust heat recovery system utilising thermoelectric cells and heat pipes. *Appl Therm Eng* 2014;73:586–95. doi:10.1016/j.applthermaleng.2014.07.056.
- [47] Wang T, Luan W, Wang W, Tu S-T. Waste heat recovery through plate heat exchanger based thermoelectric generator system. *Appl Energy* 2014;136:860–5. doi:10.1016/j.apenergy.2014.07.083.
- [48] Stevens RJ, Weinstein SJ, Koppala KS. Theoretical limits of the thermoelectric power generation from exhaust gases. *Appl Energy* 2014;133:80–8. doi:10.1016/j.apenergy.2014.07.075.
- [49] Wang JL, Wu JY, Zheng CY. Simulation and evaluation of a CCHP system with exhaust gas deep-recovery and thermoelectric generator. *Energy Convers Manag* 2014;86:992–1000. doi:10.1016/j.enconman.2014.06.036.
- [50] Niu Z, Diao H, Yu S, Jiao K, Du Q, Shu G. Investigation and design optimization of exhaust-based thermoelectric generator system for internal combustion engine. *Energy Convers Manag* 2014;85:85–101. doi:10.1016/j.enconman.2014.05.061.
- [51] Massaguer E, Massaguer A, Montoro L, Gonzalez JR. Modeling analysis of longitudinal thermoelectric energy harvester in low temperature waste heat recovery applications. *Appl Energy* 2015;140:184–95. doi:10.1016/j.apenergy.2014.12.005.
- [52] Yu S, Du Q, Diao H, Shu G, Jiao K. Start-up modes of thermoelectric generator based on vehicle exhaust waste heat recovery. *Appl Energy* 2015;138:276–90. doi:10.1016/j.apenergy.2014.10.062.
- [53] Date A, Gauci L, Chan R, Date A. Performance review of a novel combined thermoelectric power generation and water desalination system. *Renew Energy* 2015;83:256–69. doi:10.1016/j.renene.2015.04.024.
- [54] Aranguren P, Astrain D, Rodríguez A, Martínez A. Experimental investigation of the applicability of a thermoelectric generator to recover waste heat from a combustion chamber. *Appl Energy* 2015;152:121–30. doi:10.1016/j.apenergy.2015.04.077.
- [55] He W, Wang S, Zhang X, Li Y, Lu C. Optimization design method of thermoelectric generator based on exhaust gas parameters for recovery of engine waste heat. *Energy* 2015;91:1–9. doi:10.1016/j.energy.2015.08.022.
- [56] Barma MC, Riaz M, Saidur R, Long BD. Estimation of thermoelectric power generation by recovering waste heat from Biomass fired thermal oil heater. *Energy Convers Manag* 2015;98:303–13. doi:10.1016/j.enconman.2015.03.103.
- [57] Liu X, Deng YD, Li Z, Su CQ. Performance analysis of a waste heat recovery thermoelectric generation system for automotive application. *Energy Convers Manag* 2015;90:121–7. doi:10.1016/j.enconman.2014.11.015.
- [58] Remeli MF, Tan L, Date A, Singh B, Akbarzadeh A. Simultaneous power generation and heat recovery using a heat pipe assisted thermoelectric generator system. *Energy Convers Manag* 2015;91:110–9. doi:10.1016/j.enconman.2014.12.001.
- [59] Lu C, Wang S, Chen C, Li Y. Effects of heat enhancement for

- exhaust heat exchanger on the performance of thermoelectric generator. *Appl Therm Eng* 2015;89:270–9. doi:10.1016/j.applthermaleng.2015.05.086.
- [60] Zhang Y, Cleary M, Wang X, Kempf N, Schoensee L, Yang J, et al. High-temperature and high-power-density nanostructured thermoelectric generator for automotive waste heat recovery. *Energy Convers Manag* 2015;105:946–50. doi:10.1016/j.enconman.2015.08.051.
- [61] Ma H-K, Lin C-P, Wu H-P, Peng C-H, Hsu C-C. Waste heat recovery using a thermoelectric power generation system in a biomass gasifier. *Appl Therm Eng* 2015;88:274–9. doi:10.1016/j.applthermaleng.2014.09.070.
- [62] Remeli MF, Verjoporn K, Singh B, Kiatbodin L, Date A, Akbarzadeh A. Passive Heat Recovery System Using Combination of Heat Pipe and Thermoelectric Generator. *Energy Procedia* 2015;75:608–14. doi:10.1016/j.egypro.2015.07.465.
- [63] Montecucco A, Siviter J, Knox AR. Combined heat and power system for stoves with thermoelectric generators. *Appl Energy* 2017;185:1336–42. doi:10.1016/j.apenergy.2015.10.132.
- [64] Rahman A, Razzak F, Afroz R, Mohiuddin AKM, Hawlader MNA. Power generation from waste of IC engines. *Renew Sustain Energy Rev* 2015;51:382–95. doi:10.1016/j.rser.2015.05.077.
- [65] Arsie I, Cricchio A, Pianese C, Ricciardi V, De Cesare M. Modeling Analysis of Waste Heat Recovery via Thermo-Electric Generator and Electric Turbo-Compound for CO₂ Reduction in Automotive SI Engines. *Energy Procedia* 2015;82:81–8. doi:10.1016/j.egypro.2015.11.886.
- [66] Tian H, Jiang N, Jia Q, Sun X, Shu G, Liang X. Comparison of Segmented and Traditional Thermoelectric Generator for Waste Heat Recovery of Diesel Engine. *Energy Procedia* 2015;75:590–6. doi:10.1016/j.egypro.2015.07.461.
- [67] Tang ZB, Deng YD, Su CQ, Shuai WW, Xie CJ. A research on thermoelectric generator's electrical performance under temperature mismatch conditions for automotive waste heat recovery system. *Case Stud Therm Eng* 2015;5:143–50. doi:10.1016/J.CSITE.2015.03.006.
- [68] Remeli MF, Kiatbodin L, Singh B, Verjoporn K, Date A. Power generation from waste heat using Heat Pipe and Thermoelectric Generator. *Energy Procedia* 2015;75:645–50. doi:10.1016/j.egypro.2015.07.477.
- [69] Liu C, Pan X, Zheng X, Yan Y, Li W. An experimental study of a novel prototype for two-stage thermoelectric generator from vehicle exhaust. *J Energy Inst* 2015;86:1–11. doi:10.1016/j.joei.2015.01.019.
- [70] In B, Kim H, Son J, Lee K. The study of a thermoelectric generator with various thermal conditions of exhaust gas from a diesel engine. *Int J Heat Mass Transf* 2015;86:667–80. doi:10.1016/j.ijheatmasstransfer.2015.03.052.
- [71] Gao HB, Huang GH, Li HJ, Qu ZG, Zhang YJ. Development of stove-powered thermoelectric generators: A review. *Appl Therm Eng* 2016;96:297–310. doi:10.1016/j.applthermaleng.2015.11.032.
- [72] Remeli MF, Date A, Orr B, Ding LC, Singh B, Affandi NDN, et al. Experimental investigation of combined heat recovery and power generation using a heat pipe assisted thermoelectric generator system. *Energy Convers Manag* 2016;111:147–57. doi:10.1016/j.enconman.2015.12.032.
- [73] He W, Wang S, Lu C, Zhang X, Li Y. Influence of different cooling methods on thermoelectric performance of an engine exhaust gas waste heat recovery system. *Appl Energy* 2016;162:1251–8. doi:10.1016/j.apenergy.2015.03.036.
- [74] Demir ME, Dincer I. Performance assessment of a thermoelectric generator applied to exhaust waste heat recovery. *Appl Therm Eng* 2017. doi:10.1016/j.applthermaleng.2017.03.052.
- [75] Orr B, Akbarzadeh A, Lappas P. An exhaust heat recovery system utilizing thermoelectric generators and heat pipes. *Appl Therm Eng* 2016.
- [76] Meng J, Wang X, Chen W. Performance investigation and design optimization of a thermoelectric generator applied in automobile exhaust waste heat recovery. *Energy Convers Manag* 2016;120:71–80. doi:10.1016/j.enconman.2016.04.080.
- [77] He W, Wang S, Yang Y. Optimal heat exchanger dimensional analysis under different automobile exhaust temperatures for thermoelectric generator system. *Energy Procedia* 2016;104:366–71. doi:10.1016/j.egypro.2016.12.062.
- [78] Stobart R, Wijewardane MA, Yang Z. Comprehensive analysis of thermoelectric generation systems for automotive applications. *Appl Therm Eng* 2016. doi:10.1016/j.applthermaleng.2016.09.121.
- [79] He W, Wang S, Li Y, Zhao Y. Structural size optimization on an exhaust exchanger based on the fluid heat transfer and flow resistance characteristics applied to an automotive thermoelectric generator. *Energy Convers Manag* 2016;129:240–9. doi:10.1016/j.enconman.2016.10.032.
- [80] Kim TY, Negash AA, Cho G. Waste heat recovery of a diesel engine using a thermoelectric generator equipped with customized thermoelectric modules. *Energy Convers Manag* 2016;124:280–6. doi:10.1016/j.enconman.2016.07.013.
- [81] Temizer İ, Cumali İ. The performance and analysis of the thermoelectric generator system used in diesel engines 2016;63:141–51. doi:10.1016/j.rser.2016.04.068.
- [82] Huang G, Hsu C, Fang C, Yao D. Optimization of a waste heat recovery system with thermoelectric generators by three-dimensional thermal resistance analysis. *Energy Convers Manag* 2016;126:581–94. doi:10.1016/j.enconman.2016.08.038.
- [83] Cao Q, Luan W, Wang T. Performance enhancement of heat pipes assisted thermoelectric generator for automobile exhaust heat recovery. *Appl Therm Eng* 2017.
- [84] Meng F, Chen L, Feng Y, Xiong B. Thermoelectric generator for industrial gas phase waste heat recovery. *Energy* 2017;135:83–90. doi:10.1016/j.energy.2017.06.086.
- [85] He W, Wang S, Yang Y. Peak power evaluation and optimal dimension design of exhaust heat exchanger for different gas parameters in automobile thermoelectric generator. *Energy Convers Manag* 2017;151:661–9. doi:10.1016/j.enconman.2017.08.067.
- [86] Orr B, Akbarzadeh A. Prospects of waste heat recovery and power generation using thermoelectric generators. *Energy Procedia* 2017;110:250–5. doi:10.1016/j.egypro.2017.03.135.
- [87] Vale S, Heber L, Coelho PJ, Silva CM. Parametric study of a thermoelectric generator system for exhaust gas energy recovery in diesel road freight transportation. *Energy Convers Manag* 2017;133:167–77. doi:10.1016/j.enconman.2016.11.064.
- [88] Zhao Y, Wang S, Liang Z, Ge M. Performance analysis of wet flue-gas thermoelectric generator. *Energy Procedia* 2017;142:148–53. doi:10.1016/j.egypro.2017.12.024.
- [89] Lu X, Yu X, Qu Z, Wang Q, Ma T. Experimental investigation on thermoelectric generator with non-uniform hot-side heat exchanger for waste heat recovery. *Energy Convers Manag* 2017;150:403–14. doi:10.1016/j.enconman.2017.08.030.
- [90] Demir ME, Dincer I. Development and heat transfer analysis of a new heat recovery system with thermoelectric generator. *Int J Heat Mass Transf* 2017;108:2002–10. doi:10.1016/j.ijheatmasstransfer.2016.12.102.

- [91] Aranguren P, Araiz M, Astrain D, Martínez A. Thermoelectric generators for waste heat harvesting: A computational and experimental approach. *Energy Convers Manag* 2017;148:680–91. doi:10.1016/j.enconman.2017.06.040.
- [92] Kim TY, Kim J. Assessment of the Energy Recovery Potential of a Thermoelectric Generator System for Passenger Vehicles under Various Drive Cycles. *Energy* 2017. doi:10.1016/j.energy.2017.10.137.
- [93] Kim TY, Negash A, Cho G. Experimental and numerical study of waste heat recovery characteristics of direct contact thermoelectric generator. *Energy Convers Manag* 2017;140:273–80. doi:10.1016/j.enconman.2017.03.014.
- [94] Li B, Huang K, Yan Y, Li Y, Twaha S, Zhu J. Heat transfer enhancement of a modularised thermoelectric power generator for passenger vehicles. *Appl Energy* 2017;205:868–79. doi:10.1016/j.apenergy.2017.08.092.
- [95] Li Y, Wang S, Zhao Y. Experimental study on the influence of the core flow heat transfer enhancement on the performance of thermoelectric generator. *Energy Procedia* 2017;105:901–7. doi:10.1016/j.egypro.2017.03.410.
- [96] He W, Wang S, Yue L. High net power output analysis with changes in exhaust temperature in a thermoelectric generator system. *Appl Energy* 2017. doi:10.1016/j.apenergy.2016.12.078.
- [97] Kim TY, Negash AA, Cho G. Experimental study of energy utilization effectiveness of thermoelectric generator on diesel engine. *Energy* 2017. doi:10.1016/j.energy.2017.04.060.
- [98] Mostafavi SA, Mahmoudi M. Modeling and fabricating a prototype of a thermoelectric generator system of heat energy recovery from hot exhaust gases and evaluating the effects of important system parameters. *Appl Therm Eng* 2018;132:624–36. doi:10.1016/j.applthermaleng.2018.01.018.
- [99] Nithyanandam K, Mahajan RL. Evaluation of metal foam based thermoelectric generators for automobile waste heat recovery. *Int J Heat Mass Transf* 2018;122:877–83. doi:10.1016/j.ijheatmasstransfer.2018.02.029.
- [100] Lan S, Yang Z, Chen R, Stobart R. A dynamic model for thermoelectric generator applied to vehicle waste heat recovery. *Appl Energy* 2018;210:327–38. doi:10.1016/j.apenergy.2017.11.004.
- [101] Muralidhar N, Himabindu M, Ravikrishna R V. Modeling of a hybrid electric heavy duty vehicle to assess energy recovery using a Thermoelectric Generator. *Energy* 2018. doi:10.1016/j.energy.2018.02.023.
- [102] Fernandez-Yanez P, Gomez A, García-Contreras R, Armas O. Evaluating thermoelectric modules in diesel exhaust systems: potential under urban and extra-urban driving conditions. *J Clean Prod* 2018;182:1070–9. doi:10.1016/j.jclepro.2018.02.006.
- [103] Chinguwa S, Musora C, Mushiri T. The design of portable refrigerator powered by exhaust heat using thermoelectric. *Procedia Manuf* 2018;21:741–8. doi:10.1016/j.promfg.2018.02.179.
- [104] Kim TY, Kwak J, Kim B. Energy harvesting performance of hexagonal shaped thermoelectric generator for passenger vehicle applications: An experimental approach. *Energy Convers Manag* 2018;160:14–21. doi:10.1016/j.enconman.2018.01.032.
- [105] Wang Y, Li S, Xie X, Deng Y, Liu X, Su C. Performance evaluation of an automotive thermoelectric generator with inserted fins or dimpled-surface hot heat exchanger. *Appl Energy* 2018;218:391–401. doi:10.1016/j.apenergy.2018.02.176.
- [106] Durand T, Dimopoulos P, Tang Y, Liao Y, Landmann D. Potential of energy recuperation in the exhaust gas of state of the art light duty vehicles with thermoelectric elements. *Fuel* 2018;224:271–9. doi:10.1016/j.fuel.2018.03.078.
- [107] Jaber H, Ramadan M, Iemenand T, Khaled M. Domestic thermoelectric cogeneration system optimization analysis, energy consumption and CO2 emissions reduction. *Appl Therm Eng* 2018;130:279–95. doi:10.1016/J.APPLTHERMALENG.2017.10.148.

Chapitre 2. Système de Cogénération Thermoélectrique Domestique : analyse d'optimisation, consommation d'énergie et réduction des émissions de CO₂

Dans ce chapitre, un nouveau système de récupération de chaleur hybride est proposé et nommé « **Système de Cogénération Thermoélectrique Domestique** » (SCTD). Il s'agit d'un système à double récupération de chaleur qui permet d'utiliser la chaleur perdue des gaz d'échappement pour chauffer simultanément de l'eau et produire de l'électricité au moyen de générateurs thermoélectriques (GTE). Le but de ce système de récupération de chaleur hybride est de chauffer l'eau principalement, puis de générer autant que possible de l'énergie électrique.

Cette étude consiste en une introduction générale sur la récupération de chaleur des gaz d'échappement et utilise principalement des générateurs thermoélectriques présentés dans la **section 1**. La **section 2** présente le système de récupération de chaleur par cogénération thermoélectrique domestique (SCTD). Ensuite, une modélisation thermique complète du SCTD est présentée dans la **section 3**. Puis, une analyse d'optimisation basée sur la position des générateurs thermoélectriques dans le système est réalisée dans la **section 4**. En outre, une analyse économique et environnementale approfondie est fournie dans la **section 5**. Enfin, la **section 6** présente les principales conclusions et expose quelques travaux futurs.

Le système est composé d'un tuyau et d'un réservoir coaxiaux. Les gaz d'échappement passent par le tuyau dans lequel ils libèrent une partie de leur énergie thermique vers l'eau qui entoure le tuyau situé à l'intérieur du réservoir cylindrique. Simultanément, l'électricité est produite par des générateurs thermoélectriques situés sur la surface. L'objectif principal de cette étude est **d'analyser la température de l'eau et l'énergie produite** par les GTE en modifiant l'emplacement des générateurs thermoélectriques.

L'emplacement des générateurs thermoélectriques peut être à l'intérieur ou à l'extérieur de la paroi du tuyau ou à l'intérieur ou à l'extérieur de la paroi du réservoir cylindrique, ou même sur tous les côtés du tuyau et du réservoir cylindrique. À l'aide de la modélisation thermique, une analyse d'optimisation est effectuée sur les six cas répertoriés afin de comparer la température de l'eau à la puissance produite par les GTE en modifiant l'emplacement des générateurs thermoélectriques.

Le cas 1 est un système de récupération de chaleur simple utilisé uniquement pour générer de l'eau chaude sanitaire, qui servira de référence pour les autres cas. Les cas restants sont des systèmes de récupération de chaleur hybrides dans lesquels l'emplacement des GTE est modifié. Les GTE sont placés sur les parois intérieures ou extérieures du réservoir ou du tuyau (cas 2 à 5), ou sur tous (cas 6). Dans chacun des cas hybrides (2-6), la source de chaleur et le dissipateur de chaleur sont modifiés. Dans le cas 2, la source de chaleur est la paroi du réservoir cylindrique et l'air est le dissipateur de chaleur, tandis que dans le cas 3, l'eau est la source de chaleur et la paroi du réservoir cylindrique est le dissipateur de chaleur. Dans les cas 4 et 5, la source de chaleur est respectivement la paroi du tuyau et les gaz d'échappement, tandis que le dissipateur thermique est respectivement la paroi de l'eau et du tuyau. Enfin, le cas 6 est une combinaison des cas précédents 2, 3, 4 et 5.

Les résultats montrent que la localisation des GTE à la paroi du réservoir permet d'obtenir une température de l'eau plus élevée mais une production de puissance plus faible (cas 2 et 3). Cependant, lorsque les GTE sont situés sur le tuyau (cas 4 et 5), une puissance élevée est produite, mais la température de l'eau est relativement basse par rapport aux cas 2 et 3. Lorsque les GTE sont situés sur toutes les parois, la puissance totale produite est la plus haute et la température de l'eau devient la plus basse par rapport aux autres cas. Il a également été obtenu que les cas 2 et 3 produisent de l'eau chaude sanitaire à environ 97°C. Cependant, une faible puissance totale est produite (environ 7 W), ce qui rend ces deux configurations plus adaptées au chauffage de l'eau. Les cas 4 et 5 produisent de l'eau chaude à environ 80°C, couplée à 33 W d'électricité produite par le GTE. La température de l'eau est élevée mais inférieure aux cas 2 et 3 et la puissance produite est supérieure à celle des cas 2 et 3. De plus, les résultats ont révélé que la puissance totale maximale produite (52 W) est générée par la configuration 6 avec une température d'eau élevée (81°C). Cependant, la principale limitation de cette configuration est son coût élevé, qui résulte du nombre élevé de GTE requis (environ 1 000 GTE). Étant donné que la localisation des GTE à la paroi du réservoir est plus coûteuse que celle au niveau de la canalisation (davantage de GTE sont nécessaires), le cas 5 est un processus de récupération de chaleur rentable par rapport aux autres cas si le coût est une exigence majeure. Cependant, si une température de l'eau élevée est requise, le cas 3 est le meilleur choix, mais si le coût n'est pas l'exigence majeure, le cas 6 est le meilleur choix.

Enfin, les **préoccupations économiques et environnementales** sont prises en compte pour calculer l'argent économisé, la période de retour sur investissement du système proposé et pour estimer la quantité de gaz à effet de serre économisée lors de l'utilisation de ce système. L'étude économique montre que le montant total des économies réalisées est approximativement le même dans les six cas, ce qui signifie que le changement de l'emplacement des GTE a peu d'influence sur l'argent total économisé en raison du coût élevé de l'eau de chauffage par rapport au coût de production d'électricité. De plus, une meilleure période de retour sur investissement apparaît pour le cas 5 pour lequel il faut 1 an et 8 mois pour rembourser le coût du système. En revanche, le cas 6 nécessite la période de retour sur investissement la plus élevée en raison du prix élevé du système, principalement des GTE, où il faut environ 15 ans pour rembourser son coût, ce qui est élevé pour une application résidentielle. En ce qui concerne l'étude environnementale, la variation de l'emplacement des GTE n'affecte pas beaucoup la quantité réduite de CO₂ émise en raison de la faible énergie produite par les GTE par rapport à celle obtenue en chauffant l'eau. En outre, 6 tonnes de CO₂ peuvent être réduites chaque année en utilisant le système de récupération de chaleur hybride. Cette étude est publiée dans « *Applied Thermal Engineering* ».

Système de Cogénération Thermoélectrique Domestique : analyse d'optimisation, consommation d'énergie et réduction des émissions de CO₂

Hassan Jaber, Mohamad Ramadan, Thierry Lemenand et Mahmoud Khaled

Cette étude est publiée dans « **Applied Thermal Engineering** »

Résumé - Dans cet article, un système de cogénération thermoélectrique domestique (CTDS) est suggéré. Ce système permet d'utiliser la chaleur perdue des gaz d'échappement pour chauffer simultanément de l'eau et produire de l'électricité via des générateurs thermoélectriques (GTE). Pour continuer, le concept du système est dessiné et la modélisation thermique correspondante est développée. Une analyse d'optimisation, basée sur la position des générateurs thermoélectriques dans le système, est réalisée à l'aide de la modélisation thermique. Les GTE sont situés à des emplacements sur les parois intérieures ou extérieures du réservoir ou de la conduite (cas 2 à 5), ou sur tous (cas 6). Les résultats montrent que l'eau peut être chauffée jusqu'à 97 °C, lorsque les GTE sont situés sur la paroi interne du réservoir. Plus les GTE sont proches des gaz d'échappement, plus la puissance totale produite par les GTE est élevée et plus la température de l'eau est basse. La puissance produite par un GTE en contact direct avec les gaz d'échappement est de 0,35 W et la température de l'eau de 76 °C. De plus, un CTDS avec GTE situé sur toutes les couches peut générer de l'eau chaude jusqu'à 52 W et 81 °C, mais cette configuration a un coût initial élevé. Des préoccupations économiques et environnementales sont prises en compte. Les résultats montrent que le CTDS avec GTE situé sur la paroi interne du tuyau a une période de récupération de 1 an et 8 mois lorsque l'eau est chauffée 60 fois par mois. En outre, il a été démontré que l'emplacement des GTE n'affecte pas la quantité de CO₂ réduite, qui est d'environ 6 tonnes par an. Enfin, cette étude montre que la configuration dans laquelle les GTE sont placés sur la paroi interne du tuyau constitue la configuration de récupération d'énergie la plus rentable.



Research Paper

Domestic thermoelectric cogeneration system optimization analysis, energy consumption and CO₂ emissions reductionHassan Jaber^a, Mohamad Ramadan^a, Thierry Iemenand^b, Mahmoud Khaled^{a,c,*}^a Energy and Thermo-Fluid Group, School of Engineering, International University of Beirut BIU, Beirut, Lebanon^b LARIS EA 7315, ISTIA, University of Angers, Angers, France^c Univ Paris Diderot, Sorbonne Paris Cité, Interdisciplinary Energy Research Institute (PIERI), Paris, France

HIGHLIGHTS

- A domestic thermoelectric cogeneration system is suggested.
- The concept is drawn and the corresponding thermal modeling is developed.
- An optimization analysis is carried out using the thermal modeling.
- Results show that water can be heated to up to 97 °C.
- When TEGs are placed at the pipe inner wall, the concept is the most cost-effective.

ARTICLE INFO

Article history:

Received 11 September 2017

Revised 16 October 2017

Accepted 27 October 2017

Available online 7 November 2017

Keywords:

Carbon dioxide emission
Domestic hot water
Energy consumption
Domestic thermoelectric cogeneration system
Heat recovery
Optimization
Thermal modeling

ABSTRACT

In this paper, a domestic thermoelectric cogeneration system (DCS) is suggested. This system permits to use the lost heat of exhaust gases to simultaneously heat water and produce electricity via thermoelectric generators (TEG). To proceed, the concept of the system is drawn and the corresponding thermal modeling is developed. An optimization analysis, based on the position of the thermoelectric generators within the system, is carried out using the thermal modeling. The TEGs are placed on the inner or outer walls of the tank or the pipe (cases 2–5), or on all of them (case 6). Results show that water can be heated to up to 97 °C, when TEGs are located on the inner wall of the tank. More the TEGs are nearer to the exhaust gases, higher is the total power produced by the TEGs and lower is the water temperature. The power produced by one TEG in direct contact with the exhaust gases is 0.35 W and the water temperature is 76 °C. Also, a DCS with TEG located at all layers can generate up to 52 W and 81 °C hot water, however this configuration has high initial cost. An economic and environmental concerns are considered. Results show that DCS with TEGs located on the inner wall of the pipe has a payback period of 1 year and 8 months when water is heated 60 times per month. In addition to that, it was shown that the location of TEGs do not affect the amount of CO₂ gas reduced which is about 6 tons yearly. Finally, this study shows that the configuration where TEGs are placed at the inner wall of the pipe is the most cost-effective energy recovery configuration.

© 2017 Elsevier Ltd. All rights reserved.

1. Introduction

1.1. Background

The driving forces to seek new sources of energy are energy depletion, high cost of energy, and strict laws related to energy issued by governments. World population has a growth rate of

1.2% with an expected increase in population to 8.9 billion in 2050 and it certainly indicates to a high and growing rate in the demand on energy. Energy management, sustainability and renewable energy are excellent solutions envisaged to remedy to the energy increase since the new adopted solutions need to be sustainable in order to meet energy demand of future generations.

Renewable energy, which includes solar, wind, wave, biomass, and others, is being an effective new source of energy nowadays [1–5]. However, this source is facing some limitations related to its availability, location, low efficiency, high initial cost, and other

* Corresponding author at: Energy and Thermo-Fluid Group, School of Engineering, International University of Beirut BIU, Beirut, Lebanon.

E-mail address: mahmoud.khaled@liu.edu.lb (M. Khaled).

Nomenclature

A	area [m ²]	conv,air	convection between air and tank's wall
h	convection heat transfer coefficient [W/m ² K]	conv,i	convection between gases and pipe's surface
ρ	density [kg/m ³]	conv,w-p	convection between water and pipe's surface
q	heat transfer rate [W]	conv,w-w	convection between water and tank's wall
L	length of the tank [m]	g	gases
m	mass [kg]	H	hot
N	number of items	p,i	inner pipe
P	power produced [W]	w,i	inner tank wall
$P_{1\ TEG}$	power produced by one TEG [W]	p,o	outer pipe
r	radius [m]	w,o	outer tank wall
T_a	temperature [°C]	p	pipe
ΔT	temperature difference at the sides of the TEG [°C]	sur,Pi	pipe inner surface
k	thermal conductivity [W/m K]	sur,Po	pipe outer surface
R	thermal resistance [K/W]	wall,i	tank wall inner surface
e	thickness of the TEG [m]	wall,o	tank wall outer surface
V	volume [m ³]	TEG	thermoelectric generator
		w	water
Subscripts			
a	ambient		
c	cold		

major limitations that makes researchers vigilant in the implementation.

Energy management is a technique implemented actually to assist renewable energies [6–9]. This technique is highly related to finding ways of enhancing the way of using energy and/or recovering lost energy. Many residential and industrial applications depend on thermal energy, in which part of this energy is being used and the other is dumped in environment without taking advantage of it. This thermal energy lost can be dumped either by exhaust gases, or cooling air, or cooling water. Heat recovery can be applied on many applications with different methods for a variety of recovery purposes. Jaber et al. [10] presented a review on heat recovery systems classifying them according to the quality of energy lost (temperature of gases), equipment used, and purposes of the heat recovery. Heat recovery purposes could be for generating electricity, heating, cooling, or storing energy for a later use, or even by a combination of more than one purpose as a hybrid heat recovery system.

1.2. Heat recovery from exhaust gases

Heat lost in mechanical systems is usually through exhaust gases as in boilers [11–14], heat pump [15,16], industrial furnace [17,18], generators [19–21], internal combustion engines (ICE) [22–28], chimneys [29,30], and other applications [31–35] or by heating, ventilating, and air conditioning (HVAC) systems [36,37], and hot water [38–42]. Hossain and Bari [43] performed an experimental study on heat recovery from exhaust gases of a 40 kW diesel generator using different organic fluids. In a shell and tube heat exchanger, water, ammonia and HFC 134a were utilized as working fluids. Results show that using water can produce 10% additional power compared to ammonia (9%) and HFC 134a (8%). Prabu and Asokan [44] carried out a study of heat recovery from ICE using phase change material. It was shown that about 4–7% of the heat lost was recovered, and the maximum energy saved at full load in thermal storage tank achieved 0.5 kW. In addition, the heat recovery process suggested can be enhanced by increasing the effective area of the heat recovery heat exchanger. Najjar et al. [45] presented a heat recovery system applied to gas turbine in order to cool inlet air temperature to the turbine engine. Two cycles were constructed: the first cycle permits to produce power

by propane organic Rankine cycle which will be used in the second cycle; the second cycle is a gas refrigeration cycle used to cool the air entering the turbine engine. It was found that 35% and 50% increase in the net power and overall efficiency were achieved respectively, by dropping the inlet air temperature 15 °C. Economical study showed that about two years are required to payback the project. Gao et al. [46] performed a review on heat recovery from stoves using thermoelectric generators (TEG). Thermoelectric generators are utilized to drive a fan that pushes air to the furnace, optimizing the air to fuel ratio which improved combustion efficiency. TEGs can also be used to power a light or radio or other low electric consuming machines. Khaled et al. [30] carried out an experimental study about heat recovery from exhaust gases of a chimney for generating domestic hot water. Results show that by one hour temperature of water increased 68 °C, and 70% of the heat gain by water was from the bottom side of the prototype used (heat transfer by convection and radiation).

1.3. Power generation using thermo-electricity

Many studies were performed on thermoelectric generators [47–51]. Jang and Tsai [52] performed a parametric study for the thermal and electrical properties of thermoelectric module utilizing waste heat experimentally and numerically. The effect of changing the size of spreader was studied to show that when using a proper size of the spreader the thermal resistance decreases and the maximum total power increases (up to 50%). Lu et al. [53] carried out a numerical study on the effect of heat enhancement for exhaust gases on the performance of thermoelectric generators. Two types of heat transfer enhancements (rectangular offset-strip fins and metal foams) are investigated. Results show that metal foam with low porosity would maximize the power produced by TEG more than the rectangular offset-strip. Navarro-Peris et al. [54] presented a study about producing electricity by TEGs that utilized heat lost from a compressor, which increases the efficiency of refrigeration and heat pump system. An experimental study was carried out varying the heat sink type. Low power was produced when the system is cooled naturally (natural convection), around 80 W/m² and when the heat sink is subjected to forced convection the power per area increased to 280 W/m² with an increase in temperature difference (44 °C). When cooled

water was utilized as heat sink temperature, the power produced increased up to 1180 W/m². Ma et al. [55] performed a theoretical study on heat recovery from biomass gasifier using thermoelectric generators. The outlet temperature from the gasifier is up to 500 °C. A thermoelectric generator system composed of eight thermoelectric modules is utilized to recover this lost heat. Results showed that the maximum total power produced is 6.1 W with a power density of 193 W/m².

1.4. Motivation

As shown in the literature review presented above, considerable researches are devoted to heat recovery from exhaust gases and power generation using thermoelectric modules. Scarce are the studies that couple between these two energy research fields [56–58]. In this context, the present work suggests a new concept that permits to simultaneously heat water and generate electrical power, as a domestic thermoelectric cogeneration system. To proceed, the concept of the system is drawn and the corresponding thermal modeling is developed. An optimization analysis, based on the position of the thermoelectric generators within the system, is carried out using the thermal modeling. Finally, economic and environmental concerns are considered. It was shown that the configuration where TEGs are placed at the inner wall of the pipe is the most cost-effective energy recovery configuration.

2. Domestic thermoelectric cogeneration system

This section is devoted to the description of the suggested Domestic Thermoelectric Cogeneration System (DTCS). This system is a hybrid heat recovery system utilized to generate domestic hot water and produce electricity from the exhaust gases known as domestic thermoelectric cogeneration system (DTCS). The goal of this hybrid heat recovery system is to heat water mainly and then produce electric power as much as possible (Fig. 1).

Exhaust gases that pass through a pipe release its thermal energy to water that surrounds the pipe located inside a cylindrical tank. At the same time, electricity is produced by thermoelectric generators located as a cylindrical layer over a surface. The main aim from this study is to make a comparison between the temperature of the water and the power produced by TEGs by changing the location of the thermoelectric generators. The location of the thermoelectric generators can be inside or outside the wall of the pipe or inside or outside the wall of the cylindrical tank, or even located at all sides of the pipe and the cylindrical tank. Fig. 2 shows a heat recovery system that generates water heating. Such system will be improved by adding TEGs either on the surfaces of the pipe or the tank in their inner and outer side, or at all positions. Such hybrid heat recovery system can be coupled with many industrial and residential applications that generates high amount of exhaust gases or even relatively low amount of exhaust gases (Fig. 3). Gas or steam power plants, diesel power plants, industrial furnace (glass, steel furnace...), power generators, internal combustion engines, chimneys are applications capable to be coupled with

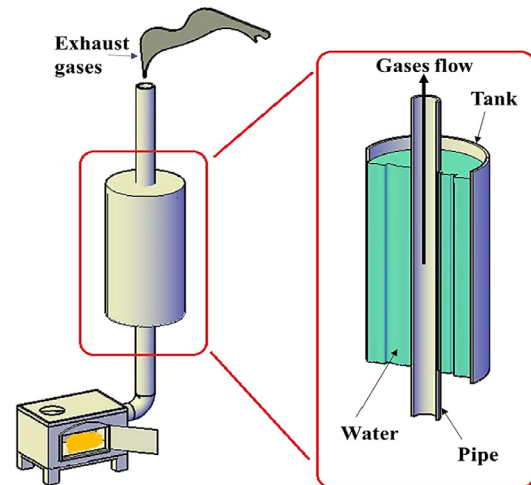

Fig. 2. Heat recovery system.

the hybrid heat recovery system. In this study the domestic thermoelectric cogeneration heat recovery system will be implemented on a chimney, in which exhaust gases from the chimney are utilized to heat water and produce electricity via TEGs.

Six cases will be taken into consideration, the first is a simple heat recovery system utilized just to generate domestic hot water which will be the reference for other cases. The remaining cases are hybrid heat recovery systems in which the location of the TEG is changed. Table 1 shows each case and its corresponding TEGs location. Thermoelectric generators are passive devices used to generate electricity when they are sandwiched in a temperature difference [59]. In each of the hybrid cases [2–6], the heat source and heat sink is changed. In case 2, the heat source is the wall of the cylindrical tank and air is the heat sink, whereas in case 3 water is the heat source and cylindrical tank wall is the heat sink. In cases 4 and 5, the heat source is pipe wall and the exhaust gases respectively whereas the heat sink is the water and pipe wall respectively. Finally, case 6 is a combination of the previous cases 2, 3, 4, and 5.

3. Thermal modeling

A thermal modeling is done in order to obtain the water temperature and the power generated by the thermoelectric generators. It is assumed that the exhaust gases are of constant temperature and mass flow rate (steady state) and one dimensional heat flow. Steps required to calculate water temperature and power output is as follows:

1. Thermal modeling of each case in terms of thermal resistance.
2. Calculation of the total thermal resistance (R_{total}).
3. Calculation of the heat flow rate (q).
4. Calculation of the temperature at each point.
5. Calculation of the temperature difference at the surfaces of the TEG.
6. Calculation of the power generated by one TEG ($P_{1\ TEG}$).
7. Calculation of the number of TEG available (N_{TEG}).
8. Calculation of the total power produced by TEGs (P_{total}).

Starting by the thermal modeling, Table 2 shows the thermal modeling of each case in terms of thermal resistance where $T_{g,i}$, $T_{sur,pi}$, $T_{sur,po}$, T_w , $T_{wall,i}$, $T_{wall,o}$, T_a , T_H and T_c are the temperature of exhaust gases, inner pipe surface, outer pipe surface, water, inner cylindrical tank surface, outer cylindrical tank surface, ambient,

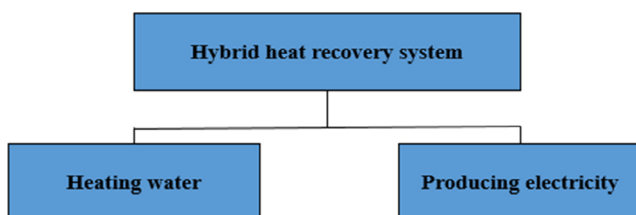

Fig. 1. Hybrid heat recovery goals.

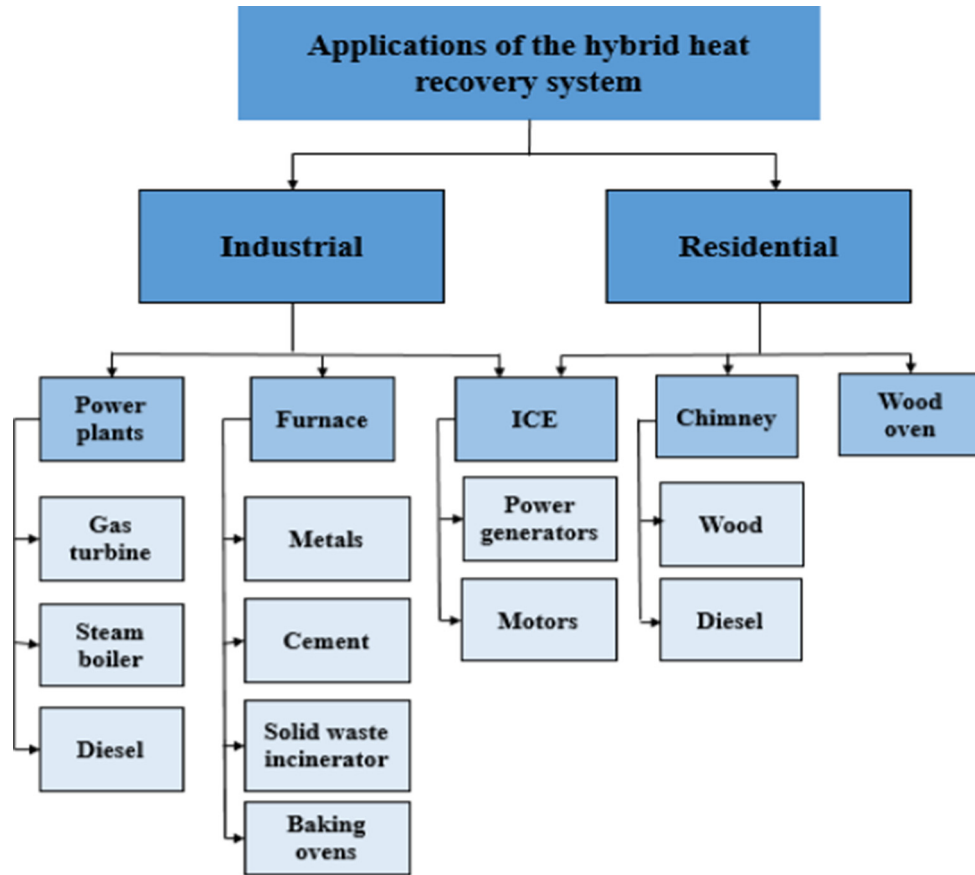

Fig. 3. Applications of the hybrid heat recovery system.

Table 1
Location of TEGs in each studied case.

Case number	TEG position	Thermal layers
1 (reference)	Without TEG	
2	At the outer radius of cylinder's wall	
3	At the inner radius of cylinder's wall	
4	At the outer radius of pipe's wall	
5	At the inner radius of pipe's wall	
6	At the inner and outer radius of the pipe and cylinder	

hot side of TEG, and cold side of TEG respectively. $R_{conv,i}$, R_p , $R_{conv,w-p}$, $R_{conv,w-w}$, R_{wall} , and $R_{conv,air}$, R_{TEG} are the thermal resistance of internal convection of gases in pipe, conduction in the pipe wall, convection between water and pipe, convection between water and cylindrical tank wall, conduction in the cylindrical tank wall, convection of tank with air, and conduction in thermoelectric generator respectively.

The heat flow rate (q) can be calculated with the following equation:

$$q = \frac{\Delta T}{R_{Total}} \quad (1)$$

where ΔT is the temperature difference between exhaust gases and ambient air:

$$\Delta T = T_{g,i} - T_a \quad (2)$$

and R_{total} is the summation of the thermal resistance in each case, described below for the studied cases.

For case 1, Fig. 4 shows a cross section of the system where the temperature points are viewed.

$R_{conv,i}$, R_p , $R_{conv,w-p}$, $R_{conv,w-w}$, R_{wall} , and $R_{conv,air}$ are as follows:

$$R_{conv,i} = \frac{1}{h_g(2\pi r_{p,i}L)} \quad (3)$$



$$R_p = \frac{\ln \left[\frac{r_{p,o}}{r_{p,i}} \right]}{2\pi k_p L} \quad (4)$$

$$R_{conv,w-p} = \frac{1}{h_w(2\pi r_{p,o}L)} \quad (5)$$

$$R_{conv,w-w} = \frac{1}{h_w(2\pi r_{w,i}L)} \quad (6)$$

$$R_{wall} = \frac{\ln \left[\frac{r_{w,o}}{r_{w,i}} \right]}{2\pi k_w L} \quad (7)$$

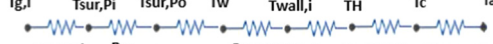
Table 2
Thermal modeling of each case.

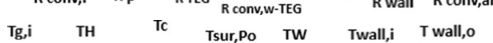
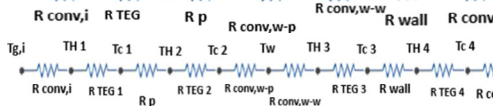
Case number	TEG position	Thermal equivalent circuit
1	Without TEG	$T_{g,i} \quad T_{sur,Pi} \quad T_{sur,Po} \quad T_w \quad T_{wall,i} \quad T_{wall,o} \quad T_a$ 
2	At the outer radius of cylinder's wall	$T_{g,i} \quad T_{sur,Pi} \quad T_{sur,Po} \quad T_w \quad T_{wall,i} \quad T_H \quad T_c \quad T_a$ 
3	At the inner radius of cylinder's wall	$T_{g,i} \quad T_{sur,Pi} \quad T_{sur,Po} \quad T_w \quad T_H \quad T_c \quad T_{wall,o} \quad T_a$ 
4	At the outer radius of pipe's wall	$T_{g,i} \quad T_{sur,Pi} \quad T_H \quad T_c \quad T_w \quad T_{wall,i} \quad T_{wall,o} \quad T_a$ 
5	At the inner radius of pipe's wall	$T_{g,i} \quad T_H \quad T_c \quad T_{sur,Po} \quad T_w \quad T_{wall,i} \quad T_{wall,o} \quad T_a$ 
6	At the inner and outer radius of the pipe and cylinder	$T_{g,i} \quad T_H 1 \quad T_c 1 \quad T_H 2 \quad T_c 2 \quad T_w \quad T_H 3 \quad T_c 3 \quad T_H 4 \quad T_c 4 \quad T_a$ 

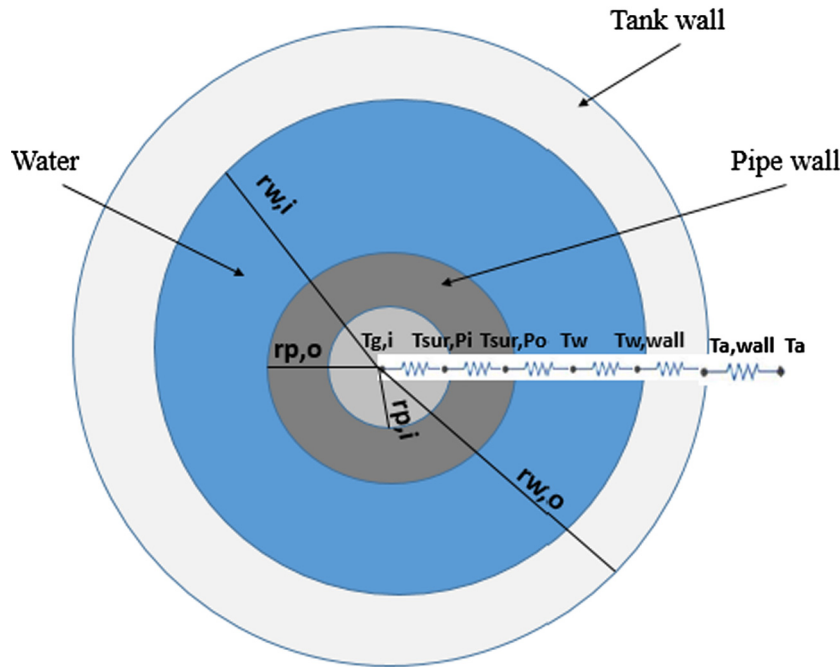

Fig. 4. Top cross sectional view of the cogeneration system in case 1.

$$R_{conv,air} = \frac{1}{h_a(2\pi r_{w,o}L)} \quad (8)$$

For case 2, Fig. 5 presents the top view of the tank, it shows the TEG layer at the outer surface of the tank.

$R_{conv,i}$, R_p , $R_{conv,w-p}$, $R_{conv,w-w}$ and R_{wall} are as case 1, whereas R_{TEG} and $R_{conv,air}$ are:

$$R_{TEG} = \frac{\ln \left[\frac{r_{w,o}+e}{r_{w,o}} \right]}{2\pi k_{TEG}L} \quad (9)$$

$$R_{conv,air} = \frac{1}{h_a(2\pi(r_{w,o} + e)L)} \quad (10)$$

For case 3, Fig. 6 shows the top view of the cylinder where the TEGs layer are located at the inner surface of the tank.

$R_{conv,i}$, R_p , $R_{conv,w-p}$, R_{wall} and $R_{conv,air}$ are as the reference case 1 whereas R_{TEG} and $R_{conv,w-w}$ are:

$$R_{TEG} = \frac{\ln \left[\frac{r_{w,i}}{r_{w,i}-e} \right]}{2\pi k_{TEG}L} \quad (11)$$

$$R_{conv,w-w} = \frac{1}{h_w(2\pi(r_{w,i} - e)L)} \quad (12)$$

For case 4, Fig. 7 presents a top cross section of the tank, TEGs are located at the outer surface of the pipe.

$R_{conv,i}$, R_p , $R_{conv,w-w}$, R_{wall} and $R_{conv,air}$ are as the reference case, whereas R_{TEG} and $R_{conv,w-p}$ are:

$$R_{TEG} = \frac{\ln \left[\frac{r_{p,o}+e}{r_{p,o}} \right]}{2\pi k_{TEG}L} \quad (13)$$

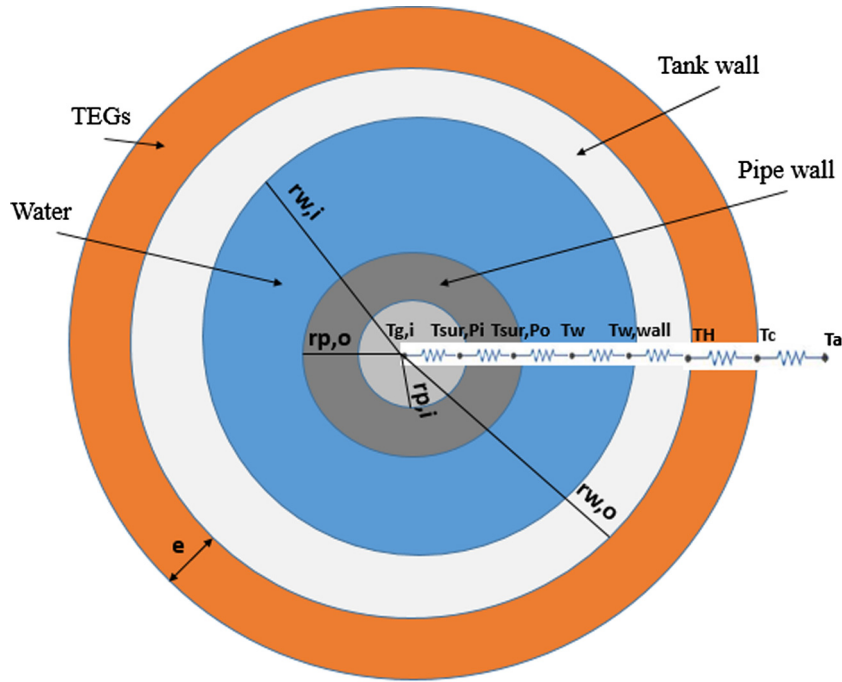

Fig. 5. Top cross sectional view of the cogeneration system in case 2.

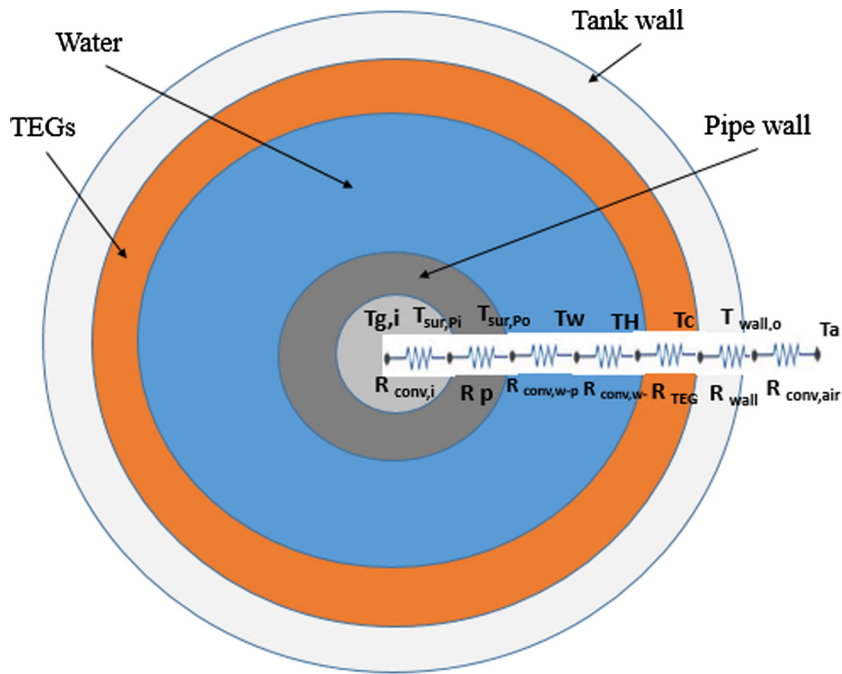

Fig. 6. Top cross sectional view of the cogeneration system in case 3.

$$R_{conv,w-p} = \frac{1}{h_w(2\pi(r_{p,o} + e)L)} \quad (14)$$

For case 5, Fig. 8 shows a cross sectional top view of the tank in which TEGs are located at the inner surface of the pipe in a direct contact with exhaust gases.

R_p , $R_{conv,w-p}$, $R_{conv,w-w}$, R_{wall} and $R_{conv,air}$ are as the reference case 1, whereas R_{TEG} and $R_{conv,i}$ are:

$$R_{TEG} = \frac{\ln\left[\frac{r_{p,i}}{r_{p,i}-e}\right]}{2\pi k_{TEG}L} \quad (15)$$

$$R_{conv,i} = \frac{1}{h_g(2\pi(r_{p,i} - e)L)} \quad (16)$$

For case 6, Fig. 9 shows the top cross sectional view in which four layers of TEGs are shown, located at the inner, and outer surface of the pipe and at the inner, and outer surface of the tank.

R_p and R_{wall} are as the reference case 1, whereas $R_{conv,i}$, R_{TEG} , $R_{conv,w-p}$, $R_{conv,w-w}$ and $R_{conv,air}$ are:

$$R_{conv,i} = \frac{1}{h_g(2\pi(r_{p,i} - e)L)} \quad (17)$$

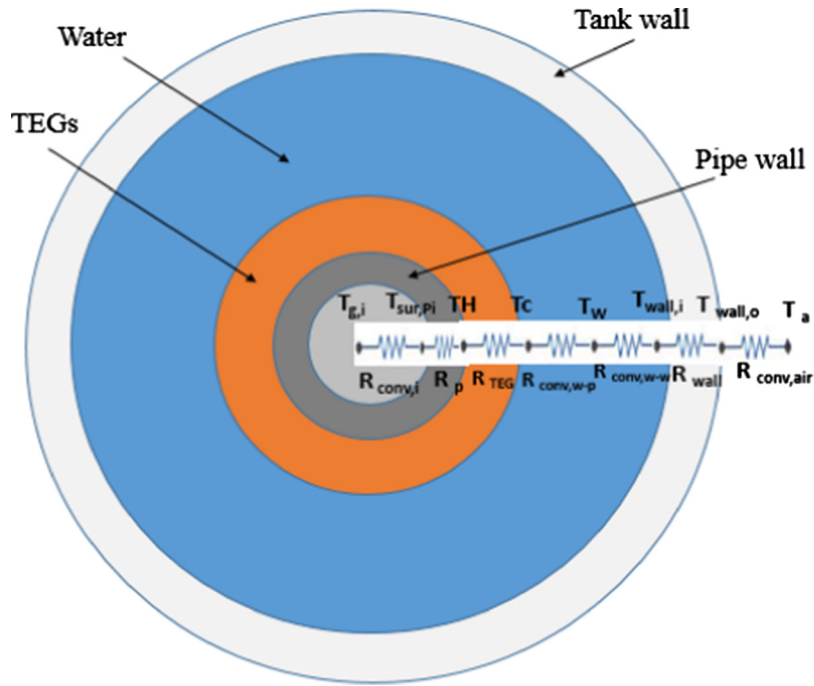

Fig. 7. Top cross sectional view of the cogeneration system in case 4.

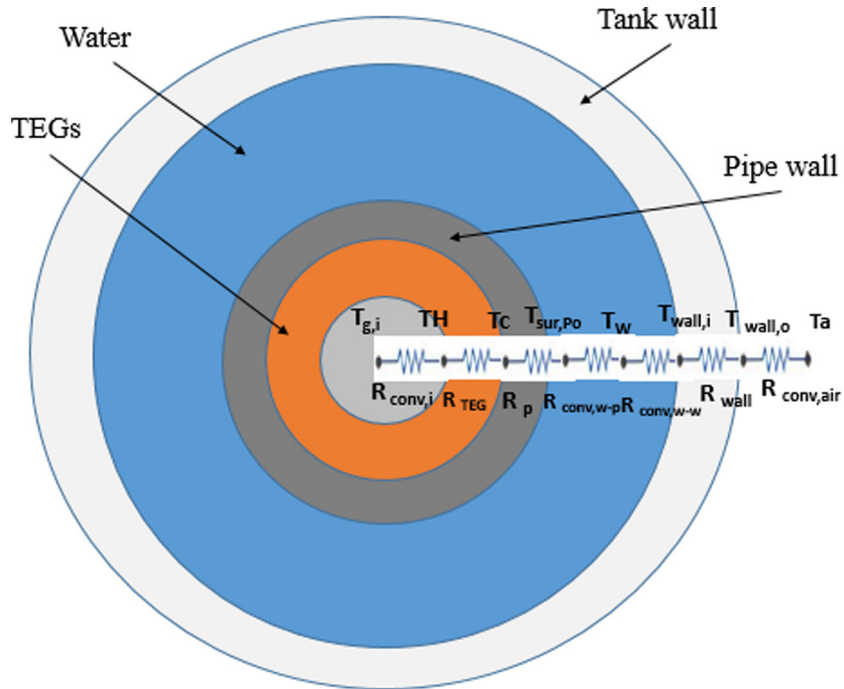

Fig. 8. Top cross sectional view of the cogeneration system in case 5.

$$R_{TEG1} = \frac{\ln \left[\frac{r_{p,i}}{r_{p,i}-e} \right]}{2\pi k_{TEG}L}$$

$$(18) \quad R_{conv,w-w} = \frac{1}{h_w(2\pi(r_{w,i} - e)L)} \quad (21)$$

$$R_{TEG2} = \frac{\ln \left[\frac{r_{p,o}+e}{r_{p,o}} \right]}{2\pi k_{TEG}L}$$

$$(19) \quad R_{TEG3} = \frac{\ln \left[\frac{r_{w,i}}{r_{w,i}-e} \right]}{2\pi k_{TEG}L} \quad (22)$$

$$R_{conv,w-p} = \frac{1}{h_w(2\pi(r_{p,o} + e)L)}$$

$$(20) \quad R_{TEG4} = \frac{\ln \left[\frac{r_{w,o}+e}{r_{w,o}} \right]}{2\pi k_{TEG}L} \quad (23)$$

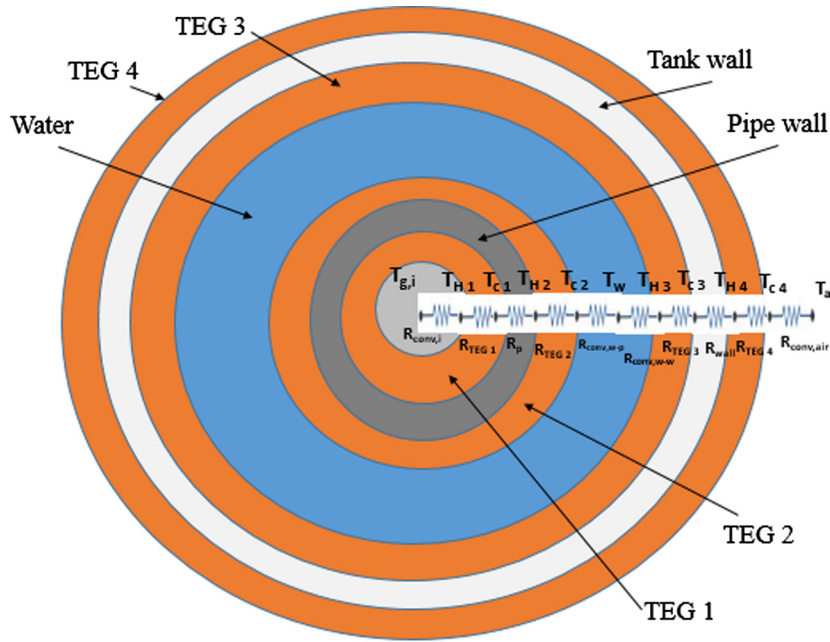

Fig. 9. Top cross sectional view of the cogeneration system in case 6.

$$R_{conv,air} = \frac{1}{h_a(2\pi(r_{w,o} + e)L)} \quad (24)$$

where $r_{p,i}$, $r_{p,o}$, $r_{w,i}$ and $r_{w,o}$ are the inner, outer radius of the pipe and inner, outer radius of the tank wall respectively, e is the thickness of the thermoelectric generator, h_g , h_w , and h_a are the convection heat transfer coefficient of the exhaust gases, water and air respectively.

Heat flow rate is constant over the system then the temperature at each point can be calculated:

$$T_{(n)} = T_{(n-1)} - qR_{(n)} \quad (25)$$

where “n” is the layer number measured from the exhaust gases to the air. Then the hot and cold temperature at the sides of the TEG is estimated, this allows the calculation of the power output of one TEG:

$$\left(\frac{P}{\Delta T^2}\right)_{Ref} = \left(\frac{P_{1TEG}}{\Delta T^2}\right) \quad (26)$$

$$P_{1TEG} = \left(\frac{P}{\Delta T^2}\right)_{Ref} \Delta T^2 \quad (27)$$

where P_{1TEG} is the output power of one TEG, ΔT is the temperature difference between the heat source and heat sink of the TEG, and $\left(\frac{P}{\Delta T^2}\right)_{Ref}$ is given by the manufacturer of the TEG.

In order to obtain the number of TEGs available, area of TEG should be calculated in addition to the area of the wall that the TEGs are located on ($A_{TEG\ wall}$), then number of TEGs (N_{TEG}) will be:

$$N_{TEG} = \frac{A_{TEG\ wall}}{A_{TEG}} \quad (28)$$

Then the total power generated (P_{total}) is:

$$P_{Total} = N_{TEG} \cdot P_{1TEG} \quad (29)$$

4. Case study, results and discussion

A case study was considered in order to check the change in the water temperature and the power generated by changing the

thermoelectric generator location, in which a heat recovery system form exhaust gases of a chimney in Lebanon has been studied. The study is composed of two stages experimental and analytical.

4.1. Experimental data

The part related to the parameters of the exhaust gases was estimated experimentally, in which an experiment was done in order to measure the temperature of the exhaust gases that flows out from the chimney. Fig. 10 shows a Diesel chimney used in the experiment.

The ambient air temperature and the exhaust gases temperature was measured using a K type thermocouple. The temperature of the exhaust gases fluctuates during the experiment (Fig. 11) having an average value of 300 °C.

4.2. Analytical study

It should be noted that the temperature of the exhaust gases was estimated experimentally. The recovery system parameters utilized in the experiment are summarized in Table 3.

About 187 L of water are contained in an iron tank. The pipe is formed from copper to enhance the heat transfer between exhaust gases and water or TEGs. The thermoelectric generator used is “TEG1-12611-8.0” 56*56 mm. It should be noticed that this study was carried out on a specific type of TEG. However when the type of TEG is changed, the thermal resistance, the power produced, the water temperature, the figure of merit, and the energy conversion efficiency will change. The exhaust gases temperature is measured directly before the gases enter the recovery tank, in which this temperature is taken as average temperature after waiting the system to stabilize (temperature fluctuates over time). Table 4 shows the main results by applying the equations listed above in the previous section.

By checking the total resistance in each case it shows that R_{total} is lowest when there is no TEG, and it starts to increase by adding TEGs. Also it increases when the location of the TEG become nearer to the exhaust gases. And it is highest when the thermoelectric generators are added in all locations (case 6). This increase in total



Fig. 10. Diesel chimney used in the experiment.

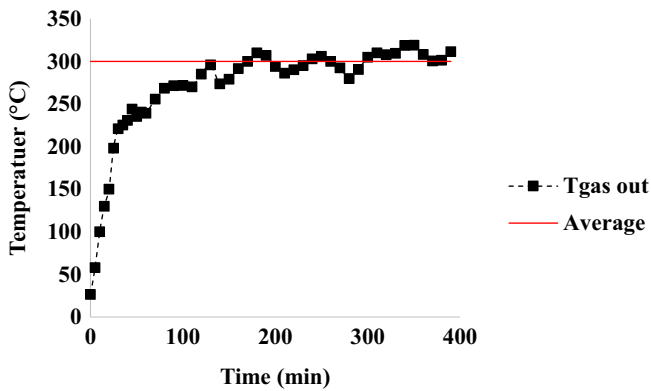

Fig. 11. Exhaust gases outlet temperature from chimney.

Table 3
Main parameters used in this study [60,61].

Parameter	Value	Unit
$r_{p,i}$	0.049	m
$r_{p,o}$	0.05	m
L	1	m
$r_{w,i}$	0.249	m
$r_{w,o}$	0.25	m
h_g	85	W/m ² K
h_{water}	300	W/m ² K
h_{air}	50	W/m ² K
k_p	401	W/m K
k_{wall}	80	W/m K
k_{TEG}	1.4	W/m K
T_g	300	°C
T_a	25	°C
e	0.005	m
$P/\Delta T^2$	0.0002	W/K ²
A_{TEG}	0.0031	m ²

resistance led to a decrease in heat flow rate from exhaust gases to the ambient, this means that lower energy is being dissipated to the environment. This change in total resistance led to a change in temperature distribution over the system as shown in Table 5 below.

It should be noted that since the temperature of the exhaust gases are assumed to be constant over the length of the tank this results will be the same along the length of the tank. Fig. 12 shows the temperature profile over the cross section of the tank. It shows that the temperature decrease rapidly at the pipe, this is due to the low convection heat transfer coefficient of gases at a small distance (radius of the pipe 25 mm). However in water, temperature decreases as it become far away from the pipe but with low slope which is due to the high convection heat transfer coefficient of water (300 W/m² K).

The main gains from this hybrid heat recovery system are the water temperature and the output power generated. Table 5 above shows that water temperature has increased in case 2, and 3 more than in the reference case 1 because of the heat trapped inside the tank by adding more thermal resistance at the wall of the tank. Besides the water temperature has increased more when the TEGs are located in the inner wall of the tank (case 3). While when the TEGs are located on the inner or outer surface of the pipe (cases 4 or 5) the water temperature becomes less than in cases 1, 2 and 3, this is due to the thermal energy absorbed by the TEGs before being given to the water. Also, by locating the TEGs in pipe's outer surface (case 5) the temperature of water is higher than when TEGs are located at the inner surface of the TEGs (case 4). This means that when the TEGs are inside the pipe (in a direct contact with the exhaust gases) they absorb more thermal energy than when they are in an indirect contact (case 2, 3, and 4). In the last case (case 6) water temperature is relatively in the range of case 4 and 5. Fig. 13 shows the water temperature in each case, the maximum water temperature achieved is 97 °C in case 3 and the minimum temperature is 76 °C in case 5. The water temperature varied in a relatively high range (about 20 °C) when the TEGs location have been changed.

Regarding the power generated by TEGs, Eq. (27), it shows that the power is directly proportional to the square of the temperature difference between the heat source and sink of the TEGs. Then as the temperature difference increases, power produced increases. Table 4 above shows that when the TEGs are in the inner surface of the tank it involves more temperature difference than when it is in the outer surface. However it implies maximum temperature difference when the TEGs are located in the inner surface of the pipe (direct contact with exhaust gases). Also it shows that the temperature difference is higher when the TEGs are located in the pipe surfaces (inner or outer) more than when the TEGs are located at the tank surfaces. For the last case (case 6) the temperature difference decreases as the TEGs location become far away from the exhaust gases.

The maximum power produced per one TEG is on the fifth case, but the maximum total power is for case 6. It should be noted that fifth case has much less TEGs than second, third, and fourth case (shown in Table 4 above) but produces higher power output. Regarding case 6 the power produced per one TEG is less than the power produced in the other cases at each stage, but the total power produced is higher than the other cases. Fig. 14 shows the power generated per one TEG, on which obviously appears that the maximum power generated by one TEG is in case 5 (0.35 W). This means that the TEGs are maximally utilized in case 5 which increases the efficiency of the thermoelectric generator.

Fig. 15 shows the total power produced by thermoelectric generators in each case.

The maximum power produced is 52 W in case 6 and minimum power is in case 2 (6.8 W). Comparing cases 2 and 3, case 3 produces about 4% more power than case 2. While in case 5 the power produced increases about 5% compared to case 4. And comparing cases 2–3 with 4–5, cases 4–5 produces about 400% more power than cases 2–3 can produce.

Table 4
Main results obtained in the six studied cases, temperatures expressed in °C.

Case number	R_{total} (°C/W)	q (W)	T_w (°C)	TEG location	ΔT	Number of TEG	Power of 1 TEG (W)	P_{total} (W)	
Case 1	0.063	4317	89	Null	0	0	0	0	
Case 2	0.065	4186	96	Outer tank's surface	9.4	385	0.0177	6.8	
Case 3	0.066	4163	97	Inner tank's surface	9.6	383	0.0180	7.1	
Case 4	0.073	3738	81	Outer pipe's surface	40	101	0.32	33.1	
Case 5	0.080	3426	76	Inner pipe's surface	42	99	0.35	34.8	
Case 6	0.094	2910	81	Inner pipe's surface	36	99	0.25	25.1	52
				Outer pipe's surface	32	101	0.19	20.1	
				Inner tank's surface	6.7	383	0.009	3.5	
				Outer tank's surface	6.6	385	0.008	3.3	

Table 5
Temperature distribution over the system and power produced by the TEGs.

Case 1	$T_{g,i}$ 300	$T_{sur,Pl}$ 135	$T_{sur,Po}$ 134	T_w 89	$T_{wall,i}$ 80	$T_{wall,o}$ 79	T_a 25				
Case 2	$T_{g,i}$ 300	$T_{sur,Pl}$ 140	$T_{sur,Po}$ 139	T_w 96	$T_{wall,i}$ 87	T_H 86	T_c 77	T_a 25			
Case 3	$T_{g,i}$ 300	$T_{sur,Pl}$ 141	$T_{sur,Po}$ 140	T_w 97	T_H 88	T_c 79	$T_{wall,o}$ 78	T_a 25			
Case 4	$T_{g,i}$ 300	$T_{sur,Pl}$ 157	T_H 156	T_c 116	T_w 81	$T_{wall,i}$ 73	$T_{wall,o}$ 72	T_a 25			
Case 5	$T_{g,i}$ 300	T_H 154	T_c 113	$T_{sur,Po}$ 112	T_w 76	$T_{wall,i}$ 69	$T_{wall,o}$ 68	T_a 25			
Case 6	$T_{g,i}$ 300	$T_{H 1}$ 176	$T_{c 1}$ 141	$T_{H 2}$ 140	$T_{c 2}$ 109	T_w 81	$T_{H 3}$ 75	$T_{c 3}$ 68	$T_{H 4}$ 67	$T_{c 4}$ 61	T_a 25

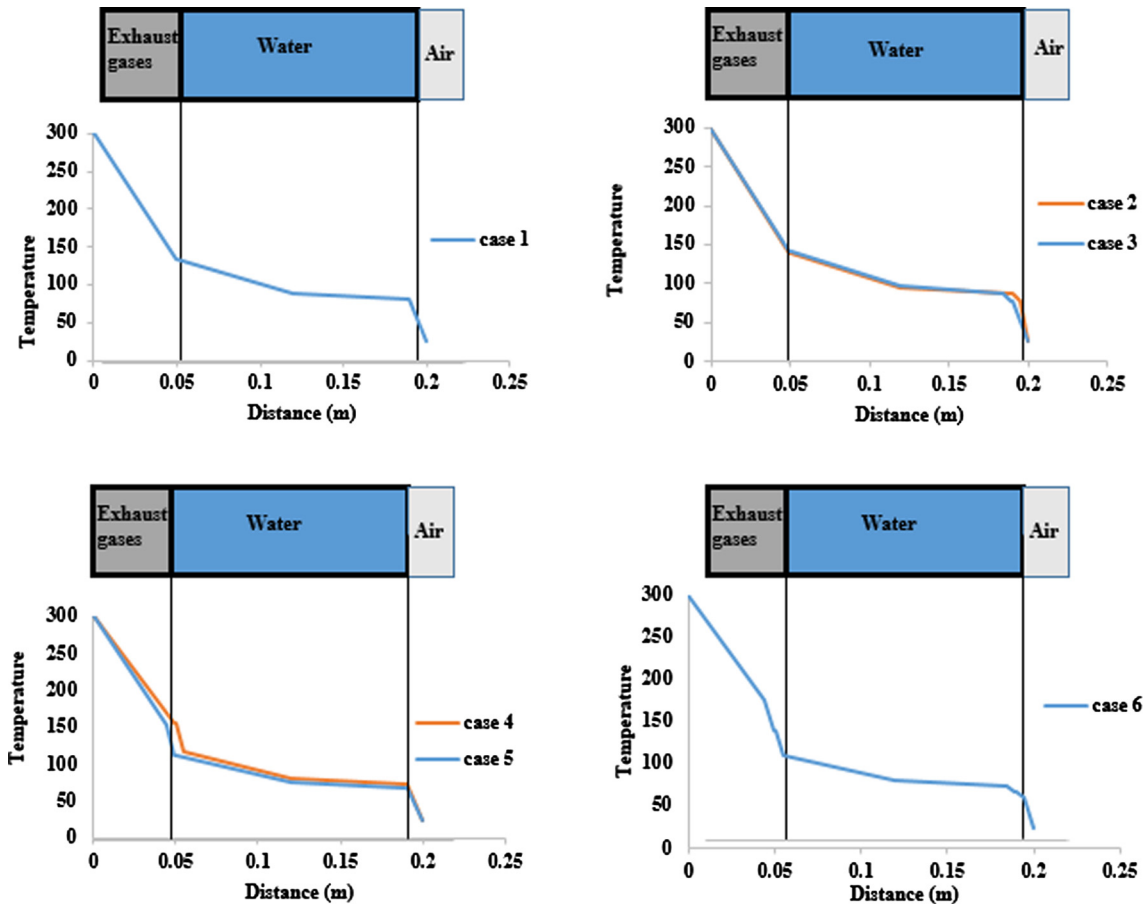

Fig. 12. Temperature profile over the cylindrical tank.

Regarding the thermal energy lost with the surrounding, Fig. 16 shows that case 5 has the lowest outer tank wall temperature, if case 6 is excluded from comparison. For the 6th case the tempera-

ture of the outer wall of the tank is lower than all the previous cases, due to the energy absorption by the multi-stages of TEGs. Comparing cases 2, 3, 4, and 5, case 5 provides the lowest thermal

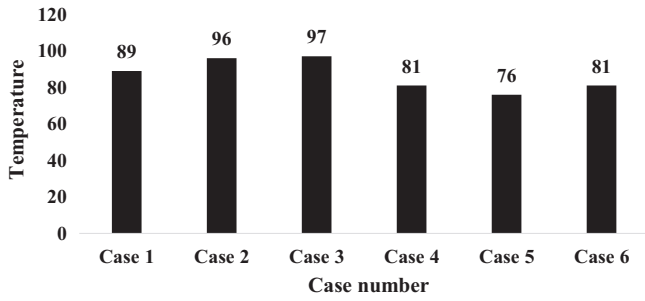

Fig. 13. Water temperature variation in each case.

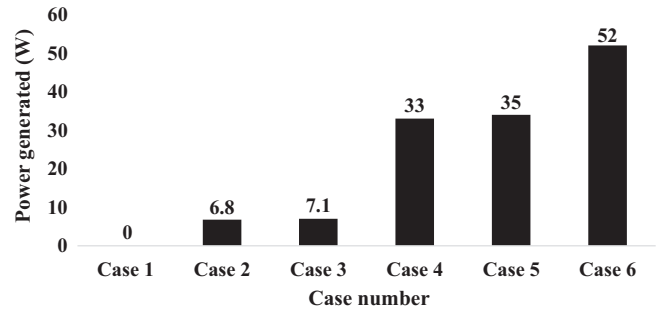

Fig. 15. Total power generated by thermoelectric generators.

energy loss. This made case 5 with the lowest thermal energy lost and highest power produced by TEGs compared to cases 2, 3, and 4.

5. Economic and environmental concerns

It should be noted that locating the TEGs at the surface of the pipe would decrease the cost 75% compared to locating TEGs at the tank's surfaces (number of TEGs located at the pipe is about 1/4 number of TEGs located at the tank). Fig. 17 shows the power generated and the cost of TEGs at each stage, knowing that the cost of one TEG is given by the manufacturer (20 \$/1 TEG) [61].

As shown in Fig. 17, if the water temperature is the major requirement, then case 3 is the best. However, if the power generated is the major requirement without taking into consideration the cost, case 6 is the best. On the other hand, if the cost and power are major requirements then case 5 is the best since case 5 has a relatively high water temperature, high power generated, low thermal energy losses with ambient air, and low cost of thermoelectric generators compared to case 2, 3, and 4.

For a cost-effective heat recovery system, case 5 is the best choice since it produces relatively high power with low number of TEGs (low cost). Also water temperature is relatively acceptable compared to the maximum water temperature and it has the lowest thermal energy losses.

Then, the total price of the system is calculated as the sum of the price of iron tank, the price of the copper pipe and the assembly process in addition to the price of the thermoelectric generators.

The price of the iron used to make the tank is calculated by the equation below:

$$\text{price of iron} = m_{\text{iron}} \times \text{price of 1 kg of iron} \quad (30)$$

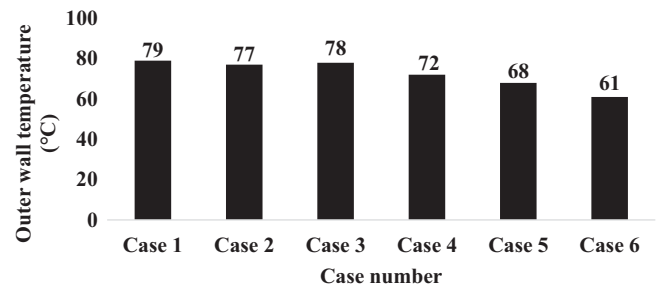

Fig. 16. Outer wall temperature in each case.

where m_{iron} is the mass of iron. The price of 1 kg of the iron used is 3 USD. The mass of the iron is estimated as follows:

$$m_{\text{iron}} = V_{\text{iron}} \rho_{\text{iron}} \quad (31)$$

where V_{iron} and ρ_{iron} are the volume and density of iron respectively. The density of iron is 7850 kg/m³. Eq. (32) shows how to calculate the volume of iron:

$$V_{\text{iron}} = \pi L(r_{w,o}^2 - r_{w,i}^2) + 2\pi r_{w,o}^2 l \quad (32)$$

where l is the thickness of the iron sheet at the upper and lower part of the tank. By applying the previous equations, $V_{\text{iron}} = 0.0024 \text{ m}^3$, $m_{\text{iron}} = 18.5 \text{ kg}$, and the total cost of the iron used is 56 \$.

Then the price of the copper can be estimated by the following equations:

$$\text{price of copper} = m_{\text{copper}} \times \text{price of 1 kg of copper} \quad (33)$$

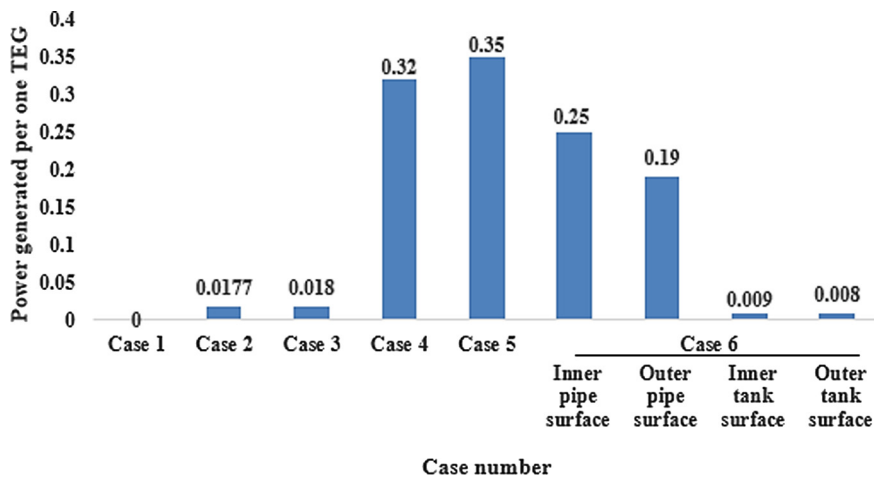

Fig. 14. Power generated per one TEG in the six studied cases.

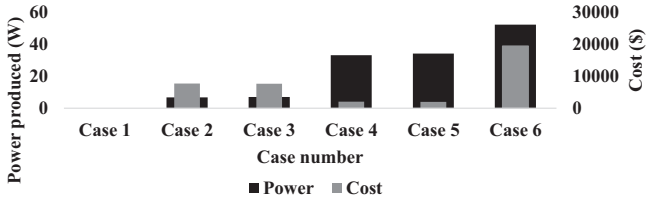

Fig. 17. Total power generated and total cost of the TEGs in each case.

$$m_{copper} = V_{copper} \rho_{copper} \quad (34)$$

$$V_{copper} = \pi L (r_{p,o}^2 - r_{p,i}^2) \quad (35)$$

where m_{copper} , V_{copper} and ρ_{copper} are the mass, volume, and density of copper respectively. The density of copper is 8940 kg/m³, and the price of 1 kg of copper used is 12 USD. By applying Eqs. (33)–(35), $V_{copper} = 0.0003 \text{ m}^3$, $m_{copper} = 2.8 \text{ kg}$, and the total cost of the copper used is 34 \$.

The assemblage process consists of rolling the iron and copper sheets as cylinders in addition to welding required gathering all the parts together. This process costs 80 \$. Then the total price of the system without the thermoelectric generators is 170 \$.

Table 6
Total price of the system in each case in USD.

Case number	Price (\$)
Case 1	170
Case 2	7870
Case 3	7830
Case 4	2190
Case 5	2150
Case 6	19530

Table 6 shows the total price of each case, in which the cost of the TEGs is added to the cost of the system without thermoelectric generators.

In order to calculate how much energy this system saves, then how much money it saves, the electric power required to heat such amount of water is calculated for a specified temperature rise. This electric power is then added to the power generated by TEGs. Fig. 18 shows a tree in which the procedure of calculating the money saving is shown.

The volume of the water found in the system is 0.187 m³ calculated by the following equation:

$$V_{water} = \pi L (r_{w,i}^2 - r_{p,o}^2) \quad (36)$$

where V_{water} is the volume of the water in the tank.

Thermal energy required Q to heat the water is calculated by:

$$Q = \rho V_{water} C_{p_{water}} \Delta T \quad (37)$$

where $C_{p_{water}}$ and ΔT are the specific heat of water at constant pressure, and the temperature rise of water respectively. Then applying Eq. (37), with $C_{p_{water}} = 4.187 \text{ kJ/kg K}$, and $\Delta T = 70 \text{ }^\circ\text{C}$, Q is obtained equal to 54.6 kJ.

A conventional water heater is used with an energy efficiency of 80%. Then the electric energy consumption for heating this amount of water is estimated by the following equation:

$$\eta = \frac{Q_{thermal}}{EEC} \quad (38)$$

$$EEC = \frac{Q_{thermal}}{\eta} \quad (39)$$

where η , EEC are the efficiency and the electric energy consumption. Then the consumed electric energy to heat the water is 68278 kJ, or 19 kWh to heat 0.187 m³ of water with 70 °C temperature rise.

Fig. 19 shows the variation of energy consumption and its equivalent cost by varying the number of times the water was

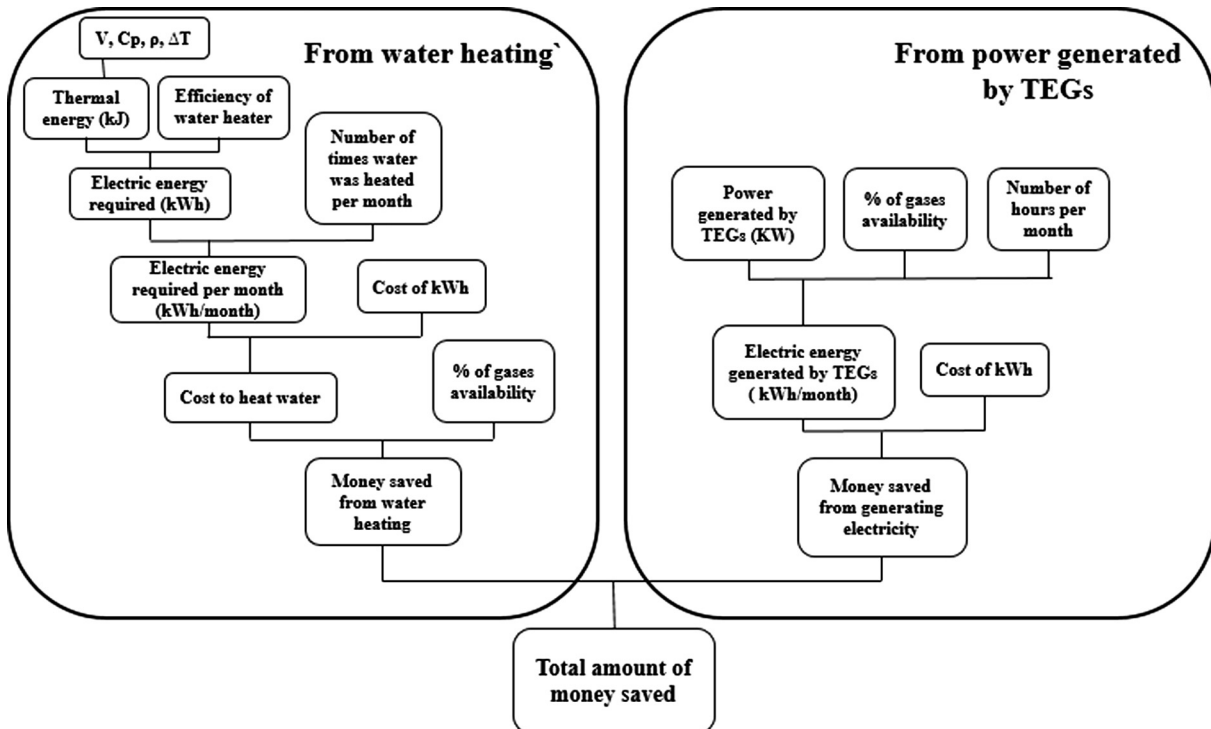

Fig. 18. Saved money calculation procedure schematic.

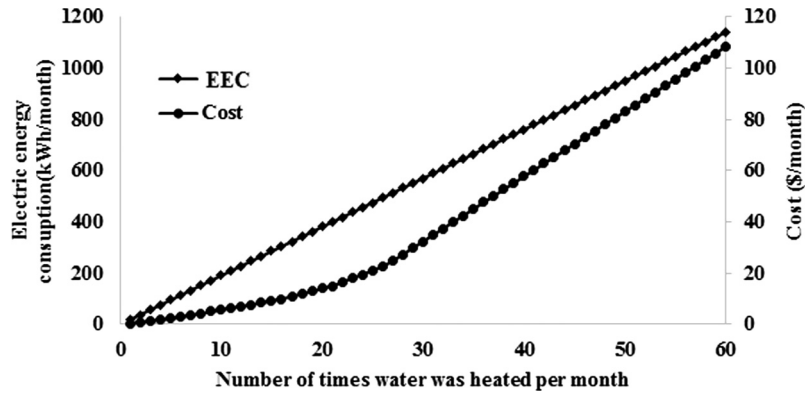

Fig. 19. Electric Energy required and its equivalent cost per month for different number of times water was heated.

Table 7
Cost of 1 kW h in Lebanon.

Electric rates in one month	Cost (\$/kW h)
0–99 kW h/month	0.023
100–299 kW h/month	0.037
300–399 kW h/month	0.053
400–499 kW h/month	0.08
>500 kW h/month	0.133

heated in one month, where the price of the electric energy is calculated according to the kW h prices in Lebanon illustrated in Table 7.

It should be noted that if the exhaust gases are always available then the amount of money saved from heating water is exactly the cost of the electric power required to heat the water. However if the exhaust gases are not always available then the amount of money saved from heat water $MS_{water\ heating}$ is:

$$MS_{water\ heating} = P_r \times C_{electric\ power\ required\ to\ heat\ water} \quad (40)$$

where P_r and $C_{electric\ power\ required\ to\ heat\ water}$ are the percentage of availability of gases to run the hybrid heat recovery system and the cost of the electric energy required to heat water respectively. Regarding the exhaust gases presence, it was important to take into consideration the availability of this gases (P_r) due to the fact that sometimes the chimney would be off. Fig. 20 shows the money saved from water heating for different percentages of gas availability.

It should be noted the high amount of money saved from heat water using the hybrid heat recovery system (more than 100 \$/month). This is due to the high electric energy consumption for heating water and it is the main source of high electric bills.

In order to estimate the total amount of money saved, which is the amount of money saved from heating the water and the price

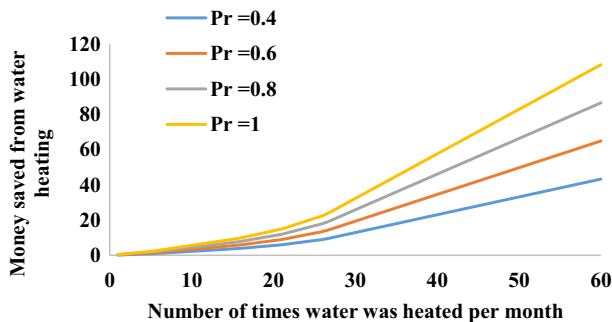

Fig. 20. Money saved from water heating process over different gases availability percentage.

of the generated electricity via TEGs, the electric energy generated per month by the thermoelectric generators $E_{generated/month}^{TEG}$ should be calculated as below:

$$E_{generated/month}^{TEG} (kW\ h/month) = P_r \times P_{generated}^{TEG} (kW) \times \left(\frac{30\ days}{month}\right) \times \left(\frac{24\ hours}{day}\right) \quad (41)$$

where $P_{generated}^{TEG}$ is the total power generated by thermoelectric generators in kW.

Fig. 21 shows the total power generated by the TEGs over one month for each case over various gases availability percentage.

The cost of the electric energy generated from the TEGs in each case is shown in Fig. 22. Assuming that the electric energy

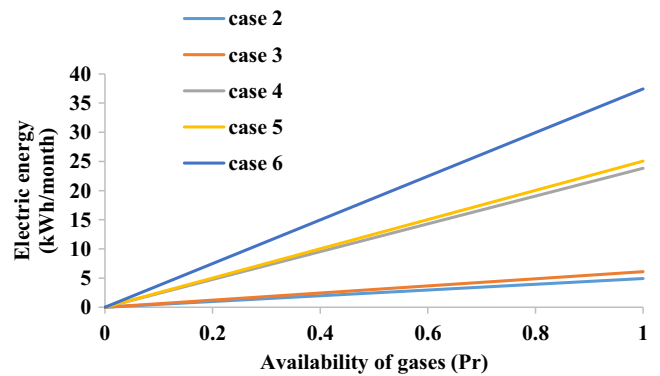

Fig. 21. Electric energy generated monthly by TEGs.

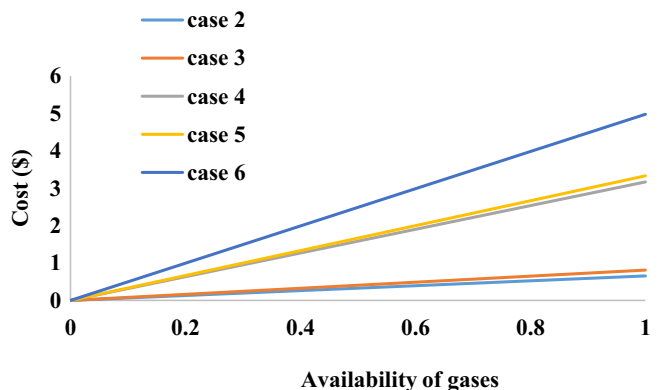

Fig. 22. Cost of generated electric energy generated by TEGs.

consumption over the month is always greater than 500 kW h, then the price of 1 kW h from the TEGs is 0.133 \$/kW h. The cost of the electric energy generated by TEGs $C_{electric\ energy}^{TEG}$ is calculated as follows:

$$C_{electric\ energy}^{TEG} = E_{generated/month}^{TEG} (kW\ h/month) \times C_{1\ kW\ h} \quad (42)$$

where $C_{1\ kW\ h}$ is the cost of one kW h expressed in \$/kW h.

The total amount of money saved MS_{total} by the hybrid heat recovery system from heating water and generating electricity is:

$$MS_{total} = MS_{water\ heating} + C_{electric\ energy}^{TEG} \text{ at constant } P_r \quad (43)$$

Fig. 23 shows the total amount of money saved with $P_r = 1$, with respect to the number of times water was heated per month for each of the six cases.

The total amount of money saved is approximately the same in the six cases which means that changing the location of TEGs have little influence in total money saved per month, due to the high cost of heat water compared to the cost of generating electricity.

The payback period Pbp of the hybrid heat recovery system is calculated using Eq. (44), it shows that it will be variable with respect to how much water is heated per month and the percentage of gases availability:

$$Pbp = \frac{HHRSC}{MS_{total}} \quad (44)$$

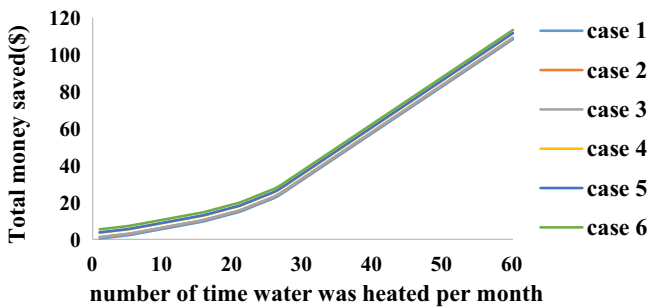

Fig. 23. Total amount of money saved at $P_r = 1$.

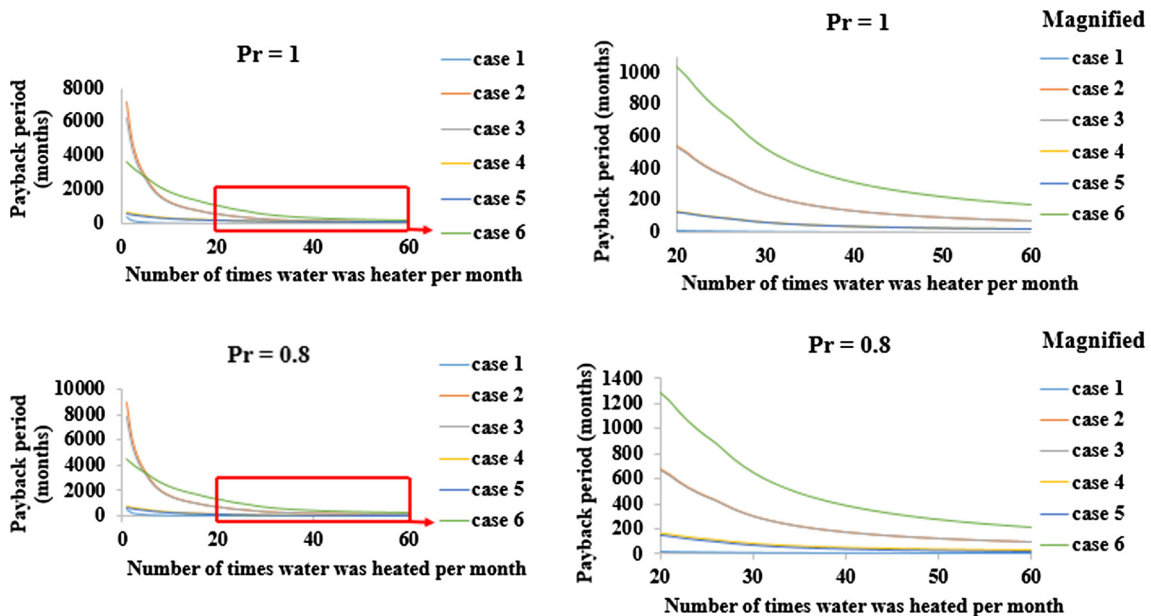

Fig. 24. Payback period for the hybrid heat recovery system for percentage availability of gases $P_r = 1$ and 0.8.

where $HHRSC$ is the total cost of the hybrid heat recovery system in each case. Fig. 24 shows the payback period of each case for different exhaust gases availability percentage.

It should be noted that if the exhaust gases are always available and comparing the hybrid heat recovery system cases, case 5 have a very good payback period of 1 year and 8 months for a 60 times of water heating. And if the water was heated 30 times the payback period is extended to about 5 years. Case 6 requires the highest payback period due to the high price of the system, mainly TEGs. It requires about 15 years to payback its cost, which is high for a residential application.

Regarding the environmental concern, heating water and producing electricity from the hybrid heat recovery system will lead to reduce the emissions of CO_2 gases resulted from burning fuel to obtain the electric power required. In order to find the reduced amount of CO_2 , the equivalent electric power reduced by water heating and the electric power produced by the TEGs is calculated. Fig. 25 shows the total power saved $P_{electrical\ total}$ which is calculated using Eq. (45). It is necessary to remind that Fig. 19 shows the electric energy saved by water heating process and Fig. 21 shows the electric energy produced by TEGs:

$$P_{electrical\ total} = P_{reduced/month}^{water\ heating} + P_{generated/month}^{TEGs} \text{ at constant } P_r \quad (45)$$

where $P_{reduced/month}^{water\ heating}$ is the electric energy saved by using the heat recovery system from the water heating.

About 0.47 kg of CO_2 is released for producing one kW h in Lebanon. This high amount of CO_2 released is due to the lack of filtering and flue gases treatment. Also it should be noted that the power grid is not 100% efficient then the power station should produce more power to transmit the required power. About 7.5% of the electricity generated is being dissipated by the power grid. Then the total power produced by the power station $P_{produced}^{power\ station}$ is:

$$P_{produced}^{power\ station} = P_{delivered} + 0.075P_{delivered} \quad (46)$$

where $P_{delivered}$ is the power delivered to the home. Then the total power saved P_{saved}^{total} is:

$$P_{saved}^{total} = (1 + 0.075)P_{electrical\ total} \quad (47)$$

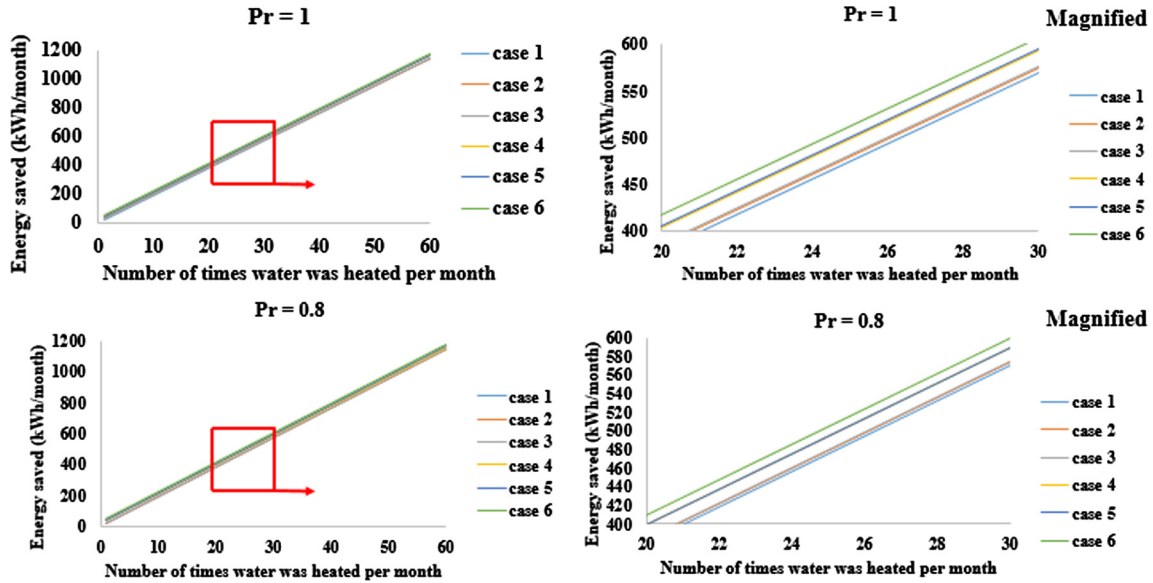

Fig. 25. Electric energy saved monthly for different gases availability percentage for percentage availability of gases $P_r = 1$ and 0.8.

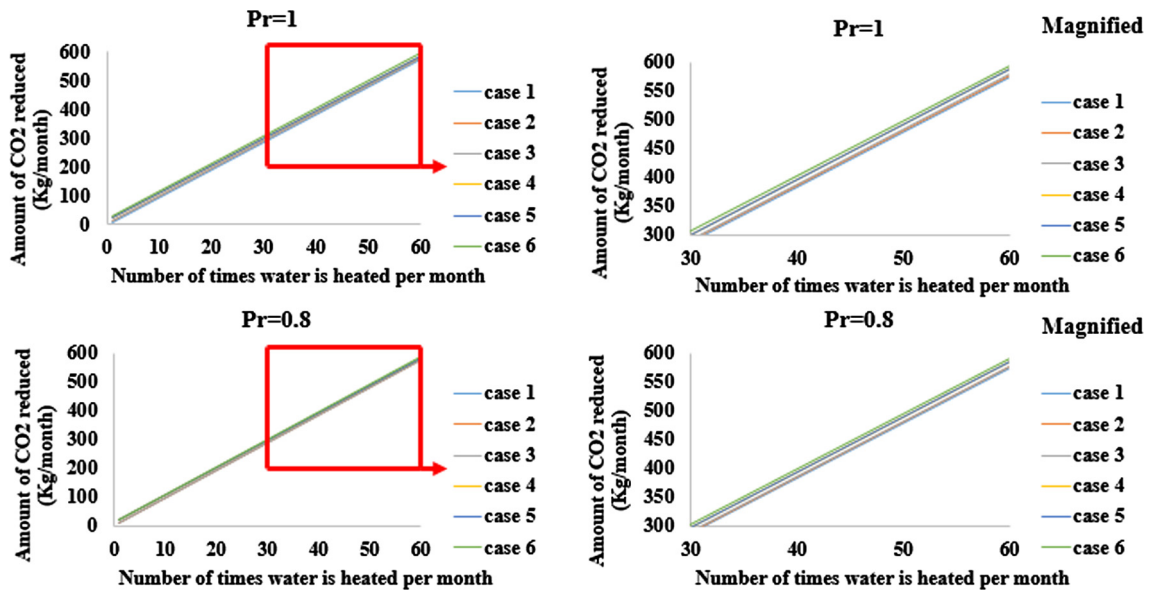

Fig. 26. Amount of CO₂ reduced by utilizing the hybrid heat recovery system monthly.

Then the reduced amount of CO₂ released $M_{CO_2}^{reduced}$ (Kg/month) is:

$$M_{CO_2}^{reduced} \text{ (kg/month)} = P_{saved}^{total} \text{ (kW h/month)} \times M_{CO_2}^{released} \text{ (kg/kW h)} \tag{48}$$

where $M_{CO_2}^{released}$ is the mass of the CO₂ gas released for producing one kW h of electricity.

Fig. 26 shows the reduced amount of CO₂ when using the hybrid heat recovery system at different gas availability percentages.

It is shown that more than half of tons of CO₂ can be reduced monthly and mainly by the heating of water, since heating water requires high power. It could reduce about 0.6 tons of CO₂ if case 6 is utilized. The effect of changing the location of TEGs is relatively low in this case which is due to the low power produced by TEGs. Such system is capable to reduce 6 tons of CO₂ gases released to the environment yearly in Lebanon.

6. Conclusion

Heat recovery process is an advanced way for benefiting from dissipated energy. Many systems and technologies are still under study and require more advanced researches. This paper deals with a hybrid heat recovery system used to recover heat from exhaust gases in order to cogenerate domestic hot water and to produce electricity via thermoelectric generators using domestic thermoelectric cogeneration heat recovery system (DTCHRS).

The effect of changing the location of the thermoelectric generators is studied by varying TEGs from the outer wall of the tank to its inner wall or to the outer wall of the exhaust gases pipe or to its inner wall, or even for having TEGs at all walls. Water temperature and power produced by thermoelectric generators are studied by applying a thermal modeling to a case study at steady state.

The following conclusions are drawn:

1. Locating TEGs at the wall of the tank provides higher water temperature but lower power produced (case 2 and 3). However, when TEGs are located at the pipe (case 4 and 5), high power is produced but relatively low water temperature compared to case 2 and 3. When TEGs are located at all the walls, the overall power produced is the highest and the water temperature becomes the lowest compared to other cases.
2. Cases 2 and 3 produced about 97 °C domestic hot water. However, these two configurations correspond to a low total power production (about 7 W) making them more suitable for water heating.
3. Cases 4 and 5 produced about 80 °C hot water along with 33 W of electricity generated by TEGs. The temperature of water is high but less than cases 2 and 3 and the power produced is higher than cases 2 and 3.
4. The maximum total power produced (52 W) is generated in configuration 6 with a high water temperature (81 °C). However the main limitation of this configuration is its high cost which is resulted from the high number of TEGs required (about 1000 TEGs).
5. Locating TEGs at the tank wall is more costly compared to locating them at the pipe (more TEGs are required). Then case 5 is a cost-effective heat recovery process compared to other cases if the cost is a major requirement. However if high water temperature is required then case 3 is the best. And if the cost is not the major requirement then case 6 is the better choice.
6. The economic study shows a best payback period for case 5 for which it needs 1 year and 8 months to payback the cost of the system. And as for the environmental study, it is shown that varying the location of the TEGs does not highly affect the reduced amount of CO₂ gases released, because of the low energy produced by TEGs compared to the energy gained by heating the water. Also it exhibits the fact that 6 tons of CO₂ can be reduced yearly by using the hybrid heat recovery system.
7. This system can be categorized as an indirect heat storage system. It can be transferred to a direct heat storage system by replacing water with energy storage materials (Phase change material). Moreover, it can be a combined system in which a layer or capsules of energy storage materials can be added to the system with the presence of water.

References

- [1] A. Herez, M. Ramadan, B. Abdulhay, M. Khaled, Short review on solar energy systems, in: AIP Conference Proceedings, 1758, Issue 1, 2016. <http://aip.scitation.org/doi/abs/10.1063/1.4959437>.
- [2] M. Ramadan, M. Khaled, H.S. Ramadan, M. Becherif, Modeling and sizing of combined fuel cell-thermal solar system for energy generation, Int. J. Hydrogen Energy. <http://dx.doi.org/10.1016/j.ijhydene.2016.08.222>.
- [3] A. Herez, M. Khaled, R. Murr, A. Haddad, H. Elhage, M. Ramadan, Using geothermal energy for cooling - parametric study, Energy Procedia 119 (2017) 783–791.
- [4] A. El Mays, R. Ammar, M. Hawa, M. Abou Akroush, F. Hachem, M. Khaled, M. Ramadan, Improving photovoltaic panel using finned plate of aluminum, Energy Procedia 119 (2017) 812–817.
- [5] F. Hachem, B. Abdulhay, M. Ramadan, H. El Hage, M. Gad El Rab, M. Khaled, Improving the performance of photovoltaic cells using pure and combined phase change materials - Experiments and transient energy balance, Renewable Energy 107 (July 2017) 567–575.
- [6] A. El Mays, R. Ammar, M. Hawa, M. Abou Akroush, F. Hachem, M. Khaled, M. Ramadan, Using phase change material in under floor heating, Energy Procedia 119 (2017) 806–811.
- [7] M. Khaled, M. Ramadan, H. El Hage, Innovative approach of determining the overall heat transfer coefficient of heat exchangers - Application to cross-flow water-air types, Appl. Therm. Eng. 99 (25) (April 2016) 1086–1092.
- [8] H. Jaber, M. Khaled, T. Lemenand, R. Murr, J. Faraj, M. Ramadan, Triple domestic heat recovery system thermal modeling and parametric study, in: Proceedings of SEEP2017, 27–30 June 2017, Bled, Slovenia.
- [9] H. Jaber, M. Khaled, T. Lemenand, J. Faraj, H. Bazzi, M. Ramadan, Effect of exhaust gases temperature on the performance of a hybrid heat recovery system, Energy Procedia 119 (2017) 775–782.
- [10] H. Jaber, M. Khaled, T. Lemenand, M. Ramadan, Short review on heat recovery from exhaust gas, in: AIP Conference Proceedings, 1758, Issue 1, 2016, 10.1063/1.4959441. <http://aip.scitation.org/doi/abs/10.1063/1.4959441>.
- [11] M. Terhan, K. Comakli, Design and economic analysis of a flue gas condenser to recover latent heat from exhaust flue gas, Appl. Therm. Eng. 100 (2016) 1007–1015, <https://doi.org/10.1016/j.applthermaleng.2015.12.122>.
- [12] M. Wei, X. Zhao, L. Fu, S. Zhang, Performance study and application of new coal-fired boiler flue gas heat recovery system, Appl. Energy 188 (2017) 121–129.
- [13] M. Sharma, O. Singh, Exergy analysis of dual pressure HRSG for different dead states and varying steam generation states in gas/steam combined cycle power plant, Appl. Therm. Eng. 93 (2016) 614–622, <https://doi.org/10.1016/j.applthermaleng.2015.10.012>.
- [14] A. Bassily, Modeling, analysis, and modifications of different GT cooling techniques for modern commercial combined cycle power plants with reducing the irreversibility of the HRSG, Appl. Therm. Eng. 53 (2013) 131–146, <https://doi.org/10.1016/j.applthermaleng.2013.01.002>.
- [15] K. Chae, X. Ren, Flexible and stable heat energy recovery from municipal wastewater treatment plants using a fixed-inverter hybrid heat pump system, Appl. Energy 179 (2016) 565–574, <https://doi.org/10.1016/j.apenergy.2016.07.021>.
- [16] M. Wei, W. Yuan, Z. Song, L. Fu, S. Zhang, Simulation of a heat pump system for total heat recovery from flue gas, Appl. Therm. Eng. 86 (2015) 326–332, <https://doi.org/10.1016/j.applthermaleng.2015.04.061>.
- [17] V. Karamarkovic, M. Marasevic, R. Karamarkovic, M. Karamarkovic, Recuperator for waste heat recovery from rotary kilns, Appl. Therm. Eng. 54 (2013) 470–480, <https://doi.org/10.1016/j.applthermaleng.2013.02.027>.
- [18] A. Mezquita, J. Boix, E. Monfort, G. Mallol, Energy saving in ceramic tile kilns Cooling gas heat recover, Appl. Therm. Eng. 65 (2014) 102–110, <https://doi.org/10.1016/j.applthermaleng.2014.01.002>.
- [19] M. Khaled, M. Ramadan, H. El Hage, Parametric analysis of heat recovery from exhaust gases of generators, Energy Procedia 75 (2015) 3295–3300, <https://doi.org/10.1016/j.egypro.2015.07.710>.
- [20] B. Fu, Y. Lee, J. Hsieh, Design, construction, and preliminary results of a 250-kW organic Rankine cycle system, Applied Thermal Engineering. 80 (2015) 339–346, <https://doi.org/10.1016/j.applthermaleng.2015.01.077>.
- [21] S. Bari, S. Hossain, Waste heat recovery from a diesel engine using shell and tube heat exchanger, Appl. Therm. Eng. 61 (2013) 355–363, <https://doi.org/10.1016/j.applthermaleng.2013.08.020>.
- [22] E. Wang, Z. Yu, H. Zhang, F. Yang, A regenerative supercritical-subcritical dual-loop organic Rankine cycle system for energy recovery from the waste heat of internal combustion engines, Appl. Energy 190 (2017) 574–590, <https://doi.org/10.1016/j.apenergy.2016.12.122>.
- [23] D. Jung, S. Park, K. Min, Selection of appropriate working fluids for Rankine cycles used for recovery of heat from exhaust gases of ICE in heavy-duty series hybrid electric vehicles, Appl. Therm. Eng. 81 (2015) 338–345, <https://doi.org/10.1016/j.applthermaleng.2015.02.002>.
- [24] Y. Lu, Y. Wang, C. Dong, L. Wang, A. Roskilly, Design and assessment on a novel integrated system for power and refrigeration using waste heat from diesel engine, Appl. Therm. Eng. 91 (2015) 591–599, <https://doi.org/10.1016/j.applthermaleng.2015.08.057>.
- [25] A. Boretti, Recovery of exhaust and coolant heat with R245fa organic Rankine cycles in a hybrid passenger car with a naturally aspirated gasoline engine, Appl. Therm. Eng. 36 (2012) 73–77, <https://doi.org/10.1016/j.applthermaleng.2011.11.060>.
- [26] R. Morgan, G. Dong, A. Panesar, M. Heikal, A comparative study between a Rankine cycle and a novel intra-cycle based waste heat recovery concepts applied to an internal combustion engine, Appl. Energy 174 (2016) 108–117, <https://doi.org/10.1016/j.apenergy.2016.04.026>.
- [27] T. Sung, K. Kim, Thermodynamic analysis of a novel dual-loop organic Rankine cycle for engine waste heat and LNG cold, Appl. Therm. Eng. 100 (2016) 1031–1041, <https://doi.org/10.1016/j.applthermaleng.2016.02.102>.
- [28] D. Lee, J. Park, M. Ryu, J. Park, Development of a highly efficient low-emission diesel engine-powered co-generation system and its optimization using Taguchi method, Appl. Therm. Eng. 50 (2013) 491–495, <https://doi.org/10.1016/j.applthermaleng.2012.06.040>.
- [29] M. Khaled, M. Ramadan, Study of the thermal behavior of multi concentric tube tank in heat recovery from chimney - Analysis and optimization, Heat Transfer Eng. J. 8 (2017) 1–11.
- [30] M. Khaled, M. Ramadan, K. Chahine, A. Assi, Prototype implementation and experimental analysis of water heating using recovered waste heat of chimneys, Case Stud. Therm. Eng. 5 (2015) 127–133, <https://doi.org/10.1016/j.csite.2015.03.004>.
- [31] M. Ramadan, M. Khaled, H. El Hage, Using speed bump for power generation - Modeling and experimental study, Energy Procedia 75 (2015) 867–872, <https://doi.org/10.1016/j.egypro.2015.07.192>.
- [32] X. Zhang, S. Yu, M. Yu, Y. Lin, Experimental research on condensing heat recovery using phase change material, Appl. Therm. Eng. 31 (2011) 3736–3740, <https://doi.org/10.1016/j.applthermaleng.2011.03.040>.
- [33] Z. Song, J. Chen, B. L. Yang, Heat transfer enhancement in tubular heater of Stirling engine for waste heat recovery from flue gas using steel wool, Appl. Therm. Eng. 87 (2015) 499–504. <http://dx.doi.org/10.1016/j.applthermaleng.2015.05.028>.

- [34] S. Niamsuwan, P. Kittisupakorn, I. Mujtaba, A newly designed economizer to improve waste heat recovery A case study in a pasteurized milk plant, *Appl. Therm. Eng.* 60 (2013) 188–199, <https://doi.org/10.1016/j.applthermaleng.2013.06.056>.
- [35] R. Soltani, I. Dincer, M. Rosen, Thermodynamic analysis of a novel multigeneration energy system based on heat recovery from a biomass CHP cycle, *Appl. Therm. Eng.* 89 (2015) 90–100, <https://doi.org/10.1016/j.applthermaleng.2015.05.081>.
- [36] M. Khaled, M. Ramadan, Heating fresh air by hot exhaust air of HVAC systems, *Case Stud. Therm. Eng.* 8 (2016) 398–402, <https://doi.org/10.1016/j.csite.2016.10.004>.
- [37] M. Ramadan, M. Gad El Rab, M. Khaled, Parametric analysis of air-water heat recovery concept applied to HVAC systems: Effect of mass flow rates, *Case Stud. Therm. Eng.* 6 (2015) 61–68, <https://doi.org/10.1016/j.csite.2015.06.001>.
- [38] M. Ramadan, T. Lemenand, M. Khaled, Recovering heat from hot drain water—Experimental evaluation, parametric analysis and new calculation procedure, *Energy Buildings* 128 (2016) 575–585, <https://doi.org/10.1016/j.enbuild.2016.07.017>.
- [39] C. Naldi, M. Dongellini, G. Morini, Summer performances of reversible air-to-water heat pumps with heat recovery for domestic hot water production, *Energy Procedia* 78 (2015) 1117–1122, <https://doi.org/10.1016/j.egypro.2015.11.068>.
- [40] L. Liu, L. Fu, Y. Jiang, Application of an exhaust heat recovery system for domestic hot water, *Energy* 35 (2010) 1476–1481, <https://doi.org/10.1016/j.energy.2009.12.004>.
- [41] N. Kumar, G. Mohan, A. Martin, Performance analysis of solar cogeneration system with different integration strategies for potable water and domestic hot water production, *Appl. Energy* 170 (2016) 466–475, <https://doi.org/10.1016/j.apenergy.2016.02.033>.
- [42] A. Ibáñez, J. Linares, M. Cledera, B. Moratilla, Sizing of thermal energy storage devices for micro-cogeneration systems for the supply of domestic hot water, *Sustain. Energy Technol. Assessments* 5 (2014) 37–43, <https://doi.org/10.1016/j.seta.2013.11.002>.
- [43] S. Hossain, S. Bari, Waste heat recovery from exhaust of a diesel generator set using organic fluids, in: 10th International Conference on Mechanical Engineering, ICME.Procedia Engineering, vol. 90, 2014, pp. 439–444. <http://dx.doi.org/10.1016/j.proeng.2014.11.753>.
- [44] S. Prabu, M. Asokan, A study of waste heat recovery from diesel engine exhaust using phase change material, *Int. J. ChemTech Res.* 8 (2015) 711–717.
- [45] Y. Najjar, A. Abubaker, A. El-Khalil, Novel inlet air cooling with gas turbine engines using cascaded waste-heat recovery for green sustainable energy, *Energy* 93 (2015) 770–785, <https://doi.org/10.1016/j.energy.2015.09.033>.
- [46] H. Gao, G. Huang, H. Li, Z. Qu, Y. Zhang, Development of stove-powered thermoelectric generators A review, *Appl. Therm. Eng.* 96 (2016) 297–310, <https://doi.org/10.1016/j.applthermaleng.2015.11.032>.
- [47] A. Montecucco, J. Siviter, A.R. Knox, Combined heat and power system for stoves with thermoelectric generators, *Appl. Energy* 185 (2017) 1336–1342, <https://doi.org/10.1016/j.apenergy.2015.10.132>.
- [48] W. He, G. Zhang, X. Zhang, J. Ji, G. Li, X. Zhao, Recent development and application of thermoelectric generator and cooler, *Appl. Energy* 143 (2015) 1–25, <https://doi.org/10.1016/j.apenergy.2014.12.075>.
- [49] J. Wang, J.Y. Wu, C. Zheng, Simulation and evaluation of a CCHP system with exhaust gas deep-recovery and thermoelectric generator, *Energy Convers. Manage.* 86 (2014) 992–1000, <https://doi.org/10.1016/j.enconman.2014.06.036>.
- [50] T. Ma, X. Lu, J. Pandit, S. Ekkad, S. Huxtable, S. Deshpande, Q. Wang, Numerical study on thermoelectric–hydraulic performance of a thermoelectric power generator with a plate-fin heat exchanger with longitudinal vortex generators, *Appl. Energy* 185(Part 2) (2017) 1343–1354, <https://doi.org/10.1016/j.apenergy.2016.01.078>.
- [51] X. Sun, X. Liang, G. Shu, H. Tian, H. Wei, X. Wang, Comparison of the two-stage and traditional single-stage thermoelectric generator in recovering the waste heat of the high temperature exhaust gas of internal combustion engine, *Energy* 77 (2014) 489–498, <https://doi.org/10.1016/j.energy.2014.09.032>.
- [52] J. Jang, Y. Tsai, Optimization of thermoelectric generator module spacing and spreader thickness used in a waste heat recovery system, *Appl. Therm. Engineering* 51 (2013) 677–689, [10.1016/j.applthermaleng.2012.10.024](https://doi.org/10.1016/j.applthermaleng.2012.10.024).
- [53] C. Lu, S. Wang, C. Chen, Y. Li, Effects of heat enhancement for exhaust heat exchanger on the performance of thermoelectric generator, *Applied Thermal Eng.* 89 (2015) 270–279, <https://doi.org/10.1016/j.applthermaleng.2015.05.086>.
- [54] E. Navarro-Peris, J. Corberan, Z. Ancik, Evaluation of the potential recovery of compressor heat losses to enhance the efficiency of refrigeration systems by means of thermoelectric generation, *Appl. Therm. Eng.* 89 (2015) 755–762, <https://doi.org/10.1016/j.applthermaleng.2015.05.086>.
- [55] H. Ma, C. Lin, H. Wu, C. Peng, C. Hsu, Waste heat recovery using a thermoelectric power generation system in a biomass gasifier, *Appl. Therm. Eng.* 88 (2015) 274–279, <https://doi.org/10.1016/j.applthermaleng.2014.09.070>.
- [56] X. Zheng, Y. Yan, K. Simpson, A potential candidate for the sustainable and reliable domestic energy generation—Thermoelectric cogeneration system, *Appl. Therm. Eng.* 53 (2) (2013) 305–311, <https://doi.org/10.1016/j.applthermaleng.2012.03.020>.
- [57] X. Zheng, C. Liu, R. Boukhanouf, Y. Yan, W. Li, Experimental study of a domestic thermoelectric cogeneration system, *Appl. Therm. Eng.* 62 (1) (2014) 69–79, <https://doi.org/10.1016/j.applthermaleng.2013.09.008>.
- [58] K. Alanne, T. Laukkanen, K. Saari, J. Jokisalo, Analysis of a wooden pellet-fueled domestic thermoelectric cogeneration system, *Appl. Therm. Eng.* 63 (1) (2014) 1–10, <https://doi.org/10.1016/j.applthermaleng.2013.10.054>.
- [59] S. Yu, Q. Du, H. Diao, G. Shu, K. Jiao, Start-up modes of thermoelectric generator based on vehicle exhaust waste heat recovery, *Appl. Energy* 138 (2015) 276–290, <https://doi.org/10.1016/j.apenergy.2014.10.062>.
- [60] F.P. Incropera, D.P. DeWitt, *Fundamentals of heat and mass transfer, sixth ed.*, John Wiley & Sons, 2007.
- [61] Tecteg, Manufacturer of thermoelectric modules, 2016, Available from <http://www.tecteg.com>.

Chapitre 3. Système de Cogénération Thermoélectrique Domestique - Analyses paramétriques et études de cas

Dans ce chapitre, le système de récupération de chaleur hybride appelé « **Système de récupération de chaleur par Cogénération Thermoélectrique Domestique** » SCTD proposé dans le chapitre 2 est étudié en appliquant des études de cas et en effectuant une analyse paramétrique pour optimiser, améliorer et prévoir les performances du système. Différents paramètres affectent le processus de récupération dans lequel ils influencent principalement le flux de chaleur, la température de l'eau et l'énergie électrique générée par les générateurs thermoélectriques. L'effet de la modification de la température des gaz d'échappement, du volume d'eau et du nombre d'occupants sur les performances du système de récupération de chaleur hybride est étudié. De plus, les performances du système sont étudiées lorsqu'il est couplé à différents générateurs électriques avec des charges différentes. De plus, une étude de cas est envisagée en couplant le SCTD avec une cheminée résidentielle.

Ce chapitre est composé de cinq études qui se présentent comme suit :

➤ **3.1 Etude de la modification de la température des gaz d'échappement** sur les performances du système de cogénération thermoélectrique domestique. Cette étude est composée d'une introduction générale sur la récupération de chaleur dans la **section 1**. La **section 2** illustre le concept du système. La **section 3** présente la modélisation thermique du système et la **section 4** présente les résultats obtenus. Enfin, une conclusion résumant l'ensemble de l'étude est réalisée. Les résultats montrent qu'en augmentant la température des gaz, le flux de chaleur et les températures à chaque couche augmentent linéairement. La puissance générée par les GTE augmente progressivement avec l'augmentation de la température des gaz d'échappement. En outre, lorsque la température des gaz double, la puissance produite augmente environ cinq fois plus. Cette étude a été publiée dans les actes de la conférence *TMREES (Technologies and Materials for Renewable Energy, Environment and Sustainability)*, au Liban, en 2017, ainsi que sous forme d'article de journal publié dans « *Energy Procedia* ».

➤ **3.2 Etude de la modification du volume d'eau** sur la performance du SCTD. Cette étude est consacrée à l'examen de l'effet géométrique sur le système de transfert de chaleur. L'étude consiste à modifier le volume d'eau c'est-à-dire modifier le rayon intérieur du réservoir et donc son rayon extérieur en gardant constants le diamètre de tuyau, l'épaisseur du réservoir et la longueur du système. Le concept de système de récupération est présenté dans la **section 2**. Ensuite, une modélisation thermique complète est réalisée et présentée dans la **section 3**. La **section 4** présente les résultats obtenus et une conclusion récapitulative est tirée dans la **section 5**. Les résultats obtenus sont : lorsque le volume augmente, la résistance totale diminue et le flux de chaleur augmente (lorsque le rayon du réservoir est doublé, le flux de chaleur augmente de 28%). En outre, à mesure que le volume augmente, la température de l'eau diminue et la puissance générée augmente. Cette étude a été publiée dans les actes de la « *International Conference of Energy and Thermal Engineering ICTE* » en 2017 à Istanbul.

➤ **3.3 Etude de la modification de la charge du générateur** lors du couplage du SCTD avec un générateur électrique diesel sur le flux de chaleur, la température de l'eau et la puissance générée. Le système de récupération de chaleur hybride est présenté à la **section 2**. La **section 3** présente une modélisation thermique du système. La **section 4** étudie plusieurs générateurs de

charges différentes, qui présentent les résultats associés. Enfin, une conclusion récapitulative est présentée à la **section 5**. Sachant que le système SCTD est composé de 100 GTE et de 187 L d'eau, lorsqu'un générateur diesel de 10 kW est utilisé, la température de l'eau atteint 47°C et la puissance produite par les GTE est de 141 W. Lorsque la charge du générateur est portée à 38 kW, la température de l'eau atteint 97°C et les GTE produisent 1412 W, soit 14,12 W par GTE. Globalement, lorsque la charge du générateur augmente, la puissance générée et la température de l'eau augmentent. De plus, la température à chaque couche du système augmente avec l'augmentation de la charge. Cette étude a été publiée dans le journal « *Case Studies in Thermal Engineering* ».

➤ **3.4 Étude de cas sur le système de récupération de chaleur hybride** grâce auquel les gaz d'échappement générés par la combustion de bois dans une cheminée résidentielle sont utilisés pour chauffer de l'eau et produire de l'électricité à l'aide de GTE. La température de l'eau est mesurée expérimentalement et la puissance générée par les générateurs thermoélectriques est estimée à l'aide d'une modélisation thermique présentée dans la **section 2**. La puissance totale générée par les GTE est estimée à l'aide des résultats expérimentaux, tandis que l'analyse analytique est présentée dans la **section 3**. La **section 4** est concernée par une étude économique et environnementale détaillée montrant la somme monétaire économisée, la période de récupération et les émissions de CO₂ réduites. Enfin, une conclusion récapitulative est présentée à la **section 5**. Les résultats expérimentaux montrent qu'un tel système de récupération de chaleur hybride avec la configuration suggérée peut produire jusqu'à 200 litres d'eau chaude sanitaire à 80°C en 400 minutes. Une analyse théorique montre que le système est capable de générer jusqu'à 0,5 W/GTE, soit une puissance totale de 192 W, à l'aide de 383 générateurs thermoélectriques fixés à la paroi extérieure du réservoir. De plus, le système de récupération de chaleur hybride présente un temps de retour sur investissement de 5 ans lorsque l'eau est chauffée 80 fois par mois et environ 5,1 tonnes de CO₂ sont économisées chaque année dans ces conditions. Cette étude a conduit à un article de journal actuellement en version révisée au journal « *Heat Transfer Engineering* ».

3.1 Effet de la température des gaz d'échappement sur les performances d'un système de récupération de chaleur hybride

Hassan Jaber, Mahmoud Khaled, Thierry Lemenand, Jallal Faraj, Hassan Bazzi et Mohamad Ramadan

Cette étude a été publiée dans les actes de la conférence TMREES (**Technologies and Materials for Renewable Energy, Environment and Sustainability**), au Liban, en 2017, ainsi que sous forme d'article de journal publié dans « **Energy Procedia** »

Résumé - La réutilisation ou la réduction de la chaleur perdue est une excellente opportunité pour réduire les coûts dans les applications industrielles et résidentielles. Ce document traite d'un système de récupération de chaleur hybride qui réutilise l'énergie thermique capturée par les gaz d'échappement pour produire de l'eau chaude domestique et générer de l'énergie électrique à l'aide de générateurs thermoélectriques (GTE). Le processus de récupération de chaleur dépend principalement de la température des gaz d'échappement. L'effet de la température des gaz sur les performances du système (température de l'eau et puissance générée) est étudié, y compris différentes applications résidentielles. Il montre que lorsque la température des gaz d'échappement augmente, le taux de chauffage, la température de l'eau et la puissance générée augmentent.

International Conference on Technologies and Materials for Renewable Energy, Environment and Sustainability, TMREES17, 21-24 April 2017, Beirut Lebanon

Effect of Exhaust Gases Temperature on the Performance of a Hybrid Heat Recovery System

Hassan Jaber ^{a,c}, Mahmoud Khaled ^{a,b,*}, Thierry Lemenand ^c, Jallal Faraj ^a, Hasan Bazzi ^a and Mohamad Ramadan ^{a,d}

^a School of Engineering, Lebanese International University LIU, PO Box 146404 Beirut, Lebanon.

^b Univ Paris Diderot, Sorbonne Paris Cité, Interdisciplinary Energy Research Institute (PIERI), Paris, France

^c LARIS EA 7315, University of Angers – ISTIA, Angers, France

^d Associate member at FCLAB, CNRS, Univ. Bourgogne Franche-Comte, Belfort cedex, France.

Abstract

The reuse or reduction of wasted heat supplies an excellent opportunity for cost saving in industrial and residential application. This paper deals with a Hybrid heat recovery system that reuses the thermal energy captured by exhaust gases to produce domestic hot water and generate electric power using thermoelectric generators (TEG). The heat recovery process is mainly affected by the temperature of exhaust gases. The effect of gases temperature on the performance of the system – water temperature and power generated – is studied including different residential applications. It shows that as the exhaust gases temperature increase the heat rate, water temperature, and power generated increases.

© 2017 The Authors. Published by Elsevier Ltd.

Peer-review under responsibility of the Euro-Mediterranean Institute for Sustainable Development (EUMISD).

Keywords: Heat recovery; Thermoelectric generators; cogeneration; Thermal modeling; Domestic hot water;

* Corresponding author. Tel.;

E-mail address: mahmoud.khaled@liu.edu.lb

1. Introduction

Due to the rapid increase in demand and consumption of energy, scientists are forced to find solutions of what is called “Energy crisis”. Fossil fuel remains still the main energy resource that feeds most industrial and residential applications. Renewable energy and energy management are certainly the most effective solutions of Energy crisis

[1]. Renewable energy which is an alternative source of energy is mainly generated from solar, wind, biomass, geothermal, and hydropower [2-11].

Energy recovery consists in the reuse of energy dumped to the environment without taking advantage of it [12-17]. Because of the high dependence of fossil fuel which is burned to generate thermal energy, high amount of exhaust gases are generated which could be the highest energy loss in the system. Recovering heat from exhaust gases can be done directly or indirectly by a mean of heat exchanger or any energy transformation process. Jaber et al. [18] did a short review on heat recovery, classifying it into different configurations. The authors classified exhaust gas heat recovery systems within three classifications that are exhaust gas temperature, utilized equipment and proposed a new classification according to recovery purposes.

This paper deals with heat recovery from exhaust gases. A hybrid heat recovery system proposed is utilized to recover exhaust gases to produce simultaneously domestic hot water and generate electricity using thermoelectric generators (TEG). The concept of study is discussed in section 2. Section 3 presents the thermal modeling of the system, and section 4 studies the effect of changing exhaust gases temperature on the performance of the system. Finally a conclusion about the whole study is carried.

Nomenclature

A	Area [m ²]
h	Convection heat transfer coefficient [W/m ² .K]
HHRS	Hybrid heat recovery system
q	Heat transfer rate [W]
L	Length of the tank [m]
N	Number of items
P	Power produced [W]
r	Radius [m]
T _a	Temperature [°C]
k	Thermal conductivity [W/m.K]
R	Thermal resistance [K/W]
e	Thickness of the TEG [m]

2. Heat recovery concept

The relatively high amount of thermal energy lost through exhaust gases forced scientists to investigate how to get benefit of this energy. Variety of studies were made in the field of heat recovery including single or hybrid heat recovery systems. This paper proposes a hybrid heat recovery system in which hot water is produced and electric power is generated. The system is composed of water tank with a pipe passing through it. At the inner wall of the pipe a thermoelectric generators layer is attached allowing a direct contact of exhaust gases with TEGs. Part of the thermal energy hold by exhaust gases transfer through the TEGs layer in which this TEG layer dissipate heat to the water at the tank. The TEGs layer is sandwiched between the exhaust gases (heat source) and the inner wall of the tube (heat sink) [19]. As the TEGs are subjected to a temperature difference an electric power is generated. Figure 1 shows a schematic of the proposed hybrid heat recovery system. It shows a pipe crosses the tank in which exhaust gases passes through the pipe with a direct contact with the TEG layer (Red layer). TEG in its turn convert part of the absorbed thermal energy to electrical energy and dissipate the other part to water. The quantity and quality of exhaust gases plays a crucial role in the recovery process. The effect of exhaust gases temperature on water temperature and power generated is examined in this paper. To proceed, a thermal modelling of the system will be carried in order to obtain the behaviour of the hybrid heat recovery system while changing the temperature of

exhaust gases

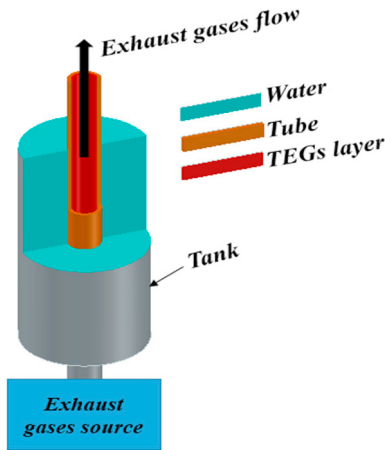

Fig. 1. Hybrid heat recovery system.

3. Thermal modeling

In order to estimate the water temperature and the power generated by water a thermal modelling of the system is carried out. Some assumptions are used to simplify the calculation: the study is done at steady state, one dimensional heat flow and constant gases temperature along the tank length. Figure 2 shows the steps required to obtain the water temperature and the power generated.

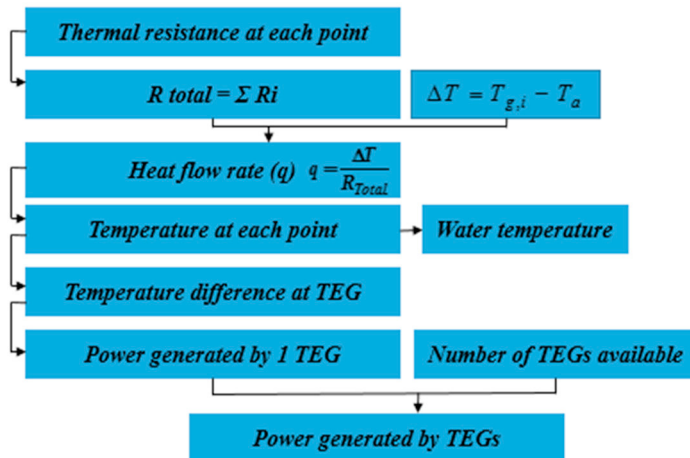

Fig. 2. Thermal modelling steps.

As shown in figure 2, in order to obtain the heat flow rate the total resistance of the HHRS should be calculated. Knowing the gases temperature and ambient air temperature, the temperature at each layer could be calculated in which the heat flow rate (q) is constant over the system. To obtain the total power, the power generated by one TEG should be estimated and multiplied by the number of TEGs available. The power generated by one TEG is estimated by a direct relation with the temperature difference at the TEG.

Figure 3 shows the thermal resistance diagram of the system. The thermal energy captured by exhaust gases

undergoes convection heat transfer with the surface of the TEG (R_g). At the TEG the energy transfer by conduction through the layers of TEG and pipe to water (R_{TEG}, R_p). Due to the change in density of water, water will undergoes natural convection with the walls of the pipe and the tank ($R_{conv,w-p}, R_{conv,w-w}$). At the tanks' wall energy transfer through the wall by conduction (R_{wall}) and with the air through convection heat transfer (R_{air}).



Fig. 3. Thermal resistance of the system.

where $T_{g,i}, T_H, T_C, T_{p,o}, T_w, T_{wall,i}, T_{wall,o}$ and T_a are the temperature of exhaust gases, hot, cold, outer pipe wall, water, inner tank wall, outer tank wall, and ambient air temperature respectively. And $R_g, R_{TEG}, R_p, R_{conv,w-p}, R_{conv,w-w}, R_{wall}$, and R_{air} , are the thermal resistance of internal convection of gases in pipe, conduction in thermoelectric generator, conduction in the pipe wall, convection between water and pipe, convection between water and cylindrical tank wall, conduction in the cylindrical tank wall and convection of tank with air respectively. The thermal resistances are calculated using the following equations [20]:

$$R_g = \frac{1}{h_g (2\pi (r_{t,i} - e) L)} \tag{1}$$

$$R_{TEG} = \frac{\ln \left[\frac{r_{t,i}}{r_{t,i} - e} \right]}{2\pi k_{TEG} L} \tag{2}$$

$$R_p = \frac{\ln \left[\frac{r_{t,o}}{r_{t,i}} \right]}{2\pi k_t L} \tag{3}$$

$$R_{conv,w-p} = \frac{1}{h_w (2\pi r_{t,o} L)} \tag{4}$$

$$R_{conv,w-w} = \frac{1}{h_w (2\pi r_{w,i} L)} \tag{5}$$

$$R_{wall} = \frac{\ln \left[\frac{r_{w,o}}{r_{w,i}} \right]}{2\pi k_w L} \tag{6}$$

$$R_{air} = \frac{1}{h_a (2\pi r_{w,o} L)} \tag{7}$$

where h_g, h_w and h_a are the convection heat coefficient of exhaust gases, water and air respectively. k_{TEG}, k_t and k_w are the conduction coefficient of the TEG, tube wall and tank wall respectively. And $r_{t,i}, r_{t,o}, r_{w,i}, r_{w,o}$ and L are the inner, outer radius of the tube and inner, outer radius of the water tank, and length of the tank respectively. e is the thickness of the thermoelectric generator.

Knowing that heat flow rate is constant over the system then the temperature at each point can be estimated by the

following equation:

$$T_{(n)} = T_{(n-1)} - q \cdot R_{(n)} \tag{8}$$

where q is the heat flow rate in “W” and n is an increment of the layers of the HHRS starting from exhaust gases to air.

By calculating the hot and cold temperature at the TEG surface the power produced by one TEG is calculated as follows:

$$P_{1TEG} = \left(\frac{P}{\Delta T^2} \right)_{ref} \Delta T^2 \tag{9}$$

where P_{1TEG} is the output power of one TEG, ΔT is the temperature difference between the hot and cold sides of TEG, and $\left(\frac{P}{\Delta T^2} \right)_{ref}$ is given by the manufacturer of the TEG. Then the total power produced by TEGs P_{Total} is estimated by equation below knowing that N_{TEG} is the number of TEGs available on the system:

$$P_{Total} = N_{TEG} P_{1TEG} \tag{10}$$

4. Results

One of the main parameters that affects the performance of heat recovery process is the gases temperature. Variety of applications that can be utilized as exhaust gases source of the system can be found. For a residential level: generators, chimney, boilers and furnaces are the main applications found. Table 1 shows the dimensions of the system used and the main parameters required for the thermal modeling. In order to simplify the study the heat convection coefficient of the exhaust gases is set as constant. It should be noted that a specific type of TEG is utilized and its main parameters are listed in Table 1 [21].

Table 1. Heat recovery system main parameters.

Parameter	Value	Unit
$r_{t,i}$	0.049	m
$r_{t,o}$	0.050	m
L	1	m
$r_{w,i}$	0.158	m
$r_{w,o}$	0.160	m
h_w	300	W/m ² K
h_a	50	W/m ² K
H_g	80	W/m ² K
k_t	401	W/mK
k_{wall}	80	W/mK
k_{TEG}	1.4	W/mK
N_{TEG}	99	Piece
T_a	25	°C
e	0.005	m
$P/\Delta T^2$	0.0002	W/K ²
A_{TEG}	0.0031	m ²

Using the table and equations above the effect of changing exhaust gases temperature on the heat rate, temperature variation, temperature difference at the TEG and power produced by TEGs is studied. Figure 4 shows the variation of heat flow by varying the exhaust gases temperature.

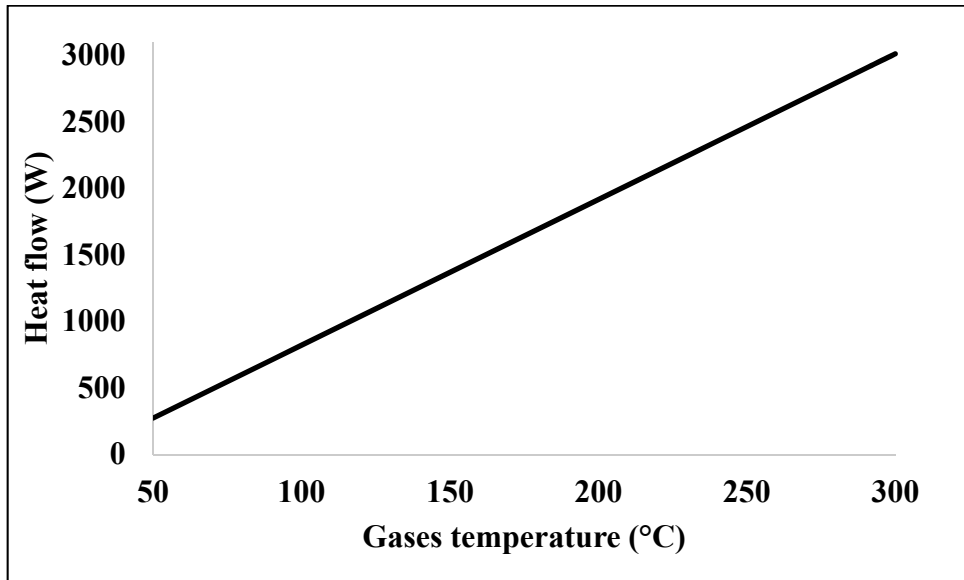

Figure 4. Effect of exhaust gases temperature on heat rate.

The heat transfer rate increases linearly with the increase in exhaust gases temperature. This is directly reflected by the following equation:

$$q(T_g) = \frac{1}{R_{total}} T_g - \frac{T_a}{R_{total}} \tag{11}$$

Figure 5 shows the temperature distribution on different layers on the system.

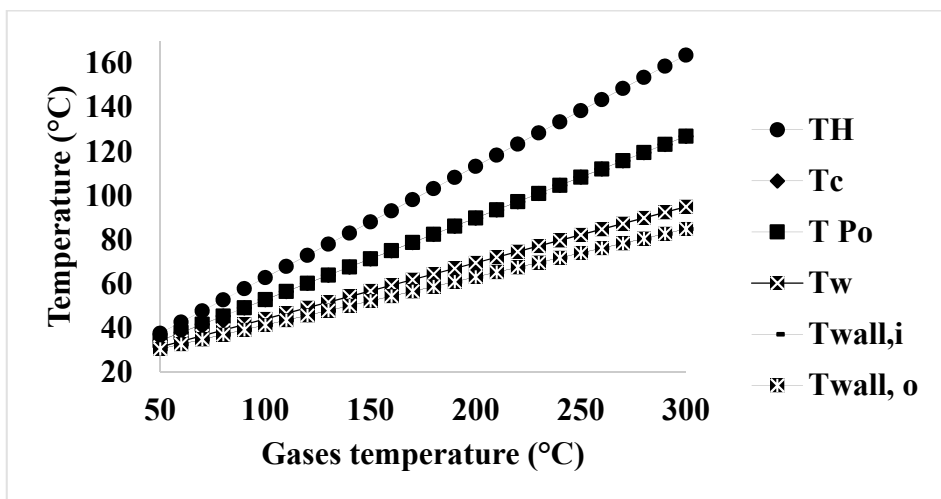

Figure 5. Variation in temperature distribution of the system.

The temperature at any layer in the system increased linearly with the increase in exhaust gases temperature. It should be noted that cold side temperature of the TEG T_c and the outer tube wall have a relatively equal temperature which is due to the small tube thickness and high thermal conductivity which reflect the invisibility of T_c on the graph.. Also $T_{wall,i}$ and $T_{wall,o}$ are approximately equal due to the low thickness of the tanks' wall.

Figure 6 shows the power generated by one TEG and the corresponding temperature difference at the two sides of the TEG.

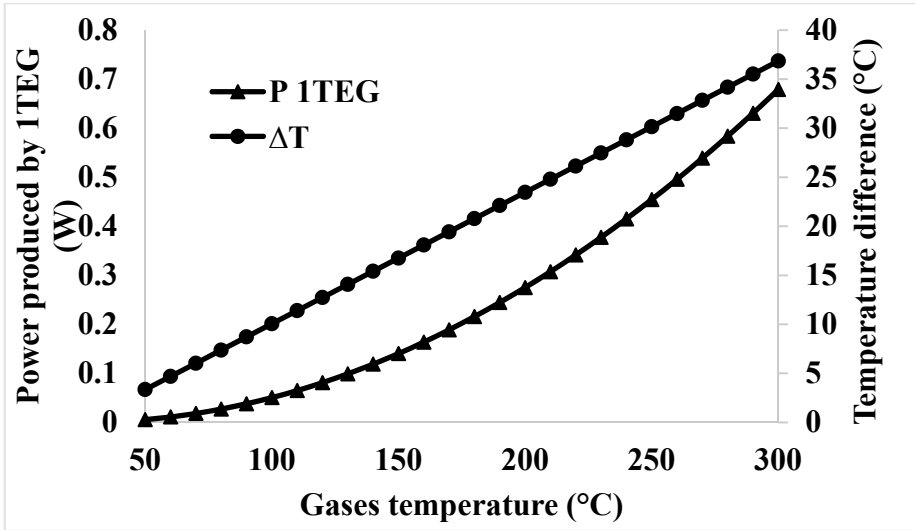

Figure 6. Temperature difference and power generated by one TEG.

It shows that the power generated by one TEG is continuously increasing with the increase in exhaust gases temperature. For a 300°C exhaust gases, 0.68 W of electricity is being produced at a 36.8°C temperature difference between the hot and cold sides of the TEG. While for 100°C, 0.14 W electric power is produced at a 17°C temperature difference.

Figure 7 shows the effect of changing the exhaust gases temperature on the total power produced by the TEGs layer.

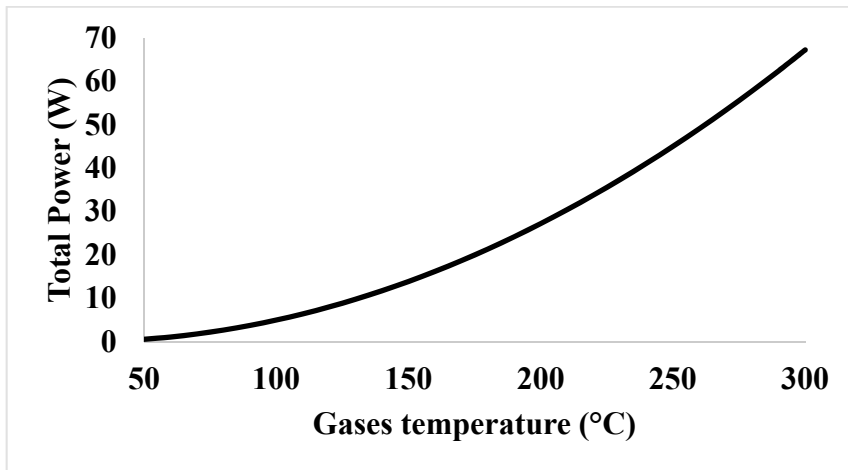

Figure 7. Total power produced by TEGs.

When the temperature of exhaust gases was 150°C the total power is total power produced is 14 W, when the exhaust gases temperature is doubled (300°C) the total power is 67 W. This indicates that the relation between power and exhaust gases is not linear and when the temperature of gases doubled the power increased 5 times from what it was.

5. Conclusion

Heat recovery offers an excellent opportunity for cost and energy saving in industrial and residential applications. The heat recovery process is mainly affected by the quality and quantity of thermal energy lost. In other words, heat recovery from exhaust gases is affected by the exhaust gases temperature and flow rate. The effect of exhaust gases on a proposed hybrid heat recovery system is studied. A domestic thermoelectric cogeneration heat recovery system is utilized in this study. The results shows that by increasing the gases temperature, the heat rate and temperatures at each layer increase linearly. The power generated by TEG progressively increases with the increase on exhaust gases temperature. Also it was shown that for the utilized configuration of HHRS, when doubling the gases temperature the power produced increases about 5 times more.

References

- [1] Williams A., Kennedy S., Philipp F., Whiteman G. Systems thinking: A review of sustainability management research. *Journal of Cleaner Production*, 2017; 148: 866-881.
- [2] Herez A, Ramadan M, Abdulhay B, Khaled M. Short review on solar energy systems. *AIP Conference Proceedings* 2016;1758,1: 10.1063/1.4959437
- [3] F. Hachem, B. Abdulhay, M. Ramadan, H. El Hage, M. Gad El Rab M. Khaled, Improving the performance of photovoltaic cells using pure and combined phase change materials – Experiments and transient energy balance, *Renewable Energy*, 2017; 107, 567–575.
- [4] M. Ramadan, M. Khaled, H.S. Ramadan, M. Becherif, Modeling and sizing of combined fuel cell-thermal solar system for energy generation, *International Journal of Hydrogen Energy*, 2016; 41, 19929–19935.
- [5] Plaza D, Martinez I, Gasch G, Sufrategui F, Garcia J. A Case Study of the Feasibility of Using Solar Concentrating Technologies for Manufacturing Ceramics. *Journal of Cleaner Production* 2015; 87: 977–991.
- [6] Kalogirou S. Solar thermal collectors and applications. *Progress in Energy and Combustion Science* 2004; 30: 231–295.
- [7] Ramadan M, Khaled M, Ramadan H, Becherif M. Modeling and sizing of combined fuel cell-thermal solar system for energy generation. *International Journal of Hydrogen Energy* 2016; 41, 44: 19929-19935.
- [8] Cherubini A, Papini A, Vertechy R, Fontana M. Airborne Wind Energy Systems: A review of the technologies. *Renewable and Sustainable Energy Reviews* 2015; 51: 1461-1476.
- [9] Giwa A, Alabi A, Yusuf A, Olukan T. A comprehensive review on biomass and solar energy for sustainable energy generation in Nigeria. *Renewable and Sustainable Energy Reviews* 2017; 69: 620-641.
- [10] Brimmo A, Sodiq A, Sofela S, Kolo I. Sustainable energy development in Nigeria: Wind, hydropower, geothermal and nuclear (Vol. 1). *Renewable and Sustainable Energy Reviews* 2017; 74: 474-490.
- [11] Tomasini-Montenegro C, Santoyo-Castelazo E, Gujba H, Romero R, Santoyo E. Life cycle assessment of geothermal power generation technologies: An updated review. *Applied Thermal Engineering* 2017; 114: 1119-1136.
- [12] Lee D, Cheng C. Energy savings by energy management systems: A review. *Renewable and Sustainable Energy Reviews* 2016; 6: 760–777.
- [13] Ramadan M, Lemenand T, Khaled M. Recovering heat from hot drain water—Experimental evaluation, parametric analysis and new calculation procedure. *Energy and Buildings* 2016; 128: 575-58.
- [14] Ramadan M, Gad El Rab M, Khaled M. Parametric analysis of air-water heat recovery concept applied to HVAC systems: Effect of mass flow rates. *Case Studies in Thermal Engineering* 2015; 6: 61-68.
- [15] Khaled M, Ramadan M, El Hage H. Parametric analysis of heat recovery from exhaust gases of generators. *Energy Procedia* 2015; 75: 3295-3300.
- [16] Khaled M, Ramadan M, Chahine K, Assi A. Prototype implementation and experimental analysis of water heating using recovered waste heat of chimneys. *Case Studies in Thermal Engineering* 2015; 5: 127-133.
- [17] Khaled M, Ramadan M. Heating fresh air by hot exhaust air of HVAC systems. *Case Studies in Thermal Engineering* 2016; 8: 398-402.
- [18] Jaber H, Khaled M, Lemenand T, Ramadan M. Short review on heat recovery from exhaust gas. *AIP Conference Proceedings* 2016; 1758: 10.1063/1.4959441.
- [19] Ramade P, Patil P, Shelar M, Chaudhary S, Yadav S, Trimbake S. Automobile Exhaust Thermo-Electric Generator Design & Performance Analysis. *International Journal of Emerging Technology and Advanced Engineering* 2014; 4.
- [20] Incorpera, F.P. and DeWitt, D.P. 2007. *Fundamentals of heat and mass transfer*. Sixth Edition. John Wiley & Sons.
- [21] Tecteg, Manufacturer of thermoelectric modules, 2016. Available from: www.tecteg.com

3.2 Systeme de cogeneration thermoelectrique domestique: analyse d'optimisation - effet du changement de volume d'eau

Hassan Jaber, Mohamad Ramadan, Mahmoud Khaled et Thierry Lemenand

Cette étude a été publiée dans les actes de la **conférence internationale sur l'ingénierie de l'énergie et du thermique ICTE** en 2017 à Istanbul

Résumé - La récupération de chaleur est la réutilisation de la chaleur perdue lors de processus générant de la chaleur, tels que des processus de combustion de carburant. De nombreux types d'approches de récupération de chaleur ont été proposés afin de tirer parti de l'énergie disponible dans la chaleur perdue. Malgré le grand nombre d'études consacrées à l'étude du concept de récupération de chaleur, rares sont celles consacrées à l'examen de l'effet géométrique du système de transfert de chaleur. Cela dit, et dans l'optique d'optimiser la quantité de chaleur récupérée, le présent travail a pour objectif de mettre en lumière l'effet de la modification du volume d'eau (rayon intérieur du réservoir) et du nombre d'occupants sur le processus de récupération. La conception du concept proposé est présentée. Il offre un double avantage : chauffer l'eau domestique et générer de l'électricité. La modélisation thermique du système est discutée tout au long du document. Une étude de cas est en cours sur l'utilisation des gaz d'échappement d'une cheminée résidentielle comme source de récupération de chaleur. Les résultats mettent en évidence l'impact de la modification du volume d'eau et du nombre d'occupants sur la température de l'eau et la puissance produite.

DOMESTIC THERMOELECTRIC COGENERATION SYSTEM: OPTIMIZATION ANALYSIS -EFFECT OF CHANGING WATER VOLUME

Hassan Jaber

School of Engineering, Lebanese International University LIU, PO Box 146404 Beirut, Lebanon.
Lebanon
LARIS EA 7315, University of Angers – ISTIA, Angers, France.

***Mohamad Ramadan**

School of Engineering, Lebanese International University LIU, PO Box 146404 Beirut, Lebanon.
Lebanon

Mahmoud Khaled

School of Engineering, Lebanese International University LIU, PO Box 146404 Beirut, Lebanon.
Lebanon

Thierry Lemenand

LARIS EA 7315, University of Angers – ISTIA, Angers, France.

Associate member at FCLAB, CNRS, Univ. Bourgogne Franche-Comte , Belfort cedex, France.
France

Keywords: Thermoelectric, cogeneration, thermal modeling, heat recovery, domestic hot water

** Corresponding author: Mohamad.ramadan@liu.edu.lb*

Abstract. *Heat recovery is the reusing of wasted heat that occurs in processes involving heat generation such as fuel combustion processes. Many types of heat recovery approaches have been proposed in order to take advantage of the available energy in waste heat. Despite the large number of studies dedicated to investigate heat recovery concept, few are those devoted to examine the geometrical effect of heat transfer system. Having said that, and in the light of optimizing the recovered amount of heat. The present work aims at shedding lights on the effect of changing the water volume (inner tank radius) and number of occupants on the recovering process. The design of the proposed concept is presented. It offers a dual advantage, heating domestic water and generating electricity. Thermal modeling of the system is discussed throughout the paper. A case study is being conducted by which exhaust gases of a residential chimney are utilized as heat recovery source. The results highlight the impact of changing the water volume and number of occupants on water temperature and produced power.*

INTRODUCTION

The new stringent laws on gases emissions and rapid escalating of fossil fuel cost are the main promptings for research center to seek for new sustainable technologies. Renewable energy which is defined as the energy produced from natural resources such as solar, wind, biomass, biofuel, wave, and river is a modern technology in which scientists are trying to benefit from [1-9]. However, such technology is restricted by many obstacles mainly availability, space, and instability [10].

On the other hand, heat recovery [11] from dissipated thermal energy is one of the main new technologies raised for mitigating energy consumption and maximizing energy usage. The major advantages of such technology are summarized by exploiting the available lost energy, simplicity and compatibility with industrial and residential applications. The common type of energy lost is thermal energy which can be carried out by cooling fluid or exhaust gases depending on the application. Typically,

about 30% and 25% of the input energy of an internal combustion engine are dissipated by exhaust gases and coolant fluid respectively [12]. This led to perform intensive studies on heat recovery from various applications including internal combustion engines, power generators, boilers, furnaces, chilled water, shower water and heat pump [13-21].

Moreover, many residential applications can be coupled with heat recovery system such as chimney. A relatively high amount of exhaust gases is generated from the combustion process of the fuel. In this context, a new heat recovery system is suggested to benefit from the wasted thermal energy of chimney's exhaust gases to heat domestic water and generate electricity. The system is composed of a water tank and a pipe passing through it by which exhaust gases pass through the pipe and transfer part of its thermal energy to water, where thermoelectric generators are attached to the walls of the pipe. The effect of changing the volume of water in the behavior of the heat recovery system is studied. Knowing that the volume of the

water found in tank is directly related to the number of occupants on home

This manuscript is categorized as follows. Section 2 illustrates the system design. The next section introduces the thermal modeling of the system which will be utilized in the following section to carry out results for changing the volume of water. Finally, in section 5 a summarizing conclusion is drawn.

SYSTEM DESIGN

Heating water is one of the biggest energy expenses in home, this made heating water from an available source of energy without paying power costs a real challenge. The suggested heat recovery system aims to heat domestic water and generate electricity. Figure 1 shows a schematic of the system with rectangular shaped system. The system consists of a pipe encapsulated with water tank by which exhaust gases passes through the pipe and water is filled inside the tank. At the walls of the pipe a layer of thermoelectric generators (TEG) is attached allowing a direct contact between exhaust gases and TEGs. Thermoelectric generators convert thermal energy to electric energy when they are subjected to temperature difference [22]. The TEGs absorb part of thermal energy and dissipate another part to the inner walls of the pipe which will transmit the thermal energy to the water. From a heat transfer point of view, thermal energy from exhaust gases is transferred to the TEG layer by convection. Then, TEGs transmit heat to the pipe by conduction. Hence, convection heat transfer is generated between water and the pipe walls. On the other hand, a part of thermal energy absorbed by the heat recovery system will be liberated to ambient air surrounding the system.

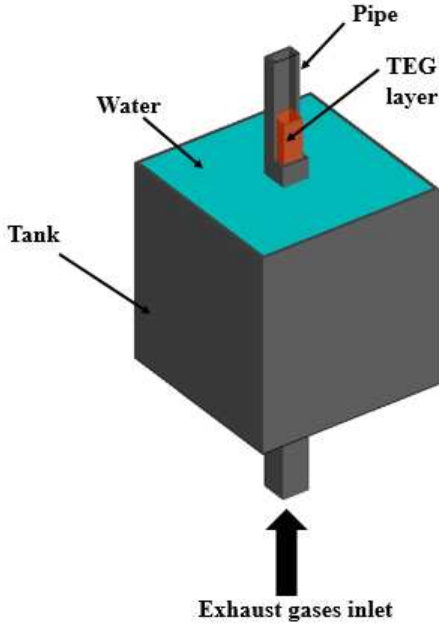

Figure 1. Schematic of the Hybrid heat recovery system.

Thermal Modeling

Regardless the volume of water in tank, the heat rate (Q) for the system is considered by the following equation [23].

$$Q = U.A . \Delta T = U.A.(T_g - T_a) = \frac{T_g - T_a}{R_{total}} \quad (1)$$

where U and A are the overall heat transfer coefficient and area of the system. T_g , T_a are the exhaust gases and ambient air temperature respectively. R_{total} is the total resistance of the heat recovery system which is evaluated by the summation of the resistances for each layer.

The thermal resistance of the system is shown in the following figure where R_g^{conv} is the convection resistance of exhaust gases, R_{TEG}^{cond} and R_p^{cond} are the conduction resistances of TEG and pipe respectively, R_{p-w}^{conv} and R_{w-t}^{conv} are the convection resistance of water with pipe and tank surfaces respectively, R_t^{cond} is the conduction thermal resistance of the tank wall and R_{t-a}^{conv} is the convection thermal resistance of ambient air and outer tank surface.

T_p^o is the outer pipe temperature, T_w^{avg} is the water temperature and T_t^i and T_t^o are inner tank and outer tank wall temperatures respectively.

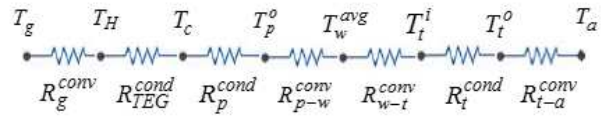

Figure 2. Thermal resistance modelling.

$$R_{total} = \left\{ \begin{array}{l} R_g^{conv} + R_{TEG}^{cond} + R_p^{cond} + \\ R_{p-w}^{conv} + R_{w-t}^{conv} + R_t^{cond} + R_{t-a}^{conv} \end{array} \right\} \quad (2)$$

The total resistance will vary with the change in water volume. Changing the water volume affects the inner diameter of the tank for a constant pipe diameter and system length. The required amount of water is restricted by the number of occupants available at home. The volume of water available at the tank is represented by

$$V_w = \pi(r_{t,i}^2 - r_{p,o}^2) . h = N_{persons} . ADHWU_{person} \quad (3)$$

where $r_{t,i}$ and $r_{p,o}$ are the inner tank and outer pipe radii respectively. h is the height of the system. $N_{persons}$, $ADHWU_{person}$ are the number of persons available and the average daily hot water usage per person.

Then for a constant outer pipe radius the inner tank radius:

$$r_{t,i} = \left(\frac{V_w}{\pi . h} + r_{p,o}^2 \right)^{\frac{1}{2}} \quad (4)$$

This will allow for the calculation of the thermal resistance of the system.

The power generated by one TEG (P_{TEG}) is estimated by the following equation:

$$P_{TEG} = \left(\frac{P}{(\Delta T)^2} \right)_{Ref} \cdot (T_H - T_c)^2 \quad (5)$$

where T_H and T_c are the hot and cold temperatures at the TEG sides. For a constant heat rate over the system the hot and cold temperatures are estimated by the following equations.

$$T_H = T_g - Q \cdot R_g^{conv} \quad (6)$$

$$T_c = T_H - Q \cdot R_{TEG}^{cond} \quad (7)$$

The total power generated by the TEG layer is the power generated by one TEG multiplied by number of TEGs available on the pipe.

$$P_{total} = N_{TEG} \cdot P_{TEG} \quad (8)$$

Where P_{total} and N_{TEG} are the total power generated and number of TEGs available.

RESULTS AND DISCUSSION

To apply the thermal modeling above a case study is considered. This section will be composed of two parts. Firstly, the effect of changing pipe to tank radii ratio (different tank volume for constant pipe volume) on the system is considered. Then, the effect of changing the number of occupants available on the power generated and water temperature is analyzed.

Table 1 shows the designed system parameters that will be utilized in the equation to study the effect of changing the inner tank radius on recovering process.

Table 1. Design parameters and heat coefficients [23].

Parameter	Value
Height of the system (h)	1 m
Inner pipe radius ($r_{p,i}$)	0.048 m
Outer pipe radius ($r_{p,o}$)	0.05 m
Area of TEG (A_{TEG})	0.00313 m ²
Thickness of TEG (e)	0.005 m ²
Ambient air temperature (T_a)	25 °C
Exhaust gases temperature (T_g)	300 °C
Conduction heat coefficient of tank (k_{tank})	80 W/m.K
Conduction heat coefficient of pipe (k_{pipe})	401 W/m.K
Convection heat coefficient of water (h_w)	200 W/m ² .K
Convection heat coefficient of air (h_a)	50 W/m ² .K
Convection heat coefficient of gases (h_g)	65 W/m ² .K

Figure 3 shows the effect of changing tank diameter on heat rate over the system.

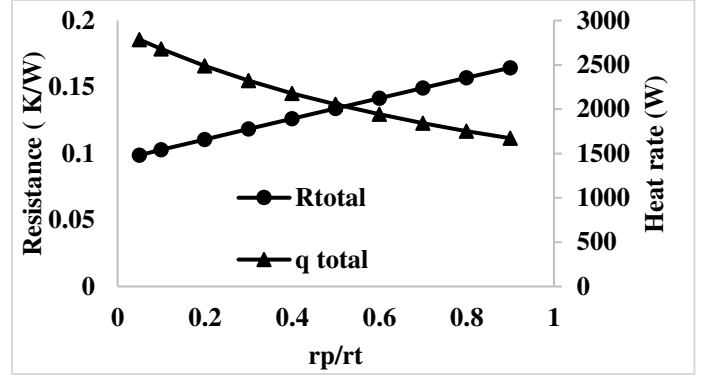

Figure 3. Effect of changing radius of the tank on heat rate and total resistance.

As shown in figure 3 above when the tank radius increases the total resistance decreases and the heat rate increases. When the radii ratio is equal to 0.9, the heat rate was minimum at 1.672 kW, it increases to 2.052 kW when the inner tank radius is double the outer pipe radius. This means that when the tank radius is doubled heat rate increased 28%.

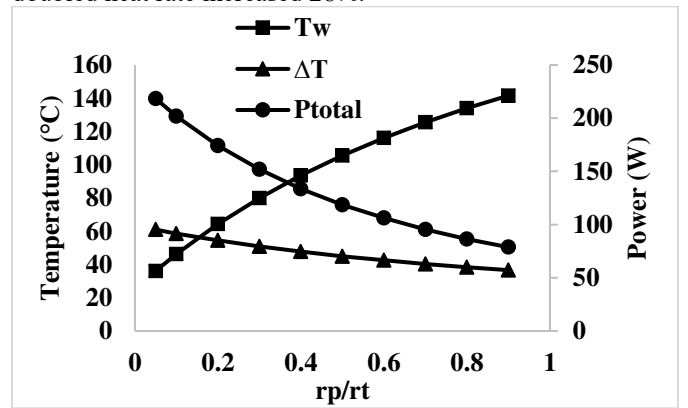

Figure 4. Effect of changing tank inner radius on water temperature, temperature difference and power generated.

Figure 4 shows the effect of changing the inner tank radius (water volume) with respect to the main aims: power generated temperature difference at TEG and water temperature. When the outer pipe to inner tank radius ratio equals to 0.9, the water temperature was maximum at 140 °C and the temperature difference at power are minimum at 36 °C and 78 W respectively. As the ratio decrease which means inner tank diameter increase, water temperature decreases and power generated increase. When the inner tank radius is five-time outer tank radius, the water temperature is 64 °C, temperature difference is 54 °C and 174 W of electric power is generated.

The volume of water required is directly related to number of persons available at a home (equation 3). Then in order to design such system the number of occupants in the home should be taken into consideration. With a 30-liter average daily usage of

hot water per person the inner radius and volume of the tank are shown in figure 5 below.

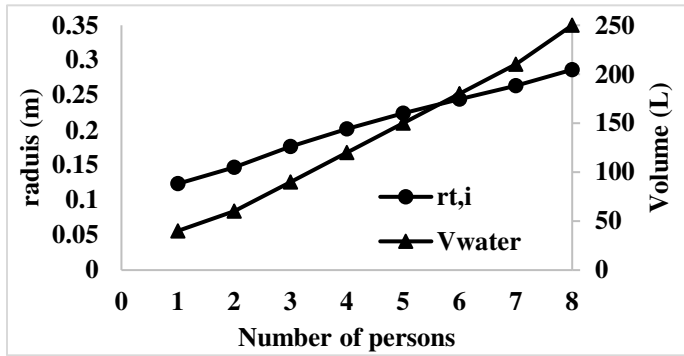

Figure 5. Variation of inner radius of the tank and water volume with respect to number of occupants.

As the number of occupants increase the inner radius of the tank will increase, implies water volume increase. About 230 liters of hot water are required daily of a family consist of 8 members. Figure 6 shows the effect of the number of occupants on the heat rate of the system.

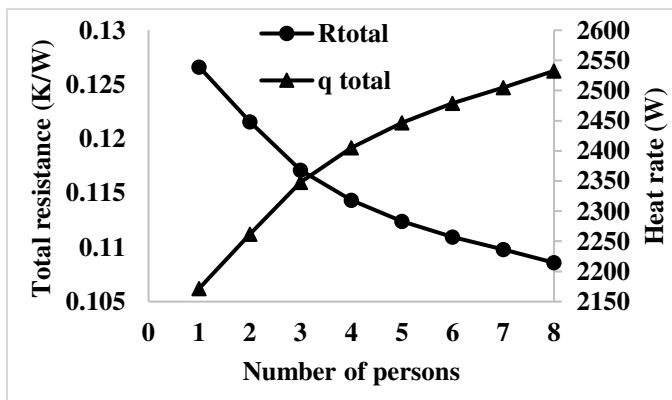

Figure 6. Effect of number of occupant's number of total resistance and heat rate.

When the number of occupants increase the required water volume increase, this will decrease the total resistance and increase the heat flow rate as illustrated above. Figure 6 shows compatible results with what figure 3 shows. For a family which is consist of 2 persons the total resistance is 0.12 K/W and 2.26 kW heat rate. However, for a family consist of 4 members (doubled) the total resistance decreased to 0.11 K/W and the heat rate increase to 2.4 kW.

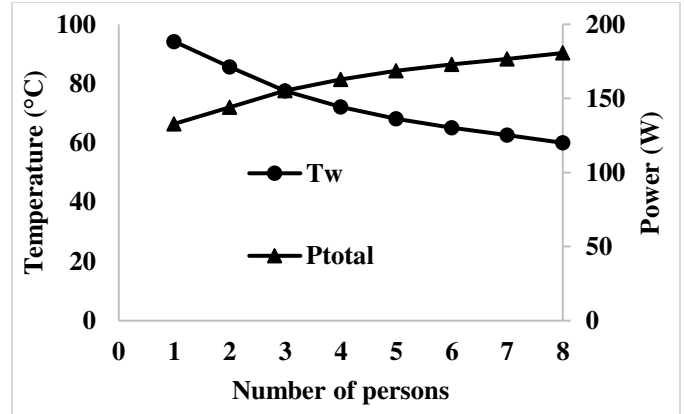

Figure 7. Effect of occupant's number on the total power generated and water temperature.

Figure 7 above shows that as the number of persons in a home increase, water temperature decreases and power generated increase. For a one person the system can heat water till 94 °C and the total power generated is 132 W. however for a family consist of 8 members the water temperature reaches 60 °C and the total power generated increase to 180 W. The decrease in water temperature is resulted from the high volume of water to be heated. And with a constant exhaust gases temperature the water temperature decreases. Figure 7 shows that for a family consisting of 4 members, water temperature is 15% less compared to a family of 2 members, and 30% less compared to a family of 8 members. The power generated by thermoelectric generators for an 8 membered family is 12.5% more than a 2 membered family.

CONCLUSION

The present work sheds light on the effect of changing the water volume and number of occupants on the heat recovering process. A heat recovery system that recover heat from exhaust gases of chimney is suggested. The main aims of the system is to heat water and generate electricity using TEGs. After presenting the concept of the design, a thermal modeling of the system was established. As for studying the effect of water volume on water temperature and power generated. Results shows that as water volume increase, total resistance of the system decrease, heat rate increase, water temperature decrease and power generated increase. Also, as the increase on the number of occupants, the water volume required to overcome daily hot water request increases. This implies to decrease in water temperature and increase in power generated. The main reason for the decrease on hot water temperature is the high amount of water that requires high temperature exhaust gases.

NOMENCLATURE

A	Area [m ²]
h	Convection heat transfer coefficient [W/m ² .K]
Q	Heat transfer rate [W]
h	Height of the tank [m]
N	Number of items
U	Overall heat transfer coefficient [W/m ² .K]
P	Power produced [W]
$P_{I\ TEG}$	Power produced by one TEG [W]
r	Radius [m]
T_a	Temperature [°C]
ΔT	Temperature difference at the sides of the TEG [°C]
k	Thermal conductivity [W/m.K]
R	Thermal resistance [K/W]
e	Thickness of the TEG [m]
V	Volume [m ³]

REFERENCES

- [1] A. Herez, M. Ramadan, B. Abdulhay, M. Khaled. Short review on solar energy systems. AIP Conference Proceedings 2016; 1758.
- [2] M. Ramadan, M. Khaled, H.S. Ramadan, M. Becherif, Modeling and sizing of combined fuel cell-thermal solar system for energy generation, International Journal of Hydrogen Energy. Volume 41, Issue 44, 26 November 2016, Pages 19929–19935.
- [3] P. Lianos, Review of recent trends in photoelectrocatalytic conversion of solar energy to electricity and hydrogen, Applied Catalysis B: Environmental, Volume 210, 5 August 2017, Pages 235-254.
- [4] J. Ram, N. Rajasekar, M. Miyatake, Design and overview of maximum power point tracking techniques in wind and solar photovoltaic systems: A review, Renewable and Sustainable Energy Reviews, Volume 73, June 2017, Pages 1138-1159.
- [5] N. Khan, A. Kalair, N. Abas, A. Haider, Review of ocean tidal, wave and thermal energy technologies, Renewable and Sustainable Energy Reviews, Volume 72, May 2017, Pages 590-604.
- [6] F. Gralla, D. Abson, A. Møller, D. Lang, H. von Wehrden, Energy transitions and national development indicators: A global review of nuclear energy production, Renewable and Sustainable Energy Reviews, Volume 70, April 2017, Pages 1251-1265.
- [7] A. Giwa, A. Alabi, A. Yusuf, T. Olukan, A comprehensive review on biomass and solar energy for sustainable energy generation in Nigeria, Renewable and Sustainable Energy Reviews, Volume 69, March 2017, Pages 620-641.
- [8] N. Gaurav, S. Sivasankari, GS Kiran, A. Ninawe, J. Selvin, Potential of biofuels from algae: Comparison with fossil fuels, ethanol and biodiesel in Europe and Brazil through life cycle assessment (LCA), Renewable and Sustainable Energy Reviews, Volume 73, June 2017, Pages 632-653
- [9] J.P. Gauthier, A.M. Giroux, S. Etienne, F.P. Gosselin, A numerical method for the determination of flow-induced damping in hydroelectric turbines, Journal of Fluids and Structures, Volume 69, February 2017, Pages 341-354
- [10] D. Zhang, J. Wang, Y. Lin, Y. Si, C. Huang, J. Yang, B. Huang, W. Li, Present situation and future prospect of renewable energy in China, Renewable and Sustainable Energy Reviews, Volume 76, September 2017, Pages 865-871.
- [11] H. Jaber, M. Khaled, T. Lemenand, M. Ramadan, Short review on heat recovery from exhaust gas. AIP Conference Proceedings 2016; Vol 1758.
- [12] S. Bari, S. Hossain, Waste heat recovery from a diesel engine using shell and tube heat exchanger, Applied Thermal Engineering, Vol 61, (2013), pp. 355-363.
- [13] M. Ramadan, T. Lemenand, M. Khaled, Recovering heat from hot drain water—Experimental evaluation, parametric analysis and new calculation procedure, Energy and Buildings, Volume 128, 15 September 2016, Pages 575-58.
- [14] M. Ramadan, M. Gad El Rab, M. Khaled, Parametric analysis of air-water heat recovery concept applied to HVAC systems: Effect of mass flow rates, Case Studies in Thermal Engineering, 6 (2015) 61-68.
- [15] M. Khaled, M. Ramadan, and H. El Hage, Parametric analysis of heat recovery from exhaust gases of generators, Energy Procedia, Vol 75, (2015), pp. 3295-3300.
- [16] M. Khaled, M. Ramadan, K. Chahine, and A. Assi, Prototype implementation and experimental analysis of water heating using recovered waste heat of chimneys, Case Studies in Thermal Engineering, Vol 5, (2015), 127-133.
- [17] M. Khaled, M. Ramadan, Heating fresh air by hot exhaust air of HVAC systems, Case Studies in Thermal Engineering, Volume 8, September 2016, Pages 398-402.
- [18] H. Tian, N. Jiang, Q. Jia, X. Sun, G. Shu, X. Lianga, Comparison of segmented and traditional thermoelectric generator for waste heat recovery of diesel engine, Energy Procedia 75 (2015) 590 – 596.
- [19] Y. Liu, J. Ma, G. Zhou, and W. wan, heat pump for heat recovery with superheated vapor, Thermal science, Vol. 19, 2015, No. 4, pp. 1468-1469.
- [20] N. iller, J. Hanson, and E. Yee, Waste heat generation: A comprehensive review, Waste Management, Vol 42, (2015), pp 166–179.
- [21] S.N. Hossain, and S.Bari, Waste heat recovery from exhaust of a diesel generator set using organic fluids, 10th International Conference on Mechanical Engineering, ICME.Procedia Engineering 90, 439 – 444, (2014).
- [22] S.B. Riffat, and X. Ma, Thermoelectrics: a review of present and potential applications, Applied Thermal Engineering. Vol 23, (2003), pp. 913–935.
- [23] Incorpera, F.P. and DeWitt, D.P. 2007. Fundamentals of heat and mass transfer. Sixth Edition. John Wiley & Sons.

3.3 Effet de la charge du générateur sur le système de récupération de chaleur hybride

Hassan Jaber, Mahmoud Khaled, Thierry Lemenand et Mohamad Ramadan

Cette étude a été publiée dans le journal « **Case Studies in Thermal Engineering** »

Résumé - La récupération de chaleur est la réutilisation de l'énergie thermique prodiguée. Ce document propose un système de récupération de chaleur hybride qui utilise les gaz d'échappement d'un générateur pour chauffer de l'eau et produire de l'électricité à l'aide de générateurs thermoélectriques. Le système est composé d'un réservoir concentrique avec un tube de cuivre le traversant. À la surface interne du tube, une couche de GTE est située. L'objectif principal de cet article est d'étudier l'effet de la modification de la charge du générateur sur la température de l'eau et la puissance générée. Sachant que 100 GTE sont utilisés, les résultats montrent que de l'eau chaude à 47 °C et 141 W sont produits lorsque la charge est de 10 kW. Cela augmente jusqu'à 97 °C d'eau chaude et 1412W lorsque la charge du générateur est de 38 kW (14,12W par GTE).

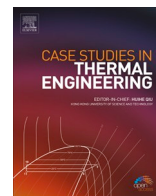

Effect of generator load on hybrid heat recovery system

Hassan Jaber^{a,c}, Mahmoud Khaled^{a,b}, Thierry Lemenand^c, Mohamad Ramadan^{a,d,*}



^a International University of Beirut LIU, Beirut, Lebanon

^b Univ Paris Diderot, Sorbonne Paris Cité, Interdisciplinary Energy Research Institute (PIERI), Paris, France

^c LARIS EA 7315, University of Angers – ISTIA, Angers, France

^d FCLAB, CNRS, Univ. Bourgogne Franche-Comté, Belfort cedex, France

ARTICLE INFO

Keywords:

Heat recovery
Thermoelectric generators
Cogeneration
Domestic hot water
Generators
Exhaust gases

ABSTRACT

Heat recovery is the reutilization of lavished thermal energy. This paper proposes a hybrid heat recovery system that utilizes exhaust gases of a generator to heat water and produce electricity using thermoelectric generators. The system is composed of a concentric tank with a copper tube passing through it. At the inner surface of the tube, a layer of TEGs is located. The main purpose of the paper is to study the effect of changing the load of the generator on the water temperature and power generated. Knowing that 100 TEGs are utilized, results show that 47 °C hot water and 141 W are produced when load is 10 kW. It increases to 97 °C hot water and 1412 W when the generator load is 38 kW (14.12 W per TEG).

1. Introduction

Nowadays, worldwide face a major problem with energy. Lack of energy availability, limited sources of energy, high cost of energy and energy extraction and strict laws and emission regulations imposed by governments obliged to seek for efficient, economical, renewable and sustainable technologies for energy utilization and conversion.

Renewable energy has been set as one of the best solutions of those problems. However, such technologies are limited by time, place and availability. Solar, wind, biomass, geothermal, hydropower are the main types of renewable energy which are exposed to high studies and researches [1–11].

Energy recovery [12–19] appears also as a perfect solution for maximum energy utilization. It deals with the re-usage of energy dissipated to the environment. Such technology offers a new source of energy, decrease polluting emissions and increase the energy utilization efficiency.

Khaled et al. [17] did a theoretical and experimental study on a suggested heat recovery system. The system which is called multi-tubes tank allows exhaust gases to enter multi-tubes that passes through a water tank. Two cases were considered by which exhaust gases are allowed to enter the tubes or to flow beside the bottom side of the tank in order to study the effect of tubes on the amount of heat transferred to water. In addition to that, effect of changing the quantity of burned fuel is studied. Results show that during one hour water temperature rises 68 °C when the tubes are open and 38 °C when the tubes are closed. Scarce are the studies on hybrid heat recovery systems that utilizes exhaust gases to heat water and generate electricity. Jaber et al. [20] performed a mathematical thermal study on hybrid heat recovery system that utilizes exhaust gases of chimney to heat water and generate electricity using thermoelectric generators. The effect of changing the location of TEGs on the suggested heat recovery system is examined. The TEGs are located in the inner or outer walls of the tube or the tank (cases 2–5) and in all walls in case 6. Results conducted shows that as the

* Corresponding author at: International University of Beirut LIU, Beirut, Lebanon.

E-mail address: mohamad.ramadan@liu.edu.lb (M. Ramadan).

<https://doi.org/10.1016/j.csite.2018.11.010>

Received 14 October 2017; Received in revised form 15 November 2018; Accepted 19 November 2018

Available online 29 November 2018

2214-157X/ © 2018 The Authors. Published by Elsevier Ltd. This is an open access article under the CC BY license (<http://creativecommons.org/licenses/by/4.0/>).

TEGs are located nearer to the exhaust gases the power generated increases, increasing the energy conversion efficiency of TEGs. In addition to that water can be heated up to 76 °C and generate about 34.8 W of electricity when the TEGs are located at the inner side of the tube. Moreover, Water temperature increases when the TEG location become more far from exhaust gases. Whereas when the TEGs are placed on all surfaces (case 6) water temperature rises to 81 °C and about 52 W electric power is generated. The paper also includes an economic and environmental study which shows that the location of TEGs does not affect the amount of CO₂ gas reduced (6 t/year) and such system with case 5 configuration requires 1 year and 8 months to payback its cost. [13] studied the effect of exhaust gases temperature on the performance of hybrid heat recovery system. Exhaust gases enter a heat recovery heat exchanger that utilizes thermal energy captured by gases to heat water and generate electricity. A thermal modeling of the system is presented. The main outcomes reached show that as the exhaust gases temperature increase, the heat rate and the temperature at each layer of the system increase and power generated by TEGs increase. It shows that when exhaust gases temperature is doubled, power generated increased five times.

This paper deals with a new proposed hybrid heat recovery system that utilizes exhaust gases to heat water and generate electricity. The study is performed on exhaust gases of a diesel engine. The effect of changing the load of the generator on the water temperature and power produced are studied.

The hybrid heat recovery system (HHRS) is demonstrated in Section 2. Section 3 shows a thermal modeling of the system. Several generators with different loads are studied in Section 4 that provides results and discussion of the associated results. Finally, a summarizing conclusion is drawn in Section 5.

2. Hybrid heat recovery system

The high amount of dissipated thermal energy obliged engineers to seek for ways to benefit from this energy. System with single or multiple stages of heat recovery was proposed and studied. This paper proposes a new hybrid heat recovery system that deals with the cogeneration of domestic hot water and production of electricity using thermoelectric generators (TEGs). Fig. 1 shows a schematic of the hybrid system where exhaust gases enter to a concentric tube tank. At the inner wall of the copper tube, a layer of TEGs is placed for the electricity production purpose. Water surrounds the copper tube which gains its heat from exhaust gases to the TEGs to the water.

Thermoelectric generators [21–25] are passive devices that convert thermal energy to electrical energy directly [26]. The TEGs are placed to gain heat from exhaust gases to water. When a temperature difference is applied at the sides of the TEG, an electric power is produced. Fig. 2 presents a schematic of a TEG which consists of P and N-type semiconductors. The main advantages of thermoelectric generators are summarized by their simplicity, minimal maintenance requirement and reliability. However, they exhibit low energy conversion efficiency and high cost [26].

3. Thermal analysis

To analyze the effect of the generator load on the water temperature and power produced by TEGs a thermal modeling is carried. The system is represented by a thermal resistance model. Some assumptions are utilized to simplify the calculations. The heat flow is assumed to be one dimensional flow at steady state. The exhaust gases and air temperature are set to be constant.

Fig. 3 presents the resistance thermal modeling of the system. It shows a seven thermal resistance model. Starting from hot exhaust gases, heat transfer occurs from gases to the hot side of the TEG by convection. Then, heat flows through TEG to the tube's wall by conduction. At the outer wall of the tube, heat transfer occurs toward water via convection in which water delivers heat to the inner wall of the tank via convection. A conduction heat transfer occurs at the tank's wall. Finally, heat is dissipated to ambient air via convection.

The heat rate occurs from the exhaust gases to the ambient air and expressed by the following equation.

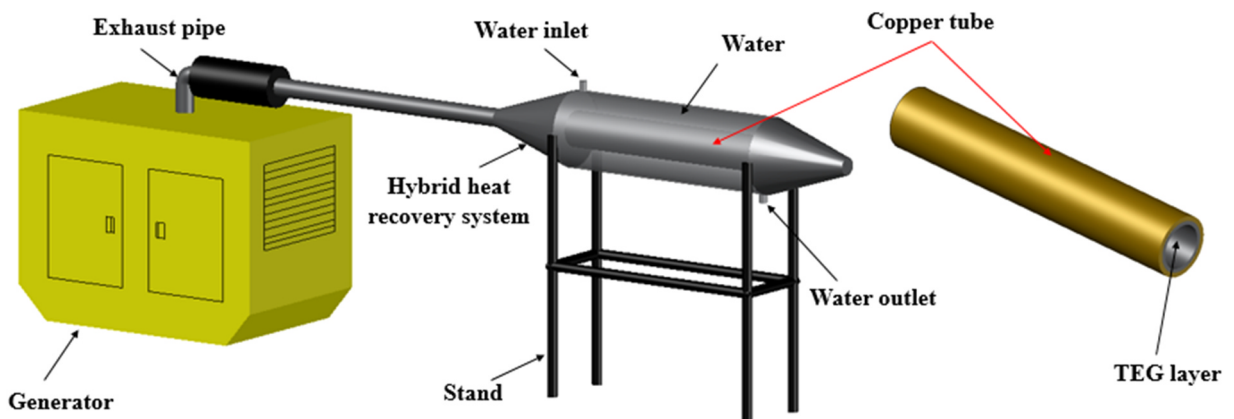

Fig. 1. Hybrid heat recovery system coupled to exhaust of an electric generator.

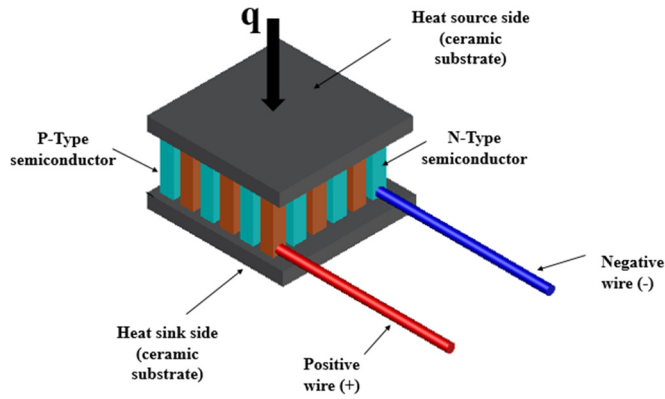

Fig. 2. Thermoelectric generator.

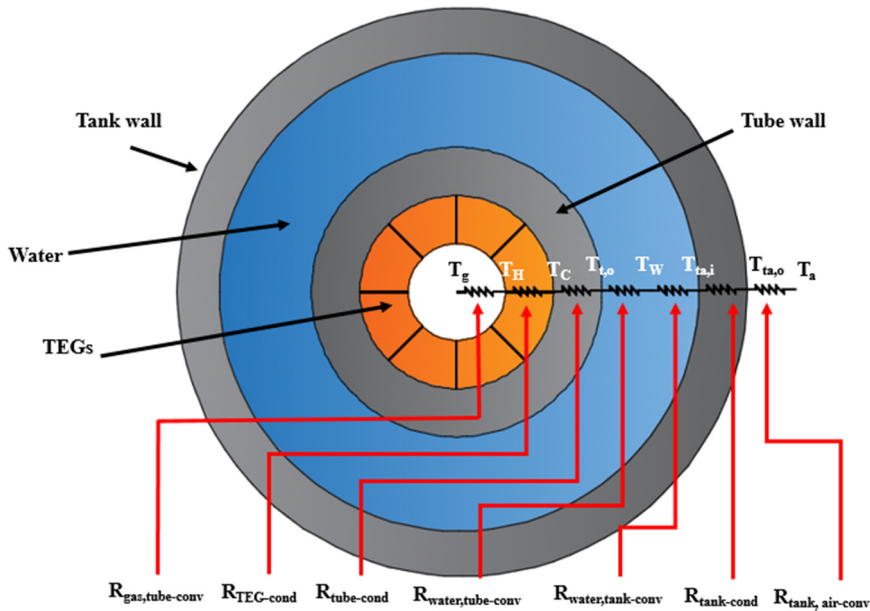

Fig. 3. Resistance thermal model of the hybrid heat recovery system.

$$q = \frac{\Delta T}{R_{total}} = \frac{T_g - T_a}{R_{total}} \tag{1}$$

where T_g , T_a are the exhaust gases and air temperature respectively. R_{total} is the summation of the seven resistances and represented by:

$$R_{total} = \sum_{n=1}^7 R_n = \left\{ \begin{aligned} &R_{gas,tube-conv} + R_{TEG-cond} + R_{tube-cond} + R_{water,tube-conv} \\ &+ R_{water,tank-conv} + R_{tank-cond} + R_{tank,air-conv} \end{aligned} \right\} \tag{2}$$

where $R_{gas,tube-conv}$, $R_{water,tube-conv}$, $R_{water,tank-conv}$ and $R_{tank,air-conv}$ are the four convection thermal resistances between exhaust gases and tube, tube and water, water and tank, tank and air respectively. $R_{TEG-cond}$, $R_{tube-cond}$ and $R_{tank-cond}$ are the three conduction thermal resistances of thermoelectric generators, tube and tank respectively.

Table 1 below shows the equation of each thermal resistance, knowing that h_g , h_w and h_a are the convection heat coefficient of exhaust gases, water and air respectively, k_{TEG} , k_t and k_{ta} are the conduction heat transfer coefficient for TEG, tube and tank. $r_{t,i}$, $r_{t,o}$, $r_{a,i}$ and $r_{a,o}$ are the inner and outer radii of the tube and tank respectively.

After estimating the total resistance, the heat rate is evaluated using Eq. (1). By calculating the heat rate, temperature at each section on the system is estimated by the following equation.

$$T_{sec} = T_{pre-sec} - q \cdot R_{sec} \tag{3}$$

where T_{sec} and $T_{pre-sec}$ are the temperature at the section and previous section respectively. R_{sec} is the thermal resistance of the section.

Table 1
Thermal resistance equations.

Heat transfer type	General form	Thermal resistance equation			
Convection	$\frac{1}{h \cdot A}$	$R_{gas,tube-conv} = \frac{1}{h_g (2\pi (r_{t,i} - t) L)}$	$R_{water,tube-conv} = \frac{1}{h_w (2\pi r_{t,o} L)}$	$R_{water, tan k-conv} = \frac{1}{h_w (2\pi r_{ta,i} L)}$	$R_{tan k, air-conv} = \frac{1}{h_a (2\pi r_{ta,o} L)}$
Conduction	$\frac{\ln \left[\frac{r_o}{r_i} \right]}{2 \pi \cdot K \cdot L}$	$R_{TEG-cond} = \frac{\ln \left[\frac{r_{t,i}}{r_{t,i} - t} \right]}{2\pi k_{TEG} L}$	$R_{tube-cond} = \frac{\ln \left[\frac{r_{t,o}}{r_{t,i}} \right]}{2\pi k_t L}$	$R_{tan k-cond} = \frac{\ln \left[\frac{r_{ta,o}}{r_{ta,i}} \right]}{2\pi k_{ta} L}$	

Then the power of one TEG $P_{generated}^{TEG}$ is calculated as follows:

$$P_{generated}^{TEG} = (P/\Delta T^2)_{ref} \cdot \Delta T_{TEG}^2 \tag{4}$$

where ΔT_{TEG} is the temperature difference at the thermoelectric generator.

The total power produced by thermoelectric generators $P_{generated}^{total}$ is the summation of all power produced by TEGs, or calculated by the following equation.

$$P_{generated}^{total} = P_{generated}^{TEG} \cdot N_{TEG} \tag{5}$$

where N_{TEG} is the number of thermoelectric generators attached to the inner wall of the tube.

4. Case study and results

To perform the study, a “13 B Toyota” 4 cylinder water cooled diesel engine is utilized [27]. The engine is of 102 mm bore and 105 mm stroke with a 217 N torque at 2200 rpm. The temperature of exhaust gases is measured at nine different loads, which are summarized in Table 2. As the load increases, exhaust gases temperature increases, from 180 °C at 7.5 kW load to 640 °C at 38 kW load.

The hybrid heat recovery system is composed of 100 TEG and 187 l water tank. The main parameters needed to apply Eqs. (1)–(5) are recapitulated in the Table 3.

By applying Eqs. (1), (2), (3), (4), (5) and using Table 2 and Table 3, the following results are conducted.

Fig. 4 shows the evolution of the different temperatures according to the generator load. As the load of the generator increases, temperature at each section increases. It shows high change in temperature at the TEGs when load is changed, T_H reached more than 500° at the maximum generator load (38 kW), that leads to a high increase in power produced by TEGs. Water temperature T_w increase from 43 to 97 °C when the load is increased from 7.5 to 38 kW. Augmentations of temperatures are more or less proportional to the increase of the generator load until about 30 kW, and beyond this value the temperature increase is slightly accelerated, indicating a decrease in the efficiency of the generator and a better recuperation of energy from the recovery heat system.

Fig. 5 shows water temperature and total power produced according to the generator load. As the load increases, water temperature and total power produced increase. When the generator load is 10 kW water temperature is 47 °C and power produced by TEGs is 141 W. While, when the generator load is increased to 38 kW water temperature reached 97 °C and TEGs generated 1412 W, i.e. 14.12 W per TEG. As Eq. (4) mentioned the power produced by TEGs is proportional to the square of the temperature difference, this leads to the high increase in power generated since the power generated is multiplied by a 10 factor when the load is increased from 10 to 38 kW.

As a brief summary of the results conducted, as the generator load increase, power generated and water temperature increases. In addition to that the temperature at each layer of the system has increased with the increase in the load. The conducted results perfectly match with the results associated by [13]. It should be noted that as the generator load increase, the quality and quantity of exhaust gases changes. In other words, mass flow rate and temperature of exhaust gases varies with the change of the load leading to the increase in heat transfer rate to water and TEGs which led to increase water temperature and power generated.

Table 2
Electric generator specification [27].

Load (kW)	Load (kVA)	Exhaust gas temperature (°C)
7.5	10	180
10	12	220
15	18	270
20	25	325
25	30	385
30	37	460
35	43	555
37.5	47	620
38	50	640

Table 3
Main parameter of the HHRS.

Item	Value	Unit
Inner tube radius	0.049	m
Outer tube radius	0.05	m
Inner tank radius	0.249	m
Outer tank radius	0.25	m
Length of the tank	1	m
Conduction heat transfer coefficient of TEG	0.25	W/m K
Conduction heat transfer coefficient of the tube (Copper)	401	W/m K
Conduction heat transfer coefficient of the tank (Iron)	80	W/m K
Convection heat transfer coefficient of exhaust gases	64	W/m ² K
Convection heat transfer coefficient of water	25	W/m ² K
Convection heat transfer coefficient of air	80	W/m ² K
Thickness of TEG	0.005	m
Area of TEG	0.0031	m ²
Ambient air temperature	25	°C
$P/\Delta T^2$	0.00065	W/K ²

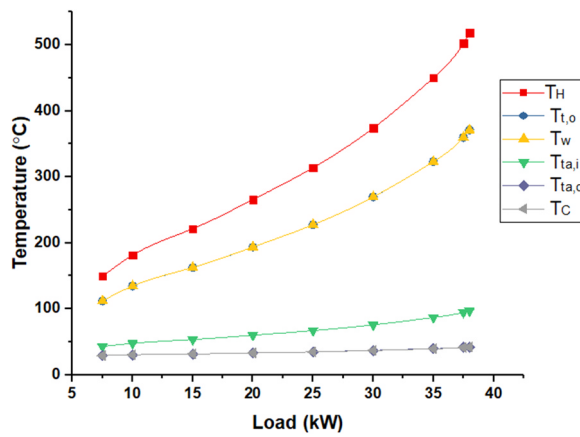

Fig. 4. Temperature at each section with the change of the load.

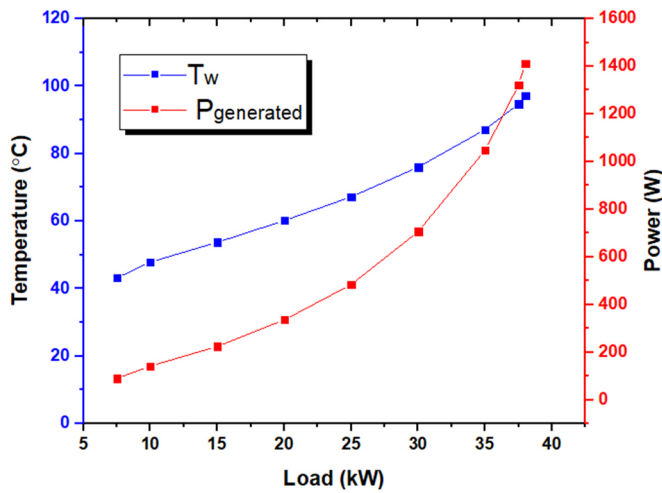

Fig. 5. Water temperature and total power produced by TEGs as function of load.

5. Conclusion

Since domestic hot water is the main electric consumption post in homes, various studies were performed to utilize new sources of energy to feed home with domestic hot water without the utilization of electric power. Heat recovery from exhaust gases provides a

source of energy that can be easily utilized to produce hot water. This paper go beyond heating water, it deals with heating water and generating electricity by a proposed hybrid heat recovery system. The recovery system is explained showing that electric power is generated using thermoelectric generators. The exhaust gases of diesel engine are set as the wasted heat source. Exhaust gases enter a concentric tube water tank equipped with layer of TEGs. A thermal modeling of the system is carried. The effect of changing the load of the generator on water temperature and electric power produced is mainly studied throughout this paper. Results show that as the load increases the water temperature and power produced increases. Such system is capable to produce 47 °C hot water and 141 W electric power for a 10 kW load generator with 100 TEGs utilized. It increases to 97 °C hot water and 1412 W electric power when 38 kW load generator is utilized with same number of TEGs.

Conflict of interest

None.

References

- [1] A. Herez, M. Ramadan, B. Abdulhay, M. Khaled, Short review on solar energy systems, in: *Proceedings of the AIP Conference*, 2016. <<https://dx.doi.org/10.1063/1.4959437>>.
- [2] T. Srinivas, B.V. Reddy, Hybrid solar–biomass power plant without energy storage, *Case Stud. Therm. Eng.* 2 (2014) 75–81.
- [3] Y. Agrouaz, T. Bouhal, A. Allouhi, T. Kousksou, A. Jamil, Y. Zeraoui, Energy and parametric analysis of solar absorption cooling systems in various Moroccan climates, *Case Stud. Therm. Eng.* 9 (2017) 28–39.
- [4] H. Semmari, A. LeDenn, F. Boudéhenn, J. Praene, F. Lucas, O. Marc, Case study for experimental validation of a new presizing tool for solar heating, cooling and domestic hot water closed systems, *Case Stud. Therm. Eng.* 10 (2017) 272–282.
- [5] G. Mokhtar, B. Boussad, S. Noureddine, A linear Fresnel reflector as a solar system for heating water: theoretical and experimental study, *Case Stud. Therm. Eng.* 8 (2016) 176–186.
- [6] D. Bishoyi, K. Sudhakar, Modeling and performance simulation of 100 MW PTC based solar thermal power plant in Udaipur India, *Case Stud. Therm. Eng.* 10 (2017) 216–226.
- [7] F. Hachem, B. Abdulhay, M. Ramadan, H. El Hage, M. Gad El Rab, M. Khaled, Improving the performance of photovoltaic cells using pure and combined phase change materials – experiments and transient energy balance, *Renew. Energy* 107 (2017) 567–575.
- [8] H. Semmari, A. LeDenn, F. Boudéhenn, J. Praene, F. Lucas, O. Marc, Case study for experimental validation of a new presizing tool for solar heating, cooling and domestic hot water closed systems, *Case Stud. Therm. Eng.* 10 (2017) 272–282.
- [9] A. Herez, M. Khaled, R. Murr, A. Haddad, H. Elhage, M. Ramadan, Using geothermal energy for cooling - parametric study, *Energy Procedia* 119 (2017) 783–791.
- [10] M. Ramadan, M. Khaled, H.S. Ramadan, M. Becherif, Modeling and sizing of combined fuel cell-thermal solar system for energy generation, *Int. J. Hydrog. Energy* 41 (2016) 19929–19935.
- [11] A. El Mays, R. Ammar, M. Hawa, M. Abou Akroush, F. Hachem, M. Khaled, M. Ramadan, Improving photovoltaic panel using finned plate of aluminum, *Energy Procedia* 119 (2017) 812–817.
- [12] A. Nemati, H. Nami, F. Ranjbar, M. Yari, A comparative thermodynamic analysis of ORC and Kalina cycles for waste heat recovery: a case study for CGAM cogeneration system, *Case Stud. Therm. Eng.* 9 (2017) 1–13.
- [13] H. Jaber, M. Khaled, T. Lemenand, J. Faraj, H. Bazzi, M. Ramadan, Effect of exhaust gases temperature on the performance of a hybrid heat recovery system, *Energy Procedia* 119 (2017) 775–782.
- [14] M. Khaled, M. Ramadan, H. El Hage, Parametric analysis of heat recovery from exhaust gases of generators, *Energy Procedia* 75 (2015) 3295–3300.
- [15] M. Khaled, M. Ramadan, Study of the thermal behavior of multi concentric tube tank in heat recovery from chimney – analysis and optimization, *Heat. Transf. Eng. J.* 8 (2017) 1–11.
- [16] M. Ramadan, M. Gad El Rab, M. Khaled, Parametric analysis of air-water heat recovery concept applied to HVAC systems: Effect of mass flow rates, *Case Stud. Therm. Eng.* 6 (2015) 61–68.
- [17] M. Khaled, M. Ramadan, K. Chahine, A. Assi, Prototype implementation and experimental analysis of water heating using recovered waste heat of chimneys, *Case Stud. Therm. Eng.* 5 (2015) 127–133.
- [18] M. Khaled, M. Ramadan, H. El Hage, Parametric analysis of heat recovery from exhaust gases of generators, *Energy Procedia* 75 (2015) 3295–3300.
- [19] H. Jaber, M. Khaled, T. Lemenand, M. Ramadan, Short review on heat recovery from exhaust gas, in: *Proceedings of the AIP Conference*, 1758, 2016. <<https://dx.doi.org/10.1063/1.4959441>>.
- [20] H. Jaber, M. Ramadan, T. Lemenand, M. Khaled, Domestic thermoelectric cogeneration system optimization analysis, energy consumption and CO₂ emissions reduction, *Appl. Therm. Eng.* 130 (2018) 279–295.
- [21] W. Li, M.C. Paul, J. Siviter, A. Montecucco, A.R. Knox, T. Sweet, G. Min, H. Baig, T.K. Mallick, G. Han, D.H. Gregory, F. Azough, R. Freer, Thermal performance of two heat exchangers for thermoelectric generators, *Case Stud. Therm. Eng.* 8 (2016) 164–175.
- [22] S. Bai, H. Lu, T. Wu, X. Yin, X. Shi, L. Chen, Numerical and experimental analysis for exhaust heat exchangers in automobile thermoelectric generators, *Case Stud. Therm. Eng.* 4 (2014) 99–112.
- [23] X. Liu, Y.D. Deng, S. Chen, W.S. Wang, Y. Xu, C.Q. Su, A case study on compatibility of automotive exhaust thermoelectric generation system, catalytic converter and muffler, *Case Stud. Therm. Eng.* 2 (2014) 62–66.
- [24] W. Li, M.C. Paul, A. Montecucco, J. Siviter, A.R. Knox, T. Sweet, M. Gao, H. Baig, T.K. Mallick, G. Han, D.H. Gregory, F. Azough, R. Freer, Multiphysics simulations of thermoelectric generator modules with cold and hot blocks and effects of some factors, *Case Stud. Therm. Eng.* 10 (2017) 63–72.
- [25] C.Q. Su, W.S. Wang, X. Liu, Y.D. Deng, Simulation and experimental study on thermal optimization of the heat exchanger for automotive exhaust-based thermoelectric generators, *Case Stud. Therm. Eng.* 4 (2014) 85–91.
- [26] S. LeBlanc, Thermoelectric generators: linking material properties and systems engineering for waste heat recovery applications, *Sustain. Mater. Technol.* 1 2 (2014) 26–35.
- [27] S. Bari, S. Hossain, Waste heat recovery from a diesel engine using shell and tube heat exchanger, *Appl. Therm. Eng.* 61 (2013) 355–363.

3.4 Système de récupération de chaleur hybride appliqué aux gaz d'échappement - Modélisation thermique et étude de cas

Hassan Jaber, Thierry Lemenand, Mohamad Ramadan et Mahmoud Khaled

Cette étude a été acceptée dans le journal « *Heat Transfer Engineering* »

Résumé - En raison de la forte augmentation du taux de demande d'énergie, l'épuisement de l'énergie est devenu une préoccupation majeure de la recherche pour les scientifiques. La récupération de chaleur est une solution prometteuse pour surmonter le gaspillage d'énergie, puis l'impact sur l'environnement. Cet article traite d'un système hybride de récupération de chaleur dans lequel l'énergie thermique contenue dans les gaz d'échappement est utilisée pour générer de l'eau chaude sanitaire et produire de l'électricité à l'aide de générateurs thermoélectriques. Une modélisation thermique et électrique est réalisée et une étude de cas est réalisée. La température de l'eau est mesurée expérimentalement dans le temps et a atteint une température maximale de 78°C. À l'aide de la modélisation thermique, la puissance produite par les générateurs thermoélectriques est calculée. Il en ressort qu'un tel système peut produire jusqu'à 135 W avec une différence de température de 33,6 °C par rapport aux générateurs thermoélectriques. Des études économiques et environnementales montrent que ce système nécessite une période de récupération d'environ 8 ans et que 5,1 tonnes de CO₂ sont économisées lorsque le système de récupération de chaleur hybride chauffe l'eau 80 fois par mois.

Hybrid heat recovery system applied to exhaust gases – Thermal modeling and case study

Hassan Jaber^{1,2}, Thierry Lemenand², Mohamad Ramadan^{1,3}, and Mahmoud Khaled^{1,4,*}

¹Energy and Thermo-Fluid group – School of Engineering –International University of Beirut BIU– PO Box 146404 Beirut – Lebanon

²LARIS EA 7315, ISTIA, University of Angers, Angers, France

³Associate member at FCLAB, CNRS, Univ. Bourgogne Franche-Comté, Belfort cedex, France.

⁴University Paris Diderot, Sorbonne Paris Cité, Interdisciplinary Energy Research Institute (PIERI), Paris, France

* Corresponding author e-mail : mahmoud.khaled@liu.edu.lb

Abstract. Due to the high increase in the rate of energy demand, energy depletion became a major research preoccupation for scientists. Heat recovery is a promising solution to overcome wasting energy and then environment impact. This paper deals with a hybrid heat recovery system in which thermal energy in exhaust gases is being used to generate domestic hot water and produce electricity using thermoelectric generators. A thermal and electrical modeling is carried and a case study is done. The water temperature is measured experimentally over time and it achieved maximum temperature of 78°C. Using the thermal modeling the power produced by thermoelectric generators is calculated. It shows that such system can produce up to 135 W at a 33.6°C temperature difference over the thermoelectric generators. Economic and environmental studies are carried out showing that such system requires about 8 years as a payback period and about 5.1 tons of CO₂ gas is reduced when the water is heated 80 times/month by the hybrid heat recovery system.

INTRODUCTION

In 2015, the total world energy consumption was around 13105 mtoe (million tons of oil equivalent) which increased to 13276.3 mtoe in 2016 at an increasing rate of 1.3% yearly [1]. The significant growth in energy demand lead to several issues, mainly energy shortage, sharp increase in energy cost, pollution, and global warming. Energy management [2-6] can appear as the main solution for those problems which is mainly about renewable energy and energy recovery [7-22]. Renewable energy mainly consists of solar, wind, biomass and geothermal [23-34]. Renewable energy is a new source of energy; however, such source of energy may be limited under specific conditions and circumstances.

It is estimated that about one third of the energy input is being dissipated to environment without taking advantage of the released energy. This released energy could be utilized in order to decrease the energy input. 10% reduction on fuel consumption can be achieved by recovering 6% of heat rejected in the exhaust gas of an ICE (internal combustion engine) [35]. Also, 1% reduction on fuel consumption for a boiler is achieved, when the combustion air is heated 200°C more or boiler fed water is heated 60°C more [36].

The recovered heat can be used directly as heat energy to heat another liquid or gas (water or space heating) or stored as sensible or latent heat or to produce electricity using thermoelectric generators (TEG) for low temperature application or Rankine cycle for high temperature application. Thermoelectric generators are passive devices used to transfer thermal energy to electric energy [37-39]. They can produce power from any temperature difference which make them attractive to be utilized in heat recovery. Thermoelectric

generators consist of N and P type semiconductor which are connected electrically in series and thermally in parallel. The main limitation of thermoelectric generators is their low efficiency (5%) [40]. Thermoelectric generators are sandwiched between a heat source (waste heat) and heat sink, this temperature difference at both sides of the device induces small voltage which describes Seebeck effect. Remeli *et al.* [41] introduced a theoretical and experimental study in generating electricity using thermoelectric generators coupled with heat pipe. The obtained results show that 1.345 kW of waste heat is recovered generating 10 W using 8 TEG. Twaha *et al.* [42] presented a comprehensive review on thermoelectric technology regarding the materials, modelling techniques, applications and performance. It was observed that the progress in performance of thermoelectric technology relies on promoting thermoelectric material research, design of installed thermoelectric devices, modifying device geometric and utilizing developed thermoelectric mathematical models. Zheng *et al.* [43] conducted an experimental study of a domestic thermoelectric cogeneration system which consists of heat exchangers designs and system construction configurations. Design and performance of heat exchangers has been introduced. To clarify the system performance at practical and theoretical level, a theoretical modelling has been carried out to analyze the performance of the system. Also, measurements of the parameters that describe the system performance under steady heat input was taken into consideration. Finally, introduction to electric, thermal energy, hydraulic and dynamic thermal performances of the system have been given. It was observed that the externally loaded electrical resistance (yields maximum power output) changes with the operating temperature. The experimental results show about 3.5 % conversion efficiency was achieved. The coolant temperature

achieved 80 degree rise with relatively low water speed. Wang *et al.* [44] performed simulation and evaluation of combined cooling, heating and power system with internal combustion engine for generating power, refrigerating and producing hot water. Utilization of thermoelectric generator and condensing heat exchanger is done for recovering exhaust gas waste heat of ICE. Results revealed that the primary energy efficiency, primary energy saving ratio and cost saving ratio can attain 0.944, 0.304 and 0.417 respectively. Also, economic adaptation was greatly progressed and the total investment increment was about 11.1%. Chen *et al.* [45] designed, modelled and tested a thermoelectric energy harvester. The harvester was formed of two thermoelectric modules, a wicked copper-water heat pipe and finned heat sink. The prototype could produce maximum open circuit voltage of $8.06 \text{ V} \pm 0.007 \text{ V}$ at 136.9°C temperature difference, and a maximum power of $2.25 \text{ W} \pm 0.13 \text{ W}$ at $246^\circ\text{C} \pm 1.9^\circ\text{C}$ source temperature by utilizing two $1.1'' \times 1.1''$ thermoelectric modules. It was found that generated power can be increased by about 50% when adding another pair of thermoelectric modules. Meng *et al.* [46] investigated the performance of thermoelectric generator installed on automobile exhaust waste recovery and optimized its design. Exhaust heat source and water-cooling heat sink were actually modeled to study the impact of cooling pattern and thermoelectric unit number on the performance of the overall system. Remeli *et al.* [47] designed and fabricated a lab scale bench-top of waste heat recovery and electricity conversion system. Experiments were investigated to estimate the performance of the system regarding heat transfer rate, heat exchanger effectiveness, and maximum output power. The results showed that when air velocity attained 1.1 m/s, highest heat exchanger effectiveness of 41% was achieved. Also, it was observed that the system is able to recover heat about 1079 W and produce about 7 W electric power. Thus, the thermal to electric conversion efficiency is 0.7%.

Several studies were made in the field of domestic thermoelectric cogeneration system [48-50]. Alanne *et al.* [51] designed a pellet fueled thermoelectric cogeneration heat recovery system. The TEGs were located inside the combustion chamber in which hot temperature at the surface of the TEG achieved 750°C . The maximum electric output is achieved is 1.9 kW with a 9 % electric efficiency. Such system reduced 21% of CO₂ emissions compared to a regular pellet fueled boiler.

Generally, heat recovery from exhaust gases is a trending technology nowadays. The fields of study are concentrated in suggesting new hybrid systems or developing new heat recovery heat exchanger and optimizing them. Based on this, this paper aims to optimize a heat recovery heat exchanger which is recently suggested by Khaled *et al.* [9] by attaching an extra layer of thermoelectric generators. It deals with the principle of hybrid heat recovery system, where thermal energy lost by exhaust gases is utilized to heat domestic hot water and to produce electricity using TEGs. Thermal and electrical modelling of this heat recovery system is done in section 2. A case study is carried out to obtain the total output power

generated by TEGs (section 3) and an economical and environmental study is achieved in section 4. Finally, section 5 draws the main conclusions of the work.

HYBRID SYSTEM AND THERMAL MODELLING

A hybrid heat recovery system is done to recover waste heat in the exhaust gas. This hybrid system consists of two stages of recovery, first by heating water then by producing electricity using thermoelectric generators. The concept of heat recovery and its thermodynamic modeling is presented in this section.

Principle

Figure 1 shows the system that is utilized in order to recover heat from exhaust gases. It shows that exhaust gases pass through multi-tube tank where they release part of their thermal energy to the water surrounding the pipes inside the cylinder. Instead of a direct contact of ambient air with the wall of the cylinder, the heat loss to air are partially recovered by attaching thermoelectric generators at the lateral area of the cylinder as shown in Figure 1 and Figure 2. The hot side of the thermoelectric generators is at the wall of the cylinder (heat source) and the cold side is subjected to ambient air (heat sink). The main aim of this work is to estimate the power produced by the thermoelectric generators which is function of the temperature difference and time.

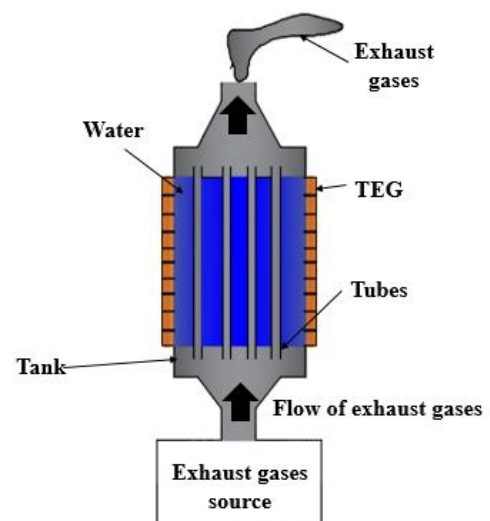

Figure 1. Domestic thermoelectric cogeneration heat recovery system.

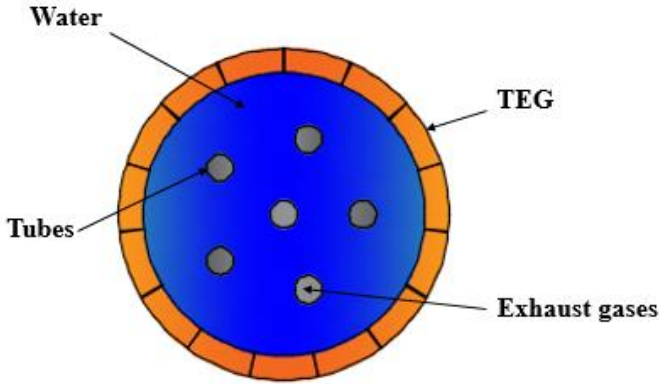

Figure 2. Top view of the hybrid recovery system

Modeling

Modeling part is composed of two stages: thermal and electrical part. Figure 3 shows the thermal model of the system in terms of thermal resistance. In order to obtain the power produced by the TEGs, the outer surface temperature of the TEGs, T_C , and the inner surface temperature of the TEGs, T_H , have to be calculated. The ambient temperature is T_a .

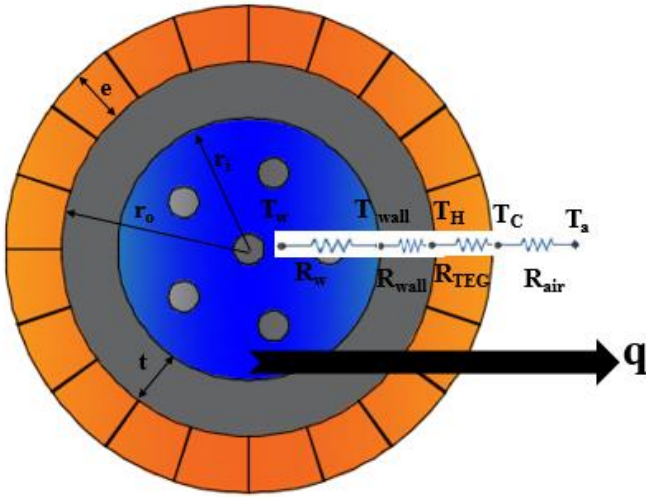

Figure 3. Thermal resistance modelling schematic of the system

Equations (1)– (10) show how T_H is estimated. Then the power is calculated using equations of electrical modelling. The thermodynamic equations are [52]:

$$q = U \Delta T \quad (1)$$

where q is the heat rate and U is the overall heat transfer coefficient. The thermal resistance shown in Figure 3 are calculated as follow:

$$R_w = \frac{1}{h_w A_{cy}} = \frac{1}{h_w (2\pi r_i L)} \quad (2)$$

$$R_{wall} = \frac{\ln(r_o/r_i)}{2\pi k_{wall} L} \quad (3)$$

$$R_{TEG} = \frac{\ln(r_f/r_o)}{2\pi k_{TEG} L} \quad (4)$$

$$R_{air} = \frac{1}{h_a A_{TEG}} = \frac{1}{h_a (2\pi r_f L)} \quad (5)$$

where R_w , R_{wall} , R_{TEG} , and R_{air} are the thermal resistance of water, wall, TEG, and air respectively. L is the length of the cylinder and A_{cy} is the lateral area of the cylindrical tank. r_i , r_o , and r_f are the inner, outer, and final radius of the cylinder respectively knowing that final radius is the outer radius of the cylinder plus the thickness of the TEG. And h_w , h_a , and k_{wall} are the convection transfer coefficient of water and air, and the thermal conductivity of the cylinder wall respectively, then

$$U = \frac{1}{\sum_i R_i} \quad (6)$$

Applying the previous equations the heat flow can be estimated. The heat rate (q) through the system is constant then:

$$q_{total} = q_{wall} = q_{TEG} \quad (7)$$

$$q = U [T_w(t) - T_a] \quad (8)$$

where $T_w(t)$ is the water temperature.

At TEG location, heat rate between T_H and T_C equals:

$$q_{TEG} = -k_{TEG} \frac{dT}{dx} = -k_{TEG} \frac{T_C - T_H}{e} \quad (9)$$

Re-arranging equation (9) with $T_C = T_a$ (cold surface temperature is too close to ambient temperature) leads to:

$$T_H = \frac{q_{TEG} e}{k_{TEG}} + T_a \quad (10)$$

where e is the thickness of the TEG, and k_{TEG} is the total thermal conductivity of the thermoelectric generator.

The temperature difference at the thermocouple is estimated, then the power output produced by one TEG is evaluated using the electric modelling [53, 54], with Figure 4 showing a thermoelectric module:

$$Q_H = N \left\{ U_{PN}(T_H - T_C) + \alpha I T_H - \frac{I R_i^2}{2} \right\} \quad (11)$$

$$Q_C = N \left\{ U_{PN}(T_H - T_C) + \alpha I T_C - \frac{I R_i^2}{2} \right\} \quad (12)$$

$$P = Q_H - Q_C \quad (13)$$

$$P = \alpha I (T_H - T_C) - I R_i^2 \quad (14)$$

$$I = \frac{\alpha (T_H - T_C)}{2 R_i} \quad (15)$$

where P is the output power (W), α is the Seebeck effect coefficient, I is the current, N is the number of semiconductors, R_i is the internal resistance, and U_{PN} is the thermal conductance of TEG (W/K).

Then power can be calculated directly, power is expressed in function of temperature difference, current, and material related properties. Also, the current is expressed in function of temperature difference then the power is in function of ΔT^2 and material properties. Which means for identical TEG the power is as follows [54]:

$$\left[\frac{P}{\Delta T^2} \right]_{\text{Ref}} = \left[\frac{P}{\Delta T^2} \right] \quad (16)$$

$$P = \left[\frac{P}{\Delta T^2} \right]_{\text{Ref}} \Delta T^2 \quad (17)$$

where $\left[\frac{P}{\Delta T^2} \right]_{\text{Ref}}$ is given by the manufacturer of the thermoelectric module.

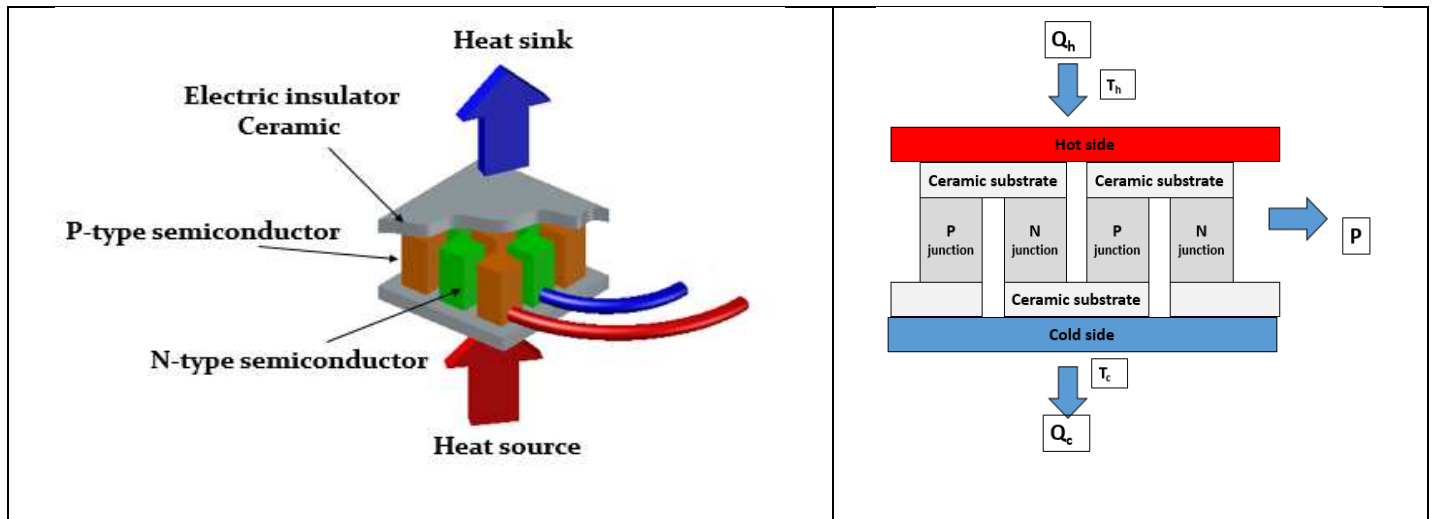

Figure 4. 3D and 2D drawing of thermoelectric generator.

CASE STUDY AND RESULTS

Experimental data

An experiment is carried out in order to obtain $T_w(t)$, the system is then coupled with exhaust gases of a diesel chimney as shown in Figure 5. The tank is made up of 2 mm thick iron sheet. It is 1 m long and 32 cm outer diameter. The tubes are made of copper with 1 mm thickness. The outer diameter of the tubes is 3 cm. The copper tubes are located inside the tank with their edges crosses the tank wall to allow the passage of exhaust gases. A 2 mm thick iron cone is flanged to the tank by which exhaust gases enters the cone then flows inside the tubes. At the outlet, a 1 mm thick iron cylinder is welded to the tank. The whole system is insulated by a 3 cm thick fiber glass thermal insulator. The diesel chimney is connected to the conical inlet via 5 inches pipes. By burning the diesel, exhaust gases are produced and driven to flow through pipes to the heat recovery system. Two type K thermocouples are connected at the inlet and outlet of the system to measure the exhaust gases temperature. Also, a thermocouple is inserted inside the tank at the upper side of the system to measure the water temperature.

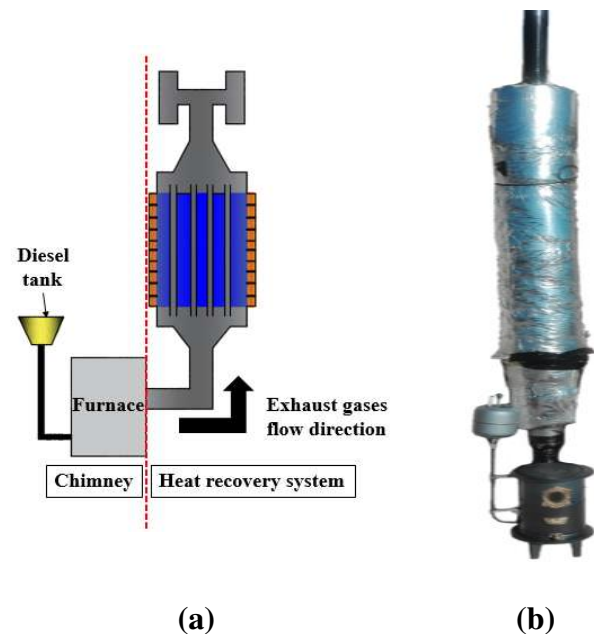

Figure 5. Heat recovery system coupled with diesel chimney: (a) schematic of the prototype; (b) constructed prototype.

Temperature of the water is recorded at specific intervals of time obtaining figure 6 which shows the experimental results obtained in which water temperature and outlet exhaust gases temperature were recorded. The water temperature rises from 26°C to 79°C in 400 minutes. Then the water temperature almost remains constant after 400 minutes, this means that steady state of the system was achieved after 400 minutes from start.

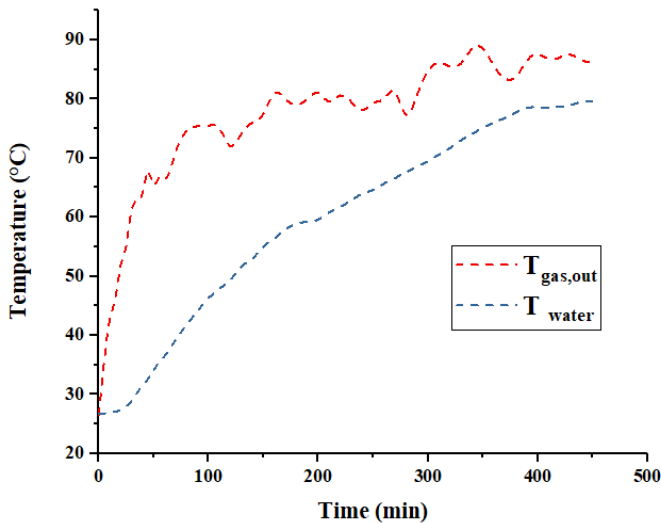

Figure 6. Variation of water and exhaust gases temperature obtained experimentally.

Whereas the exhaust gases temperature at the outlet rises from the ambient temperature (before starting the experiment) to about 80 °C. This illustrates the fact that water temperature almost remains constant when it reaches 79 °C. Also, outlet exhaust gases temperature undergoes some fluctuation which are resulted from the velocity of the air by which exhaust gases flows by buoyancy force and could be forced by the velocity of the air entering the chimney.

Since the water temperature is relatively low (less than 100 °C), a low temperature thermoelectric module is required to achieve a cost-effective system. TEG2-126LDT thermoelectric module has been used with specifications shown in Table 1. These specifications are used to calculate the generated power of the TEGs.

Table 1. TEG Module “TEG1-126LDT” specifications [55].

Module specification	Value
Hot side temperature	200 °C
Cold side temperature	30 °C
Open circuit voltage	8.6 V
Matched load resistance	6.0 ohms

Matched load output current	0.7 A
Matched load output voltage	4.3 V
Heat flow density	3.25 W/cm ²
Thermal conductivity	1.4 W/m.K
Internal resistance	3.8-4.2 ohms
$P/\Delta T^2$	0.0044 W/°C ²

Table 2 recapitulates the dimensions of the prototype used in the experiment. Knowing that the tank is made of iron and the exhaust gases pipe is in copper.

Since the analytical study is based on the experimental data measured, uncertainty analysis will be established on the temperature data. The experiments were repeatedly done to get correct measurements. For exhaust gases the “UT 325” Thermometer coupled with thermocouples type K is used while “ISHOWTIE Vovotrade” Mini Digital LCD thermometer is utilized to measure the temperature of water. The absolute uncertainty of the gas’s thermometer is ± 0.5 and with minimum exhaust temperature of 25 °C the uncertainty is 2%. Whereas, for the water thermometer the absolute uncertainty is ± 1 i.e. 4% uncertainty. For the same operation conditions (initial water and exhaust gases temperature), the mean temperature difference was found to be 0.43 °C which implies to 0.63% relative difference between the tests. In addition to that, it was found that the error of placing the thermocouples in the water is 0.4 °C. Also, it was found that the relative difference was below 1.5% at the inlet and outlet of the multi-tube tank in addition to the water temperature. Consequently, the maximum relative error due to the present method of thermocouple fixation does not exceed 2% for a 25 °C minimum temperature. Then, for a 1.5% repeatability, the uncertainty was found to be 4.7%, leading to 95.2% reliance in the data measured.

Table 2. Water tank and TEG dimensions.

Parameter	Dimension
Length of cylinder (L)	1.00 m
Outer radius of cylinder (r_o)	0.190 m
Inner radius of cylinder (r_i)	0.188 m
Thickness of TEG (e)	0.005 m
Area of one TEG (A_{TEG})	0.0031 m ²

Analytical study

By applying the thermal equations (1-10) and using the heat transfer coefficients recapitulates in Table 3, the hot temperature at the TEG side and the amount of heat rate can be estimated and plotted in Figure 7 and Figure 8 respectively.

Table 3. Heat transfer coefficients used in this study.

Heat coefficient	Value
Convection heat transfer coefficient of water	1200 W/m ² .K
Convection heat transfer coefficient of air	200 W/m ² .K
Conduction coefficient of iron	80 W/m. K

Figure 7 represents the temperature T_H and the temperature difference at the sides of the TEG. Due to heat recovery transferred to water stored in the cylinder, the water temperature increases with time, implying an increase of the temperature difference between the water temperature and ambient temperature. This temperature difference ΔT increases monotonically with time, from 0°C up to 33.6°C. Consequently, all the temperatures of the system increase and particularly the hot temperature T_H . It shows a maximum T_H of 60°C after 7 hours and half. This long time is due to the relatively low amount of exhaust gases compared to the large volume of water (up to 100 liters).

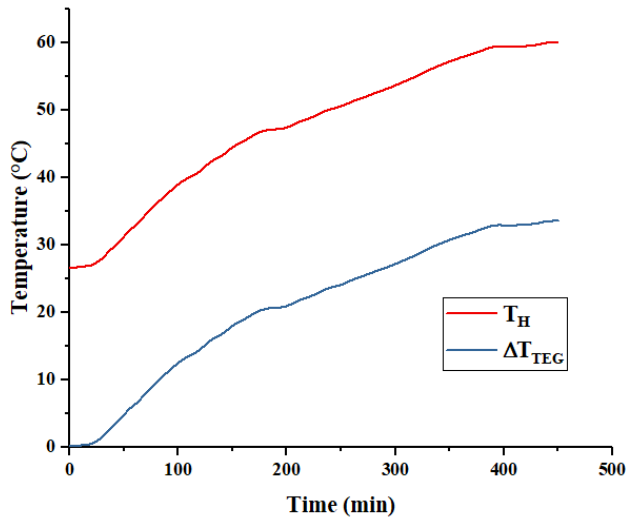

Figure 7. Hot temperature and temperature difference at the sides of the TEG.

Figure 8 represents the heat recovery rate. It shows an increase in the heat rate with time, due to the increase in water temperature. According to equation (1), the more the temperature difference, the more the heat rate. This latter value increases continuously with time, up to 5270 W.

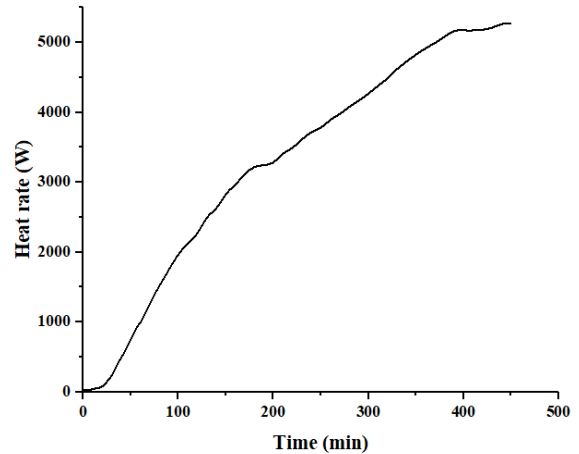

Figure 8. Heat rate through the system.

Figure 7 shows a relatively low temperature difference at the TEG, since this value increases from 0°C at the beginning of the process to a maximum value of 33.6°C at the end of it. This leads to a low power produced per TEG. Using eq. (17) with the specification supplied by the manufacturer, the power produced by one TEG is shown in Figure 9.

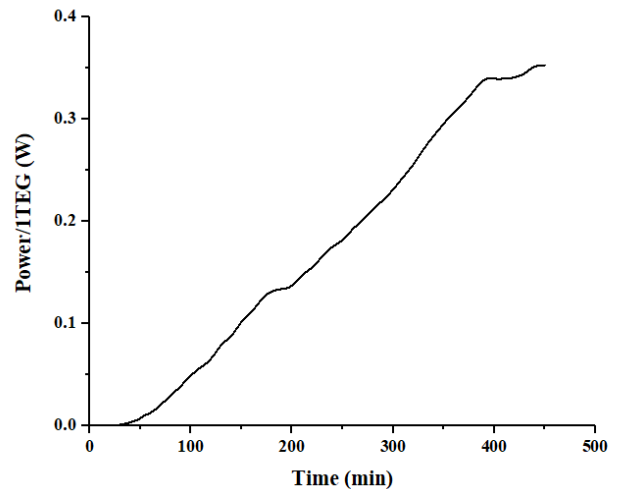

Figure 9. Power produced by one thermoelectric generator.

Figure 9 shows that at the beginning of the process, the production of electricity is zero, and the maximum power produced achieved 0.35 W after 450 minutes. By using the data of Figure 8, it should be noted that the maximum power produced was when the maximum temperature difference across the TEG is attained. This relation is directly shown in eq. (17) in which the power produced is directly proportional to the square of the temperature difference. It shows that one TEG can produce up to 0.35 W at a temperature difference of 33.6°C for a temperature T_c equals 26.5°C).

Finally, the total power produced is represented on Figure 10, it is the sum of the power generated by the TEGs attached to

the lateral area of the tank. With a TEG of 5.6×5.6 cm, 383 TEGs are attached to the wall of the tank. The maximum power produced is about 135 W at the maximum temperature difference of 33.6°C. The energy conversion efficiency of the TEGs is about 2.5%. After 4500 minutes, the hybrid heat recovery system is capable to produce 135 W of electricity and the main gain of the recovery is presented by heating about 100 liters of water to about 80°C from dissipated energy.

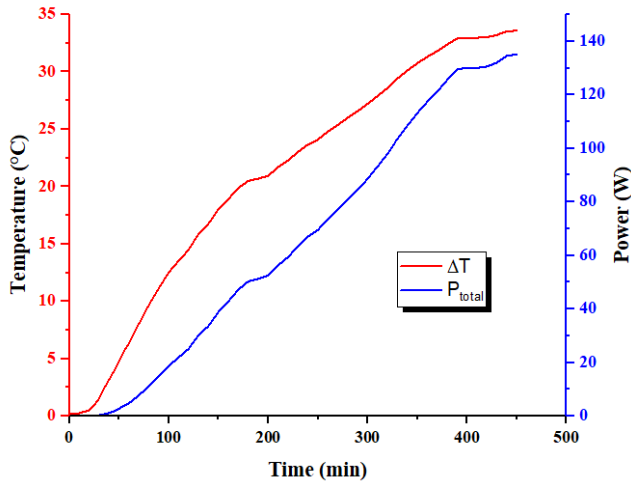

Figure 10. Total power and temperature difference at the TEG surface with respect to time.

The conducted results were compared with [7]. At 9 °C temperature gradient across the TEG, the power generated by TEGs was 6.4 W in [7] with $\left(\frac{P}{\Delta T^2}\right)_{Ref}$ equals to 0.0002 W/°C² given by the manufacturer for the selected TEG. Regarding the TEG used in the experiment the $\left(\frac{P}{\Delta T^2}\right)_{Ref}$ given by the manufacturer is 0.0003 W/°C². The power produced by TEGs at 9°C temperature gradient across the TEG was found to be about 11 W. Comparing both results conducted and if $\left(\frac{P}{\Delta T^2}\right)_{Ref}$ of the given TEG is equal to 0.0002 W/°C² the total power generated by TEGs will be 6.2 W. Then the results are 97% compatible between the two studies.

The energy captured by water and the electrical energy produced by the TEG are shown in the next figures. Knowing that the thermal energy absorbed by the water is calculated as following:

$$E_w = m_w \cdot C_{p_w} \cdot dT_w \quad (18)$$

$$E_w = \rho_w \cdot V_w \cdot C_{p_w} \cdot \{T_w(t + \Delta t) - T_w(t)\} \quad (19)$$

where m_w , ρ_w , V_w , C_{p_w} are the mass, density, volume and specific heat of water respectively.

Figure 11 shows the variation of thermal energy absorbed by water with time. The maximum thermal energy absorbed by water is 1.17 MJ after about 1 hour. The minimum thermal

energy absorbed was after 180 minutes. Figure 11 shows high fluctuation on the thermal energy absorbed by water; this is due to the small variation in water temperature. The main reason of this fluctuation is the amount, temperature, velocity of exhaust gases. And since air controls the venting of exhaust gases, the velocity of exhaust gases will fluctuate with the fluctuation of air velocity.

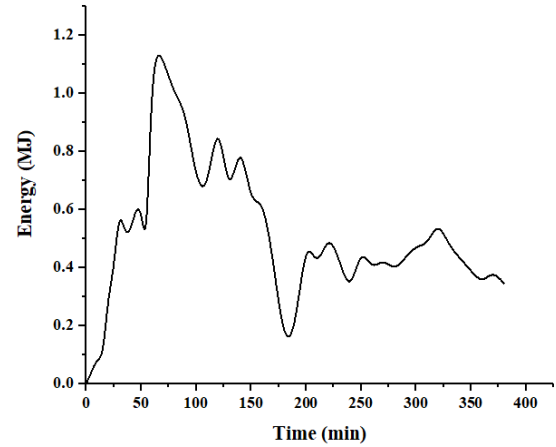

Figure 11. Thermal energy recovered by heating water.

Figure 12 shows the electric energy produced by TEGs, it shows that the TEGs are producing 1.013 kWh in 7.5 hours. In other words, TEGs has recovered about 3.65MJ in 7.5 hours of the dissipated thermal energy and convert them to electric energy.

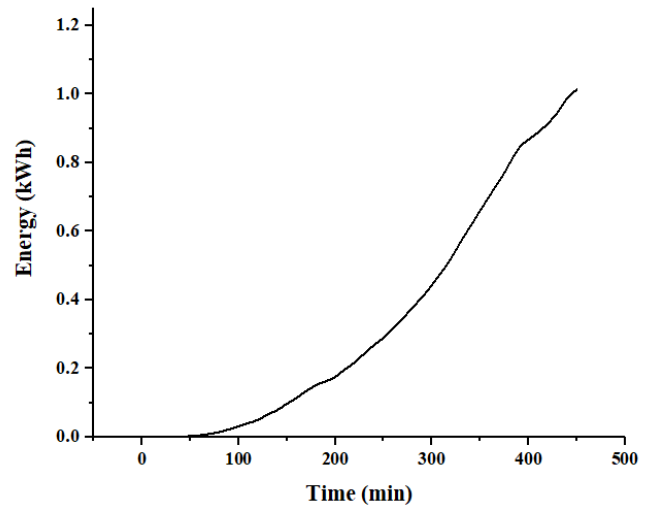

Figure 12. Electric energy generated by TEGs.

ECONOMICAL AND ENVIRONMENTAL STUDY

The total price of the prototype is summarized in the Table 4. It shows that the costliest item in the system is the thermoelectric generators. This high cost is resulted from the large number of thermoelectric generators (383 TEG).

Table 4. Price of the components of the prototype.

Part	Price (\$)
Iron tank	70
Copper tubes	60
Thermoelectric generators	6500
Welding and assembling	25
Coating (insulation)	20
Water temperature sensors	10
Exhaust gases temperature sensor	65
Total	6750 \$

In order to estimate the payback period of the hybrid heat recovery system, the total amount of money saved should be estimated. The following steps show the criterion that is followed to estimate the amount of money saved, compared to an electric hot water tank plus the same production of electricity.

- 1- To estimate the money saved from heating water:
 - a- Estimate the thermal energy required to heat the water.
 - b- Estimate the electrical energy required to heat the water.
 - c- Estimate the electrical energy required to heat water per month.
 - d- Estimate the cost of the electrical power required per month.
- 2- To estimate the money saved by generating electricity using TEGs:
 - a- Estimate the electric energy generated by thermoelectric generators per month.
 - b- Estimate the cost of the electrical energy generate by TEGs per month.

Starting by heating water, the thermal energy required to heat the water Q is calculated by the following equation:

$$Q = \rho V_{water} C_p \Delta T \quad (20)$$

where ρ , C_p and V_{water} are the density, specific heat and volume of water and ΔT is the temperature rise of water. Besides the volume of water can be expressed as:

$$V_{water} = \pi L (r_{w,i}^2 - r_{p,o}^2) \quad (21)$$

Knowing that the water temperature rise is taken at 70°C (increase from 20 to 90 degrees). The total amount of thermal energy required to heat the water is $Q = 30.4$ MJ. The efficiency η of the electrical heater is set to be 80% given from the supplier, then the total amount of electric energy required to heat water (EER) is estimated by the following equation:

$$EER = \frac{Q}{\eta} \quad (22)$$

The total amount of electric energy required is $EER = 38$ MJ, which means in order to heat the water inside the tank it requires 10.5 kWh. To estimate the total electrical energy consumed to heat water per month EEC_{month} , the electric energy required to heat the water should be multiplied by the number of times (N_t) water is raised at 70°C.

$$EEC_{month} = EER \cdot N_t \quad (23)$$

The cost of the electric energy required per one month which is the amount of money saved from heating water ($M_{saved / month}^{heating water}$) is estimated by eq. (24).

$$M_{saved / month}^{heating water} = EEC_{month} \cdot C_{kWh / month} \quad (24)$$

where $C_{kWh / month}$ is the cost of kWh per month given according to the official price of kWh in Lebanon and summarized in Table 5.

Table 5. Cost of the electric energy $C_{kWh / month}$ in Lebanon.

Electric rates in one month (kWh/month)	Cost (\$/kWh)
0 – 99	0.023
100 – 299	0.037
300 – 399	0.053
400 – 499	0.080
>500	0.133

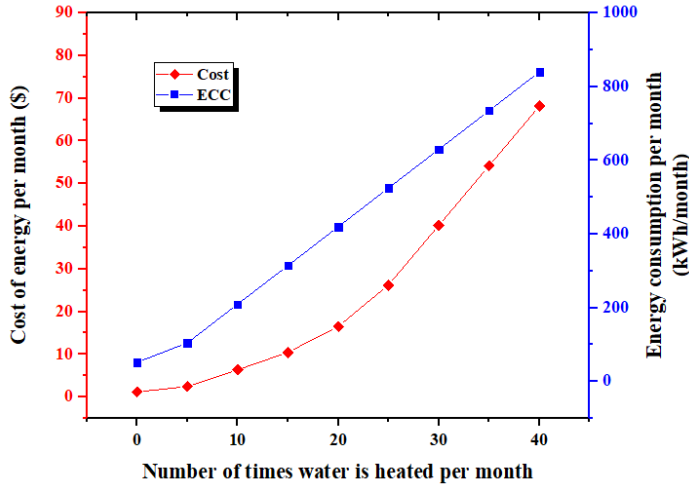

Figure 13. Electric energy consumed ECC_{month} and its cost per month $M_{saved / month}^{heating\ water}$ to heat water.

Figure 13 shows the electric energy consumed per month to heat water and the cost of the electrical energy. As much as the water is heated more by the system as much as more money is saved. It shows that if the water is heated 80 times per month, the system will reduce the electric bill by 68 \$.

In order to estimate the total amount of money saved, the cost of the electric energy generated by TEGs should be calculated. Eq. (25) expresses how to evaluate the electric energy generated by TEGs $E_{generated/month}^{TEG}$ (expressed in kWh/month):

$$E_{generated/month}^{TEG} = Pr \times P_{generated}^{TEG} \times \left(\frac{30\text{days}}{\text{month}}\right) \times \left(\frac{24\text{hours}}{\text{day}}\right) \quad (25)$$

where $P_{generated}^{TEG}$ is the total power generated by thermoelectric generators (expressed in kW), Pr is the percentage of availability of exhaust gases in month. It should be noted that exhaust gases could not be available all the time when requested, then the electric energy generated by TEGs is multiplied by the percentage of the exhaust gases availability. The cost of the electric energy generated by TEG per month is calculated by the following equation:

$$M_{saved / month}^{TEG} = E_{generated/month}^{TEG} \times C_{kwh} \quad (26)$$

The electric power produced by TEG will be taken at 135 W (maximum) in this study. Figure 14 shows the electrical energy generated by TEGs and its cost per month.

It shows that TEGs are capable to save 2 \$/ month if it recovers about 288 MJ/ month. By comparing both moneys saved by heating water and generating electricity, it shows

that the main benefit is heating water while adding extra layer of TEGs will generate relatively low power i.e. low money saved but it will minimize the heat loss between water and ambient air.

Then the total amount of money saved per month is

$$MS_{monthly} = M_{saved / month}^{heating\ water} + M_{saved / month}^{TEG} \quad (27)$$

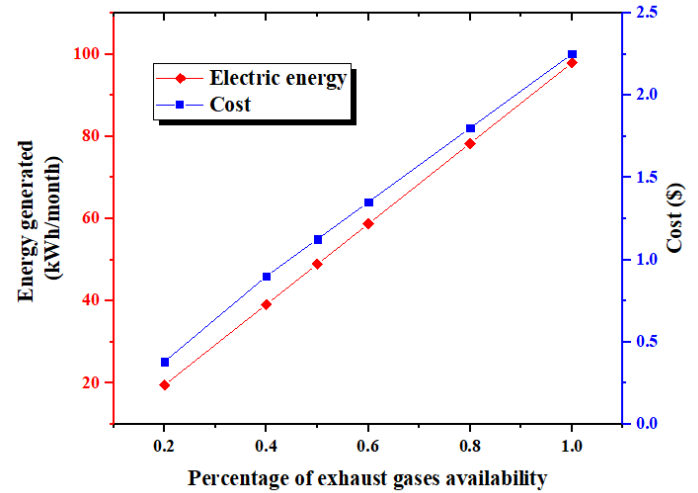

Figure 14. Electric energy generated $E_{generated/month}^{TEG}$ and its cost per month from TEGs $M_{saved / month}^{TEG}$.

However, for simplicity and to avoid the percentage of availability of exhaust gases in month, and due to the minor effect of the cost of electric energy generated from TEGs compared to what is saved from heating water, money saved monthly will be taken as for the money saved from heating water only. If the system is used 80 times per month and the exhaust gases are available all the time to total money saved is 71\$ in which 68.5\$ are from heating water only (about 97% of money saved is from heating water). Then the payback period of this system is:

$$Pbp = \frac{CHHS}{MS_{monthly}} \quad (28)$$

where Pbp is the payback period and $CHHS$ is the total cost of the hybrid heat recovery system. For the constructed system the payback period is shown in Figure 15 with respect to the number of times water is heated. It shows that the payback period decreases significantly with the increase in number of times water is heated using the hybrid heat recovery system. Results show that such system needs about 14 years to return its cost if it is used twice a day (60 times/month). Also, it may need about 8 years as a payback period if water is heated 80 times/ month. The main reason of having high payback period is the cost of the thermoelectric module that is attached to the system.

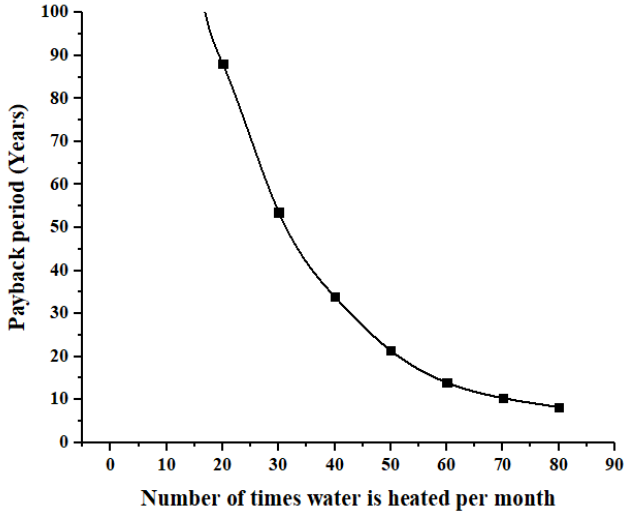

Figure 15. Payback period of the constructed system.

Besides the economic advantage of reusing dissipated energy, heat recovery provides an environmental advantage because it decreases CO₂ emissions. In another words, in order to heat water, fuel is burned (as a source of thermal energy) leading to the generation of CO₂ emissions. Due to the fact that electric power saved by heating water is much bigger than electric power generated by the TEGs, the electric power produced from heating water only will be considered in the environmental study. In Lebanon, about 0.47 kg of CO₂ are produced for each kWh of electricity produced [7]. Taking into consideration the power that is lost through the electric grid, the net total power reduced from the power station $P_{produced}^{station}$ is expressed as follows.

$$P_{produced}^{station} = P_{del} + 0.075P_{del} \quad (29)$$

where P_{del} is the power delivered to home for heating water. The constant 0.075 is the percentage of electricity dissipated by the grid (7.5%). From all of the above, the amount of CO₂ emissions reduced $Ma_{CO_2}^{reduced}$ is:

$$Ma_{CO_2}^{reduced} = P_{produced}^{station} \times Ma_{CO_2}^{released} \quad (30)$$

where $Ma_{CO_2}^{released}$ is the mass of CO₂ gas released for producing one kWh of electricity.

Figure 16 shows the amount of CO₂ reduced by utilizing the hybrid heat recovery system.

The amount of CO₂ gas reduced increases with the increase in the number of times water is heated. About 320 kg/month of CO₂ is reduced when the water is heated twice per day which increases to 425 kg/month when water is heated 80 times. This means about 5.1 tons of CO₂ gas is reduced yearly when water is heated 80 times monthly.

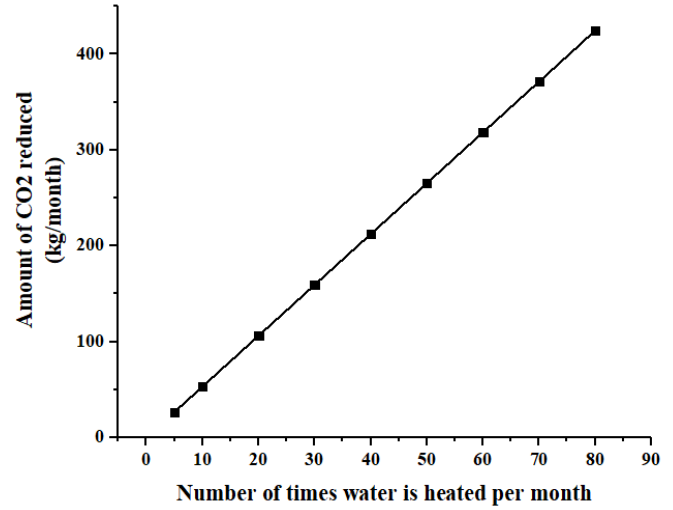

Figure 16. Amount of CO₂ gas reduced by the heat recovery system.

CONCLUSION

Heat recovery is an efficient way to reduce energy losses. In this paper a hybrid heat recovery system is done on exhaust gases in which two stages of heat recovery are implemented. A first stage is generating domestic hot water and this water in its term is utilized as heat source for thermoelectric modules for a second heat recovery stage. A thermal and electrical modeling is illustrated and a case study has been carried.

The following conclusions are drawn:

1. Such hybrid heat recovery system (HHRS) with the suggested configuration can produces up to 100 liters of 80°C domestic hot water in 450 minutes.
2. The HHRS is capable to generate up to 0.35 W/TEG, or 135 W total power using thermoelectric generators.
3. The system achieved steady state after 450 minutes from starting the chimney.
4. The main reason of taking a long time to heat the water is the large amount of water which is about 100 liters of water.
5. The high fluctuation on the thermal energy absorbed by water is due to the fluctuation of quantity (flow rate), quality (temperature), and velocity of exhaust gases.
6. The hybrid heat recovery system requires 8 years as a payback period when water is heated 80 times per month.
7. About 5.1 tons of CO₂ gas are reduced yearly when the heat recovery system heat water 80 times monthly.

NOMENCLATURE

A	Area (m ²)
C	Cost of 1 kWh (\$)
CHRS	Cost of heat recovery system (\$)
C_p	Specific heat (kJ.kg ⁻¹ .k ⁻¹)
e	TEG thickness (m)
E	Energy (J)
EEC	Electric energy consumed (MJ/month)
EER	Electric energy required (MJ)
h	Heat convection coefficient (W/m ² K)
I	Current (A)
ICE	Internal combustion engine
k	Thermal conductivity (W/m K)
L	Length of the tank (m)
M	Money saved (\$)
Ma	Mass (kg)
MS	Total money saved by system (\$)
N	Number of semi-conductors
N_t	Number of times water is heated
P	Power (W)
P_{bp}	Payback period (years)
Pr	Percentage of availability
q	Heat rate (W)
r	Radius (m)
R	Thermal resistance (K/W)
R_i	Internal resistance (Ohms)
T	Temperature (°C)
t	Tank's wall thickness (m)
TEG	Thermoelectric generator
U	Overall heat transfer coefficient (W/K)
U_{PN}	Thermal conductance of TEG (W/K)
V	Volume (m ³)

Greek Symbols

α	Seebeck coefficient (V/K)
ρ	Density (kg/m ³)
η	Efficiency
ΔT	Temperature difference (°C)

Subscripts

a	Air
c	Cold
CO₂	Carbon dioxide
C_y	Cylindrical tank
del	Delivered
f	Final
H	Hot
i	Inner
o	Outer
w	Water

REFERENCES

- [1] B. BP, "Statistical Review of World Energy," 2016.
- [2] G. Shu, L. Shi, H. Tian, and L. Chang, "Comparison and Selection Research of CO₂-Based Transcritical Rankine Cycle Using for Gasoline and Diesel Engine's Waste Heat Recovery," *Heat Transf. Eng.*, vol. 39, no. 7–8, pp. 672–686, May 2018.
- [3] T. Zhelev, K. Semkov, E. Mooney, T. Majozzi, and A. Korobeinikov, "Industrial Heat Utilization Through Water Management," *Heat Transf. Eng.*, vol. 34, no. 14, pp. 1191–1201, Nov. 2013.
- [4] F. Ma and P. Zhang, "Heat Transfer Characteristics of a Volumetric Absorption Solar Collector using Nano-Encapsulated Phase Change Slurry," *Heat Transf. Eng.*, pp. 1–11, Aug. 2017.
- [5] T. Ma, X. Wang, Y. Zhu, and Y. Li, "Operation Characteristics of a High Temperature Special Shaped Heat Pipe Used in Solar Thermochemical Reactors," *Heat Transf. Eng.*, pp. 1–9, Jan. 2018.
- [6] R. Herrera, B. Elkin, J. Raade, and V. P. Carey, "Modeling of Flow and Heat Transfer in a Molten Glass Mini-Film for High Temperature Heat Collection in a Falling-Film Solar Central Receiver," *Heat Transf. Eng.*, vol. 38, no. 14–15, pp. 1331–1342, Oct. 2017.
- [7] H. Jaber, M. Ramadan, T. Iemenand, and M. Khaled, "Domestic thermoelectric cogeneration system optimization analysis, energy consumption and CO₂ emissions reduction," *Appl. Therm. Eng.*, vol. 130, pp. 279–295, Feb. 2018.
- [8] Y. D. Jun, K. B. Lee, S. Z. Islam, and S. B. Ko, "Fouling Reduction Characteristics of a No-Distributor-Fluidized-Bed Heat Exchanger for Flue Gas Heat Recovery," *Heat Transf. Eng.*, vol. 29, no. 9, pp. 822–829, Sep. 2008.
- [9] M. Khaled and M. Ramadan, "Study of the Thermal Behavior of Multi Tube Tank in Heat Recovery from Chimney—Analysis and Optimization," *Heat Transf. Eng.*, vol. 39, no. 5, pp. 399–409, Mar. 2018.
- [10] P. S. Varbanov and J. J. Klemeš, "Total Sites Integrating Renewables With Extended Heat Transfer and Recovery," *Heat Transf. Eng.*, vol. 31, no. 9, pp. 733–741, Aug. 2010.
- [11] M. Khaled, H. El Hage, F. Harambat, and H. Peerhossaini, "Energy Management in Car Underhood Compartment—Temperature and Heat Flux Analysis of Car Inclination Effects," *Heat Transf. Eng.*, vol. 36, no. 1, pp. 68–80, Jan. 2015.
- [12] M. Ramadan, T. Iemenand, and M. Khaled, "Recovering heat from hot drain water—Experimental evaluation, parametric analysis and new calculation procedure," *Energy Build.*, vol. 128, pp. 575–582, Sep. 2016.
- [13] T. Fichter, F. Trieb, and M. Moser, "Optimized Integration of Renewable Energy Technologies Into Jordan's Power Plant Portfolio," *Heat Transf. Eng.*, vol. 35, no. 3, pp. 281–301, Feb. 2014.
- [14] A. El Mays *et al.*, "Using phase change material in under floor heating," *Energy Procedia*, vol. 119, pp. 806–811, Jul. 2017.

- [15] H. Jaber *et al.*, “Effect of Exhaust Gases Temperature on the Performance of a Hybrid Heat Recovery System,” *Energy Procedia*, vol. 119, pp. 775–782, Jul. 2017.
- [16] H. Jaber, M. Khaled, T. Lemeland, and M. Ramadan, “Short review on heat recovery from exhaust gas,” in *AIP Conference Proceedings*, 2016, vol. 1758, no. 1, p. 030045.
- [17] M. Khaled and M. Ramadan, “Heating fresh air by hot exhaust air of HVAC systems,” *Case Stud. Therm. Eng.*, vol. 8, pp. 398–402, Sep. 2016.
- [18] B. L. Yeap, G. T. Polley, S. J. Pugh, and D. I. Wilson, “Retrofitting Crude Oil Refinery Heat Exchanger Networks to Minimize Fouling While Maximizing Heat Recovery,” *Heat Transf. Eng.*, vol. 26, no. 1, pp. 23–34, Jan. 2005.
- [19] M. Khaled, M. Ramadan, K. Chahine, and A. Assi, “Prototype implementation and experimental analysis of water heating using recovered waste heat of chimneys,” *Case Stud. Therm. Eng.*, vol. 5, pp. 127–133, Mar. 2015.
- [20] G. Righetti, C. Zilio, S. Mancin, and G. A. Longo, “Heat Pipe Finned Heat Exchanger for Heat Recovery: Experimental Results and Modeling,” *Heat Transf. Eng.*, vol. 39, no. 12, pp. 1011–1023, Jul. 2018.
- [21] M. Khaled, M. Ramadan, and H. El Hage, “Parametric Analysis of Heat Recovery from Exhaust Gases of Generators,” *Energy Procedia*, vol. 75, pp. 3295–3300, Aug. 2015.
- [22] M. Ramadan, M. G. El Rab, and M. Khaled, “Parametric analysis of air–water heat recovery concept applied to HVAC systems: Effect of mass flow rates,” *Case Stud. Therm. Eng.*, vol. 6, pp. 61–68, Sep. 2015.
- [23] A. Herez, M. Ramadan, B. Abdulhay, and M. Khaled, “Short review on solar energy systems,” in *AIP Conference Proceedings*, 2016, vol. 1758, no. 1, p. 030041.
- [24] M. Kanoglu, I. Dincer, and Y. A. Cengel, “Investigation of Geothermal Energy Use in Gas Liquefaction,” *Heat Transf. Eng.*, vol. 29, no. 10, pp. 885–892, Oct. 2008.
- [25] S. Usman and N. Ozalp, “Numerical and Optical Analysis of Solar Power Level Adaptable Solar Reactor,” *Heat Transf. Eng.*, vol. 35, no. 16–17, pp. 1405–1417, Nov. 2014.
- [26] P. Refalo, R. Ghirlando, and S. Abela, “The Effect of Climatic Parameters on the Heat Transfer Mechanisms in a Solar Distillation Still,” *Heat Transf. Eng.*, vol. 35, no. 16–17, pp. 1473–1481, Nov. 2014.
- [27] G. Mittelman, O. Mouchtar, and A. Dayan, “Large-Scale Solar Thermal Desalination Plants: A Review,” *Heat Transf. Eng.*, vol. 28, no. 11, pp. 924–930, Nov. 2007.
- [28] C. B. Maia, A. G. Ferreira, R. M. Valle, and M. F. B. Cortez, “Analysis of the Airflow in a Prototype of a Solar Chimney Dryer,” *Heat Transf. Eng.*, vol. 30, no. 5, pp. 393–399, Apr. 2009.
- [29] A. Herez *et al.*, “Using Geothermal Energy for cooling - Parametric study,” *Energy Procedia*, vol. 119, pp. 783–791, Jul. 2017.
- [30] M. Ramadan, M. Khaled, H. S. Ramadan, and M. Becherif, “Modeling and sizing of combined fuel cell-thermal solar system for energy generation,” *Int. J. Hydrogen Energy*, vol. 41, no. 44, pp. 19929–19935, Nov. 2016.
- [31] F. Hachem *et al.*, “Improving the performance of photovoltaic cells using pure and combined phase change materials – Experiments and transient energy balance,” *Renew. Energy*, vol. 107, pp. 567–575, Jul. 2017.
- [32] M. Kim, G. Lee, Y.-J. Baik, and H.-S. Ra, “Performance Evaluation of Geothermal Heat Pump With Direct Expansion Type Vertical Ground Heat Exchanger,” *Heat Transf. Eng.*, vol. 36, no. 12, pp. 1046–1052, Aug. 2015.
- [33] A. El Mays *et al.*, “Improving Photovoltaic Panel Using Finned Plate of Aluminum,” *Energy Procedia*, vol. 119, pp. 812–817, Jul. 2017.
- [34] K. N. Shukla, “Thermal Energy Storage for Solar Power Generation: State of the Art,” *Heat Transf. Eng.*, vol. 3, no. 2, pp. 62–72, Oct. 1981.
- [35] C. R. Kumar, A. Sonthalia, and R. Goel, “Experimental Study on Waste Heat Recovery from an IC Engine Using Thermoelectric Technology,” *Therm. Sci.*, vol. 15, pp. 1011–1022, 2011.
- [36] R. Carapellucci and L. Giordano, “The Recovery of Exhaust Heat from Gas Turbines,” in *Efficiency, Performance and Robustness of Gas Turbines*, InTech, 2012.
- [37] S. LeBlanc, “Thermoelectric generators: Linking material properties and systems engineering for waste heat recovery applications,” *Sustain. Mater. Technol.*, vol. 1–2, pp. 26–35, Dec. 2014.
- [38] S. Baskaya, S. Karaaslan, T. Calisir, M. Zeki Yilmazoglu, and T. O. Yilmaz, “Experimental and Numerical Study on Thermoelectric Generator Performance Applied to a Condensing Combi Boiler,” *Heat Transf. Eng.*, vol. 36, no. 14–15, pp. 1292–1302, Sep. 2015.
- [39] R. Rabari, S. Mahmud, A. Dutta, and M. Biglarbegan, “Effect of Convection Heat Transfer on Performance of Waste Heat Thermoelectric Generator,” *Heat Transf. Eng.*, vol. 36, no. 17, pp. 1458–1471, Nov. 2015.
- [40] B. Orr, A. Akbarzadeh, M. Mochizuki, and R. Singh, “A review of car waste heat recovery systems utilising thermoelectric generators and heat pipes,” *Appl. Therm. Eng.*, vol. 101, pp. 490–495, May 2016.
- [41] M. F. Remeli, L. Tan, A. Date, B. Singh, and A. Akbarzadeh, “Simultaneous power generation and heat recovery using a heat pipe assisted thermoelectric generator system,” *Energy Convers. Manag.*, vol. 91, pp. 110–119, Feb. 2015.
- [42] S. Twaha, J. Zhu, Y. Yan, and B. Li, “A comprehensive review of thermoelectric technology: Materials, applications, modelling and performance improvement,” *Renew. Sustain. Energy Rev.*, vol. 65, pp. 698–726, Nov. 2016.
- [43] X. F. Zheng, C. X. Liu, R. Boukhanouf, Y. Y. Yan, and W. Z. Li, “Experimental study of a domestic thermoelectric cogeneration system,” *Appl. Therm. Eng.*, vol. 62, no. 1, pp. 69–79, Jan. 2014.

- [44] J. L. Wang, J. Y. Wu, and C. Y. Zheng, "Simulation and evaluation of a CCHP system with exhaust gas deep-recovery and thermoelectric generator," *Energy Convers. Manag.*, vol. 86, pp. 992–1000, Oct. 2014.
- [45] J. Chen, L. Zuo, Y. Wu, and J. Klein, "Modeling, experiments and optimization of an on-pipe thermoelectric generator," *Energy Convers. Manag.*, vol. 122, pp. 298–309, Aug. 2016.
- [46] J.-H. Meng, X.-D. Wang, and W.-H. Chen, "Performance investigation and design optimization of a thermoelectric generator applied in automobile exhaust waste heat recovery," *Energy Convers. Manag.*, vol. 120, pp. 71–80, Jul. 2016.
- [47] M. F. Remeli *et al.*, "Experimental investigation of combined heat recovery and power generation using a heat pipe assisted thermoelectric generator system," *Energy Convers. Manag.*, vol. 111, pp. 147–157, Mar. 2016.
- [48] J.-J. Hwang, C.-H. Lin, and J.-K. Kuo, "Performance analysis of fuel cell thermoelectric cogeneration system with methanol steam reformer," *Int. J. Hydrogen Energy*, vol. 39, no. 26, pp. 14448–14459, Sep. 2014.
- [49] M. Hasan Nia, A. Abbas Nejad, A. M. Goudarzi, M. Valizadeh, and P. Samadian, "Cogeneration solar system using thermoelectric module and fresnel lens," *Energy Convers. Manag.*, vol. 84, pp. 305–310, Aug. 2014.
- [50] X. F. Zheng, Y. Y. Yan, and K. Simpson, "A potential candidate for the sustainable and reliable domestic energy generation–Thermoelectric cogeneration system," *Appl. Therm. Eng.*, vol. 53, no. 2, pp. 305–311, May 2013.
- [51] K. Alanne, T. Laukkanen, K. Saari, and J. Jokisalo, "Analysis of a wooden pellet-fueled domestic thermoelectric cogeneration system," *Appl. Therm. Eng.*, vol. 63, no. 1, pp. 1–10, Feb. 2014.
- [52] T. L. Bergman and F. P. Incropera, *Fundamentals of heat and mass transfer*. Wiley, 2011.
- [53] Y. S. H. Najjar and M. M. Kseibi, "Heat transfer and performance analysis of thermoelectric stoves," *Appl. Therm. Eng.*, vol. 102, pp. 1045–1058, Jun. 2016.
- [54] H. B. Gao, G. H. Huang, H. J. Li, Z. G. Qu, and Y. J. Zhang, "Development of stove-powered thermoelectric generators: A review," *Appl. Therm. Eng.*, vol. 96, pp. 297–310, Mar. 2016.
- [55] Tecteg, Manufacturer of thermoelectric modules, 2015. Available from: www.tecteg.com.

Chapitre 4. Système de séchage et de cogénération thermoélectrique domestique

Il est possible d'optimiser le processus de récupération de chaleur en ajoutant des étapes de récupération multiples. Dans ce cadre, le présent chapitre suggère un nouveau système de récupération à plusieurs étages pour chauffer l'eau chaude domestique, générer de l'électricité et produire de l'air chaud pour des applications de séchage.

L'originalité du travail réside dans la suggestion d'un nouveau système de récupération de chaleur en montrant, à l'aide d'une modélisation numérique, qu'il a le potentiel pour être appliqué dans la vie réelle. La conception du système est décrite dans la **section 2**. Ensuite, une modélisation thermique complète du système est effectuée en appliquant un bilan énergétique à chaque étape du système (**section 3**). La **section 4** présente une étude de cas dans laquelle différents combustibles sont utilisés et étudiés, les résultats sont comparés, analysés et discutés. Enfin, une conclusion résumant les travaux est présentée, y compris les travaux futurs dans la **section 5**. Cette étude a été publiée dans le journal « *Energy* » et présenté à la *Conférence internationale sur. Énergie durable et protection de l'environnement* « SEEP 2017 » à Bled, Slovénie.

Le concept de ce **Système de Séchage à Cogénération Thermoélectrique Domestique** (SSCTD) est que les gaz d'échappement passent par un tuyau pour pénétrer dans un système de récupération de chaleur hybride, puis dans un échangeur de chaleur à récupération de chaleur, avant d'être rejetés dans l'environnement. Cette conception diffère du système conventionnel par les deux étapes de récupération mises en œuvre : Système de Récupération de Chaleur Hybride (SRCH) et Echangeur de Chaleur à Récupération de Chaleur (ECRC). Le système de récupération de chaleur hybride a pour objectif principal d'absorber une partie de l'énergie thermique capturée par les gaz d'échappement afin de chauffer l'eau chaude sanitaire et de générer de l'électricité. Alors que l'échangeur de chaleur à récupération de chaleur est utilisé pour transférer une partie de l'énergie thermique résiduelle des gaz d'échappement afin de chauffer l'air qui est transmis à un séchoir pour un processus de séchage.

Lors de la combustion du carburant, les gaz d'échappement issus du processus de combustion sont générés avec une énergie thermique élevée. Les gaz d'échappement traversent un tuyau, pour pénétrer dans le système de récupération de chaleur hybride, auquel sont fixés des GTE, dans lequel les gaz d'échappement sont en contact direct avec des générateurs thermoélectriques. Les générateurs thermoélectriques GTE absorbent une partie de l'énergie thermique capturée par les gaz d'échappement. Une partie de celle-ci est convertie en énergie électrique et l'autre partie est transférée dans l'eau entourant le tuyau d'un réservoir pour le chauffer. Ensuite, les gaz d'échappement entrent dans l'échangeur de chaleur à récupération de chaleur dans lequel une autre partie de l'énergie thermique est transférée à l'air. Le type d'échangeur de chaleur utilisé est un échangeur de chaleur à plaques fixe air-air. L'air chauffé est ensuite transmis par des tuyaux via une pompe ou un ventilateur au séchoir où il est utilisé pour sécher des aliments ou des vêtements. L'énergie thermique restante capturée par les gaz d'échappement est rejetée dans l'environnement et assimilée à des pertes d'énergie par le système. Il convient de noter que l'énergie perdue à travers les parois de la cheminée, les tuyaux et le système de récupération de chaleur hybride n'est pas définie comme une énergie perdue puisque cette énergie est utilisée pour chauffer l'air de la pièce.

La combinaison de ces systèmes de récupération a donné au système global l'appellation de « système de récupération de chaleur de séchage par cogénération thermoélectrique domestique ».

Afin d'étudier le comportement thermique du système, une modélisation thermique est réalisée à chaque étape. En commençant par la combustion du carburant et en terminant avec les gaz d'échappement libérés dans l'environnement, un bilan énergétique est établi à chaque étape et la température des gaz d'échappement est étudiée. La température de l'eau et la puissance générée par les GTE au niveau du système de récupération de chaleur hybride sont estimées. Enfin, l'effet de la modification du débit massique d'air nécessaire au séchage sur le processus de récupération est étudié.

Une étude de cas dans laquelle ce système est couplé à une cheminée résidentielle où les gaz d'échappement produits par la combustion de différents types de combustibles (diesel, charbon et bois) sont étudiés. Les résultats montrent que la combustion du diesel, du charbon et du bois produit des gaz d'échappement à des températures respectives de 930 K, 1041 K et 879 K et un débit massique de 35,31 kg/h, 15,44 kg/h et 8,64 kg/h respectivement. Le diesel produit la plus grande quantité de gaz d'échappement (environ trois fois plus que le bois) mais ne présente pas la température la plus élevée, les gaz d'échappement du cas diesel ont cependant l'énergie thermique la plus élevée, car cela dépend du débit massique et de la température. La puissance thermique des gaz d'échappement du diesel, du charbon et du bois à la sortie de la cheminée, c'est-à-dire à l'entrée du tuyau, est respectivement de 7066 W, 3632 W et 1603 W. De plus, le système de récupération de chaleur hybride génère environ 240 W à partir des 100 GTE pour les cas diesel et charbon, alors qu'il ne produit que 94 W pour le cas bois.

Lorsque le débit massique d'air est égal à 0,0001 kg/s, les pourcentages de récupération d'énergie ECRC pour le diesel, le charbon et le bois sont respectivement de 0,11%, 0,20% et 0,90%, passant à 4,8%, 12,2% et 40,5% avec 0,0043 kg/s de débit d'air de séchage. Pour le débit maximal étudié (0,0076 kg/s), 8,5% de l'énergie thermique des gaz d'échappement diesel est récupérée, 21,5% pour le charbon et 71,7% pour le système bois. Par conséquent, dans le cas du diesel ou du charbon, une plus grande quantité d'énergie pourrait être récupérée soit en augmentant le débit massique d'air, soit en augmentant la température de sortie d'air (supérieure à 363 K). Enfin, le système global récupère respectivement 20%, 42% et 84% de l'énergie dissipée dans l'environnement pour les cas diesel, charbon et bois.

Sécheur thermoélectrique domestique à cogénération: thermique modélisation et étude de cas

Hassan Jaber, Mahmoud Khaled, Thierry Lemenand, Rabih Murr, Jalal Faraj et

Mohamad Ramadan

Cette étude a été publiée dans le journal « **Energy** »

Résumé - La demande de réduction de la consommation de carburant et d'atténuation des gaz d'échappement responsable de l'effet de serre pousse à développer des systèmes de récupération d'énergie efficaces. Il est possible d'optimiser le processus de récupération de chaleur en ajoutant des étapes de récupération multiple. Dans ce cadre, les travaux actuels suggèrent un nouveau système de récupération à plusieurs étages pour chauffer l'eau et l'air et générer de l'électricité. Le concept du système est appliqué aux gaz d'échappement d'une cheminée. Une modélisation thermique complète du système est établie. Ensuite, une étude de cas est réalisée pour trois combustibles différents (diesel, charbon, bois). Les résultats montrent que, lorsque le diesel est utilisé, la température de l'eau atteinte est de 351 K et 240W sont générés. De plus, une zone d'échangeur de chaleur à récupération de chaleur de 0,16 m² est nécessaire pour chauffer l'air à 363 K avec un débit d'air de 0,0076 kg/s. Un tel système peut récupérer jusqu'à 84% de l'énergie perdue dans l'environnement lorsque le bois est utilisé comme combustible.



Domestic thermoelectric cogeneration drying system: Thermal modeling and case study

Hassan Jaber ^{a, c}, Mahmoud Khaled ^{a, b}, Thierry Lemenand ^c, Rabih Murr ^a, Jalal Faraj ^a, Mohamad Ramadan ^{a, d, *}

^a International University of Beirut, PO Box 146404 Beirut, Lebanon

^b Univ Paris Diderot, Sorbonne Paris Cité, Interdisciplinary Energy Research Institute (PIERI), Paris, France

^c LARIS EA 7315, University of Angers – ISTIA, Angers, France

^d Associate member at FCLAB, CNRS, Univ. Bourgogne Franche-Comte, Belfort Cedex, France

ARTICLE INFO

Article history:

Received 18 October 2017

Received in revised form

10 December 2018

Accepted 11 December 2018

Available online 12 December 2018

Keywords:

Energy

Heat recovery

Hybrid system

TEG

Cogeneration

ABSTRACT

The demand for reducing fuel consumption and mitigating exhaust fumes accountable for the greenhouse effect push toward developing efficient energy recovery systems. Optimizing the heat recovery process can be achieved by adding multi-recovery stages. In this frame, the present work suggests a new multi-stage recovery system for heating water and air and generating electricity. The concept of the system is applied to the exhaust gases of a chimney. A complete thermal modeling of the system is drawn. Then a case study is carried out for three different fed fuels (diesel, coal, wood). The results show that when diesel is used water temperature achieved 351 K and 240 W electric power is generated. Moreover, a 0.16 m² heat recovery heat exchanger area is required to heat air to 363 K at an air flow rate of 0.0076 kg/s. Such system can recover up to 84% of the energy lost to the environment when wood is utilized as a fed fuel.

© 2018 Elsevier Ltd. All rights reserved.

1. Introduction

1.1. Problem background

Nowadays there is an increasing interest in reducing global energy consumption. This interest is caused mainly by high cost of energy sources, high toxic gases emissions, global warming and obligatory governmental laws. The main sources of energy are fossil fuels which are experiencing rapid augmentation in cost, and due to the fact that energy consumption is an effective cost parameter per industrial product, alternative energy has gained significant place in scientist researches shared with effective and efficient benefiting of the available energy [1].

Energy recovery and renewable energy are a suitable solution of such problems [2–7]. The connotation of renewable energy deals with energy captured from a natural renewable source like solar, wind, wave, etc. [8–20], while energy recovery deals with wasted energy from a facility to the environment.

Large number of industrial and residential processes unleashes thermal energy that can be reutilized in order either to increase the efficiency of the system or to become an energy source for different applications [21]. Recovering wasted energy can then increase the efficiency of the system but also reduce pollution and reduce the effective cost of energy. This dissipated energy is mainly released through exhaust gases or cooling water. Many applications have high amount of wasted heat in its exhaust gases that could be recovered such as steam boilers, engines, ovens, chimneys, furnaces, etc. [22–40].

1.2. Heat recovery from exhaust gases

Heat recovery from exhaust gases can be classified according to different taxonomies such as equipment used (heat exchangers), application (source of energy lost), gases temperature or even the suggested purpose of recovery [41]. Fig. 1 shows the main recovery goals for heat recovery technology.

Khaled et al. [42] did a parametric study on waste heat recovery system from exhaust gases of a 500 kW A generator. They carried out a comparison between having on the one hand, water inside the pipes of a concentric tube heat exchanger and exhaust gases located

* Corresponding author. International University of Beirut, PO Box 146404 Beirut, Lebanon.

E-mail address: mohamad.ramadan@liu.edu.lb (M. Ramadan).

at the annulus, or on the other hand water inside the annulus and exhaust gases located inside the pipe. For a 0.75 diameter ratio and water flowing inside the tube, 26 kW of thermal energy can be captured by water and this configuration is set as the most efficient one.

Hatami et al. [43] wrote a short review on heat exchangers utilized for heat recovery from diesel engines. This work presented technologies to increase heat transfer on heat exchangers and how can these technologies be applied to transfer heat from exhaust gases of an engine. Also, it presented a complete review about previous heat exchangers used for heat recovery process.

Zhang et al. [44] suggested a novel high temperature heat exchanger with hybrid improved technologies to enhance waste heat recovery efficiency. The authors developed algorithm for high temperature heat exchanger structural design and optimization and verified it based on the experimental results. The developed algorithm was used to estimate the heat transfer and pressure drop of the suggested high temperature heat exchanger. It was obtained that the increase in gas temperature and decrease in mass flow rate increase the effectiveness of the proposed high temperature heat exchanger. The average effectiveness of the proposed high temperature heat exchanger and temperature of preheated air are 12.5% and 85.8 °C higher than those of the traditional high temperature heat exchanger with additional 70% and 22% pressure drop on air and gas sides respectively.

1.2.1. Water heating

One of the main aims of heat recovery is to benefit from the thermal energy hold by exhaust gases to heat another fluid, solid, or gas. This heating can be performed directly or indirectly. Heating water from exhaust gases thermal energy is exceedingly studied and different systems were suggested and examined.

Khaled et al. [45] developed an experimental analysis on heating water from waste heat of a chimney. A multi-concentric tank is designed in which concentric pipes pass through a water tank. Exhaust gases pass through these pipes allowing heat transfer between exhaust gases and water. The results show 68 °C increase in water temperature for only 1 h of operation with use of 350 °C exhaust gases temperature.

Elgendy and Schmidt [46] studied experimentally the performance of gas engine heat pump integrated with heat recovery subsystem for two modes (At lower air ambient temperature, engine waste heat can be used to evaporate the refrigerant in the refrigerant circuit (mode-I) or to heat the supply water (mode-II)). It was obtained that the influence of condenser water inlet temperature on the system performance is more significant than that of ambient air temperature and engine speed.

Tanha et al. [47] studied the performance of drain water heat recovery system and two solar domestic water heaters which are recently installed side-by-side at the Archetype Sustainable Twin Houses at Kortright Center, Vaughan, Ontario. The first solar

domestic water heater consists of a flat plate solar thermal collector with a gas boiler and a drain water heat recovery unit, while the second one consists of an evacuated tube solar collector, an electric tank, and a drain water heat recovery unit. It was shown that the drain water heat recovery unit can recover heat of 789 kWh where the effectiveness is about 50%. It was also obtained that the produced annual thermal energy output by the flat plate and evacuated tubes collectors based solar domestic water heater system is respectively 2038 kWh and 1383 kWh.

Ramadan et al. [48] presented a parametric study on heat recovery from the hot air of the condenser to preheat/heat domestic water. The effect of the mass flow rate of air and water was studied. The results show that water temperature can increase to 70 °C depending on cooling load and mass flow rate of air. Also, a thermal modeling of the system was performed.

1.2.2. Thermoelectric generators

Thermoelectric generators (TEG) are passive devices used to generate electric power when they are subjected to a temperature gradient at their sides. TEGs are devices that convert thermal energy into electrical energy based on Seebeck effect [49]. Fig. 2 shows a schematic for a thermoelectric module. Such devices are connected thermally in parallel, in which it is sandwiched between a heat source and heat sink, and electrically in series. TEG is a silent, non-vibrating, reliable device with no moving parts. It is a very attractive technology that can be utilized for heat recovery.

Huang et al. [50] modeled a three-dimensional thermal resistance analysis to estimate power generated from waste heat recovery system with thermoelectric generators and optimized the suggested system. They obtained that for maximizing the power generation it is required to take into consideration thermoelectric generators position and uniformity of velocity profile. Demira and Dincera [51] conducted new heat recovery system with thermoelectric generators and analyzed numerically the heat transfer of thermoelectric generators. They observed that the inlet temperature and the mass flow rate of exhaust gas entering the system has vital influence on power capacity of the system. Increasing mass flow rate and exhaust gas temperature can progress power produced by the system by 90%. Besides, rising size of thermoelectric generator by 66.7% lead to increase the overall heat transfer rate of the system by 33.8%. Kim et al. [52] conducted experimental and numerical study of waste heat recovery characteristics of direct contact thermoelectric generator. The output power was estimated and verified using numerical results and empirical correlations. The conversion was between 1 and 2% and heat recovery efficiencies between 5.7 and 11.1%. Besides, the efficiency was increased by 0.25% when decreasing coolant temperature by 10 °C. Remeli et al. [53] investigated experimentally the combined heat recovery and power generation by using heat pipe assisted with thermoelectric generator system. They obtained that for air velocity equal to 1.1 m/s highest heat exchanger effectiveness of 41% was achieved and the

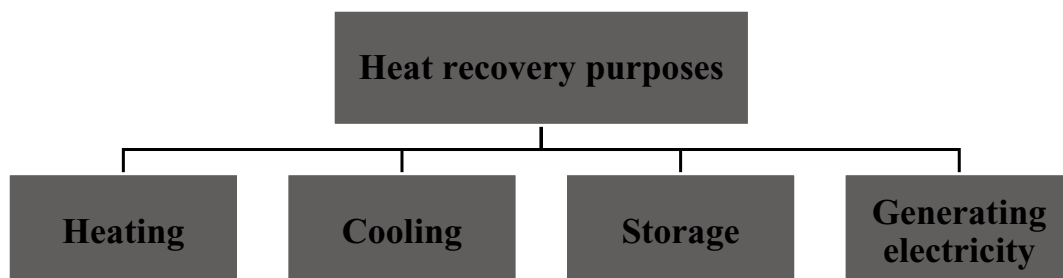

Fig. 1. Main aims of heat recovery from exhaust gases.

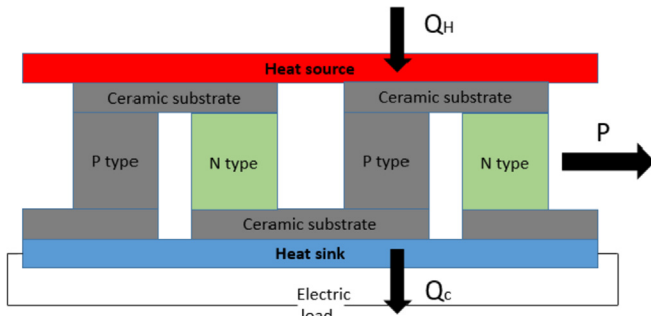

Fig. 2. Thermoelectric module.

system can recover 1.079 kW of heat and generate about 7 W electric power. Madan et al. [54] designed and fabricated TEGs for low temperature waste heat application utilizing dispenser printing. The produced prototype of the TEG attained output power of 33×10^{-6} W and power density of 2.8 Wm^{-2} with forced convection and pipe surface at 373 K, the output power achieved with natural convection was 8×10^{-6} W.

Shu et al. [55] conducted a three-dimensional numerical model of a thermoelectric generator system utilized for engine waste heat recovery. Based on existing model, the study concerned a heat exchanger with thinner wall thickness and moderate inlet dimensions to minimize the negative effects of weight increment and back pressure firstly. The authors then compared the performance of two modes with distinct structures and configurations of thermoelectric modules. It was shown that in single thermoelectric modules, there is a 13.4% increase of maximum power output compared to the original one. While in multi-thermoelectric modules the maximum output power is 78.9 W where there is enhancement of 30.8% compared to the original model. Moreover, it was reported that the fins change the optimal configuration of thermoelectric modules and increase the maximum output to 89.7 W. Nour Eddine et al. [56] investigated the behavior of thermoelectric generator during engine operation and distinguished the impact of the engine flow properties on the performance of thermoelectric generator by designing and constructing three test rigs. The results showed that engine exhaust gas composition and engine exhaust gas pulsation are the two major engine exhaust gas properties that affect the performance of thermoelectric generator. Also, the authors conducted an analytical model to identify and quantify the influence of each parameter on the convective heat transfer coefficient between the exhaust gas and the thermoelectric module, hence on the thermoelectric generator performance. It was obtained that there is difference in the thermoelectric generator output power up to 30% between hot air and real engine test at identical thermoelectric generator inlet temperature and mass flow rate. The model reveals that gas composition is responsible for 5–12% of this difference while another test rig shows that the remaining difference (88–95%) is related to engine exhaust pulsation flow.

1.2.3. Dryers

Dryers are devices used for dehydrating process by applying hot air to remove the moist in food or clothes. In the developed countries, dryers are widely used residentially to dry clothes. Such application is a trend in scientist investments, in which a variety of studies are made on dryers and mainly solar dryers.

Tańczuk et al. [57] developed a research to optimize the size of waste heat recovery heat exchanger which is used for preheating ambient air. Various heat exchanging areas ($101\text{--}270 \text{ m}^2$) were taken under study to simulate their yearly operation concerning

several parameters of outlet air and distinct ambient air temperatures. Besides, the authors estimated the energy performance of the modernization and computed the economic indicators for the analyzed cases. It was concluded that the price of natural gas provided to the system is very effective on the location of optimum of the object in contrast with electricity price which has less influence on it. Han et al. [58] conducted a study to estimate saved energy and water recovery potentials of flue gas pre-dried lignite-fired power system (FPLPS) integrated with low pressure economizer (LPE) for water-cooled units and spray tower (SPT) integrated with heat pump for air-cooled units. The results showed that for optimal LPE scheme, the water recovery ratio was 39.4% and plant efficiency improvement was 0.2%. However, in SPT scheme, the water recovery ratio was 83.3% and heat supply was 110.6 MW. The payback period for both schemes was around 3 years. Walmsley et al. [59] implemented a thermo-economic optimization of industrial milk spray dryer exhaust to inlet air heat recovery. The results of modeling related that spray exhaust heat recovery is very suitable for industrial case study from the economic point of view. Pati et al. [60] analyzed the effect of waste heat recovery on drying characteristics of sliced ginger in a biomass natural convection dryer with sensible heat storage and phase change material. It was found that time needed for phase change material to be melted and the biomass consumed noticeably mitigated when utilizing waste heat. Golman and Julklang [61] developed a simulation code for optimizing the energy usage of spray drying process via exhaust gas heat recovery. It was obtained that when using heat exchanger for exhaust air heat recovery with spray drying system, the energy efficiency increased by 16% and 50% of energy is saved. Jian and Luo [62] proposed a method to reduce energy consumption of domestic venting tumble clothes dryer by using heat recovery. The authors utilized a self-made heat pipe heat exchanger as a recovery unit for domestic venting tumble clothes dryer. The performance of clothes dryer with and without heat recovery was tested and compared under same conditions, including weighing before drying, drying and weighing after drying. It was obtained the exergy and energy efficiencies of the venting tumble clothes dryer with heat recovery increased respectively from 10.122% to 12.292% and from 47.211% to 57.335% compared to the case of no heat recovery. Also, the electricity consumption reduced 17.606% when heat recovery is used.

1.3. Closure

Jaber et al. [63] did an optimization analysis on a hybrid heat recovery system. This system allows utilizing dissipated exhaust gases to heat water and generate electricity using thermoelectric generators. It is composed of a tank and a tube passes through it, where exhaust gases passes through the tube and water is located in the tank. The study aims to demonstrate the effect of varying the location of TEGs on the performance of the system. Six cases were studied, for which TEGs are located either at the inner or outer surface, of the tank or of the tube, or on all of them. A case study was applied by coupling the recovery system to the exhaust gases of a chimney. It was deduced that water can reach high temperatures (up to 97°C). In addition to that, results show that as the TEGs are located farther from the exhaust gases flow, lower power is generated and higher water temperatures are achieved. When the TEGs are located at all surfaces the total power generated by TEGs is 52 W and hot water attained 81°C . Moreover, an economic and environmental study was performed: it shows that such system hold a 20 months payback period and it is highly affected by the location of TEGs. However, the economic study indicates that changing, the location of TEGs does not affect the amount of CO_2 gas reduced, which is about 6 tons yearly.

Khaled and Ramadan [31] performed a thermal and

experimental study on a multi-tube tank heat recovery system (MTTHRS). Exhaust gases generated by a chimney are utilized to heat water using the MTTHRS. The system is composed of a tank and several tubes pass through it, in which exhaust gases flow through tubes and water is in the annulus. Various experimental tests were done by adjusting the amount of fuel burned. Results showed that in 1 h, the temperature of 95 L of water rose by 68 °C.

Najjar and Kseibi [64] carry out a theoretical study on a three stages heat recovery system. It utilizes exhaust gases of a stove to generate electricity via TEGs, cook and heat water. A thermal modeling of the system is carried at each stage of the system. Different recovery scenarios were considered by varying the type of fed fuel used (wood, peat and manure). Results show that wood enables the most proper performance of the system, since it produces the highest exhaust gases temperature (920 K) and maximum power generated by 12 TEGs (7.9 W). The overall efficiency of the system was found to be 60% and about 80% of the thermal energy produced from combustion is used by the TEGs and space heating.

Heat recovery has reserved its heavy seat in the research field of scientists. Many studies were done on heat recovery to generate electricity, dry air and heat water but rare they are to combine them in one system. To proceed, the present work suggests a hybrid heat recovery system that recover exhaust gases thermal energy to heat domestic hot water and generate electricity and produces hot air for drying applications. A complete thermal modeling is carried out, starting from the combustion equations till the calculation of gases temperature at each stage. Such system can maximize the energy utilization efficiency, reduce the power consumed residentially and reduce the amount of harmful gases (such as carbon dioxide and carbon monoxide). However, it could increase the pressure drop along the system which will maybe turn off the chimney. Also, such system will suffer from corrosion of the tube, and it requires regular tube cleaning from the flying ashes that could stick on the tube inner surface which reduces the heat transfer rate. This system is coupled with a residential chimney in which exhaust gases produced from burning fuel for chimney are utilized to enter a domestic thermoelectric cogeneration drying system.

The originality of the work is to suggest new heat recovery system and show using a numerical modeling that it has the potential to be applied in real life. The design of the system is illustrated in section 2. Then a complete thermal modeling for the system is conducted by applying energy balance at each stage of the system (section 3). Section 4 presents a case study in which different fuels are used and studied, the results are compared, analyzed and discussed. And finally a summarizing conclusion of the work is done including future work in section 5.

2. Domestic thermoelectric cogeneration drying system

In this section the suggested thermoelectric cogeneration drying system is illustrated. Fig. 3 shows a schematic of the system in which exhaust gases of a chimney pass through a pipe to enter a hybrid heat recovery system, then to a heat recovery heat exchanger and then released to the environment.

This design differs from the conventional system by the two implemented recovery stages: hybrid heat recovery system (HHRS) and heat recovery heat exchanger (HRHE). The main purpose of the hybrid heat recovery system is to absorb part of the thermal energy captured by the exhaust gases to heat domestic hot water and generate electricity. While for the heat recovery heat exchanger, it is utilized to transfer part of the residual thermal energy of the exhaust gases to heat air which is transmitted to a dryer for a drying process (Fig. 4).

Starting from the combustion of fuel, exhaust gases from

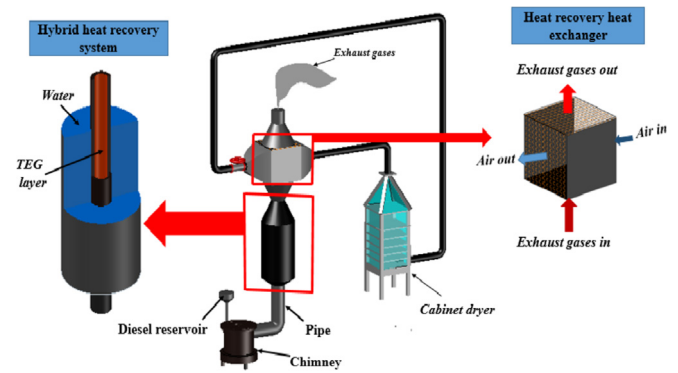

Fig. 3. Thermoelectric cogeneration drying system.

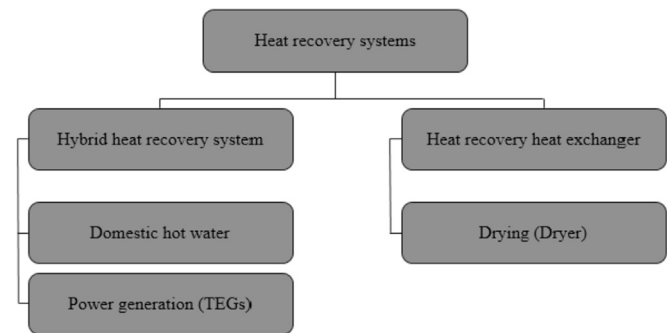

Fig. 4. Main purposes of the suggested heat recovery system.

combustion process are generated with high thermal energy. Exhaust gases move through a pipe to enter the hybrid heat recovery system through a pipe with TEGs attached to it, in which exhaust gases are in a direct contact with thermoelectric generators. Thermoelectric generators absorb part of the thermal energy captured by exhaust gases where part of it is converted to electric power and the other part transfer to the water surrounding the pipe in a tank heating it. Exhaust gases then enter the heat recovery heat exchanger in which another part of thermal energy is transferred to air heating it. The type of heat exchanger used is an air to air fixed plate heat exchanger. The heated air is then transmitted through pipes by a pump or blower to the dryer where it is used to dry either food or clothes. The remaining thermal energy captured by exhaust gases are released to environment and set as energy losses from the system. It should be noted that the energy lost through the chimney walls, pipes and the hybrid heat recovery system are not set a lost energy since such lost energy is used to heat the air of the room. The combination of these recovery systems made the overall system named as “domestic thermoelectric cogeneration drying heat recovery system”.

3. System thermal modeling

In order to study the thermal behavior of the system a thermal modeling of the system at each stage is carried. Starting from the combustion of fuel and ending with the released exhaust gases to environment, at each step energy balance is carried out and exhaust gases temperature is studied. Water temperature and power generated by TEG at the hybrid heat recovery system are estimated. Finally, the effect of changing the mass flow rate of air required for drying on the recovery process is studied.

In order to start the thermal modeling, some assumptions should be established:

1. Steady state analysis of the system
2. One dimensional heat transfer.
3. Steady flow of exhaust gases (constant mass flow rate)
4. Constant surface temperature of chimney (between inner and outer)
5. No exhaust gases leakage through all the system.
6. Neglected effect of radiation heat transfer between surfaces and ambient air except at the furnace.
7. No change in the gases convection coefficient through the system
8. Constant ambient air temperature.

In this section, thermal modeling of each part is presented alone [65], showing its energy balance and all related necessary equations in order to obtain the unknowns.

3.1. Furnace

By applying the energy balance at the furnace (Fig. 5) the thermal energy released from combustion process through exhaust gases is estimated as follows:

$$\eta_c \cdot Q_f - Q_{L,1} = Q_{gas,1} \quad (1)$$

where Q_f , $Q_{L,1}$ and $Q_{gas,1}$ are respectively, the heat rate generated from burning fuel, heat rate lost from the furnace to the ambient air and heat rate captured by exhaust gases exiting the furnace. η_c is the efficiency of combustion process.

The ideal thermal energy produced by burning fuel is function of the lower heat value (LHV) of the fuel used:

$$Q_f = \dot{m}_f \cdot LHV \quad (2)$$

where \dot{m}_f is the mass flow rate of fuel (kg/s). This heat rate should be multiplied by the efficiency of combustion to obtain the theoretical heat rate.

Moreover, the exhaust gases heat rate is function of the quantity (\dot{m}_g) and quality ($T_{g,1}$) of exhaust gases:

$$Q_{gas,1} = \dot{m}_g \cdot C_{p,g} \cdot (T_{g,1} - T_a) \quad (3)$$

where \dot{m}_g and $C_{p,g}$ are respectively the mass flow rate and specific heat at constant pressure of exhaust gases. $T_{g,1}$ and T_a are the exhaust gases and ambient air temperatures respectively.

Regarding the lost heat rate ($Q_{L,1}$), the heat rate at the inner

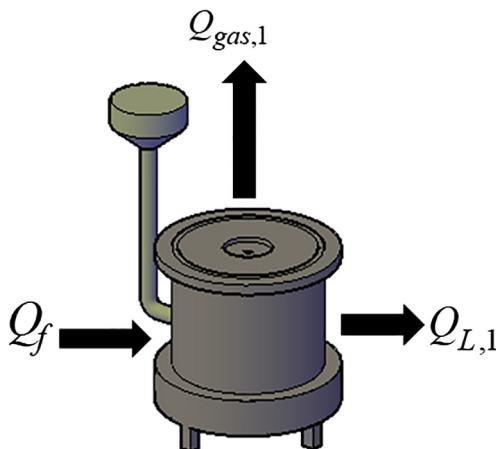

Fig. 5. Energy balance at the furnace of the chimney.

($Q_{L,1,i}$) and outer ($Q_{L,1,o}$) wall of the furnace are equal:

$$Q_{L,1} = Q_{L,1,i} = Q_{L,1,o} \quad (4)$$

The heat transfer at the inner surface of the furnace is composed of convective (Q_{conv}) and radiative (Q_{rad}) parts and expressed as follows:

$$Q_{L,1,i} = Q_{conv} + Q_{rad} \quad (5)$$

$$Q_{L,1,i} = \varepsilon_g \cdot \sigma \cdot A_f (T_{g,1}^4 - T_{s,f}^4) + h_g \cdot A_f \cdot (T_{g,1} - T_{s,f}) \quad (6)$$

where ε_g and h_g are the emissivity and convection heat transfer coefficient of exhaust gases, A_f is the furnace area, $T_{s,f}$ is the surface temperature of the furnace which is assumed to be constant at the inner and outer sides due to the fact of small thickness of the furnace wall, σ is the Stefan Boltzmann constant.

At the outer side of the furnace the lost heat rate is:

$$Q_{L,1,o} = \varepsilon_f \cdot \sigma \cdot A_f (T_{s,f}^4 - T_a^4) + h_a \cdot A_f \cdot (T_{s,f} - T_a) \quad (7)$$

where ε_f and h_a are the emissivity of the furnace wall and convection heat transfer coefficient of air.

For the combustion process with excess air, the theoretical combustion equation is:

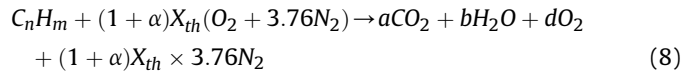

The actual air to fuel ratio $\left(\frac{A}{F}\right)_{act}$ for an excess air fuel combustion process is estimated from the theoretical air to fuel ratio $\left(\frac{A}{F}\right)_{theor}$, which is the mass of air over the mass of fuel.

$$\left(\frac{A}{F}\right)_{theor} = \left(\frac{m_a}{m_f}\right)_{theor} = \frac{X_{th} \cdot M_{O_2}}{0.23 \times m_f} \left(\frac{kg_{air}}{kg_{fuel}}\right) \quad (9)$$

$$\left(\frac{A}{F}\right)_{act} = (1 + \alpha) \cdot \left(\frac{A}{F}\right)_{theor} \quad (10)$$

$$\left(\frac{m_a}{m_f}\right)_{stoich} = \left(\frac{\dot{m}_a}{\dot{m}_f}\right)_{stoich} \quad (11)$$

where m_a , m_f , \dot{m}_a , \dot{m}_f are the masses and mass flow rate of air and fuel respectively, M_{O_2} is the molar mass of oxygen, α is the percentage of excess of air and X_{th} is the theoretical oxygen to fuel mole fraction which is estimated by stoichiometry. The mass flow rate of air is:

$$\dot{m}_a = \left(\frac{A}{F}\right)_{act} \cdot \dot{m}_f \quad (12)$$

The mass flow rate of exhaust gases released \dot{m}_g is the summation of the mass flow rate of fuel and air:

$$\dot{m}_g = \dot{m}_f + \dot{m}_a \quad (13)$$

3.2. Pipe

By applying energy balance at the pipe shown in Fig. 6, we can

write:

$$Q_{gas,1} - Q_{L,2} = Q_{gas,2} \quad (14)$$

where $Q_{gas,2}$ and $Q_{L,2}$ are the thermal energy hold by exhaust gases at the outlet of the pipe and the lost thermal energy with air respectively.

Knowing that the exiting temperature of exhaust gases from pipe is expressed by $T_{g,2}$, the exiting heat rate of exhaust gases is:

$$Q_{gas,2} = \dot{m}_g \cdot C_{pg} \cdot (T_{g,2} - T_a) \quad (15)$$

The heat loss rate at the pipe is estimated by the following equation:

$$Q_{L,2} = U_p \cdot A_{p,o} (T_{m,p} - T_a) \quad (16)$$

where U_p is the overall heat transfer coefficient of the pipe, $A_{p,o}$ is the outer area of the pipe and $T_{m,p}$ is the average mean temperature at the pipe, estimated as follows:

$$T_{m,p} = \frac{T_{g,1} + T_{g,2}}{2} \quad (17)$$

The overall heat transfer coefficient is composed of three parts of heat transfer. Starting from the convection heat transfer between gases and internal surface of the pipe ($R_{g,p}$) to the conduction through the pipe (R_p), ending with convection heat transfer between the outer surface of the pipe and air ($R_{p,a}$). It should be noted that the radiative part of heat transfer between pipe surface and ambient air is neglected.

$$U_p \cdot A_{p,o} = \frac{1}{R_{total,p}} = \frac{1}{R_{g,p} + R_p + R_{p,a}} \quad (18)$$

$$U_p \cdot A_{p,o} = \frac{1}{\frac{1}{h_g \cdot A_{p,i}} + \frac{\ln(r_{p,o}/r_{p,i})}{2\pi \cdot K_p \cdot L} + \frac{1}{h_a \cdot A_{p,o}}} \quad (19)$$

where $r_{p,i}$, $r_{p,o}$ and K_p are respectively the inner, outer radii and thermal conductivity of the pipe. The summation of the resistance over the pipe is expressed by $R_{total,p}$. The inner $A_{p,i}$ and outer $A_{p,o}$ areas of the pipe are the lateral areas and calculated as follows:

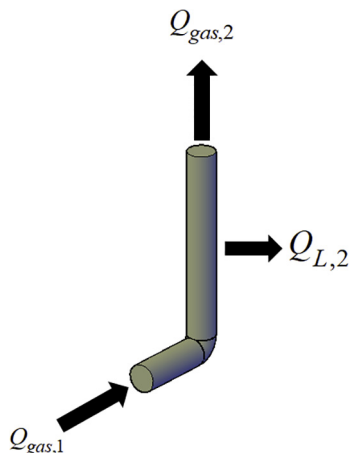

Fig. 6. Heat balance at the pipe.

$$A_{p,i} = 2 \cdot \pi \cdot r_{p,i} \cdot L_p \quad (20)$$

$$A_{p,o} = 2 \cdot \pi \cdot r_{p,o} \cdot L_p \quad (21)$$

By equating the previous equations (3) and (14)–(17), $T_{g,2}$ is equal to:

$$T_{g,2} = \frac{T_{g,1} (\beta_p - 0.5) + T_a}{\beta_p + 0.5} \quad (22)$$

where β_p is the multiple of mass flow rate and specific heat of gases at constant pressure and the total resistance over the pipe:

$$\beta_p = \dot{m}_g \cdot C_{pg} \cdot R_{total,p} \quad (23)$$

3.3. Hybrid heat recovery system – HHRS

When exhaust gases pass out from the pipe, they enter to the first part of the heat recovery process at which domestic hot water is heated and electric energy is generated using TEGs. At the hybrid heat recovery system, the thermal energy that enters the system is split: a part of it is transferred to the TEGs then to water and to the ambient air (Q_{sys}) and the other part remains captured by the exiting exhaust gases ($Q_{gas,3}$), Fig. 7 illustrates the equation (24).

$$Q_{gas,2} = Q_{sys} + Q_{gas,3} \quad (24)$$

The heat rate at the exit of the system is associated by the following equation:

$$Q_{gas,3} = \dot{m}_g \cdot C_{pg} \cdot (T_{g,3} - T_a) \quad (25)$$

where $T_{g,3}$ is the exiting temperature of exhaust gases from the system. Due to the presence of the thermoelectric generators, the heat transfer rate through the hybrid heat recovery system is:

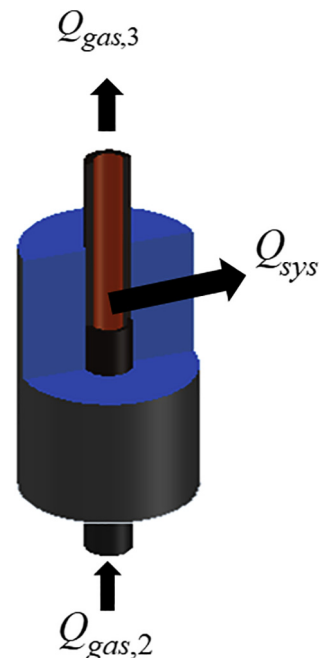

Fig. 7. Heat balance for the hybrid heat recovery system.

$$Q_{sys} = Q_{L,3} + P \quad (26)$$

where $Q_{L,3}$ and P are the heat loss rate with ambient air and the power generated by TEGs. At the TEG, the power produced is the difference of the thermal energies at the heat source and sink sides.

$$P = Q_H - Q_C \quad (27)$$

It should be noted that Q_H is equal to Q_{sys} and Q_C is equal to $Q_{L,3}$. From the electrical modeling part of thermoelectric generators, the following equations are raised showing a direct relationship between the power and the temperature difference at the TEG sides.

$$Q_H = N \left\{ U_{PN}(T_H - T_C) + \alpha \cdot I \cdot T_H - \frac{I \cdot R_i^2}{2} \right\} \quad (28)$$

$$Q_C = N \left\{ U_{PN}(T_H - T_C) + \alpha \cdot I \cdot T_C - \frac{I \cdot R_i^2}{2} \right\} \quad (29)$$

$$P = \alpha \cdot I (T_H - T_C) - I \cdot R_i^2 \quad (30)$$

$$I = \frac{\alpha(T_H - T_C)}{2R_i} \quad (31)$$

In order to simplify the calculation, and since the maximum energy conversion efficiency of TEG is about 5%, the TEG layer is represented as a layer having its own thermal resistance with a constant heat flow rate across the system. In other words, since the power generated P is very small compared to the heat transfer rate across the system (Q_{sys}), then the heat transfer rate is assumed to be constant over the system allowing to initialize the following equations.

$$Q_{sys} = U_{sys} \cdot A_{t,o} \cdot (T_{m,sys} - T_a) \quad (32)$$

where U_{sys} and $T_{m,sys}$ are respectively the overall heat transfer coefficient of the HHRS and the average mean temperature at the HHRS, and $A_{t,o}$ is the outer area of the tank. The average mean temperature is function of the entering and exiting exhaust gases temperature from the system:

$$T_{m,sys} = \frac{T_{g,2} + T_{g,3}}{2} \quad (33)$$

The overall heat transfer coefficient is estimated by the type of heat transfer and its relative area.

$$U_{sys} \cdot A_{sys,o} = \frac{1}{R_{total,sys}} = \frac{1}{R_{g,sys} + R_{TEG} + R_{tube} + R_{tu-w} + R_{w-t} + R_t + R_{a,sys}} \quad (34)$$

$$U_{sys} \cdot A_{sys,o} = \frac{1}{\frac{1}{h_g \cdot A_{TEG,i}} + \frac{\ln(r_{TEG,o}/r_{TEG,i})}{2\pi \cdot K_{TEG} \cdot L} + \frac{\ln(r_{tu,o}/r_{tu,i})}{2\pi \cdot K_{tu} \cdot L} + \frac{1}{h_w \cdot A_{tu,o}} + \frac{1}{h_w \cdot A_{t,i}} + \frac{\ln(r_{t,o}/r_{t,i})}{2\pi \cdot K_t \cdot L} + \frac{1}{h_a \cdot A_{t,o}}} \quad (35)$$

where the total resistance over the HHRS ($R_{total,sys}$) is composed of convection resistance between gases and TEG surface ($R_{g,sys}$), conduction through the TEG (R_{TEG}) and tube (R_{tube}), convection between outer tube surface and water (R_{tu-w}) and convection between water and inner tank's wall (R_{w-t}), conduction over the tank wall (R_t) and finally convection between outer tank surface and ambient air ($R_{a,sys}$). K_{TEG} , K_{tu} and K_t are the conduction coefficients of the TEG layer, tube and tank respectively. Due to the small size of TEG it is assumed as tubular shape then the inner and outer areas are:

$$A_{TEG,i} = 2 \cdot \pi \cdot r_{TEG,i} \cdot L_s \quad (36)$$

$$A_{TEG,o} = 2 \cdot \pi \cdot r_{TEG,o} \cdot L_s \quad (37)$$

where $r_{TEG,i}$ and $r_{TEG,o}$ are the inner and outer radii of the TEG, and L_s is the longitudinal length of the HHRS. The inner and outer area of the tube and tank are calculated as follow:

$$A_{tu,i} = 2 \cdot \pi \cdot r_{tu,i} \cdot L_s \quad (38)$$

$$A_{tu,o} = 2 \cdot \pi \cdot r_{tu,o} \cdot L_s \quad (39)$$

$$A_{t,i} = 2 \cdot \pi \cdot r_{t,i} \cdot L_s \quad (40)$$

$$A_{t,o} = 2 \cdot \pi \cdot r_{t,o} \cdot L_s \quad (41)$$

where $r_{tu,i}$, $r_{tu,o}$, $r_{t,i}$ and $r_{t,o}$ are the inner and outer radii of the tube and tank respectively. Then the exiting exhaust gases temperature $T_{g,3}$ is:

$$T_{g,3} = \frac{T_{g,2}(\beta_{sys} - 0.5) + T_a}{\beta_{sys} + 0.5} \quad (42)$$

where β_{sys} is a constant equated to:

$$\beta_{sys} = \dot{m}_g \cdot C_{pg} \cdot R_{total,sys} \quad (43)$$

The average water temperature is measured at the average position (mid position) and estimated by the following equation:

$$T_{w,avg} = T_{tu,o} - Q_{sys} \cdot R_{tu-w} \quad (44)$$

where $T_{tu,o}$ is the temperature of the outer surface of the tube.

The power produced per one TEG ($P_{1\ TEG}$) is directly proportional to the square of the temperature difference at the TEG (ΔT^2):

$$P_{1\ TEG} = \left(\frac{P}{\Delta T^2} \right)_{ref} \cdot \Delta T^2 \quad (45)$$

where $\left(\frac{P}{\Delta T^2} \right)_{ref}$ is the reference ratio of power generated for a specific square of temperature difference provided by the manufacturer. The total power produced by TEGs (P_{total}) is estimated by multiplying the power produced by one TEG with N_{TEG} the number of TEGs available at the pipe.

$$P_{total} = N_{TEG} \cdot P_{1\ TEG} \quad (46)$$

3.4. Dryer

After the first part of the energy lost is recovered at the HHRS, exhaust gases enter to the second part of heat recovery process in which air is heated to be used in drying process. A counter flow fixed plate air to air heat exchanger is utilized (Fig. 8). Such heat exchanger is characterized by large heat exchange area which is a crucial parameter in air to air heat recovery process. The outlet air temperature and the mass flow rate of air are suggested in order to calculate the required heat exchange area.

By applying the thermal energy balance at the heat recovery heat exchanger (HRHE) shown in Fig. 8, the following equations are raised:

$$Q_{gas,3} = Q_{HRHE} + Q_{gas,4} \quad (47)$$

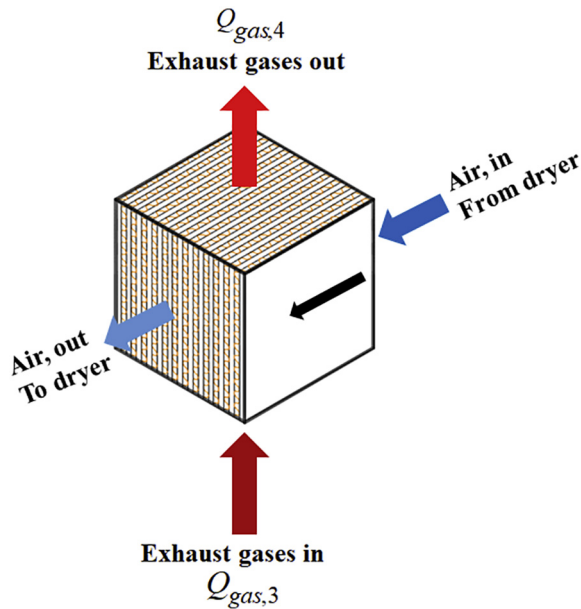

Fig. 8. Fixed plate air to air heat exchanger.

$$Q_{gas,4} = Q_{H,HE} = \dot{m}_g \cdot Cp_g \cdot (T_{g,4} - T_a) \quad (48)$$

$$Q_{C,HE} = \dot{m}_a \cdot Cp_a \cdot (T_{a,o} - T_a) \quad (49)$$

$$Q_{H,HE} = Q_{C,HE} = U_{HE} \cdot A_{HE} \cdot \Delta T_{lm} \quad (50)$$

where Q_{HRHE} is the heat transfer rate to heat exchanger, $Q_{gas,4}$, $Q_{H,HE}$ and $Q_{C,HE}$ are the sensible heat rate exiting the heat exchanger, hot and cold stream heat transfer rate at the heat exchanger respectively, \dot{m}_a , $T_{g,4}$ and $T_{a,o}$ are the mass flow rate of air, exiting exhaust gases and air temperature from the heat exchanger, and ΔT_{lm} is the logarithmic mean temperature difference, calculated as follows:

$$\Delta T_{lm} = \frac{\Delta T_{out} - \Delta T_{in}}{\ln(\Delta T_{out}/\Delta T_{in})} = \frac{(T_{g,4} - T_{a,o}) - (T_{g,3} - T_a)}{\ln\left(\frac{T_{g,4} - T_{a,o}}{T_{g,3} - T_a}\right)} \quad (51)$$

where U_{HE} and A_{HE} are the overall heat transfer coefficient and the heat exchange area of the heat exchanger. The overall heat transfer coefficient is composed of convection heat transfer of the hot stream and plate's surface and conduction heat transfer through the heat exchanger plate and convection heat transfer between the plate and cold stream.

$$\frac{1}{U_{HE}} = \frac{1}{h_h} + \frac{t_{plate}}{K_{plate}} + \frac{1}{h_c} \quad (52)$$

where h_h and h_c are the convection coefficients of the hot and cold stream, t_{plate} and K_{plate} are the thickness and conduction coefficient of the plates. The area of a fixed plate heat exchanger is defined by the number of plates N_{plates} multiplied by the height H_{plate} and width W_{plate} of the plate:

$$A_{HE} = N_{plates} \cdot H_{plate} \cdot W_{plate} \quad (53)$$

4. Case study and results

Diesel, coal and wood chimney are the main types of chimneys utilized residentially. They are different in the shape of the furnace (coal and wood include ash drawer) and residues coming out of burning. The gases flow rate of diesel chimney is steadier than coal and wood chimneys, due to the simplicity in controlling the amount of fuel added in diesel and hardness of maintaining constant rate of adding wood for wood chimneys. As presented above, the flow rate of fuel is assumed constant in this study.

4.1. Furnace

The three types of fuel are considered in this study in order to check the effect of changing the fuel used in burning on the behavior of the double stage hybrid heat recovery system. Specific types of diesel, coal, and wood are selected with its corresponding

Table 1
Theoretical chemical combustion equation for the different types of fuel.

Type of fuel	Theoretical chemical combustion equation
Diesel	$C_{12}H_{23} + X_{th}(O_2 + 3.76N_2) \rightarrow aCO_2 + bH_2O + X_{th} \times 3.76N_2$
Coal	$\frac{84.7}{12}C + \frac{2.9}{2}H_2 + \frac{1.5}{28}N_2 + \frac{1.6}{32}O_2 + \frac{0.8}{32}S + X_{th}(O_2 + 3.76N_2) \rightarrow aCO_2 + bH_2O + dSO_2 + kN_2$
Wood	$\frac{50}{12}C + \frac{6}{2}H_2 + \frac{42}{32}O_2 + \frac{1}{28}N_2 + others + X_{th}(O_2 + 3.76N_2) \rightarrow aCO_2 + bH_2O + kN_2 + others$

Table 2
Stoichiometric constants, theoretical and actual air to fuel ratio.

Type of fuel	<i>a</i>	<i>b</i>	<i>d</i>	<i>k</i>	<i>X_{th}</i>	$\left(\frac{A}{F}\right)_{theor}$ (kg _{air} /kg _{fuel})	$\left(\frac{A}{F}\right)_{act}$ (kg _{air} /kg _{fuel})
Diesel	12	11.5	–	–	17.75	24.69	32.1
Coal (Anthracite)	7.058	1.45	0.025	29.22	7.758	10.8	14.04
Wood	4.16	3	–	16.39	4.35	6.05	7.86

molecular formula. The theoretical chemical combustion equations are shown in the Table 1.

In the equations of Table 1, the constants *a*, *b*, *d*, *k* are evaluated from stoichiometry by applying mole balance for carbon, hydrogen, oxygen and others. Table 2 recapitulates the values of these constants and the corresponding theoretical air to fuel ratio calculated using equation (9) and the actual air to fuel ratio with a 30% excess air combustion process (equation (10)). Diesel fuel has the highest air to fuel ratio which is due to the molecular formula of diesel.

Table 3 recapitulates for each type of fuel its corresponding lower heat value with a constant mass flow rate of fuel for all types (1.1 kg/hr). For a 60% combustion efficiency the thermal energy generated by burning fuel is also shown in the Table 3. Diesel exhibits the highest lower heating value which implies higher thermal energy generated and higher thermal energy carried by exhaust gases.

The main parameters utilized in the thermal modeling of the furnace are given in the following Table 4.

Using those parameters and the equations of the furnace the thermal energy lost with ambient air and thermal energy captured by exhaust gases are estimated, knowing that the mass flow rate of exhaust gases is estimated using equation (13). The main results for the furnace part are summarized in the Table 5.

Diesel produces the highest quantity of exhaust gases (about

Table 3
Lower heat value, mass flow rate and thermal energy of fuel.

Type of fuel	LHV (MJ/kg)	\dot{m}_f (kg/hr)	η_c	$\eta_c Q_f$ (W)
Diesel	43.41	1.1	0.6	7958
Coal (Anthracite)	28.74	1.1	0.6	5269
Wood	14.52	1.1	0.6	2662

Table 4
Main parameters for furnace modeling.

Parameter	Value		Unit
	Diesel	Coal – Wood	
Furnace surface area (<i>A_f</i>)	0.13	0.18	m ²
Convection coefficient of gases (<i>h_g</i>) [64]	10		W/m ² .K
Specific heat of gases at constant pressure (<i>C_{p,g}</i>)	1140		kJ/kg.K
Convection coefficient of air (<i>h_a</i>) [64]	20		W/m ² .K
Ambient air temperature (<i>T_a</i>)	298		K
Exhaust gases emissivity (<i>ε_g</i>)	0.067		–
Furnace outer surface emissivity (<i>ε_f</i>)	0.46		–

Table 5
Main results for furnace part.

Type of fuel	$\eta_c Q_f$ (W)	\dot{m}_g (kg/hr)	<i>T_{g,1}</i> (K)	<i>Q_{gas,1}</i> (W)	<i>T_{s,f}</i> (K)	<i>Q_{L,1}</i> (W)
Diesel	7958	35.31	930	7066	531	886
Coal	5269	15.44	1041	3632	584	1622
Wood	2662	8.64	879	1603	507	1071

three times what wood produce) but not the highest temperature: even though coal has the highest exhaust gases temperature but diesel exhaust gases has the highest thermal energy because it is dependent on mass flow rate and temperature of exhaust gases. Since coal and wood chimneys are larger in area then the heat lost with ambient air is higher than for diesel chimney. Also since coal chimney produces highest exhaust gases temperature then the furnace outer temperature is highest, leading to high energy loss with ambient air. Table 5 shows that for diesel chimney about 11% of the generated thermal energy is dissipated to the surrounding, however for coal and wood chimney the thermal energy lost are 30% and 40% respectively. This is mainly caused by a lower quantity of exhaust gases (mass flow rate) and larger furnace area. It is obvious from the mass flow rate of exhaust gases and for the same size of the pipe, Diesel exhaust gases will flow faster than coal and wood which means that less energy can be recovered in diesel. While for wood case, exhaust gases flow in a lower speed allowing more heat transfer and more percentage of energy recovered compared to diesel system. Whereas, since exhaust gases flow with low speed it is expected that flying ashes will stick more in wood and coal cases compared to diesel system. The temperature of exhaust gases generated from wood is 96% compatible with the results conducted by Najjar and Kseibi [64].

4.2. Pipe

Exhaust gases flow out from the chimney furnace to the HHRS through a pipe. At the pipe, exhaust gases lose part of their thermal energy to ambient air. The pipe equivalent length is 350 mm including the elbow. The inner and outer radii of the pipe are 50 mm and 51 mm respectively. The conductivity heat transfer of the pipe which is made of iron is 50 W/m.K. By applying the energy balance and the equations related to pipe part, the following results are obtained and recapitulated in Table 6.

As in the furnace, coal chimney loses more thermal energy than diesel and wood ones due to the highest exhaust gases temperature. The total resistance is constant for the three types of fuel because the dimensions of the pipe are constant for the three cases. From Tables 5 and 6, exhaust gases lose about 3% of its temperature

Table 6
Main results from pipe part.

Type of fuel	<i>R_{total,p}</i> (K/W)	<i>T_{g,2}</i> (K)	<i>Q_{gas,2}</i> (W)	<i>Q_{L,2}</i> (W)
Diesel	1.355	899	6609	451
Coal	1.355	937	3132	509
Wood	1.355	740	1211	378

Table 7
Main parameters for HHRS thermal modeling.

Parameter	Value	Unit
Length of the system	1	m
Inner radius of the tube	0.050	m
Outer radius of the tube	0.051	m
Inner radius of the tank	0.249	m
Outer radius of the tank	0.25	m
Area of TEG	0.003136	m ²
Thickness of TEG	5	mm
Number of TEG available	100	–
K_{TEG}	0.18	W/m.K
K_{Cu} (Copper)	401	W/m.K
K_I (Iron)	50	W/m.K
h_w	20	W/m ² .K

when diesel is used, they decrease 9% when coal is utilized and reduce maximum when wood is utilized (15%). This decrease is mainly caused by low amount of exhaust gases when wood is utilized as a fuel of the chimney. 31% of the energy entering the pipe is lost when wood is utilized, only 16% is lost when coal is used and minimum losses are checked when diesel is used (7%). The main role of a chimney is to heat ambient air in cold weather. The heat is transferred from the combustion chamber to the air through the walls of the chimney. Also, the pipe can transfer heat to the air, then the thermal energy transferred to the air from the pipe wall is not considered as dissipated energy. Since coal has the highest $Q_{L,2}$ then, it heats the ambient air more than the wood and diesel at the pipe stage.

4.3. Hybrid heat recovery system – HHRS

At the HHRS exhaust gases release part of its thermal energy to the recovery system, producing domestic hot water and generating electricity by a thermoelectric cogeneration system. As shown in the design of the HHRS the exhaust gases are in a direct contact with TEG surface. The main parameters of the designed hybrid heat recovery system are summarized in the Table 7.

Using the thermal modeling equation of the HHRS aforementioned, the main results of the thermal behavior of the system are recapitulated in Table 8.

The hybrid heat recovery system utilized 12.5% of the energy entering the system when diesel is used to produce hot water and generate electricity. This used energy produced 78 °C hot water and generated 240 W from 100 TEGs. When coal is used 26.5% of the entering energy is utilized producing the same water temperature and power as when diesel is used. However, when using wood as a fed fuel of the chimney 43% of the entering energy is transfer to the hybrid heat recovery system producing about 58 °C hot water and

Table 8
Main results obtained for the HHRS.

Type of fuel	$R_{total, sys}$ (K/W)	$T_{g,3}$ (K)	$Q_{gas,3}$ (W)	Q_{sys} (W)	P_{total} (W)	$T_{w,avg}$ (K)	$Q_{L,3}$ (W)
Diesel	0.667	815	5777	832	240	351	832
Coal	0.667	767	2301	831	240	351	831
Wood	0.667	550	690	521	94	331	521

Table 9
Temperature distribution over the HHRS.

Type of fuel	$T_{m,sys}$ (K)	T_H (K)	T_C (K)	$T_{tu,o}$ (K)	$T_{w,avg}$ (K)	$T_{t,i}$ (K)	$T_{t,o}$ (K)	T_a (K)
Diesel	852	558	480	480	351	324	324	298
Coal	852	558	480	480	351	324	324	298
Wood	645	461	412	412	331	31	314	298

generated 94 W electric power from TEG layer. The main reason of having the same water temperature and power produced for the diesel and coal cases is that the mean temperatures are the same as shown in the Table 9. Since electric water heater is the highest consumer of electric power residentially which increases the electric bill, this stage saves money and reduce the amount of CO₂ gas released to generate the required electricity. Diesel and coal will save money more than wood system does. However, coal system could experience more corrosion phenomenon compared to diesel case since it has lower gases temperature. One hundred TEGs are attached to the tube on the system. The power generated by one TEG for the wood system is around 0.94 W. Najjar and Kseibi [64] estimated that the power generated by one TEG is about 0.7 W.

In the Table 9, the temperatures $T_H, T_C, T_{t,i}, T_{t,o}$ are respectively the hot and cold temperatures at the TEG and the inner and outer temperatures of the tank wall. It should be noted that T_C is equal to the inner surface temperature of the pipe and due to small thickness of the pipe the temperatures before and after pipe wall or before and after tank wall are the same.

4.4. Dryer

In this part of the system, air to air heat recovery heat exchanger is utilized. There are many types of air to air heat exchanger that can be utilized. Heat pipe, run around coil, rotatory wheel and fixed plate heat exchanger are the main types used. In the present work, fixed plate heat exchanger is used, it has no moving parts and consists of alternated plates, separated and sealed which form the exhaust and supply airstream passages. Fixed plate heat exchanger transfer only sensible heat but they are easy to be cleaned from ashes residues.

The effect of changing the mass flow rate on the required heat exchanger area is studied. In order to estimate the required heat transfer area of the heat exchanger the outlet air temperature is selected to be equal to 363 K. A range of the mass flow rate of air between 0.0001 kg/s to 0.0076 kg/s has been considered with an increment of 0.0003. The heat exchanger plate is made up of copper of cross sectional area of 20 × 5 cm. The effect of changing the air flow rate on the exhaust gases temperature, area and number of plates required is showed on Fig. 9.

From the Fig. 9, as the mass flow rate of air is increased, the outlet exhaust gases temperature is decreased. The Diesel exhaust gases temperature is not highly affected by the change of the air mass flow rate, it is 814 K at 0.0001 kg/s and decreased to 770 K at 0.0076 kg/s (decrease of 44 °C), this results from the high thermal energy captured by the entering gases. While for the coal exhaust gases, it experienced a 100 °C decrease in temperature with the same increase of air flow rate. At least, exhaust gases of the wood

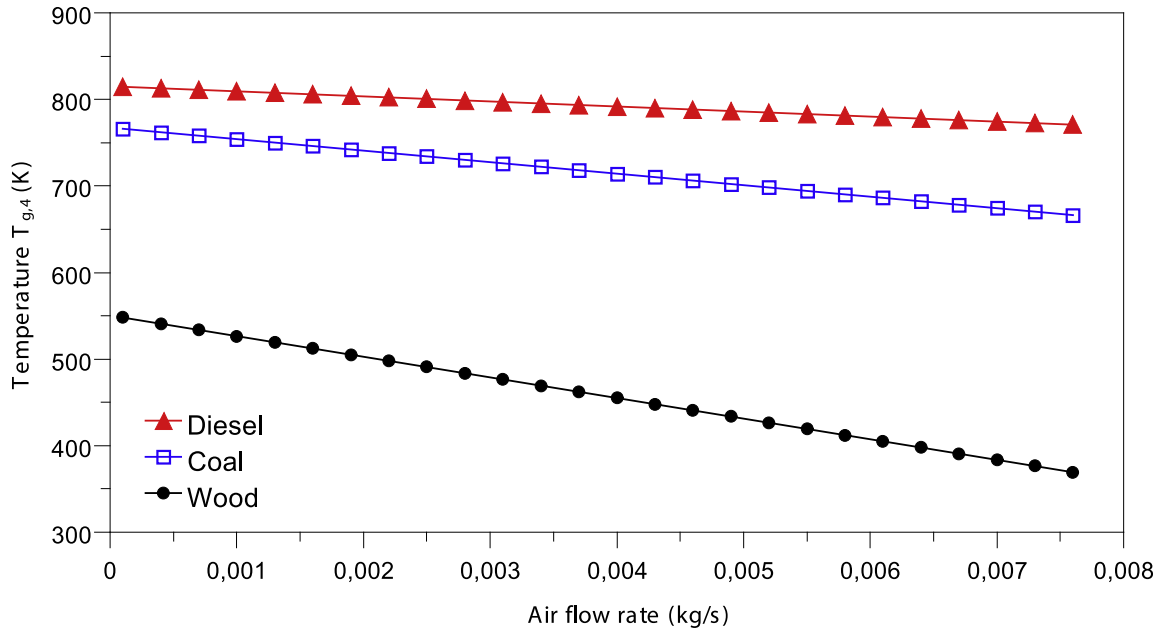

Fig. 9. Exiting gases temperature ($T_{g,4}$).

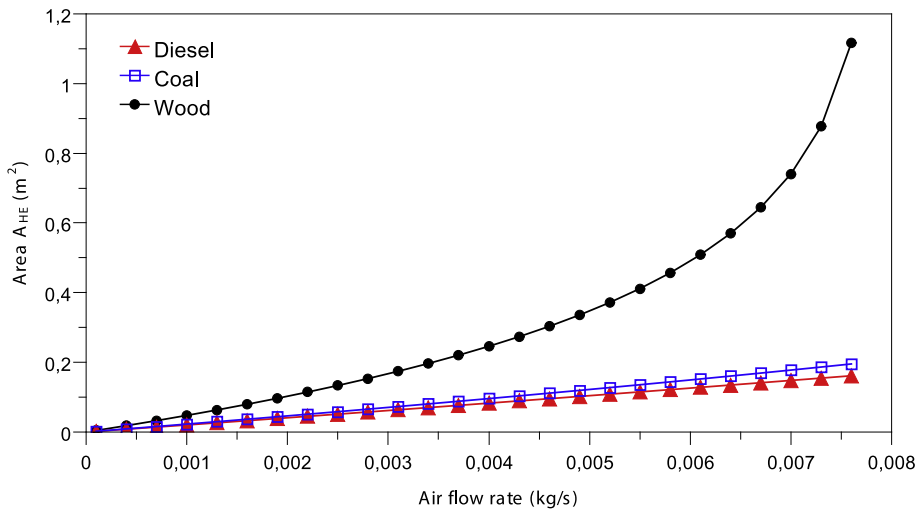

Fig. 10. Heat exchanger required area (A_{HE}).

case are the most affected by increasing the air flow rate: the exhaust gases temperature is 547 K at 0.0001 kg/s and decreased at 369 K at 0.0076 kg/s (decrease of 178 °C).

The heat exchanger area required is shown in Fig. 10 and is directly affected by changing the mass flow rate. Diesel and coal cases are slightly affected compared to the wood case. This is because of the relatively close value of the entering thermal energy of exhaust gases and the required thermal energy transferred to air. At a 0.0076 kg/s flow rate, the area required is 0.16, 0.19 and 1.11 m² for diesel, coal and wood respectively.

The number of plates is proportional to the area, and with constant width and height (20 × 5 cm) the change in the number of plates, plots in Fig. 11, evolves as the change in the area. At 0.0076 kg/s about 17 plates are required when diesel is used, 20 plates for coal case and 112 plates when wood is used as the fed fuel of the chimney. This implies that as the flow rate of air increases, more plates are required which increases the cost of the heat

exchanger especially for wood system. Increasing the number of plates will also increase the pressure drop which will increase the probability of overstock of ashes on heat exchanger.

The thermal energy of the exiting exhaust gases is in function of the gases exiting temperature. Fig. 12 shows the effect of changing air flow rate on the energy remaining with exhaust gases. At 0.0001 kg/s flow rate of air, for wood fueled system, the heat rate at the outlet of the heat exchanger is 683.5 W, i.e. 6.5 W heat is transferred from exhaust gases to the air. Besides, at 0.0076 kg/s air flow rate, about 500 W of heat is delivered from the entering gases to air. Whereas, for Diesel the heat rate is 5.7 kW which decreases to 5.2 kW at 0.0001 kg/s and 0.0076 kg/s air flow rate respectively. While for coal, the heat rate at the outlet of the heat exchanger is 2.3 kW and decreases to 1.8 kW at 0.0001 kg/s and 0.0076 kg/s air flow rate respectively.

The energy recovery percentages at the HRHE are summarized in the Table 10 for the three different fuels used and three different

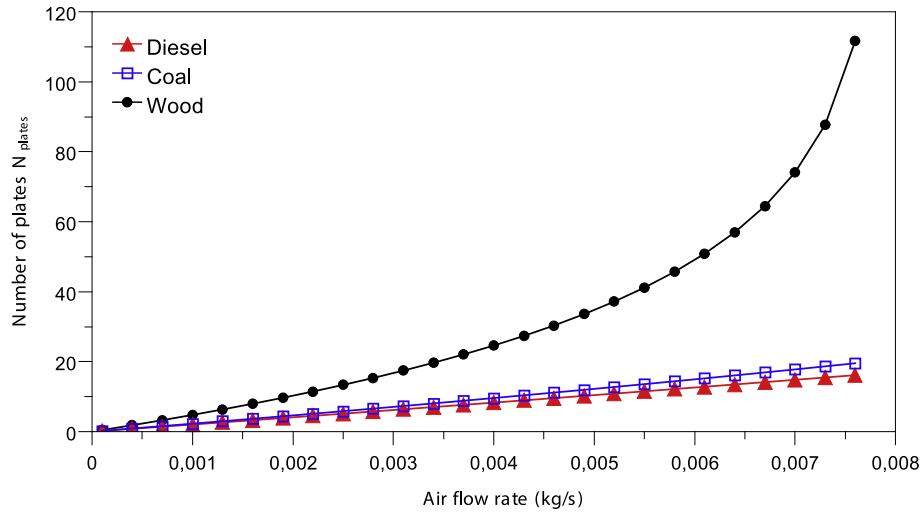

Fig. 11. Number of plates required (N_{plates}).

air flow rates. For the maximum flow rate studied (0.0076 kg/s), only 8.5% of the diesel exhaust gases thermal energy is recovered, 21.5% for coal case and 71.7% for wood system. Therefore, for diesel or coal cases, more energy could be recovered by either increasing the mass flow rate of air or increasing the outlet air temperature (higher than 363 K).

4.5. Overall system

Fig. 13 shows the variation of the exhaust gases temperature all over its pathway, at a constant mas flow rate of air 0.0076 kg/s. Coal system experiences higher decrease in exhaust gas temperature compared to diesel case knowing that coal combustion temperature is higher than diesel. This higher decrease is caused by the low mass flow rate of exhaust gases in the coal system compared to diesel one. Wood exhaust gases have the lowest burning

Table 10

Percentage of energy recovery at the HRHE to the dryer.

Type of fuel	Percentage of energy recovery		
	$\dot{m}_a = 0.0001$ kg/s	$\dot{m}_a = 0.0043$ kg/s	$\dot{m}_a = 0.0076$ kg/s
Diesel	0.11%	4.8%	8.5%
Coal	0.2%	12.2%	21.5%
Wood	0.9%	40.5%	71.7%

temperature and lowest mass flow rate, which results by the lowest exit temperature ($T_{g,4}$). Since diesel has high mass flow rate and relatively high exhaust gases temperature, its exhaust gases temperature decreases slowly over the system: decrease of about 17.2% of the initial temperature. However, for coal case the exhaust gases temperature decreased of 33% and wood case has the highest

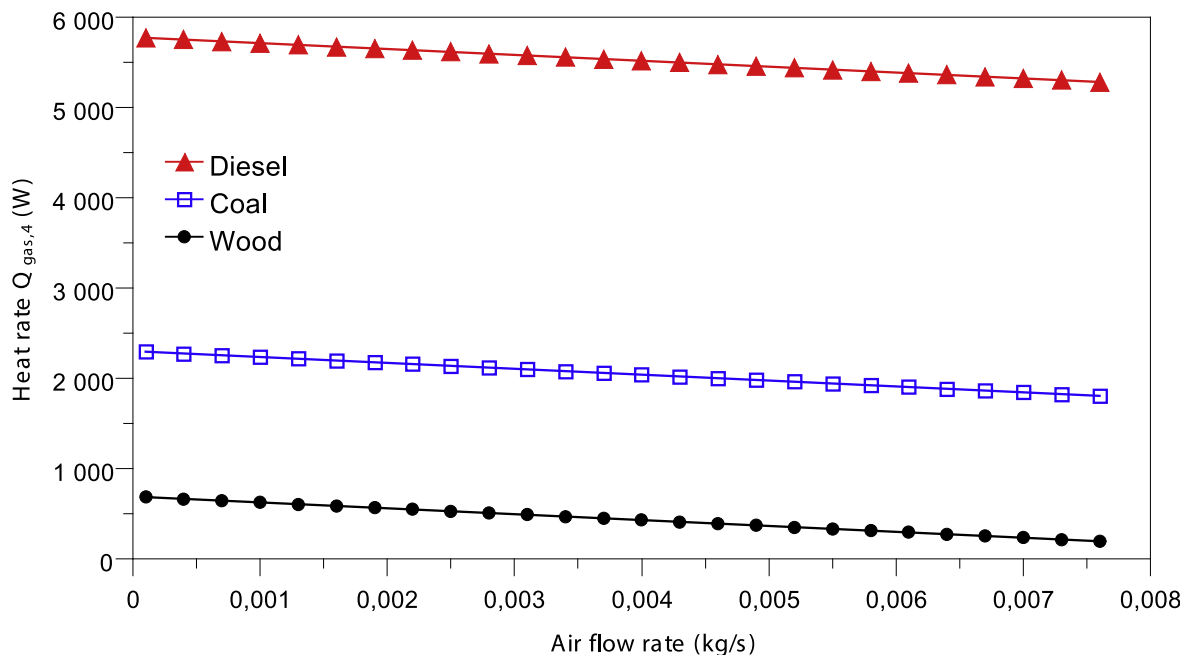

Fig. 12. Heat rate at the outlet of the heat exchanger ($Q_{gas,4}$).

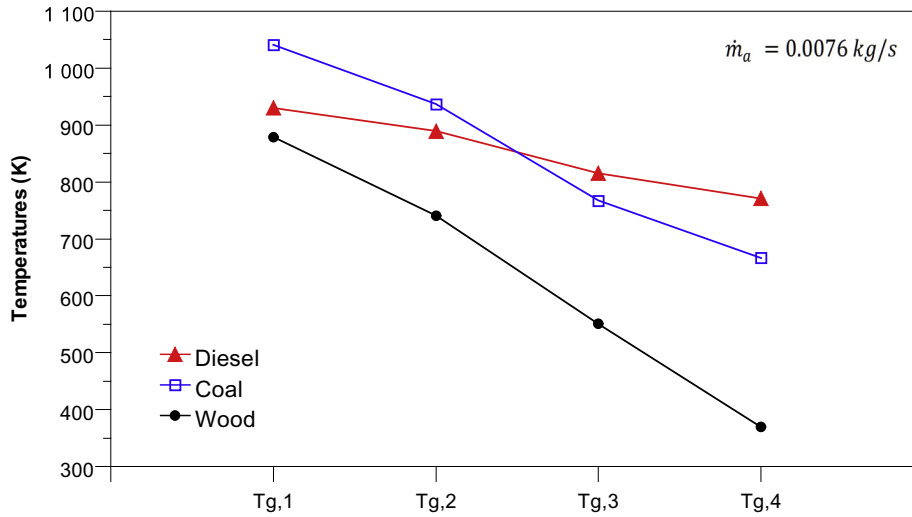

Fig. 13. Exhaust gases temperature change over the system at $\dot{m}_a = 0.0076$ kg/s.

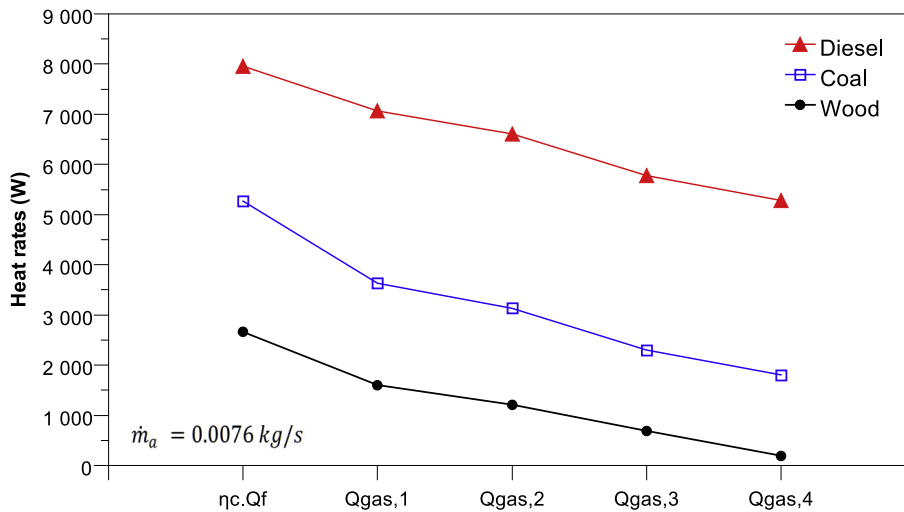

Fig. 14. Heat flow rate change over the system at $\dot{m}_a = 0.0076$ kg/s.

Table 11
Energy recovery from system.

Type of fuel	Designed chimney system (with heat recovery)		Conventional chimney system (without heat recovery)		% of energy recovered from lost energy
	% of energy used	% of energy lost	% of energy used	% of energy lost	
Diesel	34	66	17	83	20
Coal	66	34	41	59	42
Wood	93	7	54.5	45.5	84

temperature decrease of 58%.

Fig. 14 shows the variation of the heat flow rate all over its pathway in the system, at a constant mass flow rate of air 0.0076 kg/s. When diesel is used it generated 7958 W and released 5269 W to environment while when coal is used, it produced 5269 W thermal energy and lost 1805 W to environment. For wood case it generated 2662 W thermal energy and rejected 194 W to environment. A part of the thermal energy generated from burning fuel is lost to ambient air inside room and part is recovered to heat domestic hot water, produce electricity and heat drying air to be utilized in a dryer, and the remaining part is lost to the environment.

Since the main role of a chimney is to heat room's ambient air, then the thermal energy lost to the ambient air inside the room are not set as losses. The only thermal energy loss is the remaining thermal energy in exhaust gases ($Q_{gas,4}$). Table 11 shows the percentage of useful and lost thermal energy from the produced thermal energy for the three types of fuel. Then it is compared to a conventional chimney system in which it consists only of chimney and pipe.

When diesel is used to be the source of thermal energy in the chimney, it rejects the highest amount of thermal energy to the environment with or without heat recovery systems. However

Table 12

Main results, pros and cons of different scenarios considered in the study.

Case study	Main outputs	Advantages	Disadvantages
Diesel	<ul style="list-style-type: none"> > 240 W electric power generated from TEGs > 78 °C hot water > 90 °C hot drying air at 0.0076 kg/s mass flow rate > 0.16 m² heat exchanger area > 20% of the dissipated energy is recovered 	<ul style="list-style-type: none"> > Low risk for corrosion compared to other systems > Produce high power > Produce high water temperature > Low amount of sticky flying ashes compared to coal and wood > Lowest heat exchanger cost 	<ul style="list-style-type: none"> > Low percentage of energy recovered > Greater energy dissipated > Diesel is more expensive than coal and wood
Coal	<ul style="list-style-type: none"> > 240 W electric power generated from TEGs > 78 °C hot water > 90 °C hot drying air at 0.0076 kg/s mass flow rate > 0.19 m² heat exchanger area > 42% of the dissipated energy is recovered 	<ul style="list-style-type: none"> > Produce high power > Produce high water temperature > Coal has low cost compared to diesel > Low heat exchanger cost compared to wood 	<ul style="list-style-type: none"> > High amount of ashes > Risk of the pipe or heat exchanger closure resulted from ashes > Risk of incomplete combustion resulted from trapping gases in the combustion chamber
Wood	<ul style="list-style-type: none"> > 94 W electric power generated from TEGs > 58 °C hot water > 90 °C hot drying air at 0.0076 kg/s mass flow rate > 1.11 m² heat exchanger area > 84% of the dissipated energy is recovered 	<ul style="list-style-type: none"> > Wood has low cost compared to diesel and coal > High amount of energy recovered compared to other systems 	<ul style="list-style-type: none"> > High amount of ashes > Risk of the pipe or heat exchanger closure resulted from ashes > Risk of incomplete combustion resulted from trapping gases in the combustion chamber > High risk for corrosion (low gases temperature) > High heat exchanger cost

when using the heat recovery system, about 20% of the dissipated energy is being reused for producing hot water, hot air and electric power. For a conventional chimney that utilizes coal, 59% of the thermal energy generated is dissipated while when adding the heat recovery systems it rejects only 34% of its generated thermal energy. Wood chimneys are widely utilized and such system produces lower thermal energy due to the low heating value. When the wood chimney is connected with the heat recovery system, it only rejects 7% of its initial thermal energy: the heat recovery system recovers 84% of the dissipated energy.

Different types of fed fuel is studied and each scenario holds its outcomes. Table 12 below summarizes the scenarios results, shedding the light on the main results conducted, advantages and disadvantages of the heat recovery system.

The suggested triple heat recovery system has an overall efficiency of 63%, estimated by the summation of the used energy over the heat rate generated from the combustion of fuel. While Najjar and Kseibi [64] did a triple heat recovery system that generates electricity, cook and heat water, which has reached a 59% overall efficiency.

5. Conclusion

Multistage heat recovery from exhaust gases is an attractive growing field of study which is capturing the interest of scientists. The presented work suggests a new multistage heat recovery system that utilizes thermal energy released from combustion through exhaust gases to heat domestic water, generate electricity and heat air to be used in dryer. A complete thermal modeling of the system is illustrated starting from the equation of combustion till the released energy to environment. A case study is conducted in which three types of fuel (diesel, coal and wood) are studied and the results are analyzed and discussed. The main conclusions are drawn as follows:

1 At the furnace, the combustion of diesel, coal, and wood produced exhaust gases at temperature 930 K, 1041 K, 879 K

respectively at a mass flow rate of 35.31 kg/hr, 15.44 kg/hr and 8.64 kg/hr respectively.

- 2 Heat loss from furnace walls are 11%, 30%, 40% of the initial thermal energy produced from burning of diesel, coal and wood respectively.
- 3 At the pipe, the energy loss through the wall of the pipe reduced the exhaust gases temperature by 3%, 9% and 15% of the diesel, coal, and wood exhaust gases.
- 4 The hybrid heat recovery system generated about 240 W for both diesel and coal cases, while it only produces 94 W for wood case.
- 5 The water at the tank is heated up to 351 K for diesel and coal cases, however when wood is used as fed fuel the water temperature increased to 331 K at steady state.
- 6 For a mass flow rate of air equal to 0.0076 kg/s, the area of the heat exchanger required is 0.16, 0.19 and 1.11 m² for diesel, coal and wood cases respectively.
- 7 The overall system recovered 20%, 42% and 84% of the energy dissipated to the environment for diesel, coal and wood cases respectively.

More thermal energy can be recovered for coal and diesel chimneys by increasing the volume of water, adding more layers of TEG, heating more air by either increasing air outlet temperature or by increasing the mass flow rate of the air, or even by adding a cooker.

References

- [1] Agrafiotis C, Tsoutsos T. Energy saving technologies in the European ceramic sector: a systematic review. *Appl Therm Eng* 2001;21:1231–49.
- [2] Zhang D, Wang J, Lin Y, Si Y, Huang C, Yang J, Huang B, Li W. Present situation and future prospect of renewable energy in China. *Renew Sustain Energy Rev* 2017;76:865–71.
- [3] Mussard M. Solar energy under cold climatic conditions: a review. *Renew Sustain Energy Rev* 2017;74:733–45.
- [4] Ramadan M, Ali S, Bazzi H, Khaled M. New hybrid system combining TEG, condenser hot air and exhaust airflow of all-air HVAC systems. *Case Stud Therm Eng* 2017;10:154–60.
- [5] Khaled M, Ramadan M, El-Hage H, Elmarakbi A, Harambat F, Peerhossaini H. Review of underhood aerothermal management: towards vehicle simplified models. *Appl Therm Eng* 2014;73(1):842–58.

- [6] Ramadan M, Khaled M, ElHage H. Using speed bump for power generation –experimental study. *Energy Proc* 2015;75:867–72.
- [7] Ibanez-Lopez AS, Moratilla-Soria BY. An assessment of Spain's new alternative energy support framework and its long-term impact on wind power development and system costs through behavioral dynamic simulation. *Energy* 2017;138:629–46.
- [8] Sakr IM, Abdelsalam Ali M, El-Askary WA. Effect of electrodes separator-type on hydrogen production using solar energy. *Energy* 2017;140:625–32.
- [9] Herez A, Ramadan M, Abdulhay B, Khaled M. Short review on solar energy systems. *AIP Conf Proc* 2016;1758(Issue 1).
- [10] M. Ramadan, M. Khaled, H. S. Ramadan, M. Becherif. Modeling and sizing of combined fuel cell-thermal solar system for energy generation, Accepted in the *International Journal for Hydrogen Energy*.
- [11] Yang L, Entchev E, Rosato A, Sibilio S. Smart thermal grid with integration of distributed and centralized solar energy systems. *Energy* 2017;122:471–81.
- [12] El Hage H, Herez A, Ramadan M, Bazzi H, Khaled M. An investigation on solar drying: a review with economic and environmental assessment. *Energy* 2018;157:815–29.
- [13] Herez A, Ramadan M, Khaled M. Review on solar cooker systems: economic and environmental study for different Lebanese scenarios. *Renew Sustain Energy Rev* 2018;81(1):421–32.
- [14] Hachem F, Abdulhay B, Ramadan M, El Hage H, Gad El Rab M, Khaled M. Improving the performance of photovoltaic cells using pure and combined phase change materials – experiments and transient energy balance. *Renew Energy* 2017;107:567–75.
- [15] Dujardin J, Kahl A, Krut B, Bartlett S, Lehning M. Interplay between photovoltaic, wind energy and storage hydropower in a fully renewable Switzerland. *Energy* 2017;135:513–25.
- [16] Herez A, Khaled M, Murr R, Haddad A, Elhage H, Ramadan M. Using geothermal energy for cooling - parametric study. *Energy Proc* 2017;119:783–91.
- [17] Tiwari S, Tiwari G. Energy and exergy analysis of a mixed-mode greenhouse-type solar dryer, integrated with partially covered N-PVT air collector. *Energy* 2017;128:183–95.
- [18] Bosch J, Staffell I, Hawkes A. Temporally-explicit and spatially-resolved global onshore wind energy potentials. *Energy* 2017;131:207–17.
- [19] El Mays A, Ammar R, Hawa M, Abou Akroush M, Hachem F, Khaled M, Ramadan M. Improving photovoltaic panel using finned plate of Aluminum. *Energy Proc* 2017;119:812–7.
- [20] Atherton J, Sharma R, Salgado J. Techno-economic analysis of energy storage systems for application in wind farms. *Energy* 2017;135:540–52.
- [21] Remeli MF, Verojporn K, Singh B, Kiatbodoin L, Date A, Akbarzadeh A. Passive heat recovery system using combination of heat pipe and thermoelectric generator. *Energy Proc* 2015;75:608–14.
- [22] Jaber H, Khaled M, Lemenand T, Faraj J, Bazzi H, Ramadan M. Effect of exhaust gases temperature on the performance of a hybrid heat recovery system. *Energy Proc* 2017;119:775–82.
- [23] Shen S, Cai W, Wang X, Wu Q, Yon H. Investigation of liquid desiccant regenerator with fixed-plate heat recovery system. *Energy* 2017;137:172–82.
- [24] Bellocchi S, Guizzi G, Manno M, Pentimalli M, Salvatori M, Zaccagnini A. Adsorbent materials for low-grade waste heat recovery: application to industrial pasta drying processes. *Energy* 2017;140:729–45.
- [25] Mal R, Prasad R, Vijay VK. Renewable energy from biomass cookstoves for off grid rural areas. *Int Congr Environ Biotechnol Chem Eng* 2014;64:21.
- [26] El Mays A, Ammar R, Hawa M, Abou Akroush M, Hachem F, Khaled M, Ramadan M. Using phase change material in under floor heating. *Energy Proc* 2017;119:806–11.
- [27] Meng F, Chen L, Feng Y, Xiong B. Thermoelectric generator for industrial gas phase waste heat recovery. *Energy* 2017;135:83–90.
- [28] Eller T, Heberle F, Brüggemann D. Second law analysis of novel working fluid pairs for waste heat recovery by the Kalina cycle. *Energy* 2017;119:188–98.
- [29] Ramadan M, Lemenand T, Khaled M. Recovering heat from hot drain water –experimental evaluation, parametric analysis and new calculation procedure. *Energy Build* 2016;128: 575–58.
- [30] R. Carapellucci, L. Giordano. The recovery of exhaust heat from gas turbines, Department of Mechanical, Energy and Management Engineering University of L'Aquila Italy.
- [31] Khaled M, Ramadan M. Study of the thermal behavior of multi concentric tube tank in heat recovery from chimney – analysis and optimization. *Heat Trans Eng J* 2017;8:1–11.
- [32] Zalba B, Marin J, Cabeza LF, Mehling H. Review on thermal energy storage with phase change: materials, heat transfer analysis and applications. *Appl Therm Eng* 2003;23:251–83.
- [33] Khaled M, Ramadan M. Heating fresh air by hot exhaust air of HVAC systems. *Case Stud Therm Eng* 2016;8:398–402.
- [34] Hu T, Xie X, Jiang Y. Simulation research on a variable-lift absorption cycle and its application in waste heat recovery of combined heat and power system. *Energy* 2017;140:912–21.
- [35] Mezquita A, Boix J, Monfort E, Mallol G. Energy saving in ceramic tile kilns: cooling gas heat recover. *Appl Therm Eng* 2014;65:102–10.
- [36] Wei M, Yuan W, Song Z, Fu L, Zhang S. Simulation of a heat pump system for total heat recovery from flue gas. *Appl Therm Eng* 2015;86:326–32.
- [37] Khaled M, Ramadan M, El Hage H. Innovative approach of determining the overall heat transfer coefficient of heat exchangers – application to cross-flow water-air types. *Appl Therm Eng* 2016;99:1086–92.
- [38] Morgan R, Dong G, Panesar A, Heikal M. A comparative study between a Rankine cycle and a novel intra-cycle based waste heat recovery concepts applied to an internal combustion engine. *Appl Energy* 2016;174:108–17.
- [39] Lee D, Park J, Ryu M, Park J. Development of a highly efficient low-emission diesel engine-powered cogeneration system and its optimization using Taguchi method. *Appl Therm Eng* 2013;50:491–5.
- [40] Song Z, Chen J, Yang L. Heat transfer enhancement in tubular heater of Stirling engine for waste heat recovery from flue gas using steel wool. *Appl Therm Eng* 2015;87:499–504.
- [41] Jaber H, Khaled M, Lemenand T, Ramadan M. Short review on heat recovery from exhaust gas. *AIP Conf Proc* 2016;1758(Issue 1). <https://doi.org/10.1063/1.4959441>.
- [42] Khaled M, Ramadan M, El Hage H. Parametric analysis of heat recovery from exhaust gases of generators. *Energy Proc* 2015;75:3295–300.
- [43] Hatami M, Ganji D, Gorji-Bandpy M. A review of different heat exchangers designs for increasing the diesel exhaust waste heat recovery. *Renew Sustain Energy Rev* 2014;37:168–81.
- [44] Zhang P, Ma T, Li W, Ma G, Wang Q. Design and optimization of a novel high temperature heat exchanger for waste heat cascade recovery from exhaust flue gases. *Energy* 2018;160:3–18.
- [45] Khaled M, Ramadan M, Chahine K, Assi A. Prototype implementation and experimental analysis of water heating using recovered waste heat of chimneys. *Case Stud Therm Eng* 2015;5:127–33.
- [46] Elgendy E, Schmidt J. Optimum utilization of recovered heat of a gas engine heat pump used for water heating at low air temperature. *Energy Build* 2014;80:375–83.
- [47] Tanha K, Fung AS, Kumar R. Performance of two domestic solar water heaters with drain water heat recovery units: simulation and experimental investigation. *Appl Therm Eng* 2015;90:444–59.
- [48] Ramadan M, Gad El Rab M, Khaled M. Parametric analysis of air–water heat recovery concept applied to HVAC systems: effect of mass flow rates. *Case Stud Therm Eng* 2015;6:61–8.
- [49] Remeli M, Tan L, Date A, Singh B, Akbarzadeh A. Simultaneous power generation and heat recovery using a heat pipe assisted thermoelectric generator system. *Energy Convers Manag* 2015;91:110–9.
- [50] Huang G, Hsu C, Fang C, Yao D. Optimization of a waste heat recovery system with thermoelectric generators by three-dimensional thermal resistance analysis. *Energy Convers Manag* 2016;126:581–94.
- [51] Demira M, Dincer I. Development and heat transfer analysis of a new heat recovery system with thermoelectric generator. *Int J Heat Mass Tran* 2017;108: 2002–2010.
- [52] Kim T, Negash A, Cho G. Experimental and numerical study of waste heat recovery characteristics of direct contact thermoelectric generator. *Energy Convers Manag* 2017;140:273–80.
- [53] Remeli M, Date A, Orr B, Ding L, Singh B, Affandi N, Akbarzadeh A. Experimental investigation of combined heat recovery and power generation using a heat pipe assisted thermoelectric generator system. *Energy Convers Manag* 2016;111:147–57.
- [54] Madan D, Wang Z, Wright P, Evans J. Printed flexible thermoelectric generators for use on low levels of waste heat. *Appl Energy* 2015;156:587–92.
- [55] Shu G, Ma X, Tian H, Yang H, Chen T, Li X. Configuration optimization of the segmented modules in an exhaust-based thermoelectric generator for engine waste heat recovery. *Energy* 2018;160:612–24.
- [56] Nour Eddine A, Chalet D, Faure X, Aixala L, Chessé P. Effect of engine exhaust gas pulsations on the performance of a thermoelectric generator for wasted heat recovery: an experimental and analytical investigation. *Energy* 2018;162:715–27.
- [57] Tańczuk M, Kostowski W, Karaś M. Applying waste heat recovery system in a sewage sludge dryer – a technical and economic optimization. *Energy Convers Manag* 2016;125:121–32.
- [58] Han X, Yan J, Karellas S, Liu M, Kakaras E, Xiao F. Water extraction from high moisture lignite by means of efficient integration of waste heat and water recovery technologies with flue gas pre-drying system. *Appl Therm Eng* 2017;110:442–56.
- [59] Walmsley T, Walmsley M, Atkins M, Neale J, Tarighaleslami A. Thermo-economic optimisation of industrial milk spray dryer exhaust to inlet air heat recovery. *Energy* 2015;90:95–104.
- [60] Pati J, Hotta S, Mahanta P. Effect of waste heat recovery on drying characteristics of sliced ginger in a natural convection dryer. *Proc Eng* 2015;105: 145–52.
- [61] Golman B, Julklang W. Simulation of exhaust gas heat recovery from a spray dryer. *Appl Therm Eng* 2014;73:899–913.
- [62] Jian Q, Luo L. The improvement on efficiency and drying performance of a domestic venting tumble clothes dryer by using a heat pipe heat recovery heat exchanger. *Appl Therm Eng* 2018;136:560–7.
- [63] Jaber H, Ramadan M, Lemenand T, Khaled M. Domestic thermoelectric cogeneration system optimization analysis, energy consumption and CO2 emissions reduction. *Appl Therm Eng* 2018;130:279–95.
- [64] Najjar YSH, Kseibi MM. Heat transfer and performance analysis of thermoelectric stoves. *Appl Therm Eng* 2016;102:1045–58.
- [65] Incropera FP, DeWitt DP. Fundamentals of heat and mass transfer. sixth ed. John Wiley & Sons; 2007.

Chapitre 5. Utilisation d'un réservoir multitube pour la récupération de chaleur à partir de gaz d'échappement : analyses d'optimisation

L'élément clé de toute application de récupération de chaleur est l'échangeur de chaleur. De nos jours, les scientifiques et les chercheurs étudient de manière approfondie les échangeurs de chaleur et la manière de les optimiser. Les travaux actuels dans ce domaine visent à suggérer de nouveaux échangeurs de chaleur pouvant être utilisés dans la vie réelle. De plus, l'optimisation de ces nouveaux échangeurs de chaleur est un véritable défi. Ce chapitre vise à effectuer une analyse d'optimisation pour un nouvel échangeur de chaleur.

Un nouveau type d'échangeur de chaleur récemment proposé par Khaled et al. [8] appelé « Réservoir Multi-Tubes » (RMT) est étudié dans ce chapitre. Ce type d'échangeur de chaleur est proposé en particulier pour les procédés de récupération de chaleur mettant en jeu deux fluides, un au repos et l'autre en mouvement. Principalement, le fluide chaud sera les gaz d'échappement et le fluide froid sera de l'eau. L'échangeur de chaleur à récupération de chaleur est composé d'un réservoir d'eau traversé par plusieurs tubes. Le flux chaud circule dans les tubes tandis que l'eau se trouve à l'intérieur du réservoir, au niveau de l'anneau. Les gaz d'échappement générés par la combustion du carburant s'écoulent à travers les tubes, libérant une partie de leur énergie thermique vers l'eau à l'intérieur du réservoir. La chaleur est transférée par convection des gaz d'échappement aux surfaces internes des tuyaux. Ensuite, elle est transmise par conduction à travers la paroi du tuyau. L'eau du réservoir absorbe l'énergie thermique aux surfaces extérieures des tuyaux par convection (convection naturelle).

Dans ce chapitre, deux études principales sont réalisées, une simulation numérique et une étude expérimentale afin d'optimiser les performances du réservoir multi-tubes.

➤ **5.1 Une étude numérique** examine la configuration du RMT à l'aide d'un code de calcul. Pour réaliser l'étude, le logiciel de calcul numérique CFD « COMSOL » est utilisé. Le concept du système est présenté dans la **section 2**, tandis que la **section 3** présente la modélisation thermique du système en plus des conditions spatiales et initiales. La **section 4** présente l'analyse d'optimisation et une conclusion récapitulative est présentée à la **section 5**. Cette étude est acceptée dans le journal « *Energy Sources, Part A : Recovery, Utilization, and Environmental Effects* ».

Afin d'identifier la configuration optimale de l'échangeur de chaleur RMT, l'investigation numérique met en évidence **l'effet de la modification du nombre de tubes sur le comportement thermique** du système. Trois cas font l'objet d'une analyse à partir d'un système comportant soit un seul tube, soit trois tubes, soit six tubes. Modifier le nombre de tubes affecte la température de l'eau, l'énergie thermique absorbée et le temps nécessaire pour atteindre une température ou un état d'équilibre spécifique. De plus, une étude paramétrique est réalisée pour étudier les performances de chaque configuration pour une période de temps déterminée.

➤ Les résultats montrent que la température de l'eau augmente plus vite avec l'augmentation du nombre de tubes constituant chaque cas. Cela dit, l'analyse a été élargie pour couvrir davantage de critères pouvant être imposés par certains aspects matériels, économiques ou environnementaux. Les critères pris en compte sont : la température maximale de l'eau, la récupération maximale d'énergie et le seuil de température minimale de gaz. En outre, il a été

constaté qu'aucune configuration optimale ne vérifie tous les critères. À titre d'illustration, si le critère d'optimisation est le seuil minimal de température du gaz, la solution optimale est le RMT avec un tube, tandis que le RMT avec 6 tubes doit être adopté lorsqu'on considère la température maximale de l'eau.

➤ **5.2 Une étude expérimentale** porte sur l'optimisation du réservoir multi-tubes en fonction des résultats expérimentaux. Le réservoir multi-tubes est couplé à une cheminée diesel résidentielle. Les gaz d'échappement sont dirigés vers des tuyaux insérés dans un réservoir d'eau froide.

➤ L'idée principale de cette étude est d'étudier de manière expérimentale **l'effet de la modification de la forme de la tête du système de récupération sur la température de l'eau**. La description du système de récupération est effectuée à la **section 2**. La **section 3** résume les paramètres et les dimensions du système. La **section 4** récapitule les résultats expérimentaux et la discussion associée. La **section 5** concerne l'étude économique et environnementale et le document se termine par une conclusion à la **section 6**. Cette étude est soumise en version révisée au journal « *Heat Transfer Engineering* ».

Les cheminées sont conçues pour permettre le transfert de l'énergie thermique en partie vers le chauffage de locaux. La partie restante de l'énergie thermique est rejetée dans l'environnement par les gaz d'échappement. Les gaz d'échappement générés par la combustion du diesel traversent un tuyau pour pénétrer dans le système de récupération de chaleur. Lorsque les gaz d'échappement quittent le réservoir multitube (sortie des tubes), ils sont collectés par la tête du système.

Dans cette étude, deux têtes sont conçues et testées : cylindrique et conique. La géométrie de la tête influence l'écoulement du gaz d'échappement, ce qui affecte le processus de récupération. La température de l'eau à un intervalle de temps spécifié est enregistrée dans les deux cas. Les résultats sont comparés, analysés et discutés. De plus, l'effet de modification de tête est étudié du point de vue économique et environnemental.

Les résultats montrent que pour une tête cylindrique, la température de l'eau augmente jusqu'à 59°C, et jusqu'à 68°C pour une tête conique, en 275 minutes. La tête conique a la forme d'une buse, ce qui améliore le débit des gaz d'échappement et augmente le flux de chaleur. En outre, le système à tête cylindrique peut récupérer jusqu'à 9,18 MJ en 275 min, tandis que le système conique peut récupérer jusqu'à 11,68 MJ, ce qui correspond respectivement à 3,5 kWh et à 4,3 kWh d'énergie électrique. Le système en forme de tête conique offre davantage de réduction de la consommation d'énergie par rapport au système cylindrique d'environ 129 kWh/mois lorsque le système est utilisé 140 fois/mois, ce qui se traduit par des économies réalisées qui augmentent de 16 \$/mois. D'un point de vue économique, le système à tête conique a une période de retour sur investissement de six mois, soit la moitié moins que le système à tête cylindrique. Finalement, le système à tête cylindrique peut réduire chaque année environ 1,7 tonne d'émissions de CO₂, tandis que la tête conique peut en réduire environ 3,7 tonnes.

5.1 Simulation numérique d'échangeur de chaleur à plusieurs tubes : analyse d'optimisation

Mohamad Ramadan, Mahmoud Khaled, Hassan Jaber, Jalal Faraj, Hassan Bazzi et Thierry Lemenand

Cette étude est publiée dans « *Energy Sources, Part A : Recovery, Utilization, and Environmental Effects* »

Résumé - L'élément clé de toute application de récupération de chaleur est l'échangeur de chaleur. De nombreux échangeurs de chaleur ont été suggérés pour des applications de récupération de chaleur, parmi lesquels Multi Tube Tank (MTT). Le MTT est un échangeur de chaleur récemment proposé, en particulier pour les procédés de récupération de chaleur impliquant deux fluides, l'un au repos et l'autre en mouvement. Cela dit, le MTT peut être adopté pour un large éventail d'applications de récupération de chaleur et peut être appliqué dans un large panel de configurations géométriques. Néanmoins, les conditions de fonctionnement peuvent imposer des contraintes thermiques aux fluides de sortie. Tout bien considéré, pour utiliser efficacement les échangeurs de chaleur MTT, il est inévitable de comprendre son comportement thermique. Dans le cadre de cette vue, le présent article examine le fonctionnement du MTT à l'aide d'un code de calcul. Un processus de récupération de chaleur est envisagé lorsque les gaz d'échappement sont utilisés pour chauffer de l'eau. Le modèle thermique est basé sur l'équation de la chaleur ainsi que sur différentes conditions aux limites. De plus, une procédure d'optimisation est développée afin de trouver le meilleur scénario parmi trois configurations différentes incorporant respectivement un tube, trois tubes et six tubes. Trois critères d'optimisation sont pris en compte : la température maximale de l'eau, l'énergie maximale récupérée et le seuil de température minimale du gaz. Les résultats reflètent la flexibilité de l'évaluation d'optimisation. Pour donner une illustration, pour un intervalle de temps fixe, si le critère de sélection est l'énergie récupérée maximale, la configuration de six tubes est la solution optimale, tandis que si le critère est un seuil de température de gaz minimum, le MTT avec un tube est la meilleure configuration.



Numerical simulation of Multi-Tube Tank heat exchanger: optimization analysis

Mohamad Ramadan^{a,b,c}, Mahmoud Khaled^{a,b,d}, Hassan Jaber^{a,b}, Jalal Faraj^{a,b}, Hasan Bazzi^{a,b}, and Thierry Lemenand^{d,e}

^aSchool of Engineering, International University of Beirut, BIU, Beirut, Lebanon; ^bSchool of Engineering, International University of Beirut, BIU, Beirut, Lebanon; ^cAssociate Member at FCLAB, CNRS, Univ. Bourgogne Franche-Comte, Belfort cedex, France; ^dUniv Paris Diderot, Sorbonne Paris Cité, Interdisciplinary Energy Research Institute (PIERI), Paris, France; ^eLARIS EA 7315, University of Angers – ISTIA, Angers, France

ABSTRACT

The key-element in any heat recovery application is the heat exchanger. Many heat exchangers have been suggested for heat recovery applications among them Multi-Tube Tank (MTT). MTT is a heat exchanger that has been recently proposed especially for heat recovery processes that involve two fluids one at rest and the other one in motion. That said, MTT can be adopted for a broad spectrum of heat recovery applications and can be applied within a wide panel of geometrical configurations. Notwithstanding, operational conditions may impose thermal constraints on the outlet fluids. All things considered, to efficiently utilize MTT heat exchangers it is unavoidable to understand its thermal behavior. In the frame of this view, the present paper, examines the anatomy of MTT using a computational code. A heat recovery process is considered where exhaust gas is used to heat water. The thermal model is based on the heat equation along with different boundary conditions. Furthermore, an optimization procedure is developed in order to find the best scenario among three different configurations incorporating, respectively, one tube, three tubes, and six tubes. Three optimization criteria are considered, maximum water temperature, maximum recovered energy, and minimum gas temperature threshold. Results reflect the flexibility of the optimization assessment. To give an illustration, for a fixed interval of time, if the selection criterion is the maximum-recovered energy the configuration of six tubes is the optimal solution whereas if the criterion is a minimum gas temperature threshold then MTT with one tube is the best configuration.

ARTICLE HISTORY

Received 14 June 2018
Revised 11 April 2019
Accepted 28 April 2019

KEYWORDS

Heat recovery; Multi Tube Tank; water heating; energy management; simulation

Introduction

In the last decades, industrial and engineering communities started to seek for new sources of energy to reduce fossil fuels consumption, cost of energy and pollution. Alternative energy and energy management are selected to be the most effective solutions to overcome those problems (Lesel et al. 2017; Steiner et al. 2010; Tina, Arcidiacono, and Gagliano 2013; Yang et al. 2011). Alternative energy or renewable energy is the energy captured from a natural renewable source such as solar, wind, biomass, hydropower energy, and others (Al-Falahi, Jayasinghe, and Enshaei 2017; Hachem et al. 2017; Herez et al. 2016; Mussard 2017; Ramadan, Khaled, and Hage 2015; Ramadan et al. 2016; Zhou and Deng 2017). Whereas energy management deals with the enhancement of energy usage by reducing energy consumption or by reducing energy lost (Babayo, Anisi, and Ali 2017; Jaber et al. 2016; Khaled, Ramadan, and El Hage 2016).

CONTACT Mohamad Ramadan  mohamad.ramadan@liu.edu.lb  School of Engineering, International University of Beirut, BIU, PO Box 146404 Beirut, Lebanon

Color versions of one or more of the figures in the article can be found online at www.tandfonline.com/ueso.

© 2019 Taylor & Francis Group, LLC

High amount of energy produced by any industrial or residential system is being lost to the environment without benefiting of this lost energy. Mainly it is loss as thermal energy. Internal combustion engines, boilers, furnaces, generators, heat pumps, shower waters and chimneys are the main applications that losses high amount of thermal energy (Huang et al. 2017; Khaled and Ramadan 2016; Khaled et al. 2015; Khaled, Ramadan, and Hage 2015; Ramadan, El Rab, and Khaled 2015; Ramadan, Lemenand, and Khaled 2016; Wei et al. 2017). Heat recovery is an effective solution to get benefit of this lost energy by reusing this energy directly or indirectly (by converting it to another type of energy).

In order to reuse this lost energy, heat recovery heat exchangers are required (Aldyarov, Zhabbasbayev, and Ramazanova 2004; Bogaerts, Castillo, and Hanus 1997; Carling 1968; Steinboeck et al. 2011). They play a crucial role in the recovering process, which led to many studies in the field of optimization of heat exchangers (Huang et al. 2016; Najjar and Abubaker 2017; Yin, Du, and Cheng 2017).

This work is aimed to study a new type of heat exchangers named as MTT. This heat exchangers utilize exhaust gases of a residential chimney to heat water for residential usage (shower, laundry, washing, and others). An optimization analysis of the suggested heat exchanger is done numerically.

This paper is prepared as follows, a general introduction of the paper on section 1. Then the concept of operation of the suggested heat recovery heat exchanger is illustrated in section 2. Section 3 shows the optimization analysis, and section 4 presents a summarizing conclusion with future works.

System concept

The suggested heat recovery heat exchanger is composed of a water tank with concentric tubes passes through it. The hot stream flows through the tubes while the water is located inside the tank at the annulus. Exhaust gases generated from the combustion of fuel flow through the tubes releasing part of their thermal energy to water inside the tank. The heat is transferred by convection from the exhaust gases to the inner pipe's surfaces. Then it is transmitted through the pipe wall from the inner to the outer layer by conduction. The tank water absorbs the thermal energy at the outer pipe's surfaces by convection (natural convection). **Figure 1** shows a schematic of the suggested MTT heat exchanger.

The present work is aimed to numerically study the effect of changing the number of tubes on the thermal behavior of the system. Three cases are taken under investigation starting from a system with only one tube, then three tubes and six tubes. Changing the number of tubes affects the water temperature, the absorbed thermal energy and the time needed to achieve a specific water temperature or steady state. This effect is computed, studied, and analyzed below.

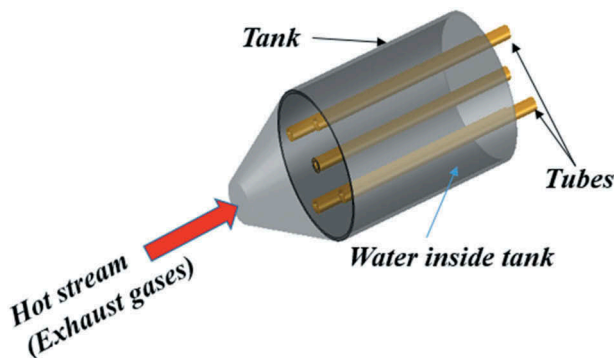

Figure 1. Multi-Tube Tank heat exchanger.

Thermal modeling

In order to perform the numerical study, a computational fluid dynamics (CFD) “Comsol” software is utilized. The equation of heat transfer in fluids is utilized in order to perform the simulation which is as follows:

$$\rho \cdot C_p \cdot u \cdot \nabla T = \nabla \cdot (k \nabla T) + Q \quad (1)$$

where ρ , C_p , u are the fluid’s density, specific heat at constant pressure and fluid velocity, respectively. ∇T is the temperature gradient. k is the thermal conductivity and Q is the heat source.

Also, boundary conditions should be applied in order to be able to run the solution of the thermal modeling. These conditions are arranged into two categories: spatial and initial conditions.

Spatial conditions

Spatial conditions are the conditions that are not related to time and do not change when the experiment is running.

Figure 2 shows the regions distribution on the system, where every region has its spatial conditions.

Region 1, which is the outer tank’s wall, is totally insulated from the surrounding (adiabatic).

$$\Omega 1 : -k \cdot \nabla T = 0 \quad (2)$$

Region 2 represents the upper and lower parts of the tank’s wall that are totally insulated from the surrounding (adiabatic region).

$$\Omega 2 : -k \cdot \nabla T = 0 \quad (3)$$

Region 3 which represents the exhaust gases inlet is conditioned by its velocity. However, this region is variable over the three studied systems.

$$\text{For one tube, } \Omega 3 : V(0) = 24 \text{ m/s} \quad (4)$$

$$\text{For three tubes, } \Omega 3 : V(0) = 7 \text{ m/s} \quad (5)$$

$$\text{For six tubes, } \Omega 3 : V(0) = 3.5 \text{ m/s} \quad (6)$$

where V is the velocity of exhaust gases at the inlet of each tube.

The temperature of exhaust gases at the inlet of the tube which is constant over the three systems is taken as follows:

$$\Omega 3 : T(0) = 163 \text{ }^\circ\text{C} \quad (7)$$

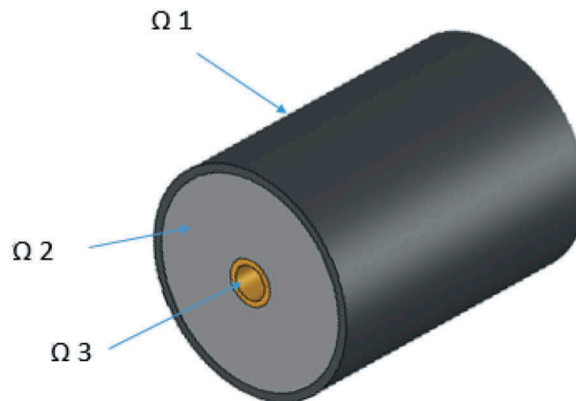

Figure 2. Regions distribution.

Initial condition

Initial conditions are conditions that are related to time and change with time. In this study, the main initial condition is the water temperature at the start of the experiment $T_w(t = 0)$ which is

$$T_w(t = 0) = 20^{\circ}\text{C} \tag{8}$$

In order to minimize errors, the mesh is refined until the temperature variation is not affected by the number of nodes. The refined mesh provides higher accuracy in temperature estimation. The stationary problem is solved several times (1) with the basic mesh and finally with the final-refined mesh to reduce the errors of the numerical results. Consequently, the relative error of temperature is estimated at +/-1% to 3% depending on the local geometry.

Optimization analysis

Figure 3 shows the optimization analysis flow chart. It shows that after introducing the geometry of the tank and tubes, and their materials, boundary conditions are to be applied. Then by establishing the thermal modeling calculation, the results are considered by three different criterions. If the results are satisfying, the system is to be taken and if not, the program enters a loop of number of tubes that changes the number of tubes and initial conditions. In the present work, just three systems are presented: one, three and six tubes heat tank.

By applying the thermal modeling and boundary conditions on the system which are summarized in section 3, the simulation is run and the following results are obtained (Figures 4–9).

Figure 4 shows the variation of water temperature on tank over time. The results shown are limited to achieve 70 degree of water temperature.

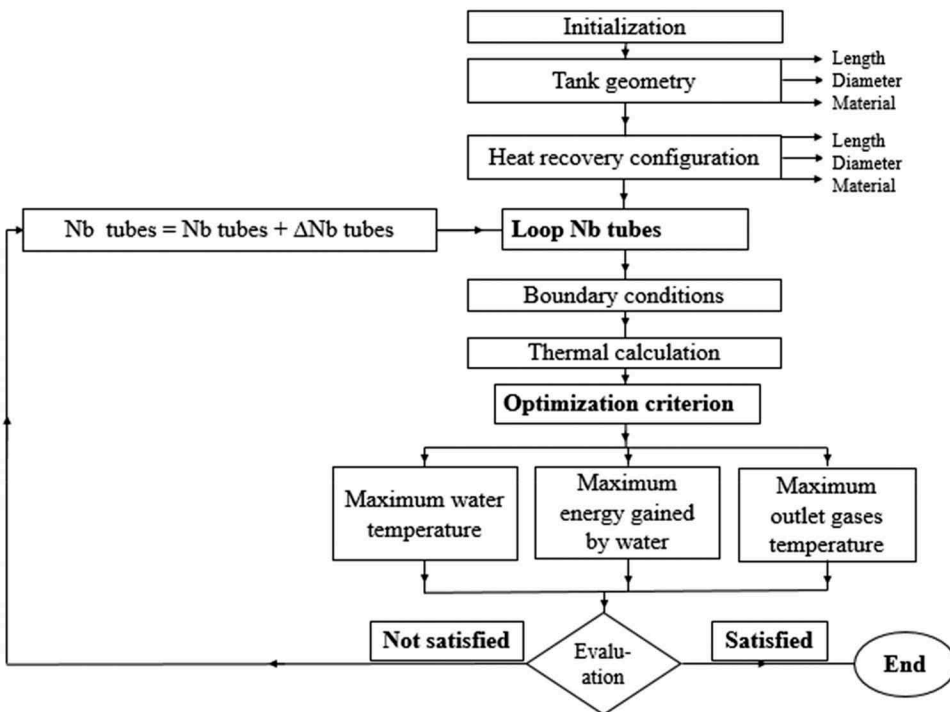

Figure 3. Optimization analysis flow chart.

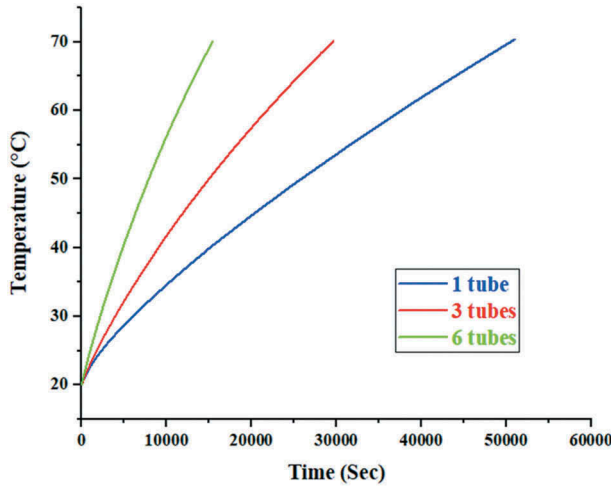

Figure 4. Water temperature variation with time.

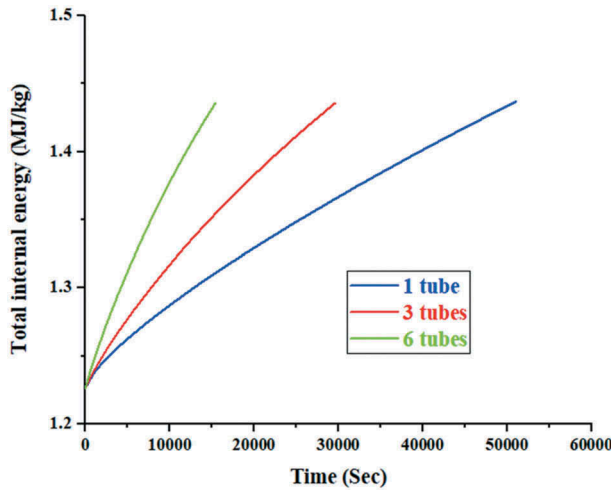

Figure 5. Total internal energy gained per unit mass of water (MJ/kg) in function of time.

It shows that it took about 14 h, 8 h and 4 h to achieve 70°C for a one tube, three tubes, and six tubes systems, respectively. In another words water requires 10-h more to reach 70°C for a system of one tube compared to a six-tubed system. By comparing systems with three and six tubes (doubling the number of tubes), the time required decreased approximately the half to reach the aimed temperature (70°C).

Figure 5 shows the total thermal energy gained per kg of water as function of time. The total thermal energy gained per kg of water E_w can be expressed by the following equation:

$$E_w = C_p \cdot (T_w(t + \Delta t) - T_w(t)) \quad (9)$$

where $T_w(t)$ is the water temperature at specific instant and Δt is the time interval.

From Equation (9), it is shown that the total internal energy gained per unit mass of water is directly proportional to the water temperature: Figure 5 clearly shows similar behavior of total internal energy compared to water temperature plots in Figure 4. The results show an increase in the

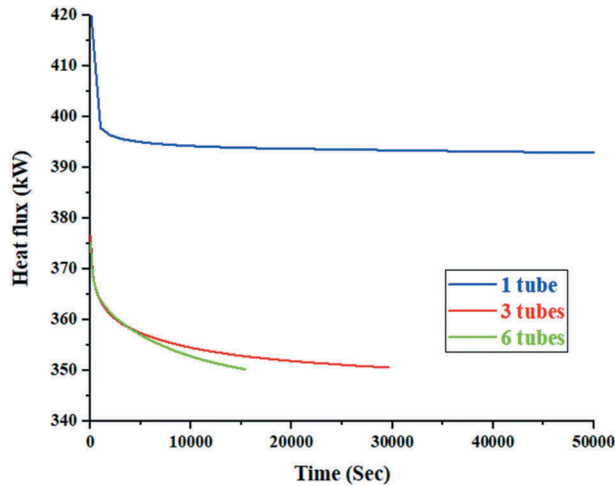

Figure 6. Variation of heat rate from exhaust gases to water with time.

internal energy of water from 1.23 MJ/kg to 1.43 MJ/kg when water temperature achieved 70°C. The main difference between the three systems is that six-tubed system requires less time (4 h) compared to others. These results are totally compatible with Figure 4 (water temperature).

Figure 6 shows the heat transfer rate from exhaust gases to water.

Figure 6 shows that the heat rate decreases with the increase of the time. This is due to the increase in water temperature over time. This heat rate is estimated for one tube of the tubes available. It shows a maximum heat transfer rate for one tube system, since all the exhaust gases just pass through this tube, while for the three and six tubes system the heat is distributed over the tubes. Heat rate in one tube heat exchanger decreased from 422 kW to 393 kW (decrease of about 7%). For three tubes heat exchanger heat rate decreases from 377 kW to 351 kW and for six tubes heat rate decreases from 376 kW to 350 kW which is also about 7% decrease in heat rate when water temperature reached 70°C.

Figure 7 shows the isotherms of the three configurations. It shows the heat diffusion over the longitudinal length of the tank. At the inlet water temperature increases rapidly over the radial cross-section of the tank. Figure 7 shows that as exhaust gases move inside the tank their thermal diffusion decreases on the radial cross-section. This is mainly resulted from the decrease in exhaust gases temperature as it moves inside the tank.

Figure 8 shows the variation of exhaust gases temperature over time at the tube exit. It should be noted that Figure 8 presents the average exhaust gases temperature for all tubes in each configuration.

At the beginning, exhaust gases release high amount of thermal energy to the water surrounding it: as the water temperature starts to increase, outlet exhaust gases temperature starts to increase. For one tube configuration, exhaust gases temperature increases from 65°C to 142°C after 20,000 s (5.5 h), the temperature increase is from 83°C to 123°C for a three-tube system, while it increases from 40°C to 117°C for a six-tubes system. It should be noted that low temperature of the exhaust gases at the start may lead to corrosion of tubes and increases the environmental damage. The corrosion is generated by the decrease of the exhaust gases temperature below the dew point leading to the condensation of some acids carried by exhaust gases generated from the combustion of fuel. This means that at the beginning, system with three-tubes is better than other systems on this criterion of corrosion since it provides the highest outlet temperature and then experiences lowest corrosion. However, for long-term usage, system with one tube seems the best choice on this criterion of corrosion, due to its high exhaust outlet temperature compared to other systems along the experiment.

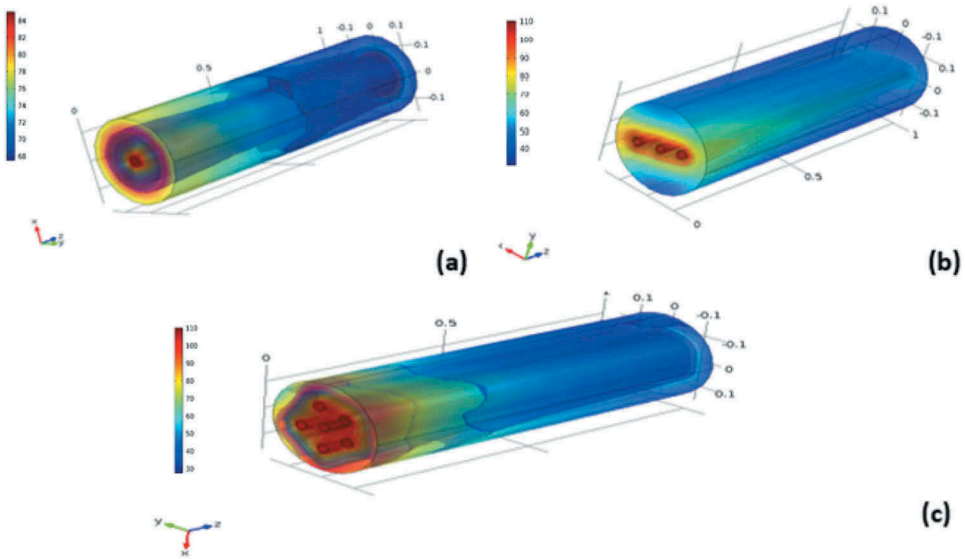

Figure 7. Isotherms of tanks: (a) one tube; (b) three tubes; (c) six tubes.

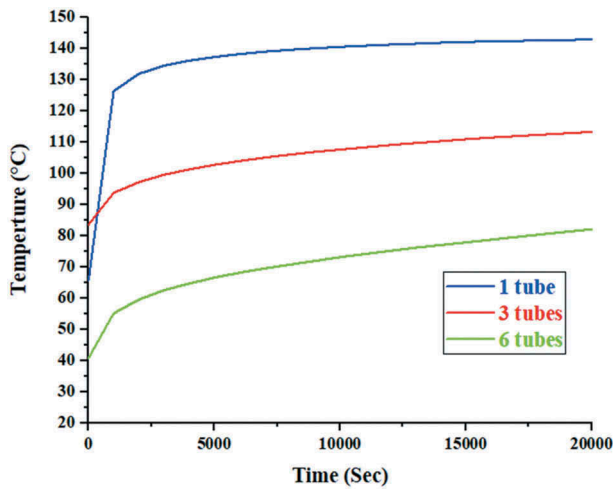

Figure 8. Exhaust gases outlet temperature.

Figure 9 presents the isotherms of the radial cross-section at the inlet and exit of the tube. It shows that at the inlet the diffusion of the thermal energy to the water is high and the water beside the tank wall has achieved relatively high temperature (red circle is dominating in the cross-section). Whereas at the exit, and due to the decrease of exhaust gases temperature, heat diffusion is lower and shown as smaller red circles around the tubes.

Based on the previous findings, results show that to increase the water temperature quickly, system with six-tubes is the best choice compared to a one or three tubes MTT heat exchanger. It is shown that for a six-tubed MTT, 4 h are required to increase water temperature from 20°C to 70°C. However, it presents the lowest lifetime since it experiences the highest corrosion phenomenon compared to other configurations. Then if the lifetime of the system is the main concern, system with one tube is the best choice since its exhaust gases temperature remains high along with the experiment compared to the other systems.

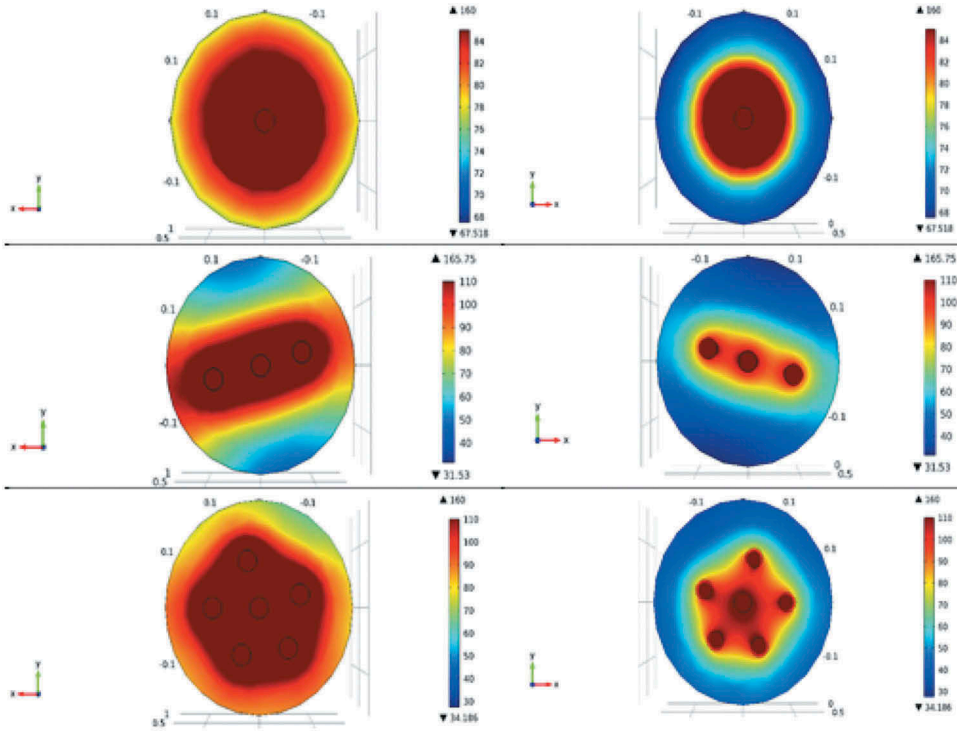

Figure 9. Cross-sectional isotherms for three configurations at the inlet (left side) and outlet (right side).

In order to verify the results conducted, this study is compared to an experimental study performed by Khaled and Ramadan (2017). The experimental Multi-Tube tank has six tubes which will be compared by results of case 3. The experimental conditions differ from the initial and boundary conditions of this study (temperature and velocity of exhaust gases, initial water temperature, and ambient air temperature). To proceed and in order to make the comparison applicable, a dimensionless number is suggested to be calculated. It is defined by the average water energy over the average exhaust gases energy ($\frac{E_w}{E_g}$). This number is estimated at different intervals and compared between the two studies.

The average energy of water in the Multi-Tube tank at a specific instant ($E_{w,in}$) is calculated by the following equation

$$E_{w,in} = m_w \cdot C_{p_w} (T_{w,in} - T_{w,i}) \quad (10)$$

where m_w , C_{p_w} , $T_{w,i}$ and $T_{w,in}$ are the mass, specific heat, initial and instantaneous temperature of water.

In order to estimate the mass of water the volume of water (V_w) is calculated

$$V_w = \frac{\pi}{4} (d_{ta}^2 - n_t \cdot d_t^2) L \quad (11)$$

where d_{ta} and d_t are the diameters of the tank and tubes, respectively. n_t is the number of tubes and L is the length of the tank.

Then the total mass is the factor of density and volume of water.

$$m_w = \rho_w \cdot V_w \quad (12)$$

where ρ_w is the density of water.

While the average exhaust gases energy is estimated by the following equation.

$$E_g = \dot{m}_g \cdot C p_g (T_{g,i} - T_a) \cdot t \quad (13)$$

where \dot{m}_g , $C p_g$ and $T_{g,i}$ are the mass flow rate, specific heat and inlet temperature of exhaust gases, respectively. t is the time and T_a is the ambient air temperature. The mass flow rate of gases is measured experimentally in (Khaled and Ramadan 2017) study and estimated from the velocity in the numerical study.

$$\dot{m}_g = \left(\rho_g \cdot V_g \cdot A_{t,i} \right) n_t \quad (14)$$

where ρ_g and V_g are the density and velocity of exhaust gases. $A_{t,i}$ is the inner area of the tube which is estimated in Equation (15) with $d_{t,i}$ is the inner diameter of the tube.

$$A_{t,i} = \frac{\pi}{4} d_{t,i}^2 \quad (15)$$

Figure 10 below shows the energy fraction (dimensionless number) of both studies as function of time. By comparing the results, it is obvious that the results are qualitatively comparable and matching. $\frac{E_w}{E_g}$ ranged between 0.5 and 0.6 for this study and between 0.2 and 0.6. The main reason of this difference is that the numerical study assumes that the system is adiabatic (totally insulated - Equation (2)) while, in the experimental study the system is experiencing heat dissipation from the system to the ambient air.

Conclusions

From a heat transfer standpoint, MTT heat exchanger is one of the most efficient heat exchangers for applications involving a fluid at rest and a moving fluid. In this work, MTT is suggested to recover waste heat of exhaust gas to heat water for residential applications. In order to identify the optimal configuration of MTT heat exchanger, a numerical investigation is carried out. The modeling is based on heat equation. The analysis is performed for three different configurations of MTT containing, respectively, one tube, three tubes, and six tubes. Moreover, a parametric study is carried out to study the performance of each configuration for a fixed period of time. As expected, the temperature of water increases with time in different amplitude depending on the configuration. For instance, to increase water temperature from 20°C to 70°C

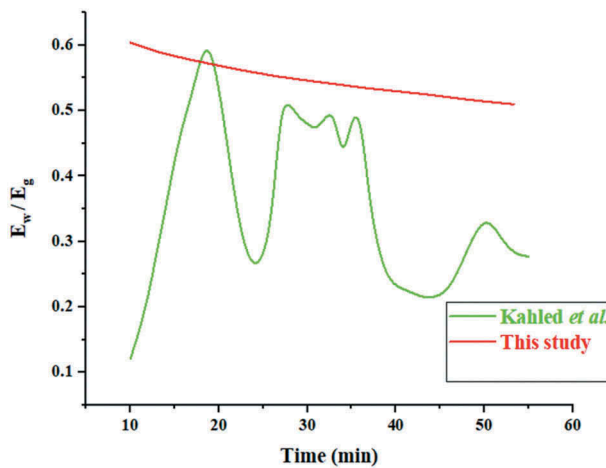

Figure 10. Energy fraction for both studies over time.



it requires 14 h in the case of one tube whereas 8 h are needed in the configuration of three tubes and only 4 h are needed in the case of six tubes. Having said that, the analysis has been broadened to cover more criteria that may be imposed by some material, economic or environmental aspects. The considered criteria are, *maximum water temperature*, *maximum recovered energy*, and *minimum gas temperature threshold*. An optimization procedure is suggested to find the optimal configuration for each imposed criterion. Interestingly, it was found that there is no optimal configuration that verifies all criteria. To give an illustration if the optimization criterion is *minimum gas temperature threshold* then the optimal solution is MTT with one tube whereas MTT with six tubes should be adopted when the criterion *maximum water temperature* is considered.

References

- Aldyarov, T. K., U. K. Zhapbasbayev, and G. I. Ramazanova. 2004. Investigation of effect of depressant additives on hydraulic resistance and heat exchange in oil mixture flow. *Mathematics and Computers in Simulation* 67 (4–5):485–92. doi:10.1016/J.MATCOM.2004.06.013.
- Al-Falahi, M. D. A., S. D. G. Jayasinghe, and H. Enshaei. 2017. A review on recent size optimization methodologies for standalone solar and wind hybrid renewable energy system. *Energy Conversion and Management* 143:252–74. doi:10.1016/J.ENCONMAN.2017.04.019.
- Babayo, A. A., M. H. Anisi, and I. Ali. 2017. A review on energy management schemes in energy harvesting wireless sensor networks. *Renewable and Sustainable Energy Reviews* 76:1176–84. doi:10.1016/J.RSER.2017.03.124.
- Bogaerts, P., J. Castillo, and R. Hanus. 1997. Analytical solution of the non-uniform heat exchange in a reactor cooling coil with constant fluid flow. *Mathematics and Computers in Simulation* 43 (2):101–13. doi:10.1016/S0378-4754(96)00059-6.
- Carling, L. N. 1968. Hybrid computer solution of heat exchanger partial differential equations. *Mathematics and Computers in Simulation* 10 (1):6–18. doi:10.1016/S0378-4754(68)80026-6.
- Hachem, F., B. Abdulhay, M. Ramadan, H. El Hage, M. G. El Rab, and M. Khaled. 2017. Improving the performance of photovoltaic cells using pure and combined phase change materials – experiments and transient energy balance. *Renewable Energy* 107:567–75. doi:10.1016/J.RENENE.2017.02.032.
- Herez, A., M. Ramadan, B. Abdulhay, and M. Khaled. 2016. Short review on solar energy systems. Presneted at the AIP Conference Proceedings, Beirut, April 15–18.
- Huang, B., Q. Jian, L. Luo, and J. Zhao. 2017. Experimental study of enhancing heating performance of the air-source heat pump by using a novel heat recovery device designed for reusing the energy of the compressor shell. *Energy Conversion and Management* 138:38–44. doi:10.1016/J.ENCONMAN.2017.01.061.
- Huang, G.-Y., C.-T. Hsu, C.-J. Fang, and D.-J. Yao. 2016. Optimization of a waste heat recovery system with thermoelectric generators by three-dimensional thermal resistance analysis. *Energy Conversion and Management* 126:581–94. doi:10.1016/J.ENCONMAN.2016.08.038.
- Jaber, H., M. Khaled, T. Lemenand, and M. Ramadan. 2016. Short review on heat recovery from exhaust gas. Presneted at the AIP Conference Proceedings, Beirut, April 15–18.
- Khaled, M., and M. Ramadan. 2016. Heating fresh air by hot exhaust air of HVAC systems. *Case Studies in Thermal Engineering* 8:398–402. doi:10.1016/J.CSITE.2016.10.004.
- Khaled, M., and M. Ramadan. 2017. Study of the thermal behavior of Multi Tube Tank in Heat Recovery from Chimney - analysis and optimization. *Heat Transfer Engineering* 39:399–409. doi:10.1080/01457632.2017.1312864.
- Khaled, M., M. Ramadan, K. Chahine, and A. Assi. 2015. Prototype implementation and experimental analysis of water heating using recovered waste heat of chimneys. *Case Studies in Thermal Engineering* 5:127–33. doi:10.1016/J.CSITE.2015.03.004.
- Khaled, M., M. Ramadan, and H. El Hage. 2016. Innovative approach of determining the overall heat transfer coefficient of heat exchangers – application to cross-flow water-air types. *Applied Thermal Engineering* 99:1086–92. doi:10.1016/J.APPLTHERMALENG.2016.01.145.
- Khaled, M., M. Ramadan, and H. E. Hage. 2015. Parametric analysis of heat recovery from exhaust gases of generators. *Energy Procedia* 75:3295–300. doi:10.1016/J.EGYPRO.2015.07.710.
- Lesel, J., D. Bourdon, G. Claisse, P. Debay, and B. Robyns. 2017. Real time electrical power estimation for the energy management of automatic metro lines. *Mathematics and Computers in Simulation* 131:3–20. doi:10.1016/J.MATCOM.2016.06.003.
- Mussard, M. 2017. Solar energy under cold climatic conditions: A review. *Renewable and Sustainable Energy Reviews* 74:733–45. doi:10.1016/J.RSER.2017.03.009.
- Najjar, Y. S. H., and A. M. Abubaker. 2017. Thermoeconomic analysis and optimization of a novel inlet air cooling system with gas turbine engines using cascaded waste-heat recovery. *Energy* 128:421–34. doi:10.1016/J.ENERGY.2017.04.029.

- Ramadan, M., M. G. El Rab, and M. Khaled. 2015. Parametric analysis of air–Water heat recovery concept applied to HVAC systems: Effect of mass flow rates. *Case Studies in Thermal Engineering* 6:61–68. doi:10.1016/J.CSITE.2015.06.001.
- Ramadan, M., M. Khaled, and H. E. Hage. 2015. Using Speed Bump for Power Generation –Experimental Study. *Energy Procedia* 75:867–72. doi:10.1016/j.egypro.2015.07.192.
- Ramadan, M., M. Khaled, H. S. Ramadan, and M. Becherif. 2016. Modeling and sizing of combined fuel cell-thermal solar system for energy generation. *International Journal of Hydrogen Energy* 41 (44):19929–35. doi:10.1016/J.IJHYDENE.2016.08.222.
- Ramadan, M., T. Lemenand, and M. Khaled. 2016. Recovering heat from hot drain water—Experimental evaluation, parametric analysis and new calculation procedure. *Energy and Buildings* 128:575–82. doi:10.1016/J.ENBUILD.2016.07.017.
- Steinboeck, A., D. Wild, T. Kiefer, and A. Kugi. 2011. A fast simulation method for 1D heat conduction. *Mathematics and Computers in Simulation* 82 (3):392–403. doi:10.1016/J.MATCOM.2010.10.016.
- Steiner, N. Y., D. Candusso, D. Hissel, and P. Moçoteguy. 2010. Model-based diagnosis for proton exchange membrane fuel cells. *Mathematics and Computers in Simulation* 81 (2):158–70. doi:10.1016/J.MATCOM.2010.02.006.
- Tina, G. M., F. Arcidiacono, and A. Gagliano. 2013. Intelligent sun-tracking system based on multiple photodiode sensors for maximisation of photovoltaic energy production. *Mathematics and Computers in Simulation* 91:16–28. doi:10.1016/J.MATCOM.2012.07.020.
- Wei, M., X. Zhao, L. Fu, and S. Zhang. 2017. Performance study and application of new coal-fired boiler flue gas heat recovery system. *Applied Energy* 188:121–29. doi:10.1016/J.APENERGY.2016.11.132.
- Yang, L., M. Dehghan, J.-N. Yu, and G.-W. Luo. 2011. Inverse problem of time-dependent heat sources numerical reconstruction. *Mathematics and Computers in Simulation* 81 (8):1656–72. doi:10.1016/J.MATCOM.2011.01.001.
- Yin, Q., W.-J. Du, and L. Cheng. 2017. Optimization design of heat recovery systems on rotary kilns using genetic algorithms. *Applied Energy* 202:153–68. doi:10.1016/J.APENERGY.2017.05.072.
- Zhou, D., and Z. Deng (Daniel). 2017. Ultra-low-head hydroelectric technology: A review. *Renewable and Sustainable Energy Reviews* 78:23–30. doi:10.1016/J.RSER.2017.04.086.

5.2 Étude expérimentale sur la récupération de chaleur à l'aide d'un réservoir multi-tubes: effet de la modification de la forme de la tête

Hassan Jaber, Mahmoud Khaled, Thierry Lemenand, Jalal Faraj, Ahmad Haddad et Mohamad Ramadan

Cette étude est soumise en version révisée au journal « **Heat Transfer Engineering** »

Résumé - Ce travail présente un système de récupération de chaleur utilisé pour chauffer l'eau des gaz d'échappement d'une cheminée. Un système de récupération de chaleur perdue suggéré par Khaled et al. [8] nommé « réservoir multi-tubes » est optimisé expérimentalement. La conception est illustrée et décrite. Le système est construit et testé. Une étude de l'effet du changement de la forme de la tête est effectuée. Deux têtes ont été construites : cylindrique et conique. Les résultats montrent que la tête conique reflète de meilleures performances que la tête cylindrique. Pour une tête cylindrique, la température de l'eau augmente au maximum à 59 °C en 275 min. tandis que pour les têtes coniques, la température de l'eau atteignait 68 °C en 275 minutes et le système était capable d'augmenter davantage la température de l'eau jusqu'à 80 °C en 400 minutes. De plus une étude économique et environnementale est réalisée. Les résultats montrent que le système à tête conique peut économiser environ 16 \$ / mois de plus que le système cylindrique lorsque le système est utilisé 140 fois / mois pendant 275 min. De plus, pour le même nombre d'utilisations, la période de récupération de la tête conique est d'environ la moitié de la tête cylindrique (6 mois). Enfin, le système à tête conique est capable de réduire les émissions de CO₂ de 2 tonnes / an de plus que la tête cylindrique lorsque le système est utilisé 140 fois / mois.

Experimental Study on Heat Recovery Using Multi-Tube Tank: Effect of Changing the Head Shape

Hassan Jaber^{a,b}, Mahmoud Khaled^{a,c,*}, Thierry Lemenand^b, Jalal Faraj^a, Ahmad Haddad^a and Mohamad Ramadan^{a,d}

^a School of Engineering, Lebanese International University LIU, PO Box 146404 Beirut, Lebanon

^b LARIS EA 7315, University of Angers – ISTIA, Angers, France

^c Univ Paris Diderot, Sorbonne Paris Cité, Interdisciplinary Energy Research Institute (PIERI), Paris, France

^d Associate member at FCLAB, CNRS, Univ. Bourgogne Franche-Comte, Belfort cedex, France

*Mahmoud.khaled@liu.edu.lb

Abstract. This work presents a heat recovery system utilized to heat water from exhaust gases of a chimney. A waste heat recovery system which is suggested by Khaled et al. named as “multi tube tank” is optimized experimentally. The design is illustrated and described. The system is constructed and tested. In order to enhance the system effect of changing the head shape is studied. Two head were constructed: cylindrical and conical. Results shows that conical head reflected better performance compared to cylindrical head. For a cylindrical head water temperature increase to maximum 59 °C in 275 min. while for conical head water temperature increased to 68 °C in 275 min and the system was able to increase the water temperature more up to 80 °C in 400 min. in addition to that economic and environmental study is carried. Results shows that conical head system can save about 16 \$/month more than the cylindrical system when the system is used 140 times/ month for 275 min. Also for the same number of usage times, the payback period of the conical head is about the half of cylindrical head (6 months). Finally, conical head system is capable to reduce the CO₂ gas emissions by 2 tons/year more than the cylindrical head when the system is used 140 times/month.

Introduction

The consumption of fossil fuels should be limited in the very near future in order to stop climate changes and temperature increase as requested by Kyoto Protocol, and ensure sustainable development of humankind. Alternative energy [1-12] and energy recovery [13-20] are the main proposed solutions to reduce the dependence of industrial and residential applications on fossil fuels. Globally, it is estimated that only about one third of all energy usage are utilized and the remaining part is dissipated to environment.

The main type of energy used as energy source is thermal energy. Applications utilize thermal energy dissipate high amount of energy that can be used as energy source for other applications. Waste heat recovery is a cost-effective solution to increase system's efficiency and reduce energy consumption [21]. Internal combustion engines, boilers, furnaces, generators, heat pumps, chillers, chimneys and other applications can be coupled with recovery system to increase the usage of available energy [22-27]. Heating water using recovered dissipated energy acquires special attention from research communities and industries alike.

Seeking for new heat loss or optimizing standard heat recovery systems is no longer the real challenge of recovery technology. The main challenges are to propose new hybrid systems or new heat recovery heat exchangers and optimize these systems.

Generally, in cold weather days water for shower is heated. Also heating systems (electric heaters, boilers, and chimneys) are utilized to condition the room temperature. Chimneys are widely used as heating system due to their low cost, simplicity, and since they don't require electric power. Chimneys mainly utilize burned diesel or wood to generate thermal energy. The generated energy flows through exhaust gases where a part of this energy is used to heat the room and the remaining part is dissipated. About 300 exhaust gases are released which can be utilized to heat water

instead of releasing them to environment. In [28], an experimental analysis on heating water using waste heat of a chimney is done. The recovery system is constructed, implemented, and tested. Results show that within one hour, the recovery system has increased the temperature of 95 liters of water by 68 °C.

Based on what is aforementioned, this paper deals with optimizing a recently suggest heat recovery heat exchanger. This HRHE is proposed by Khaled et al. [28] and optimized by studying the effect of changing number of pipes [13], location of TEGs when the system is enhanced by a layer of TEGs [29], exhaust gases temperature [30] and generator load [31]. In this paper a new parameter will be studied to optimize the performance of the heat exchanger which is known as Multi-tube tank (MTT). Effect of changing the head shape of the multi-tube tank on the water temperature is examined. The manuscript is arranged as follows: section 2 illustrates the recovery system, section 3 summarizes the system's parameters and dimensions section 4 shows the experimental results and discuss them, section 5 is concerned in the economic and environmental study in order to show the impact of changing the head, and finally the paper ends with a summarizing conclusion in section 6.

Heat Recovery System

Chimneys are made to allow burning of fuels that generate thermal energy, to transfer a part of it for space heating. The remaining part of thermal energy is thrown out through exhaust gases to the environment which causes pollution and global warming. Since water heating is one of the main power consumers in a typical home, reducing its power constitutes a real challenge and contribute in energy saving.

The main purpose of the heat recovery system (figure 1) is to recover part of the dissipated thermal energy to heat water. Exhaust gases of a chimney are directed to flow through pipes inserted inside a water tank containing cold water.

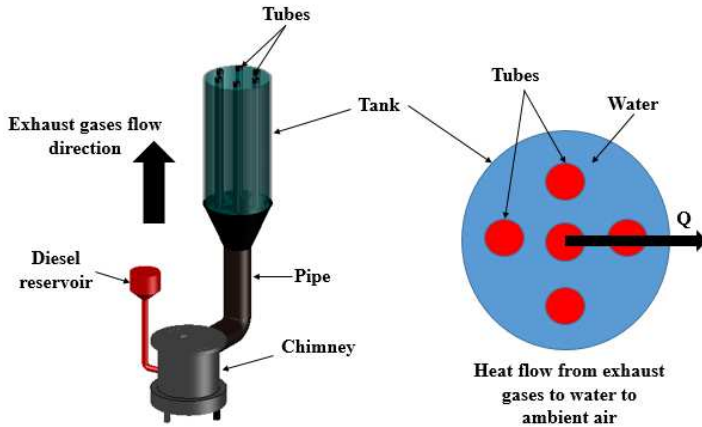

Fig. 1. Schematic of the heat recovery system coupled with diesel chimney.

Exhaust gases generated from the combustion of diesel flow through a pipe to enter the heat recovery system (HRS). At the HRS exhaust gases releases part of its thermal energy to the inner tubes' surface by convection. This thermal energy will be transmitted to the outer pipes' surface by conduction. Then, water gains heat by convection heat transfer between the outer tubes surfaces and water. Natural convection heat transfer will occur between water and the inner surface of the tank and then this heat will be transmitted to the outer surface by conduction which will experience convection heat transfer with air. When the exhaust gases leaves the water tank (exit the tubes) they are collected by a

head of the system. In this study the effect of changing the head shape of the heat recovery system on the performance of the system is studied. Two heads are designed and tested: cylindrical and conical. The geometry of the head will influence the flow of exhaust gases which in its turn affect the recovery process. The water temperature at a specified interval of time is being recorded for both cases. The results are compared, analyzed and discussed. In addition to that the effect of changing the head will be studied from economic and environmental point of view.

Prototype Dimension

In order to perform the experiment, different components of the system are designed apart then the overall system is assembled. An iron sheet of 2 mm thickness is utilized as tank wall. Multiple tubes are placed inside the tank to be the passages of exhaust gases. The tubes are of 1 mm thick and made of copper to insure high heat transfer due to high thermal conductivity of copper. The pipes are distributed in a polar way at a definite circular radius. Figure 2 shows CAD drawing of the heat recovery system.

The dimensions of each part of the prototype are listed below:

1. Iron tank of 0.32 m diameter and 1 m long.
2. Six copper pipes of 0.03 m diameter and 1 m long are located inside the tank: one pipe passes through the center of the system and the remaining five pipes are distributed in a polar way of an 8 cm radius.
3. Iron cylindrical head of 0.33 m diameter and 0.5 m long.
4. Iron conical head of 0.33 m starting diameter to 0.1 m ending diameter with 0.5 m long.

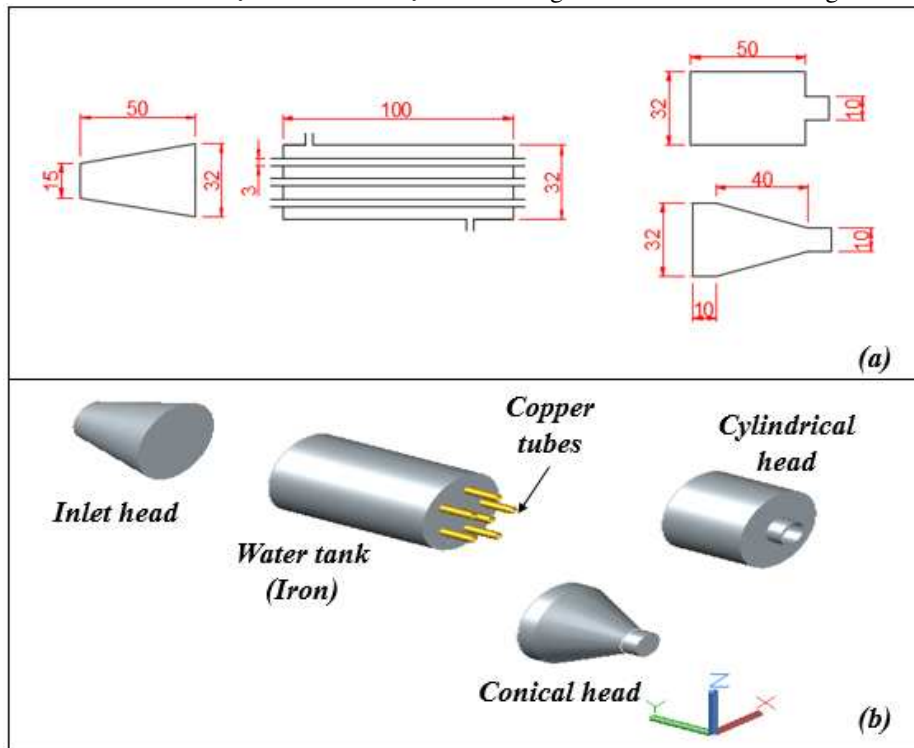

Fig. 2. AutoCAD 2D and 3D drawing of the system.

5. Thermal insulator made up of asbestos, ceramic fiber, and fiberglass of 3 cm thickness. The tank and the pipe are welded to each other while the heads are allowed to be removed (figure 3). In order to prevent leakage of exhaust gases between the tank wall and the head, a tape that can handle high temperatures is used. The overall system is coated with thermal insulator.

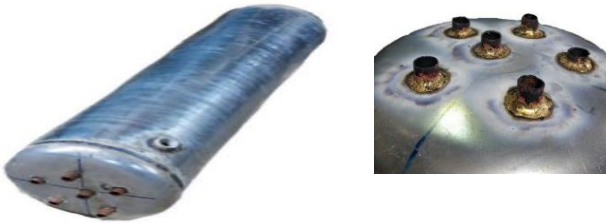

Fig. 3. Constructed heat recovery system.

It should be noted that the dimensions of the tank are designed to overcome the requirement of 3 occupants that utilize an average of 22 liters of hot water daily.

A UNI-T UT325 Digital Thermometer is utilized to obtain the water and exhaust gases temperature. This thermometer utilizes thermocouple type K as a sensor for measuring temperature. To measure the water temperature the thermocouple is placed at the top of the tank inserted in the water (8 cm away from the center of the tank at the top). While to measure the exhaust gases temperature, the thermocouple is placed at the end of the head used to estimate an average temperature of exhaust gases passing out from tubes. The mass flow rate of diesel is obtained by estimating the amount of diesel used over the time of the experiment.

The experiment is done multiple times to have accurate and correct measurements. For approximately similar initial and operating conditions (initial water and exhaust gases temperature and mass flow rate of diesel) the mean temperature difference was found 0.43 °C (i.e. 0.63% variation between the tests). It should be noted that to maintain constant flow rate of diesel when performing the experiment a big tank of diesel is connected to the chimney by which it will reduce the effect of static head of diesel on flow rate and knowing that the flow rate of diesel is very slow. The thermometer absolute uncertainty is $\pm 0.5^\circ$ and with lowest gases temperature is 25 the uncertainty of thermometer is 2%. For a 1.5% repeatability, uncertainty is estimated to be 2.5% (i.e. 97.5% the data is reliable)

Experimental Results

In order to perform the experiments, the system is coupled to a diesel chimney then two experiments are performed to record the water and exhaust gases temperature at specified interval of time.

Cylindrical head

Figure 4 shows an image of the experiment and an explanatory schematic.



Fig. 4. Heat recovery system with cylindrical head.

The experiment is done on an ambient temperature of 25 °C. The mass flow rate of diesel is 0.0003 kg/s. Figure 5 shows the variation of water temperature with respect to time.

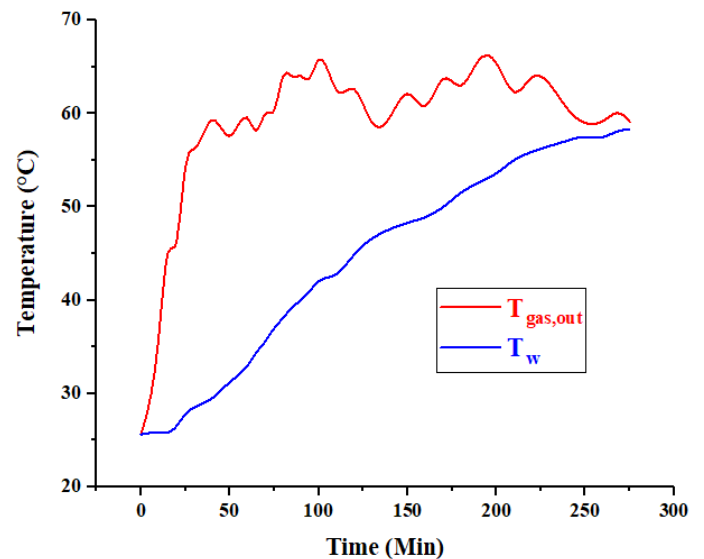

Fig. 5. Variation of water temperature over time for a cylindrical head HRS.

As shown in figure 5, at the start of the experiment the water temperature is approximately equal to the ambient air temperature. After starting the burning process, the temperature of exhaust gases started to increase rapidly in the first 20 min. in its turn water temperature increased slowly at this time. After that exhaust gases fluctuated in a range of 55–68 °C. The water temperature increased as time goes on till it achieved 59 °C at

which experiment has stopped. The average increase in water temperature is 6.28 °C/hour.

Conical head

Figure 6 shows an image of the experiment and an explanatory schematic.

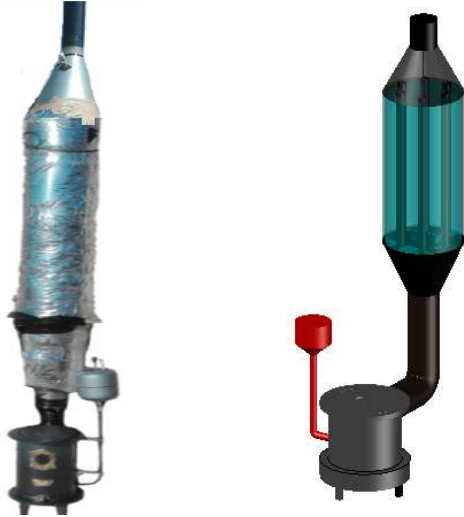

Fig. 6. Heat recovery system with conical head.

For approximately same mass flow rate of diesel, figure 7 shows the water temperature variation versus time for a conical head. It shows that for about 30 min the exhaust gases exiting temperature increased rapidly from ambient temperature 26 °C to 60 °C. Then the exhaust gases exiting temperature started to fluctuate on a range of 70-82 °C. The water temperature increased from 26 °C to 79°C throughout 400 minutes. The average increase in water temperature in one hour is 8.4 °C.

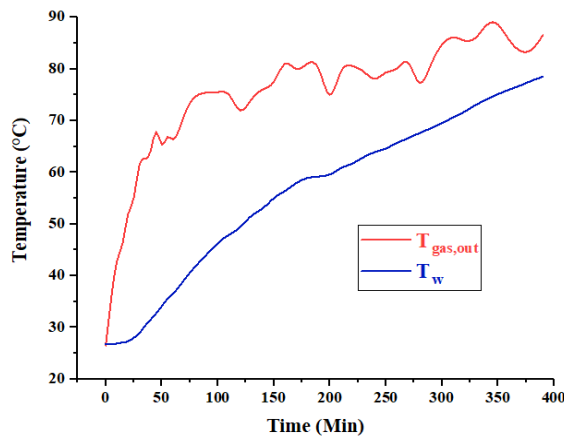

Fig. 7. Variation of water temperature over time for a conical head HRS.

Figure 7 shows that after water temperature reached 60 °C the rate of increase of water temperature has decreased, which is mainly resulted from the decrease in heat transfer rate from exhaust gases

to water (temperature difference between exhaust gases and water decreased).

By comparing both cases, water temperature increased by 33 °C for cylindrical head in 275 minutes and increased by 53 °C for conical head in 400 minutes. Approximately both cases have the same starting water temperature. After 275 minutes from experiment start, cylindrical head system produced 59 °C hot water while conical head system produced about 68 °C hot water. The main reason of this difference is that conical head has enhanced the flow of exhaust gases. Also, conical head is similar in shape to a nozzle, which increases the velocity of exiting exhaust gases leading to the increase in the draft of exhaust gases. The increase in the velocity of exhaust gases will enhance the convection heat transfer coefficient of exhaust gases. This enhancement directly affects the heat transfer rate from exhaust gases to the water.

The energy gained by water E_w for each system can be calculated as follows.

$$E_w = \rho_{water} V_{water} C_{p_w} [T_w(t + \Delta t) - T_w(t)] \quad (1)$$

where ρ_{water} , C_{p_w} , V_{water} and T_w are the density, specific heat, volume and temperature of water respectively. Δt is the time interval of data recording. The total energy gained by water for the cylindrical head system is 9.08 MJ in 275 minutes. Whereas for the conical system, the total energy gained is 11.192 in 275 minutes (i.e. 23% more than cylindrical) which increases to 14.359 MJ in 390 minutes.

The heat transfer rate to water \dot{E}_w is calculated using the following equation.

$$\dot{E}_w = \rho_{water} V_{water} C_{p_w} \left[\frac{T_w(t + \Delta t) - T_w(t)}{\Delta t} \right] \quad (2)$$

Figure 8 presents the heat gained by water for both systems over the experiment. It shows high fluctuation over time which is mainly resulted from the fluctuation of exhaust gases temperature and mass flow rate. The heat gained by water in 275 minutes for cylindrical and conical systems is 550W and 678W respectively.

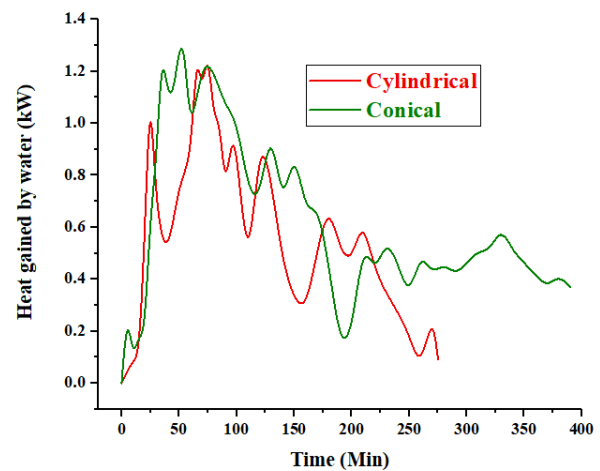

Fig. 8. Heat gained by water for cylindrical and conical HRS.

In addition to that, it should be also noted that when the cylindrical head is installed, part of exhaust gases leaked outside the chimney from its air slots. While when adding the conical head, the exhaust gases leaking from the chimney walls are reduced. This phenomenon affects the combustion process, in which it is an indicator for low velocity of exhaust gases leading to the trapping of exhaust gases in the chimney pipes. Also, this could turn off the chimney. Then, changing the head shape from cylindrical to conical head will give two main advantages: increase the energy recovery and allow normal burning of diesel (protecting chimney from turning off).

Environmental and Economic Analysis

The environmental and economic study is carried in order to estimate the amount of saved money from heating water, the payback period, and the amount of CO₂ gas reduced by both systems. Also, it is done in order to study the effect of changing the head shape of the system on the payback period and amount of CO₂ reduced.

To proceed, the total cost of the system for both cases is summarized in table 1. It shows that almost the price of both heads is equal. And the total cost of the system is relatively low which can be listed as a main advantage of such heat recovery system.

Table 1. Price of the components of the prototype.

Part	Price	
Iron tank	50 \$	
Copper tubes	40 \$	
Welding and assembling	20 \$	
Coating (insulation)	15 \$	
Water temperature sensors	10 \$	
Exhaust gases temperature sensor	65 \$	
Head of the system	Cylindrical	Conical
	20 \$	25 \$
Total	220 \$	225 \$

The study is conducted in which the experiment has run for 275 minutes for both systems. This implies that the cylindrical and conical head systems will heat water till 59 °C and 68 °C respectively. Then the recovered thermal energy Q^{rec} is written as follows.

$$Q^{rec} = \rho_{water} V_{water} C_p \Delta T_{water} \quad (3)$$

where ΔT_{water} is the water temperature rise.

The volume of water V_{water} in both cylindrical and conical HRSs is equal and calculated as follows

$$V_{water} = V_{tank} - V_{tubes}^{total} \quad (4)$$

where V_{tank} is the inner volume of the iron tank and V_{tubes}^{total} is the total outer volume of tubes. The following equations shows how

to calculate the inner volume of the tank and the total outer volume of the tubes.

$$V_{tank} = \pi \cdot r_{ta,i}^2 \cdot L \quad (5)$$

$$V_{tubes}^{total} = N \cdot [\pi \cdot r_{t,o}^2 \cdot L] \quad (6)$$

where $r_{ta,i}$ and $r_{t,o}$ are the inner and outer radii of the tank and tube respectively. L is the length of the tank and N is the total number of tubes. Then by substituting equations (5) and (6) in equation (4) the volume of water is:

$$V_{water} = \pi \cdot L \cdot [r_{ta,i}^2 - N \cdot r_{t,o}^2] \quad (7)$$

The total volume of water is estimated to be about 66 liters. Then the amount of heat recovered by heating water using the cylindrical and conical systems are 9.18 MJ and 11.68 MJ respectively. It is obvious that the conical heat recovery system recovered more heat from the cylindrical system. Then, changing the head from cylindrical to conical increased the recovery process by 27.2 % compared to cylindrical system.

To estimate the electric energy required to heat the water, a specific heater of specific efficiency is selected. For a specific electric heater whose efficiency is 0.75 %, the reduced electric energy required to heat water by the cylindrical and conical systems are 12.24 MJ and 15.58 MJ respectively. This means that, about 3.5 kWh and 4.3 kWh of electric energy are reduced by every 275-minute use of the cylindrical and conical heat recovery systems respectively.

Figure 9 shows the effect of changing the head shape on the electric energy reduced (EER) by both systems as function of the number of times the HRS is utilized.

As the HRS is more utilized, more water is heated, and more electric energy is reduced.

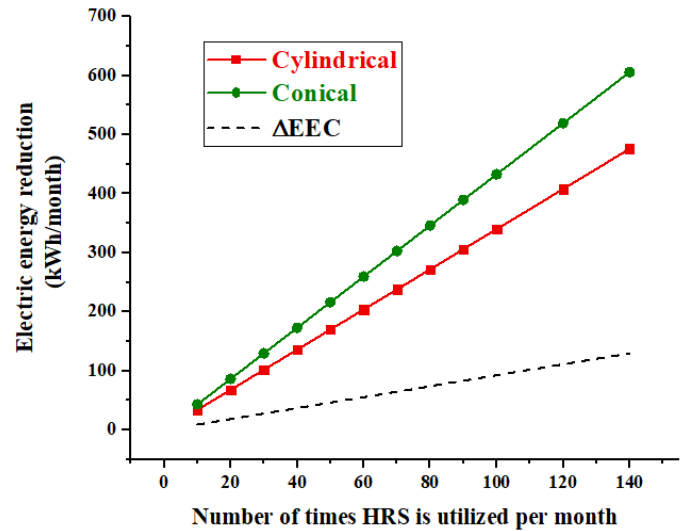

Fig. 9. Electric energy reduced by heating water using HRS.

Figure 9 shows that the conical system allow more reduction on the electric energy usage compared to cylindrical system, since it

heated water to higher temperature. The cylindrical head offers an electric energy reduction of 34 kWh/month when the system is used 10 times/month and increases to 476 kWh/month when the system is used 140 times/month (35 times/ week). However conical head heat recovery system allows a reduction of electric energy consumption by 129 kWh/month when the system is utilized 30 times/month (once per day) which increases to 605 kWh/month when the system is used 140 times/month. The dotted line on figure 9 shows the effect of changing the head shape of the system from cylindrical to conical shape. It shows that the conical head shape system offers more reduction on power consumption compared to cylindrical system of about 129 kWh/ month when the system is utilized 140 times/month.

In order to estimate the cost of the electric energy reduced from heating water using the heat recovery system, the cost of the one kilowatt-hour in Lebanon is summarized in table 2 below.

Electric rates in one month (kWh/month)	Cost (\$/kWh)
0 – 99	0.023
100 – 299	0.037
300 – 399	0.053
400 – 499	0.08
>500	0.133

Then the money saved per month MS is estimated by the following equation and shown in figure 10.

Table 2. Cost of one kWh in Lebanon.

$$MS = EER \cdot C_{kWh}$$

$$= \left. \begin{cases} 0.023 \times EER & \text{if } EER \leq 99 \\ 0.023 \times 99 + 0.037 \times (EER - 99) & \text{if } 99 < EER \leq 299 \\ 0.023 \times 99 + 0.037 \times 200 + 0.053 \times (EER - 299) & \text{if } 299 < EER \leq 399 \\ 0.023 \times 99 + 0.037 \times 200 + 0.053 \times 100 + 0.08 \times (EER - 399) & \text{if } 399 < EER \leq 499 \\ 0.023 \times 99 + 0.037 \times 200 + 0.053 \times 100 + 0.08 \times 100 + 0.133 \times (EER - 499) & \text{if } EER > 499 \end{cases} \right\} \quad (8)$$

where C_{kWh} is the cost of kWh in Lebanon.

Figure 10 shows that as the HRS is more utilized, more money is saved which is resulted from the more electric energy consumption is reduced. Results shows that cylindrical system capable to save up to 6 \$/month if the system is utilized twice per day. This save can be increased by increasing the number of times the heat recovery system is used (21 \$/month for 140 usage of system/month). Whereas, conical system saves up to 8 \$/month when the system is used twice a day and 37 \$/month when the system is used 140 times/month. The dotted curve on the figure shows the money gain when the head shape is changed and optimized. It shows that when the head shape is changed from cylindrical to conical the money saved increased by 16 \$/month when the system is used 140 times/month. About 76.2 % rise on money saved is obtained when the head of the heat recovery system is changed from cylindrical to conical. This shows marked superiority of conical head over cylindrical head.

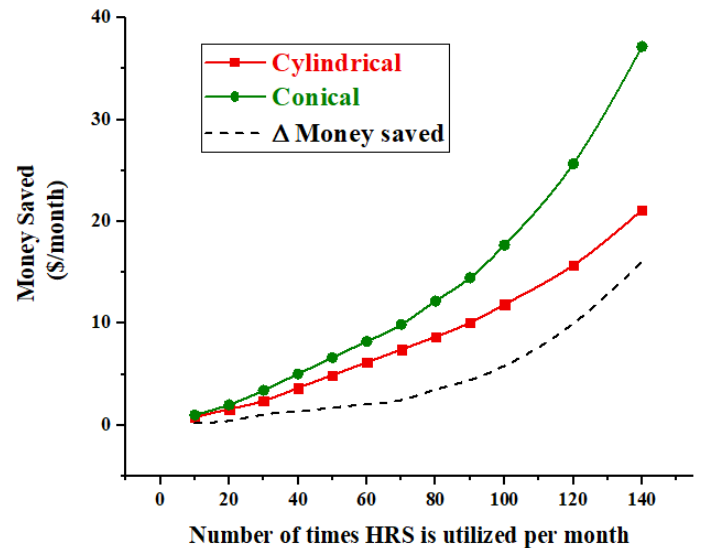

Fig. 10. Money saved from heat water using HRS per month.

Finally, the payback period of both systems is estimated using equation (9) and represented on figure 11.

$$Pbp = \frac{C_{HRS}}{MS} \quad (9)$$

where C_{HRS} is the total cost of the heat recovery system.

The cylindrical system has a payback period of about 3 years when the system is used twice per day. Which decreases to 11 months when the system is utilized 140 times/month. However, for the conical head system, the payback period decreased from 2.25 years to 6 months (half a year) when the system is utilized 60 and 140 times/month respectively. Then, as the number of times HRS is used per month, the payback period decreases, and

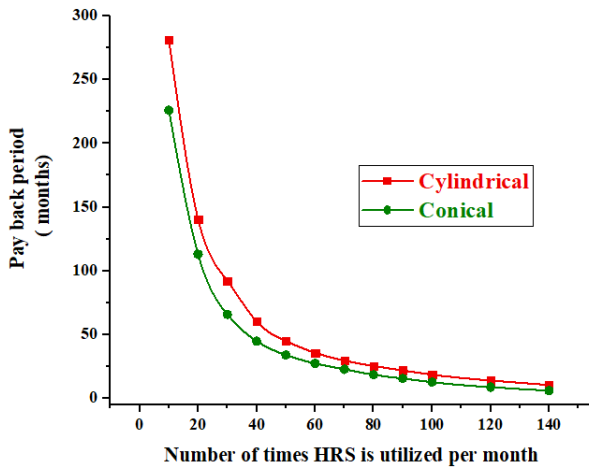
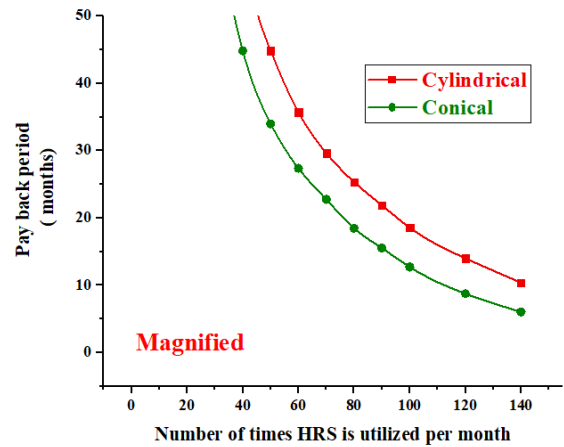

Fig. 11. Effect of changing the head shape on the payback period of each system.

the conical head system has a payback period less than the cylindrical head system. Also, these results show that as the head shape of the system is changed from cylindrical to conical the payback period could decrease till the half when the system is used 140 times/month.

For the environmental concerns, this study deals on the effect of changing the head shape on the amount of CO₂ gas reduced by heating water using the heat recovery system. It is estimated that about 0.47 kg of CO₂ are released to generate one kilowatt-hour of electricity in Lebanon [29]. Also, it should be noted that about 8% of electric energy is dissipated on the electric lines. This means that the total amount of electric energy required from power station $EER_{Power-station}$ and the reduced amount of CO₂ gas $M_{CO_2}^{reduced}$ are expressed as follow.



$$EER_{Power-station} (kWh/month) = 1.075 \times EER (kWh/month) \quad (10)$$

$$M_{CO_2}^{reduced} (kg/month) = EER_{Power-station} (kWh/month) \times M_{CO_2}(kg/kWh) \quad (11)$$

where is the amount of CO₂ gas produced from generating one kilowatt-hour.

Figures 12 shows the effect of changing the head shape on the amount of CO₂ gas reduced by each system.

The amount of CO₂ gas reduced by the cylindrical HRS is 17 kg/month which increase to 240 kg/month when the system is utilized 10 and 140 times/month respectively. While, for the conical head the amount of CO₂ gas reduced by utilizing HRS is 21 kg/month and increases to 306 kg/month (3.7 tons/year) when

this system is used 10 and 140 times respectively. Then, changing the head shape of the system affect the recovery which affect the amount of CO₂ gas produced to heat water. The conical head system capable to reduce the CO₂ gas emissions by 2 tons/ year more than the cylindrical head when the system is used 140 times/month.

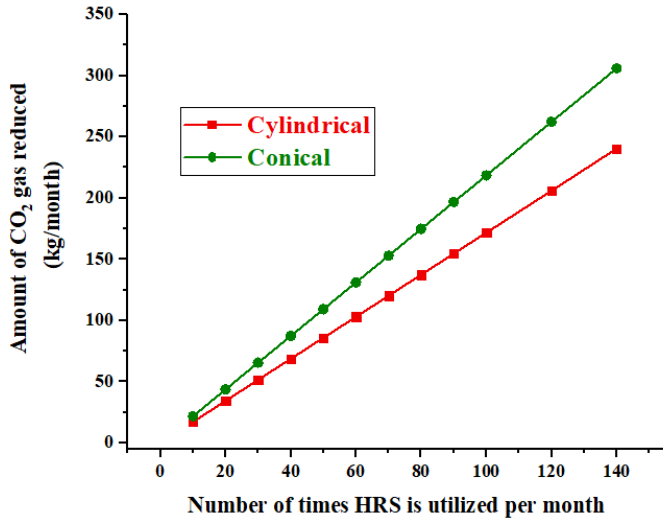

Fig. 12. Effect of changing head shape on the amount of CO₂ gas reduced.

Conclusions

Nowadays, the world is facing major problems characterized by progressive increase in energy demand, cost, air pollution as well as global warming. Waste heat recovery offers an effective solution for all these problems. Since heating water requires high electric energy, heating water from the thermal energy captured by exhaust gases of a chimney is a real gain. A multi tube tank heat recovery system which is recently suggested by Khaled et al. is optimized. The system has been designed, constructed, and tested. Effect of changing system's head shape on water temperature has been experimentally studied. Two heads are considered cylindrical and conical shapes. In addition to that, an economic and environmental study was carried to estimate the effect of changing the head shape. The results show that for a cylindrical head water temperature increased to 59 °C in 275 minutes while for a conical head water temperature increase to 68 °C in same interval of time. The conical head is shaped as a nozzle which enhanced the exhaust gases flow and increased the rate of heat transfer. Also, cylindrical head system can recover up to 9.08 MJ in 275 min. while conical system can recover up to 11.192 MJ which is equivalent to 3.5 kWh and 4.3 kWh electric energy respectively. In addition to that, the conical head shape system offers more reduction on power consumption compared to cylindrical system of about 129 kWh/ month when the system is utilized 140 times/month. Furthermore, when the head shape is changed from cylindrical to conical the money saved increased by 16 \$/month when the system is used 140 times/month. Last and not least, from the economical point of view conical head system has a 6 month payback period which is half what the cylindrical head system requires when the system is used 35 times/week. Finally cylindrical head system can reduce yearly about 1.7 tons of CO₂ gas emissions while conical head can reduce about 3.7 tons when the system is used 140 times / month.

Nomenclature

C	Cost (\$)
CO₂	Carbon dioxide
C_p	Specific heat (kJ. (kg.k) ⁻¹)
E	Energy (J)
EER	Electric energy required (MJ)
HRHE	Heat recovery heat exchanger
HRS	Heat recovery system
L	Length of the tank (m)
M	Mass (kg)
MS	Money saved (\$)
MTT	Multi-tube tank
N	Number of tubes
P_{bp}	Payback period (years)
Q	Heat rate (W)
r	Radius (m)
T	Temperature (°C)
t	Time (s)
TEG	Thermoelectric generator
V	Volume (m ³)

Greek Symbols

ρ	Density (kg/m ³)
Ė	Energy rate (W)
Δt	Time interval (s)

Subscripts

w	Water
ta,i	Tank,inner
t,o	Tube,outer
kWh	Kilowatt hour

References

- [1] L. Lu, X. Wang, S. Wang, and X. Liu, "Optimal Structure Design of a Thermosyphon Solar Water Heating System with Thermal and Dynamic Models," *Heat Transf. Eng.*, vol. 39, no. 16, pp. 1470–1481, Oct. 2018.
- [2] A. Herez, M. Ramadan, B. Abdulhay, and M. Khaled, "Short review on solar energy systems," in *AIP Conference Proceedings*, 2016, vol. 1758, no. 1, p. 030041.
- [3] L. L. Vasiliev, L. L. Vassiliev, M. I. Rabetsky, L. P. Grakovich, A. S. Zhuravlyov, A. V. Shapovalov, and A. V. Rodin, "Long Horizontal Vapordynamic Thermosyphons for Renewable Energy Sources," *Heat Transf. Eng.*, pp. 1–9, Jan. 2018.
- [4] H. El Hage, A. Herez, M. Ramadan, H. Bazzi, and M. Khaled, "An investigation on solar drying: A review with economic and environmental assessment," *Energy*, vol. 157, pp. 815–829, Aug. 2018.
- [5] A. Herez, M. Ramadan, and M. Khaled, "Review on solar cooker systems: Economic and environmental study for different Lebanese

- scenarios,” *Renew. Sustain. Energy Rev.*, vol. 81, pp. 421–432, Jan. 2018.
- [6] A. Herez, M. Khaled, R. Murr, A. Haddad, H. Elhage, and M. Ramadan, “Using Geothermal Energy for cooling - Parametric study,” *Energy Procedia*, vol. 119, pp. 783–791, Jul. 2017.
- [7] F. Hachem, B. Abdulhay, M. Ramadan, H. El Hage, M. G. El Rab, and M. Khaled, “Improving the performance of photovoltaic cells using pure and combined phase change materials – Experiments and transient energy balance,” *Renew. Energy*, vol. 107, pp. 567–575, Jul. 2017.
- [8] F. Ma and P. Zhang, “Heat Transfer Characteristics of a Volumetric Absorption Solar Collector using Nano-Encapsulated Phase Change Slurry,” *Heat Transf. Eng.*, vol. 39, no. 17–18, pp. 1487–1497, Nov. 2018.
- [9] R. Balijepalli, V. P. Chandramohan, and K. Kirankumar, “A complete design data and performance parameter evaluation of a pilot scale solar updraft tower,” *Heat Transf. Eng.*, pp. 1–14, Jan. 2019.
- [10] S. Lu, Z. Li, and Q. Zhao, “Calculation of Escaped Solar Energy in Glazing Façade Buildings,” *Heat Transf. Eng.*, vol. 39, no. 17–18, pp. 1641–1647, Nov. 2018.
- [11] M. Ramadan, M. Khaled, H. S. Ramadan, and M. Becherif, “Modeling and sizing of combined fuel cell-thermal solar system for energy generation,” *Int. J. Hydrogen Energy*, vol. 41, no. 44, pp. 19929–19935, Nov. 2016.
- [12] A. Lingayat, V. P. Chandramohan, and V. R. K. Raju, “Energy and Exergy Analysis on Drying of Banana Using Indirect Type Natural Convection Solar Dryer,” *Heat Transf. Eng.*, pp. 1–11, Jan. 2019.
- [13] M. Khaled and M. Ramadan, “Heating fresh air by hot exhaust air of HVAC systems,” *Case Stud. Therm. Eng.*, vol. 8, pp. 398–402, Sep. 2016.
- [14] R. A. Rouf, K. C. A. Alam, B. B. Saha, and K. M. A. Kabir, “Utilizing Accessible Heat Enhancing Cooling Effect with Three Bed Solar Adsorption Chiller,” *Heat Transf. Eng.*, pp. 1–11, Mar. 2018.
- [15] B. Pfeiffelmann, A. C. Benim, and F. Joos, “A Finite Volume Analysis of Thermoelectric Generators,” *Heat Transf. Eng.*, pp. 1–9, May 2018.
- [16] X. Zhao, G. Tang, Y. Shi, and Y. Li, “Experimental Study of Heat Transfer and Pressure Drop for H-type Finned Oval Tube with Longitudinal Vortex Generators and Dimples under Flue Gas,” *Heat Transf. Eng.*, vol. 39, no. 7–8, pp. 608–616, May 2018.
- [17] R. V. Rao, A. Saroj, P. Ocloñ, J. Taler, and D. Taler, “Single- and Multi-Objective Design Optimization of Plate-Fin Heat Exchangers Using Jaya Algorithm,” *Heat Transf. Eng.*, vol. 39, no. 13–14, pp. 1201–1216, Aug. 2018.
- [18] G. Shu, L. Shi, H. Tian, and L. Chang, “Comparison and Selection Research of CO₂-Based Transcritical Rankine Cycle Using for Gasoline and Diesel Engine’s Waste Heat Recovery,” *Heat Transf. Eng.*, vol. 39, no. 7–8, pp. 672–686, May 2018.
- [19] G. Righetti, C. Zilio, S. Mancin, and G. A. Longo, “Heat Pipe Finned Heat Exchanger for Heat Recovery: Experimental Results and Modeling,” *Heat Transf. Eng.*, vol. 39, no. 12, pp. 1011–1023, Jul. 2018.
- [20] M. Khaled and M. Ramadan, “Study of the Thermal Behavior of Multi Tube Tank in Heat Recovery from Chimney—Analysis and Optimization,” *Heat Transf. Eng.*, vol. 39, no. 5, pp. 399–409, Mar. 2018.
- [21] H. Jaber, M. Khaled, T. Lemenand, and M. Ramadan, “Short review on heat recovery from exhaust gas,” in *AIP Conference Proceedings*, 2016, vol. 1758, no. 1, p. 030045.
- [22] M. Ramadan, M. G. El Rab, and M. Khaled, “Parametric analysis of air–water heat recovery concept applied to HVAC systems: Effect of mass flow rates,” *Case Stud. Therm. Eng.*, vol. 6, pp. 61–68, Sep. 2015.
- [23] M. Khaled, M. Ramadan, and H. El Hage, “Parametric Analysis of Heat Recovery from Exhaust Gases of Generators,” *Energy Procedia*, vol. 75, pp. 3295–3300, Aug. 2015.
- [24] B. C. Choi and Y. M. Kim, “Thermodynamic analysis of a dual loop heat recovery system with trilateral cycle applied to exhaust gases of internal combustion engine for propulsion of the 6800 TEU container ship,” *Energy*, vol. 58, pp. 404–416, Sep. 2013.
- [25] P. Donnellan, K. Cronin, and E. Byrne, “Recycling waste heat energy using vapour absorption heat transformers: A review,” *Renew. Sustain. Energy Rev.*, vol. 42, pp. 1290–1304, Feb. 2015.
- [26] M. F. Remeli, L. Kiatbodoin, B. Singh, K. Verojporn, A. Date, and A. Akbarzadeh, “Power Generation from Waste Heat Using Heat Pipe and Thermoelectric Generator,” *Energy Procedia*, vol. 75, pp. 645–650, Aug. 2015.
- [27] M. Ramadan, T. lemenand, and M. Khaled, “Recovering heat from hot drain water—Experimental evaluation, parametric analysis and new calculation procedure,” *Energy Build.*, vol. 128, pp. 575–582, Sep. 2016.
- [28] M. Khaled, M. Ramadan, K. Chahine, and A. Assi, “Prototype implementation and experimental analysis of water heating using recovered waste heat of chimneys,” *Case Stud. Therm. Eng.*, vol. 5, pp. 127–133, Mar. 2015.
- [29] H. Jaber, M. Ramadan, T. lemenand, and M. Khaled, “Domestic thermoelectric cogeneration system optimization analysis, energy consumption and CO₂ emissions reduction,” *Appl. Therm. Eng.*, vol. 130, pp. 279–295, Feb. 2018.
- [30] H. Jaber, M. Khaled, T. Lemenand, J. Faraj, H. Bazzi, and M. Ramadan, “Effect of Exhaust Gases Temperature on the Performance of a Hybrid Heat Recovery System,” *Energy Procedia*, vol. 119, pp. 775–782, Jul. 2017.
- [31] H. Jaber, M. Khaled, T. Lemenand, and M. Ramadan, “Effect of generator load on hybrid heat recovery system,” *Case Stud. Therm. Eng.*, vol. 13, p. 100359, Mar. 2019.

Chapitre 6. Conclusions et perspectives

De nos jours, la réduction de la consommation mondiale d'énergie suscite un intérêt croissant. Cet intérêt est principalement causé par le coût élevé des sources d'énergie, les fortes émissions de gaz toxiques, le réchauffement global de la planète et les lois gouvernementales obligatoires. Les sources d'énergie principales sont les combustibles fossiles, dont les coûts augmentent rapidement. En raison du fait que la consommation d'énergie est un paramètre de coût des produits industriels, les énergies de substitution ont acquis une place importante dans les travaux scientifiques. La récupération d'énergie et les énergies renouvelables sont des solutions appropriées à ces problèmes. Les énergies renouvelables concernent l'énergie obtenue à partir d'une source renouvelable naturelle telle que le solaire, le vent, les vagues, etc. et sont intéressantes pour substituer les combustibles fossiles par des énergies avec un contenu CO₂ moindre.

La récupération d'énergie s'intéresse quant à elle à diminuer le gaspillage d'énergie d'une installation dans l'environnement. L'énergie dissipée dans l'environnement est principalement issue du fluide de refroidissement ou des gaz d'échappement. Les défis posés à la technologie thermique sont alors de proposer de nouveaux échangeurs thermiques à récupération de chaleur, de nouveaux systèmes hybrides et de les optimiser. Ces travaux de thèse portent sur la récupération de chaleur des gaz d'échappement, dans laquelle de nouveaux systèmes hybrides sont suggérés et optimisés et un échangeur de chaleur à récupération de chaleur récemment proposé est étudié et optimisé.

Sur la base du contexte susmentionné, une revue de littérature approfondie sur la récupération de chaleur et les générateurs thermoélectriques est réalisée. En outre, deux systèmes hybrides de récupération de chaleur sont proposés : un Système de Cogénération Thermoélectrique Domestique (SCTD) et un Système de Séchage de Cogénération Thermoélectrique Domestique (SSCTD). Le concept de chaque système est illustré : SCTD vise à produire de l'eau chaude et à produire de l'électricité, tandis que SSCTD cherche à chauffer de l'eau, à générer de l'électricité et à chauffer de l'air pour des applications de séchage. De plus, la modélisation thermique des deux systèmes est développée. Des études de cas et des analyses paramétriques ont été menées pour optimiser les performances de ces systèmes. En outre, l'échangeur de chaleur à récupération de chaleur récemment suggéré, connu sous le nom de Réservoir Multi-Tubes (RMT), est optimisé numériquement et expérimentalement par deux études distinctes.

Les principaux résultats de cette thèse sont résumés dans le tableau suivant :

Titre de l'étude	Méthodologie d'étude	Principaux résultats
Système de Cogénération Thermoélectrique Domestique : analyse d'optimisation, consommation d'énergie et réduction des émissions de CO ₂	<ul style="list-style-type: none"> ➤ Suggérer un système de récupération de chaleur en deux étapes pour produire de l'eau chaude domestique et générer de l'électricité à l'aide de GTE. ➤ Étudier les effets du changement de localisation des GTE sur les performances du SCTD. ➤ Étude de cas : la température des gaz d'échappement est de 300°C, celle de l'air ambiant est de 25°C. ➤ Analyse d'optimisation : <ul style="list-style-type: none"> • 6 cas sont considérés • Cas 1 : pas de GTE. • Cas 2 et 3 : GTE situés sur les parois externes et internes du réservoir. • Cas 4 et 5 : GTE situés sur les parois externes et internes du tuyau. • Cas 6 : GTE placés sur toutes les parois. 	<ul style="list-style-type: none"> ✓ La localisation des GTE sur la paroi du réservoir permet d'obtenir une température d'eau plus élevée mais une puissance produite inférieure (cas 2 et 3). ✓ Lorsque les GTE sont situés sur le tuyau (cas 4 et 5), une puissance élevée est produite, mais la température de l'eau est relativement basse par rapport aux cas 2 et 3. ✓ Les cas 2 et 3 produisent de l'eau chaude sanitaire à environ 97°C et environ 7 W d'énergie électrique. ✓ Les cas 4 et 5 produisent de l'eau chaude à environ 80°C, couplée à 33 W d'électricité générée par les GTE. ✓ Le cas 6 génère environ 52 W avec une température d'eau relativement élevée de 81°C. ✓ Le cas 5 est un processus de récupération de chaleur économique comparé à d'autres cas si le coût est une exigence majeure. ✓ Meilleure période de récupération pour le cas 5 nécessitant 1 an et 8 mois pour rembourser le coût du système ✓ Modifier l'emplacement des GTE n'affecte pas beaucoup la quantité de CO₂ libérée ✓ 6 tonnes de CO₂ peuvent être économisées chaque année en utilisant le système de récupération de chaleur hybride
Effet de la température des gaz d'échappement sur les performances d'un système de récupération de chaleur hybride	<ul style="list-style-type: none"> ➤ Etudier l'effet de la modification de la température des gaz d'échappement sur les performances du SCTD. 	<ul style="list-style-type: none"> ✓ En augmentant la température des gaz, le transfert de chaleur et les températures à chaque couche augmentent de façon linéaire. ✓ La puissance générée par les GTE augmente progressivement avec l'augmentation de la température des gaz d'échappement. ✓ En doublant la température des gaz, la puissance produite augmente environ cinq fois plus
Système de Cogénération Thermoélectrique Domestique : analyse d'optimisation - effet de la variation du volume d'eau	<ul style="list-style-type: none"> ➤ Etudier l'effet de la modification du volume d'eau sur les performances du SCTD. 	<ul style="list-style-type: none"> ✓ Lorsque le volume augmente, le rayon du réservoir augmente, la résistance totale diminue et le transfert de chaleur augmente. ✓ Lorsque le rayon du réservoir est doublé, le flux de chaleur augmente de 28%. ✓ À mesure que le volume augmente, la température de l'eau diminue et la puissance générée augmente.

Effet de la charge du générateur sur le système de récupération de chaleur hybride	<ul style="list-style-type: none"> ➤ Etudier l'effet de la modification de la charge du générateur lors du couplage du SCTD avec un générateur diesel sur les performances du SCTD. 	<ul style="list-style-type: none"> ✓ La température de l'eau atteint 47°C et la puissance produite par les GTE est de 141 W avec un générateur diesel de 10 kW. ✓ La température de l'eau atteint 97°C et la puissance produite par les GTE est de 1412 W avec un générateur diesel de 38 kW. ✓ Lorsque la charge du générateur augmente, la puissance générée et la température de l'eau augmentent.
Système de récupération de chaleur hybride appliqué aux gaz d'échappement - Modélisation thermique et étude de cas	<ul style="list-style-type: none"> ➤ Étude de cas approfondie associée à des préoccupations économiques et environnementales. ➤ Étude de cas : utilisation de gaz d'échappement d'une cheminée diesel résidentielle. 	<ul style="list-style-type: none"> ✓ La température de l'eau est mesurée expérimentalement et atteint 80°C en 400 minutes. ✓ L'analyse théorique montre que le système est capable de générer jusqu'à 0,5 W/GTE. ✓ 192 W de puissance totale générée à l'aide de 383 générateurs thermoélectriques fixés à la paroi extérieure du réservoir. ✓ La période de retour sur investissement est de 5 ans lorsque l'eau est chauffée 80 fois par mois. ✓ 5,1 tonnes d'émission de CO₂ sont réduites chaque année lorsque le système de récupération de chaleur chauffe de l'eau 80 fois par mois.
Sécheur thermoélectrique domestique à cogénération : modélisation thermique et étude de cas	<ul style="list-style-type: none"> ➤ Suggérer un système de récupération de chaleur en trois étapes qui utilise les gaz d'échappement pour produire de l'eau chaude et de l'air chaud, ainsi que de l'électricité à l'aide de GTE. ➤ Le concept du système est appliqué aux gaz d'échappement d'une cheminée. ➤ Une étude de cas est réalisée pour trois combustibles différents (diesel, charbon, bois). 	<ul style="list-style-type: none"> ✓ La combustion du gazole, du charbon et du bois produit des gaz d'échappement à des températures de 930 K, 1041 K, 879 K avec un débit massique de 35,31 kg/h, 15,44 kg/h et 8,64 kg/h. ✓ L'énergie thermique des gaz d'échappement des cas diesel, charbon et bois à la sortie de la cheminée, c'est-à-dire à l'entrée du tuyau, est respectivement de 7066 W, 3632 W et 1603 W. ✓ Le système de récupération de chaleur hybride génère 240 W pour 100 GTE pour les cas diesel et charbon, alors qu'il ne produit que 94 W pour le cas bois. ✓ Pour le débit maximal étudié (0,0076 kg/s), 8,5% de l'énergie thermique des gaz d'échappement diesel est récupérée, 21,5% pour le charbon et 71,7% pour le bois. ✓ L'ensemble du système récupère 20%, 42% et 84% de l'énergie dissipée dans l'environnement pour les cas diesel, charbon et bois respectivement.

Simulation numérique d'un échangeur de chaleur à plusieurs tubes : analyse d'optimisation	<ul style="list-style-type: none"> ➤ Optimiser un échangeur de chaleur à récupération de chaleur appelé RMT. ➤ Les gaz d'échappement sont utilisés pour produire de l'eau chaude domestique. ➤ La simulation numérique est réalisée avec COMSOL. ➤ Trois cas sont étudiés : système comportant un, trois, et six tubes. 	<ul style="list-style-type: none"> ✓ Pour augmenter la température de l'eau de 20°C à 70°C, il faut 14 heures pour un tube, 8 heures pour la configuration de trois tubes et seulement 4 heures pour un réservoir de six tubes. ✓ Si le critère d'optimisation est le seuil minimal de température du gaz, la solution optimale est le RMT avec un tube. ✓ Si le critère d'optimisation est la température maximale de l'eau, la configuration optimale est RMT avec six tubes.
Etude expérimentale sur la récupération de chaleur à l'aide d'un réservoir multitube : effet de la modification de la forme de la tête	<ul style="list-style-type: none"> ➤ Optimisation du réservoir multi-tubes sur la base de tests expérimentaux. ➤ Le RMT est couplé à une cheminée diesel résidentielle. ➤ Étudier l'effet de la modification de la forme de la tête du système de récupération sur la température de l'eau. ➤ Deux têtes sont conçues et testées : cylindrique et conique. ➤ Etudier l'effet de la modification de la tête du point de vue économique et environnemental. 	<ul style="list-style-type: none"> ✓ Pour une tête cylindrique, la température de l'eau augmente à 59°C en 275 minutes, et 68°C pour une tête conique. ✓ La tête conique est conçue comme une buse, ce qui améliore l'écoulement des gaz d'échappement et augmente le flux de chaleur. ✓ 9,18 MJ et 11,68 MJ d'énergie thermique sont récupérés en 275 minutes par le RMT cylindrique et conique, respectivement. ✓ Le système de tête de forme conique offre une réduction de la consommation d'énergie par rapport au système cylindrique d'environ 129 kWh/mois lorsque le système est utilisé 140 fois/mois. ✓ Lorsque la forme de la tête passe de cylindrique à conique, l'argent économisé augmente de 16 \$/mois. ✓ Le système à tête conique a une période de retour sur investissement de 6 mois, qui correspond à la moitié du système à tête cylindrique. ✓ Un système à tête cylindrique réduit chaque année d'environ 1,7 tonnes les émissions de CO₂, tandis qu'une tête conique diminue d'environ 3,7 tonnes.

Comme perspectives de recherche à ces travaux, nous envisageons d'introduire de nouveaux systèmes de récupération de chaleur hybrides en ajoutant des couches supplémentaires de récupération ou en mettant en œuvre de nouvelles méthodes de récupération. Le matériau à changement de phase (PCM) peut être utilisé comme couche supplémentaire de récupération de chaleur pour réduire les pertes avec l'air ambiant. L'effet du changement d'emplacement du PCM sur les performances du système de récupération de chaleur, le taux de charge et de décharge peut être étudié (similaire à l'étude du chapitre 2). Des études paramétriques peuvent également être effectuées à l'aide d'une simulation numérique (dynamique des fluides numérique) sur divers systèmes de récupération de chaleur hybrides afin de déterminer la configuration optimale, le

rendement maximal de récupération d'énergie, le système le plus rentable ou même d'étudier la possibilité de le mettre en œuvre dans un système réel. Des études expérimentales sont essentielles pour déterminer les performances du système dans différentes conditions aux limites et pour réaliser des études de corrosion et de colmatage, en particulier lorsque les gaz d'échappement sont en contact direct avec des TEG ou des tubes de cuivre.

Références

- [1] “COP21, the 2015 United Nations Climate Change Conference,” Paris <https://unhabitat.org/cop21/>.
- [2] BP, “BP Statistical Review of World Energy,” 2017.
- [3] J. S. Jadhao, and D. G. Thombare, Review on Exhaust Gas Heat Recovery for I.C. Engine, *International Journal of Engineering and Innovative Technology (IJEIT)*, vol 2, Issue 12, June 2013
- [4] H. Jaber, M. Khaled, T. Lemenand, and M. Ramadan, “Short review on heat recovery from exhaust gas,” 2016, p. 030045.
- [5] M. F. Remeli, A. Date, B. Orr, L. C. Ding, B. Singh, N. D. N. Affandi, and A. Akbarzadeh, “Experimental investigation of combined heat recovery and power generation using a heat pipe assisted thermoelectric generator system,” *Energy Convers. Manag.*, vol. 111, pp. 147–157, 2016.
- [6] C. R. KUMAR, A. Sonthalia, and R. Goel, “Experimental study on waste heat recovery from an internal combustion engine using thermoelectric technology,” *Therm. Sci.*, vol. 15, no. 4, pp. 1011–1022, 2011.
- [7] R. Carapellucci and L. Giordano, “The Recovery of Exhaust Heat from Gas Turbines,” in *Efficiency, Performance and Robustness of Gas Turbines*, InTech, 2012.
- [8] M. Khaled and M. Ramadan, “Study of the Thermal Behavior of Multi Tube Tank in Heat Recovery from Chimney—Analysis and Optimization,” *Heat Transf. Eng.*, vol. 39, no. 5, pp. 399–409, Mar. 2018.
- [9] B. Orr, A. Akbarzadeh, M. Mochizuki, and R. Singh, “A review of car waste heat recovery systems utilising thermoelectric generators and heat pipes,” *Appl. Therm. Eng.*, vol. 101, pp. 490–495, 2016.
- [10] L. Szarka and J. Ádám, “A megújuló energiafajták környezeti hatásainak összehasonlíthatóságáról (in Hungarian),” *Környezet és Energ. Konf.*, vol. ISBN 978-9, pp. 7–12, 2009.

Titre : Nouveaux systèmes hybrides de récupération de chaleur : modélisation thermique et optimisation

Mots clés : Systèmes Hybrides, Récupération de la chaleur, Modélisation thermique, Optimisation.

Résumé : Les principaux défis en matière de récupération de chaleur sont représentés par la proposition de nouvelles méthodes d'extraction de la chaleur dissipée ou en suggérant de nouveaux systèmes hybrides composés d'étapes de récupérations multiples optimisant l'utilisation de l'énergie et améliorant l'efficacité globale du système. Dans ce contexte, l'objet de ces travaux de thèse est de proposer de nouveaux systèmes/concepts de récupération de chaleurs hybrides à partir de gaz d'échappement et de réaliser des études de cas et des analyses paramétriques afin de prédire et d'optimiser les performances thermiques du système.

Deux systèmes de récupération de chaleur hybrides sont proposés dans cette thèse et étudiés analytiquement : le Système de Cogénération Thermoélectrique Domestique (SCTD) et le Système de Séchage et de Cogénération Thermoélectrique Domestique (SSCTD). Des analyses d'optimisation ont été effectuées sur un échangeur de chaleur à récupération de chaleur récemment suggéré par Khaled et al. dénommé Réservoir Multi-Tube (RMT). Un nouveau système hybride est proposé, combinant le RMT avec un échangeur de chaleur à tubes concentriques pour récupérer l'énergie thermique des gaz d'échappement et de l'eau de refroidissement d'un générateur diesel électrique.

Title : New hybrid systems of heat recovery: thermal modeling and optimization

Keywords : Hybrid Systems, Heat recovery, Thermal Modeling, Optimization

Abstract: Finding new sources of wasted heat is no longer the main challenge in heat recovery technology, it is summarized by proposing new ways for extracting the dissipated heat or by suggesting new hybrid systems that are composed of multi-recovery stages which maximizes energy utilization and improves the system efficiency. Based on the aforementioned context, the purpose of the present PhD study is to suggest new hybrid heat recovery systems/concepts from exhaust gases and perform cases studies and parametric analyses to predict and optimize the thermal performance of the system.

Two hybrid heat recovery systems are proposed in this PhD and studied analytically: Domestic Thermoelectric Cogeneration System (DTCS) and Domestic Thermoelectric Cogeneration Drying System (DTCDS). Optimization analyses are performed on a recently suggested heat recovery heat exchanger by Khaled et al. [8] named Multi-Tube Tank (MTT). New hybrid system is proposed that combines MTT with concentric tube heat exchanger to recover dissipated thermal energy from exhaust gases and cooling water respectively of a diesel electric generator.