



**HAL**  
open science

# Stochastic optimization for generation scheduling in a local energy community under renewable energy uncertainty

Xin Wen

► **To cite this version:**

Xin Wen. Stochastic optimization for generation scheduling in a local energy community under renewable energy uncertainty. Electric power. Centrale Lille Institut, 2020. English. NNT : 2020CLIL0017 . tel-03269581

**HAL Id: tel-03269581**

**<https://theses.hal.science/tel-03269581>**

Submitted on 24 Jun 2021

**HAL** is a multi-disciplinary open access archive for the deposit and dissemination of scientific research documents, whether they are published or not. The documents may come from teaching and research institutions in France or abroad, or from public or private research centers.

L'archive ouverte pluridisciplinaire **HAL**, est destinée au dépôt et à la diffusion de documents scientifiques de niveau recherche, publiés ou non, émanant des établissements d'enseignement et de recherche français ou étrangers, des laboratoires publics ou privés.

CENTRALE LILLE

THESE

Présentée en vue d'obtenir le grade de

**DOCTEUR**

*En spécialité : Génie Électrique*

Par

**Xin WEN**

DOCTORAT DELIVRE PAR CENTRALE LILLE

Titre de la thèse :

**Stochastic optimization for generation scheduling in a local energy community under renewable energy uncertainty**

**Optimisation stochastique pour la planification de la production d'électricité dans une communauté énergétique locale en situation d'incertitude liée aux énergies renouvelables**

Soutenue le 7 décembre 2020 devant le jury d'examen :

<b>Présidente</b>	<i>Luce BROTCORNE, Directeur de Recherche, INRIA Lille - Nord Europe</i>
<b>Rapporteur</b>	<i>Florence OSSART, Professeure, Sorbonne Université, GEEPS</i>
<b>Rapporteur</b>	<i>Robin ROCHE, Dr. HDR, Université Bourgogne Franche-Comté, FEMTO-ST</i>
<b>Examineur</b>	<i>François VALLEE, Professeur, Université de Mons, Belgique, EPEU</i>
<b>Examineur</b>	<i>Jérôme BOSCHE, Dr. HDR, Université de Picardie Jules Verne, MIS</i>
<b>Examineur</b>	<i>Nouredine HADJSAID, Professeur, Grenoble INP, G2ELAB</i>
<b>Membre invité</b>	<i>Vincent DEBUSSCHERE, Dr. HDR, Grenoble INP, G2ELAB</i>
<b>Directeur de thèse</b>	<i>Bruno FRANCOIS, Professeur, Centrale Lille Institut, L2EP</i>
<b>Co-directeur de thèse</b>	<i>Dhaker ABBES, Dr. HDR, Junia, L2EP</i>

Thèse préparée dans le Laboratoire L2EP

Ecole Doctorale SPI 072

**Membre du Groupe des Écoles Centrale**  
Centrale Lille

Cité Scientifique – CS20048 – 59651 Villeneuve d'Ascq Cedex – France  
Tél. + 33 (0)3 20 33 53 53 – <http://centralelille.fr>

---

## Acknowledgements

I would like to warmly thank all those who have contributed to this thesis project. This research work was carried out in Laboratory of Electrical Engineering and Power Electronics of Lille (L2EP, Laboratoire d'Electrotechnique et d'Electronique de Puissance de Lille). This thesis received financial support from China Scholarship Council (CSC), which I am sincerely appreciated.

First of all, I would like to express my sincere gratitude to Mr. Bruno FRANCOIS, who supervised my work during these three years. I appreciate his attitude towards research work, his invaluable guidance with patience, and his forward-looking view of the research field. He not only transmitted me knowledge but also taught me through his example professionalism and ethics. I would also like to warmly thank my co-supervisor Mr. Dhaker ABBES, who always provided me with constructive advices and scientific support. With his kindness, encourage and enthusiasm, it has been a real pleasure to work with him.

I am very honored that Mrs. Florence OSSART and Mr. Robin ROCHE have agreed to review this thesis. Their questions and observations were very useful to me in preparing for the thesis defense and improving the thesis. I also extend my gratitude to the president of the jury Mrs. Luce BROTCORNE, and the jury members: Mr. François VALLEE, Mr. Jérôme BOSCHE, Mr. Nouredine HADJSAID, and Mr. Vincent DEBUSSCHERE, who have evaluated my work with insightful comments during the defense.

During these three years, I had the chance to work in a very good atmosphere thanks to my colleagues in L2EP. I warmly thank them all for their enthusiasm and their listening in difficult times. I express my sincere thanks to Xingyu YAN, who has provided me with countless scientific support and guidance with great patience at the beginning of my research work. My gratitude goes to Xavier CIMETIERE, Kongseng BOUNVILAY, Loïc CHEVALLIER and Sylvie DEZODT for their kindness and help during my study at EC Lille. Many thanks to Haibo, Reda, Lorraine, Meryeme, Houssein, Emre, Ebrahim (and so many others that I cannot mention all of their names here), for their encouragement and all good times that we spent together.

I would like to give my infinite gratefulness to my family from the bottom of my heart. Nothing would have been possible without their unconditional encouragement and support during my school years. They taught me by their example how to face difficult times and that the good results only come after hard work.

Finally, my gratitude goes to my boyfriend Yuliang, who has been always understanding, patient and supportive; who gave me the strength to successfully carry out the research work; who has always been by my side with his love and trust no matter joys and sorrows.

---

# Content

<b>ACKNOWLEDGEMENTS .....</b>	<b>I</b>
<b>CONTENT.....</b>	<b>II</b>
<b>LIST OF FIGURES.....</b>	<b>VI</b>
<b>LIST OF TABLES.....</b>	<b>XI</b>
<b>LIST OF ACRONYMS AND VARIABLES .....</b>	<b>XII</b>
<b>GENERAL INTRODUCTION.....</b>	<b>2</b>
<b>CHAPTER 1 CHALLENGES AND OPPORTUNITIES OF RENEWABLE ENERGY SOURCES IN LOCAL ENERGY COMMUNITIES.....</b>	<b>10</b>
1.1 INTRODUCTION.....	10
1.2 RENEWABLE ENERGY SOURCES .....	10
1.2.1 <i>Context and motivations</i> .....	10
1.2.2 <i>Renewables in power systems: challenges</i> .....	13
1.2.3 <i>Opportunities for a better integration of renewable energy sources</i> .....	14
1.3 ENERGY MANAGEMENT IN LOCAL ENERGY COMMUNITIES.....	16
1.3.1 <i>Emergence of energy communities and evolutions</i> .....	16
1.3.2 <i>A decentralized energy community case: Local Community Microgrids</i> .....	18
1.3.3 <i>Integration of RESs, energy storage and hybrid active generators</i> .....	21
1.3.4 <i>Energy management system</i> .....	22
1.3.5 <i>Experiences in central energy management at L2EP</i> .....	25
1.4 GENERATION SCHEDULING .....	28
1.4.1 <i>State of art: Unit Commitment and Generation Scheduling</i> .....	28
1.4.2 <i>Deterministic optimization</i> .....	31
1.4.3 <i>Forecasting of RES and Uncertainties Handling</i> .....	33
1.4.4 <i>Integration of probabilistic approaches in DUC</i> .....	34
1.4.5 <i>Stochastic optimization</i> .....	35
1.5 CONCLUSION .....	37
<b>CHAPTER 2 UNCERTAINTY ANALYSIS FROM FORECASTING .....</b>	<b>40</b>
2.1 INTRODUCTION.....	40
2.2 UNCERTAINTIES IN POWER SYSTEM.....	41
2.2.1 <i>Sources of uncertainties</i> .....	41
2.2.2 <i>Solar generation uncertainty</i> .....	42
2.2.3 <i>Load demand uncertainty</i> .....	45
2.3 FORECASTING OF PV GENERATION AND LOAD DEMAND .....	47
2.3.1 <i>Fundamentals and context</i> .....	47
2.3.2 <i>BPNN application for PV production forecasting</i> .....	49
2.3.3 <i>BPNN application for load forecasting</i> .....	54
2.4 UNCERTAINTY ANALYSIS IN GENERATION SCHEDULING.....	56
2.4.1 <i>Introduction</i> .....	56



---

2.4.2	<i>Uncertainty characterization with distribution functions</i> .....	57
2.4.3	<i>Uncertainty representation in stochastic optimization</i> .....	59
2.4.4	<i>Uncertainty propagation</i> .....	62
2.4.5	<i>Sensitivity analysis</i> .....	63
2.5	CONCLUSION .....	63
<b>CHAPTER 3 DETERMINISTIC UNIT COMMITMENT UNDER UNCERTAINTY.....</b>		<b>66</b>
3.1	INTRODUCTION.....	66
3.2	STATE OF ART OF DUC WITH OR AND RESEARCH TASKS .....	67
3.2.1	<i>DUC under uncertainty</i> .....	67
3.2.2	<i>Synthesis</i> .....	67
3.3	DEALING WITH UNCERTAINTY: POWER RESERVE .....	68
3.3.1	<i>Introduction</i> .....	68
3.3.2	<i>Frequency control reserve types</i> .....	69
3.3.3	<i>Deterministic criterion for OR sizing</i> .....	71
3.3.4	<i>Probabilistic criterion with consideration of RESs uncertainties</i> .....	73
3.4	RESERVE QUANTIFICATION WITH A RISK-CONSTRAINED PROBABILISTIC METHOD .....	76
3.4.1	<i>Analysis and modelling of the uncertainty</i> .....	76
3.4.2	<i>Quantification of the power reserve</i> .....	78
3.5	RISK-BASED UC FORMULATION .....	80
3.5.1	<i>General scheme</i> .....	80
3.5.2	<i>UC objective function</i> .....	81
3.5.3	<i>UC constraints</i> .....	82
3.5.4	<i>MILP and DP methods for solving UC problems</i> .....	82
3.6	PRESENTATION OF THE URBAN MICROGRID.....	83
3.7	GENERATION SCHEDULING WITH DP .....	86
3.7.1	<i>Mathematical Formulation of the Dynamic Programming</i> .....	87
3.7.2	<i>N-1 criterion based deterministic optimization</i> .....	89
3.7.3	<i>Risk-based deterministic optimization</i> .....	92
3.8	UNCERTAINTY PROPAGATION ANALYSIS WITH PROBABILISTIC METHODS.....	94
3.8.1	<i>Characterization of PV forecast errors by confident intervals</i> .....	94
3.8.2	<i>Effect of PV uncertainty on the effective operating reserve</i> .....	95
3.9	FROM DP TO MILP .....	98
3.9.1	<i>Interests</i> .....	98
3.9.2	<i>Risk-based deterministic optimization with MILP</i> .....	100
3.10	CONCLUSION .....	101
<b>CHAPTER 4 ANTICIPATING UNCERTAINTY WITH A SCENARIO-BASED STOCHASTIC OPTIMIZATION .....</b>		<b>104</b>
4.1	INTRODUCTION.....	104
4.2	NEEDS FOR UNCERTAINTIES MODELLING IN OPERATING PLANNING .....	105
4.2.1	<i>Anticipating uncertainty with scenarios</i> .....	105
4.2.2	<i>From risk-based DUC to SUC</i> .....	107
4.3	STOCHASTIC OPTIMIZATION METHODS FOR UC .....	108
4.3.1	<i>State of the art</i> .....	108

---

4.3.2	<i>Issues and Contributions</i> .....	113
4.4	SCENARIO-BASED STOCHASTIC OPTIMIZATION ALGORITHM.....	114
4.4.1	<i>Scenario-based optimization methodology</i> .....	114
4.4.2	<i>First stage: Deterministic operational planning</i> .....	115
4.4.3	<i>Building of scenarios for the representation of uncertainty</i> .....	117
4.4.4	<i>Second stage: Stochastic operational planning</i> .....	118
4.5	APPLICATION FOR THE OPERATIONAL PLANNING WITH THE SCENARIO-BASED STOCHASTIC OPTIMIZATION .....	121
4.5.1	<i>Building of scenarios</i> .....	121
4.5.2	<i>Analysis of OR and generation scheduling</i> .....	121
4.5.3	<i>Impacts of the second stage optimization on the cost minimization</i> .....	123
4.5.4	<i>Impacts of the chosen risk criteria</i> .....	125
4.5.5	<i>Impacts of the RES self-production rate</i> .....	125
4.6	CONCLUSION .....	126
<b>CHAPTER 5 PARTICIPATION OF STORAGE FOR OPERATING RESERVE PROVISION 129</b>		
5.1	INTRODUCTION.....	129
5.2	OVERVIEW ON ENERGY STORAGE APPLICATIONS AND BENEFITS .....	130
5.2.1	<i>Home energy storage</i> .....	130
5.2.2	<i>Renewable energy time-shift</i> .....	132
5.2.3	<i>Operating reserve supply</i> .....	132
5.3	ENERGY STORAGE CONTROL STRATEGIES .....	132
5.3.1	<i>Principle and framework</i> .....	132
5.3.2	<i>Storage control strategy for power balancing (strategy 1)</i> .....	134
5.3.3	<i>Storage control strategy for power reserve provision (strategy 2)</i> .....	138
5.4	UC WITH A DETERMINISTIC OPTIMIZATION .....	140
5.4.1	<i>Presentation</i> .....	140
5.4.2	<i>Objective function</i> .....	142
5.4.3	<i>Task and data of the study case</i> .....	142
5.4.4	<i>Applications results with the power balancing strategy (1)</i> .....	142
5.4.5	<i>Applications results with the OR provision strategy (2)</i> .....	144
5.4.6	<i>Comparison of the two control strategies and discussion</i> .....	145
5.5	UC WITH A SCENARIO-BASED STOCHASTIC OPTIMIZATION.....	146
5.5.1	<i>Presentation</i> .....	146
5.5.2	<i>Building of Net Demand scenarios for uncertainties representation</i> .....	147
5.5.3	<i>Stochastic Operational Planning with a Mixed-Integer Programming Optimization..</i>	150
5.5.4	<i>Applications results with the power balancing strategy (1)</i> .....	151
5.5.5	<i>Applications results with the OR provision strategy (2)</i> .....	153
5.5.6	<i>Discussion about the two control strategies according to different uncertainties</i> .....	155
5.6	SIZING OF STORAGE UNDER UNCERTAINTY.....	159
5.6.1	<i>Principle</i> .....	159
5.6.2	<i>Load demand analysis</i> .....	160
5.6.3	<i>PV generation analysis</i> .....	164

---

5.6.4	<i>Expected net load demand</i> .....	166
5.7	CONCLUSION .....	168
<b>CHAPTER 6 MICROGRID CENTRAL ENERGY MANAGEMENT SYSTEM INTERFACE DESIGN</b>		<b>170</b>
6.1	INTRODUCTION .....	170
6.2	GUI DESCRIPTION .....	171
6.2.1	<i>MCEMS functions presentation</i> .....	171
6.2.2	<i>Home interface window design</i> .....	172
6.3	MAIN INTERFACES DESIGN .....	173
6.3.1	<i>Data collection and predictive analysis for forecasting</i> .....	173
6.3.2	<i>System uncertainty assessment and OR quantification</i> .....	175
6.3.3	<i>Deterministic optimization for operational planning</i> .....	177
6.3.4	<i>Scenario-based stochastic optimization for operational planning</i> .....	179
6.4	CONCLUSION .....	182
<b>CHAPTER 7 GENERAL CONCLUSION AND PERSPECTIVES</b> .....		<b>185</b>
<b>APPENDIX 1. BACK-PROPAGATION NEURAL NETWORK</b> .....		<b>188</b>
<b>APPENDIX 2. STATISTICS AND PROBABILISTIC THEORIES</b> .....		<b>195</b>
<b>APPENDIX 3. BRANCH-AND-CUT ALGORITHM FOR MILP</b> .....		<b>201</b>
<b>RESUME ÉTENDU EN FRANÇAIS</b> .....		<b>207</b>
<b>REFERENCES</b> .....		<b>215</b>

## List of Figures

Fig. 1-1 Global growth of renewable/ non-renewable electricity generation capacity [8] .....	12
Fig. 1-2 Global renewable energy sources capacity growth [8] .....	12
Fig. 1-3 Share of renewable energy in EU and France, base year 1990 [9] .....	13
Fig. 1-4 GHG emissions in EU and France, base year 1990 [9].....	13
Fig. 1-5 A conceptual model for community microgrid with local renewables.....	20
Fig. 1-6 Scheme of a PV based active generator in a microgrid [45] .....	22
Fig. 1-7 A conceptual model for an EMS in a microgrid community.....	23
Fig. 1-8 Timing classification of control functions in the microgrid [49]. .....	25
Fig. 1-9 Scheme of the Microgrid Central Energy Management System [45]. .....	26
Fig. 1-10 Scheme of a MG integration of prosumer and micro gas turbines [45]. .....	27
Fig. 1-11 Summary of previous research works at L2EP regarding microgrid .....	28
Fig. 1-12 Simplified scheme of a power system with generators and load. ....	29
Fig. 1-13 General scheme of an UC/generation scheduling with optimization algorithm .....	30
Fig. 1-14 DUC schemes of deterministic optimization without and with probabilistic reserve quantification .....	35
Fig. 1-15 Scheme of the SUC with stochastic optimization .....	36
Fig. 2-1 Uncertainty sources in energy system.....	41
Fig. 2-2 The correlation between UV Index and PV power .....	43
Fig. 2-3 The correlation between humidity and PV power.....	44
Fig. 2-4 The correlation between cloud cover and PV power .....	44
Fig. 2-5 The correlation between temperature and PV power .....	45
Fig. 2-6 The correlation between temperature and load power .....	46
Fig. 2-7 The correlation between PV power and load power .....	47
Fig. 2-8 PV power forecasting with ANN .....	50
Fig. 2-9 PV power forecast results on 27 <sup>th</sup> March, 2020 .....	52
Fig. 2-10 PV power forecast results on 2 <sup>nd</sup> March, 2020.....	53
Fig. 2-11 PV power forecast errors of training data at each time step.....	53
Fig. 2-12 Load power forecasting with ANN .....	54
Fig. 2-13 Load power forecast results on 2 <sup>nd</sup> March, 2020.....	55
Fig. 2-14 Load power forecast results on 24 <sup>th</sup> March, 2020 .....	55
Fig. 2-15 Load power forecast errors of training data at each time step.....	56
Fig. 2-16 General framework of handling uncertainties in energy system.....	57
Fig. 2-17 (a) Frequency distribution histogram of the PV forecast errors (b) Normal distribution of PV forecast errors at 11:00. ....	58
Fig. 2-18 A scenario tree with two stages.....	60
Fig. 2-19 A scenario tree with four stages .....	61
Fig. 3-1 Scheme of the classic approach and proposed risk-based deterministic optimization approach .....	68
Fig. 3-2 Sequential actions of primary, secondary, and tertiary frequency controls following the sudden loss of generation [179]. .....	70

---

Fig. 3-3 <i>pdf</i> of net demand forecast errors from historic database of PV and load demand forecasting errors.....	76
Fig. 3-4 Reserve calculation based on the net demand deviation $\Delta D$ with a risk index $\varepsilon$ of LOLP at 11:00.....	77
Fig. 3-5 Risk-constrained probabilistic method for reserve determination from past data. ....	78
Fig. 3-6 Risk characteristic regarding reserve at 11:00 in Villeneuve d’Ascq (Lille, France) the 23 <sup>th</sup> of June, 2020.....	79
Fig. 3-7 Half-hourly reserve requirement with $\varepsilon$ of LOLP in Villeneuve d’Ascq (Lille, France) the 23 <sup>th</sup> of June, 2020 .....	79
Fig. 3-8 General scheme of risk-based UC problem formulation.....	80
Fig. 3-9 Structure of the UC formulation.....	81
Fig. 3-10 Description of the studied energy community .....	84
Fig. 3-11 The quadratic curve fitting of the cost functions of studied three MGTs.....	85
Fig. 3-12 Half-hourly forecasted daily PV generation, and electricity consumption .....	86
Fig. 3-13 The flow chart of the presented recursive DP algorithm.....	88
Fig. 3-14 Generation planning without PV.....	89
Fig. 3-15 Operational cost at each time step without PV generation.....	89
Fig. 3-16 Obtained effective reserve without PV generation.....	90
Fig. 3-17 Generation planning under <i>N-1</i> criterion .....	90
Fig. 3-18 Operational cost at each time step under <i>N-1</i> criterion.....	91
Fig. 3-19 Obtained effective reserve under <i>N-1</i> criterion.....	92
Fig. 3-20 Optimal day-ahead generation scheduling with risk-based deterministic optimization. ....	92
Fig. 3-21 Positive effective reserve and reserve requirement.....	93
Fig. 3-22 Effective OR.....	93
Fig. 3-23 Expected, maximum and minimum operational costs .....	94
Fig. 3-24 The box plot of PV power forecasting errors at each time step. ....	95
Fig. 3-25 Forecasted PV power according to the 95 % forecast interval.....	95
Fig. 3-26 Optimal dispatching of each MGT corresponding to expected worst forecast of PV generation. ....	96
Fig. 3-27 Effective OR corresponding to the expected worst case of PV generation.....	96
Fig. 3-28 Positive effective reserve and reserve requirement.....	97
Fig. 3-29 Effective reserve at 13:00.....	97
Fig. 3-30 Expected, maximum and minimum operational costs considering expected worst case of PV generation. ....	98
Fig. 3-31 Linearization of the nonconvex cost function of studied three MGTs .....	99
Fig. 3-32 Generation planning under deterministic optimization and scheduled PV power .....	100
Fig. 3-33 Reserve requirement and obtained effective reserve with a risk-based optimization .....	101
Fig. 4-1 Comparison of forecast based planning and foresight-based planning.....	106
Fig. 4-2 Foresight framework with scenario-based scheduling .....	107
Fig. 4-3 Scheme of the proposed stochastic optimization approach in Chapter 4 and its comparison with deterministic optimization .....	107
Fig. 4-4 A two-stage scenario based stochastic optimization. ....	114
Fig. 4-5 Sequence of the two-stage stochastic programming for the reserve and energy optimization	115
Fig. 4-6 Linearization of the nonconvex emission cost function of studied three MGTs.....	116

---

Fig. 4-7 Handling uncertainties with the knowledge of past and future .....	117
Fig. 4-8 Scenario generation based on <i>pdf</i> of PV forecast error at time step $t$ .....	117
Fig. 4-9 Re-scheduling of fast generators in the second optimization stage with scenarios .....	120
Fig. 4-10 Expected PV generation under six probable scenarios .....	121
Fig. 4-11 Forecasted load demand .....	121
Fig. 4-12 Generation scheduling under stochastic optimization.....	122
Fig. 4-13 The reserve requirement for scenario 1(worst case) and effective reserve under stochastic optimization .....	123
Fig. 4-14 The fuel costs and CO <sub>2</sub> -equivalent emission costs under 6 scenarios at each time step.....	124
Fig. 4-15 Fuel cost and CO <sub>2</sub> -equivalent emission cost at 17:00.....	124
Fig. 4-16 Cost curves and emission curves regarding self-production rate .....	126
Fig. 5-1 Summary of energy storage applications .....	131
Fig. 5-2 Integration of the ESS control strategy in the generation scheduling .....	134
Fig. 5-3 Schematic diagram of ESS operation in <i>strategy 1</i> (Simplified PV power profile and load demand profile, for illustration only) .....	134
Fig. 5-4 Flowchart of storage control and reserve dispatching in <i>strategy 1</i> .....	136
Fig. 5-5 Schematic diagram of ESS operation in <i>strategy 2</i> (Simplified PV power profile and reserve requirement profile).....	138
Fig. 5-6 Flowchart of the storage control and reserve dispatching in <i>strategy 2</i> .....	140
Fig. 5-7 Deterministic operational planning with combination of storage strategy regarding reserve allocation .....	141
Fig. 5-8 Generation planning under deterministic optimization and scheduled PV power in <i>strategy 1</i> .....	143
Fig. 5-9 Reserve provided by MGTs and PV AGs at each time step under deterministic optimization in <i>strategy 1</i> .....	143
Fig. 5-10 AG power, battery power and SOC of batteries at each time step under deterministic optimization in <i>strategy 1</i> .....	143
Fig. 5-11 Generation planning under deterministic optimization and scheduled PV power in second strategy .....	144
Fig. 5-12 Reserve provided by MGTs and PV AGs at each time step under deterministic optimization in <i>strategy 2</i> .....	144
Fig. 5-13 AG power, battery power and SoC at each time step under deterministic optimization in <i>strategy 2</i> .....	145
Fig. 5-14 Reserve requirement and obtained effective reserve after the deterministic-based method .	146
Fig. 5-15 Scenario-based stochastic operational planning with combination of storage strategy regarding reserve allocation.....	147
Fig. 5-16 <i>pdf</i> analysis based net load demand scenario generation .....	148
Fig. 5-17 Reserve requirement under each scenario.....	149
Fig. 5-18 Generation planning under scenario-based optimization and storage control <i>strategy 1</i> .....	151
Fig. 5-19 Power reserve provided by MGTs and PV AGs under scenario 4.....	152
Fig. 5-20 AG power, battery power and battery energy at each time step under scenario 4.....	152
Fig. 5-21 Reserve requirement, reserve from PV AGs and MGTs at 11:00 with Strategy 1 .....	153
Fig. 5-22 Reserve requirement, reserve from PV AGs and MGTs at 16:30 with Strategy 1 .....	153
Fig. 5-23 Generation planning under scenario-based optimization and storage control <i>strategy 2</i> .....	153

---

Fig. 5-24 Power reserve provided by MGTs and PV AGs under scenario 4.....	154
Fig. 5-25 AG power, battery power and battery energy at each time step under scenario 4.....	154
Fig. 5-26 Reserve requirement, reserve from PV AGs and MGTs at 16:30 with Strategy 2.....	155
Fig. 5-27 Reserve requirement and obtained effective reserve under scenario 4.....	157
Fig. 5-28 Reserve requirement and obtained effective reserve under scenario 6.....	157
Fig. 5-29 Pareto-optimal fronts for the multi-objective optimization of the CO <sub>2</sub> equivalent emission and operational cost.....	158
Fig. 5-30 Probabilistic analysis and <i>pdf</i> of load demand in spring.....	161
Fig. 5-31 Probabilistic analysis and <i>pdf</i> of load demand in summer.....	162
Fig. 5-32 Probabilistic analysis and <i>pdf</i> of load demand in autumn.....	163
Fig. 5-33 Probabilistic analysis and <i>pdf</i> of load demand in winter.....	163
Fig. 5-34 <i>pdf</i> -based probabilistic analysis of PV generation in spring.....	164
Fig. 5-35 <i>pdf</i> -based probabilistic analysis of PV generation in summer.....	165
Fig. 5-36 <i>pdf</i> -based probabilistic analysis of PV generation in autumn.....	165
Fig. 5-37 <i>pdf</i> -based probabilistic analysis of PV generation in winter.....	165
Fig. 5-38 <i>pdf</i> -based expected net demand in spring.....	166
Fig. 5-39 <i>pdf</i> -based expected net demand in summer.....	166
Fig. 5-40 <i>pdf</i> -based expected net demand in autumn.....	167
Fig. 5-41 <i>pdf</i> -based expected net demand in winter.....	167
Fig. 6-1 Urban MCEMS functions and the applied methods/strategies.....	172
Fig. 6-2 Home Interface Window of the MCEMS.....	173
Fig. 6-3 The layout design of “Data Collection and Predictive Analysis for Forecasting” interface... ..	173
Fig. 6-4 The “Data Collection and Predictive Analysis for Forecasting” interface.....	175
Fig. 6-5 The layout design of “System uncertainty assessment and OR quantification” interface.....	175
Fig. 6-6 The “System uncertainty assessment and OR quantification” interface.....	176
Fig. 6-7 The layout design of “Deterministic optimization for operational planning” interface.....	177
Fig. 6-8 The “Deterministic optimization for operational planning” interface.....	178
Fig. 6-9 The “MGTs” sub-interface.....	178
Fig. 6-10 The layout design of “Scenario-based stochastic optimization for operational planning” interface.....	179
Fig. 6-11 The “Scenario-based stochastic optimization for operational planning” interface.....	181
Fig. 6-12 “PV Active Generators” sub-interface.....	182
Fig. 6-13 “MGTs” sub-interface.....	182
Fig. 7-1 Schemes of deterministic, probabilistic and stochastic optimization.....	185
Fig. A1- 1 Forecasting by ANN application.....	188
Fig. A1- 2 The structure of a three-layer BP network.....	188
Fig. A1- 3 Flow chart of BPNN procedure.....	191
Fig. A2- 1 An example of probability distribution of discrete random variable.....	196
Fig. A2- 2 Some examples of probability distributions of continuous random variable.....	196
Fig. A2- 3 Probability density function of a normal distribution.....	197
Fig. A2- 4 <i>pdf</i> and <i>cdf</i> of a normal distribution.....	198
Fig. A2- 5 Boxplot and <i>pdf</i> .....	199
Fig. A3- 1 Examples of IP problems with unsatisfying rounded solutions from LP relaxations [61]..	202
Fig. A3- 2 An example of a branch-and-bound tree.....	203

---

Fig. A3- 3 The flowchart of the branch-and-cut algorithm .....	204
Fig. A3- 4 An example of cutting planes .....	204
Fig. R- 1 Comparaison des approches d'optimisation déterministe et stochastique sous incertitude ...	213



---

## List of Tables

Table G0-1 Summary of the thesis contents and organization .....	7
Table 1-1 EMS functions regarding different time scales.....	24
Table 2-1 BPNN based- PV forecast errors.....	53
Table 2-2 BPNN-based load forecast errors .....	56
Table 2-3 Probability distributions for uncertainty characterization .....	58
Table 3-1 Deterministic reserve criterion of power system operators in different regions.....	73
Table 3-2 Reserves and daily operational costs under PV uncertainties.....	98
Table 3-3 The comparison of DP and MILP.....	100
Table 4-1 Summary of optimization methods for operational planning in microgrid (or isolated systems).....	111
Table 4-2 Fuel costs and CO <sub>2</sub> equivalent emission costs results.....	124
Table 4-3 Comparison of results under different risk criteria.....	125
Table 5-1 Comparison of presented energy storage control strategies .....	133
Table 5-2 Power values (in kW) for some operating points .....	137
Table 5-3 Values of parameters regarding PV AGs .....	142
Table 5-4 Day-ahead deterministic-based operational planning results comparison .....	145
Table 5-5 Allocated reserve, PV self-production rate and PV self-consumption rate.....	146
Table 5-6 Daily PV energy, daily net load demand energy and daily stored energy under each scenario .....	149
Table 5-7 Means and standard deviations regarding reserve requirement, reserve from PV AGs and MGTs under strategy 1.....	153
Table 5-8 Means and standard deviations regarding reserve requirement, reserve from PV AGs and MGTs under strategy 2.....	155
Table 5-9 Day-ahead scenario-based stochastic operational planning results comparison .....	155
Table 5-10 Reserve provision in storage control <i>strategy 1 / 2</i> under each scenario .....	156
Table 5-11 The comparison of optimization implementation in Chapter 3,4 and 5 .....	159
Table 5-12 Types of the days regarding seasons .....	160
Table 5-13 Types of the days regarding workdays/non-workdays.....	161
Table 5-14 Expected energy surplus regarding different seasons and types of days.....	168
Table 6-1 Main interfaces and function modules .....	171
Table 6-2 Summary of used data for ANN training and ANN-based PV power/load demand forecast .....	174

---

## List of Acronyms and variables

### *Acronyms*

<i>AG</i>	Active Generators
<i>ANN</i>	Artificial Neural Network
<i>ARIMA</i>	Autoregressive Integrated Moving Average
<i>AS</i>	Ancillary Service
<i>BB</i>	Branch and Bound
<i>BP</i>	Back-Propagation
<i>BPNN</i>	Back-Propagation Neural Network
<i>CCO</i>	Chance-constrained Optimization
<i>CAPEX</i>	Capital Expense
<i>cdf</i>	Cumulative Distribution Function
<i>CERTS</i>	Consortium for Electric Reliability Technology Solutions
<i>CHP</i>	Combined Heat Production
<i>CVaR</i>	Conditional Value-at-Risk
<i>DC</i>	Direct Current
<i>DER</i>	Distributed Energy Resource
<i>DG</i>	Distributed Generation
<i>DMS</i>	Distribution Management System
<i>DP</i>	Dynamic Programming
<i>DR</i>	Demand-side Response
<i>DSO</i>	Distribution System Operator
<i>DUC</i>	Deterministic Unit Commitment
<i>E-box</i>	Energy Box
<i>ECOA</i>	Enhanced Cuckoo Optimisation Algorithm
<i>EENS</i>	Expected Energy Not Served
<i>ELNS</i>	Expected Load Not Served
<i>EMS</i>	Energy Management System
<i>ENTSO-E</i>	European Network of Transmission System Operators for Electricity
<i>ESS</i>	Energy storage system
<i>EU</i>	European Union
<i>EV</i>	Electric Vehicle
<i>GDP</i>	Gross Domestic Product
<i>GHG</i>	Greenhouse gas
<i>GUI</i>	Graphical User Interface
<i>IEA</i>	International Energy Agency
<i>IEAR</i>	Interrupted Energy Assessment Rates
<i>IP</i>	Integer Programming
<i>IPCC</i>	Intergovernmental Panel on Climate Change
<i>IRENA</i>	International Renewable Energy Agency
<i>L2EP</i>	Laboratory of Electrical Engineering and Power Electronics
<i>LC</i>	Local Controller

---

<i>LOLC</i>	Loss of Load Cost
<i>LOLP</i>	Loss Of Load Probability
<i>LP</i>	Linear Programming
<i>LR</i>	Lagrangian Relaxation
<i>MCEMS</i>	Microgrid Central Energy Management System
<i>MGCC</i>	Microgrid Central Controller
<i>MGT</i>	Micro Gas Turbine
<i>MILP</i>	Mixed-Integer Linear Programming
<i>MINLP</i>	Mixed-Integer Nonlinear Programming
<i>MIP</i>	Mixed Integer Programming
<i>MPC</i>	Model-based Predictive Control
<i>ND</i>	Net Demand
<i>NN</i>	Neural Network
<i>nRMSE</i>	Normalized Root Mean Square Error
<i>nMAE</i>	Normalized Mean Absolute Error
<i>OPEX</i>	Operating Expense
<i>OR</i>	Operating Reserve
<i>P2P</i>	Peer-to-peer
<i>pdf</i>	Probability Density Function
<i>PEV</i>	Plug-in Electric Vehicle
<i>PSO</i>	Particle Swarm Optimization
<i>p.u.</i>	Per Unit
<i>PV</i>	Photovoltaic
<i>RES</i>	Renewable Energy Source
<i>RUC</i>	Robust Unit Commitment
<i>SD</i>	Standard Deviation
<i>SO</i>	Stochastic Optimization
<i>SOC</i>	State Of Charge
<i>SUC</i>	Stochastic Unit Commitment
<i>UC</i>	Unit Commitment
<i>UCTE</i>	Union for Coordination of Transmission of Electricity
<i>UV</i>	Ultraviolet
<i>VOLL</i>	Value of Lost Load

### **Variables**

$\delta_m(t)$	Commitment of generator $m$ at time step $t$ ; $\delta_m(t) \in \{0,1\}$ .
$\delta_{m,\omega}(t)$	Commitment of generator $m$ with scenario $\omega$ at time step $t$ .
$u_m(t)$	Generator $m$ is starting up at the beginning of time step $t$ ; $u_m(t) \in \{0,1\}$ .
$u_{m,\omega}(t)$	Generator $m$ is starting up at the beginning of time step $t$ in scenario $\omega$ .
$d_m(t)$	Generator $m$ is shutting down at the beginning of time step $t$ ; $d_m(t) \in \{0,1\}$ .

---

$d_{m,\omega}(t)$	Generator $m$ is shutting down at the beginning of time step $t$ in scenario $\omega$ .
$p_m(t)$	The power generation set point of generator $m$ at time step $t$ .
$p_{m,\omega}(t)$	The power generation set point of generator $m$ with scenario $\omega$ at time step $t$ .
$p_{ag}(t)$	The power generation of active PV generator $a$ at time step $t$ .
$p_{ag,\omega}(t)$	The power generation of active PV generator $a$ with scenario $\omega$ at time step $t$ .
$SoC(\tau)$	The state of charge (SoC) of batteries during time interval $\tau$ .
$SoC_\omega(\tau)$	The state of charge (SoC) of batteries during time interval $\tau$ in scenario $\omega$ .
$E_{bat}(\tau)$	The actual energy stored in battery during time interval $\tau$ .
$E_{bat,\omega}(\tau)$	The actual energy stored in battery during time interval $\tau$ in scenario $\omega$ .
$p_c(t)$	Power of charging batteries (PV AGs) at $t$ .
$p_{c,\omega}(t)$	Power of charging batteries (PV AGs) at $t$ in scenario $\omega$ .
$p_d(t)$	Power of discharging batteries (PV AGs) at $t$ .
$p_{d,\omega}(t)$	Power of discharging batteries (PV AGs) at $t$ in scenario $\omega$ .
$r_{mgt}(t)$	The total allocated reserve power provided by MGTs at time step $t$ .
$r_{mgt,\omega}(t)$	The total allocated reserve power provided by MGTs at time step $t$ in scenario $\omega$ .
$r_{ag}(t)$	The total allocated reserve power provided by PV AGs at time step $t$ , including reserve power provided by PV generation $r_{pv}(t)$ and by batteries $r_{bat}(t)$ , i.e. $r_{ag}(t) = r_{pv}(t) + r_{bat}(t)$ .
$r_{ag,\omega}(t)$	The total allocated reserve power provided by PV AGs at time step $t$ in scenario $\omega$ .

### ***Time series***

$l(t)$	The load demand forecast at time step $t$ .
$l_\omega(t)$	The load demand forecast with scenario $\omega$ at time step $t$ .
$D(t)$	The net demand forecast at time step $t$ , the difference between the total load demand forecast and photovoltaic generation forecast.
$D_\omega(t)$	The net demand forecast with scenario $\omega$ at time step $t$ , the difference between the total load demand forecast and photovoltaic generation forecast in scenario $\omega$ .
$C(t)$	The total conventional generation capacity of all the generators at time step $t$ .
$\underline{r}(t)$	Allocated operating reserve requirements at time step $t$ .
$\underline{r}_\omega(t)$	Expected operating reserve requirements with scenario $\omega$ at time step $t$ .

### ***Parameters***

$\varepsilon$	Risk index of LOLP (Loss of Load Probability).
---------------	------------------------------------------------

---

$\underline{p}_m, \bar{p}_m$	Minimum and maximum power generation limits of generator $m$ .
$\bar{p}_{bat}$	Charge or discharge power limits of active PV generator.
$SoC_{min}, SoC_{max}$	Safety lower bound and upper bound of state of charge of batteries.
$C_{bat}$	Nominal capacity of batteries.
$\eta$	Charging efficiency
$\mu$	Discharging efficiency
$c_m^u$	Start-up penalties on operating costs.
$c_m^d$	Shutdown penalties on operating costs.
$ce_m^u$	Start-up penalties on emission costs.
$ce_m^d$	Shutdown penalties on emission costs.

### Sets and indices

$m \in \mathcal{M}$	Set of conventional generators.
$m \in \mathcal{M}^{SLOW}$	Set of slow-start conventional generators; $\mathcal{M}^{SLOW} \subseteq \mathcal{M}$
$m \in \mathcal{M}^{FAST}$	Set of fast-start conventional generators; $\mathcal{M}^{FAST} \subseteq \mathcal{M}$
$t \in \mathcal{T}$	Set of time steps.
$t \in \mathcal{T}_d$	Set of time steps when batteries are capable of discharging
$a \in \mathcal{A}$	Set of active PV generators.
$\omega \in \mathcal{W}$	Set of scenarios.
$\Delta$	Feasible set of $\delta_m(t)$ under deterministic algorithm, or $\delta_{m,\omega}(t)$ under stochastic algorithm.
$p$	Feasible set of $p_m(t)$ under deterministic algorithm, or $p_{m,\omega}(t)$ under stochastic algorithm.
$r$	Feasible set of $r_m(t)$ under deterministic algorithm, or $r_{m,\omega}(t)$ under stochastic algorithm.
$\Delta, p, r \in \mathcal{F}$	Set of feasible solutions.

### Functions

$c_m(p_m(t))$	The operating costs for generator $m$ producing $p_m(t)$ or $p_{m,\omega}(t)$ .
$ce_m(p_m(t))$	The CO <sub>2</sub> equivalent emission costs for generator $m$ producing $p_m(t)$ or $p_{m,\omega}(t)$ .

# GENERAL INTRODUCTION

## GENERAL INTRODUCTION

### *Context and motivations*

In order to reach a sustainable ecological footprint in a long-term perspective, the European Union (EU) has proposed the well-known “20-20-20” targets in 2007. Thereafter, European Commission adopted new climate and energy framework by 2030 [1]. The 2030 targets include a decrease of 40% greenhouse gas (GHG) emissions from 1990 levels, as well as a higher share for renewable energy and an improvement in energy efficiency. These EU actions show the way towards the safe and prosperous low-carbon future for the environment and the economy.

### **Renewable Energy Sources Integration in Local Energy Communities**

Driven by EU climate actions and climate policy, many sectors have realized that opportunities exist for the economy when fighting global warming. For instance, with the emerging need of renewable energy sources (RESs), there is an increasing demand of technologies and devices for competitiveness and innovation. Sectors have developed sustainable buildings (e.g. household with photovoltaic panels), clean transports (electric vehicles), energy efficient products/solutions, etc. Meanwhile, by favoring renewable energy and energy efficient solutions, the dependence on imported energy is also reduced.

More and more renewable energy power plants, like solar and wind, lead to a new trend of energy generation approach: distributed generation (DG). Different from the traditional centralized power supply from large conventional non-renewable power plants, the DG provides electricity that is locally produced and consumed, avoiding losses from transmission and distribution of electricity. The emergence of DG shows its advantages and prospects in energy communities due to environmental-friendly characteristics and better power system efficiency.

With the emergence of RESs and DGs, the production and distribution of electricity is progressively moving from a traditional centralized structure to a decentralized structure. More and cleaner energy communities, like community microgrids, are emerging to bring social, environmental, economic opportunities and challenges in local energy production and use. A microgrid aims to construct small electrical systems that could manage the electricity balancing locally in sub-sections of the grid. It should be designed to improve the energy welfare of consumers: reduce local costs and emissions, to improve reliability and to provide an efficient electrical generation to local loads without transmission losses.

To well integrate RESs into community microgrids, advanced appliances and technologies, such as intelligent energy management systems, secure electrical

infrastructure and up-to-date energy storage devices, are required to provide efficiently electricity with a high reliability.

### **Handling RES Uncertainty with Operating Power Reserve**

RESs, like wind and solar, are highly dependent on meteorology, which induce unpredictable variability. Fortunately, RES electricity production is predictable but with forecasting errors. Due to this uncertainty, new challenges have occurred in the planning and operation of microgrids. RES uncertainty should be properly tackled to balance locally demand and supply with limited risks ensuring a secure operating of the electrical network.

When an unexpected imbalance between supply and demand appears, system operators and automatic controllers use an available generating capacity, the so-called Operating Reserve (OR) power, to compensate the power deficit. The OR should be well sized and ideally allocated to minimize operational costs while keeping a satisfying security level. In a traditional electrical power grid, OR is prescribed to handle generator losses and uncertainties from load demand. With more RES, the requirement of OR will be largely increased especially during the time period when there is a high variability and uncertainty of RES.

Under this context, uncertainties from RESs and load forecasting errors must be properly handled by an appropriate and reasonable OR provision and OR allocation. Risk-based uncertainty assessment approaches can be adopted. Emphasis should be given on studying the trade-off between a secure and an economic operation of power systems.

### **OR Provision with RESs with the Integration of Energy Storage System**

OR provision has an economic cost (CAPEX and OPEX) as well as an environmental cost. Traditionally, the OR is provided by conventional generating units to ensure the availability of the power supply in case of emergency. In terms of RESs, their use are limited regarding OR provision due to their intermittent generation. However, with the emerging of advanced energy storage technologies, the potential and merit of OR provision by RESs are interesting to be explored and considered. With the integration of energy storage system (ESS), hybrid and active RES are capable of providing more ancillary services by a wide range of ESS applications, e.g. electric supply reserve capacity, voltage support, primary frequency support, etc.

For the prospect, it is promising to find optimal solutions for providing OR with stored renewable energy in ESS as it is a clean technology without CO<sub>2</sub> emissions. OR allocation should be optimized regarding the availability of RES and the ESS state of charges.



**Day-Ahead Generation Scheduling with Deterministic/Stochastic Optimization**

In an electrical system, the unit commitment and power scheduling plans the operating of generating units over a short-term planning horizon in order to satisfy the load demand under system operating constraints. From the day-ahead forecasting of the load demand (and renewable energy generation if RESs are incorporated), an optimization algorithm classically finds the optimal operation set points of all controllable generators that minimize the global operational costs. Today, deterministic unit commitment (DUC) problems address the short-term scheduling of generators by assuming that all predictions regarding consumption and production from intermittent renewable energy are fixed and certain.

The high penetration of renewable energy increases power system uncertainty while demands on the electrical system reliability are growing. Hence, traditional deterministic approaches for UC should evolve to stochastic optimization. Stochastic unit commitment (SUC) has been introduced as a promising tool to deal with power generation problems involving uncertainties by including uncertainties in the solution search. However, the computational efficiency in terms of complexity and execution time is always an issue. Meanwhile, the non-convex characteristics of the problem formulation (objective function and/or constraints) are also an obstacle during the search of a feasible solution.

To overcome the drawbacks of DUC and SUC, advanced approaches should be considered and developed. As examples, probability-based DUC is a compensating solution to handle the RES uncertainty by applying probability distribution analysis. Regarding the SUC, more efficient computing methods are required (tractability), and an expressive mathematical formulation should be searched and built to make the problem easy to solve (expressiveness). The essential is the trade-off between the expressiveness of the approach and the tractability of the model.

***Tackled Problems and Objectives***

The main goal of this thesis is to propose a stochastic optimization methodology for optimal generation scheduling decisions in an urban microgrid with the wish to minimize operating costs and CO<sub>2</sub> emissions. Power and reserve provision must take into account the uncertainty due to RES and the demand side forecasting errors, while considering the trade-off between security and economic operation. Specifically, the following problems are addressed:

1. Reserve scheduling: With a probabilistic reliability assessment approach, reserve requirements should be well quantified and scheduled beforehand to ensure the security level and reduce the risks due to load and RESs uncertainties.
2. Deterministic optimization of the generation scheduling considering probabilistic reserve requirement constraints in the presented microgrid.
3. Development of algorithms and tools for stochastic optimization of the generation scheduling: Stochastic security constrained generation scheduling need to be

developed to include RESs & load uncertainties in the solution search. Optimal generation scheduling decisions need to be made regarding the expected mono-objective and multi-objective targets.

4. Contribution of energy storage systems to the provision of power reserve: When energy storage system (ESS) is implemented, optimal storage strategies should be made regarding the benefit target of the electrical network. e.g. to optimize the portion of RES energy for reserve provision, or to minimize the operating/emission costs.

### ***Scientific Roadmap and Thesis Structure***

In Chapter 1, the state of art of RESs in energy community/microgrids is reviewed. Energy management system is discussed regarding functions and control architecture. The studied microgrid is introduced. It contains hybrid PV active generators composed of renewable energy sources and storage units, micro gas turbines and loads. Meanwhile, the generation scheduling approaches under uncertainties are reviewed in terms of deterministic and stochastic optimization.

In Chapter 2, the sources of uncertainties in energy system are introduced, and PV uncertainty/load uncertainty are discussed in detail. Then; the uncertainty analysis of the energy system is presented. The correlation between PV generation and meteorological factors are investigated, as well as the correlation between load and temperature. A neural network-based algorithm is implemented to forecast PV power and load demand one day ahead.

In Chapter 3, a review of DUC is firstly presented as well as the interest to have an OR. Various criterions to size the OR are summarized regarding deterministic considerations (as the N-1 criterion) and probabilistic approaches using an assumed risk. Then with the obtained forecast errors of PV and load forecasting in Chapter 2, an OR determination method is presented by employing forecast uncertainties assessment. Thereafter, a deterministic planning is formulated and solved by a DP algorithm. Then, a study of the uncertainty propagation is undertaken in the deterministic UC solving with uncertain inputs and the impact onto the used OR is quantified. Finally, mixed-integer linear programming (MILP) approach is introduced and applied for operational planning for the studied microgrid. Obtained results with DP and MILP are compared.

In Chapter 4, following a review of SUC techniques under uncertainty, a robust approach is built with a scenario-based optimization. Uncertainties are considered through various considered PV production scenarios with their probabilities. Thus uncertainties are included in the process of the solution search. The MILP is applied to search for optimal solutions with an economic objective, environmental objective, or a tradeoff of both of them.

In Chapter 5, energy storage applications are introduced. Then two storage control strategies are presented for two applications: time-shift of electricity injection from renewable energy and provision of ancillary services. Under these two storage control strategies, a scenario-based multi-objective stochastic optimization is implemented with different optimization criteria: economic, environmental and the both. In addition, different OR allocation strategies among ESS and gas turbines are considered under different storage control strategies. Finally, the sizing methods of the storage are reviewed, followed by an application of a proposed storage sizing approach with a probabilistic analysis regarding the consideration of seasons and load types.

In Chapter 6, a user-friendly simulation tool of microgrid central energy management system (MCEMS) is developed with MATLAB/GUI (graphical user interface) to visualize the operational planning process with different optimization approaches. The MCEMS interface facilitates day-ahead energy management and uncertainty analysis in microgrid, since it provides a better way of integrating all EMS function modules. Interface design visualizes the energy management process in terms of data collection, PV generation and load demand forecasting, system uncertainty analysis, OR quantification, and operational planning with deterministic/stochastic optimization.

In Chapter 7, conclusions are made with discussions and recommendations for future research works are formulated.

The summary of the thesis contents and organization of chapters are illustrated in Table G0-1 regarding states of art, scientific developments (in terms of methods and algorithms) and applications.

Table G0-1 Summary of the thesis contents and organization

	State of Art	Methods/Algorithms developed	Applications
<b>Chap. 1</b>	<ul style="list-style-type: none"> <li>▪ Challenges and opportunities of RES</li> <li>▪ EMS of microgrids</li> <li>▪ Generation scheduling under uncertainties regarding deterministic and stochastic optimization methods</li> </ul>		
<b>Chap. 2</b>	<ul style="list-style-type: none"> <li>▪ Sources of uncertainties in energy systems</li> <li>▪ Uncertainty analysis procedure</li> </ul>	<ul style="list-style-type: none"> <li>➔ Back-Propagation Neural Network (BPNN)</li> </ul>	<ul style="list-style-type: none"> <li>➔ PV power generation forecast and load demand forecast with BPNN</li> </ul>
<b>Chap. 3</b>	<ul style="list-style-type: none"> <li>▪ Operating Reserve, deterministic OR criterion and probabilistic OR criterion</li> <li>▪ Risk-based UC approaches</li> </ul>	<ul style="list-style-type: none"> <li>➔ Determination of reserve with uncertainty assessment method</li> <li>➔ Mathematical formulation of UC</li> <li>➔ DP approach</li> <li>➔ MILP approach</li> </ul>	<ul style="list-style-type: none"> <li>➔ Risk-constrained UC scheduling with DP</li> <li>➔ Uncertainty propagation analysis with probabilistic methods</li> <li>➔ Risk-constrained deterministic operational planning with MILP</li> </ul>
<b>Chap. 4</b>	<ul style="list-style-type: none"> <li>▪ Stochastic-based UC</li> </ul>	<ul style="list-style-type: none"> <li>➔ Representation of uncertainty with scenarios</li> <li>➔ Formulation of scenario-based stochastic UC</li> </ul>	<ul style="list-style-type: none"> <li>➔ Deterministic and stochastic operational planning with MILP for the multi-objective optimization</li> </ul>
<b>Chap. 5</b>	<ul style="list-style-type: none"> <li>▪ Energy storage applications and benefits</li> <li>▪ Sizing of the storage</li> </ul>	<ul style="list-style-type: none"> <li>➔ Two storage control strategies</li> </ul>	<ul style="list-style-type: none"> <li>➔ Implementation of both storage strategies in the multi-objective scenario-based stochastic optimization method</li> <li>➔ Sizing of storage with probabilistic analysis.</li> </ul>
<b>Chap. 6</b>	<ul style="list-style-type: none"> <li>▪ Simulation tools of MCEMS</li> </ul>		<ul style="list-style-type: none"> <li>➔ A MATLAB/GUI based user-friendly urban MCEMS is developed</li> </ul>



# CHAPTER 1

# CHAPTER 1 CHALLENGES AND OPPORTUNITIES OF RENEWABLE ENERGY SOURCES IN LOCAL ENERGY COMMUNITIES

## *1.1 Introduction*

The capacity deployment of distributed energy resources (DERs) is showing its increasing trend with more and more integration of distributed generators (DGs). As a result, energy communities have emerged with individual community energy requirement [2].

In the coming decades, traditional centralized electricity supply structure is greatly challenged as the households/communities are transformed gradually from electrical ‘passive consumers’ to ‘prosumers’ (producer + consumer) and finally to active “prosumers” providing also ancillary services for the technical management of the electrical network. With the rapid increase of renewable energy technologies applications, communities have been involved in electricity provision and energy projects in many countries. There are diverse motivations, including environmental profits for more sustainable and renewable energy [3]; economic profits with social and technological innovations, e.g. more options for customer-oriented autonomous energy management, more flexible electricity tariffs, or concerns about social equity problems [4].

Under this context, the challenges and opportunities arising from these motivations should be focused and addressed. First, this chapter presents a current state of the art regarding the development of RES and local energy communities. Then, backgrounds on energy management systems are introduced with a review of research activities on this topic at the laboratory. Fundamentals on generation scheduling in an energy system are recalled then bibliographic reviews are given on employed deterministic optimization techniques. The problem of uncertainties is introduced and stochastic optimization techniques are reviewed. Hence, a synthesis of relevant information paves the scientific roadmap, that is developed in next chapters.

## *1.2 Renewable Energy Sources*

### *1.2.1 Context and motivations*

Electricity generation keeps rising in recent decades, satisfying a growing energy need in worldwide. According to IEA (International Energy Agency), global electricity demand has grown by 4% in 2018 to more than 23 000 TWh, contributing to a growth of 20% in total final consumption of energy [5]. Currently, fossil fuels, like coal, natural gas and oil, are the main sources of world electricity generation.

However, fossil fuel consumption leads to potential energy crisis in the future. With the limited non-renewable sources, more sustainable approaches are required. Furthermore, fossil fuels bring greenhouse gas (GHG) emissions, which contribute to the global warming. An IPCC (Intergovernmental Panel on Climate Change) special report showed the impacts of global warming of 1.5 °C on natural and human systems, and analyzed the threat of climate change [6].

To address these problems, many countries and regions have taken strong initiatives to increase their energy efficiency and renewable energy capacity. There has been a large increase in international agreements and national energy action plans. In March 2007, the European Union (EU) leaders have set so-called “20-20-20 targets” for the year 2020, aiming to a reduction of GHG emissions by 20% from 1990 levels, an increase of renewable energy's market share to 20%, and a 20% increase in energy efficiency. On the basis of 2020 targets, the “2030 climate and energy targets” were adopted by the European Council in October 2014, and were revised upwards in 2018. The targets for 2030 are [1]:

- Reduction of GHG emissions by 40% compared with 1990 levels,
- Increase of renewable energy by 32%,
- Improvement in energy efficiency by 32.5%.

In December 2015, the Paris Agreement sets a goal to limit the increase in global average temperature to well below 2°C above pre-industrial levels, and to attempt to limit the increase to 1.5°C. Implicit in these goals is the need for a low-carbon energy sector. All these targets and international agreements are decided to ensure the **decarbonization in European energy system** with net-zero GHG emissions by 2050.

Triggered by these demands and motivations, renewable energy sources (RES) are promoted to make more reliable, cost-effective, and environmental-friendly energy generation. The growth of RES, like hydropower, wind, solar, geothermal, biopower, has accelerated in the last decade. According to the International Renewable Energy Agency (IRENA), during 2009-2018, the renewable energy capacity has been doubled, with 1221 gigawatts (GW) of renewable energy added to the global electric power system [7]. The share of renewables in total generation capacity has increased from 22% to 33% over the period 2001-2018. In terms of the growth rate, a long-term growth in renewable generation capacity and its contribution to the global energy transition is given in Fig. 1-1. The share of renewables in the growth of electricity generation capacity (percentage of renewables in net capacity growth) has increased from about 25% in 2001, passing 50% in 2012 to reach 63% in 2018. On the contrary, as the figure shows, the expansion of non-renewable generation capacity has shown a slight sign of slowing down.



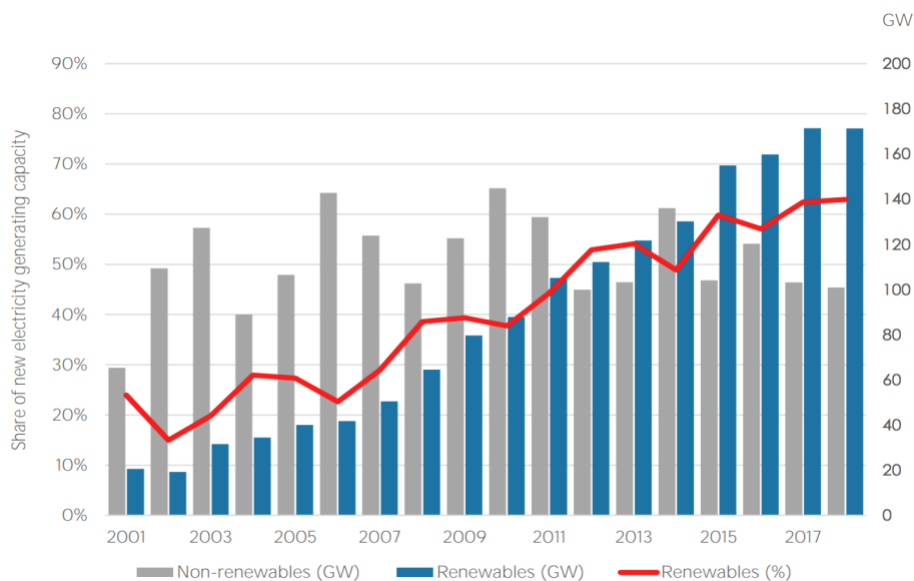

Fig. 1-1 Global growth of renewable/ non-renewable electricity generation capacity [8]

Fig. 1-2 shows renewable generation capacity growth. In 2018, solar energy continues to dominate as in 2017, with a capacity increase of 94 GW (+24%). It is followed by wind energy with an increase of 49 GW (+10%), and hydropower capacity increased by 21 GW (+2%).

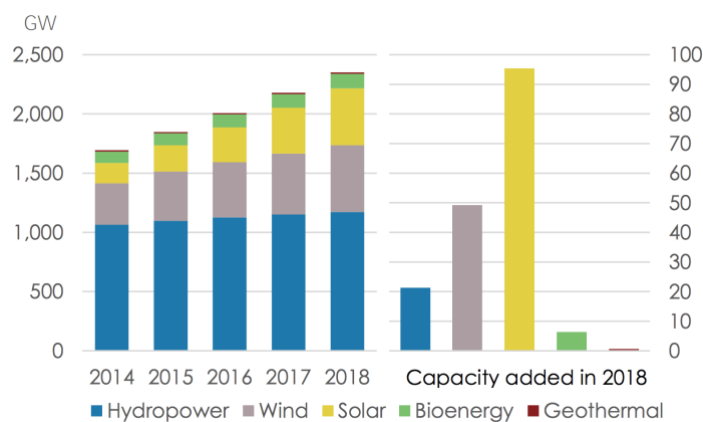

Fig. 1-2 Global renewable energy sources capacity growth [8]

The EU has made efforts to achieve the 2020 target of increasing share of renewable energy as well as reducing the GHG emissions. Fig. 1-3 shows the increasing trend of renewable energy in EU, reaching around 18% in 2018. However, the objective of 20% is not expected to be reached in 2020 with the current increasing rate.

In terms of GHG emissions in Fig. 1-4, the target has already been reached in 2013 with 20% of reduction in EU compared with 1990 levels. Whereas, the reduction rate becomes showing a stable, even a slight fluctuate trend since 2014. This implies that related measures and incentives that implemented were not enough to close the gap to

the 2020 goal. Similar trends can be observed in France regarding GHG emissions and the integration of renewable generation. Especially GHG emissions are far from attaining the goal of reduction. Overall, despite that the impressive growth of renewables, the transition to low-carbon European energy system will require more efforts not only on expanding renewable capacity, but also on retiring or converting more of their existing fossil fuel power plants.

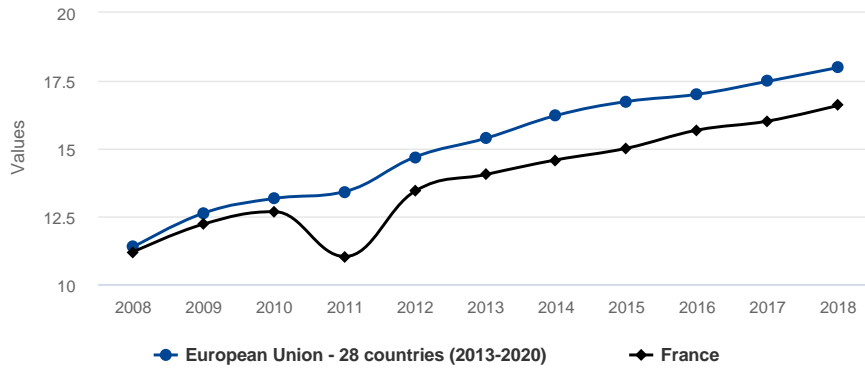

Fig. 1-3 Share of renewable energy in EU and France, base year 1990 [9]

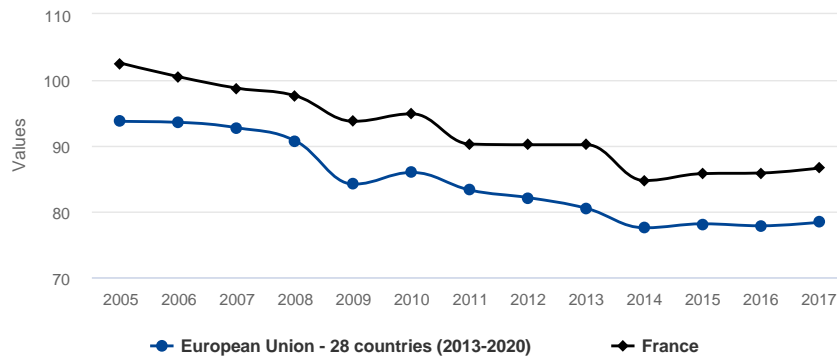

Fig. 1-4 GHG emissions in EU and France, base year 1990 [9]

### 1.2.2 Renewables in power systems: challenges

The electricity sector is experiencing its most drastic transformation since its creation, more than a century ago. Electricity is increasingly relying more on lighter industrial sectors, services and digital technologies. Its share in global final consumption is approaching 20% and is set to rise further. Policy support and technology cost reductions are leading to a rapid growth in variable renewable sources for electricity generation. Emissions reduction efforts are thus made by power sectors. Whereas, the entire system relating energy and electricity is required to operate differently from the past in order to ensure reliable supply.

Affordability, reliability and sustainability are closely interlinked in power systems. Each of them, and the trade-offs between them, require a comprehensive approach to energy policy. For example, wind and solar photovoltaics (PV) bring a major source of affordable, low-emissions electricity, but create additional requirements for the reliable operation of power systems. Furthermore, managing potential shortfalls in supply is a must for suppliers of interconnected global market [10]. The challenges of integrations of RES in power systems are summarized as follows.

Firstly, **the installations of some RESs are limited by geographic and meteorological factors.** For instance, the PV capacity is largely dependent on hours of daylight and illumination intensity of the region. Hydropower and biomass require large spaces for the natural resources' storage. Hence RESs should be implemented with the consideration of nature limits.

Secondly, **RESs, e.g. solar and wind, are highly intermittent and partially unpredictable, inducing reliability issues on the electrical power production.** The amount of power that solar and wind can produce depends on the availability of the sun and wind. As the sun radiation and wind speed are never constant, therefore the output power of a solar energy system or a wind power varies during the day. Because they are highly influenced by weather conditions, RESs bring some unpredictable generation uncertainties and risks to an on-going unbalancing between power generation and power consumption in electrical grids to enable an instantaneous power compensation. Hence, high penetration of RESs can result in risk of making the entire power system less reliable. The stochastic behavior of RESs leads to an increasing demand for flexibility in electrical grids. More flexible technologies of generation, consumption or energy storage should be developed to maintain the electricity stability.

Thirdly, **power quality problems occur with a high penetration level of RESs.** Power quality of a power system depends on voltage variations (over-voltage and under-voltage), frequency variations and harmonics [11]. Voltage fluctuations are especially challenging when RESs are participating. For example, when the PV power is injected into the electric system, or a large wind turbine is stopped, the voltage fluctuation may beyond the acceptable range. Hence the RESs-based distributed generation (DG) plant should be carefully designed to maintain the quality of the voltage in distribution and transmission networks [12]. For example, advanced PV inverters are needed for long-term dynamic stability and voltage regulation.

### ***1.2.3 Opportunities for a better integration of renewable energy sources***

For a better integration of distributed RESs, opportunities exist for at least three stakeholders: the energy source, the electrical network, and the consumer [13].

### Energy source opportunities

**The costs of solar PV, wind and battery storage showed its tendency to decline continuously.** According to IEA, costs of new solar PV have decreased by 70%, wind by 25% and battery costs by 40% since 2010 [10]. In 2016, growth in solar PV capacity was larger than for any other form of generation. The fast deployment of solar photovoltaics (PV), led by China and India, is expected to help solar become the largest source of low-carbon capacity by 2040. At that time, the share of all renewables in total power generation is expected to reach 40%. In the European Union, renewables account for 80% of additional generation capacity. Wind power will become the leading source of electricity soon after 2030, due to the strong growth of both onshore and offshore projects.

The rise of uncontrolled power generation from solar PV and wind power requires more additional power balancing capacities for compensation and so gives great importance to the flexible operation of power systems in order to guarantee the electrical grid security. Today, conventional power plants are still the main sources of system flexibility and ancillary services (ASs). **However, new flexible technologies are developed, such as centralized storage systems, hybridized storage with intermittent renewable energy generators, demand-side response with controllable loads and new interconnections for bidirectional power exchanges.** These technologies need to be further developed and well-integrated in order to provide more flexibility and controllability of the power balancing in a more economic and environmental-friendly way.

### Electrical network opportunities

The European Union makes efforts to achieve an “Energy Union” through **the emergences of new local electrical network architectures, e.g. smart grids and microgrids, which improve energy efficiency and security.** With the distributed connection of many low power RESs, more and more energy systems and energy communities are developed with a decentralized structure. Those decentralized grids are operating to create a more reliable, more sustainable and more resilient electrical energy infrastructure. Smart cities, smart grids and microgrids are always favored because of their advantages regarding generation, transmission, distribution, operation and management technologies (e.g. communication networks). These smart networks bring flexibilities for transmission and distribution thanks to their decentralized structures. Moreover, with the regulation of distributed system operators, smart networks offer opportunities for a better cooperation with varying DGs.

To manage their electrical networks and satisfy technical constraints, distribution system operators consider more and more advanced storage devices and control strategies in order to control the RMS value of AC voltages, limit currents under rated

values of lines and cables or provide ancillary services (ASs) [14]. Long-time or short-time fluctuations can be handled with the help of energy storage systems, so that dynamic power productions from RESs are more easily integrated into the networks. **Thanks to the lower costs of implementations, battery energy systems have been assessed to manage dynamic fluctuations of powers [15].**

### **Consumer level opportunities**

With increased RESs participation, the definition of ‘**prosumers**’ has emerged, referring to ‘*energy user who generates renewable energy in its domestic environment, then either stores the surplus energy for future use or sells to the interested energy buyers*’ [16]. It is crucial to coordinate prosumers to perform a sustainable and reliable sharing procedure of the local produced electricity to develop smart grids, smart energy systems and smart energy communities. For example, developed technologies of electric vehicles (EVs) and energy storage systems bring energy flexibility between consumers and producers with their conversion ability. Moreover, **demand-side response** enables the use of electricity more intelligently according to adequately with production, distribution and transmission constraints. As examples, rather than simply generating more electricity to meet short periods of huge demand, hotels might turn down their air conditioners for a while, or large factories might delay an energy-intensive process to another time, in order to reduce peak demands on the energy grid.

Under this context, these opportunities with regard to energy sources, electrical network and consumers, should be definitely considered when envisaging a better integration of distributed RESs in an electrical network. An advanced smart grid/microgrid structure should be developed with more intelligent energy management system (EMS) technologies for flexible power for energy transfers as energy storage system (ESS). In addition, up-to-date operation and management technologies, e.g. operational planning methods under RESs uncertainties, or energy storage control strategies for ancillary services provision, should be also properly implemented.

## ***1.3 Energy Management in Local Energy Communities***

### ***1.3.1 Emergence of energy communities and evolutions***

Historically, to reduce investment costs, electric power systems have been built and rely on large central power plants, sending electricity through long distance transmission lines to residential or industrial destinations where electricity is actually needed. The meshed architecture of transmission networks has also demonstrated their interest for rerouting power flows in case of faults. The emergence of distributed generation (DG) shows its advantages and prospects in energy communities due to environmental-friendly characteristics and better power system efficiency since the electricity is locally produced and consumed, avoiding losses from transport and distribution of electricity. DG offers opportunities to relief existing pressures on assets

and operations for transmission and distribution systems by offering local energy provision possibilities [17]. The integration of DERs in energy communities is based on renewable energy sources (RES) and micro-sources, e.g. photovoltaic (PV) system, wind turbine, internal combustion engines, fuel cells, gas turbines, microturbine using combined heat power (CHP) system, electric vehicles, and controllable energy storage devices, etc [18].

Under these circumstances, the concept of ‘prosumer-community’ is defined in [19] as an approach to manage and interconnect prosumers in the form of goal-oriented virtual communities. Hence organizing and managing prosumers to develop a sustainable and reliable energy-sharing process has become crucial to smart grids, energy systems and energy communities.

Recently, the definition of **clean energy communities** has been proposed in [19]: *‘social and organizational structures formed to achieve specific goals of its members primarily in the cleaner energy production, consumption, supply, and distribution, although this may also extend to water, waste, transportation, and other local resources’*. Meanwhile three types of clean energy communities’ forms are classified based on how these communities interact with the existing centralized energy systems: centralized, distributed, and decentralized clean energy communities. Various forms of clean energy communities are illustrated with different business organizations, including:

- Community-scale energy projects [4], [20],
- Virtual power plants [21],
- Peer-to-peer (P2P) trading [22],
- Community microgrids [23],
- Integrated community energy systems (ICES) [24].

**Energy communities bring social, environmental, and economic opportunities and challenges in local energy production and use.** [25] reported recent developments in the Netherlands, Germany and the UK where local energy initiatives are forming new regional clusters that are able to bring renewable energy into the mainstream. Under the economic, technological, political and physical constraints, energy communities are able to promote local sustainable energy production. Meanwhile, with challenges of new type of energy providers, energy communities provide social innovations with local, regional, and national networks in a decentralized energy system. There are many other existing local energy communities cases in terms of prosumers participation benefits [26]–[28].

Despite various difficulties and challenges, a range of successful experiences and examples of community-based energy initiatives and community projects have been developed originally in some rural area or isolated communities with limited resources.

For instance, [29] undertook a comparative analysis from case studies in Central America across Panama, Nicaragua and Costa Rica, that offered useful insights on the challenges, capability requirements, and future perspectives for further deployment and governance of community renewable energy initiatives in the developing countries. [30] presented an evolution of the current national energy policy in Thailand. It provides a new perspective on how developing countries could develop their energy capabilities in environmentally and socially sustainable ways.

### ***1.3.2 A decentralized energy community case: Local Community Microgrids***

The idea of “**microgrid**” has emerged with the occurrence of various DERs and the increasing demand for their interconnection in a decentralized community. Microgrids are proposed to find decentralized solutions that could:

- 1) manage the integration of a large amount of DERs, including a cluster of interconnected distributed generators: micro-turbines, wind turbines, fuel cells, and PVs integrated with storage devices, such as batteries, flywheels and power capacitors on low voltage distribution systems [31];
- 2) maximize reliability and resistance under inevitable power grid failures, which are caused by natural damages, cyber failures, and cascading power failures, etc.

A microgrid aims to construct a grid architecture that could manage the electricity balancing locally in sub-sections (small power systems) of the main grid. DERs in the same sub-section can be associated with each other and are jointly managed as a controllable load or generator by the utility grid. The sub-section could also be automatically isolated from the utility grid and provides local critical energy services even when the utility grid largely fails [32]. The commonly used basic microgrid architecture is known as the Consortium for Electric Reliability Technology Solutions (CERTS) architecture [33].

Earlier research studies in microgrids are focused on hardware components, self-sufficiency or inter-connectability to the main power grid [34][35]. **Recently studies draw more attention to the operating and control actions of a ‘smart microgrid’.** The smart microgrid is defined in [36] as: *‘a power distribution network comprising multiple electric loads and distributed energy resources, that can operate independently or in conjunction with the main grid via one or more common coupling points, and can operate all DERs, including load and energy storage components in a controlled and coordinated fashion to optimize system performance and operational savings while interacting with the main grid in real time’.*

Furthermore, as one of the key forms of decentralized clean energy communities, **community microgrids** are motivated by various goals and opportunities in energy supply, distribution and consumption. DERs and storage devices have the ability to be

intentionally disconnected from the main grid and be operated in isolated mode of the microgrid. They are also able to independently balance supply and electric loads in real time within the microgrid with little or no energy disruption. [23] defines a community microgrid as: *'A self-contained and self-sufficient local electricity supply system, either standalone or connected to a centralized grid of regional or national scale, comprising residential and other electric loads, and can be supported by high penetrations of local distributed renewables, other distributed energy and demand-side resources.'* **In the current study, we focus on the energy management and generation scheduling in an urban microgrid, i.e. a community microgrid which is composed of residential loads, electrical energy storage systems and a high penetration of local distributed renewables.**

The increased interest on community microgrids is triggered by the potential benefits regarding the provision of reliable, secure, efficient, flexible, environmentally friendly, and sustainable local electricity from RES. Advantages of the community microgrid are summarized as follows:

- a) Local conventional micro-sources ensure the stable operation of sensitive loads in any operating condition, thus reliability and security of power distribution system are improved.
- b) Environmental problem and energy sustainability problem can be decreased due to the increasing penetration of RES in community microgrids. Furthermore, energy can be fuel-costless from RES.
- c) Losses in transmission lines are reduced because of local uses of local power generation, then the global efficiency is increased. Furthermore, the security risk of transmission lines is reduced in terms of aging architecture in centralized power grid, or occurrence of extreme weather events.
- d) The power system efficiency increases greatly if CHP are used in the community microgrid. Moreover, from a system point of view, fuel costs and carbon emissions will be reduced [33]. The interest is to utilize the waste heat from conversion of primary fuel to electricity. Generally, more than half of the primary energy consumed in power generation is ultimately emitted to the environment. The potential gains from using this heat are significant. For example, in Denmark, during the year of 1996, CHP plants in industrial facilities met 48 percent of the domestic electricity demand and 38 percent of the domestic heat demand, with a reduction of CO<sub>2</sub> emissions by more than 10% of the total emissions of the country. European countries, notably The Netherlands, have made significant progress towards developing smaller scale (kW-scale) CHP applications, such as greenhouse heating. These kW-scale CHP applications can be implemented in microgrids [37].

A community microgrid is a modern approach for designing and operating the decentralized electric grid with the participation of local stakeholders (e.g. various renewable producers). The objectives are to provide an affordable and clean local



energy while providing local economic benefits and unparalleled community resilience. With participations of solar, wind, energy storage, electrical vehicles within community areas, a part of the energy needs is provided by local renewables. The needs are also anticipated to provide backup power for the entire community during short outages and indefinite backup power for critical facilities like fire stations, hospitals, water treatment plants, etc. Fig. 1-5 illustrates an example of a community microgrid. There are several basic components:

- Local conventional micro-sources, to make sure the reliability and security of the grid;
- RES, such as solar PV cells, or wind-driven generators;
- Energy storage or EVs, which enables the balancing of available power with the need;
- Loads, including critical loads and controllable loads;
- A central control system, to do monitoring, communication and management of the energy flows in the microgrid with the knowledge from weather forecast and electricity market.

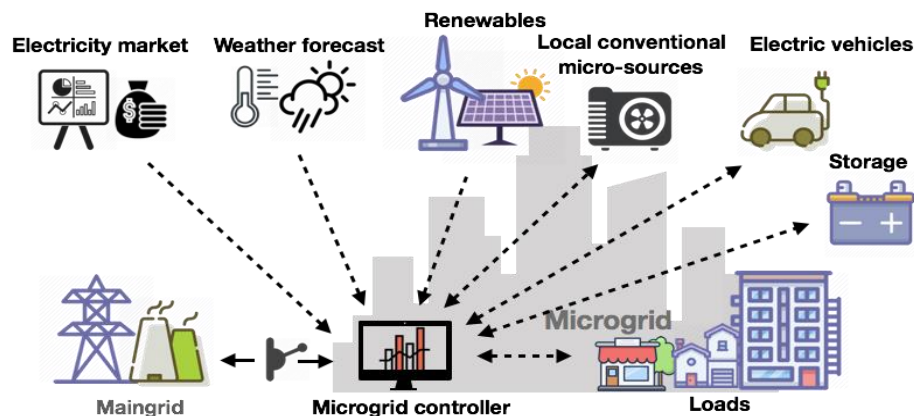

Fig. 1-5 A conceptual model for community microgrid with local renewables

Significant progress has been made for microgrid technologies in the last decade and is expected to continue. The global market for microgrids continues to grow. According to a report from Navigant Research [38], total global microgrid capacity is expected to grow from 3.5 GW in 2019 to nearly 20 GW in 2028 at a compound annual growth rate of 21.4%. The total global market for microgrids in 2019 is estimated at \$8.1 billion and expected to near \$40 billion by 2028. From an implementation point of view, the Peninsula Advanced Energy Community in East Palo Alto and Redwood City provided an opportunity to develop innovative, replicable approaches for accelerating the deployment of a Community Microgrid [39]. Supported by California Energy Commission, another microgrid project “Berkeley Energy Assurance Transformation” aims to create a microgrid in downtown Berkeley to provide solar power to key city facilities for daily use [40]. This project examined the opportunities and challenges of designing a system that could allow buildings to share renewable energy during normal

operations, and provide clean backup power to critical facilities in the event of a power outage.

Associated to the technical energy management, a Virtual Power Plants (VPP) is in charge of managing and/or aggregating participants of the community in the electricity market: energy market and ancillary market. Applied realizations can concern economic relationships between participants for local trading (peer to peer markets, ...) or between the entire community and a global market platform (pool, bilateral contracts, ...). VPP will not be detailed here since it is not in the scope of this PhD thesis.

### ***1.3.3 Integration of RESs, energy storage and hybrid active generators***

For the microgrid operation, a large-scale deployment of PV generators may cause power quality problems on the AC voltage and congestions. Control flexibilities are required to enable the operation of a local microgrid as a single controlled unit for the main utility grid, meeting the total customers' needs with local reliability and security. Owing to the facts that different renewable energy sources have intermittent and stochastic characteristics, three energy management operations can be implemented to get the balance right:

- Import/export with the main utility; in this case, the microgrid will participate in the market operation,
- Switching on/off dispatchable local loads (heat water, ...),
- Charged/discharged local energy storage systems.

Import/export with the main utility implies a participation in the market operation and an independency lost. Management of non-critical loads are possible but only in a certain range of power magnitude and duration in a day. In order to jump these limitations, ESS solutions are searched to increase sustainability of electricity produced from RES.

In order to utilize renewable energy optimally without having problems related to variability and intermittency of energy, a properly ESS can be designed in sizing and control.

Usually a combination of storage technologies, such as supercapacitors, batteries, superconducting magnetic energy storage, kinetic energy storage in flywheels, etc, are applied to exploit the most technological capabilities at the least cost [41]. The concept of hybrid active generators incorporates a combination of various energy storage devices and renewable energy based generators, and have the added technological value to supply ancillary services [42]. The power, energy, dynamic capacity of the energy

storage system depends upon the characteristics of energy compensation being required and the type and storage technologies must be selected accordingly [43].

In earlier research studies at L2EP, a PV-based hybrid active generator including lead-acid batteries and supercapacitors in a DC-coupled structure has been built in order to deliver a prescribed power reference to the grid [44]. As shown in Fig. 1-6, it is composed of [42], [45]:

- a) Photovoltaic panels as the main power source;
- b) Batteries, used as a long-term energy storage device, aim to store energy surplus and to discharge it during time when the energy is insufficient;
- c) Ultra-capacitors, used as short-term dynamic power storage devices, aim to do the fast power regulation and smooth transient PV power fluctuations;
- d) Power electronic converters, used for power generation control by receiving the control signals from the central energy management system, aim to convert electrical quantities.

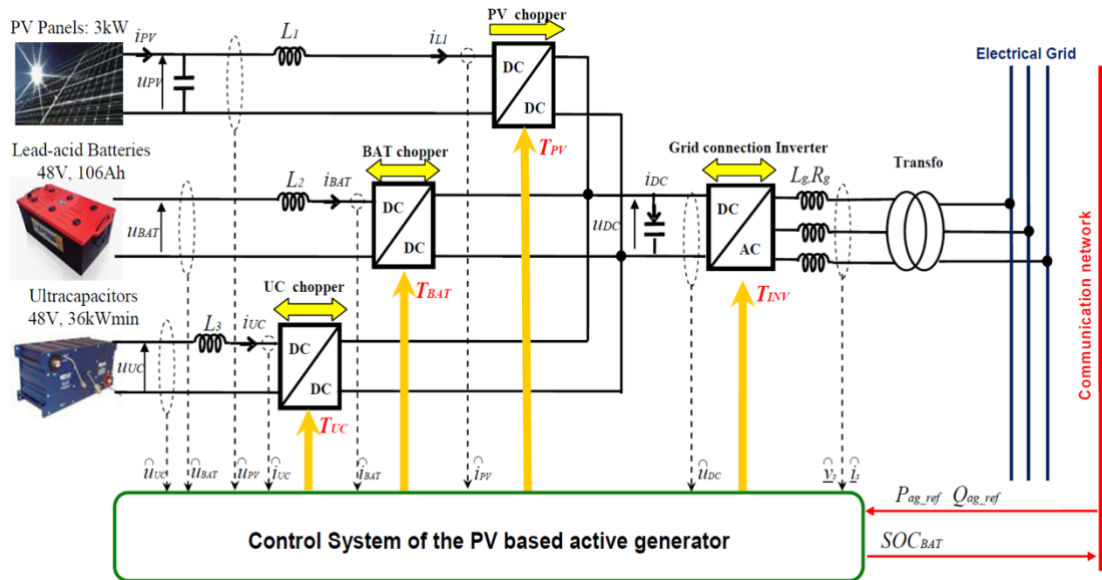

Fig. 1-6 Scheme of a PV based active generator in a microgrid [45]

With a proper control system and management system of the inner energies, the whole energy flow in the PV based active generator is controlled in order to satisfy power references send by the grid operator ( $P_{ag.ref}$ ,  $Q_{ag.ref}$ ). In normal operation of the microgrid, exceed local renewable energy generation will charge energy storage devices for later uses. Details concerning the local control system of the above PV active generator can be found in a past PhD of the L2EP laboratory [45].

### 1.3.4 Energy management system

With the integration of large amounts of DER in the microgrid, efforts are made to establish new facilities and structures for grid control to reduce congestion, to minimize

the production costs and to maintain the frequency and voltage. As intermittent RESs are used, an Energy Management System (EMS) with faster responses is required, compared with in a conventional centralized power system. EMS is defined by IEC (International Electrotechnical Commission) as “a computer system comprising a software platform providing basic support services and a set of applications providing the functionality needed for the effective operation of electrical generation and transmission facilities so as to assure adequate security of energy supply at minimum cost” [46]. As for in a microgrid community, an EMS usually consists of software modules to perform decision making strategies and send optimal decisions to each generation units, storage, and load units [47].

A conceptual model for an energy management system in a community microgrid is illustrated in Fig. 1-7 [48]. On the one hand, EMS receives forecasted and real-time information from loads, generations, electricity market. On the other hand, EMS makes appropriate decisions and imposes control actions on power flows, consumption levels in the grid, controllable loads and dispatchable DERs and etc.

As shown in Fig. 1-7, a microgrid EMS performs variety of functions. For example, data monitoring and analyzing functions are involved in energy market prices, meteorological factors, etc. Forecasting functions concern power generation of DERs and load consumption. The EMS optimization functions involve operational scheduling, unit commitment, economic dispatch, etc. These functions help EMS in optimizing MG operation, while satisfying the technical constraints. Real-time control functions relate to voltage and frequency control.

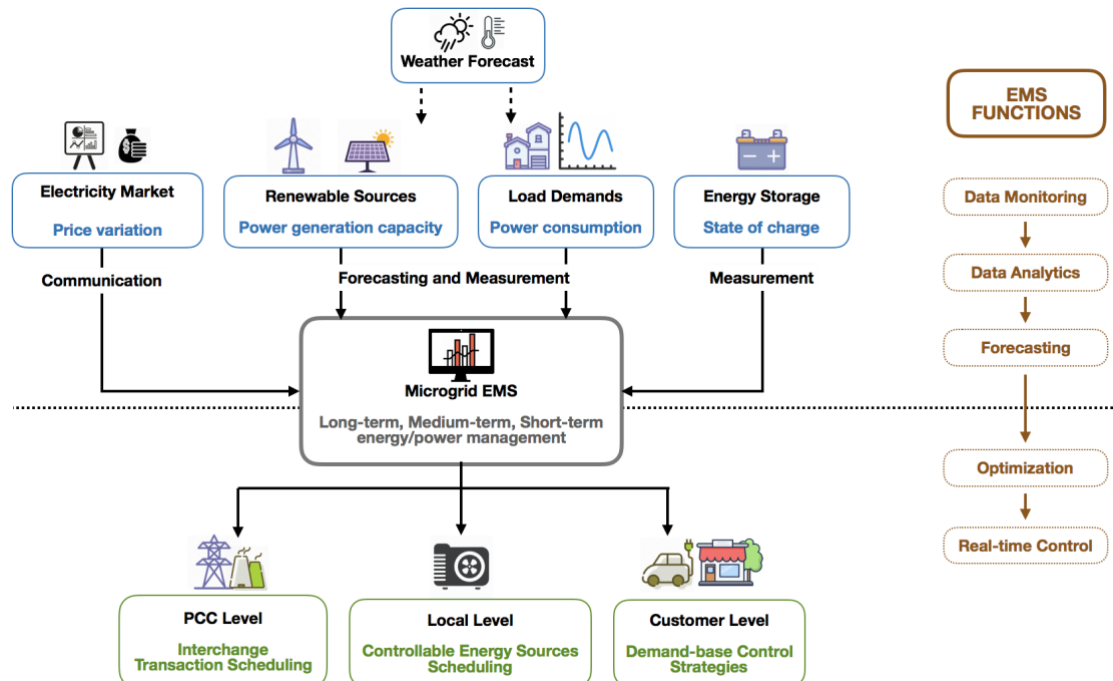

Fig. 1-7 A conceptual model for an EMS in a microgrid community.

Decisions have to be taken at different time periods, thus a microgrid EMS functions are usually organized into three timing scales (Fig. 1-8): long-term, medium-term, and short-term supervision [45]. as is demonstrated in Table 1-1.

Table 1-1 EMS functions regarding different time scales

<b>Time scales</b>	<b>EMS functions</b>
<b>Long-term</b>	<ul style="list-style-type: none"> <li>✓ The hourly (or half-hourly) RES production forecast;</li> <li>✓ The management of non-sensitive loads that can be disconnected/shed from electrical grid;</li> <li>✓ The maintenance intervals;</li> <li>✓ The provision of an appropriate level of OR power capacity by considering the energy production and the load demand forecast.</li> </ul>
<b>Medium-term</b>	<ul style="list-style-type: none"> <li>✓ The update of RES production and load demand forecasting;</li> <li>✓ The available storage energy estimation;</li> <li>✓ The correction of power set-points of each controllable power source each half hour;</li> <li>✓ The secondary regulation supply for the system AS.</li> </ul>
<b>Short-term</b>	<ul style="list-style-type: none"> <li>✓ The instantaneous “Balancing and power dispatching” among DG units and storage devices is based on the storage capacity and on the specific requirements/limitations of each DG unit;</li> <li>✓ The voltage regulation and primary frequency control.</li> </ul>

The scheme of a more detailed timing classification of EMS control functions is shown in Fig. 1-8. The short-term management functions correspond to the primary control and are executed by the local controllers (LCs) located within the generators. The medium-term management corresponds to a secondary control and adjusts decisions according the evolution of the states of the system, comparing with the expected ones (one day ahead). The Unit Commitment and the generation scheduling must be decided one day ahead with available forecasts (load demand and RES production) with the objective to minimize operating costs. As an anticipation is required, a power margin has to be decided to be sure to be able to cover risks. It is carried out by a central controller located in a dispatch center for large networks. In a microgrid, this EMS must be able to operate in islanding mode by a Microgrid Central Energy Management System (MCEMS).

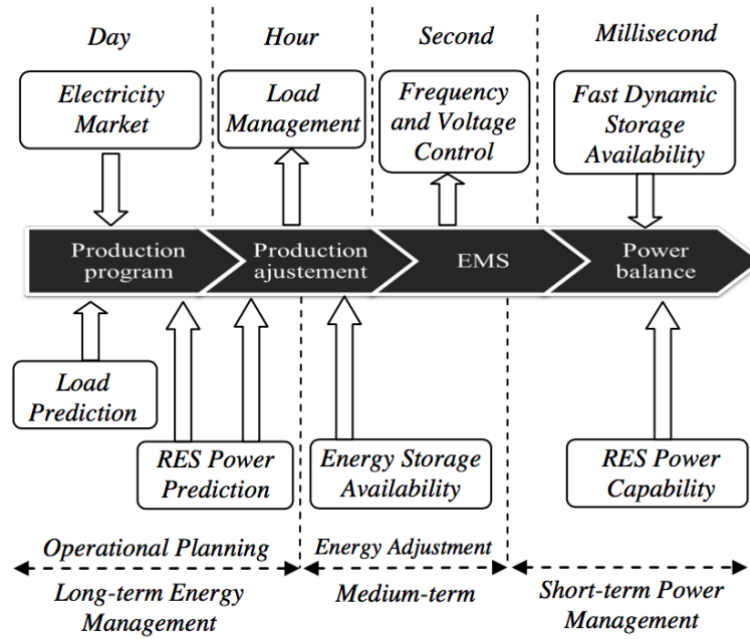

Fig. 1-8 Timing classification of control functions in the microgrid [49].

### 1.3.5 Experiences in central energy management at L2EP

This last decade, research works have been done at L2EP to better manage locally resources in order to decrease costs and pollutant emissions.

In order to implement these functions, DG must be coordinated either in a grid connected mode or in an islanded mode [50].

The long-term and medium-term energy managements of the entire microgrid system require a communication network to gather and exchange information and control signals [51] with the centralized energy management system. The short-term power management is performed quickly by resources and so is achieved locally by sensing electrical quantities of a droop control technique [52]. The power management by sensing electrical quantities is detailed in [45].

A brief review of the existing EMS architectures for microgrids is presented in [53]. In [45][54] a deterministic EMS for an urban microgrid was proposed. The microgrid is composed of advanced PV active generators with embedded storage systems and a gas microturbine. With the participation of the presented EMS, an aggregated architecture of an urban power system is considered as a mean to facilitate the integration of distributed prosumers both in the electrical system and in the market. A scheme of the proposed MCEMS for the urban microgrid is shown in Fig. 1-9.

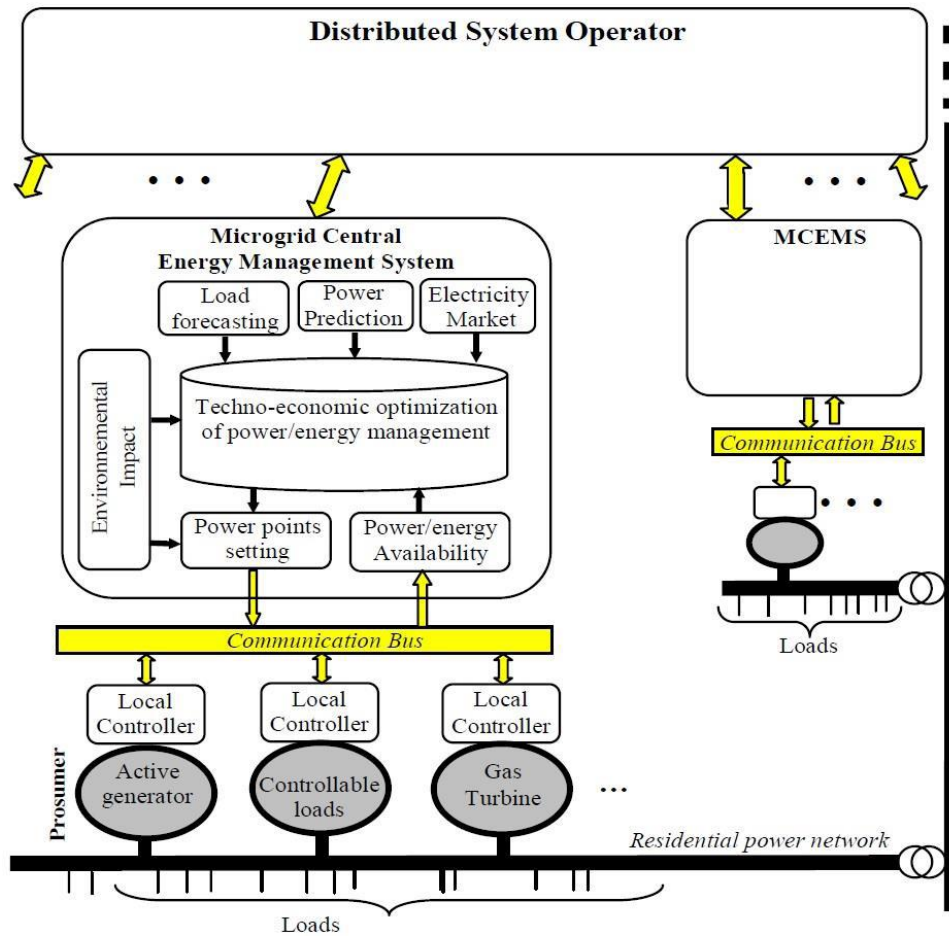

Fig. 1-9 Scheme of the Microgrid Central Energy Management System [45].

In this architecture, the Energy Management System (EMS) is the key mediator between residential participants (prosumers and consumers) on one side and the markets in addition to the other power system participants on the other side. The EMS collects from the distributed system operator (DSO) the requests and signals for prosumers. They gather the flexibilities and the contributions provided by prosumers and consumers to form grid services, then these services are offered to the different power system participants through various markets.

In this electrical system, two types of micro-sources are used: gas microturbines and PV based active generators. The MG central controller (MGCC) measures the MG state variables and dispatches orders to micro-sources through the communication bus. Local controllers (of the microturbines and the PV based active generators) receive power set points from the MGCC, as well as send information, e.g. the sensed power production. The residential MG can operate in two different modes: the islanded mode and the grid-connected mode. In the former mode, the local power generators (PV panels and microturbines) satisfy all the power demand. In the latter mode, the residential network can both provide and consume power from the utility grid.



The design of a local EMS, as well as a centralized control strategy for a MG is presented and detailed in [45]. As shown in Fig. 1-10, a single prosumer (with a local EMS), MGTs and loads are considered in the presented MG.

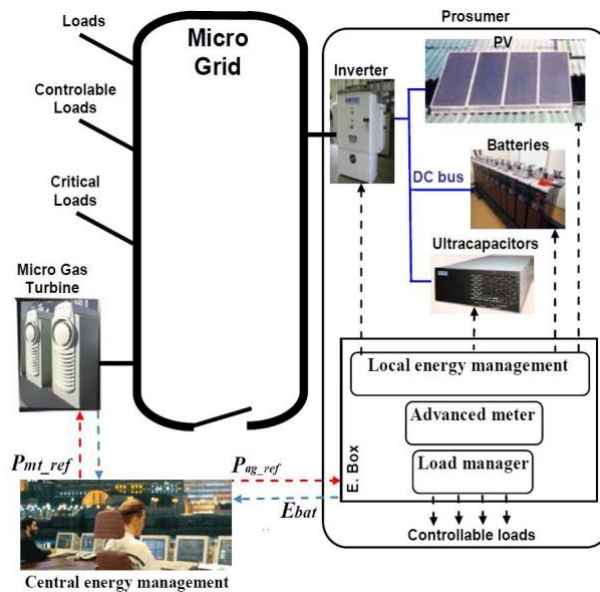

Fig. 1-10 Scheme of a MG integration of prosumer and micro gas turbines [45].

In this MG, PV based active generators are used in priority, MGTs are used as backup generators. An Energy-box (E-box) is used to follow the energy consumption and gives a remote control of facilities to the grid operators. E-boxes include :

- A load manager, which enables customers to automatically pre-program appliances or to adapt their energy consumption habits according to the electricity price. Moreover, it can disconnect controllable loads in order to reduce the stress on the utility grid;
- An advanced meter, which records consumption;
- A local energy management, which supervises PV energy consumption according to the grid operator requirement and available PV generation. When there is a pessimistic PV generation, batteries can provide the power deficit if required. On the other hand, exceed PV energy can be stored in batteries for future use when needed.

In previous research works at L2EP, studies concerning advanced PV generators, the urban microgrid structure and microgrid managing framework have been carried out. As illustrated in Fig. 1-11, Li [50], Lu [45], Kanchev [55] and Yan [49] have carried out continued studies concerning advanced PV generators, the urban microgrid structure, microgrid managing framework and generation scheduling with deterministic optimization methods.



**Peng LI, 2009; Di LU 2010**

Supervision of Multi-Source Hybrid Systems : Application to the **Management of a microgrid; Design and control of a PV AG** with integrated energy storages

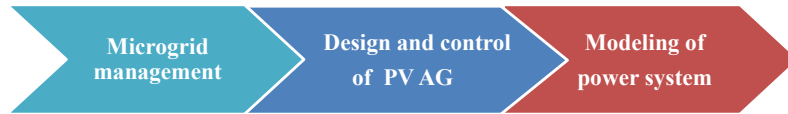

**Hristiyan KANCHEV, Jan 2014**

**Deterministic optimization** of the generation scheduling

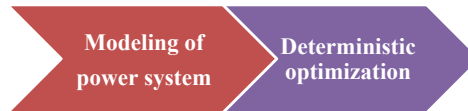

**Xingyu YAN, May 2017**

Deterministic optimization with an operating reserve power



Fig. 1-11 Summary of previous research works at L2EP regarding microgrid

The control system and the power management of PV-based hybrid active generators is detailed in [44]. [45] discussed the application of PV active generators in the energy management of an urban microgrid. [43] and [54] presented a deterministic generation scheduling including advanced PV generators with embedded storage units and micro gas turbines (MGTs). In [49], to deal with uncertainties from PV generation and load demand, a risk-constrained probabilistic method is employed for reserve quantification. A deterministic generation planning is undertaken for load/reserve dispatching regarding PV AGs and MGTs.

In this PhD, we are going to improve the generation scheduling by considering the introduction of RES and load demand uncertainties in the optimization process. In the next section, the concept and state of the art of generation scheduling is presented.

## ***1.4 Generation Scheduling***

### ***1.4.1 State of art: Unit Commitment and Generation Scheduling***

Unit commitment and generation scheduling economically schedule generating units over a planning horizon in order to satisfy the load demand and other system operating constraints [56].

In power systems, the primary objective is to ensure that users demand is met at the least cost without having competition in generation and distribution businesses. For example, we consider a given load profile which varies from hour to hour, day to day, week to week, and a given set of generation units available as shown in Fig. 1-12.

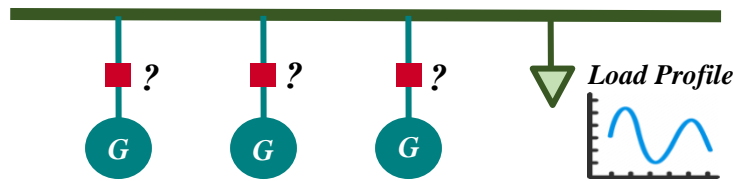

Fig. 1-12 Simplified scheme of a power system with generators and load.

It is not economical to run all the units all the time, but when should each unit be started and stopped? Selecting the generating unit states to be ON/OFF during any interval of the day is known as a **unit commitment** (UC) problem [57]. In Fig. 1-12, a unit commitment problem corresponds to the decision of each switch (square in red) to be on or off. Failure to commit enough energy sources to meet the expected load demand can lead to an unbalance and expensive actions to cover it, e.g. starting thermal turbines instantaneously and abruptly. Taking thermal plants as an example, since there exists cold/hot start-up cost, and minimum up/down time, it is necessary to decide the unit commitment in advance.

Meanwhile, if units are switched on, then how much power should each unit generate at each time step in order to meet the load demand, as well as to attain the expected minimum operational costs? This problem is regarded as a problem of **generation scheduling** [58]. Sometimes a solution search of unit commitment is included in the generation scheduling problem, and is generally called unit commitment. On the example in Fig. 1-12, a generation scheduling problem corresponds to the decision of how much power each unit  $G$  should be generated at each time step with a minimum operational cost. Obviously, the solution is not unique (it is assumed that the generation is well sized to supply the peak load).

In order to find the best solution, the studied power system must be modeled with equations that will be solved by the computer. The constraints, as well as variables to be changed (decision variables) and the objective function must be well formulated. Then, electrical engineers classically apply numerical optimization to establish several possible choices and identify optimal choices before implementation.

An optimization algorithm consists in adjusting decision variables  $X$  to minimize the objective function ( $f(x)$ ) while satisfying the constraints ( $g(x)$ ). For unit commitment and generation scheduling problems, the *objective function* is expressed as a measure of the global operational costs that we want to minimize. The *decision variables* are the set points of all controllable generators. The *constraints* define the variation domain of variables and requirements that must be satisfied. The scheme of the UC/generation scheduling with optimization algorithm for an energy system is shown in Fig. 1-13.

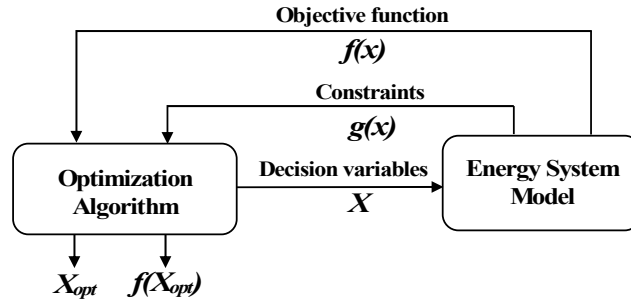

Fig. 1-13 General scheme of an UC/generation scheduling with optimization algorithm

Current identified difficulties are now exposed as follows:

### ***One versus multi objectives***

The expression of the model and the formulation of the optimization problem are essential since optimization algorithms are designed to solve a specific type, and are usually not efficient for other types of problems. In many UC and generation scheduling problems, a compromise must be sought between several different conflicting objectives. As an example, the operational costs decrease under a certain scheduling solution decision, while the emission costs are far from the optimum, leading to a non-friendly solution from environment point of view. For this type of multi-objective problems, the problem is usually solved by applying a weighting coefficient on the different single objective, or replacing some of the objectives by constraints.

### ***Constraints formulation***

Constraints can be bounds, equations of equalities or inequalities, or non-linear relationships among the variables. Constraints are directly complicating the solving algorithm, requiring computing resources and delaying the solving time. Therefore, sometimes constraints are reduced by adding penalty terms in the objective function.

### ***Continuous and discrete variables***

A part of decision variables is discrete, e.g. the on / off switch of generators. In this case, the optimization algorithm contains continuous and discrete variables. While discrete solving algorithms exist, they usually generate a sequence of continuous sub-problems. Hence, a continuous problem formulation is often implemented.

### ***Linear and non-linear formulation***

If the objective function, or constraints, or both of them are non-linear functions, the problem solving can be complicated, because convergence may not be attained during the solution search. Among all the non-linear functions, quadratic optimization is widely developed, which is usually in the form of a quadratic objective function (with linear constraints), or a linearized function through linearization methods, e.g. piecewise linear approximation, or linear approximation.

### ***Generic formulation of an UC***

From the day-ahead forecasting of the load demand (and renewable energy generation if RESs are incorporated), an optimization algorithm classically finds the optimal operation set points of all controllable generators that minimize the global operational costs and satisfying the electrical constraints. These constraints include power balance, reserve requirement, upper and lower unit generation limits, minimum up and down times limits, unit ramping rate limits over a set of time periods [58]. There are three main objectives to achieve:

- Satisfying load, which is a basic and compulsive requirement,
- Ensuring the security level, which is usually guaranteed by supplying a power reserve,
- Minimizing operating cost.

Various kinds of optimization techniques can be applied to solve the optimal UC and generation scheduling problems. A good solving algorithm finds a solution closing to the optimum, with a reasonable computing time, or has the ability to satisfy constraints. These techniques are now shortly described.

#### ***1.4.2 Deterministic optimization***

Traditionally, generation scheduling is deterministic. In the determinism, two aspects are present regarding the prescribed power reserve and the optimization process.

In practice, variations between forecasting (of the load demand, the PV production) and the real value appear. To ensure the security level, the most critical operational scenarios were considered:

- A maximum PV production with a minimum load demand,
- A minimum PV production with a maximum load demand.

Usually, the deterministic determination of the power reserve is based on the assumed representations of the worst cases rather than exploring all values taken by stochastic variables. Hence the power reserve is often quantified for a rare situation and oversized in the constraints.

A deterministic optimization uses variables without taking into account the continuous and random variations which may take place. The solving process considers that all the physical constraints and inputs are fixed and corresponds to a behavior of the system in permanent mode according to forecasting. In this work, we call this deterministic optimization process: “Classic deterministic optimization”.

Classic deterministic unit commitment (DUC) techniques include a priority list / heuristic approach, Lagrangian relaxation (LR), Branch and Bound, Dynamic

Programming (DP), Integer Programming (IP), Mixed-Integer Programming (MIP), Linear Programming (LP), etc [59].

### **Priority list**

In this approach, firstly, priorities of generating units (merit order) are determined according to their operational costs. Then units are committed in an order of priority until the power balance and security constraints are satisfied [60]. However, solutions obtained by these methods were usually far from the optimal, since the start-up cost is not necessarily included in the optimization process. Furthermore, this method is limited by curse of dimensionality, especially for large-scale problems.

### **Branch-and-bound method**

In this method, the solution space is organized as a treelike structure. The solution search can be represented as a sequence of options in branches. The first part, branching, requires several choices to be made so that the choices branch out into the solution space. Then bounding refers to setting a bound on the solution, and cutting off branches in the solution tree whose solution quality is estimated to be poor [61]. Branch-and-bound algorithms for DUC are proposed in [62]–[64]. However, they are still regarded as time consuming processes because of the successive eliminations of inappropriate solutions.

### **Integer and Mixed-Integer Programming (IP / MIP)**

Due to the characteristics of UC, integer and mixed-integer programming (IP / MIP) are often applied in a DUC problem. Because decisions of unit status on / off are regarded as values of binary variables during an optimal solution search in IP / MIP. MIP are able to solve UC problems with linear/quadratic objective functions, which are called Mixed-Integer Linear Programming (MILP) and Mixed-Integer Quadratic Programming (MIQP). The IP / MIP approach solves the unit commitment problem through the reduction of the solution search space by rejecting the infeasible subsets [65]. Meanwhile, a linear programming UC problem can be solved: 1) by a revised simplex technique; 2) by decomposing the whole problem into subproblems with Dantzig–Wolfe decomposition principle, then each subproblem is solved using linear programming [66]. The applications of IP / MIP / LP for DUC can be found in [67]–[70]. Still, computational efficiency becomes an issue with the growing size of the optimization model.

### **Lagrangian relaxation (LR)**

The LR technique is based on a dual optimization approach by forming a Lagrange function. Through the dual optimization, the LR procedure solves the unit commitment problem by “relaxing” (temporarily ignoring) the coupling constraints and solving the problem as if they did not exist. Then a dual procedure attempts to reach the constrained optimum by maximizing the Lagrangian with respect to the Lagrange multipliers, while

minimizing with respect to the other variables in the problem [59]. Applications of LR and improved LR algorithm for DUC can be found in [71]–[74].

### **Dynamic programming (DP)**

Through DP, DUC is decomposed into multi-stages sub problems. Each stage is a time step of the tomorrow planning. Inside each stage (each sub problem), many combinations of each on/off MGTs can be considered to provide the requested total power. The decision of state is made for each stage by considering the transition cost between two adjacent stages. The pedagogic explanation of DP algorithm for DUC is detailed in [59]. DP is used in [75]–[77] to solve UC problems in microgrids. The limitation of DP is the curse of dimensionality due to the enumeration process. However, the advantage of DP is its capability of solving problems with nonlinear functions. For instance, the objective function is not only limited to convex linear/quadratic functions, but also non-convex quadratic functions. The DP algorithm explanation and application with non-convex quadratic functions will discuss in detail later in chapter 3.

### **Heuristic / Meta-heuristic algorithms**

Many heuristic, or meta-heuristic algorithms are also applied in UC problems, in order to find an optimal solution among a large set of feasible solutions with less computational efforts. If more than one heuristic method is combined, then the algorithm becomes meta-heuristic. Metaheuristic algorithms include Tabu search, simulated annealing, genetic algorithm, particles swarm optimization, expert systems, fuzzy logic, artificial neural networks, evolutionary algorithms, etc [78]–[80]. A bibliographical survey for meta-heuristic techniques is detailed in [66].

### ***1.4.3 Forecasting of RES and Uncertainties Handling***

In electrical systems, the primary objective is to maintain the security and reliability, ensuring that user demands are met at the least cost in generation and distribution business. This is more critical for stand-alone power systems and local energy communities with distributed energy because a connection to a transmission network does not exist or is limited in capacity.

Many sources of uncertainties exist in electrical systems, such as faults in electrical networks, unexpected load demand variations, and intermittent renewable energy generation. One day ahead UC is decided with the help of forecasting of RES generation and load demand. Renewable energy, like solar or wind energy, leads an unpredictable power generation or a poor prediction of renewable generation as the time horizon is increasing [81]. Stochastic characteristics are coming from the unexpected renewable source variations (wind speed, irradiation, temperature, ...) and from the non-controllability of the primary resource to master the output generated power. Electricity cannot be massively and economically stored using today's technologies. As a result, it

has to be generated and provided for instantaneous consumption. Electricity being a flow, the balance between production and consumption in a power system must be assured instantaneously. The deviations between the committed (and scheduled) energy of a producer on the one hand and what it actually produces on the other hand must be compensated by costly regulatory mechanisms, both economically and environmentally. So, improving the RES predictability is fully a benefit for the production of renewable electricity.

Forecasting errors bring strong uncertainties in the operation of power systems, especially in stand-alone microgrids that are extremely dependent upon local renewable energy supplies [37], [82]. Forecasting gives the best possible estimate of a phenomenon that has not yet happened. However, the prediction with an infinitely accuracy is not possible. Hence the modelling of prediction mistakes/errors is regarded as an additionally essential information. With the knowledge of the forecast error distributions, system operator can adjust decisions according to a risk policy. The uncertainty modelling can be also an associated probability with multiple forecast scenarios.

#### ***1.4.4 Integration of probabilistic approaches in DUC***

In order to protect the system against power unbalancing and unforeseen events like generation/transmission line outages or sudden load changes, an operating reserve (OR) is determined beforehand. Hence, there is a trend of defining a power reserve according to the needs (here, forecasting errors) and to embed this additional reserve power in the optimization process. In order to ensure the security of the power system, a risk level is usually prescribed before the operation decision of the electrical system. Then, on the basis of a probabilistic analysis of forecasting errors, additional reserve power is determined and implemented in the DUC as an additional and potential power that could be used during the operation. For example, an optimal UC problem is proposed in [83] by integer programming approach with a probabilistic reserve determination. A state of the art in UC will be presented in chapter 3 (part 3.3.4).

The schemes of DUC with classic (deterministic reserve) and risk-based deterministic optimization are illustrated in Fig. 1-14. The difference between those two approaches is whether a probabilistic method is performed to calculate the reserve provision. All presented deterministic optimization techniques in the previous section can be used, as the power balancing constraint can be changed to consider an additional power reserve.

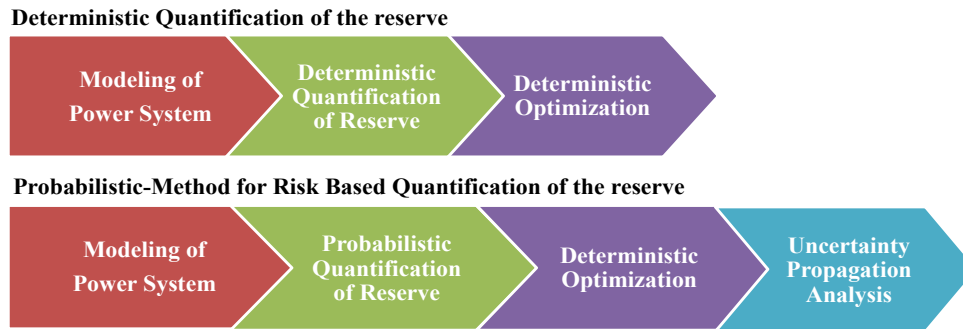

Fig. 1-14 DUC schemes of deterministic optimization without and with probabilistic reserve quantification

In [84], a probabilistic reserve assessment method is incorporated in a LR-based UC technique. Generation scheduling is updated with the reserve assessment to meet a given risk index. The optimal value of the risk index is selected with a tradeoff between the total UC scheduled energy cost and the expected cost of energy not served. In [85], the operating reserve requirement schedule was attained under wind uncertainties by solving probabilistic UC problem using LR method. In [49] a risk-constrained reserve quantification method was proposed with a probabilistic reliability assessment in a DUC problem, in order to deal with uncertainties from solar energy generation and load demand in an urban microgrid.

### 1.4.5 Stochastic optimization

DUC problems address the scheduling (e.g. day-ahead) of generators [86][87] by assuming that all predictions regarding consumption and production from intermittent renewable energy are fixed. With an increase of uncertainties in electrical systems, deterministic optimization methods become inadequate. In future generation scheduling, uncertainties coming from simultaneously the load demand and PV production forecast must be simultaneously taken into account.

A SUC takes into account all possible values of inputs/parameters and, so, include uncertainties in the solution search. The uncertainty behaviour of variables and their interactions that may potentially change the state of the system are represented. This modelling enables the determination of possible system's states and consequences when constraints are not satisfied. The uncertainty may have different sources as:

- Input variables depending on the load demand and electrical production from non-dispatchable generators (intermittent RES),
- External variables that influence input variables as meteorological conditions
- Loss of a hardware in the electrical network due to a fault (line, generator, ...).

In this research work, we focus on the uncertainty coming from the forecasting errors of the net demand (the production forecast of RESs is subtracted from the load demand forecast). Conventional and controllable generation units are then scheduled to produce



the resulting net demand. Handling the uncertainty consists in the quantification of the resulting global uncertainty on obtained optimized results (scheduling of conventional generators) due to the net demand uncertainty.

Certain existing stochastic modeling and solution approaches have been proposed to handle UC problems under various types of uncertainties [81]. No matter what stochastic approach is chosen for solving UC, the scheme of the SUC with stochastic optimization is illustrated in Fig. 1-15.

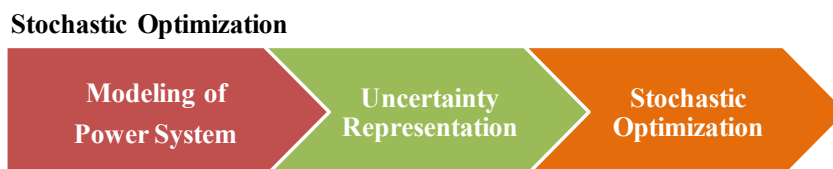

Fig. 1-15 Scheme of the SUC with stochastic optimization

### **Stochastic Unit Commitment**

The idea of SUC is to use a representation of the uncertainty by various possible scenario in the UC formulation [88]–[90]. Each considered scenario deviates from the forecasted one with a probability. Compared to simply using a fixed risk level with corresponding power reserve constraints, stochastic models have certain advantages, such as cost saving and reliability improvement [91][92].

### **Robust optimization**

In contrast to scenario-based stochastic programming models, robust unit commitment (RUC) methods try to incorporate uncertainty without the information of underlying probability distributions, and instead with only the range of the uncertainty. In place of minimizing the total expected cost as in SUC, RUC minimizes the worst-case cost regarding all possible outcomes of the uncertain parameters. Certainly, this type of models produces very conservative solutions, but computationally it can avoid incorporating a large number of scenarios. In the power system literature, RUC models have been used to address uncertainties mainly from nodal net electricity injection [93], renewable power availability [94], power systems component contingencies [95], and demand-side management [96].

### **Chance-constrained optimization (CCO)**

The idea of chance-constrained unit commitment is that certain constraints are only satisfied under a preset probability. To avoid the overestimated costs caused by extreme worst-case that are unlikely to happen, a trade-off is made between cost and robustness by means of setting a probability of the selected solution to be feasible. The CCO approaches can be classified into two types:

1) Individual CCO, the safety level is set for each constraint or each time step individually;

2) Joint CCO, safety level is set for the system as a whole [97].

Individual CCO was usually applied in UC with different sources of randomness: demand fluctuation, thermal units outage, uncertainty of renewables [98]–[100]. Despite the computational difficulty, joint CCO is considered in UC with a joint probabilistic constraint for the RES uncertainty [101]. However, a drawback of CCO is that probabilistic constraints can be nonconvex and hard to evaluate, thus making these approaches potentially computationally demanding.

### **Stochastic dynamic programming**

Similar to the setting of multistage stochastic programming, a finite-horizon, discrete-time UC problem can be formulated in a stochastic dynamic programming framework. To overcome computational complexities and drawbacks of conventional DP model, various methods have been developed to obtain an approximate solution of a DP, giving rise to the broad class of algorithms referred to as approximate dynamic programming. Generally speaking, approximate dynamic programming methods can be classified as value function approximation, policy function approximation, and state-space approximation [102][103].

In conclusion, stochastic UC problems require methods to minimize the operating costs for different probable uncertainties (or constraints under uncertainties). **Therefore, introduction of uncertainties in a UC problem adds an extra computational complexity in solving methods. This is why we will study and apply a stochastic unit commitment.**

### ***1.5 Conclusion***

In this chapter, the large-scale development of RES has been discussed. A brief state of the art on the emergence of Local Energy communities is presented with a focus on current functions and implementation of energy management systems.

Generation scheduling of generators one day ahead is a fundamental function that requires forecasting from RES production and load demand. Electrical system operators are concerned about how such a stochastic generation affects the balancing and so the security of the electrical network. A bibliographic review is exposed on the different optimization techniques and their evolutions to take into account uncertainties from forecasting errors.

In order to protect the system against power unbalancing and unforeseen events like generation/transmission, operating reserve (OR) must be determined beforehand with consideration of RESs and load uncertainties. Traditionally, OR is provided by conventional generators. Because of the large penetration of RES, there is a significant increase in the requirement for OR. The increase of OR provision costs is always an issue to solve.

In order to better size the OR, uncertainties are generated thanks to the use of an Artificial Neural Network for the forecasting (PV production and load demand). Uncertainties are then modeled by probabilistic functions and scenarios for future integration into optimization techniques.

## CHAPTER 2

# CHAPTER 2 UNCERTAINTY ANALYSIS FROM FORECASTING

## *2.1 Introduction*

Optimization of a generation scheduling in a power system implies variables and/or parameters that are not known accurately for a variety of reasons, such as tolerance on equipment, measurement errors, forecasting errors, etc. A deterministic optimization without considering the uncertainties leads to a weak optimal solution that may be far away from the real optimum in case of unexpected variation and/or deviation of constraints.

As multiple countries around the world experience significant raises in the proportion of electricity generated by RESs, an increasing attention is given to uncertainty analysis coming from RESs generation / load demand forecasting and uncertainty propagation in the energy management of electrical systems.

Uncertainty in RES, especially, introduces additional complexity for energy balancing between generation and consumption. For example, for those electrical systems implemented with PV or wind generation, uncertainty in their forecasted production cannot be avoided due to their intermittent and weather-dependent characteristics. To deal with this kind of inherent uncertainty, advanced forecasting techniques would increase the accuracy. Whereas, RESs and load demand uncertainties are both inherent and inevitable, forecasting errors always remain and it is necessary to do uncertainty analysis, i.e. to analyze how these uncertainties influence the UC and energy management of power systems. Meanwhile, sensitivity analysis is developed to identify the most influential uncertain parameters, and how uncertainties are propagated in the electrical system.

In this chapter, the main sources of uncertainties in energy systems are summarized. Solar and load demand forecasting uncertainties are examined regarding the factors that have great impacts on them. Considering these analyses, forecasting of PV generation and load demand are performed with a Back-Propagation Neural Network (BPNN) in the following section. Finally, with the aim of handling uncertainty in energy system, methodologies for uncertainty investigation are discussed, including uncertainty modeling and representation, uncertainty propagation in the optimization algorithm and sensitivity analysis.

## 2.2 Uncertainties in power system

### 2.2.1 Sources of uncertainties

Uncertainty is always an issue when we try to predict what might occur in the future. A key element for effective treatments of uncertainty is the ability to clearly distinguish two types of uncertainty [104]:

- 1) The *inherent random variability* of physical variables, inputs, disturbances and sources in a power system, often referred to aleatory or statistical uncertainty. It varies randomly with time, or space, or from sample to sample. These data include forecasting data, experimental measurements, numerical data, etc.
- 2) The *epistemic / systemic uncertainty* due to the lack of knowledge about the system. A mathematical model tries to represent a real situation with approximations due to the lack of knowledge or volunteer simplifications. These approximations are made to reduce the complexity or to facilitate equation handling.

Due to incomplete observations, a non-exact model is obtained because of the description form of equations (static, dynamic, linear, type of non-linearities). Moreover, uncertain parameters are used.

The difference between these two types of uncertainties is that, epistemic / systematic uncertainty can be reduced by accumulating knowledge and information about the system, while inherent random variability cannot be reduced by this way. Both types of uncertainties are present in PV power forecasting and load demand forecasting.

Meanwhile, as described in Fig. 2-1, sources of uncertainties in power system are divided into two groups in terms of *technical nature* and *economic nature* [105].

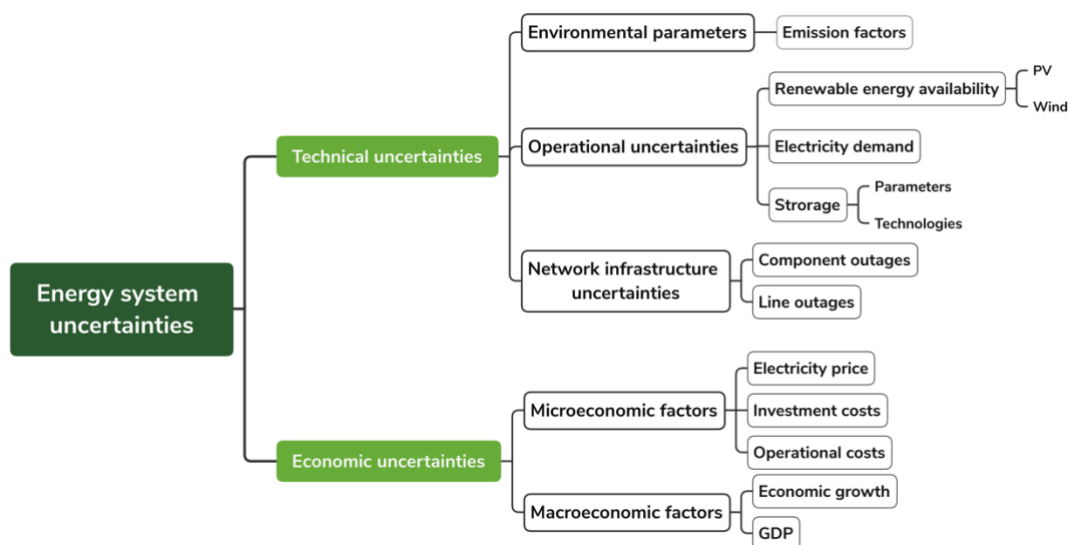

Fig. 2-1 Uncertainty sources in energy system

From a technical aspect, uncertainties are mainly from two kinds of reasons:

- 1) Operational uncertainties, e.g. load consumption, RESs generation (like wind and PV), or battery / EV charging and discharging.
- 2) Network infrastructure uncertainties, e.g. line or generator outages.

From an economic point of view, uncertainties are coming from both microeconomic and macroeconomic factors. The former includes electricity price, investment costs (CAPEX), operational costs (OPEX), etc. The latter includes economic growth, unemployment rate, gross domestic product (GDP), and etc.

In our research work, we focus on handling operational uncertainties regarding data forecasting: RES (solar) production forecast uncertainty and load demand forecast uncertainty by scheduling a reserve power.

### ***2.2.2 Solar generation uncertainty***

As one of the main sources of renewable energy, solar generation is largely dependent on meteorological and geographic factors. To handle the variability and uncertainty of PV power, many previous works has made efforts to analyse the solar generation characteristics, trying to find solutions for better integration of solar generation with the electrical system [106]. Here crucial causes of solar generation uncertainty are summarized.

*Meteorological factors:* PV power output is extremely sensitive to temperature, irradiation intensity, and cloud cover. Previously, [107] evaluated the correlation between irradiance and PV power, as well as temperature and PV power. Cloud cover impacts are detailed in [49], and several types of irradiance conditions during the day are classified with different cloud cover situations. Other weather conditions like ultraviolet (UV) index and humidity, should also be considered.

*Geographic factors:* Solar generation is dependent on location of PV panels, like longitude, latitude and altitude of a certain region. Longitude and latitude impact daily illumination time, while altitude impacts the illumination intensity. For those regions with higher illumination intensity and longer hours of daylight, the average PV generation level is definitely higher than in other regions.

To determine the most significant meteorological factors that impact the PV generation, correlations are analysed between PV generation and meteorological factors. Here in the study, the correlation coefficient  $r$  and the correlation factor  $R^2$  are calculated. More explanations regarding definitions and calculations of  $r$  and  $R^2$  can be found in **Appendix 2**. Historical data of sensed PV are collected from PV generation system

Rizomm at the HEI-L2EP laboratory; all meteorological data are obtained from the weather forecasting website The Weather Channel [108].

Fig. 2-2-Fig. 2-5 demonstrates the correlation relationship between sensed PV power and UV index, humidity, cloud cover and temperature, respectively. Two univariate histograms are shown on the horizontal and vertical axes of the plot, representing the distribution of x/y-axis variables. The more similar (or symmetric) the two histograms' shapes are, the higher the correlation is between the two variables. According to the correlation coefficient descriptions in [109], these correlation results indicate that, there is a high positive correlation between UV index vs. PV power ( $r = 0.72$ ), and a moderate correlation between humidity vs. PV power ( $r = -0.56$ ). In contrast, there is a relatively low correlation between cloud cover vs. PV power ( $r = -0.39$ ) and temperature vs. PV power ( $r = 0.35$ ). Moreover, the correlation coefficients of Fig. 2-2 and Fig. 2-5 imply the positive associations regarding UV Index vs. PV power, as well as temperature vs. PV. On the contrary, Fig. 2-3 and Fig. 2-4 indicate the negative associations regarding humidity vs. PV power, and cloud cover vs. PV power.

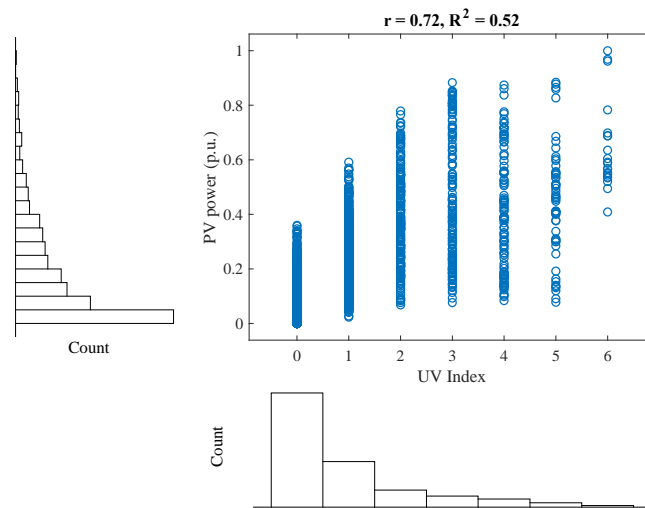

Fig. 2-2 The correlation between UV Index and PV power



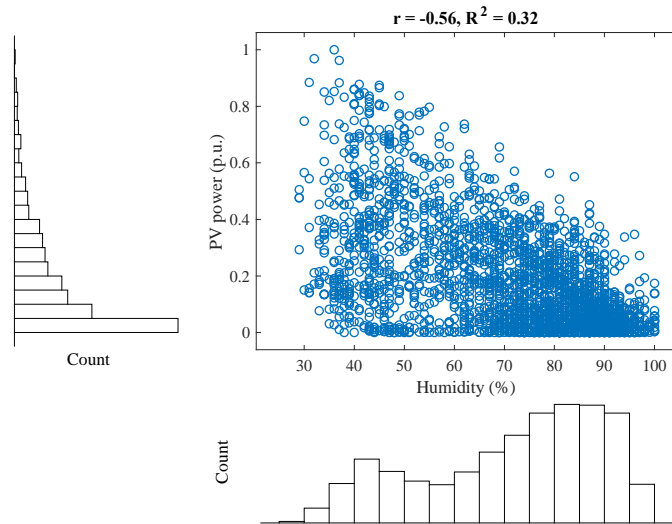

Fig. 2-3 The correlation between humidity and PV power

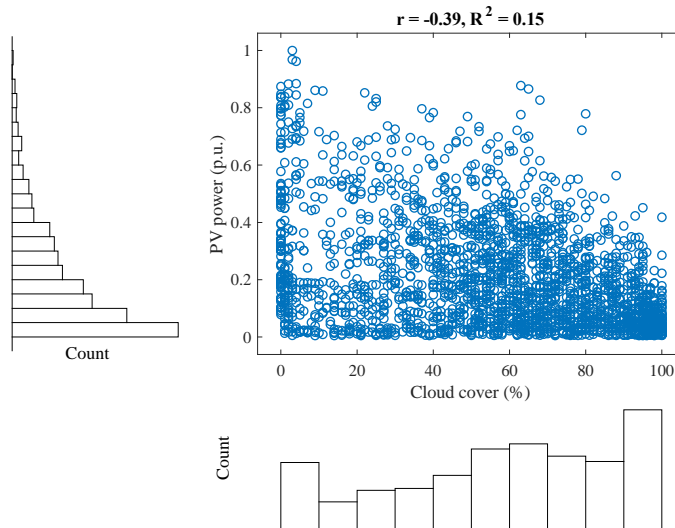

Fig. 2-4 The correlation between cloud cover and PV power

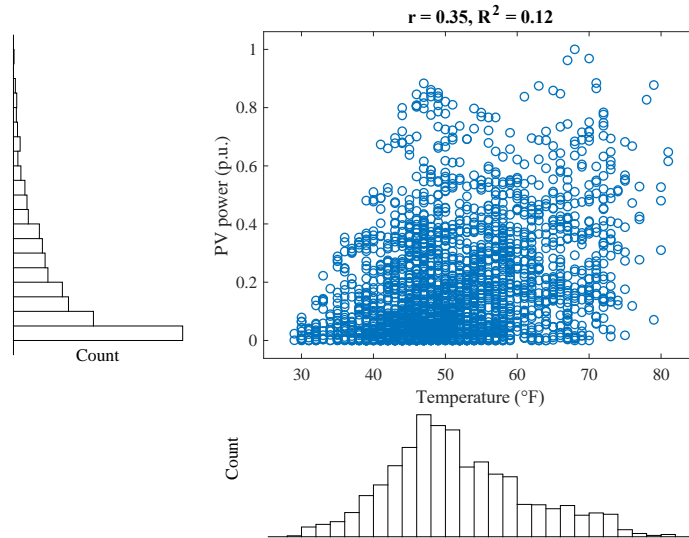

Fig. 2-5 The correlation between temperature and PV power

In conclusion, PV power has a relatively strong association with UV index and humidity, they should be considered as inputs of PV power forecasting procedure. The cloud cover and temperature are also taken into account because though they show relatively weak correlations, they will contribute to the better forecasting results.

### 2.2.3 Load demand uncertainty

The regional load demand varies with impacts from many factors. Uncertainties may derive from meteorological reason, economic reason, time reason, and other unpredictable random reasons [110].

*Meteorological factors:* Weather conditions (especially the temperature), are essential for those temperature-sensitive loads. For example, the function of air conditioning system in a building, or utilisation condition of residential heating facilities. Furthermore, weather factors apply influences on personal, social and industrial activities.

*Economic factors:* Load demand can be significantly affected by macroeconomic factors, like economic growth, GDP, and unemployment rates. They relate to, for example, local industrial activity level, or household consumption level, which are crucial for electricity consumption. Meanwhile, certain microeconomic factors are also counted, like electricity price.

*Time factors:* Load patterns are dependent on time factors including seasonal events, national / regional holidays, weekly-daily cycle pattern, etc. The peak load power is determined by season, e.g. peak load in winter is higher than in summer. Also load

pattern is determined by type of the day, i.e. workdays and non-workdays (holidays, week-ends). For example, weekly-daily cycle is caused by cycle of workday-weekend. Week-ends and national holidays can lower daily load compared with workdays because of reduced company and industrial activities.

*Other random factors:* Load uncertainty may be induced by some random events, e.g. unexpected changes of the operation status of industrial equipments. Some other events like strikes, can be foreseen, the effect on load varying is unknown, though.

In this study, we focus on the load demand uncertainty deriving from meteorological factor and time factor. Load data are collected from website of RTE (Réseau de transport d'électricité) France [111]. The used meteorological database are the same as in previous section (2.2.2).

Among all the meteorological factors, temperature shows its significant impact on load demand because of the existence of temperature-sensitive loads, e.g. residential air conditioners, heating installation. Fig. 2-6 demonstrates the correlation relationship between sensed temperature and load power. The correlation result indicates that, there is a negative correlation between temperature vs. load power ( $r = -0.58$ ). As for time factors, since the load demand power is greatly time-dependent, the historical load demand profile in past days is a useful guideline when forecasting load power.

In conclusion, load demand power has relatively a strong association with temperature and short-term historical load profile. Thus, these parameters should be considered as inputs of load demand power forecasting procedure.

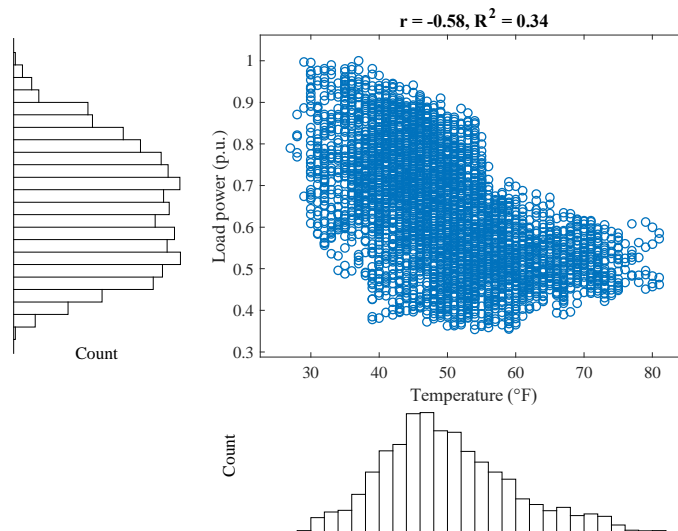

Fig. 2-6 The correlation between temperature and load power

Furthermore, to analyse if there is a possible dependence of PV production and load demand, the correlation between them is studied. Fig. 2-7 shows that there is a rather slight correlation ( $r = -0.1$ ) in the current study case. Hence the PV production and load demand is considered as independent.

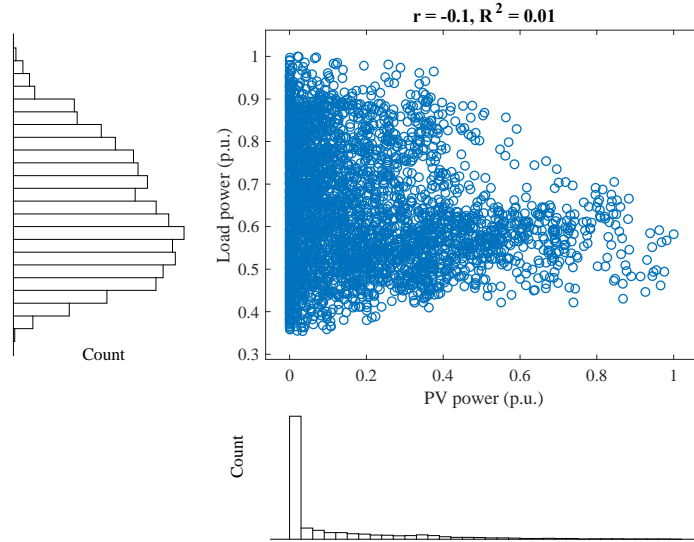

Fig. 2-7 The correlation between PV power and load power

To minimize PV uncertainty and load uncertainty properly in UC scheduling process, firstly, PV power and load demand power should be well predicted beforehand at each time step. The more the forecast values are accurate, the more the generators are scheduled reasonably, resulting in a higher security level of energy system. Hence, in the following section, with a BPNN application, forecasting of PV generation and load demand are presented.

### ***2.3 Forecasting of PV generation and load demand***

#### ***2.3.1 Fundamentals and context***

Increasing penetration level of intermittent renewable energy sources in power system makes the maintaining of its stability and reliability more complicated. RES generation influences grid regulation, load-following, power scheduling and unit commitment. Thereby, solar energy should be well predicted in order to ensure that power system operates properly and economically.

In recent decades, many techniques for forecasting have been developed, like probabilistic methods [112], time series forecasting methods and regression model forecasting methods [113], [114], neural network forecasting method [115], etc. Concerning photovoltaic (PV) power forecasting, Inman et al. [116] classified solar power forecasting methods as follows:

- 1) Statistical and regressive methods, e.g. auto-regressive, moving average, and combinations of them such as ARIMA;

- 2) Artificial intelligence techniques, e.g. Artificial neural Networks, nearest neighbors;
- 3) Numerical weather prediction based on sufficiently accurate meteorological knowledge, e.g. Global Forecast System made by U.S. Department of Energy Atmospheric Radiation Measurement [117];
- 4) Remote sensing methods, e.g. physical satellite models and statistical satellite models;
- 5) Local sensing methods;
- 6) Hybrid systems, i.e. a combination of any two or more of the methods described previously.

For a specific forecasting problem, it is essential to choose a proper forecasting technique to satisfy the needs in terms of accuracy, interpretability, traceability and reproducibility. Characteristics of forecasting are discussed as follows:

1) *Forecasting is a stochastic problem by nature.* Because of random factors, the output of a forecasting process is supposed to be in a probabilistic form, such as a probability density function, a prediction interval, some quantile of interest, a forecast under a scenario, etc. Current energy management systems cannot yet take probabilistic inputs, so the most commonly used forecasting output form is still the future expected value of a random variable.

2) *Forecast errors are inevitable.* Due to the stochastic nature of forecasting, forecasted value is never exact. Actual values will locate within a certain range from forecast values.

3) *Due to forecast errors, there is always a demand to improve the accuracy.* Potential improvements include reducing the variance or the range of forecasting errors, increasing quality of the modelling of errors, etc. Nevertheless, the accuracy will always be an issue because of the stochastic nature of forecasting. Efforts should be made to handle deviations of real data from predicted data.

The motivation of our research work is not to focus on an improvement of forecasting techniques, but to analyze forecast error uncertainty regardless of applied forecasting technique. To generate PV power and load forecast data, we have used BP neural networks (BPNN) but other forecasting techniques could also be employed as forecast error uncertainty analysis is based on generated forecasting errors.

ANNs technology for forecasting exist for decades with numerous applications. A state of art can be found in [118]. Features of ANNs are remarkable in terms of forecasting applications:

- 1) ANNs are self-adaptive methods and they learn from experiences with training process. They capture functional relationships among input and output data and while the underlying relationships can be mathematically and physically unknown.
- 2) After training with database, ANNs will generalize. They can often correctly infer the unseen part of output data (during the learning) even if the input data contain noise signals. As forecasting is performed via prediction of unseen future behavior from examples of past behavior, it is an ideal application field for neural networks.
- 3) ANNs are capable of representing nonlinear functions, which offer more capabilities comparing to linear prediction techniques.
- 4) It has been shown that an ANN can approximate any continuous function to any desired accuracy. So ANNs have more general features than the traditional statistical methods.

Fundamentals of BPNN are presented in *Appendix 1*. In the previous work of L2EP, ANN have been studied and designed according to approximation theories, and have been applied for learning multi-functional control systems [119]; for modelling nonlinear system with variable parameters [120]; and for complex adaptive calculations in real time [121].

In the next section, ANN will be employed to forecast the PV production and load demand. On the basis of work in [122], improvements regarding efficiency are made with additional inputs.

### ***2.3.2 BPNN application for PV production forecasting***

Meteorologists sample the state of the fluid at a given time and apply the equations of fluid dynamics and thermodynamics onto the sampled state of the fluid in order to estimate the future state of the fluid. Further analysis and model computation are needed to transfer solar, temperature, wind, humidity (, ...) forecasts to power production forecasts. Alternative methods use meteorological forecasts and past values as inputs to estimate directly the power production. In this study, the latter method will be used.

#### **BPNN forecast model structure**

In this section, BPNN objective is to forecast the hourly PV power generation in following 24 hours. As explained in *Appendix 1*, parameters of the BPNN will be determined by training and validating with a training set and a validation set, respectively. Then the accuracy of the forecasting capability will be tested with a test set. The architecture is determined as follows:

- i. Input layer: 5\*24 neurons are set according to the input vector, representing sensed PV generation, forecasted temperature, cloud cover, UV index (ultraviolet index) and humidity at each time step (during 24 hours). These input factors are chosen

because these information have a relatively great impact on solar energy availability, as studied in part 2.2.2.

- ii. Hidden layer: 10 neurons are set after testing different numbers. For the hidden layer, the best number of neurons will be confirmed after testing different numbers of neurons in this layer and comparing the observed performance. If the node number is too less, the accuracy of the forecasting will not be enough. On the other hand, too large number leads to an increase of the training time and may increase the observed error (with the validation set), leading to a poor generalization ability, which decreases the adaptive capacity of the neural network for untrained samples.
- iii. Output layer: 24 neurons are used to represent the 24-hourly PV forecast values.

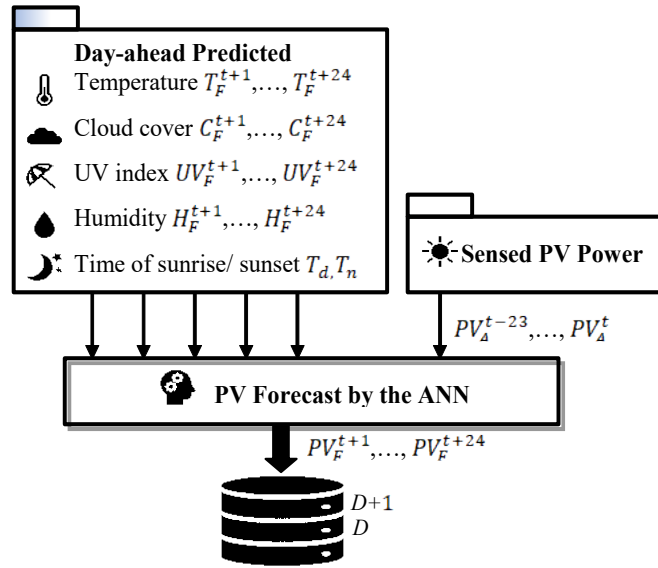

Fig. 2-8 PV power forecasting with ANN

### Training and validation of BPNN

The following historical data are set as raw input data to the BPNN:

- ✓ Day-ahead forecasted hourly meteorological data at Lille regarding: temperature, cloud cover, time of sunrise, time of sunset, UV index and humidity from 2<sup>nd</sup> October, 2019 to 11<sup>th</sup> October, 2020. All meteorological data are obtained from the weather forecasting website The Weather Channel [108]. Time of sunrise and time of sunset are used to give information regarding the time sequence of the PV production in the next day.
- ✓ Measured hourly PV generation power from 2<sup>nd</sup> October, 2019 to 11<sup>th</sup> October, 2020. PV data are collected from PV generation system Rizomm at the HEI-L2EP laboratory.

Firstly, 50% of the database is used to create the training set, 25% of the database are used for the validation set in order to validate model parameters and avoid over-fitting (*Appendix 1*). After BPNN training, 25% of the remaining database are used as test set

to test the prediction quality and accuracy of the BPNN architecture. In this study, the learning rate is set to 0.04. The maximum number of epochs is set to 200. After training the BPNN, the hourly PV power is forecasted for the following day.

### Performance of the proposed BPNN for PV forecast

To observe the performance of the trained BPNN-based PV forecast model, un-trained data in the test set are applied. Fig. 2-9 shows an example of forecast results in a rather clear sky day in Lille. Fig. 2-9 (a) shows inputs of the BPNN: Day-ahead forecasted temperature, cloud cover, humidity, UV index and day-ahead sensed PV power. Since there is no PV generation after daylight, inputs of time of sunrise and sunset are considered to distinguish daylight and night, making it possible to increase the accuracy of PV forecast performance. Then the BPNN is trained only with data during the day. Fig. 2-9 (b) shows results of hourly PV forecast, as well as obtained errors at each time step. From the obtained figures, PV forecast errors are no more than 0.17 p.u. in this case.

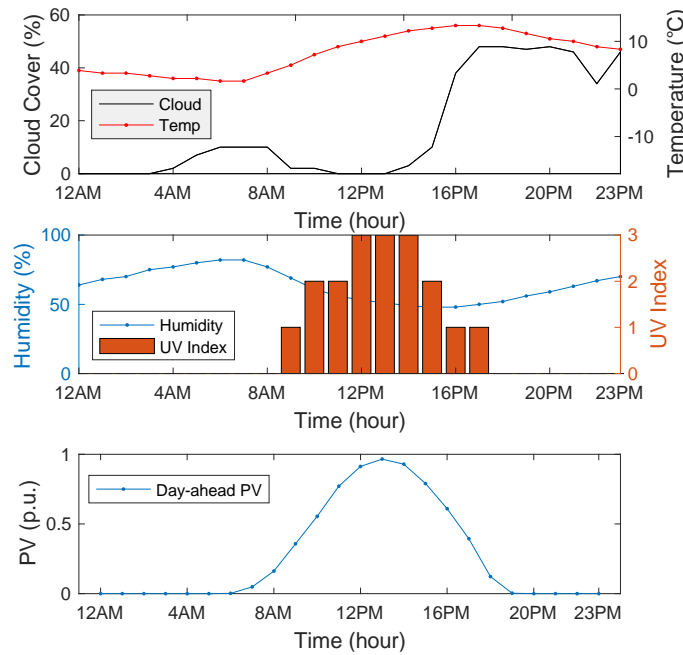

(a) Inputs: Day-ahead forecasted cloud cover and temperature, past sensed PV power



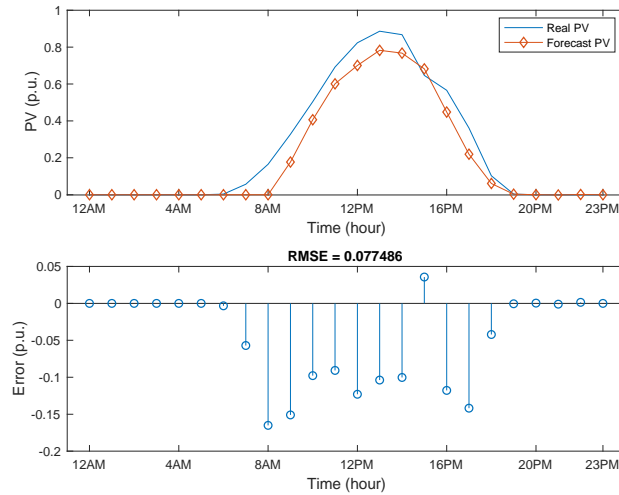

(b) Hourly PV power forecast and forecast errors  
 Fig. 2-9 PV power forecast results on 27<sup>th</sup> March, 2020

Since cloud can rapidly change PV generation with a high level of uncertainty, PV production could be more difficult to forecast. Fig. 2-10 shows an example of forecast results in a cloudy day in Lille. The high percentage of cloud cover during the day induces pessimistic PV generation. PV forecast curve shows a similar trend with real PV. However, there is a sudden increase of PV generation that is not predicted, leading to a great increase of error at 17:00. Whereas, since the database of cloudy weather days are large in Lille, forecasting in cloudy days can also be obtained with a reasonable range of error. In this case, PV forecast errors are no more than 0.07 p.u.

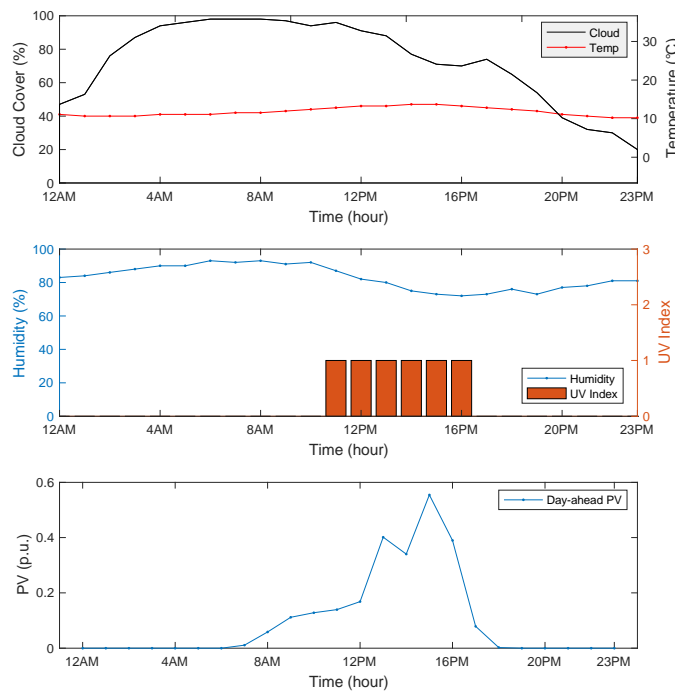

(a) Inputs: Day-ahead forecasted cloud cover and temperature, day-ahead sensed PV power

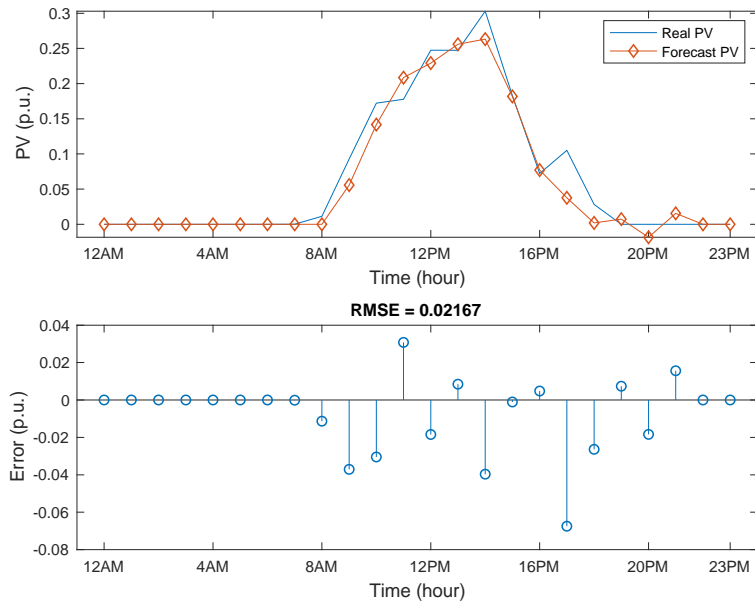

(b) Hourly PV power forecast and forecast errors  
 Fig. 2-10 PV power forecast results on 2<sup>nd</sup> March, 2020

Overall, the BPNN-based PV forecast errors of  $nRMSE$  and  $nMAE$  regarding training set, validation set and test set are summarized in Table 2-1.

Table 2-1 BPNN based- PV forecast errors

	$nRMSE$ (%)	$nMAE$ (%)
<b>Training set</b>	6.84	4.08
<b>Validation set</b>	9.36	5.64
<b>Test set</b>	12.41	7.59

In order to observe the errors more visibly at each time step, a box-and-whisker plot is created and shown in Fig. 2-11. The distributions of errors have larger variation intervals during 11:00-16:00. The ranges of intervals reach the largest value at 13:00, corresponding to the largest PV uncertainty during the day.

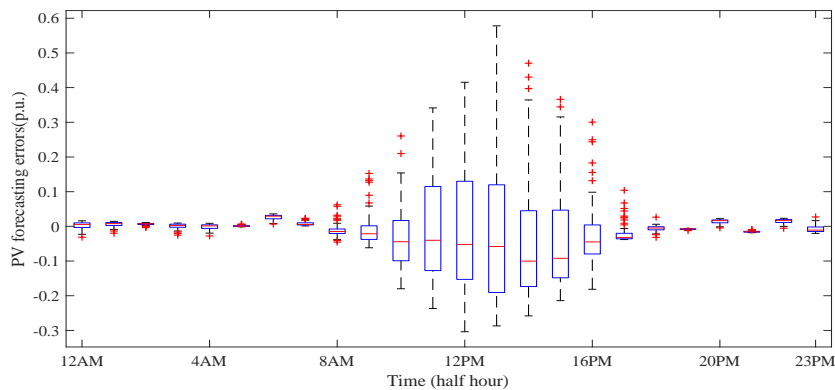

Fig. 2-11 PV power forecast errors of training data at each time step

**2.3.3 BPNN application for load forecasting**

**BPNN forecast model structure**

In this section, BPNN objective is to forecast hourly load demand power in the following 24 hours. The following ANN architecture is chosen (Fig. 2-12):

- Input layer: 3\*24 neurons are set according to the input vector of the studied case representing historical load power of D-2, historical load power of D-1, forecasted temperature at each time step (during 24 hours).
- Hidden layer: 10 neurons are set after testing different number of neurons.
- Output layer: 24 neurons are used to represent the 24 load forecast values.

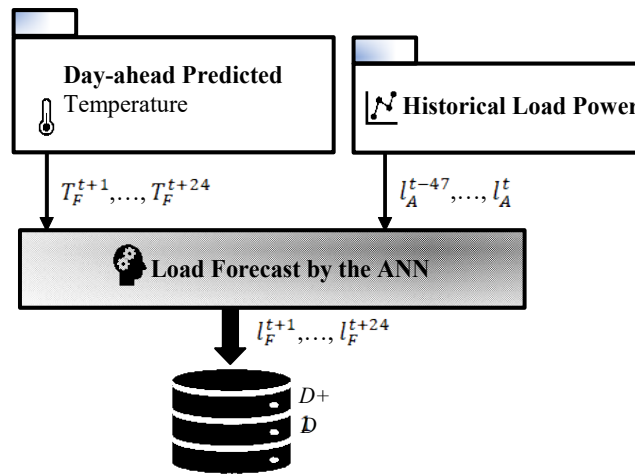

Fig. 2-12 Load power forecasting with ANN

**Training and validation of BPNN**

The following historical data are set as raw input data to the BPNN:

- ✓ Day-ahead forecasted hourly temperature data at Lille from 1<sup>st</sup> September, 2019 to 11<sup>th</sup> October, 2020. All data are obtained from the weather forecasting website of The Weather Channel [108].
- ✓ Measured historical hourly load demand power from 1<sup>st</sup> September, 2019 to 11<sup>th</sup> October, 2020. Load data are collected from website of RTE (Réseau de transport d'électricité) France and, after scaled to our urban microgrid (maximum peak load is equal to 120 kW), are used as representative load demand variations for learning the ANN forecast [111].

50% of the database is used to create the training set, 25% of the database are used for the validation set, 25% of the database are used as the test set. After training the BPNN, the hourly load power is forecasted for the following day.

**Results of load forecast**

To estimate the performance of the trained BPNN-based load forecast model, un-trained data in the test set are applied. Fig. 2-13 shows an example of forecast results of hourly load forecast and obtained errors at each time step in a workday in March 2020. Fig. 2-14 shows forecast results during a non-workday in March, 2020. It is observed that the average load consumption in workdays is more than in non-workdays. As shown in the figure, load forecast errors are no more than 0.08 p.u. and 0.06 p.u. respectively.

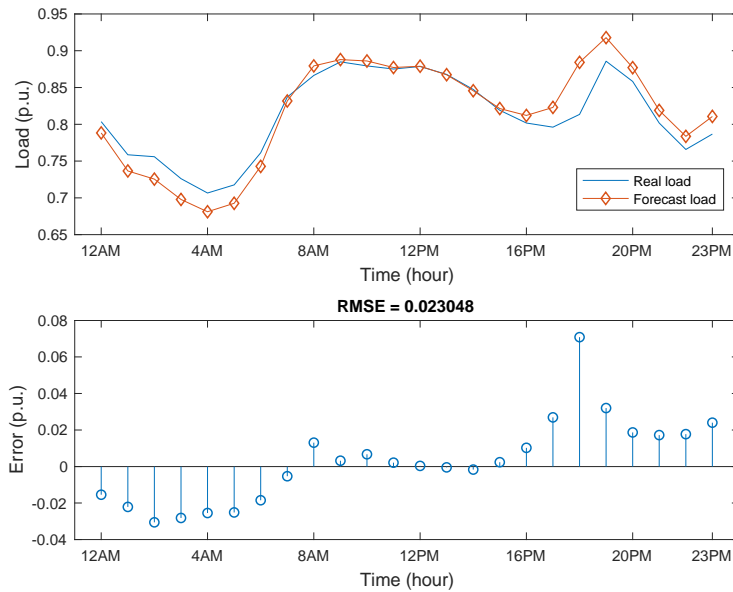

Fig. 2-13 Load power forecast results on 2<sup>nd</sup> March, 2020

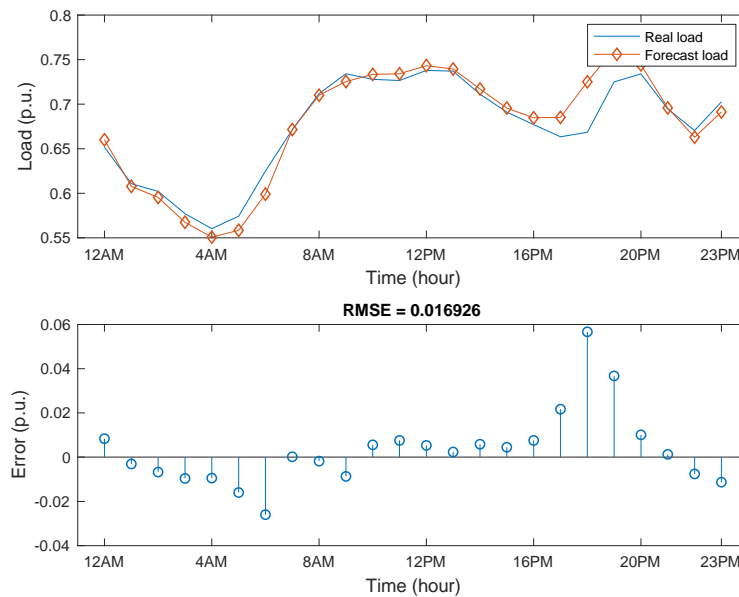

Fig. 2-14 Load power forecast results on 24<sup>th</sup> March, 2020

Overall, the BPNN-based load forecast errors of  $nRMSE$  and  $nMAE$  regarding training set, validation set and test set are summarized in Table 2-2.

Table 2-2 BPNN-based load forecast errors

	$nRMSE$ (%)	$nMAE$ (%)
<b>Training set</b>	3.60	2.77
<b>Validation set</b>	5.73	4.31
<b>Test set</b>	8.17	6.48

As illustrated in Fig. 2-15, the distributions of errors have larger variation intervals during 7:00 -12:00 and 15:00 - 19:00, implying the largest load uncertainty time periods during the day.

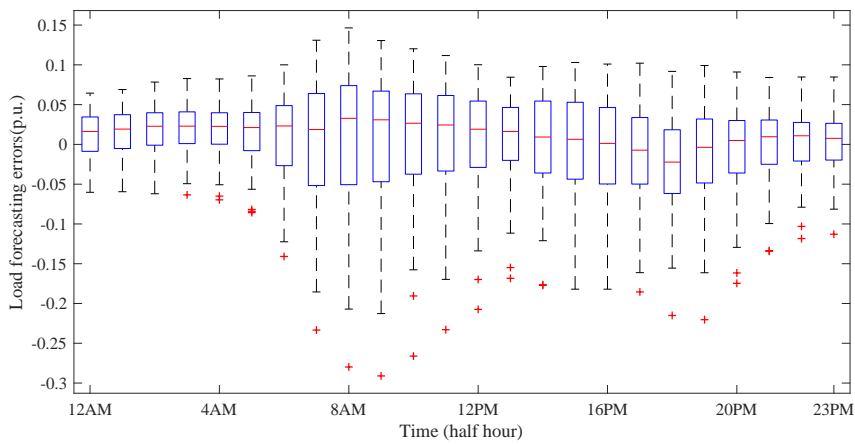

Fig. 2-15 Load power forecast errors of training data at each time step

Based on BPNN PV and load forecast, PV forecast errors and load demand forecast errors can be obtained and will be used in the next section for the following research works, which concern PV uncertainty and load uncertainty analysis, LOLP-based probabilistic analysis and reserve quantification.

## 2.4 Uncertainty Analysis in generation scheduling

### 2.4.1 Introduction

Since all forecasts have errors, the uncertainty in forecasted variables induces uncertainty on the response of the power system model, the evaluated objective function as well as the generation scheduling (chap. 1, part 1.4). The general procedure for the uncertainty analysis is mainly composed of: uncertainty characterization in input data, modelling the energy system, uncertainty propagation, and sensitivity analysis [123][124] (Fig. 2-16).

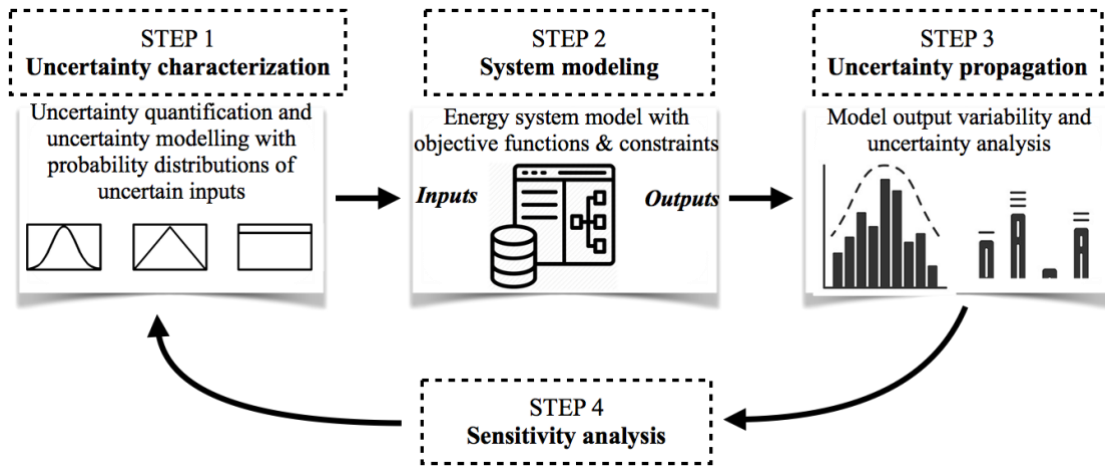

Fig. 2-16 General framework of handling uncertainties in energy system

- STEP 1: Uncertainty characterization and uncertainty modeling with probability distributions are introduced in this chapter (section 2.4.2 and 2.4.3).
- STEP 2: Energy system modeling. The mathematical formulations with objective functions and constraints are discussed in the next Chapter 3.
- STEP 3: Uncertainty propagation, with the aim of examining how uncertain inputs are propagated, and the impact they could bring to the output of the studied model. Related review of past research works is discussed in this chapter (section 2.4.4).
- STEP 4: Sensitivity analysis, making it possible to identify among the sources of uncertainty, which ones have the greatest impact on system performance. This analysis is done after application of the optimization. The state of art is described in this chapter (section 2.4.5).

### 2.4.2 Uncertainty characterization with distribution functions

The studied uncertainty is the error between the forecasted data and the real ones. The idea is simple: we would like to see if modeling and simulating the forecasting errors can help to examine and, perhaps, estimate the impact on the generation scheduling. So, the representation and mathematical modeling of uncertainties must be characterized by considering forecasting errors as random variables.

Through the statistical analysis of a database (containing values of the random variable), uncertainty characterization aims to analyze and represent uncertainty by its particular statistic features, e.g. describing values with their probability. Probability distribution functions are commonly used to model the probability law of the random variable [125]. The theoretical introduction of random variables, probability density, probability distribution function (*pdf*), cumulative distribution function (*cdf*) and normal distribution can be found in *Appendix 2*.

Different sources of uncertainties contain different natures and statistical characteristics, in consequence, varying types of probability distributions should represent them. Uncertainty characterization methods are summarized in [126]. According to [126][127], Table 2-3 summarized the mainly used probability distributions for uncertainty characterization of solar energy, wind energy and energy demands.

Table 2-3 Probability distributions for uncertainty characterization

Probability distribution	RESs		Energy demands
	Solar energy (irradiation)	Wind energy (speed)	
Normal	[128]–[133]	[134][135]	[128][136]–[139]
Weibull		[129][140]–[145]	
Uniform	[134][135]	[130][131]	[135]
Beta	[140]–[142][146]		
Rayleigh		[136][144][146]	
Lognormal		[147]	
Multiple*	[148][149]	[148][149]	[149]

\* Multiple: The combination of multiple distributions regarding different types of days, including beta, normal, Weibull, gamma, triangular, and lognormal distribution.

Sophisticated distributions may improve the uncertainty modelling [150]. Nevertheless, most of probability distributions in Table 2-3 are employed to model the RES/load uncertainties of parameters (e.g. solar irradiation, wind speed), which are different from the forecasting errors uncertainty modeling.

As in all models, a Gaussian or normal distribution is not an exact representation of the RES uncertainty but is a mathematical function that can be used easily in practice for further studies or mathematical treatments. For our studies, the forecasting errors database are observed to follow normal distributions. Thus, normal distributions have been used in our work to model forecasting errors of PV power and load demands. For example, thanks to real sensed data from the laboratory PV production (L2EP-HEI), Fig. 2-17 presents the frequency histogram and probability distribution of PV forecast errors at the time step 11:00 one day ahead.

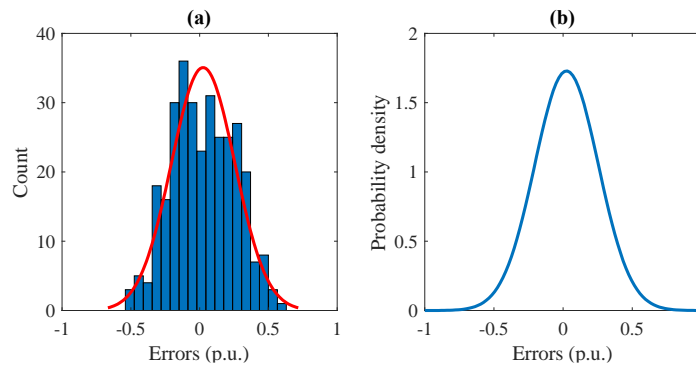

Fig. 2-17 (a) Frequency distribution histogram of the PV forecast errors (b) Normal distribution of PV forecast errors at 11:00.

Based on the given large population (312 days), the error sample data of PV forecasting errors at each time step is assumed to follow the normal distribution. In Fig. 2-17, the errors follow a normal distribution with  $\mu_{PV,t=11:00} = 0.03$ ,  $\sigma_{PV,t=11:00} = 0.23$ . A *pdf*-based modelling of forecast errors is applied for each time step in the day.

### 2.4.3 Uncertainty representation in stochastic optimization

The previous part was related to the uncertainty modelling of forecasting errors in a database. The interest now is to examine the possible influence of the uncertainty onto obtained scheduling results. Handling the uncertainty consists in the quantification of the resulting global uncertainty on obtained optimized results due to all stochastic variables/parameters.

Analytical calculations of *pdf* (section 2.4.2) of the objective function or decision variables are complex because of operations between random variables in the optimization algorithm. Issues are to apply three types of simplification [151]:

- a) Linearization enables the representation as a linear combination of random variables. The accuracy is kept if the dispersion is small around the value of random variable.
- b) Random variables must be independent to enable the use of convolutions for the calculation of values and *pdf*.
- c) Random variables must be modelled by normal distributions to enable the use of linear correlations to represent. *pdf* can be obtained by convolution or orthogonal methods (Gram-Schmidt).

Other models have been proposed to represent uncertainties on outputs with scenarios but adds an extra computational complexity in solving methods due to repetitive computations and final analysis of obtained various output values. Depending on the chosen SO methods, the representation and modeling of uncertainty can be quite different.

According to [81], uncertainty modeling can be classified into several categories: scenario-based modeling, robust modeling, and chance-constrained modeling. It is noticeable that these approaches are all depended on the probabilistic analysis and calculation of *pdfs* and *cdfs*. For example, in scenario-based optimization, uncertainty inputs are represented by a certain number of scenarios, each of them indicates a realization of a possible uncertain case with a certain possibility of occurrence. These scenarios and their possibilities are determined through *pdf* and *cdf* analysis. In robust optimization, uncertainty input is usually defined within an interval set. Upper bound and lower bound of the input are defined by using *pdf* analysis. The three main uncertainty-modeling approaches are summarized as follows.



### Scenario-based modeling

The main purpose of scenario-based uncertainty modeling is to generate a certain number of scenarios; each scenario implies a realization of the possible uncertainty with a prescribed possibility. Probability distribution of uncertainties are thus approximated by scenario representation. Two kinds of scenario generation structures are often discussed in terms of two stages or multiple stages:

- i. ***A number of parallel scenarios in a two-stage SO problem.*** Fig. 2-18 demonstrates a scenario tree with two stages. In the second stage, four scenarios are generated for the representation of uncertainties. The uncertainty is realized with different values with different possibilities at each node. For a two-stage SO problem, Monte-Carlo simulation is commonly applied to generate scenarios with probability distributions from historical data. For example, normal distribution is carried out in [152][153] to model forecast errors of the wind speed. Monte-Carlo simulations are implemented to generate scenarios for the studied UC problem.

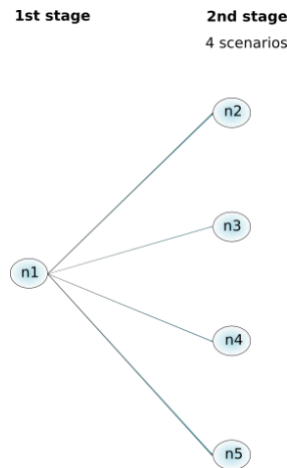

Fig. 2-18 A scenario tree with two stages

- ii. ***A scenario tree in a multi-stage SO problem.*** In a scenario tree with multi-stage, random paths are generated for scenario representation with stochastic processes approaches. At each stage, scenarios are generated by taking into account the specific uncertainty realization at the current stage. Fig. 2-19 demonstrates a scenario tree with four stages, 19 nodes and 12 scenarios. Finally, the number of generated scenarios in the model equals the number of nodes in the last stage. Since information is obtained at each time step, a decision-making is capable of managing the unit commitment, generation dispatching, and reserve requirement. It considers status of the current stage and possible uncertainty realization in the future stages. Compared with a two-stage structure, the benefit of multi-stage models is that the uncertainty realization is represented with higher accuracy and higher reliability during the process of decision-making. However, the drawback is the computational costs due to the curse of dimensionality, i.e. the dimension of the state variables is increasing exponentially.

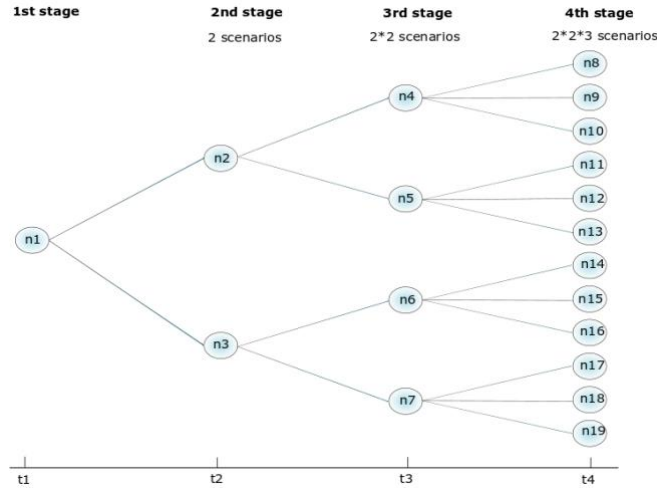

Fig. 2-19 A scenario tree with four stages

### Robust modeling (uncertainty sets)

Robust modeling is usually realized with uncertainty sets. As an uncertainty input modeling method, the uncertainty set is defined with an upper and a lower bound. By describing uncertainty within an interval, uncertainty variation range is known and may be under control, leading to a robust optimization output. By doing so, robust modeling is often used to analyze the worst-case situation in optimization. For example, box intervals are implemented in UC models in [154]:

$$[\max\{0, \bar{d} + z_{\alpha}\sigma\}, \bar{d} + z_{\beta}\sigma]$$

where  $\bar{d}$  is the expected value,  $\sigma$  is the variance of a random variable;  $z_{\alpha}$  and  $z_{\beta}$  are the  $\alpha$ - and  $\beta$ - quantile of the probability distribution ( $\alpha < \beta$ ). The uncertainty sets can represent various kinds of uncertainty inputs, like solar energy generation, or electrical loads. More details concerning quantile can be found in *Appendix 2*.

### Chance-constrained modeling (probabilistic constraints)

In chance-constrained modeling, one or several probabilistic constraints (or an objective function) must be satisfied with a high probability. The problem can be defined as [153][101]:

$$\min_{x \in X} f(x), \quad \text{s. t. } \mathbb{P}\{g(x, \xi) \leq 0\} \geq 1 - \varepsilon \quad (2-1)$$

where  $f(x)$  represents the objective function to be minimized;  $\mathbb{P}$  is the probability of a random function.  $\xi$  is a random vector, whose probability distribution is known.  $\varepsilon$  is the risk level of the chance-constrained optimization. This formulation will minimize the objective function over a deterministic feasible set while  $g(x, \xi) \leq 0$  should be satisfied with a probability of at least  $1 - \varepsilon$ . In the sample average approximation (SAA) method, true distribution of  $\xi$  is usually replaced by an empirical distribution corresponding to a Monte-Carlo sample.

The risk must be defined. As a risk-constrained probabilistic technique, Loss of Load Probability (LOLP) calculates the probability that a power shortage may occur. LOLP is a measure of expectation that the system net demand will exceed the generating

capacity during a given time step. The uncertainties coming from RES and load demand can be both taken into account:

$$LOLP_t = \mathbb{P}[C_t \leq D_t], \quad \forall t \in \mathcal{T} \quad (2-2)$$

where  $C_t$  is the total power generation capacity of all MGTs at time step  $t$ ,  $D_t$  is the actual net demand at time step  $t$ ,  $\mathcal{T}$  is the set of time steps. To ensure system reliability, constraints restricting LOLP at all time steps can be added to the UC problem, such as

$$LOLP_t \leq \varepsilon \quad (2-3)$$

where  $\varepsilon$  is the risk index.

In chance-constrained UC models, with risk measuring indices, certain constraints are added to limit the risk in a UC problem in order to maintain the preset security level of the system. Previous works in literature applied varying risk measurement methods to generate probabilistic constraints, like conditional value at risk [155][156], total profit variance [157], expected load not served [158][159], loss of load probability (LOLP) [158]–[161], etc.

Except the commonly used methods above, there exist more techniques, like in possibilistic methods, fuzzy membership functions are used to model uncertain parameter; information gap decision theory (IGDT) is applied if uncertainties cannot be modeled using *pdf* due to a lack of historical information. A state of art regarding more uncertainty representation techniques can be found in [162].

#### 2.4.4 Uncertainty propagation

Uncertainty propagation (also called uncertainty analysis) enables the quantification of the impact of input uncertainties on the performance of the simulated system model, and the evaluation of system robustness to uncertainties. We speak about propagation because the defined model in STEP 2 (in Fig. 2-16) links the inputs and outputs of the system. Thus, uncertainties in the inputs of the system lead to uncertainties in the output of the model. The model is therefore used for propagating the uncertainties of the input parameters, through the model, onto the outputs.

Uncertainty propagation analysis is commonly performed by means of Monte-Carlo simulations, worst-case methods, probability intervals, perturbation-based methods, etc. A deterministic model is fed with numbers of random but reasonable uncertain sample inputs. Then decision-maker aims to analyze the variability of the obtained outputs, trying to investigate their statistical characteristics. The way of uncertainty propagation relies on the characteristics of uncertainty modeling [163]:

- ◆ If uncertainty is set *deterministic*, i.e. within a range between minimum / maximum limits, then uncertainty propagation is performed by applying interval computation techniques using *pdf* or *cdf*;
- ◆ If uncertainty is set *probabilistic*, then uncertainty propagation is performed through Monte-Carlo sampling, Taylor quadratic approximation, etc.

Earlier studies have integrated uncertainty propagation to investigate the impact of uncertainty from RES availability and energy consumption variability. e.g. In [143] the influence of wind uncertainty is examined through uncertainty propagation during the microgrid design process. In [137] uncertainty from energy demand is analyzed in electrical system design by employing Monte-Carlo simulation. Uncertain solar generation and energy consumption are investigated in [164] by means of uncertainty propagation analysis for an off-grid system design.

#### ***2.4.5 Sensitivity analysis***

With the aim of evaluating how important each uncertain parameter is, sensitivity analysis seeks uncertain parameters that contribute most to uncertainty and variability of the model output [124]. Sensitivity analysis methods are constituted of local sensitivity analysis and global sensitivity analysis. The former quantifies parameter uncertainty by changing a single parameter at a time, keeping other uncertainties unchanged; while the latter varies all target parameters at a time.

The principal advantages of local sensitivity analysis are its user-friendly implementation and its less complicity. However, local sensitivity analysis is not ‘robust’ enough when handling uncertainties of varying sources [165]. To cover the uncertainty from different inputs at a time, global sensitivity analysis is performed to investigate various uncertain inputs with more robustness and reliability. Meanwhile, the interactions and correlations are also considered between different sources of uncertainties, thus covering uncertain parameter space more effectively [165]. The common methods and techniques relating global sensitivity analysis are detailed in [166]. As for the state of art of local and global sensitivity analysis, available methods are reviewed in [167]. Also in [168] global sensitivity analysis methods are summarized.

Sensitivity analysis is often used for optimal distributed energy system design, aiming at identifying the most essential uncertainty parameters. In the current research, sensitivity analysis is beyond the scope of our discussion.

### ***2.5 Conclusion***

In this chapter, sources of uncertainties in energy systems are firstly introduced. Uncertainties within solar generation and load consumption are mainly discussed. Those factors that have evident influence on solar energy and load demand are analyzed, respectively, like meteorological information (temperature, cloud cover) and time factor. A correlation analysis is made to show the relationship between PV power and sensed UV index, humidity, cloud cover and temperature.

Then based on these investigations, the discussion is followed by the BPNN-based forecasting of PV generation and load demand. By setting the proper input factors,

model structure and model parameters, 24-hour-ahead PV power and load power are predicted through the presented BPNN training with a historical database of day-ahead forecasted temperature, cloud cover, UV index, humidity, time of sunrise, time of sunset, and measured hourly PV power and hourly load power. Finally, forecast errors are obtained by comparing the deviation between forecast and real values, which is used to evaluate the performance of the forecasting model.

Forecasting of RESs generation could be tough due to the uncertainty and variability of weather conditions. Hence, no matter what forecasting technology is performed, it is essential to deal with uncertainties in forecasting PV generation and load consumption, for example, for scheduling a reserve provision. Usually, incorporation of RES requires more flexible power reserve than conventional generating units when the same security level is attained. Besides, as an approach of evaluating the model, forecast errors are used for power reserve determination in the next chapter (Chapter 3) with risk-constrained probabilistic methods.

Furthermore, the procedure of uncertainty analysis for energy system is discussed. The methods of uncertainty characterization are presented with relating knowledge of probability distributions and probabilistic approaches. In addition, the state of art of uncertainty modeling approaches are introduced, like scenario-based modeling, uncertainty set based modeling and chance-constrained modeling. Finally, the background of uncertainty propagation and sensitivity analysis are reviewed.

The current research aims at solving the UC problem and optimal energy management under uncertainties with formulated energy system model. Two approaches are developed regarding different types of system model. In the following Chapter 3, applications of STEP 1 - STEP 3 (in Fig. 2-16) are presented. Uncertainty propagation is analyzed with probabilistic methods in a deterministic UC model with uncertain inputs. In Chapter 4, a robust method is built with scenario-based optimization. Uncertainty is modeled through considered scenarios, including uncertainties in the process of the solution search.

## CHAPTER 3

# CHAPTER 3 DETERMINISTIC UNIT COMMITMENT UNDER UNCERTAINTY

## 3.1 Introduction

As discussed previously in Chapter 2, the studied sources of uncertainties are renewable energy and load demand forecasting. The large-scale integration of renewable energy sources (RESs) such as wind and solar generation in power systems is limited by their inner characteristics, mainly, the unpredictable variations of primary energy source and uncontrollable power generation. Deviations between forecasted values and real ones bring uncertainties in power systems, especially microgrids, and local energy community that are extremely dependent upon renewable energy supplies [36], [37], [82]. The large-scale development of small-sized variable RESs in urban microgrids can increase local high dynamic unbalances if their electrical production is not well forecasted. This can create instabilities on the inertia response and primary frequency controllers of existing conventional generators [169]. Therefore, scheduling an adequate operating reserve (OR) power is one solution to ensure the power system security, since it can be used to compensate the unpredictable imbalances between unexpected intermittent RES generations and consumptions [170].

Classically, the OR is provided by conventional and controllable generators. Generally, selecting conventional generating unit states (on/off) during any time step of the day is known as generation scheduling, namely as unit commitment (UC) problem [57]. From day-ahead forecasting of the load demand and renewable generation, UC problem classically finds the optimal generation scheduling that minimizes the global operating cost. Failure to commit enough energy resources to meet operating conditions can lead to expensive actions, for example starting thermal turbines instantaneously and abruptly.

UC problems nowadays require methods to quantify uncertainties according to probabilities and to minimize the operating costs for different uncertainties. A determination quantification method of the OR is proposed in this chapter and carried out through a probabilistic approach by considering forecast uncertainty of PV and load demand.

The introduction of uncertainties in UC and energy management problem adds extra computational complexity to current methods [171] and so solving algorithms with an acceptable accuracy and computation time are essential. In this chapter, UC techniques using dynamic programming (DP) and mixed-integer linear programming (MILP) are presented for the generation scheduling with consideration of stochastic characteristics of the PV energy forecasting errors. The impact of PV generation uncertainties on the generation scheduling, on OR powers and on operating costs (after optimization) are analyzed.

Moreover, the impact of RESs uncertainties on reserve provision is discussed. A determination quantification method of the OR is proposed and carried out through a probabilistic approach by considering forecast uncertainty of PV and load demand.

The contents of this chapter are as follows. Section 3.2 reviewed the state of art of DUC under RES uncertainty. In section 3.3, the operating reserve definition and reserve types are introduced. Also, OR criteria are reviewed in terms of deterministic and probabilistic approaches with a discussion of the RESs impact on OR provision. Section 3.4 presents a risk constrained probabilistic method to determine the OR. Section 3.5 introduces the mathematical formulation of the UC in the presented urban microgrid. The studied urban microgrid is presented in section 3.6. The DP application for UC procedure is performed in section 3.7. Then the uncertainty propagation is analyzed with probabilistic methods in section 3.8. In section 3.9, a MILP approach is applied to solve the generation scheduling with a linearized objective function. Comparisons with a DP are performed in terms of computation efforts and accuracy. Finally, the conclusion is made in section 3.10.

## ***3.2 State of Art of DUC with OR and Research Tasks***

### ***3.2.1 DUC under uncertainty***

In order to secure the production/consumption balancing of a microgrid under uncertainties coming from a large renewable energy-based production, many works have explored uncertainties model and used them to quantify a power reserve to cover risks on the production consumption balancing. Practical applications taking into account reserve allocation and risk assessment methods are discussed in [172]. Usually, a probabilistic analysis of forecasting errors of load demand and PV generation is performed and then the reserve power is quantified. In [173], an optimal microgrid economic operation is applied in the energy management system. Day-ahead power forecasting is based on different PV output characteristics under various weather conditions. Based on forecast error quantiles, a probabilistic reserve requirement quantification method has been presented by [174]. By comparing with other reserve rules, this proposed DUC method shows its advantages when dealing with uncertainty on wind power. In [175] the reserve is optimized by a constrained unit commitment solution search with a loss of load probability. A probabilistic UC problem is solved under wind uncertainty in [85] by incorporating a Lagrangian relaxation method with a scheduled operating reserve. [176] proposed a probabilistic method for generating uncertainties and is based on a point estimate method. Different renewable power uncertainty sources, like wind, solar and storage, are included in the optimal energy management of the presented microgrid. However, the impact on optimal operational costs regarding reserve under PV uncertainties is not yet analyzed.

### ***3.2.2 Synthesis***

Classic optimization of DUC considers a deterministic quantification of the power



reserve (Fig. 3-1) and, then, a risk-based deterministic optimization (MILP and DP in this chapter) is applied to determine power references of conventional generators. In the next part, fundamentals about operating reserve are recalled and then quantification of this reserve with a deterministic criterion is presented.

Then, a risk-based optimization method is proposed to solve the UC problem. In the proposed approach, based on the power system model, which is built in step 1, additional reserve power is quantified in step 2 with a risk-constrained probabilistic method. Then in step 3, a risk-based deterministic optimization is applied for DUC scheduling. Concerning the uncertainty propagation, the impact of PV variability is analyzed regarding reserve provision and operating costs in step 4.

#### Classic Optimization



#### Risk-Based Optimization for Unit Commitment



Fig. 3-1 Scheme of the classic approach and proposed risk-based deterministic optimization approach

### 3.3 Dealing with Uncertainty: Power Reserve

#### 3.3.1 Introduction

Operating reserve (OR) is one of the most principal manners of handling unexpected generation outages or load increase, with the aim of responding to imbalance between power consumption and generation. The definition of OR is specified in [177]:

*“The term operating reserve is defined as the real power capability that can be given or taken in the operating timeframe to assist in generation and load balance and frequency control.”*

Hence, OR is an amount of power that is not used in normal operation but is available in case of unexpected unbalancing. The availability of OR has an impact on electrical system security and social welfare, since it mitigates the appreciable social and economic costs of occasional outages. However, a continuous provision of OR can cost a lot because additional generating units must be committed, and some units are operated at sub-optimal set points [178]. Power system operators usually set the OR under certain criteria to ensure the system security level with a preset tolerable level of risk.

Traditionally, an UC procedure ensures that a fixed amount of OR is scheduled by

including a constant reserve constraint in the optimization process (Fig. 3-1 a)). A fixed amount of reserve requirement during the whole UC procedure can be sub-optimal, though. Owing to the variability and uncertainty of RESs, generation and consumption of power systems nowadays are becoming difficult to predict. Thus, the amount of scheduled OR may exceed the required value during some periods, inducing a less economic scheduling process; while in other periods, OR may be insufficient to compensate imbalances and frequency fluctuations, leading to potential risks to some extent.

Under this context, the compromise between increasing the OR provision and reducing the risk level of unbalancing is targeted in earlier researches. Furthermore, considerable approaches are promoted to handle optimal OR quantification, like probabilistic approaches, and inclusion of OR constraints in stochastic optimizations. In the next section, frequency control reserve types are discussed. The OR criterion in terms of deterministic and probabilistic approaches are introduced.

### ***3.3.2 Frequency control reserve types***

A power reserve is required to handle generation-load mismatches, which may occur due to a difference between the actual PV/wind power and their forecast, or as an effect of a generator/load loss. Such mismatches between load and generation induce frequency deviations. Through the sensing and surveillance of the frequency, automatic generation control may be activated to inject more power. The following Fig. 3-2 shows the system frequency as well as the primary, secondary and tertiary frequency controls when an unexpected loss of a generator occurs [179]. Each type of frequency control has its own performances in terms of power supply (delay, response time, supply duration, ...) and uses technical requirements for power supply.

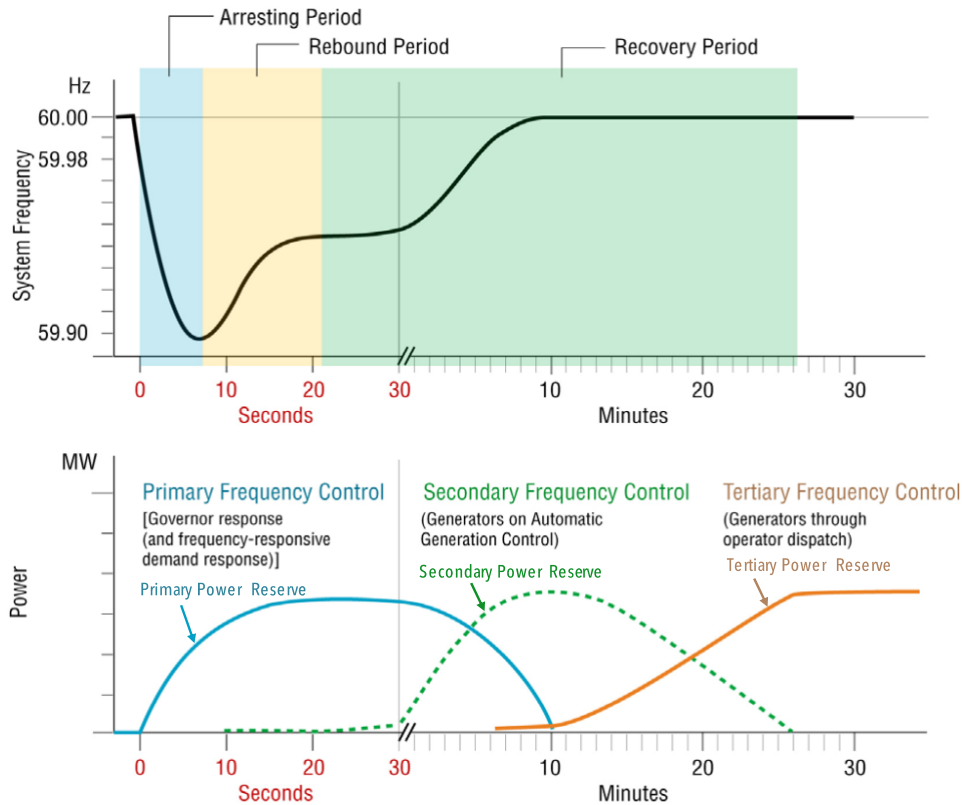

Fig. 3-2 Sequential actions of primary, secondary, and tertiary frequency controls following the sudden loss of generation [179].

Following the sudden loss of generation, reserve resources (generators, storage, ...) that provide primary frequency control actions, immediately increase power output within 30 seconds or less. Once the frequency decline is arrested, the continuous delivery of primary power reserve stabilizes the electrical system but with a lower frequency prior to the loss of generation. This is labeled the “rebound period”.

Once the variation of frequency stopped, the secondary frequency control reserve brings the frequency back to its reference value (60Hz in Fig. 3-2). For this purpose, automatic generation control actions are made. Secondary frequency control actions do not trigger until 30 seconds (or more) following the loss of generation, and can take about 5 to 15 minutes (or more) to restore the frequency to the scheduled value.

Finally, the goal of tertiary frequency control actions is to restore the power reserve that have been used to provide primary and secondary frequency control. So that the power system can respond to a subsequent loss-of-generation event. The manual deployment of tertiary frequency control represents the final stage of the “recovery period” and release the deployed primary/secondary control reserves [180].

Each type of frequency control has own performances in terms of power supply (delay, response time, supply duration, ...) and uses technical requirements for power supply.

The large-scale development of small-sized variable RES in local energy communities increases local high dynamic unbalancing between the local consumption and local generation. Power unbalancing can create instabilities on the inertia response and primary frequency controllers of existing conventional generators [169].

Since many conventional generators such as coal-fired and nuclear units have limited flexibilities regarding ramping rates and minimum on/off times, novel power generation facilities with high dynamic for power generation are developed, such as microturbines in chapter 3 and 4 and also storage system in chapter 5. Then, novel power system operational methods are required to schedule generating units more efficiently in order to accommodate the large and fast fluctuations in renewable generation outputs while maintaining power system reliability.

All reserves are not the same and how they can be brought on (ramp rate) is important according the system operating needs. In this thesis, the OR is defined as the real power that can be called for the imbalance between power generation and load demand (primary and secondary reserve). Assuming an ideal primary frequency control reserves compensating for any fast power deviation, we focus on the steady state behavior of the automatic generation control actions, namely the secondary power reserves. This automatic generation control output is distributed to certain committed generators, whose setpoints are changed by a certain percentage of the active power to be compensated.

The balance between OR requirement increase and OR provision costs is always an issue to solve. OR power should be carefully sized and dispatched on controllable generators in order to reduce the operating costs of electrical systems, and, the most important, to keep a satisfying security level.

### 3.3.3 Deterministic criterion for OR sizing

The traditional criteria to provide fixed OR requirements is the *N-1* criterion. It ensures that the power system could sustain the outage of any electrical network equipment with no need of load shedding [59]. Formally, in case of tripping of the largest committed generating unit, available OR must be enough to provide the required power and to restore the balancing stability. Traditionally, OR for the electrical system is sized as the capacity of the largest generating unit.

$$\underline{r}(t) = \max[\delta_m(t)\bar{p}_m], \quad \forall t \in \mathcal{T}, m \in \mathcal{M} \quad (3-1)$$

$\delta_m$  is the commitment of generator  $m$  at time step  $t$ ,  $\delta_m(t) \in \{0,1\}$ .  $\bar{p}_m$  is the maximum power generation limits of generator  $m$ .

In a power system, many generators can provide a part of this OR. So, for  $M$  generators that provide OR, the *N-1* criterion can be formulated as:

$$\sum_{m=1}^M r_m(t) \geq \underline{r}(t), \quad \forall t \in \mathcal{T} \quad (3-2)$$

where  $r_m(t)$  is the allocated reserve power from generator  $m$  at time step  $t$ ,  $\underline{r}(t)$  is the operating reserve requirements for the entire electrical system.

The  $N-1$  criterion is used by many power system operators. In the past, the cost of keeping reserves was part of the overhead; nowadays the entity supplying the reserve should (and in the future “would”) be compensated. Thus defining the amounts of different reserve margins becomes a critical task and this is why the grid codes in reserves vary from region to region.

Southern zone of PJM Interconnection in America [181] assumes that the outage of more than one generator is unlikely to happen. Moreover, UC scheduling outcome considering this  $N-1$  criterion is far beyond the economic optimum. Similarly, another deterministic criterion is used by system operators in Australia, Ontario and New Zealand [182] and consider the planned power  $p_m(t)$  for each time step:

$$\underline{r}(t) = \max[\delta_m(t)p_m(t)], \quad \forall t \in \mathcal{T}, m \in \mathcal{M} \quad (3-3)$$

where  $p_m(t)$  is the power generation set point of generator  $m$  at time step  $t$ . The reserve requirement is changing at each time step and corresponds to the output of the most heavily loaded generator at the current time step. Under this criterion, the reserve provision is less than with the  $N-1$  criterion, the disconnection of a single generator is not allowed, otherwise the safety cannot be assured.

Meanwhile, reserve requirement can be calculated with consideration of a fraction of the peak load. For example, in Canada, electric utilities like Yukon Electrical and NWT Power Corp. (Northwest Territories Power Corporation), determine the amount of reserve by considering [183]:

$$\underline{r}(t) = \max[\delta_m(t)\bar{p}_m] + a\% * l_{peak}, \quad \forall t \in \mathcal{T}, m \in \mathcal{M} \quad (3-4)$$

where  $l_{peak}$  is the peak load within a given period,  $a$  is a certain percentage that is decided regarding the peak load power. Usually  $a$  is set 10% (or 5% if peak load power is large).

In Europe, reserve requirement is defined by ENTSO-E, i.e. European Network of Transmission System Operators for Electricity, regarding a proportion of the peak load in the region within a given period  $l_{peak\_in\_region}$  [184]:

$$\underline{r}(t) = \sqrt{b * l_{peak\_in\_region} + c^2} + c, \quad \forall t \in \mathcal{T}, m \in \mathcal{M} \quad (3-5)$$

where  $b$  and  $c$  should be determined empirically. In general,  $b$  is set no more than 10 MW,  $c$  no more than 150 MW.

According to [178][183], Table 3-1 summarizes deterministic reserve requirement

criterion in some power systems of Europe, North America and Oceania.

Table 3-1 Deterministic reserve criterion of power system operators in different regions

	System	Criterion of $\underline{r}(t)$
<b>Europe</b>	ENTSO-E/UCTE	$\sqrt{b * l_{peak\_in\_region} + c^2} + c$
	France	ENTSO-E policy, with a minimum value of 500 MW
	Belgium	ENTSO-E policy with a minimum value of 460 MW
	The Netherlands	ENTSO-E policy with a minimum value of 300 MW
	Spain	$[3 * \sqrt{l_{peak}} + 6 * \sqrt{l_{peak}}]$
<b>North America</b>	Yukon Electrical (Canada)	$\max[\delta_m(t)\bar{p}_m] + 10\% * l_{peak}$
	Manitoba Hydro (Canada)	$80\% * \max[\delta_m(t)\bar{p}_m] + 20\% * \sum_{m=1}^M \bar{p}_m$
	Southern zone of PJM (America)	$\max[\delta_m(t)\bar{p}_m]$
	Western zone of PJM (America)	$1.5\% * l_{peak}$
<b>Oceania</b>	Australia and New Zealand	$\max[\delta_m(t)p_m(t)]$

These reserve criteria are varying extensively, because they are determined with consideration of system size and practical experiences of their owner. All techniques considering a deterministic criterion to size OR suffer from the same problem. As the generated power of RES cannot be controlled to a prescribed power reference because of the variation of the renewable primary energy, RES generation are considered as a tripping generating unit. Hence, a large amount of OR is required from conventional (and polluting) generators that will probably not be used as RES will generate. The oversizing of the OR is leading to economic losses and power system hazard.

### 3.3.4 Probabilistic criterion with consideration of RESs uncertainties

With the aim of well balancing the reserve provision and economic costs, and dealing with the rising uncertainty in RES, probabilistic OR criterion have been developed and widely discussed in earlier research projects.

A pioneering probabilistic approach for the reserve provision was proposed in [185] by considering uncertainties from conventional generators probabilities of forced outage of generators. By doing so, the predefined UC risk level is defined and reached with varying OR provision, taking into account the varying load demand level, load forecast errors and generating capacity of units. However, this approach may lead to a

suboptimal solution, since it does not optimize the OR provision regarding the operating costs of each individual generator. Instead, it just increases the committed generating capacity in order to reach the security target relating to UC risk level. Later in [83] by applying IP (integer programming) for a UC problem, the relationship between OR provision and relating risk level was discussed to have a reasonable description of security and reliability of generation scheduling. Also the expected outage costs due to the increase of marginal costs of OR were described in [186] to define the marginal utility of OR.

In [84], the amount of reserve was firstly optimized in the presented UC. The risk index is calculated during the scheduling, then OR is adjusted at certain time steps in case that the target risk index is not reached. [187] proposed an approach to balance the operating cost of the power system and the expected cost of energy not served due to load curtailments. Most applied probabilistic methods calculate the reserve requirement relating with a pre-defined reference risk level, then a compromise is made between the economic cost and system security level. More precisely, [188] has presented an approach for operating reserve evaluation in an electrical market. The interruption costs of the system is represented as a loss of load cost (LOLC). [189] described a method to calculate the optimal reserve capacity by minimizing the sum of the reserve costs and the expected interruption costs, which are represented as the interrupted energy assessment rates (IEAR). IEAR links the customer interruption costs and the adequacy indices normally used for planning and operating purposes. [190] has made efforts to weigh the cost and benefit of spinning reserve during UC process in an electrical market. The benefit is a function of the reducing expected energy not supplied (EENS), and the value of lost load (VOLL) is calculated with socioeconomic costs.

[182] proposed a function that approximates the reserve requirements to obtain the targeted loss of load probability (LOLP), with the aim to quantify the risk taking into account the individual system parameters of the considered function. The OR requirements are quantified by a function of preset  $LOLP_{preset}$ , and are added as a linear constraint at each time step during the optimization:

$$\underline{r}(t) = f(LOLP_{preset}), \quad \forall t \in \mathcal{T} \quad (3-6)$$

In [159] reserve requirement is determined by two types of reliability indicators: expected load not served ( $ELNS$ ) and  $LOLP$ . By setting OR requirements, upper bounds of  $ELNS$  and  $LOLP$  are defined regarding a max number of unavailability units, to attain the system security target at each time step:

$$ELNS(t) \leq ELNS_{UB}, \quad \forall t \in \mathcal{T} \quad (3-7)$$

$$LOLP(t) \leq LOLP_{UB}, \quad \forall t \in \mathcal{T} \quad (3-8)$$

where upper bounds  $LOLP_{UB}$  and  $ELNS_{UB}$  are hybrid metrics that are included in the presented reliability-constrained algorithm of market clearing. However, until now, the considered uncertainties are coming from load demand, load forecast errors and failure of conventional generating units, while the uncertainties from RESs are not yet included

in these works.

To handle the uncertainties from a high penetration of intermittent RES, e.g. solar and wind generation, the impact of RESs are evaluated with the aim of determining probabilistic OR in many research works. The OR does not linearly increase regarding RES penetration ratio, instead, OR is dependent on varying factors like size of the electrical system, scheduling strategy, forecast accuracy of RESs and the load, etc.

A considerable number of inspiring researches have been working on wind power integration, which advanced the art of analyzing impact of RES uncertainties on reserve calculation [191]–[193]. In [194], the prediction uncertainty arising from intermittent generation of wind forecast is assessed. By considering wind forecast uncertainties, efforts are made in [193] as an extended work of [190] to represent uncertainties by Gaussian distributions. EENS and VOLL are evaluated to make decision of UC scheduling and reserve provision.

By modeling wind uncertainty with generated scenarios, reference [195] performed a two-stage stochastic programming to optimize the reserve level as well as the reserve cost. Expected cost is minimized by considering the VOLL and the energy / reserve bids. Though the generation of scenarios is not detailed. In [170], with probabilistic forecasts of wind and load demand, the OR is defined through the risk index EENS considering different preset reserve level, with the objective of attaining the acceptable risk, as well as avoiding the unreasonable costs.

To take into account the forecast uncertainty from load, PV and wind, [196] described an approach of scenario generation, then the reserve requirement is assessed in order to cope with uncertainty dynamics in the presented microgrid. Non-parametric probability density approach (empirical cumulative distribution function) is used to model the uncertainty from variables. While the operating reserve quantification is discussed, the reserve allocation is not included in the paper.

The issues of this bibliographic study are the following:

- At each time step, the RES uncertainty must be modelled (with normal probability distribution as explained in section 2.4.2).
- The LOLP is a fundamental risk index to size the required OR for the power system
- The system OR must be allocated among conventional generators according their economic and technical characteristics.
- In this chapter, to handle the RES uncertainty, the determination and allocation of probabilistic OR are implemented by applying a risk-constrained probabilistic method, which is detailed in the following section.

To handle the RES uncertainty, we propose to determine and allocate the probabilistic OR by applying a risk-constrained probabilistic method, which is detailed in the



following section.

### 3.4 Reserve Quantification with a Risk-Constrained Probabilistic Method

#### 3.4.1 Analysis and modelling of the uncertainty

As discussed before, OR power is essential to ensure the power balance between the intermittent RES generation and load demand in case of mismatch. To achieve an optimal generation planning with the consideration of reserve allocation, reserve requirements for all the electrical system must be first quantified in advance. As uncertainties in energy forecasting vary in the day, an appropriate level of minimum power reserve must be determined at each time step, it is necessary to prescribe a risk index that quantify the desired level of system security. The task is to quantify the OR power in advance (one day-ahead) by carrying out risk-constrained probabilistic techniques.

Previously in Chapter 2, the PV power and load power are forecasted one day-ahead at each time step. According to the forecast errors within PV and load demand forecasting uncertainties, the probabilistic reliability can be assessed by an index as the Loss of Load Probability (LOLP). LOLP is the probability that a power shortage may occur. It is a measure of expectation that the load demand may exceed generating capacity of an electrical system during a given time step. Meanwhile, the “Expected Energy Not Served (EENS)” index measures the magnitude of not served net demand:

In the studied microgrid, uncertainties coming from PV power forecasting errors and load forecasting errors are both taken into account. As shown in Fig. 3-3, according to the frequency distribution histogram, PV and load forecasting errors can be modelled with a normal distribution.

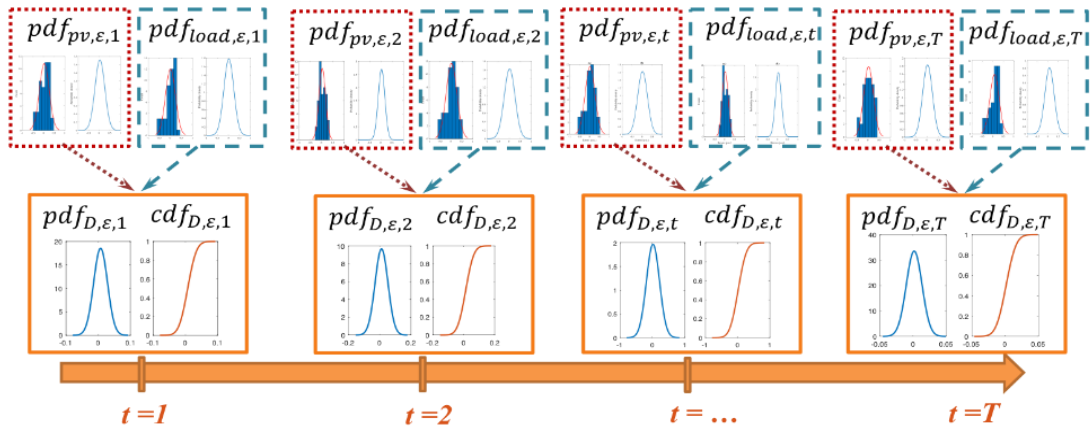

Fig. 3-3 pdf of net demand forecast errors from historic database of PV and load demand forecasting errors.

A *pdf* (probability distribution function) of past PV forecast errors  $pdf_{pv,\varepsilon,t}$  and load demand forecast errors  $pdf_{load,\varepsilon,t}$  are calculated at each time step for all days of past years. According to the frequency distribution histogram, both PV and load forecast errors are observed to follow normal distributions at each time step. Assuming that PV forecast errors follow a normal distribution  $N(\mu_{pv}(t), \sigma_{pv}(t))$ , load demand errors follow  $N(\mu_{load}(t), \sigma_{load}(t))$ . As both forecasting errors (random variables) are independent, the mean value and the standard deviation of the net demand  $\mu(t)$  and  $\sigma(t)$  can be calculated as follows [107]:

$$\mu(t) = \mu_{load}(t) - \mu_{pv}(t)$$

$$\sigma(t) = \sqrt{(\sigma_{pv}(t))^2 + (\sigma_{load}(t))^2}$$

as the mean of net demand is the difference between load demand and PV generation; the standard deviation of net demand should be calculated by considering the deviation of both PV generation and load demand. Then *pdf* of net demand forecast errors  $pdf_{D,\varepsilon,t}$ , and *cdf* (cumulative distribution function) of net demand forecast errors  $cdf_{D,\varepsilon,t}$  can be obtained.

Here the presented problem is statistically discrete, since the probability distribution of the net demand deviation at the same time step everyday (e.g. every day at 11:00) is discrete. Fig. 3-4 illustrates the calculation of the reserve requirement with a risk index  $\varepsilon$  of LOLP at 11:00.

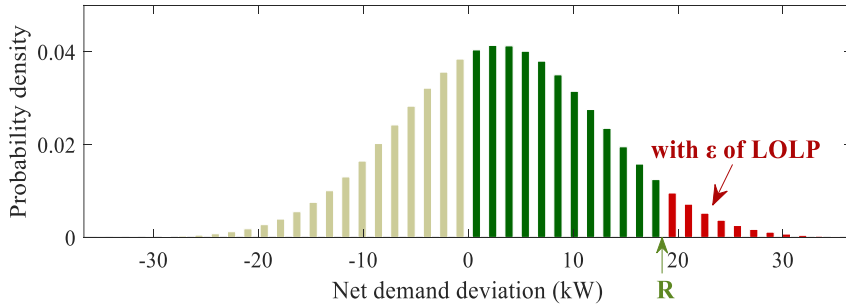

Fig. 3-4 Reserve calculation based on the net demand deviation  $\Delta D$  with a risk index  $\varepsilon$  of LOLP at 11:00.

$\Delta D(t)$  is the net demand deviation from the forecasted value. On the *pdf* curve of the net demand, the negative net demand deviation  $\Delta D(t)$  (area in grey) represents the exceed generation. The positive net demand deviation represents the power losses, which may be caused by an unexpected increase in demand or an overestimation of PV generation capacity, so that the system load exceeds the available generating capacity. To reduce the risk of a power deficit, a reserve power (area in dark green) must be planned according to a prescribed risk index  $\varepsilon$  of LOLP (area in red). An acceptable risk ( $\varepsilon$ ) corresponds then to the area in red on this *pdf* and the reserve power ( $\underline{r}(t)$ ) to cover this risk appears on the characteristic.

By considering  $\Delta D(t)$ , the net demand deviation from the forecasted value at time step  $t$ , the risk is assessed if the required reserve satisfies the equality found from the integration of the normal distribution area (Fig. 3-4):

$$\begin{aligned}
 \text{LOLP}_t: \varepsilon &= \mathbb{P}[\underline{r}(t) \leq \Delta D(t)] = 1 - \int_{-\infty}^{\underline{r}(t)} pdf(x) dx \\
 &= 1 - \int_{-\infty}^{\underline{r}(t)} \frac{1}{\sigma(t)\sqrt{2\pi}} e^{-\frac{1}{2}\left(\frac{x-\mu(t)}{\sigma_t}\right)^2} dx \\
 &= 1 - \phi(\underline{r}(t)|\mu(t), \sigma(t)) \quad \forall t \in \mathcal{T}
 \end{aligned}
 \tag{3-9}$$

$\mu_t$  and  $\sigma_t$  are the mean value and the standard deviation of the error on the net demand,  $\phi(\underline{r}_t|\mu_t, \sigma_t)$  is the cumulative distribution function considering a reserve requirement  $\underline{r}_t$ . The index EENS at each time step, it can be represented as:

$$\begin{aligned}
 \text{EENS}_t: [1 - \mathbb{P}[\underline{r}(t) \geq \Delta D(t)]] \times (\Delta D(t) - \underline{r}(t)) &= \varepsilon \times (\Delta D(t) - \underline{r}(t)) \\
 \forall t \in \mathcal{T}
 \end{aligned}
 \tag{3-10}$$

Where  $\Delta D(t) - \underline{r}(t)$  is the missed power during the time step  $t$  under certain amount of reserve  $\underline{r}(t)$ .

### 3.4.2 Quantification of the power reserve

In order to assess the electrical system security level, the system operator sets a prescribed risk index:  $\varepsilon$ . Hence, the required reserve is obtained by the inverse cumulative distribution function  $\phi^{-1}(1 - \varepsilon|\mu(t), \sigma(t))$  (Fig. 3-5).

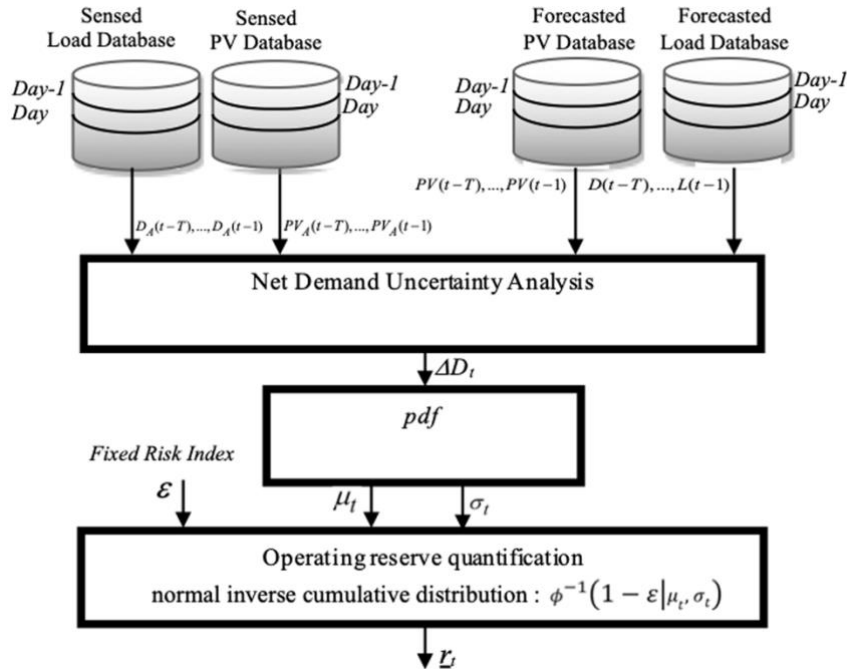

Fig. 3-5 Risk-constrained probabilistic method for reserve determination from past data.

In this way,  $\underline{r}(t)$  is set as the reserve requirement when  $LOLP(t) \leq \varepsilon$  is satisfied. i.e.  $\underline{r}(t)$  is used to cover the loss of load and makes  $LOLP(t)$  be equal or less than the given risk index. As example, Fig. 3-6 shows the characteristic of the risk according to the power reserve at 11:00 time step.

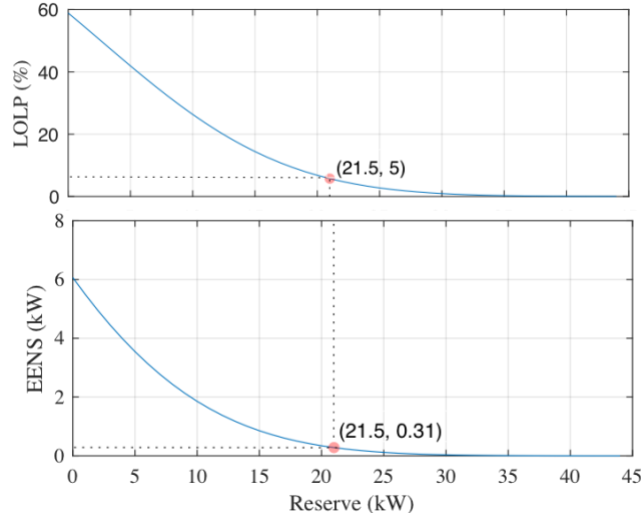

Fig. 3-6 Risk characteristic regarding reserve at 11:00 in Villeneuve d’Ascq (Lille, France) the 23<sup>th</sup> of June, 2020

A  $\varepsilon = 5\%$  risk requires a 21.5 kW reserve to obtain the wished security level  $LOLP_{11:00} \leq 5\%$ . Because of a reserve provision of 21.5 kW,  $EENS_{11:00}$  is decreased to 0.31 kW.

By calculating the reserve requirement under a risk level ( $\varepsilon$ ), the LOLP curve can be obtained at each time step during the day. Meanwhile, the required power reserve varies under different risk level, e.g. if the risk level varies from 1% to 10% of LOLP, the required reserve will decrease gradually. Fig. 3-7 illustrates the variation of reserve requirement during the day under different risk levels.

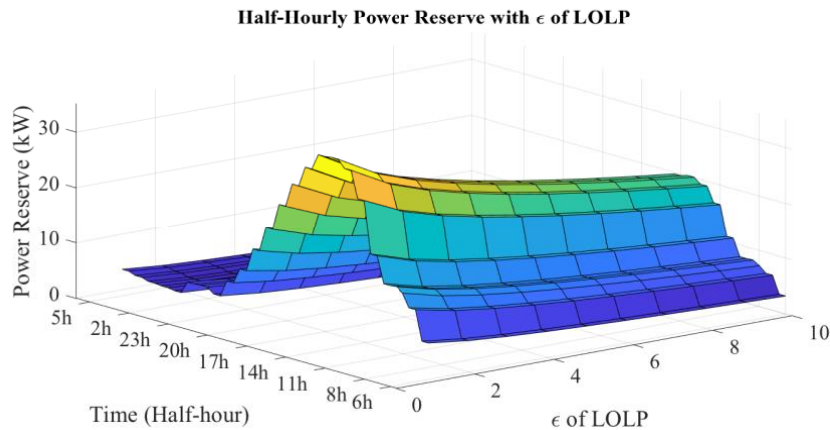

Fig. 3-7 Half-hourly reserve requirement with  $\varepsilon$  of LOLP in Villeneuve d’Ascq (Lille, France) the 23<sup>th</sup> of June, 2020

It is observed that the required reserve increases in the morning and reaches the maximum value around noon, followed by a decrease tendency during the afternoon. This variation indicates that, there is a considerable need of reserve around noon to handle the PV generation uncertainty.

In an electrical system, the effective (obtained) OR is the difference between the sum of the maximum generation limits of all committed generators and the sum of all generation setpoints (power reference) of committed generators at each time step. In this thesis, efforts are made to calculate and observe both the scheduled (day-ahead) OR and effective OR scheduling based on the capacity of MGTs at each time step during the day.

### 3.5 Risk-Based UC Formulation

#### 3.5.1 General scheme

Previously in Chapter 2, the PV power and load demand have been properly forecasted with collected data. In this Chapter (section 3.4), an uncertainty analysis of the forecasting errors is performed in order to determine the OR with a risk constrained probability method. By doing so, the net demand  $D(t)$  and reserve requirement  $r(t)$  are well prepared for unit commitment scheduling procedure as inputs. In this section, the risk-based unit commitment formulation is presented with the targeted objective function and implementations of optimization algorithms (DP and MILP) (Fig. 3-8).

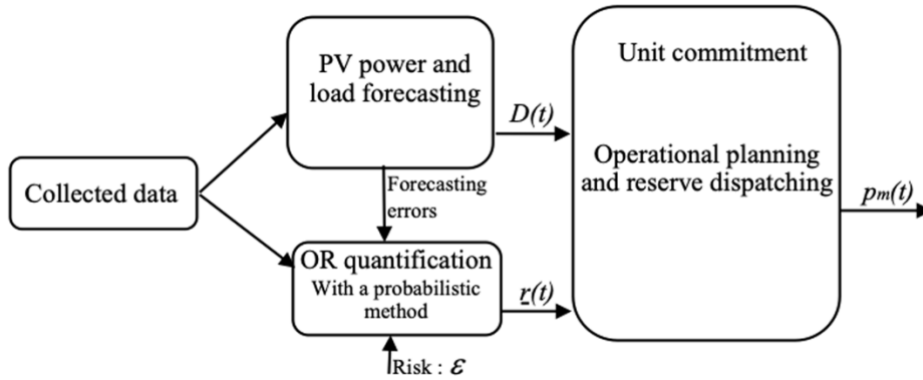

Fig. 3-8 General scheme of risk-based UC problem formulation

Unit commitment involves an optimal operational planning and reserve dispatching, aiming at the optimal solution of generating power  $p_m(t)$  and  $\delta_m(t)$  of each controllable generating unit.

The required OR as well as the missed energy from passive renewables must be provided by controllable energy sources. Among a set of  $M$  controllable generating units, UC problem is a problem of mathematical optimization that must decide whether a controllable generating unit is used to produce energy and how much power ( $p_m$ ) each unit is producing at any time step to match the demand and the required reserve power

(Fig. 3-9).

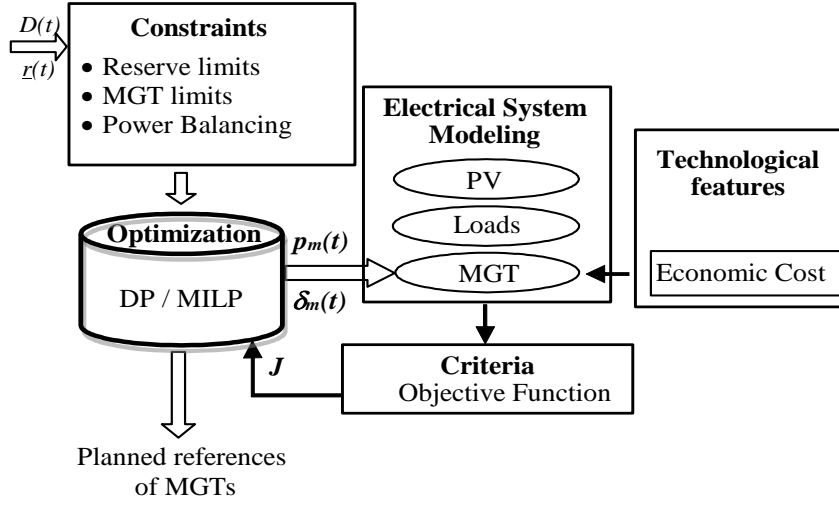

Fig. 3-9 Structure of the UC formulation

### 3.5.2 UC objective function

In the presented case, micro gas turbines (MGTs) are considered here as conventional generators. The objective is to determine the binary commitment orders,  $\delta_m(t)$ , and MGT power references,  $p_m(t)$ , in order to minimize the operating cost of  $M$  MGTs during  $T$  time steps, one day-ahead considering OR provision.  $p_m(t)$  denotes the quantity of electricity generated by MGT  $m$  at time step  $t$ . The UC problem can be formulated as:

$$\min_{\Delta, p, r} \sum_{t=1}^T \sum_{m=1}^M \{ \delta_m(t) c_m(p_m(t)) + u_m(t) c_m^u + d_m(t) c_m^d \} \quad (3-11)$$

$$\text{s.t. (3-12)-(3-15), } (\Delta, p, r) \in \mathcal{F}$$

where  $m \in \mathcal{M}$  is the set of MGTs and  $t \in \mathcal{T}$  is the set of time steps.

$c_m(p_m(t))$  is a nonlinear operational cost function of MGT  $m$ , which indicates the fuel cost for producing  $p_m(t)$  during the time step  $t$ .  $c_m^u/c_m^d$  is the start-up/shutdown penalties on the cost. In this study, a start-up penalty is considered equal to the consumed fuel cost during a 5 min operation at full load. Shutdown penalty is considered equal to a 2.5 min operation at full load [77].  $\mathcal{F}$  is the set of feasible solutions, i.e. the set of decision variables comprising feasible scheduling decisions of commitment  $\delta_m(t)$  and power generation  $p_m(t)$  for each MGT  $m$  at time step  $t$ .

Binary decision variables are defined as  $\delta_m(t)$  and refers to the state of the MGT  $m$  at time step  $t$ .  $u_m(t) = 1$  refers to a MGT  $m$ , which is starting up at the beginning of a time step  $t$ ,  $d_m(t) = 1$  refers to a MGT  $m$ , which is shut down at the beginning of a time step  $t$ :

$$u_m(t) = \begin{cases} \delta_m(t), & \text{for } t = 1 \text{ (initial time step)} \\ 1, & \text{for } t \geq 2 \text{ if } \delta_m(t) - \delta_m(t-1) \geq 1 \end{cases} \quad (3-12)$$

$$d_m(t) = \begin{cases} 0, & \text{for } t = 1 \text{ (initial time step)} \\ 1, & \text{for } t \geq 2 \text{ if } \delta_m(t-1) - \delta_m(t) \geq 1 \end{cases} \quad (3-13)$$

### 3.5.3 UC constraints

#### Power balancing and reserve provision

A power balance between the generation power and the sum of net demand forecast and reserve power should be maintained during the operation. The total amount of conventional generation at time step  $t$  must meet the net demand forecast  $D(t)$  for all time steps:

$$\sum_{m=1}^M p_m(t) = D(t) + \underline{r}(t), \quad \forall t \in \mathcal{T} \quad (3-14)$$

The net demand forecast  $D(t)$  is the difference between the load demand forecast and photovoltaic (PV) generation forecast at time step  $t$ .

To deal with the uncertainties in the generation scheduling, power reserve requirements for the power system  $\underline{r}(t)$  are considered during time step  $t$  in UC constraints [197][92]. The required reserve requirement must be properly allocated onto conventional units.

The power reserve has a cost even when it is not used. Especially in small power systems, the cost of reserve is high. Hence it is important to have OR optimal dispatching techniques taking into consideration all conventional unit constraints.

#### Generator limits

The power generation limits between the minimum power ( $\underline{p}_m$ ) and rated power ( $\bar{p}_m$ ) of each generator  $m$  are expressed as:

$$\underline{p}_m \delta_m(t) \leq p_m(t) \leq \bar{p}_m \delta_m(t), \quad \forall m \in \mathcal{M}, \quad \forall t \in \mathcal{T} \quad (3-15)$$

### 3.5.4 MILP and DP methods for solving UC problems

Since UC problem is a complex mixed-integer programming problem, various solving methods can be used to obtain the optimal generation scheduling, e.g. priority list, DP, and Lagrangian relaxation (LR) approach (as discussed previously in Chapter 1, section 1.4.2).

Currently, the most commonly applied technique is the mixed-integer linear programming (MILP). [175] proposes a loss of load constrained UC problem by optimizing probabilistic spinning reserve corresponding to unit outage events, but

uncertainties of load and RES forecasting are not considered. A MILP-based multiple time resolution (time steps of 5 min, 15 min & 30 min, and 60 min).

UC method is presented in [56] for applications with a high renewable penetration. However, if the optimization problem implies a nonlinear/non-convex objective function or nonlinear operating constraints, relaxation techniques and linear approximation methods are needed to obtain linear continuous and integer variables. As example, in order to obtain costs of consumed fuel for generating a certain amount of electricity, the cost function is approximated as a convex quadratic or piecewise linear function of the generator energy output [198]. [78] presented a mixed-integer linear formulation for the unit commitment problem of thermal units for large-scale cases, the production cost and startup cost are approximated by a piecewise linear function and a stair-wise function, respectively.

Compared with MILP, a dynamic programming method has less limits regarding the convexity and linearity of the UC problem. For example, [199] presented a dynamic programming algorithm to coordinate the wind and thermal generation scheduling problem for the operation of an isolated hybrid power system. But, in the literature, long calculation times and computing efforts are reported.

So, regarding the solving of the DUC, we are going to apply MILP and DP in order to compare their performances in the search of the solution. The interest is to see if MILP can accelerate the solution search while keeping an accurate accuracy in the found solution.

### ***3.6 Presentation of the Urban Microgrid***

In previous research works at L2EP, studies concerning an advanced PV generator has been built. The control system and the power management of the PV-based hybrid active generators is detailed in [44]. [45] has integrated the PV active generator in the energy management of an urban microgrid including prosumers and consumers. [43] and [54] presented an energy management system with a deterministic unit commitment of micro gas turbines (MGTs) for this urban microgrid. According to these studies, we are going to use the same urban microgrid to analyze the impact of PV power uncertainties on the operating reserve and operating costs. This urban network has been introduced in [49][55].

As illustrated in Fig. 3-10, the studied urban MG includes 120 kW residential rated loads, a set of 20 PV generators (installed on the house's roof) with 180 kW rated power (9 kW each), and three Combined Heat and Power (CHP) based MGTs ( $M = 3$ ).



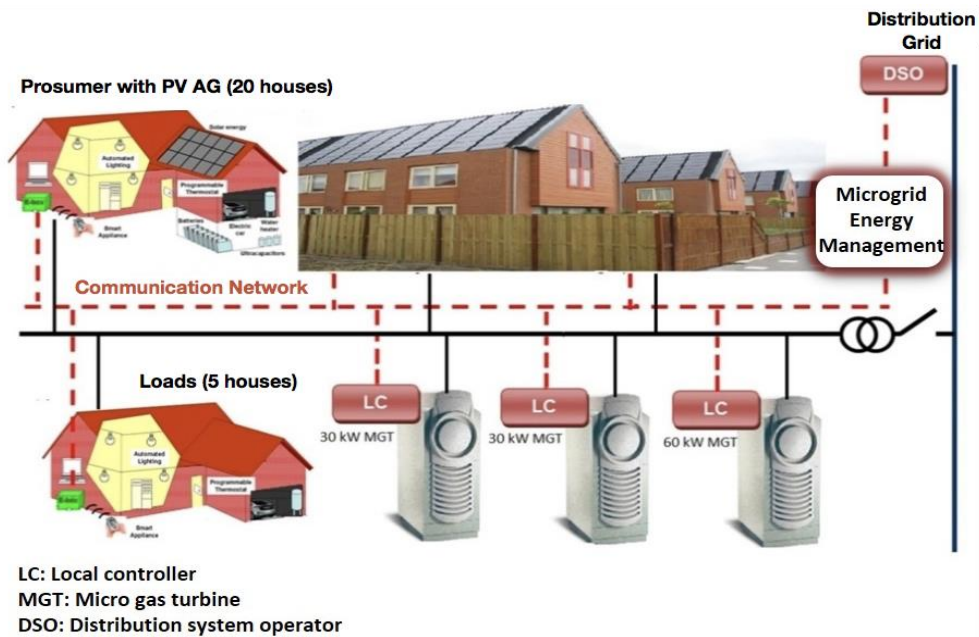

Fig. 3-10 Description of the studied energy community

Micro CHP (Micro Combined Heat & Power) enable the simultaneous production of heat and electricity in individual homes. As other DGs, small CHP units benefit the operation of local distribution systems due to its close location to the electrical loads: reduction of network power losses, deferral of network capacity expansion, improvement of supply reliability, etc.

In chapter 5, storage will be associated to PV generation in order to consider PV active generators (PV AGs) and receive power references. All generators and electrical loads are connected locally in a residential district, thus voltage drops as well as line losses are ignored. To simplify the study, the uncertainty from local line outages is ignored. Since PV generators are closely located in the current urban network, received solar irradiation is assumed to be the same for each PV generator.

MGT and houses with PV generators have local controllers, which receive local operating setting points from the central supervisor, implement power transfers with the electrical network and send local sensed quantities [33]. A central microgrid energy manager is responsible of the microgrid system operation management through the calculation of the optimal power dispatching to each local controller. To facilitate the energy management and system optimization, a user-friendly EMS and operational planning tool has been developed in [49][172]. The designed energy management system is based on the MATLAB/GUI (Graphical User Interface). It is focusing on the system uncertainty analysis and the management of generators with DP-based optimization criteria. An extension of this tool with stochastic unit commitment will be presented in chapter 6.

MGTs are used as secondary sources (backup sources) when there is a power deficit of primary sources (RESs). Since gas turbines consume fossil fuel and emit pollutant gases, it is necessary to study its characters to optimize the system operation in order to minimize gas emissions and the fuel cost in this community. The three MGTs have minimum and maximum power limits as follows:

$$MGT1: \underline{P}_1 = 30kW, \overline{P}_1 = 60kW;$$

$$MGT2: \underline{P}_2 = 15kW, \overline{P}_2 = 30kW;$$

$$MGT3: \underline{P}_3 = 15kW, \overline{P}_3 = 30kW.$$

The operational cost of the gas turbine (objective function) is assessed by considering their partial load efficiency characteristic [77]. Each operational cost function  $c_m(t)$  is fitted by a quadratic function between the maximum and minimum generation limit of each MGT. Fig. 3-11 shows approximate quadratic operational cost functions of three MGTs. Cost function of MGT1 is non-convex, leading to the non-convexity and nonlinear characteristics of the objective function in equation (3-11).

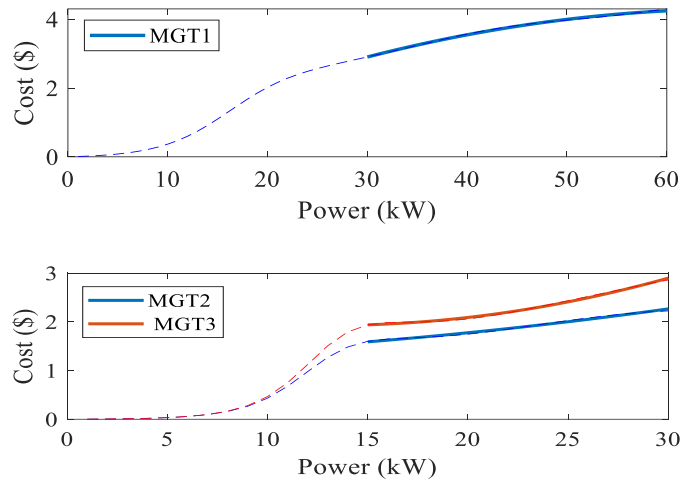

Fig. 3-11 The quadratic curve fitting of the cost functions of studied three MGTs.

Similarly, to reduce the CO<sub>2</sub>-equivalent emissions, emission costs are also modeled and are expressed as fitted quadratic /linear functions. Discussions about the emissions of MGTs will be characterized in Chapter 4 for optimizations with environmental criteria.

Owing to the stochastic characteristic of the solar energy production and load demand, predictions for both generation and consumption are essential for the optimal scheduling. As shown in Chapter 2, an artificial neural network is applied for the prediction. A day-ahead approximated PV power prediction profile is obtained from the meteorological information, the parameters of PV panels and the historic database of PV power production. Based on historic electrical power consumption, the profile of the electricity consumption is estimated one day ahead. Methods for load forecasting

are based on meteorological information and historic consumption data [111]. The profiles of half-hourly forecasted daily PV generation and electricity consumption in the studied case are given in Fig. 3-12. Under this situation, the forecasted daily PV energy is 539 kWh; the forecasted daily load demand energy is 1082 kWh.

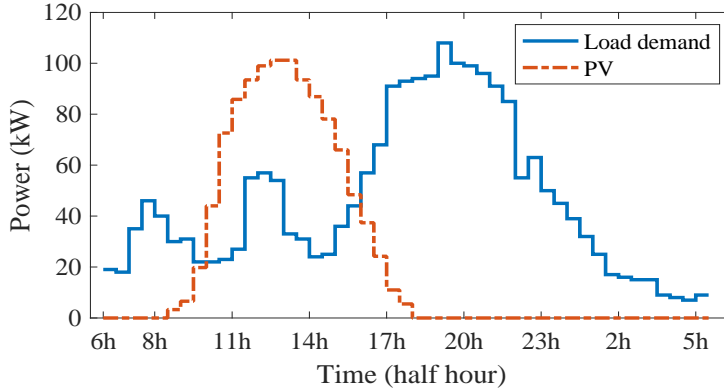

Fig. 3-12 Half-hourly forecasted daily PV generation, and electricity consumption

In the presented urban microgrid, the produced PV electricity can be directly consumed in homes. This is called “PV self-consumption” [200]. The higher the PV self-consumption rate is, the more efficient and profitable the solar installation is. Two kinds of methods are commonly used to increase the self-consumption: energy storage and demand-side management. Meanwhile, “PV self-production rate” is defined as the share of PV electricity over the total home’s electricity demand. The higher the PV self-production rate is, the more independent the microgrid is.

By comparing the average daily available PV energy and daily load demand energy during the year, the PV self-consumption rate could be about 50% in this case. And the PV self-production rate could be about 25%. If no storage is used, a part of the available PV energy for supplying the load demand will be lost (Power supply > Load demand) and so is decreasing the PV self-consumption rate and the PV self-production rate. But this unused PV power can be valued as operating reserve and will be studied in part 3.7.2 according to different risk criteria (N-1 criteria, LOLP). In chapter 5, storage will be considered with different control strategies to save this lost PV production.

### 3.7 Generation Scheduling with DP

To deal with the non-convex characteristic, a dynamic programming algorithm is chosen and the principle is first recalled. Then, the applications to our studied urban microgrids is presented. The presented DP algorithm is implemented under MATLAB R2018b. The used computer has 8 GB of installed RAM and a 2.70 GHz processor. This algorithm will be used later to analyze the propagation of the uncertainty onto results and also discussed regarding MILP.

### 3.7.1 Mathematical Formulation of the Dynamic Programming

Dynamic programming algorithm has been invented to find successive allocation of resources (multi-stage allocation) over a time horizon. The characteristic of tackled problems is the coupling between the future state of the system and past decisions taken during previous time intervals. In our scheduling problem, we have to decide the commitment of generators and their power references every half of an hour for tomorrow.

From the UC problem formulation (3-11), a recursive equation is expressed following the approach of Bellman [201]. Then, an optimization procedure will be implemented to solve it. For any MGTs state, the operational cost is expressed as the sum of:

→ The cost of electricity production during the time step  $[t-1, t]$ :

$$\sum_{m=1}^M \delta_m(t) c_m(p_m(t)) \quad (3-16)$$

→ The cost during the previous time steps  $F(t-1)$  added with the transition cost due to the start or stop of generators:

$$Tr(t-1, t) = F(t-1) + \sum_{m=1}^M \{u_m(t) c_m^u + d_m(t) c_m^d\} \quad (3-17)$$

The time is discretized in time steps. At the time step  $t$ , the UC formulation can be expressed in the form of the recursive dynamic programming equation:

$$F(t) = \sum_{m=1}^M \delta_m(t) c_m(p_m(t)) + Tr(t-1, t) \quad (3-18)$$

The objective function to be minimized is then an accumulated cost over all considered time steps. The DP technique decomposes the optimization problem into a multi-stage decision problem that can be solved successively. The DP formulation consists in 48 stages that represent the 48 time steps corresponding to each half of an hour of tomorrow [55].

According to the Bellman's principle, the solving of the optimization problem consists in considering a simpler problem from the considered time step (stage) until the final one. For each time step, the minimum cost (3-18) is found. The flow chart of the recursive DP algorithm is shown in Fig. 3-13.

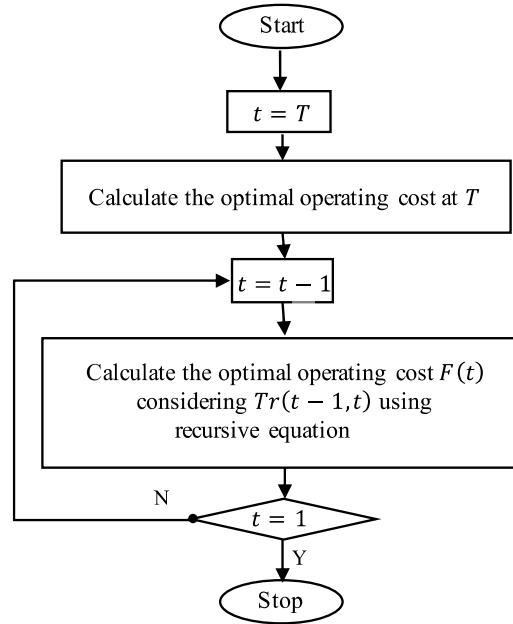

Fig. 3-13 The flow chart of the presented recursive DP algorithm.

Considering three MGTs, i.e.,  $M = 3$ , the combinations of on/off states for all the MGTs are  $2^3$  states at each time step  $t$  (each stage). Each state is a unique combination of committed and non-committed units. Potentially feasible states are the states where the power capacity of all committed MGT units is enough to supply the load demand and reserve.

At each time step, all the possible states are checked. For each realizable state, the generation output  $p_m(t)$  for each committed generator is calculated with a quadratic programming algorithm to find the optimal operational cost with quadratic optimization functions. For the implementation, we have used the function “quadprog” (quadratic programming) function from the MATLAB optimization toolbox. By doing so, the generation scheduling is found for each possible state with a minimized total production costs at the current stage (time step).

Meanwhile, for each potentially feasible state, the program considers all feasible states from the previous stage (time step) and checks if the transition to the current state (in current time step  $t$ ) is possible. If the transition to a current state (in current half-hour) is not possible from any of the states in previous half-hour, then the current state is regarded as infeasible. If the transition is possible, transition costs are calculated. Then, for each possible combination, the corresponding operational cost in (3-16) is calculated by taking into account the transition cost at the previous half-hour  $Tr(t - 1, t)$  and UC constraints. The DP procedure consists in selecting the possible combination corresponding to the minimum operational cost in each time step.

Finally, the total cost is the sum of the transition cost and the total operational cost at

the state in previous time step (stage). This procedure is repeated for all states. Total costs are then sorted and saved and the sequence of power references is found.

The UC by a DP is going to be applied by considering first the reserve power prescribed by a deterministic N-1 criterion and then by a probabilistic criterion (5% LOLP).

### 3.7.2 N-1 criterion based deterministic optimization

#### Study case with no PV generation

First as a reference case, we consider no PV generation and so MGTs are committed during the whole day to ensure the generation capacity and provide the OR regarding uncertainties from the load demand (Fig. 3-14).

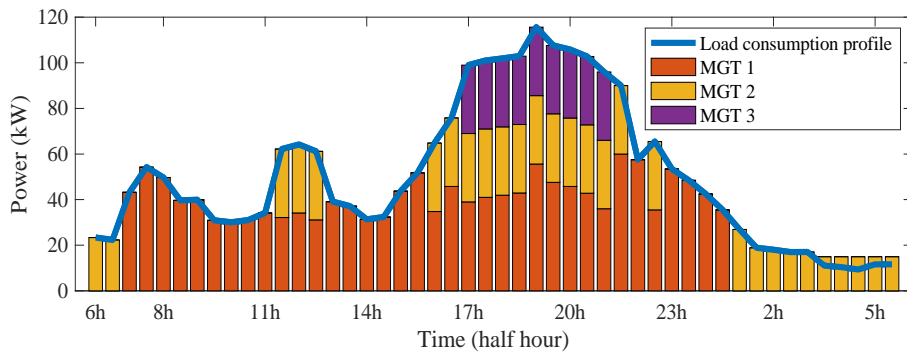

Fig. 3-14 Generation planning without PV

The daily cost is 213\$ for the generation planning in Fig. 3-14. Concerning the evolution of operational cost, the half-hour operational costs are displayed in Fig. 3-15.

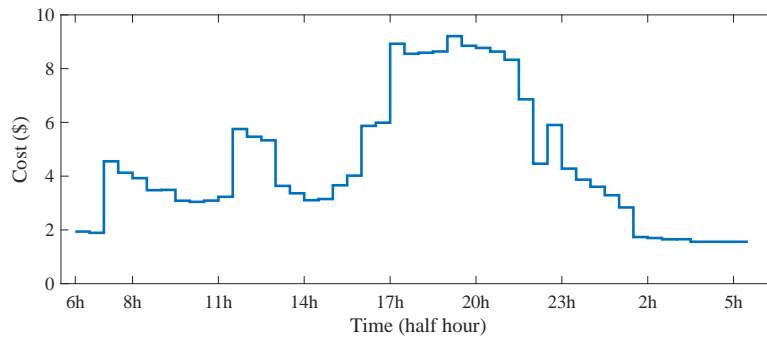

Fig. 3-15 Operational cost at each time step without PV generation

The obtained and effective OR is regarded as the difference between the total power ratings and the set point of committed generators at each time step. To highlight that the quantity of the power reserve is oversized with the *N-1* criterion, we have also represented in Fig. 3-16 the required reserve from only the load uncertainty, with exactly a 5% LOLP. A large gap between effective daily reserve and required daily reserve is observed, which implies a unreasonable scheduling of OR at each time step. The effective daily reserve is 553.5 kWh (with a ratio of required reserve to effective reserve 25%).

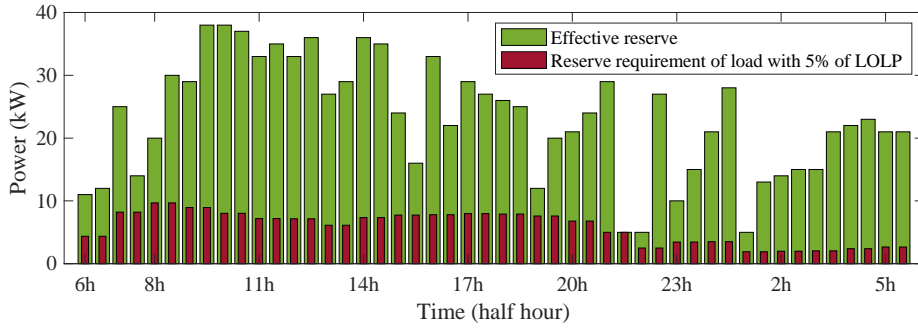

Fig. 3-16 Obtained effective reserve without PV generation

**Study case with PV generation**

In this case, as presented in section 3.3.3, the power reserve is calculated according to the largest loss of PV production. As the PV generation is regarded as a tripping generation unit (no PV generation), then MGTs are committed during the whole day to ensure the generation capacity. The *N-1* criterion is implemented as follows:

- 1) The UC and generation scheduling are calculated by considering only the load demand (no PV generation as the previous case).
- 2) According to the PV production forecast, the power set point of MGTs is reduced to satisfy the power balancing constraint.
- 3) If one (or many) MGT power reference is under their minimum power, the MGT power reference is increased to be equal to their minimum power. In consequence, the PV production is reduced to satisfy the power balancing constraint and a part of PV generation is lost.

With this criterion, all MGTs are committed by considering no PV generation, their power set points are reduced (to the minimum value if necessary) and so they are always able to produce the power for the load demand in case of the loss of the entire PV power (Fig. 3-17). As example, at 10h00, PV generation is 44 kW, load demand is 22 kW, minimum power of the committed generator MGT1 is 30kW. Hence PV generation must be limited to 0 kW, the reference power of the committed generator MGT1 is 22 kW (under its minimum). The OR from the PV is 44 kW; the OR from MGT1 is 38 kW (60 kW-22 kW); the effective OR is 82 kW (44 kW + 38 kW).

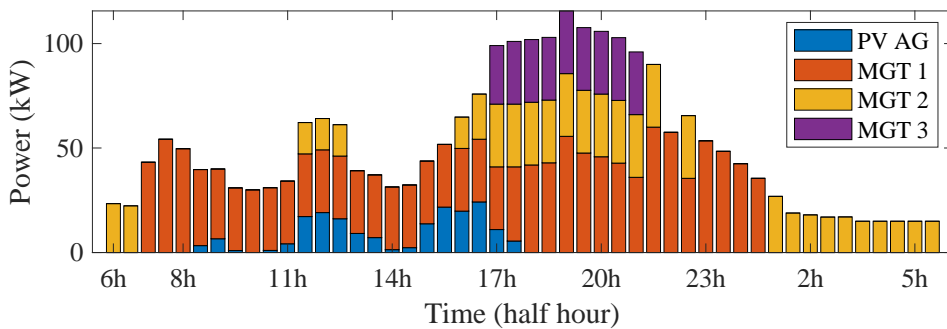

Fig. 3-17 Generation planning under *N-1* criterion

The daily cost of the MGTs planning (Fig. 3-17) is 205\$ (a little bite less than without

PV) and the half-hour operational costs are displayed in Fig. 3-18.

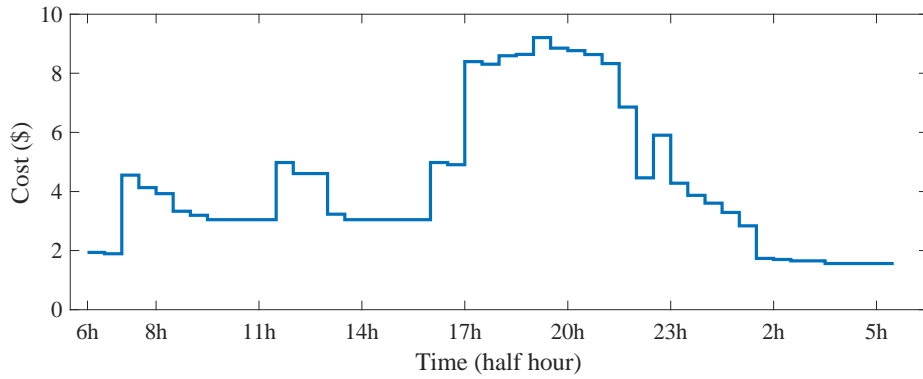

Fig. 3-18 Operational cost at each time step under N-1 criterion

With this strategy, a large part of the PV power is lost (operating under the MPPT point) because:

- all committed MGTs must remain committed with their minimum power reference and
- the PV power exceeds the load demand during the day (Fig. 3-12).

With *N-1* strategy, the daily PV self-consumption rate of PV generation is 17% and the PV self-production is 9%.

The lost PV power can be used as operating reserve because the PV production can be increased if necessary (more load demand as forecasted, faults on a MGT, ...). So, the effective reserve is now the addition of the scheduled lost PV power and power margin of committed MGTs. Fig. 3-19 shows the effective reserve under the *N-1* criterion. The effective daily reserve is 1000.3 kWh (with a ratio of required reserve to effective reserve 43%), including 446.8 kWh from PV AGs and 553.5 kWh from MGTs (Fig. 3-19 (a)). To highlight that the provision of the power reserve is unreasonable with the *N-1* criterion, we have represented on Fig. 3-19 (b) the required reserve from the net demand uncertainty. The gap between effective daily reserve and required daily reserve is large from 9:30 to 15:00, which induce an oversized reserve quantification; while from 15:30 to 19:00, the obtained effective reserve is possibly less than reserve requirement, which implies a possible risk of power deficit, though *N-1* criterion is applied for OR provision.

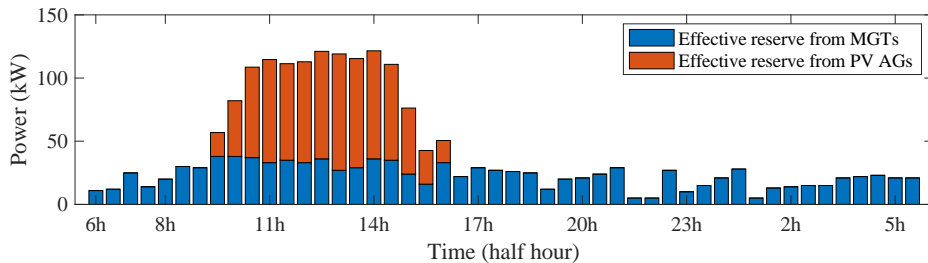

(a) Effective reserve from MGTs and PV AGs



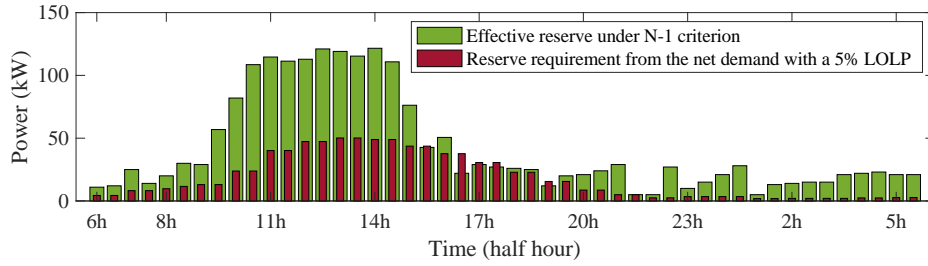

(b) Comparison of effective reserve and reserve requirement

Fig. 3-19 Obtained effective reserve under N-1 criterion

From these results, we can conclude that it is not rational to schedule OR by *N-1* criterion, since it is rare to lose all predicted PV power. In case of forecasting error, just a part of the predicted PV power is usually lost. Moreover, the *N-1* criterion leads to a sub-optimal decision as the PV production uncertainty is unknown and not quantified. The obtained reserve can be over scheduled during one period, while a deficit of reserve may occur during another period. It is the reason why deterministic methods for OR calculation are gradually replaced by probabilistic methods with a desired security level.

### 3.7.3 Risk-based deterministic optimization

In this part, the required OR to cover a 5% LOLP risk is considered (as presented in 3.5). The same DP algorithm to solve the generation planning problem gives the unit commitment result shown in Fig. 3-20. Comparing to Fig. 3-14, the scheduling of MGTs has largely decreased during the period from 8:30 until 17:00 because of available PV generation.

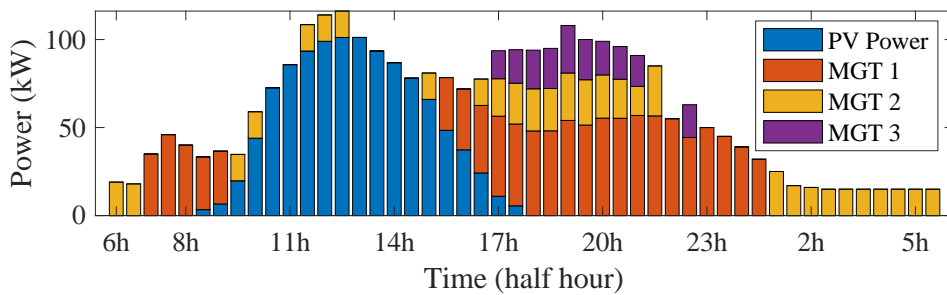

Fig. 3-20 Optimal day-ahead generation scheduling with risk-based deterministic optimization.

All MGTs are switched off between 13:00 and 15:00. With this LOLP risk strategy, the PV self-consumption rate of PV generation is 67% and the PV self-production is 25%. The PV production must be limited (operating under the MPPT point) as it is sometimes more than the load. By this way, as the PV production can be increased if necessary, the shaded power constitutes an OR that is available. Then, the positive effective OR is provided both by the PV limitation ( $r_{pv}(t)$ ) and by the difference between the maximum generation limits of committed MGTs and their output power at each time step. The

available reserve power from the PV limitation is integrated in the optimization formulation, the general balancing constraint formulation (3-14) is adapted as:

$$\sum_{m=1}^M p_m(t) = D(t) + \underline{r}(t) - r_{ag}(t), \quad \forall t \in \mathcal{T} \quad (3-19)$$

where  $r_{ag}(t)$  is reserve power from PV AGs. The comparison between the positive effective reserve and the required reserve (with a 5% LOLP risk) is illustrated in Fig. 3-21. It is observed that the obtained available effective reserve is equal or superior to the reserve requirement. The required daily reserve is 426.5 kWh; the effective daily reserve is 762.5 kWh, which gives rise to a ratio of required reserve to effective reserve 56%. Compared with the  $N-1$  criterion, here the reserve scheduling is more reasonable with a higher reserve utilization rate.

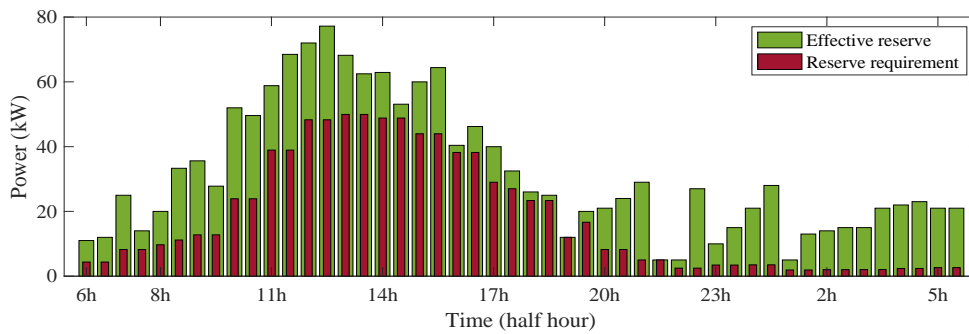

Fig. 3-21 Positive effective reserve and reserve requirement

Obtained effective OR considering forecasted data (in Fig. 3-12) is shown in Fig. 3-22, where red lines indicate the amount of positive effective OR at each time step, and yellow lines represent the negative effective OR.

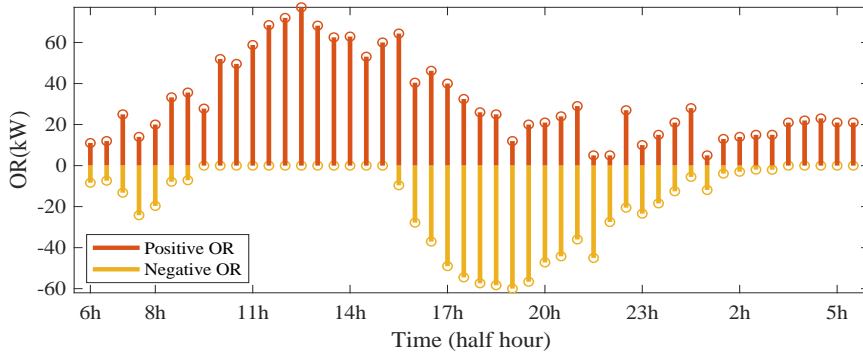

Fig. 3-22 Effective OR

The negative effective OR is obtained by the power difference between the minimum generation limits of committed MGTs and their output power at each time step. In this way, the negative OR allows the reduction of MGTs' generation under the situation of less consumption than expected, or over PV production. Both positive and negative effective OR power capacities ensure a certain level of security when there is more or less scheduled production or consumption.

Half-hourly operational costs can be calculated from the calculated fuel consumption of the MGTs with the day-ahead planned operating point as well as their minimum and maximum values (Fig. 3-23). Generator set points vary according to varying intervals of reserve power at each time step. The maximum cost is reached if the largest amount of positive effective OR is used; while the minimum cost is obtained when all negative effective OR is consumed. The daily cost of the MGTs planning is 179\$.

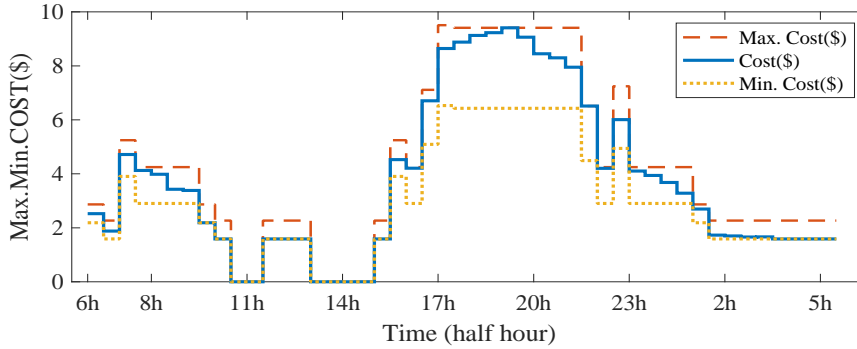

Fig. 3-23 Expected, maximum and minimum operational costs

### 3.8 Uncertainty Propagation Analysis with Probabilistic Methods

#### 3.8.1 Characterization of PV forecast errors by confident intervals

Previously, the unit commitment has been calculated with the more expected PV generation forecast and by setting a 5 % risk on the net-demand unbalancing. However, in practice, PV generation and load demand are not reliable and a probabilistic level is associated to consider predicted data. In this part, the impact of PV power forecasting uncertainty on the unit commitment, generation scheduling including OR is studied.

From the past historical data, the real PV generation (in each half of an hour time step) is considered as varying around the forecasted PV power according to a probabilistic characteristic of PV forecasting errors. As a commonly used probabilistic forecasting method, quantiles / percentiles are used to characterize a certain probabilistic level of the forecasting errors [81]. The  $q^{\text{th}}$  quantile is defined as the value where the production probability less than this value is  $q$  %.

Based on the given large population, the error sample data of PV forecasting errors at each time step  $t$  is assumed to follow a normal distribution (section 2.4.2). *pdf* of forecast errors is obtained at each time step.

In order to obtain and observe a graphical summary of PV power forecasting errors at each time step  $t$ , a box plot is shown in Fig. 3-24. Each box implies the distribution characteristics of the majority of PV forecast errors during each time step [202]. The central mark indicates the median, and the bottom and top edges of the box indicate the 25<sup>th</sup> and 75<sup>th</sup> quantiles, respectively. Their absolute values are below 0.23 per unit (p.u.).

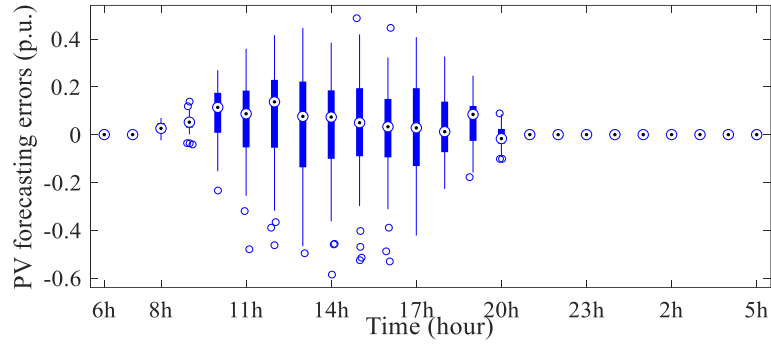

Fig. 3-24 The box plot of PV power forecasting errors at each time step.

Meanwhile, the PV power probabilistic forecasting is shown in Fig. 3-25. By applying *pdf* analysis of PV forecast errors at each time step, several probabilistic intervals are generated with PV prediction and different security level (50%, 75% and 99%). As shown in Fig. 3-25, a larger interval implies higher confidence level (CL) regarding the security. The 2.5<sup>th</sup> and 97.5<sup>th</sup> quantiles of the PV forecasting errors are applied here to obtain the upper bound and lower bound of the PV generation forecast. By doing so, a 95 % forecast interval is defined for each time step (Fig. 3-25).

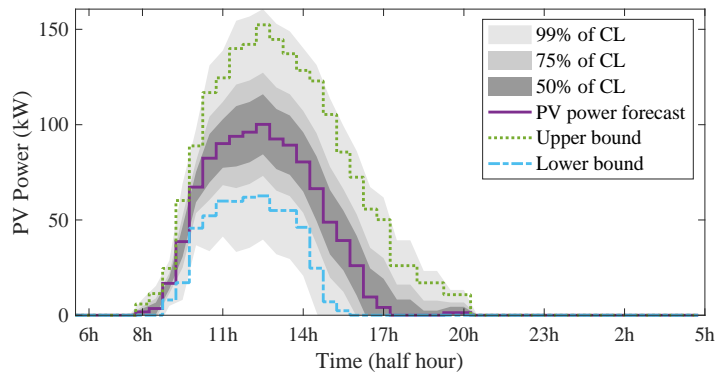

Fig. 3-25 Forecasted PV power according to the 95 % forecast interval.

### 3.8.2 Effect of PV uncertainty on the effective operating reserve

Considering the expected lower bound of PV generation, the most pessimistic PV forecast is obtained, and then a worst-case optimization can be considered. By applying the expected PV lower bound of generation, the optimal dispatching of each MGT at each time step is rescheduled in Fig. 3-26. Due to the decreased PV power, more generators are committed compared with Fig. 3-20 to compensate for the power deficit.

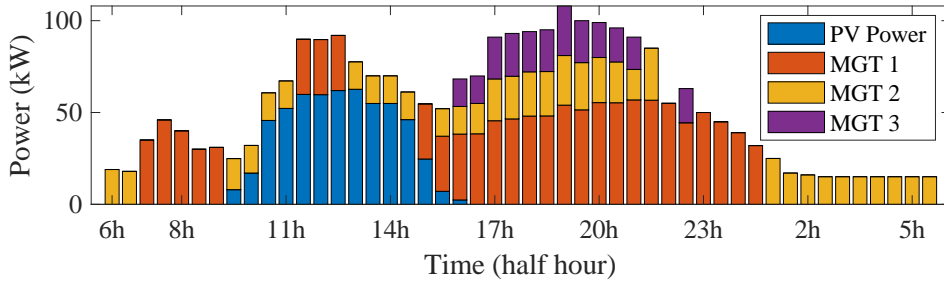

Fig. 3-26 Optimal dispatching of each MGT corresponding to expected worst forecast of PV generation.

The effective OR is recalculated by taking into account power deviations of the PV generation forecast (Fig. 3-27). If less PV power is obtained than expected, two possibilities are considered and processed respectively:

- If the pre-allocated OR power is unable to handle the half-hourly PV uncertainty, then more MGTs will be committed to provide more effective OR power to compensate the lacking PV power. For example, during time period 10:30-11:00 and 13:00-14:00, the reserve increases comparing to OR power with exact forecasting (Fig. 3-22), because more MGTs are committed (MGT 2 and MGT 3) to provide additional positive reserves.
- If the pre-allocated OR power is enough to handle the half-hourly PV uncertainty, then the effective OR is consumed to compensate the PV deficit, e.g. effective OR decreases at 9:30-10:00 comparing to Fig. 3-22, because positive OR is consumed to compensate the pessimistic PV.

Meanwhile, with the consideration of the lower bound of PV generation, the positive effective reserve and required reserve are illustrated again in Fig. 3-28. Comparing to Fig. 3-21, there is less available reserve power during the period 9:00-17:30. Due to the reduce of PV power, the reserve power is consumed to compensate the PV power deficit.

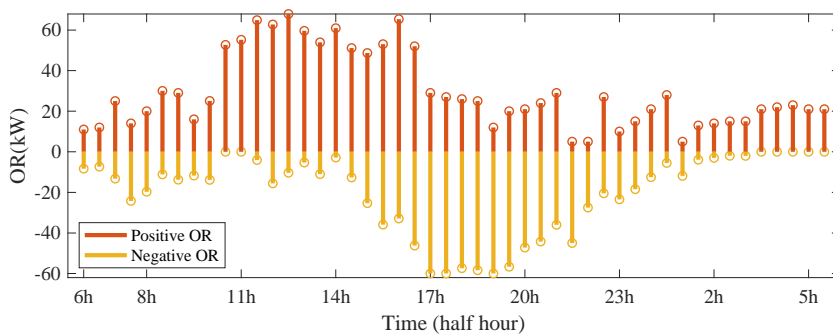

Fig. 3-27 Effective OR corresponding to the expected worst case of PV generation.

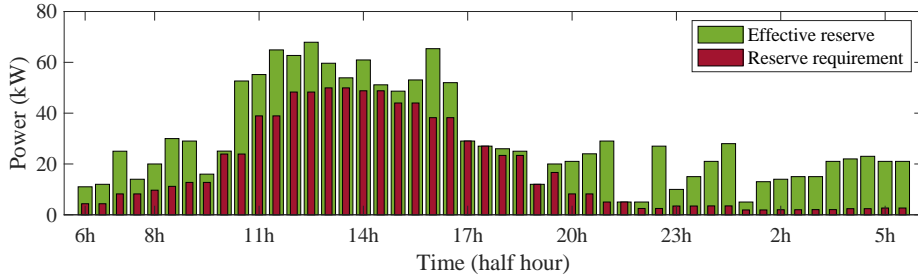

Fig. 3-28 Positive effective reserve and reserve requirement

The effective reserve in each time step varies according to the committed MGTs as well as the PV generation. After analysis results following the propagation of some PV generation scenarios, it is observed that the effective reserve can be approximated by a normal distribution. For example, the *pdf* of the effective reserve at 13:00 is shown in Fig. 3-29 with a mean  $\mu_{ER,t=13:00} = 73$  and a standard deviation  $\sigma_{ER,t=13:00} = 15$ . The fitted *pdf* curved is obtained for each time step according to the corresponding histogram.

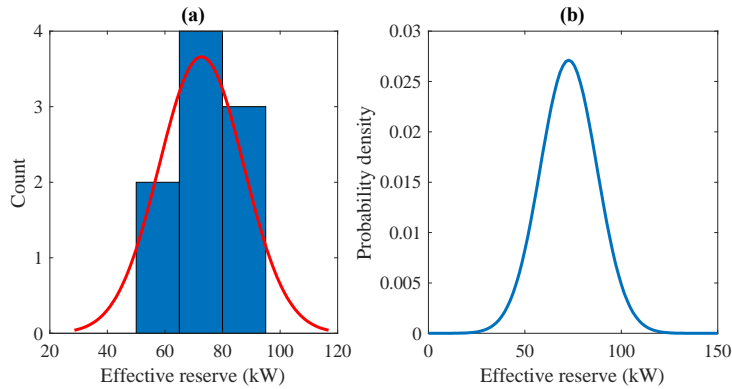

Fig. 3-29 Effective reserve at 13:00

Meanwhile, operational costs fluctuate according to generation and reserve scheduling, as shown in Fig. 3-30. For example, during 6:00-8:00, the operational cost stays the same as expected because the scheduling of the MGTs is unchanged. On the other hand, the operational cost increases during 8:30-17:00 when the scheduling is changed and there is additional MGTs turned on. The red dash line and the yellow dot line indicate variation intervals regarding cost. At each time step, the maximum cost is attained by providing the largest amount of positive OR power, and the minimum cost is reached by providing all of negative OR power.

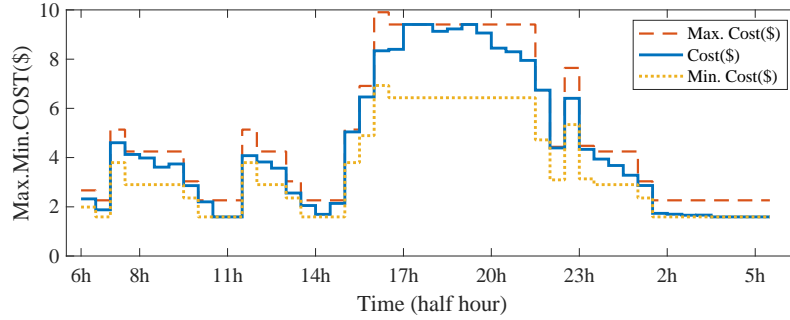

Fig. 3-30 Expected, maximum and minimum operational costs considering expected worst case of PV generation.

Reserves and daily operational costs under PV uncertainties are shown in Table 3-2. When the uncertainties of PV forecast are not considered (results are marked in bold). Expected reserves and daily costs are obtained and are based on the deterministic generation scheduling.

Table 3-2 Reserves and daily operational costs under PV uncertainties.

PV scenario	Net Demand (kWh)	PV (kWh)	Reserve (kWh)		Daily Cost (\$)		
			Positive OR	Negative OR	Max. Cost	Cost	Min. Cost
Lower bound	1230	279	712	490	236	211	164
Expected	1017	539	763	401	202	<b>179</b>	<b>141</b>
Upper bound	833	938	842	336	176	159	128

Furthermore, the results for both best (upper bound) and worst forecast (lower bound) of PV generation are presented respectively. When the PV uncertainties are considered according to the forecast intervals, the expected operational cost of the deterministic generation scheduling is no longer able to be achieved, instead, the variation intervals of maximum and minimum costs are re-calculated. The maximum cost is obtained when considering lower bound of PV generation. The minimum cost is attained when PV generation reaches upper bound of forecast interval. Meanwhile OR are re-calculated after the generation re-scheduling.

### 3.9 From DP to MILP

#### 3.9.1 Interests

Until now, with approximate quadratic operational cost functions of MGTs, a DP algorithm is implemented for optimal day-ahead generation scheduling with risk-based deterministic optimization. However, the optimization problem with a quadratic objective function can be computationally costly. or even difficult to solve when a non-convex quadratic function is included. For a multi-objective function incorporating two or more cost functions (operational cost, emission cost, ...), the computational cost is even higher.

To reduce the computational cost, as well as handle the non-convexity within the solution search, linearization of objective functions or constraints are usually employed. Among all the linear optimization methods, the mixed-integer linear programming (MILP) is one of the most common approaches to deal with UC/operational scheduling in electrical systems. The commitments of each controllable generating unit can be well represented with binary decision variables in MILP.

In this study, in order to carry on the following multi-objective optimization in Chapter 4 and Chapter 5, MILP is implemented to solve the presented generation scheduling problems. Cost functions are approximated as linear functions to increase the computational efficiency and ensure the feasibility of the optimization algorithm. Fig. 3-31 shows approximated linear functions of the operational cost functions of MGTs  $c_m(p_m(t))$ . The dash line represents the cost functions before linearization. The solid lines indicate the rated power generation intervals of three MGTs, i.e. minimum and maximum generation limits are between 30kW - 60kW for MGT1, 15kW - 30kW for MGT1 and MGT2.

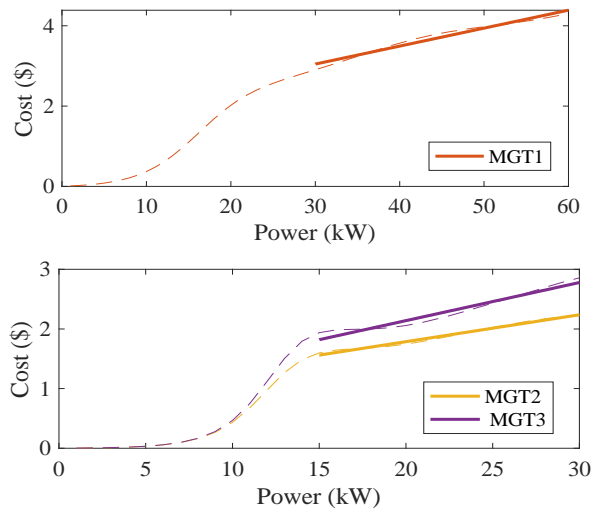

Fig. 3-31 Linearization of the nonconvex cost function of studied three MGTs

MILPs are usually solved by branch-and-cut algorithms, i.e. branch-and-bound algorithm combined with cutting planes. Hence during the search in the problem tree, optimality can be reached by proximity and convergence process in a finite time [78]. More explanations and details of branch-and-cut algorithm can be found in **APPENDIX 3**. The optimization tool is YALMIP [203] and IBM ILOG CPLEX Optimization Solver [204] with MATLAB R2018b. The comparison of both algorithms is shown in Table 3-3. The comparison proves that DP offers more opportunity of type of the objective function (linear, quadratic), while MILP is superior to DP in terms of computational efficiency.



Table 3-3 The comparison of DP and MILP

	<i>DP</i>	<i>MILP</i>
<b>Objective Function Type</b>	Quadratic	Linear
<b>Computational Time (s)</b>	4.39	2.53
<b>Optimal operational cost (\$)</b>	179	180

In section 3.9.2, generation scheduling results with risk-based deterministic optimization by MILP are presented and will be compared with stochastic optimization results in chapter 4 and 5.

**3.9.2 Risk-based deterministic optimization with MILP**

The profiles of the half-hourly electricity consumption forecast, and half-hourly forecasted daily PV generation for the corresponding day are given in Fig. 3-12. Fig. 3-32 shows obtained power set points of generators. Comparing to the scheduling result of DP algorithm in Fig. 3-20, the generation planning is almost the same, except for the time step 22:30, where MGT 2 is committed instead of MGT 3. The difference may due to the linearized cost functions using in MILP.

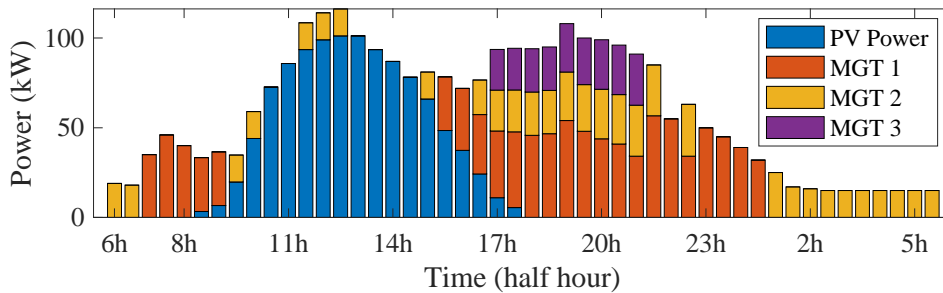
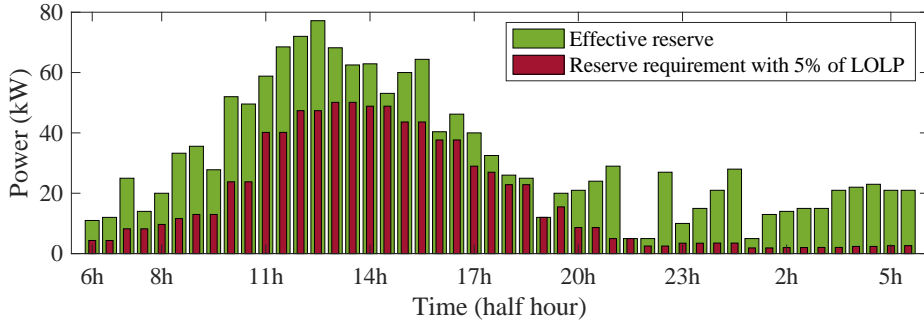

Fig. 3-32 Generation planning under deterministic optimization and scheduled PV power

Required reserve is integrated into the risk-based deterministic optimization operational planning. Fig. 3-33 (a) shows that the effective reserve is enough and more than required reserve. The pre-set security level is obtained. Fig. 3-33 (a) is the same as the results with DP algorithm (Fig. 3-21), since they hold the same generation scheduling result (except for the time step 22:30 as noticed previously).

Fig. 3-33 (b) shows reserve power allocation in slow generator and fast generators. Reserve power provided by the slow unit (MGT 1) is marked in red, and yellow bars indicate that the reserve power is provided by fast units (MGT 2, MGT 3). Blue bars imply the reserve power from PV generation (exactly by PV production limitation, see part 3.7.3). The discussion in terms of fast/slow units will presented in the following Chapter 4. Fig. 3-33 (b) is shown in order to compare with results in scenario-based stochastic optimization. The merit of fast units regarding reserve provision will be highlighted.



(a) Obtained effective reserve with a  $LOLP \leq 5\%$

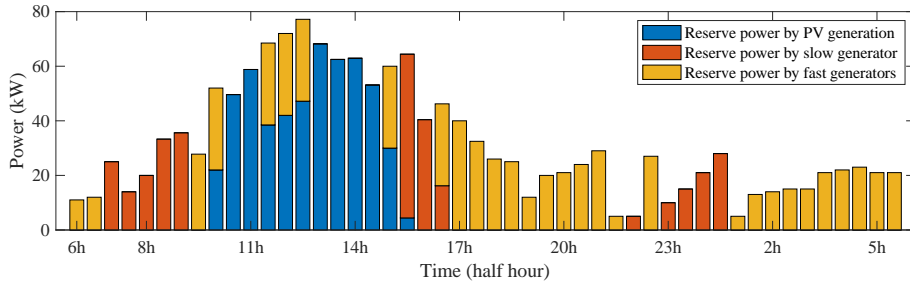

(b) Obtained effective reserve from slow and fast generators (with a  $LOLP \leq 5\%$ )

Fig. 3-33 Reserve requirement and obtained effective reserve with a risk-based optimization

In Chapter 4, a scenario-based two-stage stochastic optimization is presented. The two-stage structure includes:

- A risk-based deterministic optimization in the **1<sup>st</sup> stage** (as illustrated in 3.7.2);
- A scenario-based optimization in the **2<sup>nd</sup> stage**. Scenarios are built with different possibility of occurrences to represent the possible uncertainty during the solution search.

The obtained results in section 3.7.2 are regarded as the 1<sup>st</sup> stage optimization (risk-based) in Chapter 4. In the following Chapter 4 and Chapter 5, MILP will be applied as the approach to solve the generation planning problem with multi-objective stochastic optimization.

### 3.10 Conclusion

In this chapter, to handle RESs uncertainties that may occur during the UC procedure in the local microgrid community, the definition of operating reserve is introduced. Concerning the OR provision and determination, deterministic OR criterion and probabilistic OR criteria under RESs uncertainties are discussed in detail.

The main contribution of this chapter are as follows:

- 1) The deterministic day-ahead commitment of generators and half-hourly OR powers are decided by taking into account PV generation uncertainties and load uncertainties with a prescribed risk level: Loss of Load Probability (*LOLP*)
- 2) Based on nonlinear operational cost functions of generators, a DP algorithm is

carried out to find solutions of the non-convex mixed-integer nonlinear programming (MINLP) UC problem. Operating cost functions of conventional generators are approximated as either non-convex or convex quadratic functions, then a suitable objective function is expressed with a combination of quadratic operational cost functions.

- 3) In order to increase the computational efficiency, a MILP approach is employed with a linear approximation of operating cost functions. The obtained results will be used as the 1<sup>st</sup> stage optimization (risk-based) of the scenario-based stochastic optimization results in Chapter 4.
- 4) The impacts of PV power forecasting uncertainty on operational costs are analyzed. By considering distributed energy resources and a 95 % confidence level, a certain forecast interval is determined with a set of quantiles for every half-hourly forecasted PV generation. The effect of the PV uncertainty is analyzed under the situation of exceed or missed PV power in each half-hour. With forecast intervals, operating reserves (OR) can be recalculated by considering a certain level of security. Meanwhile, the generation scheduling is updated in order to respond to system demand conditions, and the impact of PV power uncertainty on the operational cost is analyzed. The maximum and the minimum costs regarding the PV uncertainty are then obtained.

Nevertheless, DP and MILP are risk-based deterministic optimization methods in the sense that future events are known: PV production and load demand forecasts are used in the optimization process. The obtained power references are the optimal trajectory (sequence of 48 stages with power references) corresponding to the minimization of the objective function in a deterministic situation (forecasted data with an operating power margin). In the following Chapter 4, research works will be oriented to integrate directly the uncertainty coming from forecasting errors inside the optimization algorithm in order to obtain a stochastic analysis of predicted operational costs.

## CHAPTER 4

# CHAPTER 4 ANTICIPATING UNCERTAINTY WITH A SCENARIO-BASED STOCHASTIC OPTIMIZATION

## 4.1 Introduction

Classically, with day-ahead forecasting data from load demand and renewable generation, the generation scheduling can minimize the power system operating cost at each time step of the next day [59]. However, uncertainties in the generation induces inevitable deviations between the scheduled generation decision one day ahead and the real one in the day. The increasing of intermittent RES requires more and more generation scheduling under uncertainty.

The first needs are to represent uncertainties in the UC problem formulation and to consider them in the proposed generation scheduling one day ahead. Thus, optimization problems should include uncertain variables that enable a generation scheduler to have a complete knowledge of the system behavior and, therefore be prepared for undesirable variations of RES production. The unit commitment problem under uncertainties has been extensively studied for more than decades through various considered study cases. In this chapter, a review of the literature in the field of stochastic optimization is presented in order to identify interesting published contributions, to define main features of an optimal generation scheduling under forecast uncertainties and to highlight remaining challenges.

The idea of SUC is to utilize a representation of uncertainties with different scenarios in the UC formulation. Compared with simply using reserve constraints (as in chapter 3), SUC have certain advantages, such as reliability improvement as probable uncertainties in the future are taken into account [91][92]. Based on the needs, a scenario-based stochastic optimization structure is proposed for the operational planning of controllable generators in an urban microgrid under varying and uncertain renewable energy generation. The effect of photovoltaic (PV) power generation uncertainty on operating decisions is examined by considering expected possible uncertainties with scenarios. The optimization structure is organized in two stages.

In a first stage, a deterministic optimization within a Mixed-Integer Linear Programming (MILP) method generates the unit commitment of controllable generators with the day-ahead PV and load demand prediction and the OR requirement. As previously in chapter 3, a method for forecasting uncertainty is used to model the net demand prediction error taking into account the uncertainty coming from the prediction tool. Based on distributions of forecasting errors, a LOLP-based risk assessment method is proposed to determine an appropriate amount of operating reserve (OR) for each time step of the next day.

In a second stage, a scenario-based problem is proposed to implement a stochastic operational planning with consideration of probable forecasting uncertainties. Issues of the second stage are the commitment of enough flexible generators to face probable deviations from predictions.

Different objective functions are considered in terms of economic operating cost (mono-objective), CO<sub>2</sub> equivalent emission (mono-objective) and the combination of these two (multi-objective of cost and emission) The significance of the proposed methodology is illustrated with results obtained from a studied urban microgrid system.

This chapter is organized as follows. Section 4.2 expresses the needs for uncertainty handling in generation scheduling one day ahead. Section 4.3 presented the state of art of SUC methods under RES uncertainty and then explains the explored ways in this research work. Section 4.4. describes the mathematical formulation of the scenario-based stochastic operational planning with MILP. Section 4.5 discusses the obtained results of operational planning with a scenario-based optimization in the presented urban microgrid. Section 4.6 presents the conclusions.

## ***4.2 Needs for Uncertainties Modelling in Operating Planning***

### ***4.2.1 Anticipating uncertainty with scenarios***

#### **Anticipating the future is the best way to tackle its uncertainties**

The best situation for deciding a generation scheduling is to do it while taking into account uncertainty of PV production/load demand. In the previous chapter, a decision under risk is proposed and is based on the knowledge of probabilities of forecasting errors. While the well-scheduling of reserve requirements (by risk-constrained probabilistic method) is one solution for limiting a risk and ensuring a security level to some extent, setting the future set points of generators in these conditions is not sufficient because the outcome of the decision is not known. Day ahead approaches that predict a single output (generation scheduling solution) and do not model the uncertainty in the future actions, will surely fail to achieve the optimal objective function with real RES production and load demand. On the contrary, approaches that are capable of predicting all the possible outputs are preferable. Foresight is the assessment of what might happen or be needed in the future. It is needed in order to be prepared for the future from a risk perspective. It is a means to be adaptable and robust in the face of scenarios that might knock off another generation planning.

#### **Foresight is different from prediction**

Foresight scans and anticipates possible futures. Foresight must guide the appropriate participation of generators in the face of uncertainty arises. The practice of foresight and anticipation strengthens the generator scheduling not as certainties but as

possibilities. It builds on the anticipation of a variety of future scenarios. Through implementing foresight and anticipation, the generation scheduling can more effectively prepare the use of generators with the future uncertainties at the present moment.

### Scenario based scheduling

Underestimating the realization of the uncertainty can lead to generation scheduling strategies that neither defend against the threats nor take advantage of the opportunities of RES. Although we cannot know the future, a range of possible futures can be known that can enhance our understanding of possible risks and anticipated solutions. Anticipation and preparation for possible future situations are possible if we consider various scenarios of forecasting. Considered scenarios do not present one future but several alternatives (Fig. 4-1).

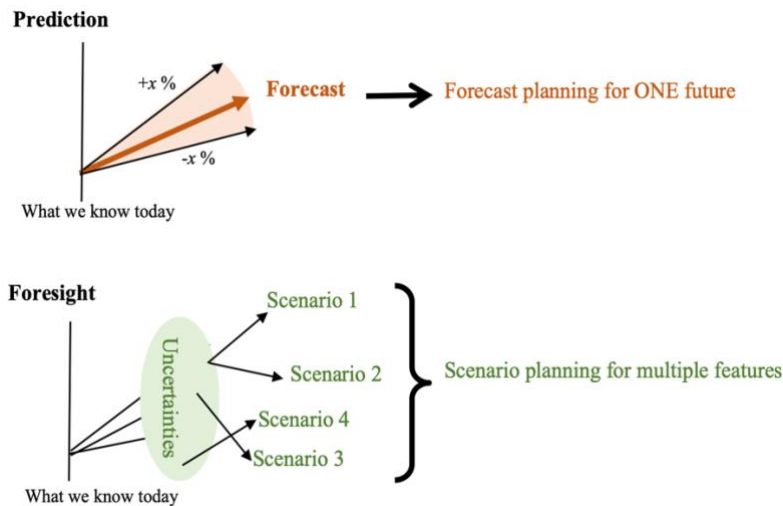

Fig. 4-1 Comparison of forecast based planning and foresight-based planning

A scenario-based planning helps making generation scheduling better including uncertainty. At its core, a scenario is a view of how the future might unfold. And that is challenging DUC. Starting points are key uncertainties to be used to define scenarios in the future. Considering exploratory scenarios helps the exploration of commitment changes and new generation scheduling. This gives the microgrid operator a way to create a flexible, futures ready strategy that allows for an agile response in case of RES change. The general method can be described by three steps (Fig. 4-2):

- A limited number of scenarios must be defined to describe distinct, plausible futures (Vision).
- The generating scheduling is evaluated against each of the scenarios and assess how robust each of actions are.
- By looking at the spectrum of possible outcomes for each uncertainty, the decision is built.

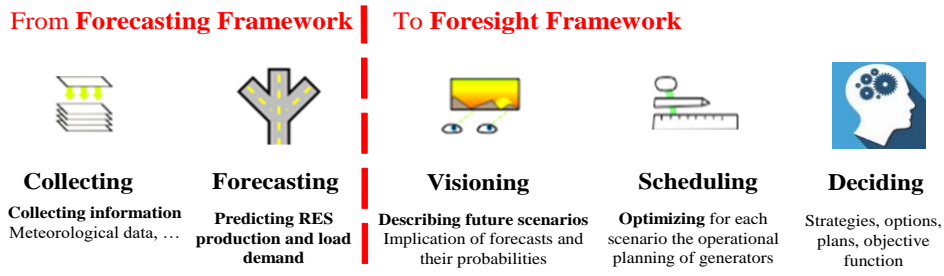

Fig. 4-2 Foresight framework with scenario-based scheduling

Foresight is the assessment of what might happen or be needed in the future. Foresight is a means to be adaptable and robust in the face of scenarios that might knock off another generation planning.

**4.2.2 From risk-based DUC to SUC**

Foresight techniques can help microgrid operator to anticipate RES production change, so that they can plan effectively in uncertain conditions, prioritize conventional generators and stay ahead the security of the electrical network. Previously in the chapter 3, a risk-based quantification of the reserve with a probabilistic method is considered before the optimization solving of the UC problem under a prescribed risk. In this chapter, instead of focusing on the analysis of uncertainty on database (of past realized operating points), efforts are made to solve the UC problem under uncertainty. The uncertainty must be modelled in the solution search and so a scenario-based stochastic optimization method is proposed (Fig. 4-3 ).

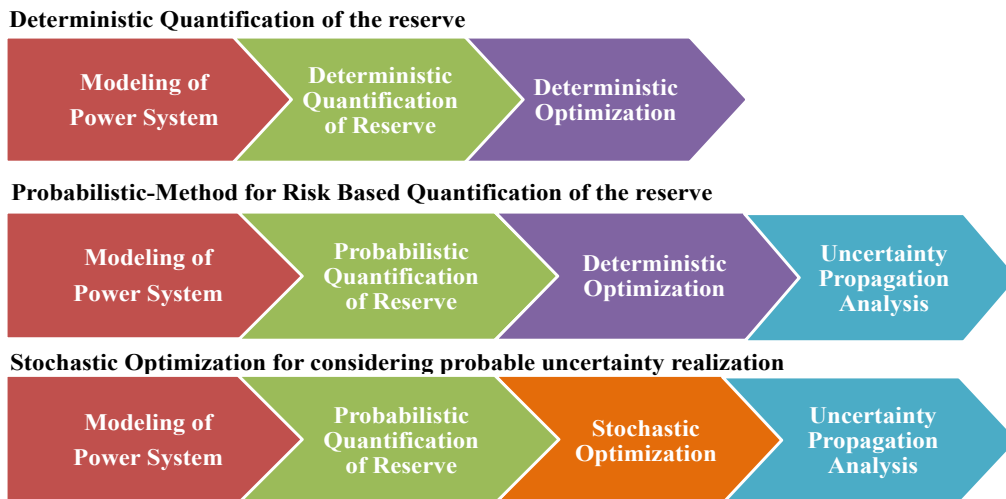

Fig. 4-3 Scheme of the proposed stochastic optimization approach in Chapter 4 and its comparison with deterministic optimization



### 4.3 Stochastic Optimization methods for UC

#### 4.3.1 State of the art

In unit commitment applications, the formulation of an optimization under uncertainty concerns the analysis of power references (decision variables) and the optimal cost (minimized objective function) for different scenarios and associated probabilities (renewable production, load demand, net demand). Performances are depending on deterministic variables and uncertain variables. Usually, the deterministic variables are the mean value of the random variables. For a standard UC problem, deterministic variables are the mean values of the forecasting error during a time step.

To study and analyse uncertainties in energy systems, three approaches are presented and classified in [127]: probabilistic methods, possibilistic methods and the combination of those two. These methods are used to analyse two types of uncertainties [151]:

- a) Quantitative uncertainty: uncertainty that is quantifiable in numerical terms by a mathematical function with deterministic parameters. This uncertainty refers to the power production of the stochastic generator in a given location. This uncertainty can be quantified in numerical terms by statistical analysis of data. This type of uncertainty is modelled using a probabilistic approach.
- b) Qualitative uncertainty: uncertainty that is initially expressed in vague, non-numerical (usually verbal) terms such as "approximately equal to" or "a small percentage". This uncertainty relates to, for example, the type of energy source (solar or wind energy) and the place of production. The network designer can have a degree of certainty about the type of source to be installed. This type of uncertainty is modelled using a possibilistic approach.

For probabilistic approaches, probability density functions (*pdf*) are commonly introduced to model uncertainty characteristics and are associated to the three methods: point estimate method, Monte Carlo simulation method, and scenario-based analysis method. SUC is using a scenario-based uncertainty representation to deal with generation planning involving uncertainties [81], [88]–[90].

As for in possibilistic methods and hybrid probabilistic-possibilistic approaches, some of input uncertain parameters are modelled as fuzzy membership functions since these uncertainties cannot be represented by *pdf*-based probabilistic methods. These modelled uncertain parameters include electricity price [205], loads [206], etc.

Previously, [207] presents a MILP method for a day-ahead SUC problem incorporating solar uncertainty, taking into account reserve constraints of the microgrids as an reserve trading with the main-grid. [208] formulates a MILP model that includes a conditional value for risk assessment of RES and load uncertainties when solving SUC problem in

isolated systems. As one of the most commonly used method in UC problems, MILP shows its advantages regarding compatibility. Commitments of generators are ideally regarded as integer decision variables in MILP. In our study, with the previous discussion about MILP in chapter 3, MILP is employed as the ultimate method to solve the optimization problem regarding operational planning and scheduling in the studied urban microgrid.

A two-stage unit commitment strategy has been formulated with wind uncertainty and considering different locations; and impacts of RES on operating costs and generation capacity are evaluated in [209]. Once the commitment decisions of slow generators are made in the first stage, they are unalterable in the second stage. While for each fast generator, the commitment and the generating point are adjustable in the second stage. However, the overall method is not adapted for urban networks or microgrids because considered transmission constraints complicates the selection of scenario, and specificities of small power systems are not taken into account.

As discussed previously in Chapter 1 (1.4.3), besides scenario-based approaches, robust optimization and chance-constrained optimization have also been applied to handle generation scheduling problems under various uncertainties [97]. e.g. [210] presents a formulation for a security-constrained SUC by considering non-spinning reserves with the integration of wind generation. In [211], a robust interval uncertainty method and a scenario-based method are detailed and compared. The results conclude that the performance of interval-based approach is greatly dependent on interval choices, while the computational cost is low. Whereas the scenario-based method leads to solutions with higher accuracy, but with higher computational complexity. A great challenge of SUC with scenario-based approach is the speed up of problem solving. It will be tackled in this proposed work through the determination of a limited number of scenario and the refined exploitation of fast generators to counter pass probable uncertainties.

To deal with forecast uncertainties and allocate reserve properly, many research works combine probabilistic methods with DUC, or apply SUC that includes reserve constraints [212]. On the other hand, compared to deterministic reserve determination, SUC has certain advantages, such as the operational cost saving for a prescribed reliability index [91], [92]. An interesting approach for modelling system operations considering load forecasting uncertainties is proposed in [92]. Unit commitment decisions are taken by considering time horizons varying from hours to days before the real operations, and the economic dispatch is performed by considering time horizons from minutes to hours ahead. However, the quantification and pre-allocation of the reserve power one day-ahead in a SUC is still a problem since efficiency and reliability when solving such a problem is greatly dependent on the number of scenarios. To overcome these disadvantages, [213] merges a probabilistic reserve constraint technique and a SUC approach with a limited number of scenarios to overcome the

problem of computational cost. By considering also the additional stochasticity from RES, [208] proposes a conditional value of risk during the SUC procedure to deal with RES uncertainties. Whereas, the separated commitment of slow and fast generators according to the uncertainty modelling would be an improvement.

Compared with traditional generation systems, urban microgrids have their specific characteristics and higher demands from citizens. Hence, some advanced control algorithms have been developed to achieve multi-objective optimization criteria. Due to the complexity of the optimisation problem and given the economic/environmental benefits that are achieved, attention has been paid to the improvement of optimisation algorithms. Table 4-1 summarized some of deterministic/stochastic-based approaches for operational planning in microgrids. The summary indicates that efforts are made by researchers to include load and RESs uncertainties during the planning and scheduling through varying stochastic approaches. However, RES utilisation is not considered in most cases during the optimization. [214] has made efforts to maximize the utilization rate of solar energy by optimizing the storage usage during the scheduling procedure.

In our case, with a proposed storage control strategy of ESS in the microgrid (in Chapter 5), the RES utilisation is considered as one of the optimization objectives during the operational planning. The RES utilisation rate regarding reserve provision is optimized, with the objective of providing the reserve by stored solar energy, and maintaining the security level with the minimum costs. The implementation of ESS and the discussion relating storage control strategies are detailed in Chapter 5.

Table 4-1 Summary of optimization methods for operational planning in microgrid (or isolated systems)

Ref.	Optimization criteria		Methods	Load and RESs Uncertainties			Risk-constrained Approach	Reserve Constraints	ESS
	Economic	Environmental		RES utilisation	Load demand	Wind speed			
[214]	✓		✓(utilisation rate)	-	-	-	-		✓
[77]	✓	✓	Deterministic DP	-	-	-	-		✓
[215]	✓		Self-adaptive DP	-	-	-	-		✓
[173]	✓		Genetic algorithm	-	-	-	-		✓
[216]	✓	✓	Game theory	-	-	-	-		✓
[217]	✓		Stochastic DP	✓	✓	✓	✓		✓
[208]	✓		MILP	✓	✓	✓	✓	CVaR	✓
[218]	✓		MIP, Lyapunov optimization	✓	✓			Forecast error bounds	✓
[207]	✓		MIP (Benders' decomposition)	✓		✓			✓
[169]	✓		MIP		✓	✓			✓
[219]	✓		MOSEK toolbox	✓	✓	✓	✓	Electricity prices	Mean-variance

									Markowitz theory
[220]	✓		MIP	✓	✓	✓	✓	DR	✓
[221]	✓		MILP, NLP, MPC		✓				✓
[222]	✓		MPC	✓	✓	✓	✓		✓
[223]	✓	✓	PSO	✓	✓			PEVs	✓
[224]	✓	✓	PSO	✓	✓	✓	✓		✓
[225]	✓		ECO A	✓	✓	✓	✓	Market price	✓

*CVaR*: Conditional value-at-risk

*MPC*: Model-based predictive control

*PSO*: Particle Swarm Optimization

*PEVs*: Plug-in Electric Vehicles

*DR*: Demand-side response

*EENS*: Expected energy not served

*ECO A*: Enhanced cuckoo optimisation algorithm

\* Here “-” indicates that the uncertainties are not included during the presented deterministic solution search.

### ***4.3.2 Issues and Contributions***

The literature review shows that both SUC and risk-based DUC have certain advantages regarding reserve determination. They should be properly adapted and combined. In this study, a co-optimization framework is studied for a local energy community with PV generation and Combined Heat and Power (CHP) generation that are used for electrical energy compensation and emergency generation (power reserve, section 3.3.2). A stochastic optimization framework for day-ahead unit commitment is proposed to include PV inherent uncertainty.

Some challenges are identified:

- Building scenarios that could represent the future uncertainty.
- Under each possible scenario, it is essential to model uncertainty sources, as well as to handle them through measures to reduce impacts coming from uncertainties.
- According to generator technologies, fast generators should be preferred for the provision of the uncertain power reserve. Since slow generators are less flexible and more expensive to be committed for reserve provision use.
- A great complexity is coming from the timing coupling in the decided generation scheduling one day ahead and the impacts on the observed system state (economic costs, emission cost, risk level, ...) after the disclosure of uncertainties in the future.

Based on the literature review, the proposed operational planning scheme in this work is organized in two stages, but with different tasks regarding the uncertainty handling.

The first stage calculates ad hoc requirements on reserve supply from an uncertainty analysis of past forecasting PV errors and then performs a deterministic optimization and unit commitments of all controllable generators with a Mixed-Integer Programming (MIP) method (as detailed in chapter 3). The second stage is a stochastic operational planning to foresight the operation of generators in case of future uncertainties. It is used to bring enough flexibility through the commitment decision of fast generators, in case that future values would deviate from forecasting values, leading to a possible deviation from the targeted optimum previously calculated. So, a second optimization is run with an anticipation of the uncertainty by considering various predicted scenarios and their corresponding probabilities. In this second step, the commitment of slow generators is not changed, only their power references may change. The commitment and power references of fast generators can also be changed. The proposed method deals with the uncertainty in forecast errors with the optimal operational planning of controllable micro gas turbines, so that minimal cost of the operation or/and CO<sub>2</sub> emissions one day ahead can be achieved.

## 4.4 Scenario-Based Stochastic Optimization Algorithm

### 4.4.1 Scenario-based optimization methodology

The main difficulty lies in the need of making decisions about the unit commitment before knowing how and when uncertainties will affect the electrical system. This complexity is broken by defining two stages, where the second-stage is the one that deals with the uncertainty (Fig. 4-4). At each stage, the optimization problem is solved and find optimal solution in expectation are found [226][227]:

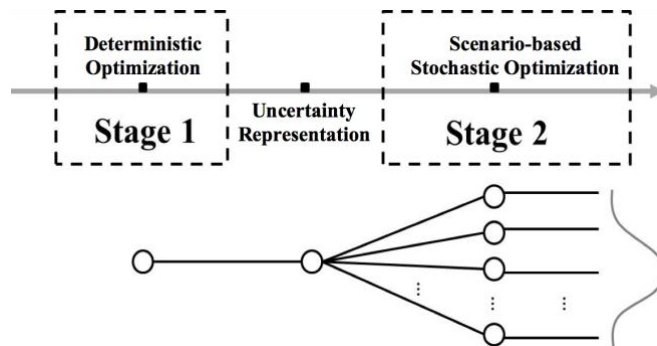

Fig. 4-4 A two-stage scenario based stochastic optimization.

The first stage is executed before the uncertain event realization. It is related to the optimal scheduling of generation capacity with the knowledge of the forecasted scenario and the reserve power requirement (as in chapter 3).

The second stage is based on a number of reasonable operating conditions that may arise in the future and so considers a probable uncertainty realization. The possible operating conditions are called scenarios. Here, uncertain PV production forecasting errors are represented by future scenarios rather than by their distributions. It is unreliable to cover a full range of uncertainties so, a finite set of scenarios  $\mathcal{W}$  is considered. After the occurrence of forecasting uncertainties in each scenario  $\omega$ , a second optimal dispatch is computed to find stochastic decision variables (power references of generators and commitment of fast generators), which depend on the set of scenarios  $\mathcal{W}$ .

Intuitively, stochastic decision variables will also depend on the commitment decision of slow generators previously made in the first-stage. Fig. 4-5 shows the sequence of the two-stage stochastic programming for the reserve and energy optimization. After the first-stage, the optimal dispatch of conventional units takes into account the scheduled power reserve. Once these values are known, the algorithm of the second-stage problem calculates, after the disclosure of uncertainties in each scenario and the activation of reserve.

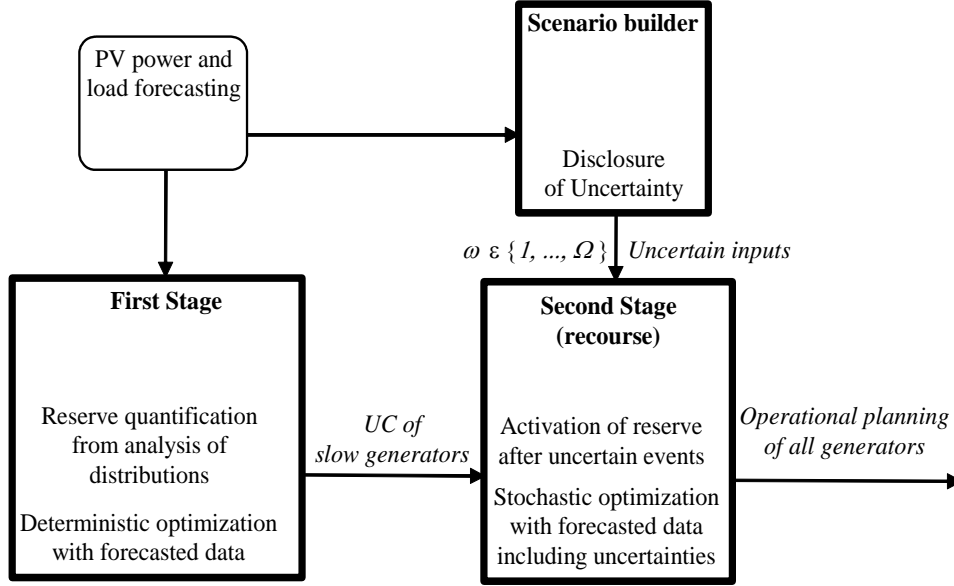

Fig. 4-5 Sequence of the two-stage stochastic programming for the reserve and energy optimization

#### 4.4.2 First stage: Deterministic operational planning

For the first stage we propose an implementation of the risk-based optimization (chapter 3) with a LOLP criteria to calculate the OR. It enables the decision of the commitment of slow generators.

Previously Fig. 3-31 showed approximated linear functions of the operating cost functions of MGTs  $c_m(p_m(t))$ . A start-up and shutdown penalty are considered on the operating costs ( $c_m^u u_m(t)$  and  $c_m^d d_m(t)$ , respectively). As discussed previously in Chapter 3, the economic cost-based mono-objective function for the operational planning in the first-stage is formulated as follows regarding:

$$J_1 = \min_{\Delta, p, r} \sum_{t=1}^T \sum_{m=1}^M \{ \delta_m(t) c_m(p_m(t)) + u_m(t) c_m^u + d_m(t) c_m^d \} \quad (4-1)$$

subject to:

$$\sum_{m=1}^M p_m(t) = D(t) + \underline{r}(t), \quad \forall t \in \mathcal{T} \quad (4-2)$$

$$\underline{p}_m \delta_m(t) \leq p_m(t) \leq \bar{p}_m \delta_m(t), \quad \forall m \in \mathcal{M}, \quad \forall t \in \mathcal{T} \quad (4-3)$$

$$(\Delta, p, r) \in \mathcal{F}$$

Following the rising of the environmental concerns in cities, objectives of the generation scheduling are evolving and consider now the minimization of the emissions. Micro Gas turbines have undesirable impacts on the environment, through the greenhouse gases emitted. For this reason, in Chapter 4 and Chapter 5, the CO<sub>2</sub> equivalent emission costs of each Micro Gas Turbine (MGT)  $m$  are modelled. CO<sub>2</sub> equivalent emission costs are estimated regarding the greenhouse gas emissions (CO<sub>2</sub>,



CO and NO<sub>x</sub>). The emissions of CO and NO<sub>x</sub> are converted to CO<sub>2</sub> equivalent emissions according to [228]: 1g of NO<sub>x</sub> is considered equivalent to 298g of CO<sub>2</sub>; 1g of CO equivalent to 3g of CO<sub>2</sub>. The following Fig. 4-6 shows approximated linear functions of the CO<sub>2</sub>-equivalent emission cost functions  $ce_m(p_m(t))$ .

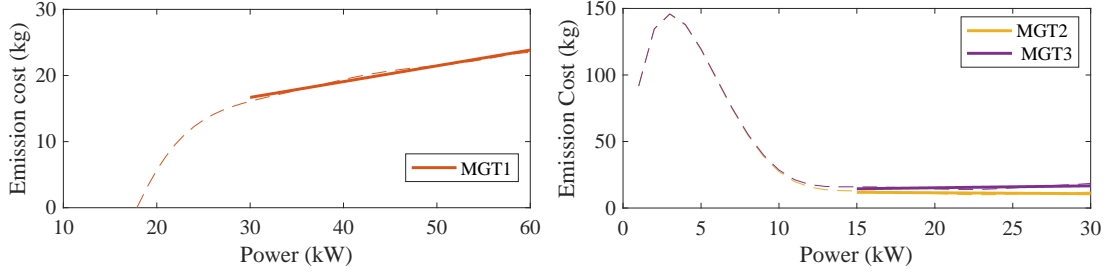

Fig. 4-6 Linearization of the nonconvex emission cost function of studied three MGTs

$ce_m^u u_m(t)$  and  $ce_m^d d_m(t)$  are the start-up and shutdown penalty on the CO<sub>2</sub> equivalent emission costs. The start-up penalty is assumed equal to the operating costs / emission costs during a 5 minutes full load operation. The shut-down penalty is assumed equal to the costs of a full load operation during 2.5 minutes [77]. The uncertainty coming from RES production implies uncertainty in the total emissions. The emission-based mono-objective function for the operational planning in the first-stage is formulated by considering the CO<sub>2</sub> equivalent emission cost:

$$J_1 = \min_{\Delta, p, r} \sum_{t=1}^T \sum_{m=1}^M \{ \delta_m(t) ce_m(p_m(t)) + u_m(t) ce_m^u + d_m(t) ce_m^d \} \quad (4-4)$$

When it comes to a cost and emission-based multi-objective function, it is negligible that the unit of each objective function  $c_m$  and  $ce_m$  is not the same, i.e. \$ and kg. Therefore, a normalization must be applied in order to make sense the target optimization function  $J_1$ . Here the value of each function is normalized into a range of [0,1] by adding parameters  $\alpha_c, \alpha_{ce}$ .  $\alpha_c$  and  $\alpha_{ce}$  satisfy the following functions:

$$\alpha_c c_m(p_m(t)) = \frac{c_m(p_m(t)) - \min [c_m(p_m(t))]}{\max [c_m(p_m(t))] - \min [c_m(p_m(t))]} \quad (4-5)$$

$$\alpha_{ce} ce_m(p_m(t)) = \frac{ce_m(p_m(t)) - \min [ce_m(p_m(t))]}{\max [ce_m(p_m(t))] - \min [ce_m(p_m(t))]} \quad (4-6)$$

By doing so, all objective functions are measured in the same unit. Thus, a multi-objective optimization is finally formulated as the sum of the two functions:

$$J_1 = \min_{\Delta, p, r} \sum_{t=1}^T \sum_{m=1}^M \{ \delta_m(t) [\alpha_c c_m(p_m(t)) + \alpha_{ce} ce_m(p_m(t))] + u_m(t) [c_m^u + ce_m^u] + d_m(t) [c_m^d + ce_m^d] \} \quad (4-7)$$

**4.4.3 Building of scenarios for the representation of uncertainty**

The challenge of building scenarios for the SUC problem is to generate several representative events that properly guide the SUC optimization in the second stage. The set of scenarios  $\mathcal{W}$  must take into account all the possible net demand events over the generation scheduling period (the following 24h) with the consideration of different PV generation scenarios.

Previously in Chapter 2, an artificial neural network (ANN) has been applied to forecast load demand and PV generation. Our method to build future scenarios assumes that past experiences (regarding uncertainties coming from forecasting errors) are applicable to consider and create future scenarios. These scenarios will be then considered to see consequences on the reserve and then decide about the best generation scheduling on day ahead (Fig. 4-7).

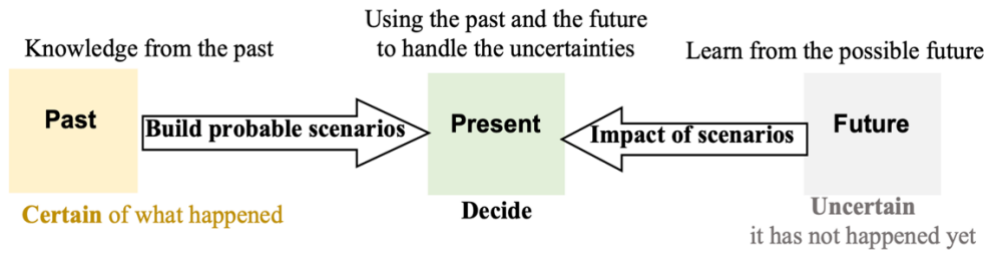

Fig. 4-7 Handling uncertainties with the knowledge of past and future

According to probabilistic characteristics of forecast errors, scenarios are generated with different PV generation predictions at each time step. The probability distribution of the PV forecast error at each time step  $t$  is approximated as a standard normal distribution function [229] and is used to describe the different values of the random variable (forecasting error). For a fixed standard deviation ( $SD$ ), an occurrence probability can be calculated [230]. As shown in Fig. 4-8, 68.2% of samples fall within an interval of  $\pm 1 SD$  around the mean, while 95.4% of samples are within an interval of  $\pm 2 SD$ , and 99.7% of samples are within  $\pm 3 SD$  from the mean.

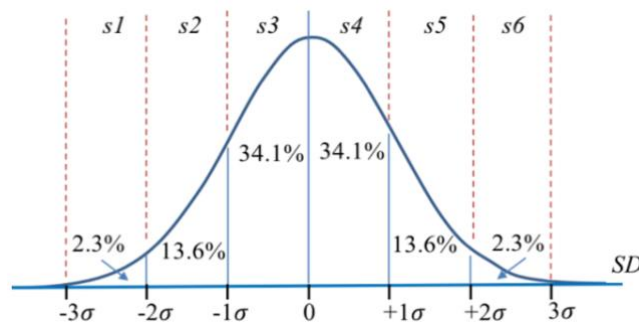

Fig. 4-8 Scenario generation based on  $pdf$  of PV forecast error at time step  $t$

By considering three standard deviations around the mean, six scenarios can be built with the PV forecasting time series ( $\widehat{pv}(t)$ ). The occurrence probability of each scenario  $\pi_\omega$  is deduced from the area of corresponding portion under the  $pdf$  curve. For example, the probability of scenario 3 ( $s3$ ) is  $\pi_3 = 34.1\%$  regarding the area under

the *pdf* curve in the interval and so the expected PV production in scenario 3 is obtained following:

$$s3: \widehat{pv}_3(t) = \widehat{pv}(t) + \mu_{pv,\varepsilon}(t) - \frac{1}{2}\sigma_{pv,\varepsilon}(t) \quad (4-8)$$

$\mu_{pv,\varepsilon}(t)$  and  $\sigma_{pv,\varepsilon}(t)$  are the mean value and standard deviation of PV forecast error at time step  $t$ , respectively. For each scenario, the expected net demand  $D_\omega(t)$  and the expected operating reserve requirements  $\underline{r}_\omega(t)$  are re-calculated. Hence, the knowledge of forecasting errors from past experiences enables the determination of a set of scenarios with their probabilities.

#### 4.4.4 Second stage: Stochastic operational planning

Interest of the second optimization is to find a unit commitment scheduling of fast generators and a power rescheduling of all controllable generators, while taking into account probable scenarios.

##### Reserve quantification for each scenario

The expected operating reserve requirements  $\underline{r}_\omega(t)$  must be rescheduled and the operating cost is re-calculated. Hence, the dispatching adjusts the previous scheduled power (in the first stage), according to the varying reserve requirement in each scenario. According to a specific scenario, the difference between the PV generation value in current scenario and the predicted PV power  $\Delta pv_\omega(t)$  can be one value among six possibilities:  $\{\mu_{pv,\varepsilon}(t) \pm 0.5\sigma_{pv,\varepsilon}(t), \mu_{pv,\varepsilon}(t) \pm 1.5\sigma_{pv,\varepsilon}(t), \mu_{pv,\varepsilon}(t) \pm 2.5\sigma_{pv,\varepsilon}(t)\}$ .

By taking into account uncertainties coming from these new scenarios, the system reserve power requirement  $\underline{r}_\omega(t)$  is deduced by considering two components:

$$\underline{r}_\omega(t) = \Delta pv_\omega(t) + \phi^{-1}(1 - \varepsilon|\mu_t, \sigma_t) \quad (4-9)$$

a) Reserve requirement for PV generation ( $\Delta pv_\omega(t)$ ), which is the difference between the predicted PV generation value  $\widehat{pv}(t)$  and PV generation value in current scenario. If the average value regarding upper and lower bound of PV generation is considered as the PV generation under scenario  $\omega$ ,  $\Delta pv_\omega(t)$  could be one value among 6 possibilities:  $\{\mu_{pv,\varepsilon,t} \pm 0.5\sigma_{pv,\varepsilon,t}, \mu_{pv,\varepsilon,t} \pm 1.5\sigma_{pv,\varepsilon,t}, \mu_{pv,\varepsilon,t} \pm 2.5\sigma_{pv,\varepsilon,t}\}$

b) Reserve requirement for net demand ( $\phi^{-1}(1 - \varepsilon|\mu_t, \sigma_t)$ ), which is quantified by carrying out risk-constrained probabilistic techniques as presented in Chapter 3, i.e. *pdf* and *cdf* of net demand deviation at each time step are calculated according to a reliability index based reserve assessment for each time step and for the following day. ( $\mu_t$  and  $\sigma_t$  are the mean value and the standard deviation of the forecasting error on the net demand,  $\phi(\underline{r}_t|\mu_t, \sigma_t)$  is the cumulative distribution function considering a reserve requirement  $\underline{r}_t$ . The net demand for each scenario is the expected load demand minus the forecasted production of PV power.

### Net demand constraints

The following constraints are related to the balance of expected generation and expected consumption under each scenario, as well as the generation limits of generators. All of them are indexed by the scenario index  $\omega$ :

$$\sum_{m=1}^M p_{m,\omega}(t) = D_\omega(t) + \underline{r}_\omega(t), \quad \forall t \in \mathcal{T}, \forall \omega \in \mathcal{W} \quad (4-10)$$

### MGTs limits constraints

By taking into account a certain quantity of OR provided by generator  $m$ , the maximum and minimum generation limits of generator  $m$  are considered:

$$\underline{p}_m \delta_{m,\omega}(t) \leq p_{m,\omega}(t) \leq \bar{p}_m \delta_{m,\omega}(t), \quad \forall m \in \mathcal{M} \quad (4-11)$$

All slow generators which are committed in the 1<sup>st</sup> stage must remain committed:

$$\delta_{m,\omega}(t) = \delta_m(t), \quad \forall m \in \mathcal{M}^{SLOW} \quad (4-12)$$

$$\forall t \in \mathcal{T}, \forall \omega \in \mathcal{W}$$

Here  $p_{m,\omega}(t)$ ,  $r_{m,\omega}(t)$  and  $\delta_{m,\omega}(t)$  are all scenario-dependent variables.

### Stochastic optimization

The optimization process must minimize the cost of the deterministic operational planning decisions of the first-stage (commitment of slow generators and the scheduled reserves) and the expected cost of the second-stage decisions (including reserve provision called upon regarding each possible scenario). The trade-off that needs to be considered in the reserve dispatching is the flexibility of fast units versus their higher operating costs (due to their higher marginal fuel costs).

Usually in an electrical system, fast generators can change commitment within one time step and have similar start up and turnoff costs to those of slow units. The unit commitment of slow generators in the first stage is kept in the second stage but their references may change. Only fast generators are committed in the second stage optimization ( $\forall m \in \mathcal{M}^{FAST}$ ). CHP have constraints in response times and minimum electrical power generation regarding heat power generation, because heat is in the form of hot water. In this study, with the largest rated power and more heat to consume, MGT 1 is a slow-start generator and its commitment cannot be rescheduled in the second stage, but their references may change. MGT 2 and MGT 3 are flexible generators (fast-start generators with a short time response) and their power reference can be rescheduled during the second stage (Fig. 4-9).

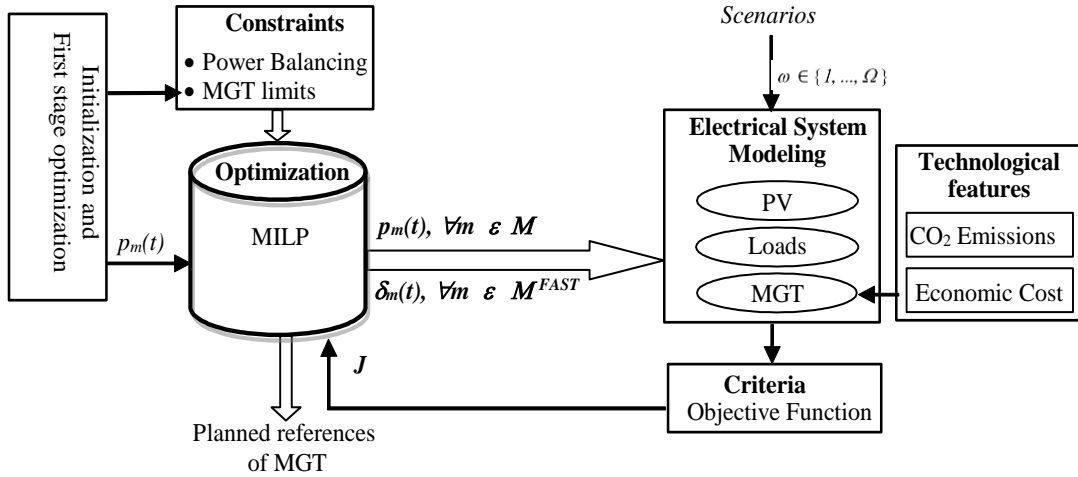

Fig. 4-9 Re-scheduling of fast generators in the second optimization stage with scenarios

The cost-based mono-objective function of the operational planning in the second-stage is formulated to take into account the occurrence probability ( $\pi_\omega$ ) of each scenario  $\omega$ :

$$J_2 = \min_{\Delta, p, r} \sum_{\omega=1}^{\Omega} \pi_\omega \sum_{t=1}^T \sum_{m=1}^M \{ \delta_{m,\omega}(t) c_m(p_{m,\omega}(t)) + u_{m,\omega}(t) c_m^u + d_{m,\omega}(t) c_m^d \} \quad (4-13)$$

subject to (4-10),(4-11),(4-12),  $(\Delta, p, r) \in \mathcal{F}$ ,  $\forall m \in \mathcal{M}$

where  $\sum_{\omega=1}^{\Omega} \pi_\omega = 1$ .  $\mathcal{F}$  is the set of scheduling decision variables  $\delta_{m,\omega}(t)$  and  $p_{m,\omega}(t)$ .

Thus, this expected cost is directly affected by the uncertainty of the PV forecasting, which is modelled through scenarios and their probabilities. Similarly, the emission-based mono-objective function for the operational planning in the second-stage is formulated by considering the CO<sub>2</sub> equivalent emission cost:

$$J_2 = \min_{\Delta, p, r} \sum_{\omega=1}^{\Omega} \pi_\omega \sum_{t=1}^T \sum_{m=1}^M \{ \delta_{m,\omega}(t) c e_m(p_{m,\omega}(t)) + u_{m,\omega}(t) c e_m^u + d_{m,\omega}(t) c e_m^d \} \quad (4-14)$$

The cost & emission-based multi-objective function is formulated as the sum of the two above functions over the whole set of scenarios:

$$J_2 = \min_{\Delta, p, r} \sum_{\omega=1}^{\Omega} \pi_\omega \sum_{t=1}^T \sum_{m=1}^M \{ \delta_{m,\omega}(t) [\alpha_c c_m(p_{m,\omega}(t)) + \alpha_{ce} c e_m(p_{m,\omega}(t))] + u_{m,\omega}(t) [c_m^u + c e_m^u] + d_{m,\omega}(t) [c_m^d + c e_m^d] \} \quad (4-15)$$

## 4.5 Application for the Operational Planning with the Scenario-Based Stochastic Optimization

### 4.5.1 Building of scenarios

Based on the probabilistic distributions of the PV generation errors at each time step, six additional scenarios with their corresponding probabilities are considered for the next day to take into account the unexpected variation of PV generation, as explained in section 4.4.3 (Fig. 4-10). Different levels of grey from dark to light indicates the possibility of occurrence from high to low, which implies 40%, 80%, 99% of probability intervals. To highlight effect of the RES uncertainty, the load demand forecast is considered as the same as in Chapter 3 without uncertainties (Fig. 4-11).

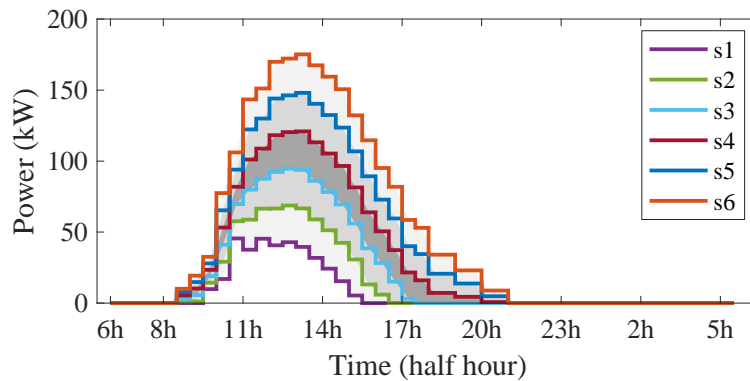

Fig. 4-10 Expected PV generation under six probable scenarios

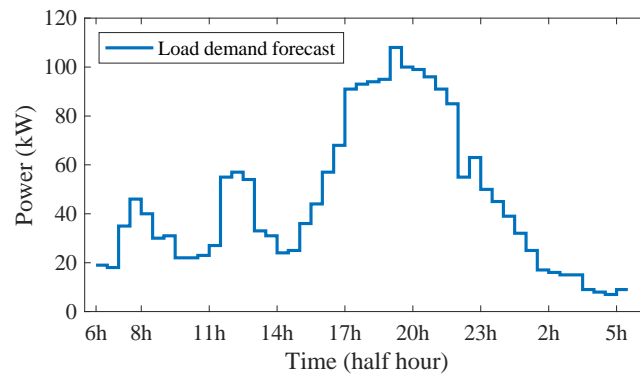

Fig. 4-11 Forecasted load demand

### 4.5.2 Analysis of OR and generation scheduling

After a multi-objective stochastic optimization with the different expected PV generation scenarios and forecasted load demand, the generation scheduling is obtained to minimize both the operating cost and CO<sub>2</sub>-equivalent emission cost (Fig. 4-12). The commitment of the slow generator MGT 1 is the same as in the first stage, whereas the strategic planning of fast generators (MGT 2 and MGT 3) has changed (in comparison

with the first stage, Fig. 3-32) in order to be able to compensate possible PV production uncertainties and according to non-linear characteristics of generators.

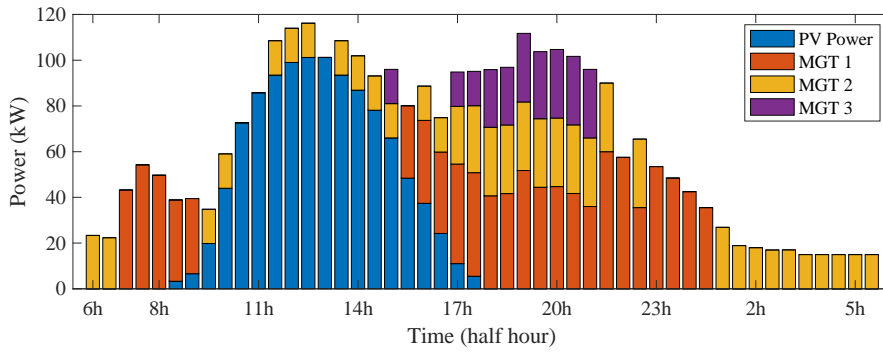
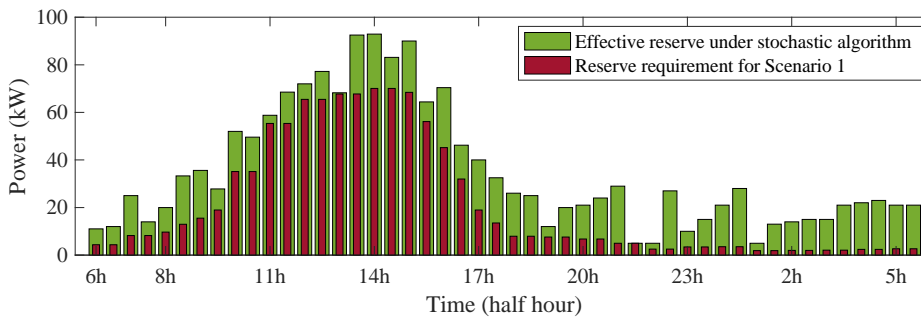

Fig. 4-12 Generation scheduling under stochastic optimization

Required reserve for each scenario is different and is calculated according to:

- The deterministic load reserve, which is allocated at the first-stage;
- The stochastic PV reserve (obtained by PV production limitation), which is re-scheduled and is based on expected PV generation under each scenario. As example, reserve requirement in the worst case regarding the net demand deviation (scenario 1), and effective reserve after stochastic optimization are shown in Fig. 4-13. Even in the worst-case situation (scenario 1), the effective reserve is capable of covering all reserve requirement at each time step.

By comparing the reserve under stochastic optimization (Fig. 4-13 (a)) with the one under deterministic algorithm (Fig. 3-33), the reserve requirement has been more precisely calculated and re-scheduled regarding each scenario, as well as obtaining the wished high security level. Meanwhile, compared with Fig. 3-33 (b), Fig. 4-13 (b) illustrates that more reserve power is provided thanks to the commitment availability of fast generators. The daily reserve energy from the slow generator is 431 kWh in both deterministic and stochastic unit commitment. As for reserve from fast generators, the daily reserve energy has increased to 406 kWh with scenario-based stochastic optimization, compared with 331 kWh of reserve energy in deterministic case, i.e. the daily reserve energy from fast generators has increased about 23%.



(a) The reserve requirement for scenario 1(worst case) and obtained effective reserve

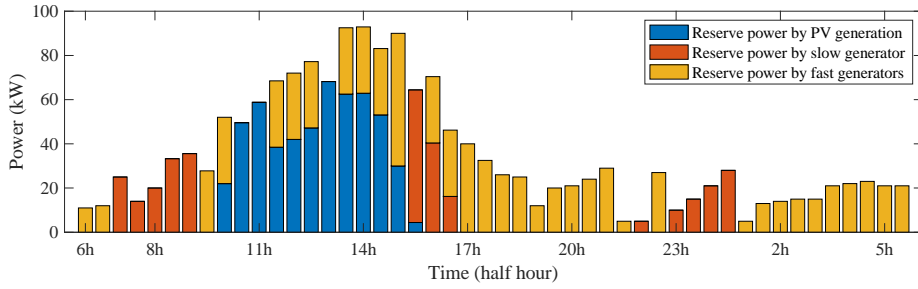

(b) Obtained effective reserve from slow and fast generators

Fig. 4-13 The reserve requirement for scenario 1(worst case) and effective reserve under stochastic optimization

**4.5.3 Impacts of the second stage optimization on the cost minimization**

The scenario-based optimization is implemented with three objective functions respectively: 1) cost-based mono-objective; 2) CO<sub>2</sub> equivalent emission-based mono-objective; and 3) multi-objective of cost and emission. Here multi-objective optimization is taken as an example to analyze the costs and emissions at each time step under six scenario S1-S6, and results are shown in Fig. 4-14. As illustrated in figures, at each time step, costs and emissions may fluctuate because of PV generation variations around the forecast value. Fig. 4-14 (a) shows impacts of PV uncertainties onto fuel costs and CO<sub>2</sub> equivalent emissions by considering only the 1<sup>st</sup> stage optimization. In this way, PV deviation  $\Delta pv_{\omega}(t)$  must be compromised by effective reserve, which is considered as an additional cost for scenario  $\omega$ .

Fig. 4-14 (b) shows fuel costs and CO<sub>2</sub> equivalent emission after the 2<sup>nd</sup> stage optimization. Costs and emissions are optimized because the reserve is properly scheduled during the 2<sup>nd</sup> stage optimization regarding uncertainties under each scenario. Table 4-2 compares fuel costs and CO<sub>2</sub> equivalent emissions before and after the 2<sup>nd</sup> stage optimization. It is concluded that both the fuel costs and CO<sub>2</sub>-equivalent emission costs are largely decreased with a scenario-based optimization.

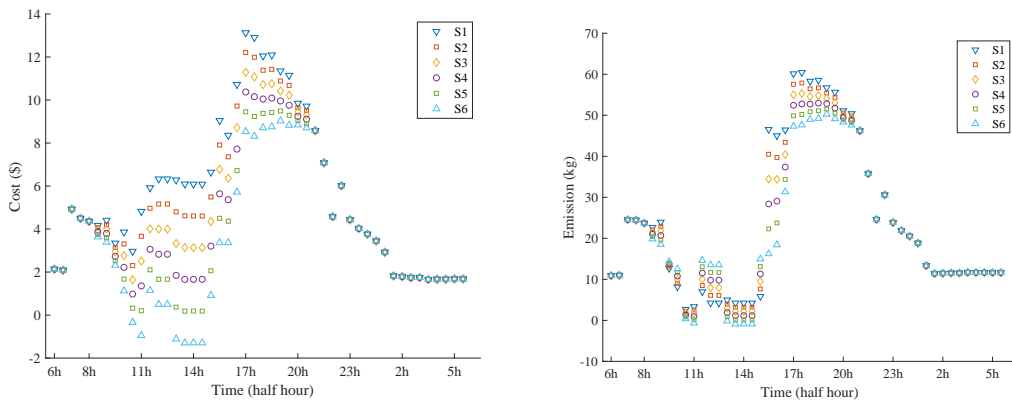

(a) Before the 2<sup>nd</sup> stage optimization



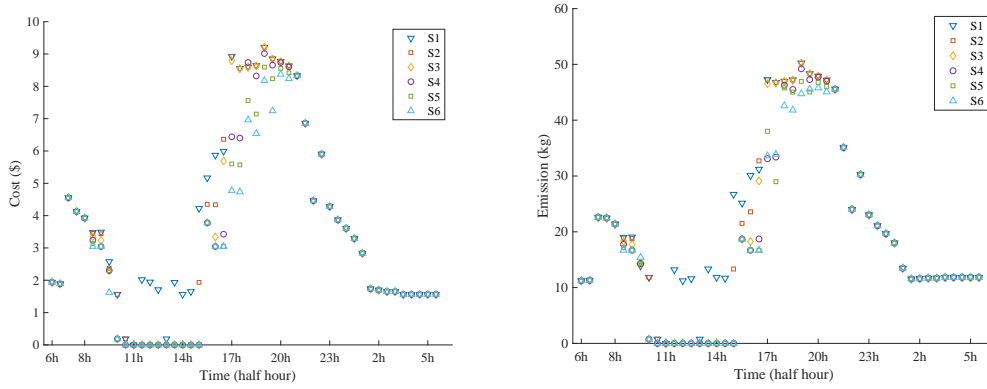

(b) After the 2<sup>nd</sup> stage optimization

Fig. 4-14 The fuel costs and CO<sub>2</sub>-equivalent emission costs under 6 scenarios at each time step

Table 4-2 Fuel costs and CO<sub>2</sub> equivalent emission costs results

2 <sup>nd</sup> Stage Optimization		S1	S2	S3	S4	S5	S6
No	Cost (\$)	272	251	230	209	189	168
	Emission (kg)	1136	1110	1088	1059	1033	1008
Yes	Cost (\$)	188	173	166	158	153	147
	Emission (kg)	1058	962	923	878	868	859

The fuel cost and CO<sub>2</sub>-equivalent emission cost vary according to the committed MGTs as well as considered PV generation. After analysis results following the propagation of some PV generation scenarios, data from the fuel cost and CO<sub>2</sub>-equivalent emission cost can be approximated by a normal distribution. For example, the *pdf* of the fuel cost at 17:00 is shown in Fig. 4-15 with a mean  $\mu_{cost,t=17:00} = 8$  and a standard deviation  $\sigma_{cost,t=17:00} = 0.1$ , as well as the *pdf* of the CO<sub>2</sub>-equivalent emission cost with  $\mu_{emission,t=17:00} = 46, \sigma_{emission,t=17:00} = 0.4$ . The fitted *pdf* curved is obtained for each time step according to the corresponding histogram. This associated probability with each result is an added information if we compare with results in chapter 3.

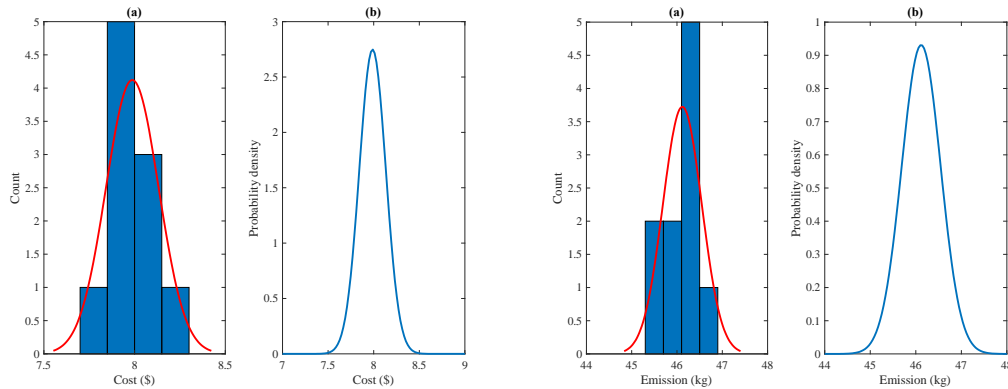

Fig. 4-15 Fuel cost and CO<sub>2</sub>-equivalent emission cost at 17:00

**4.5.4 Impacts of the chosen risk criteria**

Criteria for the system security induce different costs. Meanwhile, when the LOLP assessment is considered in the reserve determination during operational planning, different outcomes are obtained under deterministic and scenario-based stochastic optimization algorithm. Table 4-3 shows the day-ahead operational planning results under different risk criterions. Results of the deterministic UC and the risk-based optimization (1<sup>st</sup> stage) from Chapter 3 are reported in Table 4-3. After the application of scenario-based stochastic multi-objective optimization, expected optimal operating cost / emission cost with LOLP in 1<sup>st</sup> Stage and 2<sup>nd</sup> Stage are reduced by up to around 15%, compared to the N-1 criterion deterministic case. The total energy of the day-ahead reserve requirement and effective reserve are also compared.

Table 4-3 Comparison of results under different risk criterions

	Deterministic Optimization				Stochastic Optimization			
	Without Criterion		N-1 Criterion		LOLP ≤ 5% Criterion			
					1 <sup>st</sup> Stage		2 <sup>nd</sup> Stage	
	Cost (\$)	CO <sub>2</sub> (kg)	Cost (\$)	CO <sub>2</sub> (kg)	J <sub>1</sub> -based Cost (\$)	J <sub>1</sub> -based CO <sub>2</sub> (kg)	J <sub>2</sub> -based Cost (\$)	J <sub>2</sub> -based CO <sub>2</sub> (kg)
<b>Multi-objective (cost &amp; emission)</b>	149	832	213	1174	181	1017	180	1047
<b>Mono-objective (cost)</b>	147	868	211	1221	180	1034	180	1079
<b>Mono-objective (emission)</b>	157	818	220	1164	191	1001	188	1035
<b>Reserve requirement (kWh)</b>	\		\		426		500	
<b>Effective reserve (kWh)</b>	403		554		763		838	

**4.5.5 Impacts of the RES self-production rate**

Fig. 4-16 shows the cost and emission under different PV self-production rates. In the studied case, the maximum PV self-production rate is 28% if the PV energy surplus is not stored during the day. With the increase of PV self-production rate, the difference between costs of deterministic N-1 criterion and costs of LOLP criterion (based on 1<sup>st</sup> stage and 2<sup>nd</sup> stage optimization) gradually increases. Similarly, CO<sub>2</sub> equivalent emissions have tendency to decrease with the LOLP criterion, compared with the N-1 criterion. As the self-production rate grows, comparing to 2<sup>nd</sup> stage emission, 1<sup>st</sup> stage is more environmentally friendly. The operating costs are similar with a slightly difference. As for the risk level, 2<sup>nd</sup> stage planning results provide a higher level of power security because there is more effective reserve power in case of power losses. As shown in Table 4-3, more effective reserve (available reserve) is obtained under 2<sup>nd</sup> stage than in 1<sup>st</sup> stage.

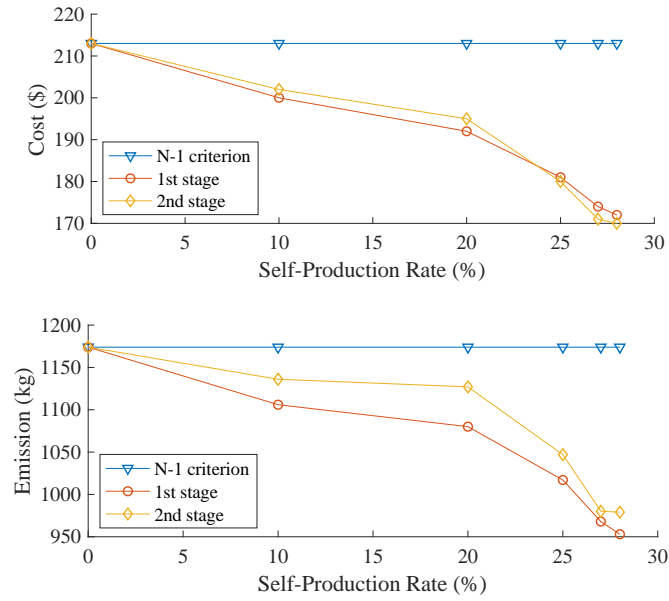

Fig. 4-16 Cost curves and emission curves regarding self-production rate

## 4.6 Conclusion

In this chapter, the state of art in SUC is reviewed. SUC advantages of handling RESs and load uncertainties are highlighted compared with DUC methods. Then optimization methods for operational planning in electrical systems and microgrids are summarized. Furthermore, an optimization framework is presented to address the problem of the optimal operational scheduling of microgrids. A two-stage optimization algorithm of generation scheduling is presented for an urban microgrid with optimal reserve dispatching.

In a first stage, half-hourly OR are decided with a prescribed LOLP-based risk level, applied on the *pdf* of the past net demand forecast errors. Then, a deterministic unit commitment gives the generation scheduling and includes PV and load forecasting in addition to OR that are calculated from past uncertainties realizations. Secondly, a stochastic day-ahead operational planning is implemented. The PV uncertainty is then considered according to different scenarios and their probabilities of occurrence at each half-hour. For each scenario, OR can be recalculated by considering the same level of security. Based on the presented PV scenario and by maintaining the commitment of slow generators, stochastic operational planning considers possible commitment of additional fast generators if necessary and adapts power set-points of all generators.

Results are presented for scenario-based stochastic algorithm, according to three different objective functions: 1) economic operating cost-based mono-objective; 2) CO<sub>2</sub> equivalent emission-based mono-objective; and 3) multi-objective of cost and emission. Three cases regarding reserve scheduling are compared: *N-1* criterion, optimization with probabilistic analysis (1<sup>st</sup> stage) and optimization with scenarios regarding probabilities of occurrence (2<sup>nd</sup> stage). Around 15% of both economic

operating costs and environmental costs are saved, compared to the deterministic generation planning (chapter 3) while ensuring the targeted security level. Moreover, a probability (*pdf*) can be obtained for each established result. As shown, this framework enables the analysis of the impact of RES penetration ratio on costs and emissions.

In the following Chapter 5, research works will be oriented to the integration of storage systems as an alternative for fast power reserve provision in replacement of fast generators and for CO<sub>2</sub> abatement.

## CHAPTER 5

## CHAPTER 5 PARTICIPATION OF STORAGE FOR OPERATING RESERVE PROVISION

### 5.1 Introduction

Until now, ancillary services, like the operating reserve (OR), are mainly provided by conventional generators because their primary energy (oil, gas, ...) is stored and so their availability is ensured. However, this way of reserve power provision is fuel-consuming, leading to a significant OPEX and emission cost. Recently, more clean and advanced technologies are explored to provide OR.

By dynamically degrading their conversion process (pitch control for wind generators, operating under MPPT for PV generators, ...), RESs have shown their potential to provide OR by increasing their power generation if necessary. But, in consequence, a significant part of renewable energy is lost. As example, in chapter 4, the self-consumption rate of PV generation is about 50%, i.e. only half of PV generation is consumed.

To overcome the discontinuous power output of RESs, energy storage systems have been used earlier for time-shifting the renewable energy. From the electricity market point of view, storage application can bring benefits to stakeholders, end users and utility customers. For instance, by considering the electricity market price, storage can bring profits by charging during off-peak times and discharging during on-peak times.

For the management of the electrical system, ESS can also provide ancillary services and so can assist in a better integration of RESs in the operation of the electrical network. Interests of the reported research works in this chapter is to assess the significant opportunity for energy storage to mitigate the effect of the net demand prediction error and so to provide OR. Three main questions are addressed:

- What type of local control system for the ESS can be considered for OR provision?
- How to take into account ESS actions in the unit commitment of the microgrid?
- How to size the storage to extend benefits in the generation scheduling and estimate the investment cost (CAPEX)?

In this chapter, distributed energy storage systems (ESSs) are considered with the application of PV active generators (PV AGs), which are composed of PV panels and batteries (as presented in Chapter 1, part 1.3.3). The control strategy of the ESS will be considered to decide, at each time step, the amount of power to charge or to discharge. With the proposed storage control strategies, the solar energy surplus is stored in ESS and can be consumed later for OR provision. This operation can be implemented only

if the ESS state of charge (SoC) is managed, making it essential to estimate the SoC according to the ESS use.

A multi-objective scenario-based stochastic optimization method is presented in this chapter for generation scheduling and allocation of OR on ESSs and MGTs. The objective is always to minimize the operational cost and CO<sub>2</sub> equivalent emission cost, but with additional constraints coming from the participation of ESS. Different objectives, i.e. the optimal economic and environmental-friendly outcome, as well as the optimal reserve provision are attained by applying presented storage control strategies in the multi-objective scenario-based optimization algorithm. The two use cases of ESS are:

- a) *Strategy 1*: Renewable production time-shift;
- b) *Strategy 2*: Operating reserve provision.

The subsequent sections are organized as follows. Section 5.2 gives an overview of energy storage applications and benefits. Section 5.3 presents the two storage control strategies. Section 5.4 details the mathematical formulation of the deterministic operational planning, then application results are exposed. Meanwhile, results of two storage control strategies are compared. In Section 5.5, with consideration of net demand scenarios, the mathematical formulation of a scenario-based optimization is explained, then application results under the two proposed storage control strategies are illustrated and compared. The sizing of storage under uncertainty is discussed in section 5.6 by applying statistical analysis methods. Finally, the conclusion is derived in Section 5.7.

## ***5.2 Overview on Energy storage applications and benefits***

### ***5.2.1 Home energy storage***

By storing energy from renewable resources, energy storage systems (ESSs) could smooth renewable generation power output, and provide additional benefits for different stakeholders in the electrical system. In addition, they could perform the role of meeting power demand or shave off demand peak [231].

In recent years, there has been growing interest in storing home-made energy from rooftop photovoltaic panels. A number of vendors have sought to capture this emerging market, including Tesla [232], and the German home energy storage provider Sonnenbatterie [233]. Meanwhile, Nissan and Mercedes-Benz also makes efforts to offer at-home battery to its customers in Europe [234][235]. Nissan has partnered with Eaton, a multinational power management company in the United States. They have designed a residential solar energy storage system *xStorage Home*, to help customers to optimize the consumption of clean energy. It is reported that with *xStorage Home*, the PV self-consumption can be increased from 30% to 70% [236].

These home energy storages are usually combined with the electric vehicle charging and a home energy management system of local flexible loads, which is trying to increase benefit for customers with a more flexible, economic and sustainable energy use. For example, home energy storage can maximize solar PV self-consumption, draw energy from the utility grid during non-peak times, and power loads in a grid event. Indeed, energy storage can bring varying benefits in terms of different applications. Fig. 5-1 summarized several main applications for energy storage: electric supply, ancillary services, renewables integration, grid system, and utility customer. Meanwhile, storage benefits are discussed in detail in [14], [237] with respect to application-specific benefits and incidental benefits.

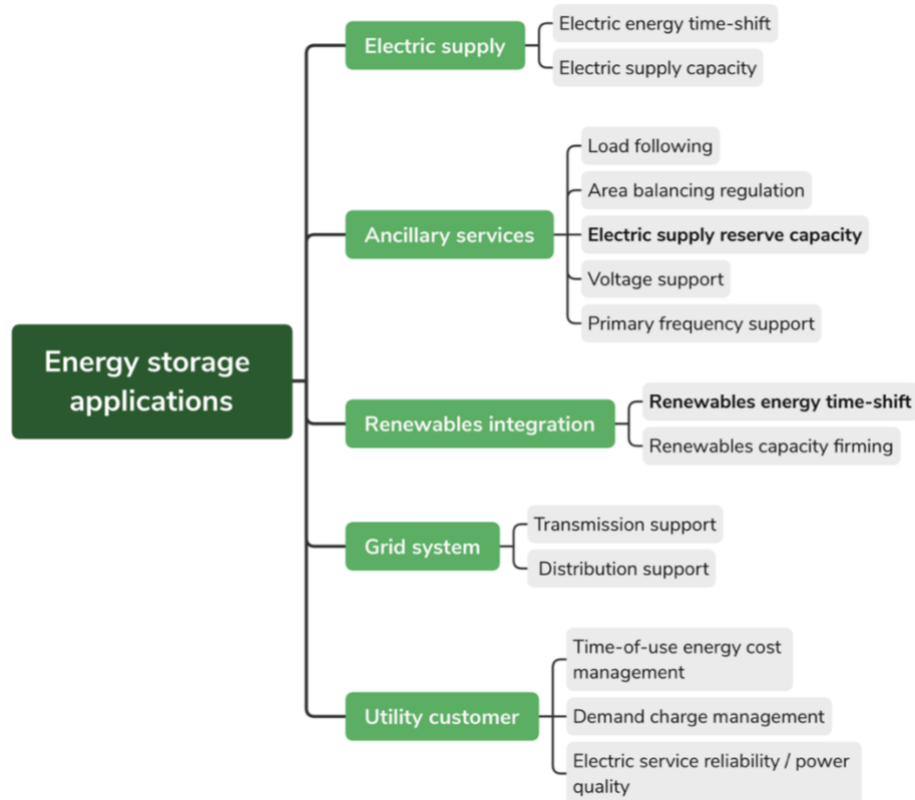

Fig. 5-1 Summary of energy storage applications

For offering flexibility and peak shaving, a multi-objective optimization model is presented in [238] to minimize the operation costs and CO<sub>2</sub> emissions in an energy community. Different battery technologies are considered under two different ownership scenarios regarding community energy storage system. An Energy Arbitrage - Peak Shaving (EA-PS) scenario is assessed and recommended to prevent problematic loads on the distribution transformer. This study is a deterministic-based optimization, though. Uncertainties from RES and load demand are only considered in real-time, and are not included in the solution search. Meanwhile, many stochastic methods, like scenario-based stochastic optimization [239], [240], robust optimization [241]–[243] and stochastic dynamic programming method [244], [245] have been applied to do generation scheduling with the integration of ESS and renewable energy. As reported in the bibliography, although ESSs are applied for economic benefits, or for hedging



RES output uncertainty by smoothing the renewable generation profile, ESSs were not served as reserve capacity in these studies. In this study, the benefits and applications regarding **renewable energy time-shift** and **operating reserve supply** are focused on and discussed in detail.

### ***5.2.2 Renewable energy time-shift***

Generally during off-peak times, electrical demand is low and this is the case in urban electrical networks at noon when all residents are outside their homes for their work and do not consume their local produced electricity. Hence, there may be a surplus energy supply capacity if PV generators are massively integrated in local energy communities. On the contrary, during peak times (19:00 in France), demand raises its peak and electricity has a rather high financial value. Typically, solar energy is accessible during the daylight with a peak generation at around noon whereas the peak times of the local load demand are mostly in the evening. To correlate the RESs peak generation and on-peak time of consumption, energy storage is used in many applications for renewable energy time-shift.

### ***5.2.3 Operating reserve supply***

Among ancillary services, storage is capable of providing electric supply reserve capacity [246]. When storage is served as reserve capacity, OR need from conventional generators are reduced, as well as economic and environmental costs are decreased. Nevertheless, if storage is used for reserve provision, the reliability and feasibility must be kept. Moreover, the stored energy should be well scheduled according to the temporal situation and the state of charge.

There are many research works focusing on the application of ESS on reserve provision under RES uncertainty in electrical system. [247] proposed an approach for optimal self-scheduling of the wind/solar generation with an efficient spinning reserve provision due to the addition of thermal energy storage capacity. However, the impact of the intermittency and variability of wind and solar generation are not considered. [248] considered optimal operation and optimal bidding of an independent storage system to provide energy and reserve in the day-ahead market of a power system with a high penetration of wind energy. However, this study focuses on the independent local storage system management rather than from a grid-scale point of view. In [249] traditional power plants are regarded as generation-side energy storage, and power system economics are evaluated under uncertainty of wind generation. Whereas, in these studies, energy storage is provided by traditional thermal plants.

## ***5.3 Energy Storage Control Strategies***

### ***5.3.1 Principle and framework***

In this chapter, the objective is to provide the reserve capacity by a clean energy with a least additional OPEX and emission cost. An ESS is considered for the renewable

energy time-shift with two proposed energy storage control strategies. As illustrated in Table 5-1, the stored energy surplus in ESS can be used either for:

- Power balancing (strategy 1), batteries are available for a renewable energy production time-shift.
- Reserve provision (strategy 2), batteries are used first to provide reserve power.

Table 5-1 Comparison of presented energy storage control strategies

	<i>Strategy 1</i>	<i>Strategy 2</i>
<b>Storage application</b>	Renewable energy time-shift and power balancing	Renewable energy time-shift and supply of operating reserve
<b>Storage benefit</b>	Energy source for load supply	Dynamic power source for reserve provision
<b>Objective</b>	Minimize operational costs and CO <sub>2</sub> equivalent emissions	Ensure the security level to a large extent

The storage strategy and reserve dispatching among ESS and MGTs are dependent on the SoC of batteries at each time step during the day. In a PV AGs, an amount of power ( $p_{bat}(t)$ ) is exchanged with the ESS so that the power delivered to the grid ( $p_{ag}(t)$ ) can be adjusted to some extent:

$$p_{ag}(t) = p_{pv}(t) - p_{bat}(t) \quad ((5-1))$$

$p_{pv}(t)$  is the produced power from PV panels. We consider that  $p_{bat}(t)$  is positive in charging mode, otherwise negative.

The output power of the active generator is then dependent to the control strategy of the storage and so the operation planning must be modified. In our proposed approach, the storage control strategy is first considered and so applied to establish the batteries limits and constraints (Fig. 5-2).

As results, a profile of the generated power from PV active generators is created and the available OR is determined. These data are used for the optimization. In the proposed generation scheduling, PV AGs will be used as the prior power sources. Meanwhile, MGTs are used as a second choice for power supply, and they are committed for security reason when there is not enough PV energy. The studied and considered control strategies are now presented.

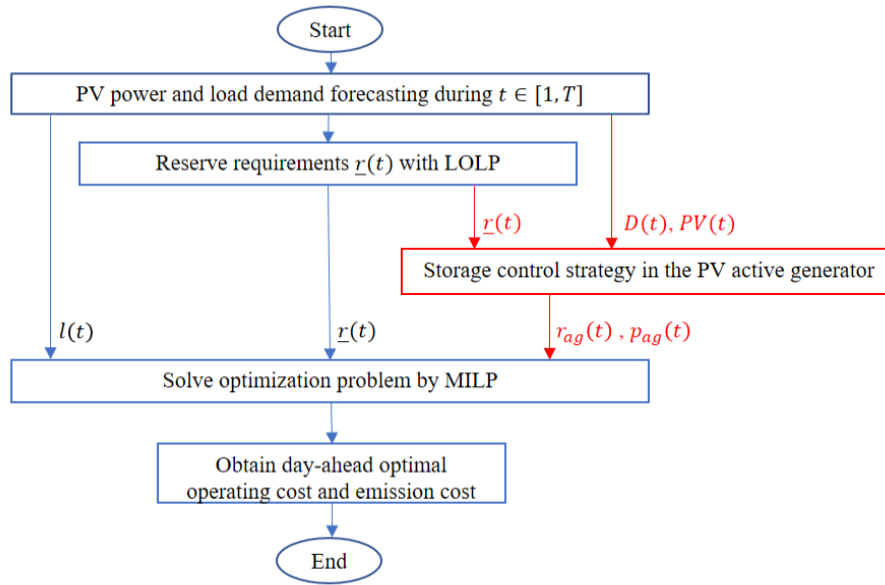

Fig. 5-2 Integration of the ESS control strategy in the generation scheduling

### 5.3.2 Storage control strategy for power balancing (strategy 1)

In this strategy, batteries are used to time shift the power production according to the net demand forecasting error, which is regarded as a deviation from the commitment. Batteries are charged or discharged under the following situations:

- Charging: When there is a renewable energy surplus, i.e. PV energy surplus (PV forecasting error > 0 or net demand  $D(t) < 0$  if MGTs are not used), the storage is used to store the PV energy excess, thus shaving PV power peak during daytime (Fig. 5-3).
- Discharging: Unless batteries are charged, the storage is discharged to produce energy for the load supply (balancing between load demand and generation). If more storage energy is available, it can be used to provide reserve power (secondary use).

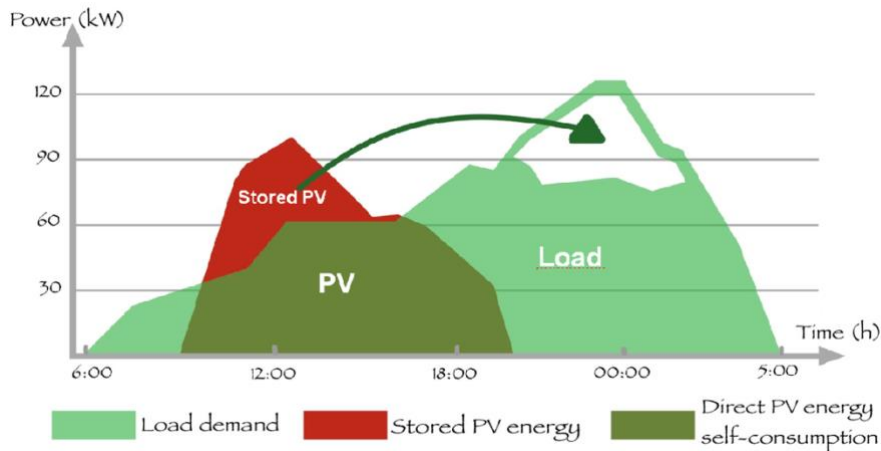

Fig. 5-3 Schematic diagram of ESS operation in *strategy 1* (Simplified PV power profile and load demand profile, for illustration only)

For the analysis, we can distinguish the charging power (  $p_c(t)$  ) and the discharging power (  $p_d(t)$  ) as:

$$p_{bat}(t) = p_c(t) - p_d(t) \quad (5-2)$$

In order to ensure that the balancing deviation is zero, the idealized and controlled storage should absorb the exact net demand difference (  $D(t)$  ) if MGTs are not used:

$$p_c(t) = -D(t) = p_{bat}(t) > 0 \quad (5-3)$$

We recall that  $p_{bat}(t)$  is positive in charging mode otherwise negative in discharging mode (generation).  $D(t)$  is positive if the load demand is more than the production, otherwise negative.

With a real storage, technical constraints must be satisfied:

- the exchanged power with the battery must be under the rated power ( $\bar{p}_{bat}$ ), otherwise, it must be saturated.
- the state of charge must be checked:  $SoC_{min} < SoC(t) < SoC_{max}$ . The state of charge of batteries is defined as:

$$SoC(t) = \frac{E_{bat}(t)}{C_{bat}} \quad (5-4)$$

$E_{bat}(t)$  is the energy (in Watt·hour) stored in battery until time step  $t$  and  $C_{bat}$  is the battery capacity.

According to the load demand forecast, the PV production forecast and the required reserve, the control system must calculate the battery power reference ( $p_{bat}(t)$ ), the produced PV power in case of limitation or not ( $p_{pv}(t)$ ) and the output generated power of the active generator ( $p_{ag}(t)$ ) that the central energy management will take into account.

The flowchart of the storage control in *strategy 1* is illustrated in Fig. 5-4 and is organized as follows:

- step (a):** PV generation and load demand forecasting at each time step.
- step (b):** Reserve requirements are calculated with the LOLP-based probability assessment method.
- step (c):** If the net demand  $D(t)$  is negative, then the power system has too much power and this exceed power can be stored if storage constraints are satisfied.

To implement this strategy, the SoC and the rated battery power are checked. Then the charging power ( $p_c(t)$ ) is deduced. If this one is limited to the rated battery power, then a part of the PV power must be curtailed and is possible to provide OR:  $r_{pv}(t) = -D(t) - \bar{p}_{bat}$ . The produced power from the active generator is then deduced:

$$p_{ag}(t) = PV(t) - p_c(t) \quad (5-5)$$

If the battery is fully charged at the end of the time step, we can add a constraint to limit the charging power reference to be under the  $SoC_{max}$  to the value:

$$\frac{C_{bat}}{\tau} \cdot \eta \cdot (SoC_{max} - SoC(t - 1))$$

$\tau$  is the time duration (Here  $\tau = 0.5$ , implying the half-hour time step).

If the net demand  $D(t)$  is positive, then the missing power in the power system can be generated by the storage if storage constraints are satisfied. To implement this strategy, the SoC and the rated battery power are checked. The discharging power ( $p_d(t)$ ) is deduced:

$$p_d(t) = D(t), p_{bat}(t) = -p_d(t) < 0 \quad (5-6)$$

The increased produced power from the active generator is then deduced:

$$p_{ag}(t) = PV(t) + p_d(t) \quad (5-7)$$

**step (d):**  $r_{ag}(t)$  indicates the reserve power provided by PV AGs, and it comes from the direct PV power limitation ( $r_{pv}$ ):

$$r_{ag}(t) = r_{pv}(t) \quad (5-8)$$

The exchanged power with the batteries is expressed as:

$$p_{bat}(t) = \eta \cdot p_c(t) - \frac{1}{\mu} \cdot p_d(t) \quad (5-9)$$

$\eta$  and  $\mu$  are efficiency index of charging and discharging, respectively ( $\eta, \mu \in [0,1]$ ).

Finally, the SoC is refreshed:

$$SoC(t) = \frac{1}{C_{bat}} [E_{bat}(t-1) + \tau \cdot p_{bat}(t)] \quad (5-10)$$

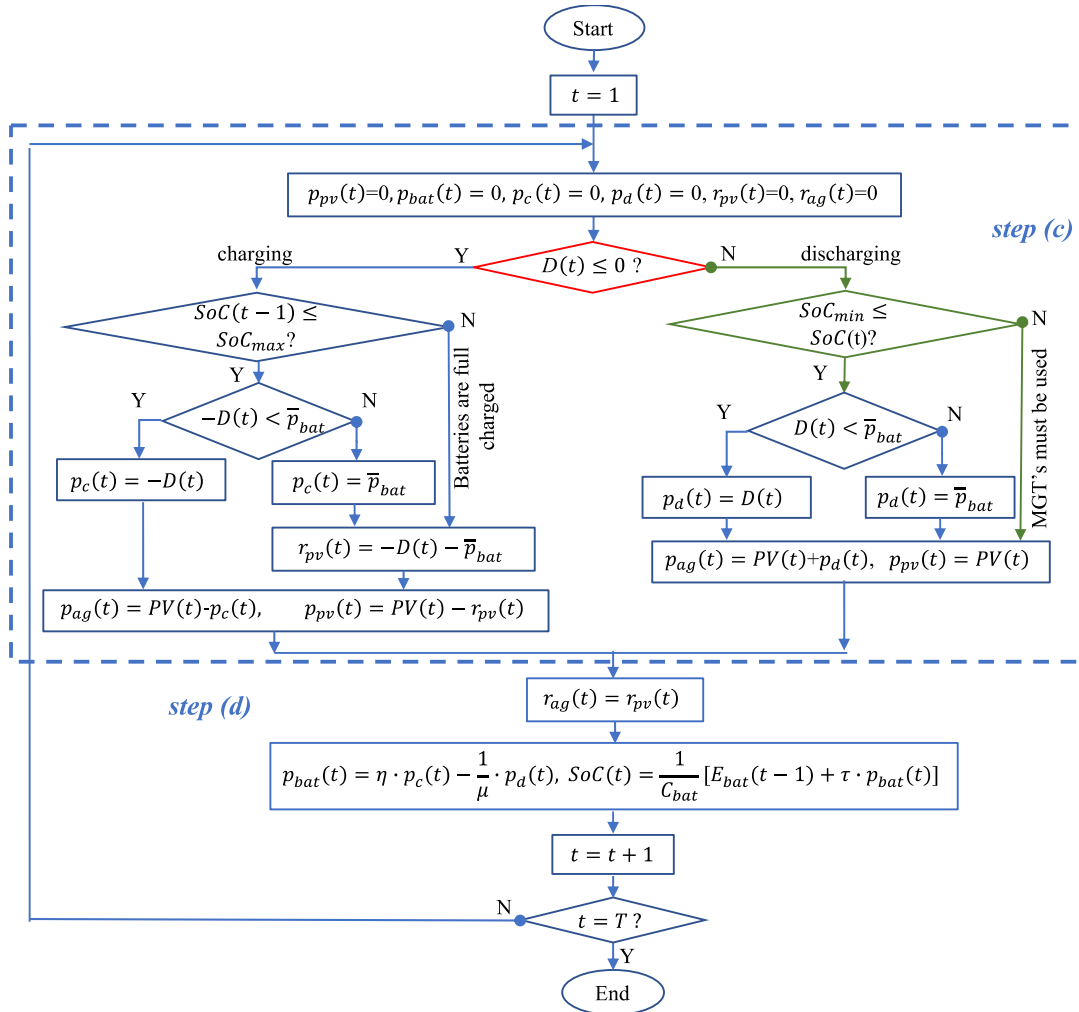

Fig. 5-4 Flowchart of storage control and reserve dispatching in *strategy I*

After the execution of this algorithm the planning of the battery power reference, the time evolution of the SoC and the offered OR are known. The calculated produced power from the active generator ( $p_{ag}(t)$ ) will be used for the determination of the operational planning.

To illustrate the *strategy 1*, four operating points are detailed by assuming one aggregated active generator and  $\bar{p}_{bat} = 60\text{kW}$  (Table 5-2).

Table 5-2 Power values (in kW) for some operating points

Time step $t$	1	2	3	4
Net load demand $D(t)$	30	-10	-90	-90
Reserve requirement $r(t)$	20	30	20	40
Available PV generation $PV(t)$	10	15	100	100
Power of discharging $p_d(t)$	30	0	0	0
Power of charging $p_c(t)$	0	5	60 (limitation)	60 (limitation)
Active generator $p_{ag}(t)$	40	5	10	10
Reserve provided by PV limitation $r_{pv}(t)$	0	0	30	30
PV generation	0	0	70	70
Reserve provided by MGTs $r_{mgt}(t)$	20	30	0	10

### Increased power capacity

At  $t = 1$ , the net demand is positive (missed PV power). Then the active generator power reference must inject more power than the predicted available PV power:  $10\text{kW} + 30\text{ kW} = 40\text{ kW}$ . This is a new possibility thanks to the storage:  $p_d(1) = 30\text{ kW}$ . The reserve requirement is provided by MGT (  $r_{mgt}(t)$  ) and decided by the optimization algorithm. We will study the impact of this control strategy on the OR cost.

### Renewable energy saving

At  $t = 2$ , the net demand is negative (PV power surplus). Then the active generator power reference must inject less power than the predicted available PV power  $15\text{kW} - 10\text{ kW} = 5\text{kW}$ . Without a storage, 5 kW from PV panels are lost. Here, this power can be stored in batteries.  $p_c(2) = 5\text{ kW}$ .

### Renewable energy saving and OR provision from PV limitation control

At  $t = 3$ , the net demand is negative (PV power surplus). Then the active generator power reference must inject less power than the predicted available PV power  $100\text{kW} - 90\text{ kW} = 10\text{ kW}$ . Without a storage, 90 kW from PV panels are lost. Here, this power can be stored in batteries but must be limited:  $p_c(3) = 60\text{ kW}$ . There is still too much PV power:  $90\text{kW} - 60\text{ kW} = 30\text{ kW}$ . So the PV production must be limited to:  $100\text{kW} - 30\text{ kW} = 70\text{ kW}$ . But this lost power can be used as a local reserve because the PV production can be increased in the future if it is needed. As the reserve requirement is

less than the lost PV power, the PV production is able to provide a “PV reserve”:  
 $r_{pv}(3) = 30 \text{ kW} > 20 \text{ kW}$ .

**Coordinated OR provision with MGTs and PV limitation control**

At  $t = 4$ , the situation is the same but the reserve requirement is more and so the missing reserve requirement is provided by MGTs:  $r_{mgt}(3) = 40 - 10 = 10 \text{ kW}$ .

After the application of the control strategy 1, the capacity of providing the OR by limiting the PV production is assessed. That means the reserve allocation regarding PV AG and MGT is done through the storage control strategy before the MILP optimization. Then, later in the operation planning, the reserve requirement from MGTs will be calculated before the optimization.

**5.3.3 Storage control strategy for power reserve provision (strategy 2)**

In this strategy, the stored PV energy is considered to provide a part of the OR (Fig. 5-5).

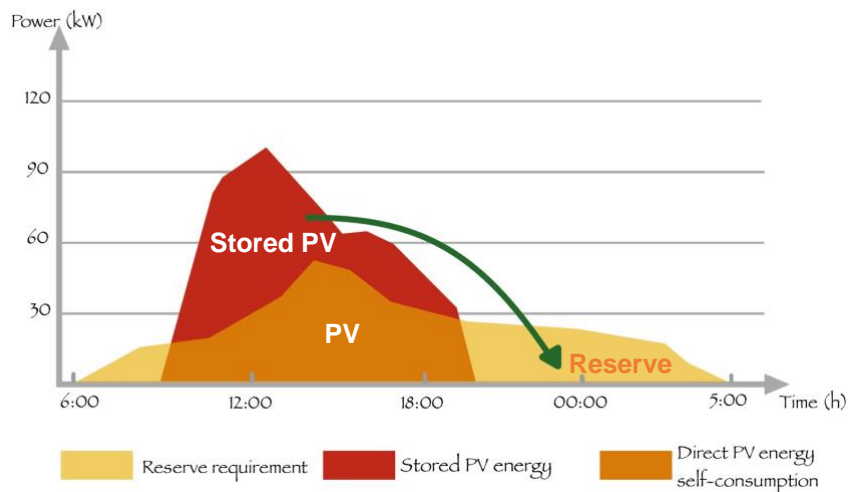

Fig. 5-5 Schematic diagram of ESS operation in *strategy 2* (Simplified PV power profile and reserve requirement profile)

Batteries are mainly used to provide a reserve capacity in the discharging mode and are charged or discharged under the following circumstances:

- Charging: Same as in the strategy 1.
- Discharging: **Storage is used as a prior OR source to provide the reserve requirement** to cover uncertainty from the net demand forecast. The surplus of storage energy after reserve provision is used for load supply and power balancing (secondary use).

The flowchart of the storage control and reserve dispatching in *strategy 2* is illustrated in Fig. 5-6. The procedure of *strategy 2* is as follows:

**step (a):** PV and load demand forecast are obtained at each time step.

**step (b):** Reserve requirements are calculated at each time step.

**step(c):** If the net demand  $D(t)$  is negative, the exceed power is stored as in strategy 1. However, in strategy 2, stored power is managed for power reserve provision in priority. So, the available power reserve from the storage is updated with the stored power during the current time step:

$$r_{bat}(t) = p_c(t) + SoC(t-1) \frac{C_{bat}}{\tau} \quad (5-11)$$

This reserve power can be delivered only if it is below the rated power; this constraint is checked.

If the net demand ( $D(t)$ ) is positive, the active generator may generate more power but in priority enough inner reserve power must be kept. So the available reserve power is estimated according the SoC:

$$r_{bat}(t) = SoC(t-1) \frac{C_{bat}}{\tau} \quad (5-12)$$

Again, this reserve power can be delivered only if it is below the rated power of the battery; this constraint is checked.

Then, if the reserve power in batteries is less than the required reserve, the remaining battery power ( $r_{bat} - \underline{r}(t)$ ) can be used to supply the loads as the net demand is positive. This is a secondary use of the stored energy. So, if the net demand is less than the available remaining battery power, then the discharged power is obtained:

$$p_d(t) = D(t) \quad (5-13)$$

Otherwise, it is limited to this value:

$$p_d(t) = \underline{r}(t) - r_{bat} \quad (5-14)$$

The battery rated power is checked and the active generator power is deduced:

$$p_{ag}(t) = PV(t) + p_d(t) \quad (5-15)$$

**step (d):** As in the previous control strategy, the SoC(t) is refreshed.

Now, the provided reserve by the PV AGs ( $r_{ag}(t)$ ) can come from the PV power limitation ( $r_{pv}$ ) or from the storage energy ( $r_{bat}$ ) or from both ones:

$$r_{ag}(t) = r_{pv}(t) + r_{bat}(t) \quad (5-16)$$



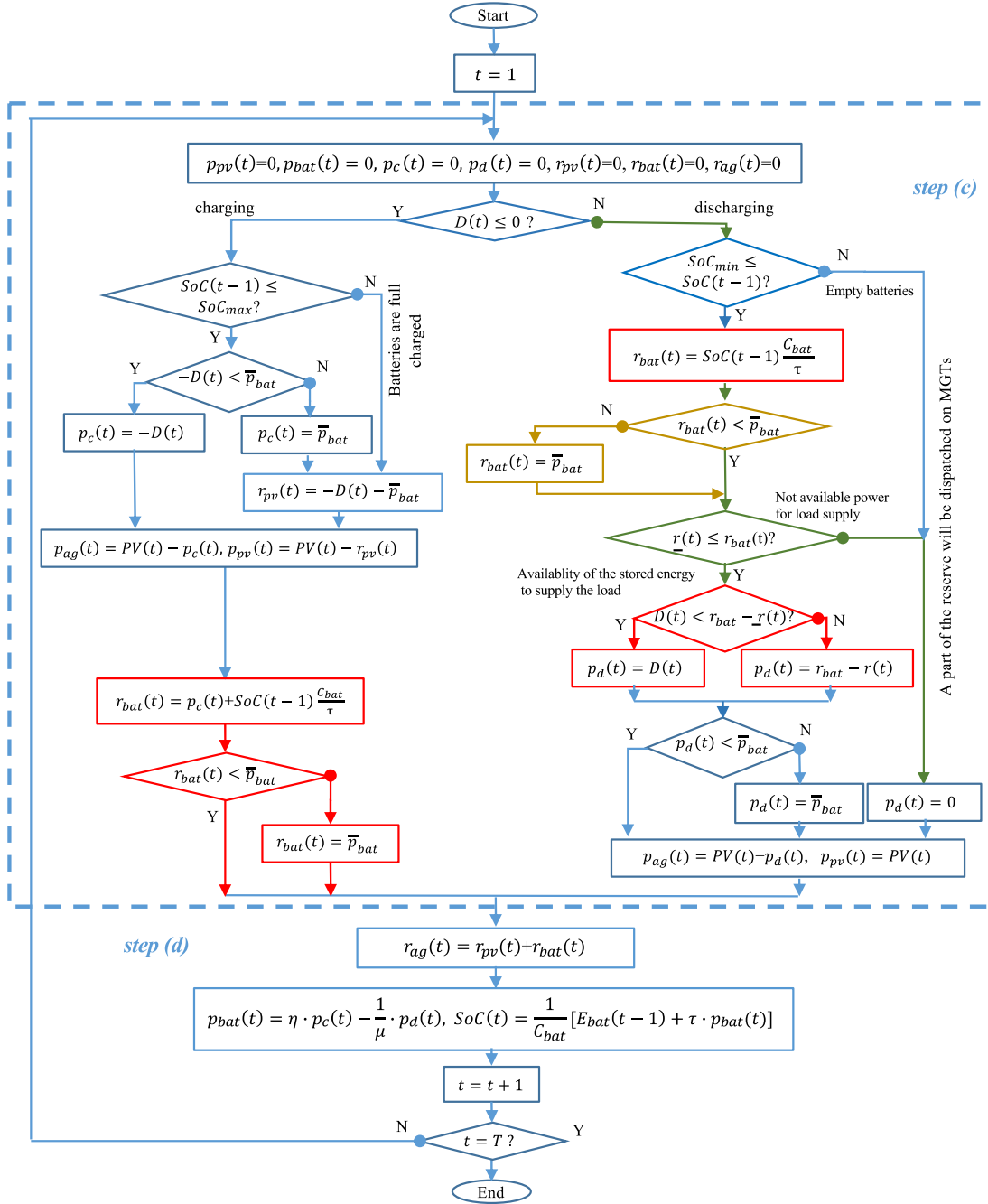

Fig. 5-6 Flowchart of the storage control and reserve dispatching in *strategy 2*

## 5.4 UC with a Deterministic Optimization

### 5.4.1 Presentation

As discussed before, PV AGs are managed as prior sources because of their benefits regarding low operating cost and gas-emission-free character. Meanwhile, MGTs are set as backup sources for the missing energy. Fig. 5-7 illustrates the scheme of the generation planning with the combination of the storage control strategy and the reserve allocation.

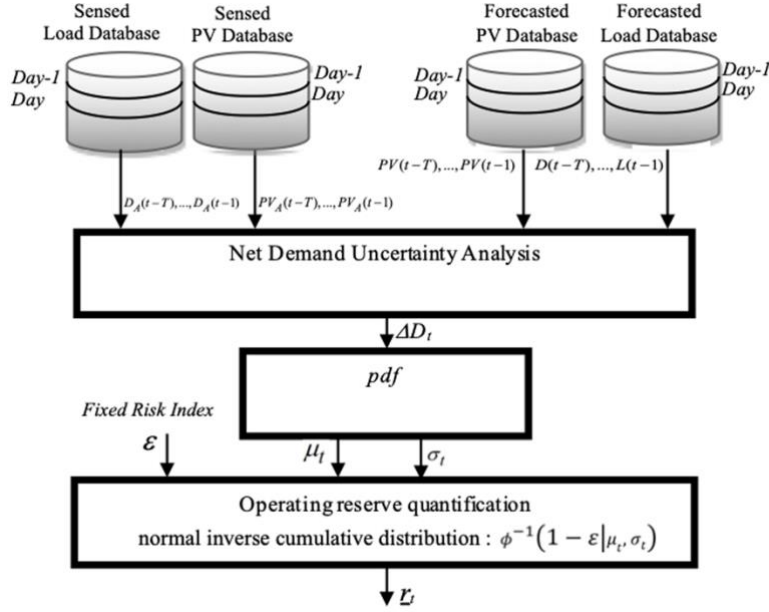

Fig. 5-7 Deterministic operational planning with combination of storage strategy regarding reserve allocation

The storage control strategy determines variables concerning batteries (including  $p_{ag}(t)$ ,  $r_{ag}(t)$ ). Then in the MILP procedure,  $p_{ag}(t)$  is used to check the power balancing constraint, and  $r_{ag}(t)$  is used in the reserve constraint.

If MGTs are used to charge batteries, emission costs may increase, making the use of batteries not environmentally friendly. Hence, from an environmental point of view, we take care that batteries are charged only by PV AGs in our proposed generation scheduling.

Since a part of the operating reserve can be provided now by the active generator, the required OR from MGTs ( $r_{mgt}(t)$ ) must be calculated for each time step.

$$r_{mgt}(t) = \underline{r}(t) - r_{ag}(t) \tag{5-17}$$

The balance between production and consumption is the first equality constraint. PV active generators can operate both as renewable energy-based generators and as energy storage devices, since they are capable of generating solar energy as well as storing solar power surplus in the battery. So, the produced PV power is replaced by the produced active generator power ( $p_{ag}(t)$ ) including the power exchanged with batteries. The total amount of conventional generation at time step  $t$  must meet the load demand forecast  $l(t)$  for all time steps with the consideration of generation of PV AGs:

$$\sum_{m=1}^M p_m(t) = l(t) - \sum_{a=1}^A p_{ag}(t) + r_{mgt}(t), \tag{5-18}$$

$$\forall t \in \mathcal{T}$$

### 5.4.2 Objective function

The cost and emission-based multi-objective function for the operational planning in the first-stage (i.e. under a deterministic optimization) is the same as in Chapter 4 (equ. (4-7)), but with different constraints regarding reserve (5-17), (5-18):

$$J_1 = \min_{\Delta, p, r} \sum_{t=1}^T \sum_{m=1}^M \{ \delta_m(t) [\alpha_c c_m(p_m(t)) + \alpha_{ce} c e_m(p_m(t))] \} \quad (5-19)$$

$$+ u_m(t) [c_m^u + c e_m^u] + d_m(t) [c_m^d + c e_m^d] \}$$

subject to (5-17), (5-18),

$$\underline{p}_m \delta_m(t) \leq p_m(t) \leq \bar{p}_m \delta_m(t) \quad (5-20)$$

$$\forall m \in \mathcal{M}, \forall t \in \mathcal{T}, (\Delta, p, r) \in \mathcal{F}$$

Constraints on the rated power of MGTs are the same as in Chapter 4 (equ. (5-20)). Similarly, the economic cost-based mono-objective function, and the emission-based mono-objective function are the same as equ. (4-1) and (4-4), respectively.

### 5.4.3 Task and data of the study case

The same urban microgrid (section 3.6) is considered and the profiles of the half-hourly electricity consumption forecast, and half-hourly forecasted daily PV generation for the corresponding day are recalled in Fig. 3-12. As discussed previously, by comparing the daily consumed PV energy and daily load energy, the PV self-production rate is about 25% and PV self-consumption rate is 50% if no storage is used. We are going to study the possibility to increase the PV self-production rate from 25% to 50%, and PV self-consumption from 50% to 100%. The energy of the ESS is sized to enable a 100% PV self-consumption if the control strategy 1 is used. Table 5-3 illustrates values of parameters of PV AGs applied in our study.

Table 5-3 Values of parameters regarding PV AGs

Parameter	Nomenclature	Value
$Nom.P_{PV}$	Nominal maximum solar power	180 kW
$SoC_{int}$	Initial state of charge	$SoC_{min}$
$SoC_{max}$	Stop charging threshold from PV	100%
$SoC_{min}$	Minimum allowable state of charge	20%
$\eta$	Charging efficiency	95%
$\mu$	Discharging efficiency	97%
$C_{bat}$	Battery Storage System Capacity	350 kWh
$\bar{p}_{bat}$	Battery (dis)charging power limit	60 kW

### 5.4.4 Applications results with the power balancing strategy (1)

Obtained power set points of generators are shown in Fig. 5-8. The required reserve is then allocated and provided by MGTs and direct PV (surplus). As shown in Fig. 5-9, the reserve power is provided only by PV AGs with a PV power limitation during the period from 13:00 to 14:30. During the remaining of the time period, the reserve is covered by MGTs. All stored energy in batteries is used for the load supply. The sum of the stored energy in the batteries during the day is 262.8 kWh. During the day, the

reserve energy from PV AGs is 6.8 kWh, the reserve energy from MGTs is 360.3 kWh, **i.e. 6.8 kWh of reserve from MGT is reduced compared with Chapter 3 (without storage).**

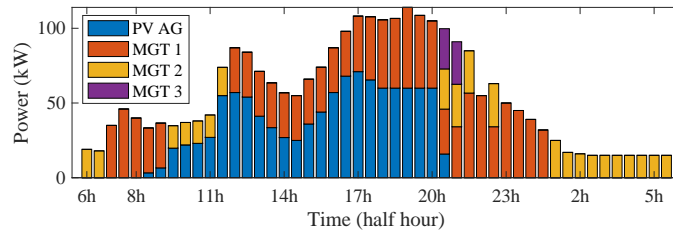

Fig. 5-8 Generation planning under deterministic optimization and scheduled PV power in *strategy 1*

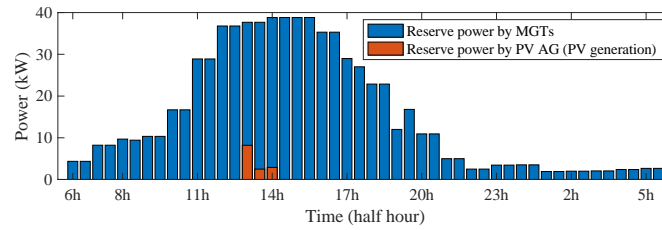

Fig. 5-9 Reserve provided by MGTs and PV AGs at each time step under deterministic optimization in *strategy 1*

Fig. 5-10 shows the active PV generator power ( $p_{ag}$ ), the battery power ( $p_{bat}$ ) and SoC during the day under the deterministic optimization in *strategy 1*. All energy stored in batteries are consumed up before 20:30 for supplying load. In this studied case, since all the PV generation is consumed or stored in batteries for later use, the PV self-production rate is 50% by comparing the daily load energy (1081.5 kWh) and daily PV energy (539 kWh). PV self-consumption is 100% since all PV generation is consumed.

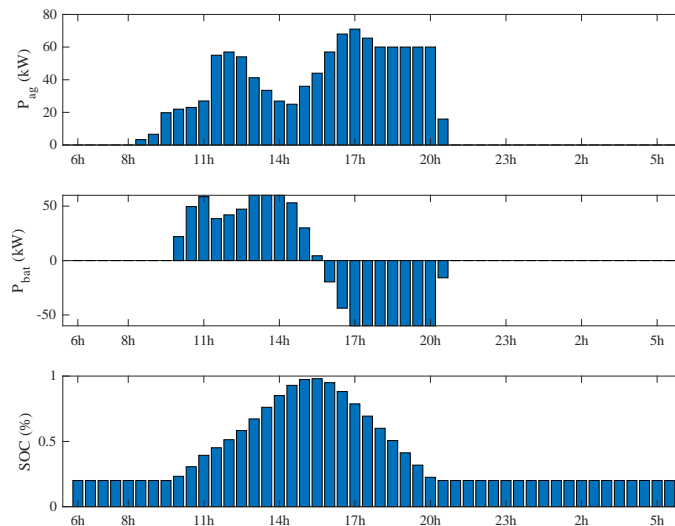

Fig. 5-10 AG power, battery power and SOC of batteries at each time step under deterministic optimization in *strategy 1*

5.4.5 Applications results with the OR provision strategy (2)

With the energy storage control *strategy 2*, obtained power set points of generators are shown in Fig. 5-11. The required reserve is then allocated and provided by MGTs and PV AGs. As shown in Fig. 5-12, the reserve power is provided by stored energy from PV AGs during period from 16:00 to 22:00. MGTs are operating as secondary sources (same as in the previous control *strategy 1*). In *strategy 2*, the stored energy in the batteries during the day is the same as in *strategy 1*, while the reserve energy from PV AGs is 123.3 kWh (including 6.8 kWh from the PV production limitation and 116.5 kWh from batteries); Reserve energy from MGTs is 243.8 kWh, with a 48% of decrease compared to *strategy 1*.

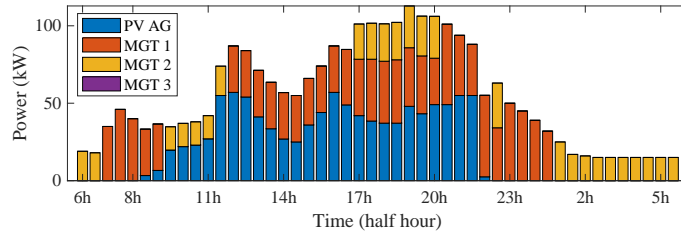

Fig. 5-11 Generation planning under deterministic optimization and scheduled PV power in second strategy

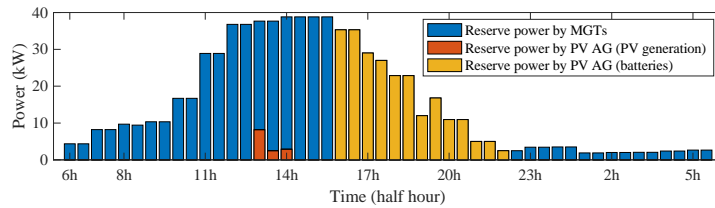

Fig. 5-12 Reserve provided by MGTs and PV AGs at each time step under deterministic optimization in *strategy 2*

Fig. 5-13 shows states of PV AGs power  $p_{ag}$  ( $\sum_{a=1}^A p_a$ ), battery power  $p_{bat}$  ( $p_c - p_d$ ) and SoC during the day under deterministic optimization in *strategy 2*. Compared with the *strategy 1* (Fig. 5-10), the energy stored in batteries are consumed from 16:00 to 21:30 for reserve provision instead of load supply.

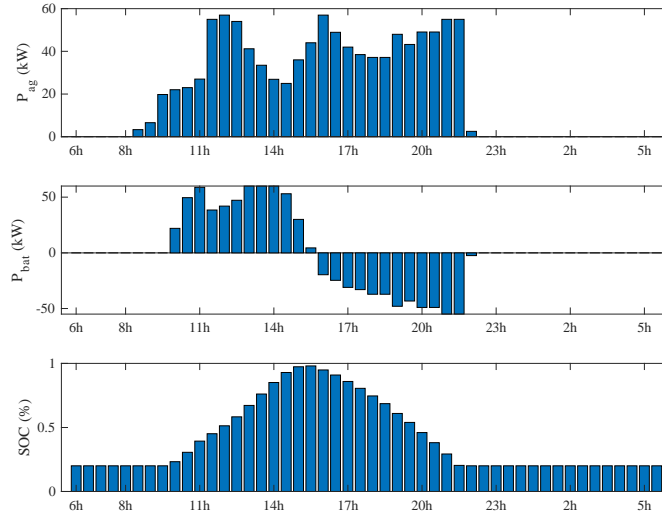

Fig. 5-13 AG power, battery power and SoC at each time step under deterministic optimization in *strategy 2*

**5.4.6 Comparison of the two control strategies and discussion**

**Objective function**

Day-ahead deterministic-based operational planning results are compared in Table 5-4 regarding the fuel cost and CO<sub>2</sub> equivalent emission cost. Both fuel and emission costs with storage are greatly decreased compared with the case without storage. Furthermore, fuel and emission costs of the *strategy 2* are less compared with *strategy 1*. The reason is that with the storage control *strategy 2*, stored energy is used to provide reserve power, then less MGTs may be committed during certain period to provide reserve, leading to a lower operational cost.

Table 5-4 Day-ahead deterministic-based operational planning results comparison

Storage control strategy	Objective	Deterministic-based method	
		Fuel Cost (€)	CO <sub>2</sub> Cost (kg)
No Storage (Ch. 4)	Multi-objective (cost & emission)	181	1017
	Mono-objective (cost)	180	1034
	Mono-objective (emission)	191	1001
1	Multi-objective (cost & emission)	170	945
	Mono-objective (cost)	169	961
	Mono-objective (emission)	179	931
2	Multi-objective (cost & emission)	167	922
	Mono-objective (cost)	167	958
	Mono-objective (emission)	176	908

**Obtained effective reserve**

Fig. 5-14 illustrates the comparison between the two storage control strategies regarding the reserve requirement and the obtained effective reserve after the deterministic-based method. Here the reserve requirement is quantified by the LOLP analysis and preset security level. *Strategy 2* is interesting because of a higher security

level with more reserve provision when there is a rather high reserve requirement (from 15:00 to 21:00).

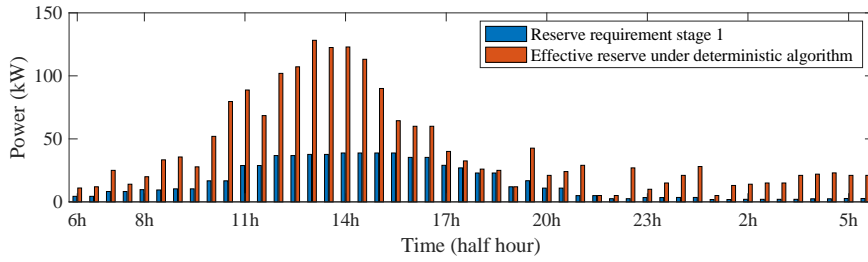

(a) Obtained effective reserve with a LOLP  $\leq 5\%$  in *strategy 1*

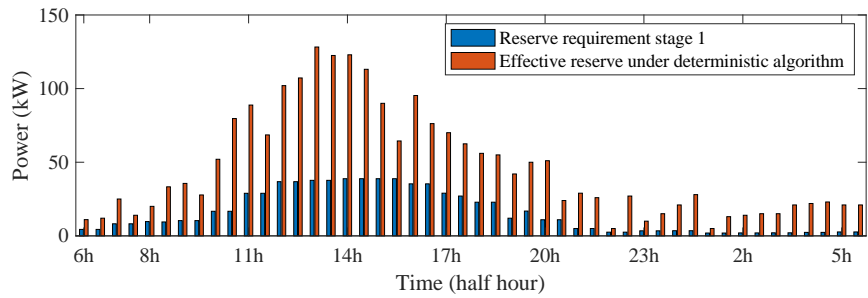

(b) Obtained effective reserve with a LOLP  $\leq 5\%$  in *strategy 2*

Fig. 5-14 Reserve requirement and obtained effective reserve after the deterministic-based method

**Comparison of daily allocated reserve energy, PV self-production rate and PV self-consumption rate**

From Table 5-5, it is observed that the integration of ESS has largely increased the PV self-production rate and PV self-consumption rate. Furthermore, in terms of the reserve allocation, more reserve power is provided by PV AGs in the storage control strategy 2 compared with strategy 1.

Table 5-5 Allocated reserve, PV self-production rate and PV self-consumption rate

Storage control strategy	Reserve from PV AGs (kWh)	Reserve from MGTs (kWh)	PV self-production rate (%)	PV self-consumption rate (%)
No storage (ch. 4)	0	367.1	25	50
Power balancing strategy 1	6.8	360.3	50	100
OR provision strategy 2	123.3	243.8	50	100

**5.5 UC with a Scenario-Based Stochastic Optimization**

**5.5.1 Presentation**

As discussed previously in Chapter 4, a scenario-based stochastic operational planning process is composed of two steps:

- 1) First stage optimization, i.e. deterministic optimization. The first stage is related to the optimal scheduling of generation capacity. The decisions of units to be committed are made in advance before the uncertain event realization. They are based on the consumption forecast, generation forecast and the calculated power reserve from contemplated past forecasting errors. This commitment step is essential for slow MGTs.
- 2) Second stage optimization, i.e. stochastic optimization. The second stage is based on a representation of a number of reasonable operating conditions (taking into account forecasting errors) that may arise in the future because of the uncertainty realization. As shown in Fig. 5-15, a set of scenarios  $\mathcal{W}$  is considered. After the occurrence of uncertainties under each scenario  $\omega$ , a second optimal dispatch can be computed based on the commitment decisions while keeping commitments of slow generators made in the first stage. Consequently, the obtained decision variables (Power references of MGTs) after disclosure of the uncertainty depend also on the determinist decision made in the first-stage. Furthermore, according to the considered storage control strategy, output power of active generators  $p_{ag,\omega}(t)$  and available OR  $r_{ag,\omega}(t)$  are calculated.

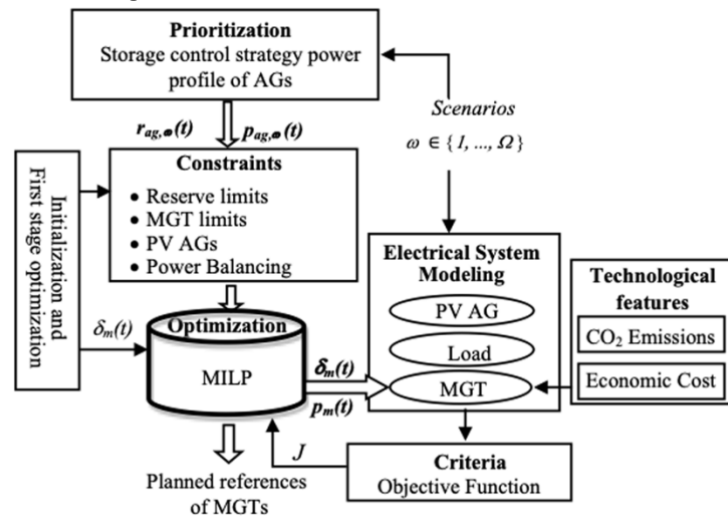

Fig. 5-15 Scenario-based stochastic operational planning with combination of storage strategy regarding reserve allocation

### 5.5.2 Building of Net Demand scenarios for uncertainties representation

Uncertainties in PV and load demand forecasting requires an ad hoc modelling in order to anticipate the future evolving. Decisions of generation scheduling for tomorrow must be optimal regarding forecasted data and probable deviations (part 4.2). Scenarios should take into account all the possible net demand uncertainties over the generation scheduling period (the following 24h) with the consideration of different PV generation scenarios and load generation scenarios. The net demand for each scenario is the expected load demand minus the PV production. The objective of this storage application is to erase the net demand forecasting error.



In Chapter 2, an artificial neural network (ANN) is applied to forecast the load consumption and PV generation. Based on probabilistic characteristics of forecast errors, scenarios are generated regarding PV generation prediction and load demand prediction. After applying ANN to forecast the PV generation and load demand, forecast errors are calculated as the difference between the forecast values and real values. Here a population of historical PV data and a population of load data (real data and forecasted data) in past one year and half are used to analyze the statistic characteristics of PV forecast errors and load forecast errors. Owing to the considerable database, the probability distributions of PV forecast errors and load forecast errors at each time step  $t$  are seen as standard normal distribution functions [229].

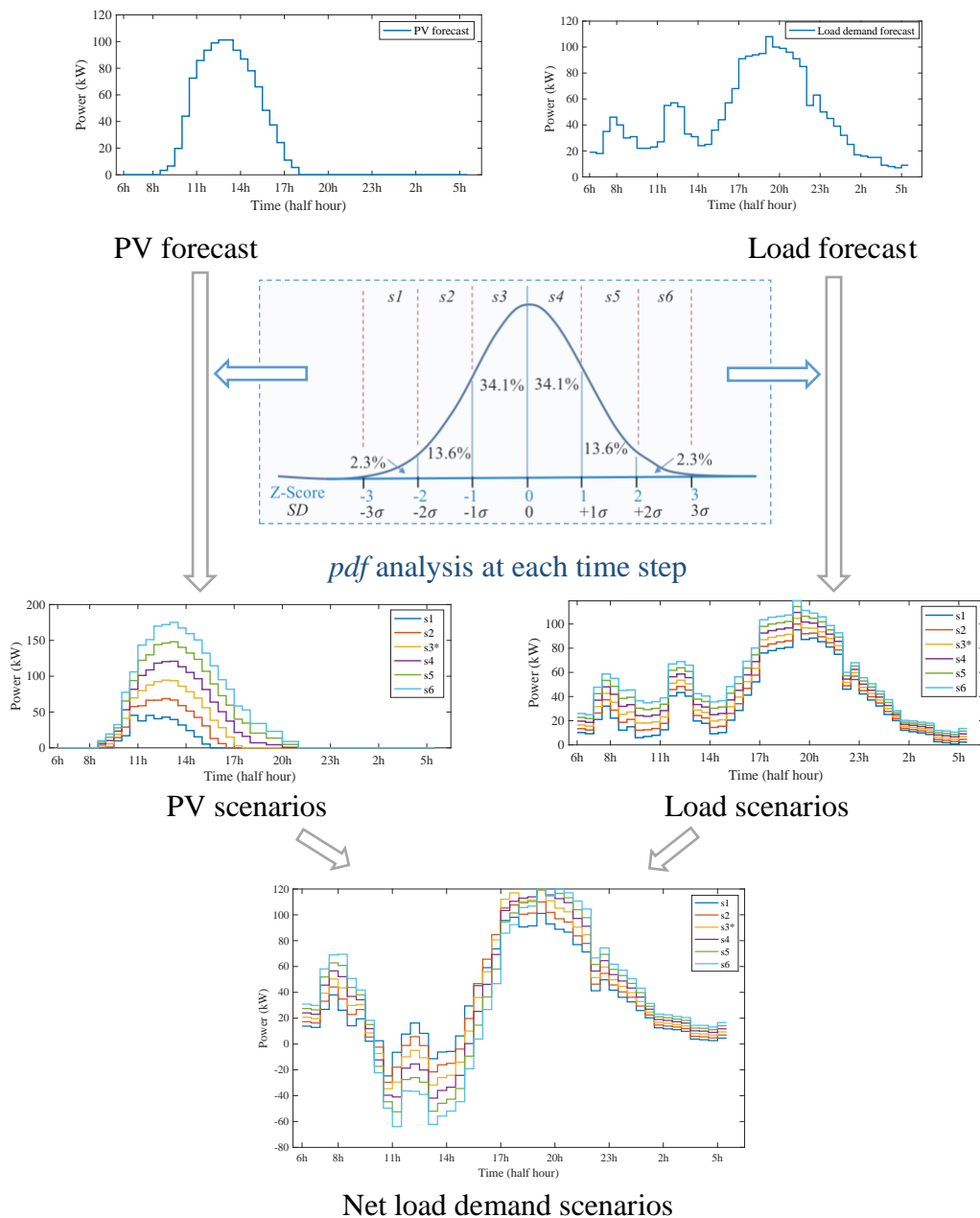

Fig. 5-16 pdf analysis based net load demand scenario generation

With a *pdf* analysis at each time step, the mean value and the standard deviation value of PV ( $\mu_{pv,\varepsilon,t}$  and  $\sigma_{pv,\varepsilon,t}$ ) and load demand ( $\mu_{load,\varepsilon}(t)$ ,  $\sigma_{load,\varepsilon}(t)$ ) are calculated. Hence, the mean value and the standard deviation value of the net demand are obtained with equations:

$$\begin{aligned} \mu_{ND,\varepsilon}(t) &= \mu_{load,\varepsilon}(t) - \mu_{pv,\varepsilon}(t) \\ \sigma_{ND,\varepsilon}^2(t) &= \sigma_{load,\varepsilon}^2(t) + \sigma_{pv,\varepsilon}^2(t) \end{aligned} \quad (5-21)$$

After net demand scenarios are built for the representation of uncertainties, 6 probable net load demand scenarios are considered with different probabilities of occurrence. Under each scenario, daily PV energy, daily net load demand energy and daily stored energy in batteries are presented in Table 5-6.

Table 5-6 Daily PV energy, daily net load demand energy and daily stored energy under each scenario

	Scenario 1	S 2	S 3	S 4	S 5	S 6
<b>Daily PV energy (kWh)</b>	177.5	316.1	480.7	676.9	888.9	1100.9
<b>Daily net load demand energy (kWh)</b>	771.3	821.3	845.5	833.0	780.6	703.5
<b>Daily stored energy (kWh)</b>	68.9	156.6	250.8	310.9	342.0	369.6
<b>RES self-production rate (%)</b>	18.7	27.8	36.3	43.8	50.4	56.9
<b>RES self-consumption rate (%)</b>	100	100	100	97.6	94.7	93.2
<b>Probability of occurrence (%)</b>	2.3	13.6	34.1	34.1	13.6	2.3

Meanwhile, Fig. 5-17 shows the reserve requirement under each scenario. The maximum reserve requirement is in S6 since there is a maximum PV generation uncertainty. The minimum value is reached in S1. By calculating the reserve requirements for each scenario, more appropriate reserve power is provided regarding each possible case, leading to a more reasonable reserve provision than in deterministic optimization.

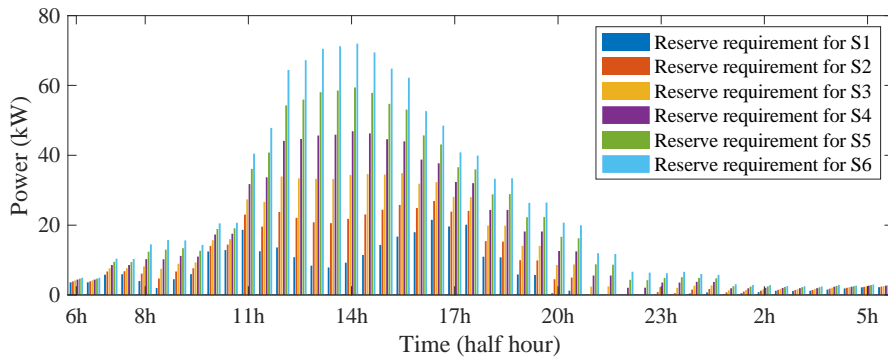

Fig. 5-17 Reserve requirement under each scenario

### 5.5.3 Stochastic Operational Planning with a Mixed-Integer Programming Optimization

#### Reserve constraints and MGTs limits

For each scenario, the expected net demand  $D_\omega(t)$  is re-calculated. Hence, the dispatching adjusts the previous scheduled power in the first stage, according to the varying reserve requirement of each scenario in the second stage. After the uncertainties coming from second-stage decision variables are considered, the system reserve power requirement  $\underline{r}_\omega(t)$  is quantified by considering uncertainties from net demand forecast errors and risk-constrained reserve provision approach:

$$\underline{r}_\omega(t) = \Delta D_\omega(t) + \phi^{-1}(1 - \varepsilon | \mu_{ND,\varepsilon}(t), \sigma_{ND,\varepsilon}(t)), \forall t \in \mathcal{T}, \forall \omega \in \mathcal{W} \quad (5-22)$$

where  $\Delta D_\omega(t)$  includes uncertainties from both PV forecast errors and load demand forecast errors.  $\Delta D_\omega(t)$  is the difference between the net demand forecast in first stage  $D(t)$  and net demand under each scenario  $D_\omega(t)$ .  $\mathcal{W}$  is the set of scenarios.  $\Delta D_\omega(t)$  could be one value among 6 possibilities:  $\{\mu_{ND,\varepsilon}(t) \pm 0.5\sigma_{ND,\varepsilon}(t), \mu_{ND,\varepsilon}(t) \pm 1.5\sigma_{ND,\varepsilon}(t), \mu_{ND,\varepsilon}(t) \pm 2.5\sigma_{ND,\varepsilon}(t)\}$ .

Afterwards, MGTs limits are set as follows:

$$\underline{p}_m \delta_{m,\omega}(t) \leq p_{m,\omega}(t) \leq \bar{p}_m \delta_{m,\omega}(t), \forall m \in \mathcal{M} \quad (5-23)$$

$$\begin{aligned} \delta_{m,\omega}(t) &= \delta_m(t), \forall m \in \mathcal{M}^{SLOW} \\ &, \forall t \in \mathcal{T}, \forall \omega \in \mathcal{W} \end{aligned} \quad (5-24)$$

#### Net demand constraints

The following constraints are related to the balance of expected generation and expected consumption under each scenario, as well as the generation limits of generators. All of them are indexed by the scenario index  $\omega$ :

$$\begin{aligned} \sum_{m=1}^M p_{m,\omega}(t) &= l_\omega(t) - \sum_{a=1}^A p_{ag,\omega}(t) + r_{mgt,\omega}(t) \\ &\forall t \in \mathcal{T}, \forall \omega \in \mathcal{W} \end{aligned} \quad (5-25)$$

#### Objective functions

As in Chapter 4, one of the broadly used mathematical methods for UC-based problems, the mixed-Integer Linear Programming (MILP), is applied to obtain the operation planning results considering constraints and objectives. Hence during the search of the problem tree, optimum can be reached by proximity and convergence process in a finite time [78]. The purpose of the optimization function is to minimize the total cost of both first and second stages, considering the recourse cost of the second-stage with a weighted probability. So, the cost and emission-based multi-objective function of the operational planning in the second-stage is formulated by taking into account the occurrence probability ( $\pi_\omega$ ) of each scenario  $\omega$ :

$$J_2 = \min_{\Delta, p, r} \sum_{\omega=1}^{\Omega} \pi_{\omega} \sum_{t=1}^T \sum_{m=1}^M \left\{ \delta_{m,\omega}(t) \left[ \alpha_c c_m(p_{m,\omega}(t)) + \alpha_{ce} c e_m(p_{m,\omega}(t)) \right] \right. \\ \left. + u_{m,\omega}(t) [c_m^u + c e_m^u] + d_{m,\omega}(t) [c_m^d + c e_m^d] \right\} \quad (5-26)$$

subject to (5-22)-(5-25),

$$r_{mgt,\omega}(t) = \underline{r}_{\omega}(t) - r_{ag,\omega}(t) \quad (5-27)$$

$$(\Delta, p, r) \in \mathcal{F}, \forall m \in \mathcal{M}, \forall t \in \mathcal{T}$$

where  $\sum_{\omega=1}^{\Omega} \pi_{\omega} = 1$ .  $\mathcal{F}$  is the set scheduling decision variables  $\delta_{m,\omega}(t)$ ,  $p_{m,\omega}(t)$  and  $r_{mgt,\omega}(t)$ . The expected cost is directly affected by the uncertainty of PV and load forecasting, which is modelled through scenarios and their probabilities. Similarly, the cost-based mono-objective function, and emission-based mono-objective function for the operational planning in the second-stage are the same as (4-13) and (4-14), respectively.

#### 5.5.4 Applications results with the power balancing strategy (1)

Owing to the different scenarios under different probabilities, the expected daily cost is re-calculated, as well as the reserve power, and the re-scheduling of all MGTs are done each half-hour. Fig. 5-18 shows the generation scheduling, which is obtained with the expected net demand scenarios during the day by applying the scenario-based optimization with integration of the storage control *strategy 1*.

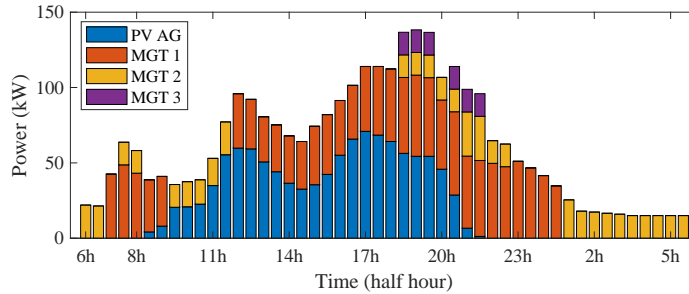

Fig. 5-18 Generation planning under scenario-based optimization and storage control *strategy 1*

The case of scenario 4 is shown as an example in Fig. 5-19, a part of the reserve power is provided by PV generation limitation at 11:00, as well as during the period from 12:30 to 14:30. The reserve is totally covered by MGTs during the remaining time steps. Fig. 5-20 shows the state of batteries under scenario 4. All energy stored in batteries are consumed up before 20:30 for the load supply.

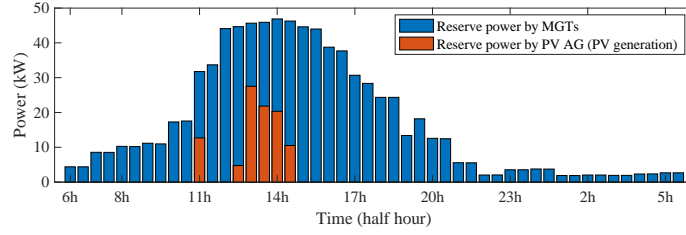

Fig. 5-19 Power reserve provided by MGTs and PV AGs under scenario 4

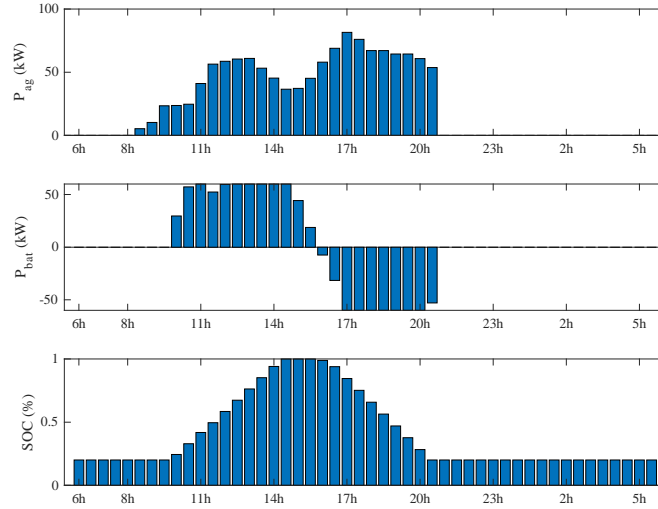

Fig. 5-20 AG power, battery power and battery energy at each time step under scenario 4

The reserve from PV AGs and MGTs varies according to the committed MGTs, SoC, as well as considered PV generation. For the different net demand scenarios, the reserve requirement, as well as the given reserve power from PV AGs and MGTs are observed to analyze the effect of uncertainties. For instance, the *pdf* of the reserve requirement, reserve from PV AGs and MGTs at 11:00 and 16:30 are shown in Fig. 5-22 and Fig. 5-22, respectively. The fitted *pdf* curve is obtained for each time step according to the corresponding histogram. The means and standard deviations are displayed in Table 5-7. At 11:00, there is PV generation surplus to provide a part of the reserve power; while at 16:30, there is no reserve from PV AGs, because there is no PV surplus, and batteries are not for reserve provision. Hence all the reserve power is coming from MGTs at 16:30.

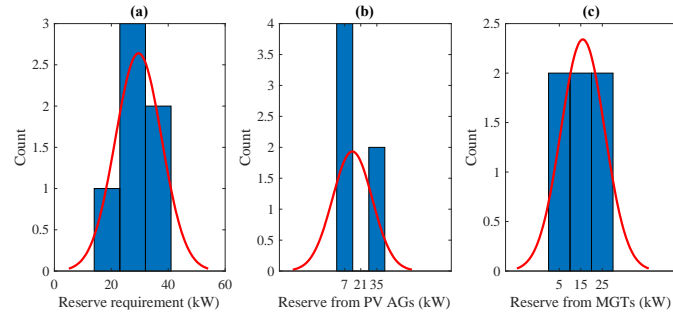

Fig. 5-21 Reserve requirement, reserve from PV AGs and MGTs at 11:00 with Strategy 1

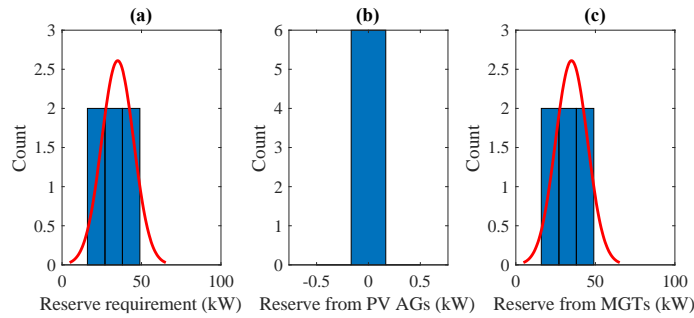

Fig. 5-22 Reserve requirement, reserve from PV AGs and MGTs at 16:30 with Strategy 1

Table 5-7 Means and standard deviations regarding reserve requirement, reserve from PV AGs and MGTs under strategy 1

$t$	11:00	16:30	
$r(t)$	$\mu_r(t)$	30	35
	$\sigma_r(t)$	8	10
$r_{ag}(t)$	$\mu_{rag}(t)$	14	0
	$\sigma_{rag}(t)$	17	0
$r_{mgt}(t)$	$\mu_{rmgt}(t)$	16	35
	$\sigma_{rmgt}(t)$	10	10

5.5.5 Applications results with the OR provision strategy (2)

With the storage control strategy 2, Fig. 5-23 shows the generation scheduling.

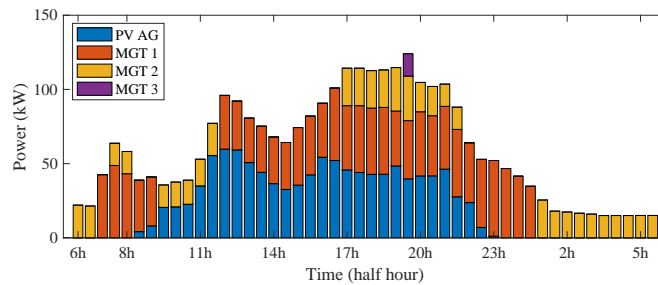

Fig. 5-23 Generation planning under scenario-based optimization and storage control strategy 2

The case of scenario 4 is shown in Fig. 5-24, the reserve power is provided by the stored energy in batteries during the period from 16:00 and 22:00. Fig. 5-25 shows the state of charge under scenario 4.

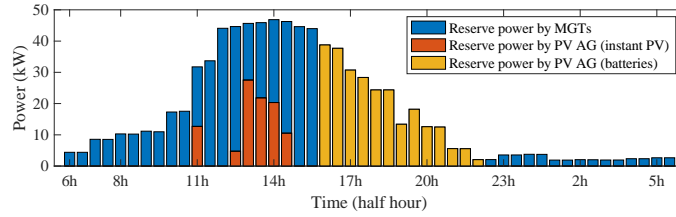

Fig. 5-24 Power reserve provided by MGTs and PV AGs under scenario 4

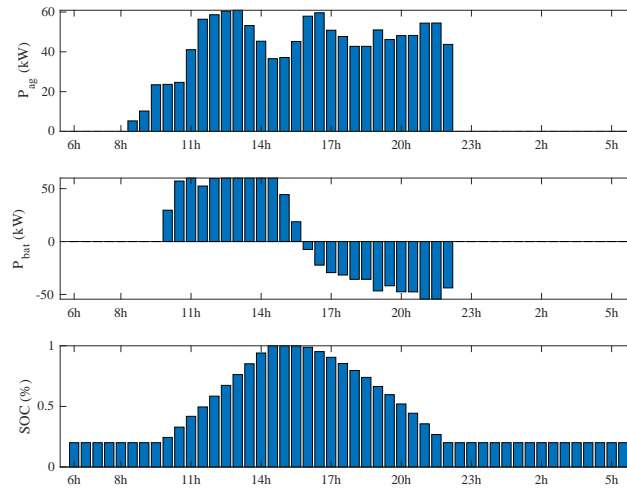

Fig. 5-25 AG power, battery power and battery energy at each time step under scenario 4

As for the *Strategy 1*, a similar *pdf* analysis is made. The reserve dispatching is the same at 11:00; while at 16:30, reserve dispatching has changed since part of reserve power is provided by batteries under strategy 2. The *pdf* of the reserve from PV AGs at 16:30 is  $\mu_{r_{ag}}(t = 19:30) = 27 \text{ kW}, \sigma_{r_{ag}}(t = 19:30) = 15 \text{ kW}$ , as well as the reserve from MGTs with  $\mu_{r_{mgt}}(t = 19:30) = 8 \text{ kW}, \sigma_{r_{mgt}}(t = 19:30) = 20 \text{ kW}$ . Comparing to the strategy 1, the mean of reserve power from PV AGs has increased  $27 \text{ kW}$ . On the contrary, the mean of reserve power from MGTs has decreased from  $35 \text{ kW}$  to  $8 \text{ kW}$ .

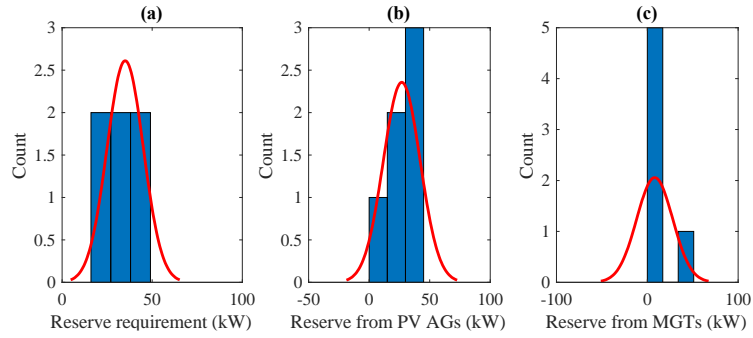

Fig. 5-26 Reserve requirement, reserve from PV AGs and MGTs at 16:30 with Strategy 2

Table 5-8 Means and standard deviations regarding reserve requirement, reserve from PV AGs and MGTs under strategy 2

$t$	16:30	
$r(t)$	$\mu_r(t)$	35
	$\sigma_r(t)$	10
$r_{ag}(t)$	$\mu_{r_{ag}}(t)$	27
	$\sigma_{r_{ag}}(t)$	15
$r_{mgt}(t)$	$\mu_{r_{mgt}}(t)$	8
	$\sigma_{r_{mgt}}(t)$	20

5.5.6 Discussion about the two control strategies according to different uncertainties

Comparison of costs

Day-ahead scenario-based stochastic operational planning results are compared in Table 5-9 regarding the fuel cost and CO<sub>2</sub> equivalent emission cost, as well as possibility of risk under worst-case (S6) and under S4 (one of the most probable case). Similarly, as in deterministic case, both the fuel costs and emission costs of the *strategy 2* are less compared with *strategy 1*. Since in the strategy 2, the stored energy in battery is used to provide the reserve power, fewer generators may be committed when the storage energy is consumed.

Table 5-9 Day-ahead scenario-based stochastic operational planning results comparison

Storage control strategy	Objective	Scenario-based Stochastic Optimization			
		Fuel Cost (€)	CO <sub>2</sub> Cost (kg)	Possibility of risk under worst-case (S6)	Possibility of risk under S4
No storage	Multi-objective (cost & emission)	211	1239	≤16.7% of time steps	≤2.1% of time steps
	Mono-objective (cost)	209	1283	≤3.6% of daily reserve energy deficit	≤0.2% of daily reserve energy deficit
	Mono-objective (emission)	215	1213	(21.2 kWh / 591.5 kWh)	(0.7 kWh / 411.7 kWh)
1	Multi-objective (cost & emission)	178	1045	≤6.25% of time steps	≤2% of time steps
	Mono-objective (cost)	177	1066		



	Mono-objective (emission)	187	1030	≤1.6% of daily reserve energy deficit (9.6 kWh / 591.5 kWh)	≤0.02% of daily reserve energy deficit (0.1 kWh / 411.7 kWh)
	Multi-objective (cost & emission)	169	977		
2	Mono-objective (cost)	168	1011	No (0 kWh / 591.5 kWh)	No (0 kWh / 411.7 kWh)
	Mono-objective (emission)	179	962		

In terms of the reserve provision with storage control *strategy 1* and *strategy 2*, Table 5-10 shows the daily reserve energy provided by PV AGs (including PV generation limitation and batteries) and MGTs under each scenario. Compared with *strategy 1*, the reserve is provided by available energy in batteries rather than by MGTs in *strategy 2*. Utilization rate of MGTs in terms of reserve provision has been greatly reduced.

Table 5-10 Reserve provision in storage control *strategy 1 / 2* under each scenario

Storage control strategy	Reserve energy sources (kWh)		Scenario 1 (S 1)	S 2	S 3	S 4	S 5	S 6
	Strategy 1	Reserve energy from PV AGs	PV limitation	0	0	2.5	48.8	129.7
Batteries			0	0	0	0	0	0
Reserve energy from MGTs		151.2	235.0	319.5	362.9	371.9	357.5	
Strategy 2	Reserve energy from PV AGs	PV limitation	0	0	2.5	48.8	129.7	234.0
		Batteries	51.1	78.1	116.3	126.0	131.2	133.8
	Reserve energy from MGTs		100.2	156.9	203.2	236.9	240.6	223.7

### Comparison of the obtained effective OR

Fig. 5-27 and Fig. 5-28 illustrate the comparison of the two storage control strategies regarding the obtained effective OR after the scenario-based stochastic method. Under scenario 4 (Fig. 5-27), from 15:30 to 21:00, there are more effective reserve in *strategy 2* than in *strategy 1*. In *strategy 1*, the reserve deficit occurs at 18:00; while all reserve requirement is satisfied by the effective reserve in *strategy 2*. In terms of risk level regarding the preset reserve requirement, among 48 time steps, only 1 time steps is at risk (effective reserve is less than reserve requirement), i.e. 2% possibility of risk during the day in *strategy 1*, the daily additional required reserve energy is 0.1 kWh in total. While in *strategy 2*, none time step is at risk, i.e. no possibility of risk occurrence.

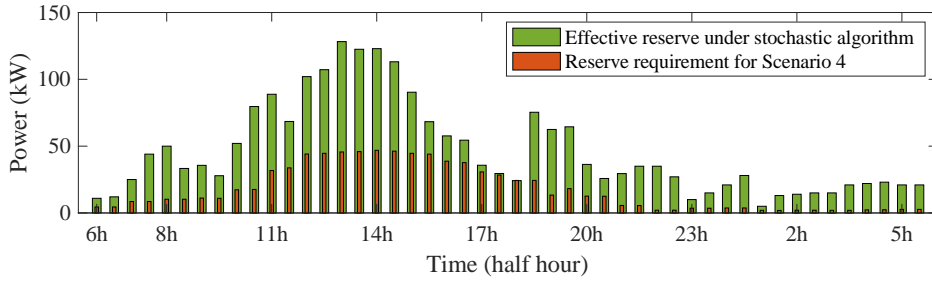

(a) Obtained effective reserve with a LOLP  $\leq 5\%$  in strategy 1

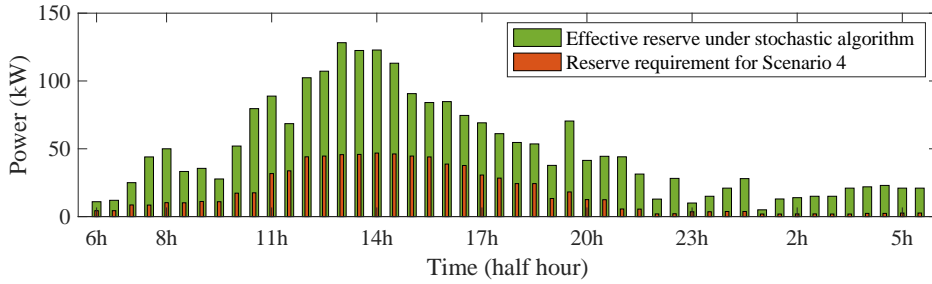

(b) Obtained effective reserve with a LOLP  $\leq 5\%$  in strategy 2

Fig. 5-27 Reserve requirement and obtained effective reserve under scenario 4

In order to study the worst-case situation, Fig. 5-28 illustrates the obtained effective reserve under scenario 6. Among the 48 time steps, 3 time steps are at risk, i.e. 6.25% possibility of risk during the day with the *strategy 1*. The daily additional required reserve energy is 9.6 kWh in total. For the compensation of the probable occurrence of reserve deficit, fast generators are capable of being committed in case of emergency to provide additional required reserve provision, but with a higher operational cost. With the *strategy 2*, none of time steps are at risk.

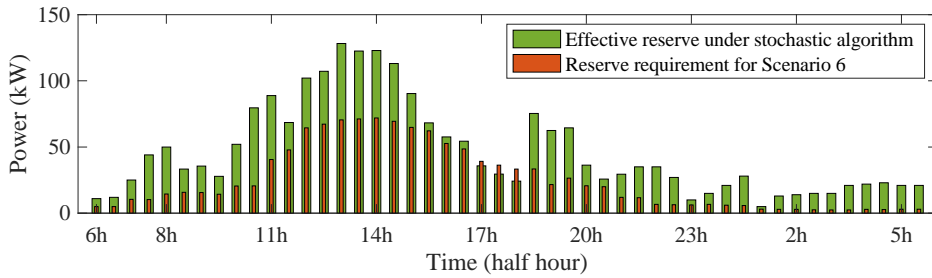

(a) Obtained effective reserve with a LOLP  $\leq 5\%$  in strategy 1

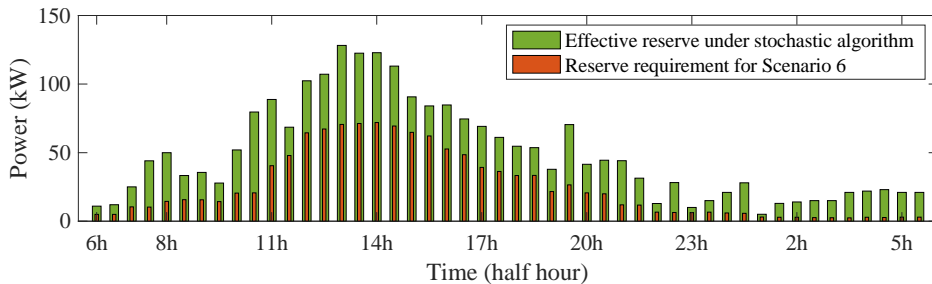

(b) Obtained effective reserve with a LOLP  $\leq 5\%$  in strategy 2

Fig. 5-28 Reserve requirement and obtained effective reserve under scenario 6

### Analysis of minimized costs with a Pareto-optimal front representation

For a multi-objective optimization problem, there is not an optimal solution when the problem objectives are conflicting. However, it has a set of incomparable optimal solutions: each one is inferior to the other one in some objectives and superior in other objectives. The set of the entire feasible decision space, i.e. the set of solutions for the objective function domain, is called Pareto set. The boundary defined by the set of all points mapped from the Pareto set is called the Pareto-optimal front [250]. Hence, in order to find the Pareto optimal solution, finding the trade-off between multiple objectives, the Pareto-optimal front should be examined.

In this study, one of the classic multi-objective optimization methods: weighted sum method, is used to find the Pareto-optimal fronts. To find solutions of a multi-objective optimization problem, the corresponding weights are added in a weighted sum method. They are multiplied by two objectives to scalarize a set of objectives into a single objective. Weight of each objective is chosen in proportion to the relative importance of the objective. Fig. 5-29 illustrates the Pareto-optimal fronts for the multi-objective optimization of the CO<sub>2</sub> equivalent emission and operational cost. The red lines imply the Pareto-optimal fronts of deterministic (stage 1) and stochastic (stage 2) optimization when ESS is not implemented. The yellow/green lines indicate the Pareto-optimal fronts when storage control *strategy 1/strategy 2* is integrated. It is observed that, the *strategy 2* leads to less costs and emissions, compared with the *strategy 1*. Both strategies benefit from reducing operational costs and CO<sub>2</sub> equivalent emissions, compared with the situation without ESS.

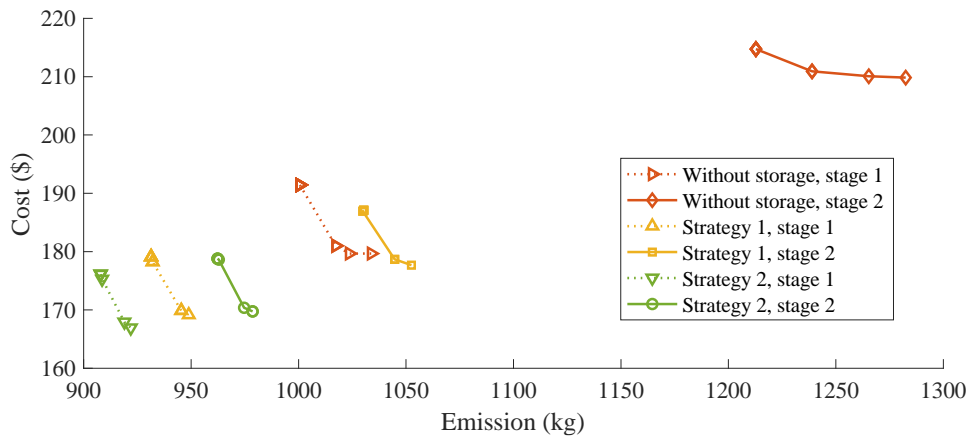

Fig. 5-29 Pareto-optimal fronts for the multi-objective optimization of the CO<sub>2</sub> equivalent emission and operational cost

### Synthesis of applied methods

To summarize, Table 5-11 shows a comparison of optimization implementation in Chapter 3, 4 and 5 regarding the optimization type, applied algorithm, objective function, building of scenarios, constraints and average computational time.

Table 5-11 The comparison of optimization implementation in Chapter 3,4 and 5

	<i>Ch.3</i>		<i>Ch. 4</i>	<i>Ch.5</i>
<b>Optimization Type</b>	<i>Deterministic</i>		<i>Stochastic</i>	<i>Stochastic</i>
<b>Algorithm</b>	<i>DP</i>	<i>MILP</i>	<i>MILP</i>	<i>MILP</i>
<b>Objective Function Type</b>	Quadratic	Linear	Linear	Linear
<b>Objective Function</b>	Operating cost	Operating cost	Operating cost + Emission cost	Operating cost + Emission cost
<b>Scenarios Generation</b>	-	-	PV	PV, Load (Net demand)
<b>Battery Constraints</b>	Not included	Not included	Not included	Included
<b>Computational Time</b>	4.39	2.53	12.13	13.92

## 5.6 Sizing of Storage under Uncertainty

### 5.6.1 Principle

In order to implement the energy storage with the optimal operations and profits, the sizing of energy storage devices is inevitable. Storage devices must be sized and located regarding power reliability, cost-effectiveness, and environmental-friendly target.

Previous researchers have focused on handling RES uncertainty when dealing with the problem of storage sizing. The optimal ESS sizing problem is discussed in [251]. With an optimal economic target, the proposed MIP approach solved the optimal sizing problem by minimizing initial investment costs of storage devices and operational costs of the microgrid with renewable unit implementation. In [252] a method is proposed for sizing the ESS and is based on the cost-benefit analysis in a microgrid. Firstly, wind speed and solar irradiation are forecasted by feed-forward neural network techniques and time series. Then, the optimal ESS size is determined by MILP by considering the islanded mode and grid-connected mode. An heuristic method is performed in [253] for optimal sizing of not only ESS, but also DERs including wind turbines, PV panels and hydrogen tanks. The microgrid sizing problem is solved by PSO algorithm, and optimization results are compared regarding scenarios with and without wind power uncertainty. [254] implemented an analytical approach to solve the sizing problem of ESS with the aim of increasing power dispatchability of wind farms. In [255], considering the RES-based ESS in autonomous small islands, PV generators and ESS are optimally sized and combined. The electrical generation cost is minimized by taking into account the maximum solar energy penetration.

While many researchers investigate above deterministic-based approaches, statistical-based approaches are less discussed. Taking an interest in these methods is significant

for RES-integrated ESSs, though. Under this context, a probabilistic method for ESS sizing under wind power forecast uncertainty is applied in [256], by taking into account the statistical behavior of SoC and forecast errors. Focusing on Loss of Power Supply Probability (LPSP) as a reliability criterion, optimum sizing of batteries and PV generators is proposed in [257] for a stand-alone PV system in isolated areas. In [258] the optimal capacity of ESS is determined in an autonomous microgrid by implementing a capacity-based statistical model. A statistical analysis is performed and is based on the capacity distribution of the presented ESS. However, in this work the ESS is used for the frequency regulation thus the optimum capacity of ESS is based on the minimum requirement of frequency regulation. Similarly, by applying a statistical approach to describe the ESS capacity distribution, an ESS sizing algorithm is carried out in [259] with a dynamic programming process. In this case, integrated ESS aimed to smooth the variations of RESs power production (wind & solar).

In our work, to find the benefits of the battery usage in terms of long-term benefits, and to take into account primary source (PV) generation in different seasons during one year, a storage sizing approach is proposed by applying the uncertainty analysis method. In this section, historical database of load demand and PV generation are analyzed with a probabilistic method to calculate the expected net demand during the day regarding varying seasons and types of the day (workdays, non-workdays). Then the *pdf*-based expected net demands are built and taken into account the time factors (seasonal characteristics, national / regional holidays, etc) of energy consumption and RESs generation. Hence, the sizing of storage is decided to save probable RES surplus.

### 5.6.2 Load demand analysis

To illustrate the sizing method, used load data have been collected from the RTE website (Réseau de transport d'électricité) [111] and, after scaled to our urban microgrid (maximum peak load is equal to 120 kW), are used as representative load demand variations for load demand analysis [111]. With historical database of hourly load demand in France during the year 2013-2014 and 2019-2020, the load demand is analyzed with temporal information, e.g. month of the year, day of the week, hour of the day. Meanwhile the public holidays are discriminated in order to separate them from workdays. In the current study, the distinction of four seasons and workdays/non-workdays are shown in Table 5-12 and Table 5-13, respectively. Four seasons are identified according to monthly average temperature at Lille: Spring and autumn: 5-15 °C; winter: below 5°C and summer: beyond 15°C.

Table 5-12 Types of the days regarding seasons

Spring	Summer	Autumn	Winter
March	June	October	December
April	July	November	January
May	August		February
	September		

Table 5-13 Types of the days regarding workdays/non-workdays

Non-workdays	Workdays
Saturday	Monday to Friday
Sunday	(except national public holidays)
National public holidays	

Finally, 8 types of load profiles are identified according to seasons and type of day (workday or not). i.e. spring & non-workdays, spring & workdays, summer & non-workdays, summer & workdays, autumn & non-workdays, autumn & workdays, winter & non-workdays, winter & workdays. With a *pdf*-based probabilistic analysis, the mean and standard deviation are calculated and the corresponding *pdf* are obtained at each time step under each load profile types.

As illustrated in Fig. 5-30-Fig. 5-33, (a1)/(b1) are normalized load profiles during non-workdays/workdays in spring (Fig. 5-30), summer (Fig. 5-31), autumn (Fig. 5-32), and winter (Fig. 5-33), respectively. At each time step, a normal distribution fitting curve is generated according the frequency distribution histogram. As an example, (a2)/(b2) presents the frequency histograms and fitted *pdf* of load power at peak load hour. (a3)/(b3) describes probability distribution of load power at each time step during the day. The solid line indicates the mean value of load power, while different levels of grey indicate confidence intervals (CIs) of 99%, 80% and 40%.

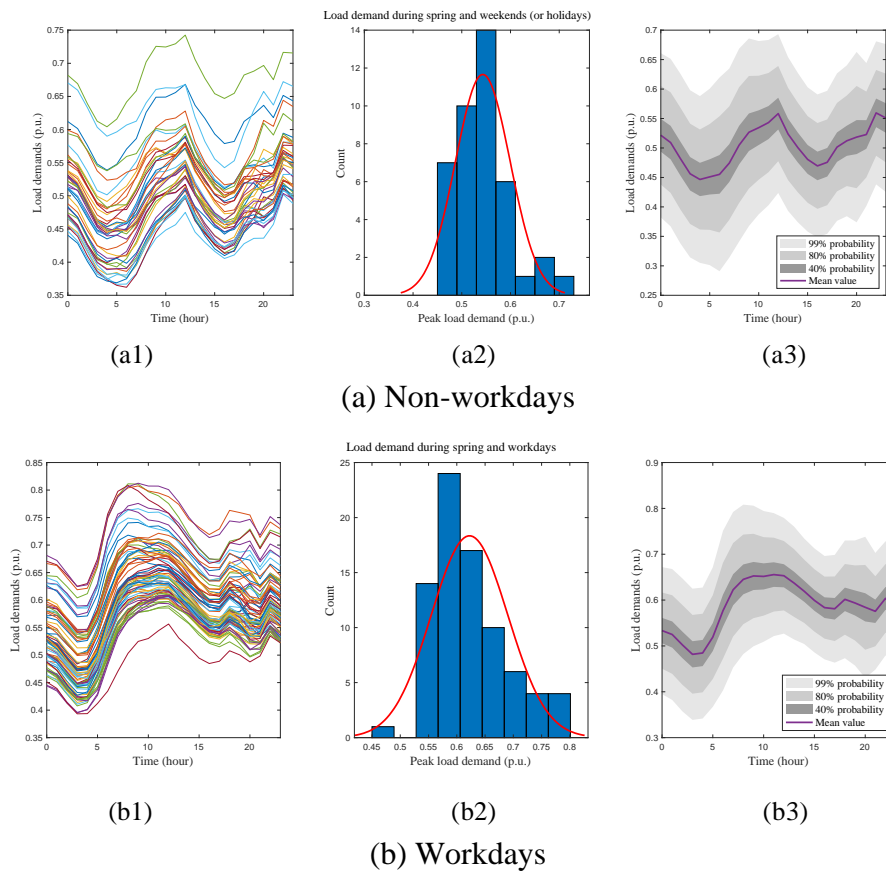
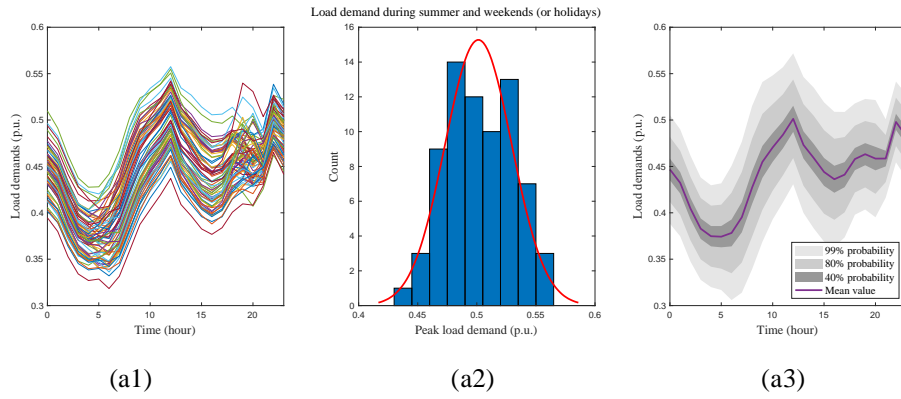
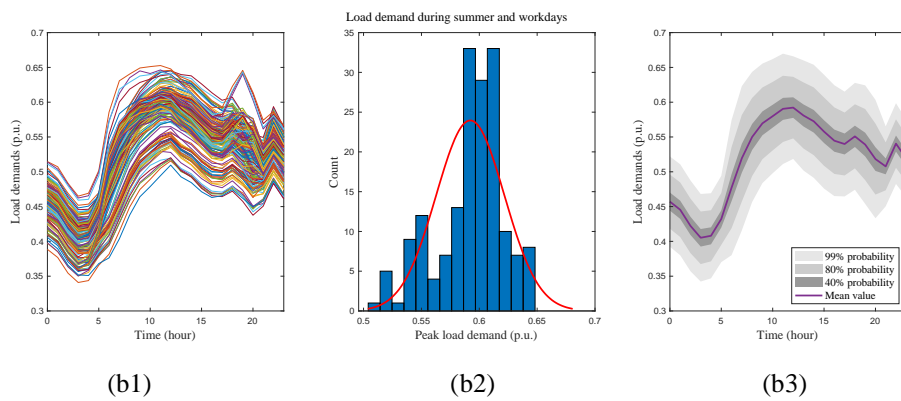

Fig. 5-30 Probabilistic analysis and *pdf* of load demand in spring



(a) Non-workdays



(b) Workdays

Fig. 5-31 Probabilistic analysis and *pdf* of load demand in summer

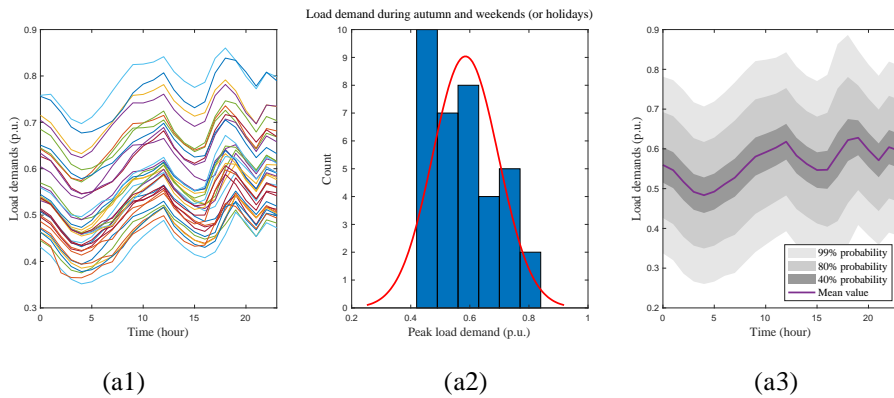

(a) Non-workdays

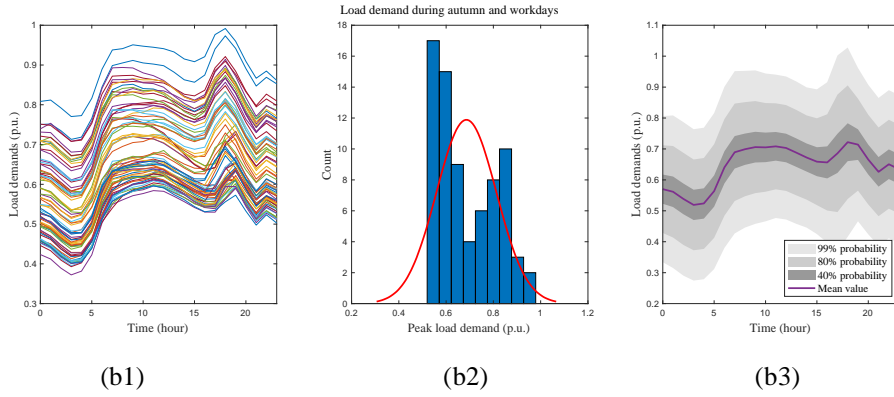

(b) Workdays

Fig. 5-32 Probabilistic analysis and *pdf* of load demand in autumn

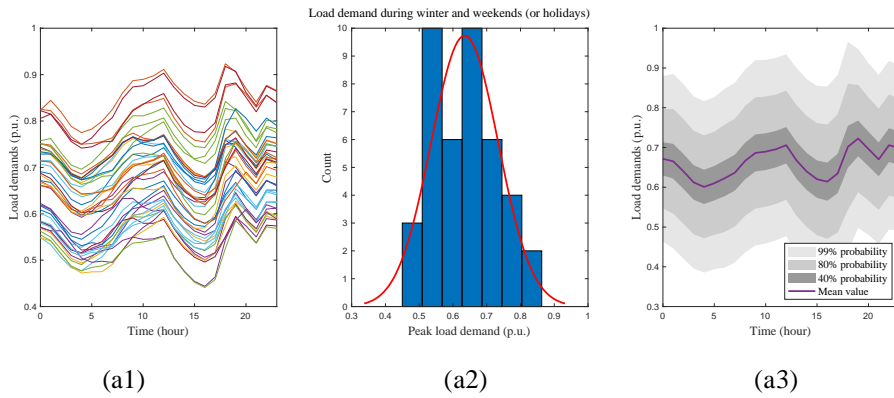

(a) Non-workdays

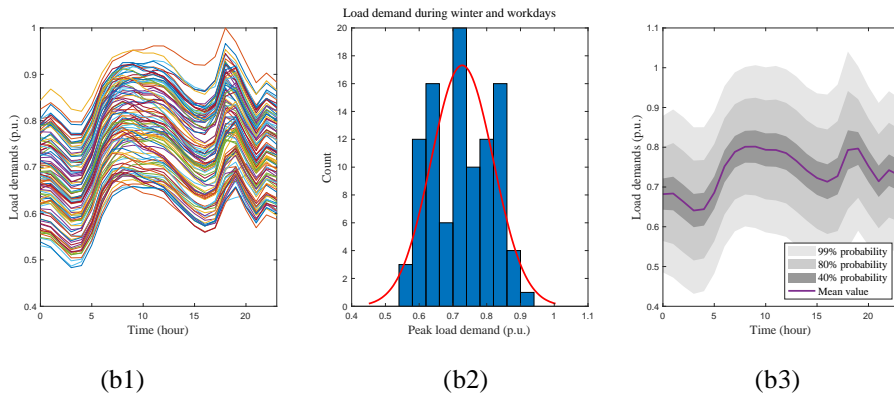

(b) Workdays

Fig. 5-33 Probabilistic analysis and *pdf* of load demand in winter

By comparing Fig. 5-30-Fig. 5-33, it is observed that the average load consumption is the lowest in summer with a peak load around 0.5-0.6 p.u., followed by spring (0.55-0.65 p.u.) and autumn (0.6-0.7 p.u.), then reach the highest value in winter (0.7-0.8 p.u.). Concerning workdays and non-workdays, the average load is always higher in workdays, with a difference of around 0.1 p.u. at peak load. When the storage is used to store the surplus RES energy, the maximum battery energy is rather small in winter,



because the consumed RES energy at this moment is more than other seasons due to the higher load consumption.

In these scaled national load data, the load demand of the industry is included, which is not relevant to the study of residential network. However, the same probabilistic method for load analysis can be employed in the residential network study.

### 5.6.3 PV generation analysis

PV energy is greatly dependent on meteorological information, e.g. temperature, irradiance, cloud cover, etc. These factors possess seasonal characteristics thus are greatly impacted by varying season types. However, unlike load demand, workdays/non-workdays types do not influence PV generation. Hence, for PV generation analysis, PV profiles are classified into 4 types regarding different seasons: spring, summer, autumn, and winter. The data of sensed PV power are obtained from PV generation system Rizomm at L2EP-HEI, and the database is built from July, 2019 until July, 2020.

With a *pdf*-based probabilistic analysis, the mean and standard deviation are calculated and the corresponding *pdf* are obtained at each time step under each PV profile types. As shown in Fig. 5-34-Fig. 5-37, (1) are the normalized PV power profiles in spring (Fig. 5-34), summer (Fig. 5-35), autumn (Fig. 5-36), and winter (Fig. 5-37), respectively. Each (2) presents the frequency histograms and fitted *pdf* of PV power at peak load hour. Each (3) describes probability distribution of PV power at each time step during the day. The solid line implies the mean value of PV power, while different levels of grey indicate CIs of 99%, 80% and 40%.

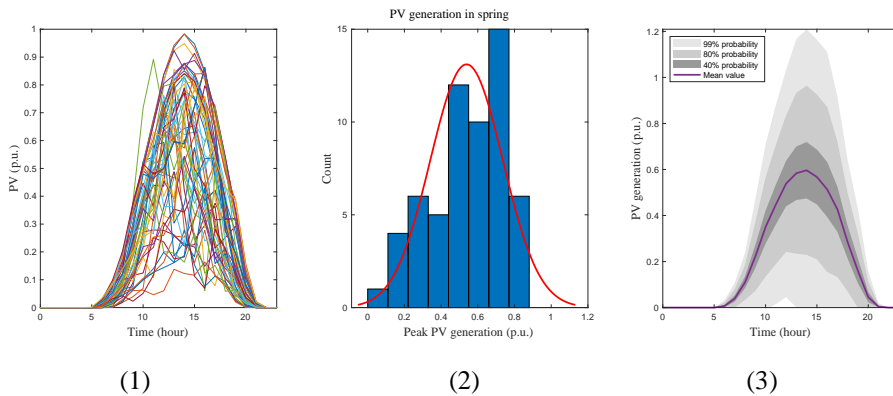

Fig. 5-34 *pdf*-based probabilistic analysis of PV generation in spring

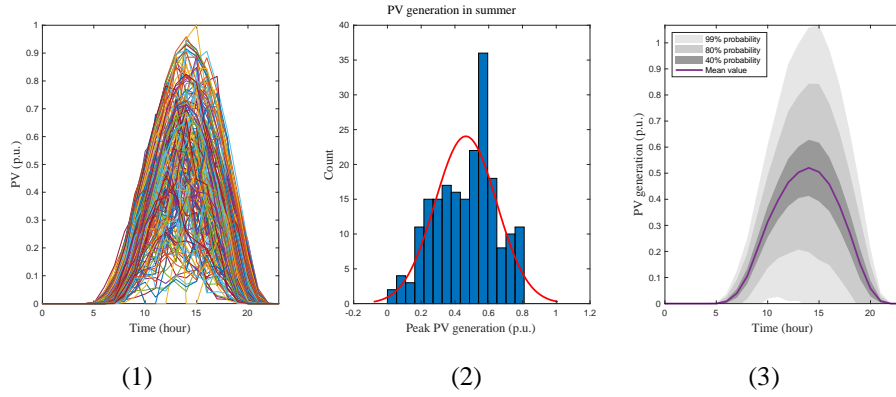

Fig. 5-35 pdf-based probabilistic analysis of PV generation in summer

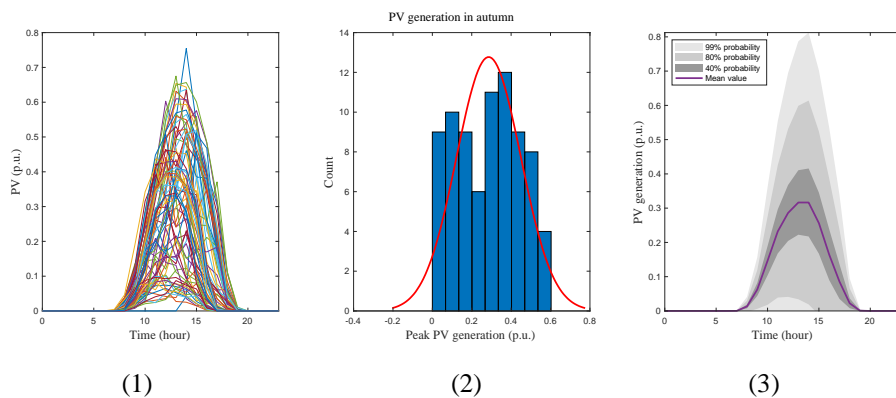

Fig. 5-36 pdf-based probabilistic analysis of PV generation in autumn

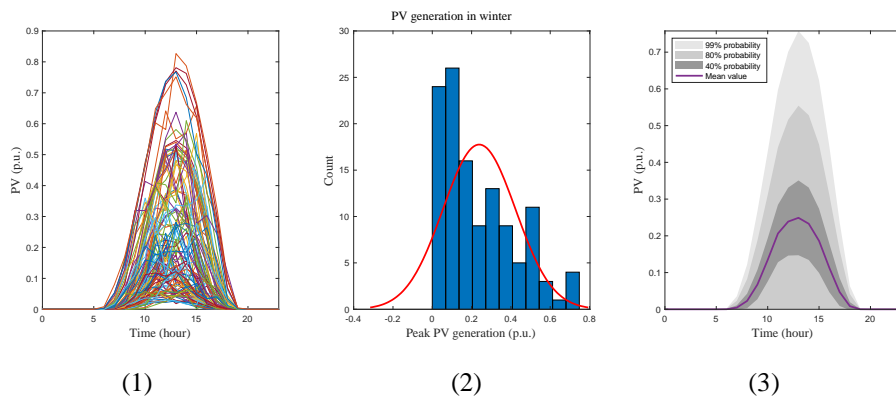

Fig. 5-37 pdf-based probabilistic analysis of PV generation in winter

Through Fig. 5-34-Fig. 5-37, it can be concluded that in this case, the average PV generation is the lowest in winter with a peak power around 0.25 p.u., followed by autumn (0.3 p.u.) and summer (0.5 p.u.), then reach the highest value in spring (0.6 p.u.). When storage is used to store surplus RES energy, the need of battery size is rather small in winter, because less RES energy is generated at this moment. On the contrary, the maximum battery energy is large in spring and summer, when there is more RES generation.

5.6.4 Expected net load demand

With a *pdf*-based probabilistic analysis of load demand and PV generation in 5.8.2 and 5.8.3, the expected net load demand can be calculated through the *pdf* analysis of the difference between load demand and RES generation. According to the 8 types of load demand profiles and 4 types of PV generation profiles, the expected net demand profiles are categorized into 8 types. As illustrated in Fig. 5-38-Fig. 5-41, probability distribution of the net demand is described at each time step during the day regarding workdays/non-workdays and four seasons. The solid line indicates the mean value of net demand, while different levels of grey indicate CIs of 99%, 80% and 40%. Considering the nominal load demand power, it is assumed that the load demand is no more than 120 kW.

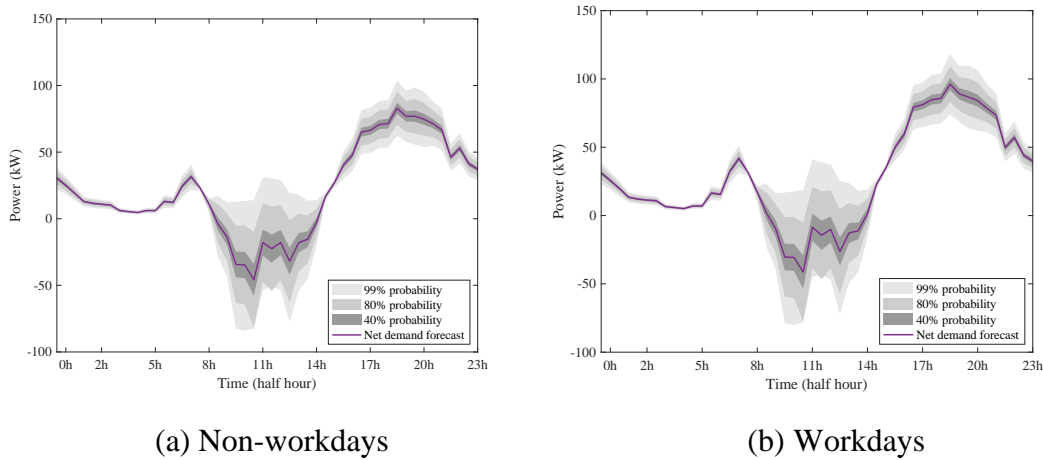

Fig. 5-38 *pdf*-based expected net demand in spring

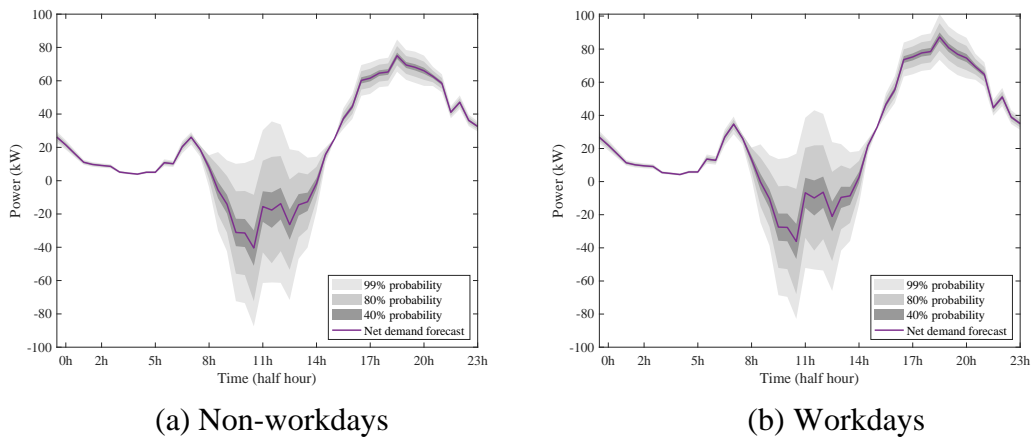
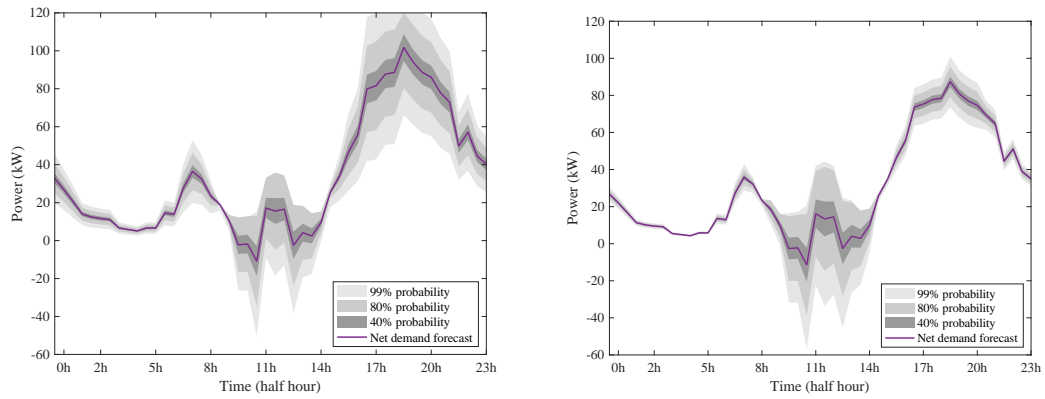

Fig. 5-39 *pdf*-based expected net demand in summer



(a) Non-workdays

(b) Workdays

Fig. 5-40 pdf-based expected net demand in autumn

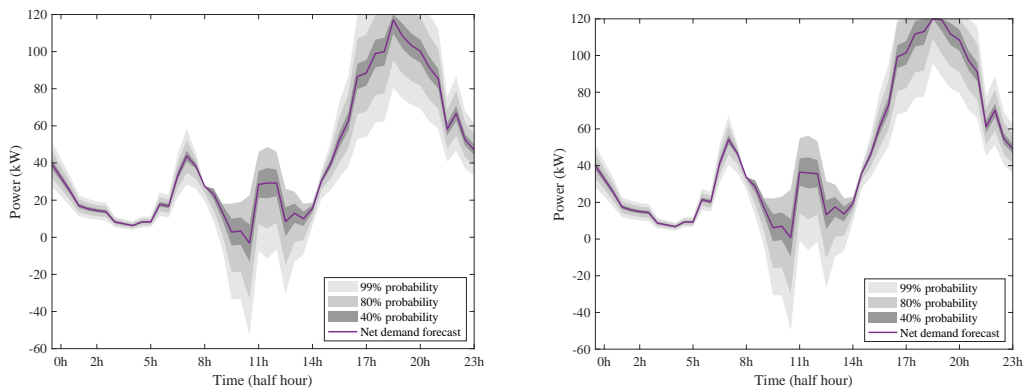

(a) Non-workdays

(b) Workdays

Fig. 5-41 pdf-based expected net demand in winter

It is observed that net load demand is rather high in winter and autumn. During the day, the net load demand reaches the highest level during 17:00-21:00, and the peak load occurs around 18:00-19:00. Concerning the variability, the largest deviation always occurs around 9:00-14:00 due to the high PV energy generation uncertainty.

In order to obtain the value of the maximum battery energy, the expected renewable energy surplus is calculated regarding different seasons and types of days. As shown in Table 5-14, mean values of renewable energy surplus are varying from 0 to 129 kWh in various time periods. Moreover, renewable energy surplus within 40% and 80% of probability is also calculated, respectively. It is concluded that the maximum battery energy can be possibly reached in spring & non-workdays, since there is the maximum renewable energy surplus during this period of time. There is also considerable amount of energy surplus in summer & non-workdays, followed by spring & workdays and summer & workdays. On the contrary, less renewable energy is generated and more load demand is required, inducing less renewable energy surplus in autumn and winter. In this study, according to the possible maximum renewable energy surplus, the required battery energy size is 280 kWh in order to store energy surplus within the 80%

of probability. Hence according to the minimum allowable state of charge (20 %), the battery is sized 350 kWh with a net storage capacity of 280 kWh.

Table 5-14 Expected energy surplus regarding different seasons and types of days

Seasons	Spring		Summer		Autumn		Winter	
	n	w	n	w	n	w	n	w
Workdays / non-workdays (w / n)								
Mean value of renewable energy surplus (kWh)	129	98	113	82	9	9	2	0
Renewable energy surplus within 40% of probability (kWh)	179	146	158	126	22	26	11	6
Renewable energy surplus within 80% of probability (kWh)	278	246	250	217	59	83	45	36

## 5.7 Conclusion

In this chapter, the use of ESS in homes is considered. Two storage control strategies are considered with a scenario-based stochastic optimization for operational scheduling under renewable energy uncertainty. First, the reviews of ESS applications and benefits are introduced. The applications and benefits of renewable energy time-shift and supply reserve power capacity are discussed in detail. Then according to these benefits, two storage control strategies are presented with respect to different objectives:

- Power balancing with optimal operational costs and CO<sub>2</sub> equivalent emissions;
- Maximization of the power reserve provision by RESs and optimal reserve allocation regarding PV AGs.

The deterministic and stochastic operational planning are applied and compared. First, reserve requirements are calculated with probabilistic analysis regarding uncertainties of load demand and PV generation. Then the deterministic operational planning is performed with the energy storage control *strategy 1* and *strategy 2*, respectively. Furthermore, in the scenario-based stochastic operational planning, net demand scenarios are considered for the representation of load and PV uncertainties. Similarly, as in the deterministic case, with the application of storage control, certain constraints are then considered in the scenario-based optimization with MILP approach. *Strategy 2* benefits from less operational costs and CO<sub>2</sub> equivalent emission costs, as well as higher security level because of the reserve provision by battery storage. Results confirm that the presented algorithm enables RESs to serve as primary source of reserve capacity, and the performance in terms of security level and environmental benefits are highlighted.

Finally, taking into account primary source (PV) generation and load demand in different seasons and different types of the day during the whole year, a storage sizing approach is proposed to save probable RES surplus by applying the probabilistic-based uncertainty analysis method.

## CHAPTER 6

## CHAPTER 6 MICROGRID CENTRAL ENERGY MANAGEMENT SYSTEM INTERFACE DESIGN

### *6.1 Introduction*

In an urban microgrid, the presence of large uncontrollable RESs makes grid control a complex task. Operational planning and energy usage scheduling are essential for keeping a balance between demand and supply, as well as handling uncertainties within RESs and load demand. Energy management system (EMS) platform is thus significant to support the monitoring and control of the microgrid in terms of appliances, applied techniques and control strategies.

Meanwhile, GUI-based simulation tools are becoming a trend since they offer simplified implementations and user-friendly interactive experiences. For example in [260], a MATLAB/GUI based simulation is presented for photovoltaic systems to analyze the parameters, like radiation and temperature. In [261] different wind turbines generator types are modelled in the developed MATLAB/GUI with user-determined parameters.

Many research works have been focused on energy management simulation tools for microgrid/smart grid. A DC microgrid graphical user interface (GUI) is presented in [262]. It served as a control and monitoring tool for the microgrid system, integrated with the implemented hardware simulation. [263] proposed a GUI of a home energy management system, which is capable of managing household loads and performing demand response for residential customers. With the integration of MATLAB SIMULINK toolbox, a real-time simulator is presented in [264] for the microgrid to analyze the dynamic behavior of loads, controllable generating units and uncontrollable RESs. A Matlab GUI simulator is illustrated in [265] for the generation of distribution grid models. By generating reasonable distribution grid topologies, more distributed and stochastic generation connects to the grid are increasing regarding distribution level, monitoring, control, and flexibility needs. However, none of these research works have made efforts to integrate the uncertainty analysis of RESs and OR determination and allocation.

Previously in [49][172], an urban Microgrid Central Energy Management System (MCEMS) is developed with MATLAB/GUI. It provides a user-friendly graphical interface to properly model and study the details of PV AGs, including PV panels and batteries, load demand, as well as MGTs. In addition, uncertainties are analyzed and OR dispatching is researched. Energy management is undertaken with a DP algorithm-based optimization.

In this chapter, to build a better supervisory control and data acquisition (SCADA) system, the MCEMS is further developed and improved regarding uncertainties study. With the building of net demand scenarios, RES and load uncertainties are represented with different probability of occurrences. The proposed tool helps to model the way appliances generate and consume power and energy under different net demand scenarios. Furthermore, it enables a better understanding of uncertainties in terms of OR dispatching in different storage control strategies. The impact of uncertainty on the system security is also explicitly demonstrated under different optimization criteria.

This chapter is organized as follows: Firstly, an urban MCEMS description is presented in section 6.2 with a summary of interfaces and function modules. In section 6.3, an urban microgrid energy management system with four main interfaces and several individual modules are designed. Finally, in section 6.4, the conclusion is made.

## 6.2 GUI description

### 6.2.1 MCEMS functions presentation

To develop a user-friendly MCEMS, several interfaces are designed with inclusion of different function modules. The presented EMS comprises four main interfaces as shown in Table 6-1.

Table 6-1 Main interfaces and function modules

Interfaces	Function Modules
<b>Data Collection and Predictive Analysis for Forecasting</b>	<ul style="list-style-type: none"> <li>• Historical Data Collection for ANN Training</li> <li>• Day-ahead Data Download for Forecasting</li> <li>• PV Power and Load Demand Forecast by Using a well-trained ANN</li> </ul>
<b>System Uncertainties Assessment and OR Quantification</b>	<ul style="list-style-type: none"> <li>• PV Power Uncertainty</li> <li>• Load Demand Uncertainty</li> <li>• Net Demand Uncertainty</li> <li>• OR Quantification</li> </ul>
<b>Deterministic Optimization for Operational Planning</b>	<ul style="list-style-type: none"> <li>• Operational Planning Results with Deterministic Optimization</li> <li>• MGTs Power References</li> </ul>
<b>Scenario-based Stochastic Optimization for Operational Planning</b>	<ul style="list-style-type: none"> <li>• Storage Control Strategies</li> <li>• Operational Planning Results with Stochastic Optimization</li> <li>• PV AGs and MGTs Power References</li> </ul>

An interface can be regarded as a function of MCEMS. For each interface, several functions are performed with the combination of methods, algorithms and strategies. In addition, different criteria and scenarios are considered. Urban MCEMS functions and the applied methods/strategies for these functions are illustrated in Fig. 6-1.



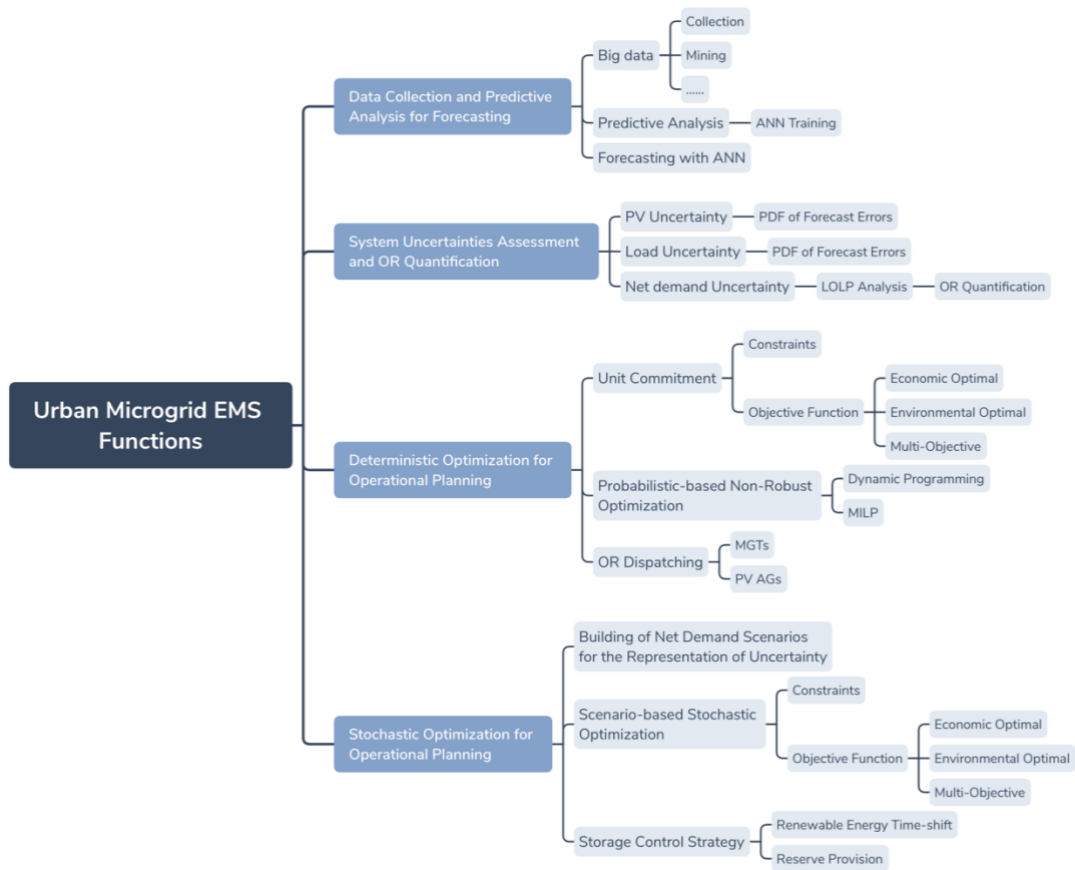

Fig. 6-1 Urban MCEMS functions and the applied methods/strategies

### 6.2.2 Home interface window design

Home Interface Window is shown in Fig. 6-2. There are four available interfaces and they can be accessed by clicking buttons:

- Button “Uncertainty Analysis” for the interface “Data Collection and Predictive Analysis for Forecasting”;
- Button “OR Quantification” for the interface “System Uncertainties Assessment and OR Quantification”;
- Button “Deterministic Algorithm” for the interface “Deterministic Optimization for Operational Planning”;
- Button “Stochastic Algorithm” for the interface “Scenario-based Stochastic Optimization for Operational Planning”.

These four interfaces are presented in detail with regard to layout design and interface design in the following sections.

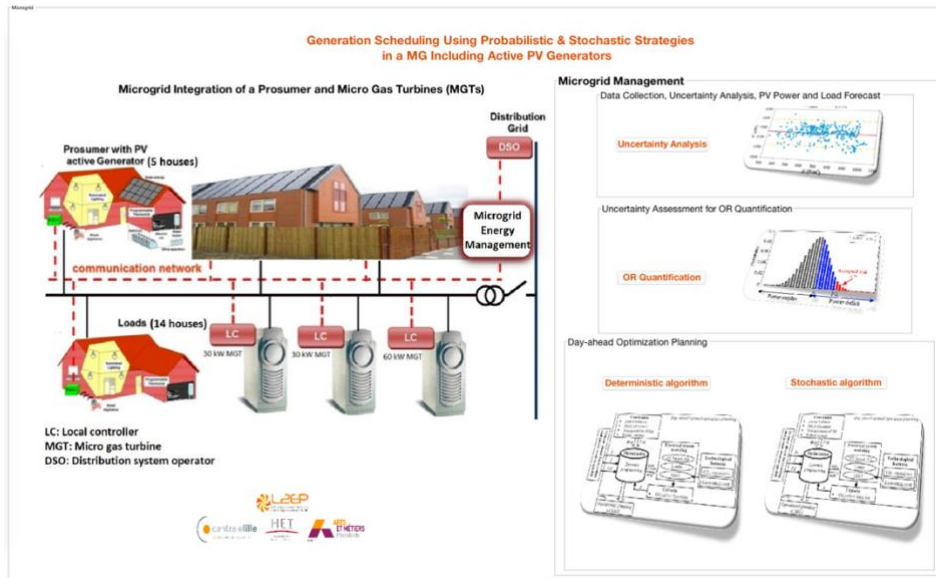

Fig. 6-2 Home Interface Window of the MCEMS

### 6.3 Main Interfaces Design

#### 6.3.1 Data collection and predictive analysis for forecasting

##### Layout design

The layout design of Data Collection and Predictive Analysis for Forecasting interface is shown in Fig. 6-3. There are four function modules including:

- Historical data collection for ANN training;
- Data download for forecasting;
- PV power and load demand forecasting by using a well-trained ANN;
- ANN training results display, day-ahead forecasting results display.

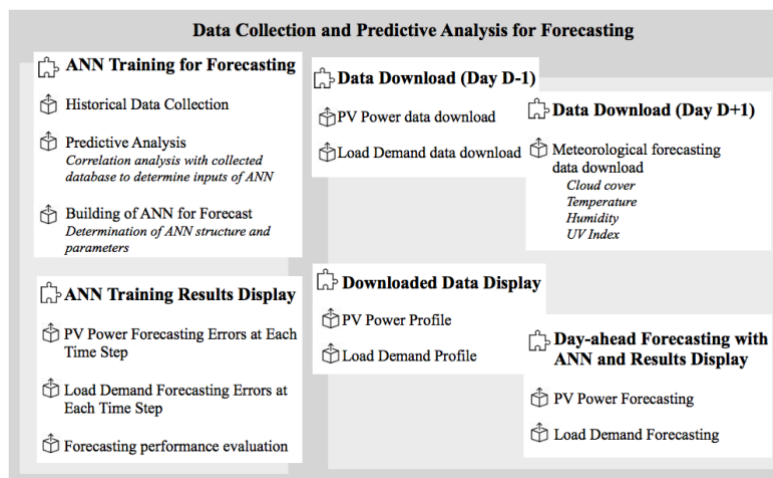

Fig. 6-3 The layout design of “Data Collection and Predictive Analysis for Forecasting” interface

**A) Historical data collection for ANN training**

Firstly, historical data are collected, e.g. past few months or years of meteorological data (temperature, cloud cover, humidity, UV index, time of sunrise/sunset, etc), PV power data, and load demand data.

The collected data are used for predictive analysis to identify correlated patterns and parameters, related to PV power output and load demand. Previously in Chapter 2, correlation analysis regarding PV uncertainty and load demand uncertainty are carried out to determine inputs of the ANN-based forecasting models.

Then, forecasting models are built for PV power and load demand forecast. As presented in Chapter 2, a three-layer BP ANN is developed for PV power and load forecast, respectively. Before implementing this tool for PV power and load demand prediction, ANNs need to be well trained with collected past data. The training, validation, and test procedures were explained in Chapter 2.

**B) Data download for forecasting**

Once the ANN is well trained, it can be used for day-ahead forecast. The first step is to download the data one day-ahead to update inputs of ANNs. For procedures A) and B) above, used data and their sources are summarized in Table 6-2.

Table 6-2 Summary of used data for ANN training and ANN-based PV power/load demand forecast

Data	Source	Use
<b>Historical database:</b>		
Meteorological data	The Weather Channel [108]	ANN Training
PV Power	Rizomm at HEI-L2EP laboratory	
Load demand	RTE (Réseau de transport d'électricité) France [111]	
<b>Forecast data of D+1:</b>		
Meteorological data	The Weather Channel	PV Power Forecast
<b>Real data of D-1:</b>		
PV Power	Rizomm	Load Demand Forecast
Load demand	RTE France	

**C) PV power and load demand forecasting by using a well-trained ANN**

With the well-trained ANN in A), PV power and load demand are forecasted one day ahead. ANN models and forecasting procedures are detailed in Chapter 2.

**Interface design**

With designed layout in Fig. 6-3, the interface is shown in Fig. 6-4. Results on the left-hand side are the data collection and predictive analysis for PV power and load forecast ANN training. On the right-hand side, downloaded data and day-ahead PV power and load forecasting results are presented.

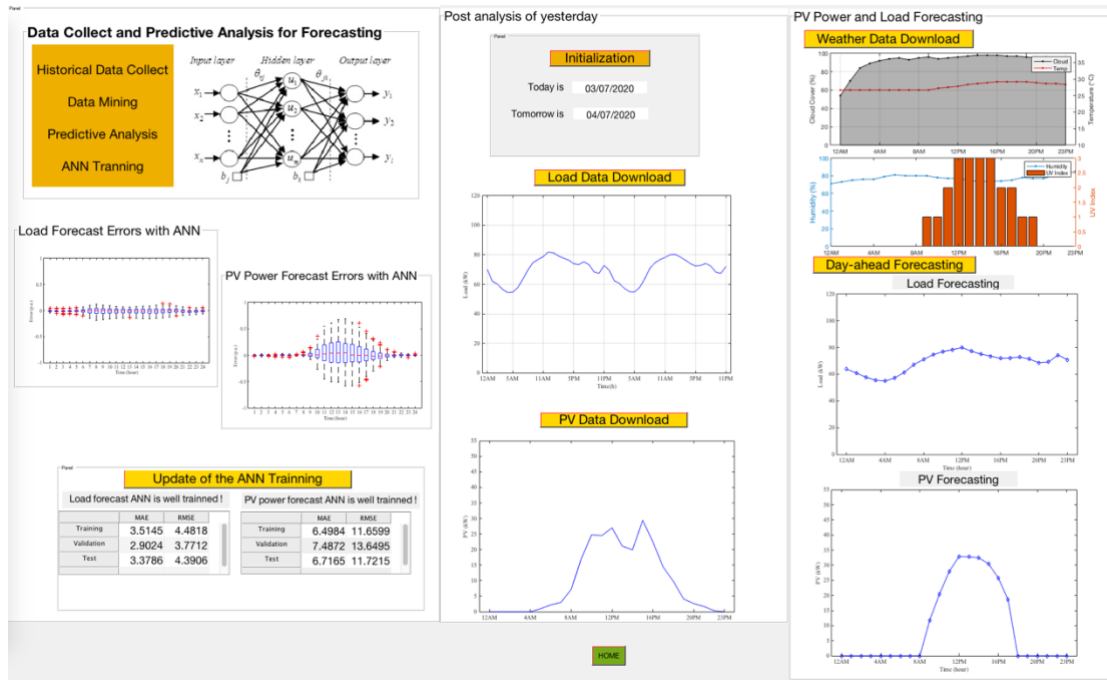

Fig. 6-4 The “Data Collection and Predictive Analysis for Forecasting” interface

### 6.3.2 System uncertainty assessment and OR quantification

#### Layout design

Fig. 6-5 illustrates the layout of the interface “System uncertainty assessment and OR quantification”. The following function modules are included:

- Uncertainty assessment;
- OR quantification;
- Uncertainties display, quantified OR display.

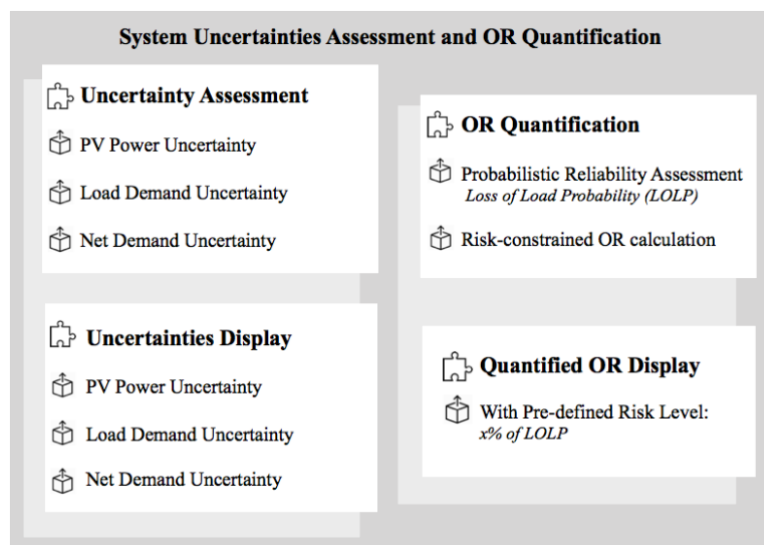

Fig. 6-5 The layout design of “System uncertainty assessment and OR quantification” interface

**A) Uncertainty assessment**

As introduced in Chapter 3, with ANN and *pdf* analysis of forecast errors, PV power and load demand forecasting uncertainties are obtained, respectively. Then, the net demand uncertainty is calculated at each time step.

**B) Risk-constrained OR Quantification**

Following the probability distribution of the net demand uncertainty, a probabilistic risk-constrained method is proposed for the OR quantification. A LOLP risk level is pre-defined as a security index. As discussed in Chapter 3 (3.3.5), a certain amount of OR power is provided at each time step by applying a *pdf* analysis of net demand forecast errors. As a result, the risk-reserve curves can be obtained. Under a preset LOLP risk level, the OR requirement is determined at each time step during the day.

**Interface design**

Fig. 6-6 is the designed interface of the System uncertainty assessment and the OR quantification. The left-hand side shows uncertainty assessment results of the PV power, load, and net demand. With a chosen quantification method (first, second) and a pre-defined risk level ( $\epsilon$  of LOLP), results of the risk-constrained OR calculation with LOLP are illustrated on the right-hand side. A risk-reserve curve can be acquired at each time step. Hence, a 3D-plot figure is illustrated to describe the required reserve at each time step under the prescribed risk level. Finally, with a selected risk level (5% LOLP in the example shown in Fig. 6-6), the required OR is displayed at each time step during the day.

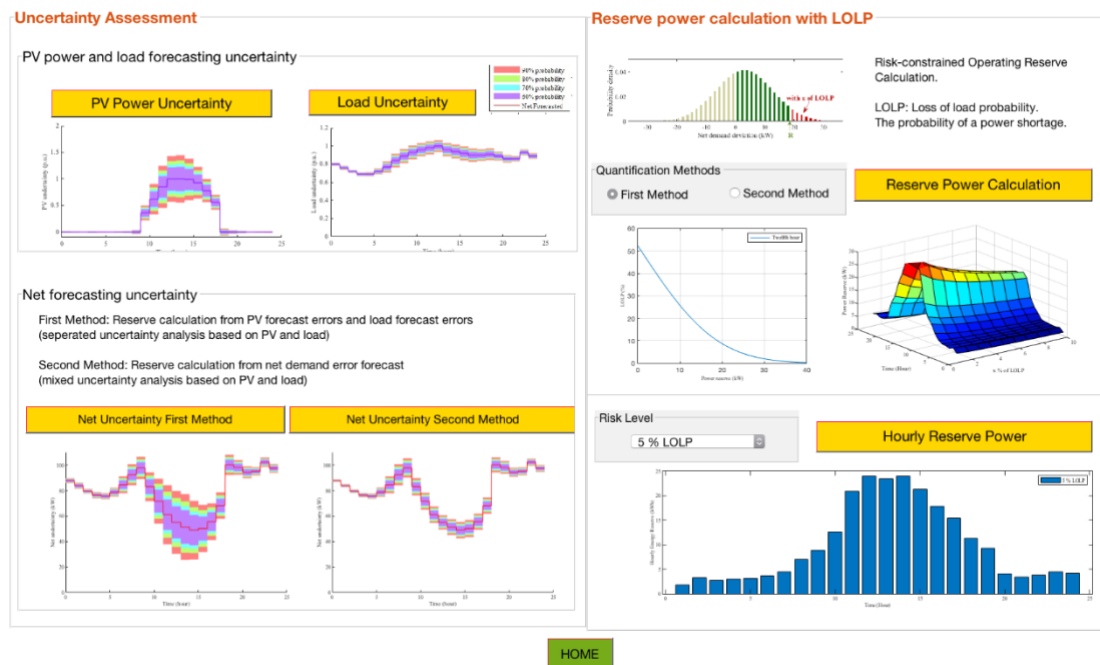

Fig. 6-6 The “System uncertainty assessment and OR quantification” interface

### 6.3.3 Deterministic optimization for operational planning

#### Layout design

Fig. 6-7 illustrates the layout of the interface “Deterministic optimization for operational planning”. The following function modules are included:

- System Parameters;
- DP for UC planning of MGTs;
- Optimization results display.
- Sub-interfaces of MGTs;

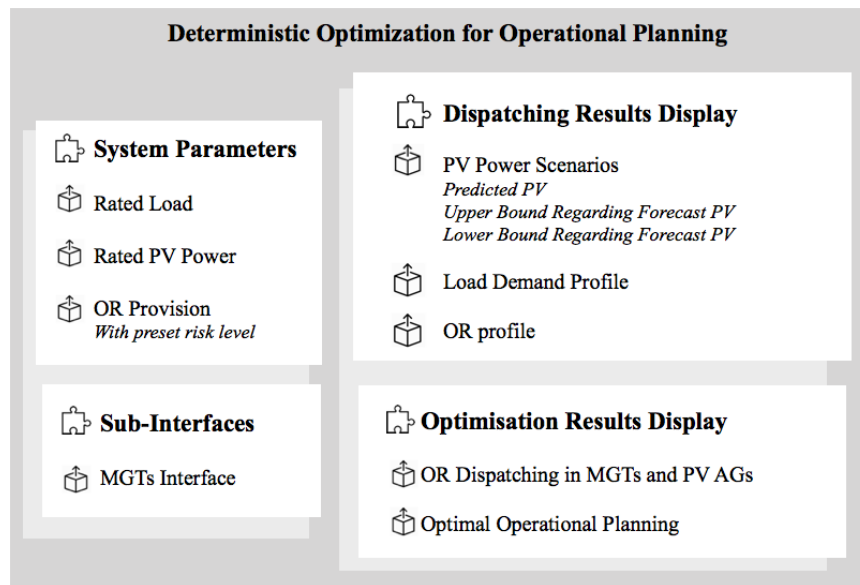

Fig. 6-7 The layout design of “Deterministic optimization for operational planning” interface

#### A) System parameters

In this area system parameters are set and shown, like rated load, rated PV power and pre-defined risk level for OR quantification.

#### B) DP for UC planning of MGTs

Previously in Chapter 3, according to the forecasted PV power profile, upper bound and lower bound of PV are obtained with an uncertainty propagation analysis. Following the chosen PV power scenarios (forecasted PV, upper bound/lower bound regarding forecast PV), OR requirement is determined.

After obtaining the profiles of forecast PV power, forecast load demand and quantified OR power, a DP algorithm is applied for UC problem. The optimal operational planning of MGTs is obtained under the economic optimization criteria. Details of the DP application for UC planning are discussed in Chapter 3.

**Interface design**

Fig. 6-8 shows the interface of Deterministic optimization for operational planning. On the right-hand side, UC planning results are shown with the chosen PV power scenario and the determined OR. The left-hand side button is a link to sub-interfaces of MGTs, which is displayed in Fig. 6-9 where the operational planning of the three MGTs are illustrated, followed with the half-hourly OR (positive and negative) and the half-hourly operating cost variation interval.

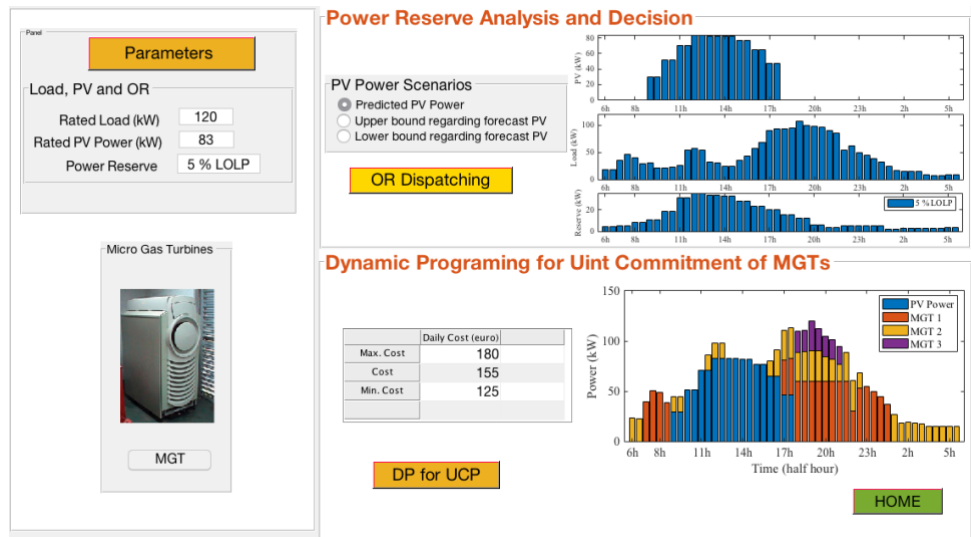

Fig. 6-8 The “Deterministic optimization for operational planning” interface



Fig. 6-9 The “MGTs” sub-interface

### 6.3.4 Scenario-based stochastic optimization for operational planning

#### Layout design

The layout design of “Scenario-based stochastic optimization for operational planning” interface is illustrated in Fig. 6-10. The following function modules are included:

- Storage control strategy;
- Stage-1 optimization;
- Stage-2 optimization;
- Optimization results display in terms of stage-1, stage-2.

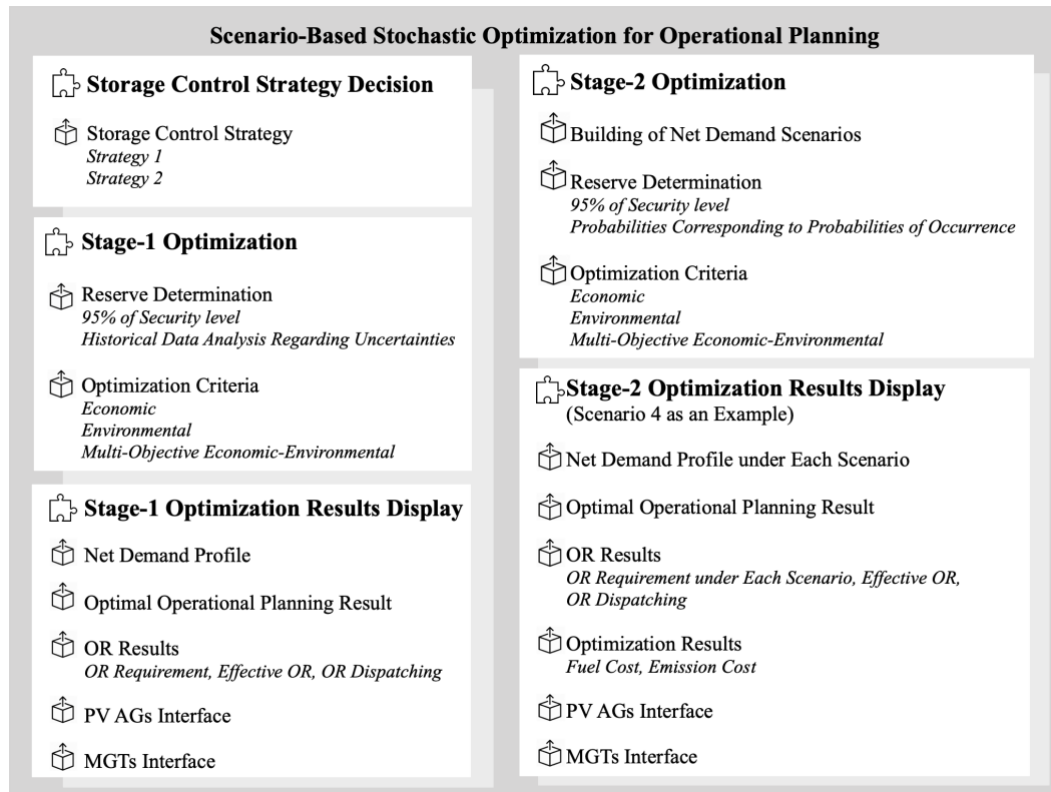

Fig. 6-10 The layout design of “Scenario-based stochastic optimization for operational planning” interface

#### A) Storage control strategy

As presented in Chapter 5, two storage control strategies are employed. *Strategy 1* is applied for the renewable energy production time-shift, while the merit of *Strategy 2* is a higher security level with more OR provision by batteries. The strategy decision should be made before the optimization.

#### B) Stage-1 optimization

First stage optimization includes the OR determination with the preset security level. Then an optimization criteria is decided. The objective function is determined to carry out the mono-objective optimization regarding economical optimum or environmental optimum, or a multi-objective optimization for both economic and environmental costs.



**C) Stage-2 optimization**

To apply the scenario-based optimization algorithm, firstly net demand scenarios are built for the representation of the PV and load demand uncertainty. Second stage optimization includes the OR determination with both preset security level under each scenario corresponding to a probability of occurrence. Details were discussed in Chapter 5. Then with a determined objective function, a mono-objective optimization regarding operating cost/CO<sub>2</sub>-equivalent cost, or a multi-objective optimization regarding both of them is carried out. A scenario-based stochastic optimization is applied for the operational planning under a selected storage control strategy.

**Interface design**

Fig. 6-11 shows the interface of the scenario-based stochastic optimization for the operational planning. Firstly, the storage strategy choice is made on the left-hand side. Then the first stage optimization is undertaken with a net demand forecast and a chosen optimization criterion (economic objective, environmental objective and multi-objective). The operational planning result is attained, followed by the available OR and OR allocation result at each time step. Meanwhile, the sub-interfaces of PV AGs and MGTs can be accessed.

On the right-hand side, the scenario-based optimization results are presented with the building of net demand scenarios in the second stage. Once the optimization objective is chosen, operational planning results are shown by considering uncertainty under each scenario. In addition, reserve requirement is acquired under each scenario. As one of the most possible scenarios, scenario 4 (with a 34.1% of probability of occurrence) is chosen as an example to observe required OR, available OR and OR allocation results. The parameters of PV AGs and MGTs are available in sub-interfaces.

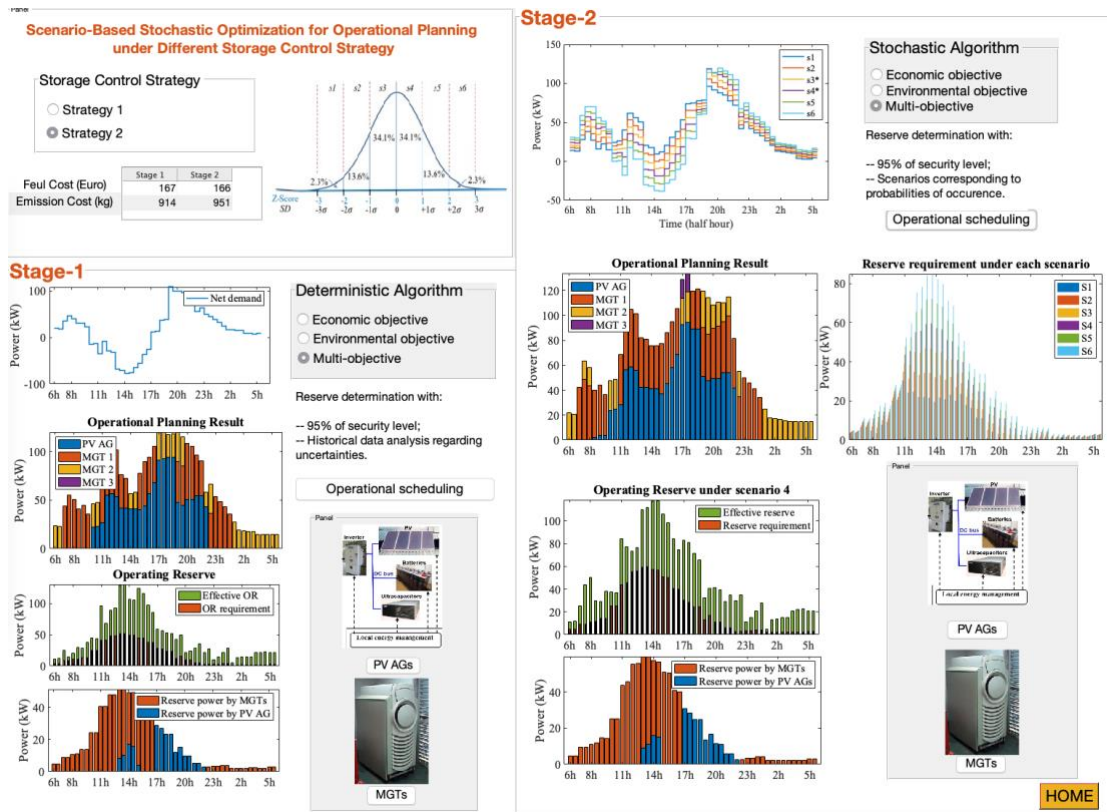

Fig. 6-11 The “Scenario-based stochastic optimization for operational planning” interface

In Fig. 6-12, parameters of PV panels and batteries are shown. At each time step, states of Active PV Generator power, battery charging/discharging power and battery state of charge are shown graphically. Furthermore, utilization ratio of each MGT and PV AGs are illustrated as pie charts. Utilization ratio of PV AGs regarding OR provision and total load can be observed visually through a proportion comparison. Fig. 6-13 presents the operational planning of three MGTs, followed with the operating cost and CO<sub>2</sub>-equivalent emission at each time step.

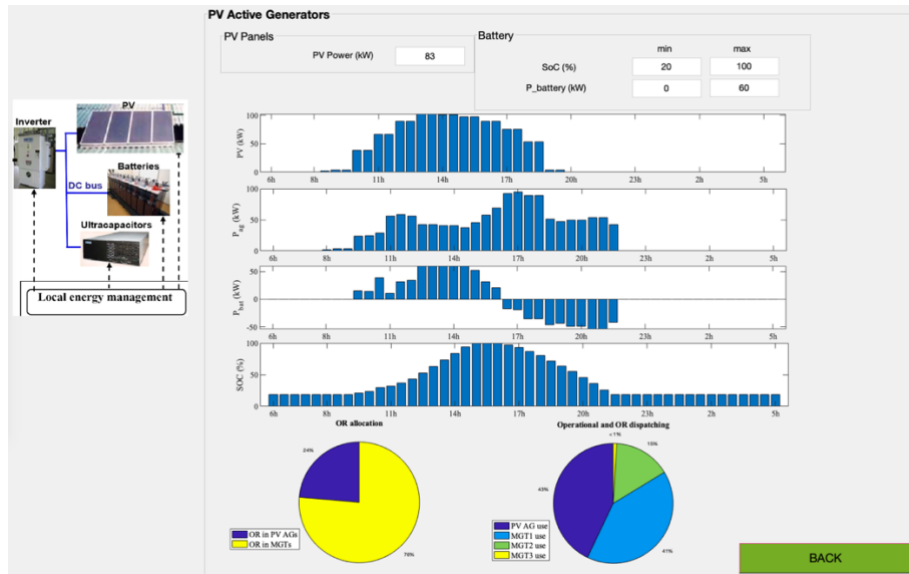

Fig. 6-12 “PV Active Generators” sub-interface

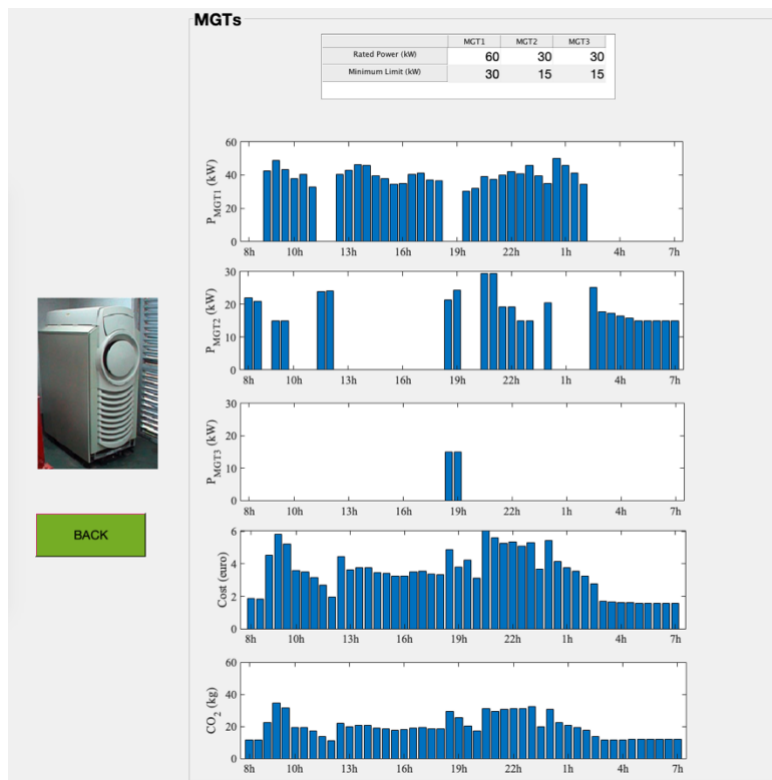

Fig. 6-13 “MGTs” sub-interface

### 6.4 Conclusion

In this chapter, a use-friendly MCEMS interface is presented with four designed interfaces with inclusion of different function modules: 1) data collection and predictive analysis for forecasting, 2) system uncertainty assessment and OR quantification, 3) deterministic optimization for operational planning, and 4) scenario-based stochastic optimization for operational planning. The MCEMS interface facilitates day-ahead energy management and uncertainty analysis in microgrid, since it provides a better

way of integrating all EMS function modules. The interface design visualizes the energy management process in terms of data collection, PV generation and load demand forecasting, uncertainty analysis, OR determination, operational planning with deterministic/stochastic optimization.

## CHAPTER 7

## CHAPTER 7 GENERAL CONCLUSION AND PERSPECTIVES

This dissertation has proposed a framework to take optimal generation scheduling decisions in the presented urban microgrid regarding energy and reserve provision in the presence of generation and load demand uncertainty. To be robust in front of uncertainties, an operating reserve must be scheduled with a minimized economic and environmental cost. Two research fields have been addressed.

The first research field has explored quantification methods of this OR by considering uncertainty modelling (based on past uncertainty realizations) with deterministic methods and probabilistic methods (Fig. 7-1) before applying a deterministic optimization of the generation scheduling. In chapter 4, a foresight framework is built to consider also future and probable uncertainty realizations and so implies a scenario-based stochastic optimization method.

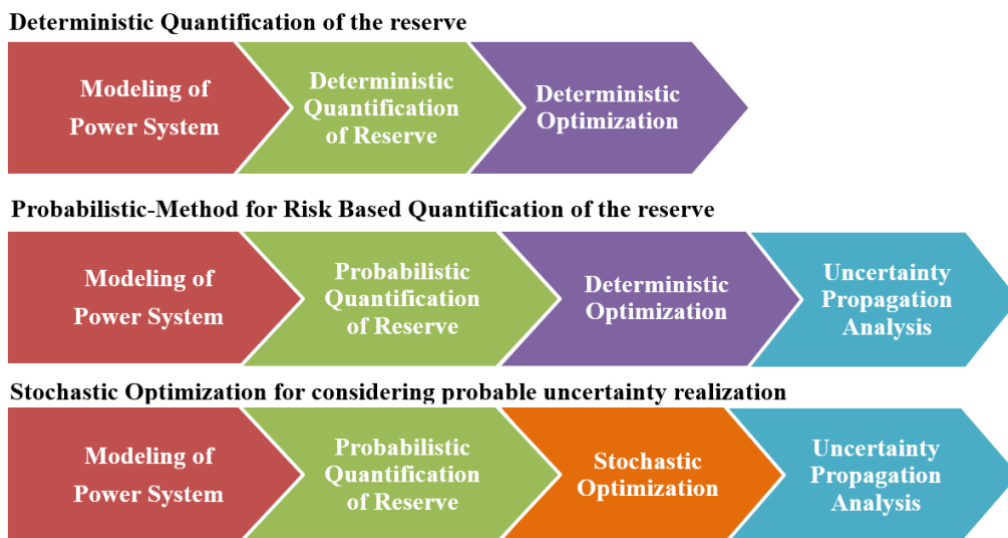

Fig. 7-1 Schemes of deterministic, probabilistic and stochastic optimization

The second research field has considered the OR provision with storage and an integration in the UC scheme (with deterministic and stochastic optimization) has been proposed.

The contributions of the dissertation can be summarized as follows:

1. Uncertainties of RESs and load are properly handled with uncertainty analysis. In Chapter 3, a risk-constrained probabilistic method is implemented for the determination of reserve.
2. A dynamic programming (DP) algorithm is carried out for the UC to find solutions of the studied non-convex mixed-integer nonlinear programming (MINLP) problem

in chapter 3. Moreover, due to advantages of MILP compared with DP, deterministic operational planning has been implemented with MILP.

3. The uncertainty propagation is analyzed with probabilistic methods in a deterministic UC model by using uncertain inputs.
4. A robust operational planning approach is employed with scenario-based stochastic optimization by carrying out Mixed-Integer Linear Programming (MILP) in chapter 4. To integrate probable uncertainties, net demand scenarios have been built considering PV uncertainty, and multi-objective scenario-based stochastic optimization has been performed for operational planning. The interest is to schedule the possible use of fast MGTs in case of future deviations between the forecasted power data and real ones while minimizing costs.
5. Storage has been considered in chapter 5 for RES production shifting and OR provision. Firstly, energy storage applications and benefits are discussed. Two storage control strategies have been integrated in the multi-objective scenario-based stochastic optimization method. Various benefits are highlighted.
6. An approach for the storage sizing is also carried out with probabilistic analysis method.
7. To integrate the operational planning procedure, and visualize the energy management system operation, a user-friendly simulation tool of an urban microgrid central energy management system (MCEMS) is developed with MATLAB/GUI (graphical user interface).

The following points may be further studied in order to broaden the understanding of the topics treated in this dissertation:

- The main sources of uncertainties, which are characterized using scenarios are the PV power generation and load demand. However, uncertainties are also presented in other appliances, like distributed network line outage, generating unit outage, are not considered. Hence, a perspective of the current work is to evaluate the impact of uncertainty within power outage on operational planning results and costs.
- In the presented optimization, a two-stage scenario-based approach has been undertaken with the built scenarios. To compare and further investigate the two-stage scenario-based approach, a multi-stage optimization could be employed and compared with the presented two-stage optimization. In a multi-stage optimization, scenarios are built with more possibilities of variation, while the computational cost can increase exponentially. Hence, a trade-off between the accuracy (number of generated scenarios) and the efficiency (computational cost) should be further researched.
- A sensitivity analysis after the optimization could be promising. The Monte Carlo simulation approach can be implemented to further analyze the impact of uncertainty on the system model outputs.

# **APPENDIX 1**

## **Back-Propagation Neural Network**



## APPENDIX 1. Back-Propagation Neural Network

### 1) Structure

An increasing attention is paid to the application of artificial neural networks (ANNs) since its emerging in 1950s. As one of the most popular algorithms in artificial intelligence field, ANN is successfully applied in various scientific researches and has become a hot topic in machine learning. ANNs provide an excellent mathematical tool for dealing with non-linear problems. Effectively, any continuous non-linear relationship can be approximated with an arbitrary accuracy by using a neural network with a suitable architecture and weight parameters [266]. Through a learning algorithm, interconnected neurons are trained so that parameters of neurons and weights are adjusted, thus obtaining a relationship between inputs and target outputs of current ANN. A diagram of forecasting by ANN application is shown in Fig. A1- 1.

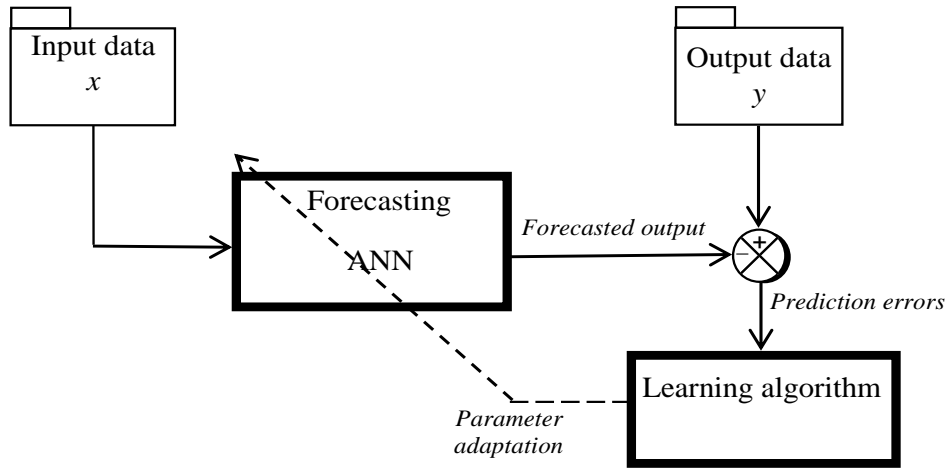

Fig. A1- 1 Forecasting by ANN application

An example of a three-layer based architecture is shown in Fig. A1- 2 with 3 neurons in the input layer, 4 neurons in the hidden layer and 2 neurons in the output layer.

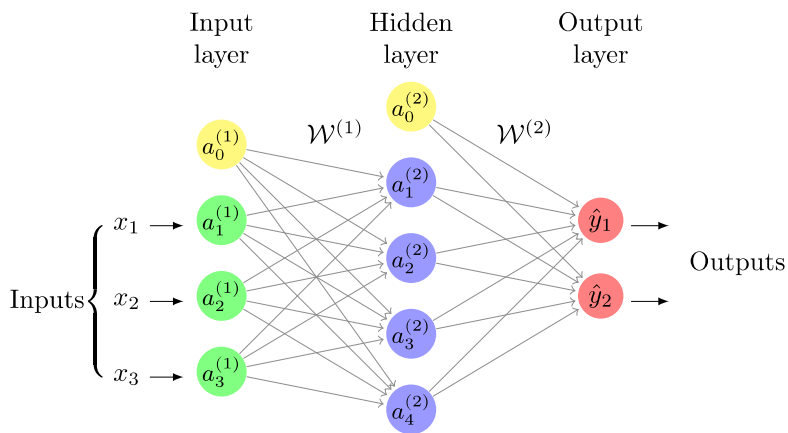

Fig. A1- 2 The structure of a three-layer BP network

Outputs and inputs of the BPNN are connected by neurons. Numbers of neurons at input layer and output layer are set according to the characteristics of the system input and system output, while hidden layer numbers are usually set by experiences and tests. All inputs ( $x_i$ ) are copied to an input neuron in the input layer. To establish mathematical representations, input neuron variables are described as a vector:

$$\mathbf{a}^{(1)} = [a_0^{(1)}, a_1^{(1)}, a_2^{(1)}, \dots, a_i^{(1)}]^T, \forall i \in [0, I] \quad (\text{A1- 1})$$

where  $a_i^{(1)}$  represents the  $i$  th neuron at first layer (input layer). Here  $a_0^{(1)} = 1$  is a constant input for bias calculation and for easier mathematical expression.

Between adjacent layers, neurons are interconnected by model parameters: weights and bias values. Each hidden neuron receives many inputs from other nodes and computes a single output based on the inputs and weights. Weights are represented as matrices

$\mathcal{W}^1 \in \mathbb{R}^{J \times (I+1)}$  and  $\mathcal{W}^2 \in \mathbb{R}^{K \times (J+1)}$ , respectively:

$$\mathcal{W}^1 = \begin{bmatrix} \mathbf{w}_0^{(1)} \\ \vdots \\ \mathbf{w}_j^{(1)} \end{bmatrix} = \begin{bmatrix} w_{10}^{(1)} & \cdots & w_{1i}^{(1)} \\ \vdots & \ddots & \vdots \\ w_{j0}^{(1)} & \cdots & w_{ji}^{(1)} \end{bmatrix} \quad (\text{A1- 2})$$

$$\mathcal{W}^2 = \begin{bmatrix} \mathbf{w}_0^{(2)} \\ \vdots \\ \mathbf{w}_k^{(2)} \end{bmatrix} = \begin{bmatrix} w_{10}^{(2)} & \cdots & w_{1j}^{(2)} \\ \vdots & \ddots & \vdots \\ w_{k0}^{(2)} & \cdots & w_{kj}^{(2)} \end{bmatrix} \quad (\text{A1- 3})$$

In the matrices,  $w_{ji}^{(1)}$  represents the weight from neuron  $a_i^{(1)}$  to  $a_j^{(2)}$ ,  $\mathbf{w}_j^{(1)} \in \mathbb{R}^{(I+1)}$  is a transverse vector representing all weights for neuron  $a_j^{(2)}$ . Equations of bias values are:

$$\mathbf{b}^1 = a_0^{(1)} \cdot \begin{bmatrix} w_{10}^{(1)} \\ \vdots \\ w_{j0}^{(1)} \end{bmatrix} = \begin{bmatrix} w_{10}^{(1)} \\ \vdots \\ w_{j0}^{(1)} \end{bmatrix}, \mathbf{b}^1 \in \mathbb{R}^J \quad (\text{A1- 4})$$

$$\mathbf{b}^2 = a_0^{(2)} \cdot \begin{bmatrix} w_{10}^{(2)} \\ \vdots \\ w_{k0}^{(2)} \end{bmatrix} = \begin{bmatrix} w_{10}^{(2)} \\ \vdots \\ w_{k0}^{(2)} \end{bmatrix}, \mathbf{b}^2 \in \mathbb{R}^K \quad (\text{A1- 5})$$

Weights and biases are initialized with random values before the training process, and they are gradually adjusted along with training iterations in order to minimize the errors between the target outputs and BPNN output values.

Values of neurons at hidden layer are calculated according to:

$$a_j^{(2)} = f_{act}(\mathbf{w}_j^{(1)} \cdot \mathbf{a}^{(1)}) \quad (\text{A1- 6})$$

where  $f_{act}$  is the nonlinear activation function. The choice of activation function can considerably change the behavior of the BPNN.

Similarly, hidden layer neurons are described by a vector:

$$\mathbf{a}^{(2)} = [a_0^{(2)}, a_1^{(2)}, a_2^{(2)}, \dots, a_j^{(2)}]^T, \forall j \in [0, J] \quad (\text{A1- 7})$$

where  $a_0^{(2)} = 1$ .

If the same activation function is chosen in the output layer, the  $k$  neuron output in the output layer can be expressed similarly:

$$\widehat{y}_k = f_{act}(\mathbf{w}_k^{(2)} \cdot \mathbf{a}^{(2)}) \quad (\text{A1- 8})$$

Output layer neuron variables are expressed as:

$$\widehat{\mathbf{y}} = [\widehat{y}_1, \widehat{y}_2, \dots, \widehat{y}_k]^T, \forall k \in [1, K] \quad (\text{A1- 9})$$

## 2) Data pre-processing

Inputs of BPNN are not identical and the values of each kind of input may have large numerical differences. So, each input must be preprocessed and normalized. Data preprocessing prevents that the larger information swallow up small numerical information. Also, it prevents that some neurons reach supersaturation state. More accurate and reliable network can be established after data normalization. Also certain training algorithms are greatly influenced by normalization, e.g. gradient descent, and other descending algorithms relating to gradient descent. With normalization, distribution of training data and testing data are the same, hence network capability of generalization is increased, while time for training is decreased.

In this BPNN algorithm, to avoid the training from diverging, and accelerating the learning speed of the network with a better fit, data are normalized to have zero mean and unit variance. Training data and test data are all normalized by the following equation:

$$X_s = \frac{X - X_{min}}{X_{max} - X_{min}} \quad (\text{A1- 10})$$

Where  $X_s$  is the normalized data,  $X$  is the real data before normalization,  $X_{max}$  and  $X_{min}$  are the maximum value and minimum value of all inputs. Thus, all data are normalized to fall within the  $[0, 1]$  range.

## 3) Selection of activation function

The choice of activation functions may strongly influence the complexity and performance of neural networks and play an important role in the convergence of the learning algorithms. In this BPNN algorithm, sigmoid functions are chosen as activation function in hidden layer and output layer. The sigmoid function is a nonlinear activation function that allows networks to compute by using only a small number of neurons, and the range of neuron values is set  $[0,1]$ . Values of neurons at hidden layer and output layer are calculated according to:

$$\mathbf{a}^{(2)} = [a_1^{(2)}, a_2^{(2)}, \dots, a_j^{(2)}]^T = \text{sigmoid}(\mathbf{w}_j^{(1)} \cdot \mathbf{a}^{(1)}) \quad (\text{A1- 11})$$

$$\hat{\mathbf{y}} = [a_1^{(3)}, a_2^{(3)}, \dots, a_k^{(3)}]^T = \text{sigmoid}(\mathbf{w}_k^{(2)} \cdot \mathbf{a}^{(2)}) \quad (\text{A1- 12})$$

where:

$$\text{sigmoid}(z) = \frac{1}{1 + e^{-z}} \quad (\text{A1- 13})$$

#### 4) Training procedure with a gradient descent-based BP algorithm

The Back-Propagation algorithm is a commonly used for feed-forward networks. Its learning rules supervise errors between the BPNN output and the targeted output. Though the training, the error is calculated and backpropagated from the output layer to the input layer. Meanwhile, weights are iteratively adjusted to optimal values in order to minimize the error.

As shown in Fig. A1- 3, the procedure of BPNN includes data preprocessing, activation function selection, training function, parameter setting and training of BPNN.

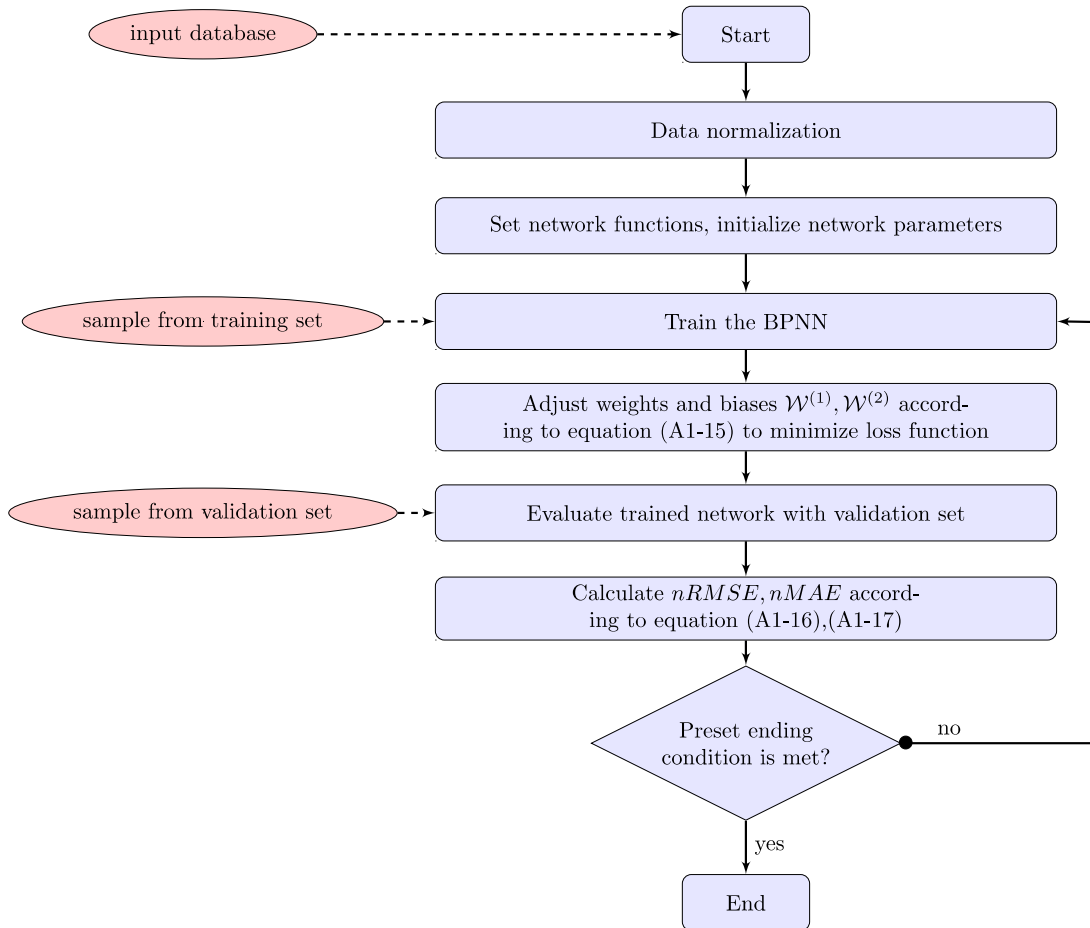

Fig. A1- 3 Flow chart of BPNN procedure

Before training the BPNN, it is necessary set the appropriate training parameters such as the learning rate. In this algorithm, gradient descent backpropagation that updates weight and bias values according to the gradient of errors, is chosen as training function.

Based on a multilayered, feed-forward topology with supervised learning, BP algorithm can be divided into two parts: feed-forward stage and back-propagation stage. In the first stage, BPNN is firstly initialized with randomly settled weights and biases. Then a training set of input database is imported and transmitted forward to output layer. Next, outputs are obtained. According to the feed-forward transmission of neuron values based on activation function, the output vector of hidden layer and output layer are calculated by equation (A1- 11) and (A1- 12).

In the second stage, back-propagation is used to calculate derivatives of performance with respect to the weight and bias variables, thus weights are gradually adjusted with errors between target values and output values propagating back to the network. At this stage, the back-propagation algorithm is based on a certain objective function, i.e. training function, and the gradient descent method to modify the weights in this case. To minimize the error  $E$  between target vector  $\mathbf{y}$  and network output vector  $\hat{\mathbf{y}}$ , the objective function (loss function) is expressed as:

$$E(w) = \sum_{k=1}^K e_k = \frac{1}{2} \sum_{k=1}^K (y_k - \hat{y}_k(w))^2 \quad (\text{A1- 14})$$

where  $w$  can be either value of  $\mathbf{w}_j^{(1)}, \mathbf{w}_k^{(2)}$  to be updated.  $K$  is the size of the output vector. Meanwhile, the gradient descent algorithm is applied to minimize value of  $E$ . For each parameter  $w$ , it is updated by:

$$w \leftarrow w - \eta \nabla E(w) = w - \eta \frac{\partial E(w)}{\partial w} \quad (\text{A1- 15})$$

where  $\eta$  is the learning rate, and (A1- 15) is used to reduce  $E(w)$  to the minimum point by adjusting the value of  $w$ . The performance of the algorithm is very sensitive to the proper setting of the learning rate. If the learning rate is set too large, the gradient descent may oscillate around the minimum and may fail to converge. If the learning rate is too small, the algorithm will take too long to converge. It is not practical to determine the optimal setting for the learning rate before training. Usually, the optimal learning rate is found during the training process.

After BPNN is trained by training set data, values of weights and biases are used to calculate  $nRMSE$  and  $nMAE$  of validation set to assess the network forecast performance:

$$nRMSE = \sqrt{\frac{1}{K} \sum_{k=1}^K (y_k - \hat{y}_k)^2} \quad (\text{A1- 16})$$

$$nMAE = \frac{1}{K} \sum_{k=1}^K |y_k - \widehat{y}_k| \quad (A1- 17)$$

Overall, the training procedure can be explained as following steps:

- 1) Set the architecture (number of layers and neurons), equations of networks (activation function, training function) and randomly initialize weights and biases;
- 2) Set the learning rate, input and output data of the training set and the validation set;
- 3) Load a sample of input and output from the training set, calculate the BPNN output with a feed-forward algorithm. Then calculate the error between target output and NN output with equation (A1- 14);
- 4) The error  $E$  between target and output values is then back propagated through the hidden layer. A gradient descent algorithm in equation (A1- 15) is used to minimize  $E$  by updating the weights and biases;
- 5) Go to the step 3) and repeat iteratively until the objective function converges to a minimum. Then the network is trained;
- 6) Test the trained network with the validation set to validate the parameters that have been obtained with the training set. If either the following condition a), b) or c) is satisfied, go to step 7), the training end: a) the number of iterations exceeds the maximum number of epochs; b) the  $nRMSE$  meets the preset target value; c) the maximum validation check value is exceeded; Otherwise, if none of the above condition is met, go to step 3), and the process is repeated until the target ending condition is reached;
- 7) Training end with well-trained weights and bias.

Finally, BPNN model is trained and adjusted with supervised learning by obtaining the optimal parameters. In a supervised learning procedure, since the sample input-output pairs are known, each pair of samples in training set is used to train the BPNN. Errors between desired output and model output are minimizing. By training the NN under supervision, the relationship between model inputs and outputs are presented by mathematical functions in BPNN structure.

### 5) Database for training and testing the ANN

The database is split into two data sets: a training set and a validation set. Firstly, the training set is used for updating and adjusting the network parameters. Then, the validation set is used for testing the performances of the trained ANN with new data through the normalized Root Mean Square Error ( $nRMSE$ ) and normalized Mean Absolute Error ( $nMAE$ ). The validation set is essential to avoid an overfitting of training data.

**APPENDIX 2**  
**Statistics and Probabilistic Theories**

## APPENDIX 2. *Statistics and Probabilistic Theories*

### 1) Correlation coefficient

In statistics, correlation coefficient ( $r$ ) and correlation factor “R squared” ( $R^2$ ) are often used to determine how closely a certain function fits a particular set of experimental data. They are applied to determine how close is the observed data with a linear relationship.  $r$  values range from -1 to 1 ( $R^2$  from 0 to 1), with  $\pm 1$  representing a perfect fit between scatters and a linear relation through them, and 0 representing no statistical correlation. The relationship between correlation coefficient  $r$  and correlation factor  $R^2$  is:

$$r^2 = R^2 \quad (\text{A2- 1})$$

$R^2$  is calculated as follows:

$$R^2 = 1 - \frac{\sum (y_i - f_i)^2}{\sum (y_i - \bar{y})^2} \quad (\text{A2- 2})$$

where  $f_i$  implies the fitted value of  $y_i$ , and:

$$\bar{y} = \frac{1}{N} \sum_{i=1}^N (y_i) \quad (\text{A2- 3})$$

### 2) Random variables

A random variable is characterized by two quantities: its value and its probability. For example, during a process of flipping a coin, there are two possible results: tail or head. If  $X$  is used to represent the outcome of one observation, then  $X$  is defined as random variable, and it is expressed as:

$$X = \begin{cases} 0, & \text{if the observation is tail} \\ 1, & \text{if the observation is head} \end{cases} \quad (\text{A2- 4})$$

The value of a random variable cannot be known before carrying out the random experiment of which it is the result. However, it is possible to know in advance the probability of occurrence of the possible values. For example, in the previous experiment,  $X$  can only take two values (0 or 1) with probabilities:

$$P(X = 0) = \frac{1}{2}, P(X = 1) = \frac{1}{2} \quad (\text{A2- 5})$$

Random variables can be distinguished into two types: *discrete random variables* and *continuous random variables* [267]. Discrete random variables can take only finite number of values, and they are usually attained by counting. e.g. numbers of tails when flipping a coin for five times, grade level of students in a class, or number of rainy days in a month. Continuous random variables can take infinite number of values, and they are often attained by measuring. e.g. heights of adults in a country, and the hourly measure temperature during the day.



**3) Probability density and probability distribution function**

In probabilistic theory, the uncertainty of a variable is represented as a random variable, which is determined with a probability distribution function or a probability density function (*pdf*). This *pdf* models the possible values that the random variable can take according to its probability of occurrence (probability law). A *pdf* of a discrete random variable, is a function *f*, which represents all the possible values of random variables and how their probabilities are distributed.

For example, Fig. A2- 1 shows the probability function of a discrete random variable  $X = \{1, 2, 3, 4, 5, 6, 7\}$  whose probabilities values are given by:

$$\begin{cases} P(X) = \frac{1}{16}, X = \{1,7\} \\ P(X) = \frac{1}{8}, X = \{2,6\} \\ P(X) = \frac{3}{16}, X = \{3,5\} \\ P(X) = \frac{1}{4}, X = \{4\} \end{cases} \quad (A2- 6)$$

In this situation, function *f* indicates the probability density of the variable *X*, and it follows these rules:

$$\begin{cases} P(X = x) = f(x) \\ \sum_{x=1}^n f(x) = 1 \\ f(x) \geq 0 \end{cases} \quad (A2- 7)$$

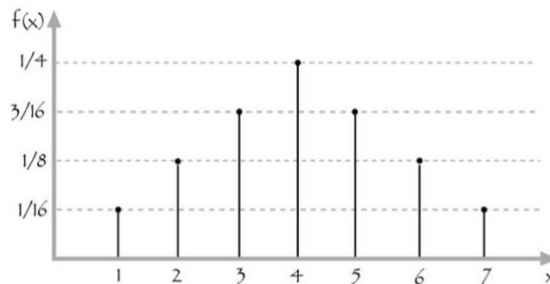
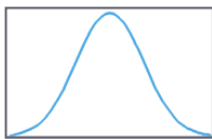

Fig. A2- 1 An example of probability distribution of discrete random variable

As for the continuous random variable, the relation between probability density function *f* and the continuous random variable is:

$$\begin{cases} P(a \leq x \leq b) = \int_a^b f(x) dx \\ \int_{-\infty}^{+\infty} f(x) dx = 1 \\ f(x) \geq 0 \end{cases} \quad (A2- 8)$$

Here are some examples of *pdf* of continuous random variable:



(a) Normal

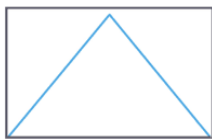

(b) Triangle



(c) Uniform

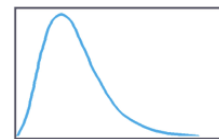

(d) Log Normal

Fig. A2- 2 Some examples of probability distributions of continuous random variable

The *pdf* is summing all probabilities of all possible values. Hence a *pdf* is always varying between 0 and 1.

**4) Cumulative distribution function**

For any discrete random variable  $X$  whose *pdf* is  $f(x)$ , the cumulative distribution function (*cdf*)  $F(x)$  of is defined as the probability of having a value of the variable  $X$  less than a given value  $x$ :

$$F(x) = P(X \leq x) = f(X) \tag{A2- 9}$$

Similarly, for any continuous random variable whose *pdf* is  $f(x)$ , the cumulative distribution function is:

$$F(x) = P(X \leq x) = \int_{-\infty}^x f(X) dX \tag{A2- 10}$$

**5) Normal distribution (Gaussian distribution)**

*Normal distribution*, also called Gaussian distribution, is the most common continuous probability distribution that can be found in nature and real life. It is often used to describe independent and randomly distributed variables. For example, heights of adults, annual income of each family in a country, and blood pressure studies, these all follow normal distribution pattern. In scientific research, errors in measurements are a typical case that can be approximated by normal distribution.

The normal probability distribution curve is a bell-shaped normal curve as shown in Fig. A2- 3. The characteristics and shape of the normal distribution rely on two parameters: the mean  $\mu$  and standard deviation  $\sigma$  of the set of random values. Supposed that the density of  $X$  is  $f(x; \mu, \sigma)$ , then we have:

$$f(x; \mu, \sigma) = \frac{1}{\sigma\sqrt{2\pi}} e^{-\frac{1}{2}\left(\frac{x-\mu}{\sigma}\right)^2}, \quad -\infty < x < +\infty \tag{A2- 11}$$

The mean  $\mu$  is the value of the random variable with the highest probability, and  $\sigma$  indicates how spread out these random variables are. 68% of values are within the standard deviation  $\sigma$  of the mean, 95% of values are within  $2\sigma$  from the mean, and 99.7% of values are within 3 *SD* of the mean. Particularly, if a normal distribution owns parameters  $\mu = 0$  and  $\sigma = 1$ , then it is defined as a *standard normal distribution*.

As in Fig. A2- 4, Graphically, the value of  $CDF(x)$  equals to the area under the *pdf* function  $PDF(x)$  (area in shade).

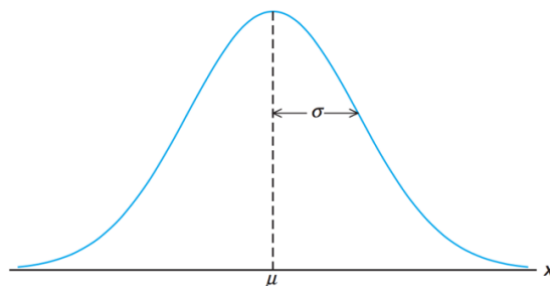

Fig. A2- 3 Probability density function of a normal distribution

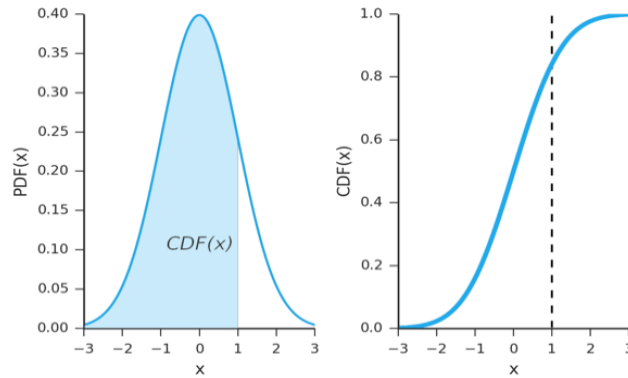

Fig. A2- 4 *pdf* and *cdf* of a normal distribution

The modelling of a random variable with a normal distribution is useful because many theorems exist and may make appear interesting properties (as central limit theorem, addition of normal distributions, etc.)

## 6) Quantile analysis

The *pdf* and *cdf* are usually used to measure a standard probability. Alternatively, quantile/percentile values can also be used to divide the range of a cumulative distribution (probability) function into continuous and regular intervals with equal probabilities. Simulation based confidence intervals can be used to provide an uncertainty estimation of a random variable.

A quantile is a measure used in statistics, indicating the value below a given percentage of observations [268]. The data are arranged in ascending order and are divided it into four roughly equal parts. The lower quartile  $0-Q1$  is the part containing the lowest data values (namely 0 to 25<sup>th</sup> percentile). The lower middle quartile  $Q1-Q2$  is the part containing the next-lowest data values (25<sup>th</sup> to 50<sup>th</sup> percentile). The upper middle quartile  $Q2-Q3$  is the part containing the next-highest data values (50<sup>th</sup> to 75<sup>th</sup> percentile). The upper quartile  $Q3-Q4$  (75<sup>th</sup> to 100<sup>th</sup> percentile) is the part containing the highest data values. Hence the data are divided according to the minimum, first quartile  $Q1$  (25<sup>th</sup>), median  $Q2$  (50<sup>th</sup>), third quartile  $Q3$  (75<sup>th</sup>) and the maximum. Meanwhile, [202] proposed the concepts of "Box and Whisker Plot" and draw a box from the  $Q1$  quartile to the  $Q3$  quartile, thus to examine a graphical summary of the data. We can show all the important values in a box-and-whisker plot, as well as their corresponding positions in *pdf* (Fig. A2- 5). IQR (interquartile range) is the distance between  $Q1$  and  $Q3$ .

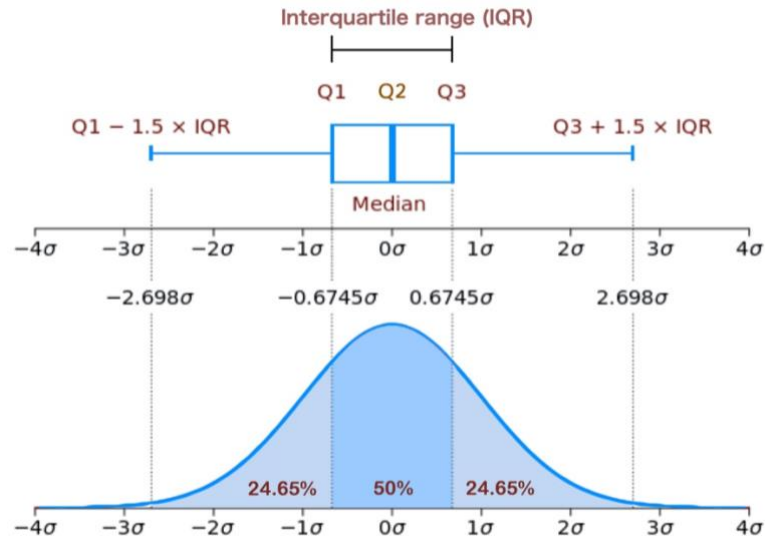

Fig. A2- 5 Boxplot and *pdf*

In descriptive statistics, a box plot is a method for graphically depicting groups of numerical data through their quartiles. In each box, the central mark indicates the median  $Q_2$ , and the bottom and top edges of the box indicate the 25th and 75th percentiles, respectively. The lines extending from the boxes (whiskers) indicate variability outside the upper and lower quartiles within a certain variation interval. Meanwhile, a 50% confidence interval of random variable  $X$  is corresponding to the area below the *pdf* curve and between the interval  $(Q_1, Q_3)$ .

**APPENDIX 3**  
**Branch-and-Cut Algorithm for MILP**

### ***APPENDIX 3. Branch-and-Cut Algorithm for MILP***

#### **1) Mixed-integer linear programming**

Compared with solving a linear programming (LP) optimization problem, solving an integer programming problem can be much harder. The mathematical model for mixed-integer linear programming (MILP) is the linear programming model with additional restrictions that certain decision variables must have integer values [61]. UC problem is a well-known MIP problem because decisions of switching on/off the generating units are binary variables [269]. A MILP problem can be generally expressed as:

$$\begin{aligned}
 & \min_{x,y} c^T x + d^T y && \text{(A3- 1)} \\
 & \text{subject to } Ax + By \leq b \\
 & \quad x \in \mathbb{Z}_+^n \\
 & \quad y \in \mathbb{R}^k \\
 & \quad A \in \mathbb{R}^{m \times n}, B \in \mathbb{R}^{m \times k}, c \in \mathbb{R}^n, d \in \mathbb{R}^k, b \in \mathbb{R}^m
 \end{aligned}$$

where  $x$  and  $y$  are decision variables ( $x$  as integer variables),  $A, B, c, d$  and  $b$  are known vectors / matrices regarding the given size above.

The MILP solving is not as simple as a relaxed linear problem (LP) (corresponding to the MILP) and rounding certain variables. Solving MILP problems by rounding the solution from a traditional LP solver (e.g. simplex method) is usually not optimal, or even not feasible, especially for large scale formulations [59].

For instance, assuming that an integer programming (IP) problem includes only integer random variables ( $x_1, x_2$ ), graphical demonstrations in Fig. A3- 1 show the rounding examples that are far beyond reach of the optimum. Fig. A3- 1 (a) shows an example where rounding the optimal solution for the LP relaxation is far from the optimum found with the IP problem. Even worse, in Fig. A3- 1 (b) an IP problem is shown where the optimal solution for the LP relaxation cannot be rounded to obtain the feasible solution of the presented IP problem. Therefore, the integer constraints have to be explicitly taken into account in the problem resolution.

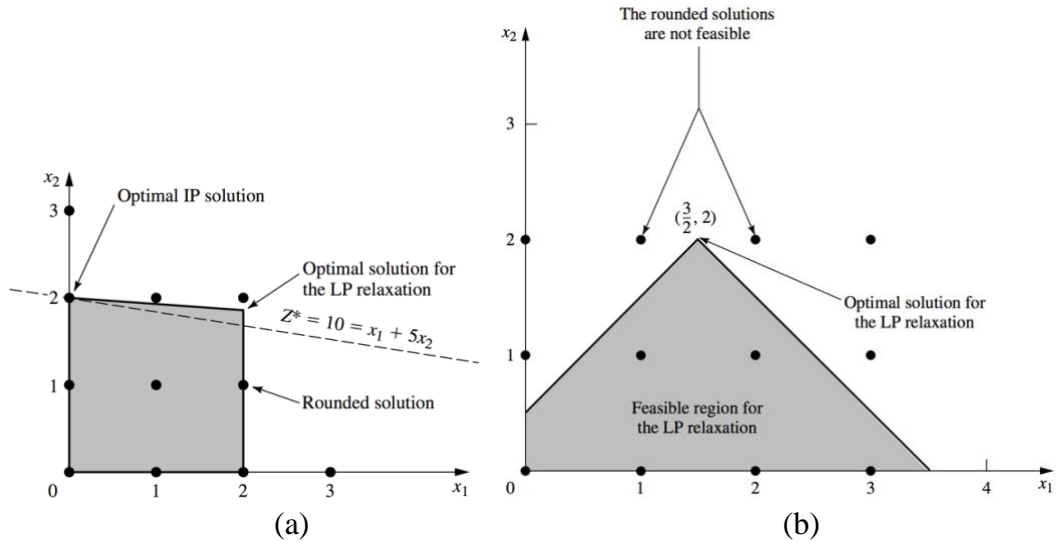

Fig. A3- 1 Examples of IP problems with unsatisfying rounded solutions from LP relaxations [61]

While improvements of algorithmic techniques and computer capabilities during the last decades, MILP problems remain difficult to solve, especially for large-scale formulations (e.g. stochastic programming). The objective is therefore to design a computationally efficient (quickly solved) formulation that accurately models the original problem so that the resulting solution is feasible and closed to the actual optimum.

The most commonly used algorithm for MILP is the **branch-and-cut, i.e. branch-and-bound search tree combined with cutting planes.**

## 2) Branch-and-bound search tree

As an example, a branch-and-bound search tree with four integer variables ( $x_1, x_2, x_3, x_4$ ) is illustrated in Fig. A3- 2. After solving a relaxed LP problem by neglecting integer constraints, the obtained root node comprises a fractional solution  $x_1 = 3.5$ . Since  $x_1$  should be an integer, two sub-nodes (subproblems) are created ( $x_1 \leq 3, x_1 \geq 4$ ), which is called branching. Similarly, the search tree keeps branching. During the solution search, upper bound is obtained/refreshed if a solution is found and  $x_1, x_2, x_3, x_4$  are all integers. This solution may not be optimal, but it is a feasible solution that satisfies all integer constraints. So it is regarded as an upper bound. Lower bounds are obtained/refreshed if a new optimal value is obtained at a node, though not all integer constraints are met. Therefore, the lower bound indicates that although an optimal value is reached, there are still integer variables that are not yet branching into an integer. If no feasible solution (nodes) is found at a node, the node is marked infeasible with no further branch. Once the gap between upper and lower bound is approximated to 0, an optimum solution is found and all integer constraints are satisfied.

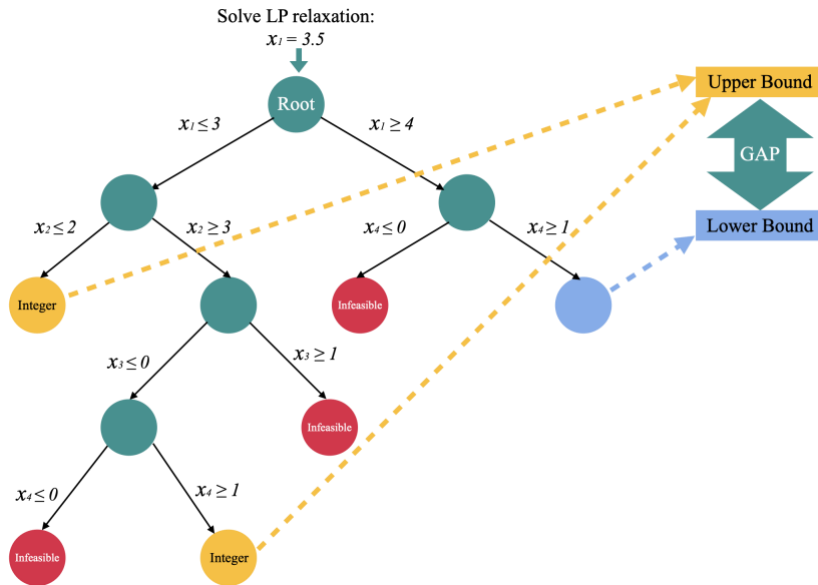

Fig. A3- 2 An example of a branch-and-bound tree

### 3) Branch-and-cut algorithm

The idea of branch-and-cut is to implicitly enumerate the feasible integer solutions. Here the branch-and-cut algorithm is explained pedagogically. More details, explanations and examples can be found in [61][270]. The flowchart of this algorithm is described in Fig. A3- 3. It is composed of a branch-and-bound algorithm procedure (blocks marked in solid line) and cutting-planes-relating processes (blocks marked in dash line). In CPLEX, the MIP optimizer applies a wide range of pre-solving techniques and heuristic approaches to increase efficiency and reduce problem size.

Firstly, **pre-solving techniques** are carried out to reduce computational complexity through identification of infeasibility and redundancy.

Secondly, with a selected node in the branch-and-bound tree, a **relaxed LP** problem is formed from original MILP formulation, while integer constraints are neglected. For the solution of the relaxed LP, if the solution contains a non-integer value (i.e. fractional solution) for a variable that is supposed to be integer, a cutting plane is added to tighten the LP relaxation.



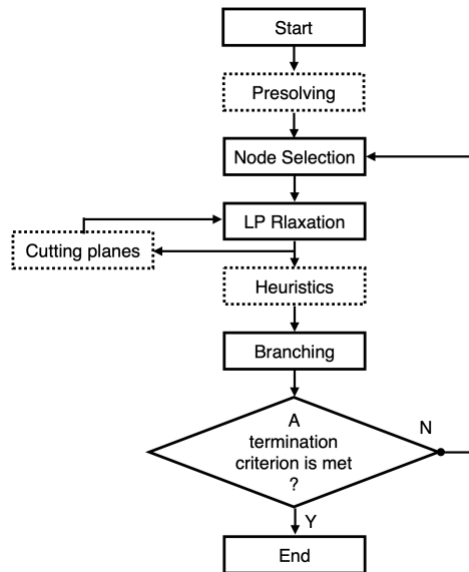

Fig. A3- 3 The flowchart of the branch-and-cut algorithm

**Adding cuts** (cutting planes) refer to find additional linear constraints to tighten the formulation in order to refine the feasible set of a problem and tighten the formulation. The addition of cuts usually reduces the number of branches needed to solve a MIP. A cut can be found during the analysis of a particular node, but all cuts are valid for all nodes of the branch-and-bound tree. In CPLEX, widely used cuts include mixed integer rounding cuts, disjunctive cuts, lift-and-project cuts, etc. For instance, MIR cuts are generated by applying integer rounding on the coefficients of integer variables and constraints. More cuts types and their explanations can be found in [271]. Cuts can reduce the feasible region for the LP relaxation without eliminating any feasible solutions for the MILP problem. As illustrated in Fig. A3- 4, undesirable fractional solutions (including the optimum of LP relaxation) are removed by adding rounding cuts during the solution process, hence formulation is tightened and computational time is reduced.

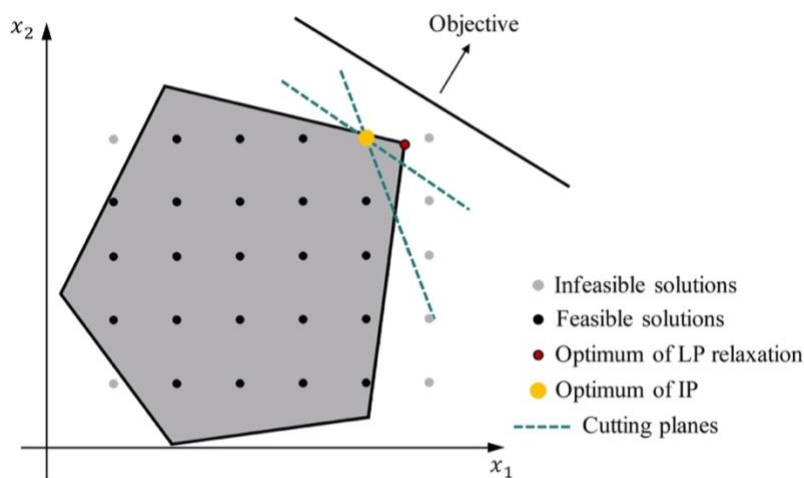

Fig. A3- 4 An example of cutting planes

In CPLEX, **heuristic approaches** are employed before branching to find integer feasible solutions and an optimum more efficiently. Subsequently, the **branching** (branch-and-bound) algorithm is started. The basic idea of this algorithm is to rely on two subroutines that compute respectively a lower and an upper bound of the optimal solution. The upper bound is an integer solution pertaining to the feasible set. The lower bound is a fractional solution (originating from relaxation). The objective is to minimize the gap between upper and lower bound by partitioning the search space into convex sets, and find lower/upper bounds for each set. The procedure necessitates the efforts to solve a sequence of LP relaxations, and is stopped when a termination criterion is met.

Termination criteria refers to: The algorithm stops when 1) all parts of the search space (all nodes) have been processed; 2) The set MIP gap tolerance (between upper bound and lower bound) is reached, i.e. an integer feasible solution has been proved to be within 0.01% of optimality; 3) A set limit is reached regarding time, number of nodes, size of tree memory, and number of integer solutions. If either of these situations is satisfied, then iterations stop with obtained optimum solution. Otherwise, another iteration is performed.

**APPENDIX 4**  
**Résumé Étendu en Français**

## Résumé Étendu en Français

### *Contexte et motivation*

La Commission européenne a adopté un nouveau cadre climatique et énergétique d'ici 2030. Les objectifs de 2030 comprennent une réduction de 40% des émissions de gaz à effet de serre par rapport aux niveaux de 1990, ainsi qu'une part plus élevée pour les énergies renouvelables et une amélioration de l'efficacité énergétique. Ces actions de l'UE montrent la voie vers un avenir sobre et prospère avec de faibles émissions de carbone pour l'environnement et l'économie.

### **Intégration des sources d'énergies renouvelables dans les communautés énergétiques locales**

Poussés par les actions climatiques de l'UE et la politique climatique, de nombreux secteurs économiques ont réalisé que des opportunités existent dans la lutte contre le réchauffement climatique. Par exemple, avec le besoin émergent de sources d'énergies renouvelables (SER), il y a une demande croissante de technologies et d'équipements innovants pour des applications telles que les bâtiments durables (par exemple, des ménages avec des panneaux photovoltaïques), des transports propres (véhicules électriques), les produits / solutions éco énergétiques, etc.

De plus en plus de production à énergie renouvelable, comme le solaire et l'éolien, conduisent à une nouvelle organisation du système électrique reposant de la production décentralisée (DG). Différente de l'alimentation électrique centralisée traditionnelle utilisant des grandes centrales électriques non renouvelables conventionnelles, la DG fournit de l'électricité produite et consommée localement. L'émergence de la DG montre des avantages et des perspectives pour la création de communautés énergétiques grâce à des caractéristiques respectueuses de l'environnement et à une meilleure efficacité du système électrique, évitant les pertes liées au transport et à la distribution d'électricité, évitant les pertes liées au transport et à la distribution d'électricité.

De plus en plus de communautés énergétiques, comme les micro-réseaux communautaires, émergent pour apporter des opportunités et des défis sociaux, environnementaux et économiques dans la production et l'utilisation locale d'énergie. L'organisation d'un système électrique avec des micro-réseaux vise à construire de petits systèmes électriques qui pourraient gérer l'équilibrage électrique localement dans des sous-parties du réseau. Il devrait être conçu pour améliorer le confort énergétique des consommateurs : réduire les coûts locaux et les émissions, améliorer la fiabilité et fournir une alimentation électrique efficace aux charges locales sans pertes de transmission.

Pour bien intégrer les SER dans les micro-réseaux communautaires, des équipements et des technologies avancés, tels que des systèmes de gestion intelligent, une infrastructure électrique sécurisée et des dispositifs de stockage d'énergie, sont nécessaires pour fournir une électricité de façon efficace avec une grande fiabilité.

### **Gérer l'incertitude des SER avec une réserve de puissance**

Les SER, comme le vent et le solaire, dépendent fortement de la météorologie, qui induit une variabilité. Heureusement, la production d'électricité à partir de SER est prévisible mais avec des erreurs de prévision. En raison de cette incertitude, de nouveaux défis sont survenus dans la planification et l'exploitation des micro-réseaux. L'incertitude des SER doit être correctement abordée pour équilibrer l'offre et la demande au niveau local avec des risques limités garantissant un fonctionnement sûr du réseau électrique.

Lorsqu'un déséquilibre inattendu entre l'offre et la demande apparaît, les gestionnaires de réseau et les automates utilisent une capacité de production disponible, appelée réserve de puissance (OR), pour compenser le déficit de puissance. L'OR pour le système électrique (entier) doit être bien dimensionnée et idéalement allouée sur les générateurs de cette puissance pour minimiser les coûts opérationnels tout en maintenant un niveau de sécurité satisfaisant. Dans un réseau électrique traditionnel, l'OR est prescrit pour gérer la perte des plus gros générateurs et les incertitudes liées à la demande de charge. Avec plus de SER, l'exigence de l'OR sera largement augmentée, en particulier pendant les moments où il y a une variabilité et une incertitude élevées des SER.

Dans ce contexte, les incertitudes liées aux erreurs de prévision des SER et des charges doivent être correctement gérées par une quantification et une allocation de l'OR appropriées et raisonnables. Des approches d'évaluation de l'incertitude fondées sur les risques peuvent être adoptées. L'accent sera mis sur l'étude du compromis entre un fonctionnement sûr et économique des systèmes électriques.

### **Fourniture de l'OR avec des SER et avec intégration de systèmes de stockage d'énergie**

La fourniture de l'OR a un coût économique (CAPEX et OPEX) ainsi qu'un coût environnemental. Traditionnellement, l'OR est fourni par des groupes électrogènes classiques pour assurer la disponibilité de l'alimentation électrique en cas d'urgence. En termes de SER, leur utilisation est limitée en ce qui concerne la fourniture de l'OR en raison de leur production intermittente. Cependant, avec l'émergence de technologies avancées de stockage d'énergie, le potentiel et les bénéfices de la fourniture de l'OR par des SER sont intéressants à explorer et à prendre en compte. Avec l'intégration de systèmes de stockage d'énergie (SSE), les SER hybrides et actifs sont capables de fournir plus de services auxiliaires pour le système électrique par un large éventail d'applications, par ex. capacité de réserve d'alimentation électrique, participation au réglage de la tension, de la fréquence primaire, etc.

Il est intéressant de trouver des solutions optimales pour fournir de l'OR à partir de l'énergie renouvelable stockée dans les SSE car il s'agit d'une technologie propre, non émettrice de CO<sub>2</sub> pour ce fonctionnement. L'allocation d'OR doit être optimisée selon la disponibilité des SER et l'état de cette charge des SSE.

### **Planification de la production d'électricité au jour le jour avec optimisation déterministe / stochastique**

Dans un système électrique, l'engagement d'unité et l'ordonnancement des générateurs planifient le fonctionnement des unités de production sur un horizon afin de satisfaire la demande des charges sous les contraintes d'exploitation du système électrique. À partir de la prévision journalière de la demande de charge (et de la production d'énergie renouvelable si des SER sont incorporés), un algorithme d'optimisation trouve classiquement les points de consigne de fonctionnement optimaux de tous les générateurs contrôlables qui minimisent les coûts opérationnels (de fonctionnement) globaux. Aujourd'hui, les problèmes d'engagement déterministe d'unité (DUC) concernent la planification à court terme des générateurs en supposant que toutes les prévisions concernant la consommation et la production d'énergie renouvelable intermittente sont fixes et certaines.

La forte pénétration des énergies renouvelables augmente l'incertitude du système électrique tandis que les demandes de fiabilité du système électrique augmentent. Par conséquent, les approches déterministes traditionnelles de l'UC doivent évoluer vers de l'optimisation stochastique. L'engagement stochastique d'unité (SUC) est un outil prometteur pour traiter les problèmes de production d'électricité en incluant les incertitudes dans la recherche optimale de solutions. Cependant, l'efficacité du calcul enferme de complexité et de temps d'exécution est toujours un problème. Parallèlement, les caractéristiques non convexes de la formulation du problème (la fonction objective et / ou les contraintes) sont également un obstacle lors de la recherche d'une solution réalisable.

Pour surmonter les inconvénients des DUC et SUC, des approches avancées doivent être envisagées et développées. À titre d'exemple, le DUC basé sur les probabilités donne une solution en appliquant une analyse de distribution de probabilité de compensation pour gérer l'incertitude SER. En ce qui concerne le SUC, des méthodes de calcul plus efficaces sont nécessaires (traitabilité), et une formulation mathématique doit être recherchée et construite pour rendre le problème facile à résoudre (expressivité). L'essentiel est le compromis entre la formulation du modèle et la traitabilité de l'approche.

### ***Problèmes et objectifs abordés***

L'objectif principal de cette thèse est de proposer de nouvelles méthodes permettant l'optimisation stochastique des décisions optimales d'ordonnancement de production

dans un micro-réseau urbain dans le but de réduire au minimum les coûts d'exploitation et les émissions CO<sub>2</sub>. La fourniture de puissance de réserve doit prendre en compte l'incertitude due aux SER et les erreurs de prévision du côté de la demande, tout en considérant le compromis entre la sécurité et le coût économique. Plus précisément, les problèmes suivants sont traités :

1. Planification des réserves : Avec une approche probabiliste d'évaluation de la fiabilité, les réserves doivent être dimensionnées et planifiées à l'avance pour garantir le niveau de sécurité et réduire les risques dus aux incertitudes des charge et des SER.
2. Développement d'algorithmes et d'outils pour l'optimisation stochastique : La planification opérationnelle des générateurs sous contraintes stochastique de sécurité doit être développée pour inclure les incertitudes considérées dans la recherche de solution. Des décisions optimales de planification de la production doivent être prises pour minimiser des fonctions mono-objectifs et multi-objectifs.
3. Contribution des systèmes de stockage d'énergie à la fourniture d'une réserve de puissance : lorsqu'un le système de stockage d'énergie (SSE) est mis en œuvre, des stratégies de stockage optimales doivent être élaborées pour maximiser les bénéfices pour le réseau. Par exemple : pour optimiser la part d'énergie SER dans la fourniture de réserves, ou pour minimiser les coûts d'exploitation / d'émission.

### ***Contributions***

Pour résoudre les problèmes, un environnement est proposé pour prendre des décisions d'engagement et de planification opérationnelle de la production optimale dans un micro-réseau urbain en ce qui concerne la fourniture d'énergie et de réserve en présence d'incertitudes des charges et des énergies renouvelables. Les contributions de la thèse peuvent être résumées comme suit :

1. Les incertitudes des SER et de la charge sont modélisées par une analyse d'incertitude et prise en compte par une méthode probabiliste sous la contrainte d'un risque.
2. Optimisation déterministe de la production en considérant la fourniture de réserve de puissance. Un algorithme de programmation dynamique (DP) est utilisé pour que l'UC résolve ce problème de programmation non linéaire non convexe à nombres entiers mixtes. De plus, en raison de ses avantages, un algorithme linéaire en nombres entiers (MILP) a été également développé et les résultats et performances composés.
3. La propagation de l'incertitude est analysée avec des méthodes probabilistes dans un modèle de UC déterministe en utilisant des entrées incertaines.
4. Une approche robuste de planification opérationnelle est employée avec une optimisation stochastique basée sur des scénarios en exécutant une programmation linéaire en nombres entiers mixtes (MILP). L'incertitude est modélisée à travers des scénarios de la demande nette, ainsi les incertitudes sont incluses dans le processus de recherche de la solution.
5. Pour considérer l'utilisation du stockage d'énergie, deux stratégies de contrôle du stockage sont présentées avec des avantages et des objectifs d'application différents.
6. Une approche de dimensionnement du stockage est proposée avec une méthode d'analyse probabiliste.

7. Pour intégrer la procédure de planification opérationnelle et visualiser le fonctionnement du système de gestion de l'énergie, un outil de simulation convivial de la gestion centralisée de l'énergie du micro-réseau urbain (MCEMS) est développé avec MATLAB / GUI (interface utilisateur graphique).

## ***Structure de la thèse***

### **Chapitre 1 Défis et opportunités des sources d'énergie renouvelables dans les communautés énergétiques locales**

Dans le chapitre 1, l'état de l'art des SER dans une communauté énergétique / un micro-réseau est présenté. Le système de gestion de l'énergie est discuté en ce qui concerne les fonctions et l'architecture contrôle. Le micro-réseau étudié est introduit. Il contient des générateurs actifs PV hybrides composés de sources d'énergie renouvelables et d'unités de stockage, de micro turbines à gaz et de charges. Parallèlement, les approches planification opérationnelle de la génération sous incertitudes sont passées en revue en termes d'optimisation déterministe et stochastique.

### **Chapitre 2 Analyse de l'incertitude des prévisions**

Au chapitre 2, les différentes sources d'incertitudes dans un système énergétique sont présentées et l'incertitude de production PV et l'incertitude de la charge sont discutées en détail. La corrélation entre la production PV et les facteurs météorologiques est étudiée, ainsi que la corrélation entre la charge et la température. Un algorithme basé sur un réseau neuronal est mis en œuvre pour prévoir la production PV et la demande de charge un jour à l'avance. Différentes techniques pour caractériser l'incertitude issue de ces prédictions sont alors présentées.

### **Chapitre 3 Planification déterministe sous incertitude**

Au chapitre 3, un état de l'art sur la planification déterministe est d'abord présenté ainsi que l'intérêt de disposer d'une puissance de réserve. Les différents critères pour dimensionner l'OR sont résumés en distinguant ceux reposant sous une considération déterministe (tel que le critère N-1) et ceux probabilistique utilisant une prise de risque. Une méthode de l'OR est proposée en utilisant l'évaluation des incertitudes de prévision. Ensuite, une planification déterministe est formulée puis résolue à l'aide d'un algorithme basé sur une programmation dynamique (DP). La propagation de l'incertitude sur la production PV est ensuite étudiée et l'impact sur la réserve de puissance est quantifié et analysé. Enfin, l'approche de programmation linéaire en nombres entiers mixtes (MILP) est introduite et appliquée pour la planification opérationnelle du micro-réseau étudié. Les résultats obtenus avec DP et MILP sont composés.

### **Chapitre 4 Anticiper l'incertitude avec une optimisation stochastique basée sur des scénarios**

Dans le chapitre 4, suite à un état de l'art sur la planification stochastique (SUC) sous incertitude, une approche robuste est construite avec une optimisation basée sur des



scénarios. Les incertitudes sont prises en compte à travers divers scénarios de production PV considérés avec leurs probabilités. Ainsi, les incertitudes sont incluses dans le processus de recherche de la solution. L'algorithme MILP est appliqué pour rechercher des solutions minimisant un objectif économique, un objectif environnemental ou un compromis entre les deux.

### **Chapitre 5 Participation du stockage pour la fourniture de puissance de réserve**

Au chapitre 5, les applications du stockage d'énergie sont présentées. Ensuite, deux stratégies de contrôle du stockage sont présentées pour deux applications : le décalage temporel de l'injection de production à base d'énergies renouvelables et la fourniture de puissance de réserve. Dans le cadre de ces deux stratégies de contrôle du stockage, l'optimisation stochastique multi-objectifs basée sur des scénarios est mise en œuvre avec différents critères d'optimisation : économique, environnemental et les deux. En outre, différentes stratégies d'allocation de la réserve entre les turbines à gaz et les unités de stockage sont envisagées selon les différentes stratégies de contrôle du stockage. Enfin, un état de l'art sur les méthodes de dimensionnement du stockage est rédigé, suivies d'une approche proposée pour le dimensionnement du stockage avec une analyse probabiliste concernant la prise en compte des saisons dans l'année et des types de charges.

### **Chapitre 6 Conception de la gestion centralisée de l'énergie dans un micro-réseau**

Au chapitre 6, un outil de simulation convivial de la gestion centralisée de l'énergie (MCEMS) est développé avec MATLAB / GUI (interface utilisateur graphique) pour visualiser le processus de planification opérationnelle avec les différentes approches d'optimisation proposées dans cette thèse. L'interface MCEMS facilite la gestion de l'énergie et l'analyse des incertitudes dans le micro-réseau, car elle offre un meilleur moyen d'intégrer tous les modules fonctionnels EMS. La conception de l'interface visualise le processus de gestion de l'énergie en termes de collecte de données, de production PV et de prévision de la demande de charge, d'analyse de l'incertitude du système, de quantification et allocation de la puissance de réserve et de planification opérationnelle avec une optimisation déterministe ou stochastique.

### **Chapitre 7 Conclusion générale et perspectives**

Enfin, au chapitre 7, des conclusions sont formulées avec des discussions et des perspectives pour de futurs travaux de recherche.

Cette thèse propose un cadre pour prendre des décisions optimales de planification de la production dans le micro-réseau urbain présenté concernant la fourniture d'énergie et de puissance de réserve en présence d'incertitudes liée à la prédiction de la production PV et de la demande. Pour être robuste face aux incertitudes, une réserve de puissance doit être programmée avec un coût économique et environnemental minimisé. Deux domaines de recherche ont été abordés.

Le premier domaine de recherche a exploré les méthodes de quantification de la puissance de réserve en considérant la modélisation d'incertitude (basée sur des incertitudes relevées pour le passé) avec des méthodes déterministes et des méthodes probabilistes (Fig. R- 1) avant d'appliquer une optimisation déterministe de la planification opérationnelle de la production. Dans le chapitre 4, une prospective est construite pour tenir compte également des réalisations futures et probables de l'incertitude et implique donc une méthode d'optimisation stochastique basée sur des scénarios.

Le deuxième domaine de recherche a considéré la fourniture de puissance de réserve avec de stockage et une intégration dans la planification opérationnelle (avec optimisation déterministe et stochastique) a été proposée.

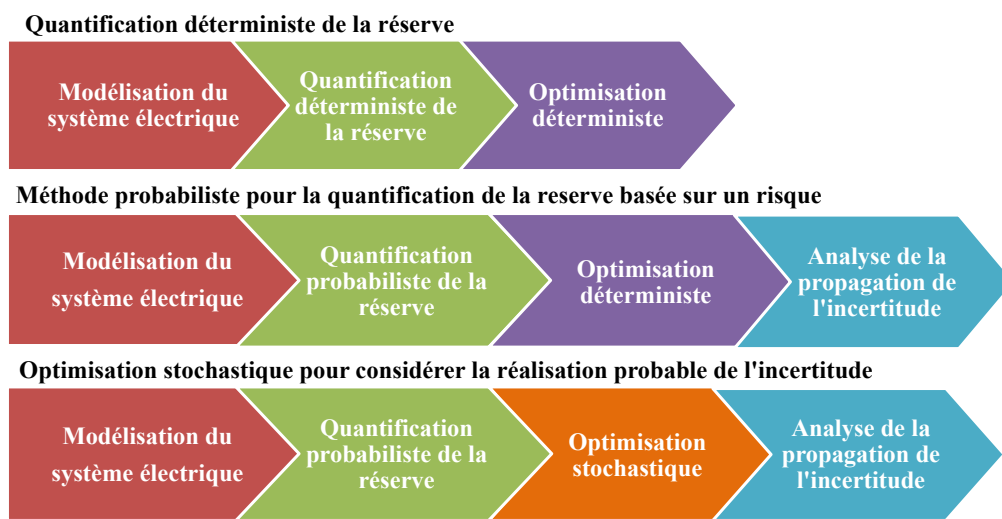

Fig. R- 1 Comparaison des approches d'optimisation déterministe et stochastique sous incertitude

## **Publications**

### **Journal articles**

WEN Xin, ABBES Dhaker, FRANCOIS Bruno, "Modelling of Photovoltaic Power Uncertainties for Impact Analysis on Generation Scheduling and Cost of an Urban Micro Grid", *Mathematics and Computers in Simulation*, 04/2020. ISSN 0378-4754, <https://doi.org/10.1016/j.matcom.2020.02.023>.

### **Conference articles**

WEN Xin, ABBES Dhaker, FRANCOIS Bruno, "Day-Ahead Generation Planning and Power Reserve Allocation with Flexible Storage Strategy", *International Conference on Electricity Distribution CIRED 2020*, 22-23 September 2020, Berlin, 09/2020

WEN Xin, ABBES Dhaker, FRANCOIS Bruno, "Impact of Photovoltaic Power Uncertainties on Generation Scheduling and Cost of an Urban Micro Grid", *13th international conference of IMACS TC1 Committee (ELECTRIMACS)*. 20-23 mai 2019. Salerne, Italie, 05/2019

YAN Xingyu, WEN Xin, FRANCOIS Bruno, ABBES Dhaker, "Management of Distributed Operating Power Reserve in an Urban Microgrid beyond DSO Risk Decision", *International Conference on Electricity Distribution CIRED 2018*, 7-8 June 2018, Ljubjana, Slovenia, 06/2018

## References

- [1] “2030 climate & energy framework | Climate Action.” [Online]. Available: [https://ec.europa.eu/clima/policies/strategies/2030\\_en](https://ec.europa.eu/clima/policies/strategies/2030_en). [Accessed: 20-Feb-2020].
- [2] E. M. Gui and I. MacGill, “Typology of future clean energy communities: An exploratory structure, opportunities, and challenges,” *Energy Research and Social Science*, vol. 35, pp. 94–107, Jan. 2018.
- [3] K. Chmutina, B. Wiersma, C. I. Goodier, and P. Devine-Wright, “Concern or compliance? Drivers of urban decentralised energy initiatives,” *Sustainable Cities and Society*, vol. 10, pp. 122–129, Feb. 2014.
- [4] B. Wiersma and P. Devine-Wright, “Decentralising energy: comparing the drivers and influencers of projects led by public, private, community and third sector actors,” *Contemporary Social Science*, vol. 9, no. 4, pp. 456–470, Oct. 2014.
- [5] IEA, “Global Energy & CO2 Status Report 2019. Available online: <https://www.iea.org/reports/global-energy-co2-status-report-2019>,” IEA, Paris, 2019.
- [6] IPCC, “Global Warming of 1.5°C. An IPCC Special Report on the impacts of global warming of 1.5°C above pre-industrial levels and related global greenhouse gas emission pathways, in the context of strengthening the global response to the threat of climate change,” 2018.
- [7] IRENA, “Renewable Energy Statistics 2019. Available online: [https://irena.org/-/media/Files/IRENA/Agency/Publication/2019/Jul/IRENA\\_Renewable\\_energy\\_statistics\\_2019.pdf](https://irena.org/-/media/Files/IRENA/Agency/Publication/2019/Jul/IRENA_Renewable_energy_statistics_2019.pdf),” 2019.
- [8] IRENA, “Renewable Capacity Statistics 2019. Available online: [https://www.irena.org/-/media/Files/IRENA/Agency/Publication/2019/Mar/IRENA\\_RE\\_Capacity\\_Statistics\\_2019.pdf](https://www.irena.org/-/media/Files/IRENA/Agency/Publication/2019/Mar/IRENA_RE_Capacity_Statistics_2019.pdf),” 2019.
- [9] “European Commission Regulation, Europe 2020 targets: statistics and indicators for France,” 2020. .
- [10] IEA, “World Energy Outlook 2018. Available online: <https://www.iea.org/reports/world-energy-outlook-2018>,” IEA, Paris, 2018.
- [11] A. Zahedi, “A review of drivers, benefits, and challenges in integrating renewable energy sources into electricity grid,” *Renewable and Sustainable Energy Reviews*, vol. 15, no. 9, Pergamon, pp. 4775–4779, 01-Dec-2011.
- [12] J. A. P. Lopes, N. Hatziargyriou, J. Mutale, P. Djapic, and N. Jenkins, “Integrating distributed generation into electric power systems: A review of drivers, challenges and opportunities,” *Electric Power Systems Research*, vol. 77, no. 9, pp. 1189–1203, Jul. 2007.
- [13] B. Robyns, A. Davigny, B. Francois, A. Henneton, and J. Sprooten, *Electricity Production from Renewables Energies*. John Wiley & Sons, 2012.

---

## REFERENCES

---

- [14] J. Eyer and G. Corey, "Energy Storage for the Electricity Grid: Benefits and Market Potential Assessment Guide," *Sandia National Laboratories*, vol. 20, no. 10, p. 5, 2010.
- [15] G. Delille, B. Francois, and G. Malarange, "Dynamic frequency control support: A virtual inertia provided by distributed energy storage to isolated power systems," in *IEEE PES Innovative Smart Grid Technologies Conference Europe, ISGT Europe*, 2010.
- [16] A. J. Dinusha Rathnayaka, V. M. Potdar, T. S. Dillon, and S. Kuruppu, "Formation of virtual community groups to manage prosumers in smart grids," *International Journal of Grid and Utility Computing*, vol. 6, no. 1, pp. 47–56, Jan. 2015.
- [17] P. Basak, S. Chowdhury, S. H. nee Dey, and S. P. Chowdhury, "A literature review on integration of distributed energy resources in the perspective of control, protection and stability of microgrid," *Renewable and Sustainable Energy Reviews*, vol. 16, no. 8, pp. 5545–5556, 2012.
- [18] H. Jiayi, J. Chuanwen, and X. Rong, "A review on distributed energy resources and MicroGrid," *Renewable and Sustainable Energy Reviews*, vol. 12, no. 9, pp. 2472–2483, 2008.
- [19] A. J. D. Rathnayaka, V. M. Potdar, and S. J. Kuruppu, "An innovative approach to manage prosumers in smart grid," in *2011 World Congress on Sustainable Technologies, WCST 2011*, 2011, pp. 141–146.
- [20] F. Mey, M. Diesendorf, and I. MacGill, "Can local government play a greater role for community renewable energy? A case study from Australia," *Energy Research and Social Science*, vol. 21, pp. 33–43, Nov. 2016.
- [21] D. Pudjianto, C. Ramsay, and G. Strbac, "Microgrids and virtual power plants: Concepts to support the integration of distributed energy resources," *Proceedings of the Institution of Mechanical Engineers, Part A: Journal of Power and Energy*, vol. 222, no. 7, pp. 731–741, Nov. 2008.
- [22] S. Hall and K. Roelich, "Business model innovation in electricity supply markets: The role of complex value in the United Kingdom," *Energy Policy*, vol. 92, pp. 286–298, May 2016.
- [23] E. M. Gui, M. Diesendorf, and I. MacGill, "Distributed energy infrastructure paradigm: Community microgrids in a new institutional economics context," *Renewable and Sustainable Energy Reviews*, vol. 72. Elsevier Ltd, pp. 1355–1365, 01-May-2017.
- [24] B. P. Koirala, E. Koliou, J. Friege, R. A. Hakvoort, and P. M. Herder, "Energetic communities for community energy: A review of key issues and trends shaping integrated community energy systems," *Renewable and Sustainable Energy Reviews*, vol. 56. Elsevier Ltd, pp. 722–744, 01-Apr-2016.
- [25] T. Van Der Schoor, H. Van Lente, B. Scholtens, and A. Peine, "Challenging obduracy: How local communities transform the energy system," *Energy Research and Social Science*, vol. 13, pp. 94–105, Mar. 2016.
- [26] G. W. De Vries, W. P. C. Boon, and A. Peine, "User-led innovation in civic energy communities," *Environmental Innovation and Societal Transitions*, vol.

- 19, pp. 51–65, Jun. 2016.
- [27] R. Beveridge and K. Kern, “The Energiewende in Germany: Background, Development and Future Challenges,” *Renewable Energy Law and Policy Review*, vol. 4, no. 1, pp. 3–12, 2013.
- [28] F. R. M. Leijten, J. W. Bolderdijk, K. Keizer, M. Gorsira, E. van der Werff, and L. Steg, “Factors that influence consumers’ acceptance of future energy systems: the effects of adjustment type, production level, and price,” *Energy Efficiency*, vol. 7, no. 6, pp. 973–985, 2014.
- [29] R. Madriz-Vargas, A. Bruce, and M. Watt, “The future of Community Renewable Energy for electricity access in rural Central America,” *Energy Research and Social Science*, vol. 35, pp. 118–131, Jan. 2018.
- [30] L. L. Delina, “Whose and what futures? Navigating the contested coproduction of Thailand’s energy sociotechnical imaginaries,” *Energy Research and Social Science*, vol. 35, pp. 48–56, Jan. 2018.
- [31] R. Zamora and A. K. Srivastava, “Controls for microgrids with storage: Review, challenges, and research needs,” *Renewable and Sustainable Energy Reviews*, vol. 14, no. 7, pp. 2009–2018, 2010.
- [32] A. Hirsch, Y. Parag, and J. Guerrero, “Microgrids: A review of technologies, key drivers, and outstanding issues,” *Renewable and Sustainable Energy Reviews*, vol. 90, pp. 402–411, 2018.
- [33] R. H. Lasseter *et al.*, “The CERTS microgrid concept. White paper on integration of distributed energy resources, prepared for transmission reliability program, Office of Power Technologies, US Department of Energy.” 2002.
- [34] W. Bower, I. Llc, J. Reilly, and R. Associates, “The Advanced Microgrid Integration and Interoperability,” *Sandia Report*, no. March, pp. 1–56, Feb. 2014.
- [35] R. H. Lasseter, “Microgrids and distributed generation,” *Journal of Energy Engineering*, vol. 133, no. 3, pp. 144–149, Sep. 2007.
- [36] W. Su and J. Wang, “Energy Management Systems in Microgrid Operations,” *The Electricity Journal*, vol. 25, no. 8, pp. 45–60, Oct. 2012.
- [37] R. Lasseter *et al.*, “Integration of distributed energy resources. The CERTS Microgrid Concept,” 2002.
- [38] NavigantResearch, “Microgrids Overview: Market Drivers, Barriers, Business Models, Innovators, and Key Market Segment Forecasts, available online: <https://www.navigantresearch.com/reports/microgrids-overview>,” 2019.
- [39] F. Wasko and W. Boyle, “FINAL PROJECT REPORT: Peninsula Advanced Energy Community, available online: [https://clean-coalition.org/wp-content/uploads/2019/07/PAEC-Final-Report\\_CEC-500-2019-025.pdf](https://clean-coalition.org/wp-content/uploads/2019/07/PAEC-Final-Report_CEC-500-2019-025.pdf),” 2019.
- [40] K. Van Dyke, M. Schwartz, K. Teeter-Moore, F. Ventura, and S. Kumar, “FINAL PROJECT REPORT: Berkeley Energy Assurance Transformation (BEAT), available online: <https://ww2.energy.ca.gov/2019publications/CEC-500-2019-014/CEC-500-2019-014.pdf>,” 2019.
- [41] P. J. Hall and E. J. Bain, “Energy-storage technologies and electricity generation,” *Energy policy*, vol. 36, no. 12, pp. 4352–4355, 2008.
- [42] A. N. Azmi, M. L. Kolhe, and A. G. Imenes, “Review on photovoltaic based

- active generator,” in *Advanced Topics in Electrical Engineering (ATEE), 2015 9th International Symposium on*, 2015, pp. 812–815.
- [43] H. Kanchev, D. Lu, B. Francois, and V. Lazarov, “Smart monitoring of a microgrid including gas turbines and a dispatched PV-based active generator for energy management and emissions reduction,” in *Innovative Smart Grid Technologies Conference Europe (ISGT Europe), 2010 IEEE PES*, 2010, pp. 1–8.
- [44] H. Fakham, D. Lu, and B. Francois, “Power control design of a battery charger in a hybrid active PV generator for load-following applications,” *IEEE Transactions on Industrial Electronics*, vol. 58, no. 1, pp. 85–94, Jan. 2011.
- [45] D. Lu, “Design and control of a PV active generator with integrated energy storages : application to the aggregation of producers and consumers in an urban micro smart grid,” Ecole Centrale de Lille, 2010.
- [46] “IEC 61970: Energy management system application program interface (EMS-API),” 2005. [Online]. Available: <https://joinup.ec.europa.eu/solution/iec-61970-12005-energy-management-system-application-program-interface-ems-api-part-1-guidelines-and>. [Accessed: 11-Jun-2020].
- [47] M. F. Zia, E. Elbouchikhi, and M. Benbouzid, “Microgrids energy management systems: A critical review on methods, solutions, and prospects,” *Applied Energy*, vol. 222. Elsevier Ltd, pp. 1033–1055, 15-Jul-2018.
- [48] C. Gamarra and J. Guerrero, “Computational optimization techniques applied to microgrids planning: A review,” *Renewable and Sustainable Energy Reviews*, no. Dc, pp. 413–424, 2015.
- [49] X. Yan, “Energy management under uncertainty: Application to the day-ahead planning and power reserve allocation of an urban microgrid with active photovoltaic generators and storage systems. PhD thesis,” Ecole Centrale de Lille, 2017.
- [50] P. Li, “Formalisme pour la Supervision des Systèmes Hybrides Multi-Sources de Générateurs d’Energie Répartie : Application à la Gestion d’un Micro Réseau,” Ecole centrale de Lille, 2009.
- [51] A. L. Dimeas and N. D. Hatziargyriou, “Operation of a multiagent system for microgrid control,” *IEEE Transactions on Power Systems*, vol. 20, no. 3, pp. 1447–1455, Aug. 2005.
- [52] F. Katiraei and M. R. Iravani, “Power management strategies for a microgrid with multiple distributed generation units,” *IEEE Transactions on Power Systems*, vol. 21, no. 4, pp. 1821–1831, Nov. 2006.
- [53] D. E. Olivares, C. A. Cañizares, and M. Kazerani, “A centralized optimal energy management system for microgrids,” in *IEEE Power and Energy Society General Meeting*, 2011.
- [54] H. Kanchev, D. Lu, F. Colas, V. Lazarov, and B. Francois, “Energy management and operational planning of a microgrid with a PV-based active generator for smart grid applications,” *IEEE transactions on industrial electronics*, vol. 58, no. 10, pp. 4583–4592, 2011.
- [55] H. Kanchev, “Gestion des flux énergétiques dans un système hybride de sources

- d'énergie renouvelable: Optimisation de la planification opérationnelle et ajustement d'un micro réseau électrique urbain," Ecole Centrale de Lille, 2014.
- [56] E. A. Bakirtzis, P. N. Biskas, D. P. Labridis, and A. G. Bakirtzis, "Multiple time resolution unit commitment for short-term operations scheduling under high renewable penetration," *IEEE Transactions on Power Systems*, vol. 29, no. 1, pp. 149–159, 2014.
- [57] S. Sen and D. P. Kothari, "Optimal thermal generating unit commitment: a review," *International Journal of Electrical Power & Energy Systems*, vol. 20, no. 7, pp. 443–451, 1998.
- [58] H. Y. Yamin, "Review on methods of generation scheduling in electric power systems," *Electric Power Systems Research*, vol. 69, no. 2–3, pp. 227–248, May 2004.
- [59] A. J. Wood, B. F. Wollenberg, and G. B. Sheblé, *Power generation, operation, and control*. John Wiley & Sons, 2013.
- [60] R. H. Kerr, J. L. Scheidt, A. J. Fontana, and J. K. Wiley, "Unit Commitment," *IEEE Transactions on Power Apparatus and Systems*, vol. PAS-85, no. 5, pp. 417–421, 1966.
- [61] F. S. Hillier and G. J. Lieberman, *Introduction To Operations Research*, 7th ed. Holden-Day Inc San Francisco, 2001.
- [62] S. Lauere, N. R. Sandell, D. P. Bertsekas, and T. A. Posbergh, "Solution of large-scale optimal unit commitment problems," *IEEE Transactions on Power Apparatus and Systems*, vol. PAS-101, no. 1, pp. 79–86, 1982.
- [63] A. I. Cohen and M. Yoshimura, "A branch-and-bound algorithm for unit commitment," *IEEE Transactions on Power Apparatus and Systems*, vol. PAS-102, no. 2, pp. 444–451, 1983.
- [64] C. L. Chen and S. C. Wang, "Branch-and-bound scheduling for thermal generating units," *IEEE Transactions on Energy Conversion*, vol. 8, no. 2, pp. 184–189, 1993.
- [65] J. A. Muckstadt and R. C. Wilson, "An Application of Mixed-Integer Programming Duality to Scheduling Thermal Generating Systems," *IEEE Transactions on Power Apparatus and Systems*, vol. PAS-87, no. 12, pp. 1968–1978, 1968.
- [66] N. P. Padhy, "Unit commitment - A bibliographical survey," *IEEE Transactions on Power Systems*, vol. 19, no. 2, pp. 1196–1205, 2004.
- [67] S. Takriti and J. R. Birge, "Using integer programming to refine Lagrangian-based unit commitment solutions," *IEEE Transactions on Power Systems*, vol. 15, no. 1, pp. 151–156, 2000.
- [68] Y. H. Chen, S. Y. Lu, Y. R. Chang, T. T. Lee, and M. C. Hu, "Economic analysis and optimal energy management models for microgrid systems: A case study in Taiwan," *Applied Energy*, vol. 103, pp. 145–154, Mar. 2013.
- [69] L. Majic, I. Krzelj, and M. Delimar, "Optimal scheduling of a CHP system with energy storage," in *2013 36th International Convention on Information and Communication Technology, Electronics and Microelectronics, MIPRO 2013 - Proceedings*, 2013, pp. 1253–1257.



- [70] D. Quiggin, S. Cornell, M. Tierney, and R. Buswell, "A simulation and optimisation study: Towards a decentralised microgrid, using real world fluctuation data," *Energy*, vol. 41, no. 1, pp. 549–559, May 2012.
- [71] J. A. Muckstadt and S. A. Koenig, "An Application of Lagrangian Relaxation to Scheduling in Power-Generation Systems," *Operations Research*, vol. 25, no. 3, pp. 387–403, Jun. 1977.
- [72] S. J. Wang, S. M. Shahidehpour, S. Mokhtari, G. D. Irisarri, and D. S. Kirschen, "Short-term generation scheduling with transmission and environmental constraints using an augmented lagrangian relaxation," *IEEE Transactions on Power Systems*, vol. 10, no. 3, pp. 1294–1301, 1995.
- [73] C. A. Li, R. B. Johnson, and A. J. Svoboda, "A new unit commitment method," *IEEE Transactions on Power Systems*, vol. 12, no. 1, pp. 113–119, 1997.
- [74] A. Frangioni, C. Gentile, and F. Lacalandra, "Solving unit commitment problems with general ramp constraints," *International Journal of Electrical Power and Energy Systems*, vol. 30, no. 5, pp. 316–326, 2008.
- [75] A. Sobu and G. Wu, "Dynamic optimal schedule management method for microgrid system considering forecast errors of renewable power generations," in *2012 IEEE International Conference on Power System Technology, POWERCON 2012*, 2012.
- [76] M. Y. Nguyen, Y. T. Yoon, and N. H. Choi, "Dynamic programming formulation of micro-grid operation with heat and electricity constraints," in *Transmission and Distribution Conference and Exposition: Asia and Pacific, T and D Asia 2009*, 2009.
- [77] H. Kanchev, F. Colas, V. Lazarov, and B. Francois, "Emission reduction and economical optimization of an urban microgrid operation including dispatched PV-based active generators," *IEEE Transactions on sustainable energy*, vol. 5, no. 4, pp. 1397–1405, 2014.
- [78] M. Carrión and J. M. Arroyo, "A computationally efficient mixed-integer linear formulation for the thermal unit commitment problem," *IEEE Transactions on Power Systems*, vol. 21, no. 3, pp. 1371–1378, 2006.
- [79] S. A. Kazarlis, A. G. Bakirtzis, and V. Petridis, "A genetic algorithm solution to the unit commitment problem," *IEEE Transactions on Power Systems*, vol. 11, no. 1, pp. 83–92, 1996.
- [80] A. Papavasiliou, S. S. Oren, and B. Rountree, "Applying high performance computing to transmission-constrained stochastic unit commitment for renewable energy integration," *IEEE Transactions on Power Systems*, vol. 30, no. 3, pp. 1109–1120, 2015.
- [81] Q. P. Zheng, J. Wang, and A. L. Liu, "Stochastic optimization for unit commitment—A review," *IEEE Transactions on Power Systems*, vol. 30, no. 4, pp. 1913–1924, 2015.
- [82] O. Erdinc, N. G. Paterakis, and J. P. S. Catalão, "Overview of insular power systems under increasing penetration of renewable energy sources: Opportunities and challenges," *Renewable and Sustainable Energy Reviews*, vol. 52, pp. 333–346, 2015.

- [83] T. S. Dillon, K. W. Edwin, H. D. Kochs, and R. J. Taud, "Integer programming approach to the problem of optimal unit commitment with probabilistic reserve determination," *IEEE Transactions on Power Apparatus and Systems*, vol. PAS-97, no. 6, pp. 2154–2166, 1978.
- [84] H. Wu and H. B. Gooi, "Optimal scheduling of spinning reserve with ramp constraints," in *IEEE Engineering Society, Winter Meeting*, 1999, vol. 2, pp. 785–790.
- [85] B. Durga Hari Kiran and M. Sailaja Kumari, "Demand response and pumped hydro storage scheduling for balancing wind power uncertainties: A probabilistic unit commitment approach," *International Journal of Electrical Power and Energy Systems*, vol. 81, pp. 114–122, 2016.
- [86] G. B. Sheble and G. N. Fahd, "Unit commitment literature synopsis," *IEEE Transactions on Power Systems*, vol. 9, no. 1, pp. 128–135, 1994.
- [87] R. Baldick, "The generalized unit commitment problem," *IEEE Transactions on Power Systems*, vol. 10, no. 1, pp. 465–475, 1995.
- [88] L. Wu, M. Shahidehpour, and T. Li, "Stochastic security-constrained unit commitment," *IEEE Transactions on Power Systems*, vol. 22, no. 2, pp. 800–811, 2007.
- [89] S. Takriti, B. Krasenbrink, and L. S.-Y. Wu, "Incorporating fuel constraints and electricity spot prices into the stochastic unit commitment problem," *Operations Research*, vol. 48, no. 2, pp. 268–280, 2000.
- [90] S. Takriti, J. R. Birge, and E. Long, "A stochastic model for the unit commitment problem," *IEEE Transactions on Power Systems*, vol. 11, no. 3, pp. 1497–1508, 1996.
- [91] P. A. Ruiz, C. R. Philbrick, and P. W. Sauer, "Modeling approaches for computational cost reduction in stochastic unit commitment formulations," *IEEE Transactions on Power Systems*, vol. 25, no. 1, pp. 588–589, 2010.
- [92] P. A. Ruiz, C. R. Philbrick, E. Zak, K. W. Cheung, and P. W. Sauer, "Uncertainty management in the unit commitment problem," *IEEE Transactions on Power Systems*, vol. 24, no. 2, pp. 642–651, 2009.
- [93] D. Bertsimas, E. Litvinov, X. A. Sun, J. Zhao, and T. Zheng, "Adaptive robust optimization for the security constrained unit commitment problem," *IEEE Transactions on Power Systems*, vol. 28, no. 1, pp. 52–63, 2013.
- [94] L. Zhao and B. Zeng, "Robust unit commitment problem with demand response and wind energy," in *Power and Energy Society General Meeting, 2012 IEEE*, 2012, pp. 1–8.
- [95] Q. Wang, J.-P. Watson, and Y. Guan, "Two-stage robust optimization for  $N_k$  contingency-constrained unit commitment," *IEEE Transactions on Power Systems*, vol. 28, no. 3, pp. 2366–2375, 2013.
- [96] C. Zhao, J. Wang, J. P. Watson, and Y. Guan, "Multi-stage robust unit commitment considering wind and demand response uncertainties," *IEEE Transactions on Power Systems*, vol. 28, no. 3, pp. 2708–2717, 2013.
- [97] W. van Ackooij, I. Danti Lopez, A. Frangioni, F. Lacalandra, and M. Tahanan, "Large-scale unit commitment under uncertainty: an updated literature survey,"

- Annals of Operations Research*, vol. 271, no. 1, pp. 11–85, Dec. 2018.
- [98] X. Ding, W. J. Lee, W. Jianxue, and L. Liu, “Studies on stochastic unit commitment formulation with flexible generating units,” *Electric Power Systems Research*, vol. 80, no. 1, pp. 130–141, Jan. 2010.
- [99] J. F. Restrepo and F. D. Galiana, “Assessing the yearly impact of wind power through a new hybrid deterministic/stochastic unit commitment,” *IEEE Transactions on Power Systems*, vol. 26, no. 1, pp. 401–410, Feb. 2011.
- [100] H. Wu, M. Shahidehpour, Z. Li, and W. Tian, “Chance-constrained day-ahead scheduling in stochastic power system operation,” *IEEE Transactions on Power Systems*, vol. 29, no. 4, pp. 1583–1591, 2014.
- [101] Q. Wang, Y. Guan, and J. Wang, “A chance-constrained two-stage stochastic program for unit commitment with uncertain wind power output,” *IEEE Transactions on Power Systems*, vol. 27, no. 1, pp. 206–215, 2012.
- [102] W. B. Powell, *Approximate Dynamic Programming: Solving the curses of dimensionality*, vol. 703. John Wiley & Sons, 2007.
- [103] W. Zhang and D. Nikovski, “State-space approximate dynamic programming for stochastic unit commitment,” in *North American Power Symposium (NAPS), 2011*, 2011, pp. 1–7.
- [104] N. R. Council, *Review of the Department of Homeland Security’s Approach to Risk Analysis*. National Academies Press, 2010.
- [105] A. Soroudi and T. Amraee, “Decision making under uncertainty in energy systems: State of the art,” *Renewable and Sustainable Energy Reviews*, vol. 28. Pergamon, pp. 376–384, 01-Dec-2013.
- [106] A. Mills *et al.*, “Understanding Variability and Uncertainty of Photovoltaics for Integration with the Electric Power System,” Dec. 2009.
- [107] X. Yan, D. Abbes, and B. Francois, “Uncertainty analysis for day ahead power reserve quantification in an urban microgrid including PV generators,” *Renewable Energy*, vol. 106, pp. 288–297, 2017.
- [108] “The Weather Channel.” [Online]. Available: <https://weather.com/>.
- [109] D. E. Hinkle, W. Wiersma, and S. G. Jurs., *Applied Statistics for the Behavioral Sciences*, 5th ed. Houghton Mifflin, 2003.
- [110] G. Gross and F. D. Galiana, “Short-Term Load Forecasting,” *Proceedings of the IEEE*, vol. 75, no. 12, pp. 1558–1573, 1987.
- [111] “RTE (Réseau de transport d’électricité) de France.” [Online]. Available: <http://www.rte-france.com>.
- [112] R. J. Bessa, A. Trindade, C. S. P. Silva, and V. Miranda, “Probabilistic solar power forecasting in smart grids using distributed information,” *International Journal of Electrical Power & Energy Systems*, vol. 72, pp. 16–23, Nov. 2015.
- [113] J. P. Gonzalez, A. M. S. Roque, and E. A. Perez, “Forecasting Functional Time Series with a New Hilbertian ARMAX Model: Application to Electricity Price Forecasting,” *IEEE Transactions on Power Systems*, vol. 33, no. 1, pp. 545–556, Jan. 2018.
- [114] J. C. Lopez, M. J. Rider, and Q. Wu, “Parsimonious Short-Term Load Forecasting for Optimal Operation Planning of Electrical Distribution Systems,”

- IEEE Transactions on Power Systems*, vol. 34, no. 2, pp. 1427–1437, Mar. 2019.
- [115] W. Kong, Z. Y. Dong, Y. Jia, D. J. Hill, Y. Xu, and Y. Zhang, “Short-Term Residential Load Forecasting Based on LSTM Recurrent Neural Network,” *IEEE Transactions on Smart Grid*, vol. 10, no. 1, pp. 841–851, Jan. 2019.
- [116] R. H. Inman, H. T. C. Pedro, and C. F. M. Coimbra, “Solar forecasting methods for renewable energy integration,” *Progress in Energy and Combustion Science*, vol. 39, no. 6, pp. 535–576, Dec. 2013.
- [117] F. Yang, H.-L. Pan, S. K. Krueger, S. Moorthi, and S. J. Lord, “Evaluation of the NCEP Global Forecast System at the ARM SGP Site,” *Monthly Weather Review*, vol. 134, no. 12, pp. 3668–3690, Dec. 2006.
- [118] G. Zhang, B. Eddy Patuwo, and M. Y. Hu, “Forecasting with artificial neural networks: The state of the art,” *International Journal of Forecasting*, vol. 14, no. 1, pp. 35–62, Mar. 1998.
- [119] B. Francois and J. P. Cambronne, “Neural network interpolator for the improvement of power rectifiers control,” in *IEEE International Symposium on Industrial Electronics*, 1996, vol. 1, pp. 362–367.
- [120] X. KESTELYN, B. FRANCOIS, and J. P. HAUTIER, “A Torque Estimator for a Switched Reluctance Motor using an Orthogonal Neural Network.”
- [121] O. Bouhali, M. Berkouk, and B. Francois, “Solving Harmonics Elimination Problem in Voltage-controlled Three Phase Inverter using Artificial Neural Networks,” *Journal of Electrical Systems*, vol. 1, no. 1, pp. 47–61, 2005.
- [122] X. Yan, D. Abbes, and B. Francois, “Solar radiation forecasting using artificial neural network for local power reserve,” in *International Conference on Electrical Sciences and Technologies in Maghreb (CISTEM), Tunis, 3-6 Novembre, 2014*, pp. 1–6.
- [123] A. Nadal, “Influence des incertitudes sur l’optimisation technico-économique de systèmes énergétiques hybrides. PhD Thesis,” Université Grenoble Alpes, 2019.
- [124] G. Mavromatidis, K. Orehounig, and J. Carmeliet, “Uncertainty and global sensitivity analysis for the optimal design of distributed energy systems,” *Applied Energy*, vol. 214, pp. 219–238, Mar. 2018.
- [125] T. Aven, “Interpretations of alternative uncertainty representations in a reliability and risk analysis context,” *Reliability Engineering and System Safety*, vol. 96, no. 3, pp. 353–360, Mar. 2011.
- [126] G. Mavromatidis, K. Orehounig, and J. Carmeliet, “A review of uncertainty characterisation approaches for the optimal design of distributed energy systems,” *Renewable and Sustainable Energy Reviews*, vol. 88. Elsevier Ltd, pp. 258–277, 01-May-2018.
- [127] A. R. Jordehi, “How to deal with uncertainties in electric power systems? A review,” *Renewable and Sustainable Energy Reviews*, vol. 96. Elsevier Ltd, pp. 145–155, 01-Nov-2018.
- [128] Z. Zhou, J. Zhang, P. Liu, Z. Li, M. C. Georgiadis, and E. N. Pistikopoulos, “A two-stage stochastic programming model for the optimal design of distributed energy systems,” *Applied Energy*, vol. 103, pp. 135–144, Mar. 2013.
- [129] Y. P. Cai, G. H. Huang, Z. F. Yang, Q. G. Lin, and Q. Tan, “Community-scale

- renewable energy systems planning under uncertainty-An interval chance-constrained programming approach,” *Renewable and Sustainable Energy Reviews*, vol. 13, no. 4, pp. 721–735, May-2009.
- [130] G. Giannakoudis, A. I. Papadopoulos, P. Seferlisa, and S. Voutetakis, “On the systematic design and optimization under uncertainty of a hybrid power generation system using renewable energy sources and hydrogen storage,” *Computer Aided Chemical Engineering*, vol. 28, no. C, pp. 907–912, Jan. 2010.
- [131] Y. Sun, P. Huang, and G. Huang, “A multi-criteria system design optimization for net zero energy buildings under uncertainties,” *Energy and Buildings*, vol. 97, pp. 196–204, Jun. 2015.
- [132] P. Arun, R. Banerjee, and S. Bandyopadhyay, “Optimum sizing of photovoltaic battery systems incorporating uncertainty through design space approach,” *Solar Energy*, vol. 83, no. 7, pp. 1013–1025, Jul. 2009.
- [133] M. Sharafi and T. Y. ElMekkawy, “Stochastic optimization of hybrid renewable energy systems using sampling average method,” *Renewable and Sustainable Energy Reviews*, vol. 52. Elsevier Ltd, pp. 1668–1679, 01-Dec-2015.
- [134] Y. Lu, S. Wang, C. Yan, and K. Shan, “Impacts of renewable energy system design inputs on the performance robustness of net zero energy buildings,” *Energy*, vol. 93, pp. 1595–1606, Dec. 2015.
- [135] A. Maheri, “Multi-objective design optimisation of standalone hybrid wind-PV-diesel systems under uncertainties,” *Renewable Energy*, vol. 66, pp. 650–661, Jun. 2014.
- [136] R. Mena, M. Hennebel, Y. F. Li, C. Ruiz, and E. Zio, “A risk-based simulation and multi-objective optimization framework for the integration of distributed renewable generation and storage,” *Renewable and Sustainable Energy Reviews*, vol. 37. Elsevier Ltd, pp. 778–793, 01-Sep-2014.
- [137] C. Z. Li, Y. M. Shi, S. Liu, Z. L. Zheng, and Y. C. Liu, “Uncertain programming of building cooling heating and power (BCHP) system based on Monte-Carlo method,” *Energy and Buildings*, vol. 42, no. 9, pp. 1369–1375, Sep. 2010.
- [138] S. Gamou, R. Yokoyama, and K. Ito, “Optimal unit sizing of cogeneration systems in consideration of uncertain energy demands as continuous random variables,” in *Energy Conversion and Management*, 2002, vol. 43, no. 9–12, pp. 1349–1361.
- [139] C. Z. Li, Y. M. Shi, and X. H. Huang, “Sensitivity analysis of energy demands on performance of CCHP system,” *Energy Conversion and Management*, vol. 49, no. 12, pp. 3491–3497, Dec. 2008.
- [140] S. H. Karaki, R. B. Chedid, and R. Ramadan, “Probabilistic performance assessment of autonomous solar-wind energy conversion systems,” *IEEE Transactions on Energy Conversion*, vol. 14, no. 3, pp. 766–772, 1999.
- [141] A. Zidan, H. A. Gabbar, and A. Eldessouky, “Optimal planning of combined heat and power systems within microgrids,” *Energy*, vol. 93, pp. 235–244, Dec. 2015.
- [142] Y. Li and E. Zio, “Uncertainty analysis of the adequacy assessment model of a distributed generation system,” *Renewable Energy*, vol. 41, pp. 235–244, May

- 2012.
- [143] A. D. Hawkes and M. A. Leach, "Modelling high level system design and unit commitment for a microgrid," *Applied Energy*, vol. 86, no. 7–8, pp. 1253–1265, Jul. 2009.
- [144] C. Kongnam, S. Nuchprayoon, S. Premrudeepreechacharn, and S. Uatrongjit, "Decision analysis on generation capacity of a wind park," *Renewable and Sustainable Energy Reviews*, vol. 13, no. 8, Pergamon, pp. 2126–2133, 01-Oct-2009.
- [145] Z. Liu, F. Wen, and G. Ledwich, "Optimal siting and sizing of distributed generators in distribution systems considering uncertainties," *IEEE Transactions on Power Delivery*, vol. 26, no. 4, pp. 2541–2551, Oct. 2011.
- [146] S. Zhang, P. Huang, and Y. Sun, "A multi-criterion renewable energy system design optimization for net zero energy buildings under uncertainties," *Energy*, vol. 94, pp. 654–665, Jan. 2016.
- [147] T. C. Hung and K. Y. Chan, "Optimization of a wind-integrated microgrid system with equipment sizing and dispatch strategy under resource uncertainty," *Journal of Mechanical Design, Transactions of the ASME*, vol. 137, no. 4, Apr. 2015.
- [148] O. Ekren and B. Y. Ekren, "Size optimization of a PV/wind hybrid energy conversion system with battery storage using simulated annealing," *Applied Energy*, vol. 87, no. 2, pp. 592–598, Feb. 2010.
- [149] O. Ekren and B. Y. Ekren, "Size optimization of a PV/wind hybrid energy conversion system with battery storage using response surface methodology," *Applied Energy*, vol. 85, no. 11, pp. 1086–1101, Nov. 2008.
- [150] M. David, F. Ramahatana, P. J. Trombe, and P. Lauret, "Probabilistic forecasting of the solar irradiance with recursive ARMA and GARCH models," *Solar Energy*, vol. 133, pp. 55–72, Aug. 2016.
- [151] W. C. B. Vicente, "Modélisation stochastique des réseaux de distribution sous incertitude. PhD thesis," Université de Grenoble, 2012.
- [152] M. A. Ortega-Vazquez and D. S. Kirschen, "Estimating the Spinning Reserve Requirements," *IEEE Trans. Power Systems*, vol. 24, no. 1, pp. 114–124, 2009.
- [153] D. Pozo and J. Contreras, "A Chance-Constrained Unit Commitment With an n-K Security Criterion and Significant Wind Generation," *IEEE Transactions on Power Systems*, vol. 28, no. 3, pp. 2842–2851, 2013.
- [154] Y. Guan and J. Wang, "Uncertainty sets for robust unit commitment," *IEEE Transactions on Power Systems*, vol. 29, no. 3, pp. 1439–1440, 2014.
- [155] R. A. Jabr, "Robust self-scheduling under price uncertainty using conditional value-at-risk," *IEEE Transactions on Power Systems*, vol. 20, no. 4, pp. 1852–1858, 2005.
- [156] Y. Huang, Q. P. Zheng, and J. Wang, "Two-stage stochastic unit commitment model including non-generation resources with conditional value-at-risk constraints," *Electric Power Systems Research*, vol. 116, pp. 427–438, 2014.
- [157] A. J. Conejo, F. J. Nogales, J. M. Arroyo, and R. García-Bertrand, "Risk-constrained self-scheduling of a thermal power producer," *IEEE Transactions*

- on Power Systems*, vol. 19, no. 3, pp. 1569–1574, 2004.
- [158] H. B. Gooi, D. P. Mendes, K. R. W. Bell, and D. S. Kirschen, “Optimal scheduling of spinning reserve,” *IEEE Transactions on Power Systems*, vol. 14, no. 4, pp. 1485–1492, 1999.
- [159] F. Bouffard and F. D. Galiana, “An electricity market with a probabilistic spinning reserve criterion,” *IEEE Transactions on Power Systems*, vol. 19, no. 1, pp. 300–307, 2004.
- [160] U. A. Ozturk, M. Mazumdar, and B. A. Norman, “A solution to the stochastic unit commitment problem using chance constrained programming,” *IEEE Transactions on Power Systems*, vol. 19, no. 3, pp. 1589–1598, 2004.
- [161] Q. Wang, J. Wang, and Y. Guan, “Stochastic unit commitment with uncertain demand response,” *IEEE Transactions on Power Systems*, vol. 28, no. 1, pp. 562–563, 2013.
- [162] M. Aien, A. Hajebrahimi, and M. Fotuhi-Firuzabad, “A comprehensive review on uncertainty modeling techniques in power system studies,” *Renewable and Sustainable Energy Reviews*, vol. 57, pp. 1077–1089, May 2016.
- [163] E. De Rocquigny, N. Devictor, and S. Tarantola, “Uncertainty in Industrial Practice: A guide to Quantitative Uncertainty Management,” *John Wiley & Sons*. John Wiley & Sons, Ltd, Chichester, UK, p. 364, 11-Apr-2008.
- [164] R. Dufo-López, E. Pérez-Cebollada, J. L. Bernal-Agustín, and I. Martínez-Ruiz, “Optimisation of energy supply at off-grid healthcare facilities using Monte Carlo simulation,” *Energy Conversion and Management*, vol. 113, pp. 321–330, Apr. 2016.
- [165] A. Saltelli and P. Annoni, “How to avoid a perfunctory sensitivity analysis,” *Environmental Modelling and Software*, vol. 25, no. 12, pp. 1508–1517, Dec. 2010.
- [166] A. Saltelli *et al.*, *Global Sensitivity Analysis. The Primer*. Chichester, UK: John Wiley and Sons, 2008.
- [167] E. Borgonovo and E. Plischke, “Sensitivity analysis: A review of recent advances,” *European Journal of Operational Research*, vol. 248, no. 3. Elsevier B.V., pp. 869–887, 01-Feb-2016.
- [168] B. Iooss and P. Lemaître, “A review on global sensitivity analysis methods,” *Operations Research/ Computer Science Interfaces Series*, vol. 59, pp. 101–122, 2015.
- [169] W. Su, J. Wang, and J. Roh, “Stochastic energy scheduling in Microgrids with intermittent renewable energy resources,” *IEEE Transactions on Smart Grid*, vol. 5, no. 4, pp. 1876–1883, 2014.
- [170] M. A. Matos and R. J. Bessa, “Setting the operating reserve using probabilistic wind power forecasts,” *IEEE Transactions on Power Systems*, vol. 26, no. 2, pp. 594–603, 2011.
- [171] N. V. Sahinidis, “Optimization under uncertainty: state-of-the-art and opportunities,” *Computers & Chemical Engineering-Elsevier*, vol. 28, no. 6–7, pp. 971–983, 2004.
- [172] X. Yan, D. Abbes, and B. Francois, “Development of a tool for urban microgrid

- optimal energy planning and management,” *Simulation Modelling Practice and Theory*, vol. 89, pp. 64–81, 2018.
- [173] C. Chen, S. Duan, T. Cai, B. Liu, and H. G., “Smart energy management system for optimal microgrid economic operation,” *IET Renewable Power Generation*, vol. 5, no. 3, pp. 258–267, 2011.
- [174] R. J. Bessa *et al.*, “Reserve setting and steady-state security assessment using wind power uncertainty forecast: A case study,” *IEEE Transactions on Sustainable Energy*, vol. 3, no. 4, pp. 827–836, 2012.
- [175] M. Q. Wang, M. Yang, Y. Liu, X. S. Han, and Q. Wu, “Optimizing probabilistic spinning reserve by an umbrella contingencies constrained unit commitment,” *International Journal of Electrical Power & Energy Systems*, vol. 109, pp. 187–197, Jul. 2019.
- [176] A. Baziar and A. Kavousi-Fard, “Considering uncertainty in the optimal energy management of renewable micro-grids including storage devices,” *Renewable Energy*, vol. 59, pp. 158–166, Nov. 2013.
- [177] M. Milligan *et al.*, “Operating Reserves and Wind Power Integration: An International Comparison; Preprint,” in *9th Annual International Workshop on Large-Scale Integration of Wind Power into Power Systems*, 2010.
- [178] M. A. O. Vazquez, “Optimizing the Spinning Reserve Requirements. PhD thesis,” University of Manchester, 2006.
- [179] J. H. Eto *et al.*, “Use of Frequency Response Metrics to Assess the Planning and Operating Requirements for Reliable Integration of Variable Renewable Generation,” Berkeley, CA (United States), Dec. 2010.
- [180] S. H. E. A. Aleem, A. Y. Abdelaziz, A. F. Zobaa, B. Ramesh, and R. Bansal, *Decision Making Applications in Modern Power Systems*. Elsevier Science & Technology, 2019.
- [181] PJM, “PJM Manual 13: Emergency Operations, Available online: <https://www.pjm.com/-/media/documents/manuals/m13.ashx>,” 2020.
- [182] D. Chattopadhyay and R. Baldick, “Unit commitment with probabilistic reserve,” in *Proceedings of the IEEE Power Engineering Society Transmission and Distribution Conference*, 2002, vol. 1, pp. 280–285.
- [183] R. Billinton and R. Karki, “Capacity reserve assessment using system well-being analysis,” *IEEE Transactions on Power Systems*, vol. 14, no. 2, pp. 433–438, 1999.
- [184] ENTSO-E, “Continental Europe Operation Handbook, Available online: <https://www.entsoe.eu/publications/system-operations-reports/#continental-europe-operation-handbook>,” 2009.
- [185] L. T. Anstine, R. E. Burke, J. E. Casey, R. Holgate, R. S. John, and H. G. Stewart, “Application of Probability Methods to the Determination of Spinning Reserve Requirements for the Pennsylvania-New Jersey-Maryland Interconnection,” *IEEE Transactions on Power Apparatus and Systems*, vol. 82, no. 68, pp. 726–735, 1963.
- [186] A. Merlin and P. Sandrin, “A new method for unit commitment at electricite de france,” *IEEE Transactions on Power Apparatus and Systems*, vol. PAS-102, no.



- 5, pp. 1218–1225, 1983.
- [187] M. Flynn, W. P. Sheridan, J. D. Dillon, and M. J. O’Malley, “Reliability and reserve in competitive electricity market scheduling,” *IEEE Transactions on Power Systems*, vol. 16, no. 1, pp. 78–87, Feb. 2001.
- [188] A. M. Leite Da Silva and G. P. Alvarez, “Operating reserve capacity requirements and pricing in deregulated markets using probabilistic techniques,” *IET Generation, Transmission and Distribution*, vol. 1, no. 3, pp. 439–446, 2007.
- [189] J. Wang, X. Wang, and Y. Wu, “Operating reserve model in the power market,” *IEEE Transactions on Power Systems*, vol. 20, no. 1, pp. 223–229, Feb. 2005.
- [190] M. A. Ortega-Vazquez and D. S. Kirschen, “Optimizing the spinning reserve requirements using a cost/benefit analysis,” *IEEE Transactions on Power Systems*, vol. 22, no. 1, pp. 24–33, 2007.
- [191] J. C. Smith, M. R. Milligan, E. A. DeMeo, and B. Parsons, “Utility wind integration and operating impact state of the art,” *IEEE Transactions on Power Systems*, vol. 22, no. 3, pp. 900–908, Aug. 2007.
- [192] E. Ela *et al.*, “Evolution of operating reserve determination in wind power integration studies,” in *IEEE PES General Meeting, PES 2010*, 2010.
- [193] M. A. Ortega-Vazquez and D. S. Kirschen, “Estimating the spinning reserve requirements in systems with significant wind power generation penetration,” *IEEE Transactions on Power Systems*, vol. 24, no. 1, pp. 114–124, 2009.
- [194] P. Pinson, “Estimation of the uncertainty in wind power forecasting,” *École Nationale Supérieure des Mines de Paris*, 2006.
- [195] J. M. Morales, A. J. Conejo, and J. Pérez-Ruiz, “Economic valuation of reserves in power systems with high penetration of wind power,” *IEEE Transactions on Power Systems*, vol. 24, no. 2, pp. 900–910, 2009.
- [196] S. Khan, W. Gawlik, and P. Palensky, “Reserve Capability Assessment Considering Correlated Uncertainty in Microgrid,” *IEEE Transactions on Sustainable Energy*, vol. 7, no. 2, pp. 637–646, Apr. 2016.
- [197] X. Yan, X. Wen, B. Francois, and D. Abbes, “Management and dispatching of distributed operating power reserve in an urban microgrid beyond DSO risk decision,” in *CIREN Workshop*, 2018.
- [198] J. M. Morales, A. J. Conejo, H. Madsen, P. Pinson, and M. Zugno, *Integrating renewables in electricity markets - Operational problems*. Springer, Boston, MA, 2014.
- [199] C. L. Chen, “Optimal wind-thermal generating unit commitment,” *IEEE Transactions on Energy Conversion*, vol. 23, no. 1, pp. 273–280, Mar. 2008.
- [200] R. Luthander, J. Widén, D. Nilsson, and J. Palm, “Photovoltaic self-consumption in buildings: A review,” *Applied Energy*, vol. 142. Elsevier Ltd, pp. 80–94, 05-Mar-2015.
- [201] R. Bellman, *Dynamic programming*. Courier Corporation, 2013.
- [202] J. W. Tukey, “Box-and-Whisker Plots.” §2C in *Exploratory data analysis*, vol. 2. Reading, MA: Addison-Wesley, 1977.
- [203] J. Löfberg, “YALMIP: A toolbox for modeling and optimization in MATLAB,” in *Proceedings of the CACSD*, 2004.

- [204] “IBM ILOG CPLEX Optimization Solver 12.8 [Online],” 2019. [Online]. Available: <https://www.ibm.com/analytics/cplex-optimizer>.
- [205] M. H. Moradi and M. Eskandari, “A hybrid method for simultaneous optimization of DG capacity and operational strategy in microgrids considering uncertainty in electricity price forecasting,” *Renewable Energy*, vol. 68, pp. 697–714, Aug. 2014.
- [206] M. Esmaili, M. Sedighzadeh, and M. Esmaili, “Multi-objective optimal reconfiguration and DG (Distributed Generation) power allocation in distribution networks using Big Bang-Big Crunch algorithm considering load uncertainty,” *Energy*, vol. 103, pp. 86–99, May 2016.
- [207] R. B. Hytowitz and K. W. Hedman, “Managing solar uncertainty in microgrid systems with stochastic unit commitment,” *Electric Power Systems Research*, vol. 119, pp. 111–118, Feb. 2015.
- [208] M. Asensio and J. Contreras, “Stochastic Unit Commitment in Isolated Systems With Renewable Penetration Under CVaR Assessment,” *IEEE Transactions on Smart Grid*, vol. 7, no. 3, pp. 1356–1367, May 2016.
- [209] A. Papavasiliou and S. S. Oren, “Multiarea stochastic unit commitment for high wind penetration in a transmission constrained network,” *Operations Research*, vol. 61, no. 3, pp. 578–592, 2013.
- [210] K. Hreinsson, M. Vrakopoulou, and G. Andersson, “Stochastic security constrained unit commitment and non-spinning reserve allocation with performance guarantees,” *International Journal of Electrical Power & Energy Systems*, vol. 72, pp. 109–115, Nov. 2015.
- [211] L. Wu, M. Shahidehpour, and Z. Li, “Comparison of Scenario-Based and Interval Optimization Approaches to Stochastic SCUC,” *IEEE Transactions on Power Systems*, vol. 27, no. 2, pp. 913–921, May 2012.
- [212] M. Håberg, “Fundamentals and recent developments in stochastic unit commitment,” *International Journal of Electrical Power & Energy Systems*, vol. 109, pp. 38–48, Jul. 2019.
- [213] K. Bruninx, K. Van den Bergh, E. Delarue, and W. D’haeseleer, “Optimization and allocation of spinning reserves in a low-carbon framework,” *IEEE Transactions on Power Systems*, vol. 31, no. 2, pp. 872–882, 2015.
- [214] M. Hijjo and G. Frey, “Multi-objective optimization for scheduling isolated microgrids,” *Proceedings of the IEEE International Conference on Industrial Technology*, vol. 2018-Febru, pp. 1037–1042, 2018.
- [215] R. Rigo-Mariani, B. Sareni, X. Roboam, and C. Turpin, “Optimal power dispatching strategies in smart-microgrids with storage,” *Renewable and Sustainable Energy Reviews*, vol. 40, pp. 649–658, 2014.
- [216] F. A. Mohamed and H. N. Koivo, “Multiobjective optimization using modified game theory for online management of microgrid,” *European Transactions on Electrical Power*, vol. 21, no. 1, pp. 839–854, Jan. 2011.
- [217] T. A. Nguyen and M. L. Crow, “Stochastic Optimization of Renewable-Based Microgrid Operation Incorporating Battery Operating Cost,” *IEEE Transactions on Power Systems*, vol. 31, no. 3, pp. 2289–2296, May 2016.

- [218] W. Hu, P. Wang, and H. B. Gooi, "Toward Optimal Energy Management of Microgrids via Robust Two-Stage Optimization," *IEEE Transactions on Smart Grid*, vol. 9, no. 2, pp. 1161–1174, Mar. 2018.
- [219] D. Wang, J. Qiu, L. Reedman, K. Meng, and L. L. Lai, "Two-stage energy management for networked microgrids with high renewable penetration," *Applied Energy*, vol. 226, pp. 39–48, Sep. 2018.
- [220] M. Vahedipour-Dahraei, H. R. Najafi, A. Anvari-Moghaddam, and J. M. Guerrero, "Security-constrained unit commitment in AC microgrids considering stochastic price-based demand response and renewable generation," *International Transactions on Electrical Energy Systems*, vol. 28, no. 9, p. e2596, Sep. 2018.
- [221] D. E. Olivares, J. D. Lara, C. A. Canizares, and M. Kazerani, "Stochastic-Predictive Energy Management System for Isolated Microgrids," *IEEE Transactions on Smart Grid*, vol. 6, no. 6, pp. 2681–2693, Nov. 2015.
- [222] L. A. Barrios, J. B. Valerino, A. R. Del Nozal, J. M. Escano, J. L. Martinez-Ramos, and F. Gonzalez-Longatt, "Stochastic unit commitment in microgrids based on model predictive control," in *2018 International Conference on Smart Energy Systems and Technologies, SEST 2018 - Proceedings*, 2018.
- [223] S. M. Moghaddas Tafreshi, H. Ranjbarzadeh, M. Jafari, and H. Khayyam, "A probabilistic unit commitment model for optimal operation of plug-in electric vehicles in microgrid," *Renewable and Sustainable Energy Reviews*, vol. 66. Elsevier Ltd, pp. 934–947, 01-Dec-2016.
- [224] V. Mohan, J. G. Singh, and W. Ongsakul, "An efficient two stage stochastic optimal energy and reserve management in a microgrid," *Applied Energy*, vol. 160, pp. 28–38, 2015.
- [225] S. Mohammadi, B. Mozafari, S. Solymani, and T. Niknam, "Stochastic scenario-based model and investigating size of energy storages for PEM-fuel cell unit commitment of micro-grid considering profitable strategies," *IET Generation, Transmission and Distribution*, vol. 8, no. 7, pp. 1228–1243, Jul. 2014.
- [226] T. Soares, "Renewable energy sources offering flexibility through electricity markets," Technical University of Denmark, Department of Electrical Engineering, 2017.
- [227] M. F. Anjos and A. J. Conejo, "Unit Commitment in Electric Energy Systems," *Foundations and Trends® in Electric Energy Systems*, vol. 1, no. 4, pp. 220–310, 2017.
- [228] S. Solomon, D. Qin, M. Manning, K. Averyt, and M. Marquis, *Climate change 2007-the physical science basis: Working group I contribution to the fourth assessment report of the IPCC*. Cambridge University Press, 2007.
- [229] G. M. Gaddis and M. L. Gaddis, "Introduction to biostatistics: Part 2, descriptive statistics," *Annals of Emergency Medicine*, vol. 19, no. 3, pp. 309–315, Mar. 1990.
- [230] K. D. Hopkins, G. V. Glass, and B. R. Hopkins, *Basic statistics for the behavioral sciences*, 2nd ed. Englewood Cliffs, NJ, US: Prentice-Hall, Inc, 1987.
- [231] T. Gönen, *Electric power distribution engineering*. CRC press, 2015.

---

## REFERENCES

---

- [232] “Tesla Motors Powerwall Tesla Home Battery,” 2020. [Online]. Available: <https://www.tesla.com/powerwall>.
- [233] “SonnenBatterie,” 2020. [Online]. Available: <https://sonnen.com.au/sonnenbatterie/>.
- [234] D. Muoio, “Nissan is going after Tesla’s other big business with a new at-home battery,” 2016. [Online]. Available: <https://www.businessinsider.com/nissan-releases-xstorage-at-home-battery-2016-5?IR=T>.
- [235] D. Muoio, “Mercedes is building a suitcase-sized battery that can help power your home,” 2016. [Online]. Available: <https://www.businessinsider.com/mercedes-creates-home-battery-2016-5?IR=T>.
- [236] “Home energy storage system: xStorage Home,” 2020. [Online]. Available: <https://www.eaton.com/gb/en-gb/company/news-insights/what-matters/residential-emea/home-energy-storage.html>.
- [237] B. Robyns, B. Francois, G. Delille, and C. Saudemont, *Energy Storage in Electric Power Grids*. Wiley-ISTE, 2015.
- [238] T. Terlouw, T. AlSkaif, C. Bauer, and W. van Sark, “Multi-objective optimization of energy arbitrage in community energy storage systems using different battery technologies,” *Applied Energy*, vol. 239, pp. 356–372, Apr. 2019.
- [239] J. García-González, R. M. R. de la Muela, L. M. Santos, and A. M. Gonzalez, “Stochastic joint optimization of wind generation and pumped-storage units in an electricity market,” *IEEE Transactions on Power Systems*, vol. 23, no. 2, pp. 460–468, May 2008.
- [240] E. A. Bakirtzis, C. K. Simoglou, P. N. Biskas, and A. G. Bakirtzis, “Storage management by rolling stochastic unit commitment for high renewable energy penetration,” *Electric Power Systems Research*, vol. 158, pp. 240–249, May 2018.
- [241] W. B. Powell and S. Meisel, “Tutorial on Stochastic Optimization in Energy - Part II: An Energy Storage Illustration,” *IEEE Transactions on Power Systems*, vol. 31, no. 2, pp. 1468–1475, Mar. 2016.
- [242] R. Jiang, J. Wang, and Y. Guan, “Robust unit commitment with wind power and pumped storage hydro,” *IEEE Transactions on Power Systems*, vol. 27, no. 2, pp. 800–810, May 2012.
- [243] A. Lorca and X. A. Sun, “Multistage Robust Unit Commitment with Dynamic Uncertainty Sets and Energy Storage,” *IEEE Transactions on Power Systems*, vol. 32, no. 3, pp. 1678–1688, May 2017.
- [244] A. Papavasiliou, Y. Mou, L. Cambier, and D. Scieur, “Application of stochastic dual dynamic programming to the real-time dispatch of storage under renewable supply uncertainty,” *IEEE Transactions on sustainable energy*, vol. 9, no. 2, pp. 547–558, 2018.
- [245] T. Kaneda *et al.*, “Optimal management of storage for offsetting solar power uncertainty using multistage stochastic programming,” in *20th Power Systems Computation Conference, PSCC 2018*, 2018.
- [246] R. Fioravanti, K. Vu, and W. Stadlin, “Large-scale solutions,” *IEEE Power and*

- Energy Magazine*, vol. 7, no. 4, pp. 48–57, 2009.
- [247] H. M. I. Pousinho, H. Silva, V. M. F. Mendes, M. Collares-Pereira, and C. Pereira Cabrita, “Self-scheduling for energy and spinning reserve of wind/CSP plants by a MILP approach,” *Energy*, vol. 78, pp. 524–534, Dec. 2014.
- [248] H. Akhavan-Hejazi and H. Mohsenian-Rad, “Optimal operation of independent storage systems in energy and reserve markets with high wind penetration,” *IEEE Transactions on Smart Grid*, vol. 5, no. 2, pp. 1088–1097, Mar. 2014.
- [249] M. U. Usama, D. Kelle, and T. Baldwin, “Utilizing spinning reserves as energy storage for renewable energy integration,” in *2014 Clemson University Power Systems Conference, PSC 2014*, 2014.
- [250] K. Deb, *Multi-objective optimization using evolutionary algorithms*. John Wiley & Sons, 2001.
- [251] S. Bahramirad, W. Reder, and A. Khodaei, “Reliability-Constrained Optimal Sizing of Energy Storage System in a Microgrid,” *IEEE TRANSACTIONS ON SMART GRID*, vol. 3, no. 4, pp. 2056–2062, 2012.
- [252] S. X. Chen, H. B. Gooi, and M. Q. Wang, “Sizing of energy storage for microgrids,” *IEEE Transactions on Smart Grid*, vol. 3, no. 1, pp. 142–151, Mar. 2012.
- [253] A. Navaeefard, S. M. M. Tafreshi, M. Barzegari, and A. J. Shahrood, “Optimal sizing of distributed energy resources in microgrid considering wind energy uncertainty with respect to reliability,” *2010 IEEE International Energy Conference and Exhibition, EnergyCon 2010*, pp. 820–825, 2010.
- [254] H. T. Le and T. Q. Nguyen, “Sizing energy storage systems for wind power firming: An analytical approach and a cost-benefit analysis,” in *IEEE Power and Energy Society 2008 General Meeting: Conversion and Delivery of Electrical Energy in the 21st Century, PES*, 2008.
- [255] J. K. Kaldellis, D. Zafirakis, and E. Kondili, “Optimum sizing of photovoltaic-energy storage systems for autonomous small islands,” *International Journal of Electrical Power and Energy Systems*, vol. 32, no. 1, pp. 24–36, Jan. 2010.
- [256] H. Bludszweit and J. A. Domínguez-Navarro, “A probabilistic method for energy storage sizing based on wind power forecast uncertainty,” *IEEE Transactions on Power Systems*, vol. 26, no. 3, pp. 1651–1658, Aug. 2011.
- [257] S. Semaoui, A. Hadj Arab, S. Bacha, and B. Azoui, “Optimal sizing of a stand-alone photovoltaic system with energy management in isolated areas,” in *Energy Procedia*, 2013, vol. 36, pp. 358–368.
- [258] H. Jia, Y. Mu, and Y. Qi, “A statistical model to determine the capacity of battery-supercapacitor hybrid energy storage system in autonomous microgrid,” *International Journal of Electrical Power and Energy Systems*, vol. 54, pp. 516–524, Jan. 2014.
- [259] A. Abbassi, M. A. Dami, and M. Jemli, “A statistical approach for hybrid energy storage system sizing based on capacity distributions in an autonomous PV/Wind power generation system,” *Renewable Energy*, vol. 103, pp. 81–93, Apr. 2017.
- [260] R. Bayindir, I. Colak, O. Kaplan, and C. Can, “MATLAB/GUI based simulation for photovoltaic systems,” in *International Conference on Power Engineering*,

- Energy and Electrical Drives*, 2011.
- [261] M. Ayaz, I. Colak, and R. Bayindir, "MATLAB/GUI based wind turbine generator types on smart grid systems," in *2016 IEEE International Conference on Renewable Energy Research and Applications, ICRERA 2016*, 2016, pp. 1158–1162.
- [262] D. H. Moore, J. M. Murray, F. P. Maturana, T. Wendel, and K. A. Loparo, "Agent-based control of a DC MicroGrid," in *2013 IEEE Energytech, Energytech 2013*, 2013.
- [263] M. Pipattanasomporn, M. Kuzlu, and S. Rahman, "An algorithm for intelligent home energy management and demand response analysis," *IEEE Transactions on Smart Grid*, vol. 3, no. 4, pp. 2166–2173, 2012.
- [264] M. C. Magro, M. Giannettoni, P. Pinceti, and M. Vanti, "Real time simulator for microgrids," *Electric Power Systems Research*, vol. 160, pp. 381–396, Jul. 2018.
- [265] E. Schweitzer, K. Togawa, T. Schlösser, and A. Monti, "A Matlab GUI for the generation of distribution grid models," in *International ETG Congress 2015; Die Energiewende - Blueprints for the New Energy Age*, 2015.
- [266] B. Francois, "Orthogonal considerations in the design of neural networks for function approximation," *Mathematics and Computers in Simulation*, vol. 41, no. 1–2, pp. 95–108, Jun. 1996.
- [267] R. Walpole, R. Myers, S. Myers, and K. Ye, *Probability and Statistics for Engineers and Scientists*, 9th ed. Pearson, 2012.
- [268] E. Langford, "Quartiles in Elementary Statistics," *Journal of Statistics Education*, vol. 14, no. 3, Jan. 2006.
- [269] J. Zhu, *Optimization of power system operation*, vol. 47. John Wiley & Sons, 2015.
- [270] J. R. Birge and F. Louveaux, *Introduction to stochastic programming*. Springer Science & Business Media, 2011.
- [271] "Cuts in solving mixed integer programming optimizer," 2020. [Online]. Available: [https://www.ibm.com/support/knowledgecenter/SSSA5P\\_12.7.1/ilog.odms.cplex.help/CPLEX/UsrMan/topics/dscr\\_optim/mip/cuts/26\\_cuts\\_title\\_synopsis.html](https://www.ibm.com/support/knowledgecenter/SSSA5P_12.7.1/ilog.odms.cplex.help/CPLEX/UsrMan/topics/dscr_optim/mip/cuts/26_cuts_title_synopsis.html).

#### Titre en français

Optimisation stochastique pour la planification de la production d'électricité dans une communauté énergétique locale en situation d'incertitude liée aux énergies renouvelables

#### Résumé en français

Dans un système électrique, la planification opérationnelle (PO) consiste à prévoir l'utilisation de générateurs ainsi que leurs références de puissance pour satisfaire la demande tout en respectant les contraintes d'exploitation du système. De nos jours, des communautés énergétiques ont émergé avec des besoins énergétiques individuels et une augmentation de la production distribuée. La forte pénétration des sources d'énergies renouvelables accroît localement l'incertitude liée à leur prévision J+1 tandis que les exigences en matière de fiabilité du système électrique augmentent. Par conséquent, les approches déterministes traditionnelles pour la PO doivent évoluer vers une optimisation stochastique. Ce travail explore l'apport des méthodes d'optimisation probabiliste et stochastique pour la planification opérationnelle de la production d'électricité et des réserves de puissance (RP) dans un micro réseau urbain avec le souhait de réduire au minimum les coûts d'exploitation et les émissions. Sur la base d'une modélisation d'incertitude avec des distributions d'erreur de prévision, une méthode d'évaluation des risques basée sur le critère probabilité de la perte de charge (LOLP) est utilisée pour déterminer une quantité appropriée de RP pour chaque pas de temps du jour suivant. Ensuite, dans une première étape, une optimisation déterministe utilisant une méthode de programmation linéaire en nombres entiers mixtes (MILP) décide la PO avec la prévision de la demande de charge et de la production PV pour la journée. Dans une deuxième étape, un ensemble de scénarios est construit pour modéliser les incertitudes futures et probables. Il est intégré dans une optimisation stochastique du PO. L'objectif de la deuxième étape est de prévoir l'utilisation éventuelle de générateurs suffisamment flexibles et rapides pour compenser les écarts inattendus de puissance par rapport aux prévisions. Pour contribuer à la diminution des émissions, la planification de systèmes de stockage locaux est ensuite considérée pour la fourniture de cette RP ; l'autoconsommation d'énergie PV s'en trouve augmentée et les coûts opérationnels réduits. La méthodologie proposée est illustrée par les résultats obtenus à partir d'un système de micro réseau urbain étudié. Un système convivial de contrôle de supervision et d'acquisition de données est développé avec l'interface graphique Matlab pour intégrer et visualiser l'opération de gestion de l'énergie.

**Mots-clés :** Optimisation stochastique, incertitude, engagement des générateurs (planification de la production), système de gestion de l'énergie, puissance de réserve, énergie renouvelable, micro réseau

#### Titre en anglais

Stochastic optimization for generation scheduling in a local energy community under renewable energy uncertainty

#### Résumé en anglais

In electrical systems, the unit commitment (UC) and power scheduling plan the operating of generating units in order to satisfy the load demand under system operating constraints. Nowadays, energy communities have emerged with individual community energy requirements and increasing capacity deployment of distributed energy resources. The high penetration of renewable energy sources (RES) and load demand increase locally the power system uncertainty. Hence, traditional deterministic approaches for one day ahead UC should evolve to stochastic optimization methods. The main goal of this thesis is to propose a probabilistic-based and stochastic optimization methodology for optimal generation and operating power reserve (OR) scheduling decisions in an urban microgrid, with the objective of addressing the minimization of operating costs and emissions. Based on an uncertainty modelling with forecasting error distributions, a loss of load probability-based (LOLP-based) risk assessment method is used to determine an appropriate amount of OR for each time step of the next day. Then, in the first stage, a deterministic optimization within a mixed-integer linear programming (MILP) method generates the unit commitment of controllable generators with the day-ahead PV and load demand prediction. In the second stage, a set of scenarios is built to model future and probable uncertainties. It is integrated into a stochastic optimization of the operational planning. Issues of the second stage are the commitment of enough flexible and fast generators to handle unexpected deviations from predictions. In order to decrease emissions, the scheduling and operational planning of local storage systems for OR provision is considered; the PV self-consumption is increased and operational costs are decreased. The significance of the proposed methodology is illustrated with results obtained from a studied urban microgrid system. A user-friendly Supervisory Control and Data Acquisition system is developed with the Matlab GUI to integrate and visualize the energy management operation.

**Mots-clés :** Stochastic optimization, uncertainty, unit commitment (generation scheduling), energy management system, power reserve, renewable energy, microgrid