



**HAL**  
open science

# Modeling of a prediction controller for energy coordination in the residential pools, considering the market model

Moch Arief Albachrony

► **To cite this version:**

Moch Arief Albachrony. Modeling of a prediction controller for energy coordination in the residential pools, considering the market model. Electric power. Université Paris-Saclay, 2021. English. NNT : 2021UPAST019 . tel-03271344

**HAL Id: tel-03271344**

**<https://theses.hal.science/tel-03271344>**

Submitted on 25 Jun 2021

**HAL** is a multi-disciplinary open access archive for the deposit and dissemination of scientific research documents, whether they are published or not. The documents may come from teaching and research institutions in France or abroad, or from public or private research centers.

L'archive ouverte pluridisciplinaire **HAL**, est destinée au dépôt et à la diffusion de documents scientifiques de niveau recherche, publiés ou non, émanant des établissements d'enseignement et de recherche français ou étrangers, des laboratoires publics ou privés.

# Modeling of A Prediction Controller for Energy Coordination in the Residential Pools Considering the Market Model

**Thèse de doctorat de l'université Paris-Saclay**

École doctorale n° 575, Electrical, Optic, Bio :  
Physics and Engineering (EOBE)

Spécialité de doctorat: Génie Electrique

Unité de recherche : Université Paris-Saclay, CentraleSupélec, CNRS, Laboratoire de  
Génie Electrique et Electronique de Paris, 91192, Gif-sur-Yvette, France.

Référent : CentraleSupélec

**Thèse présentée et soutenue à Paris-Saclay,  
Le 26 Mars 2021, par**

**Moch Arief ALBACHRONY**

## Composition du Jury

**Demba DIALLO**

Professeur, GeePs, CentraleSupélec

Président

**Yvon BESANGER**

Professeur, G2ELab, UGA

Rapporteur / Examineur

**Bruno FRANCOIS**

Professeur, Centrale Lille

Rapporteur / Examineur

**Marc PETIT**

Professeur, GeePs, CentraleSupélec

Directeur de thèse

**Quoc Tuan TRAN**

Professeur, INSTN, CEA - INES

Invité

**Duy Long HA**

Docteur, CEA - INES

Invité

**Titre :** Modélisation du contrôleur de prévision pour la coordination énergétique en zone résidentielle et dans un contexte d'ouverture du marché

**Mots clés :** Consommation d'énergie, Home Energy Management System, Transfert de charge, Coordination énergétique, Model predictive controller, Mixed Integer Linear Programming

**Résumé :** La consommation d'énergie dans le secteur résidentiel – en particulier l'électricité – est amenée à croître de plus en plus du fait d'une plus grande électrification des usages. Par ailleurs, les objectifs de décarbonations de l'énergie, et la réduction de la part du nucléaire, conduit à un fort développement des sources d'énergie renouvelable. Parmi celles-ci il y a la production solaire photovoltaïque distribuée à l'échelle locale. Dans de nombreux pays, des incitations existent pour encourager les ménages à installer un système PV local afin de répondre à leur demande. Toutefois, sans actions spécifiques de contrôle de la demande locale, un surplus de production apparaît à certains moments de la journée. Ce surplus d'énergie peut être revendu au réseau selon un tarif fixé. Néanmoins, ce tarif diminue régulièrement pour tenir compte d'une réduction des coûts des solutions photovoltaïques et pour encourager une autoconsommation. La technique de gestion de l'énergie, à savoir le transfert de charge, est introduite lorsqu'elle permet à l'utilisateur de réduire ses coûts et d'améliorer son taux d'autoconsommation (SCR). Pour anticiper cette situation, les travaux de thèse ont permis de développer une gestion d'énergie pour transformer le client résidentiel (propriétaire PV) en prosumer qui deviendrait actif dans un contexte de libéralisation du secteur électrique. Ces prosumers peuvent aussi contribuer à un objectif d'autoconsommation

collective pour réduire le soutirage d'électricité du réseau par une communauté locale d'utilisateur (consommateur et producteurs). Le problème de la coordination de la consommation et de la production dans une communauté de prosumers est complexe. D'une part, il y a de nombreux facteurs à prendre en compte pour assurer un partage optimale d'énergie. D'un autre côté, le problème de la confidentialité survient lors du partage de données entre prosumers.

Ces travaux de recherche développent un contrôle prédictif (MPC) pour le système de gestion de l'énergie en utilisant la bibliothèque MORE où le chauffe-eau électrique (EWH) est également modélisé pour valider l'objectif. Le MPC est appliqué à plusieurs stratégies de coordination énergétique, comme les contrats bilatéraux, la coordination centralisée de l'énergie et la coordination de l'énergie entre les pools. La programmation linéaire mixte (MILP) devient une optimisation pour atteindre la réduction des coûts dans chaque ménage en s'appuyant sur les données de consommation du CEA et du logiciel "load profile generator". De plus, le modèle thermique du bâtiment a également été considérée comme un facteur de important pour réduction de coût en raison du fonctionnement du contrôleur HVAC. Un case d'étude District à Chambéry et à Jakarta pour analyser l'impact des algorithmes développées dans deux climats différents.

**Title :** Modeling of a prediction controller for energy coordination in the residential pools, considering the market model

**Keywords :** Energy consumption, Home Energy Management System, Load shifting, energy coordination, Model predictive controller, Mixed Integer Linear Programming

**Abstract :** Energy consumption in residential sector particularly electricity is expected to grow more and more in the next years and decades. In addition, low emissions targets and reduction of the nuclear power plants, are driven the strong deployment of renewable energy sources. Among them, PV solar plays a huge role at a very local scale. In many countries, there are incentives to encourage residential households to install PV panels to meet their demand. Nevertheless, without specific control actions of the demand, an energy surplus will emerge at certain period of the day. This surplus can be injected into the grid and sold to an energy supplier at a fixed tariff. However, this tariff is decreasing in order to consider the drop of PV solutions costs, and to encourage self-consumption. The energy management technique namely load shifting is introduced as it enables the users to reduce its costs and to improve its self consumption rate (SCR). To anticipate this fact, Energy coordination is developed for making the prosumer (PV owner) more active, and to enable them to search their incentive through the electricity market. These prosumers can also contribute to a collective self-consumption operation inside a pool or community to subsequently reduce the dependency for grid electricity. The challenge of coordination the consumption and production in a community of prosumer complex. In one hand,

there many factor to take into account as control based on the optimal dispatch. In another hand, the privacy issue happens when sharing data between prosumer.

This thesis research has developed a Model Predictive Controller (MPC) for energy management system using the MORE library for large scale where it could handle several constraints and solve the objective function. Electric water heater (EWH) is considered to participate for improvement of cost reduction. Then, MPC is applied for several energy coordination strategies such as bilateral contracts, centralized energy coordination and pool-to-pool energy coordination. Mixed Integer Linear Programming (MILP) become an optimization to reach cost reduction in each household relying on consumption data from CEA and load profile generator software. Furthermore, the building model is also considered as supporting factor for electricity cost because of HVAC controller operation. Consequently, it should be controlled in the MPC in accordance the household occupation and the environmental factor through weather data. District Chambéry and Jakarta become the use case for energy coordination where self consumption in the both district for demonstrated the performance of developed algorithmes in two different climate.

# Acknowledgement

In general, I would like to thank all people who encouraged and supported me from both technical and human point of view during these three years of intense work. I am thankful for all enriching and valuable conversions, which increased and contributed to my technical maturity and my ideas. In particular, I want to thank both my supervisors M. TRAN Quoc Tuan, M. PETIT Marc, M.HA Duy Long and M. BRUN Adrien for choosing me as candidate for this thesis, for dedicating me their time and for guiding and advancing me with their valuable experience.

I am also grateful for the financial support received by the CEA – INES, where I conducted this work. I want to thank M. BOURRY Franck our leader in the group of Smart Energy System for the support and the enthusiasm who incited me to work hardly and serenely

I also want to say thank to all members of jury. M. FRANCOIS Bruno, M. BERANGER Yves, M. DIALLO Demba, Mme. ALONSO Corinne and M. WARBITO for willingness to evaluate my thesis.

Finally yet importantly, I would like to thank my wife Ariana, my family and my friends for their constant encouragement and presence.

# Modélisation du contrôleur de prévision pour la coordination énergétique en zone résidentielle et dans un contexte d'ouverture du marché

## *Introduction*

L'énergie devient importante pour leurs activités quotidiennes. Plusieurs fois l'énergie dans le monde a fait la transition d'un majeur à l'autre. En trois décennies, la consommation d'énergie est progressivement apparue, où les combustibles fossiles continuent de dominer la demande mondiale d'énergie primaire. En fait, plusieurs d'entre eux, comme le pétrole, le gaz et le charbon, jouent toujours un rôle dans le système énergétique mondial, même si l'efficacité énergétique permet de contrôler la demande d'énergie.

Plusieurs aspects tels que la quantité croissante de logements et d'appareils équipés pour les activités humaines influencent également la croissance de la demande d'énergie, en particulier en électricité. Du point de vue démographique, la population humaine devrait augmenter, ce qui guidera l'avenir de la demande mondiale d'énergie. Les nouvelles technologies telles que les véhicules électriques, les chauffe-eau électriques et les bâtiments thermiques contribuent également à l'augmentation de la demande d'électricité dans le monde.

L'augmentation de la consommation d'électricité devient un enjeu important qui pousse à considérer et à planifier précisément la quantité et le type de ressource électrique. Le développement de centrales à combustibles fossiles classiques pourrait contribuer à répondre à la demande. Cependant, il reste à débattre des effets néfastes sur la société et l'environnement. De plus, les accords de Paris permettent à la plupart des pays du monde de maintenir la température mondiale en hausse en dessous de 2 degrés Celsius et de limiter la température à 1,5 degré Celsius au maximum. En conséquence, les combustibles fossiles devraient être réduits.

Révolution énergétique principalement dans le secteur des énergies renouvelables, connu sous le nom de « Transition énergétique ». Au début de la « transition énergétique », les gouvernements

de plusieurs pays du monde donnent l'occasion d'acquérir la capacité de la source d'énergie renouvelable (SER) dans le secteur de l'électricité. Les SER deviennent une alternative pour réduire la dépendance énergétique externe et en même temps, elles diminuent le problème environnemental lié à la consommation de combustibles fossiles. Au cours de la dernière décennie, les SER sont devenues le tiers de la production totale d'électricité installée dans le monde et la Chine reste en tête de la production d'énergie renouvelable. En Europe, depuis 2004, l'électricité SER est progressivement augmentée lorsque l'UE révisé sa politique relative à l'objectif de pourcentage de production de SER en 2030.

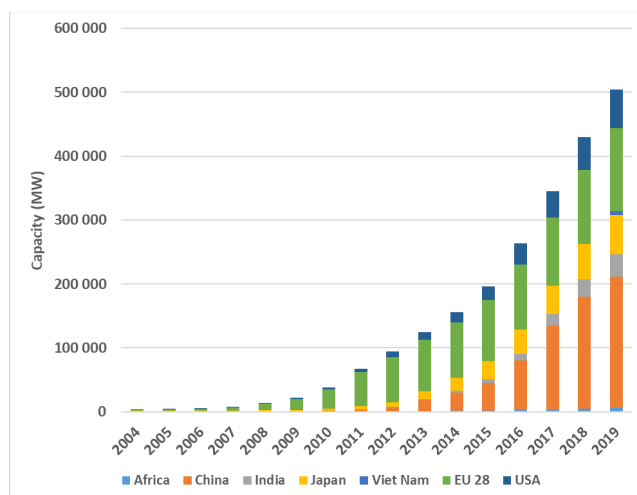

Fig.1 La capacité photovoltaïque installée dans le monde pour 2019

De toutes les sources d'énergie renouvelable, la technologie éolienne et solaire devient la plus populaire pour son utilisation. En particulier la technologie solaire, plusieurs pays augmentent leur capacité. On peut le constater à partir des données de l'AIE de 2004 à 2019. L'intérêt des gens pour cette technologie continue d'augmenter où il sera appliqué dans leur maison pour répondre à leur consommation d'électricité. De plus, le prix du module photovoltaïque est de plus en plus bas. La Chine reste en tête de liste pour la capacité photovoltaïque. Cependant, certains obstacles suivent le déploiement du photovoltaïque, tels que la technologie solaire, la livraison de projets et la vue d'ensemble de la main-d'œuvre, l'infrastructure énergétique, ainsi que la réglementation, la politique et la vue d'ensemble du marché.

Dans le secteur résidentiel, y compris les bâtiments, la demande d'électricité représente près de 31 % de la demande mondiale d'énergie pour les bâtiments. Le chauffage et le refroidissement entrent dans la demande parce qu'ils sont pris en compte pour la détermination de l'efficacité

énergétique des bâtiments. Plusieurs facteurs tels que la population, la superficie, la période de saison et la population géographique déterminent l'augmentation de la demande de refroidissement. Alors que la demande de chauffage est également augmentée dans les pays à quatre saisons. En conséquence, le gouvernement publie le règlement concernant la question de l'efficacité énergétique enveloppe tous les segments, y compris les zones de chauffage et de refroidissement. Le photovoltaïque intégré au bâtiment devient également l'alternative pour l'efficacité énergétique tandis que ses composants tels que la technologie, l'esthétique, l'efficacité énergétique, la fonctionnalité, la fiabilité et la flexibilité sont réunis dans le même concept. Plusieurs pays encouragent cette technologie et certaines entreprises à développer.

### *L'autoconsommation, Système de gestion de l'énergie domestique et partage d'énergie*

Le développement de technologies photovoltaïques dans le monde entier est prometteur devenir la principale alternative pour les transitions énergétiques. Plusieurs pays comme mentionné dans le chapitre précédent encouragent les propriétaires de maison à installer un système PV dans leur maison pour répondre à leur consommation d'énergie quotidienne ou il est connu sous le nom de « l'autoconsommation ». Le propriétaire de la maison utilise d'abord sa production photovoltaïque pour répondre à sa demande et prélève une petite partie de l'électricité du réseau. Le propriétaire de la maison qui consomme et produit de l'électricité est appelé « prosommateur » et reçoit l'indemnité du gouvernement. Ils donnent également le droit au propriétaire de vendre sa propre électricité là où le prix a été déterminé par eux. plusieurs pays ont commencé à réduire les tarifs de rachat garantis jusqu'à zéro pour les prochaines années. Pour surmonter la réduction, les propriétaires de maison devraient minimiser l'énergie renvoyée dans le réseau.

Par exemple, le pays ressemble à la France reconnaît l'autoconsommation pour leurs habitants où ils permettent aux ménages d'installer un système PV depuis 2007. la réglementation de l'autoconsommation pour les petits systèmes photovoltaïques privés a mis en place une incitation pour les systèmes photovoltaïques d'autoconsommation partielle en association avec le FiT de facturation nette. Dans le même temps, le candidat retenu pour l'appel d'offres sur l'autoconsommation photovoltaïque (système de 100 kW à 1 MW) obtiendra un bonus sur l'autoconsommation au taux proposé. Le gouvernement applique la durée du régime de



réglementation, comme l'excédent d'autoconsommation vendu en tarif des aliments pour animaux pendant 20 ans et l'offre d'autoconsommation pendant 10 ans.

Plusieurs facteurs stimulent le développement de l'autoconsommation, tels que les évolutions technologiques, les politiques publiques et les règles de régulation. Les technologies avancées rendent l'autoconsommation plus rentable avec une diminution continue du coût d'achat et d'installation des panneaux photovoltaïques. La diminution du coût de la batterie et du système de commande inclus dans le système PV contribue à la propagation du système PV. L'intérêt des ménages pour l'efficacité énergétique, en particulier la réduction des coûts énergétiques, s'est accru à mesure que les utilisateurs tentent de gérer et de réduire leur consommation. En général, le système photovoltaïque produit l'énergie excédentaire lorsqu'il peut être stocké dans un système de batteries ou injecté dans le réseau de distribution public. Lorsque l'énergie est injectée dans le réseau, une certaine compensation pour cette injection est proposée à savoir le comptage net ou la facturation nette. L'autoconsommation elle-même pourrait être représentée dans l'équation 1 et l'autosuffisance dans l'équation 2 où l'A représenté la production PV, le B représente la consommation d'énergie dans la zone de production PV et le C est la charge.

$$\text{Taux l'autoconsommation} = \frac{B}{A} \quad \dots (\text{eq. 1})$$

$$\text{Taux l'autosuffisance} = \frac{B}{C + B} \quad \dots (\text{eq. 2})$$

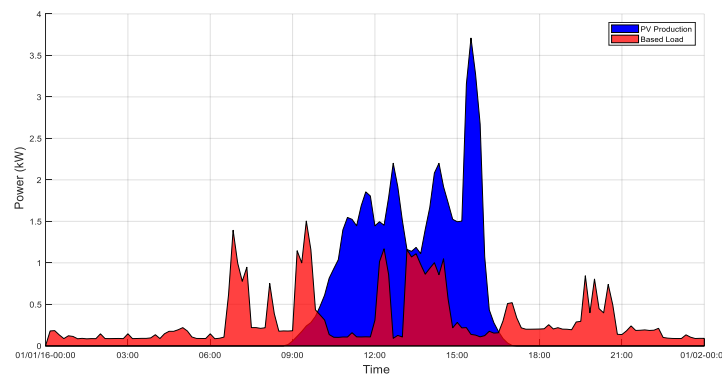

Fig 2. Schéma de la charge nette quotidienne, de la production nette et de l'autoconsommation absolue dans une installation résidentielle avec PV sur site

Il est important d'améliorer l'autoconsommation des ménages. Même eux ont de l'énergie excédentaire et la compensation comme l'alimentation en tarif continue d'être diminuée. Deux

types d'amélioration de l'autoconsommation, à savoir l'augmentation du système de gestion des batteries et la gestion de la demande.

Par définition, la gestion de la demande est la planification, la mise en œuvre et la surveillance des activités des services publics conçues pour influencer l'utilisation de l'électricité par les clients de manière à produire les changements souhaités dans la forme de la charge des services publics. Plusieurs techniques de gestion de la demande, notamment le rasage de pointe, le remplissage en vallée, le déplacement de la charge, la croissance de la charge stratégique, la conservation de la stratégie et la forme flexible de la charge.

Pour atteindre l'efficacité énergétique, les ménages résidentiels ont besoin d'un système qui intègre tous les équipements de la maison. Système de gestion de l'énergie domestique (HEMS) est un outil de gestion de l'énergie qui modifie et réduit la demande pour adapter le profil de consommation d'énergie dans la maison en fonction de la satisfaction du client et du prix de l'électricité. Il est en mesure de communiquer avec les appareils ménagers et les fournisseurs, au besoin, et de recevoir des informations de l'extérieur (production d'énergie solaire, prix de l'électricité) pour améliorer le modèle de consommation. Selon M. Baudin et al, sur la base de la réactivité, HEMS est mieux placé que l'humain pour évaluer les incertitudes demande, prix et planifier une réponse pertinente sans intervention humaine. HEMS ont plusieurs services clés pour la construction du système tels que :

1. Système de surveillance
2. Système d'enregistrement
3. Système de contrôle
4. Système de gestion et
5. Système d'alarme

Dans le cadre des réseaux intelligents, les technologies de l'information et de la communication (TIC) intégrées visent à améliorer la fiabilité du système tout en permettant une double communication (bidirectionnelle) de l'information et du flux de puissance. Intégrées à AMI avec HEMS, les TIC sont installées dans les ménages résidentiels. L'Internet des objets (IoT) devient un outil considérable dans les recherches sur le Smart grid et l'HEMS.

La production distribuée, en particulier l'énergie solaire, augmente de plus en plus. Avec l'encouragement du gouvernement de chaque pays, les propriétaires de maison réduisent leur dépendance de la source d'énergie conventionnelle par l'installation de leur propre système PV. Cela signifie que la production est moins centralisée et que la consommation de charge dans la maison sera contrôlée en fonction de la production locale. Pour résoudre ce problème, la maison est considérée comme un « prosommateur » potentiel et le système de gestion de l'énergie y participe. Du point de vue social, de nouveaux marchés émergeront où l'utilisateur final pourrait i) acheter et vendre de l'énergie et des capacités, et ii) décider de l'énergie qu'il veut acheter pour la consommation.

Pour mettre en œuvre une communauté de prosommateurs, de nouvelles technologies et méthodes sont nécessaires. Chaque maison pourrait utiliser un dispositif de gestion de l'énergie pour gérer sa consommation pour l'efficacité énergétique. Coordination entre les ménages où l'unité HEM de chaque ménage coordonne avec les autres unités HEM de la communauté (quartier) afin de minimiser le coût de leur agrégateur ou détaillant sur le marché de l'équilibre en temps réel. Le but de ce concept est de maximiser l'autoconsommation; en conséquence, l'énergie excédentaire ne retourne pas au réseau. À partir d'un cadre juridique, les communautés énergétiques sont classées en deux types, tels que les communautés d'énergie renouvelable (REC) et les communautés d'énergie citoyenne (CEC). Ils exigent une personne morale comme coordinateur et un contrôle effectif par les actionnaires.

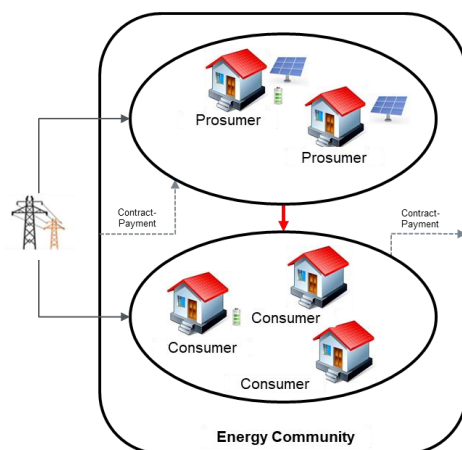

Fig.3 Schéma de communauté énergétique où le marché P2P avec le marché P2P complet et ou le marché communautaire.

La communauté de l'énergie se compose de consommateurs et de prosommateurs qui partageront leur production photovoltaïque avec les consommateurs conformément aux contrats. Le

raccordement à un fournisseur d'électricité (partie responsable de l'équilibrage) est nécessaire lorsque la demande locale de la collectivité ne correspond pas à la production photovoltaïque. Prosumer dans certains jours produisent l'énergie excédentaire après que leur système de stockage est plein. Afin de conserver leurs revenus, ils les partagent avec le prosommateur ou le consommateur qui ne répond pas à leur énergie.

Dans un autre côté, le consommateur achète l'énergie excédentaire du consommateur pour atteindre la réduction du coût de l'électricité. Lorsque l'électricité du consommateur n'est pas suffisante pour répondre à leur consommation, le consommateur pourrait prendre l'énergie supplémentaire du réseau. En raison de la limitation de l'électricité provenant du consommateur, le consommateur complétera le réseau. Le consommateur consommera toute l'électricité du réseau quand aucun « prosommateur » ne pourrait fournir l'énergie.

### *Les Component pour Gestion coordonnée de l'énergie*

Pour prouver l'efficacité du concept, l'introduction des composants sont préparés à savoir prévision de profil de charge, prévisions PV, stockage d'énergie, chauffe-eau électrique, bâtiment thermique et régime financier. Plusieurs méthodes sont préparées pour créer un profil de charge où il utilise également deux approches, à savoir l'approche descendante et l'approche ascendante. Dans cette recherche, les prévisions de profils de charge sont créées en utilisant une approche ascendante utilisant le logiciel libre « Load Profile Generator ». Cette approche est utilisée parce qu'elle montre les informations détaillées sur le comportement individuel. En attendant, le générateur de profil PV est mis à partir des données mesurées du CEA-INES. L'étape temporelle des données est 1 minute dans une année.

L'eau est une chose importante dans les activités quotidiennes de l'être humain, en particulier dans les ménages. Un réservoir d'eau chaude domestique est installé pour fournir la livraison instantanée de l'eau chaude. Un des modèles est un chauffe-eau électrique, qui chauffe l'eau dans le stockage à l'aide d'un élément de résistance électrique dans le haut ou le bas du réservoir. Le thermostat indépendant contrôle son élément. Le chauffe-eau électrique domestique (EWH) envisagé fournit de l'eau chaude pour la consommation résidentielle. L'EWH à élément unique est prise en compte dans cette étude. Le thermostat est un dispositif permettant de contrôler ou d'ajuster la température de l'eau chaude dans une certaine plage. Le thermostat contrôle le flux

d'énergie de l'EWH lorsque la température de l'eau chaude atteint la limite de basse température et arrête le flux d'énergie lorsque la température de l'eau chaude atteint la limite de haute température.

La température de l'eau est influencée par la conductivité thermique du réservoir d'eau. Kapsalis dans leur modèle de papier l'EWH dans un chauffe-eau électrique de masse unique avec une distribution de température uniforme. Ils formulent un modèle d'équation différentielle de premier ordre (voir eq. 3) où l'équation est discrétisée. Pour chaque tranche de temps, trois températures sont calculées telles que la température initiale ( $T^{ini}$ ), la température de la chaleur ( $T^{heat}$ ) et la température de l'eau ( $T^{water}$ ). La température de l'eau de chauffage et la température du réservoir d'eau sont exprimées en eq. 4 et 5, respectivement.

$$M \cdot C \cdot \frac{dT}{dt} = U \cdot A \cdot (T^{amb}(t) - T(t)) + Q \quad \dots \text{(eq. 3)}$$

$$T^{heat}(t) = T^{ini}(t) + \frac{U \cdot A \cdot (T^{amb}(t) - T^{ini}(t)) + s(t) \cdot Q}{M \cdot C} \cdot \Delta t \quad \dots \text{(eq. 4)}$$

$$T^{water}(t) = \frac{T^{heat}(t) \cdot (M - m^{cold}(t)) + T^{cold}(t) \cdot m^{cold}(t)}{M} \quad \dots \text{(eq. 5)}$$

Toutefois, le résultat du modèle EWH doit être validé. Nous proposons de le comparer avec le résultat du modèle EWH d'un autre logiciel à savoir Dymola (Dynamic Modeling Laboratory). C'est un logiciel pour la modélisation de divers types de système physique où il emploie le langage modelica. Il a la capacité de modéliser et de simuler la composante physique qui peut être décrite par des équations différentielles ordinaires des équations d'algèbre au niveau le plus bas et la composition « glisser-déposer » au niveau le plus élevé. Le modèle de validation tient compte du rayon intérieur et extérieur du réservoir et des températures intérieures et extérieures. Par la suite, la simplification de l'équation est préparée en eq.7.

$$T^{water}(t) = \frac{\left( T^{water}(t-1) \cdot \left( 1 - \frac{2 \cdot \pi \cdot L \cdot k \cdot \Delta t}{\log \frac{R_2}{R_1} \cdot V \cdot \rho \cdot C} \right) + \left( \frac{2 \cdot \pi \cdot L \cdot k \cdot T_{amb}(t) + s(t) \cdot Q}{\log \frac{R_2}{R_1} \cdot V \cdot \rho \cdot C} \right) \cdot \Delta t \right)}{V} \cdot (V - V_{intet}(t)) + T_{intet} \cdot V_{intet}(t) \quad \dots \text{(eq. 7)}$$

Le bâtiment participe à la consommation d'énergie en particulier dans le chauffage et le refroidissement parce que le chauffage, ventilation et climatisation (CVC) devient le secteur primaire de consommation d'énergie. La demande d'énergie en CVC est liée au point de consigne de la température intérieure, aux types de fenêtres (qualité des performances d'isolement), à l'infiltration d'air, au rapport des fenêtres murales et à la charge interne. Plusieurs études sur la forme du bâtiment thermique sont préparées où le type R6C2 est utilisé dans le modèle. Modèle de bâtiment utilise six résistances et deux capacitances (R6C2), Il tient compte de l'équilibre thermique apporter sur le volume d'air (int), à la surface des parois intérieures (si), au cœur de la paroi (w) ainsi qu'à l'extérieur des murs (se).

Plusieurs positions de prise de température dans cette configuration à savoir température  $T_{int}$  représentent la température intérieure dans le bâtiment,  $T_{ext}$  indiquent la température à l'extérieur du bâtiment.  $T_{si}$  indique la température sur la surface interne du mur,  $T_{se}$  représente la température sur la surface externe du mur.  $T_w$  indique la température à l'intérieur du mur, et  $T_{sky}$  représente la température du ciel qui influence le bâtiment qu'il a obtenu de la température extérieure

$$C_{int} \frac{dT_{int}}{dt} = \frac{T_{ext} - T_{int}}{R_{fi}} + \frac{T_{si} - T_{int}}{R_{si}} + \Phi_{int} \quad \dots \text{(eq. 8)}$$

$$0 = \frac{T_{int} - T_{si}}{R_{si}} + \frac{T_w - T_{si}}{R_{w12}} + \Phi_{si} \quad \dots \text{(eq. 9)}$$

$$C_w \frac{dT_w}{dt} = \frac{T_{se} - T_w}{R_{w22}} + \frac{T_{si} - T_w}{R_{w12}} + \Phi_w \quad \dots \text{(eq. 10)}$$

$$0 = \frac{T_w - T_{se}}{R_{w22}} + \frac{T_{ext} - T_{se}}{R_{se}} + \frac{T_{sky} - T_{se}}{R_{sky}} + \Phi_{se} \quad \dots \text{(eq. 11)}$$

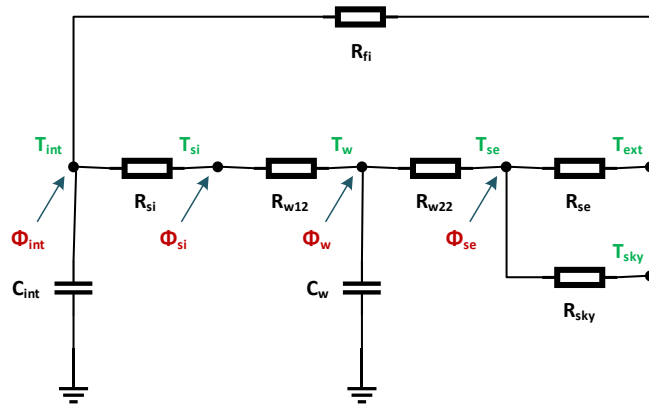

Fig.4. Configuration du bâtiment modèle R6C2

Le contrôle de la température est considéré. Maison ont une température optimale pour la satisfaction de l'utilisateur quand ils restent dans la maison. Cependant, la quantité de température optimale dépend du comportement de l'utilisateur. En condition standard, la température optimale est de 22°C. Pendant ce temps, l'utilisateur a la limitation pour leur confort où ils décident de la température minimale. Si la température intérieure est égale à la température optimale, il y a une condition confortable, donc la valeur d'inconfort est zéro. Cependant, lorsque la température intérieure est supérieure ou inférieure à la limite, l'insatisfaction augmente.

### *La gestion de l'énergie par contrat bilatéral avec SPIDER*

Avec les incitatifs offerts par le gouvernement, le taux d'installation de systèmes photovoltaïques dans le secteur résidentiel local est apparu. L'objectif des ménages était non seulement de consommer leur production photovoltaïque, mais aussi de devenir producteur, avec une vente de la production photovoltaïque au fournisseur d'électricité. Traditionnellement, les ménages utilisent leur production photovoltaïque pour répondre à la demande et partager leur surplus d'énergie au réseau afin d'obtenir l'incitatif tel que le tarif de rachat.

Dans cette thèse, nous simulons plusieurs configurations pour la gestion de l'énergie. L'une de ces configurations est un marché P2P complet, en particulier un contrat bilatéral entre un consommateur unique et un consommateur unique. Ce scénario est conçu pour aider le consommateur lorsque les tarifs de rachat garantis diminuent. Du côté des consommateurs, cette stratégie leur donne le choix d'améliorer leur coût de l'électricité à moindre coût. Comme la stratégie précédente illustrée à la figure 3, Le composant de prosumer englobent panneau PV, système de batterie, charge fixe, charges flexibles telles que lave-vaisselle et machine à laver, tandis que le système de batterie de couverture de composant de consommateur, charge fixe et charge flexible. De plus, la composante financière comprend le prix de l'électricité du réseau, le prix de l'électricité photovoltaïque et le coût de distribution, et ainsi de suite.

Tout d'abord, le consommateur répond à leur consommation avec le résultat que l'autoconsommation est également atteint. Lorsque l'énergie excédentaire est grande ou appropriée pour le partage, le consommateur consomme cette énergie pour satisfaire sa demande. En conséquence, l'autoconsommation du consommateur est apparue. Ces stratégies pourraient être élaborées de façon autonome ou sans le soutien des fournisseurs. Cependant, il n'est pas

recommandé parce que la ressource est intermittente. Le risque de cette stratégie est que les prosommateurs et les consommateurs pourraient fermer leurs activités en raison d'un manque d'électricité. Le module de simulation du CEA-INES (appelé « SPIDER ») est utilisé. Cette thèse examine le coût pour le consommateur et prosumer lorsqu'ils traitent de la stratégie de contrat bilatéral. Il est reflété dans l'équation 12-17.

*Potential incentive for Prosumer from Consumer ( $IC_{PV}$ ) :*

$$\sum_{d=1}^D \sum_{t=1}^T P_d^a(t) * (\varphi_p(t) - \varphi_{dis}(t)), \quad \forall t \in T, \forall d \in D \quad \dots \text{(Eq. 12)}$$

*Potential incentive for Prosumer from Grid ( $IC_{grid}$ ) :*

$$\sum_{d=1}^D \sum_{t=1}^T (P_d^{exc}(t) - P_d^a(t)) * (\varphi_{fit}(t) - \varphi_{dis}(t)), \quad \forall t \in T, \forall d \in D \quad \dots \text{(Eq. 13)}$$

*Total Potential incentive for Prosumer ( $IC_{tot}$ ) :*

$$IC_{tot} = IC_{PV} + IC_{grid} \quad \dots \text{(Eq. 14)}$$

*PV electricity consumption Cost ( $C_{PV}$ ) :*

$$\sum_{d=1}^D \sum_{t=1}^T (P_d^a(t) * \varphi_p(t)), \quad \forall t \in T, \forall d \in D \quad \dots \text{(Eq. 15)}$$

*Grid electricity consumption Cost ( $C_{grid}$ ) :*

$$\sum_{d=1}^D \sum_{t=1}^T (P_d^{grid}(t) * \varphi_p(t)), \quad \forall t \in T, \forall d \in D \quad \dots \text{(Eq. 16)}$$

*Total cost in Consumer ( $Cost_{tot}$ ) :*

$$Cost_{tot} = C_{PV} + C_{grid} \quad \dots \text{(Eq. 17)}$$

## *L'optimisation par essais particulières pour une gestion coordonnée de l'énergie*

La technique DSM en particulier le transfert de charge est très utile pour la réduction des coûts énergétiques. Pour atteindre le résultat optimal, il a besoin d'une programmation de l'appareil contrôlable en utilisant l'optimisation en particulier l'optimisation heuristique. Dans cette thèse,



La coordination dans un pool utilise l'optimisation des essais de particules pour étudier (i) la réduction des coûts atteinte par le consommateur et le consommateur, et (ii) la capacité de maximiser la production de PV par l'autosuffisance.

fonction objective:

$$\min_x Cost$$

Avec

$$Cost = \sum_{t=1}^N P_{grid}(t) \times Price(t)$$

... (Eq. III.32)

Avec contrainte :

$$P_{pv}(t) \geq 0$$

$$P_{grid}(t) = P_{pv}(t) + P_{loadshifting}(t)$$

$$P_{loadshifting}(t) = f(t_{activation}, LoadProfile)$$

$$s_{app} = \begin{cases} 1, & t_{min} \leq t_{activation} \leq t_{max} \\ 0, & otherwise \end{cases}$$

Dans cette simulation, plusieurs scénarios sont proposés pour atteindre l'objectif. Premier scénario, le contrat bilatéral est étudié lorsque le consommateur et le consommateur n'installent pas de système de stockage dans leur maison. En outre, le second contrat bilatéral est exécuté lorsque le prosommateur installe un système de stockage. Le résultat d'un contrat bilatéral utilisant l'optimisation de l'essaim de particules entre le prosommateur et le consommateur est indiqué dans la figure 5 ci-dessous

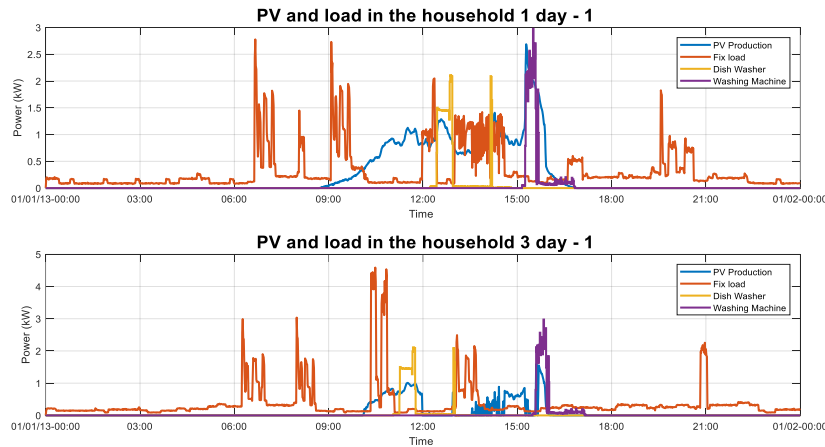

Fig.5. Profil de l'énergie dans le pool 1 entre Prosommateur HH1 et consommateur HH3

## *Élaboration d'un modèle de contrôle prédictif dans les communautés de ménages*

L'augmentation de la demande d'électricité est un défi pour le système électrique, principalement la demande dans le secteur résidentiel. Pour permettre une large intégration de la production décentralisée (en particulier du système photovoltaïque), les ménages devraient améliorer leur profil de demande afin de mieux faire face à la production locale. Les stratégies suivantes ont été élaborées pour relever ce défi par le biais d'une planification optimale où ils exploitent l'optimisation via le contrôleur de prévision de modèle (MPC). La fonction objective de cette méthode est de réduire le coût de l'électricité, où l'optimisation linéaire en nombres entiers est appliquée pour l'atteindre.

Plusieurs modèles sont créés pour supporter ce MPC à savoir, modèle de consommation de charge qu'il a divisé en deux types, charge fixe et charge flexible. La charge flexible utilise la méthode d'ordonnancement à savoir le déplacement de charge, où les appareils commenceront et finiront leurs activités dans un certain temps. Les équations sont tirées de Zdenek Bradac papier, qu'il propose de programmer pour les appareils ménagers à l'aide de L'optimisation linéaire en nombres entiers (MILP) dans le réseau de la zone résidentielle (HAN). L'équation est présentée dans l'équation 19-26.

$$P(i, t) = \sum_{i=1}^I \sum_{j=1}^J PA(i, j) * x(i, j, t), \quad \forall i, t \quad \dots \text{(eq. 19)}$$

$$\sum_{t=1}^N x(i, j, t) = TP(i, j), \quad \forall i, j \quad \dots \text{(eq. 20)}$$

$$x(i, j, t - 1) - x(i, j, t) \leq y(i, j, t), \quad \forall i, j, t: t > 1 \quad \dots \text{(eq. 21)}$$

$$x(i, j, t) \leq 1 - y(i, j, t), \quad \forall i, j, t \quad \dots \text{(eq. 22)}$$

$$x(i, j, t) \leq y(i, j - 1, t), \quad \forall i, j, t: j > 1 \quad \dots \text{(eq. 23)}$$

$$y(i, j - 1, t) - x(i, j, t) - y(i, j, t) = 0, \quad \forall i, j, t: j > 1 \quad \dots \text{(eq. 24)}$$

$$x(i, j, t) \leq UP_{i,t} \quad \forall i, j, t \quad \dots \text{(eq. 25)}$$

$$x(i, j, t) \in \{0, 1\}; y(i, j, t) \in \{0, 1\}, \quad \forall i, j, t \quad \dots \text{(eq. 26)}$$

Autre que cela, le modèle PV a également été créé où il devient la composante importante de la modélisation. Le système de stockage devient le composant pour améliorer l'autoconsommation; en conséquence, le modèle devrait être participé à la modélisation. Pour soutenir la gestion de l'énergie, l'électricité du fournisseur visent le ménage à répondre à leur consommation de charge en raison d'intermittent. Sa valeur est la somme de la consommation de charge, de la production photovoltaïque et de la batterie. Le modèle de chauffe-eau électrique et le modèle de bâtiment thermique complètent la modélisation.

Une fois le modèle créé dans le fichier GAMS, le script Matlab est préparé pour MPC-MORE. La figure 1 illustre le processus de gestion de l'énergie. Initialisation du modèle de paramètre tel que PV, charge basée, appareil contrôlable, chauffe-eau électrique et ou modèle de bâtiment thermique où le paramètre de soutien à savoir l'occupation, le coût ou le prix est appliqué. En outre, toutes les données sont écrites en entrée GDX où il transférera au logiciel de résolution de problèmes GAMS pour le processus d'optimisation.

GAMS initialise l'entrée GDX (paramètre et contraintes) et les calcule en bilans énergétiques par la suite la consommation du réseau est obtenue. En fonction objective, la consommation du réseau se multiplie avec le prix de l'électricité du réseau. Le GAMS utilise CBC (Coin-OR Branch Cut) pour l'optimisation linéaire en nombres entiers (MILP). Les données de résultat seront écrites sur la sortie GDX, puis Matlab lira la sortie GDX où elle extraira les données dans les données matlab. De plus, les données de résultats sont affichées par le graphique et le numérique.

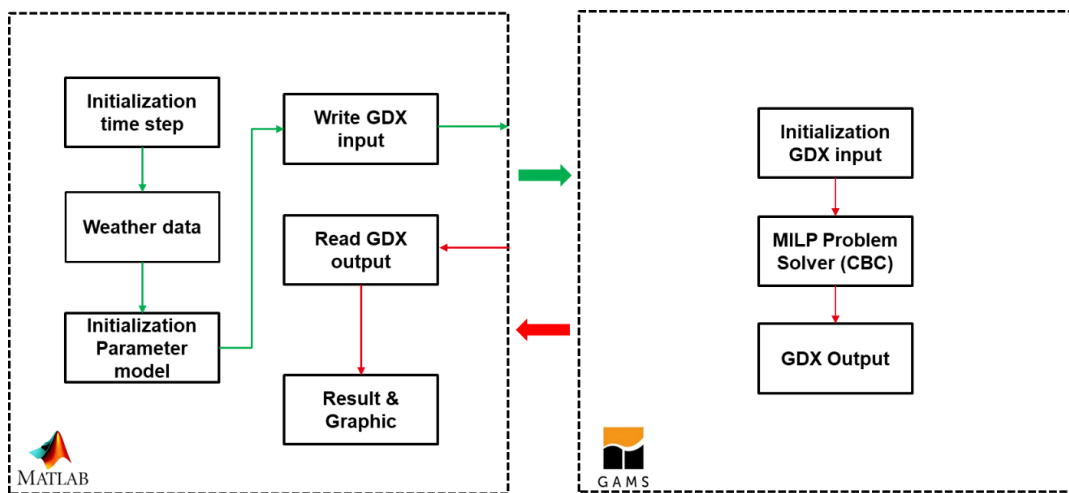

Fig.6. Illustration de MORE-GAMS

Dans cette thèse, plusieurs configurations pour la gestion de l'énergie sont préparées. Tout d'abord, le contrat bilatéral, où le consommateur et le consommateur font le contrat pour le partage de l'énergie. L'équation est présentée dans eq.27-36.

$$P_{gridPro}(t) + P_{PV}(t) - P_{loadPro}(t) \mp P_{bat}(t) = 0, \quad \forall t$$

... (eq. 27)

$$\begin{cases} P_{gridPro}(t) = 0, & P_{PV}(t) > (P_{loadPro}(t) \mp P_{bat}(t)) \\ P_{gridPro}(t) = P_{PV}(t) - (P_{loadPro}(t) \mp P_{bat}(t)), & otherwise \end{cases}$$

... (eq. 28)

$$P_{loadPro}(t) = \sum_{b=1}^B P_{unflx_l}(t) + \sum_{i=1}^I P_{flx_l}(t), \quad \forall t$$

... (eq. 29)

$$\begin{cases} P_{excessPro}(t) = 0, & P_{PV}(t) \leq (P_{loadPro}(t) \mp P_{bat}(t)) \\ P_{excessPro}(t) = P_{PV}(t) - (P_{loadPro}(t) \mp P_{bat}(t)), & otherwise' \end{cases} \quad \forall t \in N$$

... (eq. 30)

$$Cost_{pro}(t) = P_{gridPro}(t) * \gamma_{grid}(t), \quad \forall t$$

... (eq. 31)

$$Rev_{pro}(t) = P_{excessPro}(t) * (\gamma_{grid}(t) - \zeta_{grid}(t)), \quad \forall t$$

... (eq. 32)

$$\begin{cases} P_{PVCon}(t) = P_{excessPro}(t) & P_{excessPro}(t) \geq 0 \\ P_{PVCon}(t) = 0, & otherwise \end{cases}$$

... (eq. 33)

$$P_{gridCon}(t) + P_{PVCon}(t) - P_{loadCon}(t) = 0, \quad \forall t$$

... (eq. 34)

$$Cost_{con-grid}(t) = P_{gridCon}(t) * \gamma_{grid}(t), \quad \forall t$$

... (eq. 35)

$$Cost_{con-pro} = P_{PVCon} * \gamma_{pro}(t), \quad \forall t$$

... (eq. 36)

La deuxième étude de cas, Gestion centralisée de la coordination énergétique, est préparée. Dans cette configuration, le prosommateur et le consommateur participent à la communauté. L'énergie

excédentaire est consommée pour tous les membres de la communauté. L'équation de la gestion centralisée de l'énergie par coordination est présentée dans l'équation 37-42.

$$P^{PVCen}(t) = \sum_{s=1}^S P_s^{PV}(t), \quad \forall s, t \quad \dots \text{(eq. 37)}$$

$$P^{loadCen}(t) = \sum_{b=1}^B P_i^{unflx}(t) + \sum_{i=1}^I \sum_{j=1}^J P_{i,j}^{flx}(t), \quad \forall i, j, t \quad \dots \text{(eq. 38)}$$

*Équilibre de puissance:*

$$P^{PVCen}(t) + P^{loadCen}(t) + P^{bat}(t) + P^{gridCen}(t) = 0 \quad \dots \text{(eq. 39)}$$

*Fonction objectif:*

$$\min(P^{gridCen} * \gamma^{grid}), \quad \text{if } P^{gridCen} > 0 \quad \dots \text{(eq. 40)}$$

*Surplus d'énergie:*

$$P^{excessCen}(t) = P^{gridCen}(t), \quad \text{if } P^{gridCen}(t) < 0 \quad \dots \text{(eq. 41)}$$

*Revenus potentiels dans le pool:*

$$Rev(t) = P^{excessCen}(t) * (\gamma^{pro}(t) - \zeta^{grid}(t) - \zeta^{tax}(t)) \quad \dots \text{(eq. 42)}$$

Pour améliorer la couverture de la coordination, la stratégie de partage de l'énergie est élargie pour être la coordination entre les pools. Cette option n'a pas besoin d'un coordonnateur indépendant parce que le pool utilise la coordination centralisée avec plusieurs ménages dans le pool. La règle dans cette stratégie, le pool reste connecté à un fournisseur d'électricité pour couvrir la demande dans la zone de production PV extérieure et l'énergie non disponible. Pool ont plusieurs options pour envoyer l'énergie excédentaire à savoir, envoyer l'énergie excédentaire partiellement ou envoyer toute l'énergie excédentaire à un autre pool dépend de la volonté. L'équation de cette configuration se reflète dans l'équation 42-51

*Agrégation de charges dans Pool 1:*

$$P^{loadCen1}(t) = \sum_{b=1}^B P^{unflx1}(i, t) + \sum_{i=1}^I \sum_{j=1}^J P^{flx1}(i, j, t), \quad \forall i, j, t \quad \dots \text{(eq. 42)}$$

Équilibre de puissance dans Pool 1:

$$p^{PVCen1}(t) + p^{loadCen1}(t) \mp p^{bat1}(t) + p^{gridCen1}(t) = 0 \quad \dots \text{(eq. 43)}$$

Fonction objectif dans Pool 1:

$$\min(p^{gridCen1} * \gamma^{grid}), \quad \text{if } p^{gridCen1} > 0 \quad \dots \text{(eq. 44)}$$

Surplus d'énergie dans Pool 1:

$$p^{excessCen1}(t) = p^{gridCen1}(t), \quad \text{if } p^{gridCen1}(t) < 0 \quad \dots \text{(eq. 46)}$$

Production de PV in Pool 2:

$$p^{PVCen2}(t) = p^{excessCen1}(t) + \sum_{s=1}^S p_g^{PV2}(t), \quad \forall t \quad \dots \text{(eq. 47)}$$

Agrégation de charges dans Pool 2:

$$p^{loadCen2}(t) = \sum_{b=1}^B P_i^{unflx2}(t) + \sum_{i=1}^I \sum_{j=1}^J P_{i,j}^{flx2}(t), \quad \forall i, j, t \quad \dots \text{(eq. 48)}$$

Équilibre de puissance dans pool 2:

$$p^{PVCen2}(t) + p^{loadCen2}(t) + p^{bat2}(t) + p^{gridCen2}(t) = 0, \quad \forall t \quad \dots \text{(eq. 49)}$$

Fonction objectif dans Pool 2:

$$\min(p^{gridCen1} * \gamma^{grid}), \quad \text{if } p^{gridCen1} > 0 \quad \dots \text{(eq. 50)}$$

Surplus d'énergie dans Pool 2:

$$p^{excessCen2}(t) = p^{gridCen2}(t), \quad \text{if } p^{gridCen2}(t) < 0 \quad \dots \text{(eq. 51)}$$

Dans la dernière étude de cas, nous avons placé le modèle de bâtiment thermique dans le MPC pour une gestion coordonnée dans les deux districts. Nous avons choisi Chambéry comme premier district à représenter la région quatre saisons et le district de Jakarta comme région tropicale. L'objectif est de maximiser l'autoconsommation et de réduire les coûts d'électricité dans les deux districts. Enfin, l'investissement du système photovoltaïque dans le district est calculé. Par

conséquent, la collectivité ou le fournisseur d'énergie photovoltaïque pourrait estimer le budget et les avantages de l'installation du système photovoltaïque dans le district.

## *Conclusion*

Dans le contexte de la coordination de l'énergie par l'optimisation, La recherche menée dans cette dissertation visant à l'élaboration et la démonstration d'une stratégie avancée pour construire le partage de l'énergie dans la communauté, pratiquement mise en œuvre

La motivation de cette recherche est le fait que le propriétaire PV (prosommateur) fournit l'énergie excédentaire où sera libre en charge lorsque le règlement sur les aliments du bétail dans le tarif est expiré. En conséquence, le prosommateur perdra leur motivation. Pour anticiper cette condition, comme alternative, le prosommateur gagner leur réduction des coûts ainsi que d'améliorer leur auto-consommation jusqu'à ce que l'énergie excédentaire n'a pas émergé. Il existe deux méthodes, comme l'augmentation de la batterie et la gestion de l'énergie. Cependant, les ménages ont des limites pour maximiser leur consommation de 100% d'autoconsommation chaque jour, en conséquence l'énergie excédentaire sera existé. La coordination énergétique dans la piscine est d'une grande aide pour l'allocation de l'énergie existante. Le prosommateur partager leur énergie excédentaire aux consommateurs qui cherchent le prix moins cher de l'électricité en pupose pour conduire leur objectif, comme la réduction des coûts. Plusieurs types de marché de l'énergie est introduit dans les références papier et en outre, nous les nommons à la mise en œuvre de la simulation dans le but d'identifier l'amélioration de l'objectif dans le consommateur et le consommateur.

Dans cette thèse, nous proposons plusieurs méthodes de partage d'énergie où le pool est rempli par le prosommateur et le consommateur. Chaque ménage, à la fois consommateur et consommateur, effectuera la technique de gestion de l'énergie à savoir le déplacement de charge pour les appareils contrôlables dans leur maison. En route vers la simulation, les données de préparation nécessaires telles que la consommation de charge, les appareils contrôlables et la production de PV. Plusieurs méthodes de prévision de la charge sont préparées par des références. Toutefois, pour simplifier le processus, nous proposons de tirer parti de la génération de profils de charge logicielle pour obtenir les données pour la journée à venir (prévision de la charge à court terme) ou pour l'année complète (prévision de la charge à moyen terme). Il prépare également le

type et la spécification des appareils contrôlables tels que la machine à laver et lave-vaisselle. Dans le même temps, les références au document contribuent à diverses méthodes de prévision des données PV, soit en fonction de spécifications fondées sur des données d'horizon et historiques. Nous proposons d'utiliser les données PV de l'CEA qui ont été recueillies en 2014, où les données sont catégorisées dans les prévisions PV à moyen terme. De plus, EnergyPlus est également utilisé pour les prévisions PV et météorologiques lorsque le bâtiment thermique est utilisé dans la simulation.

Nous proposons également d'autres composants pour soutenir la simulation par exemple le système de batterie, le chauffe-eau électrique et le bâtiment thermique. L'équation du système de batterie simple est préparée pour viser le modèle où SOE est compté. En outre, nous informons chauffe-eau électrique que la charge supplémentaire en raison de l'importance de sa fonction pour fournir de l'eau chaude dans le ménage. La spécification du chauffe-eau électrique (EWH) est importante pour fournir le système de gestion de l'énergie dans chaque maison. Pour compléter la simulation, dans la recherche, nous proposons thermique dans le bâtiment où la température extérieure dépend de l'emplacement, influencer le bâtiment interne par la suite le ménage ont besoin du système pour le contrôler afin de maintenir leur qualité de vie.

Les MPC deviennent un outil de rechange pour la gestion complexe de l'énergie. Ils pourraient gérer plusieurs contraintes dans chaque modèle. Il commence par dériver un système de gestion de l'énergie domestique orienté contrôle (HEMS) du ménage. Une fois intégré dans le contrôleur prédictif, le rôle de HEMS est de prédire la réduction des coûts d'électricité du réseau ainsi que l'amélioration de l'auto-consommation. Par conséquent, il est crucial de se procurer un HEMS précis et efficace sur le plan informatique. Mais avant tout, le développement de l'HEMS devrait tenir compte de la qualité de vie du ménage à travers la contrainte. En vertu de cette exigence, la modélisation du Greybox est adoptée. Plusieurs composantes utilisées dans le ménage sont modélisées dans le CPL. Pour la modélisation de la précision, l'équation EWH du papier doit être validée, où dans cette recherche, la simulation EWH aboutit à Dymola devenant une référence de validation pour le modèle EWH. EWH active sa puissance en mode proportionnel. Cela signifie EWH pas besoin de travailler au taux de puissance maximum à la place en valeur aléatoire entre zéro et la valeur de taux de puissance. Le bâtiment INCA avec le modèle R6C2 devient un modèle sélectionné pour le bâtiment thermique avec le gain solaire obtenu de la simulation EnergyPlus.



Dans cette recherche, MPC utilise la bibliothèque MORE-GAMS développée par le CEA et Matlab comme support de simulation. Ce MPC formule et contrôle le problème d'optimisation basé sur l'optimisation linéaire en nombres entiers (MILP). Sa fonction objective est principalement composée d'un terme que le coût de l'électricité qui dépend du prix d'achat de l'électricité. Il est alimenté par le coût de décharge de charge et le coût de batterie de possibilité. Plusieurs coordinations de l'énergie exploitent ce MPC tels que le contrat bilatéral entre le consommateur et le consommateur ou le consommateur, la Communauté avec la coordination centralisée de l'énergie et le pool pour la coordination lorsque chaque pool utilise la coordination centralisée de l'énergie. Pour un résultat optimal, la modélisation utilise 10 minutes de pas de temps, en résultat, la fonction objective reste garder sa valeur de précision.

Dans l'intégration avec le bâtiment thermique, MPC utilise la programmation linéaire pour résoudre le problème d'optimisation en raison de la complexité de la modélisation thermique dans le district ou la communauté. La fonction objective reste la réduction des coûts de l'électricité du réseau dans le district. Le confort optimal dans le ménage est similaire et l'occupation dépend du type de ménage devient la contrainte supplémentaire dans la coordination centralisée dans le district. Le district de Chambéry représente le district quatre saisons et district de Jakarta indiquent le district deux saisons. Le simple calcul financier fondé sur l'hypothèse du coût de l'investissement donne une description du gain et du rendement de l'investissement reçus par le district.

# List of Contents

Acknowledgement .....	iii
Résumé substantiel en Langue Française.....	iv
List of Content .....	xxiv
List of Figure.....	xxviii
List of Table.....	xxxii
General Introduction .....	1
Chapter 1 Introduction Energy Consumption .....	7
1.1 Background Energy Consumption and Renewable Energy .....	7
1.1.1 Global Energy demand.....	7
1.1.2 Renewable Energy Source Development.....	13
1.1.3 Building energy consumption .....	18
1.1.4 Building Integrated Photo Voltaic (BIPV).....	20
1.2 Photovoltaic: Self-Consumption and Energy Management .....	23
1.2.1 Self-consumption in France .....	24
1.2.2 Electricity Market: Peer to Peer Trading Concept.....	28
1.3 Thesis Content and Organization.....	30
Chapter 2 State of the art of energy management for residential sector .....	34
2.1 Introduction.....	34
2.2 Participation of Smart Grid in Energy Management.....	34
2.3 Self-Consumption: Introduction and Application.....	36
2.3.1 Net metering and net billing.....	37
2.3.2 Self-consumption categories .....	38
2.3.3 Benefit and Challenges of Self-consumption.....	40
2.4 Demand Energy Strategies.....	42
2.4.1 Energy management from supply side.....	42
2.4.2 Demand side management .....	42
2.5 Home Energy Management System.....	48
2.5.1 Component of HEMS.....	48
2.5.2 Communication tool in HEMS .....	49

2.5.3 HEMS Scheduling.....	50
2.6 Prosumer in Coordination Energy Management System.....	50
2.7 Peer to Peer Energy Trading in the Communities.....	55
2.7.1 Peer to Peer Energy Market Concept.....	55
2.7.2 Type of Peer to Peer Energy Trading.....	57
2.7.3 Advantage and Drawback of Peer to Peer.....	57
2.8 Conclusion .....	57
2.9 The Challenge, Research Approach and Thesis Contribution .....	58
References.....	58
Chapter 3 Simulation platform for study case .....	62
3.1 Introduction.....	62
3.2 Load profile forecasting in the residential .....	62
3.2.1 Literature review.....	63
3.2.2 Top-down Approach .....	64
3.2.3 Bottom-up approach.....	64
3.3 PV Profile Generator.....	66
3.3.1 PV forecasting methods .....	67
3.3.2 Statistical method.....	68
3.3.3 Physical method .....	68
3.3.4 Ensemble method (hybrid).....	70
3.4 Energy Storage.....	71
3.5 Electric Water Heater.....	74
3.5.1 Parameter of Electric Water Heater .....	75
3.5.2 User Comfort .....	76
3.5.3 Electric Water Heater for modeling .....	77
3.6 Thermal Building.....	84
3.6.1 Background.....	84
3.6.2 Literature review .....	85
3.7 Financial Scheme .....	88
3.8 Energy Management method .....	90
3.8.1 Coordination Energy Management via Bilateral Contract.....	91
3.8.2 Application the bilateral contract in Heuristic .....	97
3.9 Conclusion .....	101

References.....	103
Chapter 4 Development of Model Predictive Control in Household Communities .....	107
4.1 Introduction.....	107
4.2 Model Predictive Control for EMS.....	109
4.2.1 Literature review .....	109
4.2.2 Optimal Control .....	111
4.2.3 Mixed integer programming formulation for MPC .....	112
4.2.4 Objective .....	130
4.2.5 Application MPC for Energy Management .....	130
4.3 Energy Management method and Solving .....	131
4.3.1 Coordination of Energy Management in the household.....	131
4.3.2 Coordination Energy Management via Bilateral Contract.....	134
4.3.3 Centralized Coordination Energy Management.....	136
4.3.4 Multilateral Energy Management .....	139
4.4 Conclusion .....	144
References.....	144
Chapter 5 Case study for Coordinated Energy Management validation simulation based.....	147
5.1 Introduction.....	147
5.2 Case Study with MPC for Market Model .....	148
5.2.1 Bilateral contract Prosumer to Consumer .....	148
5.2.2 Prosumer to Prosumer Coordination Energy .....	153
5.2.3 Energy management using Centralized Coordination.....	157
5.2.4 Pool to Pool Energy Coordination via MPC.....	160
5.3 Case study of Energy Coordination integrated with Thermal Building.....	164
5.3.1 Background.....	164
5.3.2 Introduction of INCAS Building.....	164
5.3.3 Local coordination of district in Chambéry .....	165
5.3.4 Local District in Jakarta .....	172
5.3.5 Return of Investment for PV system in District.....	177
5.4 Conclusion .....	181
Reference .....	182

Conclusion .....	183
Contribution .....	183
Outlook .....	185
Appendix A .....	187
Appendix B .....	193
Appendix C .....	213
Appendix D .....	219

# List of Figure

Fig. I.1. (a).Global Energy Demand by sector in 2017, (b).Final Consumption by sector between 2010 and 2017. (c).Electricity generation by fuel and technology in 2010 and 2017[5].....	8
Fig. I.2 Final energy consumption in residential sector EU28 based on fuel and use by 2017 .....	9
Fig. I.3 Evolution of electricity prices for household consumers, EU-28 and EA, 2008-2019 .....	11
Fig. I.4 Evolution of electricity prices for non-household consumers, EU-28 and EA, 2008-2019 .....	11
Fig. I.5 Statistics on renewable energy sources installed capacity in 2018 per sources in the world, in EU-28 and in BRICS.....	11
Fig. I.6 Trend in electricity generated by RES in Europe from 2005 to 2019 .....	12
Fig. I.7 Percent share of renewable energies in gross final energy consumption in 2018 for European country and fixed targets for 2020.....	12
Fig. I.8 Total investments in RES by region between 2010 and 2018.....	14
Fig. I.9 Levelized cost of electricity projection for utility scale PV system to 2050.....	15
Fig. I.10 Levelized cost of electricity projection for rooftop PV system to 2050.....	15
Fig. I.11 Percentage of PV use in worldwide for 2019.....	16
Fig. I.12 Revenue of smart home market between 2017 to 2024 .....	17
Fig. I.13 Electricity consumption of household in worldwide.....	18
Fig. I.14 Capacity of installed photovoltaic in the world for 2019 .....	19
Fig. I.15 Percentage of BIPV component in residential building and single family house .....	20
Fig. I.16 Design of Tesla solar roof .....	21
Fig. I.17 Evolution of Feed in Tariff for residential in France .....	27
Fig. I.18 Example the matching of energy generator and consumption in Piclo .....	28
Fig. II.1 Smarter Grid network architecture development based on IEA .....	35
Fig. II.2 Diagram showing Individual Self-Consumption and Collective Self-Consumption.....	37
Fig. II.3 Schematic of daily net load, net production and absolute self-consumption in a residential with on-site PV .....	40
Fig. II.4 Demand Side Management addresses all the basic load-shape objective.....	45
Fig. II.5 Utilization of Load Shifting in order to maximize self-consumption .....	46
Fig. II.6 Home Energy Management System scheme.....	48
Fig. II.7 Energy Area based on the function.....	51
Fig. II.8 Scheme of energy community where the P2P market with full P2P market and or community based market.....	54
Fig. II.9 Overview of the energy trading concept .....	56

Fig. III.1 (a) The captured view of load profile generator software. (b) The example household load consumption in matlab where the data is generated by load profile generator software .....	65
Fig. III.2 Comparison Irradiance data and PV Power output pattern in particular day .....	66
Fig. III.3 PV forecasting data in particular day.....	71
Fig. III.4 Energy storage system definition based on the triad of charging (loading), storing, and discharging (unloading), as well as the essential physical dimensions.....	72
Fig. III.5 Electric Water Heater with single element .....	75
Fig. III.6 The comparison of water temperature result among the software .....	80
Fig. III.7 One Dimensional Heat Conduction in radial direction, in steady-state .....	80
Fig. III.8 The comparison the trend of EWH after validation .....	84
Fig. III.9 Physical representation of inputs in the building model.....	86
Fig. III.10 Example of 2 <sup>nd</sup> order building model.....	87
Fig. III.11 Architecture for Coordination among Prosumer equipped by HEMS .....	90
Fig. III.12 Scheme of coordination, Independent (a) and Bilateral Contract between household (b) .....	94
Fig. III.13 HEMS coordination in the household (prosumer) illustration in Simulink .....	96
Fig. III.14 Flowchart of Particle Swarm Optimization .....	98
Fig. III.15 Profile of Energy in the Pool 1 between Prosumer HH1 and Consumer HH3 .....	101
Fig. IV.1 The strategy of Model Prediction Control_ .....	111
Fig. IV.2 HEMS implementation in the house_ .....	113
Fig. IV.3 Flexible appliances, (a) dish washer (b) washing machine .....	115-116
Fig. IV.4 Electric Water Heater component_ .....	121
Fig. IV.5 Building model R6C2 configuration .....	124
Fig. IV.6 Comfort temperature range for building .....	129
Fig. IV.7 Illustration of MORE-GAMS_ .....	131
Fig. IV.8 Individual connection scheme where the Prosumer and consumer connect with grid only_ ....	132
Fig. IV.9 Flow chart of Home Energy Management System with battery system. $P_p$ is the local generation power, and $P_l$ is the demand power_ .....	132
Fig. IV.10 Peer to peer coordination with grid connection_ .....	134
Fig. IV.11 Centralized coordination of energy management_ .....	137
Fig. IV.12 Pool to Pool Coordination .....	140
Fig. V.1 water consumption data for MPC model .....	150
Fig. V.2 Energy consumption in the household (a). prosumer HH1 (b). consumer HH3.....	152
Fig. V.3 Flow chart of sharing energy between prosumer and prosumer_ .....	154

Fig. V.4 Evolution of grid consumption in the prosumer to prosumer coordination_.....	156
Fig. V.5 Centralized Coordination in a community scheme_.....	158
Fig. V.6 On grid Pool to pool coordination_.....	161
Fig. V.7 Trend of PV consumption in pool 1 and pool 2.....	162
Fig. V.8 INCAS Building model_.....	165
Fig. V.9 Profile of the household in district Chambery_.....	170
Fig. V.10 Electricity profile in district Chambery.....	170
Fig. V.11 Profile of the household in district Jakarta_.....	175
Fig. V.12 Electricity profile in the district in Jakarta.....	176
Fig. V.13. Payback and cash flow of PV provider in the district Chambery. (1a and 1b). Return of Investment for reference SCR result and Cash flow in reference SCR result (2a and 2b). Return of Investment for optimization SCR result and Cash flow in reference optimization SCR result .....	179
Fig. V.14 Payback and cash flow of PV provider in the district Jakarta. (1a and 1b). Return of Investment for reference SCR result and Cash flow in reference SCR result (2a and 2b). Return of Investment for optimization SCR result and Cash flow in reference optimization SCR result .....	180



# List of Table

Table I.1 BIPV product and specification.....	22
Table I.2 Equation for annual consumed energy (supply) component for Prosumer .....	25
Table I.3 Energy weight coefficient (c) for prosumer in 4 timeslot.....	26
Table I.4 Power weight coefficient (b) for prosumer in 4 timeslot.....	27
Table I.5 Management Component (CG) cost for 1 year.....	27
Table I.6 The comparison of Peer to Peer project.....	29
Table II.1 Analysis of Renewable Energy community and Citizen Energy Community .....	53
Table III.1 Benefit and lack of load profile approach.....	64
Table III.2 Performance evaluation matrices in PV forecasting.....	67
Table III.3 Classification of storage based on technology .....	72
Table III.4 Data Parameter for validation in Dymola .....	79
Table III.5 Physical representation of inputs in the building model for an electro-thermal approach.....	85
Table III.6 Household type for simulation.....	95
Table III.7 Classification prosumer for bilateral contract simulation .....	95
Table III.8 Time operation of washing machine and dishwasher in each household .....	96
Table III.9 Data parameter that used in the simulation.....	100
Table IV.1 Load categories depend on flexibility.....	114
Table IV.2 Illustration of scheduling of flexible operation in the household .....	115
Table V.1 Data Parameter of MPC model in Prosumer-Consumer Coordination .....	149
Table V.2 Household type and their scheduling of dishwasher and washing machine .....	150
Table V.3 Common setting parameter in the bilateral coordination .....	151
Table V.4 Yearly Household grid cost saving and Self-Consumption ratio in the pool.....	153
Table V.5 Flow chart of sharing energy between prosumer and prosumer .....	155
Table V.6 Common setting parameter in the prosumer-to-prosumer coordination .....	155
Table V.7 Parameter for centralized coordination modeling.....	158
Table V.8 Common setting parameter in the centralized coordination.....	158
Table V.9 Time activation of appliances after optimization centralized coordination .....	159
Table V.10 Result of Centralized coordination of energy in district (community) .....	160

Table V.11 Participant of pool-to-pool coordination.....	161
Table V.12 Parameter for pool-to-pool coordination modeling.....	161
Table V.13 Scheduling of dishwasher and washing machine in the pool-to-pool coordination.....	162
Table V.14 Result of pool-to-pool coordination in district (community).....	163
Table V.15 Data component for coordination including thermal building .....	168
Table V.16 Energy consumption and cost in the district Chambery.....	171
Table V.17 Potential renewable energy in Indonesia.....	172
Table V.18 Parameter for coordination including thermal building .....	173
Table V.19 Common setting parameter in the district energy coordination .....	174
Table V.20 Energy coordination without optimization and MPC in district Jakarta .....	176
Table V.21 Evolution of the tariff for ROI calculation.....	177
Table V.22 Return on Investment for District Chambery.....	178
Table V.23 Return on Investment for District Jakarta .....	180

# General Introduction

## Background

Energy become the important thing in the human life. Electricity is a part of energy that drives the human activities. However, the electricity demand more and more increased. Acceleration of population and industries give impact to the changing of electricity consumption in worldwide particularly in the big cities. Transformation of people lifestyle also drive the growth of electricity demand. Effect of industrialization and urbanization bring the environmental issue in particular air pollution arise sharply. In order to limit these challenges, the solar technology and energy management has been developed. The decreasing of solar panel cost that mentioned in above and several countries in the world more and more install distributed generation to meet their objective. Their development is also encouraged by the directive of organization in particular Europe area have to meet EU target for renewable energy and energy efficiency. Several countries aim the house owner to install distributed generation, which they give some attractive regulation for instance, feed in tariff which it become revenue for household from their excess energy. Unfortunately, government start to reduce the feed-in tariff until zero, this case become challenge for house owner, which they have to maximize their self-consumption in order to keep their production.

The rising of electricity and improvement of system such as smart grid give opportunity for household to manage their consumption. Despite of demand and energy in the house tend increased without awareness by people that stay in there. Uncontrolled use of appliances in there, so that it make the rising of energy cost for electricity significantly. The new technology look like Home Energy Management system (HEMS) become a tool for energy management in the residential. HEMS enables the household to select and apply the strategy for their energy consumption. It give them several advantages such as a better understanding of energy consumption, accurate information of energy consumption in their home and awareness for problematic of equipment, for example, fault detection. In order to apply its function, HEMS needs aim from Information and Communication Technology (ICT). It has been studied and simulated by researchers in the universities and institutes. HEMS was also developed and commercialized by several companies where several benefit of the system is offered.

In other side, several countries give opportunity PV owner to be participant in the electricity market via energy selling. However, they only sell their electricity to the grid provider. Uberization is the new market model where the people could offer their product by online such as transportation via Uber and room renting by AirBnB. Possibility, it could be an alternative for electricity market via online, which the prosumer offer their excess energy for their revenue via online aggregator or themselves to other household that need more electricity for their consumption.

## Main Problematic

In the energy management, house owner could manage their consumption with developed technology Coordination in neighborhood is introduced, where they could make new electricity market with selling energy to the neighbors, so that they still receive income from PV electricity produced transaction. There is obstacle in this part where the connection remain rely on the public electricity distribution network. The permission from owner (DSO) is very important; however need some contract and cost for the sharing. The other obstacle, how to alter the behavior of house owner in electricity usage, so that it will not give more impact to satisfaction factor.

This thesis draws its inspiration from energy consumption management and its development context, one where the energy management in the prosumer and continue in the community where integration several household both of prosumer and consumer. High-end technologies already applied in the household where manage the appliances and other equipment to reach energy efficiency in the house.

In particular, this work is driven by some questions about energy management and still open to be explore, such as,

- Could the photovoltaic system contribute to energy consumption in the house?
- How to get maximum benefit of a household energy storage system?
- Could the excess energy in the prosumer to be shared to neighbor and how to deal with grid supplier as distribution owner?
- What is happen with the electricity if the water heater will be integrated in the system where the coordination is applied?
- Could the control of HVAC system improve the self-consumption rate?

- In the context coordination, how to maximize share the excess energy to neighbor when the feed in tariff is not favorable.

### **Thesis Objective**

The aim of this thesis is to propose the energy management strategy in the PV system owner for finding the best solution to maximize self-consumption with energy cost reduction. In here, the PV owner is given an opportunity to be producer, consumer and or seller of energy. In consequence, the energy coordination in the community is important to be applied. Energy and these method utilize the existing technology as HEMS and coordination where the method will be applied. The coordination in community require the better method to aim them for managing self-consumption and minimizing their cost for electricity. In addition, households consume all energy, no exception.

Model Predictive Controller is a promising approach to optimize the objective function such as grid cost reduction. Using the existing MPC from CEA, several configuration of energy coordination is applied. Additional of controlled appliance is prepared. Electric Water heater model become the thesis contribution. Electric water heater smart management is expected to improve self-consumption in the household. The EWH model should be validated before it is used in the energy management modeling. For reaching the target, several energy coordination configuration is prepared and analyzed both a household and community. This process allows the prosumer to share their excess energy where in each household apply demand side management. Consequently, each household in both of prosumer and consumer obtain benefit from coordination such as electricity cost reduction and additional income for prosumer, and ensure no waste excess energy when the feed in tariff already take out from market. Thermal building contribution through building model also taken into account in this thesis, where its model is considered to maximize the self-consumption in the household and community also.

### **Structure of Dissertation**

This thesis propose several strategies for electricity grid cost reduction in the prosumer or community through energy sharing configuration whereas to handle deregulated feeding tariff for renewable energy in particular photovoltaic. The contents are structured on several chapters, which

follow the brief introduction. Each chapter deals with different subject, method, and question as follow

- Chapter 1 covers the evolution of energy consumption and renewable energy in particular Photovoltaic system in the world and Europe in specific. Development of self-consumption in Europe in particular France is discussed with their regulation look like TURPE. And the last, Applying of peer to peer concept in the energy market is also studied.
- Chapter 2 focusses on the state of art of self-consumption in households where it will improve using Demand Side Management and energy storage system, what is advantage/drawbacks of the method. Coordination of energy management and possibility to increase revenue and drop in electricity cost will be explained based on references. Challenging research issues are presented, and possible solutions are discussed.
- Chapter 3 focusses in simulation platform for study case. Forecasting methods of load profile and PV profile is explained. The introduction and literature review of energy storage, electric water heater and thermal building are spelled out. It also include the improvement and validation of electric water heater model. The chapter also discusses financial scheme for the energy coordination where several tariff types for users are prepared. The first simulation of energy management based on SPIDER in Matlab platform where the households drive their self-consumption, so that it finds the best time to activate appliances. Furthermore, simulations adopt bilateral contracts where the prosumer has a contract with one consumer. Furthermore, Particle Swarm Optimization (PSO) generate the data from PV system and consumption data of household.
- Chapter 4 will explain Model Predictive Control (MPC) with their components. The detail of the component model is spelled out such as Load consumption model, PV model, battery model, grid model, Electric water heater model and building model. The chapter also describe the objective of MPC where MORE-GAMS become the library. The energy management configurations are explained with their equations.
- Chapter 5 discusses the case study of several market model. Bilateral contracts between prosumer and consumer, prosumer to prosumer and centralized coordination are verified with the simulation in the two condition such as without optimization and under optimization ( with MPC). The energy coordination in two districts of two different climates and continents are presented, and used to illustrate the application result for large-scale optimization. The HVAC

and storage, local PV production are considered in those study cases. In the last chapter, the return of investment in each region and each condition is prepared.

## Thesis Framework

This work is accomplished in collaboration with several parties:

- Commissariat à l’Energie Atomique et aux Energies Alternative (CEA)
- Riset-Pro Program, Ministry of Science and Technology, Republic of Indonesia – World Bank Loan No. 8245-ID
- Badan Pengkajian dan Penerapan Teknologi (BPPT), Republic of Indonesia
- GeePs Laboratory, Centrale Supelec, Universite Paris Saclay

This PhD thesis is jointly funded by CEA and Riset-Pro within its program *Thèses* and under secondment agreement no. 01/SA/BPPT – CEA/4/2017 between CEA and BPPT

The host laboratory is *Laboratoire des Systèmes Électrique Intelligent* (LSEI) of CEA, partly located at *Institut National de l’Énergie Solaire* (INES).

## Publication

Paper and poster presentation in CIRED Workshop 2018, **”Challenge for coordination consumption of a pool of prosumer”**, Albachrony M.A., Ha D.L., Tran Q.T., Brun A., Petit M.

Paper and oral presentation at SDEWES Conference 2018, **”Challenge for coordination consumption of a pool of prosumer”**, Albachrony M.A., Ha D.L., Tran Q.T., Brun A., Petit M.

Poster Presentation in PVSEC 2019, **”Optimizing coordination pool of prosumers using particle swarm optimization”**, Albachrony M.A., Ha D.L., Tran Q.T., Brun A., Petit M.

Paper and oral presentation IEEE ISGT 2019, Bucharest, Romania, **”Coordinated prosumer transaction based on load shifting and optimization”**, Albachrony M.A., Ha D.L., Tran Q.T., Brun A., Petit M.

---

## **Patent**

Patent CEA (internal Ref. DD20148), **”Procédure de pilotage optimal d’un pool de consommateur pour maximiser l’autoconsommation à manière”**, Ha D.L, Albachrony M.A., Tran Q.T., Bourien Y.M



# Chapter 1 Introduction Energy Consumption

## 1.1 Background Energy Consumption and Renewable Energy

### 1.1.1 Global Energy demand

In the human history, energy become important for their activities in every day. Several time the energy in the world made transition from one major to another. In three decades, energy consumption is gradually emerged, where the fossil fuel continues to dominate for global primary energy demand. In fact, several of them such as oil, gas, and coal still play a role in global energy system, even though energy efficiency gives noteworthy effect to control the energy demand. In 2018, energy demand in the world rises near 2.3 percent, nearly twice the average rate of growth since 2010[1]. Several aspects such as the increasing amount of residential and appliances that equipped for human activities also influence the growth of energy demand especially in electricity. In demography side, human population is predicted to increase from 7.5 billion today to 9.2 billion in 2040. It will guide the future of global energy demand. New technologies such as electric vehicle where have been developed in Europe, US, and several countries also contribute for the rising of electricity demand in the world.

The increasing electricity consumption become important issue that drives to consider and plan precisely the electricity resource's amount and type. Global power consumption in 2018 accelerate to 3.5 percent from 2017 or 3.1 percent per year from 2000[2]. Most of power consumption is from Asia, where China dominates it against economic and industrial growth. Demand also increased in several countries such as India, South Korea, Japan and Indonesia[3]. Moreover, global warming also take into account become additional factor, availability and electricity price compel the scientist and government around the world to observe the solution for these problems.

The use of conventional energy resources in particular fossil fuel remains under debate because of its hazardous impact to the society and environment[4]. The economy and reliability of these resources become a concern for countries in the world. In fact, some countries in the current region or developed countries still rely on it to drive the economic and social activities. Most of politicians in government, company, health expert and environmentalist debate for extraction conventional fuel where it uses extremely huge so that gives some impact to the earth. Pollution and dropped

## Introduction Energy Consumption

earth surface for example problem has been discussed. Meanwhile, the availability and price reflect the tension of political in some countries.

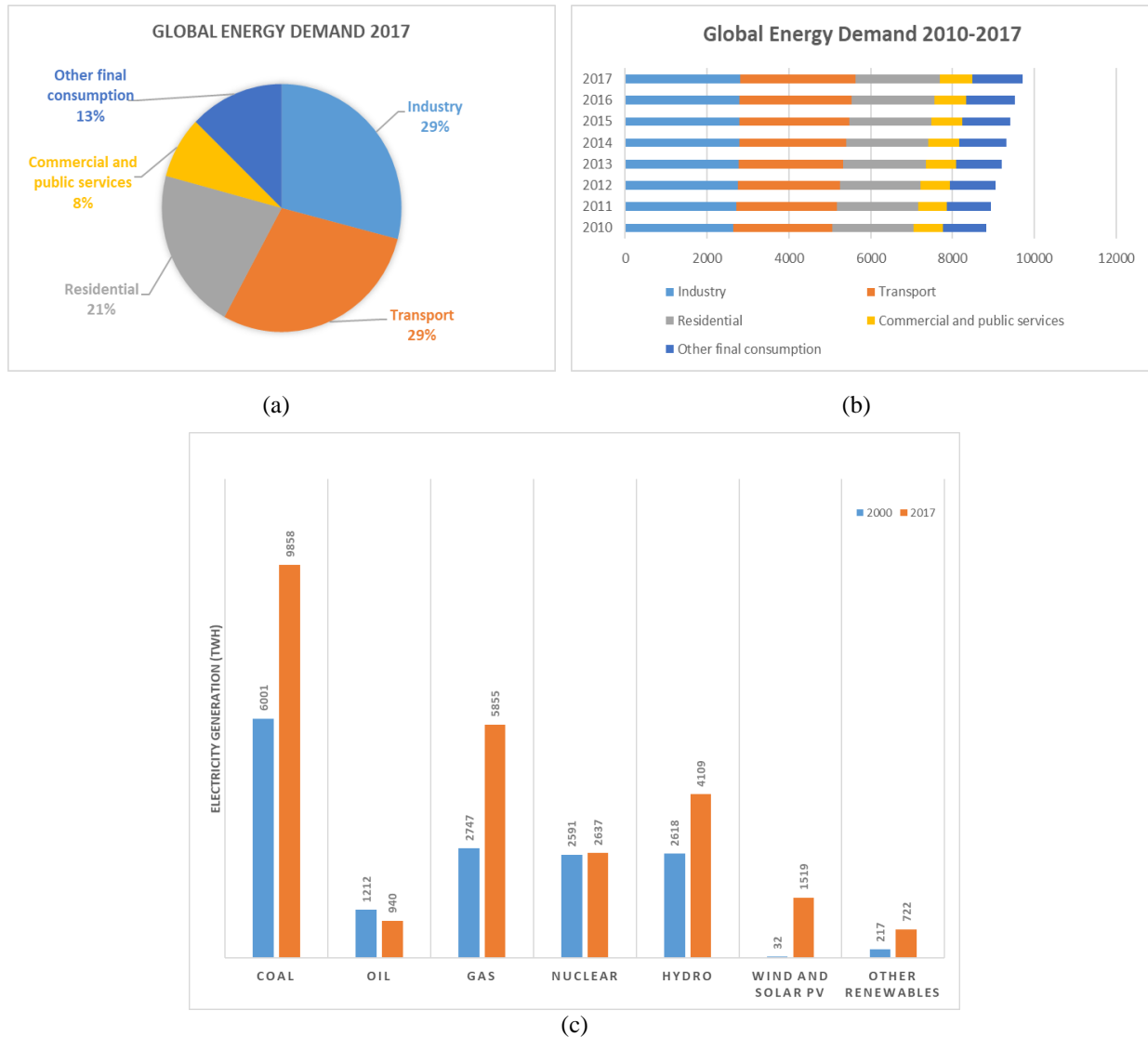

Fig. I.1 (a).Global Energy Demand by sector in 2017, (b).Final Consumption by sector between 2010 and 2017. (c).Electricity generation by fuel and technology in 2010 and 2017[5]

Climate changing also become factor on the use of energy. Paris agreements generate most of countries in the world to hold the increasing global temperature below 2 degree Celsius and limiting the temperature 1.5 degree Celsius in maximum. Fossil fuel need to be reduced in order to repair the environmental aspect. Nevertheless, higher energy demand in 2018 drive global energy related CO<sub>2</sub> emission jump 1.7 percent to the historic value of 33.1 Gt for carbon dioxide[6]. In power alone, using coal produces amount 10 Gt CO<sub>2</sub> where the countries that use this resources mostly from Asia. The rising of emission is driven by higher energy consumption

## Introduction Energy Consumption

that resulted from vigorous global economy, another stimulation from weather conditions in part of the world also drive the mounted of energy consumption for cooling and heating. Thanks to renewable energy and nuclear energy, the growth of emission 25 percent slower than energy demand in 2018. In 2019, in USA alone, produced carbon dioxide emission from electricity generation sector has produced to 1 million and 620 thousand metric ton, where its value is reduced 8 percent compared the emission in 2018[1]. While the CO<sub>2</sub> emission from retail electricity in residential sector in 2019 reach 620 thousand metric tons, which account for about 64 percent of the total emission in them. New alternative is emerged such as wind and solar that help to push electricity into the new energy system.

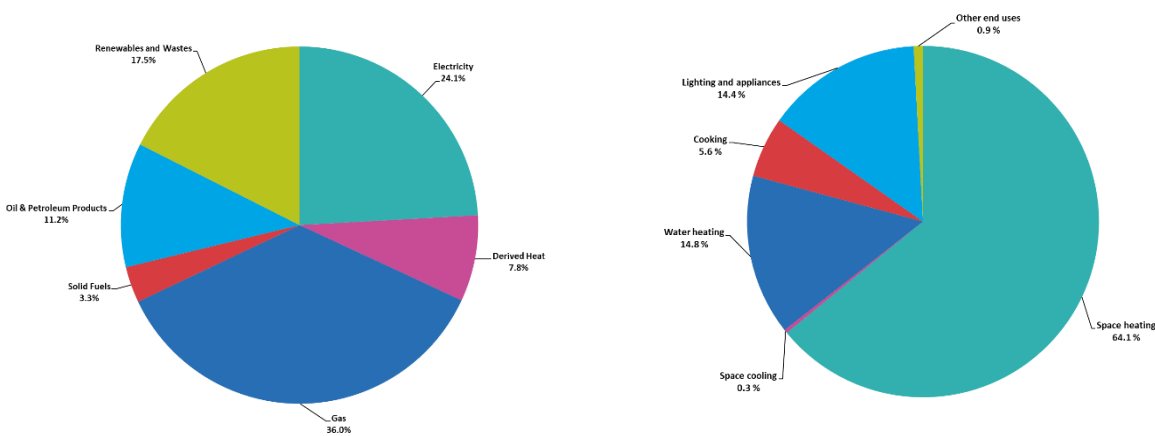

Fig. I.2 Final energy consumption in residential sector EU28 based on fuel and use by 2017[7]

World energy demand continue to grow from year to year. Until 2017, energy consumption was still dominated by fossil fuel around 79.7% of total final energy consumption (TFEC)[8] Followed by modern renewable, traditional biomass and nuclear around 10%, 7.5% and 2.2%, respectively. In modern renewable energy itself, hydropower still much used around 3.6% from TFEC, while wind, solar, biomass, geothermal and ocean energy together in 2%. International Energy Agency (IEA) note in their report 2018 as the energy demand remain consumed fossil fuel (coal, oil, and gas), nuclear, renewables and solid biomass[2].

Instead, renewables make big progress where it rises sharply until over 150 times from previous energy consumption namely 662 MToe to 1358 MToe. Meanwhile, reduction of oil for electricity generation is started, and then it has dropped to 22.4% from previous oil use. When worldwide conduct the sustainability policy scenario where it is delivering on Paris agreement, premature

death due to energy related air pollution, renewable energy will climb to 212% by 2040, and coal consumption will fall to 57% from the consumption in 2017.

Whereas the global energy demand in 2017 as shown in figure I.1(a). Industrial and transport sector dominate for consuming energy in 29 percent, while the residential use 21 percent for energy. The growth of demand in all sector also jump up from 2010 to 2017. In sector residential, rising of energy demand amount 3.92 percent while the others is resumed in figure I.1(b). Whereas the final consumption in residential uses new policy scenario that brings EU new ambition, China air cleaning policy and scheme from USA, Japan and South Korea related energy plan, it is predicted to rise 23.3%, however the residential final consumption is foreseen fall to 6% by 2040. Based on figure I.1(c), electricity generation in worldwide use coal and nuclear between 2000 and 2017 increase 2.8% and 1.7%, respectively. Meanwhile, oil consumption for electricity generation decline 22.4%, wind and solar PV jump rapidly over 500 times from previous electricity generation where in 2000 it produce 32 TWh by 2000 and rise to 1519 TWh by 2017. At the same time when new policies scenario is applied, electricity generation based on coal will be lied in 4.8% by 2040, while the one produced by wind and solar PV will climb 4.5 times from electricity generation in 2017. However, electricity based on coal will be reduced almost 79.9% by 2040, when sustainability development scenario is applied. In contrast, generation based on wind and solar PV increases sharply over 8 times from produced electricity in 2017.

Meanwhile, most of EU countries consumption remain rely on natural gas and electricity to fulfil their consumption in the residential sector[7]. Nevertheless, Denmark and Lithuania count on derived heat as the main energy carrier. In the same time, Poland and Ireland use solid fuel and petroleum product become the main energy carrier. The household consume for 27.2% of final energy consumption and most of energy is envelope by natural gas (36%) and electricity (24.1%). Where space heating dominate for energy use around 64.1% and followed water heating and lighting and appliance (exclude heating and cooling system) in 14.8% and 14.4%, successively. The portion of final consumption EU28 in residential sector are shown in figure I.2. In France and Spain, Electricity dominates the energy use in this sector around 33.7% and 39%, followed natural gas and renewable and waste in 27.9% and 21.9% of final consumption in France and 24.3% and 18.9% , respectively in Spain.

## Introduction Energy Consumption

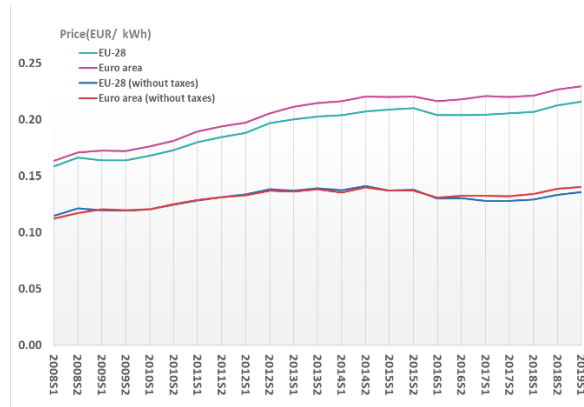

Fig. I.3 Evolution of electricity prices for household consumers, EU-28 and EA, 2008-2019[5]

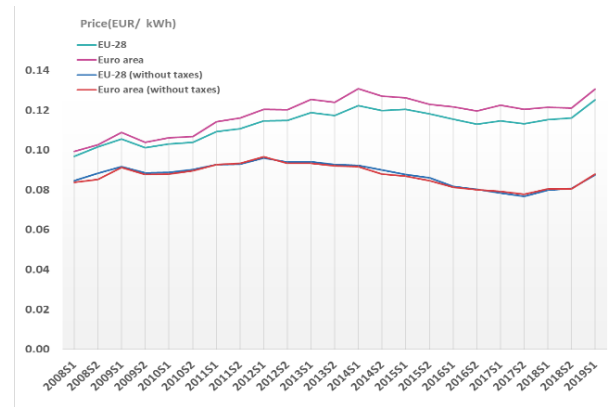

Fig. I.4 Evolution of electricity prices for non-household consumers, EU-28 and EA, 2008-2019[5]

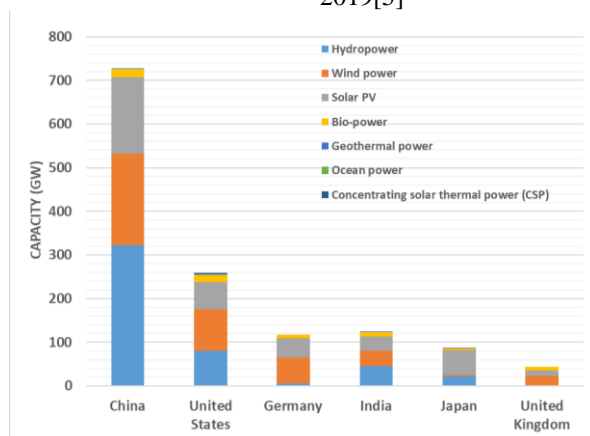
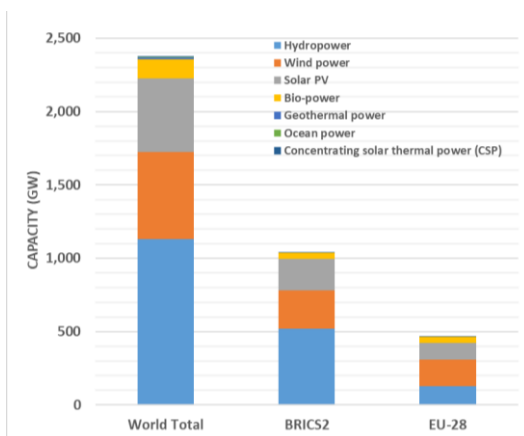

Fig. I.5 Statistics on renewable energy sources installed capacity in 2018 per sources in the world, in EU-28 and in BRICS[5]

However, electricity only take over 24.3% of the final energy consumption of residential sector, which lighting and appliance not only take full 100% use from this energy but also space cooling rely on it. Electricity also consumed for 84% of other use and 48.8% of cooking. Gas plays a role for water heating, space heating and cooking area in 47.7%, 43% and 33.6%, respectively. While renewable cover energy use 23.4% of space heating and derived heat only cover water heating and space heating, Oil and petroleum product play essential role in space heating, cooking and water heating in succession 14%, 11.8% and 10.8%. Most of countries in EU spend energy consumption in space heating where Luxembourg and Belgium consume 79% and 72%. Meanwhile, Germany and France consume energy in this part in 67.1% and 66.1%, respectively.

The worst impact of climate change and conventional energy resources become subject of public interest in Europe. In 2007, for facing the fuel-based economy, In 2009 as original directive, EU as regulator develop low carbon based economy and concern in limitation of greenhouse gas

## Introduction Energy Consumption

emission. They take action not only in developing Renewable Energy Sources (RES) for 20 percent in 2020 but also improving energy efficiency[9]. Revise of renewable energy directive is done in December 2018 as part of clean energy in Europe package that purpose to encourage Europe as global leader in renewables energy at least 30 percent in 2030 and achieve the target of emission reduction under the Paris agreement. UE also make serious effort to set down household or consumer in the center of energy transition with the clear right to produce own electricity from renewables. Household, communities and business become clean energy producer, to lure investment and create more employment from renewable energy sector.

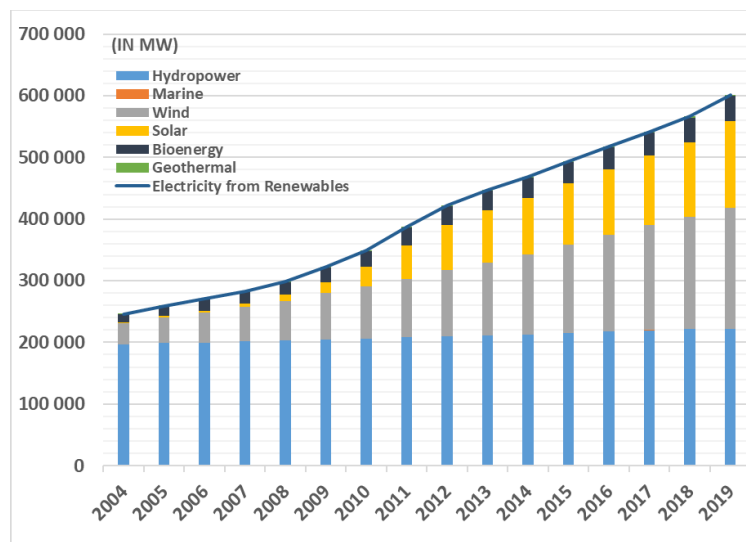

Fig. I.6 Trend in electricity generated by RES in Europe from 2005 to 2019[10]

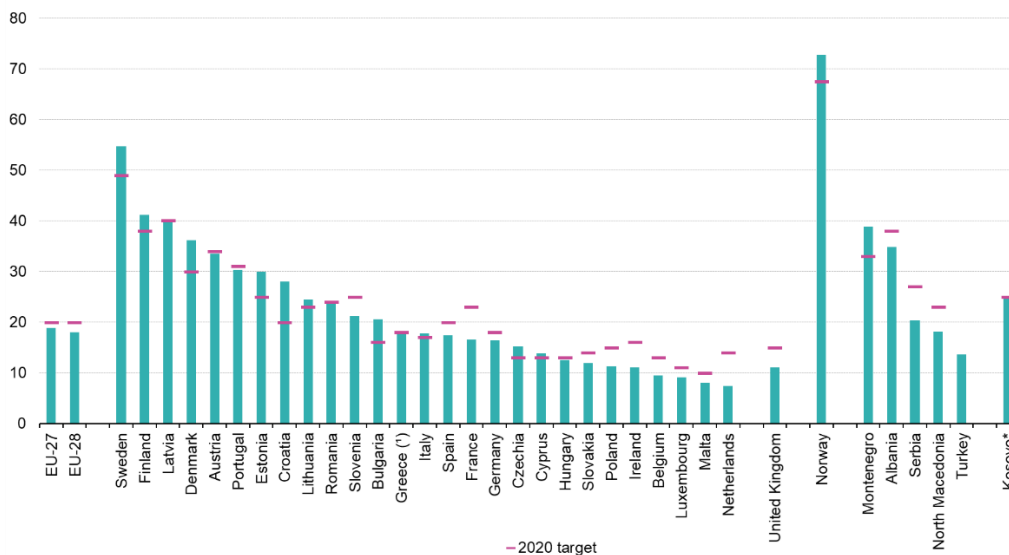

Fig. I.7 Percent share of renewable energies in gross final energy consumption in 2018 for European country and fixed targets for 2020[11]

During the last few decades, the factors and actions mentioned above have included to the increase in the electricity cost. In fact, European statistics, depicted in Fig. I.3 and Fig. I.4, highlight an increasing trend of electricity prices for both household and non-household consumers, which led to an increase of around 5.9 % and 2.4%, respectively in the price of electricity in the last five years. Electricity prices in Germany and France also slightly increased 3.8% and 3.7%, respectively, instead in Italy, the electricity price shown drop around 1.6%.

### 1.1.2 Renewable Energy Source Development

Revolution in the energy mainly in the renewable sector, which is known by the name “Energy Transition”. In beginning of the “energy transition”, governments in several countries over the world give opportunity to gain the capacity of Renewable Energy Source (RES) in power sector while it was rose to 2378 GW in 2019, as shown at figure I.5. RES become an alternative to reduce the external energy dependency and the same time, it diminishes the environment issue associated with fossil fuel consumption[12]. During the last decade, RES become one-third of total installed power generation in the world. The new installations reach 181 GW was added in 2018, which is 64% of total attached power plant, and make a new record in front of the previous year. Statistics of RES as capacity per source in the world, in Europe and in BRICS<sup>1</sup> are resumed for the year 2018, as shown in figure I.5. In region, Mainland China still dominant for renewables energy production than other countries where 727 GW electricity produced include hydropower technology. Followed by United States and India where it produce RES in 260 GW and 124 GW, successively.

Since 2004, the electricity from RES is increased gradually in Europe on path the EU policy target 20% share RES, which in 2018 the policy have revised to 32% for 2030. The energy consumed from it stood at 18.9% from 9.6% in 2004 and reflected in figure I.7. The 28 countries in Europe (EU-28) participate in 469 GW for RES installed capacity (figure I.6). Additionally, Germany represent EU countries that produce electricity 119 GW where wind and solar energy become the highest production in 59 GW and 45 GW, respectively. Governments in EU-28 have also create the national 2020 binding target for the increasing share of renewable energy which 12 countries already fulfil their target. Sweden was the highest share around 54.6% where pass their target 49%.

---

<sup>1</sup> BRICS is an English acronym used to refer to five major emerging national economies: Brazil, Russia, India, China and South Africa.

Finland become second countries in 41.2%, followed by Latvia (40.3%), Denmark (36.1%) and Austria (33.4%). Nevertheless, France and Netherlands still further away from their goal where France only reach 16.6% of 23% their target and Netherlands in 7.4% of 14%. The participation of EU countries is resumed in figure I.7

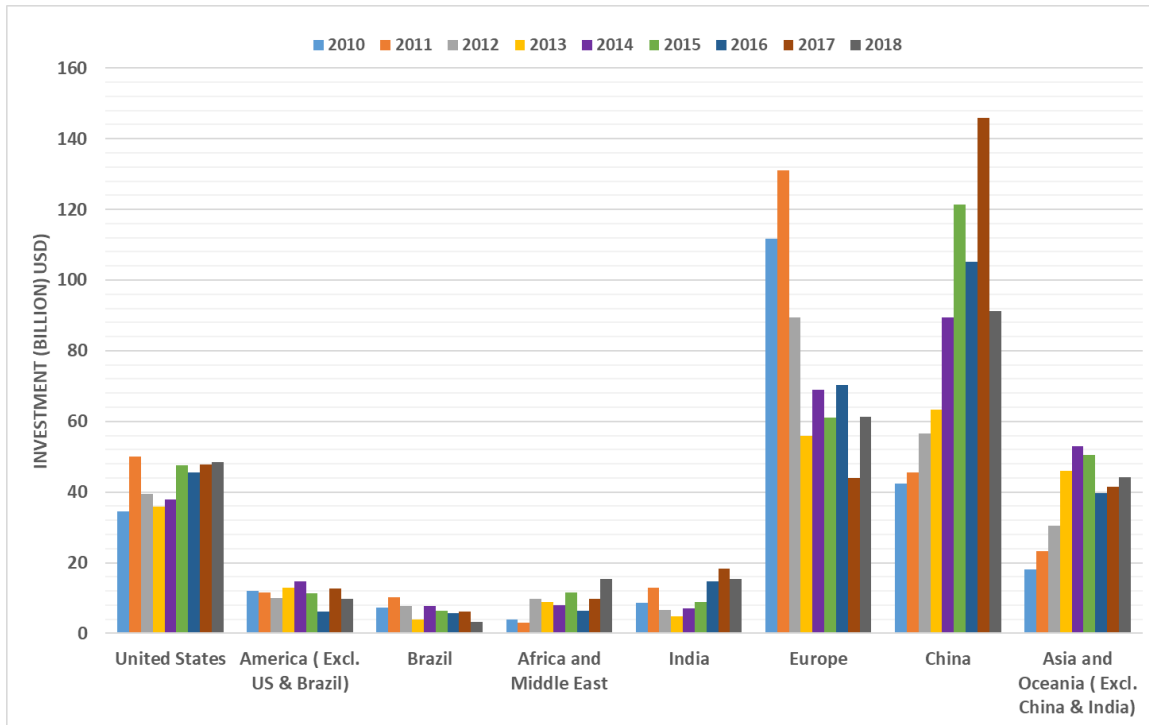

Fig. I.8 Total investments in RES by region between 2010 and 2018[8]

Through the renewable energy investment perspective, between 2010 and 2019 global investment reach USD 2.6 trillion exclude large hydro)[13], where solar is chosen for power generation with USD 1.3 trillion investment, followed wind power and biomass and waste in USD 1 trillion and USD 115 billion, respectively. China committed to invest in renewable energy sector and become top country with USD 758 billion from 2010 until the end of first half of 2019. Then followed by USA and Japan in USD 356 billion and USD 202 billion, successively. Total investment of Europe plus United Kingdom for investment reach USD 698 billion where Germany dominate in contribution amount USD 179 billion. Based on REN21 Global Status report, India and Brazil participate for RES investment where in period 2010-2018 they contribute USD 97.5 billion and USD 58.4 billion in total. While the Asia plus Oceania exclude India redound USD 346.8 billion in total. The total investment of RES is resumed in figure I.8.



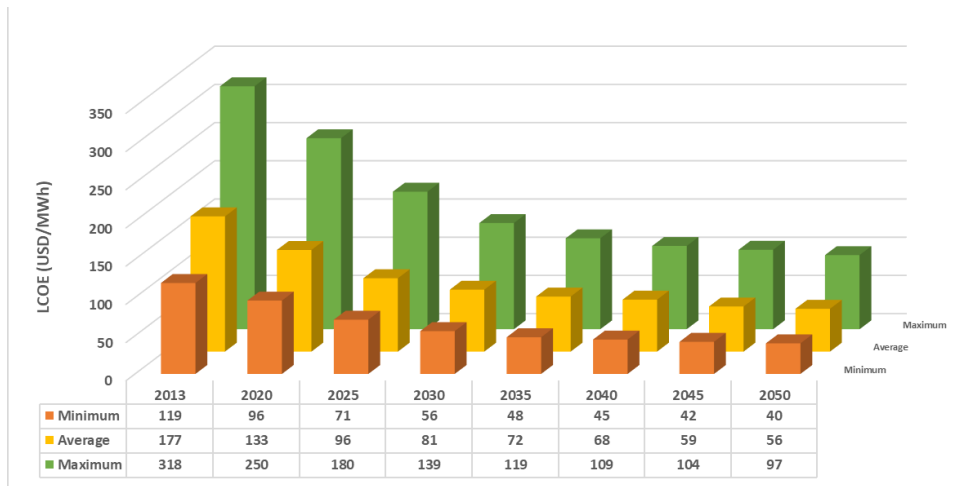

Fig.I.9 Levelized cost of electricity projection for utility scale PV system to 2050[14]

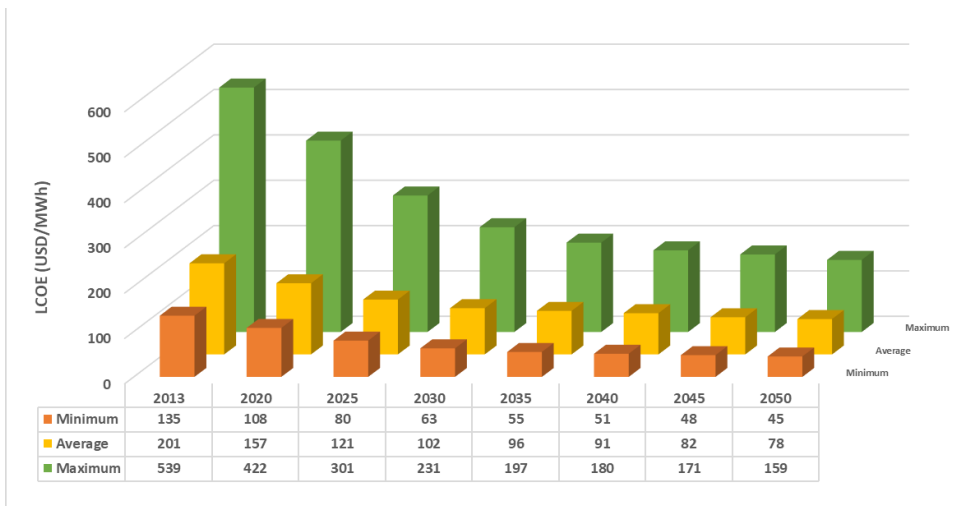

Fig. I.10 Levelized cost of electricity projection for rooftop PV system to 2050[14]

The greatest of used renewable energy such as installed power plant based on wind and solar energy technology. Several countries race to increase the capacity of it especially solar technology. IEA in 2014 make prediction in its roadmap for the global photovoltaic production in worldwide will be jump up to 16% in 2050. In another roadmap, IRENA envisage the PV system will reach to 2840 GW globally in 2030 and increasing to 8519 GW in 2050, Phenomenon in economic sector and government policies make the solar technology more and more competitive to conventional power plant technologies. Furthermore, the interest of people to photovoltaic system in their house more increased and the cost of photovoltaic is diminished in recent years, as consequence, the price of solar cells and module fall gradually. In USA, the price was plunged from USD 3.79 in first semester of 2015 to USD 2.96 in second semester of 2019[4]. IEA also organize PV price scenario where it envelope levelized cost of electricity (LCOE). They put estimation in the report

for roadmap 2013-2050, which LCOE will be cut around 65% for both utility and small-scale consumers. Estimation average LCOE for utility scale PV plant in 2020 is USD 133 per MWh and USD 157 per MWh for rooftop PV system as shown in fig. I.9 and fig. I.10 respectively. But the real result is different where IRENA report 2018, average LCOE for utility-scale PV plant already in USD 85 per MWh, so that, between 2010 and 2018 LCOE drops around 77%. In other side, IEA renew the estimation in their report 2018 where it will be diminished below USD 70 per MWh in 2030 or 40% below the level in 2017. Instead, it will drop again to USD 60 per MWh by 2040[2].

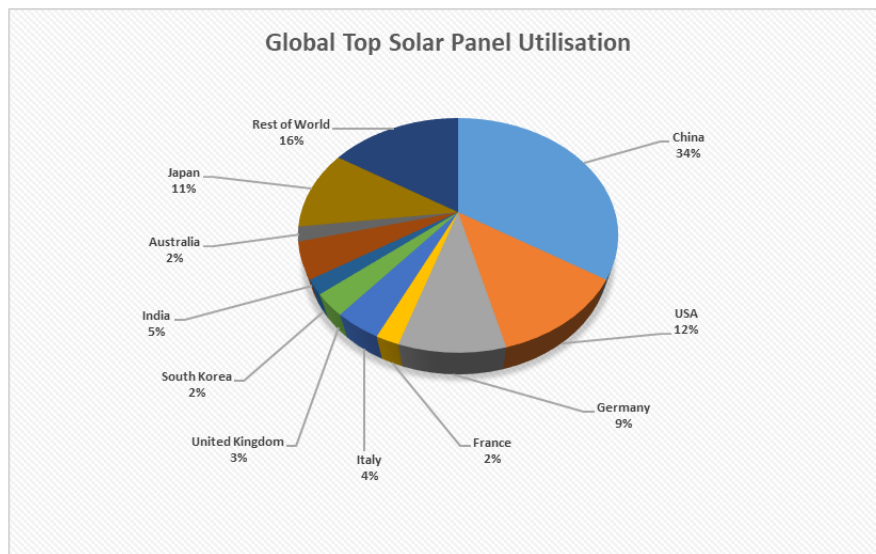

Fig. I.11 Percentage of PV use in worldwide for 2019 [15]

China has become the leading country for producing electricity from photovoltaic, with a share of 34% from total installed photovoltaic as shown in figure I.11. It is followed by USA and Japan with 12% and 11%, respectively. And the capacity that already installed in several region, China become the top country that make PV megaproject for electricity where they installed 175 GWh of PV capacity by 2017 reach to around 205 GWh by 2019[10] or rise 17% in development PV percentage. The interesting thing where China accomplished make the big progress which they only installed 77 MWh of PV in 2004. Instead, they make giant development between 2010 and 2013. Their total PV capacity are followed by EU28 and Japan where their PV capacity lied in almost 130 GWh and 62 GWh, respectively. The development of PV in region is resumed in figure I.12. In EU region, Germany remain led the PV capacity development where it capacity led in around 49 GWh and jump to 8.36% from 2018 PV capacity. Then it followed by Italy in 21 GWh or rise 3.94% from previous year. Meanwhile, In France, installed PV plant already reached 10.6

GWh and increase 9.83% compared by 2018 results and the interesting progress is in Spain where the amount of PV capacity increased sharply from 4.76 GWh to 8.76 GWh.

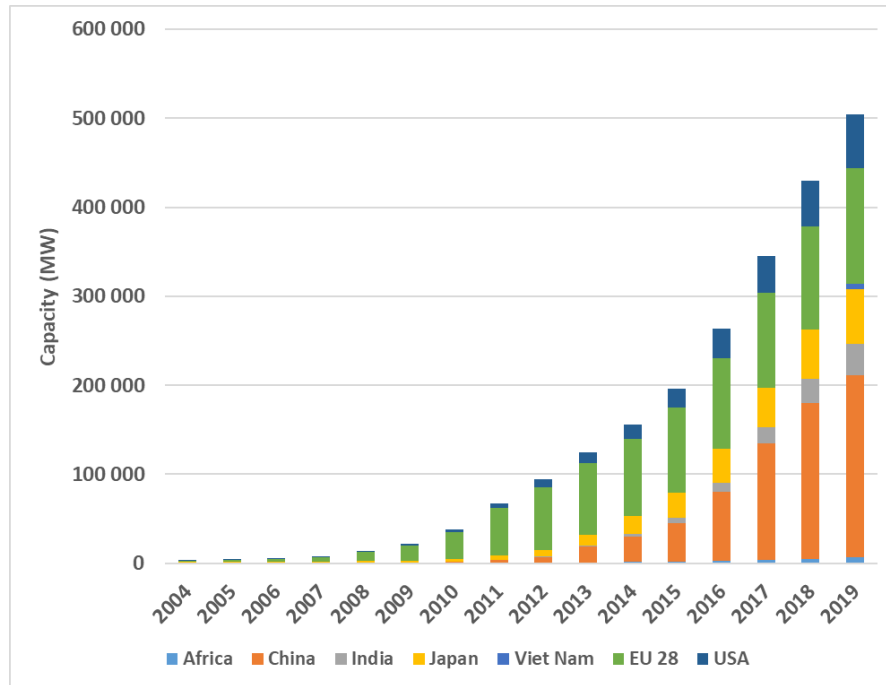

Fig. I.12 Capacity of installed photovoltaic in the world for 2019[15]

Although several countries released the policies to support the solar infrastructure, some obstacles remain following the deployment of photovoltaic divide on several criteria. IEA in its report mentions the barriers of PV development in each overview namely, solar technology, project delivery and workforces overview, energy infrastructure, and also regulatory, policy and market overview[16]. For instance for energy infrastructures, the obstacles rise from insufficient grid capacity where IEA prepares the option to make grid planning and prolongation a priority agenda. While in the grid connection constraint remain, become problem where TSO or DSO have lack capacity for grid connection. IEA offers option for the action to handle this barrier with and organizes monopoly control to allow access to Independent Power Producers (IPPs).

Furthermore, the barrier is looked from policy, regulation and market framework issues, where ‘Stop-and go’ policy approaches and retroactive changes have undermined investor confidence. IEA makes action option such as to set up policy structures that enable fair sharing of risks and benefits among all stakeholders. The barrier in investment also disturbance the development progress for instance, LCOE of solar technology is uncompetitive relative to others. The action

that offered is reforming the energy market where removing inefficient direct and indirect subsidies for conventional source of energy.

### 1.1.3 Building energy consumption

In residential sector, including buildings, electricity demand is nearly 31% of the global building energy demand[8]. Heating and cooling entered in the demand because it is considered for the determination of building energy efficiency. Space cooling is reckoned for around 13% of the overall growth of electricity demand in worldwide during 1990-2016 and 22% of the enhancing electricity consumption in the building alone[29]. Several factors drive such as population, floor area, season period and geographic population determine the boosting of the cooling demand[8], [30]. In China, cooling demand rises 71% because most of 58 million people install air conditioner annually. While India increases electricity for cooling demand in 42%. While the heating demand is also increased nearly 10% between 2010 and 2017[8]. Between 2012 and 2017, global average energy use per household rises 0.7% annually and variations depend on region as shown figure I.13.

Some countries have released some regulations and some industrial offers for developing energy management products concerning energy efficiency issue. In Europe, European Commission releases the directive where the energy efficiency target was 20% by 2020. However, it was revised in 2018 with a new energy efficiency target of 32.5% by 2030. The amendment envelopes all segments included heating and cooling areas.

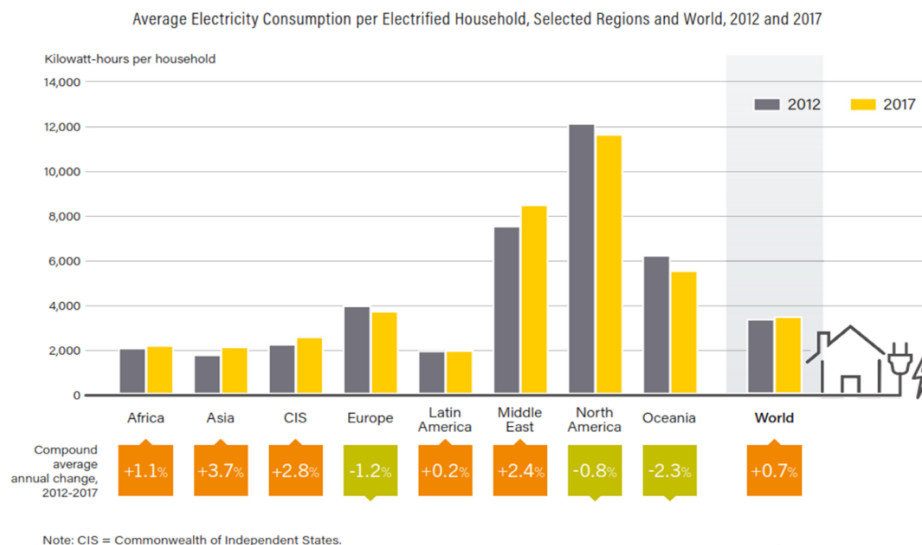

Fig. I.13 Electricity consumption of household in worldwide[8]

## Introduction Energy Consumption

---

Statista reports global energy management development through the sale product for energy efficiency solution. They predict increasing revenue from this segment and count the COVID-19 pandemic, which alter the market. Revenue in 2017 is USD 342 million will grow to USD 12,442 million by 2024. Nevertheless, in revenue growth, it decline from 32.1% by 2017 to 11.2% in 2024. The user that use smart home in 2017 in 34.3 million will be expected to increase to 234 million by 2024. In addition, penetration rate expected jump from 1.9% in 2017 to 12% by 2024. In revenue, energy management market remain dominated by USA where they get USD 2,314 million by 2020 and followed by China and Germany with USD 1379 million and USD 681 million, respectively. While household penetration in the energy management segment, Norway become highest country with 23% followed by Sweden and Denmark with 20.8% and 19.9%, respectively. France itself, the household penetration reach 7.2%

In France, Statista predicts the market of energy management will rise, where the revenue from this segment in 2017 is USD 68.76 million expected to jump to USD 256.47 million in 2024 as shown in figure I.14. This segment envelopes the sale of product and service for equipment controller and reduction energy consumption. However, smart plug and smart meter are not included in this survey of smart home market[31].

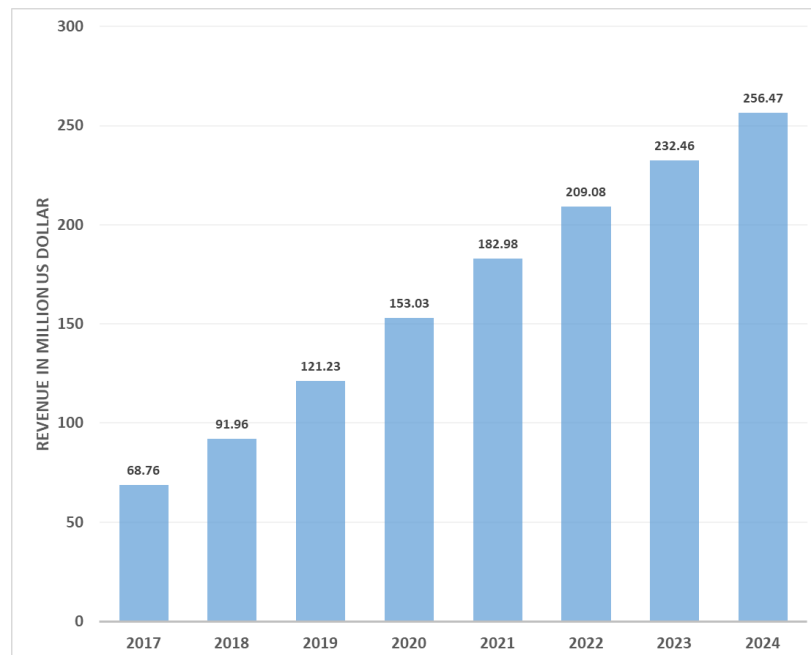

Fig. I.14 Revenue of smart home market between 2017 to 2024 [31]

### 1.1.4 Building Integrated Photo Voltaic (BIPV)

The electricity consumption for residential that mentioned above take 21% from global consumption or 40% from European total primary energy use. The other subjects, where the land is limited for solar farming and attempting for achieving EU Energy target 2030, the house is not only renovated follow the aesthetic but also developed with technology and energy integration where they are included in Building Integrated Photovoltaic (BIPV) concept. The first BIPV implementation is in Aachen, Germany 1991 where the PV integrated into a curtain wall façade with glass isolation[38]. In perspective, BIPV represent a strategic part of the future building vision and purpose to reach Net Zero Energy Building (NZEB), where it bring the worlds of construction and solar panel together with all challenges and opportunities build-in with change paradigm. With BIPV, all component such as technology, aesthetic, energy efficiency, functionality, reliability and flexibility put together in the same concept. BIPV technology can be easy integrated into the façade, roof and others of building. Percentage of segments in residential building in Façade product and single-family house in roof product is prepared in figure I.15 where solar modules take 30% and 41%, respectively.

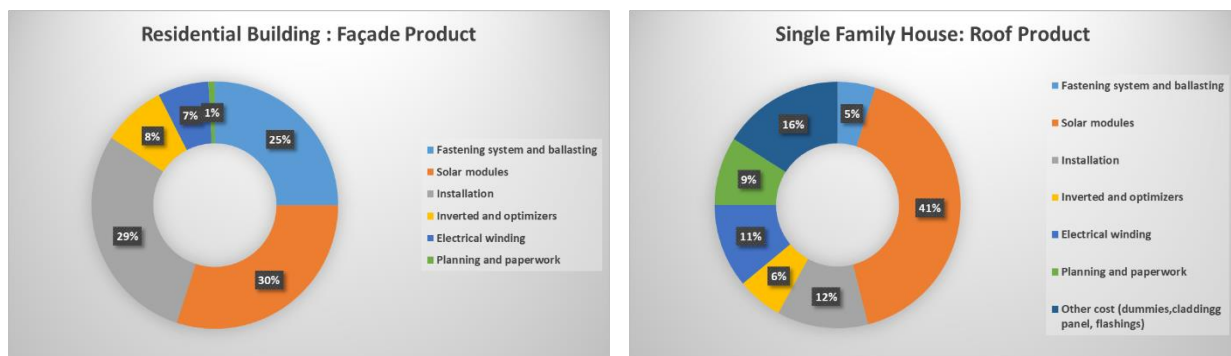

Fig. I.15 Percentage of BIPV component in residential building and single family house[39]

Based on technology integration, technology aspect is added in the building where PV modules is considered for become integrated components that envelope in the constructive system and could meet the other function by the building envelope such as weather protection, sun protection, heat insulation, noise insulation and etc. While the aesthetic integration, it is quite difficult because PV module have to develop in accordance with the aesthetic, which its definition could not determine with objectivity and certainly, what is beautiful in term of integration, however, it could help owner and architect to alter the useful reference. The potential opportunities BIPV for developing in the

## Introduction Energy Consumption

market rise from several segment such as installation cost reduction, improve aesthetic, higher technical potential, solar industrial interest and government support.

Several countries have issued promote action in order to enhance the BIPV technology development[40]. Between 2014 and 2015 BIPV market grow in 35% where the capacity increase from 1.5 GW to 2.3 GW[41], while, its contribution in global to energy capacity in 2016 was 1% being around 3.4 GW where the total solar PV around 303 GW[41]–[43]. In prediction, BIPV will grow in 2020 with 30% rate each year, which the capacity is estimated to increase to 8 GW by end of year 2020[30]. In financial, BIPV reach the improvement in the market where its global market is expected to reach USD 36.74 billion by 2025 as reported Grand View Research, Inc. While BIPV market in Europe and USA lied in €3.5 billion by 2020[44].

Several industrials have explored this area. For example, RGS Energy that produces the solar shingle where they give a name “Dow Powerhouse Solar Shingle”. It was made from thin film Copper Indium Gallium Selenide (CIGS) and then it use silicon cell in new 3.0 version[45]. Dow shingle offer in power amount 55 Watts with 15.6% efficiency and 60 Watts at 17.1%. The enterprise propose the shingle cost in USD 3.89 per Watt and it give warranty product for 11 years. In addition, they also give weather performance warranty for 25 years.

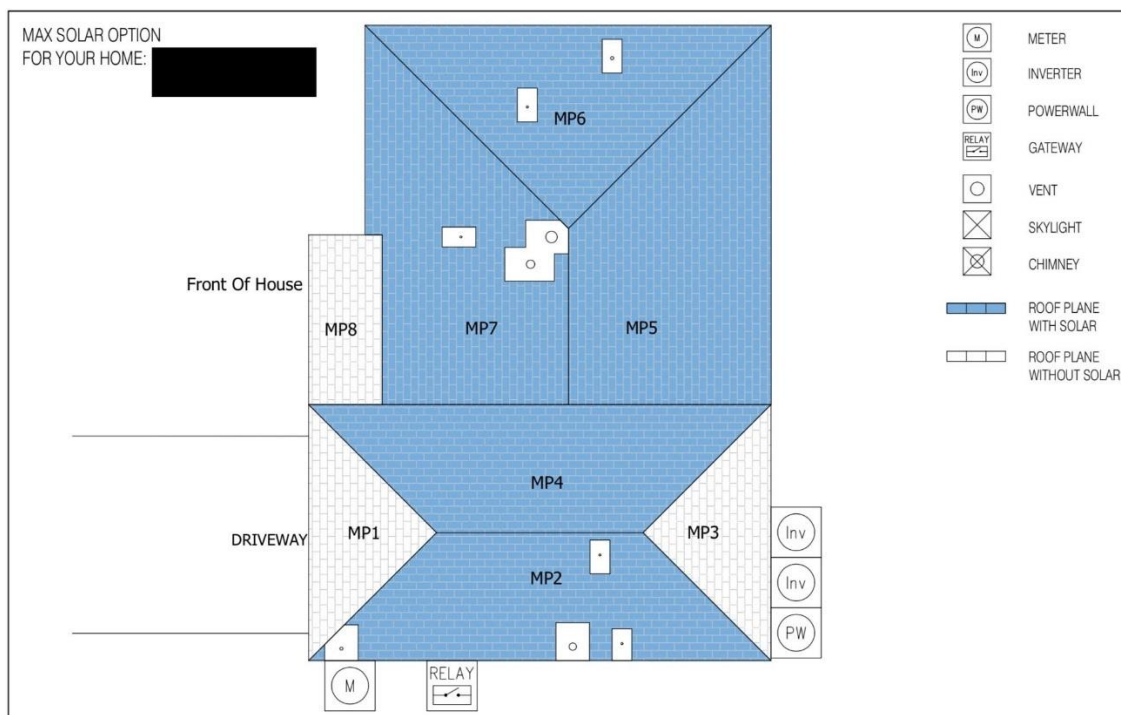

Fig. I.16 Design of Tesla solar roof [46]

## Introduction Energy Consumption

---

In other side, Tesla Solar Roof V3 released by Tesla Corporation to continue their previous BIPV product namely; Tesla solar roof V2, which it takes function of photovoltaic and integrated it into roof shingles. The design of solar roof, photovoltaic integrated with tiles in the house, so that the house does not need the platform for photovoltaic module, which it was drawn in figure I.16. The objective of marketing plan is take position for Tesla roof tiles as first choice for household that looking for aesthetic, green energy[47]. The company pegs the solar roof price at USD 1.99 per Watt where it is lower than national average cost of solar panel at USD 2.99 per Watt. They make estimation if the homeowner installs 9.45 kW system on an 1863 square foot roof, Tesla charging USD 64,634, along with USD 10,050 and another cost USD 10,630 for roof and site repair. The total is USD 85314 for entire solar roof system and installation[46], [47] . The guarantee envelope tile, power and weatherization during 25 years. Moreover, it already tested to withstand up to 1.75” hail, up to 130 mph wind and take in best fire rating in testing[48].

In another project of BIPV, Flissom, company from Switzerland develop CIGS Roofing Shingle on metal substrate under PVSite Project[49]. This roof is semi flexible, rectangle shape and lightweight with 6 kg per unit and 50 to 60 Watt in capacity per unit. Because the roof based on wood, the mounting screwed in horizontal bats. Flisom modules can operated in range temperature of -40°C to 85°C. However, the modules need secure from standing water, snow or extreme soiling. Flissom guarantee the module generate more power at lower temperature when consistent solar radiation. Several BIPV component product and specification could be seen in the table I.5.

Product Name	Company	Power	Guarantee Product	Price per watt
<b>Apollo II</b>	Certain Teed	60 watt in 14 solar cells	25 years	USD 4.9
<b>Apollo Tile II</b>				
<b>Suntegra Shingle</b>	SunTegra	64 to 67 watt in 16 solar cell	10 years	USD 3.65
<b>DowPowerHouse</b>	Dow Power house	55 to 60 watt	11 years	USD 3.89
<b>Luma Solar Power Shingle[50]</b>	Luma	65 watt per shingle	25 years	USD 4.5

Table. I.1 BIPV product and specification[51]



### 1.2 Photovoltaic: Self-Consumption and Energy Management

PV installation have several form such as ground mounted PV (GM-PV), floating PV and Rooftop PV. In Rooftop PV, PV modules installation depends on type of roof and structure characteristic of building, while the ground mounted PV are free standing and can be installed in anywhere around the house including front, side and backyard[17]. Economically, Rooftop PV is cheaper than ground mounted PV. The latter is burden by construction material, wiring, time and labor, while the former only needs a stable and well-maintained roof and generally long lasting until 20 years. Nevertheless rooftop PV has a drawback because uninstalling and reinstalling PV panels is complicated, time consuming and expensive.

Rooftop PV has become a target for Austria where the government has approved the new climate and energy strategy mission 2030 that concerns for investment support for 100000 rooftops with local storage. In Germany, the larger rooftop system have to market their electricity or take part in auction. Switzerland has a strategy to transform the energy system in 2050 and photovoltaic play a role in it. They estimate the rooftop PV potential of 50 TWh or 90% of the national energy demand. In Japan, residential rooftop entered in the market. Since 2011, they increase market share and the total capacity was 303 MW<sub>AC</sub> in the end of 2018. In Taiwan, rooftop PV installations have feed-in-tariff in the range 0.121 to 0.168 euro[18].

Several countries encourage their citizens to install their PV system with incentives (instance feed in tariff, green certificate and tax credit) to compensate the gap between PV generation cost and the revenue of utilizing and selling the PV electricity. When the retail price of electricity is higher than PV generation cost, it becomes possible to make self-consumption without subsidies. Mechanism of self-consumption is based on idea that PV production is used for local demand and should not be injected into grid. Countries like Belgium have given the right for self-consumption to the household that install PV system[19]. Incentive was given using net metering scheme where in region Wallonia and Flanders apply the net metering for prosumer with electricity below 10 kW with 1 years compensation with timeframe in annual basis[20]. Whereas, this scheme also applied in the Brussel region with electricity below 5 kW. Under net metering in Belgium, prosumer feed their surplus energy to the grid when they have oversupply. If the net metering system does not apply in the house, prosumer will receive the incentive from their surplus energy that injected to the grid. The injection price is around 3 to 5 cent euro/kWh, depend on the contract with the electricity provider, while they also have right to refuse the injection of excess energy from

prosumer[20]. The house also achieve green certificate because their PV production especially in Brussel. The house have to pay for transmission and distribution network fee, grid code and tax[19], while in Flanders, they have to pay grid tax (prosumer tariff) to local DSO for prosumer under net metering scheme.

Furthermore, in China self-consumption is also allowed. Incentive for self-consumption is given since 2012 and it revised at 2014 in order to boost the development distributed PV in there. The excess PV production can be sold at market price (0.72 Yuan) and the user still receives the bonus and the scheme duration until 20 years. In another section, PV penetration is limited to 20 MW. Moreover, the PV size limitation was transformed to 6 MW[21]

### 1.2.1 Self-consumption in France

France also recognizes self-consumption for their people where they permit households to install PV system since 2007[22]. According the report[23], the regulation of self-consumption for small private PV system set up incentive for partial self-consumption PV systems in association with the net billing FiT. At the same time, winning candidate for self-consumption PV tender (system from 100 kW to 1 MW) will obtain a bonus on self-consumption at the tendered rate. The government enforces the regulatory scheme duration such as surplus of self-consumption sold in feed in tariff for 20 years and 10 years for self-consumption tender. Again, according to this report, Grid connection fee is necessary for system over 36 kVA. The households have not to pay grid access fee if they apply total self-consumption. Whereas, they will obtain the reduced grid access fee presuming that they take partial self-consumption.

In France, Energy Regulation Committee (CRE) released the fifth tariff for utilization public grid (TURPE) regulation in 2018 and revise in June 2019, where they set the cost of public grid used by household as self-consumption actor[24]. TURPE 5 explains the cost for individual self-consumption that uses public grid and collective self-consumption. The cost components cover annual extraction component (CS), annual count component (CC), Annual component of supplementary and emergency feeding (CACS), Monthly component of subscribed power overruns (CMDPS), grouping component (CR), Annual component of reactive energy (CER), Injection component (CI), and annual management component (CG). The extraction component (CS) distinguishes in 2 criteria for collective self-consumption namely “autoproduits” that corresponding to energy generated by the production facilities is forming part of the operation and

“allo produits” means the energy supplied by the supplier who assume the responsibility of balance. This distinction corresponds to the difference between consumption and production allocated to the user of the operation. For PV installation below 36 kVA, TURPE aggregation only from three component namely CS, CC and CG. Annual consumed energy (supply) component (CS) is obtained from several components such as power weight coefficient ( $b$ ), subscribed power ( $P$ ) in kVA, energy weight coefficient ( $c$ ), and consumed energy ( $E$ ) in kWh. The equation for annual consumed energy component as show in table I.1, while the energy and power weight component prepared in the table I.2 and I.3, respectively

Type CS	Equation
$LV > 36 \text{ kVA}$	$CS = b_1 * P_1 + \sum_{i=1}^4 b_i * (P_i - P_{i-1}) + \sum_{i=1}^4 c_i * E_i$
$LV \leq 36 \text{ kVA}$	$CS = b * P + \sum_{i=1}^n c_i * E_i$

Table I.2. Equation for annual consumed energy (supply) component for Prosumer[25]

Where,

CS	=	Annual consumed energy (supply) component	€
B	=	Power weight coefficient, where $b_1$ represents power weight coefficient that is applied on the off peak period in season high. Whereas $b_i$ denotes power coefficient in $i$ - time range. In $LV \leq 36 \text{ kVA}$ , b only one type applies, even though the customer use 4-time range.	€/kVA/year
P	=	Subscribed power, where $P_1$ represents subscribed power in 1-time range	kVA
C	=	Energy weight coefficient, where $c_i$ indicates energy weight coefficient in the $i$ - time range	c€/kWh
E	=	Consumed energy, it could be symbolled in $E_i$ where it represents consumed energy in the $i$ - time range	kWh
$i$	=	Time range index	

## Introduction Energy Consumption

There are three types such as long, medium and short utilization. Long utilization is suitable for customer with high consumption throughout the year, generally more than 3500 hours per year at maximum power. Whereas the medium utilization is fitting for customer with the consumption between 2000 and 3500 hours per year. The customer take the short utilization when they consume electricity less than 2000 hours per year. The season also influences the cost where CRE put peak and off-peak tariff for long, medium and short utilization (it also depends on the contracted power, below or above 36 KVA). For instance, low voltage prosumer with power under 36 kVA in period August 1, 2019 to July 31, 2020, the power weight coefficient of CS is 5.95 €/kVA/year and will increase in further period (2020-2021) become 6.35 €/kVA/year[26]. However, in revision TURPE 5 that released at 25 June 2019, they only mention CS's power weight coefficient for prosumer period 1 August 2018 to 31 July 2019 is 6.12 €/kVA/year[27] and it is still applied in the new ENEDIS regulation[25]. Meanwhile, household as individual self-consumption with injection should pay management component (CG), for instance, household with low voltage under 36 kVA in period 31 July 2019 to 1 August 2020 have cost in contract with grid amount 21.48€. However, individual and collective self-consumption household have two types contract for annual CG that mentioned in the table I.4

Energy weight coefficient (c) in c€/kWh			High Season		Low Season	
			Peak	Off-Peak	Peak	Off-Peak
<b><i>LV ≤ 36 kVA</i></b>	Medium Utilization	PV Production	2.75	0.51	0.37	0.02
		Grid Production	5.61	3.91	1.94	1.10
	Short Utilization	PV Production	2.98	2.24	0.77	0.73
		Grid Production	7.27	5.59	2.07	1.10
	Long Utilization		1.43			
<b><i>LV &gt; 36 kVA</i></b>	Long Utilization	PV Production	2.93	2.18	1.54	0.12
		Grid Production	5.09	3.62	3.22	0.78
	Short Utilization	PV Production	2.10	2.07	1.40	0.08
		Grid Production	4.76	3.46	2.37	0.12

Table I.3 Energy weight coefficient (c) for prosumer in 4 timeslot[25], [27]

## Introduction Energy Consumption

Power weight coefficient (b) in €/kVA/year			High Season		Low Season	
			Peak	Off-Peak	Peak	Off-Peak
<b><i>LV ≤ 36 kVA</i></b>	Medium Utilization	Auto Production	6.12			
	Short Utilization	Auto Production	3.60			
	Long Utilization		60.60			
<b><i>LV &gt; 36 kVA</i></b>	Long Utilization	PV Production	20.03	15.22	11.48	8.02
	Short Utilization	PV Production	8.31	8.30	6.45	4.01

Table I.4 Power weight coefficient (b) for prosumer in 4 timeslot[25], [27]

Management Component in €/year	Individual Self consumption		Collective Self-Consumption	
	Grid access contract concluded by user	Grid access contract concluded by supplier	Grid access contract concluded by user	Grid access contract concluded by supplier
<b><i>LV &gt; 36 kVA</i></b>	208.80	180.84	260.28	232.20
<b><i>LV ≤ 36 kVA</i></b>	15.12	12.72	18.72	16.32

Table I.5 Management Component (CG) cost for 1 year[25], [27]

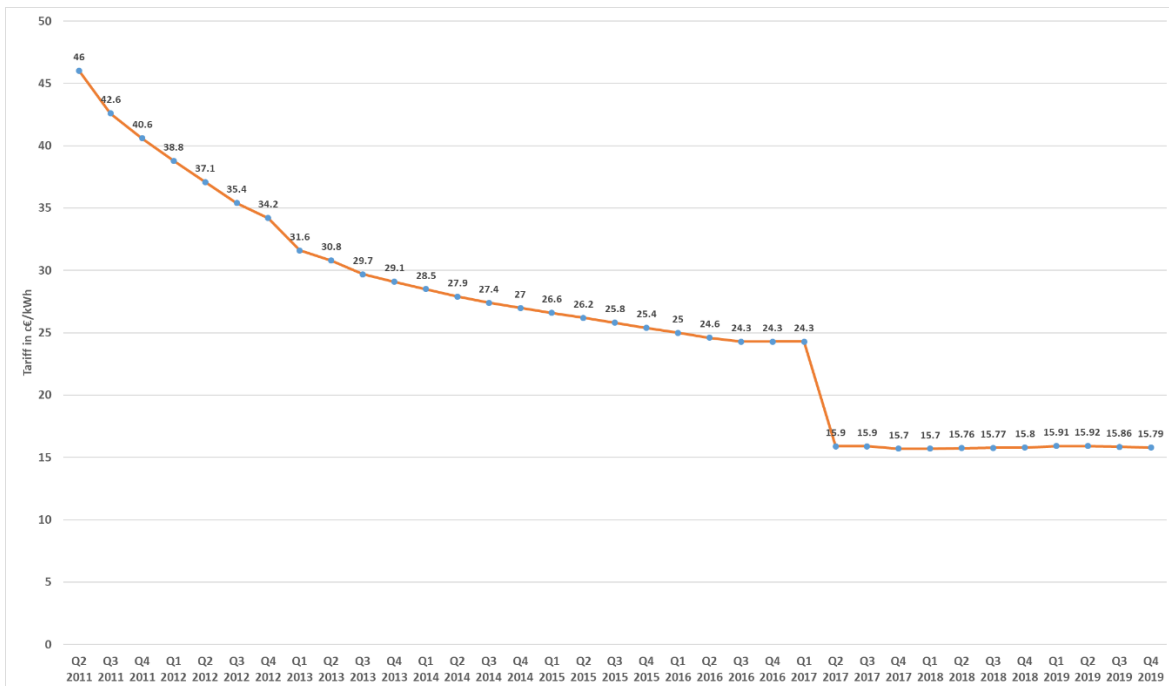

Fig. I.17 Evolution of Feed in Tariff for residential in France[28]

Overview from financial segment for PV development also necessary especially in self-consumption, where government support the people for self-consumption that mentioned above.

One of compensation is Feed-in Tariff that become benefit for prosumer. Nevertheless, with the decreased PV cost and highly interest for PV system, government begin to reduce the feed in tariff. Based on Statista report[28], the feed in tariff for residential customers in France shows a continuous decline since Q2 2011. Feed in tariff in Q2 2011 started from 46 c€/kWh and has dropped to 15.79 c€/kWh in Q4 2020. The decline of feed in tariff is illustrated in figure I.13. However, French government gives award to household using PV installation with self-consumption bonuses.

### 1.2.2 Electricity Market: Peer to Peer Trading Concept

Development of renewable energy in particular solar technology in the house owner and evolution in the economical factor included the electricity market encourage R&D to create new system to support the energy sharing. Some countries release the regulation for driving the energy sharing, which actively investigated and needs more research for going to commercial. Uberization could be an alternative for electricity market via online, which the prosumer offer their excess energy for their revenue via online aggregator.



Fig. I.18 Example the matching of energy generator and consumption in Piclo[55]

Taking from review journal[52], several industries began release the energy transaction concept in online. Company from UK, Piclo open the energy transactive in “Piclo Flex”, which some energy companies participate for providing the electricity for instance, UK power network, Scottish and Southern Electric Network, Western Power distribution and SP Energy Network[53]. The system work where the consumer could choose and buy electricity to the registered local renewable energy generation that they are desired in the Piclo application. From meter data in there, they are able to match their demand with the generated electricity, which the data is written in there every half hour. Piclo fit the generator and consumption based on preferences and locality and provide data visualization and analysis to the consumer. The example result could be seen at the fig. I.20.

Project	Country	Start year	Objective	Network size	Outcome
<b>Piclo</b>	UK	2014	P2P energy trading platform from suppliers perspective	National	A P2P energy trading platform
<b>Vandebroon</b>	Netherland	2014	P2P energy trading platform from suppliers perspective	National	A P2P energy trading platform
<b>PeerEnergyCloud</b>	Germany	2012	Cloud - based P2P Energy Trading Platform, Smart Home	Microgrid	Cloud based platform for smart home
<b>Smart Watt</b>	Germany	2011	Optimizing energy supply via ICT	Regional	A Smart meter gateway as interface to internet of energy
<b>Yeloha Mosaic</b>	USA	2015	Solar sharing network for lower energy bill	Regional	Terminated due to funded issue
<b>SonnenCommunity</b>	Germany	2015	P2P trading with storage system	National	A P2P energy trading platform

Table. I.6 The comparison of Peer to Peer project[52]

In Netherland, Vandebroon, as energy distributed company released online platform for electricity market. Several energy farm owner include PV farm in this country offer their excess energy through this company via application, so that the consumer could buy the renewable electricity directly from independent producer[54]. The price will emerged in the application; furthermore, the consumer could select the match producer for them. It act as energy provider that link the producer and consumer and balance in the whole market[52].

In different countries like Germany, peer to peer trading concept is adopted by SonnenBatterie, a storage manufacturing company in Germany, which they develop “SonnenCommunity” project. In this community, the owner as SonnenCommunity member is allowed to share their self-

production to the other. As a result, the electricity no need the conventional power supplier anymore[56]. SonnenBatterie offer the membership for SonnenCommunity, which the fee start from 19.99 euro. The advantage that received by the member namely, 10 years guarantee on SonnenBatterie, low priced energy from SonnenCommunity, Free weather forecast updates, and free remote maintenance and monitoring. The comparison of P2P project could find in table I.6

## Reference

- [1] IEA, "Energy Efficiency 2019," *IEA Paris*, 2019. <https://www.iea.org/reports/energy-efficiency-2019>.
- [2] IEA, "World Energy Outlook 2018," IEA, Paris, 2018. [Online]. Available: <https://www.iea.org/reports/world-energy-outlook-2018>.
- [3] Enerdata, "Global power consumption 2018," 2018. <https://yearbook.enerdata.net/electricity/electricity-domestic-consumption-data.html>.
- [4] E. Amicarelli, "Stratégie de gestion des réseaux électriques à fort taux de production renouvelable distribuée," Université Grenoble Alpes, 2017.
- [5] IEA, "IEA Data and Statistics," 2019. [https://www.iea.org/data-and-statistics?country=WORLD&fuel=Energy%20supply&indicator=Total%20primary%20energy%20supply%20\(TPES\)%20by%20source](https://www.iea.org/data-and-statistics?country=WORLD&fuel=Energy%20supply&indicator=Total%20primary%20energy%20supply%20(TPES)%20by%20source).
- [6] IEA, "Global Energy & CO2 Status Report : The Latest Trend in Energy and Emissions in 2018," IEA, France, 2019. [Online]. Available: [www.iea.org](http://www.iea.org).
- [7] European Union, "Energy consumption in households," *Eurostat*, May 2019. [https://ec.europa.eu/eurostat/statistics-explained/index.php?title=Energy\\_consumption\\_in\\_households#Energy\\_products\\_used\\_in\\_the\\_residential\\_sector](https://ec.europa.eu/eurostat/statistics-explained/index.php?title=Energy_consumption_in_households#Energy_products_used_in_the_residential_sector).
- [8] REN21, "Renewables 2019 Global Status Report," REN21, 2019. [Online]. Available: [www.ren21.net](http://www.ren21.net).
- [9] European Union, "Renewable Energy Directive," Apr. 15, 2020. [https://ec.europa.eu/energy/topics/renewable-energy/renewable-energy-directive/overview\\_en](https://ec.europa.eu/energy/topics/renewable-energy/renewable-energy-directive/overview_en).
- [10] IRENA, "REmap Energy Generation and Capacity," 2020. <https://www.irena.org/Statistics/View-Data-by-Topic/Energy-Transition/REmap-Energy-Generation-and-Capacity>.
- [11] European Union, "Renewable Energy statistics," *Eurostat*, Jan. 2020. [https://ec.europa.eu/eurostat/statistics-explained/index.php?title=Renewable\\_energy\\_statistics#Share\\_of\\_renewable\\_energy\\_almost\\_doubled\\_between\\_2004\\_and\\_2018](https://ec.europa.eu/eurostat/statistics-explained/index.php?title=Renewable_energy_statistics#Share_of_renewable_energy_almost_doubled_between_2004_and_2018).
- [12] A. Soares, C. H. Antunes, C. Oliveira, and Á. Gomes, "A multi-objective genetic approach to domestic load scheduling in an energy management system," *Energy*, vol. 77, pp. 144–152, Dec. 2014, doi: 10.1016/j.energy.2014.05.101.
- [13] Frankfurt School-UNEP Centre/BNEF, "Global Trends in Renewable Energy Investment 2019," Bloomberg NEF, 2019. [Online]. Available: <http://www.fs-unep-centre.org>.
- [14] "Technology Roadmap-Solar Photovoltaic Energy." IEA, 2014.
- [15] A. beauvais and N. Chevillard, "Global Market Outlook for Solar Power 2018-2022," Solar Power Europe, 2018. [Online]. Available: [www.solarpowereurope.org](http://www.solarpowereurope.org).
- [16] IEA, "Solar Energy Mapping the road ahead," Oct. 2019. [Online]. Available: <https://webstore.iea.org/solar-energy-mapping-the-road-ahead>.



- [17] M. Darcey, “Ground-Mounted vs. Rooftop-Mounted Solar Panels.”  
<https://www.solarpowerauthority.com/ground-mounted-versus-rooftop-mounted-solar-panels/>.
- [18] A. Jäger-Waldau, “PV Status Report 2019,” European Union, 2019. [Online]. Available:  
<https://ec.europa.eu/jrc>.
- [19] G. Masson, J. I. Briano, and M. J. Baez, “Review and Analysis of PV Self-Consumption Policies,” IEA-PVPS, T1-28:2016, 2016.
- [20] G. Masson, “PV Prosumer Guidelines Belgium,” PVP4Grid-Becquerel Institute, Belgium, 2019.
- [21] L. Fang, X. Honghua, W. Sicheng, L. Hailing, M. Liyun, and L. Ping, “National Survey Report of PV Power Applications in China 2018,” IEA-CPVS, China, 2018.
- [22] MyLight Systems, “French energy context,” 2020. <https://www.mylight-systems.com/en/french-energy-context/>.
- [23] M. de L’Epine, “National Survey Report of PV Power Application in France 2018,” IEA-ADEME, France, 2018.
- [24] CRE, “TURPE 5 : Projet de décision sur la tarification de l’autoconsommation, et projet de modification de la délibération de la CRE du 17 novembre 2016 portant décision sur les tarifs d’utilisation des réseaux publics d’électricité dans les domaines de tension HTA et BT,” CRE Republique Francaise, May 2018. [Online]. Available: [www.cre.fr](http://www.cre.fr).
- [25] Enedis, “TURPE 5 bis HTA/BT: Tarifs d’utilisation des réseaux publics d’électricité,” Enedis, France, 2019. [Online]. Available:  
[https://www.enedis.fr/sites/default/files/TURPE\\_5bis\\_plaquette\\_tarifaire\\_aout\\_2019.pdf](https://www.enedis.fr/sites/default/files/TURPE_5bis_plaquette_tarifaire_aout_2019.pdf).
- [26] CRE, “Délibération de la Commission de régulation de l’énergie du 7 juin 2018 portant décision sur la tarification de l’autoconsommation, et modification de la délibération de la CRE du 17 novembre 2016 portant décision sur les tarifs d’utilisation des réseaux publics d’électricité dans les domaines de tension HTA et BT,” CRE Republique Francaise, DÉLIBÉRATION N°2018-115, Juin 2018. [Online]. Available: <https://www.cre.fr/Documents/Deliberations/Decision/Tarification-Autoconsommation-et-modification-deliberation-TURPE-HTA>.
- [27] CRE, “Délibération de la Commission de régulation de l’énergie du 25 juin 2019 portant décision sur l’évolution de la grille tarifaire des tarifs d’utilisation des réseaux publics d’électricité dans les domaines de tension HTA et BT au 1er août 2019,” CRE Republique Francaise, France, Juin 2019. [Online]. Available: <https://www.cre.fr/Documents/Deliberations/Decision/Evolution-de-la-grille-tarifaire-des-tarifs-d-utilisation-des-reseaux-publics-d-electricite-HTA-BT-1er-aout-2019>.
- [28] R. Samsó, “Development of photovoltaic (PV) solar energy feed-in tariffs for residential consumers in France between 2011 and 2019, by quarter,” Statista, Feb. 2020. [Online]. Available:  
<https://www.statista.com/statistics/1097557/share-photovoltaic-electricity-generation-feed-in-tarif-france/>.
- [29] IEA, “The Future of Cooling : Opportunities for energy efficient air conditioning.” IEA, 2018, [Online]. Available: <http://www.iea.org/>.
- [30] IEA, “2019 Global Status Report for Building and Construction.” IEA-UN Environment Program, 2019, [Online]. Available:  
[https://webstore.iea.org/download/direct/2930?fileName=2019\\_Global\\_Status\\_Report\\_for\\_Buildings\\_and\\_Construction.pdf](https://webstore.iea.org/download/direct/2930?fileName=2019_Global_Status_Report_for_Buildings_and_Construction.pdf).
- [31] Christoph Blumtritt, “Smart Home revenue forecast in the segment Energy Management in France until 2024,” Mar. 2020. [Online]. Available: <https://www.statista.com/statistics/480639/revenue-in-the-smart-home-segment-energy-management-in-france/>.
- [32] B. Asare-Bediako, W. L. Kling, and P. F. Ribeiro, “Home energy management systems: Evolution, trends and frameworks,” in *2012 47th International Universities Power Engineering Conference (UPEC)*, Uxbridge, Middlesex, United Kingdom, Sep. 2012, pp. 1–5, doi: 10.1109/UPEC.2012.6398441.

- [33] M. Isshiki, M. Umejima, M. Hirahara, T. Minemura, T. Murakami, and S. Owada, "Case study of an ecological, smart home network: iZEUS-intelligent Zero Emission Urban System," in *Ecological Design of Smart Home Networks Technologies, Social Impact and Sustainability*, Elsevier, 2015, pp. 91–111.
- [34] SHARP, "Energy Manager-Home Energy Management." <https://www.sharp-cee.com/cps/rde/xchg/scee/hs.xsl/-/html/product-details-components.htm?product=SCEM24V>.
- [35] PV Europe, "SMA optimizes energy management with the new compact Sunny Home Manager 2.0," Mar. 27, 2017. <https://www.pveurope.eu/Products/Self-consumption/Energy-management/SMA-optimizes-energy-management-with-the-new-compact-Sunny-Home-Manager-2.0>.
- [36] Panasonic, "Panasonic to Develop Full-scale Smart Home Energy Management System Business," Sep. 11, 2012. <https://news.panasonic.com/global/press/data/2012/09/en120911-3/en120911-3.html>.
- [37] A. Bhaskaran, "Global Home Energy Management Systems (HEMS) and Building Energy Management Systems (BEMS) Market, Forecast to 2025," *Frost & Sullivan*. <https://store.frost.com/global-home-energy-management-systems-hems-and-building-energy-management-systems-bems-market-forecast-to-2025.html>.
- [38] R. A. Agathokleous and S. A. Kalogirou, "Status, barriers and perspectives of building integrated photovoltaic systems," *Energy*, vol. 191, p. 116471, Jan. 2020, doi: 10.1016/j.energy.2019.116471.
- [39] I. Zanetti *et al.*, "Building Integrated Photovoltaics: Product overview for solar building skins Status Report 2017," SUPSI, University of Applied Science and Arts of Southern Switzerland=SEAC Solar Energy, 2017. [Online]. Available: [https://www.solaxess.ch/wp-content/uploads/2018/04/Report-2017\\_SUPSI\\_SEAC\\_BIPV.pdf](https://www.solaxess.ch/wp-content/uploads/2018/04/Report-2017_SUPSI_SEAC_BIPV.pdf).
- [40] Y. B. Assoa *et al.*, "Thermal analysis of a BIPV system by various modelling approaches," *Sol. Energy*, vol. 155, pp. 1289–1299, Oct. 2017, doi: 10.1016/j.solener.2017.07.066.
- [41] M. Tabakovic *et al.*, "Development and Implementation of BIPV Courseware for Higher Education and Professionals," in *Smart Education and e-Learning 2019*, vol. 144, V. L. Uskov, R. J. Howlett, and L. C. Jain, Eds. Singapore: Springer Singapore, 2019, pp. 209–217.
- [42] *Renewables 2017: Global Status Report*. 2017.
- [43] G. Masson, "2016 Snapshot of Global Photovoltaic Markets," Report IEA PVPS T1-31:2017.
- [44] PVSites, "BIPV market and stakeholder analysis and needs," Oct. 2016.
- [45] M. Reynolds, "The Tesla Solar Roof compared & reviewed for cost & aesthetics with their competitors," Feb. 01, 2020. <https://www.ecohome.net/guides/3502/tesla-solar-roof-cost-competitors-review/>.
- [46] L. RICHARDSON, "Tesla Solar Roof: Elon Musk's solar roof tiles complete review (V3)," Jun. 13, 2019. <https://news.energysage.com/tesla-solar-panel-roof-the-next-solar-shingles/>.
- [47] F. Lambert, "Tesla Solar Roof V3 real quote shows price dropped by 40%," Oct. 27, 2019. <https://electrek.co/2019/10/27/tesla-solar-roof-v3-quote-price-decrease/>.
- [48] Tesla, "Solarroof." <https://www.tesla.com/solarroof>.
- [49] PVSites, "Structure, contents and operation mechanisms of BIPV products portfolio -Second version," Jan. 2020. [Online]. Available: [www.pvsites.eu](http://www.pvsites.eu).
- [50] "The Luma Solar Collections." <https://www.lumasolar.com/>.
- [51] M. Reynolds, "BIPV solar roof shingles are poised to take over rooftop solar installations with better durability, pricing and aesthetics announced for the Tesla solar roof - here we look at the competitors in the solar roof market," Feb. 01, 2020. <https://www.ecohome.net/guides/3502/tesla-solar-roof-cost-competitors-review/>.
- [52] C. Zhang, J. Wu, C. Long, and M. Cheng, "Review of Existing Peer-to-Peer Energy Trading Projects," *Energy Procedia*, vol. 105, pp. 2563–2568, May 2017, doi: 10.1016/j.egypro.2017.03.737.
- [53] "Picloflex." <https://picloflex.com/>.
- [54] "Energie uit duurzame bronnen." <https://vandebron.nl/energie>.

[55] Good Energy, "A glimpse into the future of Britain's energy economy." Department Energy and Climate Change, 2016, [Online]. Available: <https://blog.piclo.energy/>.

[56] SonnenBatterie, "What is the SonnenCommunity?" <https://sonnengroup.com/sonnencommunity/>.

# Chapter 2 State of the art of energy management for residential sector

## 2.1 Introduction

As mentioned in chapter 1, providing electricity in order to meet the increasing energy demand in community (especially household) need improvement. The energy consumption of the household sector has reached around 30–40% of the total world energy demand [1][2], and the load consumption have to meet with the available energy. Meanwhile, the conventional power plants make serious effort to expand several new power generation and infrastructure to meet the increasing demand. Unfortunately, some challenges obstruct the business of company namely geographical, financial and environmental. Companies need more field for constructing power plants and building the transmission and distribution infrastructure. A second concern is economic; companies should provide new huge investments for increasing the electric generation as well electrical facilities. After Paris Agreement to struggle against the climate change, adding new polluting power plant is more difficult to conduct. Thus, companies and institutions intend to promote new technologies that are environmental friendly. Finally, the connection among the digitally based sensing, information management, communication, computing and control technology for coordinating the electricity system is introduced[3].

The main objective of this chapter is to introduce and discuss main issues regarding development and key elements of energy management implementation i.e. smart grid, self-consumption implementation, home energy management system and energy coordination method.

## 2.2 Participation of Smart Grid in Energy Management

Power grid expansion must be done while maintaining a high level of security to prevent hazardous case such as outage and eventually blackouts that make chaos in several segments namely national economic and security[4]. Smart grid technology is introduced for reducing the risks and operating the power grid closer to its physical limits. Then, it enables to supply electricity for coping with an increasing demand. A definition of smart grid proposed by the European Union through EC Task Force for smart grid 2010a[5] is presented “A *smart grid is an electricity network that can intelligently integrate the actions of all users connected to it – generators, consumers and those*

that do both in order to efficiently deliver sustainable, economic and secure electricity supplies.” Whereas in accordance to IEA, the definition of Smart Grid is “a smart grid is an electricity network that uses digital and other advanced technologies to monitor and manage the transport of electricity from all generation sources to meet the varying electricity demands of end-users”. It co-ordinate the needs and capability of all generators, grid operators, consumers and electricity market stake-holder to operate all parts of the system as efficiently as possible, which maximizing system stability, resilience and reliability, moreover minimizing cost and environmental impact[6]. This technology offers the vision of enhancing the efficiency of electricity consumption to the end-user point[7].

Energy efficiency is very important to apply as it could reduce dependency of electricity system to fuel, create cost reduction in end user side, diminish the cost of overall electric power system, and participate to restore the environment. Smart grid adopts the technology to handle this issues, in example virtual capacity would be increased by peak shaving technique[8]. Logging of data measurement from advances sensors in several points in purpose to prevent the accident and enables to respond rapidly to faults. Data can also be used for remoting machinery maintenance (predictive maintenance) and scheduling in power generation, and ensure the highest quality of service[9]. Finally, the customer engagement and Advance Metering Infrastructure (AMI) enable demand side management actions such as peak-load reduction that means capacity and cost reduction.

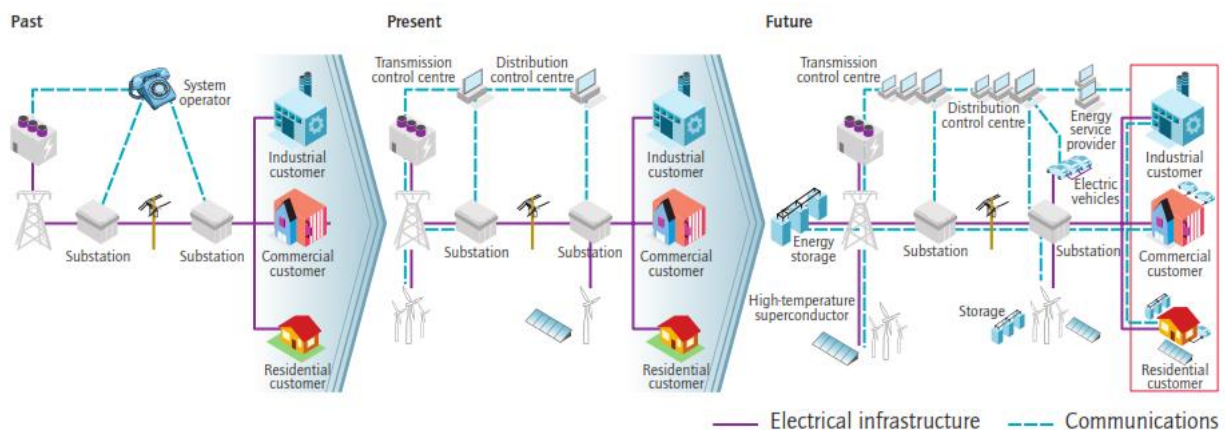

Fig. II.1 Smarter Grid network architecture development based on IEA[6]

The AMI's communication infrastructure support the interaction continuously among the provider, the end-user and the appliance. Thanks to AMI, Smart meter and HEMS are able to inform the consumption pattern and availability of energy with the price and incentives. The infrastructure is integrated among home network system, sensors, smart meter, communication network from the meters to local data concentrator, meter data management system (MDMS) and data integration into software application platform. AMI also provides a very intelligent step forward modernizing of the entire power system[10]. The illustration of smart grid architecture is shown in figure II.1, where electricity network has evolve from a non-controlled demand to a fully communicating system where the power grid is doubled with a communication network. The electricity network is growing with the rising of renewable energies that support the grid to supply electricity. Communication device also emerge when transmission and distribution control center replace human operators to communicate with transmission and generation. In addition, Energy Service providers are new entrants in the eco-system where it communicate with substations that connected with conventional power plant and distributed generation, electric vehicles, and end-user. In order to interact with the supplier, consumers use smart meter for monitoring their electricity consumption. Actually, in France the smart meter (SM) Linky is under deployment. It enables the transmission of load profiles every day to the supplier and the user can follow its consumption (energy and power) through a website.

### **2.3 Self-Consumption: Introduction and Application**

Development of PV technologies in worldwide is promising become the main alternative for energy transitions. Several countries as mentioned in previous chapter encourage the house owners to install PV system in their house for meeting their daily power consumption or it is known with the name "Self Consumption" with some policies as state in the journal[11]. In accordance with report[12], the house owner use their PV production first for their demand and take small portion of electricity from the grid. The house owner who consumes and produces electricity is called "prosumer" achieve the compensation from government. They also give right for house owner to sell the own electricity where the price has been determined by them. However, after 2010, several countries began to reduce the feed-in-tariff until zero for the next few years. To overcome the reduction, the house owners should minimize the energy sent back into the grid.

Several factors drive development of self-consumption such as the evolutions in technology, public policies, and regulating rules. Advance technologies make the self-consumption more cost-effective with a continuous decrease of the cost for buying and installing PV panels. Diminishing cost of battery and control system that included in the PV system assist in the spreading of PV system. The interest of households to energy efficiency in particular energy cost reduction has increased as users try to manage and reduce their consumption. The self-consumption becomes attractive when it protect the household against the risk of future increasing electricity price. For example in France, the retail prices/tariffs remain low. In addition, public authorities support the growth of self-consumption and the self-consumers could access the renewable energy support program such as feed in tariff and call for tenders[13]. In France, the regulator CRE gives recommendations and guidelines for self-consumption through its deliberation of 15 February 2018. The contractual framework and support mechanism respectively aim at:

- Enabling the control and optimization of self-consumption growth to fulfil energy transition objective and the best price in the community, and
- Ensuring conformance with obligatory regulation, to not jeopardize the power system safety and security.

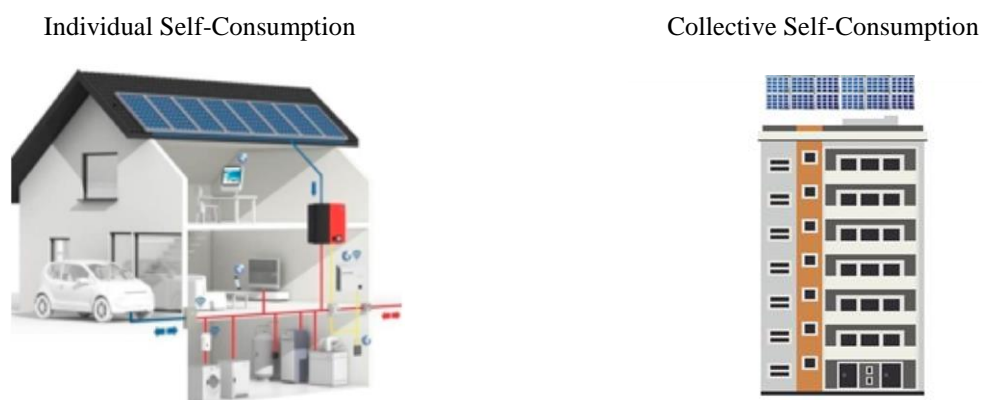

Fig. II.2 Diagram showing Individual Self-Consumption and Collective Self-Consumption[14]

### 2.3.1 Net metering and net billing

In the development of self-consumption, energy excess could not be separated from the PV system. Energy excess can be stored in a battery system and or injected in the public distribution grid. The regulator proposes compensation for this injection, typically net metering or net billing:

### a. Net Metering

The household as prosumer is charged based on their net energy usage of kWh at the end of each billing cycle. However, the electricity sold to the energy supplier has not necessarily the same price as electricity bought to the supplier (because of costs that occur in the energy distribution, and/or taxes). This condition depends on national regulations. The energy excess generated could be credited to the user for future usage. When in next month, the house owner still produces energy excess, the credit will be accumulated with the previous one. However, when the consumption is greater than PV production, the surplus credit will cover the difference between production and demand. If the credit is not enough to cover consumption, user should pay the underpayment.

### b. Net Billing

In Net Billing, both generation and consumption of electricity in the household are recorded and billed separately. As a result, customers get charged their full rate per kWh when they consume energy from the grid, but they are also compensated with the same rate for energy exported to the grid. The supplier calculate and inform the charges periodically related to net consumptions.

## 2.3.2 Self-consumption categories

There are several categories of self-consumption, namely:

1. Random self-consumption, the condition where the house owner could consume their PV production. The ideal situation is to match the production (P) perfectly to load consumption (L). In annual basis, house owner reach energy balance where total amount energy usage equal with total PV production. It condition commonly called by net Zero Energy Building (NZEB) [15]. This condition also means self-consumption ratio ( $\varphi_{SC}$ ) equal with self-sufficiency ratio ( $\varphi_{SS}$ ), where it is reflected in the eq. II.1. However, the production can be greater than load consumption occasionally. The energy excess is injected into the public distribution network. Conversely, the production is momentary smaller than load consumption. In result, the house owner will top up their electricity from provider.

$$\frac{\varphi_{SS}}{\varphi_{SC}} = \frac{\int_{t_1}^{t_2} L(t) dt}{\int_{t_1}^{t_2} P(t) dt}$$

... (eq. II.1)



2. Optimized self-consumption, the house owner reaches its self-consumption with optimizer method to reduce the instantaneous imbalance to increase energy efficiency and to be more profitable.
3. Stored self-consumption, when the house owner invests in storage system for storing electricity, and then use it later to meet load consumption.

In the connection context, self-consumption is commonly divided in two categories:

1. Isolated Self-consumption (off grid), the house owner that have PV system consume their production, and if they have excess energy, storage system should be improved and or energy management to maximize the self-consumption in order to prevent losing the electricity produced.
2. Self-consumption with grid (on-grid), PV system that installed in the house owner produce the electricity and then consumed by themselves. When the excess energy arise, they have option to store the energy and conduct energy management procedure. They are also able to distribute excess energy to public electricity network. Furthermore, on grid system could divide in two self-consumption categories in accordance utilization namely
  - Individual Self-consumption, the house owners have right to build their PV system within their property, they consume and store electricity for their own consumption or they intend to sell to a provider.
  - Collective self-consumption (CSC), people in one building or site utilize the shared PV generation. This model is recognized in certain national legal framework such as France and Austria or within pilot project[14]. Collective self-consumption has two types namely CSC in the same building and CSC on a block scale. CSC the same building works if inhabitants of a multi-apartments building share the RE production among each other. Whereas, CSC in a block scale work when buildings share their energy between each other via distribution lines[16].

Self-consumption is represented in the figure II.3, where the A and C are the PV power generation and the total power consumption respectively, and  $B = A \cap C$ . The overlapping sector is B area where PV generation is simultaneously used in the house or building. Self-consumption rate is defined as the self-produced consumption (B) divided by the total generation (A), see eq. II.2. The house owner reaches a 100% self-consumption rate for a given day when all PV production is

consumed without injection into the electric public network. Whereas, self-sufficiency rate is defined as the ratio between the self-produced consumption (B) and the total demand (C). Full self-sufficiency will be reached when all house owner load consumption will be covered by the PV power production. A 100% self-consumption rate is easy to reach with a small PV installation, whereas a 100 % self-sufficiency is hard to reach (storage is required).

$$\text{Self - consumption rate} = \frac{B}{A} \quad \dots \text{(eq. II.2)}$$

$$\text{Self - Sufficiency} = \frac{B}{C + B} \quad \dots \text{(eq. II.3)}$$

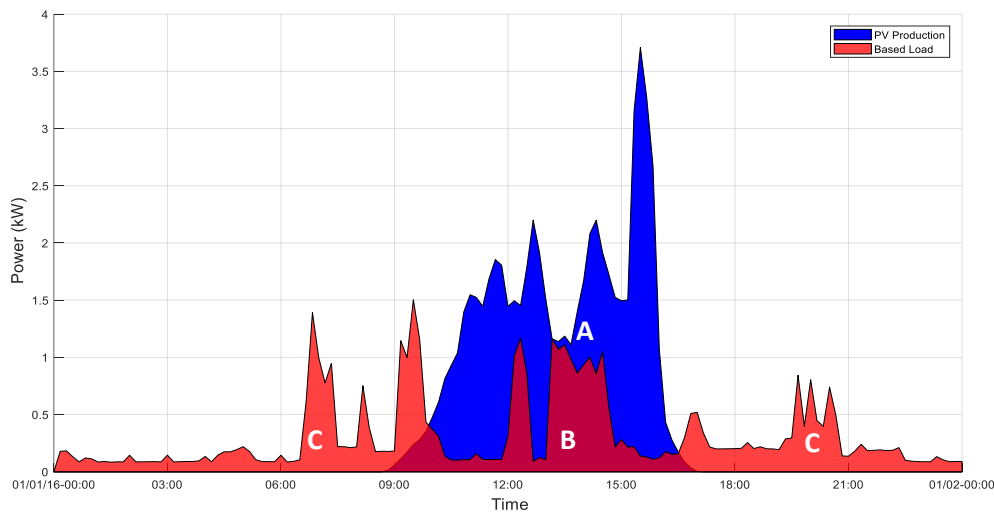

Fig. II.3 Schematic of daily net load, net production and absolute self-consumption in a residential with on-site PV[11]

### 2.3.3 Benefit and Challenges of Self-consumption

Welsch et al in their book[17] state that several benefits for the growth of self-consumption:

- Enabling transition from RES support scheme (eg. Feed in Tariff, Quota) to market integration of Renewable Energy Source (RES). Self-consumption help to smoothen the transition from the previous policies-driven support scheme to the integration of RES through market forces.
- Authorization of consumer and mobilizing new financial resources for RES (especially PV system). Self-consumption enable the household to take responsibility for their consumption. Therefore, self-consumption bring awareness of household regarding behavior of energy usage. It drive the household to adjust their consumption habits for instance, to shift the demand to the

high production. At the same time, by investing small-scale PV system to facilitate self-consumption, households can contribute to the high investment facilities in the energy transition and profit from the high of electricity bills.

- Grid Relief and cost of electricity production. Self-consumption of RES support to lower the pressure on the electricity grid emerging the feed-in of electricity from RES in particular the RES production in the high production period. Self-consumption also bring the derivation of electricity production cost. According to book information, in studies, self-consumption with storage and demand response measure can reduce the additional integration cost at high penetration level around 18% of total electricity production by an average of around 20% over all countries. Whereas, the overall additional integration cost of grid extension on the transmission and distribution with self-consumption were estimated to lower than no self-consumption.

They also include some of the challenges to support self-consumption such as:

- Socio-economic limitation and technological solutions, the main challenge of self-consumption in the context photovoltaics is deviating profile of consumption and production while the demand peak arises in the morning and evening, and PV generation is low. The behavior of users participate in this challenge where appliances usage should follow the PV production.
- Affordability and profitability of storage solutions remains the burden to reach high rate self-consumption. Cost of storage equipment is still high even if battery technologies cost continues to drop. It is reflected in the IRENA report[18], where the overall storage cost was expected to decline to between USD 108/kWh and USD 576/kWh in 2030 from USD 576/kWh as the 2016's cost.
- Demand response is mandatory for self-consumption optimization. The low penetration of smart meter and load control devices could obstruct the development of self-consumption
- Subsidies for storage devices aim at reaching high rate self-consumption. Nevertheless, uncoordinated charging of battery may have negative effect on grid balancing
- Reduce the amount of electricity that can be injected into the grid. The prosumer is given the option to limit their feed in to the grid. It is possible for general or flexible limitation for feed-in electricity from prosumer by DSOs in purpose to encourage them for self-consume the PV produced energy.

## 2.4 Demand Energy Strategies

Electricity become an important thing for household to operate their appliance, However, electricity usage could be enlarged dramatically when household pay attention with their consumption habits. In result, the electricity bills will be emerged sharply. This condition drive the burden in the supply power side. Energy management is one of strategy for helping electricity management, so that the effect from electricity usage could be diminished. There are energy paradigm of energy management namely supply management and demand management.

### 2.4.1 Energy management from supply side

In Supply management, energy management concentrates to handle conventional power system where it is built based on three assumptions: electricity generation is controllable, electricity demand is uncontrollable and the generated power is transferred from power plants to end-users. There are four methods for maintaining stability and reducing the cost; Unit commitment, economic dispatching, frequency restoration mechanism and contingency reserve. Unit Commitment and economic dispatching are scheduling methods for generator and control generator respectively[19]. Whereas frequency restoration method is used when a difference occurs between demand and generation. In addition, contingency reserves respond to a large loss of power supply.

Power consumption depends on consumer living activities which uncontrolled power consumption could lead to high peak demand. Demand management aims at reducing the high peak demand and the cost of power consumption, and avoiding the blackout in particular at time of a low generation. Demand management should fulfil the satisfaction of user (Quality of Life) and at least support minimum of satisfaction[19]. Control of power consumption also becomes a concern where it only reduces the total consumption. Demand management should consider the part of uncontrollable power consumption in consequence of human activity.

### 2.4.2 Demand side management

There are two paradigms in demand management namely demand management from supply side and demand management from demand side. Demand management form supply side is commonly called as “Demand Response”[2], [19], [20], and it used for avoiding the peaks of high demand and black out when the demand is higher than available electricity generation. Demand response

approach is centralized where the supply side manage the demand, for example, the aggregator send the top down signal to end-user for demand[21]. The aggregator position is between suppliers and end-users, and manages the demand for achieving the prospective electricity consumption pattern. Demand response works in two categories such as event based and price based[19],[22],[23]. Event based is used when the aggregator takes in charge to control household appliances remotely, which may reduce the satisfaction of user (even if an agreement has been signed between the two stakeholders).

### 2.4.2.1 Type of Demand side management

There are several methods for managing the energy:

1. Direct load control. The third party (aggregator) or supplier shuts down appliances on the end-user side for reducing the power demand at certain time[24]. Appliances are remotely controlled, and the users' satisfaction can be lower.
2. Curtailment program. The supplier or third party offers special rate, discount or concession to customer to trigger a demand reduction. For the energy provider the benefits are: reduction of peak price (expensive peak power plants will not be turn on), more cost-effective (profit) generating sources, and reduction of environmental impact of electricity generation with poor emission record.
3. Emergency program. This program offers customer payment for reducing the consumption during critical failure in the power system[25],
4. Demand bidding program (DBP), perhaps considered as the most efficient method to flatten the demand curve in the smart grid[26]. This method encourages the consumer – in particular high demand users (commercial buildings) – to reduce their consumption in accordance with their bid[27]. The customer can choose the bidding target for reduction freely, from which the reward and penalty are applied. However, Pacific Gas and Electric (PG&E) and San Diego Gas and Electric company apply DBP with incentive and without financial penalty when the customer fails to reduce energy[28], [29]. The DBP for consumer also useful for operator due to improve efficiency of distribution and electricity price stability[29].

Meanwhile demand response in price based, the aggregator sends the price signal to end users, seeking to modify the consumption pattern. Several pricing model are provided in [25][30], [31]:

1. Time of Use price, pricing that based on stepped rate structure that includes on peak rate, off peak rate and possibility include a shoulder-peak rate for determined blocks of time set by the provider. ToU rates reflect price under expected and they do not recognize the volatility of day to day supplies cost
2. Critical Peak Pricing, a variation of ToU tariff, which tries to reflect the uncertainty and volatility of supplies cost. Generally, this tariff is added during peak periods so that the tariff will be much higher than normal tariff in certain time. Two variants of this type of rate design exist: one where the time and duration of the price increase are predetermined when events are called and another where the time and duration of the price increase may vary based on the electric grid's need to have loads reduced. In USA, Southern California through demand respond factsheet, they give the customer that apply critical peak pricing the bill credit when they reduce energy usage during a CPP event. The customer receive the incentive such as bill protection for the first year, ensuring the payment will not exceed the amount that customer paid on base electricity rate[32].
3. Critical Peak Rebate, except that during critical event, electricity price remain the same while a consumer is refunded for a pre-determined rebate for any reduction in consumption relative to what the utility deemed the customer was expected to consume[33].
4. Real Time Pricing (RTP), the tariff reflect to the wholesale price in the market where it depends on the volatility and variability of cost[33]. Southern California also offer RTP program for the customer at 12-month program commitment. The electricity price based on time of day, season and temperature[32].
5. Variable Peak Pricing (VPP). The hybrid price between time of use and real time pricing. The pricing model apply during certain period and they are defined in advance (eg. 6 hours on peak in summer weekday afternoon, and the other in summer period is off peak). However, the electricity price in on peak duration is fluctuated by utility and market condition[30], [31].

### 2.4.2.2 Benefit and Drawback of Demand response

There are several benefit and drawbacks for demand response. The benefit of DR could be classified as follow

- Financial benefit include cost savings for customers (electricity bill reduction) due to the use of less energy when the price are high or due to their shifting their electricity consumption to lower priced hours.
- Reliability benefit include customer's benefit perceived from the reduced probability of supply being involuntarily curtailed in a blackout.
- Market performance, DR prevents the exercise of market power by electric power producers
- System security, System operator are endowed with more flexible means to meet contingencies
- Improved choice, costumer have more options to manage their electricity cost.

Whereas the drawbacks of DR as mentioned in[33]: customer have not been fully engage in the system for actively participate for monetary incentive; they should be informed about significance and opportunity in this system. Second, uniform standards for demand response pricing and incentive have not yet established. Moreover, measurement and cost-effectiveness of demand reduction continue to be an issue.

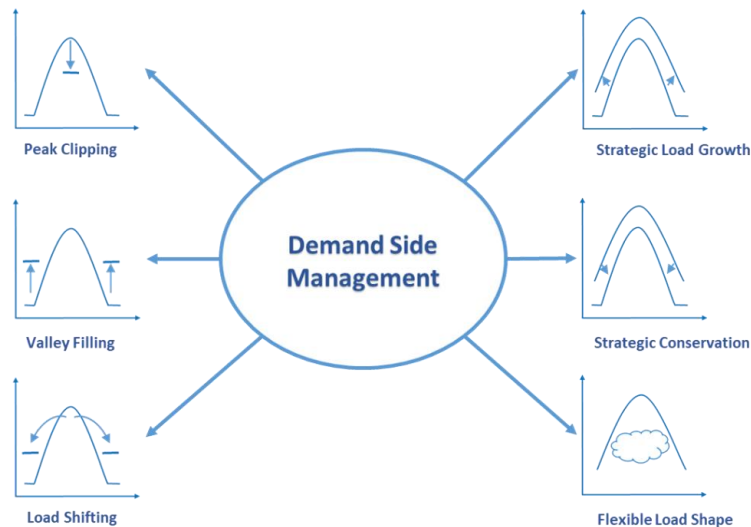

Fig. II.4 Demand Side Management addresses all the basic load-shape objective[34]

Demand management from demand side is commonly known as Demand side management, where the user gives right to modify the consumption pattern as their behavior. In definition, DSM is the planning, implementation, and monitoring of those utility activities designed to influence customer use of electricity in ways that will produce desired changes in the utility's load shape, i.e., changes

in the time pattern and magnitude of a utility's load[34]. DSM itself is built of several concept as follows[23]

1. Energy Efficiency. Efficiency of appliances (residential or building) is improved, so that energy losses is diminished. Comfort or behavior of users is not impacted.
2. Time of use. It is related to opportunities to consume at lower cost though a load shifting. In the electricity market, there are period where the energy price is lower (night period).
3. Demand response, the upper level entity makes a request to users for either increasing or decreasing the demand.
4. Spinning reserve, seeing by user namely as resource that is available to correct voltage level, system frequency or other issues, and that needs rapid consumption correction (activation on 5-10 minutes).

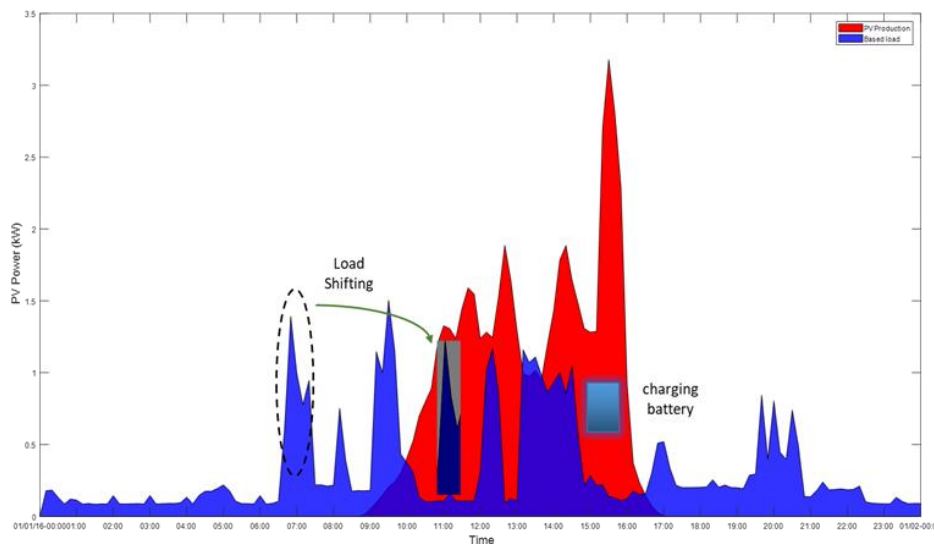

Fig. II.5 Utilization of Load Shifting in order to maximize self-consumption

### 2.4.2.3 Demand side management technique

Several tools are available to reshape the load curve and enlarge the energy efficiency (Fig. II.4):

1. Peak clipping. This strategy aim the user to reduce the consumption where it cut the peak of pattern. It reduces the amplitude between maximum and minimum demand. In result, energy efficiency and cost reduction is reached. Either appliances at the peak are not used (loss of comfort) or they are changed for ones that are more efficient.
2. Load shifting. The load in the peak period is shifted to off-peak period. This method is conducted to reduce peak load demand and the electricity cost[35]. This method does not



reduce the total load because it shift the consumption only. When the distributed generation in particular photovoltaic produces the electricity, load consumption in the off peak area shift to the PV production period. In result, the consumption takes electricity from photovoltaic. The phenomena is figured in figure II.5.

3. Valley filling. It aims at increasing the off-peak demand to flat the load profile in order to reduce the average cost of electricity. Similarly, to peak clipping, it also minimizes the difference between maximum and minimum of consumption and the result.
4. Strategic load growth, A method that has similar characteristic with valley filling where it increase the energy demand in purpose to promote the new emerging electric technologies in particular electric vehicles. In industrial sector, this method has a potential for increasing the electric energy intensity, which is motivated by reduction of fossil fuel consumption resulting in improved overall productivity.
5. Strategic conservation, a modification of load shape that involves the reduction of consumption as well as a change in the pattern of use. In other word, this method could be said “Energy efficiency”. The planning must consider the kind of conservation actions and evaluate the cost-effectiveness of the program in order to accelerate or stimulate those actions[36].
6. Flexible load shape. This method is related to electric reliability where it enables a truly integrated supply by facilitating dynamic control and response to both the consumer’s load and to their consumption of storage and distributed generation and gives impact to the decreasing of peak demand[37]. The control could be direct or by autonomous agents, by the use of controllable appliances.

However, DSM does not address to some issue[19] where the energy management does not take satisfaction into account. It also only consider the goal of each agent, so that the common goal in the group is difficult to reach. The challenges of DSM are the following: managing the consumption fully responsive, allowing agent to manage their own satisfaction, allowing adjusting the consumption pattern and allowing the agent to exchange or coordinate their consumption and generation. Lack of the ICT also take position as the challenge in DSM, because without the sophisticated AMI, DSM could not implemented to manage the user demand[38]. Updated DSM strategy that existed needs to be assessed comprehensively in order to avoid uncompetitive when it compared with traditional approach.

## 2.5 Home Energy Management System

To reach energy efficiency, residential households needs a system that integrates all equipment in the house. Home Energy Management System (HEMS) is an energy management tool that shifts and curtails demand to adapt the energy consumption profile in the house in accordance with customer satisfaction and electricity price. It is able to communicate with household devices and supplier, as needed and receive information from external (solar power production, electricity price) to improve the consumption pattern. According M. Baudin et al, based on responsiveness, HEMS is in better position than human to evaluate the uncertainties demand, price and to plan for a relevant response without human intervention[39].

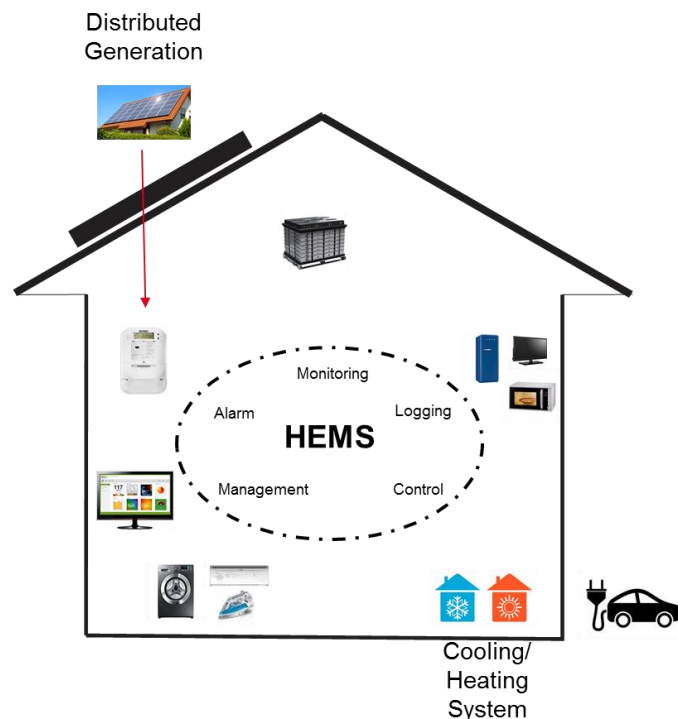

Fig. II.6 Home Energy Management System scheme[40]

### 2.5.1 Component of HEMS

In basic, HEMS offer five key services for building the system mentioned in figure II.6 [40] such as:

1. Monitoring System using measurement devices. HEMS aims the house owner at monitoring its consumption and production. It can monitor condition of household appliances and storage

condition using sensors that have detection voltage, current, temperature, motion, light and occupancy[41]. In result, it is able to avoid the failure or predict for maintenance.

2. Control System, for scheduling purpose. HEMS has functions to control the controllable household appliances (smart appliances) such as washing machine, dishwasher, electric water heater and heating cooling system.
3. Logging System. The device in HEMS records the data from all segments (distributed generation, battery SOC status, and consumption) so that the user can analyze its daily consumption.
4. Management system. It determines the activation of appliance through scheduling and optimization, manage the electricity flow from distributed generation and power grid and stores energy in battery system. It also manages the operation and maintenance information of each device in all sector and retail information from aggregator.
5. Alarm system. It gives notification to the user about the abnormal state in the HEMS system and detecting the failure throughout the effective monitoring of the device, so that the user can response quickly to solve the problem.

### 2.5.2 Communication tool in HEMS

In the framework of smart grids, embedded Information and Communication Technologies (ICT) aim at improving the reliability of the system while enabling dual communication (bi-directional) of information and power flow. Embedded in AMI along with HEMS, ICT are installed in residential households. Internet of Thing (IoT) becomes a considerable tool in the Smart grid and HEMS researches. It enables the equipped intelligent interface to connect and communicate with the user, and the social and environmental context[42], [43]. The communication architecture which supports the HEMS has three layers[7] such as

1. Physical layer. Several equipment such as smart meter, sensors are scattered in this layer in purpose to collect response information from battery status, power generation from PV module, retail price of electricity and power consumption. The response is transmitted to network layer.
2. Network layer. The main concern of this layer is data routing and communication facilitation. IoT provides integration and interfacing between the components of HEMS using Wired (e.g power cable, RS-485) and wireless (e.g Wifi, GPRS/3G/4G, Zigbee)[42] as mentioned in the

table II.1 above. GPRS works in packet switching where it uses internet protocol. Whereas Zigbee works in accordance with IEEE 802.15.4 where it has low power consumption in advantage[44]. Wifi and WiMax work based on IEEE 802.15.1 and IEEE 802.16 respectively. In addition, Rubee works with IEEE 1902.1 and Z-Wave based on Zensys communication standard[45].

3. Application layer. This layer encompasses data management and applications. It stores, processes and analyzes the data information from network layer. Battery SOC status, solar power generated, electricity prices uploaded by gateway are stored to the database platform. In the paper [46], this layer was called “Consumer Support System (CSS)”. Connection with external system such as DSO and Energy Support Provider through smart meter. CSS have five main function for instance, basic function, policies/goal/constraint management, service and device configuration, monitoring and diagnosis, and user interface.

### 2.5.3 HEMS Scheduling

All data that recorded by HEMS is used for optimizing the energy usage. Scheduling is one of strategy that used by HEMS to manage the appliances for reach the objective. Beaudin et al through their paper[47], propose Moving Window Algorithm to address the challenge of the existing scheduling technique for instance, inaccurate forecast of energy production and consumption pattern and inability to make smart decision beyond the scheduler. In other paper, Battery Energy Storage System (BESS) scheduling was taken into account for efficient HEMS and deal with the uncertainty PV[48]. The scheduling was prepared with stochastic Mixed Integer Non Linear Optimization (MINLP) with several option that applied in the home namely (i). Home send energy to the grid, (ii). Home receive the energy from the grid and (iii). Home work with islanding mode. Javed at al in their paper[49] explained metaheuristic scheduling of HEMS was proposed to minimize total cost and reduce Peak Average Ratio (PAR) in the house.

### 2.6 Prosumer in Coordination Energy Management System

Distributed Generation in particular solar energy is increasing more and more. With encouragement form government in each countries, the house owners reduce their dependency from conventional power source by own PV system installation. It means the generation is less centralized and load consumption in the house will be controlled according to the local production. To address this issue, the house is considered as a potential prosumer and the energy management

system participates in there. In social point of view, new markets will emerged where the end-user could i) buy and sell power energy and capacity, and ii) make decision about which energy they want to buy for the consumption[19], [21]. In fig. II.7, electricity generate from production area, and then it transmitted through T&D equipment in distribution area. Simultaneously, electricity distribute to end-user that located in the consumption area in particular residential sector. In this area, several factor such as energy management, satisfaction are studied.

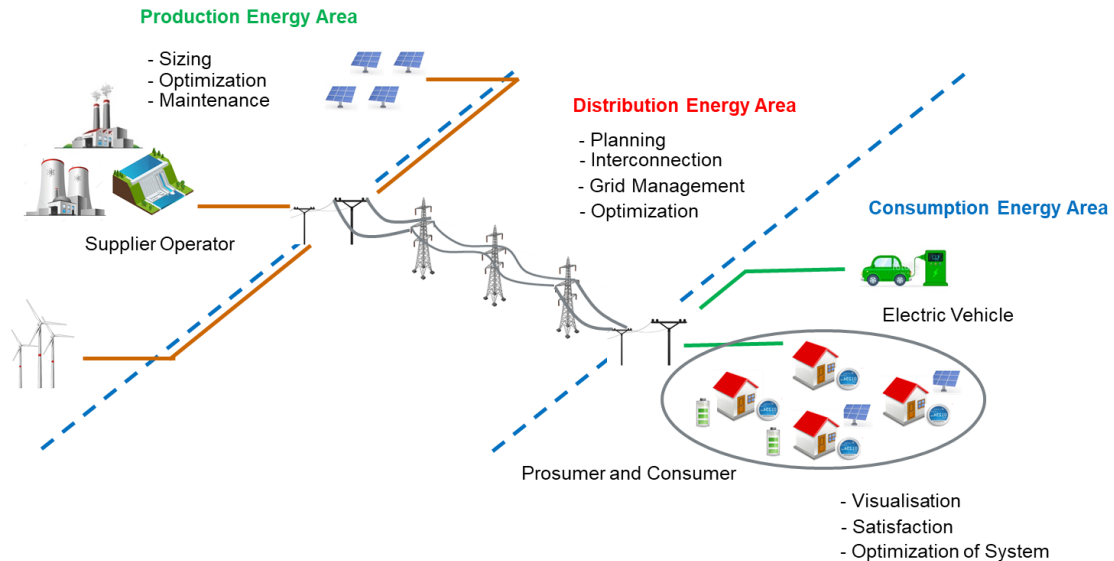

Fig. II.7 Energy Area based on the function

To implement a prosumer community, new technologies and methods are needed. Every house could use energy management device to manage its consumption for energy efficiency. Coordination among households was already proposed through paper[50] where the HEM unit in each household coordinates with the other HEM units in the community (neighborhood) in purpose to minimize the cost of their aggregator or retailer in the real-time balance market. The retailer broadcast the dynamic pricing information to the household and HEMS will optimize the system with scheduling of the appliances. This concept is adopted for community to maximize self-consumption, so that the energy surplus does not go back to the grid. Consumer households of the community also install HEMS to manage their demand even if they do not have PV panels. In this case, all household that have similar goal will be connected in the coordination network. There are several reasons for making the coordination energy management that are explained in [19] as follows:

- giving opportunity for each agent to manage their satisfaction while associating local power consumption and local power generation;
- each house owner has opportunity to become to prosumer if a PV system is installed in their site;
- prosumers get permission to create the community and manage their power taking into account common objectives for the community such as reduce the cost or increase consumption of renewable energy;
- the community member achieves full responsiveness in energy management with controllable load demand that can match uncontrollable generation.

In accordance with the CEER report [14], according to case studies, energy communities are classified in three categories as follows:

1. Community owned the generation asset. The members of such communities usually do not self-consume the energy produced, but sell it to a supplier. The incomes are reinvested in energy projects or shared with the members.
2. Virtual sharing over the grid. The communities own and operate the generation assets, they do not only share the profits, but also share the energy produced among their members. This type of sharing can be organized through common supplier who takes care of the matching between production and consumption, and supplies additional energy if needed. In France, the community could be a vehicle to organize collective self-consumption,
3. Sharing of local production through community grids. Such communities can be observed for isolated grids without connection to a main grid. But it has also been observed when a main grid exists, the goal being to consume locally.

From a legal framework, energy communities are classified in two types such as Renewable Energy Communities (REC) and Citizen Energy Communities (CEC), which characteristics are analyzed in table II.1. In energy community both REC and CEC require a legal entity as coordinator and an effective control by the shareholders. In development Energy Communities, France begin to allow collective self-consumption that it is only implemented in an experimental way for a period of five years. In 2020, they amend the article, meaning that consumer and producer can form self-serving energy community across the country[51]. Geographically, The energy community is created from the close residential that contain prosumer and consumer into

self-consumption unit. With the amendments, the perimeter of energy community is extended where the radius is 1 kilometers.

	<b>Renewable Energy Community</b>	<b>Citizen Energy Community</b>
<b>Geographic limitation</b>	Effective control is limited to the members that live in around the RE project owned by the community	No geographic limitation relating to the activities. Effective control or eligibility for membership in a CEC
<b>Membership</b>	Based on local control and exclude large enterprise	Small, medium until large enterprise could participate but are excluded from effective control
<b>Energy source</b>	All short of Renewable Energy source	All resource of Electricity, include renewable energy
<b>Major purpose</b>	Stimulating the growth of local community ownership to expand the share of renewable energy at the national level	Citizen energy community become a new noncommercial energy market actor that can join across the electricity market

Table II.1. Analysis of Renewable Energy community and Citizen Energy Community[16]

Energy community consist of consumers and prosumers that will share their PV generation with the consumers in accordance with contracts. The connection to an electricity supplier (balancing responsible party) is needed when the local demand of the community does not match with PV production. Prosumer have several reason to install PV generation namely (i). they consume PV electricity to meet their consumption, then share their produced PV generation to their neighbor or the grid when the excess energy is exist and (ii). They sell all of PV production to market to reach more incentive. In the EC concept, the energy market will held when the prosumer produce excess energy after they consume PV production for themselves and share to the consumer with lower price rather than grid price. Because of the PV is intermittent, prosumer could not provide the excess energy every day and lack of PV power for their demand. In result, they have to buy the complement electricity from the grid, or another prosumer that provide excess energy.

In another side, consumer buy the excess energy from the prosumer to reach cost electricity reduction. When the electricity from prosumer is not enough to meet their consumption, consumer could take the ancillary energy from the grid and possibility they buy it from another prosumer depending on the contract that they previously agreed on. Because of limitation electricity from prosumer, consumer will take complement form the grid. Consumer will consume all of electricity from the grid when no prosumer could provide the energy. The scheme of energy market strategies could be seen in fig. II.8. In first condition, prosumer meet electricity demand with their PV production. Prosumer also get deficit of self-PV production. Hence, they have possibility to

complete their remaining demand with buying electricity production from another prosumer with bilateral contract. Second condition, prosumer have to buy the electricity from the grid, which their price is higher than PV production price.

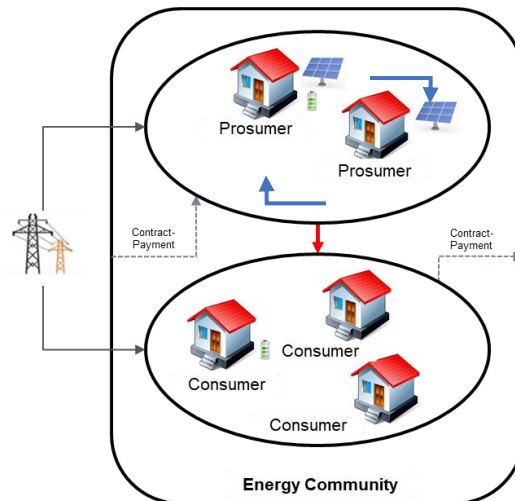

Fig. II.8 Scheme of energy community where the P2P market with full P2P market and or community based market.

Prosumer in Energy Management System have some challenges such as

1. Development of energy sharing vision. The different of vision in each household for energy management could rise the question about what benefit will be achieved after making investment in Citizen energy community
2. Stakeholder Engagement. Agreement among the supplier and the energy communities should be made mainly in implementation energy sharing. Several factors are challenging such as incentive, distribution cost, electricity price and tax.
3. Funding and investment. Not all community could handle the financial cost for capital investment. The government participates in this part to aim the community at reaching their goal with subsidies, or tax reduction.
4. Equipment Installation. The communities need the field for installation of renewable energy plant to cover their consumption. Rooftop becomes an alternative solution to handle this problem. Energy storage system is also needed to overcome the intermittent issue.
5. Management and maintenance. Cost of maintenance should be calculated. The cost includes technical staff, maintenance and troubleshooting.



6. Data Security. The data should be secured with several method of cyber security such as cryptography.

### **2.7 Peer to Peer Energy Trading in the Communities**

The presence of prosumer in around community lead to the alternative energy trading. Commonly, household create the transaction with the grid for their electricity demand. Proliferation of PV system in the household help for reducing dependency of electricity from the grid and minimize environmental jeopardy[52]. The prosumer share their surplus energy to the grid for the revenue or buy the electricity when their obtain lack of energy. In the same time, household without PV system as pure consumer buy entire electricity to the grid in accordance grid price that applied at the time.

#### **2.7.1 Peer to Peer Energy Market Concept**

Peer to peer (P2P) energy exchange is emerged to be an alternative electricity transaction. It can contribute to an effective management of energy supply and demand by facilitating a direct exchange of energy in defined local community. Hence, it give possibility to prosumer to sell their excess energy with each other directly. Comparing with conventional electricity market, P2P is able to be seen as an instance of “sharing economy”. It has resemblance to uber which share under-utilized car or Airbnb, which share under-utilized room[62]. P2P offer the mild remuneration (cheaper price than bulk grid price) for consumer that need to reduce their cost and better revenue for prosumer when the feed in tariff is less than the PV electricity price. The scenario could be created win-win situation for both energy prosumer and consumer.

P2P Energy trading concepts encompass several factor such as motivation, enabling technologies and the framework as shown in fig. II.9, where every factor have overview from some views. First motivation of energy trading is to improve efficiency mainly in network efficiency[63]. It means the energy production used up by prosumer in the short distance area. Hence, the transmission loss is reduced. Second motivation is cost optimization, which the household as prosumer could reduce electricity demand or maximize the profit. For social factor, the excess energy from prosumer could be given away to consumer that need electricity as social capital.

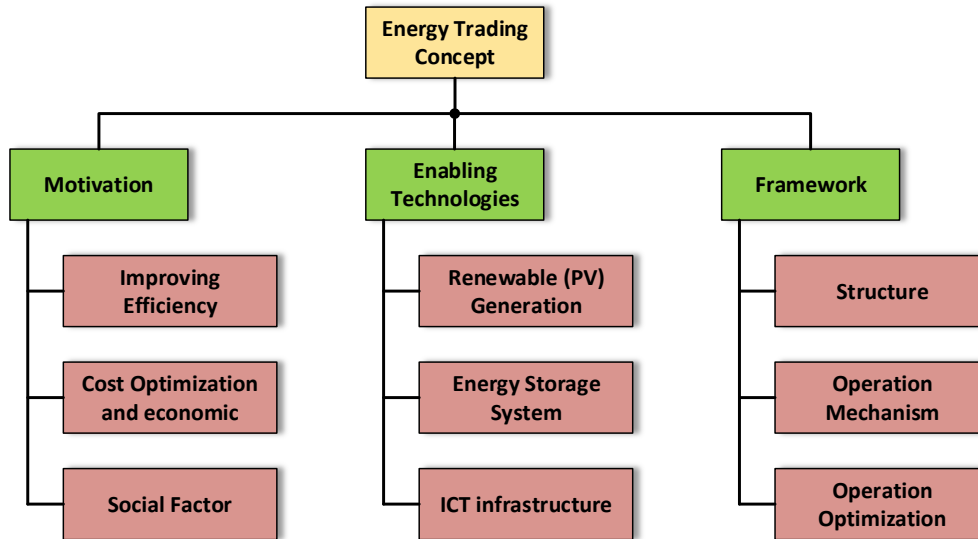

Fig. II.9 Overview of the energy trading concept[52]

Energy trading need infrastructure that facilitate for connecting several component such as energy generation, storage and sharing among prosumer. The distributed energy resources in the prosumer provide the energy for their demand. Because of the intermittent of renewable generation, energy storage system is important to be installed. It is used to store the excess electricity for backing up when the lack of PV electricity and higher demand is occurred. The last is Information Communication Technology (ICT) is used for facilitating the energy trading using protocol that mentioned in the table II.1.

The framework of energy trading cover the structure where form of energy trading is applied. Household could choose the appropriate structure to use for energy trading such as Distributed energy trading like P2P or centralized through the platform (energy market) operation. In energy trading, several operation mechanisms are applied. First, buyer or consumer could use selection approach, where they choose the available or preferable provider to obtain the supplier product. Second, the supplier and buyer make the contract with aggregator, in consequence, buyer does not participate in the energy market, because all in controlled by aggregator. Third, Buyer prioritization and aggregator matching, which buyer provide their preferences of energy type and the provider, then aggregator will match the provider and product to the preferences of the buyer. Moreover, the last, double auction in the energy trading. Operation optimization in the energy-trading concept is used for reach the objective/goals such as minimizing the generation cost, energy demand, or maximizing the profit. The target optimization could be economic aspect, reliability

and availability energy, minimizing the risk, etc. One of the implementation of the optimization is game theory.

### 2.7.2 Type of Peer to Peer Energy Trading

There are three type of P2P market[55] as follow

1. Full P2P market. In this market, household as prosumer create the consensus for energy transaction where the amount of energy and price are negotiated with each other directly without centralized supervisor.
2. Community based market. In this scheme, the market is equipped with community manager who manage the energy trading activities in the community as well as the intermediate between the community and the rest of the system.
3. Hybrid P2P market. This scheme is combination of two previous scheme where produce the different way in the energy trading. Community could not only make energy transaction with another community, but also propose the energy to individual household.

### 2.7.3 Advantage and Drawback of Peer to Peer

P2P market have several advantages or strength[55], for instance, authorization of consumer to participate in this market, focusing in trust and empathy with the collaborator, transparency and openness. The consumer have better choice of supply and they have possibility to produce and sell their PV production (prosumer). P2P market also have several drawbacks such as enormous energy transaction index and the heaviness of the negotiation mechanism. Another drawback of P2P market is life-cycle assessment of infrastructure that supporting the negotiation process. P2P market have opportunities such as democratization of energy and create the new business model. It also increase awareness of consumer toward environmental energy consumption. Nevertheless, it has several challenges namely legal and regulatory obstacle, potential failure of market by infrastructure and grid congestion. Security and privacy of data become big issue in this market.

## 2.8 Conclusion

Smart Grid become the entity of the energy management development, where it give some utilities such as communication to support the improvement of self-consumption especially in community. Type of self-consumption is prepared to support the household as their preferences. Individual self-consumption is useful for household that need independent for electricity and collective self-

consumption, which the objective for instance electricity cost reduction become their goal. Self-consumption improvement will be reached when the energy storage in the household is popular. Another method that encourage self-consumption is applying the demand energy management.

Actually, demand energy strategies support the supplier and demand side. In demand side, demand response provide two event for energy management such as event based and price based, where in each strategy have several components to support the household to manage their demand. Prosumer in the community bring the evolution in the energy fulfilment where they produce surplus energy, so that it is shared to another household or community in different purpose. P2P market become entity to success energy transaction between prosumer and consumer.

## References

- [1] H. T. Haider, O. H. See, and W. Elmenreich, "A review of residential demand response of smart grid," *Renewable and Sustainable Energy Reviews*, vol. 59, pp. 166–178, Jun. 2016, doi: 10.1016/j.rser.2016.01.016.
- [2] L. Gelazanskas and K. A. A. Gamage, "Demand side management in smart grid: A review and proposals for future direction," *Sustainable Cities and Society*, vol. 11, pp. 22–30, Feb. 2014, doi: 10.1016/j.scs.2013.11.001.
- [3] U.S. Department of Energy, "Smart Grid System Report 2018," U.S Department of Energy, Nov. 2018.
- [4] Litos Strategic Communication, "The Smart Grid : An Introduction." Department of Energy United State of America.
- [5] European Commission. Joint Research Centre. Institute for Energy and Transport. and US Department of Energy, National Energy Technology Laboratory., *Assessing smart grid benefits and impacts: EU and U.S. initiatives*. LU: Publications Office, 2012.
- [6] IEA, "Technology Roadmap - Smart Grids," IEA, no. Paris, 2011, [Online]. Available: <https://www.iea.org/reports/technology-roadmap-smart-grids>.
- [7] L. Yao, C.-C. Lai, and W. H. Lim, "Home Energy Management System Based on Photovoltaic System," in *2015 IEEE International Conference on Data Science and Data Intensive Systems*, Sydney, Australia, Dec. 2015, pp. 644–650, doi: 10.1109/DSDIS.2015.42.
- [8] Ming Zhou, Yajing Gao, and Gengyin Li, "Study on improvement of available transfer capability by Demand Side Management," in *2008 Third International Conference on Electric Utility Deregulation and Restructuring and Power Technologies*, Nanjing, China, Apr. 2008, pp. 545–550, doi: 10.1109/DRPT.2008.4523466.
- [9] K. Tazi, F. Abdi, and M. F. Abbou, "Demand and Energy Management in Smart Grid: Techniques and Implementation," in *2017 International Renewable and Sustainable Energy Conference (IRSEC)*, Tangier, Dec. 2017, pp. 1–6, doi: 10.1109/IRSEC.2017.8477305.
- [10] NETL Modern Grid Strategy, "Advance Metering Infrastructure." Office of Electricity Delivery and Energy Reliability, Feb. 2008.
- [11] R. Luthander, J. Widén, D. Nilsson, and J. Palm, "Photovoltaic self-consumption in buildings: A review," *Applied Energy*, vol. 142, pp. 80–94, Mar. 2015, doi: 10.1016/j.apenergy.2014.12.028.
- [12] G. Masson, J. I. Briano, and M. J. Baez, "Review and Analysis of PV Self-Consumption Policies," IEA-PVPS, T1-28:2016, 2016.

- [13] CRE, “Self-Consumption,” Jul. 12, 2018. <https://www.cre.fr/en/Energetic-transition-and-technologic-innovation/Self-consumption>.
- [14] CEER, “Regulatory Aspects of Self-Consumption and Energy Communities,” Council of European Energy Regulators, Brussel, Belgium, Ref: C18-CRM9\_DS7-05-03, Jun. 2019. [Online]. Available: <https://www.ceer.eu/>.
- [15] R. Fachrizal and J. Munkhammar, “Improved Photovoltaic Self-Consumption in Residential Buildings with Distributed and Centralized Smart Charging of Electric Vehicles,” *Energies*, vol. 13, no. 5, p. 1153, Mar. 2020, doi: 10.3390/en13051153.
- [16] D. Frieden, A. Tuerk, J. Roberts, S. D’Herbemont, A. F. Gubina, and B. Komel, “Overview of emerging regulatory frameworks on collective self-consumption and energy communities in Europe,” in *2019 16th International Conference on the European Energy Market (EEM)*, Ljubljana, Slovenia, Sep. 2019, pp. 1–6, doi: 10.1109/EEM.2019.8916222.
- [17] M. Welsch et al., Eds., *Europe’s energy transition: insights for policy making*. London San Diego, CA Cambridge, MA Oxford: Academic Press, 2017.
- [18] P. Ralon, M. Taylor, A. Ilias, H. Dias-Bone, and K.-P. Kairies, “Electricity storage and renewables: Costs and markets to 2030.” IRENA, 2017, [Online]. Available: <http://www.irena.org/>.
- [19] R. Verschae, T. Kato, and T. Matsuyama, “Energy Management in Prosumer Communities: A Coordinated Approach,” *Energies*, vol. 9, no. 7, p. 562, Jul. 2016, doi: 10.3390/en9070562.
- [20] N. O’Connell, P. Pinson, H. Madsen, and M. O’Malley, “Benefits and challenges of electrical demand response: A critical review,” *Renewable and Sustainable Energy Reviews*, vol. 39, pp. 686–699, Nov. 2014, doi: 10.1016/j.rser.2014.07.098.
- [21] R. Verschae, T. Kato, H. Kawashima, and T. Matsuyama, “A cooperative distributed protocol for coordinated energy management in prosumer communities,” IEICE-Kyoto University.
- [22] P. Palensky and D. Dietrich, “Demand Side Management: Demand Response, Intelligent Energy Systems, and Smart Loads,” *IEEE Trans. Ind. Inf.*, vol. 7, no. 3, pp. 381–388, Aug. 2011, doi: 10.1109/TII.2011.2158841.
- [23] P. Faria, J. Spínola, and Z. Vale, “Identified Short and Real-Time Demand Response Opportunities and the Corresponding Requirements and Concise Systematization of the Conceived and Developed DR Programs.” Mar. 2017.
- [24] T. Hesser and S. Succar, “Renewables Integration Through Direct Load Control and Demand Response,” in *Smart Grid*, Elsevier, 2012, pp. 209–233.
- [25] Rocky Mountain Institute, “Demand Response: An Introduction. Overview of Program, Technologies and Lesson Learned.” Rocky Mountain Institute, Apr. 30, 2006.
- [26] Y.-C. Li and S. H. Hong, “Real-Time Demand Bidding for Energy Management in Discrete Manufacturing Facilities,” *IEEE Trans. Ind. Electron.*, vol. 64, no. 1, pp. 739–749, Jan. 2017, doi: 10.1109/TIE.2016.2599479.
- [27] M. Perumalla, “Demand Bidding Program and its Application in Hotel Energy Management,” Governors State University, University Park, IL 60484, 2015.
- [28] “Demand Bidding Program.” Pasific Gas and Electric (PG&E), 2007, [Online]. Available: [https://www.pge.com/includes/docs/pdfs/mybusiness/energysavingsrebates/demandresponse/dbp/dr\\_dbp\\_0462.pdf](https://www.pge.com/includes/docs/pdfs/mybusiness/energysavingsrebates/demandresponse/dbp/dr_dbp_0462.pdf).
- [29] “Schedule DBP : Demand Bidding Program.” San Diego Gas and Electric Company, 2014, [Online]. Available: [https://sdge.com/sites/default/files/elec\\_elec-scheds\\_dbp2.pdf](https://sdge.com/sites/default/files/elec_elec-scheds_dbp2.pdf).
- [30] US. Department of Energy, “Recovery Act: Time Based Rate Programs.” [https://www.smartgrid.gov/recovery\\_act/time\\_based\\_rate\\_programs.html](https://www.smartgrid.gov/recovery_act/time_based_rate_programs.html).
- [31] E. Hale, L. Bird, R. Padmanabhan, and C. Volpi, “Potential Roles for Demand Response in High-Growth Electric Systems with Increasing Shares of Renewable Generation.” National Renewable Energy Laboratory, Dec. 2018, [Online]. Available: <https://www.nrel.gov/docs/fy19osti/70630.pdf>.

- [32] Southern California Edison, "Demand Response for Your Business," *Demand Response*, 2020. <https://sce.com/business/demand-response>.
- [33] S. Chen and C.-C. Liu, "From demand response to transactive energy: state of the art," *J. Mod. Power Syst. Clean Energy*, vol. 5, no. 1, pp. 10–19, Jan. 2017, doi: 10.1007/s40565-016-0256-x.
- [34] C. W. Gellings, "The concept of demand-side management for electric utilities," *Proc. IEEE*, vol. 73, no. 10, pp. 1468–1470, 1985, doi: 10.1109/PROC.1985.13318.
- [35] P. Balakumar and S. Sathiya, "Demand side management in smart grid using load shifting technique," in *2017 IEEE International Conference on Electrical, Instrumentation and Communication Engineering (ICEICE)*, Karur, Apr. 2017, pp. 1–6, doi: 10.1109/ICEICE.2017.8191856.
- [36] F. Kreith and D. Y. Goswami, *Handbook of energy efficiency and renewable energy*. Boca Raton: CRC Press, 2007.
- [37] C. W. Gellings, "Evolving practice of demand-side management," *J. Mod. Power Syst. Clean Energy*, vol. 5, no. 1, pp. 1–9, Jan. 2017, doi: 10.1007/s40565-016-0252-1.
- [38] G. Strbac, "Demand side management: Benefits and challenges," *Energy Policy*, vol. 36, no. 12, pp. 4419–4426, Dec. 2008, doi: 10.1016/j.enpol.2008.09.030.
- [39] M. Beaudin and H. Zareipour, "Home energy management systems: A review of modelling and complexity," *Renewable and Sustainable Energy Reviews*, vol. 45, pp. 318–335, May 2015, doi: 10.1016/j.rser.2015.01.046.
- [40] J. I. Lee, C.-S. Choi, W.-K. Park, J.-S. Han, and I.-W. Lee, "A study on the use cases of the smart grid home energy management system," in *ICTC 2011*, Seoul, Korea (South), Sep. 2011, pp. 746–750, doi: 10.1109/ICTC.2011.6082716.
- [41] B. Asare-Bediako, W. L. Kling, and P. F. Ribeiro, "Home energy management systems: Evolution, trends and frameworks," in *2012 47th International Universities Power Engineering Conference (UPEC)*, Uxbridge, Middlesex, United Kingdom, Sep. 2012, pp. 1–5, doi: 10.1109/UPEC.2012.6398441.
- [42] O. Vermesan, *Internet of Things: Converging Technologies for Smart Environments*. River Publishers, 2013.
- [43] W.-J. Shyr, L.-W. Zeng, C.-K. Lin, C.-M. Lin, and W.-Y. Hsieh, "Application of an Energy Management System via the Internet of Things on a University Campus," *EURASIA J MATH SCI T*, vol. 14, no. 5, Feb. 2018, doi: 10.12973/ejmste/80790.
- [44] R. Zafar, A. Mahmood, S. Razzaq, W. Ali, U. Naeem, and K. Shehzad, "Prosumer based energy management and sharing in smart grid," *Renewable and Sustainable Energy Reviews*, vol. 82, pp. 1675–1684, Feb. 2018, doi: 10.1016/j.rser.2017.07.018.
- [45] S. Zhou, "Design and Development of Energy Management System for Smart Homes & Buildings," University of Birmingham, United Kingdom, 2014.
- [46] K. Dittawit and F. A. Agesen, "Architecture and Functional Framework for Home Energy Management Systems," in *Advances in Communication Networking*, vol. 8115, T. Bauschert, Ed. Berlin, Heidelberg: Springer Berlin Heidelberg, 2013, pp. 173–184.
- [47] M. Beaudin, H. Zareipour, and A. Schellenberg, "Residential energy management using a moving window algorithm," in *2012 3rd IEEE PES Innovative Smart Grid Technologies Europe (ISGT Europe)*, Berlin, Germany, Oct. 2012, pp. 1–8, doi: 10.1109/ISGTEurope.2012.6465896.
- [48] R. Hemmati and H. Saboori, "Stochastic optimal battery storage sizing and scheduling in home energy management systems equipped with solar photovoltaic panels," *Energy and Buildings*, vol. 152, pp. 290–300, Oct. 2017, doi: 10.1016/j.enbuild.2017.07.043.
- [49] N. Javaid, A. Yasmeen, I. Fatima, Z. Nadeem, A. Khan, and Z. A. Khan, "A Metaheuristic Scheduling of Home Energy Management System," presented at the Conference: 6th International Conference on Emerging Internetworking, Data and Web Technologies (EIDWT-2018), Tirana, Albania, Jan. 2018.

- [50] T.-H. Chang, M. Alizadeh, and A. Scaglione, "Real-Time Power Balancing Via Decentralized Coordinated Home Energy Scheduling," *IEEE Trans. Smart Grid*, vol. 4, no. 3, pp. 1490–1504, Sep. 2013, doi: 10.1109/TSG.2013.2250532.
- [51] C. Rollet, "Energy communities are now allowed in France," Mar. 23, 2020. <https://www.pv-magazine.com/2020/03/23/energy-communities-are-now-allowed-in-france/>.
- [52] O. Jogunola *et al.*, "State-Of-The-Art and Prospects for Peer-To-Peer Transaction-Based Energy System," *Energies*, vol. 10, no. 12, p. 2106, Dec. 2017, doi: 10.3390/en10122106.
- [53] Verv Energy, "The Sharing Economy: Let's talk about the 'peer-to-peer' in energy trading," Apr. 25, 2018. <https://medium.com/@VervEnergy/the-sharing-economy-lets-talk-about-the-peer-to-peer-in-energy-trading-e4e679307f89>.
- [54] T. Zhu, Z. Huang, A. Sharma, J. Zu, and D. Irwin, "Sharing renewable energy in smart microgrids," presented at the 2013 ACM/IEEE International Conference on Cyber-Physical Systems (ICCPS 2013), Piscataway, NJ, 2013.
- [55] T. Sousa, T. Soares, P. Pinson, F. Moret, T. Baroche, and E. Sorin, "Peer-to-peer and community-based markets: A comprehensive review," *Renewable and Sustainable Energy Reviews*, vol. 104, pp. 367–378, Apr. 2019, doi: 10.1016/j.rser.2019.01.036.

# Chapter 3 Simulation platform for study case

## 3.1 Introduction

Growth of distributed generation increases the availability of local energy sources and can reduce the need for new large power plants to meet the users' demand. Investment in smart meters enables to have a better view of the power grid, and a better controllability of the loads. The house owners install PV system in purpose to cover their electricity demand with certain capacity in PV. However, in several days, the excess energy will emerged and the household accommodate with their storage system. With excess energy, house owners could become actors in the electricity market (prosumers) while providing electricity to other end-users. Several case study are defined and simulated in the simulation platform.

In this thesis, several case studies are prepared. In section 3.2, we would like to introduce the load consumption in the residential and how to predict the load curve. PV profile generator is also explained where the irradiance data is forecasted in 3.3. Storage system, water heater and thermal model also explained in the section 3.4, 3.5 and 3.6. Section 3.7 encompasses the financial scheme that is used in the simulation. Furthermore, the coordination is introduced in the section 3.8 where subsection 3.8.1 explains the simulation with SPIDER library, it is performed using spider library in purpose to reduce the electricity cost both of prosumer and of consumer. Whereas in the subsection 3.8.2 Optimization strategies will be shown. Particle Swarm Optimization is used for optimizing the operation of controllable appliances in purpose to reach cost reduction. The strategies are applied in the system without battery.

## 3.2 Load profile forecasting in the residential

Every day, households operate the appliances in accordance with their needs. Equipment consume the electricity when they are operated, subsequently the consumption will be representative of activities and behavior of the household. However, the increasing of the appliances usages in the house generates volatility and randomness of load consumption, leading to produce an imbalance between supply and demand[1]. Therefore, a reliable and accurate forecast of load consumption is important to address the above-mentioned problem.



### 3.2.1 Literature review

Load forecasting itself could be categorized to three groups based on the different time periods of forecasting[2] such as

1. Long term load forecasting (LTLF)

The time-period of LTLF is a few years or greater than one year to ten or twenty years ahead. It aims at planning the power system development such as new generation, transmission and distribution assets. It also aims for installation of storage system[3].

2. Medium term load forecasting (MTLF)

MTLF has time-period from a month to a year. It aims at scheduling maintenance, coordination of load dispatch. LTLF and MTLF rely on historical load, weather data, the number of customers in different groups, the economy and demographic data[4]. The author creates MTLF using neural network approach where data are based on historical monthly load data, temperature, humidity and wind speed.

3. Short term load forecasting (STLF)

The time-period of STLF is from a few minutes, hours to one day ahead. It aims at doing an economic dispatch and scheduling of function such as coordination of power generation where it helps to minimize the operation cost[5]. It becomes an important component of smart grid for cost saving where it is used for demand side management. Hence, the users receive incentive for reducing their consumption or modifying their usage pattern.

Several methods are proposed for forecasting of load consumption. Lulu Wen et al in their paper[1] propose a deep learning model to forecast the load demand of residential building with a one hour resolution with taking into account its complexity and variability. Meanwhile Dragomir et al[6] propose a tool for energy balance prediction using ANFIS (Adaptive Neuro Inference System) where the neuro predictor is modified for acquiring an accurate forecasting for medium term.

Modeling of load consumption adopts two approaches namely top-down approach and bottom-up approach. Top-down approach considers the load consumption in each home as single unit, whereas, bottom-up approach studies the energy consumption of each individual load. Furthermore, the aggregation of loads generates the global load curve for a single home or residential area. The paper[7] provides the comparative review of models for residential sector. In

addition, the comparison between top-down approach and bottom-up approach is summarized in the table III.1

### 3.2.2 Top-down Approach

Top down approach is used to aggregate all load consumption in one spot, so that the total consumption is reached [8]. This approach can be categorized to MTLF where it relies on the historical data, and is used to assess the long-term change of load profile. The advantage of top-down approach is its simplicity. However, the drawback is emerged where the type of load, behavior and load factor is negligible. Conversely, the approach cannot be used for a model dedicated to define control strategies.

### 3.2.3 Bottom-up approach

The bottom-up approach study power consumption of all appliances type that are operated by the end-user. Subsequently, aggregation of the power consumption bring the load curve for a single user or home. This approach gives authority to the user to identify the area for potential improvement (e.g. bringing the behavior or others factor to form the load curve). The drawback of this approach is the difficulty to acquire the detailed data of the consumption for each appliance that is operated by the end-user. Validation between the aggregated load curve in the model and actual measurement is required. The advantage of this approach is its simplicity because it relies on historical data of consumption and, conversely, the bottom-up approach investigates energy consumption on each appliance separately. Accordingly, by aggregation of load patterns on the appliances, the household or community obtains the load consumption curve [9].

	Benefit	Lack	Typically scale
<b>Top-Down</b>	Simplicity, easy access to data	Data information on individual behavior is limited	Regional, community, neighborhood
<b>Bottom-Up</b>	Detail information on individual behavior	High model complexity, difficulty of data acquisition	Individual, or group of residences

Table III.1 Benefit and lack of load profile approach

## Simulation platform for study case

In this research, we propose to use the data forecasting from the software 'load profile generator (LPG). This software is developed by Noah Pflugradt from TU Chemnitz[10] where they already released the updated version in 10.1.0.0. LPG is a modeling tool for residential energy consumption that harness the behavior of the human in the household to generate the load curve. The household types is taken from German households. Furthermore, LPG provide two methods for load consumption generation through automatic and manual mode.

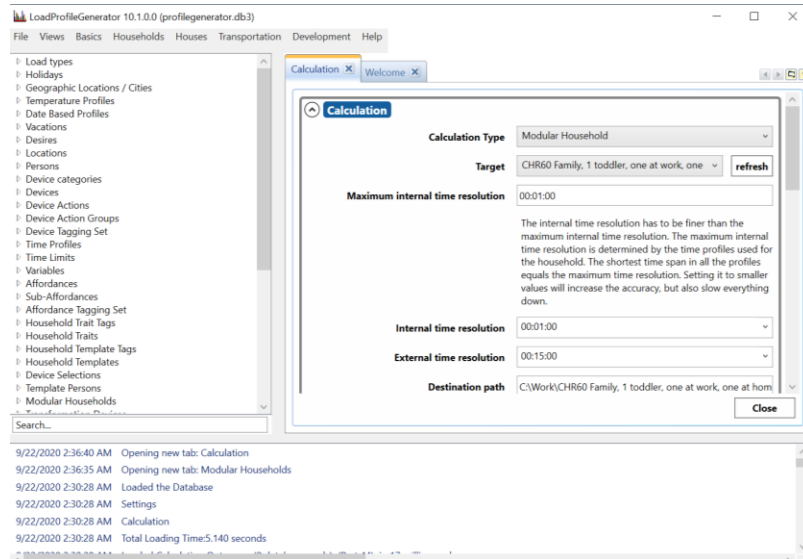

(a)

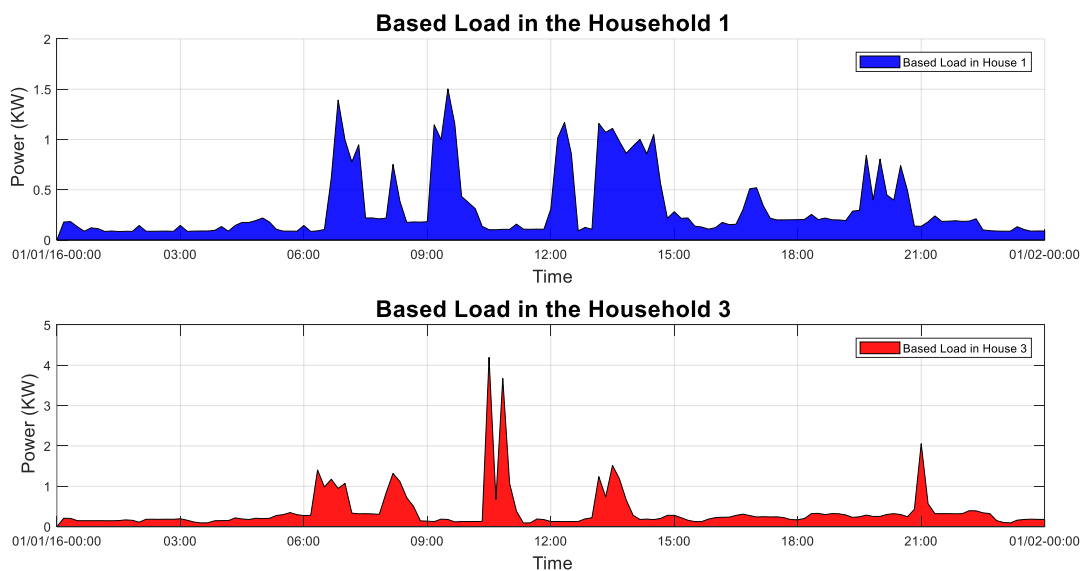

(b)

Figure III.1 (a) The captured view of load profile generator software. (b) The example household load consumption in matlab where the data is generated by load profile generator software.

LPG software can be used in automatic mode. It means the user only chooses the household type in the modular house, and then the consumption data is generated based on user needs, time resolution and temperature profile. In the new version, four temperature profile types in Germany are used. Conversely, the manual mode gives authority the user to arrange the model based on number of persons, behavior, vacation and other factors provided by the software for generating the load curve. Data is generated in format \*.csv. The load consumption profile is categorized in Middle term load forecasting, where data is taken for one year. For the scheduling research, we propose to separate the power consumption of controllable appliances (such as dishwasher and washing machine) from the total load consumption.

### 3.3 PV Profile Generator

Several years ago, government in many countries issued the regulation where they encouraged households to install their own generation plant. It was used for helping in the fulfilling energy demand. Photovoltaic is the most commonly chosen technology by users to create the power plant for covering their consumption due to modular structure.

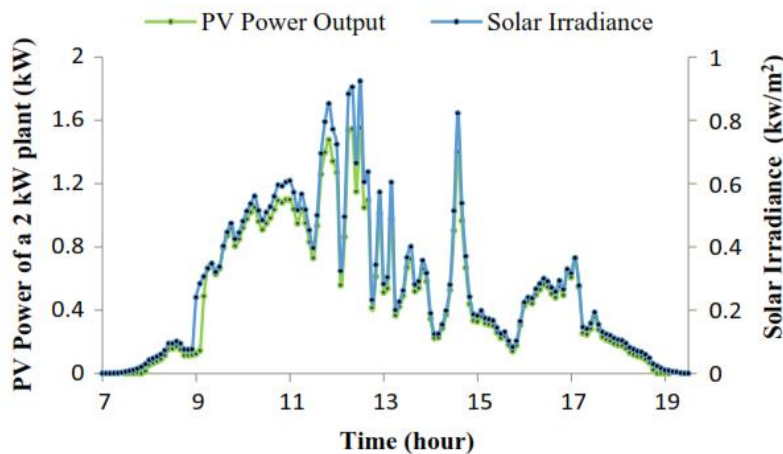

Figure III.2 Comparison Irradiance data and PV Power output pattern in particular day[11]

PV systems are also easier to be implemented in the residential sector. PV forecasting is needed for addressing the energy management issue. Ideally, the value of PV power output is quite identical with irradiance data. Nevertheless, several factors such as shading, conversion loss and other deficiencies influence the PV power output. Subsequently the value of PV power output is lower than the solar irradiance. It could be seen in fig. III.2.

### 3.3.1 PV forecasting methods

PV power generation fully depends on the erratic and uncontrollable meteorological factor namely atmospheric temperature, solar irradiance, wind pressure module temperature and humidity[11]. Thus, output power of PV system changes dynamically with time. Therefore, the accurate forecasting of PV power generation is highly difficult. The unpredictable PV power impacts the stability, reliability and scheduling of the power system alongside the financial benefit[12]. PV forecasting is divided by two sections where classification of PV forecasting could be obtained from two perspectives such as forecast horizon and historical data[11]. This section briefly describes the type of PV forecasting techniques which are categorized in the two classes[13] such as statistical methods and physical methods.

Mean Square Error (MSE)	$MSE = \frac{1}{N} \sum_{i=1}^N (W_{forecasted} - W_{true})^2$
Root Mean Squared Error (RSME)	$RSME = \sqrt{\frac{1}{N} \sum_{i=1}^N (W_{forecasted} - W_{true})^2}$
Normalized Root Mean Squared Error (RSME)	$nRSME_{\%} = \left( \sqrt{\frac{1}{N} \sum_{i=1}^N (W_{forecasted} - W_{true})^2} \right) * 100 / W_{true(max)}$
Mean Absolute Error (MAE)	$MAE = \frac{1}{N} \sum_{i=1}^N  W_{forecasted} - W_{true} $
Mean Absolute Percentage Error (MAPE)	$MAPE = \frac{1}{N} \sum_{i=1}^N \frac{ W_{forecasted} - W_{true} }{W_{true}} * 100\%$
Mean Relative Error (MRE)	$MRE = \frac{1}{N} \sum_{i=1}^N \frac{W_{forecasted} - W_{true}}{W_{total}} * 100\%$
Mean Bias Error (MBE)	$MBE = \frac{1}{N} \sum_{i=1}^N (W_{forecasted} - W_{true})$

Table III.2. Performance evaluation matrices [11], [14], [15]

### 3.3.2 Statistical method

In this method, quality of historical data is essential for accurate forecasting. Several techniques support the statistical method such as Artificial Neural Network (ANN), Support Vector Machine (SVM), Markov Chain (MC), autoregressive and regression model. Several researchers study this method to forecast the solar irradiance where the statistical method is used to rebuild the relation between the past meteorological parameter and hourly irradiance [16].

PV power generator will be harnessed for fulfilling local community and certainty of amount should be clear. Thus, PV forecasting data will be assessed with various metrics as shown in table III.2.

Where

$W_{forecasted}$	:	The forecasted PV power at each time point
$W_{true}$	:	The observed/measured PV power at each time point
$W_{true(max)}$	:	The maximum observed PV power of the scale
$W_{total}$	:	PV installation peak power capacity
N	:	Data sample for the time scale index

Mellit et al in their paper propose the ANN-MLP (Multi-Layer Perceptron) architecture for forecasting solar irradiance based on 24 hours ahead for Grid Connected Photovoltaic Plant (GCPV) in Trieste, Italy where the results indicate that the proposed model is conducted well. The correlation coefficient is in the range 98-99% for sunny days and 94-96% for cloudy days. Meanwhile the mean absolute error (MAE) and mean bias error (MBE) in the first sunny day is 3.21% and 8.54% respectively.

### 3.3.3 Physical method

Physical method or PV performance method. The main advantage from this method is no need for historical data because it relies on the output power from PV plant. The forecasting was performed using the prediction of solar irradiation and several supporting variables such as wind and temperature. Several tools conduct the forecast for instance, Numerical weather prediction, sky imagery, and satellite imaging.

### 3.3.3.1 Numerical weather prediction (NWP)

NWP aims to advance the power prediction model for renewable energy plant. The goal of this method is to provide the data information about atmospheres constrain in the current time scale. NWP could be grouped in two categories such as global models and mesoscale models. Global models give information through simulation of the characteristic of the atmosphere for worldwide area while mesoscale models bestow the information through simulation for restricted area i.e. continental, countries, regions and districts[17]. European Centre for Medium-Range Weather Forecast (ECMRWF) is one of weather service that uses global NWP models.

### 3.3.3.2 Sky imagery

Sky imagery is a forecasting method using the sky imagers that are digital cameras that produce high-quality image of the sky from the horizon to horizon. It is used for detecting clouds, estimating cloud height above earth surface and calculating cloud motion[18]. Most existing sky imagers are designed to image a hemispheric view of the sky. The camera are either oriented upwards or downward in acquiring a direct image or capturing the reflection from a spherical mirror, respectively[13].

The solar prediction based on sky imagery analysis has several element such as: (1) achieving the sky image near the prediction location by utilizing sky imager tool. (2) sky image data are analyzed to acknowledge the cloud. (3) cloud motion vector is reckoned by harnessing successive images and (4) short term probabilistic and deterministic cloud cover, irradiance and power forecasting bring the cloud site and motion vector data.

### 3.3.3.3 Satellite Imaging

The principal of satellite imaging is almost similar with sky imagery. It determines visible cloud pattern and infrared images that are taken from the satellite-based sensor flying overhead. Considering a longer prediction time horizon, the geostationary satellite data acquired from network such as National Oceanic and Atmospheric Administration (NOAA) supply the data information about cloud properties and movement[13], [18].

A Physically driven model forecast the clear sky shape at the specific location by harnessing input such as water vapour, aerosol content, elevation and ozone. Furthermore, the clear sky irradiance are modulated by irradiance forecasting acquired from the satellite image. Successive satellite

images are integrated to generate cloud motion vector field where they could be harnessed to predict the future cloud locations. These techniques is utilize effectively in forecasting irradiance in the range of one minute to five hours ahead. Nonetheless, it undertakes less effectively when the cloud is forming or dissipating fast.

### **3.3.4 Ensemble method (hybrid)**

This method combine two previous methods to cultivate the strength of them in order to reach accuracy improvement[19]. This method can be classified in two categories such as cooperation ensemble forecasting and competitive ensemble forecasting. Cooperative ensemble forecasting can divide a forecasting work into a few sub-tasks and accordingly each sub-task is solved individually in purpose to improve the performance of a forecasting technique. We assume subtask is pre-processing and post processing. In pre-processing, it split dataset into a sub-dataset. Thereafter, each sub-dataset is modelled and estimated by the predictor. The result is acquired by aggregating all output from the predictor. Meanwhile, the post-processing mention to time series data where contain more than one characteristic. Each of characteristic is fit for only one specific method. e.g ARIMA model is appropriate for modelling linear time series.

Whereas, the competitive ensemble method harness the multiple predictor with different parameter to construct individual forecast model and to create ensemble forecast model. In paper[20], authors explain that results of the forecasting model from the chosen model were aggregated by averaging. Diversity is the main feature in the competitive ensemble forecasting where it could be classified into three categories such as data diversity, parameter diversity and kernel diversity. If the base predictor return similar decision, in result, the forecasting produces less improvement. If the sub-task are similar, the output will be similar. Hence, the performance improvement of the ensemble forecasting will be insignificant.

### **3.3.5 PV data for the Research**

In this research, the PV data comes from CEA-INES measurement. This data has been recorded for a year with a 1-minute time step. Data PV production is taken in according data forecasting in 2014 and used for simulation component in this laboratory. Figure III.3 illustrates the PV production data for day-1 that was taken from the matlab file.



In the other case, in particular for case study in certain location such as Chambéry and Jakarta, Irradiance and weather data for one year were taken from PVGIS and it treated subsequently in EnergyPlus software with a 30 minutes time step.

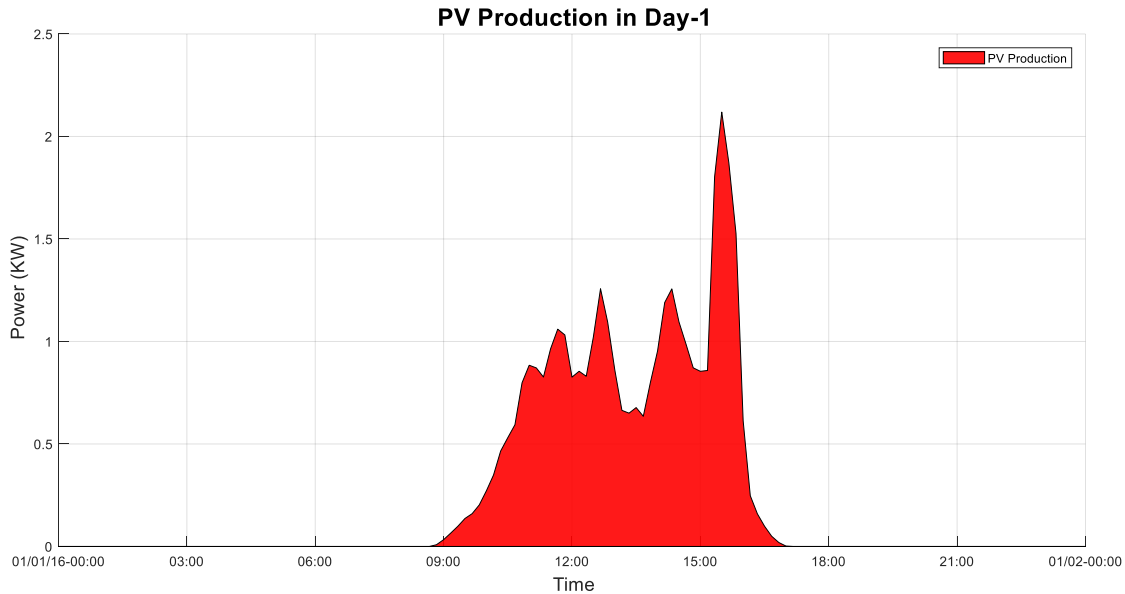

Figure III.3 PV forecasting data in particular day

### 3.4 Energy Storage

Energy storage system delivers many services in the system in particular residential sector to support the PV system in the supply energy[21]. It works in three situations such as charging, storing and discharging. It fills the electricity through loading process where they take energy from renewable energy or the grid as well as the control instruction. It will store the energy when the user do not have intention to harness the electricity. Lastly, the storage supplies electricity through a discharge process when the renewable energy does not meet the load consumption. Figure III.4 illustrate the energy storage system mode.

Energy storage systems have classification based on the technology such as electro-chemical storage, electro mechanical storage, chemical storage, pumped hydro storage and thermal storage. The sub technology type could be seen in the table III.3.

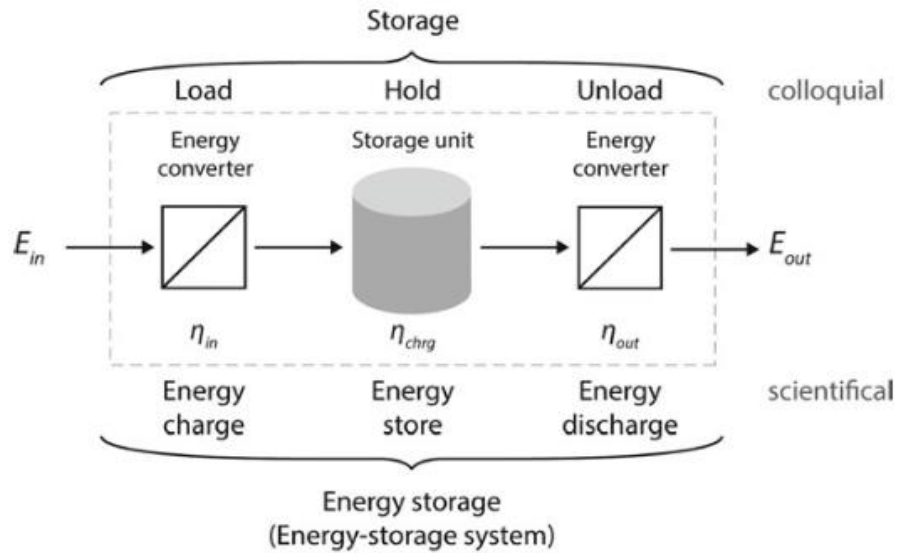

Figure III.4 Energy storage system definition based on the triad of charging (loading), storing, and discharging (unloading), as well as the essential physical dimensions[22].

Technology Type	Subtechnology Type
<b>Electro-Chemical</b>	Electro-chemical capacitor, lithium-ion battery, flow battery, vanadium bretox flow battery, lead-acid battery, metal air battery and sodium-ion battery
<b>Electro-Mechanical</b>	Compressed air storage, flywheel
<b>Chemical</b>	Hydrogen storage, liquid air energy storage
<b>Pumped hydro storage</b>	Close-loop pumped hydroelectricity storage, open-loop pumped, hydroelectricity storage
<b>Thermal storage</b>	Chilled water thermal storage, concrete thermal storage, heat thermal storage, ice thermal storage and molten salt thermal storage

Table III.3 Classification of storage based on technology[22]

As already mentioned in the first paragraph, the battery can operate in three modes: (i) discharging to help the user to meet his demand, (ii) charging when the demand is lower than the generation, and (iii) idle when the battery is fully charged or when the user does not utilize the electricity yet. A key parameter of the battery is its SOC (state of Charge). It is the remaining capacity of a battery. In other word, SOC is the amount of energy available in a battery. Generally, SOC is represented as a percentage. It is driven by the battery operating condition namely load current and temperature.

From a geographic point of view, energy storage systems are classified in several types namely centralized storage systems, decentralized storage systems, dual use storage systems, stationary storage systems and mobile storage systems[22]. Centralized storage systems are large and typically are stationary units for instance, pumping storage power plant. Their geographical and topological requirements bring the balancing for this system. Meanwhile, decentralized storage systems are modular, small and distributed storage unit. They are compatible to the decentralized character of renewable energy system. Batteries do not require specific environmental conditions. However, it needs more investment when the storage system is large. Multiple decentralized storage system can be controlled from a single point. A dual use storage system performs in dual function such as V2G system, hot water tank. Stationary storage systems are tied in a specific site. It could be centralized storage system or decentralized storage system. The disadvantage of this type, it cannot be placed where the energy is generated and used. Finally, mobile storage system can be located at a particular site for short or long periods.

In economic classification, storage systems have several parameters such as capital cost, operating cost and Annuity Investment cost. Capital cost (commonly called CAPEX that refers to Capital Expenditure) becomes the important parameter that is considered once for the storage system construction and start-up. Capital cost is based on the installed power cost (€/kW) or installed storage system capacity (€/kWh) and illustrated in eq.III.1.

$$k_0 = \frac{k_{over}}{P_{disch}} \text{ or } k_0 = \frac{k_{over}}{E_{over}}$$

... (eq.III.1)

Where  $k_0$  is specific investment cost,  $P_{disch}$  represent power of discharge in battery,  $k_{over}$  indicate the overall investment and  $E_{over}$  is battery capacity.

Second factor is operating cost, where the cost is produced from operating a storage system. It is called operational Expenditure (OPEX) where the amount of converted energy in €/kWh. Operating cost encompass the fixed operating cost such as personnel cost, maintenance, insurance, etc. Whereas, variable operating cost cover purchasing of electricity or fuel, replacement of part, maintenance etc. Finally, Annuity Investment cost are a general economic indicator for energy storage system. This financial costs are calculated from the following parameter such as investment cost, service life in year ( $t_{serv}$ ), capital interest  $i$  in 1/year and annual fixed operating

cost ( $k_{fix}$ ) in €/kW/year and €/kWh/year. The annuity factor ( $a$ ) in 1/year is calculated from the capital interest and the service life as follow eq.III.3

$$a = \frac{i * (1 + i)^{\frac{t_{serv}}{year}}}{(1 + i)^{\frac{t_{serv}}{year}} - 1}$$

... (eq.III.2)

$$k_a = k_0 * a + k_{fix}$$

... (eq.III.3)

### 3.5 Electric Water Heater

Water is an important thing in the human's daily-life activities, particularly in households. A domestic hot water tank is installed to provide instantaneous delivery of hot water. One of the models is an electrical water heater, which heats the water in the storage using electric resistance element in the up or bottom of the tank. The independent thermostat controls its element.

In the four-season zone, DEWH load contribute as much as 30% of the total household load when the winter is arrived[23]. DEWH has a potential for DSM project because the tank has a high thermal resistance (low thermal losses), and hot water in the tank acts as energy storage by heating water to a higher than normal temperature [24], [25]. The water heating could be shifted in time without significant impact for the user satisfaction. Many EWH models and control strategies have been developed for predicting and controlling the power consumption of EWH. Control strategies according to[26] could be categorized in 2 type as follow, first, utilities centered, which include the control strategies dealing with aggregate EWH load by an electric service provider for aiming peak load reduction and balancing/regulation service. Several ways to reach the objective through setting temperature adjustment[25], voltage control[27], and direct load control[28]. Second, customer center strategies support the household to reduce their bill in response to dynamic price signal.

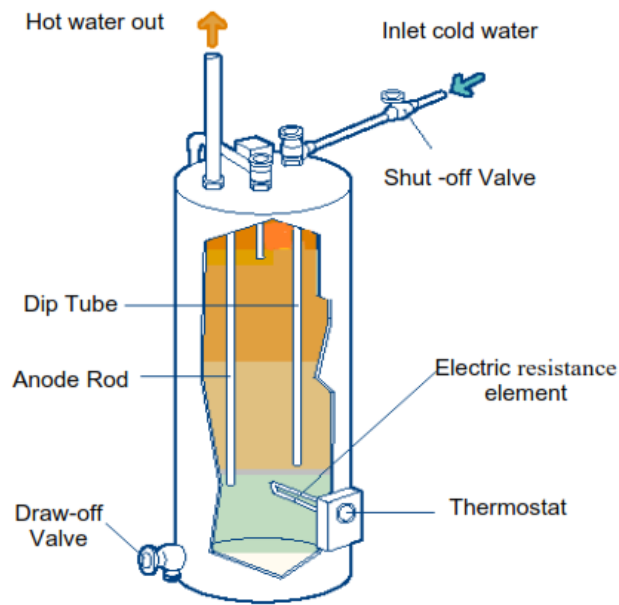

Figure III.5 Electric Water Heater with single element[29]

The domestic electric water heater (EWH) under consideration supplies hot water for residential consumption. Generally, EWH consist of a tank for storing hot water, single or dual electric element for heating water in the tank, a thermostat to adjust the temperature of water, an inlet pipe for supply water and outlet pipe for distribute hot water to the household[30].

The rated power of the electric element is typically in the range from 1000 to 5500 Watt. It depends on how the installed element are utilized and the volume of the storage tank. For example, De Dietrich 100 liters consume 1200 W and De Dietrich 150 liters takes 1800 W. EWH with dual element are more general than single element in household usage. However, for simplicity, single element EWH is considered in this study.

The thermostat is a device to control or adjust the hot water temperature in a certain range. The thermostat controls the energy flow of the EWH when the hot water temperature attain the low temperature bound ( $T_{lo}$ ) and terminate the energy flow when the hot water temperature reaches the high temperature bound ( $T_{up}$ ).

### 3.5.1 Parameter of Electric Water Heater

In this section, we would like to define several parameters of electric water heater in detail.

### **3.5.1.1 Power rate of heating resistance element**

As previously mentioned, the heating element in the water heater heats up the water inside the storage tank and a control loop works to keep it within the range of temperature. In this study, the rated power of EWH is 1200 Watt.

### **3.5.1.2 Ambient Temperature**

Ambient temperature for EWH is taken from the room temperature where the storage tank is located. Ambient temperature takes participation to calculate the heating water temperature. In reality, ambient temperature is various; it depends on the weather and thermal conditions in the room or house. In this study, we assume the ambient temperature is similar from time by time.

### **3.5.1.3 Cold Water inlet temperature**

The water from outside source brings the temperature called cold-water temperature. The temperature commonly depends on the region and climate difference. It gives impact the hot temperature in the storage tank and drives the heat up process if the hot temperature reach the minimum temperature bound.

### **3.5.1.4 Water Heater Size (Volume)**

Volume capacity of water heater gives the total amount of water that can be stored within the storage EWH tank. It is a main physical feature that determines the overall behavior of the equipment.

### **3.5.1.5 Water consumption**

Household use hot water from EWH tank for their activities such as cooking, showering, hand washing and so on. This parameter drives the heat-up process in the EWH in appropriate to the amount of the water consumption. The household type and occupation will bring using load profile generator, water consumption can be obtained until one minute time step.

## **3.5.2 User Comfort**

Each house has standard level for their satisfaction in particular hot water temperature. Thus, range of temperature is set. We assume the initial temperature similar with the lower temperature bound. Subsequently, the EWH activates the heating element to heat up the water inside the storage tank.

The comfort water temperature is in range between lower temperature and upper temperature. The heating process will be continued until the upper temperature bound is reached. After the upper temperature is reached, EWH will stop the heating process. When the hot water is taken from the storage tank, cold water from outside source enters into it. In result, the water temperature within tank is mixed with temperature of cold water.

### 3.5.3 Electric Water Heater for modeling

Electric water heater was presented as an energy storage unit and as a candidate for DSM project. Domestic EWH were installed in the several locations and the water consumption patterns in the residential sector could be taken from several strategies. Several studies show typical water draw pattern in the residential for an hour, a day, a week or a year

#### 3.5.3.1 Validation Electrical Water Heater

Water temperature is influenced by the heat conductivity in the water tank. Kapsalis in their paper[26] model the EWH in a single mass electric water heater with uniform temperature distribution. They formulate a first order differential equation model (see eq. III.4) where the equation is discretized. For every time slot, three temperatures are calculated such as initial temperature ( $T^{ini}$ ), heat temperature ( $T^{heat}$ ) and water temperature ( $T^{water}$ ). Heat water temperature and water tank temperature is formulated in eq. III.5 and III.6, respectively. In addition, water temperature become initial temperature for next time slot calculation (t+1). EWH equation that based on Kapsalis paper rely on the standby heat loss coefficient and surface area of the water tank.

$$M.C. \frac{dT}{dt} = U.A. (T^{amb}(t) - T(t)) + Q \quad \dots \text{(eq. III.4)}$$

$$T^{heat}(t) = T^{ini}(t) + \frac{U * A * (T^{amb}(t) - T^{ini}(t)) + s(t) * Q}{M * C} * \Delta t \quad \dots \text{(eq. III.5)}$$

$$T^{water}(t) = \frac{T^{heat}(t) * (M - m^{cold}(t)) + T^{cold}(t) * m^{cold}(t)}{M}$$

... (eq. III.6)

Where

$U$	=	standby heat loss coefficient	W/(m <sup>2</sup> .K)
$A$	=	surface area of the water tank	m <sup>2</sup>
$T$	=	Tank water temperature	°C
$t$	=	time	S
$M$	=	Mass of water storage	Kg
$C$	=	Specific heat capacity of water	W.s/(kg.K)
$T^{amb}$	=	Ambient Temperature	°C
$Q$	=	Power rate of EWH	W
$T^{heat}(t)$	=	Tank water temperature before water consumption in time slot - t	°C
$T^{ini}(t)$	=	Initial Temperature in time slot - t	°C
$s(t)$	=	Activation of EWH in time slot - t	-
$\Delta t$	=	Time slot duration	S
$T^{water}(t)$	=	Tank water temperature after water consumption	°C
$m^{cold}(t)$	=	Mass of water consumption in time slot - t	Kg
$T^{cold}(t)$	=	Temperature of inlet water in time slot - t	°C

Electric Water Heater have boundary for activation. When the water temperature below lower boundary EWH will be activated and  $s(t)$  value will be changed to 1. If the water temperature reach upper boundary the EWH is deactivated and  $s(t)$  will be changed to 0. In equation above, surface area of tank and heat loss is taking into account for obtaining the water temperature in the water tank.

However, the result of EWH model should be validated. We propose to compare it with the result of EWH model from another software namely Dymola (Dynamic Modeling Laboratory). It is a software for modeling of various kinds of physical system where it employ the modelica language. It has capabilities to model and simulate the physical component that can be describe by ordinary differential equations algebra equations in the lowest level and ‘drag and drop’ composition in the highest level[31]. EWH model in this software utilize several parameter in table III.4 with time sampling 1 minute for full day (24-hours). Using function of and the result is taken as a benchmark



of validation process. Applying the equation III.5-6 in other software such as Microsoft Excel and GAMS are prepared where they use similar parameter that used for modeling EWH in Dymola.

No	Parameter		Value	Unit
1	Thickness	$L$	0.1	m
2	Heat Conductivity	$k$	0.042	W/m.K
3	Volume	$V$	0.35	m <sup>3</sup>
4	Height of tank	$h$	0.5	m
5	Heat Capacity	$C$	4184	Ws/K.kg
6	Temperature Ambient	$T^{amb}$	20	°C
7	Initial Temperature	$T^0$	50	°C
8	Power rate	$Q$	2000	Watt
9	Time step	$t$	60	Second
10	Water Consumption	$m^{inlet}$	From load profile generator software	kg
11	Lower Temperature	$T^{low}$	50	°C
12	Upper Temperature	$T^{up}$	60	°C
13	Inlet Temperature	$T^{inlet}$	15	°C

Table III.4 Data Parameter for validation in Dymola

Furthermore, the result of EWH equation from both software will be compared to the result of EWH model from Dymola. The full data of comparison will be prepared in the appendix B. When the activation of EWH is begun, there are not distinction of the amount of result among the software. However, it is emerged while the EWH temperature reach maximum temperature. The differentiation of result could be seen in fig. III.6. In order to coordinate the result of dymola with the EWH model. It needs the new equation for narrowing the result gaps between dymola and GAMS.

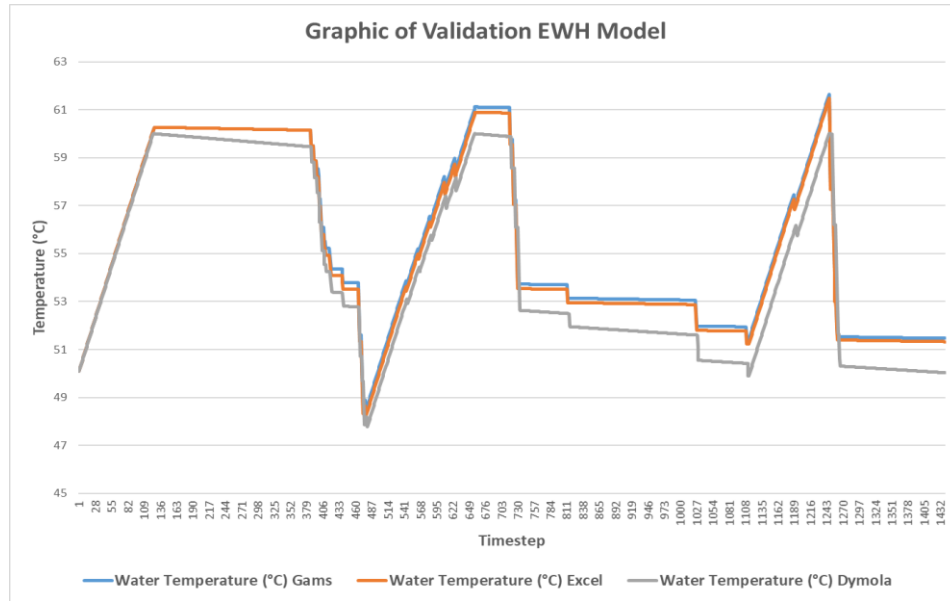

Fig. III.6. The comparison of water temperature result among the software.

Most of EWH tank in the world is cylindrical form. The heat transfer could be modeled in steady state and one-dimensional[32], [33], with the form illustrated in fig. III.7. The temperature in the tank only depends on the radial direction. It needs validation to ensure the better model for calculation.

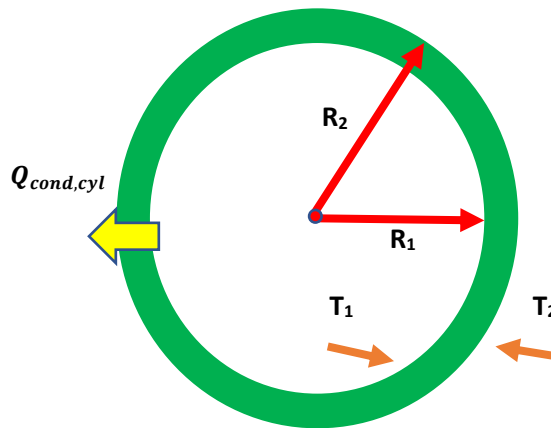

Fig. III.7. One Dimensional Heat Conduction in radial direction, in steady-state

In the new modeling for hollow sphere, heat transfer equation applies the Fourier law where there is no heat generation in the layer and thermal conductivity has a constant value[32]. The equation is given below

$$Q_{cond,cyl} = -k \cdot A \cdot \frac{dT}{dr}$$

... (eq. III.7)

Where,

$Q_{cond,cyl}$  = Heat transfer in cylinder form

$k$  = Heat conductivity

$A$  = Surface of the tank

$dT$  = Differential of temperature

$dr$  = Differential of radius

Considering the definition of the water tank surface (eq. III.8), the equation III.7 is integrated to define the heat losses as function of inner and outer radius of the tank (respectively  $R_1$  and  $R_2$ ) and inside (water temperature) and outside (ambient temperature) temperatures (resp.  $T_1$  and  $T_2$ ). Details are given by equations III.9 to III.13 below.

$$A = 2 \cdot \pi \cdot r \cdot L$$

... (eq. III.8)

$$Q_{cond,cyl} = -k \cdot (2 \cdot \pi \cdot r \cdot L) \cdot \frac{dT}{dr}$$

... (eq. III.9)

$$\frac{Q_{cond,cyl} \cdot dr}{r} = -2 \cdot \pi \cdot k \cdot L \cdot dT$$

... (eq. III.10)

$$Q_{cond,cyl} \cdot \int_{R_1}^{R_2} \frac{dr}{r} = 2 \cdot \pi \cdot k \cdot L \cdot \int_{T_0}^{T_1} dT$$

... (eq. III.11)

$$Q_{cond,cyl} \cdot \ln \frac{R_2}{R_1} = 2 \cdot \pi \cdot k \cdot L \cdot (T_2 - T_1)$$

... (eq. III.12)

$$Q_{cond,cyl} = \frac{2. \pi. k. L}{\ln \frac{R_2}{R_1}} \cdot (T_2 - T_1)$$

... (eq. III.13)

The water heater calculation also takes mass of water into account, we consider the density for converting volume value to mass unit. Water consumption is also converted. The equation is

$$m = \rho \cdot V$$

... (eq. III.14)

Where,

- m = mass of water (kg)
- $\rho$  = density of water (1000 kg/m<sup>3</sup>)
- V = volume of water (m<sup>3</sup>)

From equation III.13, it is possible to update the equation III.5, as the heat transfer coefficient defined by:

$$U \cdot A = \frac{2. \pi. k. L}{\ln \frac{R_2}{R_1}}$$

... (eq. III.15)

Thus, the time evolution of the temperature  $T^{heat}$  is given by eq. III.16 where initial temperature  $T^{ini}(t)$  represent hot water temperature  $T^{water}(t - 1)$ . The equation is adopted for excel calculation and GAMS modeling.

$$T^{heat}(t) = T^{water}(t - 1) + \frac{\frac{2 * \pi * L * k}{\log \frac{R_2}{R_1}} * (T^{amb}(t) - T^{water}(t - 1)) + s(t) * P}{V * \rho * C} * \Delta t$$

... (eq. III.16)

$$T^{water}(t) = \frac{T^{heat}(t) * (V - V^{inlet}(t)) + T^{inlet} * V^{inlet}(t)}{V}$$

... (eq. III.17)

To simplify the equation, the water temperature before water consumption equation in time slot- $t$  (eq. III.16) is spelled out in the water temperature after water consumption equation in time slot- $t$ . the new equation is shown in eq. III.18.

$$T^{water}(t) = \frac{\left( T^{water}(t-1) * \left( 1 - \frac{\frac{2 * \pi * L * k}{\log \frac{R_2}{R_1}} * \Delta t}{V * \rho * C} \right) + \left( \frac{\left( \frac{2 * \pi * L * k}{\log \frac{R_2}{R_1}} * T_{amb}(t) + s(t) * Q \right) * \Delta t}{V * \rho * C} \right) \right)}{V} * (V - V^{inlet}(t)) + T^{inlet} * V^{inlet}(t)$$

... (eq. III.18)

Where,

$t$	=	Time slot	S
$T^{heat}$	=	Heating temperature in time slot- $i$	°C
$T^{water}(t-1)$	=	Initial water temperature, or water temperature in time slot ( $t-1$ )	°C
$L$	=	Length of water storage tank	M
$k$	=	Heat conductivity of fluid (Water)	kW/m.K
$R_2$	=	Outer radius of water storage tank	M
$R_1$	=	Inner radius of water storage tank	M
$T^{amb}$	=	Ambient temperature	°C
$s$	=	Activation of EWH setting ( $s \in \{0,1\}$ )	-
$V$	=	Water storage tank capacity (volume)	m <sup>3</sup>
$\rho$	=	Fluid density ( water density )	kg/m <sup>3</sup>
$C$	=	Heat capacity of fluid (water)	kWs/kg.K
$\Delta t$	=	time slot duration	S
$T^{water}(t)$	=	Hot water temperature in the water storage tank in time slot- $t$	°C
$T^{inlet}$	=	External water temperature (inlet) that enter to water storage tank	°C
$V^{inlet}$	=	Water consumption in the house	m <sup>3</sup>

### 3.5.3.2 Result of EWH Validation

The purpose of validation is to make the result of EWH model resemble or near to the result of EWH that obtained from Dymola. The validation modeling run for a full day with a 60 seconds

time step in reason to obtain the better result. EWH model in GAMS and Excel adopt the equation III.18 while the result will be compared with the Dymola result. The validation result could be seen in the appendix.

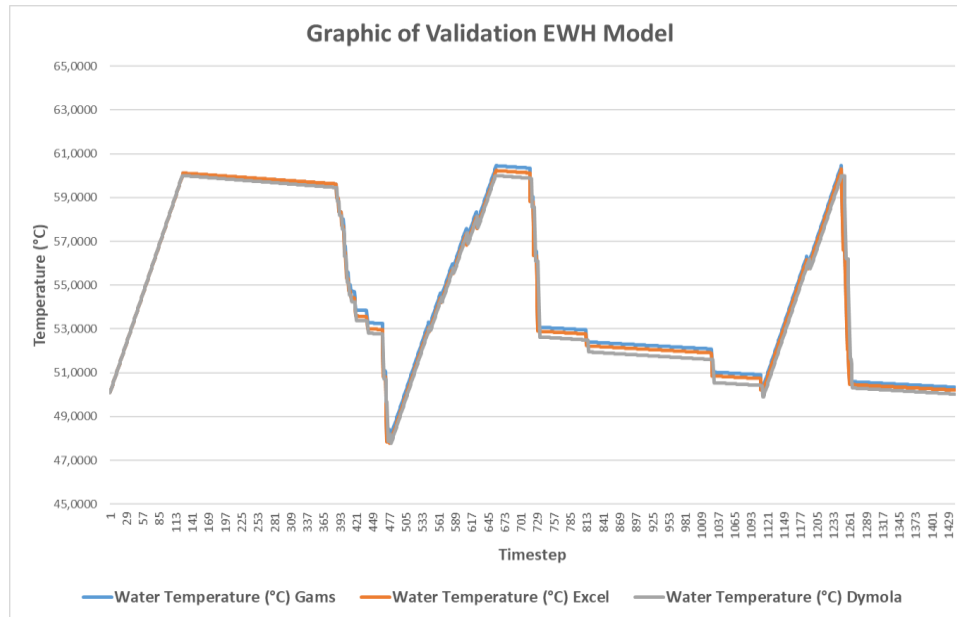

Fig. III.8 The comparison the trend of EWH after validation

In fig. III.6, there are many gaps point between GAMS and Dymola. With the new equation, the deviation between them is reduced. In figure III.8, water temperature pattern that produced by GAMS and Excel near with the Dymola pattern. The gaps of Dymola and GAMS modeling is getting narrower where the deviation is lower than 0.01%. In result, the EWH model using new equation is considered to be part of MPC component subsequently it is appropriate to be used in energy management modeling.

## 3.6 Thermal Building

### 3.6.1 Background

Building participates in the energy consumption especially in the heating and cooling because HVAC becomes the primary energy-consuming sector[34]. HVAC energy demand is related to indoor temperature set point, window types (quality of the isolating performances), air infiltration, wall window ratio and internal load. According to paper[35], 32% of total energy production consumed by utilities from commercial and residential sector. Moreover, in the US, the building energy consumption reach 41.1 % of U.S primary energy consumption, which building HVAC

control system take portion around 40% of the operating energy[36]. Thus, strategies are required to reduce the energy consumption in the house. Researchers identify the appropriate selection and operation of HVAC system could save the energy until 25% while maintaining the satisfactory of indoor environment. Modeling is needed to improve energy efficiency in the house, while taking into account the loss or gain of heat through wall, window, floor, ceiling, and roof of building.

### 3.6.2 Literature review

There are three categories for HVAC modeling namely white box, black box and grey box. White box HVAC modeling is developed by understanding process physics and underlying engineering principles[37]. It is also known as physic based, analytical and forward model. White box is progressively used and implemented in various simulation such as modelica and energy plus[38]. This model has benefits such as good prediction accuracy over a wide range of operating conditions[37]. It needs to determine/identify a large number of parameters. Nevertheless, the accuracy will be low when there is not enough measurements in their development. Second, black box HVAC is developed by measuring input and output of the system. It also uses mathematical functions both linear and nonlinear for approximating the operation of the system. With this approach, the model form and solution is often simple, in contrary, model fitting procedure could be complex[39]. Several authors use this model to simulate thermal behavior of different buildings and HVAC plant predictive control using linear parametric model such as autoregressive with exogenous input[40].

Thermal Model	Electricity
Node of lumped element	Electric potential terminal
Temperature	Electric potential
Heat flow	Electric current
Thermal resistance	Resistor
Thermal capacitance	Capacitor

Table III.5 Physical representation of inputs in the building model for an electro-thermal approach

To obtain the best model, a combination of white box model and black box model is proposed in third category namely grey box HVAC. It is developed using the physics based white box models

whose parameters are estimated by the measured input and output. N. Aoun in her thesis stated that the main concept of grey box model is to aggregate and represent the different building elements through resistances and capacities with an analogy to electrical network. Hence, the model is referred as lumped RC ( $R_xC_y$ ) model[41]. The similarity of the thermal and electricity analogies reflect in the table III.5. The grey box model benefits from the advantages of other two approaches, providing good generalization capabilities in comparison to data driven models and better accuracy than physic based models[42].

Berthou et al[43] propose the simple explanation through fig. III.9, the main physical solicitation gives effect to energy demand and internal temperature where they are represented. Solar gain on the wall ( $\phi_{se}$ ), solar gain transmitted through the wall ( $\phi_{s,int}$ ), set point temperature ( $T_{ini}$ ) and occupation (OCC) are indicated as inputs, while indoor temperature and thermal power become the output from this model. The other parameters for instance, solar radiation and weather data is taken from data forecasting. When the internal temperature ( $T_{int}$ ) goes below the minimum temperature ( $T_{min}$ ) set for the building, the heaters will release their energy (P) to normalize temperature to the ideal temperature. Instead, the cooler will operated if  $T_{int}$  is greater than maximum temperature ( $T_{max}$ ).

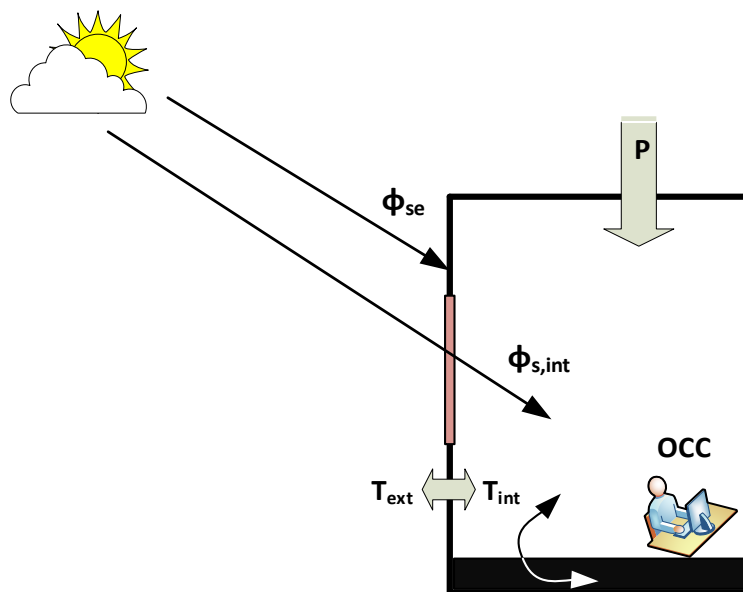

Figure III.9 Physical representation of inputs in the building model[43]

Several papers propose a building modeling using grey box with electro-thermal equivalent circuits such as model 1R1C, 2R1C, 4R2C, 6R2C and others to simulate the energy demand



prediction. Fux et al[44], compare four building models (1- to- 4 orders) to forecast the temperature in the house. They use an unoccupied period for identifying the model parameters. In result, the model R1C1 is efficient to forecast the indoor temperature of the residential house. Whereas, in paper[45], researchers used higher order models (2-to-6 order) to represent a multi-zone individual building. They conclude that the 2-order model allows a suitable prediction of the total energy consumption as well as of the energy requirements for a daily period. Whereas, a 4-order model was needed for high quality heating power and indoor temperature prediction.

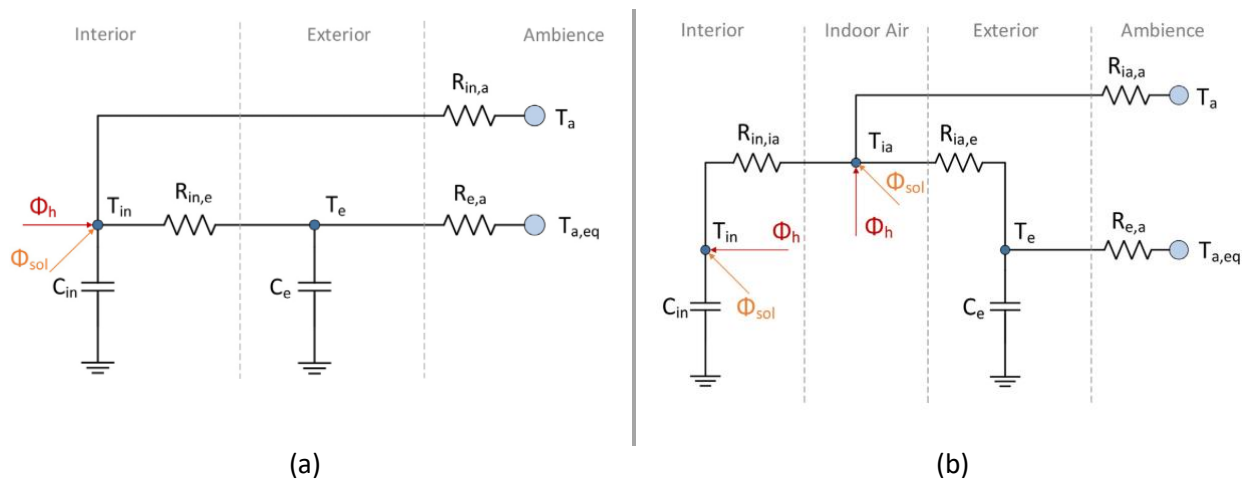

Fig III.10 Example of 2<sup>nd</sup> order building model[38]

In the figure III.10, a second order model is given with two thermal capacitance, generally one indicating the internal environment and another for the external. The convective and radiative heat exchange rate between these two components is indicated by the thermal resistance  $R_{in,e}$ . There are two types of heat exchange between building and environment.  $R_{in,e}$  is considered as transmission heat losses from internal building to external and continue by  $R_{e,a}$  that represents heat loss transmission from external to ambience. When the ventilation is assumed, heat loss transmission from internal building to the ambience is represented by  $R_{in,a}$ . Th figure (a) illustrates a three zone configuration and is commonly called 3R2C model. The heat dynamic of the 3R2C model can found in the eq. III.19-20.

$$dT_{in} = \frac{1}{R_{in,e} * C_{in}} (T_e - T_{in})dt + \frac{1}{R_{in,a} * C_{in}} (T_a - T_{in})dt + \frac{1}{C_{in}} (\Phi_{h,in} + \Phi_{sol})dt + d\omega_{in}$$

... (Eq.III.19)

$$dT_e = \frac{1}{R_{in,e} * C_e} (T_{in} - T_e)dt + \frac{1}{R_e * C_e} (T_{a,eq} - T_e)dt + \frac{1}{C_e} \Phi_{h,e}dt + d\omega_e$$

... (Eq.III.20)

Furthermore, the 4R2C model is described in the fig. III.10(b). It considers the indoor air as a separate temperature node  $T_{ia}$  without thermal capacity.

$$dT_{in} = \frac{1}{R_{in,ia} * C_{in}} (T_{ia} - T_{in})dt + \frac{1}{C_{in}} (\Phi_{h,in} + (1 - f_{conv}) * \Phi_{sol})dt + d\omega_{in}$$

... (Eq.III.21)

$$dT_e = \frac{1}{R_{ia} * C_e} (T_{ia} - T_e)dt + \frac{1}{R_{e,a} * C_{in}} (T_{a,eq} - T_e)dt + \frac{1}{C_e} \Phi_{h,e}dt + d\omega_e$$

... (Eq.III.22)

Furthermore, the model describes the internal air as a mass less node with no capacity

$$0 = \frac{1}{R_{in,ia}} (T_{ia} - T_{ia})dt + \frac{1}{R_{ia,e}} (T_e - T_{ia})dt + \frac{1}{R_{ia,A}} (T_a - T_{ia})dt + f_{conv} * \Phi_{sol}dt + \Phi_{h,ia}dt$$

... (Eq.III.23)

However, Berthou et al[43] stated the disadvantage of 4R2C thermal model as it cannot take into account solar gain coming on external walls. In the winter, the solar gain gives small impact on the load. Nevertheless, the solar gain gives more real impact to the load during summer season.

### 3.7 Financial Scheme

The motivation of energy management implementation in the household is to reduce of electricity cost and peak average ratio. Several pricing scheme have already been mentioned in the chapter 2. However, according to CRE[46], as result of deregulation in France, market offers can be contracted by users either with a new electricity supplier (known as ‘alternative’ supplier) or with EDF. Users can also keep their original regulated tariff only proposed by EDF company. EDF offers three main regulated tariffs that are subjected to at least annual change:

1. Basic Option (“Tarif de base”). In this option, the electricity price is always the same, regardless the hour of the day. According to EDF, this tariff is suitable for users that have a

few appliance and utilized in the off peak period. This tariff is no longer offered for households with contracted power greater than 18 kVA. For information, 53% household in France contract this option.

2. Off peak Option (Option “Heures Creuses”). The electricity tariff is divided in two periods namely, peak and off-peak. This option is suitable for household that have numerous appliances that can be operated in off-peak time. It gives benefit for 8-hour advantageous daily electricity price. Around 45% of households contract this option. The subscription start from 6 kVA to 36 kVA.
3. Tempo Option. The electricity tariff variations depend on both the time and the week. It is unpredictable because the price is announced in the previous evening. This option is only adapted for households that have subscription above 9 kVA. In this option, EDF combine six tariff where there are three parts of tariff namely “bleu”, “blanc” and “rouge” where peak and off-peak tariffs are applied in each part[47]. The rouge area cover 22 days between 1 November and 31 March, Monday to Friday. Rouge tariff is not applied on Saturday, Sunday and holidays. Subsequently, there are 43 days in full year for ‘blanc’ tariff except Sunday. In addition, the other is applied for ‘blue’ tariff. The hour to implement this option start from 6:00 A.M to 6:00 A.M in next day. They also apply standard tariff and 2 tariff in the peak-off peak option. For peak-off peak tariff, they use 16 hour for peak tariff between 6:00 A.M and 10:00 P.M. In same time, 8 hour for off peak tariff between 10:00 P.M and 6:00 A.M in the next day. Fournisseur-Electricite state their opinion in their website[48] as the tempo option suitable for the household with high electricity usage and who can be pretty flexible about when they operate the appliances such as dish washer and washing machine.

Furthermore, the feed in Tariff also applied in France for small-distributed generators of less (Renewable energy policy database and support) than 100 kW-installed capacity (act 1 decret du 28 mai 2016[49]). Regarding the tariff, the regulator CRE releases the updated solar tariff regulation for PV in France Metropolitan. Procedural, electricity operator are obligated by the law to enter into purchase agreement with the PV system owner. The owner contractually entitled to the payment of the shared energy. According to *journal officiel*[50], the nominal of feed in tariff referred to article 8, where the PV production from building with PV system smaller or as well as 9 kWp obtains fix tariff 10 c€/kWh. They also receive Premi T<sub>a</sub> in the first five year after

installation, if they meet all criteria mentioned in the annex 2. Furthermore, article 7 states that the duration of feed-in-tariff is 20 years from the date of installation.

### 3.8 Energy Management method

With the incentives offered by the government, the rate of PV system installation in the local residential has emerged. The household objective was to not only consume their PV production but also become producer, with a sold of the PV production to the electricity supplier. This paradigm is changed where the house owners participate in the electricity market and are called “Prosumer”. In the traditional strategy, prosumer use their PV production to meet the demand and share their surplus energy to the grid in order to gain the incentive such as feed-in tariff.

In France, the continuous drop of the FiT rate encourages prosumers to improve their self-consumption, which it is profitable for them and also to avoid the energy lost when the feed-in-tariff falls below the electricity grid price as it have not value in energy transfer to the electricity supplier. Several methods to reach the objective are used. The method to improve self-consumption is to increase energy storage and energy management implementation in particular load shifting.

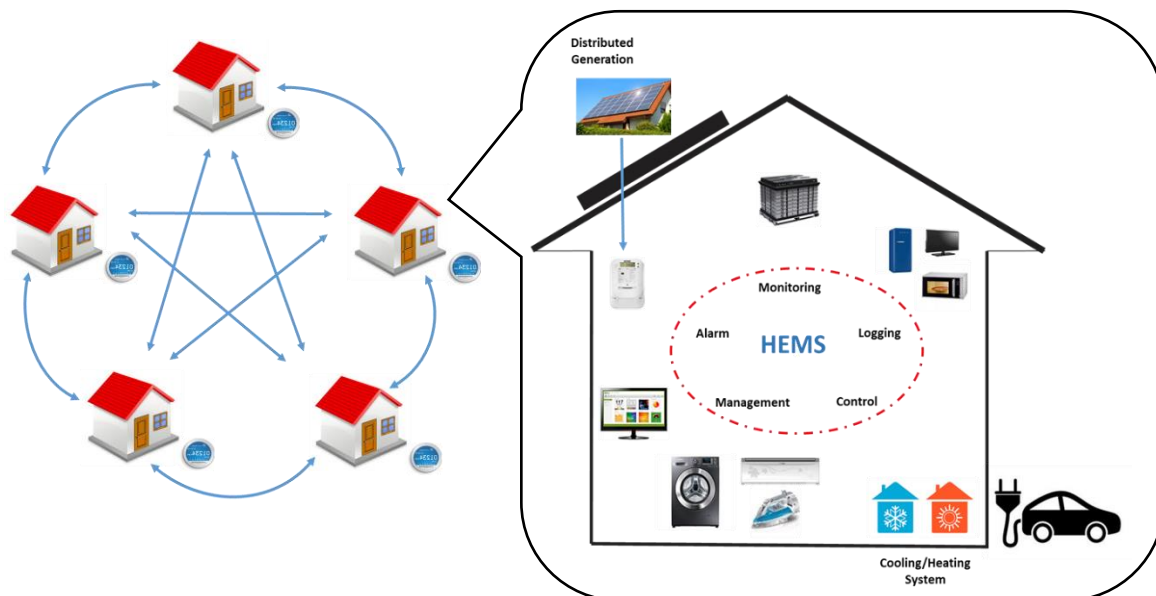

Fig. III.11. Architecture for Coordination among Prosumer equipped by HEMS

Rodrigo et al in their papers[51], [52], state that the problem of Demand Response approach is to not reduce the user satisfaction (quality of life). They propose the coordination energy management among households (prosumers and consumers) in the community. The architecture of coordination is illustrated in fig.III.11. Prosumers perform coordinated energy management of their power production and consumption without degradation of their satisfaction. This method is different from demand response approach, as it does not need any external request. The owner also has the opportunity to be producer and consumer in the electricity market. The challenge in this coordination management system is not only to coordinate a particular household's loads to reach the best Quality of Life but also to seek the benefit for their community as a whole. To handle the problem, several methods are proposed to help household or community to reach their goal for instance, centralized and decentralized coordination.

### **3.8.1 Coordination Energy Management via Bilateral Contract**

Here, we consider a full P2P market in particular bilateral contract between a single prosumer and a single consumer. This scenario is made for helping the prosumer when the feed-in-tariffs are decreasing. For Consumer side, this strategy gives them the choice to improve their electricity cost with lower price. Like the previous strategy shown in figure III.12, The component of prosumer encompass PV panel, battery system, fixed load, flexible loads such as dish washer and washing machine, whereas consumer component cover battery system, fixed load and flexible load. Furthermore, financial component include the grid electricity price, PV electricity price and distribution cost and so on. Firstly, the prosumer meet their consumption with the result that self-consumption is also reached. When the excess energy is large or suitable for sharing, the consumer consumes this energy for fulfilling its demand. In consequence, the self-consumption of consumer is emerged. This strategies could be built standalone or without provider support. However, it is not recommended because the resource is intermittent. The risk of this strategy is that both prosumer and consumer might shut down their activities due to a lack of electricity.

Electricity provider still support the scenario, so that it could send electricity to both the prosumer and the consumer. Prosumer buys electricity from provider when its PV system cannot meet with its demand. Automatically, consumer does not receive the shared energy and must also buy the full energy from provider. The contract between prosumer and consumer is created in accordance with their agreements.

### 3.8.1.1 Basic Peer to Peer Energy Trading in Community

In previous chapter, introduction of coordination via peer to peer have explained. Several prosumers with their energy excess have possibility to make benefit in the local electricity market with certain consensus between consumers. Several research consider this strategy due to the goal and satisfaction reason. In the present work, the simulation module from CEA-INES (known as ‘SPIDER’) is used.

#### 3.8.1.1.1 Benefit equation in the prosumer and consumer

Dependency of electricity demand of residential (household) to the grid absolutely gives impact to financial in consumer side. This thesis investigates the cost for consumer when they deal with the bilateral contract strategy.

*Potential incentive for Prosumer from Consumer (IC<sub>PV</sub>) :*

$$\sum_{d=1}^D \sum_{t=1}^T P_d^a(t) * (\varphi_p(t) - \varphi_{dis}(t)), \quad \forall t \in T, \forall d \in D$$

... (Eq. III.24)

*Potential incentive for Prosumer from Grid (IC<sub>grid</sub>) :*

$$\sum_{d=1}^D \sum_{t=1}^T (P_d^{exc}(t) - P_d^a(t)) * (\varphi_{fit}(t) - \varphi_{dis}(t)), \quad \forall t \in T, \forall d \in D$$

... (Eq. III.25)

*Total Potential incentive for Prosumer (IC<sub>tot</sub>) :*

$$IC_{tot} = IC_{PV} + IC_{grid}$$

... (Eq. III.26)

*PV electricity consumption Cost (C<sub>PV</sub>) :*

$$\sum_{d=1}^D \sum_{t=1}^T (P_d^a(t) * \varphi_p(t)), \quad \forall t \in T, \forall d \in D$$

... (Eq. III.27)

Grid electricity consumption Cost ( $C_{grid}$ ):

$$\sum_{d=1}^D \sum_{t=1}^T \left( P_d^{grid}(t) * \varphi_p(t) \right), \quad \forall t \in T, \forall d \in D$$

... (Eq. III.28)

Total cost in Consumer ( $Cost_{tot}$ ):

$$Cost_{tot} = C_{PV} + C_{grid}$$

... (Eq. III.29)

Where,

- $t \in [1, T]$  : Time interval index in 1 day
- $d \in [1, D]$  : Day index
- $P_d^{exc}$  : Excess PV electricity produced by prosumers in day- $d$
- $P_d^a$  : Excess PV from Prosumers consumed by local consumers in day- $d$
- $P_d^{grid}$  : Grid electricity power consumed by prosumer and consumer in day- $d$
- $\varphi_p$  : Price of PV electricity
- $\varphi_{dis}$  : Distribution fee for power injection into the grid by prosumers (whether it is sold to a local consumer or not)
- $\varphi_{fit}$  : Feed-in tariff

For the energy transaction, two scenario are considered:

1. Independent household behavior; it means household bring their demand with the provider. In prosumer side, household needs electricity from the provider to complete its demand when the local generation production cannot meet the consumption. Otherwise, prosumer shares its energy surplus to the grid with incentive expectation. The incentive is counted between the number of shared energy and feed in tariff that applied in accordance with grid regulation. Meanwhile, consumer relies on the fully conventional connection with the provider for demanding the energy. Figure III.12.(a) illustrates the scenario. The wholesale electricity price affects the electricity cost.
2. Coordinated behavior between two households; the prosumer with this scenario have several options to manage their electricity. One of the option is energy sharing with the neighbor in

the community. The scenario allows the household prosumer to be active player in the market where they sell surplus energy to another household (consumer) with the consensus. The illustration of coordination energy management in the pool could be seen in fig III.12.(b). The bilateral contract becomes the choice where prosumer shares energy excess to one consumer; in consequence, it reduces the electricity demand of consumer from the grid.

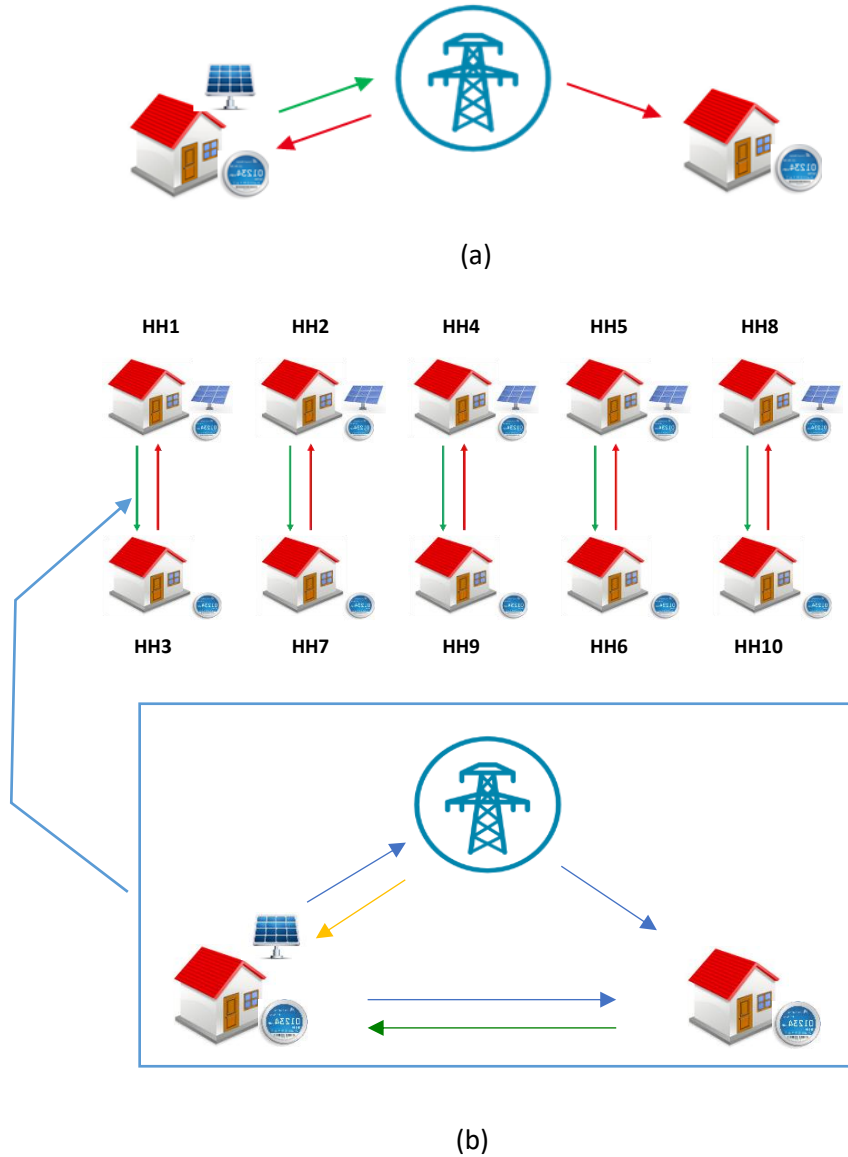

Fig. III.12 Scheme of coordination, Independent (a) and Bilateral Contract between household (b)



### 3.8.1.1.2 Application of Bilateral contract in SPIDER

To assess the efficiency of bilateral contract between prosumer and consumer, several simulations were prepared. Taking sample for 10 households in different types is applied. The load consumption of household was taken from the software *load profile generator*. The household type is prepared in the table III.6.

Furthermore, the simulation proposes a classification of households in three classes where two households have PV system and energy storage system; three only have with PV system, and five normal consumers without PV system and storage. The size of PV and storage in prosumer are detailed in table III.7.

The household's load consumption profile is created for one year without shifted appliance and it will be made as based load for simulations. Load profile is the accumulation power of the uninterruptable appliances that have more impact in household satisfaction such as kitchen appliances, lamps, television, bathroom and other.

Household type	Code	Worker index	Children index
<b>Couple no child</b>	HH1	2	0
<b>Family 1</b>	HH2	1	2
<b>Family 2</b>	HH3	1	1
<b>Family 3</b>	HH4	2	2
<b>Family 4</b>	HH5	2	1
<b>Retired Family</b>	HH6	0	0
<b>Single parent woman</b>	HH7	1	1
<b>Single parent man</b>	HH8	1	1
<b>Single woman</b>	HH9	1	0
<b>Single man</b>	HH10	1	0

Table III.6. Household type for simulation

Prosumer	PV Size (kW)	Storage (kWh)
<b>HH1</b>	8	4
<b>HH2</b>	8	0
<b>HH4</b>	8	0
<b>HH5</b>	7	4
<b>HH8</b>	7	0

Table III.7. Classification prosumer for bilateral contract simulation

Household	Time	
	Washing Machine	Dishwasher
HH1	18:00	21:00
HH2	11:00	20:00
HH3	09:00	20:30
HH4	18:30	20:00
HH5	19:00	21:00
HH6	10:00	19:00
HH7	18:00	20:00
HH8	19:30	20:30
HH9	20:30	21:30
HH10	20:00	22:30

Table III.8 Time operation of washing machine and dishwasher in each household

In the load shifting section, we also apply washing machine and dish washer as shift-able load with specification Bosh WAE 28143 2300W. The operation time of it is 2 hour 13 minutes. Meanwhile, the dishwasher has specification NEFF SD6P1F with 2110W in power that run approximately 2 hour 35 minutes per day. The schedule of dishwasher and washing machine operation is provided in the table III.8.

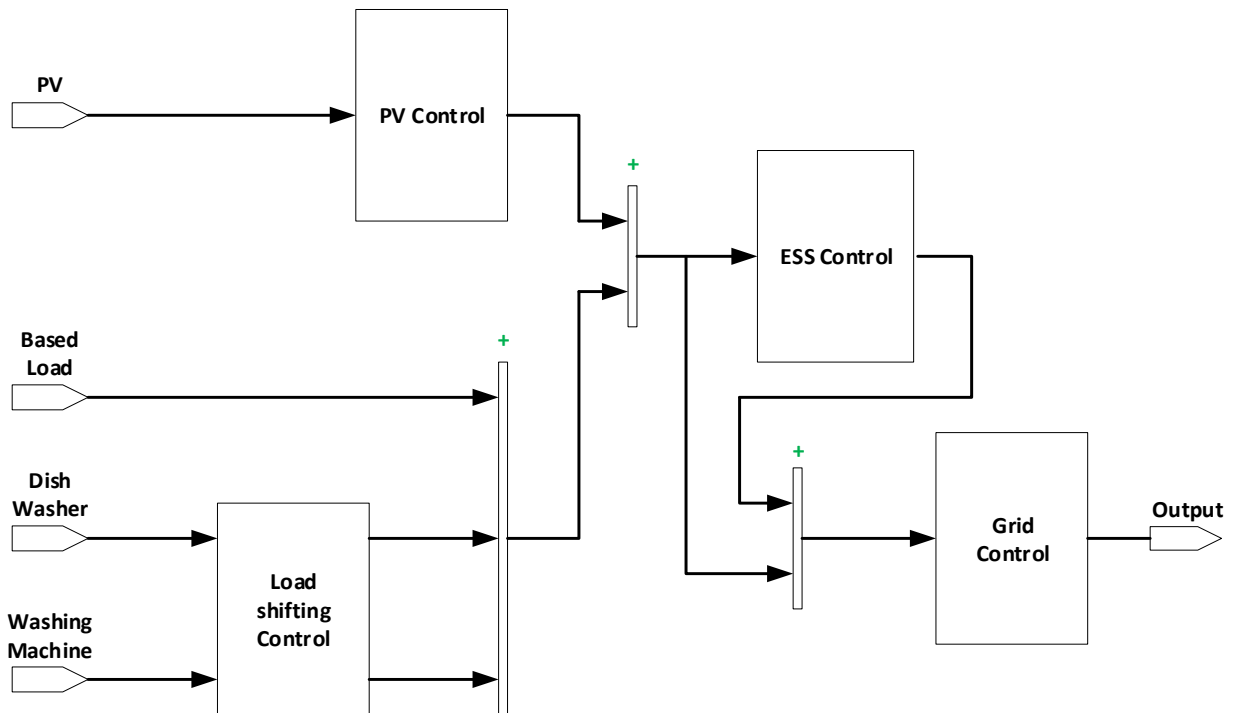

Fig. III.13 HEMS coordination in the household (prosumer) illustration in Simulink

For the financial parameter, we assume the fix tariff that are applied in France, 15.46 c€/kWh and cost assumption in distribution line around 3c€/kWh. In here, taxation cost is negligible. We also prepare five bilateral contracts between households as shown in figure III.12, where they make energy transaction to obtain cheaper price. Price of PV production is assumed to 10 c€/kWh with considering the distribution line cost, in order to find the different profile of revenue and cost for the household. When a household energy excess remains after they share with contract partner, it is sold - if possible - to the grid with PV production that is determined by Grid operator or local government policies. The equation explain the incentive that received by prosumer from both consumer and grid.

From these scenarios, households analyze differences through rewards and costs received/payed. In the first scenario, local energy management is applied in each household when the households activate their flexible appliances referred by their behavior. Daily activating time for dishwasher and washing machine are given in table III.7. In the second scenario, we prepare contract coordination between households as showed in figure III.12. Load shifting is applied in all households, where the consumers shift their appliance near peak production of solar energy, and the prosumer activate their shift-able appliances in 13:30 for washing machine and 11:30 for dishwasher.

### **3.8.2 Application the bilateral contract in Heuristic**

DSM technique especially load shifting is very useful for energy cost reduction purpose. To reach the optimal result, it needs a scheduling of controllable appliance using optimization in particular heuristic optimization. In this thesis, Coordination in a pool utilizes Particle Swarm Optimization to investigate (i) the cost reduction reached by prosumer and consumer, and (ii) ability to maximize the PV production via self-consumption.

#### **3.8.2.1 Particle Swarm Optimization**

Kennedy and Eberhart proposed Particle Swarm Optimization (PSO)[53] in 1995 where the algorithm was studied based on the simulation of animal social behaviors, such as bird flock and fish schooling. The PSO method is iconic due to its simplicity of implementation and instantaneously converge to a reasonably good solution. Similar with other population- based optimization method, PSO starts with random initialization of a population swarm or particle in

the search space. Swarm called particles is initialized randomly to seek optimum solution in an n-dimensional search space.

Each particle updates PSO is classified in two approaches such as cognitive and social. First, PSO algorithm sets the random value for initial position and maintains population of particles, each of which represents a potential solution to an optimization problem so that Personal best ( $P_{best}$ ) will be determined. Using iteration  $t$  and particle index- $i$ , we update  $P_{best}$  according to eq.III.30

$$P_{best_i}^{t+1} = \begin{cases} X_i^{t+1}, & \text{if } f(X_i^{t+1}) < f(P_{best_i}^{t+1}) \\ P_{best_i}^t, & \text{otherwise} \end{cases} \quad \text{(Eq. III.30)}$$

$$G_{best}^{t+1} = \begin{cases} X_i^{t+1}, & \text{if } f(P_{best_{bs}}^{t+1}) < f(P_{best_i}^{t+1}) \\ G_{best}^t, & \text{otherwise} \end{cases} \quad \dots \text{ (Eq. III.31)}$$

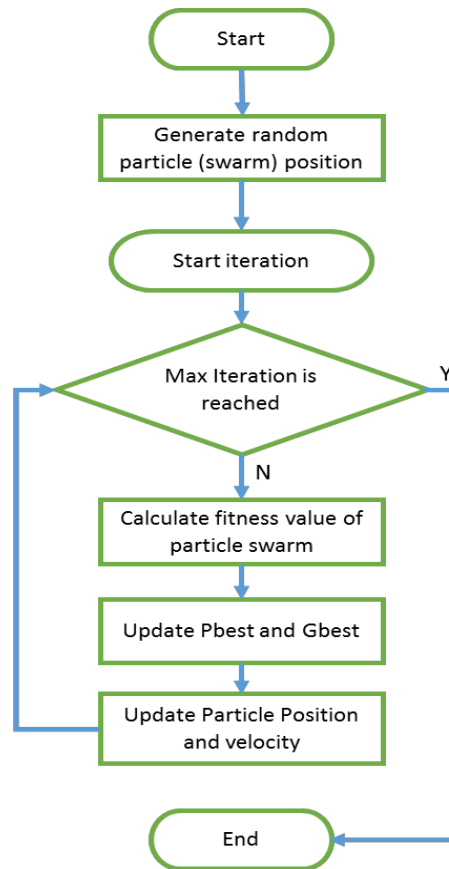

Fig. III.14. Flowchart of Particle Swarm Optimization

Firstly, PSO algorithm will compute the particle to look for the  $P_{best}$ . Secondly, the  $P_{best}$  become reference for next equation. When the updated particle value is lower than  $P_{best}$ , it will be subsequently updated. Similarly, the Global best also will be updated when the new value is lower than previous  $G_{best}$  as expressed in eq. III.31. The rule of PSO algorithm is described in flowchart given in fig. III.14

Using the PSO, we apply the optimization for Home Energy Management System (HEMS) in a household where the objective function is to reduce the cost.

Objective Function:

$$\min_x Cost$$

With

$$Cost = \sum_{t=1}^N P_{grid}(t) \times Price(t) \quad \dots \text{(Eq. III.32)}$$

With constraint

$$\begin{aligned} P_{pv}(t) &\geq 0 \\ P_{grid}(t) &= P_{pv}(t) + P_{loadshifting}(t) \\ P_{loadshifting}(t) &= f(t_{activation}, LoadProfile) \\ s_{app} &= \begin{cases} 1, & t_{min} \leq t_{activation} \leq t_{max} \\ 0, & otherwise \end{cases} \end{aligned}$$

$N$  represent total time step  $t$ , where the optimization time is in full day.  $P_{grid}$  indicates electricity that is consumed in the household because of a lack of PV generation. In addition, Price indicate the electricity price sold by the supplier in €/kWh.  $s_{app}$  denote activation of flexible appliances in the day ahead where  $t_{min}$  and  $t_{max}$  represent starting time and the last time for allowable of flexible appliances operation. The  $t_{activation}$  denotes the activation time of flexible appliances and the consumption depend on this activation time and load profile of this appliances.

Moreover, the equation from optimization not only shows the cost reduction but also schedule of controllable appliances operated by prosumer and consumer. Through the optimization, prosumer could also expect their incentive from energy injection to the consumer and the grid. The detailed equation can be found in the paper[54]

### 3.8.2.2 Case Study using PSO

In this simulation, several scenarios are proposed for reaching the objective. First scenario, the bilateral contract is investigated when prosumer and consumer do not install storage system in their house. In addition, the second, bilateral contract is performed when the prosumer installs a storage system. The participant of bilateral contract is similar with the previous as shown in table III.9.(b). Pool of bilateral contract also alike with previous simulation. However, all prosumers in this simulation use 8 kWp PV capacity. The tariff of PV production, wholesale electricity price from operator and distribution cost are given in table III.9, where the grid electricity price is taken from EDF electricity tariff for basic option (fix tariff) for 2019. Whereas, the tariff of PV production and distribution cost is an assumption. Capital cost of PV and battery, Operation and maintenance cost, taxation fee is negligible.

Parameter	Nominal	Unit
Photovoltaic	8	kWp
Tariff PV Production	10	c€/kWh
Fix Tariff (Based Option)	15.56	c€/kWh
Distribution cost	3	c€/kWh

Table III.9 Data parameter that used in the simulation

Load consumption in each household is taken from load profile generator software where controllable appliances have been removed. Hence, it is mentioned as the based load. Washing machine and dishwasher are load-shifting components. The simulation is run for a full year and the time step is one minute.

### 3.8.2.3 Performance Criteria

The simulation works with parameters of table III.9, and PV generation is determined by the PV data from CEA. In this strategy, the priority is the energy demand of the PV owner. The optimization is performed for the prosumer to reduce the cost of energy bought to the supplier (equation III.11). Through the equation, the prosumer makes the scheduling of controllable appliances and deal with user comfort. In the simulation, the user considers their washing machine and dishwasher can be operated between 07:00 am and 06:00 pm.

Lower Bound (LB)	Upper Bound (UB)	Iteration	Swarm
0	1439	100	25

Additionally, excess energy produced by the Prosumer will be shared to the consumer as additional electricity source beside grid electricity. Equation III.11 is also applied with the scheduling of washing machine and dishwasher. Figure III.15 illustrates the scheduling of controllable appliances both prosumer HH1 and consumer HH3 in the pool 1 (figure III.12) at early day of the year. In addition, the sharing energy between them. The result of this optimization also prepared in the appendix A.

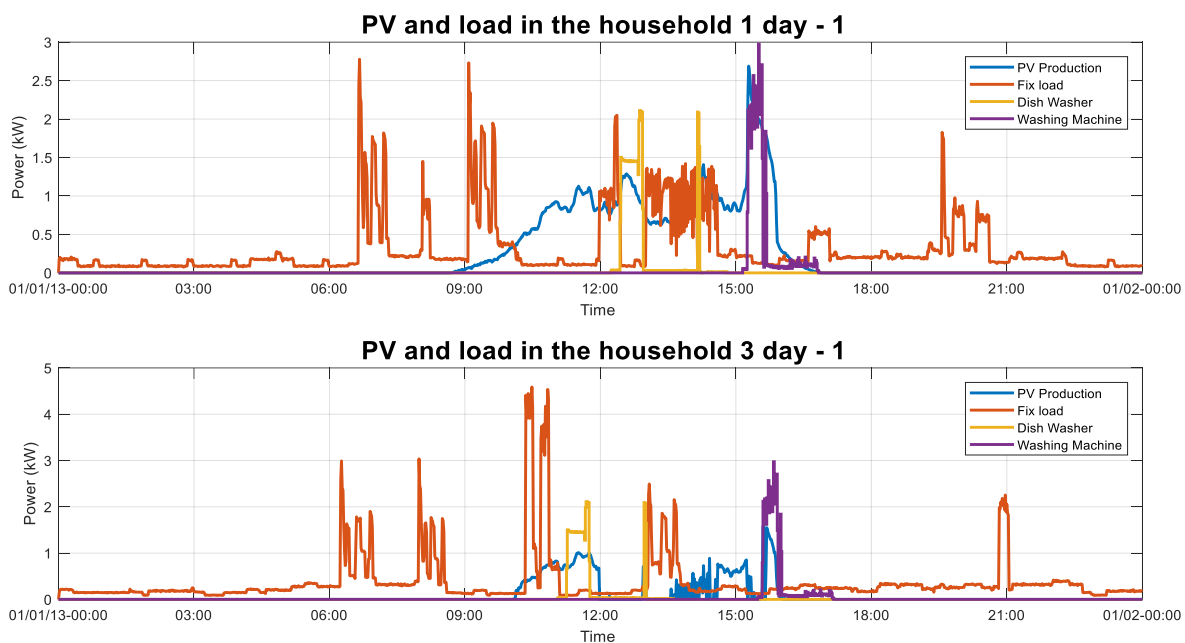

Fig. III.15 Profile of Energy in the Pool 1 between Prosumer HH1 and Consumer HH3

### 3.9 Conclusion

Load consumption profile in the household can be predicted through several methods such as short, medium, and long-term load forecast. Meanwhile, modeling of load profile can be perform through top-down and bottom-up approach which they have benefit and lack for the user, depending on the their usage. *Load profile generator* as load modeling software has been chosen for providing the data load consumption and hot water consumption.

Furthermore, the PV power generator data through solar irradiance and weather could be forecasted in accordance with the horizon and historical data. Forecasting techniques such as

statistical, physical and ensemble model is prepared to accurately forecast the PV generation. Forecasting using statistical model rely on several modeling such as ANN, Markov Chain, autoregressive and regression and evaluated by evaluation matrices such as MAE, MRE, and so on. Data forecasting from physical modeling also give contribution for weather data forecasting where using environmental phenomena such as atmosphere, sky view and cloud properties and movement. Data meteorological from CEA and PVGIS remain utilized for modeling and simulation. Data taken from PVGIS is recomputed with EnergyPlus for producing the data in particular thermal building parameter.

Storage system coupled with the PV system enables to distribute the electricity in case of a lack of solar irradiation. Several types of battery support the system in appropriate the sector. The battery can support the electricity if its energy is upper than a minimum capacity ( $SOC_{min}$ ). The business model of the battery can be assessed from the capital cost, operational and maintenance cost, and annuity investment.

Domestic electric water heater also contributes in the home energy management system. Electricity consumed by the EWH has a large influence in the electricity bill of the household. In result the EWH should be modeled. It has several parameters for heat up process in the water storage tank. In its usage, EWH should meet the user comfort where minimum and maximum temperature is determined. Validation in Electricity Water Heater model in one dimensional heat conduction bring the better model in the energy coordination modeling. Dymola become reference for the validation and furthermore the result of validation come near to the result of Dymola.

Thermal building is also introduced because their power consumption in the household. They consume electricity for heating or cooling process. Several thermal models are introduced to know the benefit and drawback of each. Financial scheme also counted in the simulation for investigating the cost that emerged in the household or community.

A use case with coordination is presented in purpose to minimize the electricity cost, not only for the prosumer but also for the consumer. With quite simple load shifting technique, scheduling controllable appliance could be performed. This method is applied in the two platforms such as SPIDER and PSO where the goal of the simulation is similar such as cost reduction.



## References

- [1] L. Wen, K. Zhou, and S. Yang, "Load demand forecasting of residential buildings using a deep learning model," *Electric Power Systems Research*, vol. 179, p. 106073, Feb. 2020, doi: 10.1016/j.epsr.2019.106073.
- [2] S. R. Khuntia, J. L. Rueda, and M. A. M. M. van der Meijden, "Forecasting the load of electrical power systems in mid- and long-term horizons: a review," *IET Generation, Transmission & Distribution*, vol. 10, no. 16, pp. 3971–3977, Dec. 2016, doi: 10.1049/iet-gtd.2016.0340.
- [3] T. Ahmad *et al.*, "Supervised based machine learning models for short, medium and long-term energy prediction in distinct building environment," *Energy*, vol. 158, pp. 17–32, Sep. 2018, doi: 10.1016/j.energy.2018.05.169.
- [4] E. A. Feilat and M. Bouzguenda, "Medium-term load forecasting using neural network approach," in *2011 IEEE PES Conference on Innovative Smart Grid Technologies - Middle East*, Jeddah, Saudi Arabia, Dec. 2011, pp. 1–5, doi: 10.1109/ISGT-MidEast.2011.6220810.
- [5] A. S. Khwaja, M. Naeem, A. Anpalagan, A. Venetsanopoulos, and B. Venkatesh, "Improved short-term load forecasting using bagged neural networks," *Electric Power Systems Research*, vol. 125, pp. 109–115, Aug. 2015, doi: 10.1016/j.epsr.2015.03.027.
- [6] O. E. Dragomir, F. Dragomir, R. Gouriveau, and E. Minca, "Medium term load forecasting using ANFIS predictor," in *18th Mediterranean Conference on Control and Automation, MED'10*, Marrakech, Morocco, Jun. 2010, pp. 551–556, doi: 10.1109/MED.2010.5547727.
- [7] L. G. Swan and V. I. Ugursal, "Modeling of end-use energy consumption in the residential sector: A review of modeling techniques," *Renewable and Sustainable Energy Reviews*, vol. 13, no. 8, pp. 1819–1835, Oct. 2009, doi: 10.1016/j.rser.2008.09.033.
- [8] A. Grandjean, J. Adnot, and G. Binet, "A review and an analysis of the residential electric load curve models," *Renewable and Sustainable Energy Reviews*, vol. 16, no. 9, pp. 6539–6565, Dec. 2012, doi: 10.1016/j.rser.2012.08.013.
- [9] M. Muratori, M. C. Roberts, R. Sioshansi, V. Marano, and G. Rizzoni, "A highly resolved modeling technique to simulate residential power demand," *Applied Energy*, vol. 107, pp. 465–473, Jul. 2013, doi: 10.1016/j.apenergy.2013.02.057.
- [10] N. Pflugradt and B. Platzer, "Behavior based load profile generator for domestic hot water and electricity use," presented at the Innostock 12th International Conference on Energy Storage, Lleida(Spain), 2012.
- [11] U. K. Das *et al.*, "Forecasting of photovoltaic power generation and model optimization: A review," *Renewable and Sustainable Energy Reviews*, vol. 81, pp. 912–928, Jan. 2018, doi: 10.1016/j.rser.2017.08.017.
- [12] A. Woyte, V. V. Thong, R. Belmans, and J. Nijs, "Voltage Fluctuations on Distribution Level Introduced by Photovoltaic Systems," *IEEE Trans. On Energy Conversion*, vol. 21, no. 1, pp. 202–209, Mar. 2006, doi: 10.1109/TEC.2005.845454.
- [13] S. Sobri, S. Koohi-Kamali, and N. Abd. Rahim, "Solar photovoltaic generation forecasting methods: A review," *Energy Conversion and Management*, vol. 156, pp. 459–497, Jan. 2018, doi: 10.1016/j.enconman.2017.11.019.
- [14] C. Yang, A. A. Thatte, and L. Xie, "Multitime-Scale Data-Driven Spatio-Temporal Forecast of Photovoltaic Generation," *IEEE Trans. Sustain. Energy*, vol. 6, no. 1, pp. 104–112, Jan. 2015, doi: 10.1109/TSTE.2014.2359974.
- [15] D. W. van der Meer, J. Widén, and J. Munkhammar, "Review on probabilistic forecasting of photovoltaic power production and electricity consumption," *Renewable and Sustainable Energy Reviews*, vol. 81, pp. 1484–1512, Jan. 2018, doi: 10.1016/j.rser.2017.05.212.

- [16] C. Cornaro, M. Pierro, and F. Bucci, "Master optimization process based on neural networks ensemble for 24-h solar irradiance forecast," *Solar Energy*, vol. 111, pp. 297–312, Jan. 2015, doi: 10.1016/j.solener.2014.10.036.
- [17] C. Monteiro, T. Santos, L. Fernandez-Jimenez, I. Ramirez-Rosado, and M. Terreros-Olarte, "Short-Term Power Forecasting Model for Photovoltaic Plants Based on Historical Similarity," *Energies*, vol. 6, no. 5, pp. 2624–2643, May 2013, doi: 10.3390/en6052624.
- [18] A. Tuohy *et al.*, "Solar Forecasting: Methods, Challenges, and Performance," *IEEE Power and Energy Mag.*, vol. 13, no. 6, pp. 50–59, Nov. 2015, doi: 10.1109/MPE.2015.2461351.
- [19] J. Antonanzas, N. Osorio, R. Escobar, R. Urraca, F. J. Martinez-de-Pison, and F. Antonanzas-Torres, "Review of photovoltaic power forecasting," *Solar Energy*, vol. 136, pp. 78–111, Oct. 2016, doi: 10.1016/j.solener.2016.06.069.
- [20] Y. Ren, P. N. Suganthan, and N. Srikanth, "Ensemble methods for wind and solar power forecasting—A state-of-the-art review," *Renewable and Sustainable Energy Reviews*, vol. 50, pp. 82–91, Oct. 2015, doi: 10.1016/j.rser.2015.04.081.
- [21] P. Ralon, M. Taylor, A. Ilias, H. Dias-Bone, and K.-P. Kairies, "Electricity storage and renewables: Costs and markets to 2030." IRENA, 2017, [Online]. Available: <http://www.irena.org/>.
- [22] M. Sterner and I. Stadler, Eds., *Handbook of Energy Storage: Demand, Technologies, Integration*. Berlin, Heidelberg: Springer Berlin Heidelberg, 2019.
- [23] M. H. Nehrir, B. J. LaMeres, and V. Gerez, "A customer-interactive electric water heater demand-side management strategy using fuzzy logic," 1999, pp. 433–436 vol.1, doi: 10.1109/PESW.1999.747494.
- [24] L. Paull, H. Li, and L. Chang, "A novel domestic electric water heater model for a multi-objective demand side management program," *Electric Power Systems Research*, vol. 80, no. 12, pp. 1446–1451, Dec. 2010, doi: 10.1016/j.epsr.2010.06.013.
- [25] Ruisheng Diao, Yu Zhang, and N. Samaan, "Electric water heater modeling and control strategies for demand response," Jul. 2012, pp. 1–8, doi: 10.1109/PESGM.2012.6345632.
- [26] V. Kapsalis, G. Safouri, and L. Hadellis, "Cost/comfort-oriented optimization algorithm for operation scheduling of electric water heaters under dynamic pricing," *Journal of Cleaner Production*, vol. 198, pp. 1053–1065, Oct. 2018, doi: 10.1016/j.jclepro.2018.07.024.
- [27] M. H. Nehrir, R. Jia, D. A. Pierre, and D. J. Hammerstrom, "Power Management of Aggregate Electric Water Heater Loads by Voltage Control," Jun. 2007, pp. 1–6, doi: 10.1109/PES.2007.386024.
- [28] C. Diduch, M. Shaad, R. Errouissi, M. E. Kaye, J. Meng, and L. Chang, "Aggregated domestic electric water heater control - building on smart grid infrastructure," Jun. 2012, pp. 128–135, doi: 10.1109/IPEMC.2012.6258873.
- [29] K. I. Elamari, "Using Electric Water Heaters (EWHs) for Power Balancing and Frequency Control in PV-Diesel Hybrid Mini-Grids," Concordia University, Quebec, Canada, 2011.
- [30] R. George, "Water heater types and selection considerations," Jun. 06, 2016. <https://www.phcppros.com/articles/2632-water-heater-types-and-selection-considerations>.
- [31] "What is Dymola?" Dassault Systemes, [Online]. Available: <https://www.3ds.com/products-services/catia/products/dymola/key-advantages/>.
- [32] M. Bahrami, "Steady Heat Conduction," Waterloo University.
- [33] S. Mergui, "Transferts Thermiques," UPMC Sorbonne Universites.
- [34] Z. Afroz, G. Shafiullah, T. Urmee, and G. Higgins, "Modeling techniques used in building HVAC control systems: A review," *Renewable and Sustainable Energy Reviews*, vol. 83, pp. 64–84, Mar. 2018, doi: 10.1016/j.rser.2017.10.044.
- [35] O. M. Brastein, D. W. U. Perera, C. Pfeifer, and N.-O. Skeie, "Parameter estimation for grey-box models of building thermal behaviour," *Energy and Buildings*, vol. 169, pp. 58–68, Jun. 2018, doi: 10.1016/j.enbuild.2018.03.057.

- [36] Y. Chen and S. Treado, "Development of a simulation platform based on dynamic models for HVAC control analysis," *Energy and Buildings*, vol. 68, pp. 376–386, Jan. 2014, doi: 10.1016/j.enbuild.2013.09.016.
- [37] A. Afram and F. Janabi-Sharifi, "Gray-box modeling and validation of residential HVAC system for control system design," *Applied Energy*, vol. 137, pp. 134–150, Jan. 2015, doi: 10.1016/j.apenergy.2014.10.026.
- [38] H. Harb, N. Boyanov, L. Hernandez, R. Streblov, and D. Müller, "Development and validation of grey-box models for forecasting the thermal response of occupied buildings," *Energy and Buildings*, vol. 117, pp. 199–207, Apr. 2016, doi: 10.1016/j.enbuild.2016.02.021.
- [39] S. Estrada-Flores, I. Merts, B. De Ketelaere, and J. Lammertyn, "Development and validation of 'grey-box' models for refrigeration applications: A review of key concepts," *International Journal of Refrigeration*, vol. 29, no. 6, pp. 931–946, Sep. 2006, doi: 10.1016/j.ijrefrig.2006.03.018.
- [40] D. L. Loveday and C. Craggs, "Stochastic modelling of temperatures for a full-scale occupied building zone subject to natural random influences," *Applied Energy*, vol. 45, no. 4, pp. 295–312, Jan. 1993, doi: 10.1016/0306-2619(93)90002-7.
- [41] N. Aoun, "Modeling and flexible predictive control of buildings space-heating demand in district heating systems," Université Paris Saclay, 2019.
- [42] A. Afram and F. Janabi-Sharifi, "Review of modeling methods for HVAC systems," *Applied Thermal Engineering*, vol. 67, no. 1–2, pp. 507–519, Jun. 2014, doi: 10.1016/j.applthermaleng.2014.03.055.
- [43] T. Berthou, P. Stabat, R. Salvazet, and D. Marchio, "Development and validation of a gray box model to predict thermal behavior of occupied office buildings," *Energy and Buildings*, vol. 74, pp. 91–100, May 2014, doi: 10.1016/j.enbuild.2014.01.038.
- [44] S. F. Fux, A. Ashouri, M. J. Benz, and L. Guzzella, "EKF based self-adaptive thermal model for a passive house," *Energy and Buildings*, vol. 68, pp. 811–817, Jan. 2014, doi: 10.1016/j.enbuild.2012.06.016.
- [45] E. Palomo Del Barrio, G. Lefebvre, P. Behar, and N. Bailly, "Using model size reduction techniques for thermal control applications in buildings," *Energy and Buildings*, vol. 33, no. 1, pp. 1–14, Nov. 2000, doi: 10.1016/S0378-7788(00)00060-8.
- [46] CRE, "A market open to competition," *Retail electricity market*, Oct. 09, 2018. <https://www.cre.fr/en/Electricity/retail-electricity-market>.
- [47] EDF, "Qu'est-ce que l'option Tempo ?," *Comprendre mon option*, 2020. <https://particulier.edf.fr/fr/accueil/contrat-et-conso/options/tempo/details.html>.
- [48] Fournisseurs electricite.com by Selectra, "EDF in France: Offers, Tariffs and Contact in 2020," 2020. <https://www.fournisseurs-electricite.com/en/edf>.
- [49] H. Vidalic, "Feed-in tariff (Tarif d'achat)," *Legal Sources on Renewable Energy*, Jul. 02, 2019. <http://www.res-legal.eu/search-by-country/france/single/s/res-e/t/promotion/aid/feed-in-tariff-tarif-dachat/lastp/131/>.
- [50] "fixant les conditions d'achat de l'électricité produite par les installations implantées sur bâtiment utilisant l'énergie solaire photovoltaïque, d'une puissance crête installée inférieure ou égale à 100 kilowatts telles que visées au 3 o de l'article D. 314-15 du code de l'énergie et situées en métropole continentale." MINISTÈRE DE L'ENVIRONNEMENT, DE L'ÉNERGIE ET DE LA MER, EN CHARGE DES RELATIONS INTERNATIONALES SUR LE CLIMAT, May 10, 2017.
- [51] R. Verschae, T. Kato, H. Kawashima, and T. Matsuyama, "A cooperative distributed protocol for coordinated energy management in prosumer communities," IEICE-Kyoto University.
- [52] R. Verschae, T. Kato, and T. Matsuyama, "Energy Management in Prosumer Communities: A Coordinated Approach," *Energies*, vol. 9, no. 7, p. 562, Jul. 2016, doi: 10.3390/en9070562.

- [53] J. Kennedy and R. Eberhart, "Particle swarm optimization," in *Proceedings of ICNN'95 - International Conference on Neural Networks*, Perth, WA, Australia, 1995, vol. 4, pp. 1942–1948, doi: 10.1109/ICNN.1995.488968.
- [54] M. A. Albachrony, D. L. Ha, Q. T. Tran, A. Brun, and M. Petit, "Coordinated Prosumer Transaction based on Load Shifting and Optimization," in *2019 IEEE PES Innovative Smart Grid Technologies Europe (ISGT-Europe)*, Bucharest, Romania, Sep. 2019, pp. 1–5, doi: 10.1109/ISGTEurope.2019.8905709.

# Chapter 4 Development of Model Predictive Control in Household Communities

## 4.1 Introduction

The increment of electricity demand is a challenge for the electrical system, mainly the demand in the residential sector. To enable a large integration of distributed generation (in particular photovoltaic system), households should improve their demand profile to better cope with the local generation. Battery storage or energy management are candidate solutions. Furthermore, energy management system concept was caught by academics and industries through the researches and development[1]: strategies were developed for handling this challenge by way of optimal scheduling where they harness optimization via model prediction controller (MPC).

Symbol	Description	Unit	Range
$t$	Time slot index		
$b$	Fixed appliance index		
$B$	Total number of fixed appliances	-	$[0, \infty)$
$i$	Flexible appliance index		
$I$	Total number of flexible appliance	-	$[0, \infty)$
$P_{tot}^{load}$	Total power consumption	kW	$(-\infty, 0)$
$p^{unflx}$	Based Load ( fix Load) consumption	kW	$(-\infty, 0)$
$p^{flx}$	Controllable appliances power consumption	kW	$(-\infty, 0]$
$p^{PV}$	PV electricity power	kW	$[0, \infty)$
$N^s$	PV panel series index	-	$[0, \infty)$
$N^p$	PV panel parallel index	-	$[0, \infty)$
$P^{PV0}$	power output of PV module in the Standard test condition (STC)	kW	$[0, \infty)$
$G(t)$	Measured irradiance in the surface of PV module in time slot- $t$	W/m <sup>2</sup>	$[0, \infty)$
$G_{STC}$	Irradiance value in the Standard Test Condition (STC)	W/m <sup>2</sup>	$[0, \infty)$
$P_{id}^{PV}$	PV power without disturbance	kW	$[0, \infty)$
$P_{loss}^{PV}$	PV loss power	kW	$[0, \infty)$
$DF$	Derating factor of PV Panel	%	$[0,100]$
$P_{bat}^{Dch}$	Battery discharge power	kW	$[0, \infty)$
$P_{bat}^{Ch}$	Battery charge power	kW	$[0, \infty)$
$SOC_{bat}$	Battery state of charge	-	
$\eta_{bat}^{Dch}$	Battery discharge efficiency	%	$[0,100]$
$\eta_{bat}^{Ch}$	Battery charge efficiency	%	$[0,100]$
$P_{grid}(t)$	Grid Power in time slot- $t$	kW	$[0, \infty)$

$T^{ini}(t)$	Initial Temperature in time slot- $t$	°C	$(-\infty, \infty)$
$T^{heat}(t)$	Heating Temperature in time slot- $t$	°C	$(-\infty, \infty)$
$T^{amb}(t)$	Ambient Temperature in time slot- $t$	°C	$(-\infty, \infty)$
$T^{water}(t)$	Water tank temperature after water draw in time slot- $t$	°C	$(-\infty, \infty)$
$T^{inlet}(t)$	External water temperature in time slot- $t$	°C	$(-\infty, \infty)$
$m^{inlet}(t)$	Water consumption mass in time slot- $t$	kg	$m^{inlet}(t)$
$U$	Specific heat loss	W/m <sup>2</sup> .K	$[0, \infty)$
$A$	Surface of water storage tank	m <sup>2</sup>	$[0, \infty)$
$M$	Water storage mass	kg	$[0, \infty)$
$C$	Heat Capacity of fluid (water)	J/K	$[0, \infty)$
$Q$	EWH Power rate	kW	$[0, \infty)$
$R_2$	Outer radius of EWH tank	m	$[0, \infty)$
$R_1$	Inner radius of EWH tank	m	$[0, \infty)$
$k$	Heat conductivity of fluid (water)	kW/(m.K)	$[0, \infty)$
$L$	Length of EWH tank	m	$[0, \infty)$
$V$	Volume of water storage	m <sup>3</sup>	$[0, \infty)$
$V^{inlet}$	Volume of water consumption in EWH storage	m <sup>3</sup>	$[0, \infty)$
$s(t)$	EWH activation in time slot- $t$	-	$\{0,1\}$
$T_{sky}$	Sky temperature	°C	$(-\infty, \infty)$
$T_{int}(t)$	Internal temperature in time slot- $t$	°C	$(-\infty, \infty)$
$T_{ext}(t)$	External Temperature in time slot- $t$	°C	$(-\infty, \infty)$
$T_{si}(t)$	Temperature on the surface internal of the wall in time slot- $t$	°C	$(-\infty, \infty)$
$T_{se}(t)$	Temperature on the surface external of the wall in time slot- $t$	°C	$(-\infty, \infty)$
$T_{wall}$	Wall temperature	°C	$(-\infty, \infty)$
$C_{int}$	Internal capacitance	J/K	$[0, \infty)$
$C_w$	Wall Capacitance	J/K	$[0, \infty)$
$R_{int}$	Internal Resistance	K/W	$[0, \infty)$
$R_{si}$	Internal convective resistance between internal air and internal surface the wall	K/W	$[0, \infty)$
$R_w$	Wall Resistance	K/W	$[0, \infty)$
$R_{se}$	external convective resistance between external air and external surface the wall	K/W	$[0, \infty)$
$R_{sky}$	Resistance between the external wall and environment	K/W	$[0, \infty)$
$R_{fi}$	Interior or glazing resistance	K/W	$[0, \infty)$
$\Phi_{int}$	Solar flux that fall in the internal building through glazing	-	
$\Phi_{si}$	Solar flux in the surface of the building	-	
$\Phi_w$	Solar flux that injected to the wall	-	
$\Phi_{se}$	Absorbed radiation in the wall	-	
$U_w$	Thermal transmission coefficient of wall	W/m <sup>2</sup> .K	$[0, \infty)$
$S_w$	Wall surface between the area (zone) and external environment	m <sup>2</sup>	$[0, \infty)$

$\beta$	Distribution coefficient of wall resistance	-	
$hc_{int}$	Internal convective exchange coefficient	W/m <sup>2</sup> .K	[0, ∞)
$hc_{ext}$	External convective exchange coefficient	W/m <sup>2</sup> .K	[0, ∞)
$H_{net}$	External thermal radiation heat transfer coefficient	W/m <sup>2</sup> .K	[0, ∞)
$Cost$	Electricity cost	€	[0, ∞)
$\gamma^{grid}(t)$	Electricity price in time slot- $t$	€	[0, ∞)
$\gamma^{PV}(t)$	PV production price in time slot- $t$	€	[0, ∞)
$P(i, t)$	power consumption of appliance- $i$ in the time slot $t$ ;	kW	[0, ∞)
$PA$	peak power in flexible appliance	kW	(-∞, 0]
$x(i, j, t)$	binary variable in phase- $j$ , appliance- $i$ and timeslot- $t$	-	{0,1}
$TP$	processing time of all appliance classes and power phase	-	
$y(i, j, t)$	binary variable in phase- $j$ , appliance- $i$ and timeslot- $t$	-	{0,1}
$UP$	occupancy of appliance in the matrix form	-	[0, ∞)
$J$	Total number of operation phase	-	[0, ∞)
$N$	Total number of time	-	[0, ∞)
$p^{pro}$	Power consumption in prosumer	kW	(-∞, ∞)
$p^{pcon}$	Power consumption in consumer	kW	(-∞, ∞)

In this chapter, we will discuss about MPC for energy management, algorithm and model for implementing the strategies. The nomenclature of equations are introduced in the table in above. Section 4.2 will discuss the Model predictive controller for EMS. A literature review of MPC is done, and several modelling for the component and objective of MPC. Section 4.3 will discuss the evolution of energy management of energy management method, and the section 4.4 will conclude the chapter. The contextualization of this architecture in a house combined with improvement of energy management algorithm is the main contribution of this chapter.

## 4.2 Model Predictive Control for EMS

### 4.2.1 Literature review

Since 1960s, Model Predictive Control has been theoretically investigated and practically applied in Chemical Engineering. More recently, it has known interest in building engineering domain, more specifically for building supervisory control. Nevertheless, it did not prove steady growing project until the last decade.

In definition, Model Prediction Controller (MPC) is a method of designing and implementing feedback control system that, in many times perform better than those built by other methods[2].

Moreover, MPC bestow efficient facility to design the large control system and it could set the multiple input and output practically. MPC refers to a class of computational control algorithm that implement an explicit model to predict the behavior of the future output[3]. It has advantages in handling of constraint capabilities, which it implement the problem constraint with various types mathematic programming models such as linear and non-linear programming. MPC have key concept[4]:

1. Forecast

MPC reckon the forecast (prediction) of signal, subsequently it takes action on the system over future horizon. The length of forecast horizon depend on the system dynamic.

2. Receding Horizon

The controller makes decision continuously with the updated predictions. The prediction is related to the current point in time and of constant length. Subsequently, as time flows, the horizon moves back. The duration or period where a resolve is taken and the horizon shifted is called the sampling time.

3. Model

MPC reckon automated estimation of the system beside the prediction horizon. Mathematical model represents the tool for solving the automation. Controller give the better models for achieving the good decision.

4. Feedback

When the controller measures the problem in the system, the feedback is given to the system, at the time used for updating model estimations.

5. Multivariable Handling

In MPC, multi input and output is handled by the controller and automatically consider the interaction among all inputs and output through mathematical model.

6. Constraint handling

Each model have limitation or constraint. MPC have the advantage to create the decision strictly in accordance with the constraint. Subsequently, the result that reached still in the range of constraint.

7. Performance criteria

In the MPC operation, performance criteria should be defined. For instance, numerical indicator what best means. Accordingly, the controller may calculate and compare the



performance criterion and thus identify the best one. Flexibility could be presented to the control through a performance criterion.

As a background, MPC calculates the equation at each sampling time where the calculation is based on prediction of the dynamic evolution of the process  $[y(t + 1|t), \dots, \text{and } y(t + N|t)]$  in each time step  $t$  through prediction horizon  $N$ . Future control action is performed to acquire the objective function such as minimizing the cost and keep the output as close as possible with the reference trajectory. The illustration could be seen in the fig IV.1.

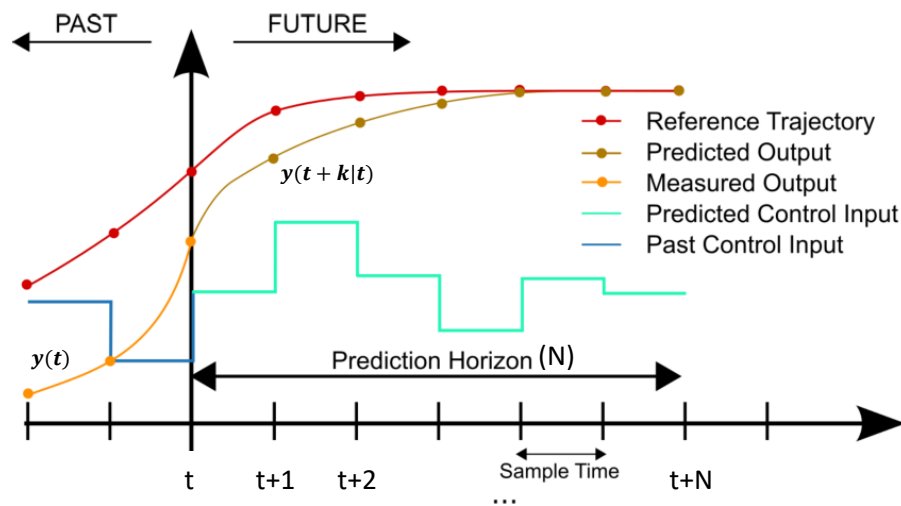

Fig. IV.1 The strategy of Model Prediction Control

### 4.2.2 Optimal Control

MPC works a controller for making decision along a finite horizon based on the prediction. It reckon the mathematical model and constraints and further to help to find the best solution according to performance criterion. It is called optimal controller. Optimal controller is configured by drawing up an optimization problem and choosing an appropriate algorithm for solving the problem.

*Minimize*

$$OF^{MPC} = \sum_{i=1}^{N^{MPC}} l(x[n], u[n])$$

... (Eq.IV.1a)

subject to :

$$x[n] = f(x[n - 1], u[n] \quad \dots \text{ (Eq. IV.1b)}$$

$$g(x[n]) \leq G \quad \dots \text{ (Eq. IV.1c)}$$

$$h(x[n]) \geq H \quad \dots \text{ (Eq. IV.1d)}$$

Eq. IV.1 represent the general discrete form of constrained optimization over a prediction horizon where  $N^{MPC}$  indicate the number of samples that considered for the optimization between prediction horizon ( $h^{MPC}$ ) and sampling time ( $\Delta t^{MPC}$ ). X denote the model state vector and u is the model input vector of controllable input (constant) and predicted uncontrollable disturbance[4]. In the objective function (equation IV.1a),  $l$  is a function that is related to performance criterion. Eq. IV.1b illustrates the function  $f$  that is a vector of equality constraint. Meanwhile,  $g$  and  $h$  in eq.IV.1c and eq.IV.1d respectively are vector of inequality constraint on the system state and controllable input. Finally,  $G$  and  $H$  are the limitation (bounding) of parameters.

The Optimization for this optimal control could use Linear Programming (LP), Non Linear Programming (NLP) and Mixed Integer Linear Programming (MILP).

### 4.2.3 Mixed integer programming formulation for MPC

Energy management system in the house could use the MPC for modeling HEMS controller that is following as HEMS agent [5] to reach objective such as cost reduction. Figure IV.2 figure the architecture of HEMS where several modules and system communications participate to create the system. MPC then transform the components in there to the mathematic model. Subsequently, the goals of the household in energy management could be reached. In this MPC, Mixed Integer Linear Programming (MILP) for optimization is applied. It have several decisions variables contained to activate the controlled appliances and the electric water heater. When the MPC is integrated with building thermal model, the activation of the system become a decision variable to reach the user comfort in the building.

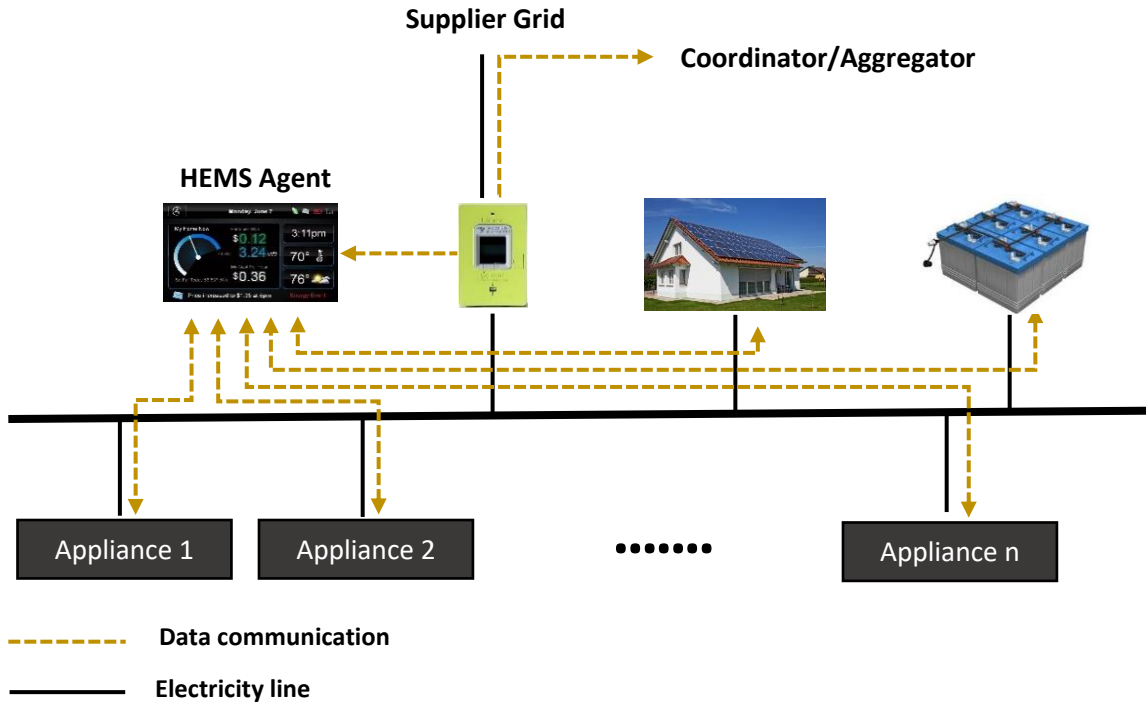

Fig IV.2. HEMS implementation in the house

#### 4.2.3.1 Load Consumption Model

Appliances have characteristic while they have potential for modification of power profile by adjusting power draw, operation duration and activation time [6]. Instead, some appliances cannot be modified on their activation time and duration because of behavior and satisfaction factor. This reason brings the load to be categorized into two types such as flexible load and non-flexible load. It can be seen in the table IV.1. Furthermore, flexible loads are also classified in two categories such as shift-able appliances and storage energy appliances. Total load profile for all households is given by the following eq. IV.2, as the aggregation among non-shift-able loads (based load) and shift-able loads.

$$P_{tot}^{load}(t) = \sum_{b=1}^B P_i^{unflx}(t) + \sum_{i=1}^I P_i^{flx}(t), \quad \forall t \in T$$

... (eq. IV.2)

Where,  $P_{tot}^{load}$  indicate the total of power consumption in the house,  $P^{unflx}$  represent power consumption of non-shift-able appliances with B is their index.  $P^{flx}$  represent power consumption of flexible or shift-able appliance with I is their index.

Load model can be completed with Load Shedding strategy where load curtailment can help to ensure the system security in case of unbalance between generation and demand. Cost of load shedding could be included in the objective function

**4.2.3.1.1 Based Load**

The based load works regardless possible constraint. Indeed, as soon as the user makes a request, the loads are activated systematically and complete their operating time without interruption, In other word, the load is not flexible as shown in table IV.1. It could be a light, a television, a refrigerator, a microwave, all equipment required to ensure the daily life convenience. The HEMS cannot control their operation, and it can be defined as

$$P^{bl} \triangleq [P_1^{bl}, \dots, P_T^{bl}] \quad \dots \text{ (eq. IV.3)}$$

Where  $P^{bl}$  represents the fixed power consumption of appliances,  $T$  is the length of time interval (e.g 24 hours).

Type Load	Flexibilities	Appliance
Flexible	Shiftable	Washing Machine, Dish Washer,
	Energy Storage	Water heater, HVAC, Electrical Car
Non-Flexible	Fixed-load	Lamp, Refrigerator, Television, microwave

Table IV.1. Load categories depend on flexibility

**4.2.3.1.2 Flexible Load**

Some appliances in the household could be interrupted and controlled by the system. Several companies already develop smart appliances, with the result that their operation is compatible with

HEMS. Flexible load could be divided to two categories such as deferrable load and load based on temperature and energy storage[7]. The deferrable appliances could be dishwasher, washing machine, dryer machine. Whereas, Electric water heater and HVAC is one of appliance that based on temperature. Demand energy management technique is applied in this section, in particular load shifting. The objective of shift-able appliances is to reduce the electricity cost based on the electricity price or availability of renewable resources.

Manual and optimization scheduling could apply the scheduling of the flexible load operation. In manual scheduling, household determine the time of operation of the appliances as follow table IV.2, in consequence, the satisfaction is full in the household hand. In figure IV.3 (a) and (b) are flexible appliance such as dishwasher and washing machine consumption profile that operated in the household.

Household	Time	
	Washing Machine	Dishwasher
Household 1	18:00	21:00
Household 2	11:00	20:00
Household 3	09:00	20:30
Household 4	18:30	20:00
Household 5	19:00	21:00

Table IV.2. Illustration of scheduling of flexible operation in the household

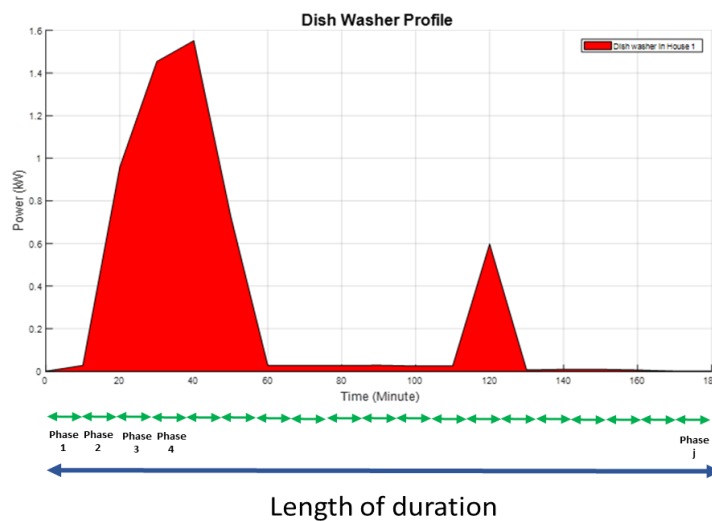

(a)

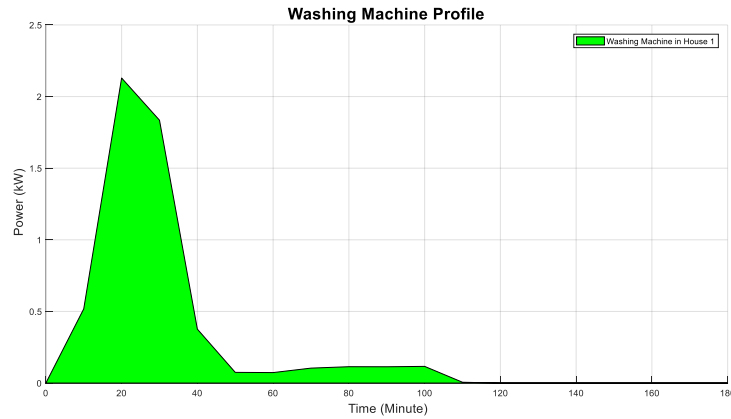

(b)

Figure IV.3. Flexible appliances, (a) dish washer (b) washing machine

The scheduling of flexible appliances use the DSM technique namely Load shifting. This technique is useful for shifting the load consumption from the peak hours to off-peak hours, which price is lower[8]. However, in the context of utilization of PV production as well as increase the self-consumption, it shift the load consumption from non-PV production area to the production PV area. This load shifting is only a rescheduling of the demand. It will not change the total energy consumption. Several load shifting studies by researcher in worldwide where they concern the appliance operation with scheduling concept for their objective such as minimizing the electricity cost and maximizing the self-consumption.

Zdenek Bradac et al in their paper[9] propose scheduling for domestic appliances using Mixed Integer Linear Programming (MILP) within Home Area Network (HAN). The present thesis also adopts their mathematical model for building the load-shifting model used in the MPC controller.

$$P(i, t) = \sum_{i=1}^I \sum_{j=1}^J PA(i, j) * x(i, j, t), \quad \forall i, t$$

... (eq. IV.4)

$$\sum_{t=1}^N x(i, j, t) = TP(i, j), \quad \forall i, j$$

... (eq. IV.5)

$$x(i, j, t - 1) - x(i, j, t) \leq y(i, j, t), \quad \forall i, j, t: t > 1$$

... (eq. IV.6)

$$x(i, j, t) \leq 1 - y(i, j, t), \quad \forall i, j, t$$

... (eq. IV.7)

$$x(i, j, t) \leq y(i, j - 1, t), \quad \forall i, j, t: j > 1$$

... (eq. IV.8)

$$y(i, j - 1, t) - x(i, j, t) - y(i, j, t) = 0, \quad \forall i, j, t: j > 1$$

... (eq. IV.9)

$$x(i, j, t) \leq UP_{i,t} \quad \forall i, j, t$$

... (eq. IV.10)

$$x(i, j, t) \in \{0, 1\}; y(i, j, t) \in \{0, 1\}, \quad \forall i, j, t$$

... (eq. IV.11)

Where  $P(i, t)$  indicates the power consumption of appliance- $i$  in the time slot  $t$ ;  $PA(i, j)$  represent power average of flexible appliance- $i$  in phase- $j$ .  $x(i, j, t)$  represent binary variable, where it will be in '1' when the phase- $j$  in the appliance- $i$  in the house is running in the time slot- $t$ . It means the controlled appliance starts the activity.  $TP$  indicates processing time of all appliance classes and power phase;  $y(i, j, t)$  denote binary variable where the condition '1' state as the phase- $j$  in the appliance- $i$  is already finished in the time slot- $t$ . It means the controlled appliance ends the activity.  $UP$  represent occupancy of appliance in the matrix form, which the user would like to operate it.  $J$  and  $I$  indices operation phase and appliance index.

Equation IV.4 explains the aggregation of all flexible appliances  $i$  in the all phase  $j$  at the time slot- $t$ . Load shifting algorithm ensures the processing time of each power phase will not exceed the amount specified by the parameter  $TP$  as shown eq. IV.5. Under equation IV.6, a power phase is uninterruptible since it starting. Meanwhile, the equation IV.7 is used as constraint of the model behavior where it could not jump into the running state anymore after the phase has been finished.

Sequential processing of all phase within one appliance is ruled in equation IV.8 and interphase delay mechanism provided in the eq. IV.9. In our model, interphase was not considered; consequently the result of summing is '0'. The next phase is begun when the previous one is needed. The appliances can be scheduled only during their time intervals describes in the matrix  $UP$  as shown in equation IV.10. Lastly, equation IV.11 states that all decision variables are binary ones.

### 4.2.3.2 Renewable Energy (PV) Model

Renewable energy sources have become an important component in the electricity system, it allows the production of electricity in a site, especially in remote area. Ideally, the photovoltaic supply electricity following technical specifications. Nevertheless, environmental and technical factors impact the PV output. Maximum irradiance could maximize the output PV power where it represents clear sky situation[10].

In PV model that developed by CEA, PV Power represent the measurement PV generation time series in certain time. It could be seen in the equation.

$$P^{PV}(t) = P_m^{PV}(t), \quad \forall t$$

... (eq. IV.12)

$$P^{PV}(t) \leq P_m^{PV}(t), \quad \forall t$$

... (eq. IV.13)

$$P^{PV}(t) \geq 0, \quad \forall t$$

... (eq. IV.14)

The PV model is created by two options such as option no derating factor (option-1) and considering the derating factor (option-2). Option-1 state that PV power ( $P^{PV}(t)$ ) is referred to time-series of the PV generator from the outside platform ( $P_m^{PV}(t)$ ) in time- $t$ . Meanwhile, in the option-2, PV ( $P^{PV}(t)$ ) value under derating factor where it is referred to equation IV.13. The value PV is always equal or greater than zero (equation IV.14).



### 4.2.3.3 Energy Storage Model

Battery is the HEMS component to help the households to improve their objective such as cost reduction and satisfaction. Battery also supports for improvement of self-consumption and handle uncontrolled RES power particularly rooftop PV system[13] where it stores the energy surplus. Then, the stored energy will be used later when the consumption level is higher or it is used when there is no PV production. The lifetime of battery becomes the concern since PV system is built because of its price.

In the study, battery component is used for storing the energy from Photovoltaic. It provides flexibility since up and down regulation is applied by discharging or charging storage unit which is denoted by  $P_{bat}^{Dch}$  and  $P_{bat}^{Ch}$  respectively. The constraints of the battery discharge power (negative value) and charge power (positive value) is given by eq. IV.15 and eq. IV.16. Meanwhile, the counting battery state of charge is taken according to previous state of charge (eq. IV.17). Whereas, the SOC also have operation range with minimum ( $SOC_{min}$ ) and maximum ( $SOC_{max}$ ) boundary as shown eq. IV.18.

$$-P_{bat_{max}}^{Dch} < P_{bat}^{Dch} \leq 0 \quad \dots \text{(eq. IV.15)}$$

$$0 \leq P_{bat}^{Ch} < P_{bat_{max}}^{Ch} \quad \dots \text{(eq. IV.16)}$$

$$\frac{SOC_{bat}(t-1) - SOC_{bat}(t)}{\Delta t} = \frac{1}{\eta_{bat}^{Dch}} * P_{bat}^{Dch}(t) + \eta_{bat}^{Ch} * P_{bat}^{Ch}(t) \quad \forall bat, t \quad \dots \text{(eq. IV.17)}$$

Where  $\eta_{bat}^{Dch}$  and  $\eta_{bat}^{Ch}$  are battery discharging and charging efficiency, respectively.  $P_{bat_{max}}^{Dch}$  and  $P_{bat_{max}}^{Ch}$  represent maximum discharging and charging power of battery as well; SOC represent State of Charge;  $\Delta t$  related to different of time or time step.

$$SOC_{min} \leq SOC \leq SOC_{max} \quad \dots \text{(eq. IV.18)}$$

#### 4.2.3.4 Grid Model

Photovoltaic system is intermittent; it means the power will increase dramatically when the light of sun emerged. Furthermore, the power value is changed to be zero when the PV panels do not obtain light of sun because it is covered by clouds. During partially cloudy conditions, the PV generation can have large variations in a time horizon. This condition is also occurred when the PV module got shading effect. In this condition, the households should have other alternatives in order to meet their electricity demand. One of alternative is to take power from the grid. Battery power also participates for taking the grid power as reflected in the eq. IV.19.

$$P_{grid}(t) = P^{load}(t) - P^{pv}(t) - P_{bat}^{Dch}(t) + P_{bat}^{Ch}(t), \quad \forall t$$

... (eq. IV.19)

Where,

$P_{grid}$	=	Grid electricity (kW)
$P^{load}$	=	Total power consumption (kW)
$P^{pv}$	=	PV power production (kW)
$P_{bat}^{dch}$	=	Battery discharging power (kW)
$P_{bat}^{ch}$	=	Battery charging power (kW)
$t$	=	Time slot index

#### 4.2.3.5 Electric Water Heater Model

To build the model, we need inputs for instance hot water consumption pattern and desirable temperature range of hot water. First, models have been developed for hot water consumption in order to forecast the individual hot water usage profile[14], which pattern is useful for demand side management. Forecasting strategies of hot water usage could be based on processing of history data of hot water demand. Second, data was recorded from flow meter at the output of the tank, or from electricity consumption of a EWH, while the average hourly consumption refers to the mean of the consumed hot water during the specific time interval[15]. Third strategy, hot water forecasting was obtained from hot water draw pattern[16], [17]. Fourth strategy, the forecast takes hot water flow manually from daily estimation. And the last strategy, where the forecast data is generated by software tools that develop hot water flow estimation and then state in time series[18].

Furthermore, the bound temperature is also considered as constraint in the scheduling of EWH. Household could deliver the flexibility in scheduling by extending the temperature range of EWH, while this strategy is able to decrease the cost. For example, the set point temperature could be adjusted according to electricity price [14].

Paterakis et al in the paper[19] state that EWH tank located in certain area will be affected by ambient temperature. According to Du and Lu paper[20], a EWH model (also adopted by Fotouhi Ghazvini et al[21]) is proposed for assessing EWH electricity demand. It takes into account several parameters including water temperature, power rate of EWH ( $P^{EWH}$ ), water volume in the tank ( $M$ ), water consumption ( $m_t$ ), time interval duration ( $\tau$ ), thermal resistance ( $R$ , in  $^{\circ}\text{C}/\text{kW}$ ) and thermal capacitance ( $C$ ,  $\text{kWh}/^{\circ}\text{C}$ ),

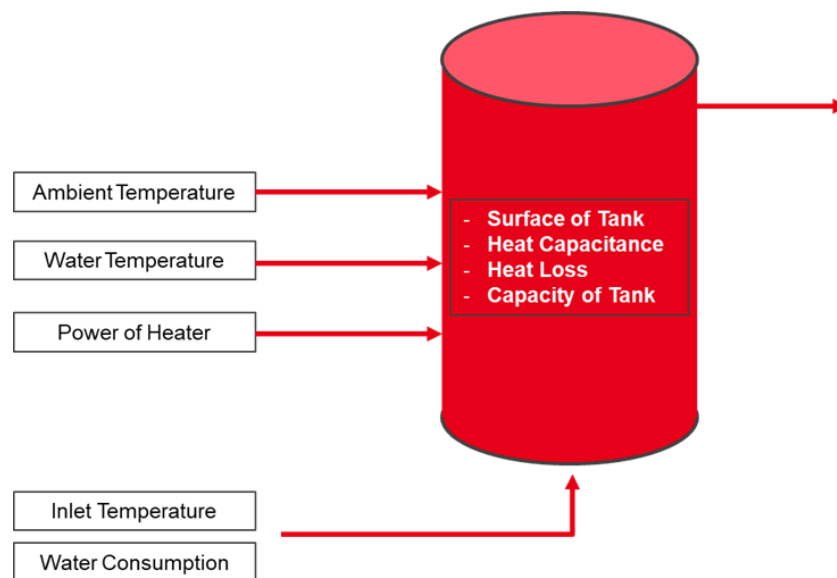

Fig. IV.5. Electric Water Heater component

However, paper[22] mention inlet water temperature also affect the water temperature within the EWH tank when it is replenish by the water from water provider or water pump. In general, to reach the water temperature around  $40^{\circ}\text{C}$ , it need water temperature between  $10^{\circ}\text{C}$  to  $20^{\circ}\text{C}$ . Nevertheless, the temperature is depend on the well. The setting of maximum water temperature in the water tank should be considered for security reason. Meanwhile, the amount of inlet temperature is varied depend on the season and the water sources. The parameters of electric water heater are taking into account, namely heat losses, size of the water tank, heat capacitance and

mass of water tank as shown in the fig.IV.5, and the equation for water temperature in first differential equation is prepared in eq. IV.20.

$$M.C. \frac{dT}{dt} = U.A.(T_{amb}(t) - T(t)) + Q$$

... (eq. IV.20)

Where,  $M$  indicate total mass of water in the water tank,  $C$  represent heat capacity of water,  $U$  and  $A$  represent standby heat loss coefficient and surface of the water heater respectively. Ambient temperature is indicated by  $T_{amb}$ , Water temperature is represented by  $T$  and  $Q$  represent power rate of the electric water heater.

Through discretization, eq. IV.20 transform from continuous model into discrete model over various time slot and it reflect in eq. IV.21. Every time slot- $t$ , three temperature is calculated namely initial temperature ( $T^{ini}$ ), heating water temperature ( $T^{heat}$ ) and water temperature in the end of time slot ( $T^{water}$ ) that is written in eq. IV.22. The decision variable of EWH model is the activation state ( $s(t)$ ) determine the function of the EWH. It enable the function when the water temperature lower than the minimum set-up temperature. Otherwise, the EWH is disable their function when water temperature reach the maximum temperature.

$$T^{heat}(t) = T^{ini}(t) + \frac{U * A * (T^{amb}(t) - T^{ini}(t)) + s(t) * Q}{M * C} * \Delta t$$

... (eq. IV.21)

$$T^{water}(t) = \frac{T^{heat}(t) * (M - m^{inlet}(t)) + T^{inlet}(t) * m^{inlet}(t)}{M}$$

... (eq. IV.22)

Where,  $m^{inlet}$  denote mass of hot water consumption of the household in the house or the mass of external water that enter to the water yank. Moreover,  $T^{inlet}$  is identified as inlet water temperature that coming from the well/water source.

Furthermore, we propose to use the new equation for second EWH model where it consider one dimensional heat conduction in the cylindrical EWH water storage. The equation is shown in Eq. IV.23. Inner and outer radius participate to produce the water temperature. In Chapter 3, we

propose the validation of EWH model where the result of this equation near with Dymola result. Consequently, we adopt this EWH model for model prediction control.

$$T^{water}(t) = \frac{\left( T^{water}(t-1) * \left( 1 - \frac{\frac{2 * \pi * L * k}{\log \frac{R_2}{R_1}} * \Delta t}{V * \rho * C} \right) + \left( \frac{\frac{2 * \pi * L * k}{\log \frac{R_2}{R_1}} * T_{amb}(t) + s(t) * Q}{V * \rho * C} \right) * \Delta t \right)}{V} * (V - V_{inlet}(t)) + T_{inlet} * V_{inlet}(t)$$

... (eq. IV.23)

Water storage temperature in time slot-t ( $T^{water}(t)$ ) is acquired by several component such as initial water temperature or water temperature in time slot t-1, inner radius ( $R_1$ ), outer radius ( $R_2$ ). The length of water tank ( $L$ ) and density of water ( $\rho$ ) also participate to produce the water temperature.

#### 4.2.3.6 Building Model

##### 4.2.3.6.1 Building thermal Model

For contribution in the thesis, building model uses six resistances and two capacitances (R6C2), It is taking into account thermal balance bring on the volume of air (int), at the surface of the internal walls (si), at the core of wall (w) as well as at the external of the walls (se).

Building model 6R2C proposed by Brun in his CEA technical report[23] and adopted in the paper[24] can be seen in figure IV.6. Several temperature take position in this configuration namely temperature  $T_{int}$  represent indoor temperature in the building,  $T_{ext}$  indicate temperature outside of the building.  $T_{si}$  indicate temperature on the surface internal of the wall,  $T_{se}$  represent temperature in the surface external of the wall.  $T_w$  indicate temperature inside of the wall, and  $T_{sky}$  represent sky temperature that influence the building which it obtained from external temperature that showed in eq.IV.24

$$T_{sky} = 0.0552 * T_{ext}^{1.5}$$

... (eq. IV.24)

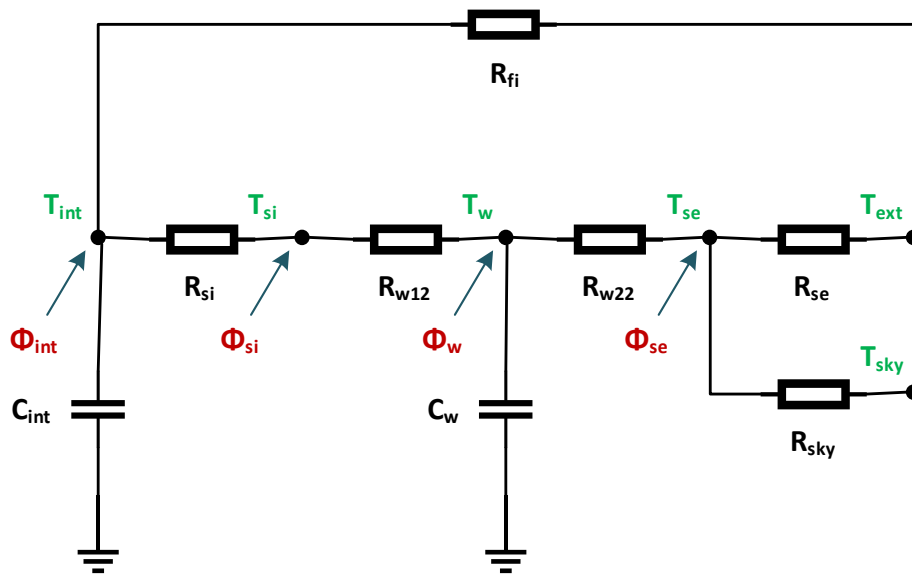

Fig. IV.6. Building model R6C2 configuration[24]

Furthermore, the 6R2C model bring their analogies of the circuit based on the assumption encompass,

1. The entire walls are categorized in the one wall with equivalent  $C_w$  and  $R_w$ .
2. The wall represented by the building model 2R1C which  $R_w$  is the total of conductive resistance of the wall such as  $R_{w12}$  and  $R_{w22}$ . Wall capacitance ( $C_w$ ). is also applied in here.
3. The interior and glazing equivalent resistance represented by  $R_{fi}$ , it possible to take into account heat transfers through the low inertia elements for instance, glazing window, door and ventilation.
4.  $R_{si}$  represents the internal convective resistance which located between internal air and internal wall surface. The value equivalent for all the partition/wall such as floor, ceiling and vertical wall.
5. Whereas,  $R_{se}$  is categorized by external convective resistance which located between external air and external wall surface.
6.  $R_{sky}$  represents infrared radiation between external wall and environment (long wavelength).

7. Solar flux that falls into the inner surface in the building is represented by  $\Phi_{si}$ , which encompasses the flux of sun that passes through the glazing, and then absorbed by surface, as well as the radiative component of the internal load and the HVAC.
8. Flux injected inside the wall, allowing modeling an active floor or wall component. It is integrated in the equation system. However, its value will be zero thereafter. It is represented by  $\Phi_w$
9. The absorbed radiation is applied in the external node of the equivalent wall which it is integrated by  $\Phi_{se}$
10.  $\Phi_{int}$  indicate the radiation of the sun that fall in the indoor through the glazing

The equations that govern the evolution of the temperatures  $T_{int}$ ,  $T_{si}$ ,  $T_{wall}$  and  $T_{se}$  are given by:

$$C_{int} \frac{dT_{int}}{dt} = \frac{T_{ext} - T_{int}}{R_{fi}} + \frac{T_{si} - T_{int}}{R_{si}} + \Phi_{int}$$

... (eq. IV.25)

$$0 = \frac{T_{int} - T_{si}}{R_{si}} + \frac{T_w - T_{si}}{R_{w12}} + \Phi_{si}$$

... (eq. IV.26)

$$C_w \frac{dT_w}{dt} = \frac{T_{se} - T_w}{R_{w22}} + \frac{T_{si} - T_w}{R_{w12}} + \Phi_w$$

... (eq. IV.27)

$$0 = \frac{T_w - T_{se}}{R_{w22}} + \frac{T_{ext} - T_{se}}{R_{se}} + \frac{T_{sky} - T_{se}}{R_{sky}} + \Phi_{se}$$

... (eq. IV.28)

Hereinafter, the equation in above spelled out in the system state form such as:

$$\frac{dX}{dt} = A * X + B * U$$

Where,

- t = Time
- X = Vector of state variables
- U = Solicitation vector
- A and B = Matrices of coefficient

Vector of state variable is filled by all temperature in the house except external temperature and sky temperature. Meanwhile, solicitation vector cover the flux in the house environment. Matrix A and B encompass the calculation all resistance and capacitance in the house. Thereafter, the equations become:

$$\begin{bmatrix} \frac{dT_{int}}{dt} \\ 0 \\ \frac{dT_w}{dt} \\ 0 \end{bmatrix} = \begin{bmatrix} -A_{int} & B_{int} & 0 & 0 \\ A_{si} & -B_{si} & C_{si} & 0 \\ 0 & B_{wc} & -C_{wc} & D_{wc} \\ 0 & 0 & C_{se} & -D_{se} \end{bmatrix} * \begin{bmatrix} T_{int} \\ T_{si} \\ T_w \\ T_{se} \end{bmatrix} + \begin{bmatrix} -A_{int} & 0 & I & 0 & 0 & 0 \\ 0 & 0 & 0 & J & 0 & 0 \\ 0 & 0 & 0 & 0 & K & 0 \\ E_{se} & F_{se} & 0 & 0 & 0 & L \end{bmatrix} * \begin{bmatrix} T_{ext} \\ T_{sky} \\ \Phi_{int} \\ \Phi_{si} \\ \Phi_w \\ \Phi_{se} \end{bmatrix}$$

In which,

$$A_{int} = \left(1/R_{fi} + 1/R_{si}\right)/C_{int}$$

$$A_{si} = 1/R_{si}$$

$$B_{int} = 1/(R_{si} * C_{int})$$

$$B_{si} = 1/R_{si} + 1/R_{w12}$$

$$B_{mc} = 1/(R_{w12} * C_w)$$

$$C_{si} = 1/R_{w12}$$

$$C_{wc} = \left(1/R_{w12} + 1/R_{w22}\right)/C_w$$

$$C_{sc} = 1/R_{w22}$$

$$D_{wc} = 1/(R_{w22} * C_w)$$

$$D_{se} = 1/R_{w22} + 1/R_{se} + 1/R_{sky}$$

$$E_{int} = 1/(R_{fi} * C_{int})$$

$$E_{se} = 1/R_{se}$$

$$F_{se} = 1/R_{sky}$$

$$I = 1/C_{int}$$



$$\begin{aligned}
 J &= 1 \\
 K &= 1/C_w \\
 L &= 1
 \end{aligned}$$

... (eq. IV.29)

Several parameter such as thermal transmission coefficient, distribution coefficient influence the thermal resistance and thermal capacitance in the household where the equation is reflected in equation below

$$R_{w12} = 1/(U_w * S_w) * (1 - \beta), \quad \text{in } K/W$$

... (eq. IV.30)

$$R_{w22} = 1/(U_w * S_w) * \beta, \quad \text{in } K/W$$

... (eq. IV.31)

$$R_{si} = 1/(hc_{int} * S_w), \quad \text{in } K/W$$

... (eq. IV.32)

$$R_{se} = 1/(hc_{ext} * S_w), \quad \text{in } K/W$$

... (eq. IV.33)

$$C_w = C_w * S_w, \quad \text{in } J/W$$

(eq. IV.34)

$$R_{sky} = 1/(H_{net} * S_w), \quad \text{in } K/W$$

... (eq. IV.35)

Where

- $U_w$  = Thermal transmission coefficient of wall in  $W/m^2.K$
- $S_w$  = Wall surface between the area (zone) and external environment ( $m^2$ )
- $\beta$  = Distribution coefficient of wall resistance
- $hc_{int}$  = Internal convective exchange coefficient in  $W/m^2.K$
- $hc_{ext}$  = External convective exchange coefficient in  $W/m^2.K$

$H_{net}$  = External thermal radiation heat transfer coefficient in  $W/m^2.K$

### 4.2.3.6.2 Thermal comfort of building

Based on ASHRAE Comfort standard 55-2017, several parameters drive the thermal comfort such as metabolic rate, clothing insulation, air temperature, radiant temperature, air speed and humidity[25]. Nevertheless, in this chapter, we only consider air temperature to consider occupant comfort. The constraint of comfort zone will be taken with minimum optimal temperature and maximum optimal temperature (eq. IV.36)

$$T_{opt_{min}} \leq T_{opt} \leq T_{opt_{max}}$$

... (Eq. IV.36)

Based on fig. IV.7, House have optimum temperature for user satisfaction when they stay in the house. However, the amount of optimum temperature depends on the user behavior. In standard condition, optimum temperature is  $22^{\circ}C$ . Meanwhile, the user have the limitation for their comfortability where they decide the minimum temperature. Hence, a range of temperature is considered ( $T_{opt} \mp \Delta T$ ) around the optimal temperature ( $T_{opt}$ ).

$$Uncomfort = \frac{T_{in} - T_{opt}}{\Delta T}$$

... (Eq. IV.37)

$$Uncomfort = -\frac{T_{in} - T_{opt}}{\Delta T}$$

... (Eq. IV.38)

$$T_{opt_{min}} = T_{opt} - \Delta T$$

... (Eq. IV.39)

$$T_{opt_{max}} = T_{opt} + \Delta T$$

... (Eq. IV.40)

In the equation, uncomfortable index represent the condition where the user is not satisfied with the ambient temperature. If the indoor temperature equals with the optimal temperature, there is no uncomfortable condition, thus the uncomfort is zero. However, when the indoor temperature over or less than limitation, then the unsatisfaction increase.

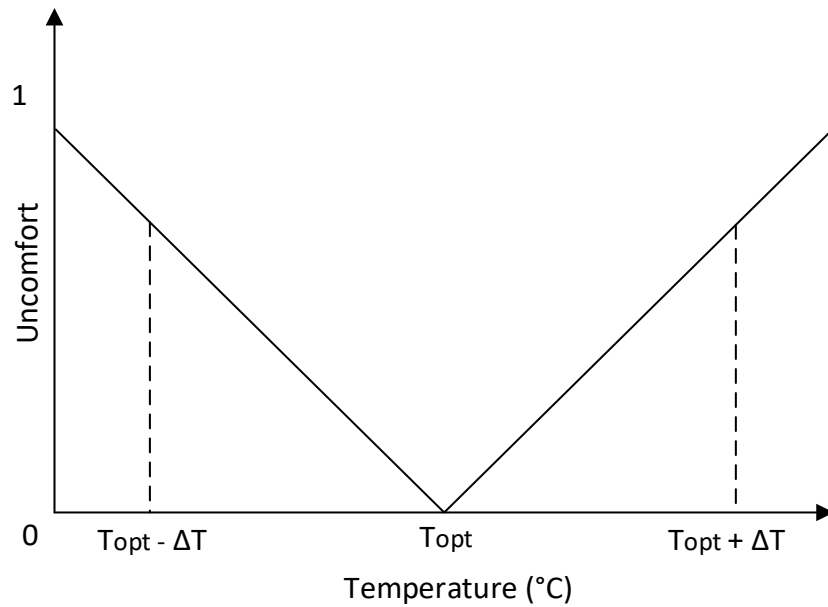

Fig. IV.7. Comfort Temperature range

To handle the comfort issue in the residential, several study investigate the effect of HVAC to thermal comfort. M.Bojic et al[26] propose the optimization of thermal comfort in the adequate building through natural ventilation and composition. With the thermal comfort as objective function, they investigate several residential in La Reunion. Thus, the result states that the modification of wall thickness influence the thermal comfort.

Harb et al through their paper[27] develop and validate a grey box model for thermal response prediction in the house using several  $R_xC_y$  models which take some parameter such as indoor temperature, heat consumption of the building, outdoor temperature and global solar radiation ion horizontal surface. Lastly, they compare the model using measurement accuracy, parameter plausibility and validation model.

Zhao et al bringing into play Model Predictive Controller (MPC) for achieving the goal of reducing energy and improving user comfort in commercial buildings. Utilizing EnergyPlus, they harness

several parameters namely, relative humidity and air flow rate[28]. They also make assumption in weekday and weekend set point, weather, schedule and comfort assumption.

### 4.2.4 Objective

Household consume the electricity rely on the PV system, Nevertheless, intermittent factor and weather disturbance cause declining of the available electricity. This situation encourage the household to complete their demand with the grid electricity. To reach the objective of the household for their consumption, the global cost can be formulated as:

$$Cost = \sum_{t=1}^N (P^{grid}(t) * \gamma^{grid}(t) - P^{PV}(t) * \gamma^{PV}(t))$$

... (eq. IV.41)

Where,

- $Cost$  = Energy cost that should paid by household (c€)
- $P^{grid}$  = Grid electricity consumption (kWh)
- $P^{PV}$  = PV Power (kWh)
- $\gamma^{grid}$  = Grid electricity price (c€/kWh)
- $\gamma^{PV}$  = PV power price (c€/kWh)
- $t$  = Time-slot index
- $N$  = Total number of time-slot

### 4.2.5 Application MPC for Energy Management

After all the model is introduced where the model created in the GAMS file, Matlab script is prepared for MPC-MORE[29]. Figure IV.8 Illustrate the process of energy management. Firstly, Time step should be initialized (e.g 10 minutes in time step). User apply the weather data for modeling in particular when the building thermal model is applied in the modeling. Furthermore, initialization of parameter model such as PV, based load, controllable appliance, electric water heater and or thermal building model where the supporting parameter namely occupancy, cost or price is applied. After initialization parameter model, All data is written in GDX input where it will transfer to problem solver software GAMS for optimization process.

Furthermore, GAMS initialize GDX input (parameter and constraints) and computes them into energy balances subsequently the grid consumption is obtained. In objective function, grid consumption multiply with grid electricity price. GAMS use CBC (Coin-OR Branch Cut) for Mixed Integer Linear Programming (MILP)[30]. If the optimization process is accomplish, the result data will be written to GDX output. However, if the optimization is fail, GAMS will send the message to Matlab about the fail. Matlab read the GDX output where it extract to the data in matlab data. Moreover, the result data is displayed by the graphic.

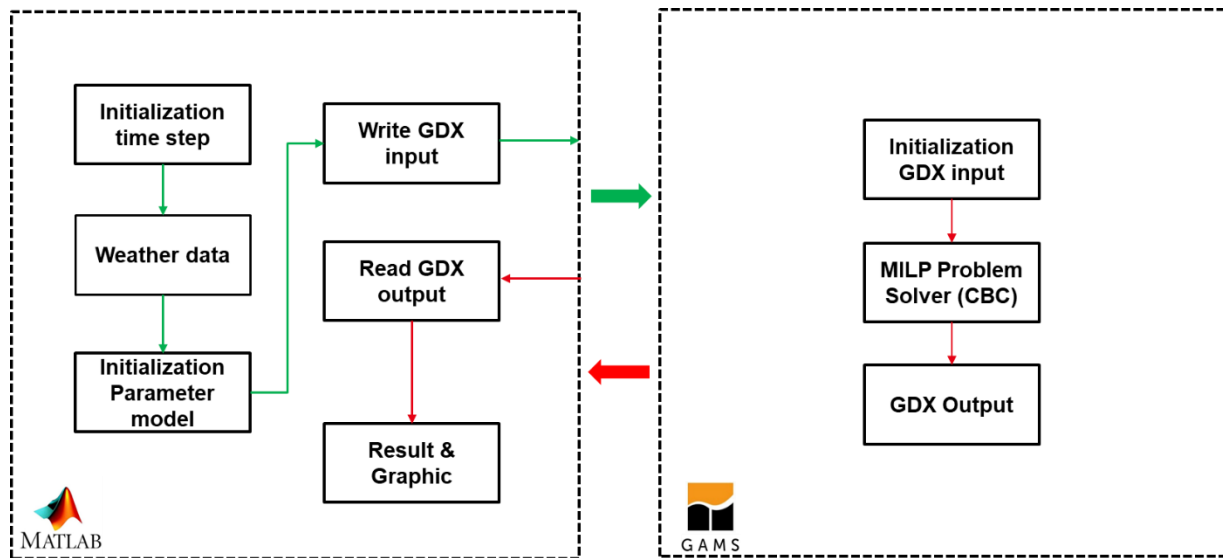

Fig. IV.8 Illustration of MORE-GAMS[29]

### 4.3 Energy Management method and Solving

#### 4.3.1 Coordination of Energy Management in the household

To reach their objective, households have a strategy namely individual (independent scenario). They only perform electricity activities in their household as shown in figure IV.2. For example, prosumer as PV system owner only connected to the utility grid for buying and selling the electricity. When the excess energy is emerged, prosumer will share to the grid. In other hand, consumer buy the electricity from provider to meet their net electricity demand. The objective of both prosumers and consumers are similar such as electricity cost reduction with the activation of controlled appliances (dishwasher and washing machine) and electric water heater as the decisions variables. In this research, we propose the scheme of interaction between grid and household both prosumer and consumer as shown in fig. IV.9. For reach the goals, two strategies also proposed.

In the first strategy, households use the electricity without sacrifice their satisfaction. They create their consumption pattern in accordance with their behavior in particular flexible appliances operation as shown in the table IV.2.



Fig. IV.9 Individual connection scheme where the Prosumer and consumer connect with grid only

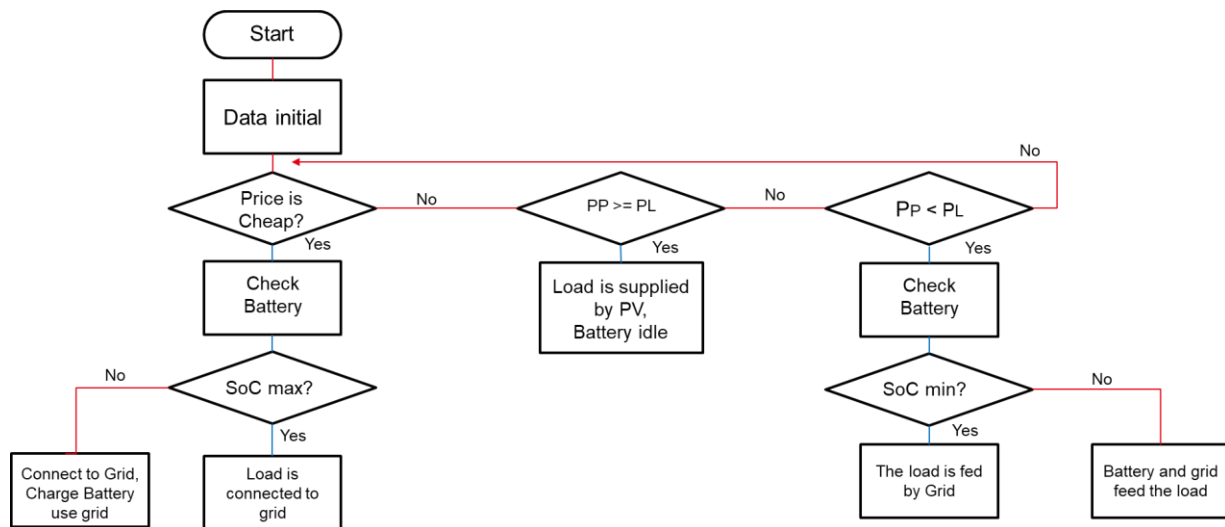

Fig. IV.10 Flow chart of Home Energy Management System with battery system.  $P_p$  is the local generation power, and  $P_L$  is the demand power

The flowchart in the fig. IV.10 explains the HEMS operation in the house when a battery system operates. The HEMS will check the production of solar electricity and load demand. There are three cases. In the first case, the solar electricity is greater than the consumption; HEMS will check the battery capacity. The PV unit will either feed the load consumption only, or feed both the load and battery (charging mode). In the second case, the solar electricity index is similar with the load consumption, as a result the production only feeds the demand. In the last case, solar electricity is

less than load demand. In consequence, all production feeds the load consumption with a complement supplied by the grid and/or the battery.

Furthermore, in the second case, for optimizing the cost reduction, households need to apply demand side management techniques such as optimal load shifting. The load shifting calculation could refer to eq. IV.4-IV.11. The power balance in the coordination is created where the aggregation of all component produce zero value. It illustrated in the eq. IV.42 whereas eq. IV.43 reflects the cost that must be paid by household for their electricity consumption form the grid.  $\gamma^{grid}$  indicates the fixed electricity price form grid in t-time and  $P^{grid}$  represent the power consumption from the grid. N indicate total of time interval (e.g 24 hour). This equation become objective function in the MPC.

$$\sum P_{pv}(t) + \sum P_{bat}(t) + \sum P_{basedLoad}(t) + \sum P_{controlLoad}(t) + \sum P_{EWH}(t) + \sum P_{grid}(t) = 0, \quad \forall t$$

... (eq. IV.42)

*Objective Function :*

$$minimize \sum_{t=1}^N P_{grid}(t) * \gamma_{grid}(t)$$

... (eq. IV.43)

*Subject to :*

PV :  $0 \leq P_{pv}(t) \leq P_{max}^{PV}, \quad \forall t$

Battery :  $\frac{SOC_{bat}(t-1) - SOC_{bat}(t)}{\Delta t} = \frac{1}{\eta_{bat}^{Dch}} * P_{bat}^{Dch}(t) + \eta_{bat}^{Ch} * P_{bat}^{Ch}(t)$

$SOE_{min} \leq SOE \leq SOE_{max}$

$-P_{bat_{max}}^{Dch} < P_{bat}^{Dch}(t) \leq 0, \quad \forall t$

$0 \leq P_{bat}^{Ch}(t) < P_{bat_{max}}^{Ch}, \quad \forall t$

Flexible load :  $P(i, t) = \sum_{i=1}^I \sum_{j=1}^J PA(i, j) * x(i, j, t), \quad \forall i, t$

$x(i, j) = \begin{cases} 1, & t_{start} \leq t_{occ} \leq t_{fin} \\ 0, & otherwise \end{cases}$

$x(i, j) = 0, \quad if \quad occ = 0$

Water heater : Eq. IV.23

$$s(t) = \begin{cases} 1, & T_{min}^{ewh} \geq T^{ewh} \\ 0, & T_{max}^{ewh} \leq T^{ewh} \end{cases}$$

$$T_{min}^{ewh} \leq T^{ewh} \leq T_{max}^{ewh}$$

$$P_{min}^{ewh} \leq P^{ewh} \leq P_{max}^{ewh}$$

### 4.3.2 Coordination Energy Management via Bilateral Contract

Here, we consider a full P2P market in particular bilateral contract between a single prosumer and a single consumer. This scenario is made for helping the prosumer when the feed-in-tariffs are decreasing. For Consumer side, this strategy give them the choice to improve their electricity cost with lower price. Like the previous strategy shown in figure IV.11, firstly, the prosumer meet their consumption with the result that self-consumption is also reached. When the excess energy is enormous or suitable for sharing, the consumer consumes this energy for fulfilling its demand. In consequence, the self-consumption of consumer is emerged. This strategies could be built standalone or without provider support. However, it is not recommended because the resource is intermittent. The risk of this strategy is that both prosumer and consumer might shut down their activities due to a lack of electricity.

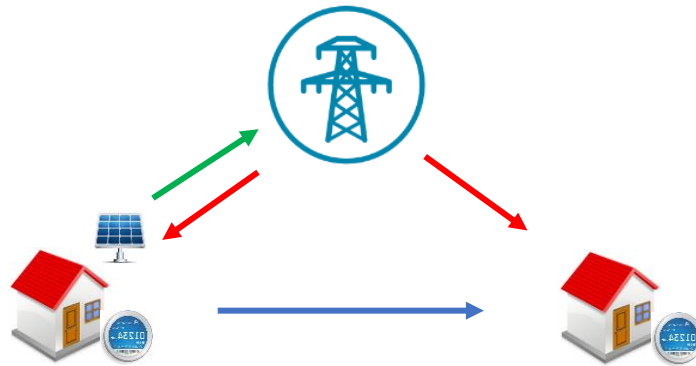

Fig. IV.11. Peer to peer coordination with grid connection

Electricity provider still support the scenario, so that it could send electricity to both the prosumer and the consumer. Prosumer buys electricity from provider when their PV system could not meet with its demand. Automatically, consumer does not receive the shared energy and must buy the



full energy from provider. The contract between prosumer and consumer is created in accordance with their agreements.

In the operation of this strategy, the owner of PV system (prosumer) estimates its consumption and production considering the fixed (unflexible) and flexible load.

$$P_{gridPro}(t) + P_{PV}(t) - P_{loadPro}(t) \mp P_{bat}(t) = 0, \quad \forall t$$

... (eq. IV.44)

$$\begin{cases} P_{gridPro}(t) = 0, & P_{PV}(t) > (P_{loadPro}(t) \mp P_{bat}(t)) \\ P_{gridPro}(t) = P_{PV}(t) - (P_{loadPro}(t) \mp P_{bat}(t)), & otherwise \end{cases}$$

... (eq. IV.45)

$$P_{loadPro}(t) = \sum_{b=1}^B P_{unflx_l}(t) + \sum_{i=1}^I P_{flx_l}(t), \quad \forall t$$

... (eq. IV.46)

$$\begin{cases} P_{excessPro}(t) = 0, & P_{PV}(t) \leq (P_{loadPro}(t) \mp P_{bat}(t)) \\ P_{excessPro}(t) = P_{PV}(t) - (P_{loadPro}(t) \mp P_{bat}(t)), & otherwise' \end{cases} \quad \forall t \in N$$

... (eq. IV.47)

$$Cost_{pro}(t) = P_{gridPro}(t) * \gamma_{grid}(t), \quad \forall t$$

... (eq. IV.48)

$$Rev_{pro}(t) = P_{excessPro}(t) * (\gamma_{grid}(t) - \zeta_{grid}(t)), \quad \forall t$$

... (eq. IV.49)

Where  $P_{gridPro}$  reflect the power consumption in the prosumer;  $P_{PV}(t)$  and  $P_{loadPro}(t)$  represent PV production in the household (prosumer) and load consumption from appliances that are operated at t-time.  $P_{loadPro}(t)$  result is aggregation of  $l$ -fixed load ( $P_{unflx_l}(t)$ ) and  $l$ -flexible load ( $P_{flx_l}(t)$ ) at t-time where  $L$  represent appliances index.  $P_{excessPro}(t)$  denote excess energy that produced by prosumer where it will share to the consumer or the grid. Meanwhile, for the consumer, the excess energy from prosumer is taken as additional energy where denoted by

$P_{PVCon}(t)$  that represented by eq.IV.50. However, if the prosumer could not to share their excess energy, the consumer fully consume the electricity from the grid.

$$\begin{cases} P_{PVCon}(t) = P_{excessPro}(t) & P_{excessPro}(t) \geq 0 \\ P_{PVCon}(t) = 0, & otherwise \end{cases} \quad \dots \text{ (eq. IV.50)}$$

$$P_{gridCon}(t) + P_{PVCon}(t) - P_{loadCon}(t) = 0, \quad \forall t \quad \dots \text{ (eq. IV.51)}$$

$$Cost_{con-grid}(t) = P_{gridCon}(t) * \gamma_{grid}(t), \quad \forall t \quad \dots \text{ (eq. IV.52)}$$

$$Cost_{con-pro} = P_{PVCon} * \gamma_{pro}(t), \quad \forall t \quad \dots \text{ (eq. IV.53)}$$

Because of unavailable of battery system, power balance in the consumer consist of  $P_{gridCon}$ ,  $P_{PVCon}$  and  $P_{loadCon}$ , where they represent Grid consumption, Prosumer excess energy and load consumption, respectively. Consumer have two cost such as grid cost ( $Cost_{con-grid}$ ) and injected PV cost ( $Cost_{con-pro}$ ).

### 4.3.3 Centralized Coordination Energy Management

To improve self-consumption in the community, coordination could also participate to reach the goal. We propose a strategy such as Centralized energy management as shown in the figure IV.12. One prosumer as coordinator collects consumption data of households and have a direct access to control the appliances (controllable appliances) in each household through the secure AMI, as long as they participate in the community. The smart meter and HEMS send the data and preferences to the coordinator and then it performs optimization for scheduling the appliances in the household. Privacy data is big deal for this scheme, consequently, the additional system for data security.

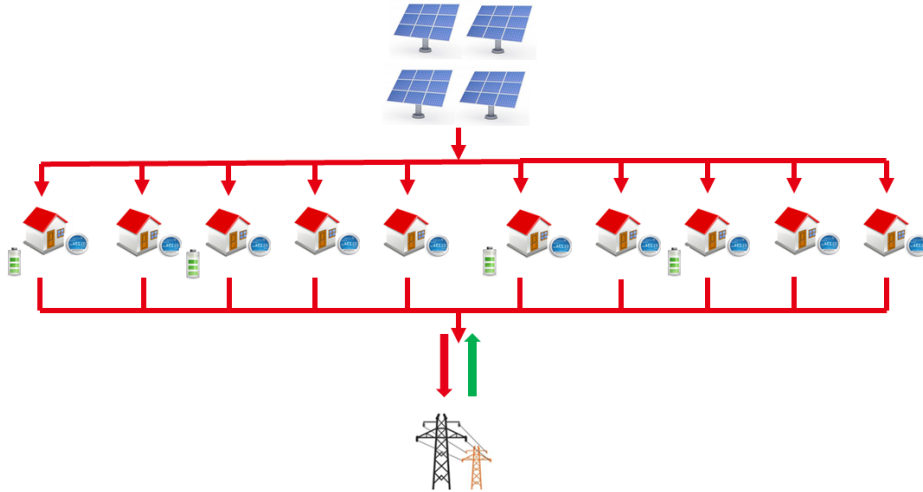

Fig. IV.12. Centralized coordination of energy management

In this section, the centralize coordination is set for several households where the PV and battery is utilized together. The optimization schedules the appliances in the households and the goal is to reduce the electricity bill in all households and reach the maximum collective self-consumption.

$$P^{PVCen}(t) = \sum_{s=1}^S P_s^{PV}(t), \quad \forall s, t$$

... (eq. IV.54)

$$P^{loadCen}(t) = \sum_{b=1}^B P_i^{unflx}(t) + \sum_{i=1}^I \sum_{j=1}^J P_{i,j}^{flx}(t), \quad \forall i, j, t$$

... (eq. IV.55)

*Power Balance :*

$$P^{PVCen}(t) + P^{loadCen}(t) + P^{bat}(t) + P^{gridCen}(t) = 0$$

... (eq. IV.56)

*Objective Function :*

$$\min(P^{gridCen} * \gamma^{grid}), \quad \text{if } P^{gridCen} > 0$$

... (eq. IV.57)

Subject to :

$$\text{PV} \quad : \quad P^{PVCen} \geq 0$$

$$\text{Battery} \quad : \quad \frac{SOC_{bat}(t-1) - SOC_{bat}(t)}{\Delta t} = \frac{1}{\eta_{bat}^{Dch}} * P_{bat}^{Dch}(t) + \eta_{bat}^{Ch} * P_{bat}^{Ch}(t)$$

$$SOE_{min} \leq SOE \leq SOE_{max}$$

$$-P_{bat_{max}}^{Dch} < P_{bat}^{Dch}(t) \leq 0, \quad \forall t$$

$$0 \leq P_{bat}^{Ch}(t) < P_{bat_{max}}^{Ch}, \quad \forall t$$

$$\text{Flexible load} \quad : \quad P(i, t) = \sum_{i=1}^I \sum_{j=1}^J PA(i, j) * x(i, j, t), \quad \forall i, t$$

$$x(i, j) = \begin{cases} 1, & t_{start} \leq t_{occ} \leq t_{fin} \\ 0, & otherwise \end{cases}$$

$$x(i, j) = 0, \quad \text{if } occ = 0$$

$$\text{Water heater} \quad : \quad \text{Eq. IV.23}$$

$$s(t) = \begin{cases} 1, & T_{min}^{ewh} \geq T^{ewh} \\ 0, & T_{max}^{ewh} \leq T^{ewh} \end{cases}$$

$$T_{min}^{ewh} \leq T^{ewh} \leq T_{max}^{ewh}$$

$$P_{min}^{ewh} \leq P^{ewh} \leq P_{max}^{ewh}$$

Availability (Excess) Power:

$$P^{excessCen}(t) = P^{gridCen}(t), \quad \text{if } P^{gridCen}(t) < 0$$

... (eq. IV.58)

Potential revenue in the pool:

$$Rev(t) = P^{excessCen}(t) * (\gamma^{pro}(t) - \zeta^{grid}(t) - \zeta^{tax}(t))$$

... (eq. IV.59)

The PV aggregation ( $P^{PVCen}$ ) is created from  $G$  - PV index in  $t$ -timeslot. It will cover the entire load from community or district with helping from battery system in the prosumer. In result, total power of community will reached.  $P^{loadCen}$  represent the aggregation of all load consumption both fixed and flexible appliances in all household. Using the centralized coordination, self-

consumption is expected to reach near or 100 percent. Cost of electricity in community ( $Cost$ ) is obtained from multiplication power grid ( $P^{gridCen}$ ) and grid electricity price ( $\gamma^{grid}$ ). If the excess energy ( $P^{excessCen}$ ) still exist, it is shared to the grid where the community will receive incentive from grid that represented by  $Rev$  in eq. IV.59

<b>Algorithm Centralized Coordination</b>	
1	Start
2	Determine the time step – t
3	Load the data component (PV, Based load consumption, Appliances power, water consumption) in each household
4	Set the financial parameter ( grid price ( $\gamma^{grid}$ ), pv price in FiT ( $\gamma^{fit}$ ), grid cost ( $\zeta^{grid}$ ) and cost of load shedding ( $\zeta^{load}$ ) and set the price in accordance with option ( fix price, peak-off-peak price)
5	Initialization model and create set of the model (PVmodel, LoadModel, etc)
6	Aggregation the PV power in the community ( $\sum P^{PV}$ )
7	Set option derating PV power through the choice. Set ‘1’ if no derating or ‘2’ if derating possible. $option '1' \rightarrow P^{PV} = P_{max}^{PV}$ or $option '2' \rightarrow 0 \leq P^{PV} \leq P_{max}^{PV}$
8	Set battery model in n-battery, cost of battery is represented by $\zeta^{dis}$
9	Set based load model and bring the each power in aggregation $\sum P^{load}$ and set option for load shedding where $option '1' \rightarrow \zeta^{load} = 0$ or $option '2' \rightarrow \zeta^{load} = load\ price$
10	Set controllable appliances model, availability, power and duration. If availability ‘1’ subsequently $P^{app} = s^{app} * Q^{app}$
11	Set electric water heater model include the equation and initialization of the parameter
12	set the grid model, power grid ( $P^{grid}$ ), and grid cost ( $\zeta^{grid}$ ).
13	Set bus connection from aggregation of each components in the system
14	Optimize for objective function where $\min(P^{grid} * \zeta^{grid} + P^{load} * \zeta^{load} + P^{dis} * \zeta^{dis})$
15	end

#### 4.3.4 Multilateral Energy Management

To improve the coverage of coordination, the strategy of sharing energy is expanded to be coordination among the pools. This option does not need an independent coordinator because the pool utilizes centralized coordination with several households in the pool. The rule in this strategy, the pool is remaining connected to an electricity provider to cover the demand in the outside PV production area and unavailable energy. Pool have several options to send excess energy namely,

send excess energy partially or send all excess energy to another pool depend on the willingness. Meanwhile, the prosumers in each pool perform the maximization of their self-consumption, and then they share their energy excess to consumers. If it remains an energy excess, it is sent to another pool. The scheme of pool-to-pool coordination is drawn in fig. IV.13.

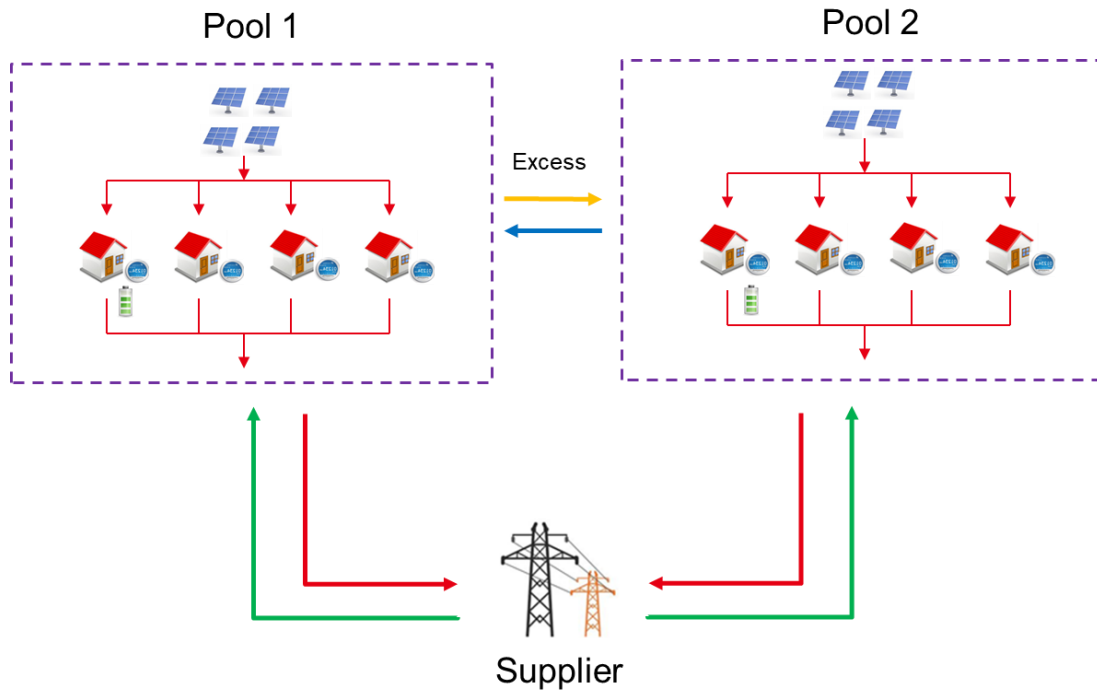

Fig. IV.13. Pool to Pool Coordination

The intermittent of the PV system in the prosumer lead to a deficiency of the excess energy that will be shared with other pools or the grid. Consequently, all households should buy the electricity from the provider where the other pool also performs the similar method to complete their demand. In result, the grid electricity cost will be applied. The pool buys surplus energy from another pool with the lower price compared with the grid price. The mathematical model for this scheme is proposed in equation where the pool 1 perform the optimization

*Load Aggregation in Pool 1:*

$$p^{loadCen1}(t) = \sum_{b=1}^B p^{unflx1}(i, t) + \sum_{i=1}^I \sum_{j=1}^J p^{flx1}(i, j, t), \quad \forall i, j, t$$

... (eq. IV.60)

Power Balance in Pool 1:

$$P^{PVCen1}(t) + P^{loadCen1}(t) \mp P^{bat1}(t) + P^{gridCen1}(t) = 0 \quad \dots \text{(eq. IV.61)}$$

Objective Function in Pool 1:

$$\min(P^{gridCen1} * \gamma^{grid}), \quad \text{if } P^{gridCen1} > 0 \quad \dots \text{(eq. IV.62)}$$

Subject to :

PV :  $P^{PVCen1} \geq 0$

Battery :  $\frac{SOC_{bat}(t-1) - SOC_{bat}(t)}{\Delta t} = \frac{1}{\eta_{bat}^{Dch}} * P_{bat}^{Dch}(t) + \eta_{bat}^{Ch} * P_{bat}^{Ch}(t)$

$$SOE_{min} \leq SOE \leq SOE_{max}$$

$$-P_{bat_{max}}^{Dch} < P_{bat}^{Dch}(t) \leq 0, \quad \forall t$$

$$0 \leq P_{bat}^{Ch}(t) < P_{bat_{max}}^{Ch}, \quad \forall t$$

Flexible load :  $P^{flx1}(i, t) = \sum_{i=1}^I \sum_{j=1}^J PA(i, j) * x(i, j, t), \quad \forall i, t$

$$x(i, j, t) = \begin{cases} 1, & t_{start} \leq t_{occ} \leq t_{fin} \\ 0, & \text{otherwise} \end{cases}$$

$$x(i, j, t) = 0, \quad \text{if } occ = 0$$

Water heater : Eq. IV.23

$$s(t) = \begin{cases} 1, & T_{min}^{ewh} \geq T^{ewh} \\ 0, & T_{max}^{ewh} \leq T^{ewh} \end{cases}$$

$$T_{min}^{ewh} \leq T^{ewh} \leq T_{max}^{ewh}$$

$$P_{min}^{ewh} \leq P^{ewh} \leq P_{max}^{ewh}$$

... (eq. IV.63)

Availability (Excess) Power in Pool 1:

$$p^{excessCen1}(t) = p^{gridCen1}(t), \quad \text{if } p^{gridCen1}(t) < 0$$

... (eq. IV.64)

Where  $P^{loadCen1}$  is aggregation from unflexible (fixed) load and flexible load in pool 1,  $P^{PVCen1}$  and  $P^{bat1}$  represent PV production and battery, respectively in the pool 1. Meanwhile, the grid consumption in the pool 1 is denoted by  $P^{gridCen1}$  that used to determine the cost of electricity. When the excess energy ( $P^{excessCen1}$ ) is emerged, it share to the next pool. It will be added by the PV production in the pool 2 for supplying energy in there.

PV production in Pool 2:

$$p^{PVCen2}(t) = p^{excessCen1}(t) + \sum_{s=1}^S P_g^{PV2}(t), \quad \forall t$$

... (eq. IV.65)

Load Aggregation in Pool 2:

$$p^{loadCen2}(t) = \sum_{b=1}^B P_i^{unflx2}(t) + \sum_{i=1}^I \sum_{j=1}^J P_{i,j}^{flx2}(t), \quad \forall i, j, t$$

... (eq. IV.66)

Power Balance in Pool 2:

$$p^{PVCen2}(t) + p^{loadCen2}(t) + p^{bat2}(t) + p^{gridCen2}(t) = 0, \quad \forall t$$

... (eq. IV.67)

Objective Function in Pool 2:

$$\min(p^{gridCen1} * \gamma^{grid}), \quad \text{if } p^{gridCen1} > 0$$

... (eq. IV.68)



Subject to :

$$\text{PV} \quad : \quad P^{PVCen2} \geq 0$$

$$\text{Battery} \quad : \quad \frac{SOC_{bat}(t-1) - SOC_{bat}(t)}{\Delta t} = \frac{1}{\eta_{bat}^{Dch}} * P_{bat}^{Dch}(t) + \eta_{bat}^{Ch} * P_{bat}^{Ch}(t)$$

$$SOE_{min} \leq SOE \leq SOE_{max}$$

$$-P_{bat_{max}}^{Dch} < P_{bat}^{Dch}(t) \leq 0, \quad \forall t$$

$$0 \leq P_{bat}^{Ch}(t) < P_{bat_{max}}^{Ch}, \quad \forall t$$

$$\text{Flexible load} \quad : \quad P^{flx2}(i, t) = \sum_{i=1}^I \sum_{j=1}^J PA(i, j) * x(i, j, t), \quad \forall i, t$$

$$x(i, j, t) = \begin{cases} 1, & t_{start} \leq t_{occ} \leq t_{fin} \\ 0, & otherwise \end{cases}$$

$$x(i, j, t) = 0, \quad \text{if } occ = 0$$

$$\text{Water heater} \quad : \quad \text{Eq. IV.23}$$

$$s(t) = \begin{cases} 1, & T_{min}^{ewh} \geq T^{ewh} \\ 0, & T_{max}^{ewh} \leq T^{ewh} \end{cases}$$

$$T_{min}^{ewh} \leq T^{ewh} \leq T_{max}^{ewh}$$

$$P_{min}^{ewh} \leq P^{ewh} \leq P_{max}^{ewh}$$

Availability (Excess) Power in Pool 2:

$$P^{excessCen2}(t) = P^{gridCen2}(t), \quad \text{if } P^{gridCen2}(t) < 0$$

... (eq. IV.69)

Where  $P^{PVCen2}$  represent the aggregation of PV in the pool-2 ( $P_s^{PV2}$ ) and the surplus PV production from previous pool (pool 1). It purpose to help the pool to reduce their grid consumption as well as diminish their electricity cost in the pool-2. The other method is relative similar with the centralized coordination, which the pool aggregate the local household load consumption and availability battery system. The excess energy that is emerged in this pool will be share to another pool or the grid.

### 4.4 Conclusion

MPC is a very important tool for reach the goals in particular in the energy sector. MPC based on HEMS is important where HEMS become the agent that help household to manage their electricity demand through demand side management. Several model support the HEMS for performing its function. Load consumption is divided to two part, namely fixed appliances and shift-able appliance. PV module as renewable energy model is determined by sun radiation and index of solar panel. Moreover, battery system aim to supply energy in the household and improve self-consumption. Grid continue to provide electricity when the lacking distributed energy is occurred.

Considering the hot water usage, Domestic water heater model take position in the simulation. The EWH is taking into account several parameter namely temperature (ambient temperature, water temperature, inlet water temperature) and dimension of EWH such as surface and height of water tank. Meanwhile, integration HEMS with HVAC is also conducted where occupancy factor will drive the growth of HVAC power consumption. Taking into account the 6R2C model, several parameter contained in the resistance and capacitance model. Moreover, this model have two temperature be variable namely indoor and wall temperature. Electricity price influence the model goals where the household choose to use the PV system for diminishing of electricity cost in the house.

Several technique are available for household in managing their electricity. They could coordinate the appliances in the house using their behavior for energy consumption. In another word, they bring full quality of life. However, scheduling with optimization give improvement in the energy consumption where the cost reduction is reached. Consequently, the quality of life of household will be decreased.

### References

- [1] R. Hemmati and H. Saboori, "Stochastic optimal battery storage sizing and scheduling in home energy management systems equipped with solar photovoltaic panels," *Energy and Buildings*, vol. 152, pp. 290–300, Oct. 2017, doi: 10.1016/j.enbuild.2017.07.043.
- [2] S. V. Raković and W. S. Levine, Eds., *Handbook of Model Predictive Control*. Cham: Springer International Publishing, 2019.
- [3] R. Godina, E. Rodrigues, E. Poursmaeil, J. Matias, and J. Catalão, "Model Predictive Control Home Energy Management and Optimization Strategy with Demand Response," *Applied Sciences*, vol. 8, no. 3, p. 408, Mar. 2018, doi: 10.3390/app8030408.

- [4] N. Aoun, "Modeling and flexible predictive control of buildings space-heating demand in district heating systems," Universite Paris Saclay, 2019.
- [5] B. Chelik, "Coordination mechanisms for smart homes electric energy management through distributed resource scheduling with demand response programs," Université Bourgogne Franche-Comté, 2017.
- [6] M. Afzalan and F. Jazizadeh, "Residential loads flexibility potential for demand response using energy consumption patterns and user segments," *Applied Energy*, vol. 254, p. 113693, Nov. 2019, doi: 10.1016/j.apenergy.2019.113693.
- [7] R. Sharifi, S. H. Fathi, and V. Vahidinasab, "Customer baseline load models for residential sector in a smart-grid environment," *Energy Reports*, vol. 2, pp. 74–81, Nov. 2016, doi: 10.1016/j.egy.2016.04.003.
- [8] A. Sinha and M. De, "Load shifting technique for reduction of peak generation capacity requirement in smart grid," in *2016 IEEE 1st International Conference on Power Electronics, Intelligent Control and Energy Systems (ICPEICES)*, Delhi, India, Jul. 2016, pp. 1–5, doi: 10.1109/ICPEICES.2016.7853528.
- [9] Z. Bradac, V. Kaczmarczyk, and P. Fiedler, "Optimal Scheduling of Domestic Appliances via MILP," *Energies*, vol. 8, no. 1, pp. 217–232, Dec. 2014, doi: 10.3390/en8010217.
- [10] M. Hofmann, S. Riechelmann, C. Crisosto, R. Mubarak, and G. Seckmeyer, "Improved Synthesis of Global Irradiance with One-Minute Resolution for PV System Simulations," *International Journal of Photoenergy*, vol. 2014, pp. 1–10, 2014, doi: 10.1155/2014/808509.
- [11] M. R. Maghami, H. Hizam, C. Gomes, M. A. Radzi, M. I. Rezadad, and S. Hajjghorbani, "Power loss due to soiling on solar panel: A review," *Renewable and Sustainable Energy Reviews*, vol. 59, pp. 1307–1316, Jun. 2016, doi: 10.1016/j.rser.2016.01.044.
- [12] HOMER, "PV Derating Factor." [https://www.homerenergy.com/products/pro/docs/latest/pv\\_derating\\_factor.html](https://www.homerenergy.com/products/pro/docs/latest/pv_derating_factor.html).
- [13] S. Nan, M. Zhou, and G. Li, "Optimal residential community demand response scheduling in smart grid," *Applied Energy*, vol. 210, pp. 1280–1289, Jan. 2018, doi: 10.1016/j.apenergy.2017.06.066.
- [14] L. Gelažanskas and K. Gamage, "Forecasting Hot Water Consumption in Residential Houses," *Energies*, vol. 8, no. 11, pp. 12702–12717, Nov. 2015, doi: 10.3390/en8112336.
- [15] F. S. Goldner, "Energy use and domestic hot water consumption - Phase 1. Final report," NYSERDA--94-19, 10108256, Nov. 1994. doi: 10.2172/10108256.
- [16] Rish Ghatikar, J. Lutz, E. Edelson, and S. Meyers, "Hot Water Draw Patters: Findings from Field Studies," 2006, doi: 10.13140/RG.2.1.2881.4888.
- [17] S. Edwards, I. Beausoleil-Morrison, and A. Laperrière, "Representative hot water draw profiles at high temporal resolution for simulating the performance of solar thermal systems," *Solar Energy*, vol. 111, pp. 43–52, Jan. 2015, doi: 10.1016/j.solener.2014.10.026.
- [18] N. Pflugradt and B. Platzer, "Behavior based load profile generator for domestic hot water and electricity use," presented at the Innostock 12th International Conference on Energy Storage, Lleida(Spain), 2012.
- [19] N. G. Paterakis, O. Erdinc, A. G. Bakirtzis, and J. P. S. Catalao, "Optimal Household Appliances Scheduling Under Day-Ahead Pricing and Load-Shaping Demand Response Strategies," *IEEE Trans. Ind. Inf.*, vol. 11, no. 6, pp. 1509–1519, Dec. 2015, doi: 10.1109/TII.2015.2438534.
- [20] P. Du and N. Lu, "Appliance Commitment for Household Load Scheduling," *IEEE Transactions on Smart Grid*, vol. 2, no. 2, pp. 411–419, Jun. 2011, doi: 10.1109/TSG.2011.2140344.
- [21] M. A. Fotouhi Ghazvini, J. Soares, O. Abrishambaf, R. Castro, and Z. Vale, "Demand response implementation in smart households," *Energy and Buildings*, vol. 143, pp. 129–148, May 2017, doi: 10.1016/j.enbuild.2017.03.020.

- [22] V. Kapsalis, G. Safouri, and L. Hadellis, "Cost/comfort-oriented optimization algorithm for operation scheduling of electric water heaters under dynamic pricing," *Journal of Cleaner Production*, vol. 198, pp. 1053–1065, Oct. 2018, doi: 10.1016/j.jclepro.2018.07.024.
- [23] A. Brun, "Méthodologie et outils pour la Garantie de Performance Energétique," CEA-INES, Le Bourget du Lac, Confidential, 2013.
- [24] G. Faggianelli, A. Brun, E. Wurtz, and M. Muselli, "Grey-Box Modelling for Naturally Ventilated Buildings," presented at the 14th Conference of International building Performance Simulation Association, Hyderabad, India, Dec. 2015, [Online]. Available: <https://hal-cea.archives-ouvertes.fr/cea-01615331/document>.
- [25] "ANSI/ASHRAE Standard 55-2017, Thermal environmental Conditions for Human Occupancy." ASHRAE, 2017, [Online]. Available: [https://ashrae.iwrapper.com/ASHRAE\\_PREVIEW\\_ONLY\\_STANDARDS/STD\\_55\\_2017](https://ashrae.iwrapper.com/ASHRAE_PREVIEW_ONLY_STANDARDS/STD_55_2017).
- [26] M. Bojic, A. Patou-Parvedy, and H. Boyer, "Optimization of thermal comfort in building through envelope design," presented at the International Conference on Efficiency, Cost, Optimization, Simulation and Environmental Impact of Energy Systems, ECOS 2012, Perugia, Italy, 2012, [Online]. Available: <https://arxiv.org/abs/1302.5941>.
- [27] H. Harb, N. Boyanov, L. Hernandez, R. Streblow, and D. Müller, "Development and validation of grey-box models for forecasting the thermal response of occupied buildings," *Energy and Buildings*, vol. 117, pp. 199–207, Apr. 2016, doi: 10.1016/j.enbuild.2016.02.021.
- [28] J. Zhao, K. P. Lam, B. E. Ydstie, and O. T. Karaguzel, "EnergyPlus model-based predictive control within design–build–operate energy information modelling infrastructure," *Journal of Building Performance Simulation*, vol. 8, no. 3, pp. 121–134, May 2015, doi: 10.1080/19401493.2014.891656.
- [29] D. L. Ha and G. Pichenot, "MORE-GAMS-Lib, Agence pour la Protection des Programmes." 2019.
- [30] GAMS Development Corp. and GAMS Software GmbH, "CBC (COIN-OR Branch and Cut." [https://www.gams.com/31/docs/S\\_CBC.html?search=CBC](https://www.gams.com/31/docs/S_CBC.html?search=CBC).

# Chapter 5 Case study for Coordinated Energy Management validation simulation based

## 5.1 Introduction

PV production in the households is emerging more and more, nevertheless there can be several days per year with energy surplus. While feed-in-tariffs (FiT) are existing it doesn't matter for the user, but with the expected disappearance of FiT prosumers will search for alternative strategies not to lose money in periods of energy surplus.

Uberization concept is discussed in several online media, blog and it perhaps implemented by industrial. In the dictionary, Uberization is *“the act or process of changing the market for a service by introducing the way of buying or using it, especially using mobile technology”*. It is an economic model generated from several trends namely the impulse for independence of prosumers and consumers first, looking for a better service and new consumer experience, and penetrating deployment of digital technology[1]. Bring this concept, the prosumer perhaps like the local virtual power plant where they provide the electricity not only in the local community but also in the wide area. The producer will display the amount of energy surplus produced in its site in the social-network application smart phone based. Subsequently, local consumers could select the prosumer that is available for sharing energy.

In the previous chapter, MPC for Energy management has been introduced with its components, objective function and constraints. It is appropriate for coordinated energy management for energy trading between prosumer and consumer and it becomes the basic for embodying of energy uberization. This chapter will provide the case study for several market models with MPC in the section 5.2, where Bilateral contract prosumer and consumer, prosumer and prosumer, community centralized energy coordination and Pool to Pool coordination become the object in subsections 5.2.1, 5.2.2, 5.2.3 and 5.2.4 respectively. The complete case study of a district is also proposed in section 5.3, where the location of coordination is determined in Chambery and Jakarta.

## 5.2 Case Study with MPC for Market Model

Using MORE-GAMS library developed by CEA, energy coordination strategy between prosumer and consumer is performed. The optimization namely maximizing self-consumption and minimizing the electricity in the house for both is referred to formulation problem in chapter 4 and it solved with a MILP solver. The motivation of this case study only to show how this configuration reach the objective function in the energy coordination and alternative for utilizing all of PV energy production in order to avoid the loss of excess energy.

### 5.2.1 Bilateral contract Prosumer to Consumer

Using MPC, Prosumer creates the bilateral contract with a consumer to reach the objective such as cost reduction, reach more incentive in prosumer side, and aim the partner as consumer to reduce their electricity cost. Maximizing of self-consumption also to be focus to handle degradation of feed in tariff in the future. The concept is similar with the previous simulation where the prosumer enable the load shifting to reach their goal. When the energy excess is available, consumer will take it to meet its demand. Grid provider will provide electricity if one or both of participant have lack of PV production.

#### 5.2.1.1 Parameters and Simulation

Coordination between prosumer and consumer become the alternative to reach the goal in both. In this research, the modeling utilizes library and add the additional load such as electric water heater in their demand. We consider 5 pools bilateral contract and investigate the cost reduction and self-consumption in each prosumer and consumer. The data parameter for bilateral contract is given in table V.1. PV and battery is applied in the prosumer whereas consumer has not the battery system in their house.

Model	Parameter	Value	Unit	
PV		8	kWp	Prosumer
Battery		5	kW	Prosumer
Based Load	Consumption data from load profile generator software		kW	Prosumer and Consumer
Dish Washer			kW	Prosumer and Consumer
Washing Machine			kW	Prosumer and Consumer
Electric Water Heater	Power rate	1.2	kW	Prosumer and Consumer
	Heat conductivity	$4.2 \cdot 10^{-5}$	kW/m.K	
	Heat Capacity	4.184	kWs /kg.K	
	Tank Volume	0.35	m <sup>3</sup>	
	Height of Tank	0.1	m	
	Inner radius	0.3338	m	
	thickness	0.1	m	
	Water density	1000	Kg/m <sup>3</sup>	
Grid		20	kW	Prosumer and Consumer

Table V.1 Data Parameter of MPC model in Prosumer-Consumer Coordination

### 5.2.1.2 Constraint of Bilateral Contract

#### 5.2.1.2.1 Constraint in EWH

Several inputs drive the EWH performance such as type of temperature and water consumption. In this research, initial temperature, minimum and maximum temperature of EWH is defined in assumption. EWH initial water temperature starts at 50°C where EWH will turn on if the water temperature goes below 50°C and turn off if the water temperature reaches 60°C. Water temperature from outside (inlet cold water when hot water is drawn) is also considered as parameter and is set to a constant value (15°C). Ambient temperature in the house depends on the season and thermal conditions in the house. The value of ambient temperature is supposed constant and set to 20°C. Meanwhile, Water consumption also depends on the household usages. The load-profile-generator software provides the water consumption data based on the household type. The water consumption in household 1 (HH1) and household 3 (HH3) for first day is illustrated in figure V.1

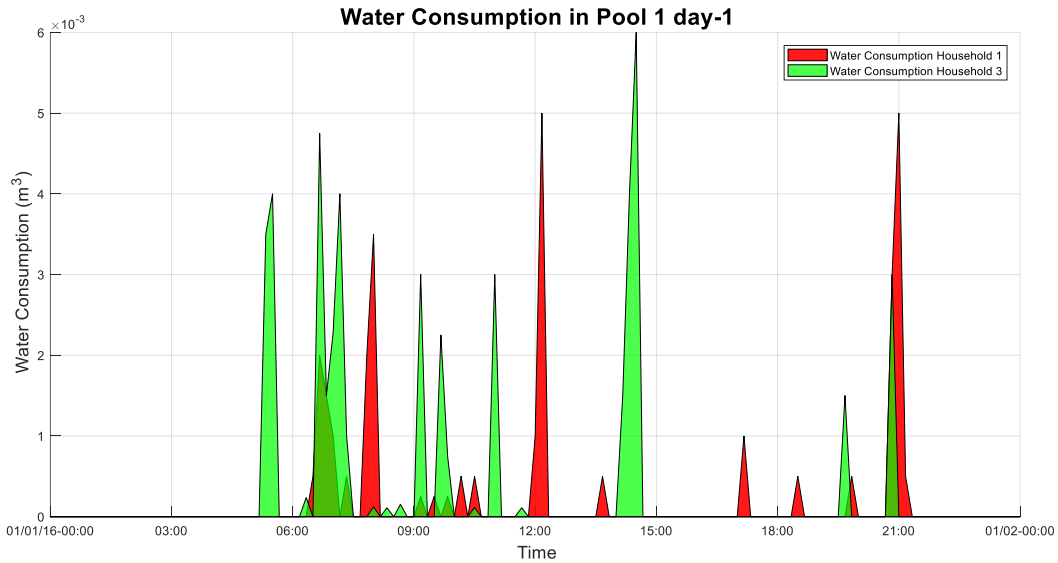

Fig V.1 Data Parameter of MPC model

### 5.2.1.2.2 Occupancy in the household

Household’ members have dynamic activities. Subsequently, they have restriction to do inside house activities. Several appliances does not need to be controlled and are operated every day, such as refrigerator. However, dishwasher and washing machine are fully flexible. They will be shifted to the time where the objective function as well as cost reduction is reached. For the modeling, their operation is possible from 6:00 am to 5:00 pm. Controllable appliances operation follows the schedule in the table V.2 where the household only enables their appliance as their needs. Green color represent the activation of dishwasher and red color for washing machine.

Type	Number of Person		Worker	Utilization of Dish washer					Utilization of Washing Machine								
	Adult	Child		S	M	T	W	T	F	S	S	M	T	W	T	F	S
HH1	2	0	2	Green		Green		Green		Green				Red			Red
HH2	2	2	1	Green	Green	Green	Green	Green	Green	Green	Red	Red	Red	Red	Red	Red	Red
HH3	2	1	1	Green	Green			Green	Green	Green	Red			Red		Red	
HH4	2	2	2	Green		Green	Green		Green	Green	Red			Red			Red
HH5	2	1	2	Green		Green	Green	Green			Red		Red			Red	
HH6	2	0	0		Green		Green		Green		Red	Red			Red		
HH7	1	1	1	Green	Green			Green		Green	Red				Red		
HH8	1	1	1	Green	Green		Green		Green				Red				Red
HH9	1	0	1			Green				Green	Red						
HH10	1	0	1			Green		Green									Red

Table V.2. Household type and their scheduling of dishwasher and washing machine



The household also have holiday period in each year where all member in the household is assumed to take vacation. Meanwhile in the weekend, the household members stay at home. This phenomenon is taking into account in the modeling. Consequently, it will drive the operation of controllable appliances, electricity cost and availability excess PV power in the prosumer. Based on load profile generator, each household type have several day for holiday. The equation V.1 explain the setting condition of controllable appliance where  $s^{app}$  represent the appliances activation and  $occ$  denote the available of human in the house.

$$s^{app} = \begin{cases} 0, & \text{if } occ = 0 \\ 1, & \text{otherwise} \end{cases} \quad occ \in \{0,1\}$$

... (Eq. V.1)

### 5.2.1.3 Application result and observation

To reach the objective function where cost reduction remains the point of view in the modeling, in this section the modeling of each scenario are presented along with discussion.

In first scenario household with their appliances, comparison of bilateral contract without optimization and under optimization are prepared. We propose financial parameter where the price of grid electricity ( $\gamma^{grid}$ ) is taken from EDF tariff (basic tariff). Whereas, the assumption is applied for PV production price ( $\gamma^{grid}$ ) and distribution cost ( $\varphi^{grid}$ ). In this modeling, the tax, installment cost and battery cost is negligible.

Objective function namely electricity reduction for full year is achieved through modeling of bilateral contract through MPC. The time sampling ( $\Delta t^{MPC}$ ) is 10 minutes. In addition, prediction horizon ( $h^{MPC}$ ) is 24 hours, in result, there are  $N^{MPC} = 144$  time slots. This choice enables a better accuracy of the results in comparison with a 1-hour time sampling.

$\gamma^{grid}$	$\gamma^{PV}$	$\varphi^{grid}$	$\Delta t^{MPC}$	$h^{MPC}$	$N^{MPC}$
0.1546 €/kWh	0.1 €/kWh	0.03 €/kWh	10	24	144

Table. V.3 Common setting parameter in the bilateral coordination

In this case study, bilateral contract scheme refer to fig. III.9(b) that described in the chapter 3. Prosumer 1 (HH1) and consumer (HH3) make the contract for energy coordination in pool 1 where is explained in chapter 4. At first, the prosumer 1 complete their energy coordination in their house

for gain the objective function. Furthermore, prosumer 1 will share their excess energy to consumer 3. Lastly, they use the excess energy for scheduling in their house. For optimization in the pool 1, MPC perform the process for 6414.51 second (around 1 hour 47 minutes) and approximate 11 hour 34 minutes in 5 pools.

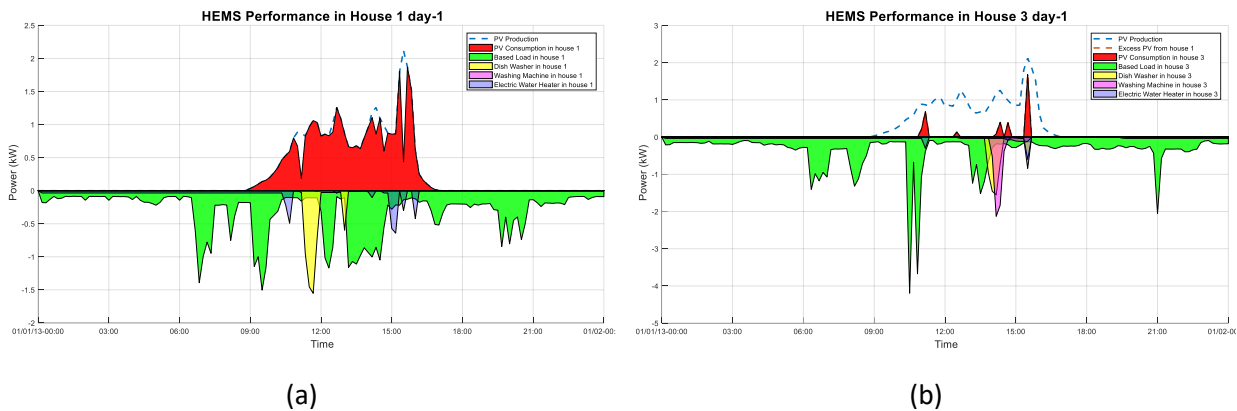

Fig. V.2 Energy consumption in the household (a). prosumer HH1 (b). consumer HH3

Based on figure V.2(a), Prosumer consume the PV electricity close with the total PV production in the first day, consequently consumer only receive the excess energy in a little portion. Hence, consumer have to buy electricity from the grid to complete their demand. EWH in HH1 consume small portion of electricity (34.8 Wh/10 minutes in average) to keep the hot water temperature and more electricity in the PV production area. The average of electricity consumption in first day is 35 Wh with the maximum power rate of EWH in 642.5 W. Whereas, in figure V.2(b) EWH in consumer HH3 also consume small portion of electricity where the average of energy consumption is 34.8 Wh with maximum power rate of EWH in 841.4 W. For flexible appliance scheduling, HH1 operates their dishwasher at 11:10 HH3 operate their appliances such as dishwasher and washing machine at 13:40 and 14:00 respectively.

The total of PV production in this day reach 36.1 kWh when the prosumer HH1 consume amount 32.5 kWh and produce the excess energy. Prosumer also buy the energy from the grid amount 23.6 kWh for covering their consumption in their household. In battery usage, the prosumer’s battery absorb 10.2 kWh and discharge the battery for complete the consumption amount 10.6 kWh. Meanwhile, the consumer HH3 buy the energy from prosumer amount 3.6 kWh and buy energy from the grid amount 10.4 kWh.

	Cost(Euro)				Saving (Euro)		SCR (%)	
	Consumer		Prosumer		Consumer	Prosumer	No Opt	Opt
	No Opt	Opt	No Opt	Opt				
<b>Pool 1</b>	562.29	471.84	299.69	238.11	90.45	61.58	35.76	55.85
<b>Pool 2</b>	313.53	264.74	572.39	452.56	48.78	119.83	40.65	60.04
<b>Pool 3</b>	310.92	282.88	514.63	435.70	28.04	78.93	30.33	48.93
<b>Pool 4</b>	284.07	256.33	567.42	438.63	27.74	128.79	39.89	59.03
<b>Pool 5</b>	243.52	208.35	271.30	263.22	35.17	8.14	25.85	43.51

Table. V.4 Yearly Household grid cost saving and Self-Consumption ratio in the pool

Table V.4 provide the grid cost in each household that joined in the pool where their transaction utilize bilateral contract without optimization and under optimization. For instance, Pool 1 where HH1 and HH3 conduct the bilateral contract. Grid cost in the bilateral contract without optimization reach 562.29 € for consumer 3. However, they reduce the cost through optimization to 471.84 € or saving 16.09%. Self-consumption ratio in the pool 1 also grow up when the grid cost reduced. Bilateral contract coordination under optimization gain until 55.85%, where they only obtain self-consumption ratio at 35.76% using coordination without optimization.

MPC for prosumer to consumer energy coordination bring the self-consumption improvement for prosumer as well as reducing their grid cost. In another side, consumer increase their grid cost reduction. Electric water heater performance under MPC is improved which it work with this scheme, household perform the optimization for themselves subsequently the consumption data is safely.

### 5.2.2 Prosumer to Prosumer Coordination Energy

Bilateral contract not only relation with prosumer and consumer but also prosumer and prosumer in the certain area. Based on principle of “uberization”, prosumer that lack of PV production in their site could consume the shared energy from another prosumer that have surplus energy. This phenomenon is expected to aim the prosumer to reduce more electricity cost from the grid. The modeling procedure and scenario is similar with the bilateral coordination between prosumer and consumer. The common parameter also refer to table V.1.

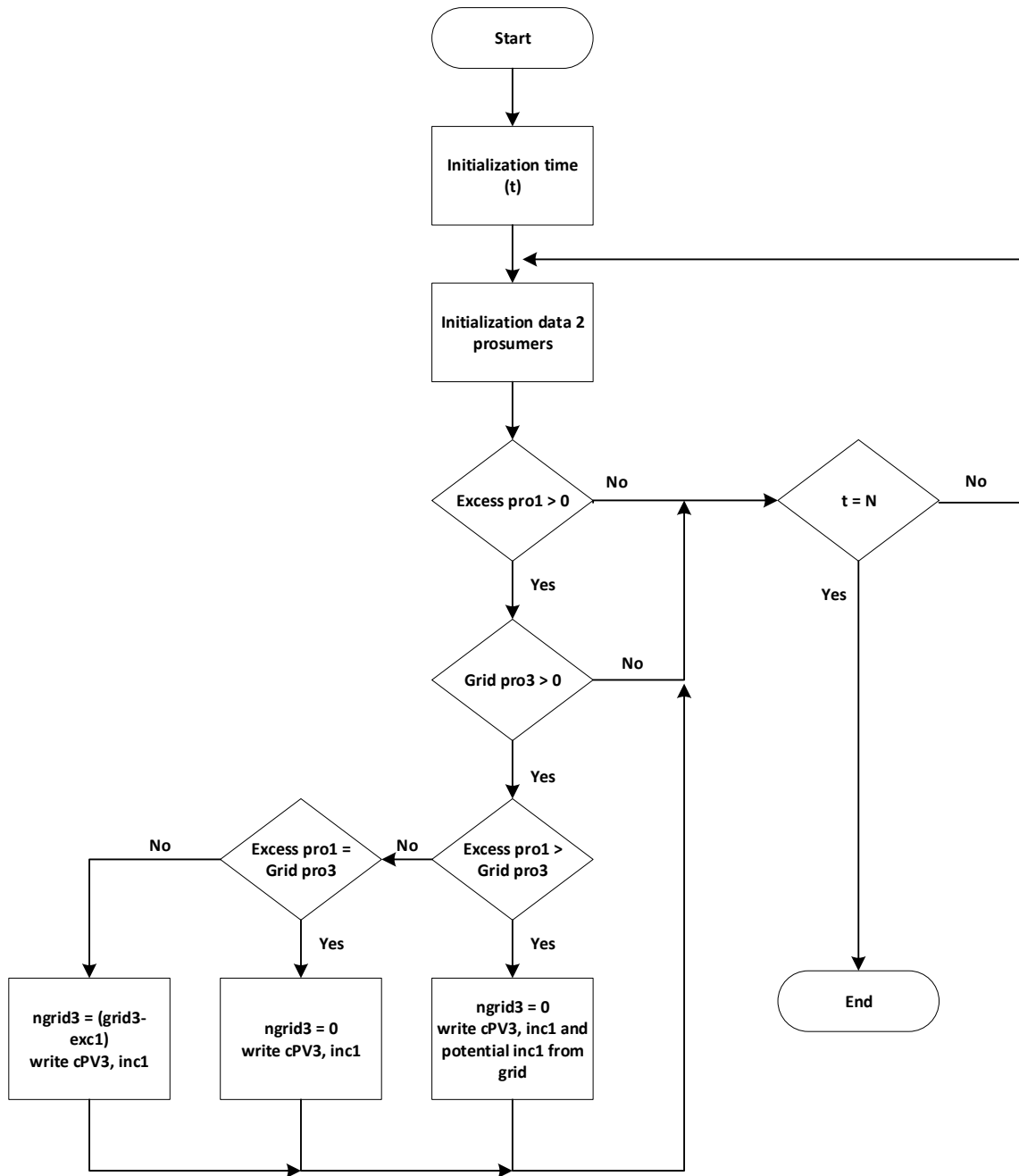

Fig. V.3. Flow chart of sharing energy between prosumer and prosumer

The prosumer remain reach their cost reduction as objective function with activating controlled appliances as decision variable. To support this method, it could use the excess energy from another when their PV energy could not meet their consumption. The PV and battery capacity is created in different value in purpose to see the process of energy sharing between the prosumers. Figure V.3 explain the procedure for coordination energy sharing between prosumer and another

prosumer. A prosumer with small PV and small battery (called prosumer P3) will make a contact with a prosumer with larger assets (called prosumer P1). Firstly, prosumer P1 mention as first party will perform optimization for scheduling their controllable appliance and trying to fulfil all their needs. This activities also conducted by prosumer P3 (named as second party). Secondly, when the prosumer P1 has a surplus energy, the consumption from the grid by prosumer P3 is assessed. Otherwise, the prosumer P1 will complete their consumption with the energy surplus from prosumer P3 when it was available.

New grid consumption ( $n_{grid}$ ) will be zero when the surplus energy from first party greater than or equal the grid consumption in the second party. In this situation, first party take incentive ( $inc$ ) from second party and from grid, if the remaining surplus energy is also injected to the grid.

Model	Parameter	Value	Unit	
PV		8	kWp	Prosumer P1
		4	kWp	Prosumer P3
Battery		3	kW	Prosumer P1
		3	kW	Prosumer P3
Based Load	Data from load profile generator		kW	Prosumer P1 and P3
Grid		20	kW	Prosumer P1 and P3

Table. V.5. Flow chart of sharing energy between prosumer and prosumer

The modeling based on parameter in the table V.5. where the PV in the first party and second party is different in capacity value. It also applied in the battery that they used. It is taken for obtain the information about the energy sharing between the prosumers. The common parameter still use like the table V.6 where the feed in tariff still exist. The procedure for this section, prosumer perform the optimization with their PV system. Grid consumption that occurred in the PV production area will be compensated by the existed energy from partner coordination in accordance with the time slot-t.

$\gamma^{grid}$	$\gamma^{PV}$	$\phi^{grid}$	$\Delta t^{MPC}$	$h^{MPC}$	$N^{MPC}$
0.1546 €/kWh	0.1 €/kWh	0.03 €/kWh	10	24	144

Table. V.6 Common setting parameter in the prosumer-to-prosumer coordination

Economic parameter use electricity price from EDF, however, the PV electricity price and distribution cost remain in assumption. It could be seen in table V.6. The modeling was operated in time slot 10 minutes where the scheduling of appliances and occupancy are applied.

The daily of PV production in the prosumer 1 reach 209.2 kWh where they consume 78.5 kWh in 18 October. They share excess energy amount 130.7 kWh. Meanwhile, in prosumer 3, the PV production is 104.6 kWh with 59.6 kWh in PV consumption. They also buy the excess energy amount 1.6 kWh from prosumer 1. In consequence, the prosumer 3 improve their self-consumption and cost reduction through energy coordination. The energy process could seen in fig. V.4. In accordance with mentioned procedure above, prosumer 1 reach self-consumption rate (SCR) at 21.74% in full year. With prosumer 3 in P2P scheme, prosumer 1 produce the SCR at 23.46% or growth 1.72% if compared the previous result. In incentive scheme, prosumer also take opportunity to achieve it.

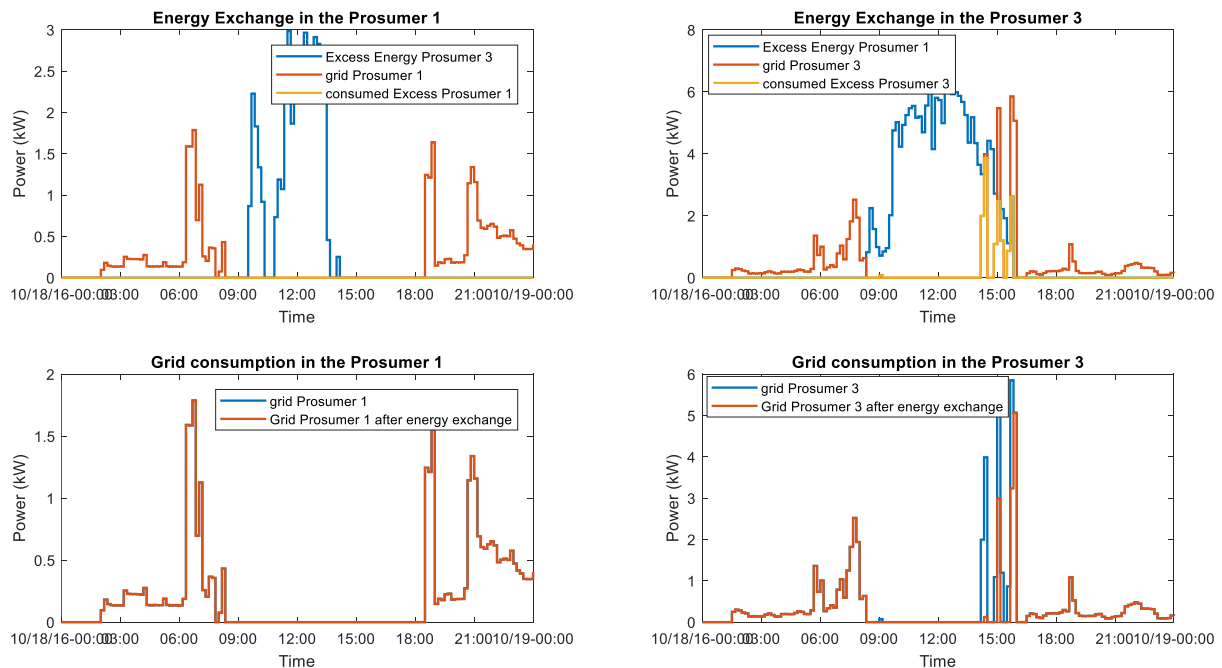

Fig. V.4. Evolution of grid consumption in the prosumer to prosumer coordination

Where in this simulation, prosumer 1 only buy excess energy from prosumer 3 at 77 c€ in total and reach the incentive 71.33€ under scheme where the distribution cost is applied. The computing time of the optimization for prosumer 1 and prosumer 3 on full year take 2887.06 second and 3527.45 second respectively.

### 5.2.3 Energy management using Centralized Coordination

In the local community, prosumer could be connected with several consumer and prosumer. They enforce the DSM technique such as load shifting to improve their cost and self-consumption ratio. However, they remain produce the surplus energy, in result they should increase the storage system or it is injected to the grid. Consequently, the electricity could be free of incentive when the operator eliminate the regulation of feed-in tariff. Increasing the storage system will increase the capital cost where it will burden the PV system owner. To avoid these problems, Centralized Coordination configuration is proposed. The purpose of centralized is to encourage the prosumer to share their excess energy to the other households in the community. In consequence, the PV production is used full collective.

In this method, a participant joins a community where both prosumers and consumers have similar objectives or goals. In this research, 10 households are proposed to create a centralized community. As a main rule, all households in the community consume energy from PV and battery of local prosumers. It needs aggregation of load consumption. Participants should send their electricity demand to a coordinator of the community. Thus, controllable appliances operation will be adjusted by scheduling.

The participant type follow the table III.5 in chapter 3 and the coordination scheme adhere fig V.5. The assumption of participant is applied. The community includes 2 prosumers and 8 consumers. The PV capacity for each prosumer is 10 kWp and the battery is 5 kW. The households perform the controllable appliances such as washing machine and dishwasher. They also control electric water heater for their hot water consumption. The community will take the energy from the grid when the local PV production does not match with their demand.

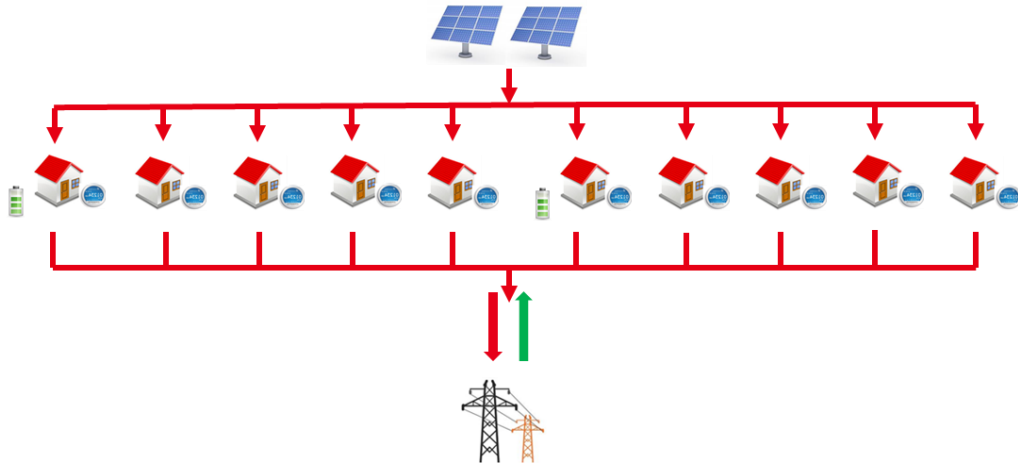

Fig. V.5 Centralized Coordination in a community scheme

Model	Parameter	Value	Unit	
PV		10 x 2	kWp	Prosumer
Battery		5 x 2	kW	Prosumer
Based Load	load data from load profile generator			All Household
Grid		20	kWh	All Household

Table. V.7 Parameter for centralized coordination modeling

To deal with economical parameter, the centralized coordination remain follow the bilateral contract economical parameter where all of them in assumption approach and illustrated in table V.8. Furthermore, modeling is performed with 30 minutes time sampling ( $\Delta t^{MPC}$ ) where the prediction horizon ( $h^{MPC}$ ) in 24 hours as well as the time slot index ( $N^{MPC}$ ) is 48. It means the optimization for reaching the objective function is performed in each day. The simulation is proposed for full year. The time sampling is chosen in 30 minutes for minimize the computing time, subsequently the optimization could perform for full year.

$\gamma^{grid}$	$\gamma^{PV}$	$\varphi^{grid}$	$\Delta t^{MPC}$	$h^{MPC}$	$N^{MPC}$
0.1546 €/kWh	0.1 €/kWh	0.03 €/kWh	30	24	48

Table. V.8 Common setting parameter in the centralized coordination



Household	Autumn (15 Oct)		Winter (15 Jan)		Spring (15 Apr)		Summer (15 Jul)	
	Dish Washer	Washing Machine	Dish Washer	Washing Machine	Dish Washer	Washing Machine	Dish Washer	Washing Machine
HH1	10:30	-	11:00	-	14:00	14:30	08:30	10:30
HH2	08:30	13:00	13:30	14:00	09:00	14:00	09:00	12:30
HH3	06:30	14:30	13:30	14:00	08:00	-	-	-
HH4	14:30	14:00	10:30	14:00	14:00	12:30	08:00	11:00
HH5	06:00	6:30	14:00	14:00	-	-	-	-
HH6	-	-	-	-	-	-	-	-
HH7	14:30	13:00	13:30	13:30	11:00	-	-	-
HH8	11:00	-	10:30	-	-	14:00	-	8:30
HH9	-	12:30	-	10:30	07:30	-	09:30	-
HH10	-	-	-	-	-	09:30	-	13:00

Table V.9. Time activation of appliances after optimization centralized coordination

Scheduling of the appliances in each household after optimization is prepared in the table V.9 where dishwasher in HH1 are online at 10:30 in the autumn season (15 October). However, the washing machine is offline because of the scheduling in this household. Meanwhile, in the summer (15 July), both of appliances are started at 08:30 and 10:30.

The daily of total PV production in this configuration reach 193.6 kWh in day-212 (summer season) where the charging and discharging power in battery 1 obtain 6.3 kWh and 7.3 kWh respectively. Whereas the charging and discharging power in the battery 2 attain 6.4 kWh and 7.5 kWh. Meanwhile, the community consume electricity from the grid amount 61 kWh.

Seeing the table V.10, for full year simulation, grid consumption in the community reaches 12907 kWh in the autumn season when they use 6550 kWh PV electricity. In result, the average of self-consumption rate reaches 76.75%. However, in summer season, total grid consumption reach 7862 kWh and average of SCR at 60.59%. Community has surplus PV production will be injected into the grid. Considering the distribution cost, the community have receive 229.26€ for energy injection in the autumn season and 438.49€ in the summer season. Community should pay to grid for electricity consumption amount 973.47€. In contrast, they have less payment at summer season amount 607.75€.

Day in Season	Total Grid (kWh)	Total PV (kWh)	Surplus (kWh)	Average SCR (%)	Cost to Grid (€)	Potential Incentive (€)
Autumn	12907	6550	1878	76.75	997.70	229.26
Winter	12593	5544	2720	75.77	973.47	194.03
Spring	7726	10384	6382	62.98	597.18	363.43
Summer	7862	9957	6279	60.59	607.75	438.49

Table V.10 Result of Centralized coordination of energy in district (community)

The MPC perform the optimization for full year. It has computing time around 9040.158 seconds. Centralized coordination have a challenge where the prosumer could not compute their incentive. Several possibility could be taken to solve this problem such as distribution of incentive equally among prosumer. Another option could be taken for instance; revenue from surplus energy is used for the community development such as PV capacity development. Possibility, the PV collective company is appropriate for energy providing in this scheme. The member’s consumption data privacy could be a big issue for this configuration, where each household should send the consumption data to coordinator.

### 5.2.4 Pool to Pool Energy Coordination via MPC

In this subsection, energy transaction between two pools is investigated. Each pool uses centralized coordination, where they take one participant as coordinator. The purpose of this configuration is to avoid lost excess energy value in the pool when the feed-in tariff is removed. The alternative is to inject the excess energy to another pool. When the community (ex Pool 1) produces energy surplus, it has an option to share it to another community (ex Pool 2) as shown in the figure V.6. Hence, the Pool 2 could buy electricity to Pool 1 when its PV production is not enough. Community (Pool 1) could sell its surplus to the grid when the other community (Pool 2) does not need it.

We propose the participants in this coordination based on table III.5 in the chapter 3. They are divided to two pools where each pool has 5 households as illustrated in table V.12. Both of pool 1 and pool 2, two of which are prosumer with PV and battery. The amount of equipment is shown in table V.13

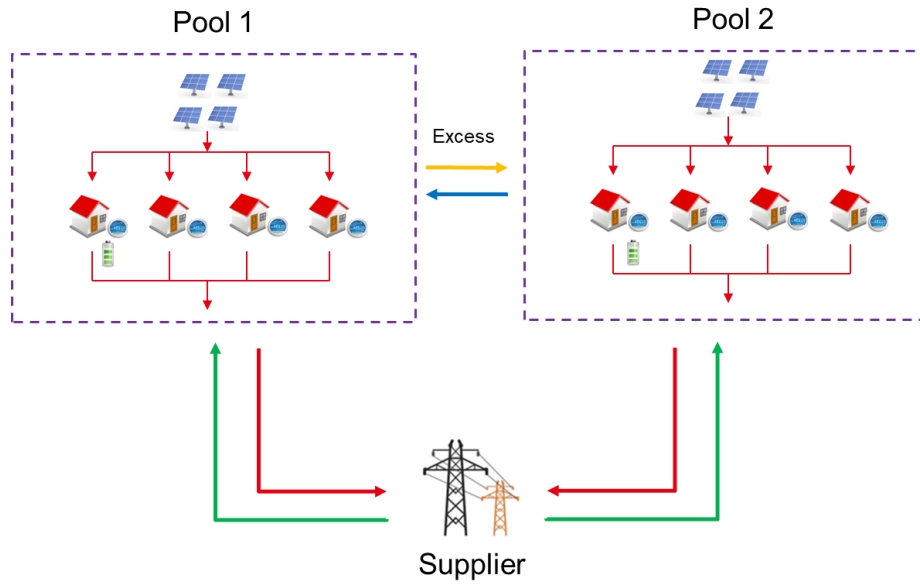

Fig. V.6 On grid Pool to pool coordination

Pool 1		Pool 2	
Participants	Code	Participants	Code
Family 1 (1 worker, 2 children)	HH2	Couple (2 workers)	HH1
Family 2 (1 worker, 1 child)	HH3	Retired couple ( No work )	HH6
Family 3 (2 workers, 2 children)	HH4	Single Parent Woman (worker, 1 child)	HH7
Family 4 (2 workers, 1 child )	HH5	Household 9 (Single woman, worker)	HH9
Single Parent Man (worker, 1 child)	HH8	Household 10 (Single man, worker)	HH10

Table V.11 Participant of pool-to-pool coordination

Model	Pool	Value	Unit	
PV	Pool 1	8	kWp	Prosumer P1 (HH2)
		4	kWp	Prosumer P2 (HH4)
	Pool 2	4	kWp	Prosumer P1 (HH1)
		2	kWp	Prosumer P2 (HH10)
Battery	Pool 1	5 x 2	kW	
	Pool 2	3 x 2	kW	
Based Load	load data from load profile generator			All Household
Grid		20	kWh	All Household

Table V.12 Parameter for pool-to-pool coordination modeling

Economical parameters are those used in previous bilateral contract where the electricity price from grid, PV production price and distribution cost are assumed at 0.1546€, 0.1€ and 0.03€

respectively. The optimization is in 24-hour time prediction with 30 minutes time sampling as well as the time slot index is 48. The coordination is perform in full year, subsequently determination of current time sampling is important to estimate time of modeling.

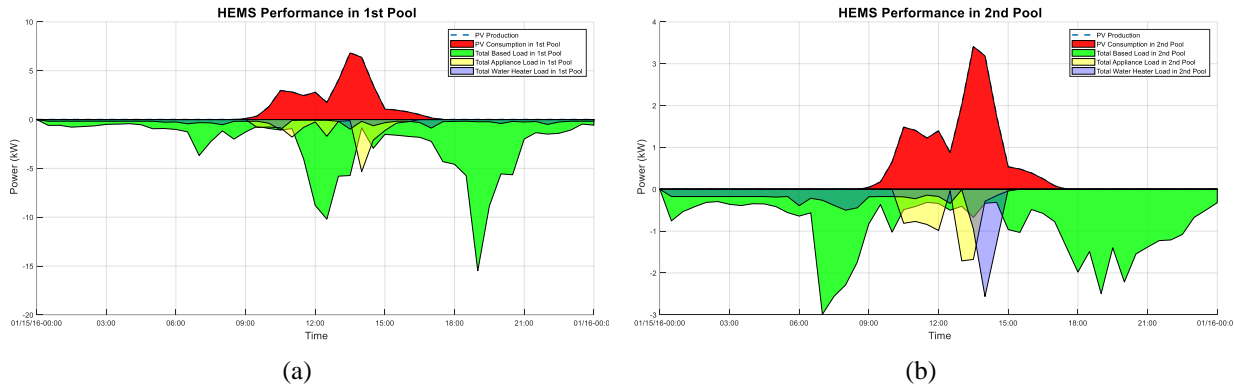

Fig. V.7 Trend of PV consumption in pool 1 and pool 2

Pool 1 perform the optimization for scheduling the appliances in each household until the objective function of pool is reached. In fig. V.7 (a), Pool 1 consume all PV production on 15 January, in result, the surplus energy is not exist and there are not sharing energy process. Whereas, pool 2 also consume their PV production to support households demand without additional energy from pool 1 (fig. V.7 (b)).

	House	Winter (15 Jan)		Spring (15 Apr)		Summer (15 Jul)		Autumn (15 Oct)	
		DW	WM	DW	WM	DW	WM	DW	WM
Pool 1	HH2	10:30	14:00	11:00	11:00	08:00	14:00	12:00	13:00
	HH3	14:30	12:30	08:30	-	-	-	13:00	12:30
	HH4	09:30	14:00	10:30	08:30	14:30	09:30	11:30	13:30
	HH5	11:00	14:00	-	-	-	-	06:30	12:30
	HH8	14:00	-	-	09:00	-	13:30	09:00	-
Pool 2	HH1	10:30	-	09:30	14:00	12:00	11:30	12:00	-
	HH6	-	-	-	-	-	-	-	-
	HH7	11:30	13:00	13:00	-	-	-	10:30	06:30
	HH9	-	13:30	10:30	-	12:00	-	-	11:30
	HH10	-	-	-	13:30	-	13:30	-	-

Table V.13 scheduling of dishwasher and washing machine in the pool-to-pool coordination

Optimization in this coordination could schedule the appliance where the pool reach the objective such as cost reduction. For instance, Dish washer in HH2 turn on at 10:30 whereas washing machine at 14:00 in a day in the winter season. Seeing the table V.13, Household in pool 1 enable

their appliances in the same time for achieving the goal. Conversely, we found the variation activation time in the household of pool 2. HH1 operate their dishwasher at 10:30 in a day of winter season. Through this modeling, activation time of dishwasher is shifted to 12:00 in a day in the summer. In the table, Household HH6 does not enable their flexible appliances because of the scheduling.

		Winter	Spring	Summer	Autumn
Grid Cost (€)	Pool 1	627.96	388.42	394.21	647.85
	Pool 2	359.17	216.84	215.21	360.26
Total Grid (kWh)	Pool 1	8124	5025	5100	8381
	Pool 2	4646	2805	2784	4661
Total PV (kWh)	Pool 1	3517	6773	6626	4289
	Pool 2	1929	3669	3518	2255
Average SCR (%)	Pool 1	85.57	73.34	72.69	89.51
	Pool 2	79.45	58.08	55.96	81.11
Potential Revenue (€)	Pool 1	50.44	115.05	109.04	26.88
	Pool 2	23.58	59.33	57.68	15.24
Surplus (kWh)	Pool 1	1441	3287	3115	768
	Pool 2	1991	4648	4469	1042

Table V.14 Result of pool-to-pool coordination in district (community)

Pool 1 pay the grid cost in the winter season amount 627.96€ and diminished gradually to 388.42€ in spring. In the summer, they pay less for grid electricity until 1.26 euro because of the availability of PV production. In Self-consumption section, pool 1 obtain average SCR amount 50.44% in winter season, however, it is dropped to 73.34% in the spring. Based on the table V.14, self-consumption in summer only reach 72.69%. It is caused by the household consumption and availability of PV supply. Furthermore, the pool 2 reach 79.45% of average SCR where they consume more PV production in winter and autumn. This case could be emerged because of low production that driven by weather condition. Pool 1 gain the revenue 50.44€ in the winter season where it contain incentive from pool 2 and grid. It grows up to 115.05€ in of the spring.

Computing time for this scheme is long. For one day ahead in winter season, computing time of MPC reach 1732 seconds and take more than 5320 seconds for day ahead in all season. Alike the Centralized coordination, Pool to pool based on centralized scheme has a challenge in sharing incentive when two prosumers or more exist in one pool. PV collective company is recommended

to provide energy; subsequently the recipient of incentive is clear. Data privacy also become big issue in this scheme.

### 5.3 Case study of Energy Coordination integrated with Thermal Building

#### 5.3.1 Background

The main principal of building especially house is to protect the human from weather and climate. The unremitting effort of humankind drive to find the adequate house design[2]. Social and economy sector also bring the development of the house in shape and function. Social sector encompass the increment of population, prestige, welfare and behaviour drive the growth of energy consumption where they look for convenience in the house[3]. Building sector take 30% to 40% of worldwide energy consumption[4], [5] where residential sector in France take 27.5% of energy consumption[6]. Heating and cooling equipment take a part into energy consumption where used for controlling the temperature of residential and commercial building. Their power consumption is driven by thermal comfort, where it is a factor that drive satisfaction of household (occupants). The motivation of this case study is to analyze contribution of thermal building for maximizing the self-consumption. We would like to create two condition such as energy coordination without optimization and under optimization via MPC-MILP.

#### 5.3.2 Introduction of INCAS Building

In this section, the energy management integrates the HVAC consumption, while the building INCAS model is applied (fig.V.8). This model was developed by CEA-INES for study the effect of thermal to energy consumption when it is applied in the energy management system. INCAS building model has several key characteristics such as

- Three thermal zones
- Dimension of ground floor is 6.5 x 7.5 x 2.5 m
- Glass surface in the ground floor where in the south is 18.75 m<sup>2</sup> or 39.5%, Glass surface in the west is 2.5 m<sup>2</sup> or 15.3%, Nord glass surface is 0.59 m<sup>2</sup> or 3.1%, lastly, glass surface in the east amount 0.46 m<sup>2</sup> or 2.8%
- Inertia of partition and inertia of floor are not modelled
- Vertical walls composition: coated, with 17 cm isolation and 5 cm concrete
- Floor composition; 20 cm isolation, 16 cm of slab and 8 cm of screed

- Temperature sky depends on the weather data
- Entrance door with  $0.8 \text{ W/m}^2\cdot\text{K}$
- The building does not install solar protection and roller shutters
- Ventilation flow is simulated equivalent with double flux ( modulation in single flux)

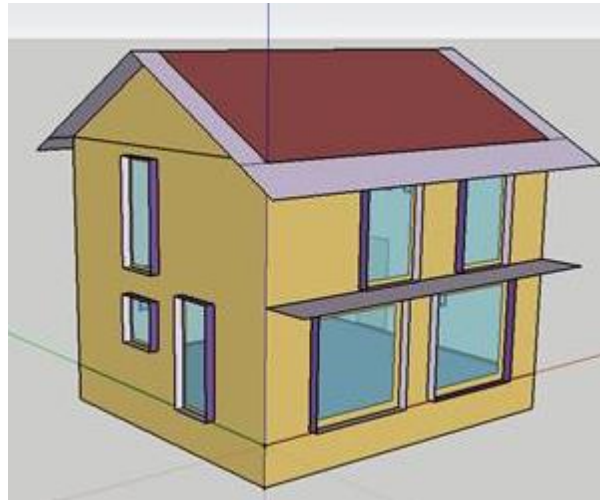

Fig. V.8. INCAS Building model

Using MPC, integration thermal building model in the energy management system is performed where the household is equipped with models such as PV, electric water heater, storage, load where the aggregation between based load and controller load is performed, and grid. The objective function in this MPC is focused on cost reduction in the household. Using coordination in the community, several households make the aggregation of their loads, batteries and PV's capacities.

For the use cases, two locations are considered: Chambéry ( $45^{\circ}34'0.01''\text{N}$ ,  $5^{\circ}55'59.99''\text{E}$ ) in France for a four season analysis, and Jakarta ( $6^{\circ}12'52.63''\text{S}$ ,  $106^{\circ}50'42.47''\text{E}$ ) in Indonesia with a tropical climate. There are 10 participants under coordination that follow the characteristics of table III.6 in the chapter 3. Using weather and PV data from each location, we will investigate where the occupation, price and time activation drive the better objective function.

### 5.3.3 Local coordination of district in Chambéry

#### 5.3.3.1 Concept of Coordination

The ten households of the energy community have the same goal to minimize the electricity cost as well as maximizing collective self-consumption. The PV and the battery devices could be from

the prosumers who decide to share them together in the district. All households collect their load data both based load, controllable load, and water heater load. Furthermore, the data will be aggregated with the others. All components perform aggregation to find the objective function in below

$$\min P_{grid} * \gamma_{grid} \quad \dots \text{(Eq. V.2)}$$

With energy balance as illustrated in eq

$$\sum P_{pv} + \sum P_{bat} + \sum P_{Load} + \sum P_{EWH} + \sum P_{House} + \sum P_{grid} = 0 \quad \dots \text{(Eq. V.3)}$$

The constraint of the components in the MPC were given in chapter 4. Here we add the building constraints that encompass the minimum and maximum of temperature that should be set in the house, thermal production (for heating and cooling) and HVAC power. Thermal production from heating ( $\Phi_{HVAC_{heat}}$ ) and cooling ( $\Phi_{HVAC_{cool}}$ ) process is determined, where it has lower and upper boundary. The mathematic model is prepared in equation V.4-8. Power of heating and cooling are determined by conversion factor ( $\epsilon$ ) where the heating appliance conversion factor ( $\epsilon_{heat}$ ) and cooling conversion factor ( $\epsilon_{cool}$ ) are assumed in 1/3000 and 1/980, respectively. Because of the PV production in positive so we create the power of HVAC in the negative position consequently the grid consumption could be determined if the PV production could not meet the demand.

$$0 \leq \Phi_{HVAC_{heat}} \leq \Phi_{HVAC_{heatmax}} \quad \dots \text{(Eq. V.4)}$$

$$\Phi_{HVAC_{coolmin}} \leq \Phi_{HVAC_{cool}} \leq 0 \quad \dots \text{(Eq. V.5)}$$

$$P_{HVAC_{heat}} = \epsilon_{heat} * \Phi_{HVAC_{heat}} \quad \dots \text{(Eq. V.6)}$$

$$P_{HVAC_{cool}} = \epsilon_{cool} * \Phi_{HVAC_{cool}} \quad \dots \text{(Eq. V.7)}$$



$$P_{HVAC} = P_{HVAC_{heat}} + P_{HVAC_{cool}}$$

... (Eq. V.8)

Case study for district Chambéry utilizes weather data produced by CEA. The others parameter for building such as Flux energy, solar radiation, Resistance and capacitance for the definition of matrix A and B are also prepared from CEA data. Accordingly, the data will be entered in the building model equation.

Occupancy also contributes to drive the building model result. The constraint of occupancy covers the appliance usage and take into account if occupants are working or on holiday. We use binary for the condition where ‘1’ means the occupant is located at home and ‘0’ otherwise. The limitation is represented by time when occupants start and finish their work. Weekend also impacts the building temperature, where the occupant have choice to stay at home or to go away. The controllable appliances are manage in accordance with the schedule from the customer. The schedule of dishwasher and washing machine is given in table III.7. However, in the weekend, enabling the appliance also refers to the occupancy of the occupant. If the household stay at home, the schedule refer to scheduling in table V.2. However, the appliances remain offline when the household take vacation in the holiday. In household’s holiday period, the appliances are also in offline condition.

The economic parameter for this coordination uses the updated data from EDF in 2019 where the “option base” price amount is 0.1546 €/kWh. The assumption data is prepared for distribution cost and feed in tariff when they have surplus energy that is injected into the grid. We assume a distribution cost amount 0.03 €/kWh and a feed in tariff of 0.1 €/kWh. The load shedding cost is not applied, we assume the load shedding is not occurred.

### **5.3.3.2 Observation of the Simulation**

The aim of this modeling is to reach objective function through centralized coordination in the community. District Chambéry install PV and battery for fulfil the electricity demand of the members. 10 households become the community’s member where they share their consumption data for optimization purpose. Data component for this optimization could be seen in table V.15. PV data time series and weather data is taken from European PVGIS where they contribute in the PV data model and thermal building model. Maximizing of self-consumption in the community

also becomes the target to anticipate elimination of feed in tariff. However, in this modeling, the feed in tariff still exists and is used for the energy surplus that cannot be shared amongst the community.

Model	Parameter	Value	Unit	
PV		20	kWp	District
Battery		2x10	kW	District
Based Load	Consumption data from load profile generator software for 10 households		kW	
Dish Washer			kW	
Washing Machine			kW	
Electric Water Heater	Power rate	1.2	kW	All household
	Heat conductivity	$4.2 \cdot 10^{-5}$	kW/m.K	
	Heat Capacity	4.184	kWs /kg.K	
	Tank Volume	0.35	m <sup>3</sup>	
	Height of Tank	0.1	m	
	Inner radius	0.3338	m	
	thickness	0.1	m	
	Water density	1000	kg/m <sup>3</sup>	
Grid		100	kW	All household
HVAC	Cooling power rate	1	kW	All household
	Heating power rate	3	kW	

Table. V.15. Data component for coordination including thermal building

The centralized coordination apply the manual load-shifting method. Aggregation between the based load and flexible loads is applied where the dishwasher and washing machine operate at 12:00 pm and 11:00 am respectively. In the scenario, the occupants leave home at 08:00 am to go to workplace, and come back at home at 05:00 pm. The occupants also stay at home during the weekend. The modeling use common parameter such as time sampling ( $\Delta t^{MPC}$ ) 30 minutes in prediction horizon ( $h^{MPC}$ ) 90 days. Subsequently, time slot for computing ( $N^{MPC}$ ) is 4320.

Furthermore, electric water heater is an equipment that is used for optimization in each household. For this MPC, initial temperature is set in 50°C where the lower bound and upper bound of EWH

temperature is adjusted in 50°C and 60°C respectively. In addition, the inlet water temperature is assumed at 15°C, and the ambient temperature is fixed in 20°C. The volume of entered water is equal with water consumption in the household, in consequence the volume of water storage is not changed. Water consumption data is based on data from load profile generator software.

In HVAC, we consider the heating power conversion where 0.98 kW heating power (thermal) is equal with 1 kW in electric power. Whereas in cooling power conversion, 3 kW of cooling energy is equal with 1 kW of electric power. In setting temperature, upper bound for the house is set at 26°C and the lower bound is 18°C. The optimal temperature of the house is set at 22°C with a 2°C tolerance.

### 5.3.3.3 Result of Energy Management in District Chambery

Results of the simulation are illustrated in the fig V.9 and 10 where data are related to 1 month (January) in the building 1. The following observations can be made:

- MPC sets the indoor temperature settle in optimum temperature 22°C constantly even if the outdoor temperature goes below the lower temperature of the building. Then the uncomform indicator remains zero.
- In the fig. V.9, the temperature of water heater in the household 1 stand in 50°C, with the maximum hot water reached at 50.74°C. To reach the objective function (minimizing electricity cost), MPC operates the EWH proportionally. Household 1 consume 87 kWh in January for EWH or 3.4 kWh/day in average. Whereas, it consume amount 307 kWh for 90 days. In fig. V.10, total EWH power consumption in district Chambery on January is 1025 kWh where the average EWH energy consumption is 44.57 kWh per day and 5526 Wh in maximum when the EWH operates. Furthermore, total of energy consumption for first 90 days is 3825 kWh with EWH average energy amount 42.50 kWh per day.

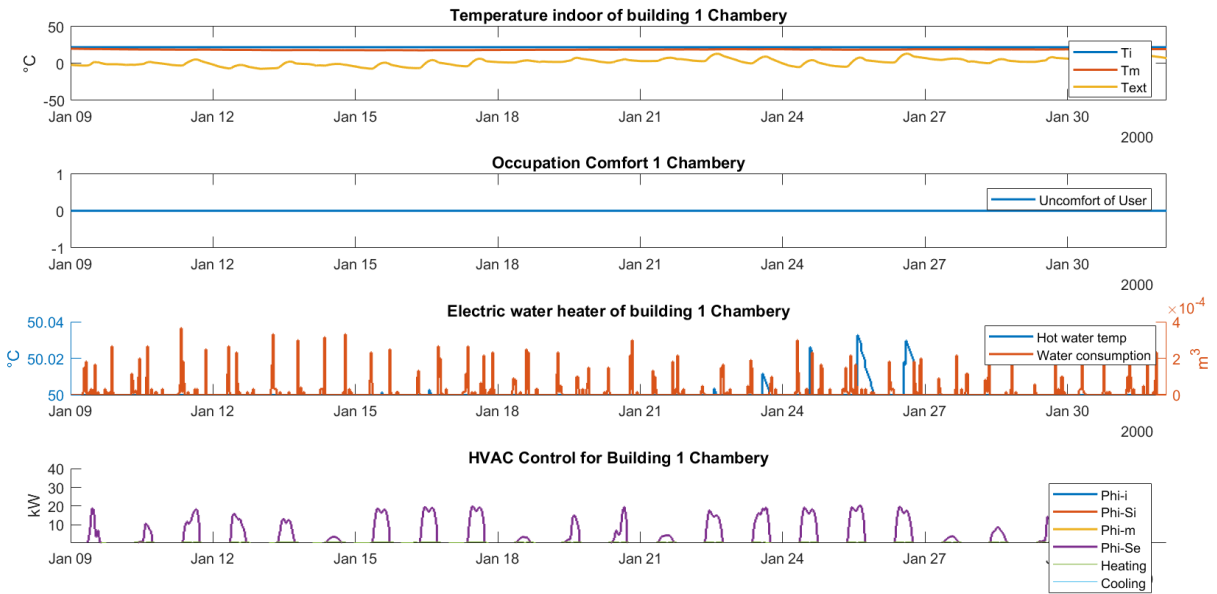

Fig. V.9. Profile of the household in district Chambery

- MPC also drives the HVAC proportionally. In household 1, HVAC power that used for reaching the optimum temperature for 90 days is 1882 kWh where the average of energy that used at 435.7 Wh in 30 minutes. In addition, district Chambery consume 18817 kWh with 4.35 kWh per 30 minutes.

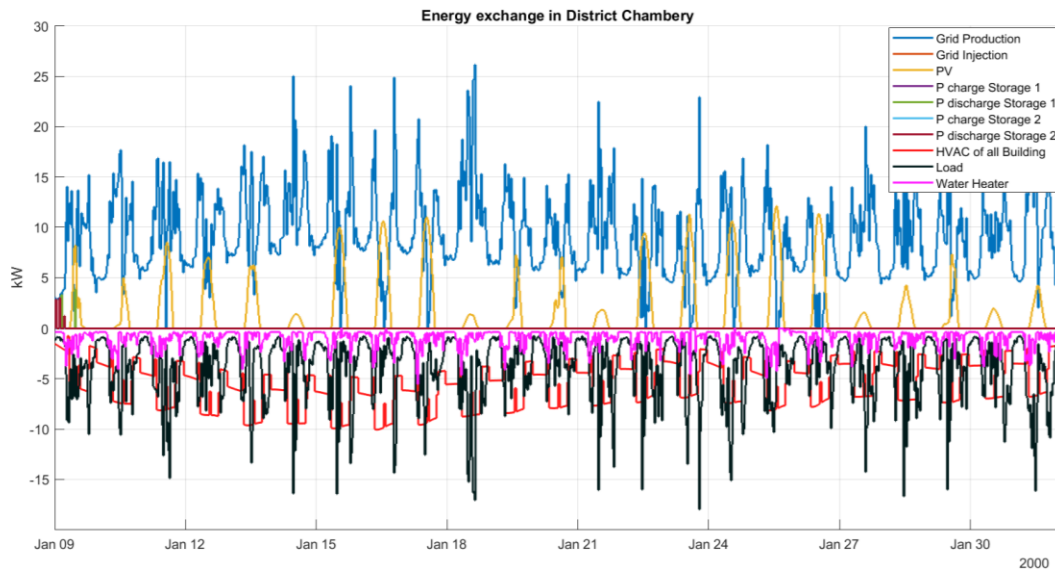

Fig. V.10. Electricity profile in the community

- In this scheme, MPC utilizes all PV power for covering all demand in the district of Chambéry as illustrated in fig V.10. Subsequently collective self-consumption reaches 100% and there are not energy surplus in the district. The water heater and HVAC in all households are operated every day, as result the grid consumption will also emerge.

In the further observation, result of MPC with optimization will be compared with district without optimization (DWO). In DWO scheme, the household operate their flexible appliances such as dishwasher and washing machine is activated in accordance of household behavior. The schedule of activation flexible appliance refer to the table III.7 in chapter 3. However, the household occupancy (holiday and weekend condition) influences the scheduling of appliances operation. The scheduling refer to table V.2. The comparison is prepared based on the season and it could be seen in the table V.16.

Season	District without optimization (DwO)					
	Cost Grid (€)	Cost PV (€)	Grid (kWh)	PV (kWh)	SCR (%)	Excess (kWh)
Winter (Jan – Mar)	5172	828	33454	8281	91.72	747
Spring (Apr – Jun)	2582	1066	16702	10655	62.63	6357
Summer (Jul – Sep)	2574	937	16649	9374	57.78	6850
Autumn (Oct – Dec)	4969	629	32142	6295	91.39	593
Season	District under Optimization (DuO)					
	Cost Grid (€)	Cost PV (€)	Grid (kWh)	PV (kWh)	SCR (%)	Excess (kWh)
Winter (Jan – Mar)	4517	903	29217	9028	100	0
Spring (Apr – Jun)	1171	1701	7576	17012	100	0
Summer (Jul – Sep)	968	1622	6262	16224	100	0
Autumn (Oct – Dec)	4392	689	28409	6888	100	0

Table. V.16. Energy consumption and cost in the district Chambéry

In winter, MPC could reduce the grid cost where the district save 655€ (12.66%) than grid cost without optimization. However the greatest saving reached by MPC when the summer season data is measured. In total energy cost, DuO in the winter for district energy consumption reach 5420€ or saving 9.67% when it is compared by total energy cost of DwO. Furthermore, DuO could saving 26.22% than total energy cost of DwO in summer season. The length of PV production area drives these phenomena whereas MPC maximizes the amount of PV production for energy demand. It could be seen from Self-Consumption Rate (SCR) and Excess Energy where SCR of MPC reach

100% and 0 kWh respectively. In contrast, the district without optimization SCR only reach 57.78% and excess energy in 6850 kWh.

Applying feed in tariff in this scenario perhaps brings benefit for the district. Nevertheless, the district should be looked for the new opportunity to reach the incentive when the feed in tariff is eliminated from the system, for instance, excess energy is sold to the other district or consumer that need the cheapest electricity. In addition, PV production is dropped in 6888 kWh in autumn, consequently SCR achieve 100% the cost PV is 689€ or lower than PV cost in other season. Whereas, district without optimization achieve SCR 91.39% in another word, the MPC could improve 9.61% energy cost of district.

### **5.3.4 Local District in Jakarta**

#### **5.3.4.1 Background**

Indonesia is an archipelago located in the equator zone with population more than 270 million and fourth largest in the world after China, India and USA. Indonesia challenges to reify energy sustainable. Furthermore, Indonesia as developed country faces the energy problem such as limitation of fuel energy and pollution in particular air pollution. The growth of residential in this country in particular Jakarta gives impact to energy providing and in emission also. These condition drive the government and civil society to look for alternative energy solutions for supplying electricity

<b>Renewable Energy Potential in Indonesia</b>	
<b>Source</b>	<b>Produced Energy Potential</b>
Hydro	94.3 GW
Geothermal	28.5 GW
Bio Energy	Bio Power Plant :32.6 GW
Biofuel	200000 Bph
Solar	207.8 GWp
Wind	60.6 GW
Sea Wave	17,9 GW

Table. V.17. Potential renewable energy in Indonesia

Indonesia has several resource potentials that can be used for electricity production, in particular solar energy. According to table V.17 [7], it becomes one of alternative energy resources with an

estimated potential of production that reaches 207.8 GWp, subsequently it is extremely valuable for solar energy development.

For economic point of view, Electricity tariff from Electricity Company (PLN) in Indonesia is Rp.1430/kWh or 0.0841€/kWh where it will be evaluated after 3 month. Indonesian government through ministry of Energy and Mineral Resources regulation encourage the residents to install local PV system and offer net metering where the energy excess will be multiplied by credit factor amount 65%. Subsequently the grid consumption in the next 3 month will be reduced with excess power.

Based on the location, Indonesia has two seasons such as dry and wet. It will highly influence the solar irradiance. The modeling is prepared in purpose to investigate the cost reduction and self-consumption if the INCAS building is installed in Jakarta, Indonesia.

Model	Parameter	Value	Unit	
PV		20	kWp	District
Battery		2x10	kW	District
Based Load	Consumption data from load profile generator software for 10 household		kW	
Dish Washer			kW	
Washing Machine			kW	
Electric Water Heater	Power rate	1.2	kW	All household
	Heat conductivity	$4.2 \cdot 10^{-5}$	kW/m.K	
	Heat Capacity	4.184	kWs /kg.K	
	Tank Volume	0.35	m <sup>3</sup>	
	Height of Tank	0.1	m	
	Inner radius	0.3338	m	
	thickness	0.1	m	
	Water density	1000	Kg/m <sup>3</sup>	
Grid		100	kW	All household
Building	Cooling power rate	1	kW	All household
	Heating power rate	3	kW	

Table. V.18. Parameter for coordination including thermal building

### 5.3.4.2 Simulation

District Jakarta applies centralized coordination scheme where district members use PV and battery system in collective way. PV data time series and weather data is taken from European PVGIS where they contribute in the PV data model and thermal building model. In this scheme, DSM technique such as load-shifting method is performed manually. Aggregation between the based load and flexible loads is applied where the dishwasher and washing machine operated at 12:00 pm and 11:00 am respectively. It was applied for all household in the community. The scenario also apply occupancy of the household that refer to table V.4. Occupants leave home at 08:00 am for going to workplace, and come back at home at 05:00 pm and further they stay at home when the weekend is arrived.

For research simulation, MPC still applies the electricity from PLN amount 0.0841€/kWh. In addition, MPC takes assumption for feed in tariff amount 0.0547€/kWh and distribution cost is negligible (According to Permen ESDM no.49 2018, there is not distribution cost that paid by customer to the grid (PLN)). To ease the modeling, we propose to divide 2 season in full year where the dry season start from April to September and the wet season is October to March. Subsequently for modeling is performed. it use common parameter such as time sampling ( $\Delta t^{MPC}$ ) is 30 minutes in 90 days prediction horizon ( $h^{MPC}$ ). Subsequently,  $N^{MPC}$  is 4320.

In HVAC, we consider the heating power conversion where 0.98 kW heating power (thermal) is equal with 1 kW in electric power. Whereas in cooling power conversion, 3 kW of cooling energy equal with 1 kW of electric power. However, the module could not reach optimum when the cooling system placed 1 kW in cooling electric power. Consequently, we propose two cooling system with similar power for the modeling. In setting temperature, the upper bound for the house is 26°C and the lower bound is 18°C. The optimum temperature of the house is set in 22°C where the tolerance of temperature is 2°C.

$\gamma^{grid}$	$\gamma^{PV}$	$\phi^{grid}$	$\Delta t^{MPC}$	$h^{MPC}$	$N^{MPC}$
0.1546 €/kWh	0.1 €/kWh	0.03 €/kWh	30	2160	4320

Table. V.19 Common setting parameter in the district energy coordination



### 5.3.4.3 Result

MPC operate all the model and the result could be seen in figure V.11-12 where the performance of building 1 in January is shown. From these plots, the following observation are made

- MPC keep the indoor temperature of building in 22°C even though the external temperature is higher. It is reflected in the occupation comfort plot where the uncomfortable of user ratio near to zero.
- MPC adjust the hot water temperature of EWH in building 1 between lower bound and upper bound. However, in order to reach optimum of objective function, EWH do not operate until the upper bound. In consequence, the EWH consume electricity proportionally. It means the EWH should not consume the electricity until maximum power rate in its operation. Based on the fig. V.11, the hot water kept in 50°C and the highest temperature that reached in this MPC is 50.48°C. Most of activation EWH is perform when the PV production is existed. Subsequently, it help the district to maximize self-consumption as well as grid consumption reduction. The average power rate that used by EWH to keep the hot temperature around 79.2 W and the maximum power rate of EWH is 1200 W. In fig. V.12, the average energy consumption of EWH in January is 3407 Wh/day. In addition, the average energy consumption in January reach 3407 Wh/day where the maximum EWH energy consumption in the district Jakarta stand in 12 kWh ( fig. V.12)

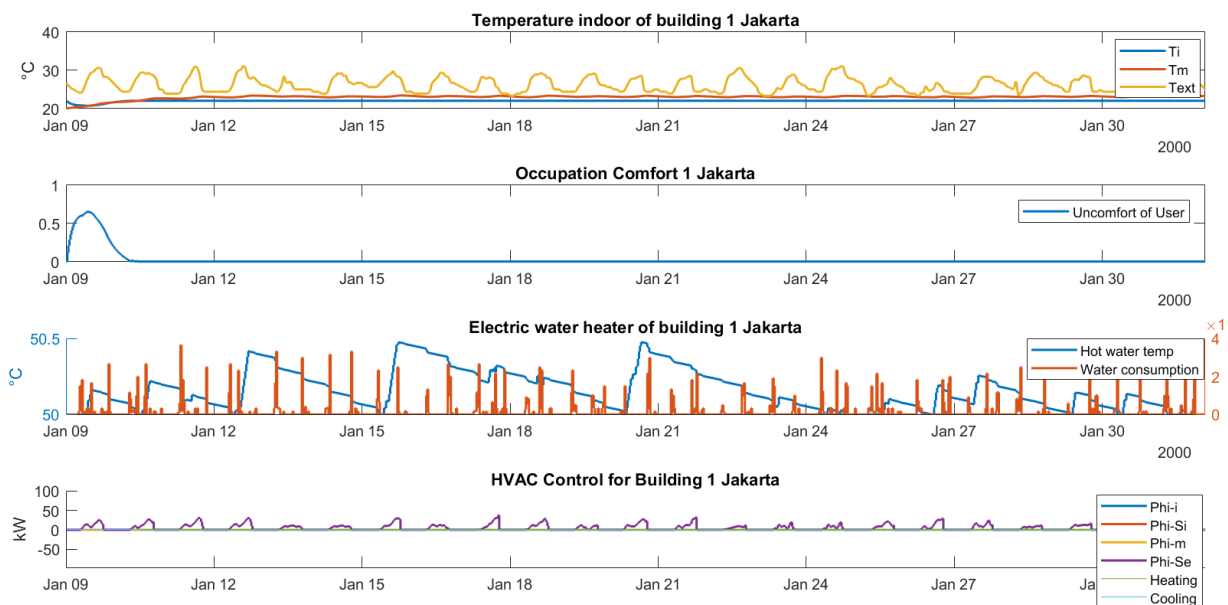

Fig. V.11. Profile of the household in district Jakarta

- MPC also adjust the HVAC power rate in the building 1 proportionally where the cooling process is applied. HVAC always in status ‘on’ in purpose to cool the room of building 1. With this method, HVAC make participation to reduce the grid consumption as well as cost reduction and reach the comfortable condition at home. Energy consumption of District Jakarta’s HVAC in January reach 2433 Wh in average and 3473 Wh in maximum.

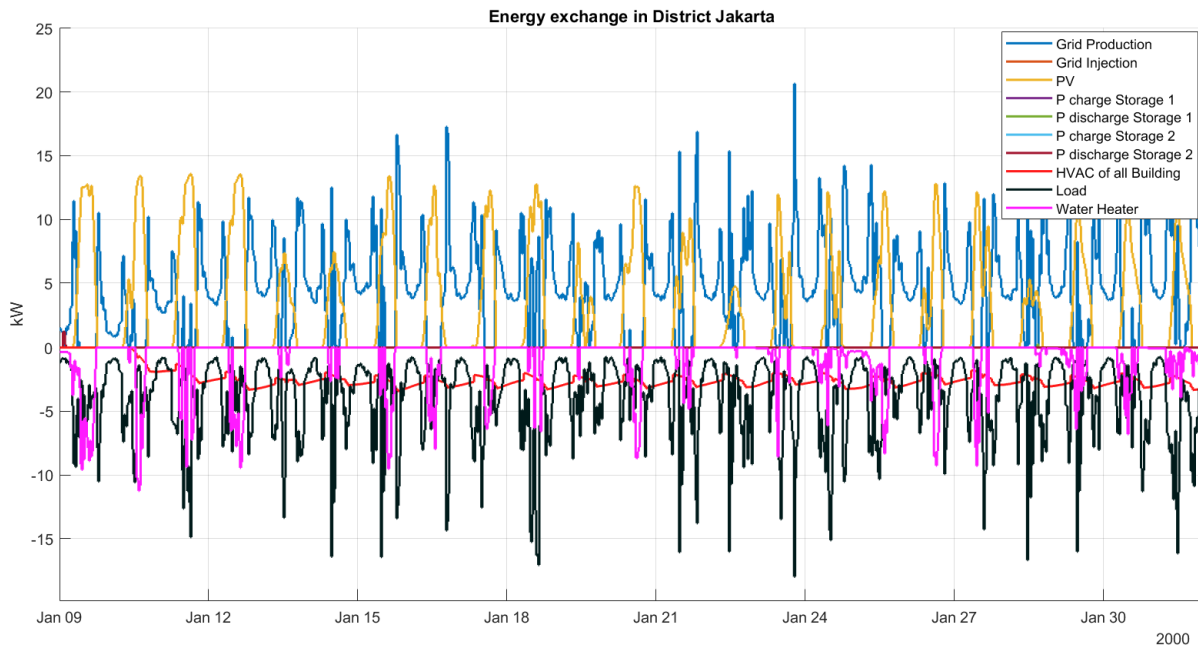

Fig. V.12. Electricity profile in the district in Jakarta

Season	District without Optimization (DwO)					
	Cost Grid (€)	Cost PV (€)	Grid (kWh)	PV (kWh)	SCI (%)	Excess (kWh)
Dry (Apr – Sep)	4761	552	56603	19461	97.31	600
Wet (Rain) (Oct-Mar)	4416	463	52493	21502	86.82	3308
Season	District under Optimization (DuO)					
	Cost Grid (€)	Cost PV (€)	Grid (kWh)	PV (kWh)	SCI (%)	Excess (kWh)
Dry (Apr – Sep)	4050	623	48147	20061	100	0
Wet (Rain) (Oct-Mar)	3424	466	40704	24810	100	0

Table. V.20. Energy coordination without optimization and MPC in district Jakarta

Table V.20 show the full year data that divided in 2 season for District without optimization and under optimization. Several data are taken from both to show the different of performance between them. We observe some criteria as follow

- MPC bring maximum self-consumption in all season. PV production provide the electricity to support the district demand. In the dry season, district Jakarta with DuO consume PV amount 20061 kWh or it grow 3.08% than PV consumption in the DwO. Total PV consumption for full year of DuO increase 9.54% when it is compared by DwO's total PV consumption.
- MPC reduce the grid consumption as well as diminish the electricity cost from provider. It saving 18.56% if compared with DwO's grid cost. Because of the PV consumption, collective PV cost in DuO grow to 9.54% than DwO's PV consumption.
- In the energy cost issue, DuO in Jakarta should pay 4050€ to the grid for grid consumption in dry season. It save 14.93% than DwO's grid cost. Furthermore, DuO's total energy cost in the dry season saving 679€ or 11.64% than DwO's total energy cost.

### **5.3.5 Return of Investment for PV system in District**

Investment of PV system in the district for collective self-consumption is important to be calculated in order to get the profit. We propose to investigate the gain of PV consumption to community investment. Consequently, Cost from installation of PV system that cover the capital expenditure (CAPEX), operational expenditure (OPEX) and tax is considered. We propose the example of ROI calculation in the two district with similar parameter where they have SCR result in DuO and DwO. Firstly, we assume the financial parameter that use for ROI calculation where they are illustrated in table V.21

<b>Financial Component</b>		<b>unit</b>
<b>Customer tariff</b>	0.1546	€/kWh
<b>Feed in Tariff (After grid cost)</b>	0.07	€/kWh
<b>Carbon credit</b>	0.01	€/kWh
<b>Tax Rate</b>	10%	
<b>Inflation adjustment</b>	3%	per annum
<b>depreciation FiT</b>	10%	per annum
<b>improvement carbon credit</b>	1%	per annum

Table V.21. Evolution of the tariff for ROI calculation

In this calculation, Customer tariff is taken from based option from EDF, which the inflation of the tariff will be considered. Feed in tariff has been reduced by grid cost in order to gain thee ROI. Feed in tariff will be diminished, in consequence depreciation is considered. Carbon credit is also taken into account for consumed PV appreciation. We assume it will be improved 1% per year in the future. Tax rate for PV production determined in 10%.

PV system itself, the performance ratio and annual degradation are presupposed on 75% and 0.75%, respectively. Investment and installation cover the EPC turnkey and project development where they are on 2250 €/kWp and 10000 €. Furthermore, we suppose the maintenance and operational 100 €/kWp/year and insurance premium from initial investment is 0.8%.

Financing from bank is needed when the district would like to build the PV system. In this case study, the district take debt funding 50% of their investment. We assume the bank give interest 10% with maturity time on 5 years.

**District Chambery for 30 years**

<b>Annual Insolation</b>			1591.24	kWh/m <sup>2</sup>
<b>Total PV</b>			49152.84	kWh
<b>District without Optimization (DwO)</b>	SCR - 70.4%	Project Return Post Financing and Tax	4%	
		ROI (Return on Investment)	26	years
<b>District under Optimization (DuO)</b>	SCR - 100%	Project Return Post Financing and Tax	9%	
		ROI (Return on Investment)	16	years

Table V.22. Return on Investment for District Chambery

In simulation, PV total in District Chambery is 49152.84 kWh. District without Coordination have SCR in 70.4%, Investment for PV system gain the investment return over 30 years around 4% where the ROI is in 26 years. Meanwhile, the District under coordination (DuO) with 100% of SCR reach the project return in 9% with ROI in 16 years. In consequence, the PV producer begin to obtain the profit (see table V.22).

First year, OPEX in district Chambery is 2940 €/year, its value will be increased because of evolution of inflation amount 3%. Consequently in year 30<sup>th</sup> the OPEX value is 5556 €/year. The equity payout of DwO start the net operating cash flow from 1146 €. Nevertheless, the PV producer have to pay to bank around 7254 €. Cash equity move to positive value when the debt service is finish in 5 year where they receive 3316 of investment gain. This trend is illustrate in figure V.13 (1a). Figure V.13 (1b) show the payback period where the PV owner invest their money and start to receive the revenue from PV production from period 6<sup>th</sup>. In addition, they begin to make profit after 26 years.

Furthermore, DuO where the households apply fully controlled bring net operating cash flow and equity in 2269 € and -2236 €, respectively (see figure V.13 (2a)). After 5 year and investment gain around 9%, the DuO start receive the revenue 4349 €. Moreover, figure V.13 (2b) show the

payback of PV investment where the DuO start their revenue until ROI is reached and even take the profit until new investment period is arrived. The detail financial calculation is available in Appendix D.

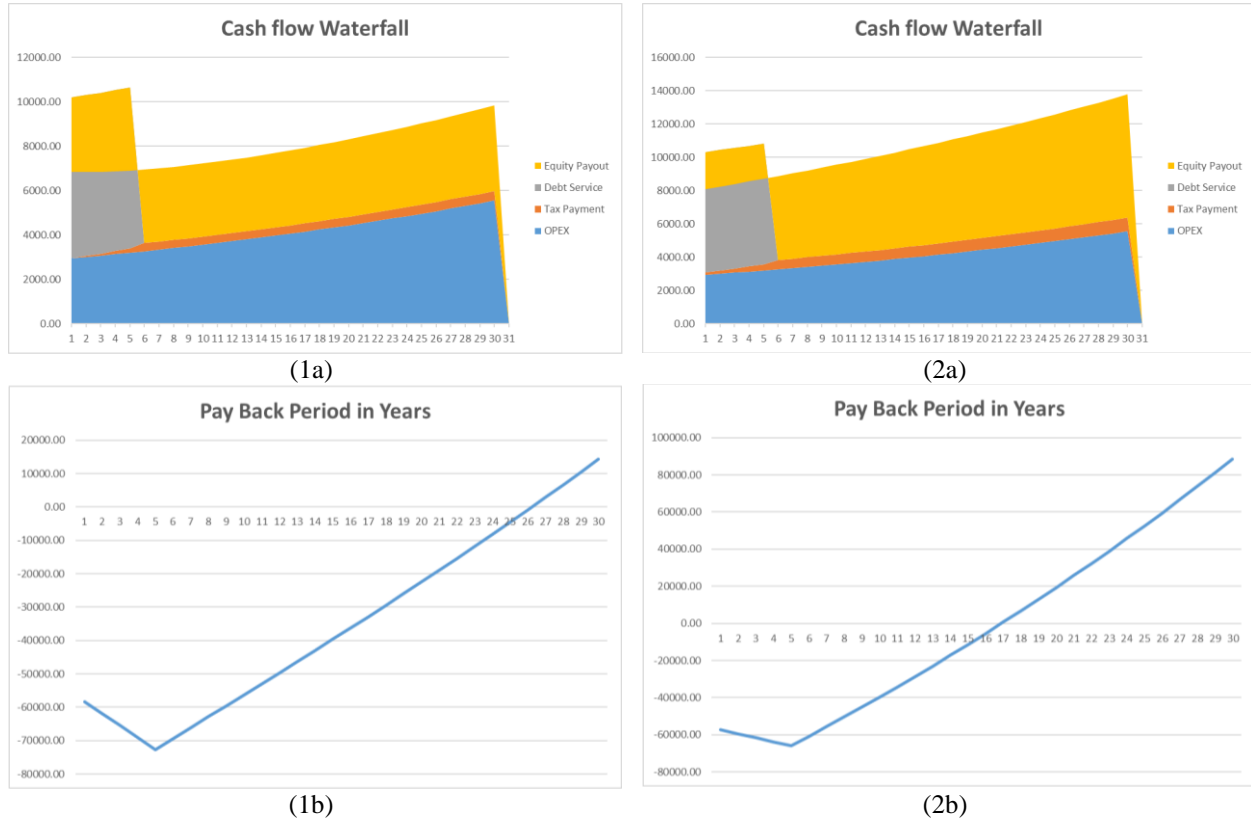

Fig.V.13. Payback and cash flow of PV provider in the district Chambéry. (1a and 1b). Return of Investment for reference SCR result and Cash flow in reference SCR result (2a and 2b). Return of Investment for optimization SCR result and Cash flow in reference optimization SCR result

Meanwhile, District Jakarta also gain the profit from their PV system investment both without optimization and under optimization. In this simulation, we use France electricity basic tariff references. According to table V.23, Total PV production in District Jakarta is 44871 kWh and it gain SCR 91.29% when the district do not apply optimization (using their behavior). Investment gain of this method reach 6% and they start to make profit after 21 years. However, The return of Investment is improved when the district apply optimization, It use all PV production (SCR is 100%), in consequence the investment gain of this method reach 7% and they start to make profit after 19 years.

District Jakarta for 30 years

<b>Annual Insolation</b>			1503.15	kWh/m <sup>2</sup>
<b>Total PV</b>			44871	kWh
<b>District without Optimization (DwO)</b>	SCR - 91.29%	Project Return Post Financing and Tax	6%	
		ROI (Return on Investment)	21	years
<b>District under Optimization (DuO)</b>	SCR - 100%	Project Return Post Financing and Tax	7%	
		ROI (Return on Investment)	19	years

Table V.23. Return on Investment for District Jakarta

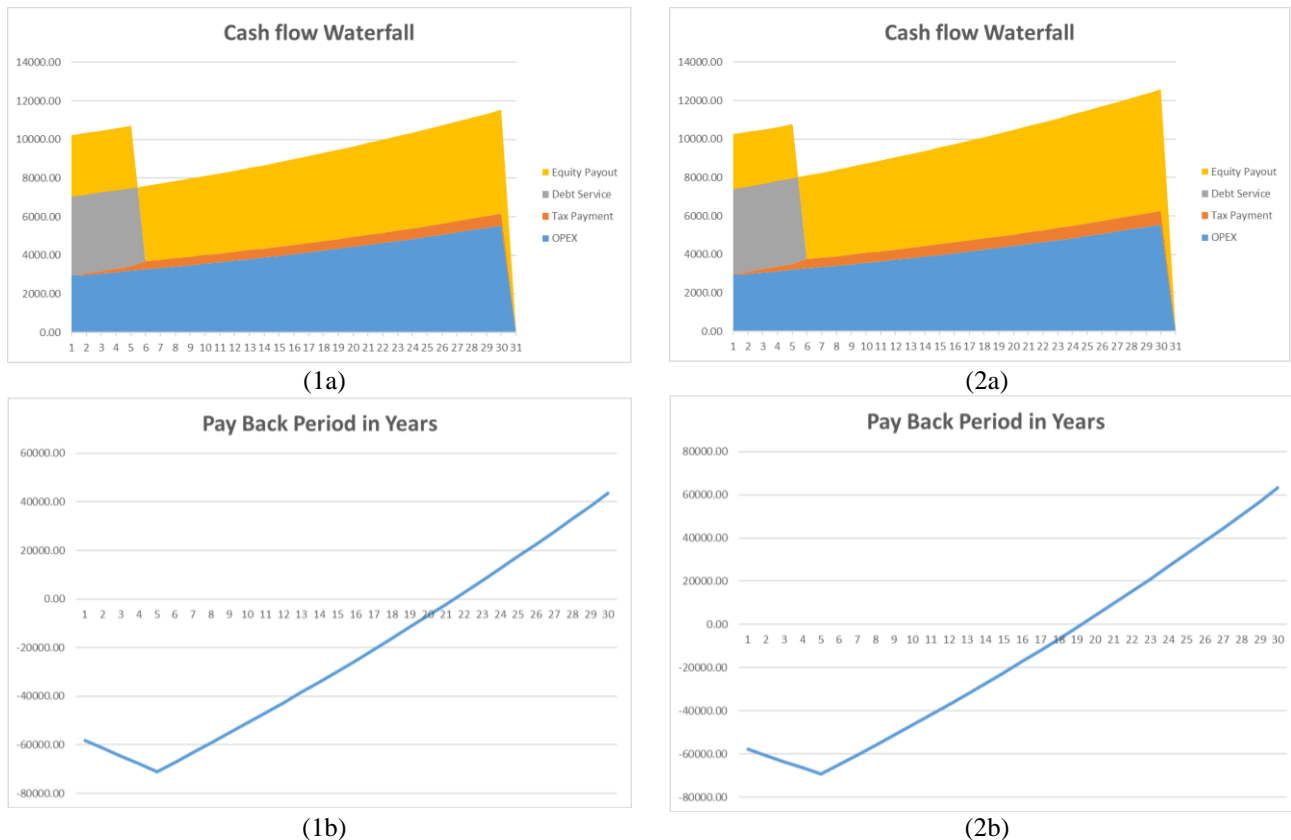

Fig.V.14. Payback and cash flow of PV provider in the district Jakarta. (1a and 1b). Return of Investment for reference SCR result and Cash flow in reference SCR result (2a and 2b). Return of Investment for optimization SCR result and Cash flow in reference optimization SCR result

The cash flow and payback period of DwO is illustrated on figure V.14 (1a and 1b) where the first net operating cash flow is 1337 €. After bank payment in 5 years, the district start receive the revenue around 3891 €. It value become the equity of district which it will be increased until the new investment is applied. At the same time, DuO open their net operating cash flow from 1634 € where the bank debt service will be paid in 5 years (figure V.14 (2a)). This district begin to

withdraw the revenue at 6<sup>th</sup> year with investment gain around 4349 €. Similar with DwO financial calculation, the gain will be become the district equity and it continue grow until new investment period is arrived (figure V.14 (2b)).

### 5.4 Conclusion

In this case study, several market model for electricity is proposed such as bilateral contract between prosumer and consumer. Its goal to reduce the electricity cost in prosumer and consumer, gain the self-consumption and revenue in prosumer side. Constraint of EWH and occupancy participate in the modeling. Occupancy based on the holiday that taken by household and appliance usage in each week. Bilateral contract with optimization help the prosumer to improve SCR as well as cost reduction. It also help consumer for decreasing of grid electricity. Thus, Scheduling of flexible appliance in both of prosumer and consumer give the better result than basic scheduling (based on user behavior).

To gain the cost reduction, prosumer could also take energy from another prosumer. This coordination is formed where the simulation apply parameter and condition in the prosumer to consumer energy coordination. The procedure of this method almost similar with previous method where each prosumer perform the optimization. Cost reduction in the second prosumer will be occurred when they consume surplus energy that produced by first prosumer. The similar condition, first prosumer consume the surplus energy of second prosumer when they have a lack energy. Prosumer to prosumer coordination also help to improve SCR in the prosumer and give benefit in the incentive part. Consequently, the coordination is mutually beneficial between them.

Centralized coordination in the community give opportunity for household as member to reduce their cost. Prosumer in this scheme could improve their SCR because of participation of the coordination member. It also give opportunity to prosumer to gain the incentive from energy sharing and the consumer to reduce their electricity cost. Nevertheless, it is difficult to determine the incentive, because the PV is mingled. The alternative of centralized coordination is to use the independent PV provider, subsequently the incentive of cost could be counted. The challenge in this configuration is household data privacy protection. Where the household shares several data to the community.

In Pool-to-Pool coordination, the excess energy from the pool could share to another pool in purpose to support the lack of energy. The pool also could use the excess energy if their PV production could not meet the demand. This problem will be similar with centralized coordination when the pool use centralized interaction among the household.

Thermal building is an important component in the energy coordination because of its usage in every day. The quality of life of occupant is depend on the indoor temperature. Optimum temperature is applied to reach the comfort condition. Thermal building is integrated to energy coordination. The modeling of energy coordination in Chambéry and Jakarta improve self-consumption rate from 70.4% to 100% and 92.07% to 100%, respectively. In cost saving, district of Chambéry and Jakarta reach 2794 € and 1489 €, respectively. In investment sector, PV producer in the district have the differentiation between DuO and DwO. ROI in DwO of district Chambéry reach 16 years than ROI in DuO that obtain 26 years. Furthermore, the ROI in DwO of District Jakarta reach 19 years than ROI in DuO that obtain 21 years.

## Reference

- [1] E. Morel, "Towards the « uberization » of the electricity market?," Apr. 18, 2016. <http://www.smartcitiesbymachnteam.com/en/2016/04/18/towards-the-uberization-of-the-electricity-market/>.
- [2] V. V. Tyagi and D. Buddhi, "PCM thermal storage in buildings: A state of art," *Renewable and Sustainable Energy Reviews*, vol. 11, no. 6, pp. 1146–1166, Aug. 2007, doi: 10.1016/j.rser.2005.10.002.
- [3] IEA, "Energy Efficiency 2019," *IEA Paris*, 2019. <https://www.iea.org/reports/energy-efficiency-2019>.
- [4] B. Abu-Jdayil, A.-H. Mourad, W. Hittini, M. Hassan, and S. Hameedi, "Traditional, state-of-the-art and renewable thermal building insulation materials: An overview," *Construction and Building Materials*, vol. 214, pp. 709–735, Jul. 2019, doi: 10.1016/j.conbuildmat.2019.04.102.
- [5] N. Fumo, "A review on the basics of building energy estimation," *Renewable and Sustainable Energy Reviews*, vol. 31, pp. 53–60, Mar. 2014, doi: 10.1016/j.rser.2013.11.040.
- [6] Odyssee-Mure, "Energy efficiency trends and policies," *FRANCE PROFILE*. <https://www.odyssee-mure.eu/publications/efficiency-trends-policies-profiles/france.html#buildings>.
- [7] Suharyati, S. H. Pambudi, J. L. Wibowo, and N. I. Pratiwi, "Indonesia Energy Outlook 2019." National Energy Council, 2019, [Online]. Available: <https://www.esdm.go.id/assets/media/content/content-outlook-energi-indonesia-2019-bahasa-indonesia.pdf>.



# Conclusion

## Contribution

In the context of Energy Coordination through optimization, The research led in this dissertation aimed at the development and demonstration of an advance strategy for building the energy sharing in the community, practically implementable

The motivation for this research is the fact that PV owner (prosumer) provide the surplus energy where will be free in charge when the regulation about feed in tariff is expired. In result the prosumer will loss their incentive. To anticipate this condition, as alternative, the prosumer gain their cost reduction as well as improve their self consumption until the surplus energy did not emerged. There are two methods such as increment of battery and energy management. However, the household have limitation to maximize their consumption for 100% self-consumption every day, in result the surplus energy will be existed. Energy coordination in the pool is great help for allocating the existed energy. Prosumer share their excess energy to consumer that looking for the cheaper price of electricity in pupose to drive their goal such as cost reduction. Several type of energy market is introduced in paper references and further, we nominate them to simulation implementation in purpose to indentify the improvement of the goal in the household both prosumer and consumer.

In this thesis, we propose several methods for energy sharing where the pool is filled by prosumer and consumer. Each household both prosumer and consumer will perform energy management technique namely load shifting for controllable appliances in their house. Heading to the simulation, preparation data needed such as load consumption, controlable appliances and pv generation. Several methods for load forecasting is prepared by references. However, for simplifying the process, we propose to harness software load profile generation to achieve the data for day ahead (short time load forecasting) or full year (medium term load forecasting). It also prepare the type and specification of controllable appliances such as washing machine and dish washer. Meanwhile, the paper references contribute various method for PV data forecasting either specification based on horizon and historical data. We propose to use PV data from CEA that taken on 2014 where the data is categorized in medium term pv forecasting. In addition, EnergyPlus also

## Conclusion

---

used for expect the PV and weather forecasting when the thermal building is applied in the simulation.

We also propose other components to support the simulation for instance battery system, electric water heater and thermal building. The simply battery system equation is prepared for aim the model where SOE is counted. Furthermore, we apprise electric water heater as the additional load because of importance its function for providing hot water in the household. Specification of EWH is importance for furnishing the energy management system in each house. To complete the simulation, in the research, we propose thermal in the building where the external temperature depend on the location, influence the internal building subsequently the household require the system to control it in order to keep their quality of life.

SPIDER library from CEA is introduced for first simulation where energy coordination through bilateral contract between prosumer and consumer is applied. It gain the cost reduction in the both side and improve incentive in the prosumer side. Nevertheless, The simulation could not define the optimal objective because of manually setting time for controllable appliances. Therefore, heuristic optimization with PSO is proposed for finding the optimal load shifting, subsequently the goal of energy coordination is reached maximally. With 1 minutes time step, it could find the activation time for controllable appliances as well as the the optimal objective function such as cost reduction. Nevertheless this method need more swarm to find the accurate result, in consequence it need more time to solve the objective function and extremely complicated when it is applied in the bigger energy coordination such as community or perhaps regional.

MPC becomes an alternative tool for complex energy management. It could handle several constraints in each model. It starts by deriving a control-oriented home energy management system (HEMS) of the household. Once integrated in the predictive controller, the role of HEMS is to predict the electricity cost reduction from the grid as well as improvement of self consumption. Hence, it is crucial to procure an accurate and computationally efficiently HEMS. But foremost, development of the HEMS should consider the quality of life the household through the constraint. Under these requirement, greybox modeling is adopted. Several component that utilized in the household is modeled in the MPC. For accuracy modeling, the EWH equation from paper need validation, where in this research, EWH simulation result in Dymola become a validation reference for EWH model. EWH activate its power in proportional mode. It means EWH no need work at

## Conclusion

---

the maximum power rate instead in random value between zero and power rate value. Building INCA with 6R2C model become a selected model for thermal building with the solar gain that obtained from EnergyPlus simulation.

In this research, MPC utilizes MORE-GAMS library that was developed by CEA and Matlab as simulator media. This MPC formulates and controls optimization problem based on Mixed Integer Linear Programming (MILP). Its objective function is mainly composed of a term that electricity cost which depend upon electricity purchase price. It is driven by load shedding cost and possibility battery cost. Several energy coordination harness this MPC such as Bilateral contract between prosumer and consumer or prosumer, Community with centralized energy coordination and pool to pool coordination where in the each pool use centralized energy coordination. For optimal result, the modeling use 10 minutes time step, in result, the objective function remain keep its accuracy value.

In the integration with thermal building, MPC use Linear programming for solving the optimization problem because of complexity in the thermal modeling in the district or community. Subsequently, the load shifting is not applied in this MPC. The objective function remains in cost reduction for grid electricity in the district. Optimal comfort in the household is similar and occupancy depend on the household type become the additional constraint in centralized coordination in the district. The district of Chambéry represent the four season district and district of Jakarta indicate the two season district. The simple of financial calculation based on assumption of investment cost gives the description about the investment gain and return of investment that is received by the district.

## Outlook

Identified of outlook in this research include the following:

1. The MPC-HEMS with MORE-GAMS library is implemented in the market type especially in the full P2P market and community based market. Perhaps, it could be integrated in the hybrid market where the prosumer will contribute in the increment of energy providing in the community and otherwise.
2. With integration load shifting model, MPC found the challenge in the simulation, where the elapsed time for simulation become longer, especially if the MPC is integrated with EWH and

thermal building model. The other challenge is arisen when the centralized energy coordination is applied where the prosumer could not count their incentive.

3. In the numerical simulation, scaling-up to centralized energy coordination in the community using Distributed MPC (DMPC), each household operated with grid price signal.
4. With MPC, optimal comfort in the building is considered, However, the error such as linear infeasible will be emerged when the optimum temperature and objective function (cost reduction) is not reached. This error come when the district Jakarta is simulated. Adding the cooling equipment is considered to reach optimum comfort.
5. The MPC could be improved for financial calculation such as PV system installation investment where financial parameter such as Capital Expenditure (CAPEX), Operational Expenditure (OPEX), tax and other component are applied. Consequently, the household or company could predict the Return of Investment (ROI) and their profit from their PV system.
6. With the actual condition, tariff and investment cost, the financial equation will be matched with the real district provide. This calculation only helps to give the description how the PV community coordination give the benefit to the PV owner.

# Appendix A

## Coordinated Energy Management with manual scheduling using SPIDER

The Energy sharing between prosumer and consumer under bilateral contract. First, prosumer will complete their demand with the PV production. However, the prosumer will consume the grid electricity when the demand is in outside PV production area or the PV production could not meet the demand. Secondly, prosumer will share the excess energy to outside, when the PV electricity still exist after completing the demand. In another side, consumer only interact with grid to consume the electricity for completing their demand. Thanks to the prosumer and consumer coordination, consumer have opportunity to consume the excess energy from prosumer, in consequence it could reduce their electricity cost through buying electricity from prosumer.

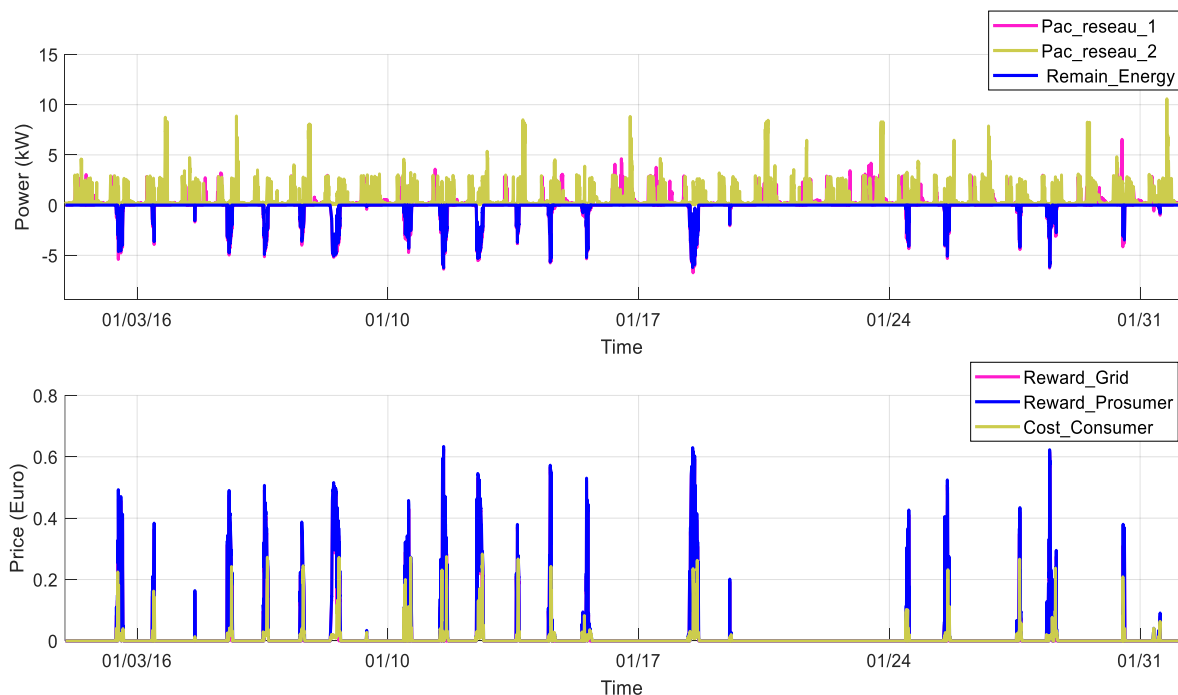

Fig App.A1. Prosumer and Consumer interaction in bilateral contract

Using SPIDER library, we propose bilateral contract between prosumer and consumer where the proposed result is taken from full year duration. The simulation is shown in fig. App.A1 illustrate the grid electricity that consumed by prosumer (Pac\_reseau\_1) and consumer (Pac\_reseau\_2). The excess energy (remain energy) that is emerged in this process will sell to the grid. From this

transaction, prosumer with excess energy gain the incentive from consumer and grid. Whereas the consumer reach the benefit to reduce the electricity cost from the grid.

### Comparison of no coordination Household and Coordinated Household

In figure App.A2, the energy from grid in household without coordination is higher than coordinated households. Using bilateral contract, households reduce the grid consumption until 28% in total than grid consumption in individual. For example, HH1 as Prosumer only uses 737 kWh for one year when applying load shifting instead they consume 1076 kWh when they do not apply it.

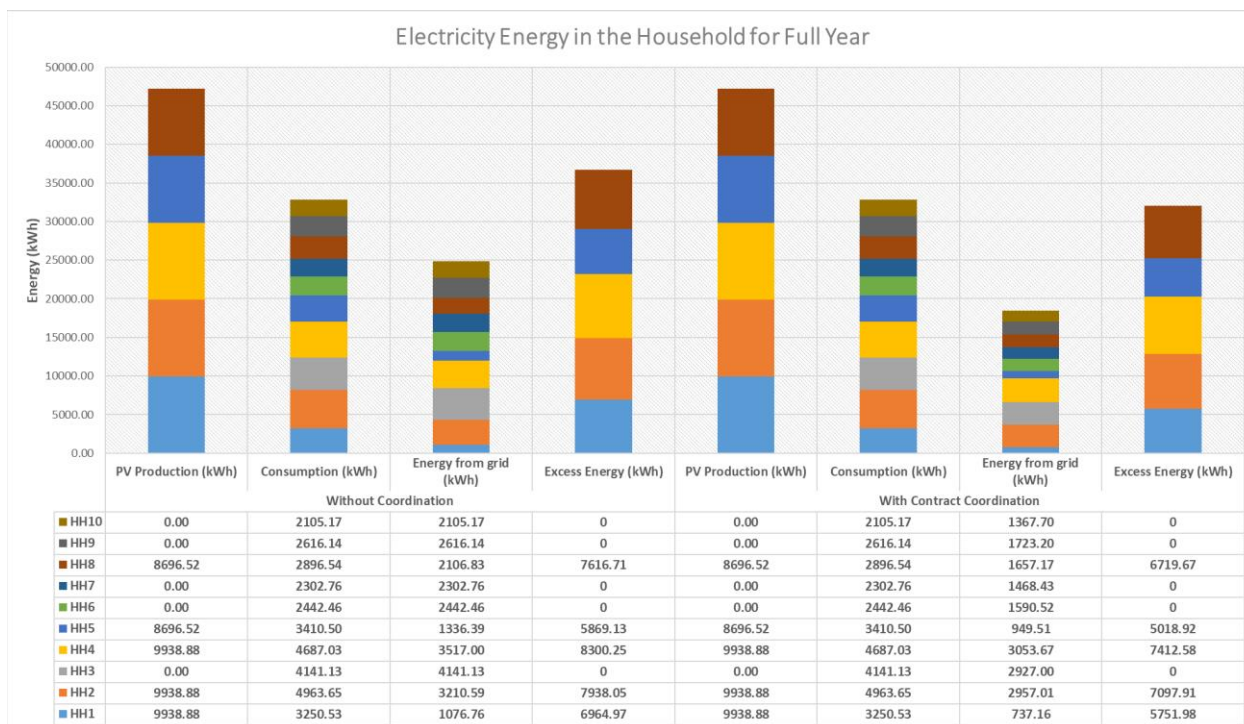
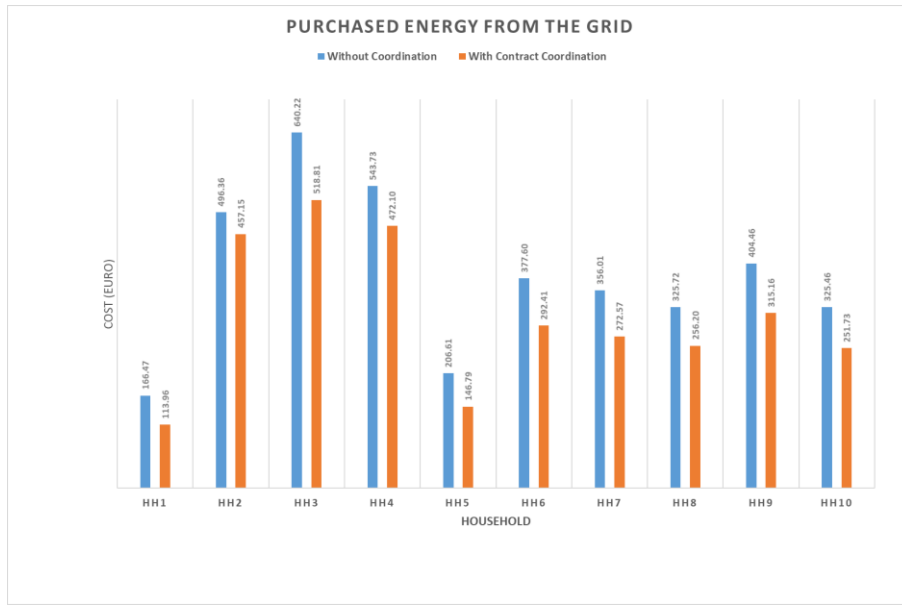
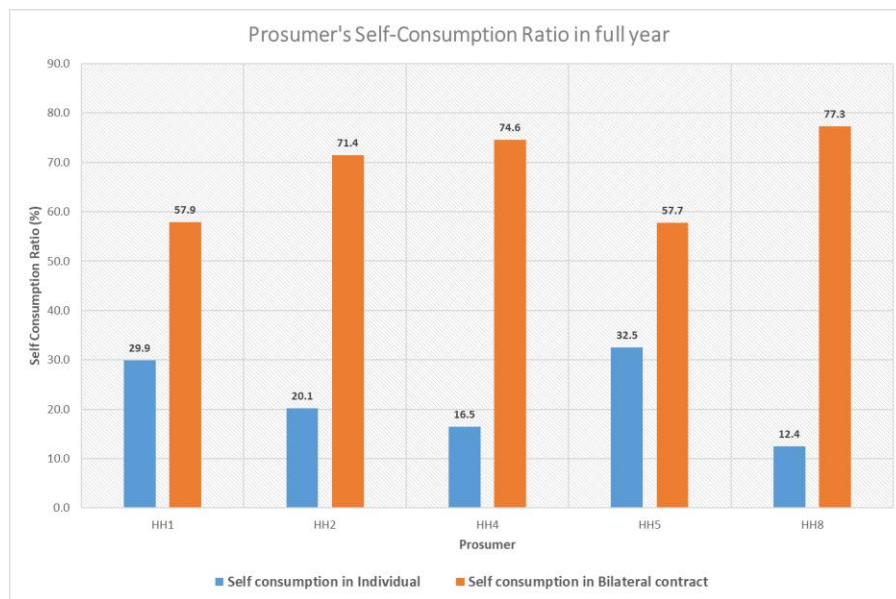

Fig. App.A2 Result of Household No Coordination and Using Coordination

In consumer side, with contract coordination, their energy demand covered by excess energy from prosumer. Meanwhile, the consumers without contract rely heavily on electricity from grid. Prosumer without coordination only sell their energy excess to grid. However, in bilateral contract scenario, prosumers is able to share their energy production excess before selling to the grid.



(a)



(b)

Figure App.A3 (a). Energy purchased from the grid, and (b). Self consumption ratio in the individual and bilateral contract

From the simulation, fig.App.A3 (a) show the household’s energy purchased from the grid when they are in individual and contract coordination. The household gain the benefit from this section such as grid consumption deduction. In the same time, they reach grid cost reduction. Household 1 (HH1) reduce their grid demand till 31.54% when they use load shifting method and contract coordination than grid consumption in individual usage. Moreover, household 3 (HH3) as pure

consumer gain the grid cost reduction until 29.32% under load shifting and contract. Whereas, prosumer also improve self-consumption through contract coordination in full year. HH1 reach 28% improvement than individual usage.

### Comparison based on time activation of appliance in coordinated Household

Applying time activation in each household both prosumer and consumer drive the different result in household in particular consumer in the context cost saving. Load shifting could be applied in consumer only, or it applied in both prosumer and consumer. There are four condition in the comparison graphics where original time means activation time of appliance as well as the user behaviour. Meanwhile, in LS consumer only, prosumer remain operate the appliance in the origin time. However, consumer apply the load shifting in the certain time. Furthermore, LS Pro & Co, the prosumer and consumer perform load shifting in their house. Lastly, LS Pro & Co midi section, the prosumer run their appliance at noon (12:00) and consumer apply load shifting in certain time.

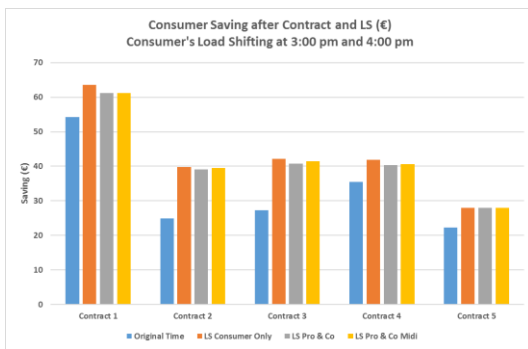

(a)

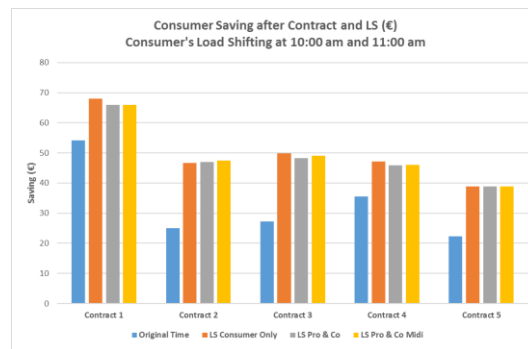

(b)

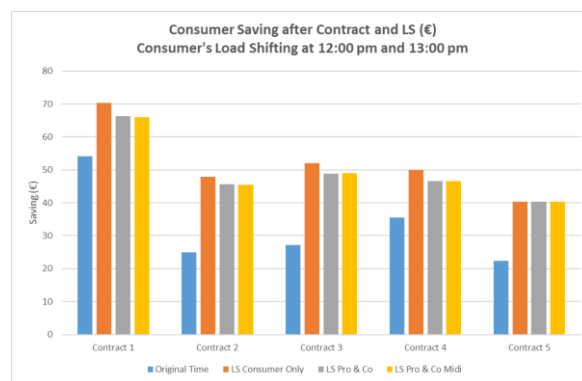

(c)

Fig. App.A4 Saving of Consumer Comparison



In fig. App.4 (a) Consumer apply the load shifting where they operate dish washer at 3:00 pm and washing machine at 4:00 pm. In contract 1 that HH1 and HH3 perform the bilateral contract, HH3 as consumer reach the higher saving amount 63.5 euro for the electricity cost both grid and prosumer’s PV cost. Whilst, Consumer saving in the fig App.4 (b) achieve 68.10 euro when the consumer activate the dish washer at 10:00 am and washing machine at 11:00 am. Finally, Consumer activate their appliance at noon where they run the dishwasher at 12:00 pm and washing machine at 13:00 that it reflect in fig. App.4 (c). They make saving of cost amount 70.3 euro when the prosumer does not perform load shifting method. Meanwhile, contract 2 to contract 4 where were filled by HH7, HH6 and HH9 as consumer reach the highest saving in LS consumer only section. Conversely, in the contract 5, the similar saving cost is occurred when the prosumer using origin time or apply load-shifting method where they reach 80.3 euro saving for full year.

### Bilateral Contract with Particle Swarm Optimization

After simulation by SPIDER library, the bilateral contract between prosumer and consumer propose to utilize the heuristic optimization such as particle swarm optimization (PSO). Prosumer reduce their electricity cost use scheduling of flexible appliances through this optimization, in consequence the self-consumption in the prosumer side will be increased and excess energy is reduced.

The simulation take duration for full year with time sampling 1 minutes with range 24 hour (full day). The prosumer complete their demand with PV production first. When the excess energy is exist, the prosumer share to consumer that interact via bilateral contract. Grid electricity will be consumed only when the PV production could not meet the demand.

Pool index	Full Year					
	Self-Consumption Ratio (%)			Incentive for Prosumer (Euro)		
	References	Opt No Battery	Opt with Battery in Prosumer	References	Opt No Battery	Opt with Battery in Prosumer
Pool 1	22.57	34.75	34.99	422.20	407.49	403.12
Pool 2	21.08	33.38	34.23	377.53	363.84	358.04
Pool 3	17.18	29.60	30.18	395.69	381.94	376.95
Pool 4	23.16	35.27	36.13	384.09	369.89	364.17
Pool 5	12.85	24.83	25.40	410.00	394.75	390.79

Table App.A1 Result of bilateral contract in the several pool for full year

In the table App.A1, We propose 5 transaction pools where in each pools contain a prosumer and consumer. Comparison among the difference schemes is prepared. Reference in the table means the pools perform the transaction where each household keeps their behavior in the appliance scheduling. The optimization without battery and with battery also prepared. Average self-consumption comparison each month of full year in pool 1 is shown in the fig. App.A4.

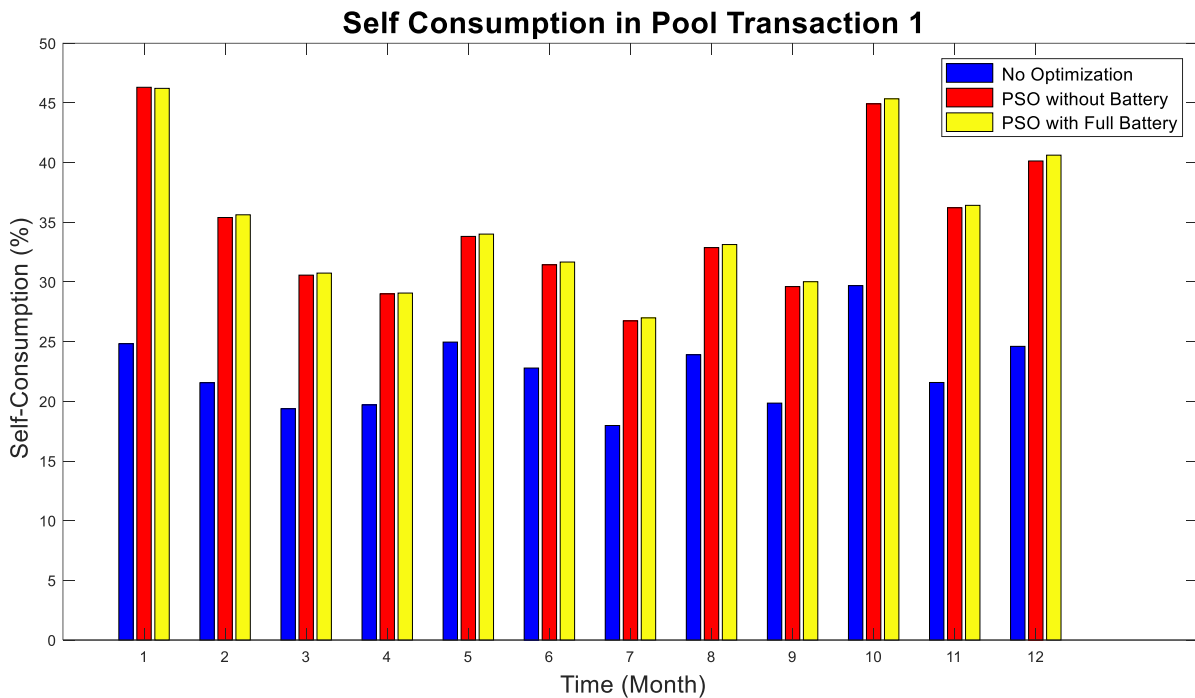

Fig. App.A4 Average self-consumption of pool 1 in each month

Average self-consumption rate (SCR) of pool 1 in the first month for reference reach 24.83%. The optimization PSO improve their SCR to 46.31%. Battery is not give impact in the first month optimization because the SCR only in 46.22%. However, the average SCR with optimization in first month is the greater than other months. The lowest average SCR using reference and optimization is occurred in 7<sup>th</sup> month. The SCR with reference only in 17.97%. The optimization improve the SCR to 26.74% and PSO with battery to 26.99%.





















## Appendix B

1403	84180	51.4756	50.2599	50.0865	1.22E+00	1.39E+00	1.73E-01
1404	84240	51.4752	50.2584	50.0849	1.22E+00	1.39E+00	1.74E-01
1405	84300	51.4748	50.2570	50.0833	1.22E+00	1.39E+00	1.74E-01
1406	84360	51.4744	50.2555	50.0817	1.22E+00	1.39E+00	1.74E-01
1407	84420	51.4741	50.2541	50.0801	1.22E+00	1.39E+00	1.74E-01
1408	84480	51.4737	50.2527	50.0785	1.22E+00	1.40E+00	1.74E-01
1409	84540	51.4733	50.2512	50.0769	1.22E+00	1.40E+00	1.74E-01
1410	84600	51.4729	50.2498	50.0753	1.22E+00	1.40E+00	1.74E-01
1411	84660	51.4725	50.2484	50.0738	1.22E+00	1.40E+00	1.75E-01
1412	84720	51.4722	50.2469	50.0722	1.23E+00	1.40E+00	1.75E-01
1413	84780	51.4718	50.2455	50.0706	1.23E+00	1.40E+00	1.75E-01
1414	84840	51.4714	50.2440	50.0690	1.23E+00	1.40E+00	1.75E-01
1415	84900	51.471	50.2426	50.0674	1.23E+00	1.40E+00	1.75E-01
1416	84960	51.4706	50.2412	50.0658	1.23E+00	1.40E+00	1.75E-01
1417	85020	51.4703	50.2397	50.0642	1.23E+00	1.41E+00	1.76E-01
1418	85080	51.4699	50.2383	50.0626	1.23E+00	1.41E+00	1.76E-01
1419	85140	51.4695	50.2369	50.0611	1.23E+00	1.41E+00	1.76E-01
1420	85200	51.4691	50.2354	50.0595	1.23E+00	1.41E+00	1.76E-01
1421	85260	51.4687	50.2340	50.0579	1.23E+00	1.41E+00	1.76E-01

1422	85320	51.4684	50.2326	50.0563	1.24E+00	1.41E+00	1.76E-01
1423	85380	51.468	50.2311	50.0547	1.24E+00	1.41E+00	1.76E-01
1424	85440	51.4676	50.2297	50.0532	1.24E+00	1.41E+00	1.77E-01
1425	85500	51.4672	50.2282	50.0516	1.24E+00	1.42E+00	1.77E-01
1426	85560	51.4669	50.2268	50.0500	1.24E+00	1.42E+00	1.77E-01
1427	85620	51.4665	50.2254	50.0484	1.24E+00	1.42E+00	1.77E-01
1428	85680	51.4661	50.2239	50.0468	1.24E+00	1.42E+00	1.77E-01
1429	85740	51.4657	50.2225	50.0452	1.24E+00	1.42E+00	1.77E-01
1430	85800	51.4653	50.2211	50.0436	1.24E+00	1.42E+00	1.77E-01
1431	85860	51.465	50.2196	50.0420	1.25E+00	1.42E+00	1.78E-01
1432	85920	51.4646	50.2182	50.0405	1.25E+00	1.42E+00	1.78E-01
1433	85980	51.4642	50.2168	50.0389	1.25E+00	1.43E+00	1.78E-01
1434	86040	51.4638	50.2153	50.0373	1.25E+00	1.43E+00	1.78E-01
1435	86100	51.4634	50.2139	50.0357	1.25E+00	1.43E+00	1.78E-01
1436	86160	51.4631	50.2125	50.0341	1.25E+00	1.43E+00	1.78E-01
1437	86220	51.4627	50.2110	50.0326	1.25E+00	1.43E+00	1.78E-01
1438	86280	51.4623	50.2096	50.0310	1.25E+00	1.43E+00	1.79E-01
1439	86340	51.4619	50.2081	50.0294	1.25E+00	1.43E+00	1.79E-01
1440	86400	51.4615	50.2067	50.0278	1.25E+00	1.43E+00	1.79E-01























# Appendix C

## Graphic of District Chambery

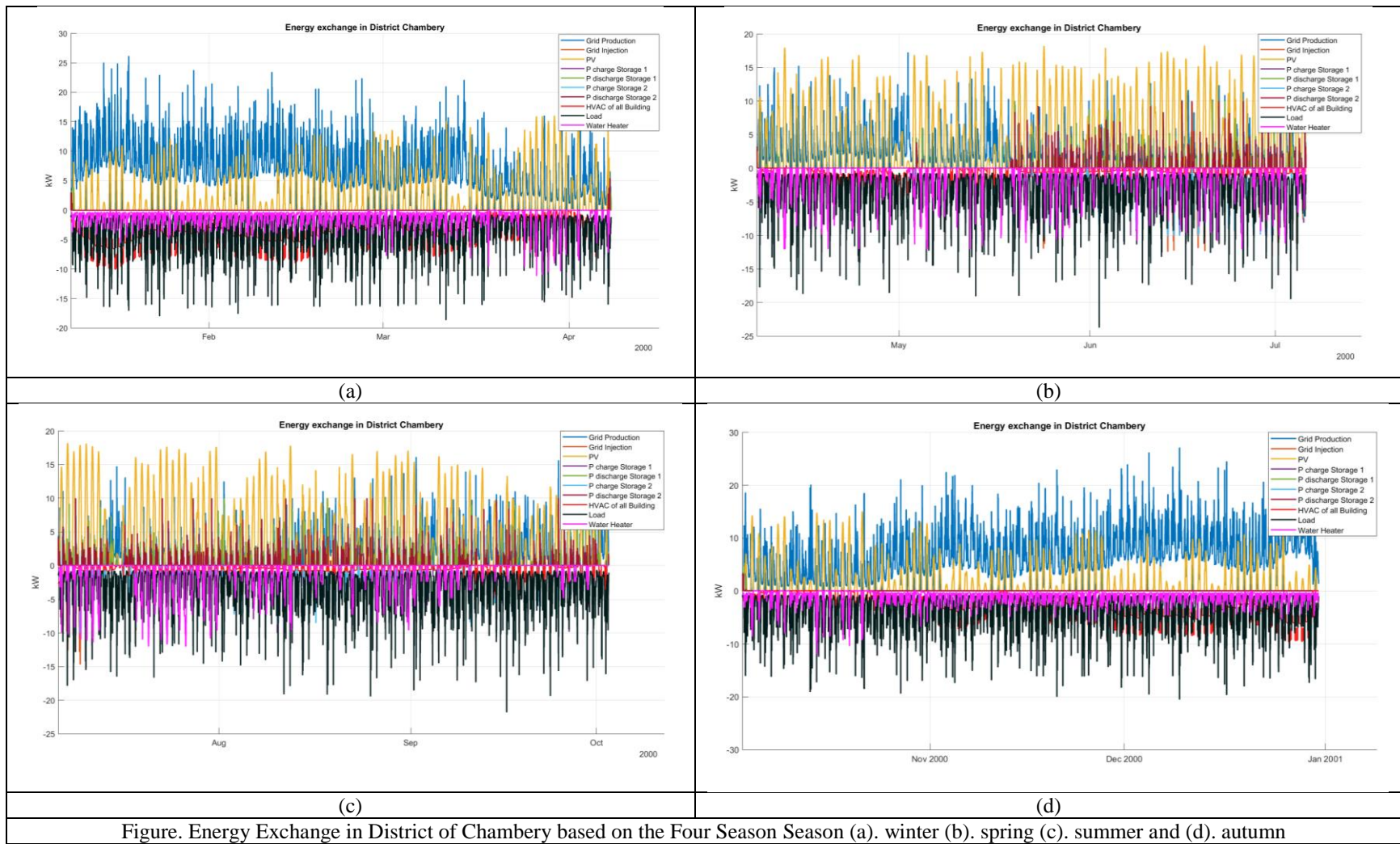
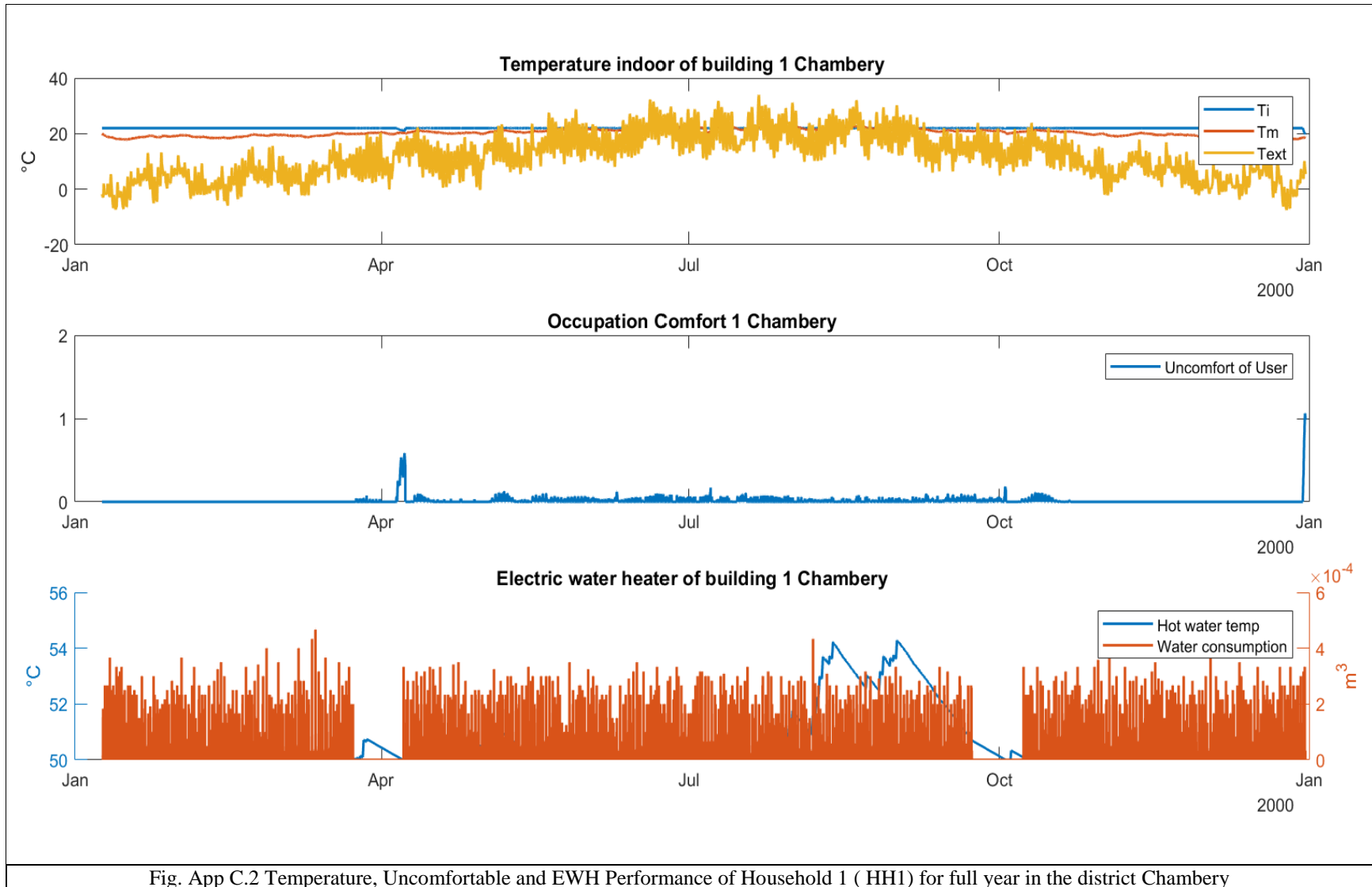

Figure. Energy Exchange in District of Chambery based on the Four Season Season (a). winter (b). spring (c). summer and (d). autumn





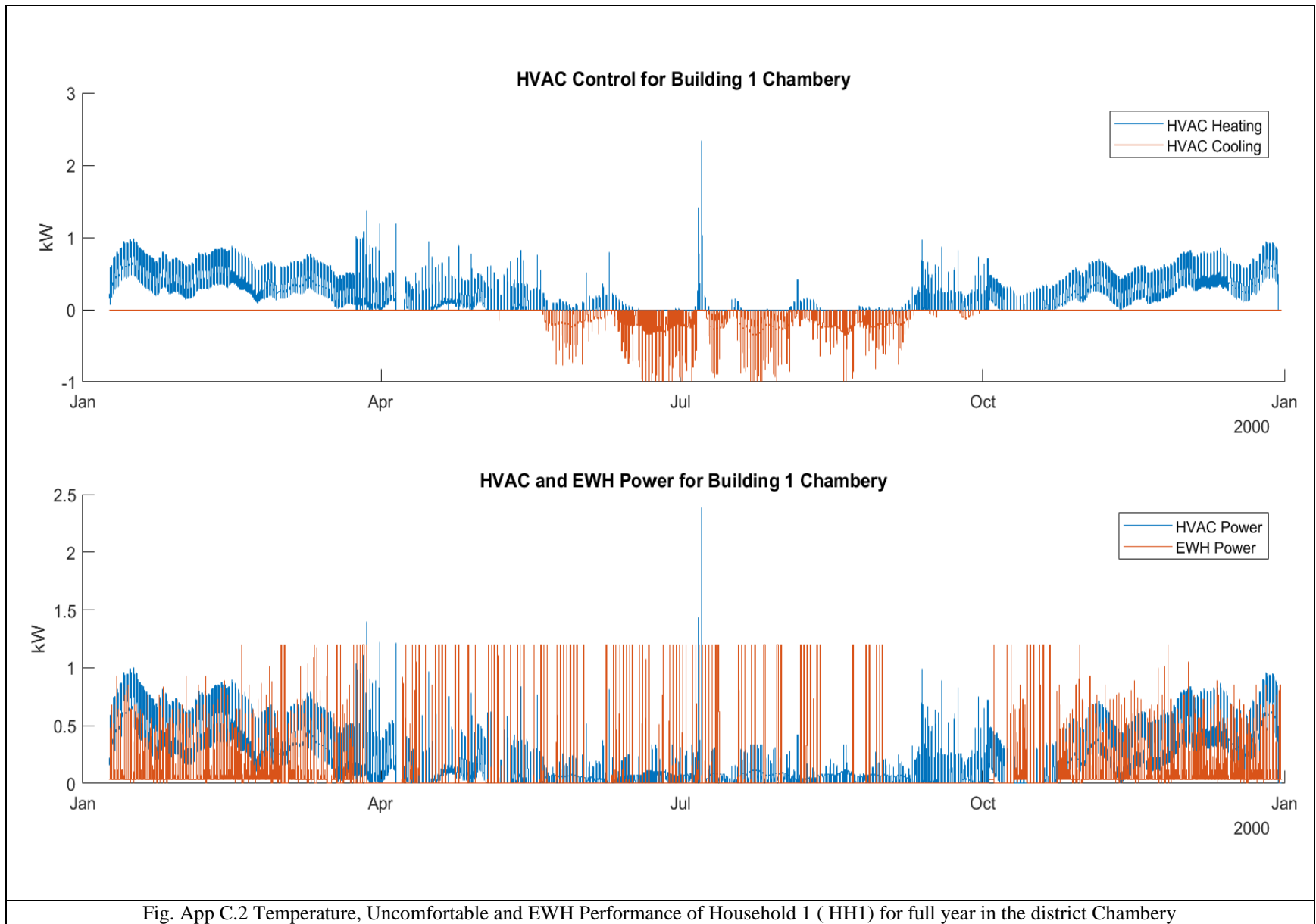

Fig. App C.2 Temperature, Uncomfortable and EWH Performance of Household 1 ( HH1) for full year in the district Chambery

# Graphic of District Jakarta

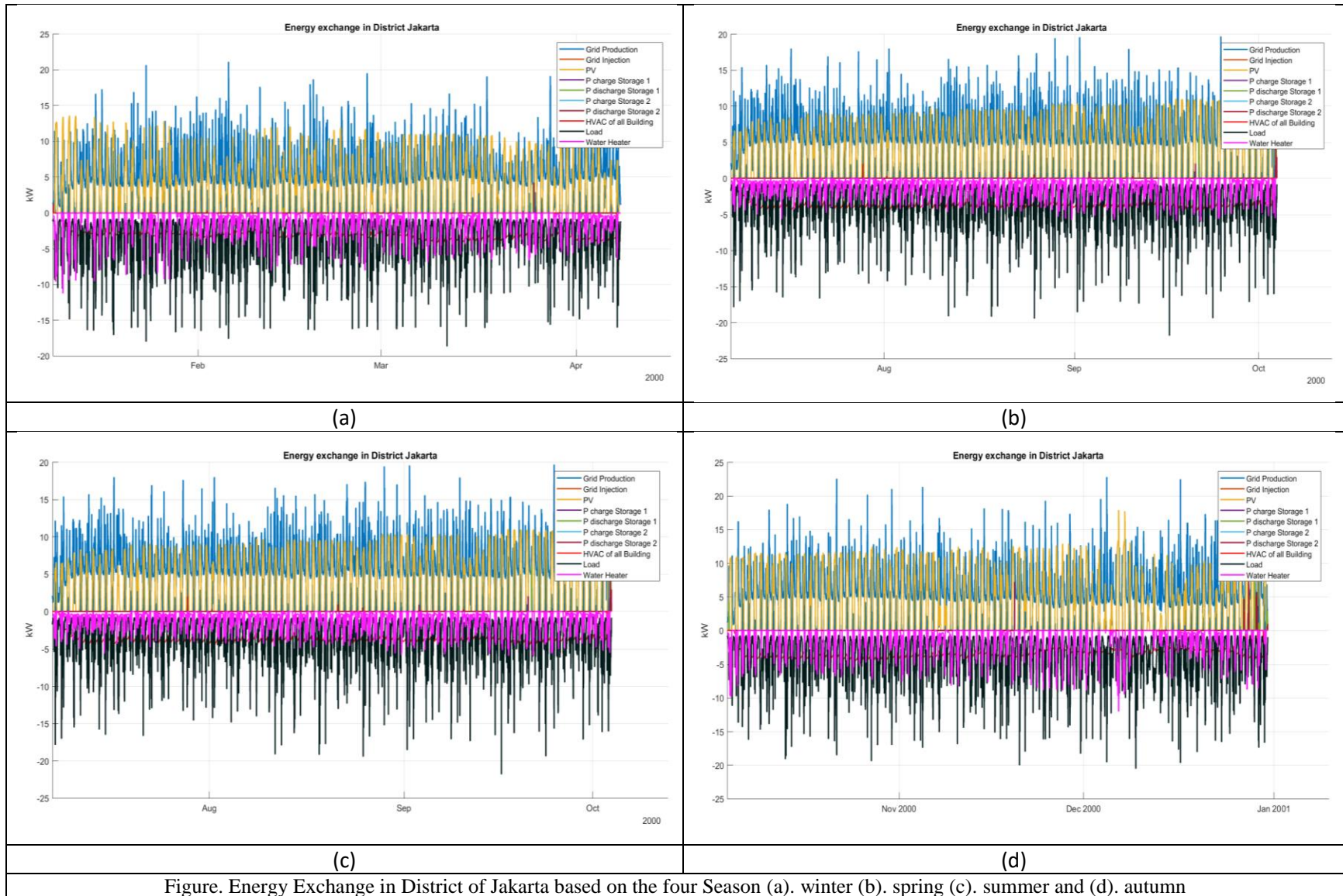
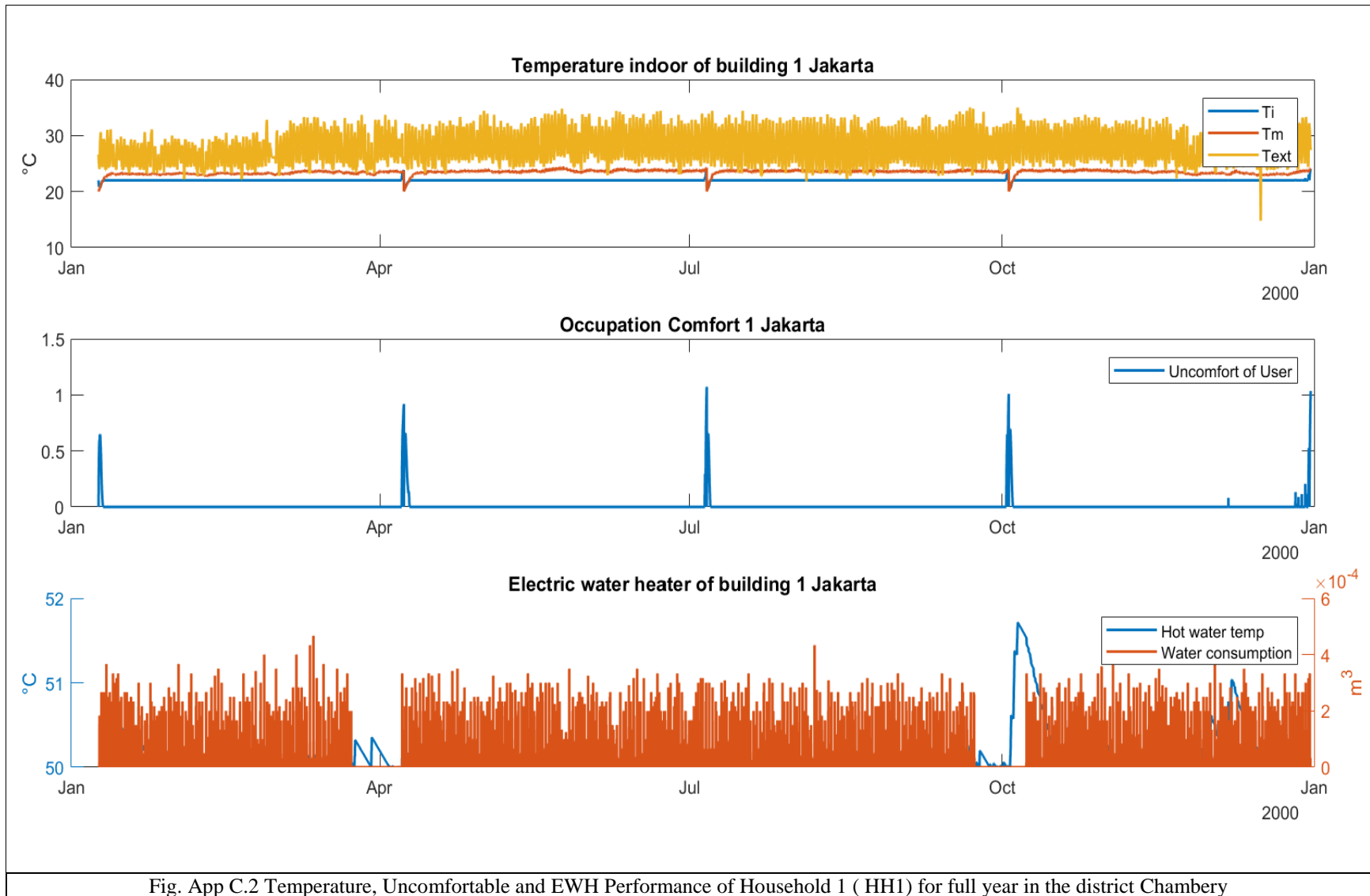

Figure. Energy Exchange in District of Jakarta based on the four Season (a). winter (b). spring (c). summer and (d). autumn



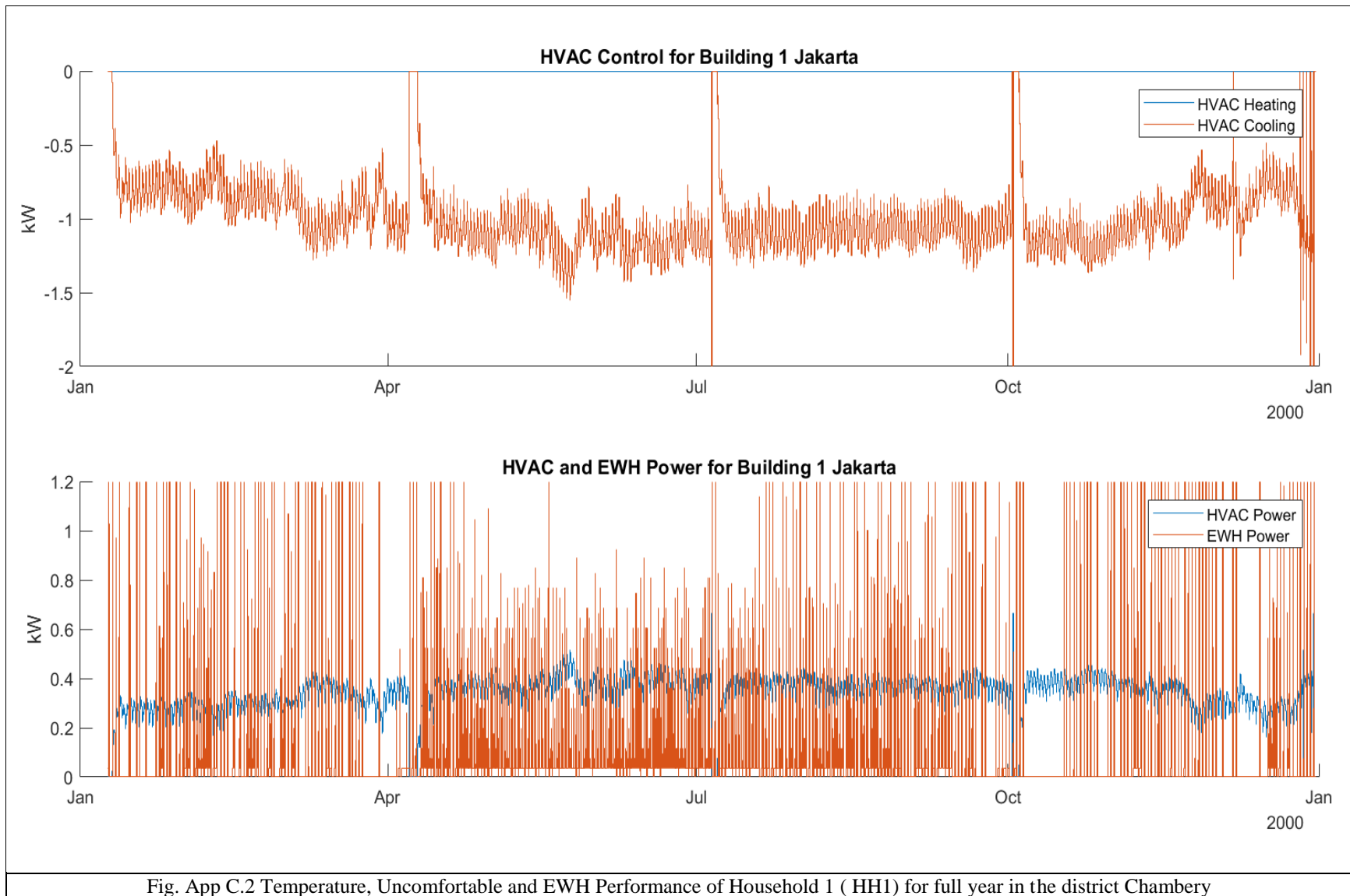

Fig. App C.2 Temperature, Uncomfortable and EWH Performance of Household 1 ( HH1) for full year in the district Chambery











