



HAL
open science

Smart Mobility and Routing in Intermittent Infrastructure-based Internet of Vehicles

Chahrazed Ksouri

► **To cite this version:**

Chahrazed Ksouri. Smart Mobility and Routing in Intermittent Infrastructure-based Internet of Vehicles. Embedded Systems. Université de Bordeaux; Université de Sfax (Tunisie), 2020. English. NNT : 2020BORD0286 . tel-03275319

HAL Id: tel-03275319

<https://theses.hal.science/tel-03275319>

Submitted on 1 Jul 2021

HAL is a multi-disciplinary open access archive for the deposit and dissemination of scientific research documents, whether they are published or not. The documents may come from teaching and research institutions in France or abroad, or from public or private research centers.

L'archive ouverte pluridisciplinaire **HAL**, est destinée au dépôt et à la diffusion de documents scientifiques de niveau recherche, publiés ou non, émanant des établissements d'enseignement et de recherche français ou étrangers, des laboratoires publics ou privés.

THÈSE-THESIS

en cotutelle entre-with joint supervision between

L'UNIVERSITÉ DE BORDEAUX

&

L'UNIVERSITÉ DE SFAX

Par-By

Chahrazed KSOURI

POUR OBTENIR LE GRADE DE-TO GET THE DEGREE OF

DOCTEUR-DOCTOR

INFORMATIQUE-COMPUTER SCINCE

.....
**Smart Mobility and Routing in Intermittent Infrastructure-based Internet
of Vehicles**
.....

Sous la direction de Pr. Mohamed MOSBAH, de Pr. Abdelfettah BELGHITH et de Dr. Imen
JEMILI.

Soutenue le 17 Décembre 2020 à Bordeaux

Membres du jury :

Mr. AHMED, Toufik	Pr à Bordeaux INP	Président
Mme. IDOUDI, Hanen	MCF à ENSI, Université de la Manouba	Rapporteure
Mr. MBAREK, Nader	MCF à Université de Bourgogne Franche-Comté	Rapporteur
Mr. DRIRA, Khalil	DR au LAAS-CNRS	Examineur
Mr. MOSBAH, Mohamed	Pr à Bordeaux INP	Directeur
Mr. BELGHITH, Abdelfettah	Pr à ENIS, Université de Sfax	Directeur
Mme. JEMILI, Imen	MCF à FSB, Université de Carthage	Invitée
Mme. CHAARI, Lamia	Pr à ISIMS, Université de Sfax	Invitée

Titre : Mobilité Intelligente et Routage dans l'Internet des Véhicules basé sur une Infrastructure Intermittent

Résumé : De grands progrès ont été réalisés dans le domaine des transports, ce qui a conduit à l'émergence du concept de la Smart Mobility. Dans cette thèse, nous nous intéressons à l'aspect technologique du concept. Nous proposons une vision plus large de la Smart Mobility, tout en spécifiant trois domaines de mobilité; à savoir terrestre, aérien et marin. Nous nous concentrons ensuite sur le domaine terrestre, plus précisément, les protocoles de routage dans l'Internet des véhicules (IoV). Dans l'environnement véhiculaire, trois catégories de scénario de réseau doivent être distinguées: infrastructure basée, sans infrastructure et infrastructure intermittente. Dans ce travail, nous souhaitons permettre aux véhicules d'atteindre l'infrastructure en temps opportun dans le troisième scénario. À cette fin, nous proposons ILTS (Infrastructure Localization Service and Tracking Scheme) qui extrait des informations précieuses de l'échange de messages périodiques afin de localiser l'infrastructure et de suivre les chemins disponibles vers elle. Ensuite, nous proposons un protocole de routage basé sur un mécanisme de prise de décision, HyRSIC (Hybrid Routing for Safety data with Intermittent V2I Connectivity), qui permet aux véhicules de faire le choix optimal lors de la transmission des données.

Mots clés : Internet des Véhicules, Protocoles de Routage, Infrastructure Intermittente, Service d'Information de Localisation.

Title : Smart Mobility and Routing in Intermittent Infrastructure-based Internet of Vehicles

Abstract : Great progress has been made in the transportation field, which has led to the emergence of the Smart Mobility concept. In this thesis, we are interested in the technological aspect of the concept. We propose a broader vision of Smart Mobility, while specifying three mobility domains; namely terrestrial, aerial and marine. We then, focus on the terrestrial domain, more precisely, routing protocols in Internet of Vehicles (IoV). In the vehicular environment, three categories of network scenario are to be distinguished: infrastructure-based, infrastructure-less and intermittent infrastructure. In this work, we are interested in enabling vehicles to reach the infrastructure in a timely manner in the third scenario. To this end, we propose ILTS (Infrastructure Localization service and Tracking Scheme) that extracts valuable information from periodic message exchange in order to localize infrastructure and track available paths towards it. Then, we propose a routing protocol based on a decision making mechanism, HyRSIC (Hybrid Routing for Safety data with Intermittent V2I Connectivity), that enables vehicles to make the optimal choice when transmitting data.

Keywords : Internet of Vehicles (IoV), Routing protocols, Intermittent Infrastructure, Localization Information Service (LSI).

Unité de recherche

Univ. Bordeaux, Bordeaux INP, CNRS, LaBRI, UMR5800, F-33400 Talence, France

Acknowledgments

First of all, I would like to express my gratitude to my supervisors Pr. Mohamed Mosbah, Pr. Abdelfettah Belghith and Dr. Imen Jemili for providing this opportunity and their endless support and advice on this Ph.D. I am grateful for their trust and their technical, emotional and financial support over the thesis journey.

I would also like to thank the jury members of my defence. I express my gratitude to Mme. Hanen IDOUDI, MCF at ENSI, Manouba University and Mr. Nader Mbarek, MCF at Burgundy Franche-Comté University, who agreed to review my manuscript. Many thanks to Mr. Toufik Ahmed, Professor at Bordeaux INP and Mr. Khalil Drira, Research Director at CNRS LAAS Toulouse, for agreeing to evaluate my work. I also would like to thank Mme. Lamia CHAARI, Professor à ISIMS, Sfax University, who accepted to participate at my defense. Ultimately, I thank all of them for the attention they have given to my work as well as their valuable comments.

Furthermore, my sincere gratitude go to colleagues and professors at LaBRI and ENIS, with whom I had stimulating discussions on the thesis work as well as my teachings during this period. I would like to name: Slim Kammoun, Lamia Chaari, Akka Zemmari, Francne Krief, Xavier Blanc, Mohamed Lamine Lamali, Serge Chaumette, Lionel Clément, Christophe Maillet and Antoine Rollet.

I thank my fellow lab-mates in University of Bordeaux (Karim Aberghal, Karim Alami, Christelle Al Hasrouty, Remi Laplace, Remi Guiraud, Joachim Bruno-Queyreix, Barbara Jolivent, Lucie Lu, Michael Clément, Nadia Kammoun, Simon Da Silva, Simon Gorecki, Samah Bouzid and Maha Boussabbeh), and University of Sfax (Amal Hammami, Nesrine Tarhouni and Mariem Slim), and many others who made this journey exceptional. A particular thank goes to Nadia Chaabouni, who has been of great support during challenging times.

Many thanks also go to the administrative team at LaBRI, Maïté Labrousse, Cathy Roubineau, Sylvaine Granier, Sylvie Le-Laurain, and at ENIS, Salwa Belgacem, Salma Abid and Noura Sellami, for their help and support.

IV

Moreover, I would like to thank my friends, Hasnae, Ryslène, Elisa, Ahmad, Siham, Dhikra, Sabrine and Karima for their moral support, their true friendship and love and their encouragement. A special thank goes to my dear friends Wafa and Amal, with whom I shared the difficult and joyful moments of this journey, for their listening and support and their enormous help in administrative procedures.

And finally, I thank my family, Mohamed for having supported me spiritually throughout the writing of the manuscript, as well as all my beloved ones to whom I did not devote enough time.

Title : Smart Mobility and Routing in Intermittent Infrastructure-based Internet of Vehicles**Abstract**

Advances in fields such as Information and Communication Technologies (ICT), automation and artificial intelligence have powered major technological revolutions in the transportation domain such as the invention of electric vehicles, autonomous cars, connected vehicles, unmanned aerial and marine vehicles, etc. Transport of goods and people is at the heart of any city activities and influences all other aspects, including economy, tourism, health care, and so on. Great progress has been made in this area, which has led to the emergence of the Smart Mobility concept. In this thesis, we are interested in the technological aspect of the concept. We propose a broader vision of Smart Mobility, in line with recent technological advances, while specifying three mobility domains; namely terrestrial, aerial and marine. We then, focus on the terrestrial domain, more precisely, routing protocols in Internet of Vehicles (IoV). IoV results from the integration of Vehicular Ad-Hoc Networks (VANETs) with Internet connection. VANET is a terrestrial networking paradigm where vehicles are equipped with On Board Units (OBUs) enabling them to communicate with their surrounds (vehicles, Road Side Units (RSUs), human and sensor) in order to exchange information relative to safety, comfort or entertainment applications. These networks are characterized by distinctive properties, mainly high-speed, dynamic topology changes and variable network density, raising challenges on data routing. In the vehicular environment, three categories of network scenario are to be distinguished: infrastructure-based, infrastructure-less and intermittent infrastructure. In this work, we are interested in enabling vehicles to reach the infrastructure in a timely manner in the third scenario. To this end, we propose ILTS (Infrastructure Localization service and Tracking Scheme) that extracts valuable information from periodic message exchange in order to localize infrastructure and track available paths towards it. Then, we propose a routing protocol based on a decision making mechanism, HyRSIC (Hybrid Routing for Safety data with Intermittent V2I Connectivity), that enables vehicles to make the optimal choice when transmitting data.

Keywords : Smart Mobility (SM), Internet of Vehicles (IoV), Vehicular Ad-Hoc Networks (VANETs), Routing protocols, Intermittent Infrastructure, Localization Information Service (LSI), Path Tracking, Decision Making Algorithm.

Titre : Mobilité Intelligente et Routage dans l'Internet des Véhicules basé sur une Infrastructure Intermittente

Résumé

Les avancées dans des domaines tels que les technologies de l'information et de la communication, l'automatisation et l'intelligence artificielle ont alimenté des révolutions technologiques majeures dans le domaine des transports telles que l'invention des véhicules électriques, des voitures autonomes, des véhicules connectés, des véhicules aériens et marins sans pilote, etc. Le transport de marchandises et de personnes est au cœur de toutes les activités et influence tous les autres aspects, y compris l'économie, le tourisme, les soins de santé, etc. De grands progrès ont été réalisés dans ce domaine, ce qui a conduit à l'émergence du concept de la mobilité intelligente. Dans cette thèse, nous nous intéressons aux aspects technologiques de ce concept. Nous proposons une vision plus large de la mobilité intelligente, en phase avec les récentes avancées technologiques, tout en spécifiant trois domaines de mobilité; à savoir terrestre, aérien et marin. Nous nous concentrons alors sur le domaine terrestre, plus précisément, les protocoles de routage dans l'Internet des Véhicules. L'Internet des véhicules (IoV) résulte de l'intégration des réseaux ad hoc de véhicules (VANET) avec une connexion Internet. VANET est un paradigme de mise en réseau terrestre où les véhicules sont équipés d'unités embarquées leur permettant de communiquer avec leur environnement (véhicules, unités de bord de route, humain et capteur) afin d'échanger des informations relatives à des applications de sécurité, de confort ou de divertissement. Ces réseaux sont caractérisés par des propriétés distinctives, principalement des vitesses élevées, des changements de topologie dynamiques et une densité de réseau variable, ce qui pose des problèmes de routage des données. Dans l'environnement véhiculaire, trois catégories de scénario de réseau doivent être distinguées: infrastructure, sans infrastructure et infrastructure intermittente. Dans ce travail, nous cherchons à permettre aux véhicules d'atteindre l'infrastructure en temps opportun dans le troisième scénario. À cette fin, nous proposons ILTS (Infrastructure Localization service and Tracking Scheme) qui extrait des informations utiles de l'échange périodique de messages afin de localiser l'infrastructure et de suivre les chemins disponibles vers elle. Par la suite nous proposons un protocole de routage basé sur un mécanisme de prise de décision, HyRSIC (Hybrid Routing for Safety Data with Intermittent V2I Connectivity), qui permet aux véhicules de faire le choix optimal lors de la transmission des données.

Mots clés : Mobilité Intelligente, Internet des Véhicules, Réseaux Ad hoc de Véhicules, Protocoles de Routage, Infrastructure Intermittente, Service d'Information de Localisation, Suivi de Chemin, Algorithme de Prise de Décision.

Titre : Mobilité Intelligente et Routage dans l'Internet des Véhicules basé sur une Infrastructure Intermittente

Résumé détaillé

Les problèmes techniques, sociaux, économiques et organisationnels soulevés par la croissance démographique et l'urbanisation croissante génèrent de nouveaux défis auxquels les villes doivent faire face, tels que la congestion routière, la pollution de l'air, les difficultés de gestion des déchets, la rareté des ressources et les problèmes de santé humaine [1]. Au cours de la dernière décennie, avec l'émergence de nouvelles technologies et de paradigmes innovants tels que l'Internet des objets [2], les technologies de l'information et de la communication [3] et le Cloud Computing [4], la tendance est à une vision d'une ville intelligente, qui maintient la durabilité économique et environnementale pour offrir de meilleures conditions de vie à ses citoyens. Quelque soit le contexte de la ville, les avantages de l'application du paradigme de la ville intelligente seront répartis dans tous les aspects de la vie urbaine, allant des transports et de l'éducation aux espaces verts et aux soins de santé.

Le transport de marchandises et de personnes est au cœur des activités de la ville intelligente et influence tous les autres aspects, y compris l'économie, le tourisme, les soins de santé, etc. De grands progrès ont été réalisés dans ce domaine, ce qui a conduit à l'émergence du concept de la mobilité intelligente. Le domaine fait face à une croissance importante car le concept de la mobilité en tant que service prend de plus en plus d'importance et une gestion commune de tous les moyens de transport est nécessaire. Dans les futures villes intelligentes, un service multimodal de mobilité peut combiner non seulement des moyens de transport routier classiques, tels que voitures, vélos, bus, mais aussi des moyens de transport aérien comme les drones ou les systèmes de transport maritime.

Dans la littérature, la mobilité intelligente est décrite comme étant la combinaison de technologies intelligentes et de solutions de mobilité, aboutissant à une gouvernance intelligente pour une mobilité durable, axée sur la technologie et les citoyens [5]. En fait, les systèmes de transport intelligents et plus récemment l'Internet des Véhicules ont attiré beaucoup d'attention de la part de la recherche universitaire et industrielle en tant que composantes de base de l'écosystème de la mobilité intelligente. Les systèmes de transport intelligents sont décrits comme étant l'incorporation des technologies de l'information et de la communication dans les infrastructures de transport et les véhicules [6], tandis que l'Internet des véhicules résulte de l'intégration des réseaux ad hoc de véhicules, un paradigme de réseau terrestre, avec une

connexion Internet, afin de permettent aux véhicules d'échanger des informations avec leur environnement (véhicules, routes, humain et capteur) [7]. Dans la littérature, les études et recherches portent principalement sur le domaine terrestre. Par conséquent, l'environnement véhiculaire est limité uniquement au domaine terrestre, en particulier les voitures ainsi que d'autres modes de transport tels que les bus et les trains, et la vision de la mobilité intelligente actuelle ne concerne que la mobilité urbaine terrestre. En fait, les communications véhicule-avec-tout sont les plus développées.

Les réseaux ad-hoc de véhicules font référence au paradigme de réseau terrestre le plus important, permettant la communication entre les véhicules et les unités de bord de route placées le long des routes afin d'améliorer la sécurité routière et de fournir le confort des voyageurs [8]. Les caractéristiques spécifiques de ces réseaux, telles que la vitesse élevée des nœuds et les changements fréquents de topologie, imposent des défis pour le processus de routage. De plus, l'avènement du concept de l'Internet des véhicules ainsi que les voitures autonomes et connectées contribuent à la prolifération de nouvelles applications innovantes avec des exigences de qualité de service différentes, soulevant de nouveaux problèmes plus complexes pour le transfert de données.

Dans les réseaux ad-hoc de véhicules traditionnels, nous pouvons distinguer trois principaux niveaux de communication [9]: véhicule-à-véhicule, infrastructure-à-véhicule et hybride. La fourniture efficace des applications et services entre les nœuds du réseau est étroitement liée à la flexibilité et aux performances des protocoles de routage déployés, qui sont freinés par le support partagé et la faible bande passante qui caractérisent l'environnement véhiculaire. Le processus de routage est nécessaire pour relayer les informations entre les véhicules jusqu'à atteindre la destination. En fait, les véhicules doivent s'appuyer sur des communications multi-sauts pour atteindre les nœuds ou l'infrastructure distants s'ils ne sont pas à proximité. Un protocole de routage régit la manière dont les entités échangent des informations; l'établissement de la route et la transmission des paquets sont des composants essentiels du processus de routage, en plus des opérations requises pour la maintenance des données de routage et la reprise après défaillance de la route [10].

Les unités de bord de route sont considérées comme des composants importants de l'environnement véhiculaire car ils ont un grand impact sur les performances du réseau [11]. En fait, elles sont déployées aux intersections et le long des routes afin de contribuer à améliorer la connectivité du réseau, la livraison de données et la fourniture de services [12]. De plus, de nombreuses applications émergentes dépendent de l'infrastructure, comme le cloud public/privé, le serveur d'autorité gouvernementale, la gestion de la sécurité, etc [12]. Cependant, le déploiement à grande échelle de l'infrastructure est entravé par son coût élevé

XII

d'installation et de gestion [12]. Plusieurs techniques d'optimisation du déploiement des unités de bord de route ont été proposées afin de parvenir à un compromis entre le coût de déploiement et les performances du réseau [11, 12, 13]. Pour maximiser leur disponibilité dans les réseaux véhiculaires, des solutions telles que; l'utilisation de bus [14, 15, 16], des véhicules du gouvernement [12] et des véhicules en stationnement [17, 18, 19] comme infrastructure fixe et mobile, ont été proposées. Cependant, de telles solutions ne sont pas envisageables dans l'environnement autoroutier car nous n'avons pas de véhicules stationnés et de bus fréquents dans ce contexte. Ainsi, à moins d'un déploiement massif d'unités de bord de route, qui est très coûteux, des angles morts le long des autoroutes dans lesquelles les véhicules perdent la connexion à l'infrastructure peuvent exister [11]. Afin d'accéder à l'infrastructure, dans un tel scénario, deux options sont disponibles en fonction de la densité du réseau. Dans les réseaux de véhicules clairsemés, les techniques à enregistrement/réémission peuvent être utilisées pour contourner ce problème en stockant le paquet à envoyer dans le cache du véhicule jusqu'à ce qu'il trouve une opportunité de le relayer vers l'infrastructure [20]. Dans les réseaux denses, les véhicules peuvent compter sur les communications véhicule-à-véhicule pour transférer le paquet jusqu'à atteindre l'infrastructure [21]. Dans le second scénario, la position de l'infrastructure est nécessaire pour lui transmettre les informations. Les travaux abordant ce scénario spécifique supposent que la position de l'infrastructure est censée être connue, soit en l'acquérant à partir de la carte routière [21], soit en la demandant à d'autres nœuds véhiculaires [12]. Cependant, la première hypothèse ne peut pas être réaliste car tous les véhicules sur les routes ne sont pas équipés pour accéder à la carte routière et la dernière est effectuée de manière réactive, donc les données sont transférées avec un retard qui n'est pas tolérable, en particulier pour les informations liées à la sécurité, qui ont besoin être transféré en temps opportun.

Les réseaux de véhicules promettent des routes plus sûres et une conduite fluide en offrant un certain nombre d'applications de sécurité telles que l'avertissement coopératif de collision et l'avertissement d'angle mort [22]. Cette catégorie d'application est considérée comme sensible au retard et nécessite une transmission rapide et fiable des informations vers la destination concernée (véhicules ou infrastructure). Pour ce faire, une pléthore de protocoles de routage a été proposée dans la littérature [23]. Les protocoles basés sur les données géographiques sont considérés comme les mieux adaptés à ce type de réseau car la diffusion des données, pour de nombreuses applications véhiculaires est étroitement liée à la position géographique des nœuds impliqués (émetteur, transitaire et récepteur) [24]. Cette famille de protocoles de routage fonctionne conjointement avec des services de localisation dont la mission est de fournir et de maintenir des informations de localisation. Habituellement, le service de routage et de localisation sont gérés séparément, ce qui induit un contrôle énorme et une surcharge

du réseau [25]. La fusion des deux processus réduit la surcharge et améliore également les performances [25]. Notre objectif est de relever les défis liés à la transmission des informations de sécurité vers l'infrastructure dans les réseaux intermittents. En fait, une infrastructure véhiculaire dispersée conduit à une couverture non homogène, en particulier dans les autoroutes, car elles s'étendent sur de longues distances et la mise en place d'une infrastructure est très coûteuse. Avec une connectivité discontinue, les véhicules ne peuvent pas avoir de communication directe avec l'infrastructure, ce qui pose d'énormes défis, en particulier lorsque les véhicules ont des messages liés à la sécurité à envoyer. Dans un tel scénario, les véhicules peuvent s'appuyer sur les communications véhicule-à-véhicule pour transférer le paquet jusqu'à atteindre l'infrastructure [26, 27]. Cependant, les solutions multi-sauts véhicule-à-véhicule et hybrides proposées n'offrent aucune garantie pour le délai de livraison de bout en bout des données critiques.

Les travaux présentés dans cette thèse comprennent les contributions suivantes:

- Nous avons proposé une vision plus large de l'écosystème de la mobilité intelligente prenant en compte les nouvelles avancées réalisées dans le domaine du transport. Cette nouvelle proposition structure le concept autour de trois domaines, à savoir terrestre, aérien et marin et souligne la nécessité d'une coopération approfondie entre tous les modes de transport. Nous avons également discuté de certaines des orientations futures de recherche les plus importantes pour permettre une intégration complète des transports terrestres, aériens et maritimes pour une mobilité multimodale.
- Nous avons mené une étude sur la collecte et la transmission de données pour les applications de sécurité de l'Internet des véhicules. Les défis de l'IoV résident dans le choix de la technologie appropriée pour transmettre les différents types d'informations avec des exigences de QoS hétérogènes et dans la garantie de la priorité et d'un délai minimal des données d'urgence afin de préserver la pertinence de l'information. À cette fin, nous avons identifié les types de voitures, les technologies et les types de données et exposé les différents niveaux de communication utilisés dans la quête de la réalisation de la sécurité.
- Nous avons fourni une étude des protocoles de routage dans le domaine terrestre. Plus précisément, nous avons présenté les différentes taxonomies et leurs variantes, en plus de proposer de nouveaux critères pour leur classification, tout en fournissant une liste exhaustive des terminologies existantes dans la littérature. Au cours de cette étude, nous nous sommes concentrés sur l'acheminement géographique dans les réseaux véhiculaires en présentant une description générique de ses principaux éléments. Nous avons

XIV

également mis en évidence certaines techniques d'optimisation, à savoir les approches bio-inspirées, l'intelligence informatique et les paradigmes de réseautage utilisés pour proposer des algorithmes de routage plus efficaces et plus robustes.

- Nous avons proposé ILTS (Infrastructure Localization service and Tracking Scheme), un système de transmission d'informations qui permet d'estimer les informations nécessaires pour atteindre les RSU dans des réseaux basés sur une infrastructure dispersés. ILTS permet aux véhicules de déterminer de manière proactive la position de l'infrastructure et de déduire les chemins disponibles vers celle-ci en s'appuyant sur le système de balisage.
- Nous avons proposé HyRSIC (Hybrid Routing for Safety data with Intermittent V2I Connectivity), un protocole de routage pour les réseaux basés sur une infrastructure intermittents. Il est basé sur un algorithme de prise de décision pour les communications V2V et V2I couplé à un service de localisation d'infrastructure, où la décision de routage appropriée est prise en fonction des informations de routage à temps à savoir la distance de l'infrastructure, la disponibilité et la qualité du chemin, la stabilité de la liaison et l'estimation du retard.

Contents

List of Tables	XXI
List of Figures	XXV
Introduction	1
0.1 Problem statement and motivation	2
0.2 Main contributions	4
0.3 List of publications	5
0.4 Thesis outline	6
1 Smart Mobility	7
1.1 A unified Smart Mobility system integrating terrestrial, aerial and marine intelligent vehicles	7
1.1.1 Involved domains	8
1.1.2 Communication levels	11
1.1.3 Smart Mobility challenges	13
1.2 Terrestrial domain	14
1.2.1 Applications	14
1.2.2 Wireless technologies	16
1.2.2.1 Overview of IoV Wireless Technologies	16
1.2.2.2 Dedicated Short Range Communications	20
1.3 Conclusion	22
2 Localization Services and Routing Protocols in the Terrestrial Domain	23
2.1 Introduction	23
2.2 Location information service classification	23
2.2.1 Location server structure	24
2.2.2 Messages exchange patterns	25
2.2.3 Network structure	26
2.2.4 Communication technology	26

2.3	Routing challenges	27
2.4	Routing protocols classifications	29
2.4.1	Existing taxonomies	29
2.4.2	Proposed taxonomies	32
2.5	Conclusion	38
3	Infrastructure Localization service and Tracking Scheme	39
3.1	Introduction	39
3.2	State of the art	39
3.3	Model assumptions	40
3.4	ILTS functional behaviour	41
3.4.1	Data collection mechanisms	42
3.4.1.1	WSA information	43
3.4.1.2	BSM information	45
3.4.2	Path track	49
3.4.2.1	Link to the previous RSU	50
3.4.2.2	Link to the subsequent RSU	53
3.5	Performance evaluation	56
3.5.1	Evaluation set-up	57
3.5.2	Simulation metrics	58
3.5.3	Simulation results and analysis	58
3.5.3.1	Localization information service evalutaion	59
3.5.3.2	Tracking scheme evalutaion	60
3.6	Conclusion	62
4	Hybrid Routing for Safety Data with Intermittent V2I Connectivity	63
4.1	Introduction	63
4.2	Related work	64
4.2.1	Hybrid routing	64
4.2.2	State of the art	64
4.3	Preliminaries and Notations	65
4.3.1	Model notations	65
4.3.2	Greedy forwarding	66
4.4	HyRSIC functional behaviour	67
4.4.1	Data collection mechanism	68
4.4.2	Path track	73

4.4.3	Decision process	78
4.4.3.1	Path selection	78
4.4.3.2	Next hop selection	79
4.5	Performance evaluation	83
4.5.1	Evaluation set-up	83
4.5.2	Simulation metrics	85
4.5.3	Simulation results and analysis	86
4.5.3.1	First phase of evaluation	86
4.5.3.2	Second phase of evaluation	89
4.6	Conclusion	90
	Conclusion	91
	References	95

List of Tables

1.1	IoV short range wireless technologies.	17
1.2	IoV medium range wireless technologies.	18
1.3	IoV wide range wireless technologies.	19
2.1	VANETs location services comparison.	27
2.2	Routing parameters at the different layers	35
2.3	Summary of classification taxonomies.	38
3.1	Related work comparaisn.	40
3.2	Simulation set-up.	58
4.1	Related work comparison.	65
4.2	Notations descriptions.	66
4.3	Simulation set-up.	85

List of Figures

1.1	Smart Mobility ecosystem.	8
1.2	VANETs architecture.	9
1.3	FANETs architecture.	10
1.4	SANETs architecture.	11
1.5	Communication levels.	12
1.6	Smart Mobility shared infrastructure.	14
1.7	Layered architecture for DSRC communication in the US [58].	20
1.8	DSRC band plan channel designation [58].	21
2.1	Location service aspects taxonomy.	24
2.2	VANETs routing protocols existing classifications.	30
2.3	VANETs routing protocols new classifications.	32
3.1	Illustration of vehicles transmission range.	41
3.2	WSA message format.	43
3.3	BSM message format.	43
3.4	RSU Table.	44
3.5	WSA information extraction.	44
3.6	BSM message.	46
3.7	Neighbours Table.	47
3.8	BSM exchange.	47
3.9	BSM exchange example scenario.	49
3.10	Neighbours Table of vehicle A.	49
3.11	Level organization.	49
3.12	Collecting information relative to previous RSU.	51
3.13	Collecting information relative to previous RSU at T1.	53
3.14	Collecting information relative to previous RSU at T2.	53
3.15	Collecting information relative to subsequent RSU from vehicles in the same direction.	54

3.16	Collecting information relative to subsequent RSU from vehicles from the opposite direction.	55
3.17	Collecting information relative to subsequent RSU at T1.	57
3.18	Collecting information relative to subsequent RSU at T2.	57
3.19	Notification Delay with IC=0 Vs Vehicles max speed and vehicles number, with Road Length = 3 Km.	59
3.20	Notification Delay with AM=1 Vs Vehicles max speed and vehicles number, with Road Length = 3 Km.	60
3.21	Notification Delay with IC =0 Vs max speed and Road Length (1, 3 and 6 Km), with vehicles number = 30 vehicle/Km.	61
3.22	Notification percentage in CL-P Vs Vehicles number and Road Length (1, 3 and 6 Km), with max speed = 30 m/s.	61
3.23	Notification percentage in CL-N Vs vehicles number and Road Length (1, 3 and 6 Km), with max speed = 30 m/s.	62
4.1	Illustration of GPSR operations: Greedy forwarding and Right-hand rule. . . .	67
4.2	Level organization example and forwarding possibilities.	68
4.3	RSU Table.	69
4.4	WSA information extraction.	70
4.5	Neighbours Table.	70
4.6	BSM exchange example scenario.	73
4.7	Neighbours Table of vehicle A.	73
4.8	HN-P calculation for curved road.	74
4.9	HN-N calculation for curved road with information from vehicle in the opposite direction.	75
4.10	HN-N calculation for curved road with information from vehicle in the same direction.	76
4.11	Link-backward only available.	82
4.12	Link-ahead only available.	82
4.13	Links available towards both RSUs.	83
4.14	End-to-End delay Vs Vehicles max speed and vehicles number, with Road Length = 3 Km.	86
4.15	End-to-End delay Vs Road Length and vehicles number, with vehicles max speed = 30 m/s.	87
4.16	End-to-End delay Vs Number of source and vehicles number, with vehicles max speed = 30 m/s and Road Length = 3km.	88

4.17	RSU choice Vs Distance from RSU with Road Length = 3 Km, vehicles number and vehicles max speed = 30 m/s.	88
4.18	PDR Vs Vehicles number, with Road Length = 3 Km and vehicles max speed = 30 m/s.	89
4.19	End-to-End delay Vs vehicles number, with vehicles max speed = 30 m/s and Road Length = 3km.	90

Introduction

Technical, social, economic and organizational problems raised by population growth and increased urbanization generate new challenges to be faced by cities such as traffic congestion, air pollution, difficulty in waste management, scarcity of resources and human health concerns [1]. During the last decade, with the emergence of new technologies and innovative paradigms such as Internet of Things (IoT) [2], Information and Communication Technologies (ICT) [3] and Cloud Computing [4], the trend is towards a vision of a Smart City, which maintains economic and environmental sustainability to provide better conditions of life to its citizens. Regardless the city context, the benefits of applying the Smart City paradigm will be spread through all aspects of the urban life, ranging from transportation and education to green spaces and healthcare.

Transport of goods and people is at the heart of Smart City activities and influences all other aspects, including economy, tourism, health care, and so on. Great progress has been made in this area, which has led to the emergence of the Smart Mobility (SM) concept. The domain is facing important growth as the concept of Mobility as a Service (MaaS) is becoming more and more important and a common management of all the means of transportation is required. In future Smart Cities, a multi-modal service of mobility may combine not only classical means of road transportation, such as cars, bikes, buses, but also air transportation means like drones or marine transportation systems.

In this context, Vehicular Ad-Hoc Networks (VANETs) refer to the most important terrestrial networking paradigm, enabling the communication among vehicles and Road Side Units (RSUs) placed along the roads in order to improve road safety and provide travellers comfort [8]. The specific characteristics of VANETs, such as high-speed of nodes and frequent topology changes, impose challenges for the routing process. In addition, the advent of the Internet of Vehicles concept along with the autonomous and connected cars contribute to the proliferation of new innovative applications with different quality of service requirements, rising new challenging issues for data transfer.

In traditional VANETs, we can distinguish between three major communication levels [9]: Vehicle-to-Vehicle communication (V2V), Roadside-to-Vehicle communication (R2V) (also referred to as Infrastructure-to-Vehicle communication (I2V)) and Hybrid Vehicular Communication (HVC) (both V2V and R2V). The effective delivery of VANET applications

and services among network nodes is tightly related to the flexibility and performance of deployed routing protocols, which are held back by the shared medium and the low bandwidth, characterizing the vehicular environment. The routing process is needed in order to relay information between vehicles until reaching the destination. In fact, vehicles must rely on V2V multi-hop communications to reach remote nodes or infrastructure if there is no nearby RSU for direct V2I communications. A routing protocol governs the way that entities exchange information; route establishment and packet forwarding are essential components of the routing process, besides required operations for route maintenance and route failure recovery [10].

0.1 Problem statement and motivation

In the literature, SM is described as being the combination of smart technologies with mobility solutions, resulting in smart governance for sustainable, technology-driven and citizen-oriented mobility [5]. Actually, Intelligent Transportation Systems (ITS) and, more recently, Internet of Vehicles (IoV) have attracted a lot of attention from academic and industrial research as building blocks of the Smart Mobility ecosystem. ITS are described as being the incorporation of information and communications technology into transport infrastructures and vehicles [6], while IoV results from the integration of Vehicular Ad-Hoc Networks (VANETs), a terrestrial networking paradigm, with Internet connection, in order to enable vehicles to exchange information with their surrounds (vehicles, roads, human and sensor) [7]. Most studies and researches focus mainly on the terrestrial domain. Therefore, the vehicular environment is restricted only to the terrestrial domain, especially cars as well as other transport modes such bus and train, and the current SM vision only involves terrestrial urban mobility. In fact, Car-to-Everything communications are the most developed ones.

Road Side Units (RSUs) are considered as important components of the vehicular environment as they have a great impact on the network performance [11]. In fact, RSUs are deployed at intersection and along roads in order to enhance network connectivity, data delivery and service providing [12]. In addition, many emerging applications are infrastructure-dependent such as public/private Cloud, government authority server, security management, etc. [12]. However, RSUs large scale deployment is hindered by its high cost of installation and management [12]. Several RSUs deployment optimization techniques were proposed in order to achieve a trade-off between deployment cost and network performance [11, 12, 13]. To maximize the availability of RSUs in the VANETs, solutions such as; using bus [14, 15, 16], government vehicles [12] and parked vehicles [17, 18, 19] as fixed and mobile infrastructure, were proposed. However, such solutions cannot be envisaged in the highway

environment as we do not have parked vehicles and frequent bus in such context. Thus, unless a massive deployment of RSUs, which is very expensive, blind spots along highways in which vehicles lose the connection to the infrastructure may exist [11]. In order to reach the infrastructure, in such scenario, two options are available according to the network density. In sparse vehicular networks, Store Carry Forward (SCF) techniques can be used to get around this problem by storing the packet to send in the cache of the vehicle until it finds an opportunity to relay it to the infrastructure [20]. In dense networks, vehicles can rely on V2V communications to forward the packet until reaching the infrastructure [21]. In the second scenario, the position of the RSU is need in order to forward the information towards it. Works tackling this specific scenario assume that the position of the RSU is supposed to be known, by either acquiring it from road map [21] or by requesting it from other vehicular nodes [12]. However, the first assumption cannot be realistic as not all vehicles in roads are equipped to access road map and the last one is performed reactively, therefore data is transferred with a delay which is not tolerable especially for safety related information, that need to be transferred in a timely manner.

In fact, vehicular networks are promising safer roads and a smooth driving by offering several safety applications such as cooperative crash and blind spot warning [22]. This category of application is considered as delay sensitive and requires rapid and reliable forwarding of information to the concerned destination (vehicles or RSUs). To do so, a plethora of routing protocols for VANETs has been proposed in the literature [23]. Geography-based protocols are considered to be best suited for this type of network, as the data dissemination, for many vehicular applications, is closely linked to the geographic position of the involved nodes (emitter, forwarders and receiver) [23]. This family of routing protocols work jointly with location-based services whose mission is to provide and maintain location information. Usually, routing and location service are handled separately inducing huge control and localization overhead [25]. Merging the two processes reduces overhead and also improves performance [25].

Our objective is to deal with the challenges related to safety information forwarding towards the RSU in intermittent infrastructure-based networks. In fact, a scattered vehicular infrastructure leads to non-homogeneous coverage, especially in highway scenarios extending over long distances; it is very expensive to set up an infrastructure across the entire road. With a discontinuous connectivity, vehicles cannot have direct communication with the RSUs, which poses enormous challenges, especially when vehicles have safety related messages to send to the infrastructure. In such scenario, vehicles can rely on V2V communications to forward the packet until reaching the infrastructure [26, 27]. However, the multi-hop V2V and hybrid proposed solutions do not offer any guarantee for the critical data end-to-end delivery delay.

0.2 Main contributions

The work presented in this thesis include the following contributions:

- We proposed a wider vision of Smart Mobility ecosystem taking into account the new advances made in the field of transport. This new proposition structures Smart Mobility around three domains namely terrestrial, aerial and marine and stresses out the need for a thoroughly cooperation between all transport modes. We also discussed some of the most significant future research directions for enabling a full integration of land, air and sea transport for a multi-modal mobility.
- We conducted a study on data gathering and transmission for Internet of Vehicles safety applications. The challenges of IoV reside on how to choose the appropriate technology to transmit different types of information with heterogeneous QoS requirements and how to guarantee priority and minimal delay for emergency data to preserve the relevance of the information. To this purpose, we identified the car-types, technologies, and data types and exposed the different communication levels used in the quest of safety realization.
- We provided a survey of routing protocols in the terrestrial domain. More precisely, we presented the different taxonomies and their variants, in addition to proposing new criteria for their classification, while providing an exhaustive list of existing terminologies in the literature. During this study, we focused on the geographical routing in VANETs by presenting a generic description of its main building blocks. We also, highlighted some optimization techniques namely bio-inspired approaches, computational intelligence and networking paradigms, used to come up with more efficient and robust routing algorithms.
- We proposed ILTS (Infrastructure Localization service and Tracking Scheme), a forwarding information scheme that allows to estimate necessary information to reach the remote infrastructure. ILTS enables vehicles to proactively determine the infrastructure position and deduce available paths towards it by relying on the beaconing system.
- We proposed HyRSIC (Hybrid Routing for Safety data with Intermittent V2I Connectivity), a routing protocol for intermittent infrastructure-based networks. It is based on a decision making algorithm for V2V and V2I communications coupled with infrastructure location service, where the suitable routing decision is made based on the fresh routing information namely the distance from the infrastructure, the availability and quality of the path, the link stability and the delay estimate.

0.3 List of publications

Here is a list of our publications during this thesis work:

1. Journals

- Chahrazed Ksouri, Imen Jemili, Mohamed Mosbah, Abdelfettah Belghith: "Towards General Internet of Vehicles Networking: Routing Protocols Survey", *Concurrency & Computation; Practice and Experience*.
DOI:[10.1002/cpe.5994](https://doi.org/10.1002/cpe.5994).
- Chahrazed Ksouri, Imen Jemili, Mohamed Mosbah, Abdelfettah Belghith: "Infrastructure Localization Service and Tracking Scheme." Submitted to the special issue: Internet of Vehicle in Smart City. *Annals of Telecommunications*, Springer.
- Chahrazed Ksouri, Imen Jemili, Mohamed Mosbah, Abdelfettah Belghith: "Wireless Sensor Networks in Smart Cities: A Survey on Applications, Challenges and Technologies Integration." Submitted to *Networks* an international journal, Wiley Online Library.

2. Conferences

- Chahrazed Ksouri, Imen Jemili, Mohamed Mosbah, Abdelfettah Belghith: "Data gathering for Internet of Vehicles safety." *2018 14th International Wireless Communications & Mobile Computing Conference (IWCMC)*.
DOI:[10.1109/IWCMC.2018.8450498](https://doi.org/10.1109/IWCMC.2018.8450498)
- Chahrazed Ksouri, Imen Jemili, Mohamed Mosbah, Abdelfettah Belghith: "VANETs Routing Protocols Survey: Classifications, Optimization Methods and New Trends." *2019, International Workshop on Distributed Computing for Emerging Smart Networks*.
DOI: [10.1007/978-3-030-40131-3_1](https://doi.org/10.1007/978-3-030-40131-3_1)
- Chahrazed Ksouri, Imen Jemili, Mohamed Mosbah, Abdelfettah Belghith: "A Unified Smart Mobility System Integrating Terrestrial, Aerial and Marine Intelligent Vehicles." *2020, International Workshop on Communication Technologies for Vehicles*.
DOI: [10.1007/978-3-030-66030-7_18](https://doi.org/10.1007/978-3-030-66030-7_18)

0.4 Thesis outline

The remainder of the thesis is structured as follows. In the first chapter [1](#), we propose a more general vision of the Smart Mobility ecosystem, while specifying future research work towards a consistent deployment of such a wider vision. We then, focus on the terrestrial domain, we present its main applications, communications levels and wireless technologies. In the second chapter [2](#), we present the state-of-art of localization services and routing protocols in the terrestrial domain. First, we present a classification for localization services in VANETs. Then, we expose routing challenges in such context. And, we propose a classification of the existing routing solutions. The third chapter [3](#) presents our tracking scheme, called ILTS. It details the functional behavior of the proposed scheme. Besides, it gives an overview on Localization Information Services used in the vehicular environment. A performance evaluation of ILTS is conducted in this chapter. It shows that the proposed scheme enables an up-to-date information maintenance. Chapter [4](#) presents our effort in designing a routing approach based on a decision making algorithm, HyRSIC, enabling optimal forwarding path selection. The evaluation of the proposed solution shows that it can reach high reliability for different simulation scenarios. Finally, the conclusion where we summarize the thesis contributions and we discuss the potential directions for future works.

Chapter 1

Smart Mobility

In this chapter, we present a new Smart Mobility vision structuring the concept around three domains namely terrestrial, aerial and marine. We stress out the need for a thoroughly cooperation between all transport modes by pointing out the challenges to address in SM. We then, pay particular attention to the terrestrial domain, as the rest of the thesis work is relative to communications in this domain. We present different safety and non-safety applications, communication levels and wireless technologies used in this domain.

1.1 A unified Smart Mobility system integrating terrestrial, aerial and marine intelligent vehicles

Heretofore, Smart Mobility is perceived as a concept that integrates pervasive intelligence with transportation solutions in order to offer a safer and more efficient on road traffic. However, ITS and IoV concepts, hence Smart Mobility, should not be restricted to the terrestrial domain. In fact, transport accidents are not limited to road and highway, but affect all transport mode. In a city like Venice (Italy) where boats are the main transport mode, equipping them with technologies to avoid collisions would be beneficial to preserve lives. Besides, Urban Aerial Mobility (UAM), a new concept resulting from the emergence and deployment of novel aerial vehicles such as delivery and medical drones, has emerged. One of the main advantages of adopting aerial vehicles solutions is to lighten the road traffic by relaying on in-sky travel. Moreover, enabling cooperation between the vehicles of the different domains offers a more efficient transportation options. As stated in **Figure 1.1**, we propose a Smart Mobility ecosystem structured around three domains, namely terrestrial, aerial and marine.

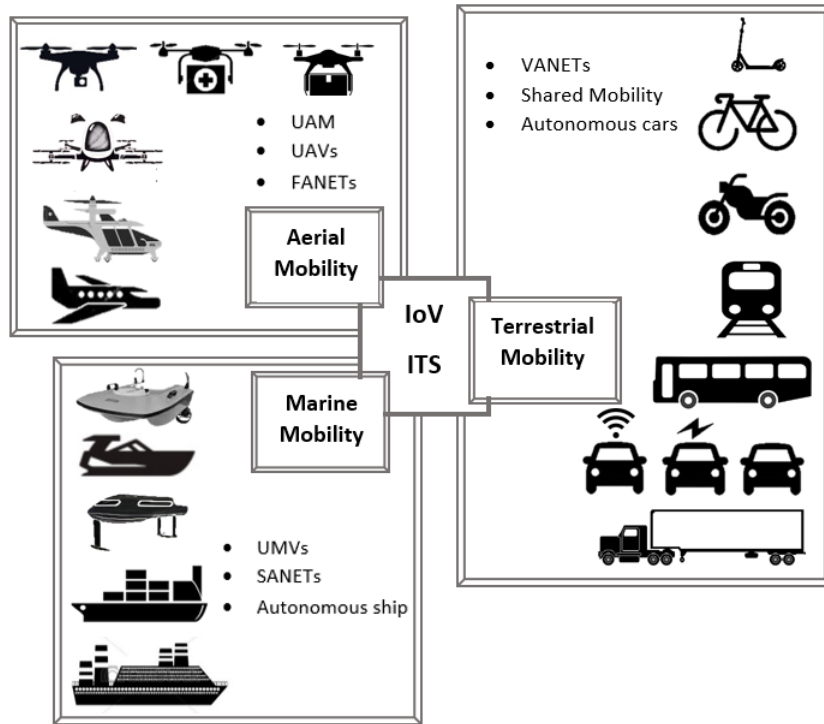

Figure 1.1: Smart Mobility ecosystem.

1.1.1 Involved domains

In the following, we present the different Smart Mobility domains:

The terrestrial domain includes all means of transport ranging from two-wheeled commuters (electric scooters, bicycles and bikes), bus, cars (ordinary, electrical, connected and autonomous), transport truck to rail. New services such as carpooling and shared mobility (electric scooters and electric and ordinary cars and bicycles) have revolutionized the urban mobility perception by making available, at a city scale, energy efficient and environmentally friendly transport solutions. Vehicular Ad-Hoc Networks refer to the most important terrestrial networking paradigm, enabling the communication among vehicles and Road Side Units placed along the roads in order to improve road safety and provide travellers comfort [8], as depicted in **Figure 1.2**. Several communications-related applications, which we refer to by Cooperative-ITS are proposed [28]. For instance, platooning, which describes vehicles on the road with some common interests that can cooperatively form a platoon-based driving pattern, in which a vehicle follows another one and maintains a small and nearly constant distance to the preceding vehicle [29].

Along with the emergence of innovative solutions, major challenges are arising :

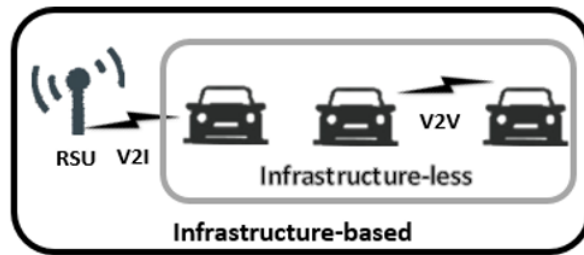

Figure 1.2: VANETs architecture.

- Large scale field trials are needed to pave the path to a more autonomous driving and a better integration with the vehicular cyber-physical systems [30].
- The response time and detection of Vulnerable Road Users (VRUs), such as pedestrians and cyclists, is of the utmost importance for both ordinary and self-driving vehicles [31].
- Security and privacy are aspects that need to be thoroughly studied to prevent from attacks conducted against connected and autonomous cars and to secure the data exchange [32].
- With IoV concept integrating Internet into the vehicular environment, new services with different requirements in terms of Quality of Service (QoS) and Experience (QeE) are emerging and must be satisfied.

In the aerial domain, in addition to drones commercialization, many urban aerial applications have emerged these past few years such as drone delivery, medical drone and taxi drone; In cities like Dubai, we can even speak about taxi drone stations [33]. In north Latin American countries, Voom, an on-demand helicopter booking platform connecting travellers with air taxi companies, is already operational [34]; it enables travellers to fly over terrestrial traffic quickly and easily. The convergence of this set of innovative transport solutions has led to the emergence of a new concept, Urban Air Mobility. UAM can contribute significantly to a multi-modal mobility system and help build more liveable cities [35], we can cite efforts of Airbus [35] to build a sustainable global mobility system by exploiting the airspace to expand existing ground transport network into the sky. In the air sector, the networking paradigm Flying Ad hoc Networks (FANETs) is attracting a lot of attention, as presented in **Figure 1.3**. In these networks, the communicating nodes are UAVs (Unmanned Aerial Vehicles) [36], which are characterized by low capital cost, fast deployment and large area coverage.

To enable urban transport expanding in the sky, more efforts are still needed:

- The integration of UAM solutions with existing urban infrastructure and the study of those required (helipad, taxi drone station) must be investigated to enable UAM operations scaling in cities [37].

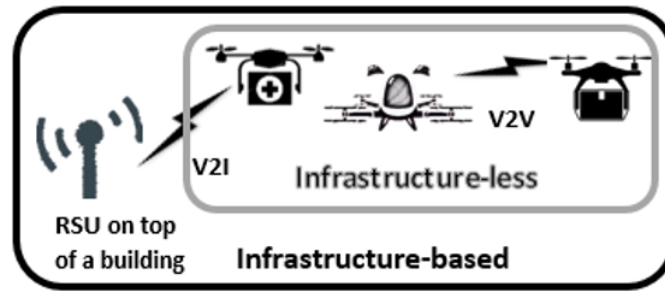

Figure 1.3: FANETs architecture.

- Further research are needed to define mobility models that depict the movements of autonomous aerial vehicles in a specified area with high 3D mobility [38].
- On the near future the aerial domain of cities will see an overcrowding, then, measures must be taken to insure regulation in the air by establishing traffic laws. In fact, regulations concerning the management of commercial UAV are already developed, while those related to transportation services still in process [39].
- While energy and computational capacity do not represent a major drawback in the terrestrial domain, more research must be conducted to solve these problems in the aerial sector [40].

The Marine domain includes many vehicle types: UMVs (Unmanned Marine Vehicles) at the surface and underwater, gondola, cargo ship (ordinary and autonomous), cruise ships. Similar to other domains, the maritime transportation is evolving with the proliferation of the new communication and computational features and many research are being conducted to upgrade the maritime industry. For instance, Rolls-Royce is developing unmanned cargo ships that can be remotely controlled by captains using a virtual-reality recreation of a vessel's bridge [41]. SANET (Ship Adhoc Network), presented in **Figure 1.4**, is a networking paradigm that is being considered as a cost efficiently alternative for satellite marine communications [42]. In fact, it enables ship-to-ship direct communications to exchange information, hence reduces the use of expensive satellites. Besides, the deployment of marine Internet, employing cellular links for data transmission from marine user equipment on a ship to a cellular base station [43] and wireless multi-hop network communication for ships with embedded systems [44], is being investigated.

With the technological developments in the maritime domain, some challenges are arising:

- In order to bring Internet to the sea, investments must be made to expand the coast infrastructure to ensure a wider coverage area [43, 44].

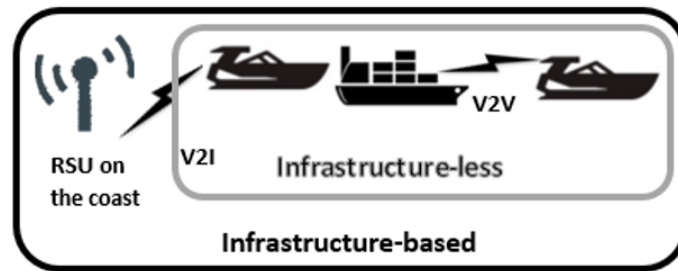

Figure 1.4: SANETs architecture.

- The continued unfolding of digitalization of ships must be handled by analyzing current and emerging cybersecurity threats and vulnerabilities [45].
- While the development of autonomous ships is gathering momentum, there are still legitimate concerns about the safety, security and reliability of autonomous ships operation, in addition, the regulatory scoping must be further revised to cover this recently added technology [46].

Terrestrial, aerial and marine inter-urban mobility is fully developed and the underlying sectors namely routes planning, transport logistics, traffic control and legislative are well specified. However, in urban areas only terrestrial and marine (in city such Venice) mobility is defined. In addition to being a transport mode of the future, which will alleviate some of the on road congestion, aerial vehicles have the potential to play a prominent role in the terrestrial mobility. In fact, several works investigate the possibility of monitoring road traffic conditions by UAVs [47] and also UAVs assisting data dissemination in VANETs [48]. As in the terrestrial domain, drones are used in the maritime domain to conduct certain operations such as surveying ships, supervising offshore installations [49] and delivering goods and supplies [50]. Nevertheless, certain aspects must be addressed independently, in fact, the technological challenges and applied legislative are specific to each area. For instance, the signal propagation model on the air and over water surface are not the same. Furthermore, the types of vehicles, communication levels as well as the wireless technologies differ from one field to another.

1.1.2 Communication levels

As shown in **Figure 1.5**, in addition to intra-domain communication levels, inter-domain communications between the vehicles and the infrastructure of the different domains can be achieved. Therefore, by enabling communication among all the ecosystem components, Smart Cities will be able to transport people and goods more safely, efficiently and environmentally. These interactions enable new services, such as terrestrial traffic monitoring by drones in Smart

Cities [51] and VANETs services connectivity assistance by UAVs [52]. The vehicles rely on wireless technologies to communicate with other entities of the ecosystem. In the following, we identify the possible IoV communications, referred to as Vehicle-to-Everything (V2X) communications:

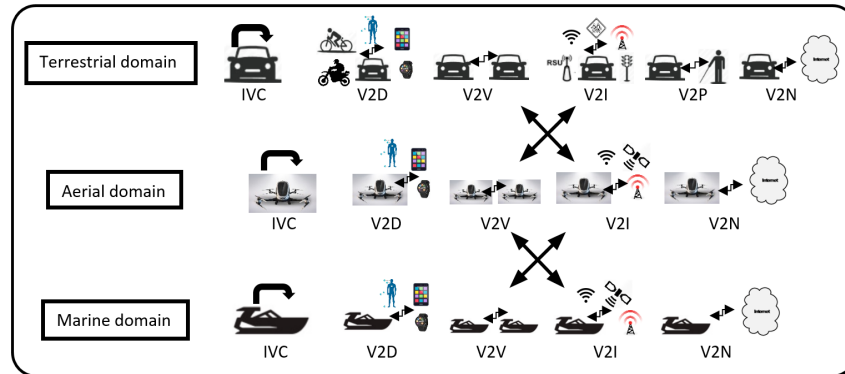

Figure 1.5: Communication levels.

- Intra-Vehicle Communication (IVC) refers to internal information transmissions. Regular state notifications and alert messages will be displayed only to the driver. This information is derived from the analyses of data transmitted by the internal sensors, such as temperature sensor and pressure sensor [53].
- Vehicle to Device communication (V2D) enables to link cars to many internal and external devices. It enables cars to communicate with the external devices, such as two-wheeled commuters (bicycle, motorbike) in order to exchange safety information. Internal V2D communications concern personal devices of the driver and passengers, such as smart-watch, smart-phone and body sensors. For example, if the driver is about to feel unwell (blood pressure drop), the car can take the control and navigate to the nearest emergency room [53].
- Vehicle to Vehicle communication (V2V) enables cars to communicate with each other. Based on wireless communications, the car is able to inform the driver about the surrounding cars, so he can avoid collision or choose the most efficient road to keep away from traffic jam [53].
- Vehicle to Infrastructure Communication (V2I) enables the exchange of safety and non-safety data between vehicles and roadway infrastructure, like Road Side Units, traffic lights, base stations and sensors. For example, V2I alerts drivers of upcoming red

lights. The information is also transmitted in the other direction, from vehicles to the infrastructure to report accidents or any other situation, such as the misbehavior of a vehicle [53].

- Vehicle to Pedestrian communication (V2P) allows communication between cars and pedestrians; such communication will be particularly beneficial to elderly persons, school kids and physically challenged persons. V2P may establish a communication between pedestrian's smartphones and vehicles and acts as an advisory tool to avoid imminent collision [54].
- Vehicle to Business communication (V2B) represents the connection of vehicles and drivers to the Internet to facilitate applications related to multiple domains, such as remote management of embedded systems, logistics, access to a broad range of service provider (car insurance). Remote diagnostic is considered as the most important benefit brought by V2B communication in the context of road safety [55].

1.1.3 Smart Mobility challenges

The proposed vision of the Smart Mobility will imply a set of new directives at different levels:

- Laws, civil legislative and jurisdictional issues for a holistic framework managing the cooperation and interactions between terrestrial, aviation and maritime operations need to be further explored.
- International and national standardization bodies, consortia and industry have to collaborate in order to provide homogenized platforms, architectures and communications technologies. The specification and the deployment of a V2X fifth generation-based ecosystem still requires considerable work.
- For cost efficient solutions, communication infrastructure must be adapted to enable access to the different vehicles. For instance, at a city scale, the infrastructure related to cellular network should provide services for both terrestrial and aerial vehicles, as illustrated in Figure 1.6.
- Physical channel characteristics of land-air-sea communications should be further investigated in order to offer more reliable links with higher bandwidth for time-sensitive and safety applications.

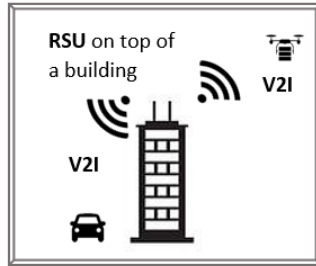

Figure 1.6: Smart Mobility shared infrastructure.

- While heterogeneous-based routing protocols enabling the direct exchange of information between terrestrial and aerial vehicles were proposed [56, 57], more work is needed to enable aerial-marine multi-hop communications.
- One important challenge is to preserve the confidentiality of sensitive information (e.g. location) of other vehicles and UAVs. An investigation must be conducted to identify new threats resulting from the integration of the domains. Then, security mechanisms such as the encryption algorithm or security modules like the key management mechanism, the intrusion detection system and the trust management mechanism, must be deployed.
- In order to meet specific requirements for stakeholder and end users, large scale field experiments and tests are needed to approve the integration solutions.

1.2 Terrestrial domain

The terrestrial domain is the most developed one, and the mobility applications are very diverse and have reached a certain maturity. In fact, the potential applications of IoV are diverse ranging from ensuring the road safety, increasing the efficient flow of traffic, reducing environmental impacts to offering infotainment services. IoV represents a platform where the providers can present their services to driver and car passengers. In the following, we present safety and non-safety applications in the terrestrial domain, in addition to the wireless technologies used to enable vehicular nodes to communicate.

1.2.1 Applications

IoV applications have different QoS and QoE requirements, in addition to specific needs in delay and reliability for safety applications. In the following, we present examples of the different applications types.

Safety applications [58]: These applications aim to ensure road safety. Several security applications exist, among them we site:

- Blind Spot Warning: The application receives periodic updates regarding the position and speed of surrounding vehicles via vehicle-to-vehicle communication. This application warns the driver when he/she intends to change lanes and his/her blind spot is occupied by another vehicle.
- Cooperative Adaptive Cruise Control: This application relies on V2V communication to obtain lead vehicle dynamics and enhance the performance of current adaptive cruise control. This application can be enhanced by relying on V2I communication, which could include intelligent speed adaptation through school zones, work zones, off-ramps, etc.
- Cooperative Collision Warning: The application helps the driver in avoiding or mitigating collisions with other vehicles. In fact, the vehicle receives data regarding the position, velocity, heading, yaw rate, and acceleration of other vehicles in the vicinity. Using this information along with its own position, dynamics, and roadway information, the vehicle determines whether a collision with another vehicle is likely to occur.
- Lane Change Warning: The application receives periodic updates of the position, heading, and speed of surrounding vehicles via V2V communication. When the driver signals a lane change intention, the application uses this communication to predict whether or not there is an adequate gap for a safe lane change based on the position of vehicles in the adjacent lane. If the gap between vehicles in the adjacent lane is not sufficient, the application determines that a safe lane change is not possible and provides a warning to the driver.
- Pre-Crash Sensing: Pre-crash sensing can be used to prepare for imminent, unavoidable collisions. This application could use vehicular communication in combination with other sensors to mitigate the severity of a crash. Countermeasures may include pre-tightening of seat belts, airbag pre-arming, front bumper extension, etc.

Comfort applications [8]: This type of application also known as traffic efficiency application aims to improve the comfort of users on the road by providing mechanisms enabling to enhance traffic flow and mitigate road congestion. Several examples are listed below:

- Congestion Road Notification: It detects and alerts drivers about traffic congestions. Drivers can use the notifications to plan their trips to avoid the congestion.

-
- Speed Management: it assists drivers in controlling their speed in order to improve urban traffic flow and avoid unnecessary braking.
 - Cooperative Navigation: it facilitates navigations among vehicles (e.g. platooning).

Infotainment applications [8]: Infotainment applications are referred to as non-safety applications which aim to make drivers and passengers trips more pleasant. we provide, in what follows, a few use cases of such applications:

- Internet Access: In IoV, vehicles can connect to Internet via single hop communications with fixed gateways (e.g. RSUs) or with mobile gateways (e.g. 4G/LTE-enabled buses). If there is no fixed or mobile gateway in the vicinity of a vehicle, it can initiate multi-hop communications with a gateway several hops away.
- Advertising Services: The application can be provided by fixed or mobile sources which broadcast information about nearby restaurants, pubs, clothing stores, movies in nearby theatres, and scores in baseball games, etc. These sources broadcast advertisement messages within an area of interest; upon receipt of these messages, vehicles may request for much more detailed data (i.e. text/image/voice/video) to the source.

1.2.2 Wireless technologies

The different elements of IoV rely on wireless technologies to ensure the data exchange and maintain the different applications and services such as road safety and infotainment services. Wireless communications suffer from interference, collision and low bandwidth due to the shared channel. And the guaranteed delivery of packets within the required stipulated time is a challenge. In addition, the characteristics inherent in the vehicular network, such as high-speed and frequent topology changes, make data transmission in such an environment more difficult. Several wireless technologies were adapted to be used in the vehicular environment at the different communication levels. So, with the important amount of data related to the vehicular applications and the panoply of wireless technologies available, the challenges of IoV reside on how to choose the appropriate technology to transmit different types of information with heterogeneous QoS requirements and how to guarantee priority and minimal delay for emergency data to preserve the relevance of the information.

1.2.2.1 Overview of IoV Wireless Technologies

In this subsection, we present a comprehensive study of the main used technologies that we classify into short range, medium range and wide range wireless communications.

IoV Short Range Wireless Technologies: The short range wireless technologies available for IoV, are the following:

- **Zigbee:** It is widely used from the low power environment such as wireless body area networks [59]. In the IoV domain, zigbee technology can be deployed for low data rate transmissions between fairly close equipments, such as sharing information between car sensors and between vehicles and devices like body sensors. Operating on 2.4 GHz like many other wireless technologies, occurrence of interference constitutes a main issue for its deployment in IoV [59].
- **Bluetooth:** Bluetooth technology was designed as a short range wireless communication standard, intended to maintain high levels of security [59]. In addition to its widespread use in the automotive industry to ensure applications such as toll road payments, garage door control and devices connection to speakers, it is also deployed to ensure the transmission of safety data in the IoV environment. However, the imposed piconet structure and the master/slave communications will be difficult to maintain in IVC [59].
- **UWB:** A derived option of the Bluetooth standard is the Ultra Wide-Band (UWB) technology, it uses a very low energy level for short-range and high-bandwidth communications. This technology is used on many safety applications such as radar applications and collision-detection systems [60]. Thanks to its high data rate, it can insure the delivery of multimedia content such as video for IVC and V2D communications. Besides interference problems, the UWB’s radio coverage could extend to uninvolved vehicles which could generate false or irrelevant information [60].

We summarize, in **Table 1.1**, the short range wireless technologies:

	Zigbee	Bluetooth	UWB
Range	10m	10m	> 10m
Data Rate	128Kbps	3Mbps	500Mbps
Frequency	2.4 GHz	2.4 GHz	2.4 GHz
Communication Levels			
IVC	Car sensors [61]	Automobile components [62]	Automobile components [62]
V2D	Body sensors [59]	Body sensors [59]	–
V2V	Safety [63]	Safety [64]	–

Table 1.1: IoV short range wireless technologies.

IoV Medium Range Wireless Technologies: We present, here, the medium range wireless technologies available for terrestrial IoV, namely:

- **DSRC:** *"Dedicated Short Range Communications (DSRC) are one-way or two-way and short-range to medium-range wireless communication channels, specifically designed for automotive"* [65]. It is a multi-channel wireless standard operating in 75 MHz licensed spectrum at 5.850 to 5.925 GHz band. DSRC uses seven channels of 10 MHz bandwidth which include six service channels and one control channel to support high priority safety messages.
- **WiFi:** Wireless Fidelity allows users to surf the Internet at broadband speeds when connected to an access point or in ad-hoc mode, which is quite suitable for vehicular communications [66]. It is ideally used for large data transfers and for infotainment services in vehicular networking such as video streaming, as it is supported by most smart devices. If deployed for V2V communications, high energy consumption will be an important issue to tackle especially for electric cars. Besides, it is not designed to support high mobility of nodes, frequent topology changes and network fragmentation [60], which are intrinsic characteristics of a vehicular environment.
- **LiFi:** Light Fidelity is a wireless optical networking technology using light emitting diodes for data transmission [67]. LiFi is a high-speed, bidirectional and fully networked wireless communication technology. It is ideal for high density data transmission. Besides, it represents a good alternative technology to avoid radio interference. The utilization of LiFi in the vehicular network is limited, since it requires a near or perfect line of sight to transmit data.

We present, in **Table 1.2** the medium range wireless technologies:

	DSRC	WiFi	LiFi
Range	300-1000m	100m	15m
Data Rate	6Mbps	150Mbps	> 1Gbps
Frequency	5.9 GHz	2.4 GHz	400-700 THz
Communication Levels			
V2V	Safety [68]	Safety [66]	Safety [69]
V2I	Safety [70]	Safety [64]	Road Sign [71]
V2P	Crash avoidance [68]	Crash avoidance [68]	Crash avoidance [68]

Table 1.2: IoV medium range wireless technologies.

IoV Wide Range Wireless Technologies: The wide range wireless technologies available for IoV, are the following:

- **WiMax:** *Worldwide Interoperability for Microwave Access (WiMax)" aimed to provide wireless data over long distances in a variety of ways, from point-to-point links to full*

mobile cellular type access" [60]. WiMAX offers a signal radius of about 50 km and sufficient bandwidth to support different services in vehicular communications [60].

- **Cellular V2X:** C-V2X encompasses both LTE (Long Term Evolution) and forthcoming 5G-based V2X systems [72]. The standard includes two radio interfaces. The cellular interface supports V2I communications and the PC5 interface supports V2V communications based on direct LTE sidelink. Release 14 introduces two new communication modes (modes 3 and 4), specifically designed for V2V communications. Radio resources allocation constitutes the main difference between the two modes. Resources are allocated by the cellular network under mode 3, while for mode 4, vehicles select their radio resources. This technology is well suitable for IoV use cases requiring low-latency, high reliability and high bandwidth.
- **LoRaLPWAN:** Long Range Low-Power Wide-Area Networks (LoRaLPWAN) is one of the new technologies called Low-Power Wide-Area Network, designed for the realization of the different systems belonging to IoT under the Smart City umbrella such as intelligent transportation system, smart building and environmental monitoring [73]. LoRa enables power efficient wireless communications over very long distances, allowing cars to communicate directly with the sink. Hence, it simplifies the communication scheme for non-delay-critical services with low-bandwidth requirements. Besides, a smaller density of base stations is required to cover vast areas, greatly reducing the costs of roadside elements [73].

We present, in **Table 1.3** the wide range wireless technologies:

	WiMax	C-V2X	LoRaLPWAN
Range	50Km	30Km	5-15 km
Data Rate	70Mbps	1Gbps	50Kbps
Frequency	5-6 GHz	5-6 GHz	433-868 MHz
Communication Levels			
V2D	–	Cyclist [74]	
V2V	–	Safety [74]	Safety [73]
V2I	Safety [66] Entertainment [66]	Safety [74] Entertainment [74]	Safety [73]
V2P	–	Crash avoidance [68] [74]	–
V2B	Internet connection [66]	Internet connection [74]	Diagnostic [75]

Table 1.3: IoV wide range wireless technologies.

1.2.2.2 Dedicated Short Range Communications

The suite of standards for vehicular communication consists of (i) Dedicated Short Range Communications: IEEE 802.11p is an approved amendment to the IEEE 802.11 standard encompassing a set of techniques from the PHY and MAC layers; and (ii) IEEE P1609.x: Wireless Access in Vehicular Environment (WAVE), which is a set of standards that define the behavior of nodes equipped with DSRC. In the following, we present the content of DSRC standards, as exposed in **Figure 1.7**, this includes the IEEE 802.11p amendment for wireless access in vehicular environments, the IEEE 1609.2, 1609.3, and 1609.4 standards for Security, Network Services and Multi-Channel Operation, and the SAE J2735 Message Set Dictionary [58]:

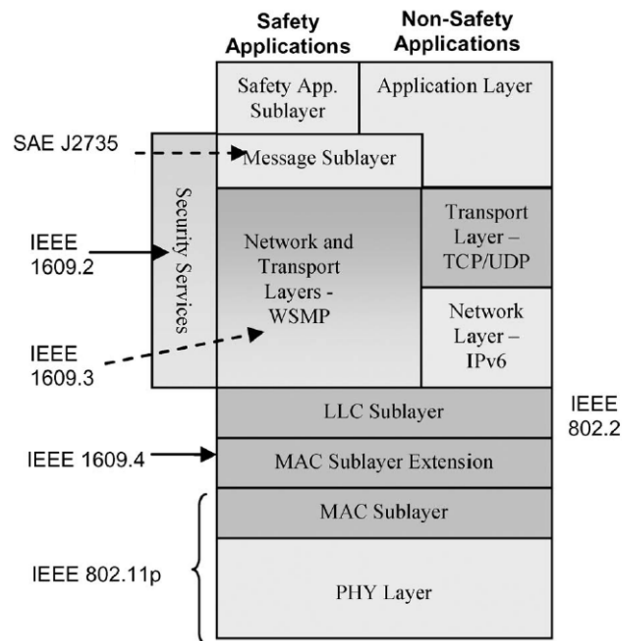

Figure 1.7: Layered architecture for DSRC communication in the US [58].

- Physical layer: The layer is defined in IEEE 802.11, it utilizes the Orthogonal Frequency Division Multiplexing (OFDM) technique. The Federal Communication Commission (FCC) has allocated the spectrum from 5.850 GHz to 5.925 GHz, i.e. the "5.9 GHz band," for DSRC operation in the United States. This spectrum is divided into seven 10 MHz channels with a 5-MHz guard band at the low end, as illustrated in **Figure 1.8**. Pairs of 10 MHz channels can also be combined into a 20 MHz channel. Each channel is either a Service Channel (SCH) or a Control Channel (CCH). 172 is the channel elected to be used for V2V safety communication.
- Data link layer (MAC (Medium Access Control) and LLC (Logical Link Control)):

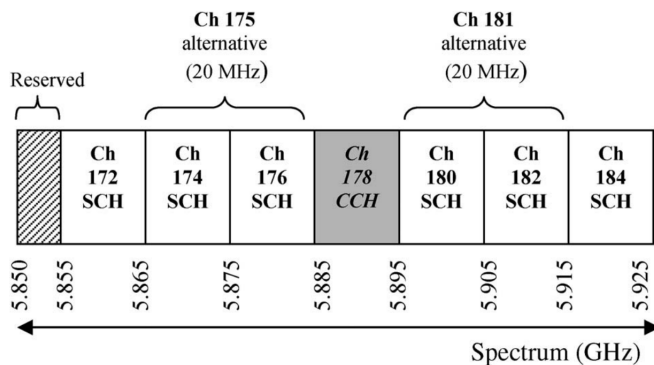

Figure 1.8: DSRC band plan channel designation [58].

- MAC sub-layer: Its purpose is to establish rules for accessing the common medium so that it can be shared efficiently and fairly among a set of vehicular nodes. The basic medium access paradigm of IEEE 802.11 is Carrier Sense Multiple Access/Collision Avoidance (CSMA/CA). The Enhanced Distributed Channel Access (EDCA) QoS mechanism provides different priorities of wireless access primarily through selection of the idle time and back-off range parameters.
 - LLC sub-layer: This sub-layer of the DSRC protocol stack uses the standard IEEE 802.2 protocol.
 - MAC sub-layer extension: It is defined in IEEE 1609.4 and it is applicable when DSRC is operating in a multi-channel environment. It defines the mechanism by which devices that are switching among multiple channels will find each other.
- Network and Transport layers: A service can choose to run over WSMP or traditional Internet protocols, depending on its requirements:
- Over WSMP: It uses the WAVE Short Message Protocol (WSMP) defined in IEEE 1609.3 which is optimized for the non-routed data exchanges that are common to vehicular networks, e.g., V2V safety messages.
 - Over traditional Internet protocols: The second uses traditional Internet protocols, principally IPv6, UDP, and TCP.
- Application layer: This layer includes application processes and additional protocols that provide direct support to applications such as DSRC message set dictionary standard, defined by SAE J2735. It defines the messages that collectively enable a core set of DSRC applications.

-
- Security service: It is defined by IEEE 1609.2, it explains security services for applications and management messages such as authentication and encrypting mechanisms.

1.3 Conclusion

In this chapter, we have proposed a broader vision of Smart Mobility, in line with recent technological advances, while specifying the different mobility domains; namely terrestrial, aerial and marine. In addition, we discussed some of the most significant future research directions for enabling a full integration of land, air and sea transport for a multi-modal mobility. In the rest of the chapter, we focused on the terrestrial domain, where we presented a set of safety and non-safety applications and we introduced the different wireless technologies used in IoV.

In the next chapter, we will provide the state-of-art of localization services and routing protocols in the terrestrial domain.

Chapter 2

Localization Services and Routing Protocols in the Terrestrial Domain

2.1 Introduction

Vehicular Ad-hoc Networks are still considered as a hot research topic with the emergence of Internet of Vehicles and the increasing interest from car manufacturers to provide innovative mobility solutions. These networks are characterized by distinctive properties, mainly high-speed, dynamic topology changes and variable network density, raising challenges on data routing. The discovery phase is required to initialize a data transmission procedure. In fact, it consists on gathering all required information for the subsequent phases. In geographic based routing protocols, information, such as the destination and the forwarder position and speed, are collected by using Location Information Service (LIS). And in topology-based routing, a path discovery phase is performed either in a reactive, proactive or hybrid way before the data is forwarded. In this chapter, we first present routing protocols challenges. Then, we present the state of the art of location information services. And finally, we review the taxonomies of VANETs routing protocols and we suggest new criteria for their classification, while providing an exhaustive list of existing terminologies in the literature.

2.2 Location information service classification

A LIS classification is the structure responsible of managing the operations of request, update and replay of location information in a network [76]. As illustrated in Figure 2.1, several classification criteria for vehicular location services exist [76], among them we cite:

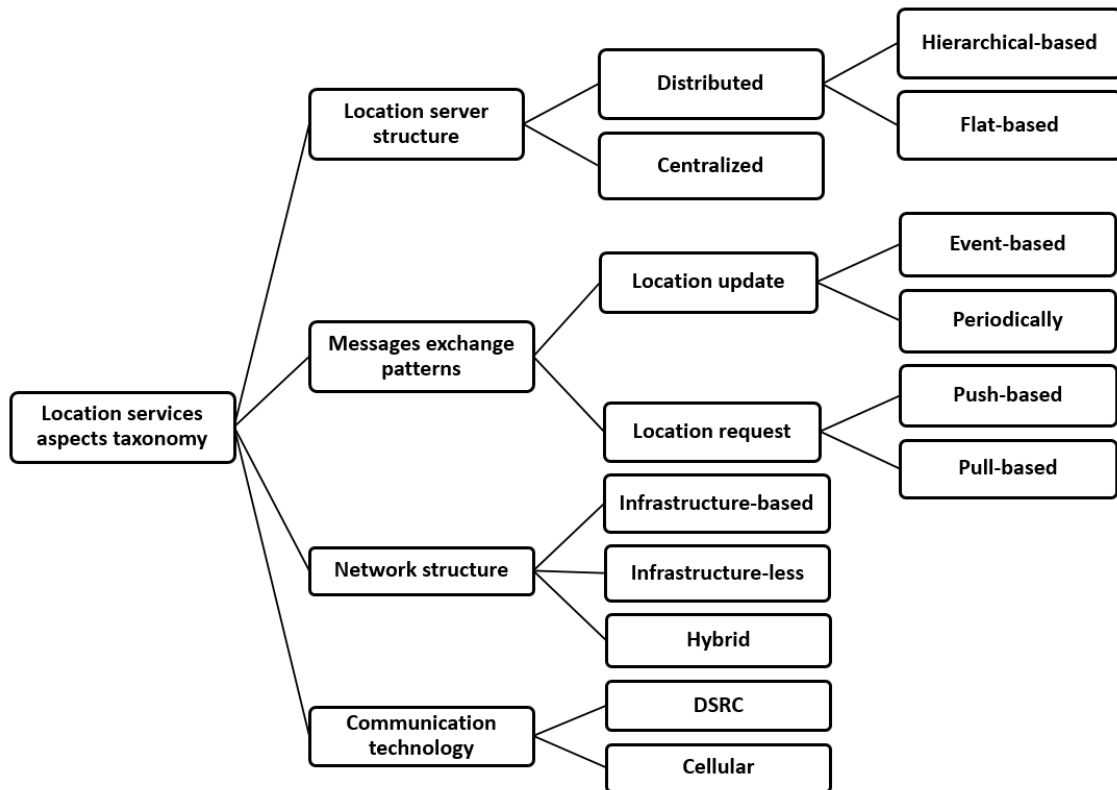

Figure 2.1: Location service aspects taxonomy.

2.2.1 Location server structure

The structure of the location server is the first criterion proposed by [76] to classify location services solutions. The servers are the network entities designated to maintain and store location information of vehicles. According to this criterion, we can distinguish between:

- Distributed location services: In such case, location servers are re-partitioned through the network and each one of them maintains information relative to some vehicles [76]. There are two kinds of data structure for distributed location servers:
 - Hierarchical-based: For a hierarchical-based data structure, the network area is recursively divided into a hierarchy of smaller grids (squares). For each hierarchical level of the grid, one or more location servers are chosen and assigned to the network nodes [76].
 - Flat-based: In such a structure, all location servers of the network have equal responsibility [76]. This technique can be restrictive in large-scale networks where the servers can be considerably distant, resulting in long transmission times of control packets.

- Centralized location services: A central location server maintains all information of vehicles in the system and is solicited by all network nodes [76]. However, in addition to the single point of failure problem, the structure is not convenient for vehicular networks due to large scale of road systems [76].

2.2.2 Messages exchange patterns

A location service technique includes location update and location request mechanisms. According to the routing strategy criterion, we can distinguish between two methods for both of them.

For the Location Update (LU) service, each destination vehicle advertises its location to the designated location server. We distinguish between two update mechanisms:

- Event-based: Sending an update packet is triggered by an event, for example when the vehicle turns left or right or whenever a given distance is traveled [76]. For instance, at peak hours where vehicles speed is low and less control messages should be generated, this mechanism may lighten the network burden by preserving bandwidth. However, it does not guarantee the accuracy of information which may lead to routing faults.
- Periodically: A vehicle sends its location update message periodically to the corresponding location server [76]. A more accurate and up-to-date information is offered by this mechanism, but at the expense of the network resources, required to exchange control messages.

In Location Request (LR) mechanisms, a source vehicle acquires destination location information from the location servers in one of the following ways:

- Push-based: The vehicles continuously monitor a broadcast process from the LIS and retrieve the data items they need, without making any explicit requests [76]. The broadcast system allows, indeed, to have fresh information while avoiding response waiting time. However, the risk of occurrence of the broadcast storm problem is very high which has led routing protocols designer to abandon this technique.
- Pull-based: A pull-based method is an on-demand traditional client-server system where the source vehicles send requests at the beginning of the data transfer; the LIS system responds upon receiving a request. This mechanism may generate less control packets since only vehicles with pending data will exchange request and replay messages with the location servers, preserving consequently the network resources. However, a waiting

delay needed to retrieve the information from the LIS will be added before being able to send the information to the destination.

2.2.3 Network structure

This criterion is related to the network architecture and the available communication levels. We distinguish between:

- Infrastructure-based: The existing infrastructure is exploited in the discovery phase process and vehicle can rely on it to get location information. For instance, the location server can be located at the infrastructure level, or the location information is exchanged between vehicles through the infrastructure [76]. With infrastructure-based LISs, the service performances are maintained in large-scale vehicular networks [76]. However, the accidental unavailability of the infrastructure makes the service drop.
- Infrastructure-less: In infrastructure-less networks, vehicles play the role of location servers and cooperate with each other to maintain up-to-date location information. The location information system is maintained solely through the vehicles cooperation [76]. The shortcoming of this structure for LISs is its limited scalability in highly dense vehicular networks, due to the large number of service request messages [76].
- Hybrid: A combination of both infrastructure-based and infrastructure-less structures constitutes a hybrid solution. For instance, a fixed location server can be located at the infrastructure level and a mobile one at the vehicle's level and they cooperate to handle the location information system.

2.2.4 Communication technology

After reviewing the recent location services propositions, we introduce a fourth classification criterion, which is the communication technology. In fact, several wireless technologies can be deployed in the vehicular environment, thus the location services surveyed can either work on DSRC or on the cellular access technology. The data exchange and the location service information can be either communicated through the same wireless technology or these two functionalities can be decoupled to be handled by different access wireless technologies. In the context of the second scenario, a new concept called chain of location servers was proposed by authors in [77] for infrastructure-less DSRC-based networks. Thus, the IEEE 802.11p ad hoc network is used for transferring data traffic, while the LTE network is used for control traffic.

2.3. Routing challenges

A comparison of location services solutions are given in **Table 2.1**. We have compared 10 solutions for LISs proposed between 2013 and 2018 as a complementary study of the work presented in [76], reviewing solutions proposed between 2008 and 2012.

Location Service	Location Service Structure	Message Exchange Patterns	Network Structure	Service Technology	Additional Information
Katsaros et al.[78]	Centralized	LU: periodically LR: pull-based	Infrastructure-based	Cellular	Cloud service
ZLS [79]	Distributed-flat	LU: periodically LR: pull-based	Infrastructure-less	DSRC	Traffic density, QoS
DFLS [80]	Distributed-flat	LU: periodically LR: pull-based	Infrastructure-less	DSRC	Vehicle's velocity, density, direction and antenna height
E2ED [81]	Centralized	LU: periodically LR: pull-based	Infrastructure-based	Cellular	–
SFLS [82]	Distributed-flat	LU: periodically LR: pull-based	Infrastructure-less	–	–
Balouch-zahi et al. [83]	Distributed-hierarchical	LU: periodically LR: pull-based	Infrastructure-based	DSRC	Cooperative cashing
ZGLS [77]	Distributed-flat	LU: periodically LR: pull-based	Infrastructure-less	DSRC	–
Fireworks [84]	Distributed	LU: – LR: pull-based	Infrastructure-less	DSRC	–
Nebbou et al. [85]	Distributed	LU: periodically LR: pull-based	Infrastructure-based	DSRC	Link connectivity
MoGLS [86]	Distributed-hierarchical	LU: periodically LR: pull-based	Hybrid	DSRC	Traffic condition

Table 2.1: VANETs location services comparison.

2.3 Routing challenges

Some of the intrinsic characteristics of VANET networks along with other external factors constitute challenges for the routing process [10, 87, 88, 89]:

- **Highly dynamic topology:** Although vehicle movements are restricted by roads map, VANET networks are characterized by a frequent topology changes due to the high-speed of nodes and unpredictable movements related to driver's behaviour [10]. This phenomenon is more accentuated in urban areas where we find multiple crossroads. The routing process is severely affected by this aspect of VANETs, especially, in the case of topology based routing protocols. In fact, due to the frequent topology changes, the generation of a large amount of control packets is required in order to maintain fresh information leading to decrease in network performance.

-
- **Frequent link disruptions:** Network partition is frequent in VANETs due to the high mobility of nodes, resulting in unstable routing paths and inaccurate exchanges of information [89]. This problem is significantly accentuated in sparse networks. The short time connectivity among the vehicular nodes caused by frequent link disruption makes routing a more challenging task. In fact, the intermittent communications among nearby nodes prevent them to get the information needed for the routing process. In addition, links between vehicles can quickly disappear while transmitting information [89], resulting in loss of information and potential re-transmissions.
 - **Scalability:** The scalability of a routing protocol refers to its ability to handle the rise of the number of nodes without losing the performances or increasing the organizational complexity [90]. In VANETs, during peak hours in both urban and highway contexts, the number of nodes can raise drastically affecting the routing performances. Furthermore, flooding and broadcast require operations for routing and information dissemination, which may increase the exchanged packets number and cause the broadcast storm problem [91], a scenario in which there is a high level of contention and collisions due to an excessive number of broadcast packets [92]. Routing protocols should encompass scale adaptability mechanisms to deal with density variation in VANET networks and maintain an effective management of network resources.
 - **Environmental impact:** The transmission over the wireless medium makes routing process sensitive to external factors such as weather, tunnels, and also obstacles (trees and buildings). In fact, these environmental factors may affect the functioning of the Global Position System (GPS) needed to route data in geographic based routing, in addition to increase the probability of collisions and interference occurrences. Hence, the environmental impact must be considered while designing VANET routing protocols.
 - **Security and Safety:** The rapid evolution of VANET networks and the sophistication of cyberattacks, coupled with VANETs inherent vulnerabilities such as the use of wireless media, impose major challenges in ensuring the security of vehicular communications and maintaining the safety and privacy of drivers and passengers. Vehicular attacks cannot only compromise private information, but also waste network resources, which can disrupt communications and cause accidents [93, 94]. Security attacks can violate security services such as availability, confidentiality, authentication, and data integrity. Here, we site some of well known routing based attacks [95]:
 - Sinkhole attack: The objective of this attack is to make the malicious node the best choice to relay packets in its surrounding. In fact, the attacker gives itself more

attraction by altering the information contained in the route response, respecting the routing metrics. Once the attack succeeds, the traffic becomes controlled by the compromised node which can launch other attacks such as selective forwarding [95].

- **Sybil attack:** In this kind of attack, the malicious node tends to infiltrate a restricted network by creating a random identity or stealing the identity of a legitimate node, thus receiving the information intended to it. The attacker may have multiple identities which enable him to stay undetected by misleading behavior detection algorithms [96].
- **False routing attack:** This attack allows to propagate false routing information in the network [97]. It can be implemented in several ways: (i) the replay attack, where compromised node uses old stored control packets; for example if a route was temporary unavailable in the past, the adversary node continues to spread this information, (ii) Overflowing routing table with nonexistence routes and (iii) poisoning either routing table or routing cache (applicable for on-demand routing protocols).

2.4 Routing protocols classifications

VANETs routing protocols may be classified according to several criteria. In this section, we will discuss the different taxonomies, reviewed by previous surveys, and their corresponding nomenclatures. In addition, we introduce new criteria able to be used for vehicular protocols classification.

2.4.1 Existing taxonomies

In this subsection, we will detail and discuss the different taxonomies addressed by the previous surveys, as exposed in **Figure 2.2**:

The different classification criteria are the following:

- **Forwarder selection information:** Forwarder selection information was the first criterion to be used to classify vehicular routing protocols, as this step can affect deeply the performance of the routing process. It was presented initially in [98] and adopted by almost all classification surveys conducted afterward [10, 99, 100, 101, 102]. According to this criterion, we can distinguish between Topology-based and Geographic-based routing. In the first approach, forwarding nodes are selected based on the network

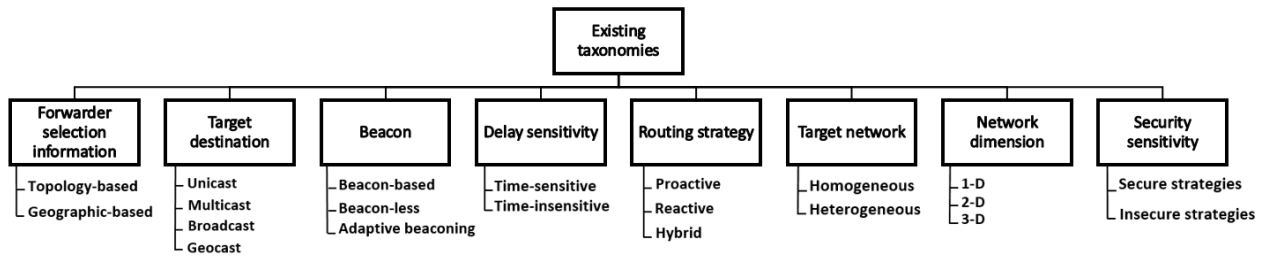

Figure 2.2: VANETs routing protocols existing classifications.

topology information [87]. Packets are delivered based on the information relative to the network links. To cope with the highly dynamic changes of the vehicular topology, this approach may overhead the network with control packets which makes it not suitable for VANET networks, especially in dense scenarios. For the second routing protocols family, several geographical metrics were stated to perform forwarding namely: location, position, mobility (speed, direction, velocity). Such information can be retrieved from street maps (map-based protocols [101]), navigational systems such as global positioning system [103], the vehicle sensors and location services.

- **Target destination:** This classification was initially presented in [87, 104]. A routing protocol can serve one or several target destinations. We can distinguish between four of them, namely Unicast, Multicast, Broadcast and Geocast. The main goal of a Unicast routing in VANETs is to transmit data from a single source to a single destination via wireless multi-hop transmissions or store-carry-forward techniques (SCF) [104], where the node carries the packet until it reaches the destination or an eligible relaying node. A Multicast transmission allows to send packets from a single source to specific group members by multi-hop communication or SCF [104]. The primary objective of the Broadcast technique in VANETs is to disseminate information from a source to many unspecified destinations [87]. Geocast routing, also described as a location-based multi-cast routing [98], is a special case where nodes in a certain geographic location called Zone of Relevance (ZOR) or Zone of Interest (ZOI) can be the destinations [98], also referred to as GeoBroadcast [105]. If the destination is only one node located in a certain position, we call it GeoUnicast [105].
- **Beacon:** Beacons are packets exchanged periodically among nodes to share information relative to their position, speed, direction, etc. Such useful information may be exploited by routing process, MAC protocols and many applications such ADAS (Advanced Driver-Assistance Systems). According to [10], we can distinguish between two

categories: Beacon-based protocols using information gathered from beacons to perform discovery, forwarding, maintenance and recovery phases, and Beacon-less protocols that do not rely on such information. To reduce the network overhead related to beacon-based approaches, many adaptive beaconing mechanisms have been proposed in the literature [106, 107].

- **Delay sensitivity:** The delay sensitivity criterion was introduced in [10] and reconsidered in [101, 102]; it is tightly related to the traffic type. In fact, safety-related applications are non-delay-tolerant (time-sensitive) since the data must be disseminated in a timely manner to keep the information relevance. In contrast, comfort and some infotainment applications, called delay-tolerant (time-insensitive) applications, considered as tolerate disruptive and intermittent network connectivity. A routing protocol can be designed to manage only one or both types of traffic.
- **Routing strategy:** The routing strategy classification was primarily proposed by authors in [10] and completed by [108]. We can distinguish between three routing strategies in the vehicular context [108]: (i) Proactive protocols, also known as table-driven routing protocols [108], keep an updated routing table thanks to the periodic exchange of control packets between neighbours to maintain the links states [10]. This protocol family achieves low latency since routing information (path towards the destination) is available upon lookup. However, it consumes a great part of the network bandwidth, especially in high-density networks. (ii) Reactive routing protocols, also called on-demand, establish a route when it is requested by a node to send packets [10]. In contrast with proactive routing, this category of protocols does not consume a lot of bandwidth. However, the discovery process initiated to establish the path towards the destination leads to a high latency, (iii) hybrid routing that combines attractive features of both proactive and reactive mechanisms in order to minimize the control overhead and reduce the delay of the route discovery process relative to on-demand routing protocols [108].
- **Target network:** The network technology recently became a criterion upon which routing protocols can be classified [101], as many communication technologies can be used to exchange information between the vehicular components (vehicles, RSUs, road signs, etc.), to cite a few examples: DSRC (Dedicated Short Range Communication), 5G, LiFi (Light Fidelity) [53]. For V2V communications, the main deployed technologies are DSRC and cellular communications [109]. Based on the target networks, we can distinguish between two network models [101]: homogeneous network, where only one technology is used and heterogeneous network, where two or more technologies are

deployed. In the second case the vehicular nodes are supposed to have multiple wireless transceivers [101]. Routing protocols can be designed to operate in one of these two environments [109].

- **Network dimension:** As stated in [101], the classification of routing protocols according to the network dimension can be divided into three categories 1-D, 2-D and 3-D. The one dimension category (1-D), also referred to as planar, encompasses highways and streets without intersections, where vehicles are spread over one or more lanes and move either in the same or in the opposite direction. The two dimensions (2-D), is also planar and encompasses streets with intersections, where more than two routing directions are possible. Finally, three dimensional networks (3-D) are non-planer and they have a hierarchical structure of road plane with a vertical direction for routing [110].
- **Security sensitivity:** This classification was recently proposed by [102]. In fact, the real deployment of connected and autonomous cars and the emergence of new cyber-attacks underscore the need to step up efforts to secure vehicular communications. In order to minimize exposure to risks, VANET routing protocols must integrate security mechanisms. From this perspective, two categories of routing protocols can be considered [102]: secure strategies and insecure strategies. In secure approaches, more computational resources and additional time are needed to run the encryption algorithm or the security modules such as key management mechanism, intrusion detection system and trust management mechanism [102].

2.4.2 Proposed taxonomies

Many criteria can be used to offer other classifications, as shown in **Figure 2.3**. However, they were not reported by previous surveys as classification criterion for vehicular routing protocols.

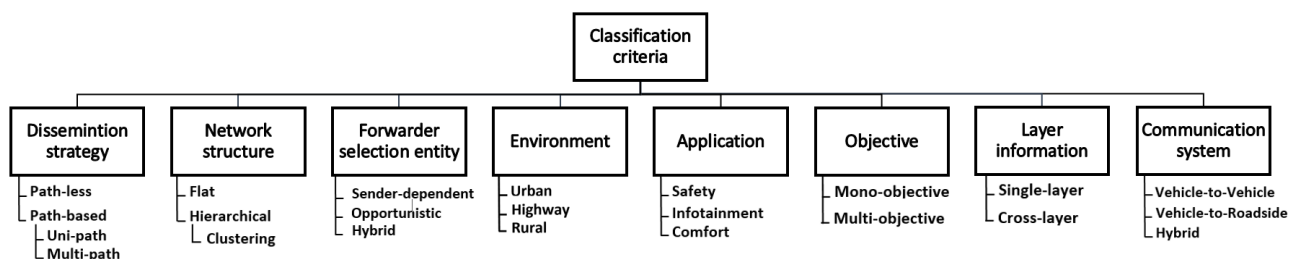

Figure 2.3: VANETs routing protocols new classifications.

- **Dissemination strategy:** Several transmission strategies may be used in the vehicular environment, namely path-less and path-based strategies. When a routing protocol is

based on path-less mechanism, a full route from the source to the destination is not required as the next forwarder is selected at each hop. The second strategy is path-based, where a route joining the source to the destination is chosen at the beginning of the routing process. For this latest strategy, the packet carries the position of all intermediate nodes [111], which results in a significant overload. In addition, in a highly dynamic environment, the risk of frequent disconnections is increased, which can lead to high packet drop. This class is divided into two categories: (i) Uni-path mechanism in which a unique route from the source to the destination is computed. (ii) In order to achieve more reliability by offering load balancing and higher fault tolerance, multi-path routing, providing multiple routes between a source and a destination [112], is considered as a salient alternative. However, in order to compute several routes, the complexity and the overhead of routing protocols are increased [113].

- **Network structure:** The network structure criterion is an inheritance from MANET routing [114], which has been overlapped with the forwarder selection information criterion in certain previous surveys [98, 99, 100, 101, 108]. It enables to sort vehicular routing protocols into two categories: Flat Routing and Hierarchical Routing. In flat routing, all nodes have equal role and are involved in the routing process. This routing scheme becomes inefficient when the network size increases leading to links and processing overhead [114]. In contrast to uniform flat routing, the hierarchical routing assigns different roles to network nodes, improving consequently the protocol scalability [114]. The most common hierarchical approach in vehicular routing is Clustering. This technique is used in highly dense networks. It consists on grouping the network nodes, which share common characteristics for a period of time such as direction, velocity, speed, distance, into clusters. One member from each cluster is chosen to be the cluster-head; this leader node supports inter and intra cluster communications and routing management [115]. The main shortcoming of this approach is the generation of a significant number of control packets to deal with the frequent reformation of clusters induced by the frequent topology changes [115].
- **Forwarder selection entity:** This criterion describes the entities responsible for the selection of the forwarder node in the routing process. We can distinguish between three categories. First, the sender-dependent mechanism allows the sending vehicle to be responsible of selecting the next relay node, according to specific criteria. In source routing approach, the source will specify in the packet all relaying nodes along the whole path. In hop-by-hop approach, the current forwarder will choose the next hop. Second,

the receiver-dependent approach, also, referred to as opportunistic routing, in which the direct neighbours decide whether or not to take part in the routing process. In fact, the packet will be sent by the source/current forwarder and upon receiving the packet, each nearby node will determine if it is eligible to be the forwarder node, in other words, it determines if it satisfies the forwarding criteria; only an eligible node will contend to be the relay node [100, 103]. An extensive survey on opportunistic routing in wireless communication networks was conducted in [116]. Finally, hybrid solution represents a combination of the previous schemes. The source will select a set of potential forwarders, these next hop nodes will follow the opportunistic approach.

- **Environment:** The targeted environment influences the protocols design. In the context of VANETs, properties such as speed limits and safe following distances differ from one mobility model to another, specific to each zone or location. In addition, propagation models of the environments affect differently the routing process. In fact, according to [117], the average pathloss exponent ranges from 1.77 for highway, 1.68 for the urban to 1.53 for the rural environment. The study was based on empirical data collected from an extensive measurement campaign performed in Line-Of-Sight (LOS), Non-Line-Of-Sight (NLOS) and at varying traffic densities. The environment criterion was adopted by other surveys [104, 108, 89], but only in summarizing tables; we can distinguish between three categories urban, highway and rural. Urban environment, corresponding to a city center, is characterized by an ubiquitous infrastructure providing direct R2V communications. Specific routing based techniques were developed to be suitable for the city environment such as junction-based routing [118, 119], intersection-based routing [120, 121, 122] and anchor-based routing [123] which allow selecting the routing direction when the vehicle is at a crossroad. Highways allow to connect cities together through predefined roads, with less exits and no junctions; moreover, vehicle speed is higher than in urban areas. Finally, rural areas are situated at the suburbs of cities, and are, mostly, characterized by a low traffic compared to other environments. In addition, the infrastructure is nearly non-existent and vehicles must rely exclusively on V2V communications.
- **Application:** The routing protocols can be designed to handle one or multiple types of traffic, as each application may have its own QoS needs. This classification results from the diversification of VANETs applications and services [124]. We distinguish between safety, infotainment and comfort applications. Safety information needs to be delivered in a timely manner. Thus, the most important aspect of safety-related routing protocols is the delay metric. Infotainment/Advertising applications require enough bandwidth

2.4. Routing protocols classifications

and a communication with a high QoS so the corresponding routing protocols have to satisfy criterion like End-to-End Delay (E2ED) and QoE (Quality of Experience). Finally, comfort applications are more delay-tolerant than the other ones.

- **Objective:** We can differentiate between two categories of vehicular routing protocols: mono-objective protocols and multi-objective protocols [125]. The routing process tries to reach the destination through the best route with one or multiple criteria such as end-to-end delay, QoE, hop number, transmission cost, the links stability, network density, etc. The choice of the criteria is tightly related to the traffic type and the application requirements.
- **Layer information:** For routing process, the protocol can rely on a single-layer or a cross-layer design [103]. Cross-layer design exploits the dependency between protocol layers to achieve better performances. In fact, it allows information exchange between mainly physical, medium access control and network layers to optimize routing process. Such techniques were surveyed in [103]. Table 2.2 presents the different routing parameters associated to each layer, based on [103]. Besides, we added the node degree as a network metric used for the forwarder selection.

Layer	Routing parameters
Physical	<ul style="list-style-type: none"> • RSSI: Received Signal Strength Indicator • SINR: Signal-to-Interference-plus-Noise Ratio • SNR: Signal-to-Noise Ratio • Packet error rate: is based on the bit error rate, calculated using SINR information. • Channel rate: the tight upper bound on the rate at which information can be reliably transmitted over a communication channel.
Mac	<ul style="list-style-type: none"> • Mac frame error rate: is based on the packet error rate • Queuing information: gives information regarding buffer space. • Retransmission count: is recorded along the path from source to destination. • Inter-arrival time: is the time elapsed between two consecutive packet arrivals in the queue. • Packet train size: reflects the average value of the number of packets sent in a single transmission period. • Service time: is the total time required for channel contention and actual transmission.
Network	<ul style="list-style-type: none"> • Hop count: the number of hops between source and destination. • Node degree: number of nodes in the coverage area.

Table 2.2: Routing parameters at the different layers

- **Communication system:** The vehicular ecosystem encompasses mobile nodes (vehicles) and fixed ones (infrastructure) and several communication levels ensure the data exchange between these elements namely; Vehicle-to-Vehicle communication, Roadside-to-Vehicle communication (in both directions R2V and V2R) and both [9]. A vehicular node

communicates directly with another one forming a one-hop communication, otherwise, for remote destination, vehicles have recourse to a routing protocol to forward messages through relay nodes until reaching the destination (vehicle or infrastructure). According to the communication level criterion, we can distinguish between routing protocols relying only on V2V communications or on both V2V and V2I communications to deliver the packet to the destination. In the second case, to reach their destination, vehicles may rely on information sent by the infrastructure to route the packet, or they may transmit the data to the infrastructure that will take care of sending the packet to the destination.

In **Table 2.3**, we cite examples of routing protocols for each sub-category of the different existing and proposed taxonomies. In addition, we provide specific surveys, comparative and performance studies for each category:

Criterion	Sub-category	Examples of routing protocols	Existing surveys
Forwarder selection information	Topology-based	AOMDV[126], IOLSR[127], MTAODV[128]	2013 [129]
	Geographic-based	GeoNetworking[105], DGOR[120], Li et al[130], GACOR[123], LCGL[131] <ul style="list-style-type: none"> • Position: Tian et al[134], OPBR[135], CJBR[119] • Mobility:RB-MP[140], DHC[141], DABFS[139], PBRP[142] 	2016 [132], 2018[133] 2013[136], 2015[137], 2019 [138], 2020 [139] –
	Hybrid	TO-GO[143], HybTGR [144], ERT0 [145]	–
Target destination	Unicast	VIRTUS [146], Bhoi et al[147]	2010 [148], 2014 [149]
	Multicast	Bitam et al[150], MTAODV[128]	2015[151]
	Broadcast	RB-MP[140], Tian et al[134], MBM-EMD[152], ABOR[153]	2017[154], 2018 [155]
	Geocast	GeoNetworking [105], RGRP-SA[156], RGRP-CA[157]	2012[158], 2013[159]
Beacon	Beacon-based	RB-MP[140], CJBR[119]	2012[160]
	Beacon-less	DBD[161], QOALITE[162]	–
	Adaptive beaconing	Bohm et al[163], ABOR[153]	2013[106], 2016[107]
Delay sensitivity	Time-sensitive	CMGR[164]	2015[165]
	Time-insensitive	GeoSpray [166], GSaR[167]	2015[165], 2016[132], 2019[168]
Routing strategy	Proactive	AOMDV[126]	–
	Reactive	IOLSR[127], VIRTUS [146]	–
	Hybrid	ZRP[169] , HARP[170]	–
Network dimension	1-D	SCAOR[171], DABFS[139]	–
	2-D	RTISAR[121], Darwish et al[122]	–
	3-D	C-TDR[172], LSHR[173]	2018[110]

2.4. Routing protocols classifications

Target network	Homogeneous	<ul style="list-style-type: none"> • DSRC: ECLCR[174] • Cellular: KHAN et al[175], A-MAPS [176] 	–
	Heterogeneous	<ul style="list-style-type: none"> • DSRC/Cellular: VMaSC [177], Rayeni et al [178] • WLAN/WiMax: WWDTR[179] 	2018[109]
Security sensitivity	Secure strategies	MTAODV[128], CLAS[180]	2006 [95], 2019 [181]
	Insecure strategies	All cited work besides the ones in the secure strategies	–
Dissemination strategy	Path-less	GeoNetworking[105], DGOR[120]	–
	Path-based	<ul style="list-style-type: none"> • Uni-path: All cited works besides the ones in the multi-path strategies • Multi-Path: AOMDV[126], JMSR[118] 	2011[182]
Network structure	Flat	All cited work besides the ones in the hierarchical strategies	2008[183]
	Hierarchical	Zhao et al [184], THERA[185] <ul style="list-style-type: none"> • Clustering: DHC[141], SACBR [186], Ge et al[187] 	2015[188], 2016[115], 2020[189]
Forwarder selection entity	Sender-dependent	JMSR[118], Kumar et al[190]	–
	Receiver-dependent	DGOR[120], SCAOR[171], ABOR[153], OPBR[135], GACOR[123], ERTO [145]	2015[116]
Environment	Urban	JMSR[118], DGOR[120], RTISAR[121], Darwish et al[122], CJBR[119]	2014 [149]
	Highway	SCAOR[171], DABFS[139]	–
	Rural	RVC[191], Bohm et al[163]	–
Application	Safety	DBD[161], QOALITE[162], QORE [192], Tian et al[134], DABFS[139]	–
	Infotainment	VIRTUS[146]	–
	Comfort	RGRP-SA[156], RGRP-CA[157]	–
Objective	Mono-objective	<ul style="list-style-type: none"> • QoS: Rayeni et al [178] • Delay: ECLCR[174], DAPF[193] • QoE: QOALITE[162], QORE [192] 	2017[154], 2018 [194]
	Multi-objective	QOALITE[162]	–

Layer information	Single-layer	<ul style="list-style-type: none"> • Physical: LCGL [131] • MAC: Wu et al [195] • Network: DAPBR[196] 	2014[197]
	Cross-layer	AOMDV[126], ECLCR[174]	2017[103]
Communication system	Vehicle-to-Vehicle	MBM-EMD[152]	2012[198]
	Roadside-to-Vehicle	Wan et al[191]	—
	Hybrid	Li et al[130]	—

Table 2.3: Summary of classification taxonomies.

2.5 Conclusion

In this chapter, we provided a survey of localization services and routing protocols in VANETs context. Routing, in such dynamic environments, remains a widely open research topic, especially with the proliferation of new IoV applications and the emergence of autonomous vehicles, bringing new QoS and security challenges. This study was initially published in a conference paper entitled "VANETs Routing Protocols Survey: Classifications, Optimization Methods and New Trends". Then, it was selected to be extended in a journal version, entitled "Towards General Internet of Vehicles Networking: Routing Protocols Survey".

In the next chapter, we present our localization and tracking scheme for infrastructure called Infrastructure Localization Service and Tracking Scheme.

Chapter 3

Infrastructure Localization service and Tracking Scheme

3.1 Introduction

In large scale VANETs, overhead related to localization services and path discovery step can drain the network resources and overload network, thus slowing down the routing process. Proactively perform these phases can considerably reduce the related generated overhead. Road Side Units are significant components of the vehicular environment [11]. In fact, RSUs are deployed at intersections and along roads in order to enhance network connectivity, data delivery and service providing [12]. In addition, many emerging applications are infrastructure-dependent such as public/private cloud, government authority server, security management, etc. [12]. However, RSUs large scale deployment is hindered by their high cost of deployment and management [12]. In this chapter, we present ILTS, an Infrastructure Localization service and Tracking Scheme designed to supply vehicles with contextual information relative to the infrastructure and the neighbourhood, in order to track available paths able to forward promptly safety related information. This chapter is structured as follows. Section 3.2 presents the related work; Section 3.4 introduces our scheme. In Section 3.5, we evaluate the scalability and reliability of ILTS; In Section 3.6, we conclude the chapter.

3.2 State of the art

Unlike the localization services designed for vehicles [84, 77, 78, 79, 80, 81, 82, 83, 85, 86], very few work were proposed for the localization of the vehicular infrastructure. In [199], authors proposed LAGAD protocol (Location-Aided Gateway Advertisement and Discovery),

initially proposed for heterogeneous wireless and mobile networks. It permits gateway clients to discover nearby gateways and the route towards them in a hybrid manner. The reactive phase consists of; initially, the gateways do not advertise themselves. Only when a vehicle needs to reach the gateway, even if it is in the coverage area of the gateway, it generates a request message, which will be flooded through the entire vehicular network. When the required gateway receives the request message, it generates a reply message and unicast it to the source vehicle. The gateway's reply message contains the routing information to itself. The proactive phase consists of; the gateway will periodically advertise it-self in the proactive zone, which is the zone where the source vehicle is expected to be situated. In fact, the gateway will determine this zone by using the location information and the velocity of the source vehicle.

A version of the protocol more adapted to the vehicular characteristics, was proposed in [200]. The gateways advertise periodically themselves in one hop distance. When a request message is received, the gateway generates a reply message and sends it to the original source vehicle and will continue to track the vehicles by determining its expected zone and send unicast advertisement messages.

In **Table 3.1**, we compare ILTS to LAGAD in terms of objectives and methods employed:

	ILTS	LAGAD [200]
Objective	<ul style="list-style-type: none"> • Enabling any vehicle in an uncovered area to reach the infrastructure. 	<ul style="list-style-type: none"> • Enable a well known vehicle situated in the expected zone to reach the gateway.
Description	<ul style="list-style-type: none"> • Vehicles are tracking the infrastructure: Vehicles cooperate to determine the available paths towards the infrastructure. 	<ul style="list-style-type: none"> • Infrastructure is tracking source vehicles: The infrastructure send the information about the route towards itself in the discovery reply to the source vehicle.
Method	<ul style="list-style-type: none"> • Proactive • Integrating the beaconing system • Sent periodically • Distributed, only vehicles processing • All the vehicles posses routing needed information. 	<ul style="list-style-type: none"> • Adaptative (both proactive and reactive) • A stand-alone protocol • Based on request/reply mechanism • Distributed, vehicles ans RSUs processing • The replay is sent in unicast, so only the designated vehicle will have the necessary information to reach the infrastructure.

Table 3.1: Related work comparaison.

3.3 Model assumptions

To simplify the discussion, we have made the following assumptions about the general model we are considering:

- Vehicles are travelling in a multi-lane bidirectional highway without obstacles.

3.4. ILTS functional behaviour

- Each vehicle knows its own location and direction, thanks to GPS, which feeds vehicles with accurate information about time and position.
- All vehicles have an omnidirectional antenna so a vehicle's coverage area is a circle with radius R , see Figure 3.1. The width of the lanes is negligible compared to the transmission range, thus vehicle's coverage area covers vehicles from current, previous and subsequent levels, including vehicles from the opposite direction. All vehicles have the same transmission range R_x . In addition, the hearing communication range is symmetric; it means that if a vehicle A hears a vehicle B, then, B can also hear A.

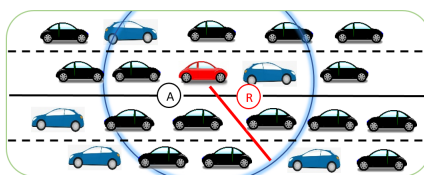

Figure 3.1: Illustration of vehicles transmission range.

- The vehicles communicate with each other and with the infrastructure by using DSRC technology. The choice of DSRC as communication technology is motivated by its aptitude to handle safety related information exchange. In addition, it is the most mature vehicular technology and has proven to be effective in managing the delivery of critical information [201].
- RSUs are dispersed all along the highway and cannot communicate with each other neither by wireless nor by wired communications.
- We assume that at some point vehicles may pass through uncovered areas along their travel; an uncovered area is an area located between two remote RSUs where vehicles cannot communicate directly with the infrastructure.

3.4 ILTS functional behaviour

ILTS is a forwarding information scheme that allows to estimate necessary information to reach RSUs in dispersed infrastructure-based networks. The scheme ensures two crucial phases:

- Localization service: This phase presents a proactive flat distributed location service for RSUs. It is based on periodic updates insured by the exchange of beacons among vehicles.
- Path tracking: A tracking mechanism for available paths towards the infrastructure is proposed. It extracts valuable information from exchanged beacons.

ILTS aims to deal with connectivity problems relative to scattered vehicular infrastructure for highway scenarios. The scheme enables vehicles in uncovered areas to determine the infrastructure position and to keep track of the possible paths towards previous and/or subsequent RSUs. In fact, to enable vehicles to keep up-to-date information about available paths, ILTS relies on information gathering from exchanged messages between vehicles and received from the infrastructure to build a local view of its environment. Each vehicle exploits this information to proactively deduce available paths to the infrastructure, which contributes to reduce the end-to-end delay of warning messages and enhance the reliability. We present in what follows the characteristics of ILTS:

- It is distributed and flat-based scheme, which does not require a central location server; all vehicles have the same responsibility in maintaining the information up-to-date.
- ILTS does not encompass a location request/replay mechanism as the information is updated through periodic exchanges between nearby vehicles.
- ILTS is infrastructure-less; the vehicles cooperate with each other to keep location information up-to-date. However, this information is initially acquired through V2I communications.
- The localization service and the data exchange are both sharing the same communication technology, DSRC. In fact, the ILTS is integrated in the beaconing system of the standard.

In the following, we describe the various phases of ILTS scheme in detail. First, we illustrate how information concerning the surrounding environment is gathered. Then, we present ILTS path track phase towards the previous and subsequent RSUs.

3.4.1 Data collection mechanisms

In this section, we present the data collection mechanisms needed by ILTS to trace the infrastructure and to have an overview about available paths. For each vehicle, the gathered information is relative to its one-hop nearby neighbours and the existing RSUs in the surrounding. For the design of our scheme, we opted for the exploitation of the vehicular beacon messages instead of using additional control packets that may burden the network. We extract the information from the messages relative to DSRC technology:

- Wave Service Advertisement (WSA): is sent by vehicular nodes to advertise about available services. WSA includes; an advertiser identifier field associated to the

advertising device, a service information field providing a definition of the service, and the last field, channel information that indicates the characteristics of the channel associated with the service [202].



Figure 3.2: WSA message format.

- **Basic Safety Message (BSM):** is exchanged between vehicles to inform about their corresponding speed, direction, position, etc. The BSM message consists of two general sections, defined as Part I and Part II. The information in Part I is always sent, it contains information regarding the general status of the vehicle such as its identifier, its position, its direction and its speed. Part II is sent when needed and with content which may vary. The definition allows many additional (and therefore optional) data items to be included in the Part II content when the sender feels these are useful. This information is intended to assist the receiving devices in further processing [203].

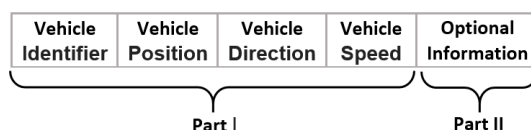

Figure 3.3: BSM message format.

In the following subsections, we detail the information extraction mechanisms from both WSA and BSM messages.

3.4.1.1 WSA information

ILTS updates the Infrastructure Connectivity (IC) parameter (proposed in [21]) that indicates if the vehicle is being in a covered or a non-covered area. More specifically, based on the reception or not of WSA messages, ILTS can distinguish between two situations. The first situation is deduced by the reception of a WSA, and the vehicle is considered to have direct V2I communications with the infrastructure. In the second situation, the vehicle has not received several consecutive WSAs and has lost connectivity with the attached RSU, hence, it must rely on multi-hop V2V communication to reach the infrastructure. ILTS exploits the information gathered about the infrastructure in order to allow vehicles to acquire some knowledge about the sender RSU. In fact, in order to execute the path track mechanism, ILTS needs to store the time at which the last WSA was received from the RSU (V-TIME), in addition to the associated

vehicle position (the end of the RSU coverage) at this time (V-POS). This information is stored in the **RSU-Table**, including the following fields; RSU-ID, V-POS and V-TIME, see **Figure 3.4**.

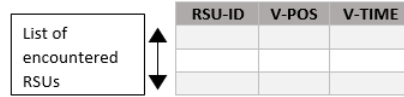

Figure 3.4: RSU Table.

As illustrated in **Figure 3.5** (a), as long as the vehicle is in a covered area, the infrastructure connectivity parameter is set to one at each WSA reception from the RSU. In addition, the WSA reception time and the vehicle's position are saved in the **RSU-Table**. Once out of the coverage area of the RSU (1), the IC parameter will be set to 0, and remains unchangeable all along the way until arriving in the RSU (2) transmission range. In order to distinguish between the disconnection from the infrastructure and collisions occurrence, we fix a WSA-Threshold equal to 5, the number of consecutive non received WSAs. As exposed in **Figure 3.5** (b), when a vehicle enters a covered area, it adds a new entry (new RSU) and sets the infrastructure connectivity parameters to one, once it sends three BSMs containing the information relative to the new RSU.

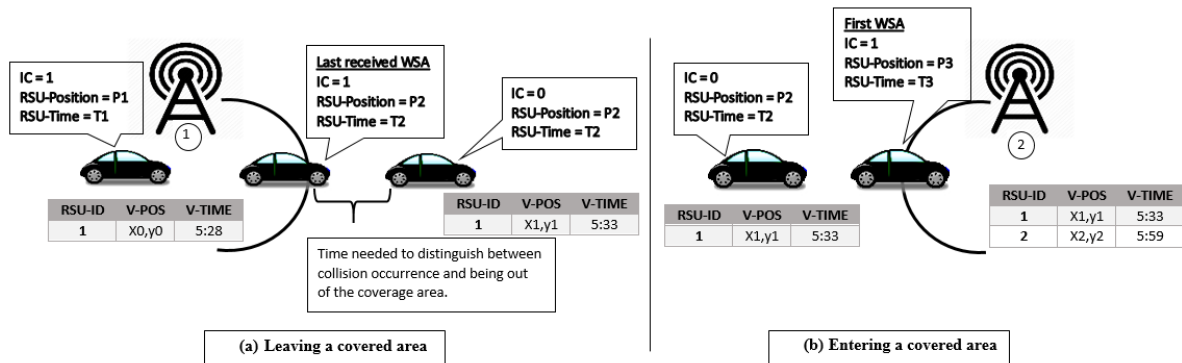

Figure 3.5: WSA information extraction.

As exposed in **Algorithm 1**, when the vehicle is being in the transmission range of an RSU (line 1), the infrastructure connectivity parameter is set to one (line 2) at each WSA reception from the RSU (line 1). The latter is added to the **RSU-Table** (line 6) if it is detected for the first time (line 5), otherwise (line 7) its reception time and its position will be updated at each WSA reception (line 8). In order to distinguish between the disconnection from the infrastructure and collisions, we rely on a WSA-Threshold, equal to 5, which refers to the time needed for the reception of five consecutive WSAs. A WSA-Timer is triggered upon the reception of each

WSA (line 3), it corresponds to the interval of time after which the vehicle is supposed to receive the next message. The WSA-Counter is used to count the number of WSAs not received; it will be initially set to 0 (line 4) and will be incremented (line 12) each time the WSA-Timer expires (line 11). When it reaches the WSA-Threshold (line 13), the vehicle will consider itself out of the coverage area of the RSU and set the infrastructure connectivity parameter to zero (line 14). Once out of the coverage area of the infrastructure, each vehicle must keep track of path towards the left RSU (line 15). Vehicles will rely on BSMs to gather information about other RSUs deployed on the area, specifically the next RSU on the movement direction.

Algorithm 1: RSU connectivity verification pseudo-code

Data: *RSUs-TABLE*: RSUs-Table of vehicle *V*,
RSU-ID: The RSU identifier,
WSA-Counter = 0: Number of non-received WSA from the RSU,
WSA-Timer = *X*: Interval time to receive the next WSA,
WSA-Threshold = *Y*: Threshold of the Infrastructure Connectivity,
IC = 0.

Result: *IC* : infrastructure connectivity.

```

1 if receive WSA then
2   | IC = 1;
3   | WSA-Timer on;
4   | WSA-Counter = 0;
5   | if RSU-ID  $\notin$  RSU-Table then
6     |   Add RSU to RSUs-Table;
7   | else
8     |   Update RSU-Table;
9   | end
10 end
11 if WSA-Timer expires then
12   | WSA-Counter ++ ;
13   | if WSA-Counter  $\succ$  WSA-Threshold then
14     |   IC = 0;
15     |   Path track towards the previous RSU (Algorithm 3);
16   | end
17   | WSA-Timer on;
18 end

```

3.4.1.2 BSM information

BSM messages allow vehicles to keep up-to-date information about the nearby neighbours. More specifically, ILTS adds new fields to BSM messages in order to track available paths towards existing RSUs in the surrounding. In fact, vehicles rely on these periodic exchanges

to acquire knowledge about the remote infrastructure, when travelling in uncovered areas. As presented in **Figure 3.6**, the information contained in BSM messages are the following:

- V-ID: The vehicle identifier is a unique identification for each vehicle.
- V-Position: The vehicle current position, retrieved from GPS, is used to calculate the distances between vehicles as well as the distance separating the vehicle from the infrastructure.
- V-Direction: The vehicle direction, retrieved from GPS, is used to determine both CL-P and CL-N parameters.
- V-Speed: The vehicle current speed, retrieved from the speedometer, is used by several safety applications.
- IC: Infrastructure Connectivity: It informs about the RSU presence and is used to launch and interrupt the path track process.
- HN-P: Previous Number of Hops, indicates the number of hops needed to reach the left RSU.
- CL-P: Previous Covered Levels, indicates the number of covered hops leading to the left RSU.
- HN-N: Next Number of Hops, indicates the number of hops needed to reach the subsequent RSU.
- CL-N: Next Covered Levels, indicates the number of covered hops leading to the next RSU.
- P-Pos: The position where ends the previous RSU coverage area, is used by vehicles in the opposite direction to calculate the distance separating them from the RSU.
- N-Pos: The position where begins the next RSU coverage area, is used by vehicles in the same direction to calculate the distance separating them from the RSU.

V-ID	V-POS	V-DIR	V-SPD	IC	HN-P	CL-P	HN-N	CL-N	P-POS	N-POS
------	-------	-------	-------	----	------	------	------	------	-------	-------

Figure 3.6: BSM message.

3.4. ILTS functional behaviour

The information relative to each neighbour is stored in the **Neighbours-Table** which includes V-ID, V-Position, V-Direction, V-Speed, IC, HN-P, CL-P, HN-N, CL-N, P-POS and N-POS fields, as presented in **Figure 3.7**.

One-hop neighbours entries	V-ID	V-POS	V-DIR	V-SPD	IC	HN-P	CL-P	HN-N	CL-N	P-POS	N-POS

Figure 3.7: Neighbours Table.

As illustrated in **Figure 3.8**, the fields HN-P, CL-P, HN-N, CL-N, P-POS and N-POS of vehicle **A** are set to 0. In fact, if the vehicle is in a covered area, the fields related to the path tracking will be set to 0. Likewise, if the vehicle is in an uncovered area with no neighbours, those fields could remain set to 0, which is the case of vehicle **B**, that can determine only its distance from the left RSU based on the information in its **RSU-Table**. Vehicle **C** will receive information about the existence of RSU (2) from vehicle **D** and proceeds to the path tracking by updating the related fields namely; HN-N, CL-N and N-POS. After entering the RSU coverage area, the vehicle **D** will set the fields related to path tracking to 0, only after it has sent three BSMs with full information in order to notify the vehicles behind.

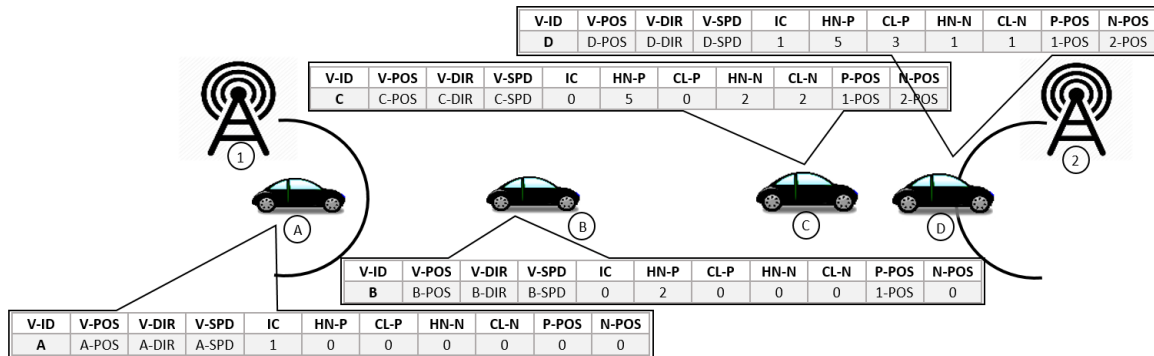

Figure 3.8: BSM exchange.

As detailed in **Algorithm 2**, upon receiving a BSM (line 1), the vehicle triggers BSM-Timer (line 2) to keep track of connectivity with this neighbour. The BSM-Counter is used to count the number of time that the vehicle lost its connection with its neighbour; it will be initially set to 0 (line 3) and will be incremented (line 11) each time the BSM-Timer expires (line 10). When it reaches the Neighbour-Threshold (line 12) it removes the neighbour from its **Neighbours-Table** (line 13). If the vehicle is already in the **Neighbours-Table** (line 4), its information will be updated (line 5), otherwise (line 6) it will be added (line 7). The existence of a subsequent RSU

is determined if; the neighbour vehicle is in the same direction and its N-POS filed is different from 0, or if it is in the opposite direction (line 17). Then, the path track towards the subsequent RSU is launched (line 18).

Algorithm 2: Neighbour connectivity verification pseudo-code

Data: *Neighbours-Table*: Neighbours-Table of vehicle X,
V-ID: The identity of the BSM sender V,
V-Direction: The direction of neighbour vehicle V,
X-Direction: Current direction of vehicle X,
BSM-Counter = 0: Number of non-received BSM from the neighbour V,
BSM-Timer = X: Interval time to receive the next BSM ,
Neighbour-Threshold = Y: Threshold of neighbour existance.

```

1 if receive BSM then
2   | V.BSM-Timer On;
3   | V.BSM-Counter = 0;
4   | if V-ID  $\exists$  Neighbours-Table then
5     | Update Neighbours-Table;
6   | else
7     | Add V to Neighbours-Table.
8   | end
9 end
10 if V.BSM-Timer expires then
11   | V.BSM-Counter ++;
12   | if V.BSM-Counter  $\succ$  Neighbour-Threshold then
13     | Delete neighbour V from Neighbours-Table ;
14   | end
15   | V.BSM-Timer On;
16 end
17 if (X-Direction=V-Direction && V.N-POS  $\neq$  0) || (X-Direction $\neq$ V-Direction) then
18   | Path track towards to the subsequent RSU (Algorithm 4);
19 end

```

As shown in **Figure 3.9**, vehicle **A** will receive BSMs from its nearby neighbours; vehicles **B**, **C** and **D** and will store their corresponding information on its **Neighbours-Table**, as shown in **Figure 3.10**.

Both vehicles **C** and **D** have full paths towards the infrastructure as they have both equal HN-N and CL-N. Therefore, the vehicle **A** has the possibility to reach the previous RSU (1) by relaying the information to vehicle **D** in the opposite direction. And, to reach the subsequent RSU (2) it can forward the information to vehicle **C**.

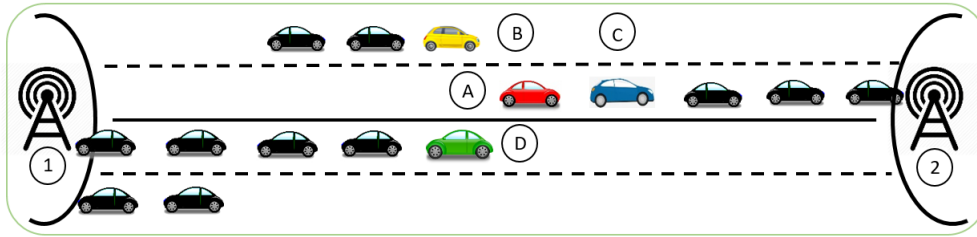

Figure 3.9: BSM exchange example scenario.

V-ID	V-POS	V-DIR	V-SPD	IC	HN-P	CL-P	HN-N	CL-N	P-POS	N-POS
B	B-POS	B-DIR	B-SPD	0	5	3	6	6	1-POS	2-POS
C	C-POS	C-DIR	C-SPD	0	6	1	5	5	1-POS	2-POS
D	D-POS	D-DIR	D-SPD	0	7	7	5	5	2-POS	1-POS

Figure 3.10: Neighbours Table of vehicle A.

3.4.2 Path track

When a vehicle is found to be in an uncovered zone, the path track mechanism is launched in order to collect information about existing RSUs and to deduce available paths towards them. On a two way multi-lane highway without side exits, the number of RSUs is limited to two for a specific uncovered area. The respective RSUs will be designated by previous/left RSU and subsequent/next RSU, like exposed in **Figure 3.11**. In fact, to keep track of eventual paths towards the infrastructure, we organize uncovered vehicles into levels based on their distance from the first connected vehicle to the known RSUs. This organization will enable vehicles to know precisely whether or not there are paths available towards the existing infrastructure. As shown in **Figure 3.11**, the length of a level corresponds to a perimeter smaller than the vehicle coverage area, in order to allow vehicles located on underlying levels to reach each other, which is the case of vehicle **A** that can reach vehicles **B** and **C**. The first level in the uncovered area, level 2, refers to the immediate neighbours of covered vehicles, which are already left the RSU coverage. The intermediate levels encompasses vehicles located beyond two hops from both RSUs. The last level in the uncovered area corresponds to the immediate neighbours of covered vehicles, which will enter the subsequent RSU coverage area.

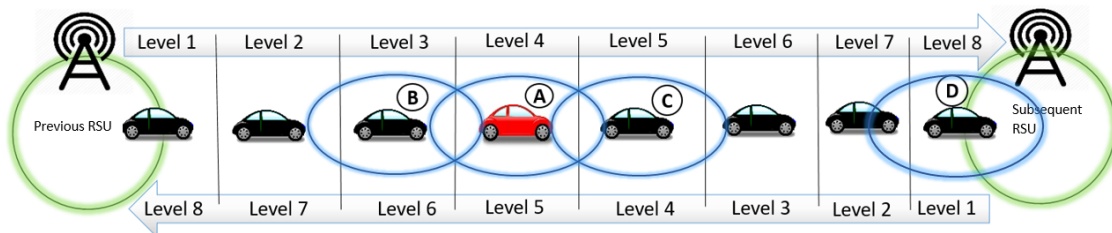

Figure 3.11: Level organization.

Each vehicle calculates its own level based on its current position and the **RSU-Table** information (V-POS). Thanks to BSMs exchange, each node will share this information with its nearby neighbours. This will enable each vehicle to know if its subsequent and previous levels are covered and send it to vehicles in its transmission range. In this way, each vehicle will be able to determine if all the previous levels towards the left RSU are covered or not. The same process is applied to the subsequent RSU. In fact, the first vehicle entering the next RSU coverage area, in our example it is vehicle **D**, will take charge of relaying the position (N-POS) of the beginning of the transmission range to the previous vehicles. Or if the vehicles encounter a vehicle coming from the opposite direction (P-POS). Then, based on their position and the P-POS/N-POS field contained in BSM, vehicles will calculate the number of hops that separates them from the next RSU. And in a progressive way, the acquired information will be relayed from hop to hop using BSMs to build a collective awareness that encompass all network vehicles, thus enabling them to acquire a global view about paths towards both previous and/or next RSUs. Vehicle **A** receives information about the availability of paths toward RSUs from vehicle **B** and **C**. Thereafter, it will share this information with its neighbours. Thus, vehicle **B** will be aware of the presence of a RSU in front and vehicle **C** will be sure of the existence of a path that serves the previous RSU.

3.4.2.1 Link to the previous RSU

When a vehicle leaves the RSU coverage area, it must; firstly, make sure to keep up-to-date the distance that separates it from the latter to determine the HN-P (number of hops needed to reach the left RSU) parameter and transmit it to its neighbours, and secondly, continuously verify if it has a full path towards this RSU and update the CL-P (number of covered hops leading to the left RSU) parameter that will be also transmitted to its neighbours so they can deduce their own possibilities of reaching this RSU.

For the first step, when the vehicle is out of the coverage area of the RSU, it can deduce the distance separating it from the RSU, HN-P, using the function hops number calculation. It only needs the vehicle transmission range R_x , the vehicle current position, called V-Position and the last position when it was covered, corresponding to the last entry on the **RSU-Table**. The **Function** *hopsnumbercalculationprevious* (3.1), is defined by:

$$HN_P = \frac{V_{Position} - V_{Lastposition}}{R_x} \quad (3.1)$$

The HN-P parameter will be equal to 0 if the vehicle is in a covered area, otherwise its value is determined using **Function 3.1**:

$$HN_P(i) = \begin{cases} HN_P = (V_{Position} - V_{Lastposition})/R_x & \text{if } IC = 0 \\ 0 & \text{if not} \end{cases}$$

In order to update the CL-P parameter, the vehicle will rely on the information received from nearby vehicles. In fact, as exposed in **Figure 3.12**, each vehicle will inform neighbouring vehicles about the number of hops that separates it from the left RSU, HN-P, and the number of covered levels, CL-P. We choose a scenario where we have at each level a vehicle that can handle the message forwarding, so the vehicles of each level will have a full path towards the previous RSU, thus the number of covered levels is equal to the number of hops, as explained in **Figure 3.12**.

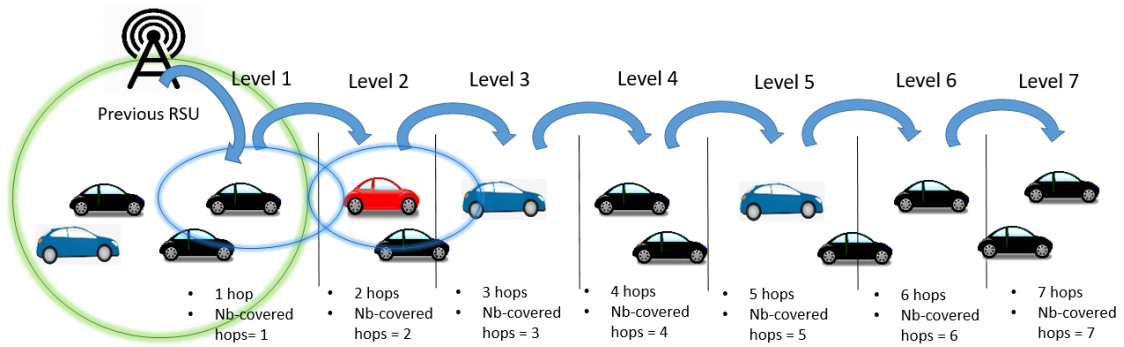

Figure 3.12: Collecting information relative to previous RSU.

Algorithm 3, explains how vehicles determine the availability or not of a path towards the previous RSU when being out of its coverage range (line 1). In fact, the vehicle considers that it can reach the previous RSU (line 16) (CL-P = HN-P), if in the **Neighbours-Table** (line 4) there is at least one vehicle in the same direction (line 5) with the number of covered levels to it corresponding previous RSU CL-P, is superior or equal to the number of hops mines one (line 6). Or, if in the **Neighbours-Table** (line 4) there is at least one vehicle from the opposite direction (line 9) with the number of covered levels to it corresponding next RSU CL-N, is superior or equal to the number of hops mines one (line 10). Therefore, the possibility to reach the previous RSU via V2V multi-hop communication is available (line 16). If no link is available in both directions (line 17), we consider that we do not have a full path towards the previous RSU (line 18).

In the following, we give an example scenario at different times. For each, we specify the messages sent by the cars as well as the **Neighbours-Table** of vehicle **A**:

At T1, as presented in **Figure 3.13**, vehicle **A** receives BSM messages from its nearby neighbours, vehicles **X** and **Y**. It will store their corresponding information in its **Neighbours-Table** and use it to determine the information that will contain the next generated

Algorithm 3: Path track towards the previous RSU pseudo-code

Data: *Neighbours-Table*: Neighbours-Table of vehicle X,
RSUs-Table: RSUs-Table of vehicle X,
X-Position: Current position of vehicle X,
X-Direction: Current direction of vehicle X,
Rx: Transmission range of vehicle X,
HN-P: Current HN-P of vehicle X,
CL-P: The CL-P of the neighbour i,
CL-N: The CL-N of the neighbour i,
Link-backward-same = false: Indicates path backward availability in the same direction,
Link-backward-opposite = false: Indicates path backward availability in the opposite direction,
Link-backward = false: Indicates path backward availability.
Result: link-backward.

```
1 while IC = 0 do
2   for each BSM sending do
3     HN-P= Calcul-nb-of-hops-previous(Rx, X-Position, RSUs-Table);
4     for i=0,i++, Neighbours-Table of X do
5       if X-Direction = Direction(i) then
6         if CL-P(i)  $\geq$  HN-P - 1 then
7           Link-backward-same = true;
8         end
9       else if X-Direction  $\neq$  Direction(i) then
10        if CL-N(i)  $\geq$  HN-P - 1 then
11          Link-backward-opposite = true
12        end
13      end
14    end
15    if Link-backward-same || Link-backward-opposite then
16      Link-backward = true;
17    else
18      Link-backward = false;
19    end
20 end
```

BSM as follow; HN-P equal to five is calculated using the equation 3.1 the CL-P is equal to its HN-P which means that there is a full path to reach the previous RSU. The CL-P is calculated by using the first entry in the table; the CL-P of neighbour X is equal to HN-P-1, so the CL-P of vehicle A will be updated.

At T2, as presented in Figure 3.14, vehicle A receives BSM messages from its only neighbour, vehicles X. It will update its corresponding information in its Neighbours-Table and use it to determine the information that will contain the next generated BSM as follows, HN-P

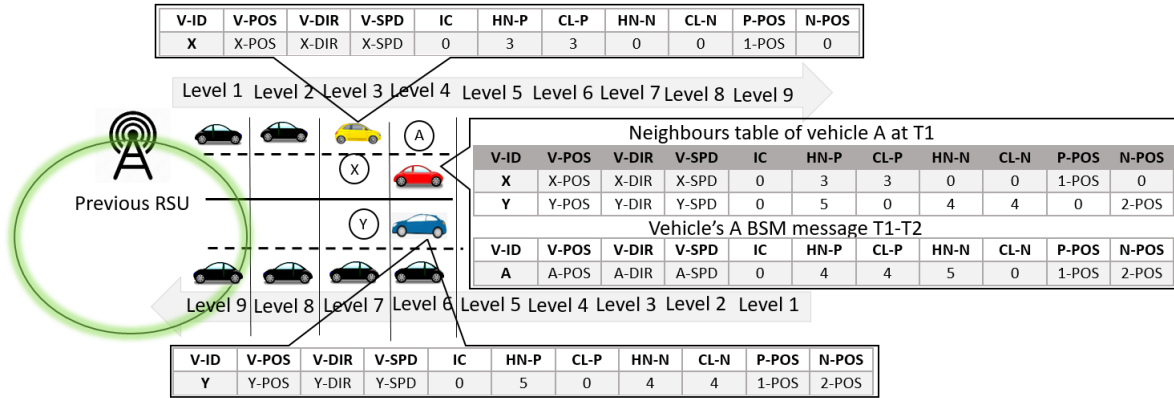

Figure 3.13: Collecting information relative to previous RSU at T1.

equal to five is calculated using the equation 3.1. The current CL-P is equal to the previous one which means that there is no a full path to reach the previous RSU. The CL-P is calculated by using the first entry in the table; the CL-P of neighbour X is different from HN-P-1, so the CL-P of vehicle A will remain the same as T1.

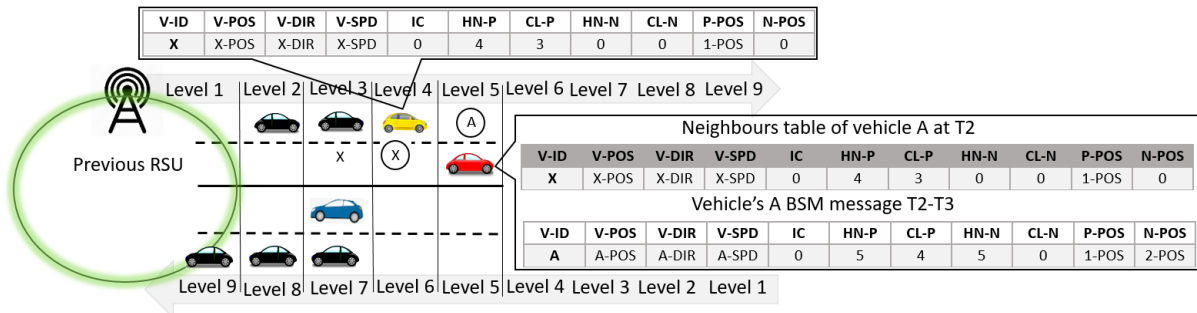

Figure 3.14: Collecting information relative to previous RSU at T2.

3.4.2.2 Link to the subsequent RSU

To enable uncovered vehicles situated behind to communicate with the subsequent RSU, vehicles, having reached the infrastructure, must inform their successors about its existence by indicating its position in the N-POS field. Or they can use the information stored in the P-POS field of BSM messages received from vehicles coming from the opposite direction. In fact, as presented in Figure 3.15, when a vehicle enters a coverage area of a new RSU, it must inform vehicles behind by adding its position where it received the first message from the new RSU in N-POS field. Upon receiving a BSM including such information, any uncovered vehicle must estimate the number of hops towards this RSU, HN-N, using the following Function 3.2, hops number calculation:

The **Function** *hopnumbercalculationnext* is defined by:

$$HN_N = \frac{N_{Pos} - V_{Position}}{Rx} \quad (3.2)$$

The **HN-N** parameter will be equal to 0 if the vehicle is in a covered area, otherwise its value is determined using Function 3.2:

$$HN_N(i) = \begin{cases} HN_N = (N_{Pos} - V_{Position})/Rx & \text{if } IC = 0 \\ 0 & \text{if not} \end{cases}$$

In fact, before one vehicle enters the subsequent RSU coverage area or encounters a vehicle on the opposite side, vehicles are unaware of the existence of the upcoming RSU:

- Once, the front vehicle receives the first WSA from the RSU, it will indicate the position where it received this WSA in the N-POS field of its BSM message. When, the vehicles behind receive such information, they will estimate the number of hops separating them from the RSU, the number of covered levels. Then, each vehicle at each level will specify in its BSM its level, the number of covered levels and the N-POS relative to the next RSU, as explained in **Figure 3.15**.

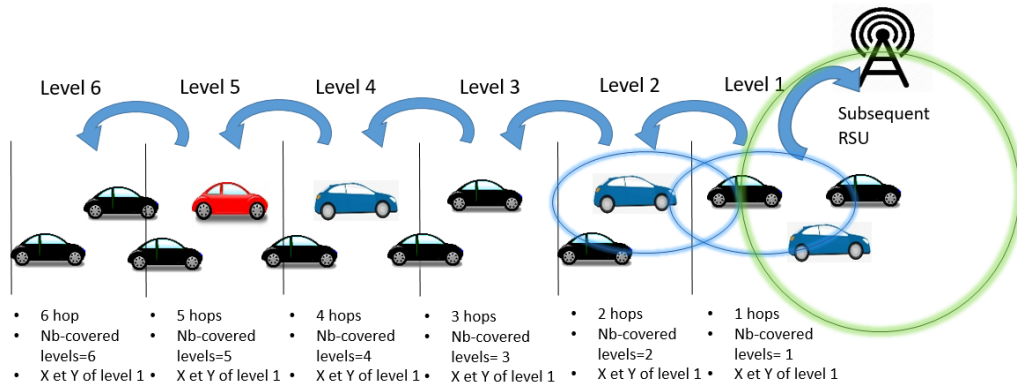

Figure 3.15: Collecting information relative to subsequent RSU from vehicles in the same direction.

- Once, a vehicle encounters a vehicle from the opposite direction, its will use the P-POS field of the neighbour's BSM as its N-POS. It will determine the number of hops separating it from the RSU, the number of covered levels and transmit these information to the vehicles behind. Upon the reception of the message, each vehicle at each level will determine its HN-N, CL-N and send its BSM, as explained in **Figure 3.16**.

The paths tracking process towards the next RSU uses the same principle adopted in the last section. As explained in **Algorithm 4**, while being in uncovered area (line 1), vehicles rely on

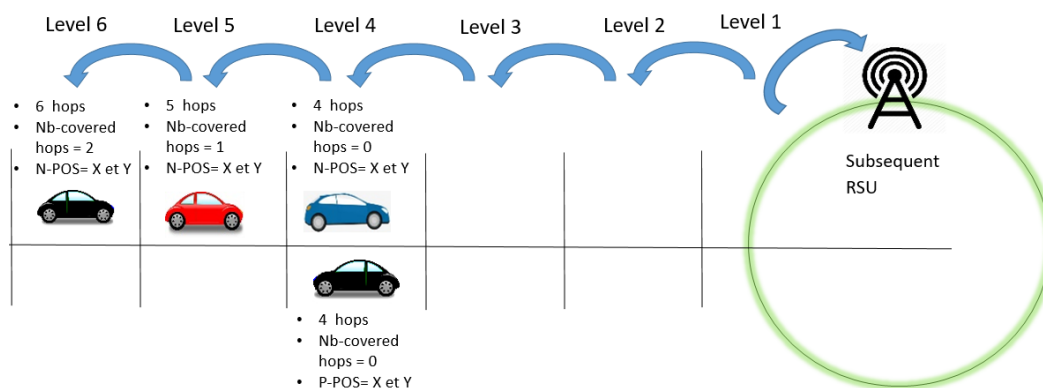

Figure 3.16: Collecting information relative to subsequent RSU from vehicles from the opposite direction.

the information contained in **Neighbours-Table** (line 4); if there is at least one neighbour in the same direction (line 5) with the number of covered levels to it corresponding subsequent RSU CL-N, is equal to the number of hops mines one (line 6), then a path to the subsequent RSU is considered available (line 7). A full path is also considered available (line 11), if in the **Neighbours-Table** (line 4) there is at least one vehicle from the opposite direction (line 9) with the number of covered levels to its corresponding previous RSU CL-P, is equal to the number of hops mines one (line 10). If no link is available in both directions (line 17) we consider that we do not have a full path towards the subsequent RSU (line 18).

In the following, we give an example scenario at different times. For each, we specify the messages sent by the cars as well as the **Neighbours-Table** of vehicle **A**:

At T1, as presented in **Figure 3.17**, vehicle **A** receives BSM messages from its nearby neighbours, vehicles **X** and **Y**. It will store their corresponding information in its **Neighbours-Table** and use it to determine the information that will contain the next generated BSM as follows, HN-N equal to six is calculated using the **Function 3.2** and N-POS parameter of neighbour **X**. The CL-N is equal to its HN-N which means that there is a full path to reach the subsequent RSU. The CL-N is calculated by using the first entry in the table; the CL-N of neighbour **X** is equal to HN-P-1, so the CL-N of vehicle **A** will be updated to six.

At T2, as presented in **Figure 3.18**, vehicle **A** receives BSM messages from its only neighbour, vehicles **X**. It will update its **Neighbours-Table** and use it to determine the information that will contain the next generated BSM as follows, HN-N equal to five is calculated using the **Function 3.2**. The current CL-N is also equal to its HN-N which means that there is a full path to reach the subsequent RSU. The CL-N is calculated by using the first entry in the table; the new CL-N of neighbour **X** is equal to the current HN-P-1, so the CL-N of vehicle **A** will be updated to five.

Algorithm 4: Path track towards the subsequent RSU pseudo-code

Data: *Neighbours-Table*: Neighbours-Table of vehicle X,
RSUs-Table: RSUs-Table of vehicle X,
X-Position: Current position of vehicle X,
X-Direction: Current direction of vehicle X,
Rx: Transmission range of vehicle X,
HN-P: Current HN-P of vehicle X,
CL-P: The CL-P of the neighbour i,
CL-N: The CL-N of the neighbour i,
Link-ahead-same = false: Indicates path ahead availability in the same direction,
Link-ahead-opposite = false: Indicates path ahead availability in the opposite direction,
Link-ahead = false: Indicates path ahead availability.
Result: link-ahead.

```
1 while IC = 0 do
2   for each BSM sending do
3     HN-N= Calcul-nb-of-hops-next(Rx, X-Position, N-POS);
4     for i=0,i++, Neighbours-Table of X do
5       if X-Direction = Direction(i) then
6         if CL-N(i)  $\geq$  HN-N - 1 then
7           Link-ahead-same = true;
8         end
9       else if X-Direction  $\neq$  Direction(i) then
10        if CL-P(i)  $\geq$  HN-N - 1 then
11          Link-ahead-opposite = true
12        end
13      end
14    end
15    if Link-ahead-same || Link-ahead-opposite then
16      Link-ahead = true;
17    else
18      Link-ahead = false;
19    end
20 end
```

3.5 Performance evaluation

In this section, we first present our evaluation set-up (Section 3.5.1), before briefly illustrating the simulation metrics (Section 3.5.2). We then, evaluate the performance of ILTS in terms of scalability and reliability (Section 3.5.3).

3.5. Performance evaluation

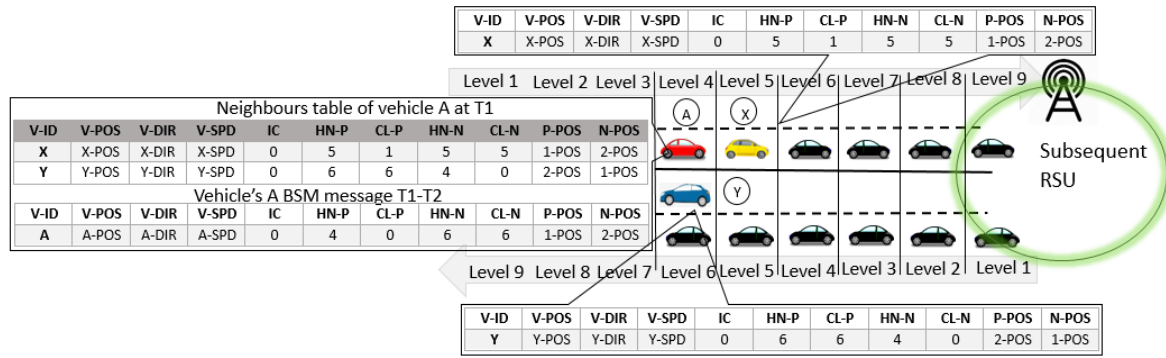

Figure 3.17: Collecting information relative to subsequent RSU at T1.

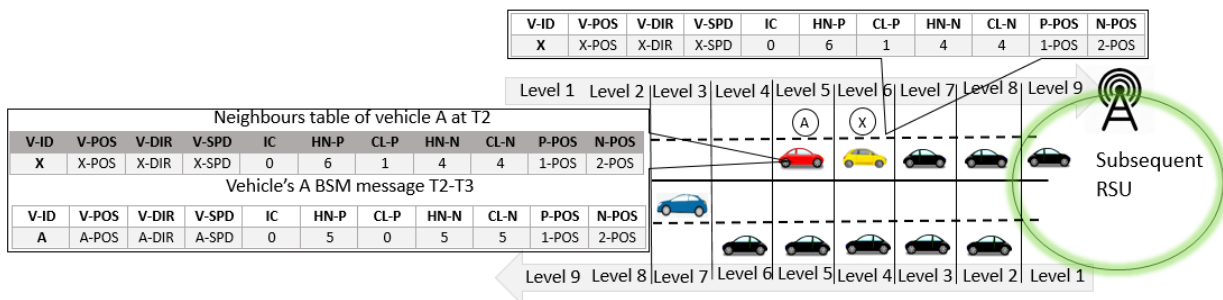

Figure 3.18: Collecting information relative to subsequent RSU at T2.

3.5.1 Evaluation set-up

The working environment of this chapter is composed of; SUMO (Simulation for Urban MObility) [204] (version 0.32.0) as vehicular traffic generator. SUMO is an open source, discrete time, continuous space traffic generator that uses a collision free vehicle following model to assign position and speed to individual vehicles. The information relative to nodes movement is fed into the OMNeTpp network simulator (version 5.4.1) using the Veins (version 4.7.1) framework. OMNeTpp [205] is an extensible, modular, component-based C++ simulation framework, basically used for building network simulations. Finally, Veins [206] (Vehicles in Network Simulation) allows dynamic interaction between SUMO and OMNeTpp. Veins is the main backbone of the simulation which builds a tunnel between SUMO and OMNeTpp, thus transferring the vehicle movements that are generated by SUMO into OMNeTpp network simulator.

We choose to evaluate our scheme for different network densities, thus the number of vehicles are chosen to be 5, 15, 20, 30, 40, 50. We consider a highway scenario of various road length (1,2 and 3 Km) assuming 2 lanes in each direction of the road and two RSUs situated in both extremities of the uncovered area. The vehicles are randomly distributed and

we fix the maximum speed allowed (20-40 m/s). The alert message is generated by the source vehicle at different position in the network. For each test scenario, we repeated this 10 times for the same position, which give as 30 repetitions for the same scenario. Two Ray Ground radio propagation model was used to compute the wireless channel fading characteristics. The simulation parameters are listed in **Table 3.2**.

Type	Parameter	Value
PHY	Propagation model	Two Ray Ground (TRG)
	Radio range	300m
MAC	Protocol	IEEE 802.11p (DSRC)
APPLICATION	Broadcast interval	1 s
	Data rate	6 Mbps
	Sources	1
	Packet size	512 bytes
SCENARIO	Mobility model	Traffic Simulator-based
	Traffic simulator	SUMO
	Network simulator	OMNETpp
	Road Length	1, 3, 6 Km
	Source position	Front, middle and back of the network
	Vehicle speeds	20-40 m/s
	Vehicle densities	5, 15, 20, 30, 40, 50 vehicle/Km
SIMULATION	Total time	300 s
	Simulation runs	10/source position
	Level size	250m

Table 3.2: Simulation set-up.

3.5.2 Simulation metrics

The simulation results were analyzed by comparing two different metrics to assess the performance of the location service and the tracking scheme, these metrics are as follows:

- **Notification delay:** It is the time needed to notify the source vehicle for the first time about the existence of the infrastructure. The metric is measured at two different times:
 - The vehicle enters in the uncovered area (IC=0).
 - The alert message is generated (Alert Message, AM=1).
- **Notification percentage:** It represents the percentage of time spent in the uncovered area during which the vehicle has a full path to the infrastructure (CL).

3.5.3 Simulation results and analysis

In this subsection, we present and discuss the outcomes of the proposed scheme.

3.5.3.1 Localization information service evaluation

The results corresponding to the notification delay, measured for a fixed road length (3 Km) while varying both vehicles maximum speed and vehicles number, are depicted in **Figure 3.19**. The ILTS notification delay decreases with increasing speed, while SCF notification delay remains unchanged. In fact, for ILTS, vehicles coming from opposite directions can pass each other more quickly and inform each other about their previous RSUs, thus the potential source node will be notified about the subsequent RSU as fast as it enters the networks. The increase of the notification delay reported for densities greater than 40 vehicle per Km are due to contention among vehicles. For SCF technique, a vehicle will only become aware of the existence of the RSU when it enters its coverage area. This means that it must travel the entire network to be notified, which explains the longer delays for the same network densities and vehicles speeds compared to ILTS.

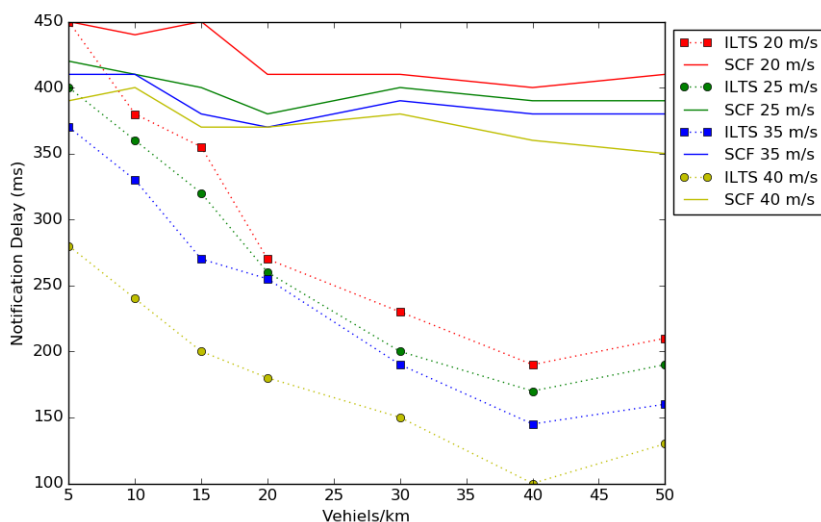

Figure 3.19: Notification Delay with IC=0 Vs Vehicles max speed and vehicles number, with Road Length = 3 Km.

The **Figure 3.20** illustrates the notification delay results, calculated upon an alert message is generated. For a fixed road length (3 Km) we vary the vehicles number and the maximum vehicle speed. Along with the increase in speed, the ILTS notification delay decreases, with an increase when the number of nodes reaches 40. And SCF notification delay is still unchangeable with density variations. As precised in **Table 3.2**, we vary the source position, that mean that the alert message is likely to be generated when the source is already notified about the RSU existence using ILTS, which gives shorter notification delay compared to the results obtained when entering the uncovered zone presented by 3.19. The SCF technique notification delay are also shorter and this is also due to the message alert position generation. If the message is

generated when the vehicle approaches the infrastructure, this means that it does not have much distance to go before it reaches the RSU.

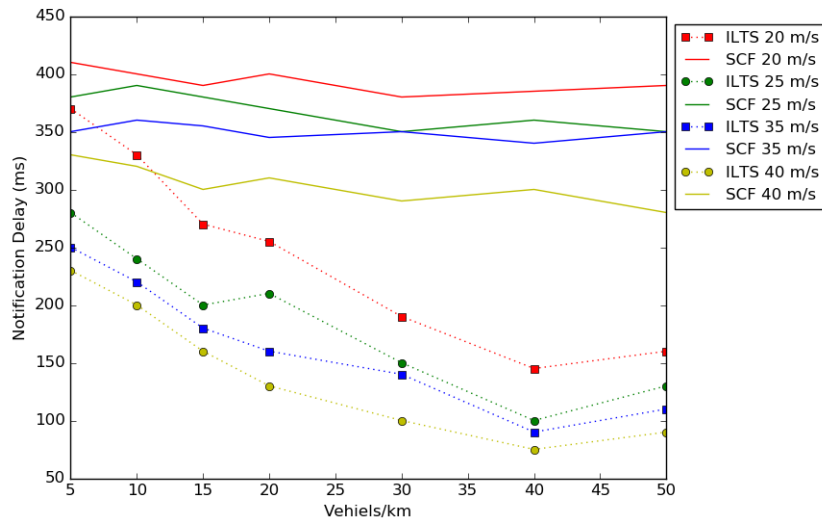

Figure 3.20: Notification Delay with AM=1 Vs Vehicles max speed and vehicles number, with Road Length = 3 Km.

In **Figure 3.21**, we illustrate the notification delay, calculated upon the vehicles enter the uncovered area. We fixed the number of vehicles to 30 vehicle/Km and we vary the vehicles maximum speed and the road length. We can see that for the same road length the notification delay is inversely proportional to the maximum speed. In fact, with higher speed, vehicles from opposite directions reach each other quickly and then, exchange information about the infrastructure earlier. We can also see that for the same fixed maximum speed the notification delay is higher for the longest road. In fact, vehicles will spend more time to reach each other, thus the notification time is delayed.

3.5.3.2 Tracking scheme evaluation

In **Figure 3.22**, we measure the notification percentage of the link to the previous RSU for different vehicles number and road length. The notification percentage increases with the number of vehicles and reaches the highest value, faster for shorter roads (1 km). For low network density, vehicles encounter network gaps (CL-P is inferior to HP-P) in the path due to the reduced availability of vehicles in the radio range. For the same network density, vehicles in shorter road encounter less gaps as the number of vehicles used to reach the infrastructure is reduced and the vehicle is more likely to have relaying nodes in each level. ILTS is able to allow vehicles to keep the connectivity with the infrastructure. In fact, at first, vehicles will get

3.5. Performance evaluation

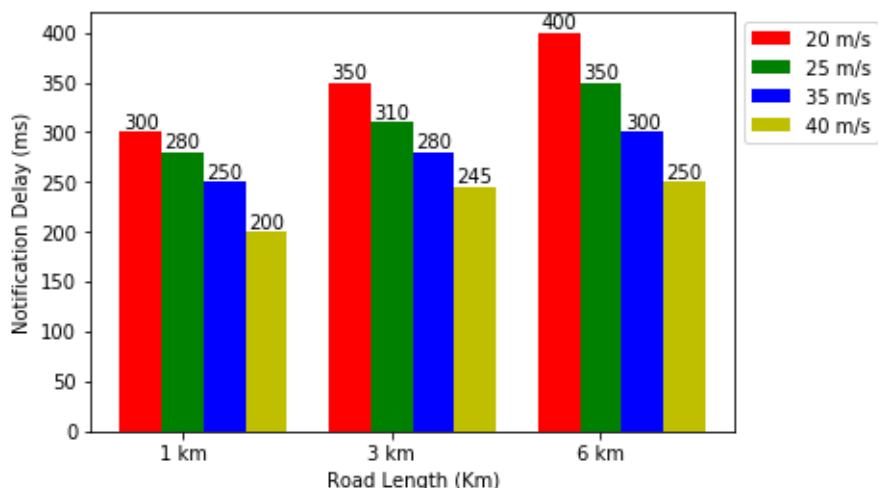

Figure 3.21: Notification Delay with IC = 0 Vs max speed and Road Length (1, 3 and 6 Km), with vehicles number = 30 vehicle/Km.

the information from the vehicles behind in the same direction. And, in the middle of the road, full paths may also be available from vehicles in the opposite direction.

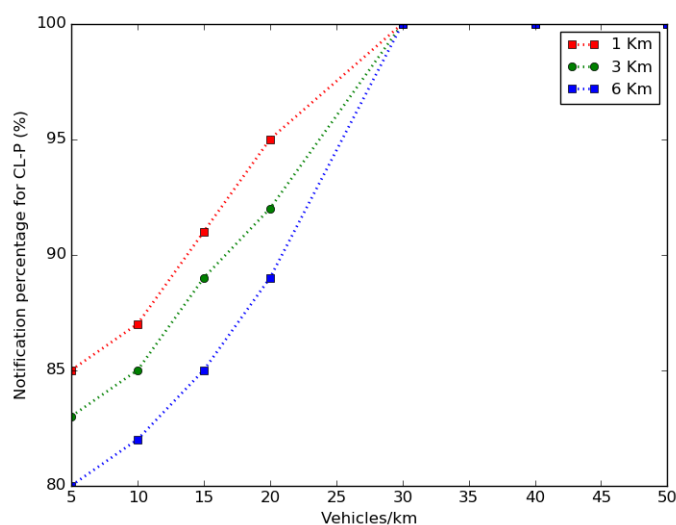

Figure 3.22: Notification percentage in CL-P Vs Vehicles number and Road Length (1, 3 and 6 Km), with max speed = 30 m/s.

In **Figure 3.23**, we measure the notification percentage in the link to the next RSU for different vehicles number and road length. With the increase of the number of vehicles, the notification percentage increases. In longer road and for the same network density, vehicles will encounter more gaps as the number of vehicles needed to reach the infrastructure is higher. Paths to the next RSU will be more prone to breaking (CL-N is inferior to HP-N), in low network density, as less vehicles are available at the different levels. Same as the information

about the previous RSU, vehicles can maintain the connectivity with the next RUS by relying on vehicles travelling in the opposite direction. However, it will take much more time as vehicles need to come across vehicles from the opposite direction to be notified about the subsequent RSU and begin the path tracking process. This explains the higher number of gaps for the same simulation metrics.

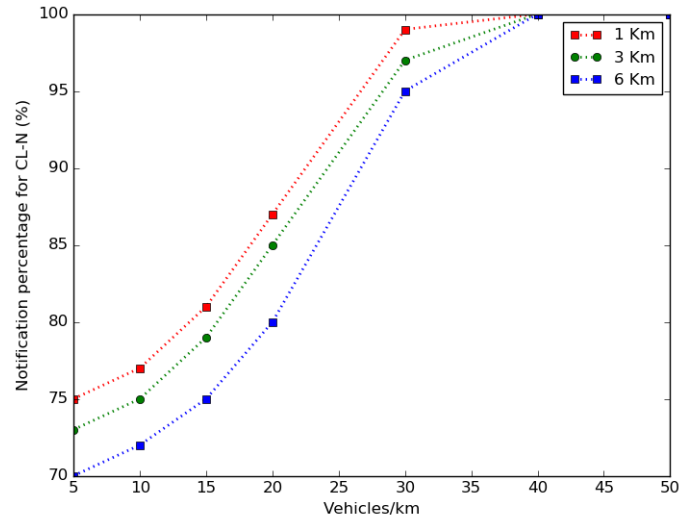

Figure 3.23: Notification percentage in CL-N Vs vehicles number and Road Length (1, 3 and 6 Km), with max speed = 30 m/s.

3.6 Conclusion

In this chapter, we proposed the ILTS scheme. ILTS is based, on one hand, on the information sent from RSUs to vehicles and exchanged between vehicles, and on the other hand, on a distributed mechanism executed by all the mobile nodes. More specifically, ILTS enables vehicles out of the coverage area of RSUs to collect location information and path information needed to reach the deployed infrastructure in the network.

In the next chapter, we will present our approach, HyRSIC, enabling vehicles to make better routing decisions when transmitting messages in an uncovered area.

Chapter 4

Hybrid Routing for Safety Data with Intermittent V2I Connectivity

4.1 Introduction

V2I communications complement V2V safety applications by dealing with crash scenarios that the V2V program cannot handle or that could be addressed more effectively. However, depending on the deployed infrastructure, we can distinguish between three situations regarding allowed communications: infrastructure-based, infrastructure-less and intermittent infrastructure. We will focus in vehicular networks with an intermittent connectivity, where the unavailability of direct communication with RSUs poses huge problems, especially when vehicles have to send safety-related messages to the infrastructure. In fact, a scattered vehicular infrastructure leads to non-homogeneous coverage, especially in highway scenarios extending over long distances; it is very expensive to set up an infrastructure across the entire road. Our objective is to deal with the challenges related to safety information forwarding towards the RSU in such networks by enabling vehicle to make the optimal forwarding decision based on contextual information relative to the infrastructure and the neighbourhood. In this chapter, we present HyRSIC (Hybrid Routing for Safety data with Intermittent V2I Connectivity), a routing approach proposed to deal with data forwarding in intermittent infrastructure-based networks. The chapter is structured as follows. Section 4.2 presents related work; Section 4.3 introduces the notations used in this chapter. Section 4.4 details the functional behaviour of our scheme. In Section 4.5, we evaluate the scalability, reliability and efficiency of HyRSIC ; and Section 4.6 concludes the chapter.

4.2 Related work

In this section, first, we present hybrid routing which relies on topology and geographical information to select the next forwarder. Then, we review the state of the art of previous works that tackled the scattered infrastructure based routing in VANETs.

4.2.1 Hybrid routing

The forwarder selection information can either be related to topology information or geographical information. A third category, that combines the first two was adopted in previous works [143, 144]. In fact, this category represents the merging of functional behaviours of both families. For instance, the work presented in [143], makes use of road topology information acquired via 2-hop beaconing to assist geo-routing in order to select the best target forwarder, thereby improving the routing overall performance. In [144], the authors proposed a hybrid routing protocol that selects the optimal route for data transmission by assigning a weight value to each network node based on both geographical and topological information namely, the moving speed, the link lifetime, the number of vehicles present in the vicinity of the node and the distance to the destination node.

4.2.2 State of the art

The intermittent infrastructure-based networks in highway scenarios was tackled in both [26] and [27]. Authors, in [26], designed a message delivery algorithm to minimize the delivery delay based on an analysis model considering the size of the message, vehicle density and speed, RSU coverage and density, and both V2V and V2I transmission rate. The proposed solution is intended to deliver large-size multimedia messages, e.g., danger notification for live traffic status in the vicinity of an accident scene and focuses on the provision of stable data delivery with ultra-low E2E latency. Different message delivery phases are considered in the analysis model. First, the forward phase where a message may be carried by a vehicle or forwarded in the travelling direction until it is transmitted to the upcoming RSU. Second, the backward phase where a message may be carried and forwarded to the vehicles in the opposite direction and uploaded to the RSU behind the source. An enhanced version was presented in [27], where the main focus is the large-size message uploading using both V2I and multi-hop V2V transmissions. The uploading capacity and delivery delay are analyzed in order to optimize the resource utilization and reduce the data delivery delay.

We compare, in **Table 4.1**, our scheme and the aforementioned work:

	Location service	Decision making algorithm	Routing
HyRSIC	<ul style="list-style-type: none"> • For RSUs • Proactive • Integrating the beaconing system 	Curved and straight highways Four possibilities <ul style="list-style-type: none"> • Previous RSU via same direction • Previous RSU via opposite direction • Next RSU via same direction • Next RSU via opposite direction 	Enhanced Greedy Forwarding
Ni et al. [26, 27]	—	Only straight highways Two possibilities: <ul style="list-style-type: none"> • RSU behind via opposite direction • RSU in front via same direction 	Clustering

Table 4.1: Related work comparison.

4.3 Preliminaries and Notations

In this section, we present the notations used in this chapter. Furthermore, we describe in detail Greedy Forwarding mechanism, which will be improved for the transmission of alert messages. In this chapter, we employ the same assumptions as the previous chapter (See Section 3.3), to which we add two new assumptions:

- The entire emergency message can be contained in one packet.
- We assume the network is secure, no malicious nodes are trying to disrupt the routing process by injecting false routing information or redirect the traffic.

4.3.1 Model notations

We present, in **Table 4.2**, the different notations used in this chapter:

Notation	Description
<i>IC</i>	Infrastructure Connectivity, informs about the RSU presence
<i>HN-P</i>	Previous Number of Hops, the number of hops needed to reach the left RSU
<i>CL-P</i>	Previous Covered Levels, the number of covered hops leading to the left RSU
<i>HN-N</i>	Next Number of Hops, the number of hops needed to reach the next RSU
<i>CL-N</i>	Next Covered Levels, the number of covered hops leading to the next RSU
<i>P-CR</i>	Previous Coverage Ratio, the ratio of covered hops leading to the next RSU
<i>N-CR</i>	Next Coverage Ratio, the ratio of covered hops leading to the next RSU
<i>LC-P</i>	Previous Link Counter, the number of time that the vehicle does not have a full path towards the previous RSU
<i>LC-N</i>	Next Link Counter, the number of time that the vehicle does not have a full path towards the next RSU
<i>LS</i>	Link Stability, informs about the strength of the link between a vehicle and its neighbour
<i>P-POS</i>	The position where ends the left RSU coverage area
<i>N-POS</i>	The position where begins the next RSU coverage area
<i>D_v</i>	V2V data rate
<i>D_i</i>	V2I data rate
<i>S</i>	Message size
<i>L</i>	Level size
<i>TT</i>	Travel Time
<i>FT</i>	Forward Time

Table 4.2: Notations descriptions.

4.3.2 Greedy forwarding

The technique was firstly used in the Greedy Perimeter Stateless Routing protocol (GPSR) [207] and later widely adopted [207, 208, 209]; it consists in selecting as forwarder the most geographically closest neighbour vehicle to the destination. The aim of this approach is to decrease the number of relay nodes involved in data transfer from a source to a destination [207]. As shown in **Figure 4.1** (a), when the source node **S** intends to transmit packets to the destination node **D**, the greedy routing manages the packet to make as much progress as possible towards the destination **D**. The main drawback of this technique is the local optimum problem, a situation where the current packet holder found to be the nearest node to the destination. This problem can be solved using recovery schemes such as perimeter routing technique that uses the

right-hand rule. As depicted in **Figure 4.1** (b), it consists in taking the positional relationship between the neighbour nodes and the destination node into account to select the neighbour with minimum angle as the next hop to forward packets.

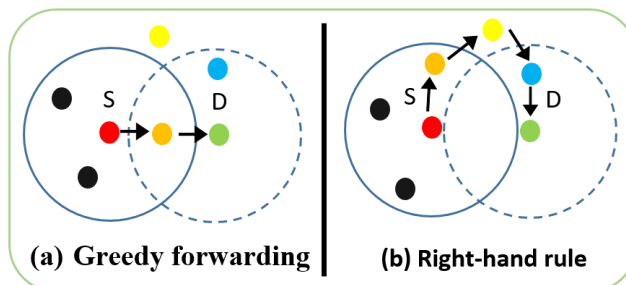

Figure 4.1: Illustration of GPSR operations: Greedy forwarding and Right-hand rule.

Several enhancements were proposed to better cope with the vehicular environment. In [208], an enhanced version of GPSR was proposed where the greedy forwarding technique was modified in order to reduce packet loss rate; the closest node to the destination with the highest stability is chosen as the next-hop. In fact, the authors proposed Maxduration-Minangle GPSR (MM-GPSR) that calculates the cumulative communication duration measuring the stability of nodes [208]. Adaptive GPSR (AGPSR) relies also on a variant of greedy forwarding [209]. To select the next-hop, neighbours trust status information is added to the neighbours table, it indicates if a local maximum occurred when sending a packet to a specific node. Thus, this approach enables to bypass in recovery mode the nodes that already delivered the previous packets.

4.4 HyRSIC functional behaviour

HyRSIC is a hybrid routing protocol for safety data in intermittent infrastructure based networks, which relies on a decision making algorithm designed to select the most suitable path, based on fresh routing information. Our objective is to enable the vehicles in the uncovered areas to reach the infrastructure in a timely manner. First, the forwarding direction is decided according to whether or not full paths are available towards the known RSUs. Second, in the case of multiple forwarding options are possible in the chosen direction, the selection of the next hop will be based on an Enhanced Greedy Forwarding (EGF) mechanism. In the uncovered area, the vehicles are organized into levels in order to be able to track paths towards both previous and subsequent RSUs. In fact, depending on the collected data and the distance from the RSUs, the decision making algorithm will allow to choose among the available options:

- Relying information to the previous RSU through vehicles in the same direction or in the opposite one, whenever a path is available.
- Relying information to subsequent RSU through vehicles in the same direction or in the opposite one, whenever a path is available.
- keeping the information if no relay node exists or the next RSU is close.

As illustrated by **Figure 4.2**, four forwarding possibilities can be offered to vehicles in an uncovered area according to the infrastructure availability and reachability and to vehicles positions. For example, when an urgent safety message is generated by the car **A**, the latter should forward the information towards the previous RSU (1) passing by the cars behind, car X_1 . For the second car **B**, according to its position, it is more suitable to deliver the information to the next RSU (2) as it has a full path towards it through vehicle X_4 , the vehicle must be already notified by its subsequent neighbours about the RSU presence. The third car **C** can rely on the vehicles in the opposite side, vehicle X_2 , that will relay the information towards RSU (1). Finally, the fourth car **D** will be able to reach the RSU (2), through the cars in the opposite direction, vehicle X_3 .

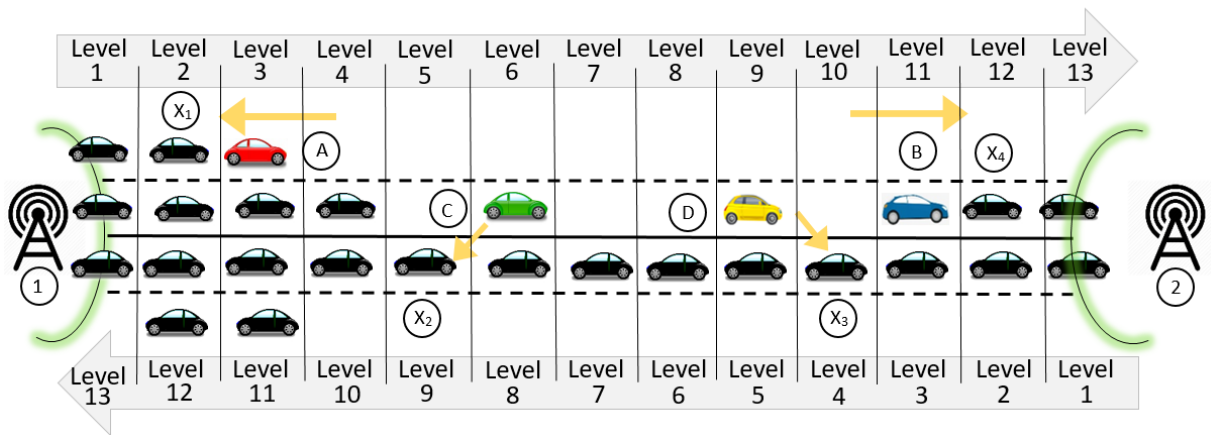

Figure 4.2: Level organization example and forwarding possibilities.

In this following subsections, we detail the different steps of our proposed protocol, HyRSIC.

4.4.1 Data collection mechanism

Inspired by ITLS data collection mechanism, HyRSIC will gather information about the surrounding environment from periodic exchanged messages, BSM and WSA. While being in

the coverage area of the infrastructure, upon the reception of each WSA, HyRSIC stores in the **RSU-Table** the RSU-ID, the position of the vehicle (V-POS) and the time (V-POS). Additional information are required for the forwarding phase. In fact, highways are not always straight and curvatures can be encountered throughout the uncovered area, which distorts the calculation of the hop number based on the euclidean distance. To overcome this issue, the vehicle uses internal information to determine the distance to the left RSU. Then, when the vehicle exits the coverage area of the RSU, it puts the IC parameter to 0 in order to indicate that it is in an uncovered area and no direct V2I communications are available. As shown in **Figure 4.3**, the vehicle will also store the mileage (V-MIL) which is the number of kilometers traveled when exiting the RSU coverage. This information will be useful to track the paths towards the previous RSU.

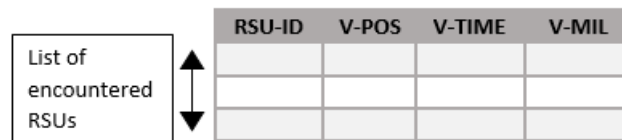
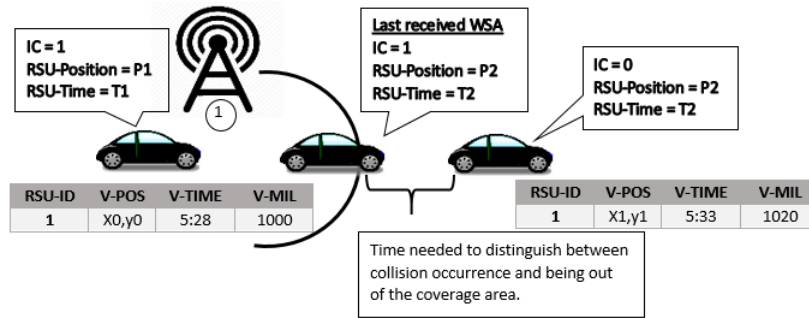

Figure 4.3: RSU Table.

As illustrated in **Figure 4.4** (a), the WSA reception time, the vehicle’s position and mileage are saved in the **RSU-Table**. Once out of the coverage area of the RSU (1), the IC parameter will be set to 0, and remains unchangeable all along the way until arriving in the transmission range of RSU (2). As shown in **Figure 4.4** (b), when the vehicle enters the coverage area of RSU (2) and receives a WSA, it adds a new entry relative to the new RSU in its **RSU-Table** and sets the IC parameter to one after sending three BSMs with information relative to the new RSU.

Each node extracts information from received BSM messages and stores in the **Neighbours-Table**: the vehicle identifier (V-ID), the vehicle current position (V-Position), direction (V-Direction), speed (V-Speed), the Infrastructure Connectivity (IC), the Previous Number of Hops (HN-P), the Previous Covered Level (CL-P), the Next Number of Hops (HN-N), the Next Covered Level (CL-N), the position where ends the previous RSU coverage area (P-Pos) and the position where begins the next RSU coverage area (N-Pos), as depicted in **Figure 4.5**:



(a) Leaving a covered area

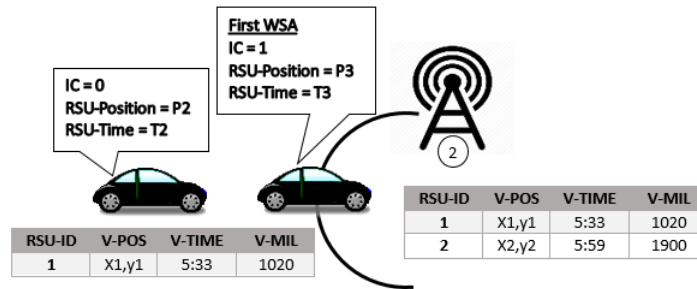

(b) Entering a covered area

Figure 4.4: WSA information extraction.

One-hop neighbours entries	V-ID	V-STA	V-POS	V-DIR	V-SPD	IC	HN-P	CL-P	HN-N	CL-N	P-POS	N-POS	P-CR	N-CR	LS	LC-P	LC-N

Figure 4.5: Neighbours Table.

To choose the best next hop for safety message forwarding, additional parameters were added to the **Neighbours-Table**:

- The status field (V-STA): It indicates whether the neighbour is valid or not.
- Coverage Ratio (CR): It provides information about the coverage rate of paths to previous (P-CR) and next (N-CR) infrastructures. It indicates the ratio of hops among those that separate the vehicle from the infrastructure are covered. This parameter will be used in the decision making process when an alert message is generated:

- The P-CR is calculated using the **Function** *Ratiocalculationprevious* 4.1, defined by:

$$P_{CR} = \frac{CL_P}{HN_P} \quad (4.1)$$

Where HN-P is the number of hops that separate the vehicle from the previous RSU and CL-P is the number of covered levels towards the left RSU.

- N-CR is calculated using the **Function** *Ratiocalculationnext* 4.2, defined by:

$$N_{CR} = \frac{CL_N}{HN_N} \quad (4.2)$$

Where HN-H is the number of hops that separate the vehicle from the subsequent RSU and CL-N is the number of covered levels towards the next RSU.

- Link Stability (LS): It informs about the link stability between the current message holder and its immediate neighbours from whom it receives the BSM. It corresponds to the number of times where the expected BSM message has not been received. The loss of BSM may be due to the neighbour moving away, a collision having occurred, or the wireless link being affected by external factors such as weather conditions.
- Link Counter (LC): It is very important to be informed of the quality of the paths provided by neighbouring vehicles in order to make more relevant decisions when choosing the next forwarder. The LC parameter is calculated for the previous (LP-P) and subsequent (LP-N) RSUs. It consists of counting the number of times the neighbouring vehicle does not have a full path to the given RSU.

As detailed in **Algorithm 5**, upon receiving a BSM (line 1), if the vehicle is already in the **Neighbours-Table** (line 4), its information will be updated (line 5) and its status set to valid (line 6), otherwise (line 7), it will be added (line 8). In addition, it will determine its corresponding P-CR (line 9) and N-CR (line 10). If the CL-P is different from the HN-P (P-CR different from 1) (line 11), this means that the vehicle does not have a full path towards the left RSU, then the vehicle will increment the LC-P (line 12). The same process is applied to the paths towards the subsequent RSU, if the CL-N is different from the HN-N (N-CR different from 1) (line 14), the LC-N will be incremented (line 15). The vehicle also triggers BSM-Timer (line 2) to keep track of connectivity with this sender neighbour. The BSM-Counter is used to count the number of time that the vehicle lost its connection with this neighbour; it is initially set to 0 (line 3) and will be incremented (line 20) each time the BSM-Timer expires (line 19). When the BSM-Counter reaches the Validity-Threshold (line 22), the vehicle will put the neighbour's status to invalid (line 23). And when it reaches the Neighbour-Threshold (line 25), the neighbour will be deleted (line 26). The existence of a subsequent RSU is determined whenever the BSM is received from a neighbour vehicle in the same direction and its N-POS

Algorithm 5: Neighbour connectivity verification pseudo-code

Data: Neighbours-Table of vehicle X,
V-ID: The identity of the BSM sender V,
BSM-Counter = 0: Number of non-received BSM from the neighbour V,
BSM-Timer = X: Interval time to receive the next BSM ,
Validity-Threshold = Y: Threshold of the neighbour validity,
Neighbour-Threshold = Y: Threshold of neighbour existence,
P-CR = Coverage ratio of the path towards the previous RSU of the neighbour V,
N-CR = Coverage ratio of the path towards the next RSU of the neighbour V,
LS = Stability of link between the vehicle X and its neighbour Y,
LC-P = Link counter of the previous path of neighbour Y,
LC-N = Link counter of the subsequent path of neighbour Y,
N-POS: The position where begins the next RSU coverage area.

```
1 if receive BSM then
2   V.BSM-Timer On;
3   V.BSM-Counter = 0;
4   if V-ID  $\exists$  Neighbours-Table then
5     Update Neighbours-Table;
6     V-STA = valid ;
7   else
8     Add V to Neighbours-Table ;
9     P-CR=Ratiocalculationprevious(CL-P,HN-P);
10    N-CR=Ratiocalculationnext(CL-N,HN-N);
11    if P-CR  $\neq$  1 then
12      LC-P ++ ;
13    end
14    if N-CR  $\neq$  1 then
15      LC-N ++ ;
16    end
17  end
18 end
19 if V.BSM-Timer expires then
20   BSM-Counter ++;
21   LS ++ ;
22   if V.BSM-Counter  $\succ$  Validity-Threshold then
23     V-STA = invalid ;
24   end
25   if V.BSM-Counter  $\succ$  Neighbour-Threshold then
26     Delete neighbour V from Neighbours-Table ;
27   end
28   V.BSM-Timer On;
29 end
30 if (X-Direction=V-Direction && V.N-POS  $\neq$  0) || (X-Direction $\neq$ V-Direction) then
31   Path track towards to the subsequent RSU (Algorithm 8);
32 end
```

filed is different from 0, or from a neighbour in the opposite direction (line 29). Then, the path track towards the subsequent RSU is launched (line 30).

As shown in **Figure 4.6**, vehicle **A** will receive BSMs from its nearby neighbours, vehicles **B**, **C** and **D**, and will store their corresponding information on its **Neighbours-Table**, as shown in **Figure 4.7**.

Both vehicles **C** and **D** have full paths towards the infrastructure as they have both maximum N-CR and P-CR respectively. Therefore, the vehicle **A** has the possibility to reach the previous RSU (1) by relaying the information to vehicle **D** in the opposite direction. And, to reach the subsequent RSU (2), it can forward the information to vehicle **C**.

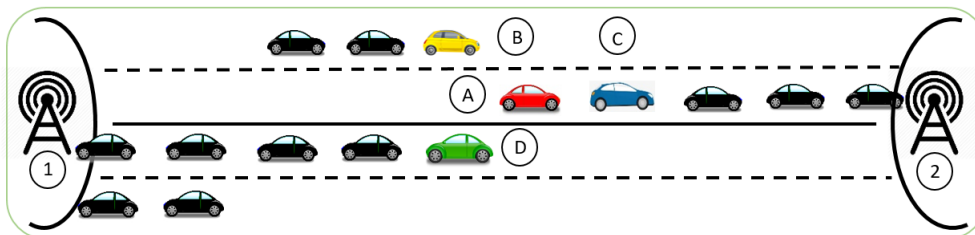

Figure 4.6: BSM exchange example scenario.

V-ID	V-STA	V-POS	V-DIR	V-SPD	IC	HN-P	CL-P	HN-N	CL-N	P-POS	N-POS	P-CR	N-CR	LS	LC-P	LC-N
B	1	B-POS	B-DIR	B-SPD	0	5	3	6	6	1-POS	2-POS	0.6	1	6	20	6
C	1	C-POS	C-DIR	C-SPD	0	6	1	5	5	1-POS	2-POS	0.16	1	8	8	3
D	1	D-POS	D-DIR	D-SPD	0	7	7	5	5	2-POS	1-POS	1	1	5	6	5

Figure 4.7: Neighbours Table of vehicle A.

4.4.2 Path track

We organize uncovered vehicles into levels in order to track paths towards the infrastructure by estimating the number of hops and the RSU remoteness. The concept of levels is used to determine the correct distance between the vehicle and the infrastructure. This will enable to track more effectively the paths towards the infrastructure. In fact, the level concept will enable vehicles to compute the correct number of hops in curved road, a scenario in which the euclidean distance gives wrong HN-P as depicted in **Figures 4.8, 4.9** and **4.10**.

To obtain accurate HN-P and HN-N, each vehicle proceeds as follows:

Link to the previous RSU: As depicted in **Figure 4.8**, when the vehicle **A** leaves the RSU coverage, it uses the hops number calculation previous **4.3**. It needs the vehicle transmission range R_x , the vehicle current mileage (C-MIL), and the last mileage (V-MIL) recorded when exiting the RSU coverage, corresponding to the last entry on the **RSU-Table**. The Function *hopsnumbercalculationprevious* (**4.3**), is defined by:

$$HN_P = \frac{C_{MIL} - V_{MIL}}{R_x} \quad (4.3)$$

The use of the vehicle mileage will enable vehicle **A** to determine the correct distance from the left RSU, thus the correct number of levels, that will be transmitted to vehicle **B**.

The vehicles determine the availability or not of a path towards the previous RSU when being out of its coverage range using **Algorithm 6**. While being in an uncovered area (line 1) the vehicle will track the path at each BSM sending (line 2). It will refresh its HN-P (line 3) and determine if there is a full path (line 15 to line 19) and in what direction (line 7 and line 11). In addition, in case there is pending-data (line 20), **Algorithm 10** will be called (line 21).

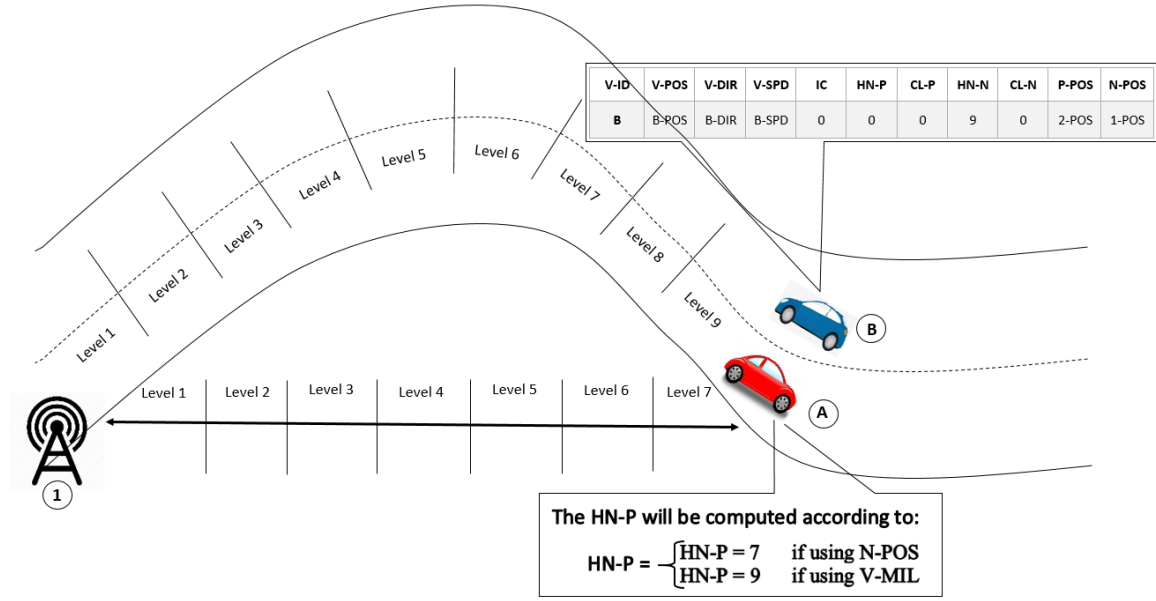

Figure 4.8: HN-P calculation for curved road.

Algorithm 6: Path track towards the previous RSU pseudo-code

Data: Neighbours-Table: Neighbours-Table of vehicle X,
 RSUs-Table: RSUs-Table of vehicle X,
 X-MIL: Current mileage of vehicle X,
 X-Direction: Current direction of vehicle X,
 Rx: Transmission range of vehicle X,
 HN-P: Current HN-P of vehicle X,
 CL-P: The CL-P of the neighbour i,
 CL-N: The CL-N of the neighbour i,
 Link-backward-same = false: Indicates path backward availability in the same direction,
 Link-backward-opposite = false: Indicates path backward availability in the opposite direction,
 Link-backward = false: Indicates path backward availability.

Result: link-backward.

```

1 while IC = 0 do
2   for each BSM sending do
3     HN-P= Calcul-nb-of-hops-previous(Rx, X-MIL, RSUs-Table);
4     for i=0,i++, Neighbours-Table of X do
5       if X-Direction = Direction(i) then
6         if CL-P(i) ≥ HN-P - 1 then
7           Link-backward-same = true;
8         end
9       else if X-Direction ≠ Direction(i) then
10        if CL-N(i) ≥ HN-P - 1 then
11          Link-backward-opposite = true
12        end
13      end
14    end
15    if Link-backward-same || Link-backward-opposite then
16      Link-backward = true;
17    else
18      Link-backward = false;
19    end
20    if pending-data then
21      Decision making (Algorithm 10);
22    end
23  end

```

Link to the subsequent RSU: As shown in **Figures 4.9** and **4.10**, vehicle **A** can be notified about the existence of the next RSU either by a vehicle from the opposite direction **4.9** or a vehicle in the same direction **4.10**. The processing used to determine the number of hops that separate it from the next success is slightly different in the two cases.

- As depicted in **Figure 4.9**, when the vehicle **A** receives information about the existence of the subsequent RSU from vehicle **B**, it checks if the HN-P of vehicle **B** is equal ± 1 (to cover vehicles from same, previous and subsequent levels) to its HN-N determined using the hops number calculation next **Function 3.2**. If they are equal, the vehicle **A** will continue to determine the distance that separates it from the next RSU using the **Function 3.2**. If it is not the case, each L m (which corresponds to the level size) it will decrement the HN-P of vehicle **B**.

$$HN_N(i) = \begin{cases} HN_N = (N_{Pos} - V_{Position})/Rx & \text{if } HN_N(A) = HN_P(B) \pm 1 \\ HN_N(A) = HN_P(B) - L & \text{otherwise} \end{cases}$$

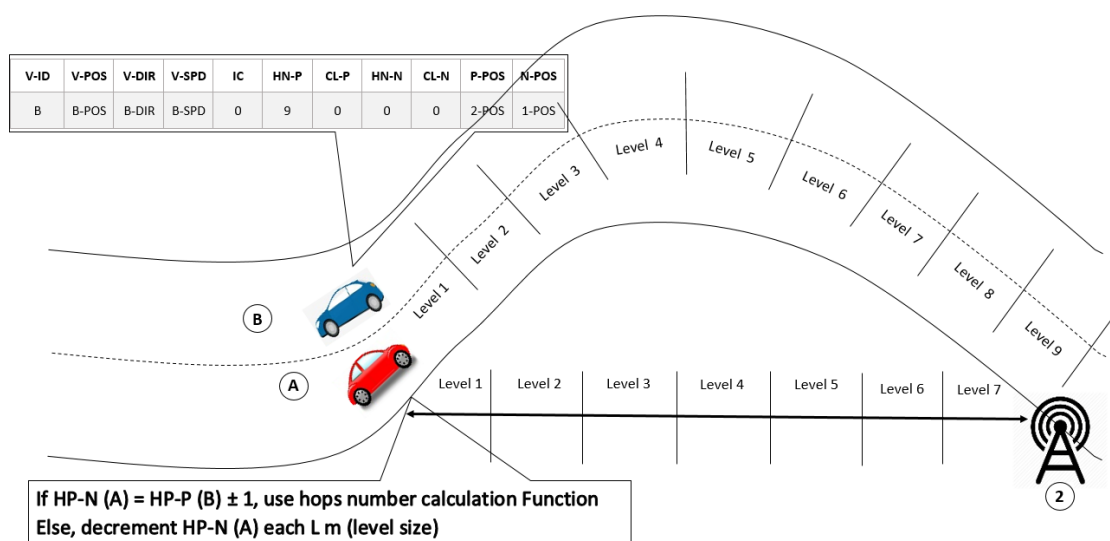

Figure 4.9: HN-N calculation for curved road with information from vehicle in the opposite direction.

- As depicted in **Figure 4.10**, when the vehicle **A** receives information about the existence of the subsequent RSU from vehicle **B**, it checks if the HN-N of vehicle **B** is equal ± 1 to its HN-N determined using the hops number calculation next **Function 3.2**. If they are equal, the vehicle **A** will continue to determine the distance that separates it from the next RSU using the **Function 3.2**. If it is not the case, each L m (which corresponds to the level size) it will decrement by one the HN-N of vehicle **B**. In this case, we assume

that the vehicle **B** has been already notified by the subsequent RSU existence either by vehicle in the same or opposite direction.

$$HN_N(i) = \begin{cases} HN_N = (N_{Pos} - V_{Position})/Rx & \text{if } HN_N(A) = HN_N(B) \pm 1 \\ HN_N(A) = HN_N(B) - L & \text{otherwise} \end{cases}$$

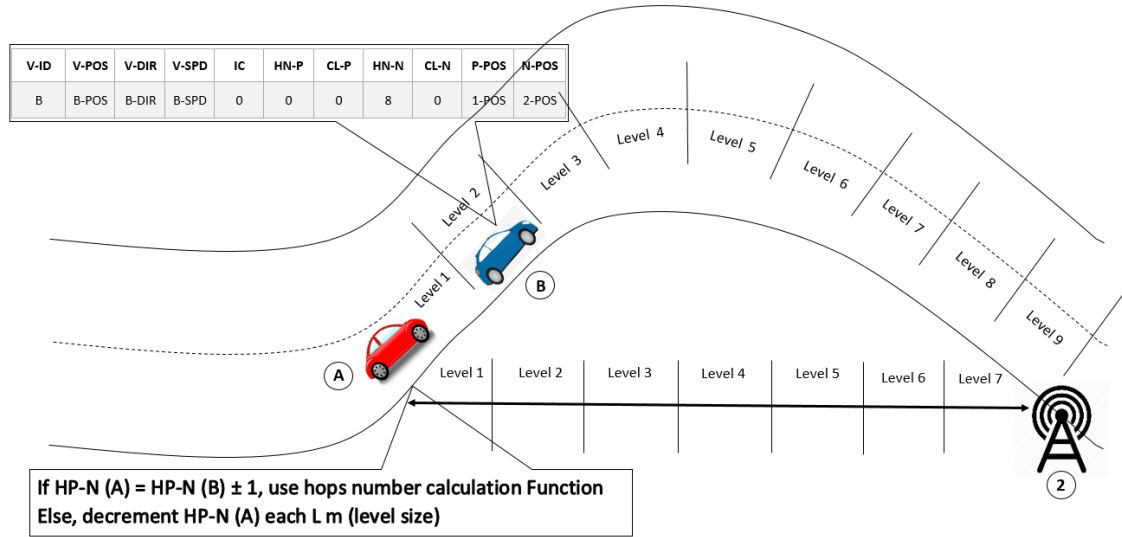

Figure 4.10: HN-N calculation for curved road with information from vehicle in the same direction.

As described in **Algorithm 7**, initially, the vehicle will determine its current HN-N using the hops number calculation next Function 3.2 (line 1). If the neighbour vehicle is in the opposite direction and the number of hops to the subsequent RSU is equal ± 1 to the HN-P of the neighbour vehicle, or if the neighbour vehicle is in the same direction and the HP-N is equal ± 1 to the HN-N of the neighbour (line 2); this mean that the road is straight and the vehicle will continue to determine the NH-N using the **Function 3.2** (line 3). Otherwise, the road is curved (line 4) and the HN-N of the vehicle will be determined by decrementing the HN (HN-P/HN-N) of the neighbour while crossing each level (line 5).

Same for the path track towards the subsequent RSU process, the vehicles determine the availability or not of a path by using **Algorithm 8**. At each BSM sending (line 2) and while being in an uncovered area (line 1) the vehicle checks if its has a full path towards the infrastructure or not. It will refresh its HN-P (line 3) and determine if there is a full path (line 15 to line 19) and in what direction (line 7 and line 11). **Algorithm 10** will be called (line 21), in case there is pending-data (line 20).

4.4. HyRSIC functional behaviour

Algorithm 7: HN-N calculation pseudo code

Data: *N-POS*: The position where begins the next RSU coverage area,
X-Position: Current position of vehicle *X*,
Rx: Transmission range of vehicle *X*,
HN-N (X): Current HN-N of vehicle *X*,
HN-P (V): Current HN-P of neighbour *V*,
HN-N (V): Current HN-N of neighbour *V*,
L = Y: The level size.

Result: HN-N

```

1 HN-N= Calcul-nb-of-hops-next(Rx, X-Position, N-POS);
2 if (X-Direction!=V-Direction && HN-N (X) = HN-P (V) ± 1) ||
   (X-Direction=V-Direction && HN-N (X) = HN-N (V) ± 1 ) then
3   | use Calcul-nb-of-hops-next Function 3.2 ;
4 else
5   | HN-N (X) = HN (V) - L ;
6 end

```

Algorithm 8: Path track towards the subsequent RSU pseudo-code

Data: *Neighbours-Table*: Neighbours-Table of vehicle *X*,
RSUs-Table: RSUs-Table of vehicle *X*,
X-Position: Current position of vehicle *X*,
X-Direction: Current direction of vehicle *X*,
Rx: Transmission range of vehicle *X*,
HN-P: Current HN-P of vehicle *X*,
CL-P: The CL-P of the neighbour *i*,
CL-N: The CL-N of the neighbour *i*,
Link-ahead-same = false: Indicates path ahead availability in the same direction,
Link-ahead-opposite = false: Indicates path ahead availability in the opposite direction,
Link-ahead = false: Indicates path ahead availability.

Result: link-ahead.

```

1 while IC = 0 do
2   | for each BSM sending do
3     |   HN-N= HN-N calculation (Algorithm 7) ;
4     |   for i=0,i++, Neighbours-Table of X do
5       |     if X-Direction = Direction(i) then
6         |       | if CL-N(i) ≥ HN-N - 1 then
7         |       |   | Link-ahead-same = true;
8         |       |   end
9         |     else if X-Direction != Direction(i) then
10        |       | if CL-P(i) ≥ HN-N - 1 then
11        |       |   | Link-ahead-opposite = true
12        |       |   end
13        |     end
14    |   end
15    | if Link-ahead-same || Link-ahead-opposite then
16    |   | Link-ahead = true;
17    |   else
18    |   | Link-ahead = false;
19    |   end
20    | if pending-data then
21    |   | Decision making (Algorithm 10) ;
22    |   end
23 end

```

4.4.3 Decision process

In the decision making process, we opted for a hybrid strategy (See Section 4.2.1), as both topological and geographical information are used to perform data transmission. According to the positive progress towards the destination, the algorithm can choose between forwarding the message or keeping it until reaching the infrastructure. We have four possible options: (i) link available only towards previous RSU, (ii) link available only towards next RSU, (iii) both RSUs are reachable, (iv) no links available towards the infrastructure. In fact, two actions are taken, the first is the choice of the targeted RSU and the forwarding direction and the second one is the forwarder selection at each hop. For the first step, both targeted RSU and forwarding direction are chosen based on the source distance from the destination, path availability and delay analyses. For the second phase, we will apply an enhanced greedy forwarding algorithm. In the following, we detail the different aforementioned steps and we present the decision making algorithm with detailed scenarios of the different alternative cases.

4.4.3.1 Path selection

By relying on topological information and choosing to forward the message in the direction where we have a full path until the destination, we avoid the occurrence of voids in the routing direction in addition to the local optimum problem (See Section 4.3.2). The targeted RSU and the forwarding direction are selected as follows:

- Select the targeted RSU based on the paths availability and delay analyses: This step consists in checking towards which RSU we have available paths. The delay estimation is needed in the decision making algorithm to decide whether the vehicle should send the message via V2V multi-hop until reaching the infrastructure or if it will be better to buffer the packet until reaching the subsequent RSU. The delay estimation enables to determine both the Travel Time (TT) and the Forwarding Time (FT) delays that will be used in the decision making process:

$$Delayestimation = \begin{cases} TT = & SCF + V2I \\ FT = & V2V + V2I \end{cases}$$

- Travel Time corresponds to the time needed by the source vehicle to reach the next RSU. It is calculated using *Travel time calculation Function 4.4*. The Travel Time is composed of two delays the first one is the SCF phase, during which the message is buffered at the source vehicle and the second one is the uploading delay where

the message will be delivered to the RSU with V2I communication. The **Function 4.4** is defined by:

$$TT = \frac{HN_N * Rx}{V_{Speed}} + \frac{S}{D_i} \quad (4.4)$$

Where, D_i is the V2I data rate, S the message size, Rx is the vehicle transmission range, the V-Speed is the vehicle speed and HN-N is the number of hops separating the vehicle from the subsequent RSU.

- Forwarding Time corresponds to the time needed to forward the message relying on V2V communications until delivering it to the previous RSU. It is also composed of two delays; the first one is the V2V delay where the message is relayed HN-N time with V2V data rate D_v , and the second one is the uploading delay where the message will be delivered to the RSU with V2I data rate D_i . The **Function Forwarding time calculation, 4.5**, is defined by:

$$FT = \sum_{i=0}^{HN_N} \left(\frac{S}{D_i} \right) + \frac{S}{D_v} \quad (4.5)$$

Where, D_i is the V2I data rate, D_v is the V2V data rate, S the message size, and HN-N is the number of hops separating the neighbour vehicle from its corresponding subsequent RSU.

As described in **Algorithm 9**, the Travel Time needed by the source node to reach the infrastructure ahead (line1) and the Forwarding Time needed to reach the infrastructure by V2V communications (line2) are determined. If the TT is higher than the FT (line3) then the SCF technique can be adopted (line 4). Otherwise (line 5), the SCF technique is not the option to adopt (line 6).

- Select the forwarding direction based on the hops number: Once the targeted RSU is selected two options may be available: (i) relying on vehicles in the same direction or (ii) using vehicles in the opposite direction.

4.4.3.2 Next hop selection

Once the forwarding direction is chosen, the next hop is selected using several parameters such as the distance from the destination, the link stability and the path stability. We use an Enhanced Greedy Forwarding technique; the forwarder will not only be the closest neighbour to the destination, but the one who also has the highest LC and more stable link with the message

Algorithm 9: Delay estimation pseudo-code

Data: *N-POS*: The position where begins the next RSU coverage area,
X-Position: Current position of vehicle *X*,
X-Speed: Current speed of vehicle *X*,
V-Position: Current position of neighbour *V*,
V-Speed: Current speed of neighbour *V*,
HN-N: Current HN-N of vehicle *V*,
Di: Data rate of V2V communication,
Dv: Data rate of V2I communication,
Forwarding time: Time required to forward the information to the previous RSU,
Travel time: Time need to reach the next RSU,
SCF = false: Indicates if we should apply or not the SCF technique while a path is available.

Result: SCF

```
1 Travel time = Travel-time-calculation (N-POS, X-Position, X-Speed,  $D_v$ , S);
2 Forwarding time = Forwarding-time-calculation (HN-N,  $D_v$ ,  $D_i$ , S);
3 if Travel time < Forwarding time then
4   |   SCF = true;
5 else
6   |   SCF = false;
7 end
```

holder. In fact, our aim is to follow the most stable path and to choose the optimal next hop among the nodes within the transmission range. To this end, for each eligible next hop, we compute a weight score while considering:

- The distance of the forwarder candidate from the message holder.
- The quality of the paths provided by neighbouring vehicles, Link Counter.
- The link stability which corresponds to the number of times that the current forwarder has not received the BSM message from the corresponding neighbour.
- The coverage ratio of the path proposed by the neighbour.

We distinguish between two cases; when the vehicle has a full path towards the infrastructure and where it has not. In the first case the eligible forwarders are the vehicles situated in the chosen direction and that have a full path towards the infrastructure. In the second case to be an eligible forwarder the vehicle has to be in the chosen direction. Based on this computed score, the node with the highest W will be selected as next hop:

- In the first case, the weight score is computed as follows 4.6, and we refer to it by EGF:

$$W(i) = w_1 \times \frac{1}{D} + w_2 \times LC + w_3 \times LS \quad (4.6)$$

4.4. HyRSIC functional behaviour

Where, w_1 , w_2 and w_3 are the weighting factors for the corresponding system parameters, D the distance of the neighbour from the destination, LC the quality of the path proposed by the neighbour, LS the quality of the link between the vehicle and its neighbour.

- In the second case, the weight score is computed as follows 4.7, and we refer to it by EGF+:

$$W(i) = w_1 \times \frac{1}{D} + w_2 \times LC + w_3 \times LS + w_4 \times CR \quad (4.7)$$

Where, w_1 , w_2 , w_3 and w_4 are the weighting factors for the corresponding system parameters, D the distance of the neighbour from the destination, LC the quality of the path proposed by the neighbour, LS the quality of the link between the vehicle and its neighbour, CR the rate of the coverage of the path proposed by the neighbour.

As explained in **Algorithm 10**, when an alert message is generated or received (line 1), the node has to refresh the HN-P and HN-N parameters (line 2 and 3) and determine the SCF parameter (line 4):

Link-backward only available: When only full paths towards the previous RSU are available (line 5), the SCF technique will be applied (line 7), if the vehicle is closer to the subsequent RSU (line 6) and the SCF parameter is set to 1. Otherwise, the vehicle is closer to the previous RSU (line 8), if the full path is available in the opposite direction (line 9), the EGF technique will be applied in this direction (line 10), otherwise (line 11), it will choose to relay the packet to its predecessor vehicles moving in the same direction (line 12).

As shown in Figure 4.11, in this first scenario, we have only full paths towards the previous RSU, the decision process will be based on the concerned vehicle position. In the case presented in Figure 4.11 (a), vehicle **A** has to choose between two forwarding directions, it will choose to relay the packet through vehicles in the opposite side as they make a positive progress towards the previous RSU. Then, by using enhanced greedy forwarding, vehicle **X** will be chosen as the next forward as it is closer to the RSU and its other parameters (LC and LS) are similar to those of the vehicle **Y**. In fact, a path based on vehicles in the same direction may be prone to failures, as we may not have a vehicle in the RSU range when the packet reaches the last vehicle. In Figure 4.11 (b), the source of the alert message, vehicle **A** is too close to the subsequent RSU and by estimating the delay it determines that the time to reach it directly is less than the time needed to reach the previous RSU through the available full path, thus, the SCF technique will be applied in this case.

Link-ahead only available: In case we only have full paths towards the subsequent RSU (line 16), we will apply the EGF in the opposite direction (line 18) if the vehicle is closer to

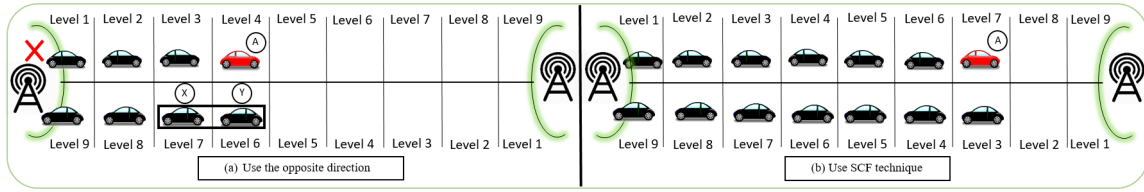

Figure 4.11: Link-backward only available.

the previous RSU and there is a vehicle at its transmission range in the opposite direction (line 17). If the vehicle is closer to the subsequent RSU (line 19), it will choose to relay the warning message to vehicles in the same direction (line 21), if the full path available is on the same direction (line 20), otherwise (line 22), it will apply EGF in the opposite direction (line 23).

Figure 4.12 presents the second scenario where only paths towards the subsequent RSU are available. Similar to the first case, the decision process will take into account the concerned vehicle position. In **Figure 4.12** (a), vehicle **X** will be chosen to relay the packet as it is being in the direction that make positive progress towards the next RSU, and the path in the opposite direction may no longer be available if there is no vehicles in the RSU coverage area. In **Figure 4.12** (b), the source vehicle, **A**, is closer to the previous RSU and can reach it by relying on vehicle **X**, moving in the opposite direction. It selects this alternative, despite the fact that a full path towards the subsequent RSU through vehicles in the same direction exists.

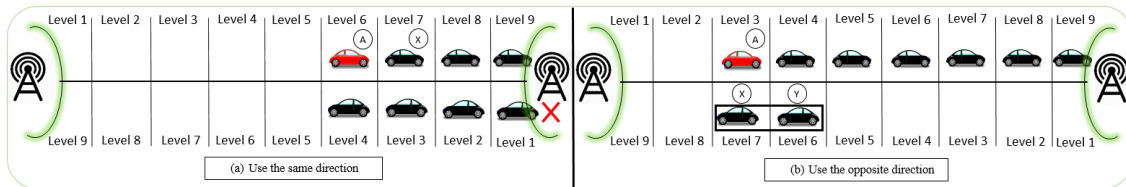

Figure 4.12: Link-ahead only available.

Links available towards both RSUs If full paths towards both RSUs are available (line 27), EGF will be applied in the opposite direction (line 30), if the vehicle is closer to the subsequent RSU (line 28), and there is a vehicle in the opposite direction (line 29), otherwise (line 31), the forwarding direction will be chosen based 6:13 (line 32). However, if the vehicle is closer to the subsequent RSU (line 34), the forwarding direction will be chosen based on 20:24 (line 35).

In this last scenario, as shown in Figure 4.13, the source vehicle, **A**, has the possibility to reach both RSUs. At the first place, the RSU with the lowest hop number paths will be chosen. Then, according to the scenario, scenario 1 or scenario 2, the transmission direction will be chosen. In case we have full paths towards both RSUs (line 26), EGF will be applied in the opposite direction (line 29), if the vehicle is closer to the subsequent RSU (line 27), and there

4.5. Performance evaluation

is a vehicle in the opposite direction (line 28), otherwise (line 30), the forwarding direction will be chosen based 6:13 (line 31). However, if the vehicle is closer to the subsequent RSU (line 33), the forwarding direction will be chosen based on 20:24 (line 34).

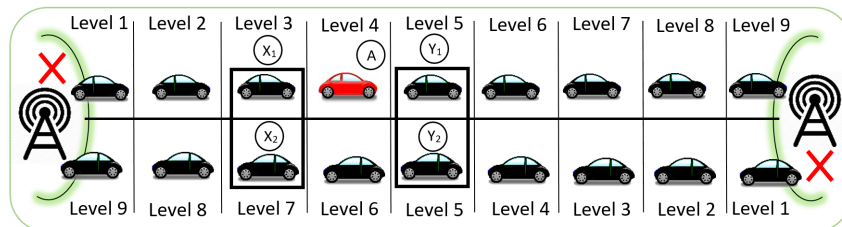

Figure 4.13: Links available towards both RSUs.

No links available towards any of the RSUs When we have no full path available towards any of the RSUs (line 38), the EGF+ will be applied in the opposite direction (line 41) if the vehicle is closer to the previous RSU and there is a vehicle in the opposite direction (line 40). If there is a vehicle in the same direction (line 42), the EGF+ will be applied in the same direction (line 43). In case it is closer to the next RSU (line 44), and there is a vehicle in the same direction (line 45), the EGF+ technique applied in the same direction (line 46). Otherwise (line 47), the SCF technique will be applied (line 48). If there is no node available in the vicinity (line 50) the SCF technique will be applied.

4.5 Performance evaluation

In this section, we first present our evaluation set-up (Section 4.5.1), before briefly illustrating the simulation metrics (Section 4.5.2). We then, evaluate the performance of HyRSIC in terms of scalability, reliability and efficiency (Section 4.5.3).

4.5.1 Evaluation set-up

In this section, we assess the performance of HyRSIC while varying the network density, the road length, the maximum speed of vehicles and the number of sources of warning messages. We compare HyRSIC to GPRS (See Section 4.3.2) and a variant of GPRS integrating ILST (See Chapter 3). GPRS was used in this evaluation with its basic functionalities, the destination position is provided and the GRPS considers only the distance metric and choose to route the generated alert message towards the closest RSU. In its variant that integrates ILTS, the destination will be chosen based on the path tracking mechanism and then the next hop selection steps will be performed based on two metrics the distance in addition to the availability of a

Algorithm 10: Decision making pseudo-code

Data: *Neighbours-Table: Neighbours-Table of vehicle X,*
RSUs-Table: RSUs-Table of vehicle X,
C-MIL: Current mileage of vehicle X,
Rx: Transmission range of vehicle X,
HN-P: Current HN-P of vehicle X,
HN-N: Current HN-N of vehicle X,
Link-backward: Indicates paths availability towards previous RSU,
Link-ahead: Indicates paths availability towards next RSU,
SCF= false: Indicates if we should use the SCF technique or not.

```
1 When an alert message is generated or received do;
2 HN-P= Calcul-nb-of-hops-previous(Rx, C-MIL, RSUs-Table);
3 HN-N= HN-N calculation (Algorithm 7) ;
4 SCF= Delay estimation;
5 if link-backward && ! link-ahead then
6   if (HN-P  $\geq$  HN-N) && SCF then
7     use SCF technique;
8   else
9     if Link-backward-opposite then
10      EGF in the opposite direction;
11    else
12      EGF in the same direction;
13    end
14  end
15 end
16 if ! link-backward && link-ahead then
17   if (HN-P  $\leq$  HN-N) && (vehicle  $\in$  opposite direction) then
18     EGF in the opposite direction;
19   else
20     if Link-ahead-same then
21       EGF in the same direction;
22     else
23       EGF in the opposite direction;
24     end
25   end
26 end
27 if link-backward && link-ahead then
28   if HN-P  $\leq$  HN-N then
29     if vehicle  $\in$  opposite direction then
30       EGF in the opposite direction;
31     else
32       choose the direction based on 6:13;
33     end
34   else
35     choose the direction based on 20:24;
36   end
37 end
38 if ! link-backward && ! link-ahead then
39   if (HN-P  $\leq$  HN-N) then
40     if vehicle  $\in$  opposite direction then
41       EGF+ in the opposite direction;
42     else if vehicle  $\in$  same direction then
43       EGF+ in the same direction;
44     else if HN-P  $>$  HN-N then
45       if vehicle  $\in$  same direction then
46         EGF+ in the same direction;
47       else
48         use SCF technique;
49       end
50     else
51       use SCF technique;
52     end
53 end
```

4.5. Performance evaluation

path. In HyRSIC, the destination and the forwarding direction will be fixed, and then, the next hop selection will be based on several metrics, the distance, path availability, path quality, link stability and the coverage ratio. In the first phase of the evaluation, we evaluate the performance of HyRSIC, and in the second phase we compare our approach with GPRS and its variant, ILTS+GPRS. All protocols are implemented using the network simulator OMNET and the INET framework (version 0.0.4); INET is an open-source model library providing protocols, agents and different models for communication networks. The simulation parameters are listed in **Table 4.3**:

Type	Parameter	Value
PHY	Propagation model	Two Ray Ground (TRG)
	Radio range	300m
MAC	Protocol	IEEE 802.11p (DSRC)
NETWORK	Protocols	GPRS, ILTS+GRPS and HyRSIC
	Weight factors	EGF: w1=0.2, w2=0.4, w3=0.4 EGF+: w1=0.2, w2=0.3, w3=0.3, w4=0.2
APPLICATION	Broadcast interval	1 s
	Traffic	Event driven Alert message
	Data rate	6 Mbps
	Sources	1, 3 and 5
	Packet size	512 bytes
SCENARIO	Mobility model	Traffic Simulator-based
	Traffic simulator	SUMO
	Network simulator	OMNETpp
	Road length	1, 3, 6 Km
	Source position	Front, middle and back of the network
	Vehicle speeds	20-40 m/s
	Vehicle densities	5, 15, 20, 30, 40, 50 vehicle/Km
SIMULATION	Total time	300 s
	Simulation runs	10/source position
	Level size	250m

Table 4.3: Simulation set-up.

In the following, we present the simulation metrics and the obtained results.

4.5.2 Simulation metrics

To evaluate the performance of our routing approach in vehicular networks with an intermittent-based infrastructure, we focus on the following metrics:

- **End-to-End delay of safety messages:** It is the time required to transmit a safety message from the source node to the RSU.

- **RSU choice:** It represents the number of times the RSU in question has been chosen by the decision algorithm.
- **Packet Delivery Ratio (PDR):** It is the proportion of successfully received warning messages by RSUs.

4.5.3 Simulation results and analysis

In this subsection, we present and discuss the outcomes of the evaluation of HyRSIC, and the comparison of our approach with GPRS and its variant, ILTS+GPRS.

4.5.3.1 First phase of evaluation

In **Figure 4.14**, we illustrate the End-to-End delay, measured for a fixed road length (3 Km) while varying the vehicles number and the vehicles speed. As expected, the End-to-End delay is high for low densities due to the unavailability of relays at each level to forward generated message. With the increase of vehicle density, the End-to-End delay decreases. The increased contention between vehicles tends to increase the End-to-End delay for topologies with 50 vehicles per km. The simulation results relative to low speed, offers the best End-to-End delay as the vehicles stay longer nearby, ensuring sufficient time between the decision and receipt of the message by the forwarder which reduces re-transmission attempts. At very high speed (40 m/s), the connection time between vehicles is very short which explains the high End-to-End delay; paths frequently experience failures, thus vehicles tend to keep the message until reaching the infrastructure or finding a new path.

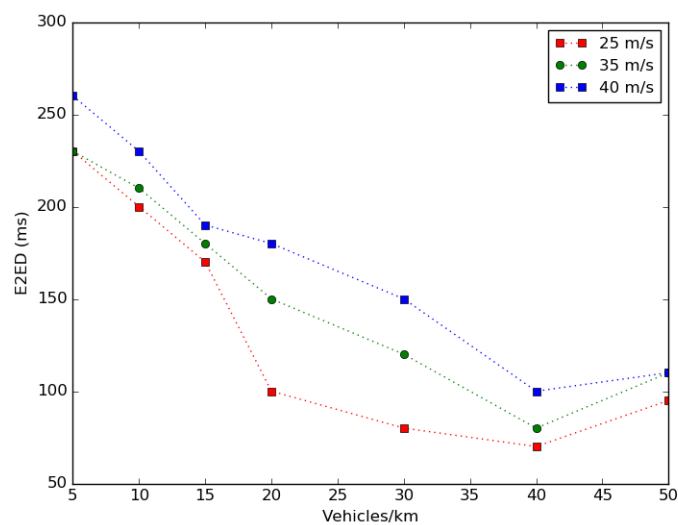

Figure 4.14: End-to-End delay Vs Vehicles max speed and vehicles number, with Road Length = 3 Km.

The results corresponding to the End-to-End delay while varying both road length and vehicles number, are depicted in the **Figure 4.15**; we fix the maximum speed to 30 m/s. End-to-End delay decreases with increasing number of vehicles. However, when the number of vehicles is too high, the End-to-End delay increases as there is more contention between vehicles for channel access. For the different road lengths, the End-to-End delay decreases as the number of vehicles increases. Shorter roads with less hops to reach the infrastructure offer reduced End-to-End delay, mainly 1 km roads in our case.

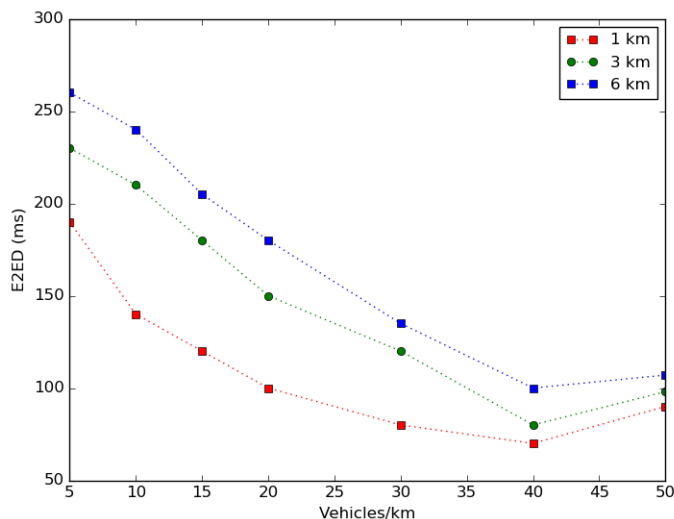

Figure 4.15: End-to-End delay Vs Road Length and vehicles number, with vehicles max speed = 30 m/s.

In **Figure 4.16**, we illustrate the End-to-End delay while varying the vehicles number and the number of source for a fixed vehicles max speed (30 m/s) and road length (3 Km). For the low densities, the End-to-End delay is high due to the unavailability of relays to forward the generated messages. With the increase of vehicle density the End-to-End delay decrease. However, it tends to increase when the vehicle number is high, as there is more contention between vehicles. The End-to-End delay increases with the increase of the number of senders. As the number of the alert messages on the road increases, End-to-End delay of safety message goes up due to the contention.

Figure 4.17 illustrates the decision to forward the alert message to the previous RSU, RSU (1), or to the subsequent RSU, RSU (2) at different distances from the infrastructure. We can see that for a distance of 700 m which corresponds to 3 HN-P, the source vehicle make the choice to forward the message to the previous RSU. The 15% where the vehicle choose to send the message to the subsequent RSU while being closer to the previous RSU corresponds to the cases where no vehicle in both direction are available to rely the message or only vehicles ahead in the same direction are available. When the source vehicle is in the middle of the network and

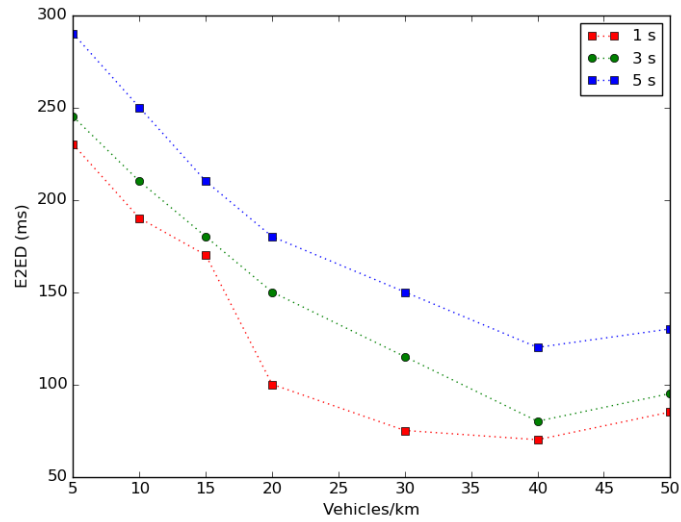

Figure 4.16: End-to-End delay Vs Number of source and vehicles number, with vehicles max speed = 30 m/s and Road Length = 3km.

has approximately the same distance from both RSUs, the percentage of choice of destination are getting closer. The longer distance between the source location and the previous RSU leads to choose to deliver the message to the subsequent RSU, either by V2V communications or SCF technique.

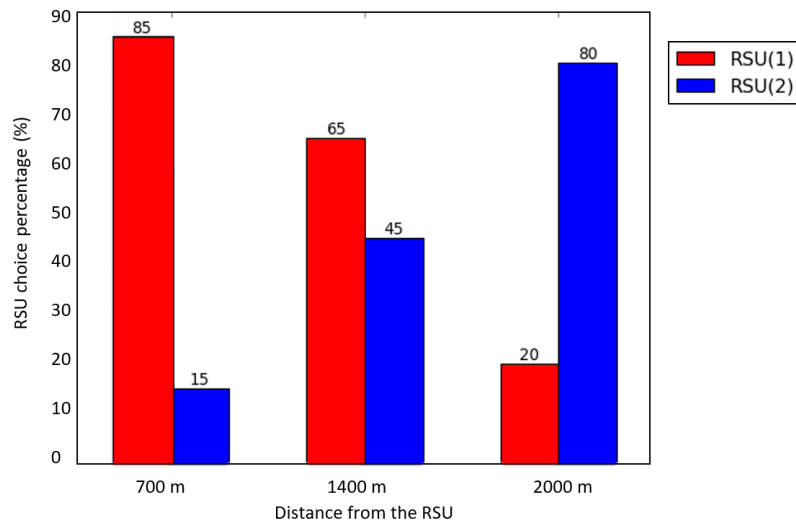

Figure 4.17: RSU choice Vs Distance from RSU with Road Length = 3 Km, vehicles number and vehicles max speed = 30 m/s.

4.5.3.2 Second phase of evaluation

Figure 4.18 shows the comparison of packet delivery ratio between GPSR, ILTS+GPRS and HyRSIC with different number of vehicles. The packet delivery ratio of the three protocols are increasing with the rise of the number of nodes. For low densities, the distribution of nodes is relatively sparse, and it is difficult to find a forwarding node. When the number of vehicles gradually increases, the distance between the nodes becomes short, resulting in significant increase in packet delivery ratio. Compared with GPSR and ILTS+GPRS, HyRSIC has the higher packet delivery ratio in the whole process, and has better performance of avoiding communication interruptions. This is due to the fact that HyRSIC, first, checks the availability of paths towards to two RSUs, then, selects as the next forwarder the node that has the most stable path and with whom it has the strongest connection, thus the most reliable and robust communication link is chosen. While ILTS+GPRS will choose as the next forwarder the closest node to the infrastructure with a full path and GPSR selects the next hop node based only on its distance from the destination. In both cases, the current message holder is more likely to choose a node situated at the edge of its communication range, the chosen node can easily move out of the transmission range, leading to a link failure and packet loss.

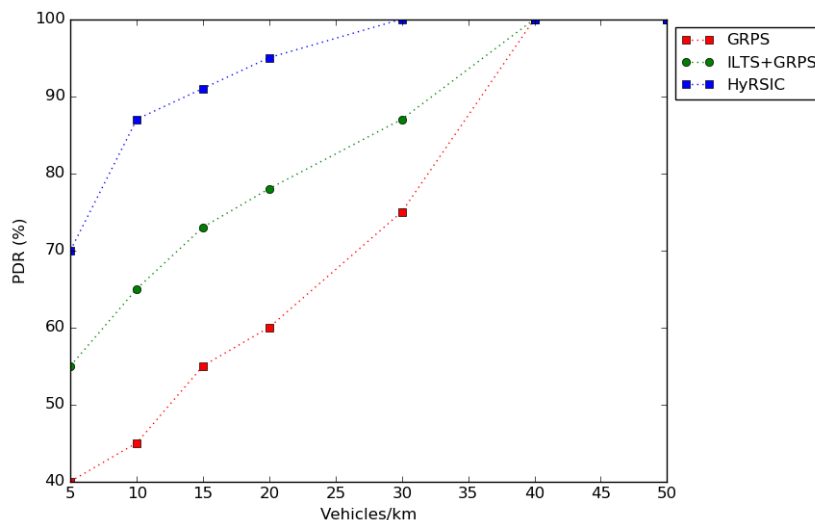

Figure 4.18: PDR Vs Vehicles number, with Road Length = 3 Km and vehicles max speed = 30 m/s.

Figure 4.19 shows the performance of End-to-End delay with various number of vehicles. The End-to-End delay of the three protocols decreases gradually with the rise of the number of vehicles, and it suddenly up rise when the number of nodes comes to 40. In fact, when the number of vehicles increases, the contention to access the channel between vehicles rise, resulting in significant increase in the End-to-End delay. When the number of vehicles in the network is small, less forwarding possibilities are available and the message holder is forced to

use SCF technique more often which explains the high E2E delay. We can easily infer from the figure that HyRSIC outperforms well both traditional GPSR and ILTS integrating GPSR. In fact, in addition to choose the forwarding direction that makes the most positive progress towards the infrastructure, HyRSIC, also uses delay estimation mechanism to choosing the forwarding direction that offers the lowest delay.

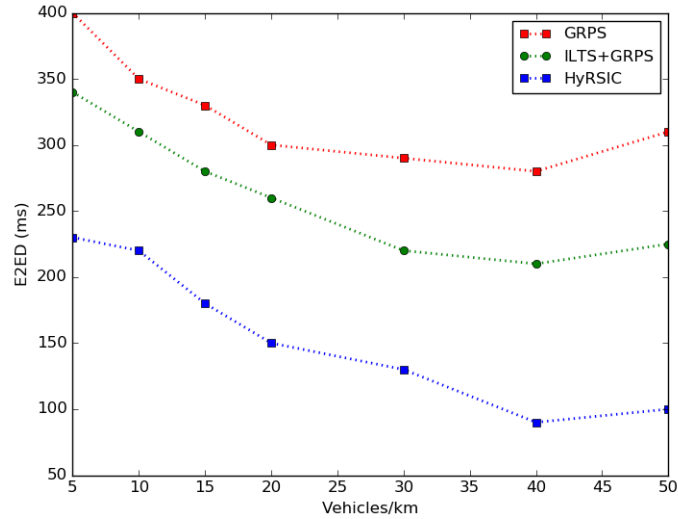

Figure 4.19: End-to-End delay Vs vehicles number, with vehicles max speed = 30 m/s and Road Length = 3km.

4.6 Conclusion

Delivering warning messages in the vehicular environment is a crucial application and tremendous work were carried out in order to guarantee high reliability and low delay for such a task. Previous approaches tackled mainly infrastructure and infrastructure-less based networks rather than dispersed infrastructure-based ones. In this chapter, we proposed the HyRSIC scheme. HyRSIC is routing approach based on a decision making algorithm enabling vehicles traveling in an uncovered area to reach the surrounding infrastructure in a timely manner.

In the next chapter, we conclude this work; we summarize the thesis contributions and then, we discuss some future research directions.

Conclusion

As a major Smart City domain, Smart Mobility becomes one of the most active research fields and attracts the attentions of stakeholders from the automotive, academic and government sectors. It plays an important role in solving various driving and traffic problems and defining new innovative mobility solutions through the integration of technological advances. The concept of Smart Mobility is expanding rapidly and stakeholders must work together to identify the potential of inter-modal mobility solutions and address their requirements and limitations. The safety of drivers and passengers is at the origin of the advances seen in the field of mobility such as ITS and IoV. In this context, alert messages are generated by a source vehicle when an emergency situation occurs (e.g. hard brake and vehicle crash) to alert other vehicular nodes (vehicles, RSUs) about the event. The task of routing emergency messages in VANETs is a high priority and time-critical procedure. And the challenge is exacerbated in environments where V2I communications are not available, such as highways. Routing protocols work conjointly with localization information service. In addition to delay factor, bandwidth plays an important role in designing these services. In a nutshell, it is necessary to design a routing protocol that ensures lower delay, high reliability and efficient bandwidth utilization. In what follows, we summarize the contributions of the research presented in this dissertation over the previous state of the art and suggests directions for future work.

Summary of Contributions

The work presented in this thesis include the following contributions:

- We proposed a broader vision of Smart Mobility in line with recent technological advances, while specifying the different mobility domains; namely terrestrial, aerial and marine. We stressed out the need for a thoroughly cooperation between all transport modes to enable an unified integrated Smart Mobility system. We discussed open research issues and future trends relative to the new vision of Smart Mobility.
- We conducted a study on data gathering for Internet of Vehicles safety applications, where we identified the car-types and exposed the different communication levels and technologies used in the quest of safety realization.

-
- We provided a survey of routing protocols in the terrestrial domain. More precisely, we presented the different taxonomies and their variants. During this study, we presented an insightful overview of the main design building blocks of geographical routing protocols. We also outlined several optimization techniques and paradigms namely bio-inspired approaches, computational intelligence and networking paradigms, introduced to improve the design and management of routing protocols.
 - We proposed ILTS (Infrastructure Localization service and Tracking Scheme), a forwarding information scheme, relying on the beaconing system, that allows to estimate necessary information for routing protocols in intermittent infrastructure-based networks. In ILTS, the vehicles cooperate with each other by using contextual information relative to the neighbouring vehicles and the infrastructure in order to build a local view of the surrounding environment. The exchange of these processed views enables the vehicles to acquire a collective awareness and determine the infrastructure position and track paths towards it. The integration into the beaconing system and the proactive processing reduce the transmission delay and enhance the reliability. In fact, the results obtained show the ability of ILTS to supply vehicles, with fresh information regarding the availability of the infrastructure relatively quickly, while being able to keep track about available paths to reach it. In fact, during an average of 90% of the time spent in an uncovered area; the vehicles have full paths to the infrastructure.
 - We proposed HyRSIC (Hybrid Routing for Safety Data with Intermittent V2I Connectivity), routing protocol based on a decision making algorithm for V2V and V2I communications coupled with infrastructure location service, where the suitable routing path is selected based on the in-time routing information. The available options for uncovered vehicles to reach the infrastructure are to; (i) rely information to the previous RSU through vehicles in the same direction or in the opposite one, (ii) rely information to subsequent RSU through vehicles in the same direction or in the opposite one, (iii) keep the information if there is no relay node or until it is delivered to the next RSU if it is near. We have lead a thorough evaluation from three different perspectives: scalability, reliability and efficiency. As a result, it appears that HyRSIC is able to scale quickly and adapt promptly to density and speed variations. Compared to GRPS and its variant ILTS+GRPS, HyRSIC offers a better PDR for scarce network and the lowest End-to-End delays.

Future research directions

In this subsection, we present our research plan and future research directions:

- Several wireless technologies can be used in the vehicular environment in order to interconnect the different nodes (vehicles, RSUs, pedestrian, sensors) as explained in section Section 1.2.2. In this context, many initiatives are carried out [177, 178], in order to enable devices equipped with different wireless interfaces to choose among the available wireless technologies. According to the survey presented in [210] and the comparative studies conducted in [211, 212, 201], DSRC and C-V2X are complementary and more effort should be made to define a common mean of accessing available resources. In fact, the maturity of DSRC standard to handle critical information delivery constitutes its major advantage and the ability of C-V2X to support non-safety-related applications, thanks to its low-latency and high reliability properties, represents its added value to the network. We would like to test the efficiency of our proposed work in a heterogeneous Internet of Vehicles environment. To this end, we can use Veins LTE, a simulator for heterogeneous vehicular networks. It provides a simulation environment based on both IEEE 802.11p and LTE [213].
- In both work "Data Gathering for Internet of Vehicles Safety" and "VANETs Routing Protocols Survey: Classifications, Optimization Methods and New Trends", we focused on the terrestrial aspects of the Smart Mobility concept. In the first one, we tackled the data collection and transmission problems related to the safety by identifying the car-types and exposing the different communication data levels and means used in the quest of safety realization. In the second one, we surveyed the different taxonomies for vehicular routing protocols, while exposing several optimization techniques used to enhance routing protocols. We would like to conduct similar studies in both aerial and marine domains. In order to provide a holistic view of Internet of Vehicles and foster the deployment of robust IoV routing protocols at large scale.
- In our work entitled "Towards General Internet of Vehicles Networking: Routing Protocols Survey", we presented a set of networking paradigms such as SDN and Fog computing that are newly introduced to the vehicular environment to deal with different aspects such as routing, security and management. SDN is a networking paradigm that decouples the control plane from the data plane and enables the communication between them through an Application Programming Interface (API) [214, 215]. Several SDN based Vehicular Ad-hoc Network (SDNV) architectures were proposed to improve the

performances of VANETs [216]. In SDNV, routing decisions are taken at the controller level and communicated to the vehicles. Thus, more efficient routing decisions will be made thanks to the global view of the controller upon the network. We would like to propose an implementation of our proposed schemes ILTS and HyRSIC upon an SDN-based VANETs.

References

- [1] Hafedh Chourabi et al. “Understanding smart cities: An integrative framework”. In: *2012 45th Hawaii international conference on system sciences*. IEEE. 2012, pp. 2289–2297.
- [2] Luigi Atzori, Antonio Iera, and Giacomo Morabito. “The internet of things: A survey”. In: *Computer networks* 54.15 (2010), pp. 2787–2805.
- [3] Ruoshui Liu and Ian J Wassell. “Opportunities and challenges of wireless sensor networks using cloud services”. In: *Proceedings of the workshop on Internet of Things and Service Platforms*. ACM. 2011, p. 4.
- [4] HaaS: <http://searchstorage.techtarget.com/definition/Hadoop-as-a-service-HaaS>. [Accessed September-2020].
- [5] I. Šemanjski, S. Mandžuka, and S. Gautama. “Smart Mobility”. In: *2018 International Symposium ELMAR*. 2018, pp. 63–66.
- [6] ETSI ITS: <https://www.etsi.org/images/files/ETSITechnologyLeaflets/IntelligentTransportSystems.pdf>. [Accessed September-2020].
- [7] N Liu. “Internet of Vehicles: Your next connection”. In: *Huawei WinWin* 11 (2011), pp. 23–28.
- [8] Saif Al-Sultan et al. “A comprehensive survey on vehicular ad hoc network”. In: *Journal of network and computer applications* 37 (2014), pp. 380–392.
- [9] M. L. Sichitiu and M. Kihl. “Inter-vehicle communication systems: a survey”. In: *IEEE Communications Surveys Tutorials* 10.2 (2008), pp. 88–105. ISSN: 1553-877X.
- [10] Kevin C Lee, Uichin Lee, and Mario Gerla. “Survey of routing protocols in vehicular ad hoc networks”. In: *Advances in vehicular ad-hoc networks: Developments and challenges*. IGI Global, 2010, pp. 149–170.
- [11] Zhenyu Wang et al. “A centrality-based RSU deployment approach for vehicular ad hoc networks”. In: *IEEE International Conference on Communications (ICC)*. IEEE. 2017, pp. 1–5.

-
- [12] Donghyun Kim et al. “A new comprehensive RSU installation strategy for cost-efficient VANET deployment”. In: *IEEE Transactions on Vehicular Technology* 66.5 (2016), pp. 4200–4211.
- [13] Jeongyoon Heo et al. “Performance-Cost Tradeoff of Using Mobile Roadside Units for V2X Communication”. In: *IEEE Transactions on Vehicular Technology* 68.9 (2019), pp. 9049–9059.
- [14] Xiaoxiao Jiang and David HC Du. “A BUS vehicular network integrated with traffic infrastructure”. In: *2013 International Conference on Connected Vehicles and Expo (ICCVE)*. IEEE. 2013, pp. 562–567.
- [15] Miguel Rios, Vladimir Marianov, and Melisa Pérez. “Locating fixed roadside units in a bus transport network for maximum communications probability”. In: *Transportation Research Part C: Emerging Technologies* 53 (2015), pp. 35–47.
- [16] Fang Jia et al. “A BUS-aided RSU access scheme based on SDN and evolutionary game in the Internet of Vehicle”. In: *International Journal of Communication Systems* (2019), e3932.
- [17] Andre B Reis, Susana Sargento, and Ozan K Tonguz. “Parked cars are excellent roadside units”. In: *IEEE Transactions on Intelligent Transportation Systems* 18.9 (2017), pp. 2490–2502.
- [18] Yingying Sun et al. “End to end performance analysis of relay cooperative communication based on parked cars”. In: *2018 20th International Conference on Advanced Communication Technology (ICACT)*. IEEE. 2018, pp. 311–317.
- [19] Andre Braga Reis, Susana Sargento, and Ozan K Tonguz. “Smarter cities with parked cars as roadside units”. In: *IEEE Transactions on Intelligent Transportation Systems* 19.7 (2018), pp. 2338–2352.
- [20] Sushant Nerkar, Darpana Dakhode, and Mohini Chaudhari. “Avoiding Discontinuity In Vanet Using Store Carry Forward Approach”. In: 2016.
- [21] Anna Maria Vegni and Thomas DC Little. “A message propagation model for hybrid vehicular communication protocols”. In: *2010 7th International Symposium on Communication Systems, Networks & Digital Signal Processing (CSNDSP 2010)*. IEEE. 2010, pp. 382–386.
- [22] Hannes Hartenstein and Kenneth Laberteaux. *VANET: vehicular applications and inter-networking technologies*. Vol. 1. John Wiley & Sons, 2009.

REFERENCES

- [23] Chahrazed Ksouri et al. “VANETs Routing Protocols Survey: Classifications, Optimization Methods and New Trends”. In: *International Workshop on Distributed Computing for Emerging Smart Networks*. Springer. 2019, pp. 3–22.
- [24] Chahrazed Ksouri et al. “Towards general Internet of Vehicles networking: Routing protocols survey”. In: *Concurrency and Computation: Practice and Experience* (2020), e5994.
- [25] Marwane Ayaida et al. “HHLS: A hybrid routing technique for VANETs”. In: *2012 IEEE Global Communications Conference (GLOBECOM)*. IEEE. 2012, pp. 44–48.
- [26] Yuanzhi Ni et al. “Delay analysis and message delivery strategy in hybrid V2I/V2V networks”. In: *2016 IEEE Global Communications Conference (GLOBECOM)*. IEEE. 2016, pp. 1–6.
- [27] Yuanzhi Ni et al. “Data uploading in hybrid V2V/V2I vehicular networks: Modeling and cooperative strategy”. In: *IEEE Transactions on Vehicular Technology* 67.5 (2018), pp. 4602–4614.
- [28] C-ITS: <https://www.etsi.org/technologies/automotive-intelligent-transport>. [Accessed September-2020].
- [29] D. Jia et al. “A Survey on Platoon-Based Vehicular Cyber-Physical Systems”. In: *IEEE Communications Surveys Tutorials* 18.1 (2016), pp. 263–284.
- [30] Furqan Jameel et al. “Internet of autonomous vehicles: architecture, features, and socio-technological challenges”. In: *IEEE Wireless Communications* 26.4 (2019), pp. 21–29.
- [31] José Javier Anaya et al. “Vehicle to pedestrian communications for protection of vulnerable road users”. In: *2014 IEEE Intelligent Vehicles Symposium Proceedings*. IEEE. 2014, pp. 1037–1042.
- [32] S. Parkinson et al. “Cyber Threats Facing Autonomous and Connected Vehicles: Future Challenges”. In: *IEEE Transactions on Intelligent Transportation Systems* 18.11 (2017), pp. 2898–2915.
- [33] Dubai: <https://www.volocopter.com/en/urban-mobility/>. [Accessed September-2020].
- [34] Voom: <https://www.airbus.com/innovation/urban-air-mobility/voom.html>. [Accessed September-2020].
- [35] UAM: <https://www.airbus.com/innovation/urban-air-mobility.html>. [Accessed September-2020].

- [36] Ilker Bekmezci, Ozgur Koray Sahingoz, and Şamil Temel. “Flying ad-hoc networks (FANETs): A survey”. In: *Ad Hoc Networks* 11.3 (2013), pp. 1254–1270.
- [37] Infrastructure: <https://www.airbus.com/innovation/urban-air-mobility/infrastructure.html>. [Accessed September-2020].
- [38] Yong Zeng, Qingqing Wu, and Rui Zhang. “Accessing from the sky: A tutorial on UAV communications for 5G and beyond”. In: *arXiv preprint arXiv:1903.05289* (2019).
- [39] UAM regulation: <https://www.airbus.com/newsroom/stories/urban-air-mobility-the-sky-is-yours.html>. [Accessed September-2020].
- [40] R. D’Andrea. “Guest Editorial Can Drones Deliver?” In: *IEEE Transactions on Automation Science and Engineering* 11.3 (2014), pp. 647–648.
- [41] Rolls-Royce: <https://interestingengineering.com/rolls-royce-partners-with-intel-to-build-autonomous-ships>. [Accessed September-2020].
- [42] Y. Xu. “Quality of Service Provisions for Maritime Communications Based on Cellular Networks”. In: *IEEE Access* 5 (2017), pp. 23881–23890.
- [43] Y. Kim, Y. Song, and S. H. Lim. “Hierarchical Maritime Radio Networks for Internet of Maritime Things”. In: *IEEE Access* 7 (2019), pp. 54218–54227.
- [44] K. A. Yau et al. “Maritime Networking: Bringing Internet to the Sea”. In: *IEEE Access* 7 (2019), pp. 48236–48255.
- [45] Cybersecurity: https://eprints.lancs.ac.uk/id/eprint/72696/1/Cyber_Operations_in_the_Maritime_Environment_v2.0.pdf. [Accessed September-2020].
- [46] IMO: <http://www.imo.org/en/MediaCentre/HotTopics/Pages/Autonomous-shipping.aspx>. [Accessed September-2020].
- [47] M. Elloumi et al. “Monitoring road traffic with a UAV-based system”. In: *2018 IEEE Wireless Communications and Networking Conference (WCNC)*. 2018, pp. 1–6.
- [48] F. Zeng et al. “UAV-Assisted Data Dissemination Scheduling in VANETs”. In: *2018 IEEE International Conference on Communications (ICC)*. 2018, pp. 1–6.
- [49] Offshore installations: <https://www.offshore-mag.com/field-development/article/16755873/role-of-drones-expanding-over-offshore-installations>. [Accessed September-2020].
- [50] Delivering goods: <https://www.bairdmaritime.com/work-boat-world/tug-and-salvage-world/harbour-tugs-and-operation/kotug-tests-drones-for-safer-tug-operations/>. [Accessed September-2020].

REFERENCES

- [51] Juan Jesús Roldán et al. “SwarmCity Project: Can an Aerial Swarm Monitor Traffic in a Smart City?” In: *2019 IEEE International Conference on Pervasive Computing and Communications Workshops (PerCom Workshops)* (2019), pp. 862–867.
- [52] Omar Sami Oubbati et al. “UAV-assisted supporting services connectivity in urban VANETs”. In: *IEEE Transactions on Vehicular Technology* 68.4 (2019), pp. 3944–3951.
- [53] C. Ksouri et al. “Data Gathering for Internet of Vehicles Safety”. In: *2018 14th International Wireless Communications Mobile Computing Conference (IWCMC)* (2018), pp. 904–909. ISSN: 2376-6506.
- [54] M.Alam Movimento Group Vehicle-to-Everything (V2X) Technology Will Be a Literal Life Saver – But What Is It? <http://eecatalog.com/automotive/2016/05/19/vehicle-to-everything-v2x-technology-will-be-a-literal-life-saver-but-what-is-it/>. [Accessed September-2020].
- [55] Fangchun Yang et al. “An overview of internet of vehicles”. In: *China communications* 11.10 (2014), pp. 1–15.
- [56] O. S. Oubbati et al. “CRUV: Connectivity-based traffic density aware routing using UAVs for VANets”. In: *2015 International Conference on Connected Vehicles and Expo (ICCVE)*. 2015, pp. 68–73.
- [57] Vishal Sharma, Ravinder Kumar, and Neeraj Kumar. “DPTR: Distributed priority tree-based routing protocol for FANETs”. In: *Computer Communications* 122 (2018), pp. 129–151.
- [58] John B Kenney. “Dedicated short-range communications (DSRC) standards in the United States”. In: *Proceedings of the IEEE* 99.7 (2011), pp. 1162–1182.
- [59] Rim Negra, Imen Jemili, and Abdelfettah Belghith. “Wireless body area networks: Applications and technologies”. In: *Procedia Computer Science* 83 (2016), pp. 1274–1281.
- [60] S Habib et al. “Inter-vehicle wireless communications technologies, issues and challenges”. In: *Information Technology Journal* 12.4 (2013), pp. 558–568.
- [61] Hsin-Mu Tsai et al. “Zigbee-based intra-car wireless sensor networks: a case study”. In: *IEEE Wireless Communications* 14.6 (2007), pp. 67–77.
- [62] G.S.Bickel Inter/Intra-Vehicle Wireless Communication. <http://www.cse.wustl.edu/~jain/cse574-06/ftp/vehicular-wireless.pdf>. [Accessed September-2020].

- [63] Alfred Daniel. “Vehicle to vehicle communication using Zigbee protocol”. In: *Proceedings of the 29th Annual ACM Symposium on Applied Computing*. 2014, pp. 715–716.
- [64] G.S.Bickel: Chapter 9. Vehicle to Infrastructure interaction (V2I). <http://www.mogi.bme.hu/TAMOP/jarmurendszerk-iranyitasa-angol/math-ch09.html>. [Accessed September-2020].
- [65] Harvey J Miller, Shih-Lung Shaw, et al. *Geographic information systems for transportation: principles and applications*. Oxford University Press on Demand, 2001.
- [66] Lerotholi S Mojela and Marthinus J Booyesen. “On the use of WiMAX and Wi-Fi to provide in-vehicle connectivity and media distribution”. In: *2013 IEEE International Conference on Industrial Technology (ICIT)*. IEEE. 2013, pp. 1353–1358.
- [67] Study Paper on LiFi (Light Fidelity) and its Applications: <http://tec.gov.in/pdf/Studypaper/lifi-20study-20paper-20-20approved.pdf>. [Accessed September-2020].
- [68] Laying the Foundation for Vehicle-to Pedestrian Communications: <https://www.volpe.dot.gov/news/laying-foundation-vehicle-pedestrian-communications>. [Accessed September-2020].
- [69] M Guptaa and S Sharmab. “Infrastructure-less vehicular communication system using Li-Fi technology”. In: *International Journal of Computer (IJC)* 23.1 (2016), pp. 53–60.
- [70] Sourav Kumar Bhoi and Pabitra Mohan Khilar. “Vehicular communication: a survey”. In: *IET networks* 3.3 (2013), pp. 204–217.
- [71] M Peden and al. “Chapter 2 Vehicular Communications Standards”. In: *Springer International Publishing* (2017).
- [72] Rafael Molina-Masegosa and Javier Gozalvez. “LTE-V for sidelink 5G V2X vehicular communications: A new 5G technology for short-range vehicle-to-everything communications”. In: *IEEE Vehicular Technology Magazine* 12.4 (2017), pp. 30–39.
- [73] Ramon Sanchez-Iborra et al. “Integrating LP-WAN communications within the vehicular ecosystem.” In: *J. Internet Serv. Inf. Secur.* 7.4 (2017), pp. 45–56.
- [74] V2X cellular solutions: <http://www.5gamericas.org/files/2914/7769/1296/5GA-V2X-Report-FINAL-for-upload.pdf>. [Accessed September-2020].
- [75] Yu-Shang Chou et al. “i-Car system: A LoRa-based low power wide area networks vehicle diagnostic system for driving safety”. In: *2017 International Conference on Applied System Innovation (ICASI)*. IEEE. 2017, pp. 789–791.

REFERENCES

- [76] Eghbal Heidari et al. “Survey on location information services for Vehicular Communication Networks”. In: *Wireless Networks* 20.5 (2014), pp. 1085–1105.
- [77] Maaz Rehan et al. “ZGLS: a novel flat quorum-based and reliable location management protocol for VANETs”. In: *Wireless Networks* 24.6 (2018), pp. 1885–1903.
- [78] Konstantinos Katsaros, Mehrdad Dianati, and Long Le. “Effective implementation of location services for VANETs in hybrid network infrastructures”. In: *2013 IEEE international conference on communications workshops (ICC)* (2013), pp. 521–525.
- [79] Maaz Rehan et al. “ZLS: A next-door lightweight QoS aware location service technique for VANET on highways”. In: *2014 international conference on computer and information sciences (Iccoin)* (2014), pp. 1–6.
- [80] Celimuge Wu et al. “Toward a totally distributed flat location service for vehicular ad hoc networks”. In: *2014 IEEE 79th Vehicular Technology Conference (VTC Spring)* (2014), pp. 1–6.
- [81] Konstantinos Katsaros et al. “End-to-end delay bound analysis for location-based routing in hybrid vehicular networks”. In: *IEEE Transactions on Vehicular Technology* 65.9 (2015), pp. 7462–7475.
- [82] Selma Boumerdassi and Eric Renault. “A flooding-based solution to improve location services in VANETs”. In: *2016 IEEE international conference on communications (ICC)* (2016), pp. 1–6.
- [83] Nik-Mohammad Balouchzahi, Mahmood Fathy, and Ahmad Akbari. “An efficient infrastructure based service discovery in vehicular networks using P2P structures”. In: *The Journal of Supercomputing* 72.3 (2016), pp. 1013–1034.
- [84] Ilker Basaran and Hasan Bulut. “Fireworks: an intelligent location discovery algorithm for vehicular ad hoc networks”. In: *Wireless Networks* 24.5 (2018), pp. 1361–1378.
- [85] Tawfiq Nebbou et al. “An urban location service for vehicular area networks”. In: *Concurrency and Computation: Practice and Experience* (2018), e4693.
- [86] Hyeonje Woo and Meejeong Lee. “A hierarchical location service architecture for VANET with aggregated location update”. In: *Computer Communications* 125 (2018), pp. 38–55.
- [87] Wai Chen et al. “A survey and challenges in routing and data dissemination in vehicular ad hoc networks”. In: *Wireless Communications and Mobile Computing* 11.7 (2011), pp. 787–795.

-
- [88] G.Kayhan et al. "Routing Protocols in Vehicular Ad hoc Networks: Survey and Research Challenges". In: *Network Protocols and Algorithms* 5 (Dec. 2013), p. 39.
- [89] Cunha Felipe et al. "Data Communication in VANETs: A Survey, Challenges and Applications". In: *Ad Hoc Networks* (Mar. 2014).
- [90] B Clifford Neuman. "Scale in distributed systems". In: *ISI/USC* (1994).
- [91] M Chitra and S Siva Sathya. "Selective epidemic broadcast algorithm to suppress broadcast storm in vehicular ad hoc networks". In: *Egyptian informatics journal* 19.1 (2018), pp. 1–9.
- [92] Nawaporn Wisitpongphan et al. "Broadcast storm mitigation techniques in vehicular ad hoc networks". In: *IEEE Wireless Communications* 14.6 (2007), pp. 84–94.
- [93] Cesar Bernardini, Muhammad Rizwan Asghar, and Bruno Crispo. "Security and privacy in vehicular communications: Challenges and opportunities". In: *Vehicular Communications* 10 (2017), pp. 13–28.
- [94] Fatih Sakiz and Sevil Sen. "A survey of attacks and detection mechanisms on intelligent transportation systems: VANETs and IoV". In: *Ad Hoc Networks* 61 (2017), pp. 33–50.
- [95] Emanuel Fonseca and Andreas Festag. "A survey of existing approaches for secure ad hoc routing and their applicability to VANETS". In: *NEC network laboratories* 28 (2006), pp. 1–28.
- [96] Bo Yu, Cheng-Zhong Xu, and Bin Xiao. "Detecting sybil attacks in VANETs". In: *Journal of Parallel and Distributed Computing* 73.6 (2013), pp. 746–756.
- [97] Arash Tayebi, Setevan Berber, and Akshya Swain. "Wireless Sensor Network attacks: An overview and critical analysis". In: *2013 Seventh international conference on sensing technology (ICST)* (2013), pp. 97–102.
- [98] Fan Li and Yu Wang. "Routing in vehicular ad hoc networks: A survey". In: *IEEE Vehicular technology magazine* 2.2 (2007), pp. 12–22.
- [99] Rakesh Kumar and Mayank Dave. "A Comparative Study of Various Routing Protocols in VANET". In: *International Journal of Computer Science Issues* 8.1 (Aug. 2011), pp. 643–648.
- [100] A.Dua, N.Kumar, and S.Bawa. "A systematic review on routing protocols for Vehicular Ad Hoc Networks". In: *Vehicular Communications* 1.1 (2014), pp. 33 –52. ISSN: 2214-2096.
- [101] J. Cheng et al. "Routing in Internet of Vehicles: A Review". In: *IEEE Transactions on Intelligent Transportation Systems* 16.5 (2015), pp. 2339–2352.

REFERENCES

- [102] Lylia Alouache et al. “Survey on IoV routing protocols: security and network architecture”. In: *International Journal of Communication Systems* 32.2 (2019), e3849.
- [103] A. Awang et al. “Routing in Vehicular Ad-hoc Networks: A Survey on Single- and Cross-Layer Design Techniques, and Perspectives”. In: *IEEE Access* 5 (2017), pp. 9497–9517.
- [104] Yun-Wei Lin, Yuh-Shyan Chen, and Sing-Ling Lee. “Routing Protocols in Vehicular Ad Hoc Networks: A Survey and Future Perspectives”. In: *J. Inf. Sci. Eng.* 26.3 (May 2010), pp. 913–932.
- [105] ETSI. “Intelligent Transport Systems (ITS); Vehicular Communications; GeoNetworking; Part 1: Requirements”. In: EN 302 636-1 V1.2.1 (Apr. 2014).
- [106] Kayhan Zrar Ghafoor et al. “Beaconing approaches in vehicular ad hoc networks: A survey”. In: *Wireless personal communications* 73.3 (2013), pp. 885–912.
- [107] Syed Adeel Ali Shah et al. “Adaptive beaconing approaches for vehicular ad hoc networks: A survey”. In: *IEEE Systems Journal* 12.2 (2016), pp. 1263–1277.
- [108] K.Jagadeesh, G.Laxmi S.Sathya, and B.Battula. “A Survey on Routing Protocols and its Issues in VANET”. In: *International Journal of Computer Applications* 28 (2011).
- [109] Abdennour Zekri and Weijia Jia. “Heterogeneous vehicular communications: A comprehensive study”. In: *Ad Hoc Networks* 75 (2018), pp. 52–79.
- [110] A. Brummer, R. German, and A. Djanatliev. “On the Necessity of Three-Dimensional Considerations in Vehicular Network Simulation”. In: *2018 14th Annual Conference on Wireless On-demand Network Systems and Services (WONS)* (2018), pp. 75–82.
- [111] Sabri M Hanshi et al. “Review of geographic forwarding strategies for inter-vehicular communications from mobility and environment perspectives”. In: *Vehicular communications* 14 (2018), pp. 64–79.
- [112] Swati Atri and Sanjay Tyagi. “Multi-path Priority Based Route Discovery Mechanism”. In: *International Conference on Next Generation Computing Technologies* (2018), pp. 321–329.
- [113] Ali Abdul Wahhab Mohammed and Assad H Thary Al-Ghraiiri. “Differences between Ad Hoc Networks and Mobile Ad Hoc Networks: A Survey”. In: *Journal of Southwest Jiaotong University* 54.4 (2019).
- [114] Nagham H Saeed, Maysam F Abbod, and Hamed S Al-Raweshidy. “MANET routing protocols taxonomy”. In: *2012 International Conference on Future Communication Networks* (2012), pp. 123–128.

-
- [115] Craig Cooper et al. “A comparative survey of VANET clustering techniques”. In: *IEEE Communications Surveys & Tutorials* 19.1 (2016), pp. 657–681.
- [116] Nessrine Chakchouk. “A survey on opportunistic routing in wireless communication networks”. In: *IEEE Communications Surveys & Tutorials* 17.4 (2015), pp. 2214–2241.
- [117] Okechukwu Onubogu et al. “Empirical vehicle-to-vehicle pathloss modeling in highway, suburban and urban environments at 5.8 GHz”. In: *2014 8th International Conference on Signal Processing and Communication Systems (ICSPCS)* (2014), pp. 1–6.
- [118] Pavlos Sermpezis, Georgios Koltsidas, and Fotini-Niovi Pavlidou. “Investigating a junction-based multipath source routing algorithm for VANETs”. In: *IEEE Communications letters* 17.3 (2013), pp. 600–603.
- [119] Khalid Zahedi, Yasser Zahedi, and Abdul Samad Ismail. “CJBR: connected junction-based routing protocol for city scenarios of VANETs”. In: *Telecommunication Systems* 72.4 (2019), pp. 567–578.
- [120] Debasis Das. “Distributed Algorithm for Geographic Opportunistic Routing in VANETs at Road Intersection”. In: *2017 IEEE 15th Intl Conf on Dependable, Autonomic and Secure Computing, 15th Intl Conf on Pervasive Intelligence and Computing, 3rd Intl Conf on Big Data Intelligence and Computing and Cyber Science and Technology Congress (DASC/PiCom/ DataCom/CyberSciTech)* (2017), pp. 1202–1209.
- [121] Yusor Rafid Bahar Al-Mayouf et al. “Real-time intersection-based segment aware routing algorithm for urban vehicular networks”. In: *IEEE Transactions on Intelligent Transportation Systems* 19.7 (2018), pp. 2125–2141.
- [122] Tasneem SJ Darwish, Kamalrulnizam Abu Bakar, and Khalid Haseeb. “Reliable intersection-based traffic aware routing protocol for urban areas vehicular ad hoc networks”. In: *IEEE Intelligent Transportation Systems Magazine* 10.1 (2018), pp. 60–73.
- [123] Weifeng Sun et al. “A GIS-Based Optimize Routing Algorithm for VANET in Urban Scenarios”. In: *2019 IEEE International Conference on Smart Internet of Things (SmartIoT)* (2019), pp. 356–360.
- [124] Theodore L Willke, Patcharinee Tientrakool, and Nicholas F Maxemchuk. “A survey of inter-vehicle communication protocols and their applications”. In: *IEEE Communications Surveys & Tutorials* 11.2 (2009), pp. 3–20.

REFERENCES

- [125] Salim Bitam, Abdelhamid Mellouk, and Sherali Zeadally. “Bio-inspired routing algorithms survey for vehicular ad hoc networks”. In: *IEEE Communications Surveys & Tutorials* 17.2 (2014), pp. 843–867.
- [126] Yufeng Chen et al. “A cross-layer AOMDV routing protocol for V2V communication in urban VANET”. In: *2009 Fifth International Conference on Mobile Ad-hoc and Sensor Networks* (2009), pp. 353–359.
- [127] Jamal Toutouh, José García-Nieto, and Enrique Alba. “Intelligent OLSR routing protocol optimization for VANETs”. In: *IEEE transactions on vehicular technology* 61.4 (2012), pp. 1884–1894.
- [128] Hui Xia et al. “Towards a novel trust-based multicast routing for VANETs”. In: *Security and Communication Networks* 2018 (2018).
- [129] Kashif Naseer Qureshi and Hanan Abdullah. “Topology based Routing Protocols for VANET and their comparison with MANET”. In: *Journal of Theoretical and Applied Information Technology* 58.3 (2013), pp. 707–715.
- [130] Yilin Li et al. “Multihop Routing for Data Delivery in V2X Networks”. In: *arXiv preprint arXiv:1901.04962* (2019).
- [131] Qingwei Zeng et al. “A Geographical Routing Protocol Based on Link Connectivity Analysis for Urban VANETs”. In: *Journal of Internet Technology* 21.1 (2020), pp. 41–49.
- [132] Tong Wang et al. “A survey on geographic routing protocols in delay/disruption tolerant networks”. In: *International Journal of Distributed Sensor Networks* 12.2 (2016), p. 3174670.
- [133] Souaad Boussoufa-Lahlah, Fouzi Semchedine, and Louiza Bouallouche-Medjkoune. “Geographic routing protocols for Vehicular Ad hoc NETWORKS (VANETs): A survey”. In: *Vehicular Communications* 11 (2018), pp. 20–31.
- [134] Daxin Tian et al. “A distributed position-based protocol for emergency messages broadcasting in vehicular ad hoc networks”. In: *IEEE Internet of Things Journal* 5.2 (2018), pp. 1218–1227.
- [135] Ali Ghaffari. “Hybrid opportunistic and position-based routing protocol in vehicular ad hoc networks”. In: *Journal of Ambient Intelligence and Humanized Computing* (2019), pp. 1–11.

-
- [136] Sardar Muhammad Bilal, Carlos Jesus Bernardos, and Carmen Guerrero. “Position-based routing in vehicular networks: A survey”. In: *Journal of Network and Computer Applications* 36.2 (2013), pp. 685–697.
- [137] Sushil Kumar and Anil Kumar Verma. “Position based routing protocols in VANET: A survey”. In: *Wireless Personal Communications* 83.4 (2015), pp. 2747–2772.
- [138] Ankita Dhiman and Rakesh Kumar. “A Comparative Study of Position Based Routing Protocols in VANETs”. In: *2019 International Conference on Intelligent Sustainable Systems (ICISS)* (2019), pp. 306–311.
- [139] Ankita Srivastava, Arun Prakash, and Rajeev Tripathi. “Location based routing protocols in VANET: Issues and existing solutions”. In: *Vehicular Communications* (2020), p. 100231.
- [140] Peiyuan Lai et al. “A reliable broadcast routing scheme based on mobility prediction for VANET”. In: *2009 IEEE Intelligent Vehicles Symposium* (2009), pp. 1083–1087.
- [141] Ghada H Alsuhli, Ahmed Khattab, and Yasmine A Fahmy. “Double-head clustering for resilient VANETs”. In: *Wireless Communications and Mobile Computing 2019* (2019).
- [142] Mao Ye, Lin Guan, and Mohammed Quddus. “Mpbrp-mobility prediction based routing protocol in vanets”. In: *2019 International Conference on Advanced Communication Technologies and Networking (CommNet)* (2019), pp. 1–7.
- [143] Kevin C Lee, Uichin Lee, and Mario Gerla. “TO-GO: TOpology-assist geo-opportunistic routing in urban vehicular grids”. In: *2009 Sixth International Conference on Wireless On-Demand Network Systems and Services* (2009), pp. 11–18.
- [144] Shahrbanou Arianmehr and Mohammad Ali Jabraeil Jamali. “HybTGR: a hybrid routing protocol based on topological and geographical information in vehicular ad hoc networks”. In: *Journal of Ambient Intelligence and Humanized Computing* (2019), pp. 1–13.
- [145] Ning Li et al. “Geographical and Topology Control based Opportunistic Routing for Ad Hoc Networks”. In: *arXiv preprint arXiv:1912.08100* (2019).
- [146] Cristiano Rezende et al. “A reactive and scalable unicast solution for video streaming over VANETs”. In: *IEEE Transactions on Computers* 64.3 (2014), pp. 614–626.
- [147] Sourav Kumar Bhoi et al. “Local traffic aware unicast routing scheme for connected car system”. In: *IEEE Transactions on Intelligent Transportation Systems* (2019).

REFERENCES

- [148] Abdul Wahid, Hongseok Yoo, and Dongkyun Kim. “Unicast geographic routing protocols for inter-vehicle communications: a survey”. In: *Proceedings of the 5th ACM workshop on Performance monitoring and measurement of heterogeneous wireless and wired networks* (2010), pp. 17–24.
- [149] Syed Adeel Ali Shah et al. “Unicast routing protocols for urban vehicular networks: review, taxonomy, and open research issues”. In: *Journal of Zhejiang University SCIENCE C* 15.7 (2014), pp. 489–513.
- [150] Salim Bitam and Abdelhamid Mellouk. “Bee life-based multi constraints multicast routing optimization for vehicular ad hoc networks”. In: *Journal of Network and Computer Applications* 36.3 (2013), pp. 981–991.
- [151] Waqar Farooq et al. “A survey of multicast routing protocols for vehicular ad hoc networks”. In: *International Journal of Distributed Sensor Networks* 11.8 (2015), p. 923086.
- [152] Sizheng Li and Chuanhe Huang. “A multihop broadcast mechanism for emergency messages dissemination in VANETs”. In: *2018 IEEE 42nd Annual Computer Software and Applications Conference (COMPSAC)* 1 (2018), pp. 932–937.
- [153] Mohammad Naderi, Farzad Zargari, and Mohammad Ghanbari. “Adaptive beacon broadcast in opportunistic routing for VANETs”. In: *Ad Hoc Networks* 86 (2019), pp. 119–130.
- [154] Abir Mchergui et al. “A survey and comparative study of QoS aware broadcasting techniques in VANET”. In: *Telecommunication Systems* 66.2 (2017), pp. 253–281.
- [155] Tsvetan Marinov, Maria Nenova, and Georgi Iliev. “Comparative Analysis of Broadcasting Protocols in VANET”. In: *2018 IX National Conference with International Participation (ELECTRONICA)* (2018), pp. 1–4.
- [156] Fatima Zohra Bousbaa et al. “Novel geocast routing protocols for safety and comfort applications in VANETs”. In: *2013 IEEE Globecom Workshops (GC Wkshps)* (2013), pp. 1308–1313.
- [157] Fatima Zohra Bousbaa et al. “Robust geocast routing protocols for safety and comfort applications in VANETs”. In: *Wireless Communications and Mobile Computing* 16.10 (2016), pp. 1317–1333.
- [158] Salim Allal and Saadi Boudjit. “Geocast routing protocols for vanets: Survey and guidelines”. In: *2012 Sixth International Conference on Innovative Mobile and Internet Services in Ubiquitous Computing* (2012), pp. 323–328.

-
- [159] Salim Allal and Saadi Boudjit. “Geocast Routing Protocols for VANETs: Survey and Geometry- Driven Scheme Proposal.” In: *J. Internet Serv. Inf. Secur.* 3.1/2 (2013), pp. 20–36.
- [160] Hassan Keshavarz and Rafidah Md Noor. “Beacon-based geographic routing protocols in vehicular ad hoc networks: a survey and taxonomy”. In: *2012 IEEE Symposium on Wireless Technology and Applications (ISWTA)* (2012), pp. 309–314.
- [161] Mario De Felice et al. “A distributed beaconless routing protocol for real-time video dissemination in multimedia VANETs”. In: *Computer communications* 58 (2015), pp. 40–52.
- [162] Carlos Quadros et al. “Beacon-less video streaming management for VANETs based on QoE and link-quality”. In: *2015 IFIP/IEEE International Symposium on Integrated Network Management (IM)* (2015), pp. 191–198.
- [163] Annette Bohm, Magnus Jonsson, and Elisabeth Uhlemann. “Adaptive cooperative awareness messaging for enhanced overtaking assistance on rural roads”. In: *2011 IEEE Vehicular Technology Conference (VTC Fall)* (2011), pp. 1–5.
- [164] Kaveh Shafiee and Victor CM Leung. “Connectivity-aware minimum-delay geographic routing with vehicle tracking in VANETs”. In: *Ad Hoc Networks* 9.2 (2011), pp. 131–141.
- [165] Radityo Anggoro and I RoyyanaMuslim. “A Survey on non-DTN and DTN Geographic based Protocols for VANETS”. In: *ICIS* (2015).
- [166] Vasco NGJ Soares, Joel JPC Rodrigues, and Farid Farahmand. “GeoSpray: A geographic routing protocol for vehicular delay-tolerant networks”. In: *Information Fusion* 15 (2014), pp. 102–113.
- [167] Yue Cao et al. “Geographic-based spray-and-relay (GSaR): an efficient routing scheme for DTNs”. In: *IEEE Transactions on Vehicular Technology* 64.4 (2014), pp. 1548–1564.
- [168] Vishakha Chourasia, Sanjay Kumar, and Sudhakar Pandey. “A study of geographical routing protocols in vehicular delay tolerant networks”. In: *International Journal of Vehicle Information and Communication Systems* 4.1 (2019), pp. 20–42.
- [169] Marwane Ayaida et al. “HHLS: A hybrid routing technique for VANETs”. In: *2012 IEEE Global Communications Conference (GLOBECOM)* (2012), pp. 44–48.

REFERENCES

- [170] Navid Nikaein, Christian Bonnet, and Neda Nikaein. “Harp-hybrid ad hoc routing protocol”. In: *Proceedings of international symposium on telecommunications (IST)* (2001), pp. 56–67.
- [171] Vahid Sadatpour, Farzad Zargari, and Mohammad Ghanbari. “A collision aware opportunistic routing protocol for VANETs in highways”. In: *Wireless Personal Communications* 109.1 (2019), pp. 175–188.
- [172] Ying He et al. “Routing protocol for complex three-dimensional Vehicular Ad Hoc Networks”. In: *2014 International Conference on Connected Vehicles and Expo (ICCVE)* (2014), pp. 739–744.
- [173] Ying He et al. “A link state aware hierarchical road routing protocol for 3D scenario in VANETs”. In: *International Conference on Internet of Vehicles* (2014), pp. 11–20.
- [174] Shafi Shaik, D Venkata Ratnam, and BN Bhandari. “An efficient cross layer routing protocol for safety message dissemination in VANETS with reduced routing cost and delay using IEEE 802.11 p”. In: *Wireless Personal Communications* 100.4 (2018), pp. 1765–1774.
- [175] Zahid Khan et al. “Two-level cluster based routing scheme for 5G V2X communication”. In: *IEEE Access* 7 (2019), pp. 16194–16205.
- [176] Saleh A Alghamdi. “Novel Path Similarity Aware Clustering and Safety Message Dissemination via Mobile Gateway Selection in Cellular 5G-based V2X and D2D communication for Urban Environment”. In: *Ad Hoc Networks* (2020), p. 102150.
- [177] Seyhan Ucar, Sinem Coleri Ergen, and Oznur Ozkasap. “Multihop-cluster-based IEEE 802.11 p and LTE hybrid architecture for VANET safety message dissemination”. In: *IEEE Transactions on Vehicular Technology* 65.4 (2015), pp. 2621–2636.
- [178] Mehdi Sharifi Rayeni, Abdelhakim Hafid, and Pratap Kumar Sahu. “Quality of service aware multicasting in heterogeneous vehicular networks”. In: *Vehicular Communications* 13 (2018), pp. 38–55.
- [179] Kaveh Shafiee, Alireza Attar, and Victor CM Leung. “WLAN-wimax double-technology routing for vehicular networks”. In: *2011 IEEE Vehicular Technology Conference (VTC Fall)* (2011), pp. 1–6.
- [180] Zhiyan Xu et al. “Efficient Certificateless Aggregate Signature Scheme for Performing Secure Routing in VANETs”. In: *Security and Communication Networks* 2020 (2020).
- [181] Afef Slama and Ilhem Lengliz. “Survey on secure routing in VANETs”. In: *International Journal of Network Security & Its Applications (IJNSA) Vol 11* (2019).

-
- [182] Jing Wu and Yuhao Wang. *Performance study of multi-path in VANETs and their impact on routing protocols*. Scientific Research Publishing, 2011.
- [183] Pau Arce et al. “Performance evaluation of video streaming over ad hoc networks using flat and hierarchical routing protocols”. In: *Mobile Networks and Applications* 13.3-4 (2008), pp. 324–336.
- [184] Zhongliang Zhao et al. “Mobility prediction-assisted over-the-top edge prefetching for hierarchical VANETs”. In: *IEEE Journal on Selected Areas in Communications* 36.8 (2018), pp. 1786–1801.
- [185] Muhammad Tahir Abbas and SONG Wang-Cheol. “THERA: Two-level Hierarchical Hybrid Road-Aware Routing for Vehicular Networks.” In: *KSII Transactions on Internet & Information Systems* 13.7 (2019).
- [186] Kashif Naseer Qureshi et al. “Self-Assessment Based Clustering Data Dissemination for Sparse and Dense Traffic Conditions for Internet of Vehicles”. In: *IEEE Access* 8 (2020), pp. 10363–10372.
- [187] Xianlei Ge, Qiang Gao, and Xunzhong Quan. “A novel clustering algorithm based on mobility for VANET”. In: *2018 IEEE 18th International Conference on Commujournalnication Techno-logy (ICCT)* (2018), pp. 473–477.
- [188] Peizhi Yang et al. “Clustering algorithm in VANETs: A survey”. In: *2015 IEEE 9th international conference on anti-counterfeiting, security, and identification (ASID)* (2015), pp. 166–170.
- [189] Poonam Thakur and Anita Ganpati. “A Comparative Study of Cluster-Head Selection Algorithms in VANET”. In: (2020), pp. 143–157.
- [190] Rajesh Kumar and Sudhir K Routray. “Ant Colony based dynamic source routing for VANET”. In: *2016 2nd International Conference on Applied and Theoretical Computing and Communica- tion Technology (iCATccT)* (2016), pp. 279–282.
- [191] Shen Wan, Jian Tang, and Richard S Wolff. “Reliable routing for roadside to vehicle communica- tions in rural areas”. In: *2008 IEEE International Conference on Communications* (2008), pp. 3017–3021.
- [192] Carlos Quadros et al. “QoE-driven dissemination of real-time videos over vehicular networks”. In: *Computer Communications* 91 (2016), pp. 133–147.
- [193] Hamayoun Shahwani et al. “DAPF: Delay-aware packet forwarding for driving safety and efficiency in vehicular networks”. In: *IET Communications* 14.9 (2020), pp. 1404–1411.

REFERENCES

- [194] Michael Oche et al. “VANETs QoS-based routing protocols based on multi-constrained ability to support ITS infotainment services”. In: *Wireless Networks* (2018), pp. 1–31.
- [195] Celimuge Wu et al. “A routing protocol for VANETs with adaptive frame aggregation and packet size awareness”. In: *2015 IEEE International Conference on Communications (ICC)* (2015), pp. 6565–6570.
- [196] Anant Ram and Manas Kumar Mishra. “Density aware position based routing (DAPBR) protocol for VANET”. In: *2016 Sixth International Symposium on Embedded Computing and System Design (ISED)* (2016), pp. 142–146.
- [197] Sana Ajmal et al. “Classification of VANET MAC, Routing and Approaches A Detailed Survey.” In: *J. UCS* 20.4 (2014), pp. 462–487.
- [198] Bijan Paul and Mohammed J Islam. “Survey over VANET routing protocols for vehicle to vehicle communication”. In: *IOSR Journal of Computer Engineering (IOSRJCE)* 7.5 (2012), pp. 1–9.
- [199] Azzedine Boukerche, Kaouther Abrougui, and Richard W Pazzi. “An efficient hybrid adaptive location-aided gateway advertisement and discovery protocol for heterogeneous wireless and mobile networks”. In: *GLOBECOM 2009-2009 IEEE Global Telecommunications Conference*. IEEE. 2009, pp. 1–6.
- [200] Kaouther Abrougui, Azzedine Boukerche, and Richard Werner Nelem Pazzi. “Location-aided gateway advertisement and discovery protocol for VANets”. In: *IEEE Transactions on Vehicular technology* 59.8 (2010), pp. 3843–3858.
- [201] Zhigang Xu et al. “DSRC versus 4G-LTE for connected vehicle applications: A study on field experiments of vehicular communication performance”. In: *Journal of Advanced Transportation* 2017 (2017).
- [202] IEEE Std 1609.3-2010. *IEEE Standard for Wireless Access in Vehicular Environments (WAVE)– Networking Services*. 2010.
- [203] CDRS Michaels et al. “DSRC Implementation Guide A guide to users of SAE J2735 message sets over DSRC”. In: *SAE International* (2010).
- [204] SUMO:Simulation of Urban MObility: <http://sumo-sim.org/>. [Accessed September-2020].
- [205] OMNET: OMNET++ Network Simulation Framework: <http://www.omnetpp.org/>. [Accessed September-2020].
- [206] VEINS: Vehicles in Network Simulation: <https://veins.car2x.org/>. [Accessed September-2020].

-
- [207] Brad Karp and Hsiang-Tsung Kung. “GPSR: Greedy perimeter stateless routing for wireless networks”. In: *Proceedings of the 6th annual international conference on Mobile computing and networking*. ACM. 2000, pp. 243–254.
- [208] Xiaoping Yang et al. “Improvement of GPSR protocol in vehicular ad hoc network”. In: *IEEE Access* 6 (2018), pp. 39515–39524.
- [209] A. Silva, K. M. Niaz Reza, and A. Oliveira. “An Adaptive GPSR Routing Protocol for VANETs”. In: *2018 15th International Symposium on Wireless Communication Systems (ISWCS)*. 2018, pp. 1–6.
- [210] Khadige Abboud, Hassan Aboubakr Omar, and Weihua Zhuang. “Interworking of DSRC and cellular network technologies for V2X communications: A survey”. In: *IEEE transactions on vehicular technology* 65.12 (2016), pp. 9457–9470.
- [211] Alessio Filippi et al. “Ready to roll: Why 802.11p beats LTE and 5G for V2x”. In: *NXP Semiconductors, Cohda Wireless and Siemens White Paper* (2016).
- [212] Alessio Filippi et al. “IEEE802.11p ahead of LTE-V2V for safety applications”. In: *Autotalks NXP* (2017).
- [213] Florian Hagenauer, Falko Dressler, and Christoph Sommer. “Poster: A simulator for heterogeneous vehicular networks”. In: *2014 IEEE Vehicular Networking Conference (VNC)*. IEEE. 2014, pp. 185–186.
- [214] B. A. A. Nunes et al. “A Survey of Software-Defined Networking: Past, Present, and Future of Programmable Networks”. In: *IEEE Communications Surveys Tutorials* 16.3 (2014), pp. 1617–1634.
- [215] D. Kreutz et al. “Software-Defined Networking: A Comprehensive Survey”. In: *Proceedings of the IEEE* 103.1 (2015), pp. 14–76.
- [216] W. Ben Jaballah, M. Conti, and C. Lal. “A Survey on Software-Defined VANETs: Benefits, Challenges, and Future Directions”. In: *arXiv e-prints* (2019).