



**HAL**  
open science

# Innovation et diffusion des énergies renouvelables : quelle efficacité des politiques climatiques ?

Guillaume Bourgeois

► **To cite this version:**

Guillaume Bourgeois. Innovation et diffusion des énergies renouvelables : quelle efficacité des politiques climatiques ?. Economies et finances. Université Grenoble Alpes [2020-..], 2020. Français. NNT : 2020GRALE007 . tel-03282011

**HAL Id: tel-03282011**

**<https://theses.hal.science/tel-03282011v1>**

Submitted on 8 Jul 2021

**HAL** is a multi-disciplinary open access archive for the deposit and dissemination of scientific research documents, whether they are published or not. The documents may come from teaching and research institutions in France or abroad, or from public or private research centers.

L'archive ouverte pluridisciplinaire **HAL**, est destinée au dépôt et à la diffusion de documents scientifiques de niveau recherche, publiés ou non, émanant des établissements d'enseignement et de recherche français ou étrangers, des laboratoires publics ou privés.

## THÈSE

Pour obtenir le grade de

### DOCTEUR DE L'UNIVERSITÉ GRENOBLE ALPES

Spécialité : **Sciences Economique**

Arrêté ministériel : 25 mai 2016

Présentée par

### Guillaume BOURGEOIS

Thèse dirigée par **Sandrine MATHY**, Directrice de recherche  
CNRS, laboratoire GAEL (Grenoble Applied Economics Lab)

et codirigée par **Nadine MASSARD**, Professeur des Universités,  
Université Grenoble Alpes – Laboratoire GAEL

Préparée au sein du **Laboratoire GAEL**

Dans l'**École Doctorale de Sciences Economiques**

## « Innovation et diffusion des énergies renouvelables : quelle efficacité des politiques climatiques ? »

Thèse soutenue publiquement le **18 Décembre 2020**,  
devant le jury composé de :

**Mme Mireille CHIROLEU ASSOULINE**

Professeure des Universités, Université Paris Panthéon Sorbonne (Rapporteur)

**M. Matthieu GLACHANT**

Professeur, Mines ParisTech (Rapporteur)

**Mme. Marie-Estelle BINET**

Professeure des Universités, Université Grenoble-Alpes (Présidente)

**M. Pierre MOHNEN**

Professeur des Universités, Université de Maastricht (Examinateur)

**M. Marc BAUDRY**

Professeur des Universités, Université Paris Nanterre (Examinateur)

**Mme. Sandrine MATHY**

Directrice de recherche CNRS, Université Grenoble-Alpes (Directrice de  
thèse)

**Mme Nadine MASSARD**

Professeure des Universités, Université Grenoble-Alpes (Co-Directrice de  
thèse)



# Résumé

---

Les énergies renouvelables (ENR) jouent un rôle central pour décarboner les systèmes énergétiques et lutter contre le réchauffement climatique. Du fait de défaillances de marché, des politiques publiques visant à soutenir ces technologies sont nécessaires. Cette thèse vise à évaluer l'efficacité des politiques climatiques de soutien à l'innovation et à la diffusion dans les ENR. Cet objectif général se décline en trois problématiques qui sont abordées dans trois différents chapitres.

Deux types de politique de soutien aux ENR sont généralement distinguées: les politiques de soutien à l'innovation (dites *techno-push*) et les politiques de soutien à la diffusion (dites *demand-pull*). Un débat existe dans la littérature académique pour définir la répartition optimale entre soutien *demand-pull* et soutien *techno-push*. En effet, il existerait un fort déséquilibre entre les dépenses publiques accordées aux deux types de politiques. Ce constat pose la question de la pérennité du processus de changement technologique en cours et de la nécessité, ou non, d'un redéploiement par l'innovation. Cette thèse vise à éclairer ce débat en se basant sur une revue des études empiriques. Cette revue de la littérature montre que l'effet des politiques sur l'innovation et la diffusion varie selon le type de politique et selon le niveau de maturité des ENR. Les politiques indifférenciées quant aux technologies ciblées (certificats verts par exemple), stimulent l'innovation dans les technologies matures et proches de la compétitivité alors que les prix garantis (tarifs d'achat par exemple) sont plus appropriés pour les technologies plus coûteuses.

Les résultats de notre revue de la littérature font également ressortir un manque d'études sur l'effet des *spillovers* de connaissances sur les performances en innovation des pays dans les ENR. Le chapitre deux vise à combler cette lacune en étudiant, au niveau national, la relation entre la performance relative en innovation dans les énergies éoliennes et solaires photovoltaïques (PV) et la performance relative en innovation dans leur(s) principale(s) technologie(s) complémentaire(s). Les résultats montrent que les innovations dans le domaine des transports, de la mécanique et du bâtiment jouent un rôle crucial pour le développement de l'énergie éolienne. Les innovations en matière d'optique, de revêtement et de chimie sont essentielles pour le solaire PV. Ce chapitre aboutit à l'identification de pays qui auraient un fort intérêt à innover davantage dans les ENR du fait de leur spécialisation dans les technologies complémentaires (en particulier la France dans les énergies éoliennes et la Belgique dans les énergies solaires PV).

Par ailleurs, la littérature empirique existante semble se heurter à des difficultés à modéliser et à prendre en compte les interactions entre les politiques publiques, la performance en innovation et la performance à l'export, alors que dans un objectif de croissance verte ces enjeux sont cruciaux pour les pays. L'objectif du chapitre trois est de contribuer à combler cette lacune en utilisant des modèles PVAR (*Panel Vector Autoregressive*). Nos résultats montrent que les dépenses publiques de RD semblent être plus appropriées que les politiques de diffusion pour améliorer les performances à l'exportation pour les deux technologies (éolien et solaire PV). Pour les technologies éoliennes et solaires PV nous concluons également à l'absence de cercle

vertueux entre les performances relatives en innovation et à l'export. Nous constatons néanmoins quelques résultats différents entre les deux technologies, qui pourraient être expliqués par les différences de barrières à l'entrée et sur les coûts irrécupérables.

## Summary

---

Titre de la thèse en anglais : « Innovation and diffusion of renewable energies: how effective are climate policies? »

Renewable energies (REN) are essential to decarbonize energy systems and tackle climate change. Due to market failures, governments implement public policies to support these technologies. This thesis aims at assessing the effectiveness of climate policies supporting innovation and diffusion in REN. From this general objective, we define three problematics addressed in three different chapters.

Generally, we distinguish two types of climate policies: those supporting innovation (techno-push) and those supporting diffusion (demand-pull). There is a debate in the academic literature about the optimal distribution between demand-pull and techno-push support. Indeed, there would be a strong imbalance between public spending on the two types of policies. This observation raises the question of the sustainability of the ongoing technological change and the need, or not, for redeployment through innovation. This thesis will aim to fuel this debate with a review of empirical studies. This literature review shows that the effect of policies on innovation and diffusion varies according to the type of policy and the level of maturity of REN. The undifferentiated policies (e.g. green certificates) stimulate innovation in mature and near-competitive technologies, while guaranteed prices (e.g. feed-in tariffs) are more appropriate for more expensive technologies.

The results of our literature review also highlight a lack of studies on the effect of knowledge spillovers on the innovation performance of countries in REN. The chapter two aims at filling this gap by investigating, at the national level, the relations between the relative innovation performance in wind and solar photovoltaic (PV) energy and the relative innovation performance in their main complementary technologies. Our results show that innovations in transport, mechanical and building technologies play a crucial role in the development of wind energy. Innovations in optics, coatings and chemistry are essential for solar PV. This chapter leads to the identification of countries that would have a strong interest to innovate further in REN because of their specialization in complementary technologies (in particular France in wind energy and Belgium in solar PV).

Moreover, the existing empirical literature seems to face difficulties to model and to take into account the interactions between public policies, innovation performance and export performance in REN, whereas in a green growth context these issues are crucial at the country level. The objective of the third chapter is to fill this gap using PVAR (Panel Vector Auto Regressive) models. Our results show that public RD expenditures seems to be more appropriate than demand-pull policies to improve export performance for both technologies

(wind and solar PV). We also conclude that there is no virtuous circle between relative innovation and export performance for both technologies. Nevertheless, we find some different results between them, which could be explained by the different barriers to entry and sunk costs.

# Table des matières

Résumé .....	1
Summary .....	2
Table des matières .....	4
Liste des figures .....	10
Liste des tableaux .....	12
<b>Introduction générale</b> .....	14
1. Tentatives de coordination internationale pour lutter contre le changement climatique .	14
2. Le défi du développement des énergies renouvelables .....	15
2.1. Les énergies renouvelables, un pilier de la lutte contre le changement climatique...	15
2.2. Le développement des ENR entravé par deux principales défaillances de marché ..	18
2.2.1. Externalités environnementales.....	18
2.2.2. Externalités de connaissance .....	19
2.2.3. Autres défaillances de marché.....	19
3. Présentation des politiques publiques .....	20
3.1. Politiques <i>techno-push</i> de soutien direct à l'innovation .....	20
3.2. Politiques <i>demand-pull</i> de soutien à la diffusion.....	21
3.2.1. Politiques de diffusion basées sur les prix .....	21
3.2.2. Politiques de diffusion basées sur les quantités .....	21
4. Enjeux et objectifs de la recherche.....	24
4.1. Déséquilibres entre <i>techno-push</i> et <i>demand-pull</i> : quelle efficacité de chacune de ces politiques ? .....	24
4.2. Quel impact des flux de connaissances intersectoriels sur les performances en terme d'innovation dans les ENR ?.....	25
4.3. Quelles interactions entre politiques climatiques, performance en innovation et performance à l'export dans le domaine des ENR ? .....	26
5. Structure de la thèse .....	27
6. Principaux résultats .....	28
<b>Chapitre1 : Quel impact des politiques climatiques sur les énergies renouvelables : une revue des études économétriques ? .....</b>	<b>30</b>
Introduction .....	30
1. Impact des politiques énergie / climat sur l'innovation dans les ENR.....	32
1.1. Impact des politiques de soutien direct à l'innovation .....	36
1.2. Impact sur l'innovation des politiques de diffusion basées sur les prix .....	37

1.3.	Impact sur l'innovation des politiques de diffusion basées sur les quantités .....	38
2.	L'impact des politiques climatiques sur la diffusion des technologies .....	39
2.1.	Impact des politiques basées sur des prix sur la diffusion.....	43
2.2.	Impact des politiques basées sur des quantités sur la diffusion.....	44
3.	Discussion et conclusion .....	46
<b>Chapter 2: Specialization in complementary technologies and innovation performance in solar PV and wind technologies: a dynamic social network analysis .....</b>		<b>49</b>
1.	Introduction .....	49
2.	Related literature and research questions .....	51
2.1.	Intra- and inter-technology spillovers and the life-cycle of technologies.....	51
2.1.1.	Upstream knowledge spillovers .....	51
2.1.2	Intra and inter-technological spillovers.....	51
2.1.3.	Life cycle of technologies .....	52
2.2.	Identify key technologies .....	52
2.3.	Solar PV vs wind innovations: 2 different life-cycles.....	53
2.4.	Research questions .....	54
3.	Methodology .....	54
3.1.	Patents as proxy of innovation.....	54
3.2.	Identification of solar PV and wind EPO patents with the CPC classification .....	55
3.3.	Patent citations to trace knowledge spillovers.....	57
3.4.	Five-year rolling periods .....	59
3.5.	Identification of key technologies with a social network analysis .....	59
3.5.1.	Social network analysis: basic vocabulary.....	59
3.5.2.	Networks of co-occurrence of technologies within spillovers.....	60
3.5.3.	Structure of networks and identification of key technologies.....	61
4.	Data .....	64
4.1.	Short description of the PATSTAT database .....	64
4.2.	Backward citations for wind and solar PV patents.....	64
4.3.	Temporal dynamic of innovation in wind and solar PV products.....	65
4.3.1.	Wind innovation: from blades and rotor to mechanical and electric components, 5 periods in the life cycle .....	65
4.3.2.	Innovation in Solar PV: mainly cells technologies .....	67
5.	Technological pattern of spillovers and key complementary technologies .....	69
5.1.	A large part of spillovers is inter-technological .....	69

5.2.	Duration of technology occurrence among spillovers .....	71
5.3.	Social network centrality analysis .....	72
5.3.1.	Network analysis – wind backward spillovers: transport, electric power, engineering .....	74
5.3.2.	Network analysis – solar PV backward spillovers: transport, electricity, engineering .....	75
6.	Countries Specialisation in ENR and complementary technologies .....	76
6.1.	Objectives and methodology .....	76
6.2.	Wind technologies .....	79
6.2.1.	Specialization in wind complementary technologies .....	79
6.2.2.	Specialization in wind technologies .....	81
6.3.	Solar PV technologies .....	83
6.3.1.	Specialization in solar PV complementary technologies .....	83
6.3.2.	Specialization in solar PV technologies .....	85
7.	Conclusion.....	88
<b>Chapter 3: Revealed technological advantage and revealed comparative advantage in wind and solar PV technologies: a Panel VAR analysis using trade and patent data ....</b>		
1.	Introduction .....	90
2.	Literature review .....	92
2.1.	Unidirectional effect between innovation and export performances.....	93
2.2.	Endogeneity issues between export and innovation .....	94
2.3.	Effect of public policies on innovation and export.....	95
2.4.	Issues hardly addressed by the literature and aim of this chapter.....	98
3.	Theoretical framework and hypotheses.....	99
3.1.	Possible endogeneity between innovation and exports: the coexistence of two hypotheses .....	99
3.1.1.	The learning-by exporting hypothesis.....	99
3.1.2.	Self-selection hypothesis.....	100
3.2.	The possible endogeneity of public policies.....	101
4.	Variables and data .....	102
4.1.	Relative export performance .....	102
4.2.	Relative technological advantage .....	105
4.3.	Public policies indicators.....	105
5.	Descriptive statistics.....	106



5.1.	Data coverage and label of variables .....	106
5.2.	Missing data leading to two different models .....	108
5.3.	Main descriptive statistics for each set of countries .....	110
5.4.	Countries typology by RTA and RCA .....	112
5.4.1.	Wind technologies: Denmark leader, no clear relation between RTA and RCA 112	
5.4.2.	Solar PV technologies: Japan leader, no clear relation between RTA and RCA 116	
6.	Estimation strategy and pre-estimation investigations.....	120
6.1.	Temporal shocks: CUSUM (CUmulative SUM).....	122
6.2.	Cross sectional dependence .....	123
6.3.	Unit root.....	125
6.4.	Cointegration .....	127
6.5.	Number of lags .....	128
6.6.	PVAR estimation.....	129
6.7.	Granger causality test .....	130
6.8.	Post estimation investigations .....	130
6.8.1.	Impulse response functions (IRF) .....	130
6.8.2.	Forecast Error Variance Decomposition (FEVD).....	131
7.	Results .....	132
7.1.	Results of the econometric analysis: wind technologies .....	132
7.1.1.	Self-reinforcement for both RTA and RCA.....	132
7.1.2.	Bidirectional relation between RTA and RCA (not robust to all specifications) 133	
7.1.3.	Effect of policies on RTA: positive effect of “share cap” and “RD expenditures” for some specifications.....	134
7.1.4.	Effects of policies on RCA: negative impact of share cap on RCA all codes, no influence of public RD expenditures.....	135
7.1.5.	Endogeneity of diffusion policies with export performance in the model with the RD variable .....	136
7.1.6.	Exogenous variables.....	136
7.2.	Results of the econometric analysis: solar PV technologies .....	136
7.2.1.	Self-reinforcement of RTA and RCA: robust in the model without RD – not robust in the model with RD .....	136
7.2.2.	RTA and RCA: no unidirectional or reverse causality .....	138

7.2.3.	Public RD expenditures: no effect on RTA but a significant positive effect on RCA	138
7.2.4.	Share of installed capacities: no effect on RTA, no robust negative effect on RCA	139
7.2.5.	No effect of both performances on public policies .....	139
7.2.6.	Exogenous variables.....	140
7.3.	Comparison of results between the two technologies .....	140
8.	Conclusion and discussion .....	140
	Conclusion générale .....	143
1.	Rappel du contexte et des principaux enjeux .....	143
2.	Principaux résultats .....	144
3.	Perspectives de recherche.....	146
3.1.	Politiques climatiques, performances relatives en innovation et à l'export : causalités hétérogènes selon les pays.....	146
3.2.	Innovation et productivité des entreprises françaises, une application au secteur des énergies renouvelables avec un modèle CDM .....	148
	<b>Bibliographie</b> .....	150
	<b>Annexes</b> .....	161
	Annexes du chapitre 2 .....	161
	A-1: Not structuring spillovers: should not bias our analysis .....	161
	A-2: Details about the methodology for the network centrality analysis.....	162
	A-3: Procedure to draw the graph for analysing the evolution of the innovation efforts in wind and solar PV patents .....	164
	A-4: Centrality Analysis: wind spillovers.....	165
	A-5: Centrality Analysis: solar PV spillovers .....	168
	A-6: Correspondence between iso2 codes and country name.....	171
	A-7: Wind technologies: world map of mean weighted RTA over 1977-2011 .....	172
	A-8: Weighted RTA in complementary technologies for each country – wind technologies .....	173
	A-9: solar PV technologies: world map of relative innovation performance .....	179
	A-10: Weighted RTA in complementary technologies for each country – solar PV technologies.....	180
	Annexes du chapitre 3 .....	184
	B-1: Literature review .....	184
	B-2: China's share in global exports of wind and solar PV technologies .....	196

B-3: Mean of variables for each country, wind technologies and solar PV .....	198
B-4: Graphical representation of performance within countries – wind technologies.....	199
B-5: Graphical representation of performance within countries – solar PV technologies.	201
B-6: Estimation strategy: technical econometric aspects .....	203
B-7: CUSUM graphs .....	206
B-8: Information criteria: relevant number of lags .....	207
B-9: Hansen’s J-test for wind technologies.....	208
B-10: Panel Granger causality tests – wind technologies .....	209
B-11: Panel VAR stability, wind technologies .....	211
B-12: PVAR estimations – wind technologies.....	213
B-13: IRF analysis – wind technologies .....	220
B-14: FEVD analysis – wind technologies .....	225
B-15: Results for wind model without RD on 15 countries.....	229
B-16 : Hansen J-test for solar PV technologies.....	230
B-17: Panel stability – solar PV technologies.....	230
B-18: Panel Granger causality – solar PV technologies.....	232
B-19: PVAR estimations – solar PV technologies.....	234
B-20: IRF analysis – solar PV technologies.....	241
B-21: FEVD analysis – solar PV technologies .....	245
B-22: Results for solar PV model without RD on 11 countries.....	248

# Liste des figures

○ Figure 1 : Investissements annuels (2010-2030) nécessaires pour atteindre une trajectoire 2°C par rapport aux investissements dans un scénario de référence. Source (IPCC , 2014) .....	16
○ Figure 2: Part des énergies éoliennes et solaires dans le mix électrique mondial (capacités installées), source : auteur & Enerdata .....	17
○ Figure 3 : Dépenses dans les politiques techno-push et demand-pull réalisées dans 6 pays européens, source : Zachmann et al. (2014) .....	24
○ Figure 4 : Impact des politiques de soutien à l'innovation et à la diffusion sur le changement technologique.....	31
○ Figure 5: Effet des dépenses publiques de RD sur l'innovation dans les énergies éoliennes et solaires (gauche : nombre d'observation ; droite : % des observations) .....	36
○ Figure 6: Effet sur l'innovation des politiques basées sur les prix pour les technologies éolienne et solaire (gauche : nombre d'observation ; droite : % des observations) .....	37
○ Figure 7: Effet sur l'innovation des politiques basées sur les quantités pour les technologies éolienne et solaire (gauche : nombre d'observation ; droite : % des observations) .....	39
○ Figure 8: Effet sur la diffusion des politiques prix pour les technologies éolienne, solaire et ENR .....	43
○ Figure 9: Effet sur la diffusion des politiques quantités pour les technologies éolienne, solaire et ENR (gauche : nombre d'observation ; droite : % des observations).....	45
○ Figure 10: 2 models of the technology life cycle approach (from Huenteler et al. 2016)...	53
○ Figure 11: Backward patent citation.....	57
○ Figure 12 : technological content of upstream knowledge spillovers measured by backward citations.....	58
○ Figure 13: Share of non-patent literature among citations .....	59
○ Figure 14: simple representation of a network .....	60
○ Figure 15 : identification of upstream knowledge spillovers through patent citations .....	60
○ Figure 16: procedure to create the network of co-occurrences of technological codes among upstream knowledge spillovers .....	61
○ Figure 17: network example .....	63
○ Figure 18: Number of patent families at the EPO for wind and solar PV backward citations samples .....	65
○ Figure 19: Evolution of the focus of innovation in wind technologies - from Huenteler et al. (2016).....	66
○ Figure 20: technological content of wind patent families – CPC codes.....	67
○ Figure 21: Evolution of the focus of innovation in solar PV technologies - from Huenteler et al. (2016).....	67
○ Figure 22: Technological content of solar PV patent families .....	68
○ Figure 23: Cell technological content of solar patents .....	68
○ Figure 24 : share of non-wind codes within spillovers concerning wind.....	70
○ Figure 25 : share of non-solar PV codes within spillovers concerning solar PV innovation .....	70

○ Figure 26: Share of non-3D codes within spillovers concerning the innovation in the 3D imaging .....	71
○ Figure 27: Share of non-nano codes within spillovers concerning the innovation in the nanotechnologies .....	71
○ Figure 28: Duration of technology occurrence within spillovers .....	72
○ Figure 29: Number of nodes - wind and solar networks .....	73
○ Figure 30: Number of links - wind and solar networks .....	73
○ Figure 31 : Density - wind and solar networks.....	74
○ Figure 32: Top 20 of countries – mean symmetric weighted RTA over 1977-2011 for all neighbouring technologies to wind energy.....	79
○ Figure 33: Top 20 of countries – mean symmetric weighted RTA over 1977-2011 for wind energy .....	82
○ Figure 34: Relative innovation performance of countries in wind and in all neighbouring technologies .....	83
○ Figure 35: Top 20 of countries – mean symmetric weighted RTA over 1978-2011 for solar PV complementary technologies .....	84
○ Figure 36: Top 20 of countries – mean symmetric weighted RTA over 1977-2011 for solar PV energy .....	86
○ Figure 37: Relative innovation performance of countries in solar PV and in all neighbouring technologies .....	87
○ Figure 38: Main manufacturer solar PV industry (2017) .....	106
○ Figure 39: Main manufacturer wind industry (2017) .....	106
○ Figure 40: share of the exports of the 24 countries in our panel (source: author).....	107
○ Figure 41: Wind: countries included in the RD model (green) and those excluded (red). 109	
○ Figure 42: Solar PV: countries included in the RD model (green) and those excluded (red) .....	110
○ Figure 43: Mean of performance variable over each sub period - wind technologies .....	115
○ Figure 44: Mean of performance variable over each sub period - solar PV technologies	119
○ Figure 45: Visual summary of the estimation strategy.....	122

# Liste des tableaux

○ Table 1: Analyse des instruments de soutien aux énergies renouvelables, adapté de Menanteau et al. (2003).....	23
○ Table 2: Etudes économétriques évaluant l'impact des politiques de soutien à l'innovation et à la diffusion sur l'innovation dans les ENR.....	35
○ Table 3: Etudes économétriques évaluant l'impact des politiques de soutien à l'innovation et à la diffusion sur la diffusion des ENR au sein des pays.....	41
○ Table 4 : CPC codes for the wind renewable technologies.....	56
○ Table 5 : CPC codes for the solar PV technologies.....	56
○ Table 6: network example - structure indicators.....	63
○ Table 7: network example - degree and betweenness centrality.....	63
○ Table 8: main statistics for our two samples.....	65
○ Table 9 : Key technologies in the technological structure of spillovers toward wind patents.....	75
○ Table 10: Key technologies in the technological structure of spillovers toward solar PV patents.....	76
○ Table 11: IPC codes of wind technologies.....	78
○ Table 12: IPC codes of solar technologies.....	79
○ Table 13: Specialisation of a selection of countries in complementary technologies - wind technologies.....	81
○ Table 14: Specialisation of a selection of countries in complementary technologies - solar PV technologies.....	85
○ Table 15: Two HS codes wind technologies.....	103
○ Table 16: All HS codes- wind technologies.....	104
○ Table 17: Two HS codes - solar PV technologies.....	105
○ Table 18: All HS codes – solar PV technologies.....	105
○ Table 19: Label and source of data for wind technologies.....	108
○ Table 20: Missing data RD variable - wind technologies.....	108
○ Table 21: Missing data RD variable - solar PV technologies.....	109
○ Table 22: Main statistics over the 24 countries - wind technologies.....	111
○ Table 23: Main statistics over 15 countries - wind technologies.....	111
○ Table 24: Main statistics over the 24 countries - solar PV technologies.....	111
○ Table 25: Main statistics over 11 countries - solar PV technologies.....	111
○ Table 26: Evolution of the mean of the variable between the two sub periods - wind technologies.....	116
○ Table 27: Evolution of the mean of the variable between the two sub periods - solar PV technologies.....	120
○ Table 28: The eight specifications of our analysis.....	121
○ Table 29: Cross sectional dependence test - wind technologies model without RD variable.....	124
○ Table 30: Cross sectional dependence test - wind technologies model with RD variable.....	124
○ Table 31: Cross sectional dependence test - solar PV technologies model without RD variable.....	125

- Table 32: Cross sectional dependence test - solar PV technologies model with RD variable ..... 125
- Table 33: Pesaran CADF unit root test – wind technologies model with RD..... 126
- Table 34: Pesaran CADF unit root test –..... 126
- Table 35: Pesaran CADF unit root test – solar PV technologies with RD:..... 126
- Table 36: Pesaran CADF unit root test – solar PV technologies without RD..... 127
- Table 37: Westerlund cointegration test - wind without RD (p-values)..... 128
- Table 38: Westerlund cointegration test - wind with RD (p-values)..... 128
- Table 39: Table 16: Westerlund cointegration test - solar PV without RD (p-values) ..... 128
- Table 40: Table 16: Westerlund cointegration test - solar PV with RD (p-values)..... 128
- Table 41: 8 Specifications for wind technologies ..... 129
- Table 42: 8 Specifications for solar PV technologies..... 130
- Table 43: Cholesky decomposition – variable ordering explanations..... 131

# Introduction générale

---

L'année 1972 marque un premier tournant dans la prise de conscience de l'effet des activités humaines sur le changement climatique. Cette année-là est publié un rapport qui a contribué largement à l'émergence du concept de développement durable : le rapport du Club de Rome sur les limites de la croissance (également appelé rapport Meadows). Ce rapport se base sur une approche systémique afin de modéliser nos sociétés contemporaines et les interactions entre la croissance économique, la pollution, la croissance démographique, la production agricole, l'exploitation des ressources naturelles... A travers différents scénarios, ce rapport prédit l'effondrement de notre société avant 2100 si la recherche effrénée de croissance basée sur les énergies fossiles se poursuit. Par exemple, la croissance stimulée par la croissance démographique et l'exploitation des ressources naturelles provoque de la pollution qui elle-même entraînera un recul économique et/ou démographique. En 2008, Graham Turner confronte les projections du rapport du club de Rome avec les données réelles sur la période 1970 - 2000. Il conclut que la tendance suivie par nos sociétés n'est pas durable confirmant ainsi les principales conclusions du rapport sur les limites de la croissance.

## **1. Tentatives de coordination internationale pour lutter contre le changement climatique**

Au cours des années 1980 les premières recherches mettent en évidence le lien entre les émissions de CO<sub>2</sub> et le changement climatique. Sous l'influence des scientifiques qui tentent de sensibiliser les décideurs publics, est créé en 1988 le GIEC (groupe d'experts intergouvernemental sur l'évolution du climat). En 1990, il remet son premier rapport qui alerte sur un réchauffement possible de 3 degrés en 2050 par rapport à l'ère préindustrielle. Dès le début des années 1990, des tentatives de coordination au niveau international pour lutter contre le changement climatique ont été mises en œuvre. La convention-cadre des Nations Unies sur les changements climatiques (CCNUCC) est adoptée lors du Sommet de la Terre à Rio en 1992. Il s'agit de l'une des trois conventions signées lors de ce sommet. Son objectif est de parvenir à stabiliser le niveau de gaz à effet de serre (GES) dans l'atmosphère « à un niveau qui empêche toute perturbation anthropique dangereuse »<sup>1</sup>, tout en permettant un développement durable de l'économie. Cette convention aboutit à la répartition des efforts selon trois groupes de pays. Les pays sont classés suivant leur niveau de développement et de contribution historique aux émissions de GES. Les pays dits de l'annexe 1 sont les pays les plus développés et ceux qui ont donc le plus contribué aux émissions de GES. C'est à ces pays qu'il incombe de prendre des mesures afin de ramener en l'an 2000 leurs émissions au niveau de 1990. Les pays les plus développés doivent également aider les pays les moins avancés dans leur lutte contre le changement climatique à travers un soutien financier et technique.

---

<sup>1</sup> <https://unfccc.int/resource/ccsites/haiti/ccweb/conven/text/textcomplet.html>



La convention entre officiellement en vigueur en 1994. Dès lors, l'ensemble des pays signataires s'engage à se retrouver chaque année afin de poursuivre la lutte contre le changement climatique au niveau international. C'est ainsi qu'a lieu la première conférence des parties à Berlin en 1995. La 3<sup>ème</sup> Conférence des Parties à Kyoto au Japon en 1997 aboutit au premier accord international contraignant visant à réduire les émissions de GES. Au niveau mondial l'objectif est de réduire de 5% les émissions de GES en 2012 par rapport à 1990. Seuls les pays développés ont des objectifs de réduction. Le protocole conserve en effet le principe de la Convention cadre de 1992 en imposant des objectifs différenciés selon le niveau de développement des pays et donc leur responsabilité historique dans les émissions de GES. Le protocole de Kyoto incite les transferts technologiques et financiers entre les pays du nord et du sud via notamment le mécanisme de développement propre. Avec la Conférence des Parties de Doha en 2012 et la fin de la première période d'engagement du protocole de Kyoto, l'objectif des négociations internationales est alors de réussir à ce que l'ensemble de la communauté internationale, pays du Nord comme pays du Sud, s'engage dans des objectifs de réduction des émissions de GES pour la période 2013-2020.

Ceci n'aboutit qu'en 2015, avec la 21<sup>ème</sup> Conférence des Parties (COP) tenue à Paris. 195 pays signent alors un accord juridiquement contraignant sur le climat dont l'objectif principal est de limiter le réchauffement climatique en dessous de +2°C et le plus proche possible de 1,5°C par rapport à l'ère préindustrielle. Pour respecter l'Accord de Paris, les émissions de CO<sub>2</sub> du système énergétique mondial devront être nulles et atteindre la neutralité carbone dès le courant de la seconde moitié du 21<sup>ème</sup> siècle (IPCC, 2014, 2018). Ce nouvel accord international marque un changement de paradigme dans les négociations internationales. Alors que les précédents accords imposaient directement des objectifs de diminution aux pays de manière à respecter un objectif global de réduction des émissions, l'accord de Paris est basé sur les contributions individuelles de chaque pays signataire. Chaque pays a donc pu individuellement fixer ses propres objectifs de réduction d'émissions de GES en fonction de ce qu'il pense être réalisable, en accord avec ses capacités technologiques, ses perspectives de croissance économique et ses priorités de développement.

## **2. Le défi du développement des énergies renouvelables**

### **2.1. Les énergies renouvelables, un pilier de la lutte contre le changement climatique**

L'agence internationale de l'énergie en 2010 identifiait 3 principaux leviers pour la réduction des émissions de GES : adoption rapide et à grande échelle des énergies renouvelables (ENR) ; développement des technologies de capture et de stockage du carbone ; amélioration du rendement des centrales thermiques électriques (AIE, 2010). Plus précisément, une limitation du réchauffement climatique à 2°C nécessite une électrification des usages énergétiques, des investissements dans les énergies décarbonées et l'amélioration de l'efficacité énergétique et des désinvestissements dans l'extraction d'énergies fossiles et leur exploitation (Figure 1).

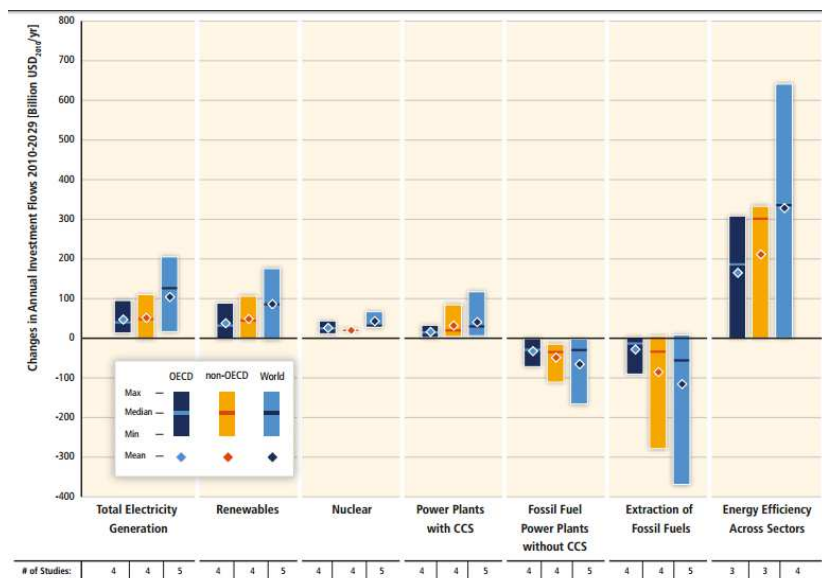

Figure 1 : Investissements annuels (2010-2030) nécessaires pour atteindre une trajectoire 2°C par rapport aux investissements dans un scénario de référence. Source (IPCC , 2014)

Chacune des solutions technologiques décarbonées préconisées est sujette à des enjeux particuliers. Certaines technologies ne font pas consensus au sein de la société bien qu'elles soient matures et largement développées. C'est le cas du nucléaire, en particulier depuis la catastrophe de Fukushima en 2011 qui a conduit au renforcement des normes de sécurité de la technologie difficilement atteignables à des coûts maîtrisables. D'autres technologies sont encore immatures et non compétitives par rapport aux technologies traditionnelles émettrices de GES. C'est le cas de certaines ENR ou du stockage de l'électricité nécessaire pour gérer l'intermittence des énergies solaires et éoliennes et leur permettre une diffusion à grande échelle. Enfin d'autres technologies comme la capture et le stockage de carbone (CCS) sont à un stade de développement technologique encore très précoce ne permettant pas d'espérer rapidement des perspectives de commercialisation.

Le développement des ENR présente des atouts économiques indéniables. En particulier, le déploiement de cette filière sera créateur d'emplois (Ram et al., 2020) et permettra aux pays de renforcer leur indépendance énergétique en valorisant énergétiquement des ressources disponibles (Guivarch et Monjon, 2017). Limiter la dépendance aux importations d'énergies fossiles est en effet un enjeu crucial pour éviter de subir les fluctuations des marchés internationaux de l'énergie et les aléas géopolitiques qui peuvent engendrer une grande volatilité des prix. Le développement des technologies renouvelables pourrait ainsi permettre de réduire le coût de l'énergie pour les agents économiques et contribuer à lutter contre la précarité énergétique.

Les ENR sont ainsi au cœur des stratégies de décarbonation des systèmes énergétiques et les pays fixent des objectifs ambitieux de pénétration de ces technologies dans leur mix énergétique. Par exemple, en France, la loi relative à la transition énergétique pour la croissance verte promulguée en 2015 fixe à 23 % la part des énergies renouvelables dans la consommation finale d'énergie en 2020 et à 32 % en 2030 (même objectif que celui de l'union européenne).

Ainsi les énergies renouvelables prennent une place de plus en plus importante dans le mix électrique mondial bien que les énergies fossiles restent majoritaires. En 2000 les énergies éoliennes et solaires représentaient moins de 1% du mix électrique mondial contre respectivement 8.5% et 7.5% en 2019 (Figure 2). Par ailleurs, ces dernières années, le marché mondial des énergies renouvelables s'est non seulement développé, mais il est également devenu plus ouvert. Le marché international des énergies renouvelables est confronté à une concurrence croissante avec l'entrée des pays en développement sur le marché (De la Tour et al., 2011). Par exemple, des capacités d'énergie éolienne ont été installées dans quelques pays dans les années 1990, mais la technologie existait dans plus de 82 pays en 2010. Le leadership dans le secteur manufacturier est passé de l'Europe à l'Asie. En 2009, la Chine a produit 40 % de l'approvisionnement mondial en énergie solaire photovoltaïque et 30 % des turbines éoliennes du monde (REN21, 2010).

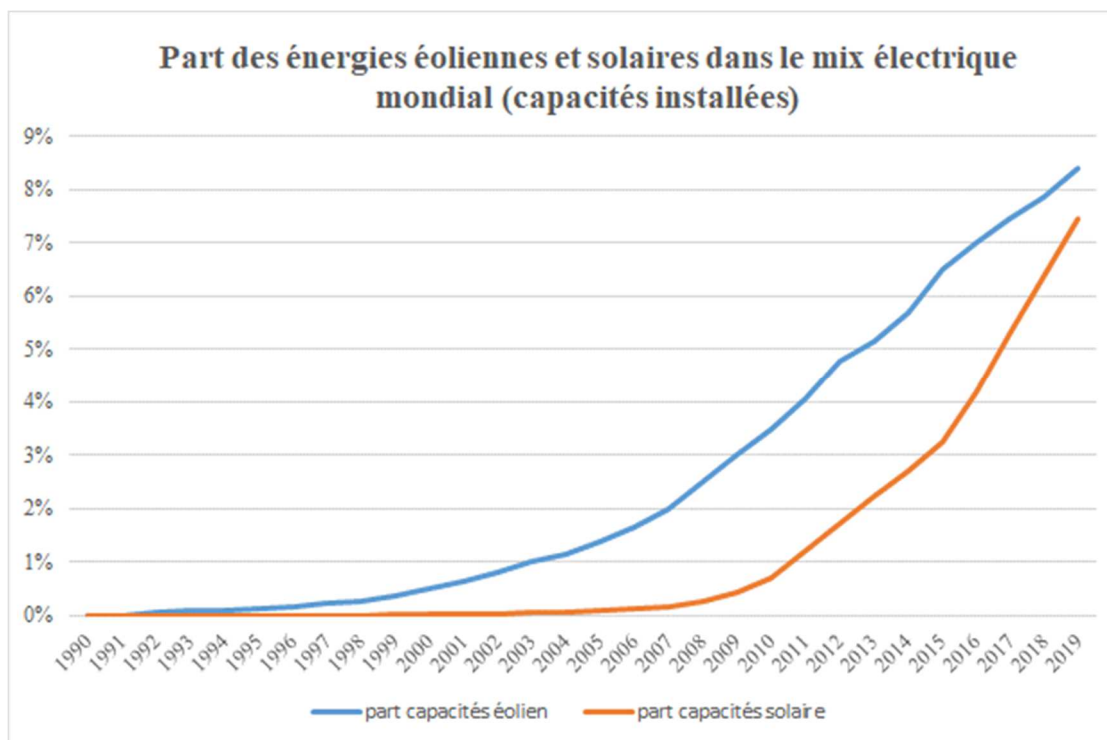

Figure 2: Part des énergies éoliennes et solaires dans le mix électrique mondial (capacités installées), source : auteur & Enerdata

L'utilisation de plus en plus large des ENR et les efforts d'innovation ont permis de réduire fortement le coût de ces technologies jusqu'à les rendre compétitives par rapport aux énergies fossiles traditionnelles. L'IRENA (*International Renewable Energy Agency*) estime ainsi que les coûts des énergies éoliennes ont diminué de 39% entre 2010 et 2019, et de 82% pour les énergies solaires PV. Le coût de l'électricité produite par le solaire PV a atteint environ sept centimes USD par kilowattheure en 2019. Le coût de l'éolien terrestre était de 0.053 USD/kWh et celui de l'éolien en mer de 0.115 USD/kWh (IRENA, 2020). Plusieurs facteurs peuvent expliquer ces baisses de coûts. Kavlak et al. (2018) montrent que l'augmentation de l'efficacité des modules photovoltaïques grâce aux efforts de recherche et développement (RD) et aux économies d'échelles a été la principale cause de faible niveau de réduction des coûts des énergies solaires entre 1980-2012, contribuant à près de 25 % de cette diminution. La RD

financée par le gouvernement et le secteur privé a été le mécanisme le plus important au cours de cette période. Or, ces coûts ne prennent en compte que ceux concernant les installations de production mais pas les coûts de système (liés à l'acheminement fiable, au bon moment, de l'électricité produite) et les coûts externes (externalités environnementales liées aux émissions de polluants) qui sont particulièrement déterminants. Selon Samadi (2017), quand l'ensemble de ces coûts sont pris en compte, plusieurs technologies de production d'électricité n'émettant pas de GES dont les énergies éoliennes et solaires PV, ont un coût social par kWh inférieur à celui des technologies fossiles.

## **2.2. Le développement des ENR entravé par deux principales défaillances de marché**

Les ENR ont un rôle crucial à jouer dans la lutte contre le changement climatique. Néanmoins, leur développement technologique et leur adoption sont entravés par deux principales défaillances de marché : les externalités environnementales des énergies fossiles et les externalités de connaissance (Fischer et al., 2003; Jaffe et al., 2005). Du fait de ces externalités, les forces du marché conduisent à un sous-investissement dans les ENR par rapport à l'optimal social. Il est alors crucial pour les gouvernements de mettre en place des politiques publiques afin de soutenir le développement technologique et la diffusion des technologies renouvelables.

### **2.2.1. Externalités environnementales**

Les énergies fossiles sont émettrices de pollution et notamment de GES. En se substituant à ces technologies, les ENR permettent de réduire ces dommages environnementaux. D'après la théorie économique, ces bénéfices environnementaux peuvent être considérés comme un bien public. En effet, leur utilisation est non rivale (le fait qu'un agent en profite n'empêche pas les autres agents économiques d'en profiter également) et non excluable (il est difficile d'empêcher les autres acteurs économiques d'en profiter). Du fait de ses caractéristiques les agents privés ne sont pas incités à contribuer à la production d'un bien public dont ils ne vont pas pouvoir se réserver l'exploitation (Varian, 1992). On peut alors voir émerger des comportements de passagers clandestins.

Afin de développer les ENR, un premier enjeu est donc d'internaliser les externalités environnementales c'est-à-dire leur donner une valeur économique. Selon Pigou (1920) la manière la moins coûteuse de traiter ces externalités est d'appliquer une taxe sur les émissions de GES égale au dommage marginal qu'elles induisent. Cela permet alors de rendre les technologies fossiles plus coûteuses et moins rentables par rapport aux technologies alternatives respectueuses de l'environnement. Par ailleurs, ce signal sur le prix du carbone renforce les perspectives de rentabilité des technologies vertes et incite les agents économiques à investir dans des programmes de RD.

Cependant, la taxe pigouvienne n'est efficace que si le niveau correct du coût social du carbone est connu. Jusqu'à présent, il n'y a pas de consensus sur les dommages et l'impact économique de l'émission d'une tonne de CO<sub>2</sub> sur la société, ce qui signifie que le niveau correct

correspondant de la taxe est également difficile à calculer. Deuxièmement, même si le coût social correct du carbone est déterminé, l'internalisation de ce coût par le biais d'une taxe sur le carbone n'est pas toujours possible, principalement en raison d'obstacles politiques, tels que l'acceptabilité, la crédibilité et l'efficacité (Fay et al. 2015). En raison de ces problèmes liés à la mise en œuvre de la tarification du carbone, il est essentiel d'étudier les politiques alternatives et leurs implications. Ces politiques consistent notamment à soutenir directement les technologies non émettrices.

### **2.2.2. Externalités de connaissance**

Ces défaillances sont liées au caractère public de la connaissance (Arrow, 1962 ; Geroski, 1995) qui vont entraîner des comportements de passager clandestin. Les spillovers de connaissance sont un exemple de ces externalités positives. Ils correspondent au fait que les entreprises sont capables d'obtenir de l'information créée par d'autres firmes sans avoir à payer pour cela et que le propriétaire initial de cette information n'a pas la possibilité d'empêcher les autres firmes d'exploiter cette information (Grossman et Helpman, 1992). A cause de ces spillovers les inventeurs ne vont pas pouvoir s'accaparer tous les bénéfices de l'innovation. Cet investissement en recherche sera alors inférieur à l'optimum social. De plus, il existe un risque de copie de l'innovation si aucun instrument de protection de la propriété intellectuelle n'est mis en place. Une autre conséquence de ces externalités positives de connaissance est liée au fait que plus on va innover sur un produit et moins les coûts seront importants (Arrow, 1962). Donc un producteur est incité à attendre que d'autres agents innovent ce qui lui permettra de bénéficier des spillovers (Baldwin et Childs, 1969 ; Kamien et al., 1992), et ensuite d'innover à un coût moins important (voir Nemet, 2012 pour une estimation de ce phénomène dans l'industrie éolienne Californienne).

### **2.2.3. Autres défaillances de marché**

Le secteur de l'énergie est fortement capitalistique et oligopolistique, dominé par de grandes compagnies spécialisées dans les technologies fossiles comme Total, Shell, BP... Ces grandes firmes peuvent voir d'un mauvais œil les alternatives renouvelables qui risquent de réduire leurs parts de marché et leur performance économique. Elles peuvent donc stratégiquement entraver l'innovation et la diffusion des ENR par des actions de lobbying ou par des stratégies de lock-in (visant directement à lutter contre l'émergence de nouveaux standards technologiques).

Nous retrouvons également des défaillances institutionnelles qui limitent les possibilités de financement des projets de développement des ENR. Tant qu'elles sont plus coûteuses que les énergies conventionnelles, elles représentent un risque plus important pour les investisseurs et les organismes financiers. Par ailleurs, dans de nombreux pays en développement, les investissements dans les énergies renouvelables sont limités par l'instabilité politique et la volatilité de la monnaie.

Enfin, des défaillances plus générales, que l'on rencontre usuellement dans les processus d'innovation peuvent exister pour les énergies renouvelables. Nous pouvons notamment citer les défaillances liées aux redondances dans les efforts d'innovation liés aux courses à

l'innovation (Aoki, 1991 ; Baye et Hoppe, 2003) et les défaillances liées aux capacités d'absorption des agents qui peuvent limiter les transferts de connaissances.

Pour faire face à ces défaillances de marché et afin de favoriser le développement technologique et l'adoption des ENR les pouvoirs publics ont à leur disposition plusieurs politiques.

### **3. Présentation des politiques publiques**

Il est important que les différentes politiques de soutien à l'innovation soient mises en place le plus rapidement possible et cela pour deux raisons majeures. Premièrement, il existe une dépendance historique (que l'on appelle dépendance au sentier) dans les choix d'innovation des agents comme l'ont montré Aghion et al. (2012) dans le secteur automobile en distinguant l'innovation dans des technologies « propres » (voitures électriques et hybrides) et l'innovation dans des technologies « sales » (liées à la combustion du carburant par exemple). Cette dépendance au sentier est susceptible d'entraîner des verrouillages technologiques (*lock-in*) et ainsi d'empêcher le développement de nouvelles technologies plus performantes. Ces dépendances au sentier s'expliquent notamment par les effets d'apprentissage : les courbes d'apprentissage considèrent ainsi que le coût des technologies diminue en fonction de la diffusion des technologies (Arrow, 1962; Rosenberg, 1982).

Plusieurs étapes composent le processus d'innovation, de la recherche fondamentale à la diffusion de l'invention, avec des feedbacks entre les différentes étapes. Des politiques spécifiques visent chaque étape du processus. De manière générale nous distinguons deux théories pour expliquer le changement technologique (Dosi, 1982). L'approche *techno-push* se place du côté de l'offre technologique et privilégie la RD pour inciter au développement et à la diffusion des technologies (Bush, 1945). En contrepoint, Schmookler (1966), a développé l'approche « *demand-pull* » selon laquelle la demande du marché est un élément clé du changement technologique.

#### **3.1. Politiques *techno-push* de soutien direct à l'innovation**

Les politiques technologiques *techno-push* (de soutien à l'innovation) peuvent prendre la forme de financements publics pour la RD dans les technologies bas carbone. Globalement, ces politiques ont 5 objectifs (CNEPI, 2016) : « augmenter les capacités privées de RD ; accroître les retombées économiques de la recherche publique ; développer les projets de coopérations entre acteurs ; promouvoir l'entrepreneuriat innovant ; soutenir le développement des entreprises innovantes ». Les dépenses de RD du gouvernement peuvent compenser le sous-investissement des firmes privées dans certains champs technologiques qui ne laissent pas espérer une rentabilité suffisante à court terme, dans des projets à l'aboutissement plus incertain ou cherchent à compenser la perte de bénéfices des inventeurs liée aux *spillovers*.

Nous pouvons distinguer deux catégories d'aides publiques à l'innovation : les aides directes et les aides indirectes (Lallement, 2011). Les aides directes correspondent à des subventions destinées à des projets précis ou bien couvrant un type précis de dépenses. Ces subventions peuvent prendre différentes formes :: primes, avances remboursables, prêts bonifiés... Dans le

cadre de commandes publiques, les PME peuvent bénéficier d'une « discrimination positive », c'est-à-dire être favorisées pour l'accès aux marchés publics. Les garanties d'emprunt ont pour objectif de corriger les difficultés d'accès au crédit des jeunes entreprises par exemple.

Les aides indirectes prennent la forme d'allègements fiscaux (impôts, charges sociales, ...). Par exemple, en France, la principale aide indirecte est le crédit d'impôt recherche (CIR). Ces aides indirectes peuvent être aussi des facilités d'amortissement des immobilisations comme c'est le cas au Royaume-Uni ou au Danemark. Les allègements fiscaux sur les revenus des brevets sont un autre exemple d'aides indirectes.

### **3.2. Politiques *demand-pull* de soutien à la diffusion**

Nous distinguons généralement les politiques *demand-pull* basées sur les prix et les politiques *demand-pull* basées sur les quantités.

#### **3.2.1. Politiques de diffusion basées sur les prix**

Les tarifs d'achat ont historiquement été très largement utilisés notamment dans les pays de l'Union Européenne à partir des années 2000. Dans un système de tarifs de rachat garanti, les entreprises de distribution s'engagent à racheter l'électricité produite à partir de sources renouvelables à un tarif prédéterminé garanti pour une certaine durée à tous les producteurs qui en font la demande. Les tarifs pratiqués sont différents entre les technologies : ils sont plus élevés pour les technologies les moins matures, cela évitant aux producteurs de dégager des rentes lorsqu'ils exploitent des technologies moins coûteuses. Les tarifs sont réévalués à intervalles réguliers afin de prendre en compte les processus d'apprentissage et ainsi fournir de meilleures incitations à innover et éviter que les producteurs dégagent des rentes trop importantes. De plus, le coût de cette politique est la plupart du temps supporté par les consommateurs comme c'est le cas en France via la CSPE (Contribution au Service Public de l'Electricité). Ainsi, des tarifs de rachat élevés peuvent peser lourdement sur les budgets des ménages et réduire l'acceptabilité sociale de la politique. Cette politique a eu des effets significatifs sur la diffusion des ENR grâce à des prix garantis très rémunérateurs pour les producteurs, par exemple en Allemagne et en Espagne (Percebois, 2014).

Afin d'éviter ces deux inconvénients (rente et coût élevé pour le consommateur) des systèmes de primes sont de plus privilégiés par rapport aux tarifs de rachat garantis. Dans le cadre d'un système de prime, l'électricité produite à partir de sources d'énergie renouvelables est généralement vendue sur le marché spot de l'électricité et les producteurs reçoivent une prime en plus du prix du marché de leur production d'électricité. La prime de rachat peut être soit fixe (c'est-à-dire à un niveau constant indépendant des prix du marché), soit mobile (c'est-à-dire avec des niveaux variables en fonction de l'évolution des prix du marché).

#### **3.2.2. Politiques de diffusion basées sur les quantités**

Nous présentons ici deux principales politiques : les appels d'offre et les certificats verts.

Dans le cadre des appels d'offres le régulateur définit une certaine quantité d'énergie renouvelable à produire et organise la compétition entre les producteurs de renouvelables pour

allouer cette quantité. Les fournisseurs d'électricité sont obligés d'acheter l'électricité aux producteurs sélectionnés. La compétition se fait sur le prix par kilowattheure proposé. Les propositions des producteurs sont ordonnées par prix croissant et sont acceptées jusqu'à ce que la quantité voulue soit atteinte. Chacun des producteurs sélectionnés est alors rémunéré du prix qu'il a proposé.

Pour les certificats verts, le régulateur oblige les fournisseurs d'électricité à justifier qu'une proportion de leurs ventes provienne de sources renouvelables. Cette politique peut être ou non contraignante. Aux Etats-Unis nous rencontrons les deux systèmes: les RPS (contraignants) et les RPG<sup>2</sup> (non contraignants). Cette politique peut également s'adresser directement aux producteurs d'électricité. Les agents concernés ont à leur disposition plusieurs options pour se conformer aux objectifs :

- Produire de l'électricité renouvelable et se voir attribuer des certificats<sup>3</sup>
- Acheter de l'électricité renouvelable couplée avec des certificats
- Acheter séparément des certificats sur le marché dédié
- Payer la pénalité si au final ils ne possèdent pas suffisamment de certificats ou si cela leur revient moins cher que de se procurer des certificats.

Finalement le tableau suivant synthétise les avantages et inconvénients de ces politiques selon quatre critères : capacité à stimuler la production d'électricité renouvelable ; coût global pour la communauté ; incitations à réduire les coûts et les prix ; incitations à l'innovation

---

<sup>2</sup> RPS = Renewable Portofolio Standard ; RPG = Renewable Portofolio Goal

<sup>3</sup> De manière générale, un certificat correspond à une unité d'électricité renouvelable (MWh, kWh, etc.).



	Tarifs d'achat	Appels d'offre	Certificats verts
Stimuler la production d'électricité renouvelable	<p>Efficace car assurent un certain niveau de retour sur investissement et suppriment les risques de marché.</p> <p>Coûts de transaction faibles</p>	<p>Rentes des producteurs limitée grâce à la compétition entre ceux-ci</p> <p>Risque sur la rentabilité des projets soumis (qui nécessitent en amont des coûts de préparation importants)</p> <p>Acceptabilité des projets difficile</p>	<p>Incitations au développement corrélées aux changements de prix de marché de l'électricité. Effets négatifs sur l'investissement si forte volatilité du prix des certificats (marché pas suffisamment liquide).</p>
Coût global pour la communauté	<p>Coûts administratifs faibles mais subventions fournies importantes (des tarifs décroissants pour prendre en compte les effets d'apprentissage réduisent ce « subventionnement »).</p> <p>Financement supporté de façon inéquitable entre consommateurs et producteurs.</p>	Possible de contrôler le montant des subventions	Incite à utiliser les sources d'énergie les moins onéreuses pour une même technologie grâce aux échanges de certificats.
Incitations à réduire les coûts et les prix	Faible car il est très dur de faire accepter une réduction des tarifs d'achat. Les réductions doivent être annoncées très en amont.	Forte	Les producteurs vendent l'électricité au prix du marché qui a tendance à diminuer du fait de la dérégulation et de la compétition de plus en plus importante. Le marché de certificat incite également à réduire les coûts.
Incitations à l'innovation	Surplus du changement technologique réparti entre les producteurs et les fabricants des technologies. Les effets d'apprentissage sont importants. Permet de fixer des niveaux de subvention adaptés et différenciés en fonction du niveau de maturité des technologies	Surplus du changement technologique bénéficie au consommateur → limite les capacités d'investissement en RD des firmes	Peut réduire les incitations dans les technologies les moins matures (et donc les plus onéreuses)

Table 1: Analyse des instruments de soutien aux énergies renouvelables, adapté de Menanteau et al. (2003)

## 4. Enjeux et objectifs de la recherche

Cette thèse vise à évaluer l'efficacité des politiques climatiques de soutien à l'innovation et à la diffusion des ENR. Cet objectif général se décline en trois problématiques qui seront abordées dans trois différents chapitres. Les trois sous-sections suivantes présentent ces trois problématiques.

### 4.1. Déséquilibres entre *techno-push* et *demand-pull* : quelle efficacité de chacune de ces politiques ?

Un débat existe dans la littérature académique pour définir la répartition optimale entre soutien *demand pull* et soutien *techno push*. Ainsi Zachmann et al. (2014) font état d'un fort déséquilibre entre les dépenses publiques accordées aux deux types de politiques en 2010 (Figure 3). Dans cette étude, les dépenses de RD et les dépenses pour le déploiement des technologies éoliennes et solaires sont reconstituées pour 6 pays de l'union européenne (Allemagne, Espagne, France, Italie, Royaume-Uni, République-Tchèque) et aboutissent à 48 298 M€ accordés aux politiques de déploiement des technologies vs 315 M€ accordés au soutien de la RD (chiffres pour 2010)

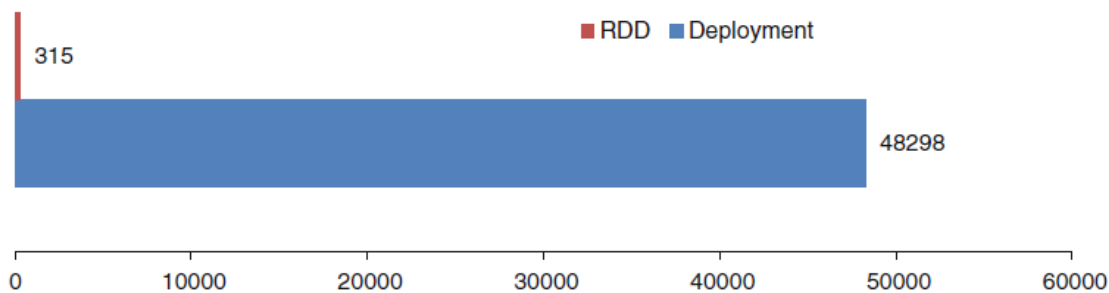

Figure 3 : Dépenses dans les politiques *techno-push* et *demand-pull* réalisées dans 6 pays européens, source : Zachmann et al. (2014)

Les dépenses de déploiement sont égales à la différence entre les coûts de déploiement<sup>4</sup> et la valeur actuelle nette de la future production d'électricité<sup>5</sup>.

Selon Fischer, Newell et Preonas (2013) le ratio optimal entre les dépenses pour le déploiement de la technologie et les dépenses pour la RD ne doit pas excéder 1 pour les technologies éoliennes. Selon Grubb (2004) ce ratio doit diminuer avec la maturité de la technologie. Ainsi, le ratio pour l'Europe d'environ 150 pour 1 paraît totalement disproportionné. Les efforts

---

<sup>4</sup> Les coûts de déploiement sont égaux au produit du coût d'installation par MWe et de la capacité déployée. Les données sur les coûts unitaires d'installation sont fournies par l'AIE : « Projected Costs of Generating Electricity 2010 »

<sup>5</sup> La valeur nette actuelle de l'électricité produite est calculée en actualisant, au taux de 10% ici, les revenus futurs qu'il est possible d'obtenir ainsi que la production par technologie et par pays.

actuels pour le développement devraient donc se faire par une augmentation des dépenses d'aides à la RD (Dechezleprêtre et al., 2016).

Ce constat pose la question de la pérennité du processus de changement technologique en cours et de la nécessité, ou non, d'un redéploiement par l'innovation (Dechezleprêtre *et al.*, 2016; Fischer *et al.*, 2014).

Les chiffres présentés ne concernent que les technologies éoliennes et solaires photovoltaïques. De plus, ces deux technologies semblent être celles qui ont le plus important potentiel de développement étant donné leurs avancées technologiques et leurs niveaux de compétitivité par rapport aux énergies fossiles. Nous allons dans cette thèse nous concentrer principalement sur ces deux technologies. Par ailleurs, leur diffusion sont soumises à des contraintes différentes, notamment sur les coûts de transport et les démarches administratives.

Cette thèse contribuera à éclairer ce débat en se basant sur une revue des études empiriques disponibles dans la littérature. Cette revue nous permettra de mieux comprendre l'efficacité spécifique de chacun des types de politiques de soutien aux ENR, d'observer et de comprendre des effets hétérogènes de ces politiques suivant les technologies ENR, selon le design des politiques ou selon d'autres critères.

## **4.2. Quel impact des flux de connaissances intersectoriels sur les performances en terme d'innovation dans les ENR ?**

Nemet (2012) montre que les principaux développements technologiques dans le secteur de l'énergie ont été basés sur des connaissances provenant de secteurs technologiques complémentaires (comme la chimie, l'électronique ou l'électricité). En outre, de nombreuses innovations dans le domaine de l'énergie ne proviennent pas d'entreprises de ce secteur mais d'entreprises du secteur des semi-conducteurs (innovations dans les panneaux solaires photovoltaïques), des machines électromécaniques (inventions dans les turbines à gaz), de l'agriculture (inventions dans le domaine des matières premières pour biocarburants) et de la biochimie (inventions dans les technologies de conversion des biocarburants) (Markard, 2011 ; Wiesenthal et al., 2011). Plus généralement, les innovations dans le domaine des ENR sont liées à des innovations dans les technologies de l'énergie et en dehors de ce secteur (Dechezleprêtre et al., 2014, Noailly et Shestalova, 2017, OCDE 2010, Popp et Newell, 2012).

Or, ces relations intersectorielles dans les dynamiques d'innovation peuvent créer de potentiels effets indirects des politiques publiques. Par exemple, si l'innovation dans les technologies éoliennes est basée sur la connaissance du secteur aéronautique, l'innovation dans ce domaine pourrait influencer le rythme de l'innovation dans les énergies renouvelables. En raison de ces *spillovers* de connaissances, les politiques de soutien à l'innovation dans le secteur aéronautique pourraient avoir un effet indirect sur l'innovation dans le domaine des énergies renouvelables. Ainsi, afin d'améliorer notre compréhension des dynamiques d'innovation dans les ENR, il paraît crucial d'étudier le contenu technologique de ces *spillovers* de connaissance. Cela permettra de donner des indications sur le périmètre technologique pertinent à considérer lorsque l'on souhaite étudier l'effet des politiques publiques et dans quelle mesure le débat que

nous avons présenté précédemment doit prendre en compte des politiques qui ciblent d'autres technologies.

De plus, afin d'avoir une première idée de l'influence des *spillovers* de connaissance sur les dynamiques d'innovation des ENR, nous pouvons analyser la cohérence au niveau des pays entre la spécialisation dans les technologies complémentaires et la spécialisation dans les technologies renouvelables. Cela permettra d'identifier des pays spécialisés à la fois dans les technologies complémentaires et dans les ENR correspondantes, et qui ont donc probablement su exploiter les flux de connaissances intersectoriels. Nous pourrions également mettre en évidence des pays spécialisés dans les technologies complémentaires mais pas dans les ENR correspondantes. Ces pays, du fait de leurs bases de connaissances solides susceptibles d'entraîner des flux de connaissances intersectoriels auraient un intérêt stratégique fort à se concentrer sur l'innovation dans les ENR.

Cela nous amène ainsi à nous demander : « Quel est le rôle des *spillovers* de connaissance intersectoriels dans les performances en innovation des pays dans les technologies éoliennes et solaires photovoltaïques? ».

### **4.3. Quelles interactions entre politiques climatiques, performance en innovation et performance à l'export dans le domaine des ENR ?**

Pour faire face aux défaillances de marché, les gouvernements mettent en œuvre des politiques de diffusion spécifiques et soutiennent la RD afin d'encourager l'innovation et la diffusion des énergies renouvelables. Au-delà du développement technologique (innovation et adoption des ENR), ces politiques se fixent pour objectif de soutenir le développement économique des pays (notamment en incitant les agents à plus exporter). Théoriquement, ces deux objectifs sont complémentaires : une meilleure performance à l'export doit permettre de développer la performance en innovation et inversement. Or, ces deux objectifs peuvent être en contradiction au sein d'un pays. Étant donnée la mondialisation des échanges, l'adoption des technologies (diffusion au sein du pays) peut se faire via des importations. Cela favorise alors les industries étrangères au détriment des industries locales et entrave le développement de celles-ci et leurs capacités à atteindre une taille critique leur permettant d'entrer sur les marchés internationaux.

Le marché international des énergies renouvelables est confronté à une concurrence croissante à mesure que les pays en développement entrent sur le marché (De la Tour et al., 2011). Comme évoqué précédemment dans cette introduction, plusieurs pays dans le monde ont pour objectif le développement de leur industrie renouvelable. La recherche des mêmes objectifs de pénétration des marchés internationaux, avec des pays qui vont parvenir à exporter et d'autres qui assureront la pénétration des ENR dans leur mix via des importations, est susceptible de créer des tensions commerciales.

Durant la dernière décennie, des frictions commerciales sont apparues, par exemple entre les États-Unis ou les pays européens, les anciens leaders du marché des énergies renouvelables et les nouveaux leaders tels que la Chine (Hajdukiewicz et Pera, 2020). Les États-Unis et l'Union européenne ont tous deux mis en œuvre des sanctions *antidumping* avec la Chine concernant

les panneaux solaires. En 2012, les États-Unis ont imposé des droits de douane allant de 24 % à 36 % sur les panneaux solaires importés de producteurs chinois, car ils considéraient que les entreprises solaires chinoises avaient reçu des subventions déloyales et exportaient des produits sur le marché américain à des prix inférieurs aux coûts. En juillet 2013, la Chine a taxé de plus de 50 % les importations de polysilicium pour l'industrie solaire en provenance des États-Unis, alors qu'elle était l'un des plus gros clients de l'industrie américaine. En juin 2013, l'Union européenne a imposé des droits de douane de 11,8 % sur les importations chinoises de panneaux solaires. Ces droits ont été supprimés après que les Chinois et l'UE se soient mis d'accord sur un prix plancher et un quota pour les modules chinois (Luo et al. 2017).

Dans ce contexte de tensions de plus en plus grande sur les marchés internationaux il apparaît donc crucial d'analyser et d'évaluer l'effet des politiques climatiques sur les performances en innovation et à l'export, au niveau national, pour les technologies éoliennes et solaires photovoltaïques. Les deux mesures de performance sont-elles complémentaires, substituables ou bien ont-elles des effets indépendants ?

## 5. Structure de la thèse

Cette thèse se compose de trois chapitres. Le premier chapitre est une revue de la littérature des études économétriques évaluant l'effet des politiques climatiques sur l'innovation et la diffusion dans les ENR. Cette revue couvre plus de 50 études économétriques qui se placent en grande majorité à l'échelle nationale. Dans un premier temps, ce chapitre examine l'effet des politiques sur l'innovation en distinguant celles qui ont un effet direct (RD) de celles ayant un effet indirect (politiques de diffusion par les prix et par les quantités). Dans un second temps, ce chapitre traite de la question du soutien à la diffusion en différenciant les politiques basées sur les prix (tarifs d'achat) et les politiques basées sur les quantités (quota, certificats verts). Cette revue fait ressortir deux principales problématiques qui ne sont pas suffisamment traitées dans la littérature. La première concerne l'effet des flux de connaissances (*spillovers*) intersectoriels sur l'innovation. La seconde porte sur les interactions entre les politiques publiques, l'innovation et la diffusion des ENR. Cette revue de la littérature a été publiée dans un numéro spécial de la revue *Innovations - Revue d'économie et de management de l'innovation* (CNRS, rang 4) en 2017<sup>6</sup>.

Le chapitre deux vise à améliorer la compréhension de l'impact des *spillovers* de connaissances sur l'innovation et la performance économique dans les énergies éoliennes et solaires photovoltaïques, en décrivant au niveau national la relation entre la performance relative en innovation dans ces ENR et la performance relative en innovation dans leur(s) principale(s) technologie(s) complémentaire(s) (*i.e.* les principales technologies à l'origine des *spillovers* de connaissances vers ces ENR). Ce chapitre permet d'adresser une lacune de la littérature identifiée dans le premier chapitre.

---

<sup>6</sup> Bourgeois, G., Mathy, S., Menanteau, P., 2017. L'effet des politiques climatiques sur les énergies renouvelables : une revue des études économétriques. *Innovations* 54, 15. <https://doi.org/10.3917/inno.054.0015>

Dans un premier temps, la démarche est de : i) quantifier la part des flux de connaissances intersectoriels (entre deux technologies renouvelables) et intersectoriels (entre une énergie renouvelable et une technologie d'un autre secteur) ii) comparer l'évolution des *spillovers* de connaissance en fonction du cycle de vie technologiques des énergies solaires et éoliennes iii) identifier les principales technologies complémentaires aux ENR solaires et éoliennes à l'origine des *spillovers*. Pour cela, le chapitre se base sur des données de citations entre brevets et sur une analyse de réseau dynamique. A notre connaissance il s'agit du premier papier cherchant à caractériser au fil du temps, selon le cycle de vie technologique, le contenu technologique des *spillovers* de connaissances vers les ENR avec une approche réseau. Ce chapitre vise ensuite à comparer les niveaux de spécialisation en innovation des pays dans les technologies éoliennes et solaires PV et leurs technologies complémentaires, ce qui permet d'analyser la cohérence des niveaux de spécialisation au sein des pays. Nous pouvons ainsi identifier des pays pour lesquels les niveaux de spécialisation sont cohérents, par exemple une forte spécialisation dans les énergies solaires PV et une forte spécialisation dans les technologies complémentaires à cette ENR. Au contraire, nous distinguons des pays avec une incohérence dans les niveaux de spécialisation, par exemple lorsque le pays a une forte spécialisation dans les technologies complémentaires et une faible spécialisation dans les ENR. Cette analyse permet alors d'identifier des pays qui auraient un intérêt conséquent à investir dans l'innovation dans les ENR du fait de leurs bases de connaissances dans les technologies complémentaires.

Le troisième et dernier chapitre aborde l'étude de l'effet des politiques climatiques sur les performances à l'export des ENR. Plus largement, ce chapitre cherche à étudier les interactions entre la performance relative en innovation, la performance relative à l'export et les politiques publiques de soutien à l'innovation/diffusion. L'analyse économétrique se base des modèles PVAR (*Panel Vector Auto Regressive*) permettant de prendre en compte les potentiels problèmes d'endogénéité entre les différentes variables. Les données couvrent 24 pays entre 1989 et 2014, sur les technologies éoliennes et solaires photovoltaïques. L'originalité de notre approche par rapport à la littérature existante repose sur trois éléments : la prise en compte de l'endogénéité qui améliore la qualité des résultats, l'étude des performances relatives et non absolues qui permet de considérer les dynamiques concurrentielles sur les marchés internationaux, et le fait d'appliquer cette étude aux énergies renouvelables.

## **6. Principaux résultats**

La littérature empirique existante montre que l'effet des politiques sur l'innovation et la diffusion varie selon le type de politique (politiques d'offre de soutien à l'innovation, politiques de diffusion basée sur les prix, politique de diffusion basée sur les quantités) et selon la technologie renouvelable (en particulier selon le niveau de maturité de la technologie). Les spécifications des modèles économétriques semblent également influencer les résultats. En particulier, il paraît crucial de distinguer les différentes technologies renouvelables (une régression économétrique par technologie) et d'utiliser des mesures de politiques prenant en compte le design de celles-ci. Les politiques indifférenciées quant aux technologies ciblées (certificats verts par exemple), stimulent l'innovation dans les technologies matures et proches

de la compétitivité alors que les prix garantis (tarifs d'achat par exemple) sont plus appropriés pour les technologies plus coûteuses. Les résultats de notre revue de la littérature font également ressortir le manque d'étude sur l'effet des *spillovers* de connaissances qui pourtant peuvent induire des effets indirects de politiques initialement non dirigées vers des technologies renouvelables. Par ailleurs, la littérature empirique existante semble se heurter à des difficultés à modéliser et à prendre en compte les interactions entre les politiques publiques, l'innovation et la diffusion des politiques. Or, la littérature théorique nous permet clairement d'envisager des effets de rétroactions et d'interdépendances entre toutes ces variables.

Nous montrons qu'une grande partie des *spillovers* est inter-technologique, c'est-à-dire qu'elle implique des connaissances dans des secteurs non renouvelables. Le contenu technologique des *spillovers* vers les technologies éoliennes et solaires photovoltaïques évolue avec le cycle de vie de ces technologies. Plus précisément, les innovations dans le domaine des transports, de la mécanique et du bâtiment jouent un rôle crucial pour le développement de l'énergie éolienne. Les innovations en matière d'optique, de revêtement et de chimie sont essentielles pour le photovoltaïque solaire. Dans de futures études, les politiques ciblant spécifiquement ces secteurs complémentaires seraient à prendre en compte afin d'affiner la réflexion sur les efforts à mettre en œuvre concernant les politiques ciblant directement les ENR. Par ailleurs, l'analyse des performances en innovation des pays dans les énergies solaires PV et leurs technologies complémentaires montre la forte domination du Japon. Seules la Belgique et l'Inde disposent d'une base de connaissances solide pour innover dans les nouvelles technologies solaires telles que les cellules organiques et les cellules à colorant alors que leur performance globale en innovation dans les technologies solaires PV est relativement faible. Ainsi, du fait de la domination du Japon nous avons très peu de pays avec une incohérence entre les niveaux de spécialisation. Pour les technologies éoliennes, les incohérences entre les niveaux de spécialisation sont plus prononcées. En particulier, la France bénéficie d'une très bonne performance dans les technologies aéronautiques mais cela ne s'est pas concrétisé par une surspécialisation dans l'innovation en matière d'énergie éolienne. La Grande-Bretagne, la Suède et l'Australie sont dans une situation similaire.

Enfin, nos résultats montrent que les dépenses publiques de RD semblent être plus appropriées que les politiques de diffusion pour améliorer les performances à l'exportation pour les deux technologies (éolien et solaire photovoltaïque). En effet, les politiques de soutien à la diffusion peuvent favoriser le développement des marchés intérieurs au détriment des exportations et même renforcer les importations. Pour les technologies éoliennes et solaires photovoltaïques nous concluons également à l'absence de cercle vertueux entre les performances relatives en innovation et à l'export. Nous constatons néanmoins quelques résultats différents entre les deux technologies, qui pourraient être expliqués par les différences de barrières à l'entrée et sur les coûts irrécupérables.

# Chapitre 1 : Quel impact des politiques climatiques sur les énergies renouvelables : une revue des études économétriques ?

---

*Ce chapitre a été publié dans la revue Innovation* : Bourgeois, G., Mathy, S., Menanteau, P., 2017. L'effet des politiques climatiques sur les énergies renouvelables : une revue des études économétriques. *Innovations* 54, 15. <https://doi.org/10.3917/inno.054.0015>

## Introduction

Des politiques spécifiques pour inciter à la fois à l'innovation et à la diffusion de ces technologies, ont été mises en œuvre dans un certain nombre de pays. D'un côté, le financement public de la RD par les incitations fiscales (crédits d'impôts recherche) ou financières (subventions, prêts à taux zéro) qui vise à soutenir l'innovation dans les nouvelles technologies. Et de l'autre, des politiques de soutien à la diffusion qui visent à assurer leur déploiement et sont classiquement organisées en deux catégories : les politiques basées sur les prix et les politiques basées sur les quantités. Dans la première catégorie, les tarifs d'achat garantis (FIT pour *Feed In Tariff*) et les dispositifs de primes ont pour objectif d'inciter les agents à investir dans de nouvelles capacités de production, en garantissant un prix de rachat qui assure la rentabilité des investissements dans un cadre stable et prévisible. Dans la seconde, les politiques basées sur les quantités fixent des objectifs d'intégration des ENR dans le mix énergétique et s'appuient sur des systèmes d'enchères ou des dispositifs de flexibilité tels que les certificats verts (Butler et Neuhoff, 2008; del Río, 2012; Dinica, 2006; Fouquet et Johansson, 2008). Ces instruments "quantités" ont été plus largement employés aux Etats-Unis via les *Renewable Portfolio Standards*<sup>7</sup> (RPS), alors que les pays européens ont eu majoritairement recours aux instruments "prix".

Les politiques de soutien à la diffusion visent bien évidemment à inciter les agents économiques à adopter les innovations. Ces politiques peuvent néanmoins avoir un impact sur l'innovation elle-même (*cf.* Figure 4), soit directement si l'amélioration de la rentabilité des projets qui en résulte permet aux développeurs d'investir dans la RD, soit indirectement, si l'élargissement de la diffusion de la technologie produit de nouvelles innovations par le biais d'effets d'apprentissage par exemple (Menanteau *et al.*, 2003 ; Söderholm et Klaassen, 2007).

---

<sup>7</sup> Les Renewable Portfolio Standards sont des quotas de production renouvelable généralement associés à un dispositif de flexibilité (type certificats verts)



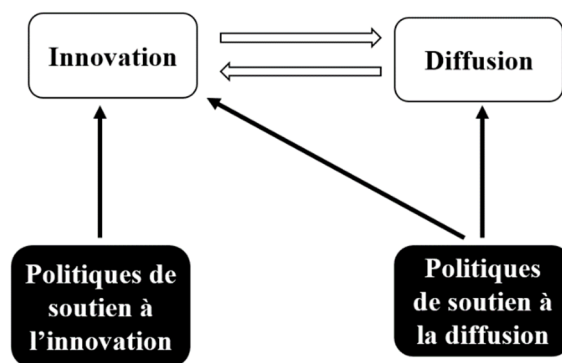

Figure 4 : Impact des politiques de soutien à l'innovation et à la diffusion sur le changement technologique

Il apparaît toutefois nécessaire d'étudier l'efficacité des politiques mises en œuvre dans ce domaine de manière à mieux comprendre les mécanismes en jeu, mais aussi de façon à éclairer la décision publique et constituer un mix de politiques à même de répondre à l'enjeu de décarbonation totale des systèmes techniques. Il existe en effet un débat sur le bon équilibre à établir entre le soutien à la diffusion et le soutien à l'innovation des ENR. Zachmann *et al.*, (2015) ont ainsi mis en évidence un déséquilibre important en faveur des politiques de diffusion qui pose la question de la pérennité du processus de changement technologique en cours et de la nécessité, ou non, d'un redéploiement par l'innovation (Dechezleprêtre *et al.*, 2016; Fischer *et al.*, 2014)

Cet article vise à éclairer ces enjeux en menant une revue de la littérature empirique, en fort développement dans les dix dernières années, qui traite de l'impact des politiques climatiques sur l'innovation et la diffusion des ENR. Plusieurs méthodologies pour l'analyse de ces impacts ont été déployées: des études de cas (del Río et Gual, 2007 ; Dutra et Szklo, 2008; Lipp, 2007) ou des enquêtes (Burer et Wüstenhagen, 2009; Lüthi et Wüstenhagen, 2012; Masini et Menichetti, 2012) associées ou non à des analyses de statistique descriptive. Notre analyse porte ici principalement sur les travaux cherchant à mettre en avant des régularités plus générales grâce à l'économétrie mais nous rappelons en début de chaque partie les principaux résultats obtenus dans la littérature non économétrique pour chaque type de politique énergie / climat. Plus de 50 études économétriques ont ainsi été identifiées qui se placent en grande majorité à l'échelle nationale. Afin d'identifier les papiers pertinents pour notre revue de la littérature nous n'avons pas utilisé d'approche systématique avec un ensemble de mots clés bien défini par la littérature en cherchant dans l'ensemble des sources disponible (y compris de littérature grise) car cela aurait été trop chronophage. Nous nous sommes basé sur les combinaisons des mots clés suivants : « Politiques publiques », « énergies renouvelables », « innovation », « diffusion », « études économétriques », « éolien », « solaire », « photovoltaïque », « capacités installées », « production électricité renouvelable ». Nous avons cherché à identifier des publications en français et en anglais.

Les effets des politiques nationales sur l'innovation sont étudiés dans la section 1, en examinant d'abord les politiques ayant un effet direct sur l'innovation (RD) puis dans un deuxième temps les politiques pouvant impacter indirectement l'innovation (politiques de diffusion par les prix

et par les quantités). Dans la section 2, nous étudions les effets des politiques sur la diffusion des technologies en traitant dans une première partie, les politiques de prix (FIT) puis les politiques quantités (RPS, certificats verts). La dernière partie de conclusion discute l'ensemble des résultats fournis par cette revue de littérature, aborde certains aspects méthodologiques et ouvre quelques perspectives de recherche ultérieures.

## **1. Impact des politiques énergie / climat sur l'innovation dans les ENR**

Dans la littérature non économétrique, la RD joue un rôle clé parmi les éléments qui influent sur la direction et le rythme de l'innovation, avec la dynamique d'apprentissage directement liée à la diffusion (Criqui *et al.*, 2000). La question de l'importance relative de ces deux facteurs a été notamment traitée par la littérature sur l'endogénéisation du progrès technique et les courbes d'apprentissage à deux facteurs (Kahouli-Brahmi, 2008 ; Kouvaritakis *et al.*, 2000). Malgré une certaine variabilité, les résultats montrent que les investissements de RD ont un effet positif sur l'innovation en permettant une baisse du coût des technologies de l'énergie (Kahouli-Brahmi, 2008 ; Jamasb, 2007), en particulier dans les premières phases de développement de la technologie (Grübler *et al.*, 1999). La littérature fait état également de nombreuses synergies et d'effets de *feedback* entre la RD, la baisse des coûts et la croissance des capacités. De ce fait, les investissements de RD sont plus efficaces lorsqu'ils sont complétés par d'autres politiques qui visent notamment à stimuler la demande pour ces technologies (IPCC, 2012 ; Sagar et Van der Zwaan, 2006 ; Nejj, 2008).

La littérature confirme également l'impact indirect des politiques de soutien à la diffusion sur la dynamique d'innovation. Selon Canton et Linden (2010), les politiques indifférenciées quant aux technologies ciblées (type RPS), stimulent l'innovation dans les technologies matures et proches de la compétitivité alors que les prix garantis (FIT) sont plus appropriés pour les technologies plus coûteuses et moins matures. Ceux-ci, en confortant les investisseurs sur la rentabilité des projets à long terme, ont aussi incité à l'innovation sur les technologies de l'éolien (Sawin, 2001; Hvelplund, 2001 ; Lewis et Wiser, 2005). A l'inverse, les politiques quantités (enchères et certificats verts), qui mettent l'accent sur la baisse des prix et la concurrence entre les technologies, ont entravé l'innovation et le développement industriel en Grande Bretagne (Mitchell *et al.*, 2006 ; Butler et Neuhoff, 2008). De façon générale, les politiques prix en renforçant la stabilité et la prévisibilité du marché des nouvelles technologies de l'énergie ont suscité l'intérêt des banques et attiré des capitaux privés vers la RD, ce que les politiques quantités n'ont pas été en mesure de réaliser (Sawin, 2006). D'après cette littérature, les instruments prix présentent un avantage clair sur les instruments quantités pour inciter à l'innovation.

Ces résultats sont-ils confirmés par la littérature économétrique ? Nous nous appuyons ci-après sur 21 études économétriques qui ont évalué l'impact sur l'innovation dans les ENR, de

politiques publiques de soutien à l'innovation, d'une part, et de soutien à la diffusion de l'autre (Figure 4). Ces études emploient principalement des modèles de comptage. Certaines réalisent plusieurs régressions économétriques, une par technologie renouvelable étudiée, ce qui fournit à partir de ces 21 études, 41 observations dont 13 concernant les technologies éoliennes et 11 les technologies solaires.

Nous avons choisi de nous focaliser sur les études qui utilisent les brevets comme mesure de l'innovation (qui pourrait être mesurée également par les dépenses de RD ou le capital humain participant aux activités de recherche). Bien entendu, les brevets ne sont pas la seule façon de protéger une invention et ils présentent des qualités intrinsèques hétérogènes mais l'intérêt de cette méthode est que l'accès aux données de brevets est relativement aisé et qu'ils constituent par ailleurs un *output* du processus d'innovation contrairement aux dépenses publiques de RD par exemple. De plus, la classification internationale permet de cibler des champs technologiques particuliers.

Globalement, les articles retenus confirment que la signature du Protocole de Kyoto a eu un effet déclencheur sur l'adoption dans les pays de politiques de diffusion et/ou d'innovation et a impacté positivement l'innovation dans les ENR (Johnstone *et al.*, 2010 ; Nicolli et Vona, 2016 ; Rübbelke et Weiss, 2011). Nesta *et al.* (2014) concluent également à un effet positif mais uniquement sur le dépôt de brevets de faible qualité<sup>8</sup>, le dépôt de brevets de qualité élevée ne semblant pas impacté. La raison avancée serait un problème de mauvaise allocation des ressources, les pays fournissant un effort de recherche trop important dans les domaines où ils manquent d'expertise.

Au-delà de ces politiques climatiques, différentes variables de contrôle sont généralement prises en compte, et en particulier le prix de l'électricité qui constitue un indicateur de la rentabilité attendue des investissements en innovation car un investissement dans la technologie génèrera d'autant plus de revenus que le prix de l'électricité est élevé. Empiriquement, Johnstone *et al.* (2010) ainsi que Nicolli et Vona (2016) observent que des prix de l'électricité élevés incitent effectivement à l'innovation dans les technologies solaires alors que Johnstone *et al.* (2010), Nicolli et Vona (2016), Rübbelke et Weiss (2011) ainsi que Walz *et al.* (2011) ne trouvent aucun effet sur l'innovation dans l'éolien. Cette différence proviendrait, selon les auteurs, de niveaux de maturité différents entre les deux technologies, la plus grande proximité du coût de l'éolien avec les prix de marché nécessitant un effort d'innovation moins soutenu.

Le nombre total de brevets déposés par un pays, toutes technologies confondues, qui reflète la dynamique globale d'innovation à l'échelle nationale est parfois pris en compte. Il est alors attendu que si le nombre de brevets augmente, le nombre de brevets dans le secteur des ENR augmente également. Cet effet est confirmé par Johnstone *et al.* (2010), Lanzi *et al.* (2012), Lindman et Söderholm (2016), Nesta *et al.* (2014) et Walz *et al.* (2011) pour les technologies éoliennes et solaires.

---

<sup>8</sup> La qualité est mesurée en pondérant chaque brevet par la taille de sa famille (nombre d'offices dans lesquels l'innovation a été brevetée) ou en ne considérant que les brevets triadiques c'est-à-dire ceux qui sont déposés dans les trois principaux offices de brevet : l'office américain, l'office européen et l'office japonais.

Le stock de connaissances dans les ENR<sup>9</sup> est également considéré, avec une distinction entre stock domestique et étranger. On observe que le stock existant d'innovations dans les ENR augmente la propension des agents à innover dans ces mêmes technologies, indiquant une certaine dépendance au sentier. Braun *et al.* (2010), Dechezleprêtre et Glachant (2014), Grafström et Lindman (2017) ou Nicolli et Vona (2016) le constatent notamment pour l'éolien et Braun *et al.* (2010) ou Peters *et al.* (2012) pour le solaire.

---

<sup>9</sup>Le stock de connaissances intègre un effet d'obsolescence calculé en actualisant le nombre de brevets déposés (Bosetti *et al.*, 2008; Buonanno *et al.*, 2003) en général à 15% (Grafström et Lindman, 2017).

Reference	Tech	Periode	Couv.geo	dfit	mfit	drps	mrps	mrd	inc	fisc	cap
Boehringer et al. (2014)	T	1990-2009	Allemagne					1			1
Boehringer et al. (2014)	T	2000-2009	Allemagne		0			0			
Braun et al. (2010)	E	1978-2004	OCDE	0		0		1			
Braun et al. (2010)	S	1978-2004	OCDE	0		0		1			
Choi et Anadon (2014)	S	2001-2009	OCDE+ Chine		1	0		0			
Dalmazzone et Corsatea (2012)	B	1997-2007	Italie					1			0
Dalmazzone et Corsatea (2012)	E	1997-2007	Italie					1			1
Dalmazzone et Corsatea (2012)	S	1997-2007	Italie					1			0
Dalmazzone et Corsatea (2012)	T	1997-2007	Italie					1			1
Dechezleprêtre et Glachant (2014)	E	1991-2008	79 pays					1			
Emodi et al. (2015)	E	1997-2011	OCDE	0				0			
Emodi et al. (2015)	S	1997-2011	OCDE	0				0			
Grafström et Lindman (2017)	E	1991-2008	Europe		0			0			
Johnstone et al. (2010)	B	1978-2003	OCDE		0		0	0	0	0	
Johnstone et al. (2010)	E	1978-2003	OCDE		0		1	1	0	0	
Johnstone et al. (2010)	S	1978-2003	OCDE		1		0	1	0	0	
Johnstone et al. (2010)	T	1978-2003	OCDE		1		1	1	1	0	
Kim et al. (2015)	E	1991-2006	OCDE	1		2		1	2	0	1
Kim et al. (2017)	S	1992-2007	OCDE	1		0		1	2	0	1
Kim et Kim (2015)	E	1991-2007 (solaire)	OCDE	1		0		1	0	2	
Kim et Kim (2015)	S	1997-2008 (éolien)	OCDE	1		0		1	0	0	
Kruse et Wetzel (2014)	E	1978-2009	OCDE					1			
Kruse et Wetzel (2014)	S	1978-2009	OCDE					0			
Lanzi et al. (2012)	T	1978-2008	OCDE					1			
Liang et Fiorino (2013)	T	1974-2009	USA					1			
Lindman et Söderholm (2016)	E	1977-2009	Europe		1			1			
Nesta et al. (2014)	T	1976-2007	OCDE					0			
Nicolli et Vona (2016)	B	1980-2007	Europe		0		0	1			
Nicolli et Vona (2016)	E	1980-2007	Europe		0		1	1			
Nicolli et Vona (2016)	S PV	1980-2007	Europe		1		0	0			
Nicolli et Vona (2016)	S Th	1980-2007	Europe		0		1	0			
Peters et al. (2012)	S	1978-2005	OCDE					1			1
Rexhäuser et Löschel (2015)	T	1992-2009	Allemagne					0			
Rübbelke et Weiss (2011)	E	1980-2008	OCDE		1			1	1	1	
Vincenzi et Ozabaci (2017)	S	1990-2008	OCDE		1		0	1			
Walz et al. (2011)	E	1991-2007	OCDE	0		1		1			

Table 2: Etudes économétriques évaluant l'impact des politiques de soutien à l'innovation et à la diffusion sur l'innovation dans les ENR

**Légende :**

E : Eolien ; S : Solaire ; B : Biomasse ; G : Géothermie ; S PV = Solaire Photovoltaïque ; S Th= Solaire Thermique ; H : Hydraulique ; M : Énergie Marines ; T : Toutes les ENR

dfit, mfit : mesure d'une politique prix avec respectivement une variable dummy et avec le montant du FIT

drps, mrps : mesure d'une politique quantité avec respectivement une variable dummy et avec le % de pénétration des ENR requis

mrd : Montant des dépenses publiques de RD dans la(les) technologie(s) étudié(es)

inc : incitations financière (subvention, prêts à taux zéro)

fisc : Incitations fiscales : crédits d'impôt

cap : capacités installées (mesure de la diffusion des technologies ENR)

0 : effet non significatif

1 : effet significativement positif

2 : effet significativement négatif

### 1.1. Impact des politiques de soutien direct à l'innovation

L'effet des dépenses de RD publiques est largement étudié dans la littérature empirique à la différence d'autres politiques de soutien à l'innovation comme les crédits d'impôts ou les subventions. Les dépenses de RD privées qui ne sont pas disponibles à un niveau sectoriel désagrégé, ne sont pas directement prises en compte dans ces travaux mais on peut faire l'hypothèse d'un lien entre dépenses publiques et dépenses privées de RD, l'impact sur l'innovation étant *in fine* imputable à l'une et à l'autre.

L'effet attendu des politiques publiques de RD est une incitation des agents à innover qui se traduit par un accroissement du nombre de brevets déposés. Globalement, les estimations empiriques confirment cela pour l'ensemble des ENR avec un effet particulièrement marqué pour les technologies solaire et éolienne (Figure 5).

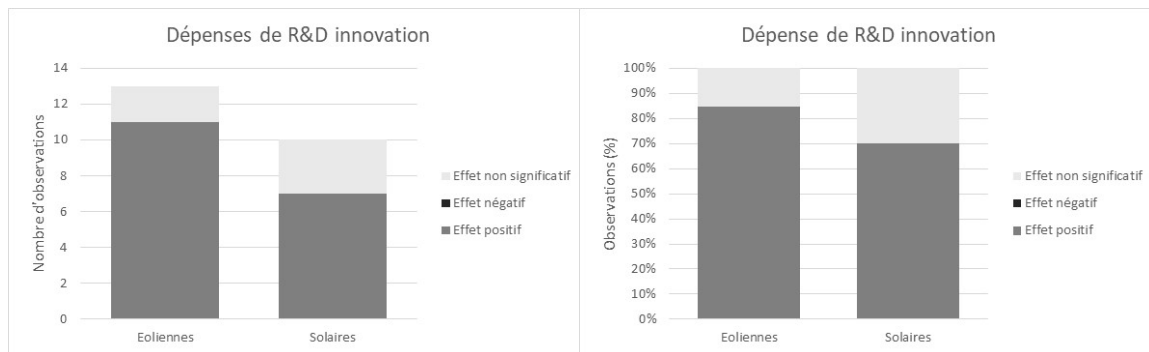

Figure 5: Effet des dépenses publiques de RD sur l'innovation dans les énergies éoliennes et solaires (gauche : nombre d'observation ; droite : % des observations)

Parmi d'autres, Dalmazzone et Corsatea (2012), Lanzi *et al.* (2012), Peters *et al.* (2012), Rübhelke et Weiss (2011), Walz *et al.* (2011), Boehringer *et al.* (2014) observent un effet positif des dépenses publiques de RD sur l'innovation dans les ENR (en particulier pour les énergies solaires et éoliennes). Cependant, respectivement 18% et 30% des études référencées dans cette

revue ont conclu à un effet non significatif sur les énergies éoliennes et solaires (e.g.Boehringer *et al.*, 2014; Emodi *et al.*, 2015; Nesta *et al.*, 2014; Rexhäuser et Löschel, 2015)<sup>10</sup>.

Certaines études s’intéressent également aux effets des dépenses de RD étrangères et donc aux effets de *spillovers* entre pays. L’accroissement des dépenses de RD dans un pays A doit induire une hausse des innovations ainsi qu’une augmentation du stock de connaissances dans ce pays et donc des flux de connaissances plus importants vers le pays B. L’effet de cet accroissement du stock de connaissance est toutefois moins important, pour le pays B, que l’effet des dépenses de RD domestiques, du fait de l’existence de barrières à la diffusion des connaissances (Jaffe *et al.*, 1993). Pour les technologies solaires et éoliennes, Peters *et al.* (2012) et Lindman et Söderholm (2016) ne trouvent toutefois aucun effet des dépenses de RD réalisées à l’étranger. Mais ce résultat serait selon eux à considérer avec prudence du fait de problèmes de corrélation entre variables qui pourraient expliquer l’absence d’impact significatif des dépenses de RD réalisées à l’étranger.

## 1.2. Impact sur l’innovation des politiques de diffusion basées sur les prix

L’objectif premier des politiques de diffusion n’est pas d’inciter les agents à innover mais, comme le montre la littérature non économétrique, celles-ci peuvent avoir un effet indirect sur l’innovation dans les ENR en améliorant les perspectives de rentabilité et donc le déploiement de la technologie.

La Figure 6 présente une synthèse du tableau 1 sur l’effet des politiques prix sur l’innovation dans les technologies éoliennes et solaires. On observe des effets très contrastés entre l’éolien et le solaire. Si une nette majorité d’études fait apparaître un effet positif des politiques prix sur l’innovation pour les technologies solaires (6 études économétriques soit 75% des observations), ce n’est pas le cas pour les technologies éoliennes (4 études soit 40% des observations).

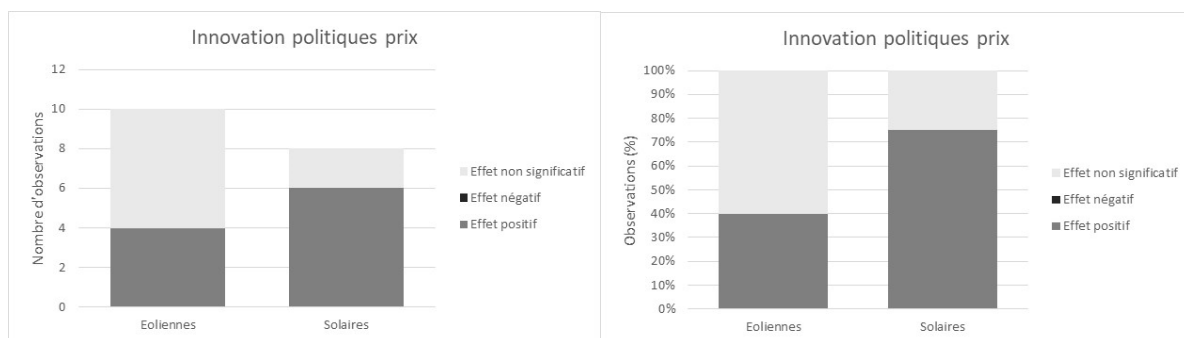

Figure 6: Effet sur l’innovation des politiques basées sur les prix pour les technologies éolienne et solaire (gauche : nombre d’observation ; droite : % des observations)

<sup>10</sup> Il est important de constater que deux de ces études (Boehringer *et al.*, 2014 ; Rexhäuser and Löschel, 2015) s’intéressent à l’innovation en Allemagne uniquement. Il serait ainsi intéressant d’approfondir ces analyses sur ce pays afin de mieux comprendre les mécanismes d’incitation à l’innovation et de mieux comprendre les interactions entre politiques de diffusion et politiques d’innovation.

Selon certains auteurs, cette différence d'impact sur l'innovation entre les technologies éolienne et solaire s'explique par la différence de maturité entre ces filières qui justifierait un effort de RD moindre pour les technologies les plus proches de la compétitivité économique.

Les auteurs qui n'observent pas d'effet significatif des politiques prix sur l'innovation pour le solaire utilisent une variable dummy (Braun et al., 2010 ; Emodi et al., 2015). En revanche, Choi et Anadón (2014) ; Johnstone *et al.*, (2010) ; Nicolli et Vona (2016) ainsi que Vincenzi et Ozabaci (2017), obtiennent des effets positifs de ces mêmes politiques sur le solaire mais utilisent pour cela une variable plus précise comme mesure de la politique (le montant du FIT). Les résultats obtenus dépendent donc en partie de la façon dont sont définis le modèle économétrique et les variables de politiques, une plus grande précision dans la caractérisation des politiques conduisant à des résultats plus favorables.

De même, l'absence de précision dans la caractérisation des technologies conduit à des résultats non significatifs. Boehringer *et al.* (2014) concluent à l'absence d'impact des FIT sur l'innovation en considérant l'ensemble des technologies ENR. La raison invoquée renvoie au fait qu'une politique "prix" va plutôt conduire à des innovations incrémentales par le *learning-by-doing*, alors que les brevets concernent plutôt des innovations de rupture, étant donné les coûts engendrés par leur dépôt et la possibilité d'avoir recours à d'autres moyens de protection d'une innovation (Boehringer *et al.*, 2014).

D'une certaine façon, l'absence d'effet significatif observé par Johnstone et al. (2010) ainsi que Nicolli et Vona (2016) pour les technologies de la biomasse peut s'expliquer également par une caractérisation trop imprécise d'une famille qui regroupe des technologies assez différentes les unes des autres.

### **1.3. Impact sur l'innovation des politiques de diffusion basées sur les quantités**

Les études sont ici moins nombreuses que pour la catégorie précédente et présentent des résultats très contrastés. Elles tendent à montrer que les politiques quantités sont plus efficaces pour inciter à l'innovation dans l'éolien que dans le solaire comme le montre la Figure 7 ci-dessous. La totalité des études qui évaluent l'effet des politiques quantité sur l'innovation dans le solaire observent un effet non significatif alors que la moitié des études qui concernent l'énergie éolienne conclue à un effet significativement positif.



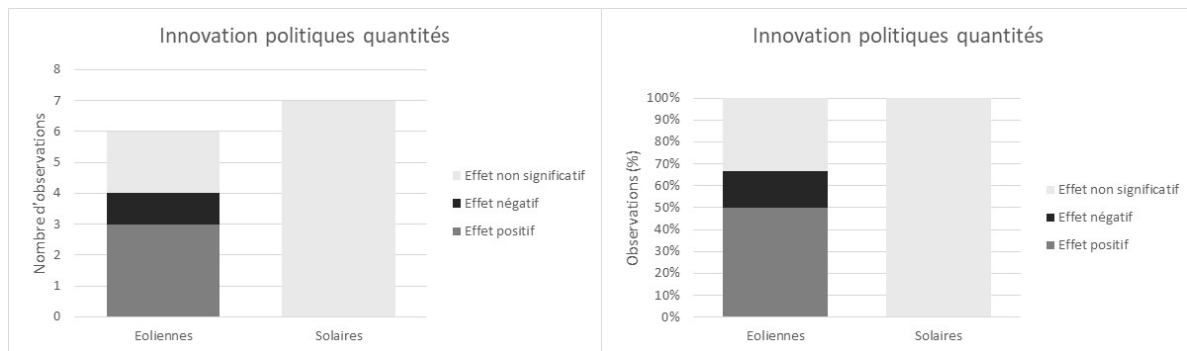

Figure 7: Effet sur l'innovation des politiques basées sur les quantités pour les technologies éolienne et solaire (gauche : nombre d'observation ; droite : % des observations)

Pour Johnstone *et al.* (2010) ainsi que Nicolli et Vona (2016) les politiques quantités favorisent l'innovation dans l'éolien mais n'ont aucun effet significatif sur l'innovation dans le solaire. Pour Braun *et al.* (2010), qui utilisent une variable dummy, ces politiques quantités n'ont pas plus d'effet sur l'innovation dans les technologies solaires que dans les énergies éoliennes<sup>11</sup>.

La principale raison invoquée est que les politiques quantité, en introduisant une concurrence entre les différentes ENR, favorisent les moins coûteuses et les plus matures comme les énergies éoliennes. Ces dispositifs n'offriraient pas de débouchés suffisants aux technologies encore trop peu compétitives comme le solaire et n'inciteraient donc pas à l'innovation.

A l'inverse l'absence d'effet positif sur les technologies de la biomasse observée par certains auteurs (Johnstone *et al.*, 2010 ; Nicolli et Vona, 2016) peut être à rechercher du côté de la trop grande maturité de ces technologies et de perspectives de progrès technique jugées par les acteurs trop limitées.

## 2. L'impact des politiques climatiques sur la diffusion des technologies

La littérature non économétrique sur l'impact des politiques de soutien à la diffusion des ENR est importante et comprend des études de cas nationales, des analyses comparatives entre plusieurs pays, et des travaux plus théoriques. Les unes et les autres concluent de façon générale à la supériorité des tarifs d'achat sur les dispositifs de quotas échangeables pour l'accroissement des capacités de production ainsi que pour l'efficacité économique.

Klessman *et al.* (2011) observent ainsi que les pays qui présentent la plus grande efficacité des politiques ont tous utilisé des prix garantis alors qu'à l'inverse, les performances sont moindres dans les pays ayant adopté des dispositifs de quotas. Stern (2007) conclut, avec d'autres (EC, 2008 ; Ragwitz *et al.*, 2007 ; del Rio & Bleda, 2012 ; IEA, 2008 ; Resch *et al.*, 2009), que les mécanismes de prix permettent d'atteindre une pénétration des renouvelables plus importante

<sup>11</sup> Kim *et al.* (2017) observent même un effet négatif des politiques quantités sur l'innovation dans l'éolienne (et un effet non significatif sur l'innovation dans le solaire).

et à moindre coût que les quotas et les dispositifs d'enchères. Cela est notamment lié au fait que la stabilité qu'ils apportent est plus importante que celle fournie par les politiques quantités (Haas *et al.*, 2011, Menanteau *et al.*, 2003).

Ces résultats sont confirmés par les analyses empiriques portant sur un ou plusieurs pays. Verbruggen et Lauber (2012) pour la Belgique, Butler et Neuhoff (2008) ou Mitchell *et al.* (2006) pour la Grande Bretagne et l'Allemagne, confirment la plus grande efficacité des systèmes de prix face aux quotas échangeables. Pour les Etats-Unis, qui n'ont eu recours qu'à des dispositifs de quotas, les résultats sont plus nuancés, l'efficacité des dispositifs de quotas n'étant avérée que dans certains Etats (van der Linden *et al.*, 2005 ou Wiser *et al.*, 2007).

Dans cette seconde partie, nous présentons les résultats des études économétriques qui portent sur l'évaluation de l'impact des politiques climatiques sur la diffusion des technologies d'énergie renouvelable. Nous nous basons pour cela sur 35 études économétriques qui comportent au total 55 observations dont 19 pour les technologies éoliennes et 12 pour les technologies solaires (Table 3). Des modèles de panel sont majoritairement utilisés. La diffusion y est mesurée principalement grâce à deux indicateurs: la production issue d'ENR (énergie) ou les capacités installées de production d'ENR (puissance). Ces indicateurs sont exprimés en valeur absolue ou en pourcentage du mix énergétique.

Les variables de contrôle prises en compte dans ces études économétriques sont multiples : les facteurs économiques reflétant la plus forte propension des pays riches à favoriser les nouvelles technologies (Romano *et al.*, 2017), la dépendance aux énergies fossiles (Bolkesjø *et al.*, 2014; Carley, 2009; Jenner *et al.*, 2013; Marques et Fuinhas, 2012), la densité de population limitant la place disponible pour développer les ENR (Adelaja *et al.*, 2010; Hitaj, 2013), les facteurs politiques mesurant le degré de conscience environnementale des élus (Carley, 2009) ou la couleur politique du gouvernement (Adelaja *et al.*, 2010).

Outre l'effet des politiques ciblées sur les ENR, celui de l'augmentation du prix de l'électricité sur la diffusion est également analysé. Si des prix déjà élevés peuvent inhiber les investissements dans des moyens de production encore plus onéreux, on attend qu'une augmentation du prix de l'électricité améliore la rentabilité relative de la production renouvelable (Carley, 2009). Et, de manière générale, les études montrent un effet positif d'une augmentation du prix sur la diffusion des ENR (Dijkgraaf *et al.*, 2014; Gavard, 2016; Romano *et al.*, 2017).

Reference	Tech	Periode	Couv.geo	dfit	mfit	sfit	drps	mrps	isirps	rpst	inc	fisc
Adelaja et al. (2010)	E	2000	USA				1	1		1	2	
Aguirre et Ibikunle (2014)	T	1990-2010	38 pays								0	2
Bolkesjø et al. (2014)	E	1990-2012	Europe			1			0			
Bolkesjø et al. (2014)	S	1990-2012	Europe			1			0			
Bolkesjø et al. (2014)	B	1990-2012	Europe			0			1			
Bowen et Lacombe (2015)	T	1990-2012	USA						1		0	
Carley (2009)	T	1998-2006	USA				1				0	
Carley et al. 2016	T	1990-2010	164 pays	1			1				0	
Choi et Anadon (2014)	S	2001-2009	OCDE		1		0					
del Río et Tarancón (2012)	E	2006	Europe	0		0						
Delmas et Montes-Sancho (2011)	T	1998-2007	USA				1				0	
Dijkgraaf et al. (2014)	S	1990-2011	OCDE		1							
Dong (2012)	E	2005-2009	53 pays	1			0					
Gavard (2016)	E	2000-2010	Danemark	1	1							
Grafström et Lindman (2017)	E	1991-2008	Europe		1							
Hitaj (2013)	E	1998-2007	USA					0			1	1
Hitaj et al. (2014)	E	1996-2010	Allemagne		1							
Jenner et al. (2013)	E	1992-2008	Europe	1		1			0			0
Jenner et al. (2013)	S	1992-2008	Europe	0		1			0			0
Kilinc-ata (2016)	T	1990-2008	Europe + USA	1			0					1
Kim et al. (2015)	S	1992-2007	OCDE	1			0				2	2
Kim et al. (2015)	E	1991-2006	OCDE	0			1				1	2
Krasko et Doris (2013)	S	2010	USA							1		
Li et al. (2017)	E	1996-2013	Europe	1			1				1	1
Li et al. (2017)	S	1996-2013	Europe	1			0				0	0
Menz et Vachon (2006)	E	1998-2003	USA				1			1		
Nicollini et Tavoni (2017)	T	2000-2010	Europe		1						1	
Polzin et al. (2015)	T	2003-2011	OCDE								0	1
Polzin et al. (2015)	E	2003-2011	OCDE								0	0
Polzin et al. (2015)	S	2003-2011	OCDE								1	0
Polzin et al. (2015)	B	2003-2011	OCDE								1	0
Popp et al. (2011)	E	1991-2004	OCDE		0			0				
Popp et al. (2011)	B	1991-2004	OCDE		0			0				
Romano et al. (2017)	T	2004-2011	22 pays (PED)	2			1				2	1
Romano et al. (2017)	T	2004-2011	34 pays (ind.)	2			2				0	1

Table 3: Etudes économétriques évaluant l'impact des politiques de soutien à l'innovation et à la diffusion sur la diffusion des ENR au sein des pays

Reference	Tech	Periode	Couv.geo	dfit	mfit	sfit	drps	mrps	isirps	rpst	inc	fisc
Sarzynski et al. (2012)	S	1997-2009	USA				1			1	1	0
Schmid (2012)	T	2001-2009	Inde		0							
Shrimali et al. (2015)	T	1991-2010	USA						1		0	
Shrimali et al. (2012)	T	1990-2010	USA						0		0	
Shrimali et al. (2012)	B	1990-2010	USA						0		1	
Shrimali et al. (2012)	G	1990-2010	USA						0		0	
Shrimali et al. (2012)	S	1990-2010	USA						0		0	
Shrimali et al. (2012)	E	1990-2010	USA						0		0	
Shrimali et Jenner (2013)	S	1998-2009	USA				0					0
Shrimali et Kniefel (2011)	T	1991-2007	USA					1			1	
Shrimali et Kniefel (2011)	E	1991-2007	USA					0			1	
Shrimali et Kniefel (2011)	S	1991-2007	USA					1			0	
Shrimali et Kniefel (2011)	B	1991-2007	USA					2			1	
Shrimali et Kniefel (2011)	G	1991-2007	USA					1			1	
Smith and Urpelainen (2014)	T	1979-2005	OCDE		1							
Smith and Urpelainen (2014)	E	1979-2005	OCDE		1							
Yin et Powers (2010)	T	1993-2006	USA				0	2	1	0	0	
Zhang (2013)	E	1991-2010	Europe		0							
Zhao et al. (2013)	B	1980-2010	122 pays	1			1				1	1
Zhao et al. (2013)	E	1980-2010	122 pays	1			2				1	0

Légende :

E : Eolien ; S : Solaire ; B : Biomasse ; G : Géothermie ; S PV = Solaire Photovoltaïque ; S Th= Solaire Thermique ; H : Hydraulique ; M : Energies Marines ; T : Toutes les ENR

dfit, mfit : mesure d'une politique prix avec respectivement une variable dummy et avec le montant du FIT

drps, mrps : mesure d'une politique quantité avec respectivement une variable dummy et avec le % de pénétration des ENR requis

mrd : Montant des dépenses publiques de RD dans la(les) technologie(s) étudiée(s)

inc : incitations financière (subvention, prêts à taux zéro)

fisc : Incitations fiscales : crédits d'impôt

cap : capacités installées (mesure de la diffusion des technologies ENR)

0 : effet non significatif

1 : effet significativement positif

2 : effet significativement négatif

## 2.1. Impact des politiques basées sur des prix sur la diffusion

Quinze études économétriques qui analysent l'impact des politiques prix sur la diffusion des ENR ont été recensées. La plupart concerne les pays développés ou de l'OCDE et quelques-unes prennent en compte des pays en développement (Carley *et al.*, 2016 ; Dong, 2012 ; Schmid, 2012 ; Romano *et al.*, 2017 ; Zhao *et al.*, 2013). Nous concentrons notre analyse sur l'éolien et le solaire, les autres technologies ayant été peu couvertes dans la littérature. Mentionnons pour mémoire, la variable agrégée (Toutes) qui intègre l'ensemble des ENR et présente des résultats très contrastés (Figure 8) en raison certainement de son caractère indifférencié.

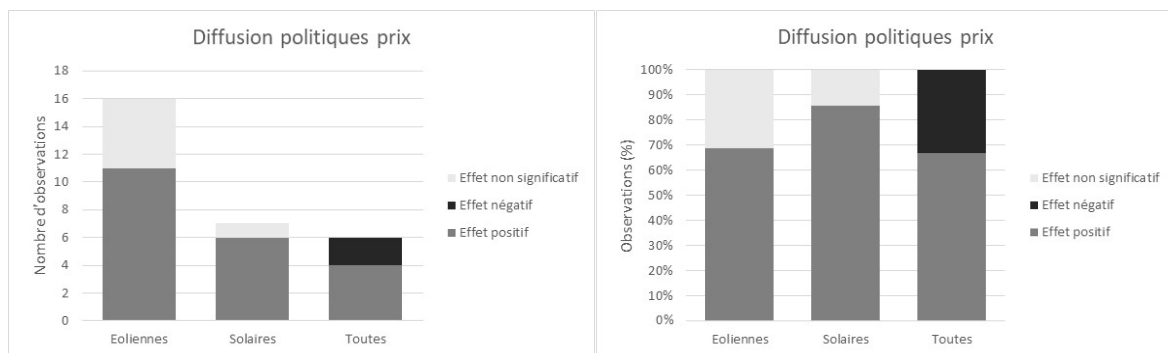

Figure 8: Effet sur la diffusion des politiques prix pour les technologies éolienne, solaire et ENR

Malgré un plus faible nombre d'études pour les technologies solaires, les résultats font clairement apparaître un effet positif de l'introduction des dispositifs de prix garantis sur la diffusion des ENR.

Pour le solaire, la quasi-totalité des études que nous avons identifiées montre un effet positif significatif pour les politiques prix (Bolkesjø *et al.*, 2014; Dijkgraaf *et al.*, 2014; Li *et al.*, 2017). Les résultats apparaissent également majoritairement positifs pour les technologies éoliennes (Dong, 2012; Hitaj *et al.*, 2014; Li *et al.*, 2017) ou éventuellement positifs mais non significatifs (Popp *et al.*, 2011; Zhang, 2013). Le principal argument utilisé pour expliquer un effet non significatif est que les technologies éoliennes, plus matures que les technologies solaires, sont d'ores et déjà proches de la compétitivité. Une politique de diffusion basée sur les prix, ne serait alors plus aussi indispensable qu'elle peut l'être pour des technologies moins matures (photovoltaïque par exemple). Certains auteurs évoquent également l'effet contre-incitatif que créeraient des prix d'achats élevés soupçonnés d'être non pérennes par les agents (Popp *et al.*, 2011; Zhang, 2013).

Au-delà de ces effets généraux, les résultats des études économétriques apportent des enseignements intéressants sur l'influence des éléments de design dans les modèles économétriques. Ainsi, Jenner *et al.* (2013) définissent un indicateur qu'ils nomment SFIT<sup>12</sup> et

<sup>12</sup> Plus précisément, cet indicateur mesure le ratio du profit par kWh produit (en prenant en compte le montant du tarif) sur le coût total unitaire de production.

qui permet de prendre en compte la différence entre le montant du prix d'achat et le coût de production ainsi que la durée du contrat. Alors qu'une dummy conduit à un impact non significatif pour le solaire, la prise en compte de l'indicateur SFIT fait apparaître un impact significativement positif : une augmentation de 10 points de pourcentage du SFIT impliquant une croissance des nouvelles capacités solaires de 5,6% pour Jenner *et al.* (2013) et de 18,71% pour Bolkesjø *et al.* (2014).

Dans le même esprit, alors qu'avec le seul montant du tarif comme élément de design, Zhang (2013) ne trouve aucun effet significatif du tarif d'achat sur l'innovation pour l'éolien, l'inclusion dans le modèle de la durée du contrat de rachat (en années) et d'une dummy pour l'existence d'une obligation d'achat conduisent à un effet positif de la politique sur la diffusion de l'éolien : une prolongation de 1 % de la durée du contrat augmente les installations annuelles de 0,3 %. Zhang (2013) explique ce résultat par le fait que, toutes choses étant égales par ailleurs, l'augmentation de la durée du contrat permettrait de réduire l'incertitude sur la rentabilité des investissements dans de nouvelles capacités de production. Dijkgraaf *et al.* (2014) trouvent également un effet positif de la durée du contrat sur la diffusion des technologies photovoltaïques. La stabilité de la politique qui apparaît comme un élément déterminant sur l'adoption des ENR dans de nombreuses études de cas est peu documentée dans la littérature économétrique, mais néanmoins confirmée par del Río et Tarancón (2012) et Dijkgraaf *et al.*, (2014).

Gavard (2016) compare enfin l'effet d'une politique de prix garantis avec une politique de type « premium<sup>13</sup> » sur la diffusion des énergies éoliennes et observe que la première est plus efficace pour assurer le déploiement de l'éolien car elle limite le risque subi par les investisseurs par rapport à un dispositif de premium qui expose le producteur à la variabilité des prix sur le marché de gros de l'électricité.

## **2.2. Impact des politiques basées sur des quantités sur la diffusion**

Vingt-deux études économétriques traitant des politiques quantités ont été identifiées dont une grande majorité concerne les États-Unis puisque les instruments quantités y ont été largement utilisés. Popp *et al.* (2011) ainsi que Dong (2012) analysent respectivement des données de 26 pays de l'OCDE et de 53 pays différents (liste non précisée dans le papier). Romano *et al.* (2017) s'intéressent à 56 pays développés et en développement. Peu d'analyses couvrent l'Union Européenne (Bolkesjø *et al.*, 2014 ; Jenner *et al.* 2013 ; Li *et al.*, 2017). Les résultats obtenus pour l'éolien et le solaire sont synthétisés sur la Figure 9.

---

<sup>13</sup> Avec une politique « premium », le producteur d'ENR est rémunéré par la vente d'électricité sur le marché de gros (prix variables) et par une prime fixe.

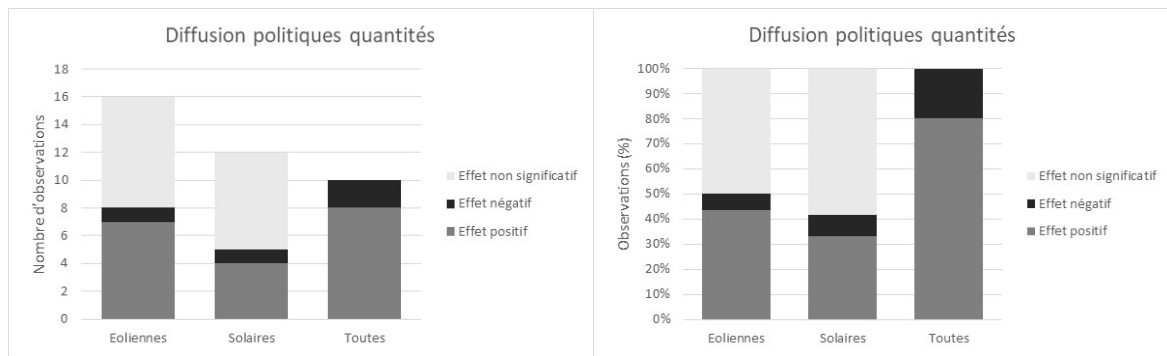

Figure 9: Effet sur la diffusion des politiques quantités pour les technologies éolienne, solaire et ENR (gauche : nombre d'observation ; droite : % des observations)

Les résultats confirment ce qu'indiquent les études non économétriques qui comparent l'efficacité des politiques de soutien aux renouvelables : les politiques prix présentent de manière générale une plus grande efficacité que les politiques quantités. On observe ainsi que la proportion des études qui fait apparaître des effets positifs de la mise en œuvre de politiques quantités est sensiblement plus faible que pour les instruments prix (cf. Figure 5). Cette proportion est plus faible encore pour les technologies solaires, ce que les études non économétriques ont bien souligné<sup>14</sup>.

Parmi les instruments quantités, les certificats verts ont été relativement peu utilisés en Europe et ils semblent avoir peu contribué à la diffusion du solaire et de l'éolien. Dans le cas du solaire, l'effet de ces politiques n'est pas significatif (Jenner *et al.* 2013; Bolkesjø *et al.*, 2014) et, il ne l'est pas non plus pour l'éolien selon Jenner *et al.* (2013) ou Bolkesjø *et al.* (2014) si on examine l'indicateur ISI (*Incremental Share Indicator*) qui mesure la différence entre la pénétration à une date  $t$  des ENR et l'objectif fixé par la politique quantité. Ce résultat est confirmé par Popp *et al.* (2011) ainsi que par Dong (2012). Ce manque d'effet significatif des dispositifs de certificats verts est toutefois probablement lié à leur faible utilisation en Europe où d'autres politiques quantités comme les appels d'offres ont été privilégiées.

Les effets des politiques de diffusion basées sur des quantités sont plus apparents aux États-Unis où ils ont été plus systématiquement utilisés sous la forme de dispositifs de RPS et sur une période plus longue: ainsi, en 2009, 31 Etats des Etats-Unis utilisaient une politique de type RPS (Carley, 2009). Les instruments quantité ont également été utilisés en Europe mais sous la forme de système d'enchères et dans 5 pays seulement: Royaume-Uni, Irlande, France, Portugal, Lettonie (Jenner *et al.*, 2013).

Aux Etats-Unis, l'impact sur la diffusion est clairement positif (Adelaja *et al.*, 2010; Bowen and Lacombe, 2015; Delmas and Montes-Sancho, 2011; Krasko and Doris, 2013; Sarzynski *et al.*, 2012) ou plus rarement non significatif (Shrimali et Jenner, 2013). Adelaja *et al.* (2010); Menz et Vachon (2006) montrent ainsi un effet positif des politiques RPS sur la diffusion de l'énergie éolienne. Avec un dispositif de soutien comme le RPS qui met en concurrence les technologies quel que soit leur niveau de maturité, les résultats sont beaucoup moins favorables pour le solaire en raison de son coût plus élevé. Certains auteurs, tels que Shrimali *et al.*, (2011)

<sup>14</sup> On observe comme pour les politiques prix que l'impact des politiques quantités sur la totalité des technologies ENR conduit à des résultats contrastés, avec une forte proportion de résultats positifs mais également des résultats négatifs qu'il est difficile d'expliquer.

et Sarynski et al (2012) obtiennent néanmoins des résultats positifs mais ne proposent pas d'explication à ce résultat qui peut tenir à la nature spécifique des programmes considérés (politiques quantités ciblées sur la technologie solaire par exemple).

L'expérience des Etats Unis qui n'ont pas utilisé les politiques prix, rappelons-le, atteste du fait que les politiques quantités peuvent également stimuler la diffusion alors qu'en Europe le retour d'expérience est plus controversé. L'expérience accumulée sur ces dispositifs se révèle également un élément important puisque certains auteurs observent que le nombre d'années depuis la mise en place de la politique a un effet sur la diffusion des technologies renouvelables aux Etats-Unis (Adelaja *et al.*, 2010 ; Menz et Vachon, 2006; Sarzynski *et al.*, 2012).

Enfin, quelques études ont évalué l'effet des appels d'offres sur la diffusion des ENR (Bolkesjø et al., 2014; Jenner et al., 2013; Kilinc-Ata, 2016) avec des résultats mitigés : positifs et significatifs pour Kilinc-Ata (2016) sans distinction entre les technologies, positifs également pour l'éolien mais non significatifs pour le solaire et la biomasse selon Bolkesjø *et al.* (2014). La période considérée explique ici certainement les résultats, les premiers dispositifs d'enchères utilisés en Europe ayant produit des effets très peu significatifs en termes de capacités installées alors que les appels d'offres récents, pour l'éolien offshore ou pour les centrales PV au sol semblent bien plus efficaces.

### **3. Discussion et conclusion**

Cet article propose une synthèse des principales études économétriques sur l'effet des politiques de soutien à l'innovation et à la diffusion dans le domaine des ENR. Il fait ressortir les résultats de ces travaux et leur convergence avec les conclusions de la littérature non économétrique sur l'impact de ces politiques.

Comme attendu, les études économétriques confirment l'impact des dépenses publiques domestiques de RD sur l'innovation, mesurée par le nombre de brevets, pour l'ensemble des technologies renouvelables (pas de disparité entre technologies). En revanche, elles ne font pas apparaître d'effet significatif sur l'innovation des dépenses publiques de RD réalisées à l'étranger, alors que cet effet était également attendu.

De façon plus indirecte, les politiques de diffusion (basées sur les prix ou les quantités) ont également un effet sur la dynamique d'innovation. Mais sur ce plan, les instruments prix qui renforcent la stabilité et la prévisibilité du marché pour les nouvelles technologies de l'énergie présentent des résultats plus nettement positifs que les instruments quantités.

Les études économétriques confirment également ce que les études non économétriques avaient mis en avant, c'est-à-dire, un impact positif des politiques de diffusion sur le déploiement des technologies. Politiques de prix et politiques quantités présentent des effets nettement positifs mais les politiques prix apparaissent plus efficaces pour des raisons qui ont été bien décrites dans les travaux non économétriques.

Les impacts sur le changement technologique peuvent être différenciés selon le niveau de maturité des technologies. Ainsi, l'effet des politiques de prix, qui protègent les nouvelles technologies de la concurrence directe facilitent leur émergence et se révèlent donc plus



significatif pour la diffusion des technologies solaires que pour la diffusion des technologies éoliennes. Pour cette même raison, les politiques de diffusion basées sur les quantités qui exposent les nouvelles technologies à la concurrence sont plus adaptées à la diffusion des technologies éolienne que solaire.

Cette synthèse des études économétriques et la statistique descriptive qu'elle a permise font ainsi apparaître des conclusions plus spécifiques à certaines technologies, à certains types de politiques... Il serait certainement intéressant de prolonger ce travail par une méta-analyse s'appuyant sur une recherche bibliographique plus systématique qui permettrait sans doute de mieux identifier les sources d'hétérogénéité dans les résultats.

Par ailleurs, cette synthèse de la littérature fait ressortir certains aspects encore peu étudiés.

Premièrement, la littérature semble ne pas suffisamment analyser l'impact des *spillovers* de connaissances. Or, la mise en œuvre d'une politique de diffusion dans un pays peut se traduire par une incitation à innover dans d'autres pays par le biais des transferts de technologies et des importations. Ces *spillovers* de connaissances géographiques peuvent aussi avoir un effet négatif sur l'innovation dans un autre pays du fait des relations de compétitions sur les marchés internationaux. Au-delà de cette dimension géographique, les *spillovers* de connaissance peuvent se produire entre secteurs technologiques. Par exemple, l'innovation dans l'éolien a pu se baser sur des technologies de l'aéronautique notamment pour perfectionner la rotation des pales. Dès lors, du fait de ces *spillovers* de connaissances intersectoriels, des politiques de soutien aux industries aéronautiques peuvent influencer directement la dynamique d'innovation dans les énergies éoliennes.

Deuxièmement, Grafström et Lindman (2017) ou Kim et Kim (2015), par exemple, cherchent à comprendre les mécanismes de rétroaction en jeu dans les processus de changement technologique. Cette prise en compte des *feedbacks* entre innovation et diffusion constitue une limite importante des études économétriques actuelles et une difficulté persistante de modélisation empirique des processus interactifs. Or les politiques publiques, dans un objectif de croissance verte, cherchent à assurer le développement technologique des solutions bas carbone ainsi que la croissance économique et la création d'emplois dans ces secteurs. De plus, la littérature économétrique sur la diffusion des innovations entre les pays apparaît très peu fournie alors que les enjeux en termes d'emplois et de stratégie industrielle sont importants.

C'est pourquoi dans le deuxième chapitre, nous aborderons la question des *spillovers* de connaissance intersectoriels et leur rôle dans les dynamiques d'innovation dans les énergies renouvelables éoliennes et solaires photovoltaïques. Dans ce chapitre, après avoir identifié clairement les principales technologies complémentaires aux ENR, nous comparons les performances en innovation dans les ENR et dans leurs technologies complémentaires, au sein des pays.

Notre troisième chapitre, cherchera quant à lui, à dépasser les difficultés de modélisation économétrique afin d'étudier les interactions entre les politiques publiques, le développement technologique des ENR et la performance économique des pays dans ce secteur. En particulier, afin d'étudier la diffusion des technologies entre les pays et les *spillovers* que cela implique, nous analyserons la performance économique via les exportations d'ENR éoliennes et solaires photovoltaïques. Des indicateurs de performance relative (avantages comparatifs révélés)

permettront de prendre en compte les relations de concurrence commerciale sur les marchés internationaux.

# Chapter 2: Specialization in complementary technologies and innovation performance in solar PV and wind technologies: a dynamic social network analysis

---

## 1. Introduction

Knowledge may flow through different channels: geographic proximity (Marshall 1890, Arrow 1962, Romer 1986, Jacob 1969, Porter 1990), cooperation between economic agents (Freeman, 1988 ; Kulve and Smit, 2003), commercial relations (Dechezleprêtre et al. 2013; Kim and Kim, 2015). In the economic literature assessing the effect of climate policies on REN, the impact of knowledge spillovers is hardly addressed (see chapter 1). Some issues related to intra-technology and inter-technology spillovers were analysed (Noailly and Shestalova, 2017, Krafft et al; 2011, Choe et al. 2016, Battke et al. 2016), but the temporal evolution of these spillovers along the life cycle of technologies, particularly for the renewable energies got little attention.

Yet, Nemet (2012) shows that key technological developments in the energy sector have been based on knowledge from other technological sectors (as chemical, electronics, or electrical). Furthermore, many energy innovations do not come from energy companies but from semiconductor firms (solar PV panel innovations), from electro-mechanical machinery firms (gas turbines inventions), from agriculture (biofuel feedstocks inventions), and from biochemistry (biofuel conversion technology inventions) (Markard, 2011; Wiesenthal et al., 2011). More generally, innovations in renewable energies interact with a multitude of energy and non-energy technologies (Dechezleprêtre et al., 2014, Noailly and Shestalova, 2017, OECD 2010, Popp and Newell, 2012).

Therefore, innovation in renewable energy may be influenced by knowledge externalities (knowledge spillovers) from various sectors. These knowledge externalities can lead to indirect effects of public policies targeting complementary technologies. For example, if innovation in wind technologies is based on knowledge of the aeronautical sector, innovation in this field could influence the pace of innovation in wind. Thus, policies supporting innovation in the aeronautics sector could have an indirect effect on innovation in renewable energy due to these knowledge spillovers. Knowledge spillovers have heterogeneous effect across REN because the technological sectors at the origin of these spillovers are specific to each REN and each complementary technology has its own innovation dynamic. The effects of knowledge spillovers can also be heterogeneous across countries. In fact, innovations in a complementary sector affect the knowledge created by a country's inventors only if this country has the appropriate knowledge base to absorb external knowledge. These absorption capacities depend in particular on the country's knowledge stocks, *i.e.* its past innovation choices. The effects of spillovers may also depend on how each country incentivize inter-sectoral cooperation. Thus, when one try to study the impact of public policies on innovation in renewable energies, it is likely to get heterogeneous effects depending on technologies and on countries.

The first objective is to identify complementary technologies to wind and solar photovoltaic energies. The technology content is likely to evolve over time, following the technological evolution of REN (Huenteler et al., 2016). We therefore study knowledge spillovers in a dynamic and not in a static way. In particular, we seek to identify complementary non-renewable energy sectors in order to be able to justify potential effects of non-climate public policies. The results will then allow us to compare the key complementary technologies between the two REN.

The second objective is to get some insights on the heterogeneity across countries of the effects of knowledge spillovers. More specifically, we characterise countries depending on the consistency of their innovation performance in complementary and REN technologies: good performance in both, low performance in complementary technologies but good performance in renewable technology... This may help justifying potential heterogeneous policy effects across countries.

Methodologically, we rely on the PATSTAT patent database and more particularly on patent citations as a proxy of knowledge spillovers to investigate dynamically the technological pattern of knowledge spillovers toward wind and solar PV. In order to identify the sectors that play a key role in solar PV and wind innovation we build the networks of co-occurrence of technologies within these citations. Then, in order to study the consistency of countries' levels of specialization in complementary and REN technologies, we use a relative performance indicator derived from the revealed comparative advantage indicator developed by Balassa (1965).

Our results show that, on the one hand, innovations in transport, in mechanical and building engineering play a crucial role for wind technological development. On the other hand, innovations in optic, coating and chemistry are key for solar PV. Because of Japan's strong innovation dominance in solar technologies and their complementary technologies, only Belgium and India have a strong knowledge base to innovate in new solar technologies such as organic cells and dye-sensitized cells. For wind technologies, the inconsistencies between the levels of specialization are more pronounced. In particular, France benefits from a very good performance in aeronautical technologies but this has not materialized in an over-specialization in wind energy innovation. Great Britain, Sweden and Australia are in a similar situation.

This analysis may help improving further empirical studies evaluating the dynamics of innovation in renewable energy, particularly in terms of public policy evaluation and justify heterogeneous effect across country and REN technologies.

The paper proceeds as follows. Section 2 deals with the related literature to introduce our main research questions. Section 3 describes the methodology and section 4 the data. In Section 5 we identify the key complementary technologies to wind and solar PV energies. In section 6, we describe the level of specialization in complementary technologies of countries around the world and analyses the consistency between their specialization in complementary technologies and in REN. Section 7 concludes.

## **2. Related literature and research questions**

### **2.1. Intra- and inter-technology spillovers and the life-cycle of technologies**

#### **2.1.1. Upstream knowledge spillovers**

Factors that may influence the intensity and the direction of innovation are various. They depend on inventor specific factors and on characteristics of his environment, for instance:

- The access to financial support to fund innovation which is, by definition, a hazardous investment;
- The concentration degree of the market or the size of the innovative firms (Pavitt, 1999);
- The price of substitute goods (Hicks, 1932)
- The policy mix (Porter and Van der Linde, 1995)

Furthermore, some technology push or technology pull factors may influence innovation:

Firstly, according to Weitzman (1998) “*new ideas arise out of existing ideas in some kind of cumulative interactive process*”. From this point of view, the innovation process recombines existing knowledge and transforms it into something different and new. Innovating means assimilating and recombining various pieces of knowledge, creating knowledge spillovers between technologies. Therefore, to analyze the impact of knowledge spillovers on the dynamics of innovation in RENs it is necessary to focus on the fields of knowledge that are recombined to create new renewable technologies.

Secondly, a knowledge can be recombined with other pieces of knowledge to produce future innovations. These future applications are potential markets and influence innovation dynamics through a "demand-pull" process (Schmookler, 1962, 1966) in which markets with high profit expectations encourage innovation (see Peters et al., 2012 for an empirical evidence).

Thus, to understand the dynamics of innovation in renewable energies it is crucial to evaluate the technological content of spillovers, particularly upstream spillovers.

#### **2.1.2 Intra and inter-technological spillovers**

Based on Gilfillan (1935) and Usher (1954), previous literature attempted to trace the origins of innovations. These studies dealing with knowledge flows, knowledge spillovers and the characteristics of knowledge emphasize that novel technologies build upon and recombine existing knowledge from near and distant technologies. Some knowledge tend to generate knowledge flows mostly within the same technology, reinforcing the existing technological trajectories and thereby locking-ins. Other knowledge generates spillovers across technologies and thus has the potential to increase technological variety (Van den Bergh, 2008; Schoenmakers and Duysters, 2010; Battke et al. 2016).

Therefore, technologies involved in the upstream knowledge spillovers may belong to the same technological sector (renewable energy for instance) or to another sector. Innovating in a technology depends not only on the production of knowledge in it, but also on the production of external knowledge. According to Fleming and Sorenson (2001), knowledge production has a co-relational pattern. Consequently, it is possible to distinguish intra- and inter-technological knowledge spillovers.

The literature shows that there is more intra technological spillovers than inter-technological spillovers and explains this with two main arguments:

- Empirically, more incremental innovation than breakthrough innovation occurs as, once a technological standard has been defined, innovations become very predominantly incremental (Dosi, 1982; Cohen and Levinthal, 1990). While innovations with very diverse knowledge bases and areas of knowledge distant from those of innovation are mainly breakthrough innovations (Van den Bergh, 2008; Schilling and Green, 2011), incremental innovations are mainly based on pieces of knowledge close to those concerned by the innovation.
- The second reason is that identifying, understanding, assimilating and recombining external knowledge may be more costly, time consuming and risky than integrating nearer knowledge (Nemet and Johnson, 2012).

### **2.1.3. Life cycle of technologies**

The pattern of technological knowledge spillovers is likely to evolve over the life cycle of the technology (Abernathy, 1978), depending on the evolution of its maturity level. Schematically, the technology life cycle theory distinguishes two phases: the experimentation and standardization phase.

During the experimentation phase, the potential applications of the technology are diverse and imprecise as several technological sectors may show an interest for the new technology. During this first phase, the possible innovation trajectories of the technology are manifold and many breakthrough innovation occur. Innovation in the technology may tend to recombine innovation from various knowledge sectors including from distant knowledge fields.

Then, during the standardisation phase, innovation becomes more and more incremental as the trajectories become less and less diverse (Mina et al., 2007; Verspagen, 2007). The share of inter-technology spillovers among upstream spillovers is likely to decrease during this second phase.

The evaluation of the degree of diversification of the technological knowledge spillovers can help to formulate recommendations to implement either generic (targeting many technological sectors) or specific (targeting a particular technology sector) policies. For example, if technological developments in the REN technology are driven by knowledge from various technological domains, then more generic support targeting the development of inter-technology spillovers may be more appropriate (Noailly and Shestalova, 2017).

## **2.2. Identify key technologies**

Beyond the identification of these intra or inter-technology spillovers considered independently from each other, it may be important to understand how the various technologies included in spillovers are recombined to create innovations in renewable energies. This refers to the necessary identification of the global technological structure of all the knowledge spillovers for two reasons:

- A technology is implicated in many spillovers and interacts directly with a lot of other technologies involved in spillovers. In the following, we will call these technologies ‘crucial source of knowledge’.
- A technology enables indirect interactions between many other knowledge fields in the sense that without them, these interactions could not exist. The literature refers to these technologies as “broker” or “gatekeeper” (Carnabuci and Bruggeman, 2009) as they influence the structure of combinations of pieces of knowledge in spillovers, helping to establish a relation between two other knowledge fields.

### 2.3. Solar PV vs wind innovations: 2 different life-cycles

Wind energy has become mature earlier than solar PV energy, even if the cost of solar PV decreased dramatically during the last few years. The two technologies have followed distinct technological trajectories as shown by Huenteler et al. (2016). They use the ‘technology life-cycle’ approach to describe the temporal patterns of technological innovation of wind and solar PV technologies (Abernathy and Utterback, 1978; Davies, 1997; Utterback and Abernathy, 1975). Briefly, the literature distinguishes the life cycle of mass-produced product and the life cycle of complex products and systems (Figure 10).

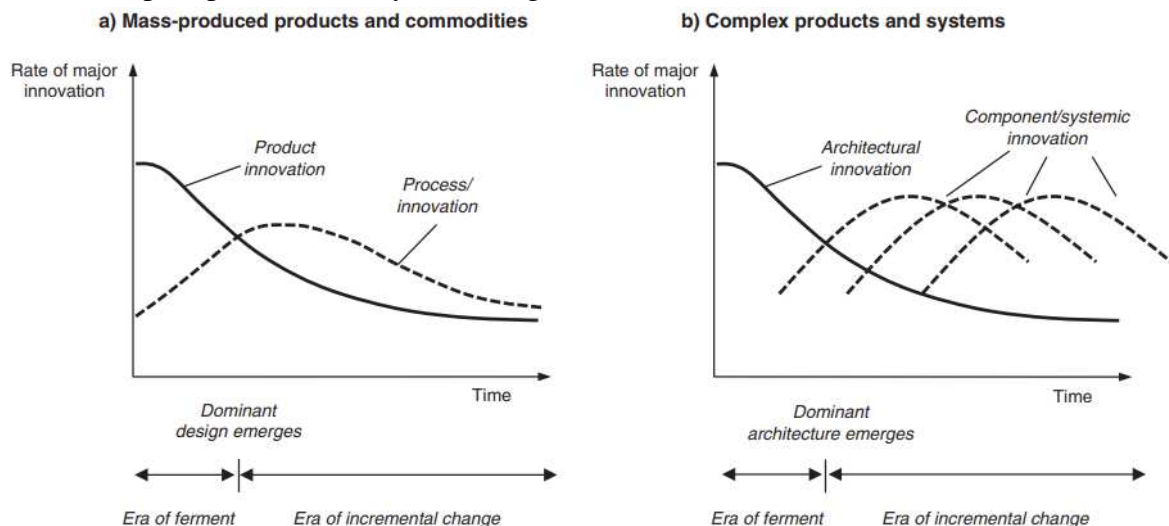

Figure 10: 2 models of the technology life cycle approach (from Huenteler et al. 2016)

On the one hand, according to the mass-produced product life cycle, the early stages of the development of the technology focus on product innovation where firms compete in the market with several alternative product designs. Then, when the dominant design emerges (*i.e.* the core components of the technology become standardized), innovation focuses on process innovation to reduce the production costs of the technology with incremental innovation.

On the other hand, the complex product life cycle represents technologies for which there is not a decrease of product innovation over time. They never reach a phase of process innovation (Davies, 1997). After the emergence of the “dominant design” innovation efforts focus on the different components of the technology and the share of incremental innovation over breakthrough innovation may not be dominant.

Huenteler et al. (2016) showed that solar PV followed the life-cycle pattern of mass-produced goods: first innovation efforts are mainly product innovations followed mainly by process

innovations (in solar PV cell production for solar PV). On the contrary, wind technologies followed the life cycle of complex products and systems where “*the focus of innovative activity shifted over time through different parts of the product, rather than from product to process innovations*” (Huenteler et al., 2016).

## 2.4. Research questions

Given this literature review and our objective to understand innovation processes in the field of renewable technologies, we propose to focus separately on wind and solar PV technologies on the following research issues:

- To identify the share of intra-technological and inter-technological spillovers;
- To confront the temporal dynamic of knowledge spillovers changes with the life-cycle of renewable technologies;
- To evaluate the global structure of spillovers in order to identify technologies which are key source of knowledge within the spillovers, potential gatekeepers and whether such technologies are renewable specific technologies or external technologies.
- To describe the level of specialization in complementary technologies of countries around the world and analyse their consistency between the specialization in complementary technologies and in REN

## 3. Methodology

This section describes the methodology to answer these research questions. First, we justify the choice to proxy innovation by patent filed. Then, we present how we identified wind and solar PV technologies with technological codes. The third subsection explains how we measure spillovers and their technological content through patent citation data. Then, we detail our empirical approach.

### 3.1. Patents as proxy of innovation

Measuring innovation is not trivial. Several options exist (OECD, 2010): R & D expenditures, the number of researchers in a company, etc. However, relying on these indicators has many disadvantages: the data are often incomplete or only available at an aggregate level and they are "inputs" of the innovation process. As Lanzi et al. (2012) pointed out, it is extremely difficult to retrieve total R & D expenditures data since there is no private R & D expenditures database and the published R & D data is limited to the public R & D. On the contrary, patents are an output of the innovation process (Griliches, 1990)<sup>15</sup>. Moreover, patent data provide a lot of information such as the identity of the applicant, his country of origin, the nature of the

---

<sup>15</sup> According to the WIPO (World Intellectual Property Organization) a patent is “*an exclusive right granted for an invention, which is a product or a process that provides, in general, a new way of doing something, or offers a new technical solution to a problem. Patent protection means that the invention cannot be commercially made, used, distributed, imported or sold by others without the patent owner's consent. The protection is granted for a limited period, generally 20 years from the filing date of the application.*” <http://www.wipo.int/patents/en/> the 10/22/2018



invention, the technological knowledge field(s) embodied in innovations, etc. They thus allow focusing on particular technological fields. Finally, patents are positively correlated with R & D expenditures and are, therefore, a good proxy for the innovation activity of companies (Griliches, 1990).

However, patent-based measures suffer from some shortcomings as well. First, they are just one way to protect innovation, as there are other options such as industrial secrecy, lead-time (Cohen et al., 2000, Frietsch and Schmoch, 2006). Second, the propensity to patent varies across industries: Cohen et al. (2000) shows that some industries such as medical equipment patent more than 2/3 of their inventions while others like the textile industry patent less than 15%. Third, the intrinsic value of patent is heterogeneous as some patents are filed in order to impede rival firms to innovate (*i.e.* blocking patents).

Nevertheless, a lot of previous studies proxy innovation intensity with patents (Grafström and Lindman, 2017; Johnstone et al., 2010; Kim et al., 2017; Kruse and Wetzel, 2014; Nesta et al., 2014; Nicolli and Vona, 2016).

More specifically, we use some other pieces of information about patents:

- The patent family refers to a collection of patent applications covering the same or similar technical content. The applications in a family are related to each other through priority claims<sup>16</sup>. For our study, in order to avoid some redundancies in our observations we measure the knowledge spillovers and their technological content at the family level.
- The priority date is the filing date of the very first patent application of a specific invention. Therefore, it is the nearest date to the date of invention.
- The “granted” variable is a dummy equal to "1" if there exists a publication of the grant and "0" otherwise. For wind and solar PV patents, we keep only granted patents. This allows preventing one caveat of patent as measure of innovation: the heterogeneity of patent value.

### **3.2. Identification of solar PV and wind EPO patents with the CPC classification**

In order to identify wind and solar PV patents we use the Cooperative Patent Classification (CPC) defined in 2013 by the European Patent Office (EPO) and the United States Patent and Trademark Office (USPTO).<sup>17</sup> Following this classification system, one or several technological codes are assigned to each patent. If a patent has only one technological code, this means the knowledge included in it belongs to only one technological knowledge sector. Most of the patents are associated with several technological CPC codes as they may belong to several technological fields.

---

<sup>16</sup> <https://www.epo.org/searching-for-patents/helpful-resources/first-time-here/patent-families.html>.

<sup>17</sup> The former classification is the International Patent Classification (IPC). It is less accurate than the CPC classification as it contains far few different technological codes. Indeed, the IPC classification contains about 75000 distinct codes whereas the CPC classification has about 250 000 distinct codes. Therefore, we choose to retrieve patent according to their CPC codes only

This classification system has a specific section dedicated to “technologies or applications for mitigation or adaptation against climate change (Y02)”, a sub-class of this section concerns “reduction of greenhouse gas [ghg] emissions, related to energy generation, transmission or distribution (Y02E)” where we can find the codes listed in Table 4 for the wind renewable technologies.

CPC code	Description
Y02E 10/72	Wind turbines with rotation axis in wind direction
Y02E 10/721	Blades or rotors
Y02E 10/722	Components or gearbox
Y02E 10/723	Control of turbines
Y02E 10/725	Generator or configuration
Y02E 10/726	Nacelles
Y02E 10/727	Offshore towers
Y02E 10/728	Onshore towers
Y02E 10/74	Wind turbines with rotation axis perpendicular to the wind direction
Y02E 10/76	Power conversion electric or electronic aspects
Y02E 10/763	for grid-connected applications
Y02E 10/766	concerning power management inside the plant, e.g. battery charging/discharging, economical operation, hybridisation with other energy sources

Table 4 : CPC codes for the wind renewable technologies

CPC codes for solar PV renewable technologies, refer to codes starting by “Y02E 10/5” (Table 5)

CPC code	Description
Y02E 10/52	PV systems with concentrators
Y02E 10/54	Material technologies
Y02E 10/541	CuInSe <sub>2</sub> material PV cells
Y02E 10/542	Dye sensitized solar PV cells
Y02E 10/543	Solar PV cells from Group II-VI materials
Y02E 10/544	Solar PV cells from Group III-V materials
Y02E 10/545	Microcrystalline silicon PV cells
Y02E 10/546	Polycrystalline silicon PV cells
Y02E 10/547	Monocrystalline silicon PV cells
Y02E 10/548	Amorphous silicon PV cells
Y02E 10/549	Organic PV cells

Table 5 : CPC codes for the solar PV technologies

Filtering patents by CPC code is not the only possible approach. The IPC classification<sup>18</sup> or a “key word research” in patent textual information (title, abstract or technical description) could be used as well. Nevertheless, Kapoor et al. (2015) showed that CPC is better than the IPC for identifying patents relevant to the wind power industry and according to Montecchi et al. (2013)

---

<sup>18</sup> The IPC is the former technological classification; it is still used in many offices. This classification is less accurate than the CPC classification as it contains only 75 000 different codes instead of 250 000 for the CPC classification

using technological classification is more efficient than keyword research because of translation problems.

### 3.3. Patent citations to trace knowledge spillovers

As mentioned before, an innovation is based on previous pieces of knowledge assimilated and recombined by the inventors during the innovation process. Patent citations represent this knowledge base. These citations may refer to either patent or non-patent literature (NPL). For instance, a research paper, a PhD dissertation, reports is a NPL. Therefore, generally NPL relates to fundamental public knowledge. During the innovation process, these citations, and particularly patent citations, are crucial as they help to define the technological scope of the patent by giving some clues on what should be excluded from the patent's claims (Duguet and MacGarvie, 2005).

To evaluate upstream knowledge spillovers, we rely on backward citations (Figure 11). Let's suppose that a patent A cites another patent B, we can say that patent A inherits some knowledge from patent B, this citation is therefore a marker of the flow of knowledge from patent B to patent A (Jaffe et al., 1993).

We decide to use patent citations to delimit the boundaries of the knowledge relevant to a certain technology field (as in Jaffe et al. 1993). Nevertheless, some previous studies adopted different approaches such as keyword search strategies (e.g. Meyer, 2006a, 2006b; Bonaccorsi and Thoma, 2007), lexicographic approaches (e.g. Bassecoulard and Zitt, 2004), or more hybrid methods (e.g. Leydesdorff, 2004). On the one hand, our approach may exclude a few patents, which, albeit not cited by a REN patent, have influenced the corresponding invention. On the other hand, by including only citations, we avoid the risk of considering irrelevant patents.

Finally, for patent involved in backward citations we keep both granted and non-granted as we presume that even if they have not been granted (yet) they have been considered as a relevant source of knowledge by the EPO examiners.

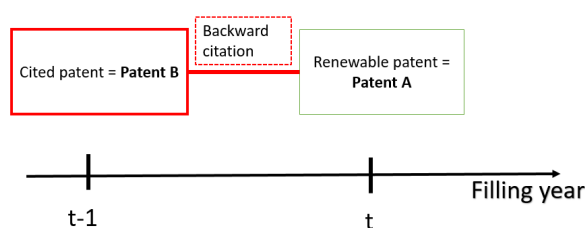

Figure 11: Backward patent citation

Nevertheless, we have to keep in mind that patent citations are not a perfect indicator of knowledge spillovers. Indeed, in some offices, patent examiners add most of the citations. Even if this makes these citations more objective, it means that the citation does not necessarily indicate that the inventor knew about the existence of this previous knowledge when he developed the technology.

Furthermore, citations practices vary from one office to another. More specifically, at the EPO, a searcher, member of the Office, carries out search on the relevant prior art to cite and add citations, while in the U.S. system the patent applicant has to send to the patent examiner a

complete list of relevant prior art (Karvonen and Kässi, 2013). Michel and Bettels (2001) report that US patents cite about three times as many patent references compared with European patents. In order to get rid of these differences between patent offices, we focus only on renewable patent filed at the EPO.

After retrieving relevant wind and solar PV patent filed at the EPO and their backward cited patents, we retrieve the technological codes of these cited patents. As for wind and solar PV, we focus only on CPC codes of cited patents. Hence, with both citations and technological codes it is possible to trace the knowledge sectors involved in upstream knowledge spillovers (Figure 12).

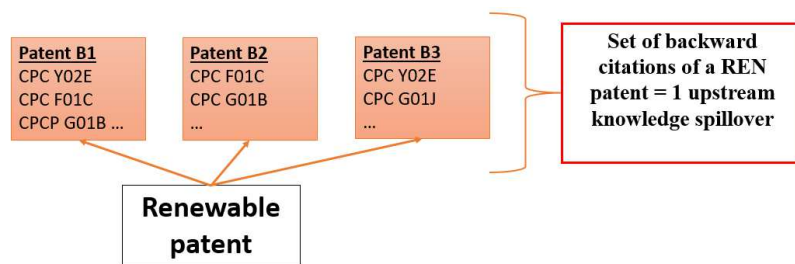

Figure 12 : technological content of upstream knowledge spillovers measured by backward citations

Finally, it is worth noticing that it is difficult to have a common methodology for identifying the technological fields involved in spillovers for both patent literature and non-patent literature. Indeed, the CPC (or IPC) classification only apply for patents. It is possible to identify the fields of knowledge involved in scientific publications with the "Web of science categories" or the JEL codes. However, it is difficult to establish correspondences with the CPC classification (for example, there is no Web of science category for renewable energies). This is the main reason why we have chosen not to consider non-patent literature in our networks.

Thus, we measure knowledge spillovers only with citations between patents, excluding non-patent literature. Figure 13 shows that doing so, we loose some citations, but this allows to gain consistency in the analysis of the technological content of spillovers. In particular, we lose the influence of fundamental and non-patented research because it has no industrial applicability, for example. In this case, fundamental research would be published as research articles or reports. This figure shows in particular that the share of NPL is higher for solar PV patents than for wind patents, showing the lower maturity level of this technology relatively to wind.

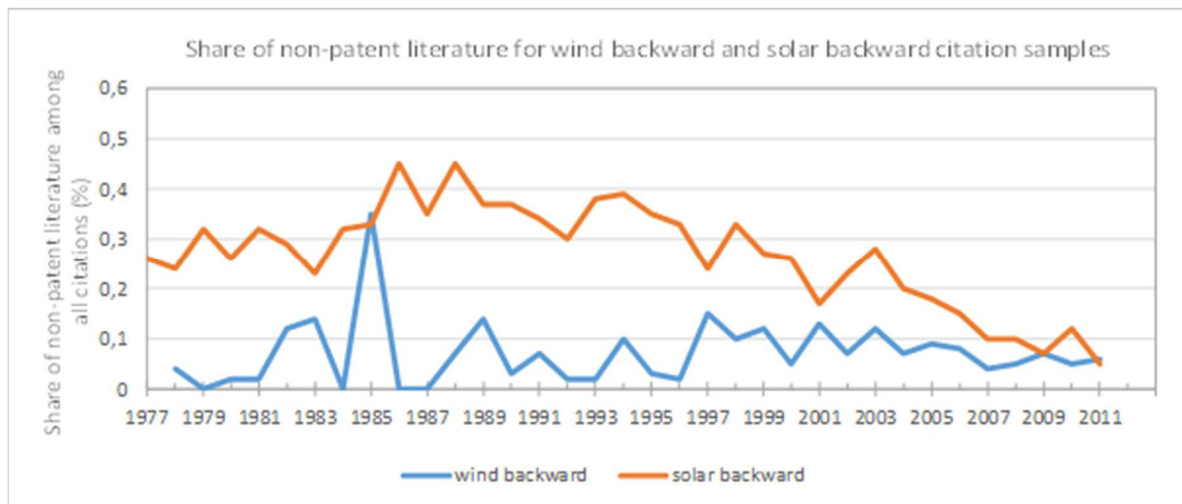

Figure 13: Share of non-patent literature among citations

### 3.4. Five-year rolling periods

In order to characterize the evolution dynamics of technological spillovers, we classify all the data according to the priority year of renewable patents. As “most learning by the patentee about the value of his patent takes place in the first 5 years or so” (Hall, 2009) we group the data in five-year rolling periods. As priority years run from 1978 to 2011, we create the following subsets: [1978-1982];[1979-1983]; ...; [2007-2011].

### 3.5. Identification of key technologies with a social network analysis

#### 3.5.1. Social network analysis: basic vocabulary

To go beyond a descriptive statistics analysis, we carry out a dynamic social network analysis.

A network is “in its simplest form, a collection of points joined together in pairs by lines. In the jargon of the field the points are referred to as vertices or nodes and the lines are referred to as edges or links” (Newman, 2010). In particular, a “path” connects two nodes if a sequence of distinct links connect them. Its length is its number of distinct links. Two nodes may be indirectly connected through a path. Several paths, of different lengths, are generally possible between two nodes. Therefore, there is at least one shortest path between two nodes. A component is a set of nodes connected to each other by a path. The nodes of a component have no direct or indirect links with the nodes of another component.

The Figure 14 is a simple representation of a network. This network has seven nodes labelled with letters from “a” to “g” and seven links between these nodes. Node “e” is directly connected with node “d” but not with node “f”: a path of length 2 connects nodes “e” and “f”. There are two components: the first includes nodes {“e”, “f”, “g”, “h”} and the second {“a”, “b”, “c”}.

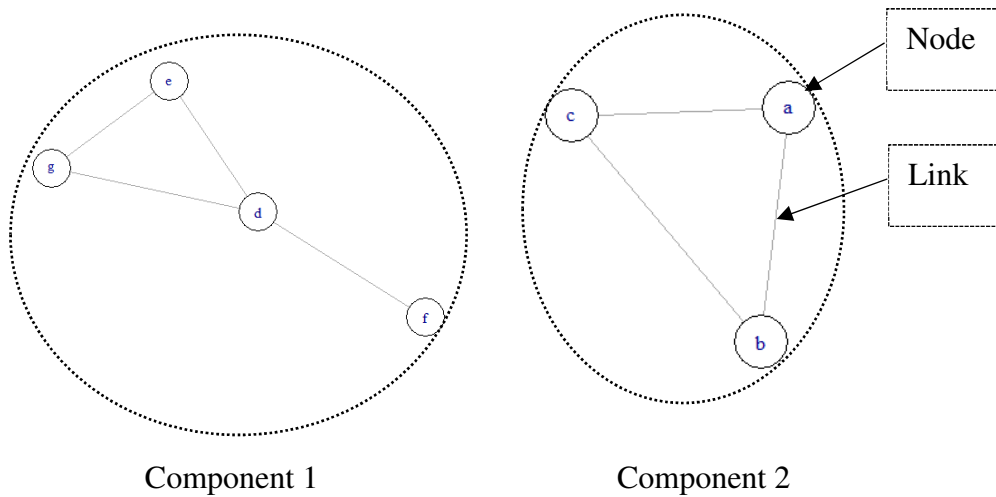

Figure 14: simple representation of a network

### 3.5.2. Networks of co-occurrence of technologies within spillovers

With a network approach, it is possible to investigate the technological structure of the upstream spillovers. We consider that the set of backward citations of a renewable patent represents one upstream knowledge spillover.

In the Figure 15, upstream knowledge spillovers are in red. Two patents may cite the same patent or be cited by the same patent (in the figure the red dot identifies such patent: patent 2)

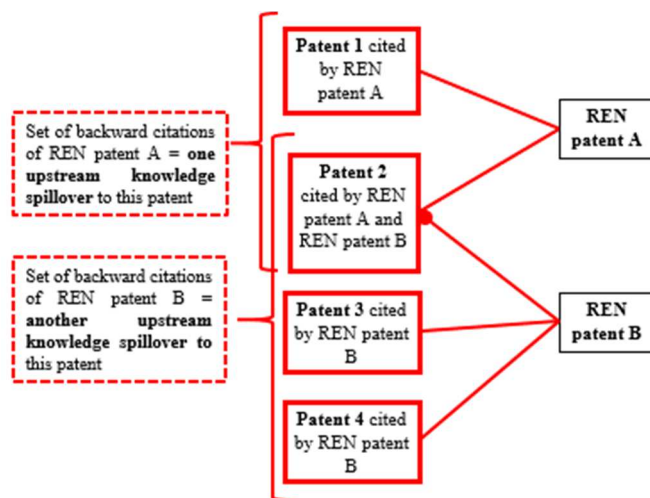

Figure 15 : identification of upstream knowledge spillovers through patent citations

Each patent involved in these citations has at least one technology classification code. These classification codes are the different knowledge fields included in these patents. Therefore, all the different technological codes included in the cited patents are the set of technological content of one upstream knowledge spillover. Consequently, we can assume that all the technological codes included in one spillover interact with each other. We build such networks in which the nodes are the technological codes and the links between the nodes are the occurrence of codes in the upstream technological knowledge spillovers.

However, as the CPC classification is extremely accurate and some codes contain more than 10 digits, if we keep the entire digits, the technological structure of the spillovers would be too complex to analyse. Therefore, we keep only the first 3-digits of the technological codes<sup>19</sup>. Moreover, within each spillovers we consider each code only one time to avoid “self-loops” in the co-occurrence networks.

The Figure 16 describes this procedure.

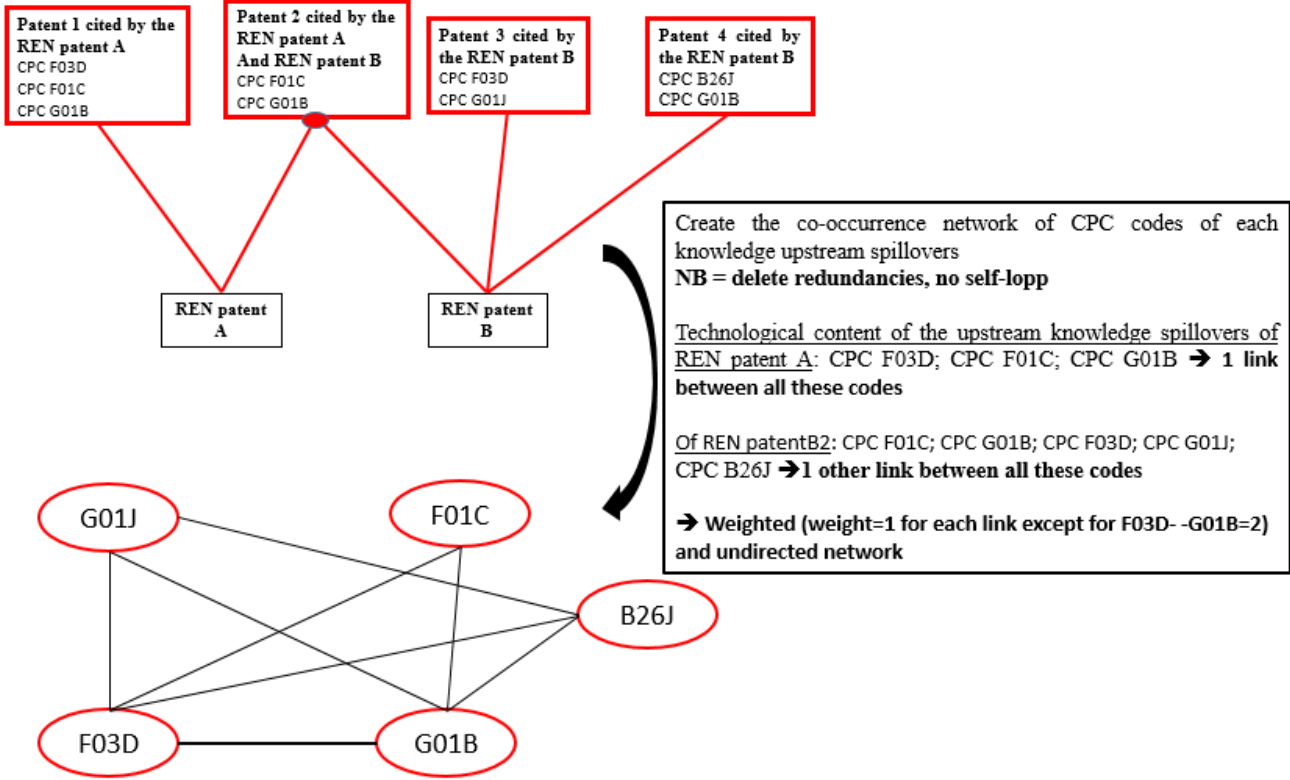

Figure 16: procedure to create the network of co-occurrences of technological codes among upstream knowledge spillovers

We build one network for each five-year rolling period. Doing so, we exclude from networks all the spillovers containing only one distinct technological codes. Indeed, by definition, there is no co-occurrence of codes within these spillovers and they do not influence the overall structure of the knowledge recombination. (Nevertheless, after checking this potential problem, it appears that this should not change significantly our results, see appendix A-1).

**3.5.3. Structure of networks and identification of key technologies**

The analysis of such networks relies on several structure and centrality indicators.

Structure indicators capture how easily the information flows between all the nodes of the network:

- The number of components

<sup>19</sup> With an exception for codes specific to the studied renewable energy for which we keep the entire digits

- The density *i.e.* the number of links in the network over the total number of links possible between the nodes<sup>20</sup>. It measures the intensity of the connectivity between nodes. If the network has more than one component, the density is calculated on the main component. In a network where all are the nodes directly connected to each other the density is equal to 100%.
- The diameter *i.e.* the longest shortest path in the network. It measures to what extent a network is spread, and therefore if information may flow quickly between nodes.

Centrality indicators capture the “importance” of a node within the network:

- 1- Degree centrality: a node is important in the network if it is directly connected to many other nodes, *i.e.* if its degree is high.
- 2- Betweenness centrality: it evaluates how a node lies “between” other nodes in the network, by measuring the fraction of shortest paths containing the nodes over all the shortest paths between all the pairs of nodes in the network. The betweenness of a node measures the extent to which a node is a gatekeeper (Breschi and Catalini, 2010).

Let’s imagine the following unweighted and undirected network with 10 nodes, labelled with letters from ‘a’ to ‘k’ (Figure 17). The value of the structure indicators are reported in Table 6 and those of the centrality indicators in Table 7. Looking to centrality values, we can notice that the most central node according to the degree centrality (h) is not the same according to the betweenness centrality (e).

This example illustrates that we need to compute both degree and betweenness centrality to identify key technologies within knowledge spillovers toward wind and solar PV patents.

More specifically, for our co-occurrence networks, we apply the so-called “Jaccard coefficient” to the weight of each link and then we normalise the value of the centrality to be able to compare the centrality values between the rolling periods. For more information about this methodology, please see appendix A-2.

---

<sup>20</sup> We compute it by dividing the number of links ( $l$ ) over the number potential link ( $l_p$ ). We have  $l_p = \frac{n(n-1)}{2}$  where  $n$  is the number of nodes in the network, so  $density = \frac{l}{l_p} = \frac{l}{\frac{n(n-1)}{2}}$ .



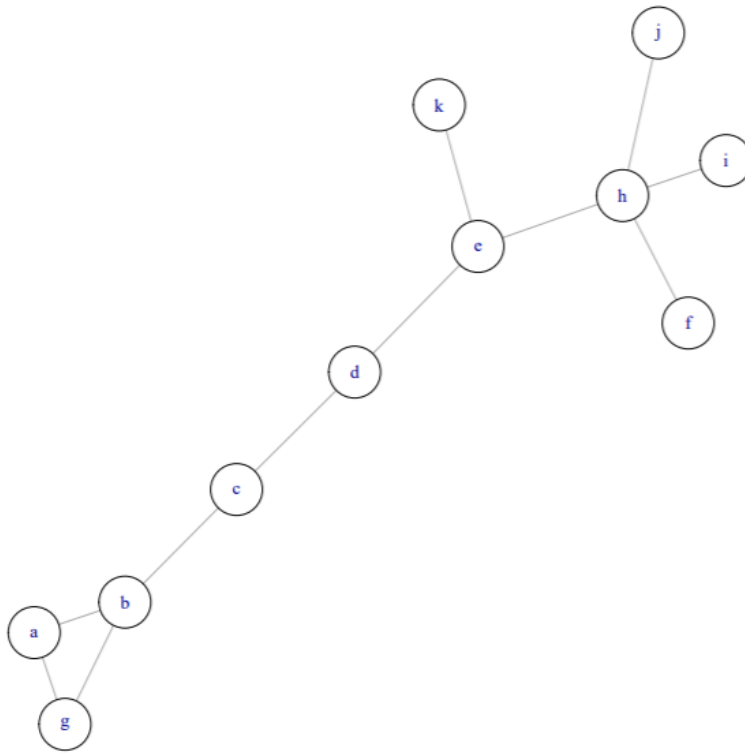

Figure 17: network example

Indicators	Values
Number of components	1
Size of the main component (%)	100
Number of nodes	11
Number of links	11
Number of links per node	1
Density	0,2
Diameter	6

Table 6: network example - structure indicators

Node	Degree	Node	Betweenness
h	4	e	29
b	3	h	24
e	3	d	24
a	2	c	21
c	2	b	16
d	2	a	0
g	2	g	0
k	1	k	0
f	1	f	0
i	1	i	0
j	1	j	0

Table 7: network example - degree and betweenness centrality

## **4. Data**

This section describes the data relying on the PATSTAT database and provides some descriptive statistics on the data.

### **4.1. Short description of the PATSTAT database**

Patent Statistical Database (PATSTAT) is a public database including about 80 million patents from more than 120 national and international patent offices from 1782 to 2017. This database is updated twice a year with a spring and a fall version. We use the version PATSAT fall 2017.

We extract from the whole PATSTAT database:

- wind and solar PV patent filed at the EPO;
- Patents involved in backward citations from these solar PV and wind patents;
- Several information about these citations, particularly the Cooperative Patent Classification (CPC) codes assigned to patents involved in these citations.

We create two samples, one related to wind backward citations and another one to solar PV backward citations.

### **4.2. Backward citations for wind and solar PV patents**

Figure 18 displays the number of wind and solar PV patent families filed at the EPO by priority year. The first granted patent families appeared in 1978 for wind innovations and in 1977 for solar innovations. We limit our samples to 2011 for both wind and solar PV samples as the number of granted families starts to decrease dramatically after. This decrease is probably due to patent filing procedures that last several months and create a gap between the filing year and the granted year of a patent. Until, 2011 the number of granted patent families at the EPO is greater for solar PV patents than for wind patents, then the number of granted wind families grown up dramatically and get higher than the number of solar PV families.

The Table 8 displays some key descriptive statistics on our four samples. Overall, even if the number of distinct solar PV and wind patents are similar, the number of family implicated in backward citation for solar is much higher than for the wind sample.

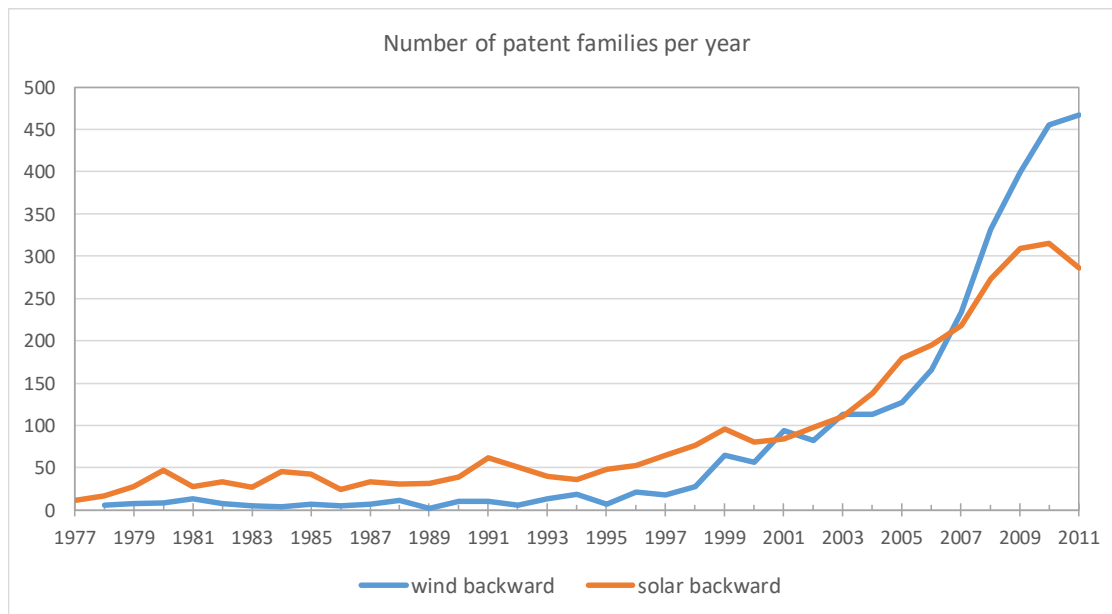

Figure 18: Number of patent families at the EPO for wind and solar PV backward citations samples

		Wind backward	Solar PV backward
<b>Number of distinct renewable patent families</b>		3339	3505
<b>Number of distinct family implicated in the citation</b>		11687	17202
<b>Publication year of families in citations</b>	<b>Min</b>	1865	1901
	<b>Max</b>	2015	2015
	<b>Mean</b>	1997	1999
	<b>Median</b>	2003	2002

Table 8: main statistics for our two samples

### 4.3. Temporal dynamic of innovation in wind and solar PV products

#### 4.3.1. Wind innovation: from blades and rotor to mechanical and electric components, 5 periods in the life cycle

We pointed out that wind and solar PV have different technological development patterns: the cycle of complex product for wind and the cycle of mass-produced product for solar PV (Huenteler et al., 2016). Therefore, over time, concentration of innovation efforts may have focused on different element of the technology. The aim of this subsection is to describe precisely the life cycle of wind and solar PV inventions and to identify the key dates in these life cycles. To do so, we rely on two architectures: the one used by Huenteler et al. (2016)<sup>21</sup> and

<sup>21</sup> Huenteler et al. (2016) manually coded the abstracts and claims of the patents to identify the focus of innovation over the technology life-cycle.

another base on the CPC codes related to wind and solar PV technologies (for more details see appendix A-3)

In their analysis, Huenteler et al. (2016) show that innovation in wind technologies focused on the different subcomponents of the technology (Figure 19). Thus, from their results it is possible to distinguish 5 distinct periods:

- 1- 1978-1984: innovation in wind technologies focused mainly on rotor;
- 2- 1984-1995: innovation in wind technologies focused mainly on power train;
- 3- 1995-2000: innovation starts to focus on grid connection components;
- 4- 2000-2005: innovation starts to focus on mounting and encapsulation components;
- 5- 2005-...: innovation focus less on grid connection components and on mounting and encapsulation components, but more on rotors.

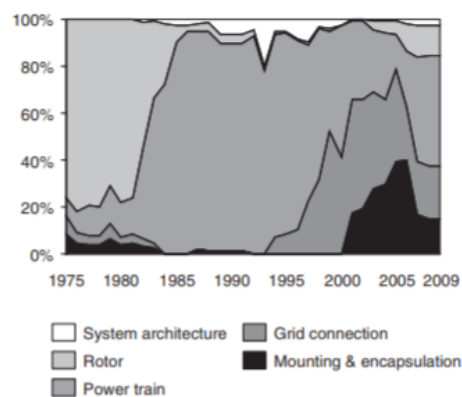

Figure 19: Evolution of the focus of innovation in wind technologies - from Huenteler et al. (2016)

Figure 20 is drawn from the CPC codes specific to wind technologies. Innovation effort focused mainly on wind turbines with axis perpendicular to the wind directions. Nevertheless, they received more attention before 1993 (about 45% of the wind Y\* codes), then its share decreased steadily to reach 20% in 2011. The main reason is that the technological standard (Danish standard, i.e. wind turbines with 3 blades) appeared early. Meanwhile, the share of “grid-connection”; “components or gearbox” and “generator or configuration” increased. Therefore, the concentration of innovation efforts in wind shifted from blades/rotor to mechanical and electric components. Before the 1980’s, innovation in wind technologies focused mainly on the rotor, then on power train between 1983 and the end of the 1990’s, and after 2000 on grid connection and mounting & encapsulation. Finally, even if the decomposition of wind technologies is a little different, the figure confirms the trend highlighted by Huenteler et al. (2016).

Therefore, in the dynamic analysis of the technological pattern of knowledge spillovers toward wind patents we will consider the 5 periods described above.

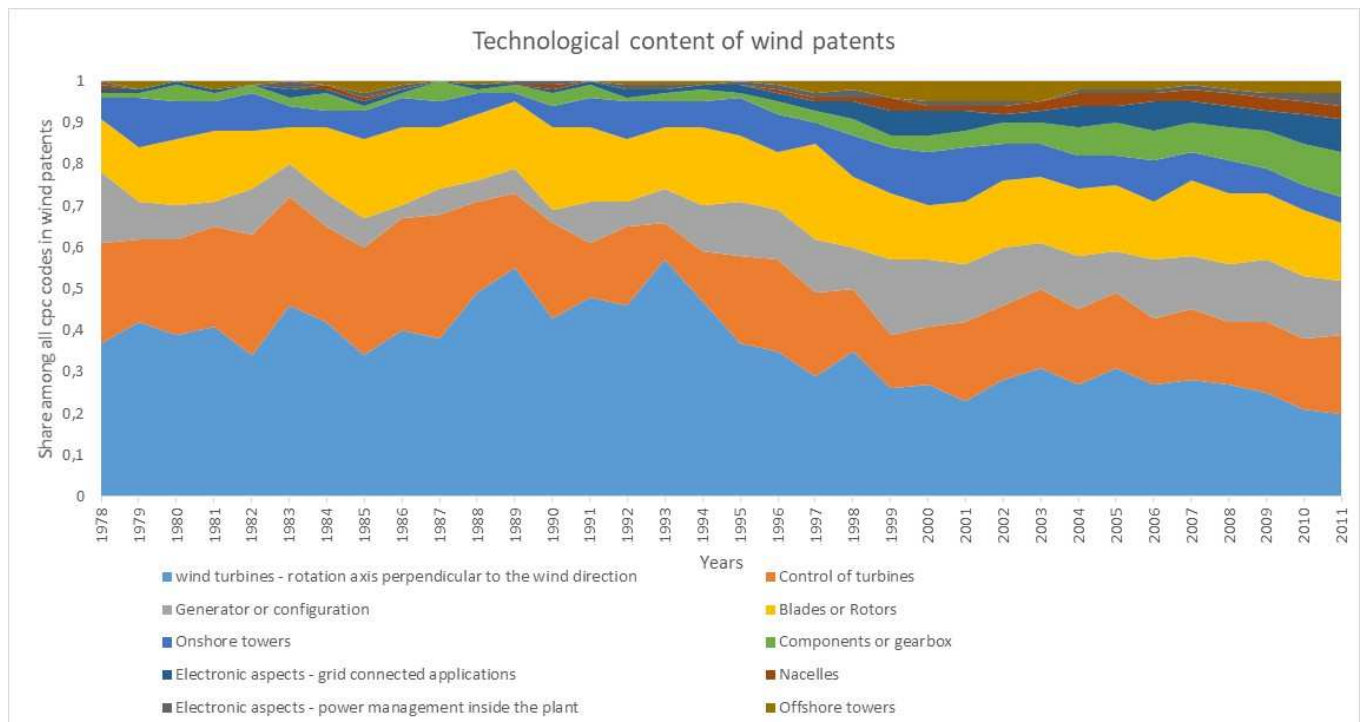

Figure 20: technological content of wind patent families – CPC codes

### 4.3.2. Innovation in Solar PV: mainly cells technologies

From the figure by Huenteler et al. (2016), it stands out innovation in solar PV technology focused mainly on cells all along the life cycle of the technology (Figure 21). Nevertheless, it seems possible to distinguish different sub periods:

- 1- 1977-1984: Focus on modules;
- 2- 1984-1996: innovation starts to focus on mounting system components;
- 3- 1997-2004: innovation starts to focus on grid connection components;
- 4- 2004-....: innovation focus less on grid connection components and on mounting system components, but more on cells.

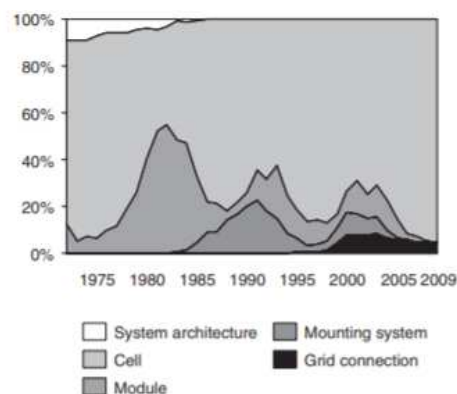

Figure 21: Evolution of the focus of innovation in solar PV technologies - from Huenteler et al. (2016)

This focus on cells is confirmed by the figure below drawn with the CPC codes related to solar PV technologies (Figure 22)<sup>22</sup>. Over the period, it represents around 75%. Maximum Power Point Tracking (MPPT) systems received interest mainly during the 1990's. Since then, the efforts focus more and more on grid applications. More specifically, innovation in solar PV cells focused less and less on amorphous solar PV cell and on cells from group II-VI materials before 1996, after this year innovation focused mainly on dye sensitized cells and organic cells (Figure 23). Therefore, it seems possible to distinguish two sub periods in solar PV cell innovations: before and after 1996.

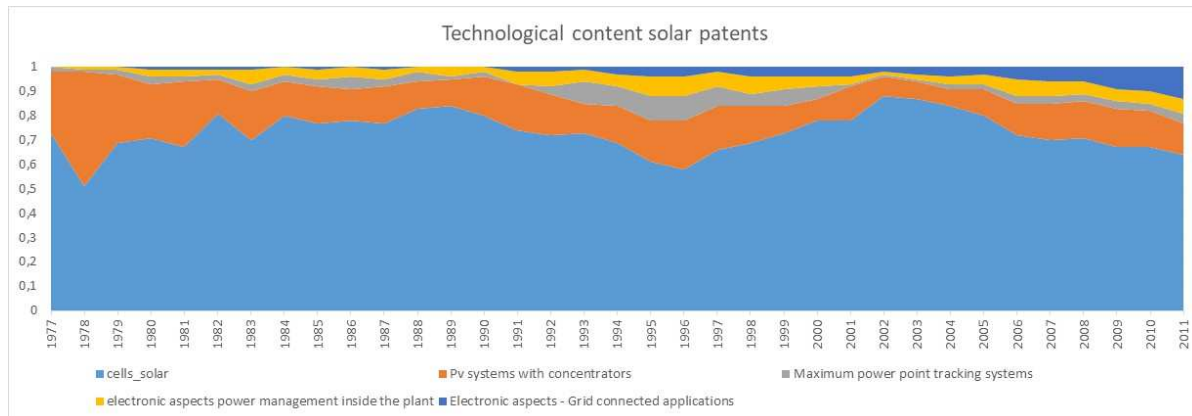

Figure 22: Technological content of solar PV patent families

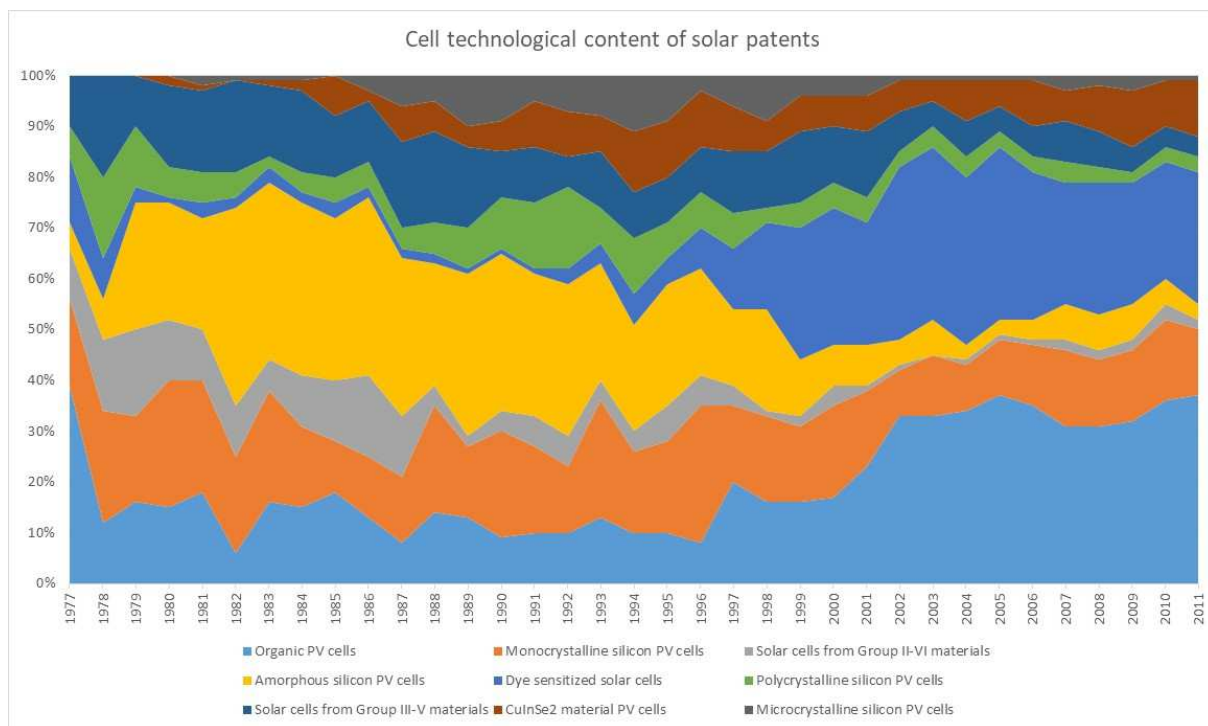

Figure 23: Cell technological content of solar patents

Finally, for the rest of the analysis, we will consider 4 sub periods in the life cycle of solar PV technologies:

<sup>22</sup> For more clarity, we regroup all the codes corresponding to cells knowledge in a unique subclass

- 1- 1975-1984: Focus on modules, amorphous solar PV cells, monocrystalline PV cells
- 2- 1984-1996: innovation starts to focus on mounting system components + focus on amorphous solar PV cells, monocrystalline PV cells
- 3- 1997-2004: innovation starts to focus on grid connection components + focus on organic PV cells, dye sensitized solar PV cells
- 4- 2004-...: innovation focus less on grid connection components and on mounting system components, but more on cells, focus on organic PV cells, dye sensitized solar PV cells

## **5. Technological pattern of spillovers and key complementary technologies**

### **5.1. A large part of spillovers is inter-technological**

We distinguish three different types of spillovers:

- 1- “100 % studied renewable energy spillovers” - Technological knowledge spillovers (*i.e.* the set of all the backward citations of a patent family) include only the renewable technology;
- 2- “100% inter-technology spillovers - spillovers are not related to the renewable knowledge;
- 3- “Mixed spillovers” – spillovers include both renewable technology and other technologies. More precisely, for each of these mixed-spillovers, we compute the share of technological code not related to the renewable studied technology, *i.e.* the share of inter-technology spillovers. For example if a spillover contains 4 codes related to wind technologies and 6 other codes this share is equal to  $6/10 = 60\%$ .

The figures below display the temporal evolution of the share of each of these types of spillovers among all the spillovers respectively for wind and solar PV innovation.

For wind innovations (Figure 24), the share of 100% inter technology spillovers increased from 11% in [1977-1982] to 24% in [1992-1996], then it decreased to attain 9% in [2007-2011]. Moreover, the majority of spillovers contains more than 50% of non-wind technologies, and we have only few pure wind spillovers (peak of 7% in [1989-1993]). More precisely, after [1992-1996] non-wind technologies became more and more dominant within spillovers as the share of spillovers containing less than 40% of non-wind codes decreased dramatically.

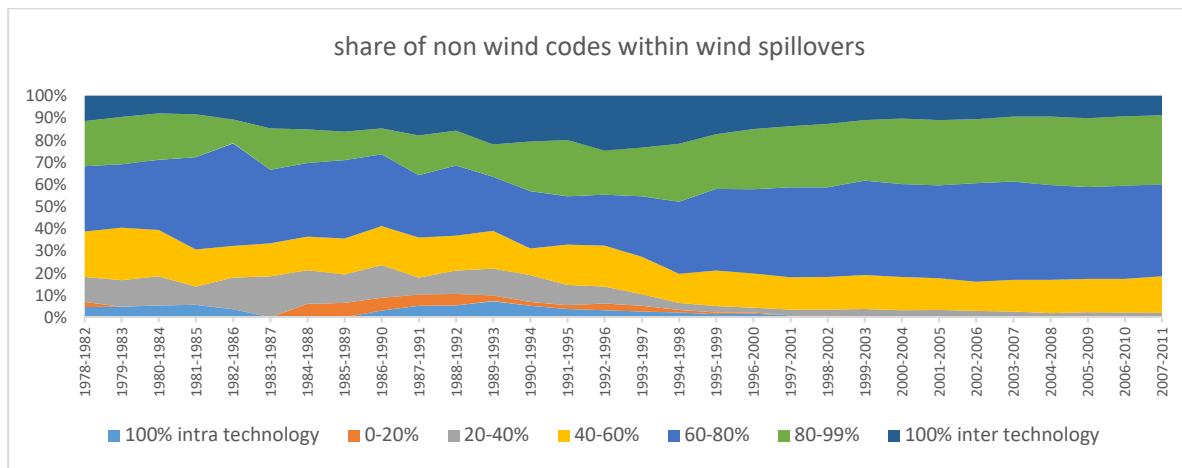

Figure 24 : share of non-wind codes within spillovers concerning wind

The evolution of the different types of spillovers is quite different for solar PV technologies (Figure 25). First, the share of 100% inter technologies is much higher than for wind technologies as it is between 35% and 55%, with a significant increase between [1995-1999] and [2000-2004]. Furthermore, there is almost no 100% intra technology spillover.

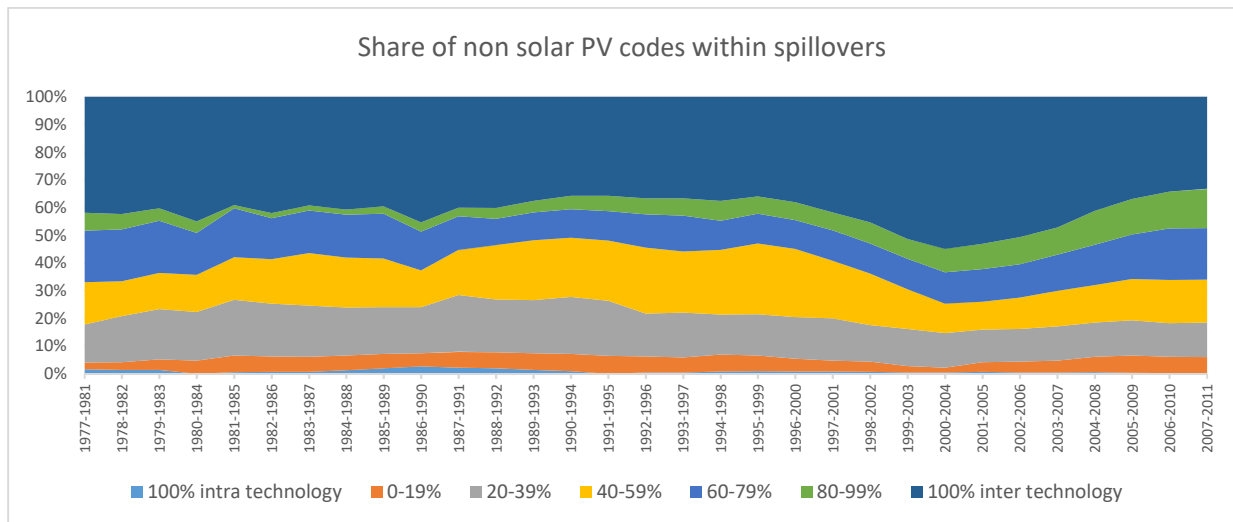

Figure 25 : share of non-solar PV codes within spillovers concerning solar PV innovation

For both technologies, almost all the spillovers contain renewable and non-renewable codes. The share of “100% inter technology spillovers” reaches around 45% for solar PV compared to around 10% for wind.

These trends are compared in the structure of spillovers for two major technologies that have undergone relatively recent development, nanotechnologies and 3D imaging (Figure 26, Figure 27). These comparisons show the specificity of 3D technology compared to wind and solar PV, with a high proportion of spillovers with a high intra-sectoral content. On the other hand, the structure of spillovers in nanotechnology is similar to that of solar PV energy.



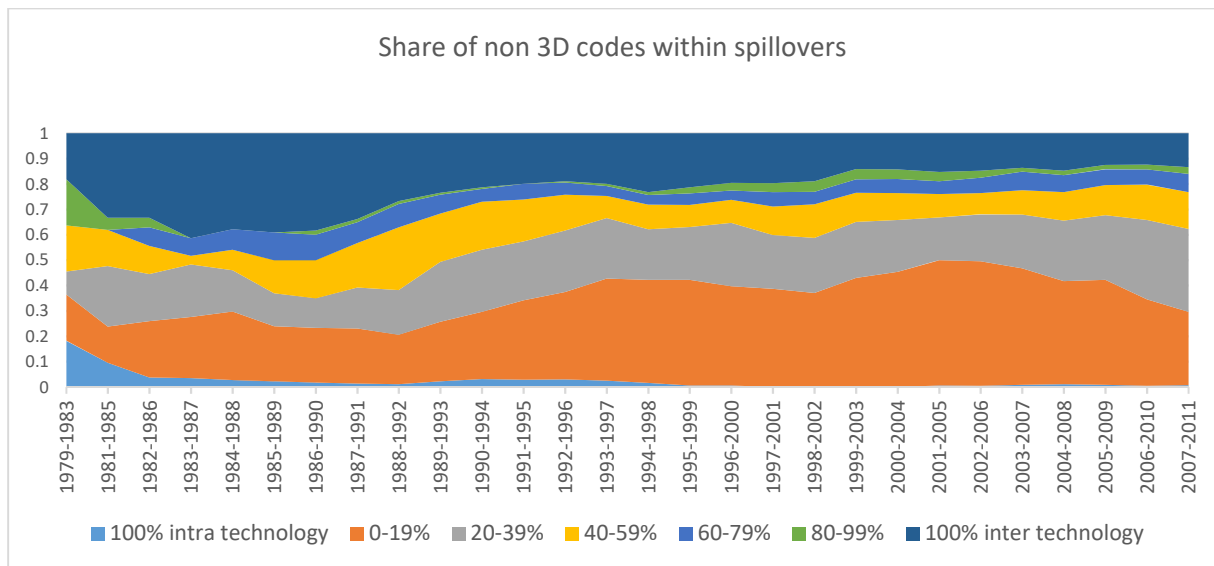

Figure 26: Share of non-3D codes within spillovers concerning the innovation in the 3D imaging

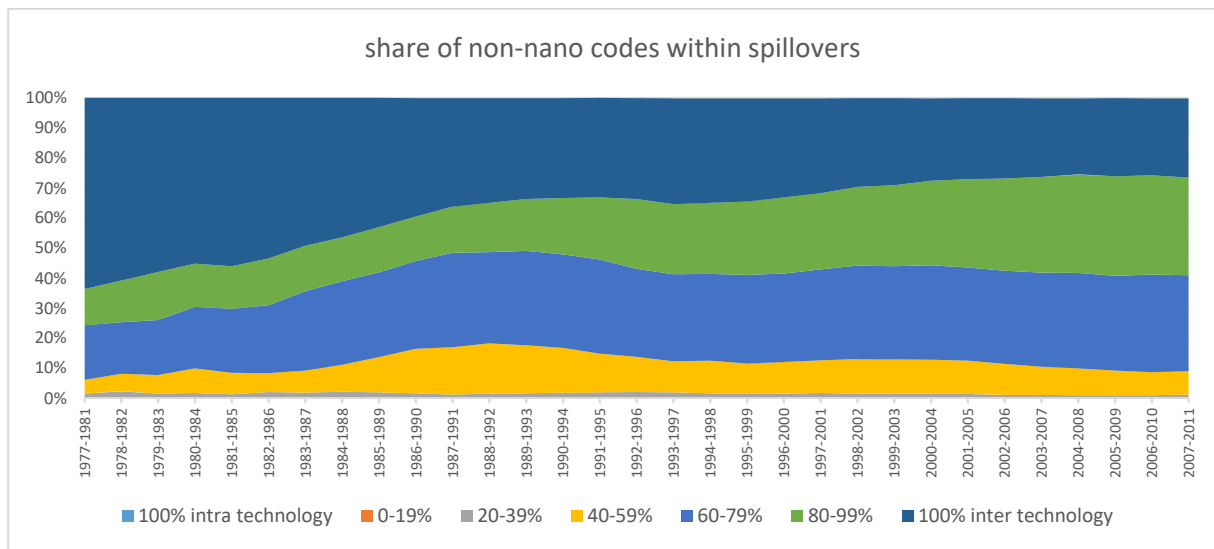

Figure 27: Share of non-nano codes within spillovers concerning the innovation in the nanotechnologies

## 5.2. Duration of technology occurrence among spillovers

We evaluate the number of years a given CPC technology code is involved within knowledge spillovers in order to have a first idea of the extent to which the technological content of spillovers may change during the life cycle of the technologies. We compute the number of years in which the technological codes appear.

Results are reported in Figure 28. It could read it like this: “among all the distinct technologies involved in the knowledge spillovers toward wind innovation, 16% are involved in at most 2 distinct years”.

The number of years a technology appears in spillover is higher for solar PV spillovers than for wind spillovers. In wind, 50% of technologies identified in backward spillovers appear at most 7 distinct years, whereas for solar PV backward spillovers only 42% of the technologies are

involved in at most 7 years. Nevertheless, the technological content of spillovers, for both wind and solar PV innovation, is likely to change significantly over the years. This is probably due to the two different life cycles of wind and solar PV technologies. Huenteler et al. (2016) showed that innovation in wind technologies focus on the different sub components over the years, whereas, in solar PV technologies, innovation focused mainly on solar PV cells.

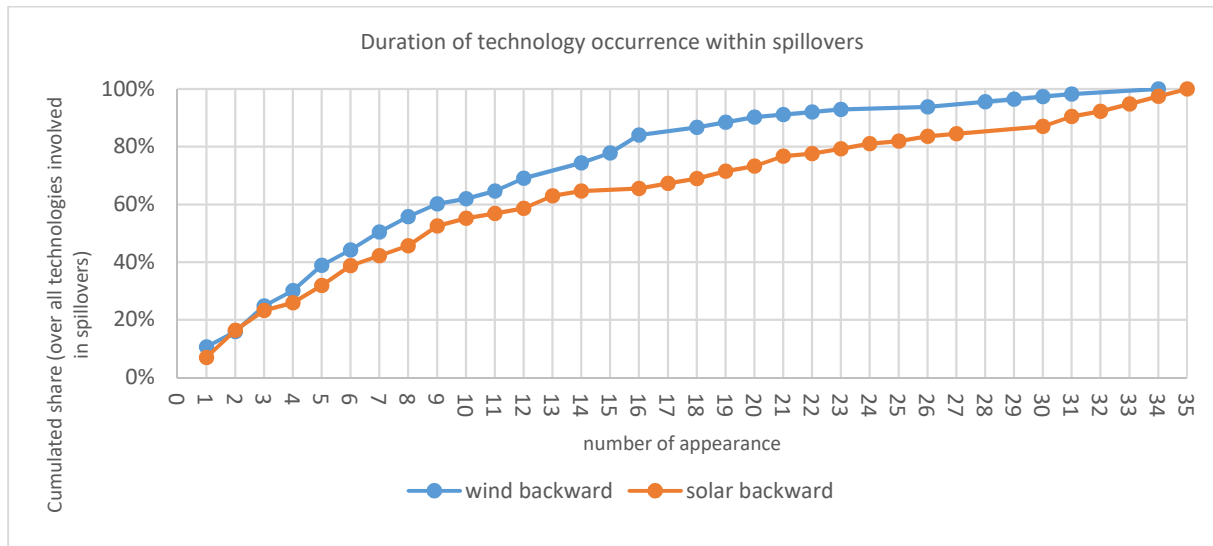

Figure 28: Duration of technology occurrence within spillovers

### 5.3. Social network centrality analysis

In the two first subsections, we have shown that most of the spillovers in wind innovation (resp. solar PV) contain wind (resp. solar PV) knowledge. Nevertheless, the share of spillovers containing only external knowledge is not trifling. Moreover, we could expect that key technologies may vary from one period to another; some technologies may disappear or appear changing the pattern of the knowledge recombination of the innovation process.

In this subsection, we present and discuss results related to the social network analysis. We calculate the two centrality indicators - degree and betweenness presented in section 3.5. First, we present some statistics about the structure of the networks (number of nodes, number of links, density, diameter, number of components)

#### Network size: dramatic increase during the last periods

The number of nodes is always higher for the solar PV than for the wind network (Figure 29). For both networks, there is an increase in the number of nodes and links around 1995/1997 whereas before this period the networks' size was almost constant. Finally, while the number of nodes increases linearly, the number of links increases exponentially (Figure 30). This shows that knowledge spillovers involve more and more different technologies, and renewable innovations use more and more diverse technologies.

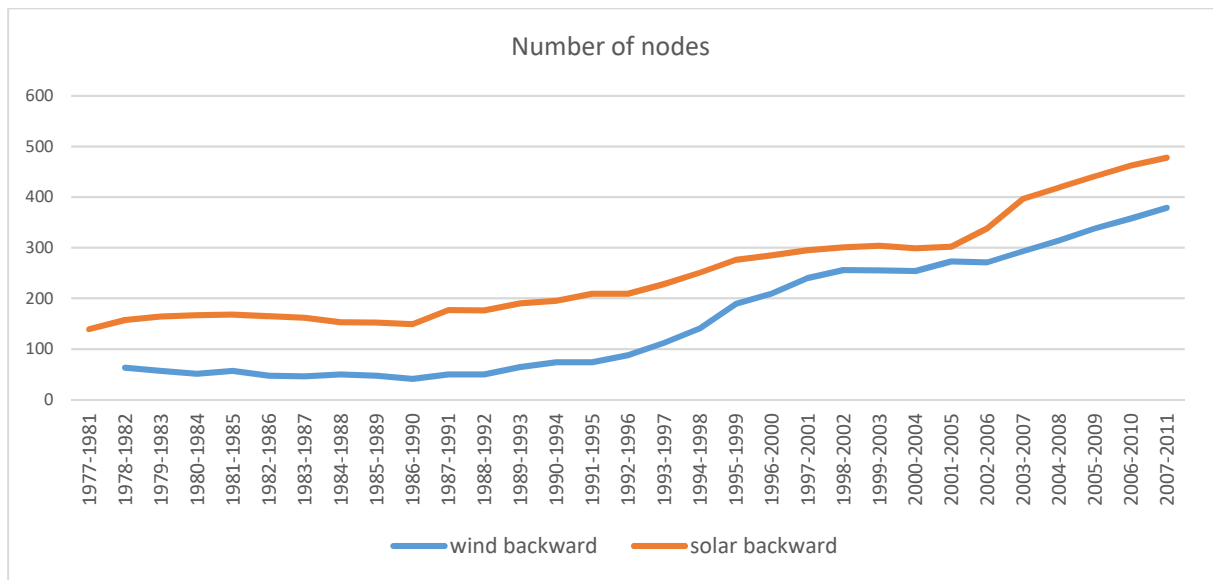

Figure 29: Number of nodes - wind and solar networks

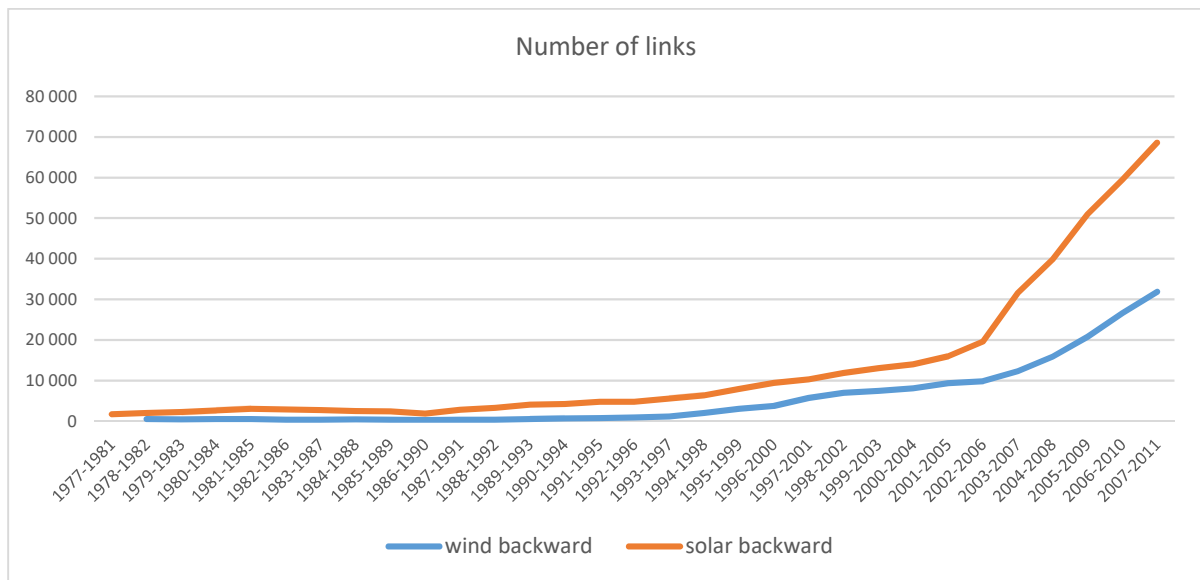

Figure 30: Number of links - wind and solar networks

### Only one network component, no trouble with centrality measures

The large majority of the networks has one component. The number of components and the size of the main component could influence the interpretation of other indicators; particularly centrality indicators (see results section for the centrality analysis of our networks). Indeed, some indicators have to be computed only on the main component to enable comparison between nodes.

### Density and diameter

Until the period [1996-200], the density is higher for wind network than for the solar PV network. The density remains relatively constant over the periods (around 10-15%), except an increase during the second period, for wind network.

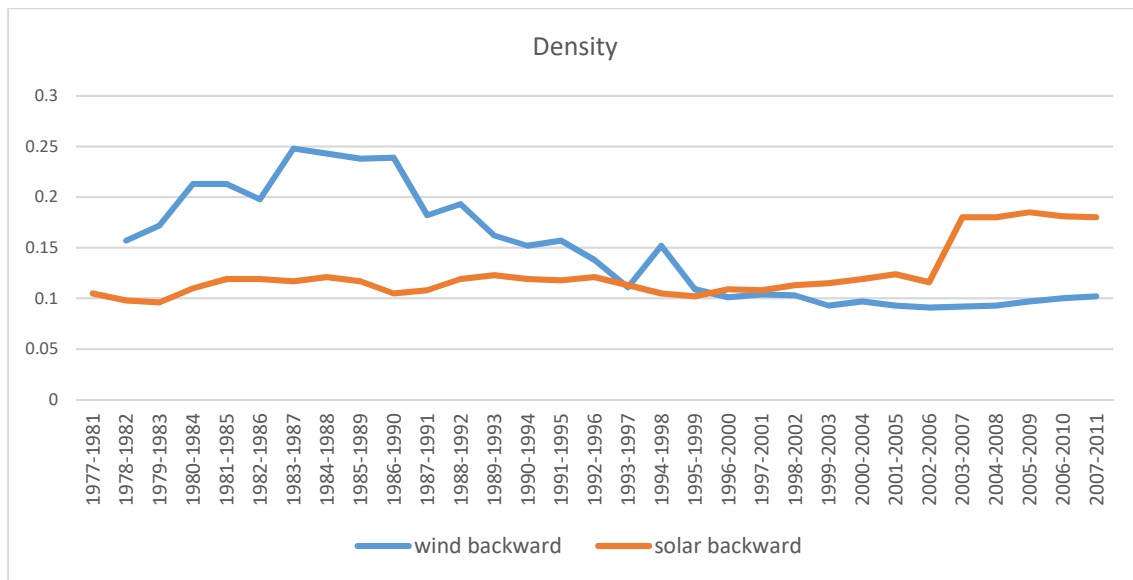

Figure 31 : Density - wind and solar networks

The diameter of both wind and solar PV networks remains constant around 4-5 for all the five-year rolling periods.

### 5.3.1. Network analysis – wind backward spillovers: transport, electric power, engineering

We start with the analysis of the wind backward citation networks.

Table 9 lists key technologies in the technological structure of the spillovers toward wind patents. Details about the evolution of the centrality values for key technologies are in appendix A-4.

Results show that the technological structure of the spillovers change along the life cycle of wind technologies, as the focus of innovation changed from a sub component to another. Thus, technologies related to “Aircraft, aviation cosmonautics” and to “Ships or other waterborne vessels” where particularly key when innovation focused on Power Train components. At the contrary, technologies related to “Structure of building”; “Hydraulic engineering”; “Hoisting; lifting; hauling”, “Measuring” helped for the technological development in wind when innovation focused on “Mounting/encapsulation components and grid connection technologies”. Knowledge in technologies for “Generation; conversion or distribution of electric power” mainly contributed to the development of wind innovations during these two last periods, unsurprisingly. Indeed, we can think they have been crucial for the development of wind grid connection applications.

Finally, as we could expect because generally innovation is based on ‘near knowledge’, specific wind knowledge is very central all along the periods.

Key knowledge Field (3-digits)	Trend	Periods				
		1978-1984	1984-1995	1995-2000	2000-2005	2005-2011
Wind technologies	↘→	++	++	++	++	++
Indexing schemes relating to engines or pumps	↗→	++	++	++	++	++
Ships or other waterborne vessels	↘	+	++	+	+	+
Aircraft, aviation; cosmonautics	↘	+	++	+	+	+
Generation; conversion or distribution of electric power	↗	++	+	+	++	++
Engineering elements and units	↗	++		+	++	++
Machines or engines in general	↘→	+	+	+	+	+
Hydraulic engineering	↗				+	+
Structure of building	↗				+	+
Measuring	↗				+	+
Hoisting; lifting; hauling	↗				+	+

Table 9 : Key technologies in the technological structure of spillovers toward wind patents

++ = highly key technology; + = key technology; grey = non-key; ↗ = increasing trend;

↘ = decreasing trend; → = constant trend

### 5.3.2. Network analysis – solar PV backward spillovers: transport, electricity, engineering

Table 10 presents the results of the network centrality analysis for solar PV innovations. More details are available in appendix A-5, particularly the graph representing the evolution of the value of betweenness and degree centrality over the years. Innovation in solar PV technologies has been mainly driven by solar PV knowledge and “basic electric elements” (this category contains, among other, semiconductor technologies). Many technologies play a key role along the life cycle of the solar PV technologies, like “Heating, range, ventilating”; “optics”; “Photography, cinematography, holography”; “crystal growth”. In the last period, as innovation has increasingly focused on the electrical aspect of the technology, “Generation; conversion or distribution of electric power” plays a key role within the spillovers.

Unsurprisingly, as innovation focus mainly on dye sensitized solar PV cells and organic cells during the two last periods, technologies related to “Dyes; paints; polishes; natural resins; adhesives” and “organic chemistry”; “Organic macromolecular compounds” play a crucial role.

Moreover, during the last two periods, we note the key role of nanotechnologies, whose similarity of the inter / intra technological structure of spillovers with solar PV technologies was mentioned earlier.

Key knowledge Field (3-digits)	Trend	Periods			
		1977-1984	1984-1996	1996-2004	2004-2011
Solar PV technologies	↗→	++	++	++	++
Basic electric elements	→	++	++	++	++
Dyes; paints; polishes; natural resins; adhesives	↗	+	+	+	++
Generation; conversion or distribution of electric power	↗→	+	+	+	++
Coating metallic materials	↘→	+	+	+	+
Crystal growth	→	+	+	+	+
Heating, range, ventilating	→	+	+	+	+
Optics	↗→	+	+	+	+
Photography, cinematography, holography	→	+	+	+	+
Layered products	↗→		+	+	+
Other electric techniques	↗		+	+	+
Organic chemistry	↗			+	++
Organic macromolecular compounds	↗			+	++
Nanotechnology	↗→			+	+
Controlling, regulating	→				+

Table 10: Key technologies in the technological structure of spillovers toward solar PV patents

++ = highly key technology; + = key technology; grey = non-key; ↗ = increasing trend; ↘ = decreasing trend; → = constant trend

Finally, when we compare the results of the network centrality analysis for wind and solar PV innovations, it stands out that for the two technologies the technological pattern of knowledge spillovers change over the years, following the life cycle of the technologies. Nevertheless, this pattern seems to fluctuate less for solar PV than for wind technologies. This could be explained by the fact that solar PV technologies follow the life cycle of mass produced products.

## 6. Countries Specialisation in ENR and complementary technologies

### 6.1. Objectives and methodology

During the previous sections, we identified the complementary technologies to wind and solar PV technologies. The objective of this section is first to study the degree of relative specialization of countries around the world in these complementary technologies and the heterogeneity of relative specializations within the 20 most specialized countries on average for all complementary technologies. Secondly, we compare the countries' relative specializations in complementary technologies and in wind/solar PV technologies. This allows us to get first insights on the links between these different levels of relative specialization. In particular, we seek to identify countries that are over-specialized in both complementary technologies and

wind/solar PV technologies and, on the contrary, countries that are not specialized. We also seek to identify inconsistencies between these levels of relative specialization within countries, i.e. countries that are over-specialized in complementary technologies but under-specialized in wind/solar PV. This last characterization could lead to reflections on the strategies of these countries on the REN markets. Indeed, this over-specialisation in complementary technologies may help to achieve a good innovation performance in the corresponding renewable energy through inter-technology knowledge spillovers.

We could choose to base our analysis on a direct measure of innovation performance, for instance by considering the number of patents filed by inventors in a country. However, a relative performance indicator allows taking into account two key aspects: the technological potential (the dynamics of innovation in the industry) and the competitive relations between economic agents. These competitive relations can lead to positive externalities where knowledge developed in one country can be absorbed by another country helping improving its innovative capacities. These externalities can also be negative as technological development in one country may reduce technological development for another country.

To measure the degree of specialization of each country, we rely on an indicator widely used in international economics: the Balassa's revealed comparative advantage (RCA). This indicator represents the success in exporting relative to the rest of the world, at the country level. This indicator measures the degree of relative export specialization of countries by comparing the share of a technology in a country's total exports to the share of exports of that technology in total world exports. To measure the degree of technological specialization of countries we will use the relative technological advantage (RTA) indicator. This measure of relative innovation performance relies on the same logic than RCA but instead of using exports data, it uses patent data. By analogy to the revealed comparative advantage. The formula is:

$$RTA_{ij} = \frac{\frac{P_{ij}}{\sum_{i'} P_{i'j}}}{\frac{\sum_{j'} P_{ij'}}{\sum_{i'} \sum_{j'} P_{i'j'}}}$$

Where, P is the number of patent filed, i refers to the technology and j to the country. The index is equal to zero when the country has no patents in a given technology. When it is equal to 1, the country's share in the sector equals its share in all fields (i.e. no specialisation). If it is greater than 1, this means that the country j is technologically over-specialised in technology i. In order to identify patent filed by a country, we rely on the country of inventors. For instance, if a patent has two inventors one French and the other American we consider that this patent is filed by France and USA, without including any fractioning count which would give 0.5 patent for France and 0.5 patent for the USA in this case. However, patents have the disadvantage of having a heterogeneous quality. Indeed, some patents are developed solely to impede the innovation of other firms. These patents do not have any commercial purpose. These patents are therefore considered to have a lower quality. The literature highlights different ways to measure the quality of a patent (see Bonnet, 2016 for a review of this literature). For our analysis, we chose to weight the patents by the size of their families, i.e. the number of offices in which a patent is filed to protect the same invention. As it is expensive to file a patent in an

office, the size of the patent family is assumed proportional to the commercial potential of the invention.

The main drawback of RTA is that it takes values between 0 and  $+\infty$  which implies that its distribution may not be symmetrical around its neutral value (1). This makes statistical analysis and comparison of values between countries difficult. Therefore, scholars developed alternative indicators symmetrical around their neutral value. We use here the alternative proposed by Laursen (2015): the symmetric relative performance:  $Symmetric\ RTA = \frac{RTA-1}{RTA+1}$ . The values of this symmetrical indicator range between -1 and 1, the neutral value is now 0. This means that the country is over-specialized in innovation if its symmetric RTA is between 0 and 1.

We identify the nationality of a patent with the country of origin of its inventors. If the inventors of a patent belong to several countries, we consider that the patent belongs to each of these countries without any weighting. For example, if the inventors of a patent come from France and Italy, we consider that both countries developed the invention.

To compute RTA our source of data is the autumn 2017 version of the EPO Worldwide Patent Statistical Database (PATSTAT) for the previous part of this chapter. In order to identify wind and solar PV patents we use the International Patent Classification (IPC). For wind energy, we keep the patents with the following IPC codes for wind technologies (Table 11)

IPC code	Signification
F03D 1	Wind motors with rotation axis substantially in wind direction
F03D 3	Wind motors with rotation axis substantially at right angle to wind direction
F03D 5	Other wind motors
F03D 7	Controlling wind motors
F03D 9	Adaptations of wind motors for special use;
F03D 11	Details, component parts, or accessories not provided for in, or of interest apart from, the other groups of this subclass

Table 11: IPC codes of wind technologies

In order to identify solar PV patent we use the following IPC codes (Table 12) (the star \* represents here the generic character):

Codes	Libellé
B32B 2457/12	Photovoltaic modules
H01L 31/04*	Semiconductor devices adapted as photovoltaic conversion devices
H01L 31/05*	Semiconductor devices adapted as photovoltaic conversion devices: Electrical interconnection means between PV cells inside the PV module, e.g. series connection of PV cells (electrodes, electrical interconnection of thin film solar cells formed on a common substrate ...)
H01L 31/06*	Semiconductor devices adapted as photovoltaic conversion devices, characterized by at least one potential-jump barrier or surface barrier
H01L 31/07	Semiconductor devices adapted as photovoltaic conversion devices, characterized by at least one potential-jump barrier or surface barrier, the potential barriers being only of the Schottky type
H01L 31/188	Apparatus specially adapted for automatic interconnection of solar cells in a module
H02N 6*	Generators in which light radiation is directly converted into electrical energy
H02S*	Generation of electric power by conversion of infra-red radiation, visible light or ultraviolet light, e.g. using photovoltaic modules (created in 2014)



Table 12: IPC codes of solar technologies

We keep here the same period of analysis as for the network analysis. Thus, we will focus on patents filed in wind complementary technologies between 1977 and 2011, and between 1978 and 2011 for solar PV complementary technologies. For each country, we calculate the symmetric RTA for each complementary technology and each year

It is important to note that our analysis does not cover years beyond 2011. It is therefore difficult with our purely descriptive approach to carry out technology foresight. Our objective is to establish an inventory of the countries' average specializations in complementary technologies during the specific period.

## 6.2. Wind technologies

### 6.2.1. Specialization in wind complementary technologies

We begin our analysis of specializations in complementary technologies with a graph representing the top 20 most specialized countries on average for all complementary technologies (Figure 32). We indicate the iso2 code of country to identify them. A table giving the correspondence between the iso2 codes and the names of the countries is available in appendix A-6. The figure in Appendix A-7 completes this analysis by providing a world map that represents, with a colour chart, the average country specialization in all these technologies.

We see that the most specialized countries are in Europe, North America and are rich countries: Norway (NO), Sweden (SE), France (FR), Germany (DE), Australia (AU), Finland (FI), Denmark (DK), Great Britain (GB), Canada (CA), New Zealand (NZ), Austria (AT), USA (US), Poland (PL), Italy (IT), Switzerland (CH), Russia (RU), Spain (ES), South Africa (ZA), Brazil (BR) and Romania (RO).

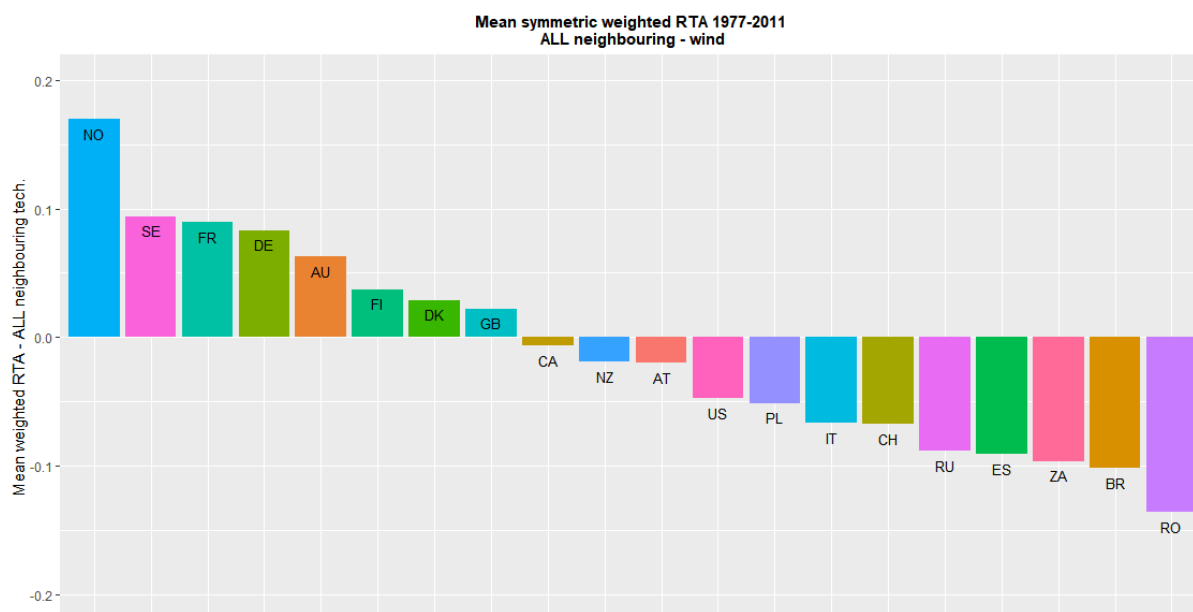

Figure 32: Top 20 of countries – mean symmetric weighted RTA over 1977-2011 for all neighbouring technologies to wind energy

Let's now take a detailed look at the level of specialization of each of these countries for each of the technologies. The following table summarizes the results (Table 13). Details of the levels of specialization by country are available in appendix A-8. We represent the main countries in rows and the different complementary technologies in columns. A "+" in the table means that the country is over-specialized in innovation on average over the period 1977-2011, while a "-" indicates an under-specialization. The last column of the table gives the number of complementary technologies in which the country is over-specialized. In order to refine the analysis, we highlighted in green if the country is among the top three countries in the world in terms of level of specialization in the corresponding technology. We note that several countries stand out, on different technologies: Norway, France and Germany.

Norway is the most performing country overall, in particular thanks to its good performance in B63 technologies (Ships or other waterborne vessels), as well as in those related to hydraulic engineering (E02). This is not surprising as the country has carried out major innovation programs in the maritime field (*e.g.* Global Maritime Knowledge Hub). Finland also has a strong relative performance in maritime transport technology (B63) and hydraulic engineering (E02). These countries, bordered by seas, are potential huge markets for the development of offshore wind technologies. Moreover, Finland and Norway are over-specialized in lifting and hoisting technologies (B66) which includes marine technologies such as capstan.

The results show that France is over-specialized in the largest number of complementary technologies. In particular, this country seems to be well positioned for the development of blade and rotor technologies. Indeed, it is the most specialized country in "Aircraft aviation cosmonautics" technologies (B64), thanks in particular to its aeronautics industry (Airbus) and the public policies implemented to support innovation in this sector (competitiveness cluster Aerospace Valley).

Germany is specialized in another aspect of wind technology: motors and other mechanical components. Indeed, it is one of the countries most invested in innovation in F01 (Machines or engines in general) and F16 (Engineering elements and units) technologies in particular thanks to its good performance in the manufacturing industry, especially the automotive industry.

Country	all tech	B63	B64	B66	E02	E04	F01	F05	F16	G01	H02	Total
France	+	+	+	-	+	+	+	+	+	+	+	10
Germany	+	-	+	+	-	+	+	+	+	+	+	9
Great-Britain	+	+	+	-	-	+	+	+	+	+	-	8
Australia	+	+	-	+	+	+	-	-	+	+	-	7
Norway	+	+	-	+	+	+	-	-	+	+	-	7
Sweden	+	+	-	+	+	+	+	-	+	-	-	7
Denmark	+	+	-	-	-	+	-	+	+	-	+	6
Austria	-	-	-	+	+	+	+	-	+	-	+	6
Poland	-	+	-	+	+	+	-	-	+	+	-	6
Finland	+	+	-	+	+	+	-	-	-	-	-	5
New-Zealand	-	+	-	-	+	+	-	-	+	-	+	5
Russia	-	+	+	-	+	-	-	-	-	+	-	4
Brazil	-	+	-	+	-	+	-	-	+	-	-	4
USA	-	-	+	-	-	-	+	+	-	+	-	4
Canada	-	+	-	-	+	+	-	-	-	+	-	4
Romania	-	-	-	-	+	+	-	-	-	+	+	4
Spain	-	+	-	+	-	+	-	-	+	-	-	4
Italy	-	+	-	+	-	+	-	-	+	-	-	4
South-Africa	-	+	-	-	+	+	-	-	-	-	-	3
Switzerland	-	-	-	+	-	+	-	+	-	-	-	3

Table 13: Specialisation of a selection of countries in complementary technologies - wind technologies

### 6.2.2. Specialization in wind technologies

Overall, the countries that are among the most specialized in wind technologies (Figure 20) are among the best in complementary technologies (e.g. Denmark, Norway, Germany, Finland, Canada). Denmark, which has long been involved in wind energy and has largely contributed to the standardization of the technology (three-bladed wind turbines, perpendicular to the ground) is logically the most specialized country. We also see countries outside the top for complementary technologies. These are notably small countries with relatively low total innovation capacities such as Moldova (MD), Croatia, Bulgaria (BG). The position of these countries can be related to the way the RTA is calculated. Since these countries have relatively low total innovation capabilities, a small amount of patents in REN accounts for a significant share of their total innovations, thus inflating the numerator of the indicator. It is also possible that these countries benefit from spillovers of knowledge from their European neighbours. The link between levels of specialization in wind turbines and their complementary technologies is therefore not as obvious as it might seem.

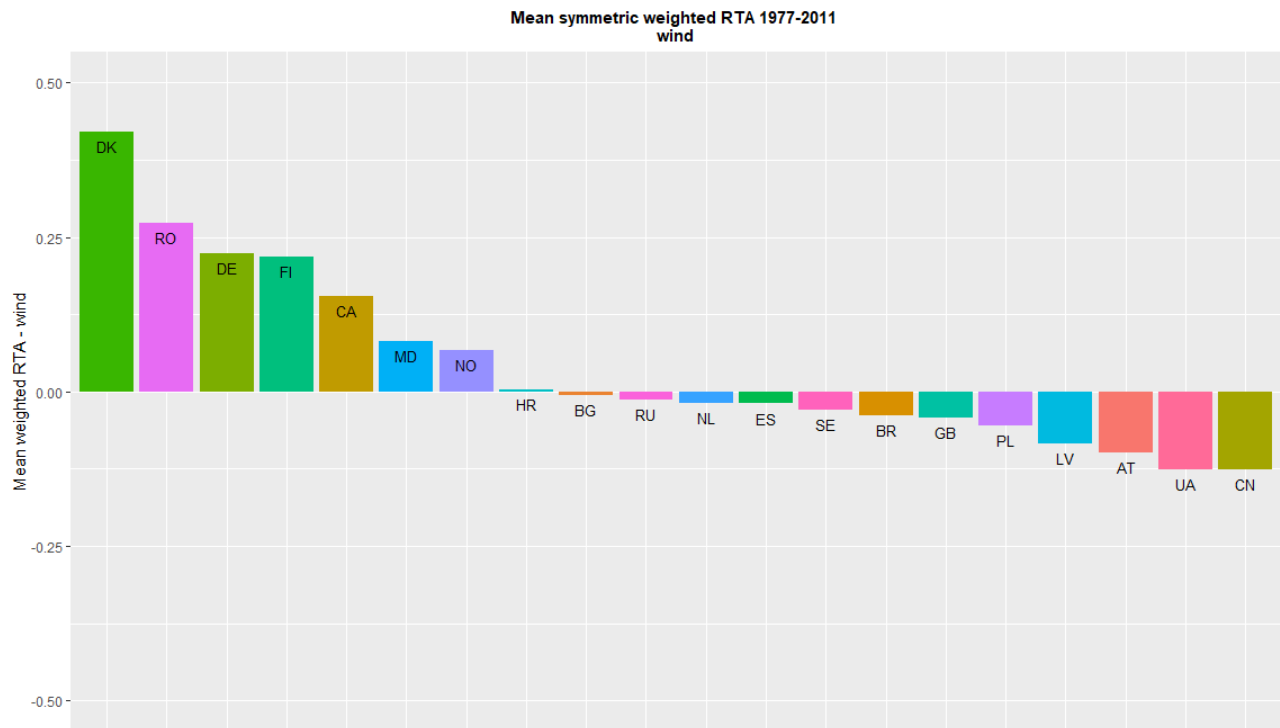

Figure 33: Top 20 of countries – mean symmetric weighted RTA over 1977-2011 for wind energy

The graph below (Figure 34) shows the level of specialization of countries in wind technologies according to their specialization in complementary technologies. We have defined four categories of countries represented by four distinct zones on the graph. For each of these zones we have used a particular colour. Note that the labels indicate the iso2 code of each country (see Appendix A-6 for the table of correspondence between the iso2 codes and the names of the countries). We obtain an over-specialization in wind technologies, for only half of the countries with a positive RTA on average for all complementary technologies: Denmark, Finland, Germany and Norway. For these countries, there is therefore full consistency between the levels of specialization of these different technologies. For the other four countries, there is some inconsistency between the levels of specialization. We can mention the case of France in particular. This country is highly over-specialized in aeronautical technologies, which could represent an advantage, particularly in blade and rotor innovation. These technologies did not undergo technological development between 1995 and 2005 due to standardization. Nevertheless, innovation efforts have been directed towards these technologies in recent years, and it would be in France's interest to allocate its innovation efforts to them. Sweden, Great Britain and Australia would also have an interest in innovating more in wind turbine technologies. Other countries, although not over-specialized in complementary technologies, have a good relative innovation performance in wind technology. Here we find countries with lower innovation capacities such as Moldova, Romania or Croatia. Finally, other countries such as Spain, Austria and Russia are close to having a positive RTA in wind although they are under-specialized in complementary technologies. Maybe this is due to spillovers of knowledge from other European countries.

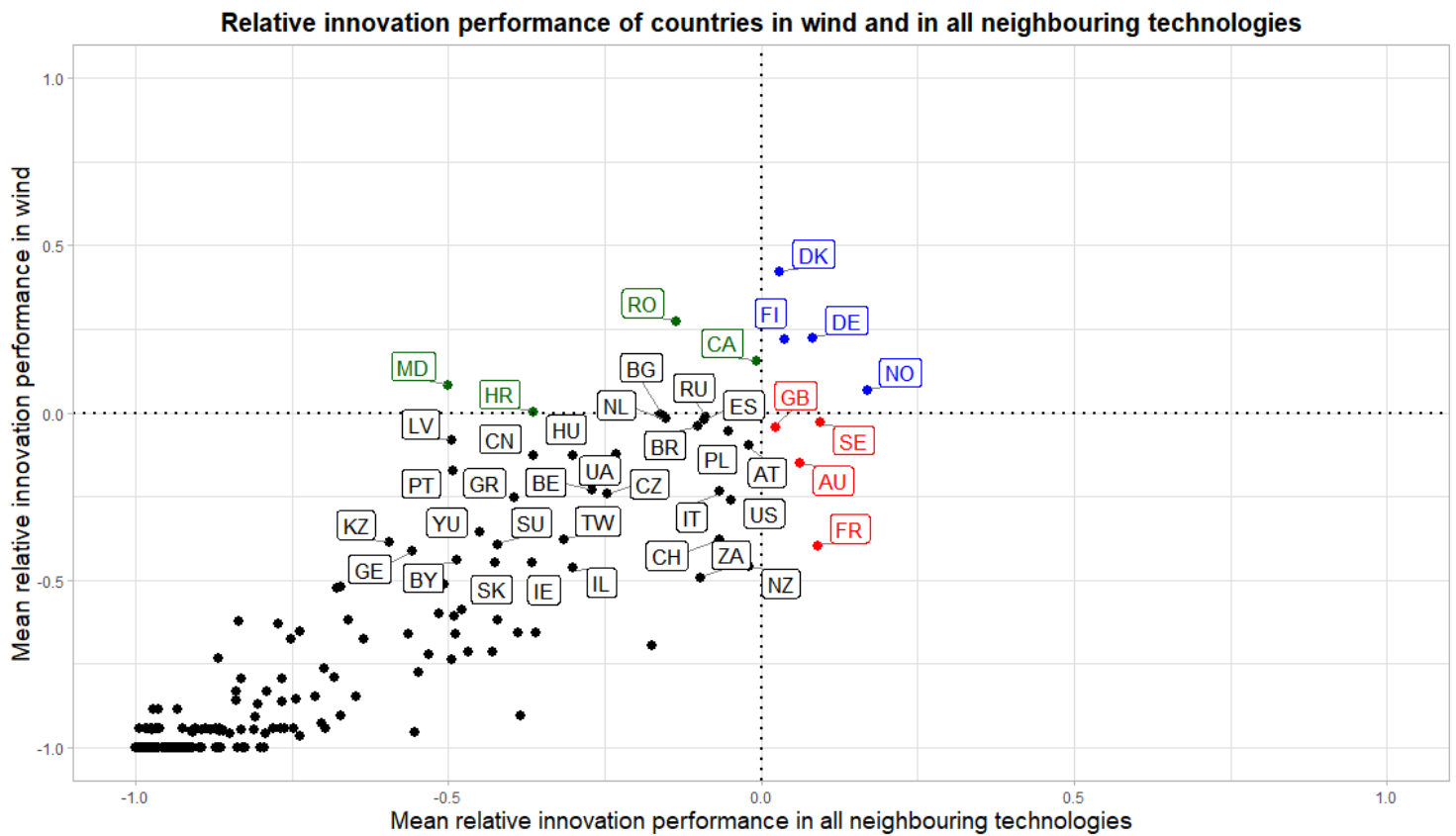

Figure 34: Relative innovation performance of countries in wind and in all neighbouring technologies

### 6.3. Solar PV technologies

#### 6.3.1. Specialization in solar PV complementary technologies

The graph below (Figure 35) as well as world map in appendix A-9 show that the countries with the highest average RTA in all solar PV complementary technologies are Japan, United States, Germany, the Netherlands, France, Belgium, Great Britain, Switzerland, Austria, Canada, Israel, Russia, Italy, Australia, Sweden, Romania, South Korea, India, Singapore, Ireland. It is nevertheless important to note that Japan and the United States are the only two

countries with a positive RTA on average over the entire period. This marks the dominance of these two countries in terms of innovation in complementary solar PV energy technologies.

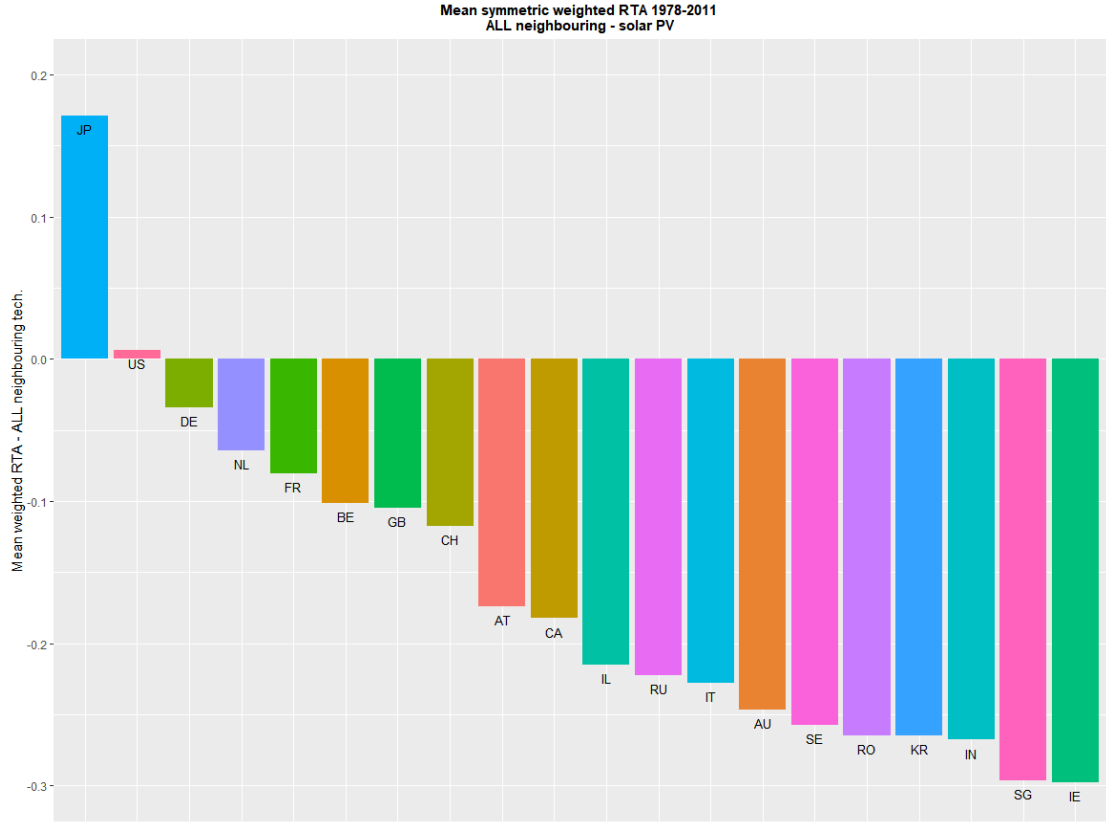

Figure 35: Top 20 of countries – mean symmetric weighted RTA over 1978-2011 for solar PV complementary technologies

As for wind technologies, the following table summarizes the level of specialization of each in each of the complementary technologies, over the entire period. The signs and colours have the same meaning as for wind power. Details of the relative innovation performance within each country are available in appendix A-10.

Japan is among the leaders in many technologies. In particular, Japan is specialized in technologies related to optics (G02), photography (G03) and surface coating (C23). These technologies are particularly useful for optimizing the outer frame of photovoltaic panels and for finding the right angle of incidence in relation to the sun's rays in order to optimize panel performance. In addition, the country has a strong innovation base to assist in the development of photovoltaic cells. Indeed, Japan is among the most successful in nanotechnology (B82) and crystal growth (C30). Finally, it has a good RTA on electrical aspects in general (H01 and H05). We can think that this is partly due to its audio-visual and electronics industry supported by firms such as Sony, JVC, Toshiba, Sharp, Panasonic or Hitachi.

However, we observe that Japan is not among the best innovators regarding the organic chemical industry (C07 and C08 codes) and the "Dyes; paints; gloss; natural resins; adhesives" (C09) industry. Yet, both are useful for the development of new photovoltaic technologies such as light-sensitive pigment cells or organic cells. Performance and innovation in these sectors are dominated by Switzerland, Belgium and India. Belgium has important research centers in organic chemistry such as Vito and NovAlix. Switzerland benefits from the dynamism of its pharmaceutical (Roche or Novartis) to be successful in innovation in organic chemistry. The

chemical industry is developing more and more in India, with companies like Arkema. This company, which specializes in polymer materials, is in India since the 1990s and works in particular on technical solutions for the photovoltaic industry.

Country	all tech	B32	B82	C07	C08	C09	C23	C30	F24	G02	G03	G05	H01	H02	H05	Total
Japon	+	+	+	-	+	+	+	+	-	+	+	+	+	+	+	13
USA	+	+	-	+	+	+	+	+	-	-	-	+	-	-	+	9
Netherlands	-	-	-	+	+	+	-	-	-	+	+	-	+	-	+	7
Germany	-	-	-	+	+	+	-	-	+	-	-	+	-	+	-	6
Belgium	-	+	-	+	+	+	+	-	-	-	+	-	-	-	-	6
France	-	+	-	+	+	-	-	+	-	-	-	-	-	+	-	5
Switzerland	-	-	-	+	+	+	-	-	-	-	-	-	-	-	-	3
Austria	-	-	-	-	-	-	+	-	+	-	-	-	-	+	-	3
Italy	-	-	-	+	+	-	-	-	+	-	-	-	-	-	-	3
Great-Britain	-	-	-	+	-	+	-	-	-	-	-	-	-	-	-	2
Israel	-	-	-	+	-	-	-	-	+	-	-	-	-	-	-	2
Sweden	-	+	-	-	-	-	-	-	+	-	-	-	-	-	-	2
Korea	-	-	-	-	-	-	-	-	+	-	-	-	+	-	-	2
India	-	-	-	+	+	-	-	-	-	-	-	-	-	-	-	2
Singapore	-	-	-	-	-	-	-	-	-	-	-	-	+	-	+	2
Canada	-	-	-	+	-	-	-	-	-	-	-	-	-	-	-	1
Russia	-	-	-	-	-	-	-	+	-	-	-	-	-	-	-	1
Australia	-	-	-	-	-	-	-	-	+	-	-	-	-	-	-	1
Romania	-	-	-	-	-	-	-	-	-	-	-	-	-	+	-	1
Ireland	-	-	-	-	-	-	-	-	-	-	-	-	-	-	-	0

Table 14: Specialisation of a selection of countries in complementary technologies - solar PV technologies

### 6.3.2. Specialization in solar PV technologies

The graph below (Figure 36) represents the 20 countries most specialized in PV solar technology innovation. Among these countries, only Taiwan is not among the most specialized in complementary technologies. However, we again note that few countries have a positive average RTA over the whole period. This is partly due to the large dominance of Japan, which automatically pulls the relative performance of the other countries down.

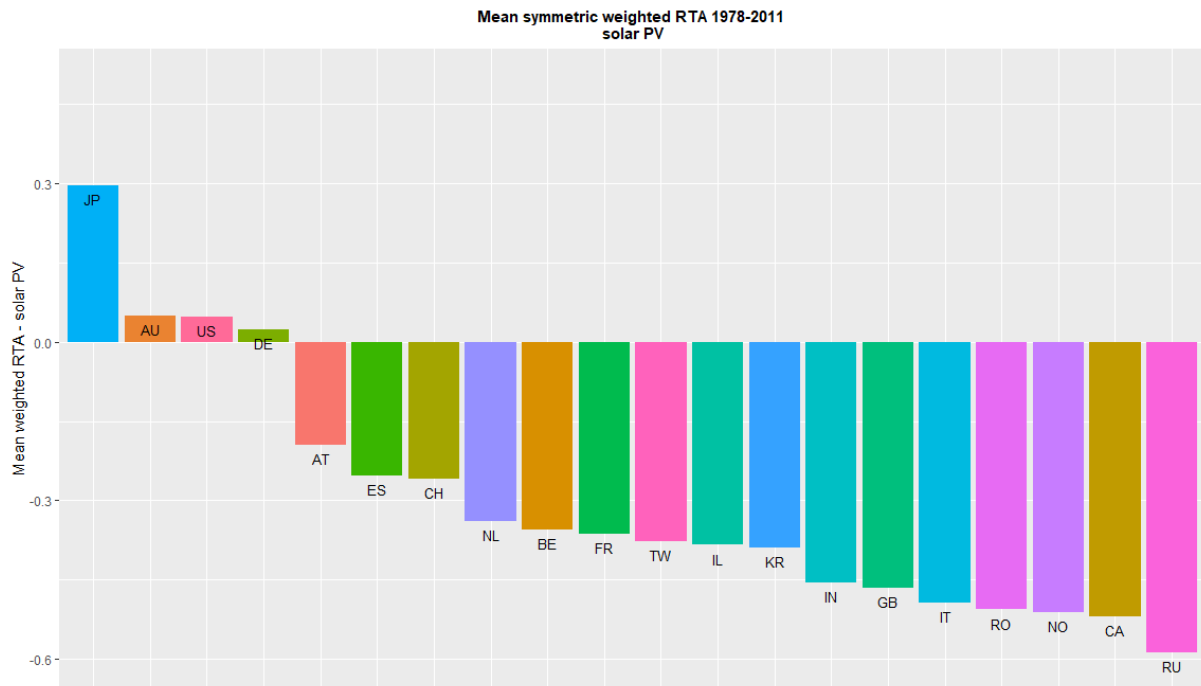

Figure 36: Top 20 of countries – mean symmetric weighted RTA over 1977-2011 for solar PV energy

The graph below (Figure 37) compares the specialization in innovation in complementary technologies and in solar PV technologies for each country. This graph again shows Japan's superiority over all technologies, so that for only two countries (Japan and USA) we have two positive relative performances. Two countries manage to reach a positive RTA for solar PV technologies while they are under-specialized in complementary technologies: Australia and Germany. We think that these two countries support solar innovation directly enough to be able to achieve a good relative innovation performance in the solar sector despite not optimal local complementary knowledge. In contrast to wind energy, where several countries were close to the origin of the graph, the under-specialized countries here are relatively far from it. This is due to the strong superiority of Japan, which influences the relative performance of all other countries. Overall, this graph seems to show more consistency between countries' levels of specialization than for wind technologies, but this is partly related to Japan's dominant position in both solar and complementary technologies.



Relative innovation performance of countries in solar PV and in all neighbouring technologies

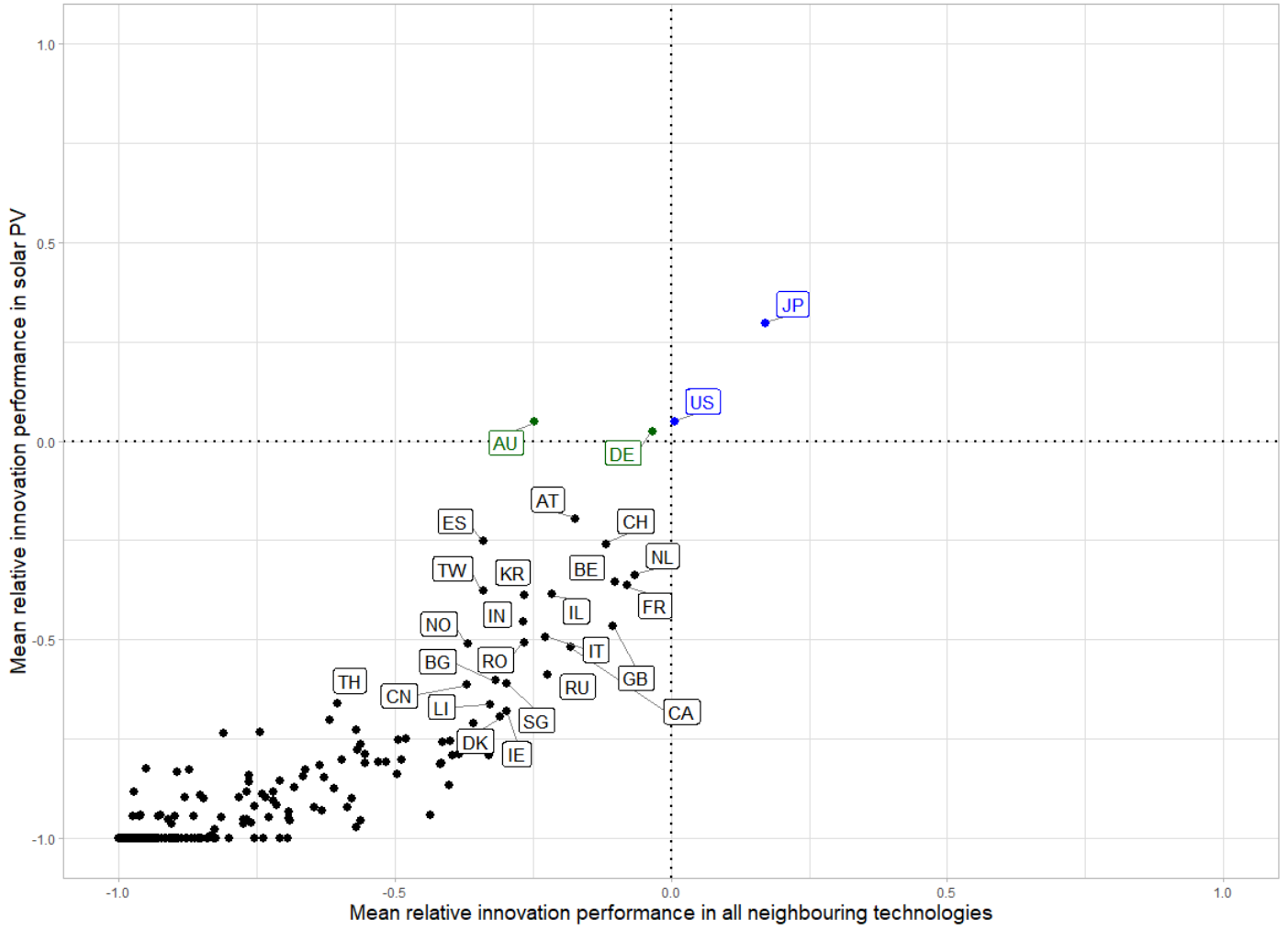

Figure 37: Relative innovation performance of countries in solar PV and in all neighbouring technologies

## 7. Conclusion

Four main objectives guide our analysis:

- i) Measure the knowledge spillovers toward solar PV and wind renewable innovations;
- ii) Explore the technological pattern of knowledge spillovers;
- iii) Study the temporal evolution of the technological pattern of such knowledge spillovers. More particularly, we have distinguished specific renewable technologies and external knowledge within spillovers.
- iv) Describe the level of specialization in complementary technologies of countries around the world and analyse their consistency between the specialization in complementary technologies and in REN

Using patent citation data, we implement a new empirical approach in the literature by implementing a social network analysis based on the co-occurrence of technologies among spillovers, in order to study the technological pattern of knowledge spillovers. Then, we computed the relative innovation performance of countries around the world in REN technologies and their complementary technologies in order to identify the consistency and inconsistencies between these performance levels.

For wind and solar innovations, almost all the spillovers contain renewable and non-renewable codes. The share of “100% inter technology spillovers” reaches around 45% for solar PV compared to around 10% for wind.

We show that, the technological content of spillovers toward wind and solar PV technologies evolves with the life cycle of these technologies.

Innovations in transport, in mechanical and building engineering play a crucial role for wind technological development. Innovations in optic, coating and chemistry are key for solar PV.

Finally, the last section analyses the degree of specialization in complementary technologies in each country and compares the specializations in REN and their complementary technologies for each country. We observe more consistency between relative innovation performance in complementary technologies and REN for solar PV than for wind. This is due to Japan's strong dominance in solar and complementary technologies, which pulls down the performance of all other countries. Japan is so dominant that no country has a strong performance in complementary technologies and an under-specialization in solar and therefore would be well placed to innovate in this technology. Japan enjoys a good innovation performance in various complementary technologies (optics, photography and surface coating). Nevertheless, Switzerland, Belgium and India have a strong knowledge base to innovate in new solar technologies such as organic cells and dye-sensitized cells. For wind technologies, the inconsistencies between the levels of specialization are more pronounced. In particular, France benefits from a very good performance in aeronautical technologies but does not lead to an over-specialization in wind energy innovation. Great Britain, Sweden and Australia are in a similar situation.

This analysis may help improving further empirical studies evaluating the dynamics of innovation in renewable energy, particularly in terms of public policy evaluation and justify heterogeneous effect across country and REN technologies.

The first two chapters provide justification for differentiated effects of public policies according to REN technologies and countries. Because of the strong knowledge base in complementary technologies, some countries are more likely to enhance significantly their innovation performance through public policy support. Nevertheless, from a green growth perspective, these public policies also aim to ensure the commercialisation of new technologies and to create jobs. As shown in chapter 1, because of difficulties in econometric modelling, academic literature on the effect of policies on innovation and technology diffusion has mainly focused on only one of the two aspects. However, for endogeneity problems that can influence the results, it is crucial to take into account all the interactions between policies, technological development and economic performance. In the following chapter, we deal with this gap in the literature.

# **Chapter 3: Revealed technological advantage and revealed comparative advantage in wind and solar PV technologies: a Panel VAR analysis using trade and patent data**

---

## **1. Introduction**

Green growth is becoming an increasingly key topic for policy makers who want to maintain a prosperous and environmentally friendly economy that respects international climate agreements. Within countries, the development of the renewable energy industry is one of the wedges for achieving these two objectives. In this regard, governments implement specific diffusion policies and support research & development (RD) to incentivize innovation and diffusion of renewable energies. Thus, beyond technological development (innovation and adoption of REN), these policies seek to support the economic development of countries (in particular by encouraging economic agents to export). Theoretically, these two objectives are complementary: a better export performance should enable the development of innovation performance and vice versa. However, these two objectives can be in contradiction within a country. Given the globalization of trade, the adoption of technologies (diffusion within the country) can take place via imports. This then favours foreign industries at the expense of local industries and hinders the development of the latter and their capacity to reach a critical size enabling them to enter international markets.

Moreover, as all countries aspire to this green growth, this creates tensions on the international markets for renewable technologies. Trade frictions between the United States or European countries, former leaders in the renewable energy market, and new leaders such as China illustrate this situation (Hajdukiewicz and Pera, 2020).

In this context, it seems crucial to investigate the interrelations between public policies, innovation performance and international trade performance of countries.

Recently, several studies have investigated endogenous forces that may create productivity differences across countries and industries (Sampson, 2016; Somale, 2017; Cai et al., 2017). These studies show that innovation and international diffusion of technologies across countries are the main sources of differences in productivity. Furthermore, international trade activities can also affect domestic RD through learning-by-exporting and global market expansion. A number of studies tried to analyse the feedback from international trade, including learning-by-exporting, to firm RD (Delgado et al. 2002; Love and Ganotakis, 2013; Silva et al. 2012; among others). According to these studies, exporting activity can affect positively RD investment and furthermore enhance productivity in the exporting firm. De Loecker (2007) emphasizes that firms can become more productive by starting exporting and the productivity gains are higher when firms export to high-income countries.

However, this literature considered the one-way effect of RD on trade or vice versa, excluding the potential mutual endogeneity of domestic innovation, trade and public policies. Therefore, this may bias the results. Considering the two phenomenon jointly may show which one explains better innovation and exporting (Love and Mansury, 2009).

Zachmann (2016) investigates the potential relation between relative technology advantage (RTA) and relative comparative advantage (RCA) for four green technologies (electric vehicles, wind turbines, batteries, solar photovoltaic) in several countries including the 27 European countries (see chapter 2 for a description of RCA and RTA). Zachmann looks at the temporal evolution of the RTA and RCA, and considers the innovative performance of countries in technologies closely related to the four green technologies. He shows that countries specialized in nearby technologies<sup>23</sup> are already also specialised in the studied low-carbon technology, and countries that are good at exporting certain products are often good at patenting in related technologies. However, he does not carry out any econometric analysis and therefore cannot conclude to any accurate causality between RTA and RCA.

Given this state of the art, this chapter investigates econometrically, with a Panel VAR model, the interactions between RTA and RCA considering also the effect of climate policies and potential endogeneity between all these variables. We focus on two REN technologies: wind and solar photovoltaic (solar PV). Our panel covers 24 countries from 1989 to 2014. To the best of our knowledge, this is the first focusing on wind and solar PV technologies that analyse interactions between RTA and RCA as well as the impact of public policies on these two indicators, by considering the potential endogeneity problem between these variables.

We analyse whether the relationships between innovation performance and international trade performance are complementary or act as substitutes. More precisely, we are interested in examining the existence of a virtuous circle between RTA and RCA where RTA has a positive effect on RCA (technological advantage which leads to a higher competitiveness), and recursively RCA has a positive effect on RTA (learning by exporting).

Moreover, we will investigate the effect of public policies on RTA and RCA and find if there are different effect depending on the type of policy. Indeed, the previous literature may suggest that the effect may be different between regulatory instruments, price based market pull policies and quantity based market pull policies (see chapter one).

Finally, we are also interested in the self-reinforcement over time of countries' innovation and export performance. This then informs whether it is crucial for countries to position themselves quickly as a technological leader or to obtain a dominant position on international markets as quickly as possible.

Our results show that public RD expenditures appears to be more appropriate than diffusion policies to improve export performance. On the one hand, for both technologies, we find that diffusion policies have no effect on exports or even a negative effect. On the other hand, for solar technologies, RD expenditures have a significantly positive effect on export performance. This may be explained by the low level of maturity of these technologies. For wind

---

<sup>23</sup> He determines the related technologies by investigating the co-occurrences of technological IPC codes within patents (for more information, see annex 3 of his paper).

technologies, the effect of RD expenditures on exportations is indirect, through the support of relative innovation performance. Indeed, we find that RD expenditures help the development of relative innovation performance, which has a positive influence on relative export performance. In solar energy, there is no technological standard unlike wind energy, so if a country offers a more efficient technology the demand can move to that country. Our results for wind technologies also highlight the necessity to take into account the heterogeneity of patent values.

This result is different from the conclusions of the existing literature, where there seems to be a positive link between diffusion policies and the amount of exports on the one hand, and an ambiguous effect of RD expenditures on exports, on the other hand. Thus, by considering the endogeneity between the variables and the dynamic effects, we make an original contribution to the existing literature.

The second key result concerns the relations between the two performance measures in each technologies. For both technologies, we reject the learning-by-exporting hypothesis. Moreover, we find a self-selection effect for wind only. Differences in barriers to entry and higher sunk costs for the wind industry explain these disparities between solar PV and wind technologies.

These two main results have consequences for countries that wish to support green growth and internationalize their renewable industries. For both technologies, it is necessary to focus on innovation support rather than diffusion support. The latter can indeed promote the development of domestic markets at the expense of exports and even enhance imports (Ogura, 2020). Given their cost structure and the barriers to entry into international markets, wind energy requires a strong innovation performance to improve export performance.

We note the importance of reputation effects on international markets and the need for players to enter these markets as soon as possible. Indeed, we observe a strong self-reinforcement of the relative export performance for both technologies.

This chapter proceeds as follows. Section 2 is a non-exhaustive literature review focused on recent studies examining the determinants of countries' innovation and export performance. This review highlights gaps in the literature and justify our approach. Section 3 provides a theoretical framework for the endogeneity problems that we address in our study. The fourth section presents the variables that we include in our Panel VAR models as well as the data sources. Section 5 provides several descriptive statistics and seeks in particular to establish a first typology of countries according to their innovation and export performance and according to the relationship between performances within each country. The sixth section details our estimation strategy and gives the theoretical elements associated with the estimation of the Panel VAR models. Finally, the seventh section presents the results and the eighth section discusses and concludes our study.

## **2. Literature review**

This section presents recent econometric publications dealing with the relations between innovation and export performance: unidirectional dependence from one performance to another, or bidirectional dependence. In addition, we present a short literature review of studies

evaluating the effect of policies on exports, particularly in renewable energy. This review covers 45 papers (see appendix B-1).

Only a few studies focus on renewable technologies (some even cover several technologies/industries without making any distinction) or try to deal with dynamic mechanisms and self-reinforcement of the performance measures. In addition, most of the papers use micro data, therefore giving few insights on the mechanisms at stake at the country level.

Overall, the results show a positive unidirectional effect from innovation performance to export performance (and vice versa) and a virtuous cycle between these two performances (for the papers dealing with the bidirectional issue). However, papers use only absolute measures (amount of innovation, RD expenditures, export value, simply dummy variables) and not relative performance like revealed comparative advantage (Balassa, 1965). The objective of countries is to innovate and export more. Nevertheless, it is crucial to compare with other countries this increase in order to take into account the dynamics of competition on the international markets. Moreover, relative measures prevent biases related to the size of countries that influences their maximum innovation capacities, for example. Therefore, comparing performance between countries is easier with a relative performance indicator (Laursen, 2015).

In addition, the current literature performance does not consider sufficiently patent quality in innovation performance, even though this would allow taking into account that some innovations do not lead to commercial applications or are filed to impede innovation of other economic agents.

## **2.1. Unidirectional effect between innovation and export performances**

We will start by the literature dealing with unidirectional effect between the two performances.

The 11 papers estimating the influence of innovation performance on export performance mainly show a positive unidirectional dependence (*e.g.* Rodil et al., 2016; Azar and Ciabushi, 2017; Belderbos et al., 2009). In particular, Wu et al. (2019) conclude that this result is robust to several specifications considering the level of productivity of firms, type of industry (either labour intensive or capital intensive), and the type of firm (either private or public). Some papers however, find that the unidirectional effect is not significant (Falk and de Lemos, 2019; Cieřlik and Michałek, 2018 for product/management and marketing innovation). Moreover, Cieřlik et al. (2018) highlight for a sample of Chinese firms that the influence may not be constant between two periods as they find that product innovation<sup>24</sup> has a positive effect on export in 2012 but had no significant effect in 2003. Conversely, their results show that process innovation had a positive effect on exports in 2003 but no significant effect in 2012. According to the authors, *“This may suggest that Chinese firms are moving away from process innovation toward product innovation, which makes them more similar to the firms from advanced*

---

<sup>24</sup> For the definition of the different types of innovation (product, process, organizational, marketing, ...) please refer to the Oslo's manual (OECD, 2019)

*economies where product innovation plays a more important role than process innovation”*. (Cieřlik et al., 2018 p.37)

Results are also nuanced in Elliott et al. (2019) where the positive effect of innovation on export is greater on intensive margins (*i.e.* exports by exporting firms) than on extensive margins (*i.e.* the number of firms exporting). Brunel (2019) analyses drivers of exports in wind and solar PV technologies and find heterogeneous results depending on the technologies, mainly because they have different level of maturity. She finds a positive unidirectional effect for wind technologies and a not significant effect for solar PV technologies. Nevertheless, we have to be careful with these conclusions as the dataset of Brunel (2019) only covers the period 1988-2003 and therefore does not include the post-2003 period of high dynamism of the REN market.

In this literature review, we found nine papers estimating econometrically the influence of export on innovation. These papers are all at the firm level (*e.g.* Trachuk and Linder, 2018, 2019 ; Olabisi, 2017 ; Salomon and Shaver, 2005). Almost all of them find a positive influence, except Yang (2019) who concludes of a negative impact of process export (*i.e.* export of goods based on imported intermediate product) on new product sales (used as one of the proxy for innovation) of Chinese firms. From Di Cintio et al. (2020) it stands out that direct exporters have an higher probability of introducing product innovation than indirect exporters (*i.e.* a firm that chooses a trade intermediary instead of directly exporting to consumers abroad) because the trade intermediary is for the exporter a barrier to acquisition of knowledge from the foreign market. Salomon and Jin (2010) show that the effect of export on innovation is greater for technologically leading firms comparatively to technologically lagging firms, in Spain. According to the authors, leading firms benefit more from their exports because it is easier for them to transform knowledge acquired in international markets into innovation. Love and Ganotakis (2013) deal with the effect of cumulated exposure to export market on innovation. They find heterogeneous results between service firm and manufacturing firms. Service firms are able to reap earlier the benefits of exposure to export markets than manufacturing firms.

## **2.2. Endogeneity issues between export and innovation**

However, this literature considers the one-way effect of RD on trade or vice versa, excluding the potential mutual endogeneity of domestic innovation and trade. Therefore, this may bias the results. Considering the two phenomenon jointly may show which one explains better innovation and export (Love and Mansury, 2009). We cover 13 papers trying to deal with this potential endogeneity issue. Most of these find a virtuous circle between innovation performance and export performance (*e.g.* Neves et al., 2016; Esteve-Pérez and Rodriguez, 2013; Zhao and li, 1997). Nevertheless, results may vary by geographic area or industrial sector. For Rehman (2017), the existence of a virtuous circle is robust to two sub-populations of firms: the Eurasian firms and the Central and Eastern Europe firms. However, according to Girma et al. (2018), there is a positive effect of innovation on export for British firms but not for Irish ones, whereas export influences positively innovation of Irish firms only. Heterogeneity may exist across industries as shown by Alarcón and Sánchez (2016) for food and agriculture. They conclude with a virtuous cycle for the food industry but only a positive significant impact of innovation on export for the agricultural sector. Moreover, concerning the influence of export on innovation, some studies find no significant relation and therefore no virtuous circle between



the two performances. (Végazonès-Varoudakis and Plane, 2019; Ayllón and Radic, 2019; Salim and Bloch, 2009). Unfortunately, these papers give few explanations. Végazonès-Varoudakis and Plane (2019) conclude that it is because innovation rely more on “*business environment, human capacity, access to infrastructure and financing seem to count for innovation*” (Végazonès-Varoudakis and Plane, 2019 p.4466). Ayllón and Radic (2019) find only a positive contemporaneous effect of export on innovation, as the lagged export variable has no influence.

Kim and Kim (2015) is the unique econometric paper carrying out an analysis on the potential virtuous circle between innovation performance and export performance for the renewable energy industry. According to their results, there is a virtuous cycle between export and innovation performance for wind technology but not for solar PV technologies. Specifically, while they find a positive effect of innovation on exports for both technologies, solar exports do not influence innovation for solar PV technologies. They mainly explain this divergence by the different level of maturity and different market expansion of these technologies: “*This result suggests that the set of determinants varies with the internationalization processes of renewable energy technology. The more mature and competitive the renewable energy technology becomes, the further the international market expands, leading to increases in market entry of developing and developed countries*” (Kim and Kim, 2015 p.723).

Finally, Zachmann (2016) highlights that the innovative performance of a country in related technologies to renewable energies could affect significantly RTA and RCA in this country. However, his study rely on descriptive statistics and cartography and not on econometric estimation. Therefore, he cannot test empirically the relations between RTA and RCA.

### **2.3. Effect of public policies on innovation and export**

In this sub-section, we are interested in econometric studies analysing the effect of policies on innovation and diffusion mainly in the renewable energy sector.

As presented in the first chapter, we generally distinguish between two main types of policies: techno-push policies (*e.g.*, public expenditure on RD) and demand-pull policies (*e.g.*, feed-in tariffs, quotas). This first chapter provides a review of the literature on the effect of climate policies on innovation in REN. The results show that techno-push policies have a significant positive effect on innovation in REN, regardless the technology studied. Moreover, the effect of demand-pull policies depends on the REN technologies. Quantity-based policies seem to be more effective in supporting innovation in mature renewable technologies such as wind technologies while price-based policies seem to be more effective in supporting innovation in solar PV, a less mature technology (for more details on results and interpretations see chapter 1).

Here, we will therefore mainly cover studies evaluating the effect of policies on technology diffusion. The effect of climate policies on exports is based on international trade theories (Ricardian or Heckscher-Ohlin-Samuelson comparative advantage) and on Porter's hypothesis (Porter and Van der Linde, 1995, Van Leeuwen and Mohnen, 2017). According to classic theories, environmental regulations are harmful to the growth of firms because they create

additional costs, thus affecting the competitiveness of the firms subject to these regulations. Porter in 1991 as well as Porter and Van der Linde in 1995 challenged this statement. They believe that well-defined environmental policies can encourage innovation and create benefits greater than the costs they induce (Porter hypothesis later abbreviated to PH). Jaffe and Palmer (1997) refine this theory by distinguishing three versions of the PH. While the weak and narrow versions concern the effect of climate policies on innovation, the strong version of the Porter hypothesis states that environmental policies improve the economic performance of firms because the gains associated with innovation will offset the costs incurred by compliance with environmental regulations. Regarding the international competitiveness of countries, Jaffe and Palmer (1997) also refer to the "narrowly strong" version, which states that governments enjoy improved competitiveness and domestic profits through the introduction of environmental policy. The PH influenced politics, particularly in the United States (Gore, 1992). However, Palmer, Oates and Portney (1995) argue that the PH is inconsistent with the assumption that firms seek to maximize their profits. Indeed, why would regulation be necessary to encourage firms to adopt innovations that increase their profits? In reality, the PH is based on the idea that firms ignore certain opportunities although they are profitable for them.

Let us mention here that another theory has been developed: the pollution haven hypothesis. It states that strict environmental standards harm export performance to the benefit of countries with less stringent environmental regulations. Indeed, according to this hypothesis, in countries with high environmental standards, firms face additional costs if they have to comply with regulations. These firms then choose between relocating their production to countries with low standards or not relocating but becoming less competitive and thus losing market share.

Concerning climate policies supporting renewable energy, as presented in the first chapter, we can expect a positive effect on exports. The costs of most renewable energy technologies remain high compared to fossil fuels, especially since many renewable energy technologies are still technically relatively immature. Thus, there is high potential profitability improvement in these technologies (Arent et al., 2011). According to Söderholm and Klaassen (2007), the economic development of renewable technologies is mainly based on creating the potential for technological innovation and diffusion by reducing costs. Supporting RD leads to increased specialization and production (Jha, 2009) by helping component manufacturers to reduce production costs and improve export quality (Khalil et al., 2010). Thus, public spending indirectly affects diffusion through its impact on costs.

Demand-pull policies include, in particular, feed-in tariffs. The central principle of this type of policy is to create the basis for future market stability and greater security of investment in renewable energy technologies by offering guaranteed prices for electricity produced from renewable energy sources, for a set period. Indirectly, this increases competition and provides incentives for technological developments, leading to cost reductions and volume growth (Lund, 2009). Nevertheless, Nemet (2009) points out that uncertainty about the longevity of these policies can hamper investment. Therefore, it is crucial that a feed-in tariff policy is stable and that communication from policy makers is clear. Feed-in tariffs can promote innovation in various renewable energy technologies by exploiting their diffusion potential, which in turn can lead to specialization and higher exports (Sung and Song, 2013). However, if prices on international markets are lower than the prices guaranteed by feed-in policies, this can have a negative effect on exports, as producers focus on the domestic market.

Quantity-based policies such as quotas are a type of demand-pull policy. They define a penetration target in the energy mix, most of time without systematically targeting a particular renewable technology. Just like feed-in tariffs, this policy ensures a certain level of profitability, but in this case by guarantying sales volumes. Nevertheless, the price of imported products must be higher than the price of goods produced by domestic companies, otherwise renewable technologies will be imported and local producers will not be able to develop and then enter international markets.

We have identified 12 recent papers studying econometrically the relationship between climate/environmental policies and exports. Three of these studies do not concern renewable energies: Zhao (2011) on energy intensive industries, Costantini and Mazzanti (2012) on five manufacturing sectors classified according to their technological and environmental characteristics, and Hwang and Kim (2017) on manufacturing industries classified according to their energy intensity.

Methodologically, the studies mainly use approaches based on static panels (gravity models) and dynamic panels (panel vector autoregressive). Dynamic models have the advantage of taking into account the potential endogeneity between exports and public policies. They also allow to measure inertia in exports by measuring the impact of exports at date  $t-1$  on exports at date  $t$ . Overall the studies conclude that there is such inertia in export dynamics (Sung and Wen, 2018; Sung and Song, 2014; Sung et al., 2017).

Among these 12 studies, non-renewable energy papers study environmental policies: carbon tax (Zhao, 2011), energy tax, environmental tax. The last two policies are measured either by dummy variables (Hwang and Kim, 2017) or by their revenues as percentage of total revenues (Costantini and Mazzanti, 2012). The results of these studies reject the strong version of Porter's hypothesis. Indeed, Zhao et al (2011) find a negative effect of carbon taxes on exports in energy-intensive industries. Hwang and Kim (2017) also conclude that energy and environmental taxes harm the international competitiveness of different manufacturing sectors. Costantini and Mazzanti (2012) point out that the results may differ according to the technology level of the sectors and therefore it is key to consider this heterogeneity. According to their study, environmental and energy taxes have a positive effect only on the export of high-tech goods (no effect in other sectors).

The effect of public spending on RD is also studied. These are directly measured by the public budget allocated to each of the renewable technologies. The lack of data on private RD expenditures is nevertheless a limitation. The results are different from one study to another: two find a positive effect (Kim and Kim, 2015; Groba, 2014), two find a non-significant effect (Sung and Song, 2014 for wind and biomass; Sung and Song, 2013) and two find a negative effect (Sung and Wen, 2018; Sung and Song, 2014 for solar). Therefore, it is difficult to interpret these results (more details in the table in appendix B-1). The time necessary before the effect of RD expenditures on exports can be detected may explain the difficult to estimate this

effect. Finally, dynamic panel studies do not conclude that exports are endogenous to RD expenditures.<sup>25</sup>

The studies also look at the effect of price-based diffusion policies on exports. Among price-based diffusion policies, feed-in tariffs are the most widely used measure in the world, as well as auction systems and guaranteed price systems. Policies are measured by dummy variables (e.g., Ogura, 2020; Kim and Kim, 2015), by the amount of feed-in tariff (Ogura, 2020), by the share of renewable energy in electricity generation/in installed capacity, or by the length of time since the implementation of the policy (Groba, 2014; Groba and Cao, 2015). Overall, although the results are mixed, there is a significant positive effect of these policies on exports. Kuik et al (2019), Sung and Song (2014), Kim and Kim (2015) find a positive effect on exports for wind and solar technologies. For solar, Groba (2014) and Groba and Cao (2015) find a positive effect too. In particular, Groba (2014) shows that the time since the implementation of the policy has a significantly positive impact on exports, confirming the need for stable policies to reduce risks for investors. However, according to Groba and Cao (2015), the significant diffusion policies implemented by wind technology importers from China has a significantly negative effect on China's exports. They justify this by the existence of a highly developed wind industry in many countries outside China, including Denmark, Germany and the United States. In these countries where the wind industry is developed, the demand is satisfied by local production. Thus, these countries do not need to rely on imports. Finally, it is difficult to conclude on a potential endogeneity of exports with price-based policies as there is an endogeneity according to Sung and Song (2014) but no endogeneity according to Sung and Wen (2017).

Finally, studies analyse the effect of quantity-based policies on exports. In the literature, we find quite different results between wind and solar technologies. For wind technologies, it seems that these diffusion policies implemented in the exporting country do not provide incentives for exports (Kim and Kim, 2015; Ogura, 2020). We saw in chapter 1 that quantity-based policies are particularly effective in providing incentives for domestic diffusion of wind. This may therefore explain this significantly negative result. Moreover, policies in the importing country seem to favour exports (Ogura, 2020; Groba and Cao, 2015). For solar technologies, results are heterogeneous between studies. In the exporting country, Kim and Kim (2015) show a positive effect on exports while Ogura (2020) show a negative effect. In the importing country the effect is insignificant for Ogura (2020) and negative for Groba and Cao (2015). It is unclear what could explain these discrepancies between studies as the authors do not give much insight to explain these results.

#### **2.4. Issues hardly addressed by the literature and aim of this chapter**

Several aspects do not seem to be sufficiently addressed in the literature. First, all the papers mentioned above are at the micro level, except Brunel (2019), Salim and Bloch (2009), Kim and Kim (2015). Although a macroeconomic approach does not focus on the agents who

---

<sup>25</sup> We could expect a positive effect of exports on RD expenditures. Indeed, exports support economic growth and therefore higher revenues. Thus, governments would have more budget to subsidize research. Nevertheless, these phenomena may take time to be perceptible or governments may allocate budgets to other technologies.

ultimately make the decisions to innovate and export, it does allow us to consider the international competition between countries that plays a crucial role in our globalized world. Second, there are very few papers dealing specifically with renewable technologies that is a wedge of countries' national green growth strategies. Third, they do not show the dynamic impact of policies on the interrelations between RD activity and international trade.

Considering these limitations in the literature, this chapter analyses whether the relationships between innovation performance and international trade performance are complementary or act as substitutes. More precisely, as it is the most often premise made by policy designers, we explore the existence of a virtuous circle between RTA and RCA, *i.e.* RTA has a positive effect on RCA (technological advantage which leads to a higher competitiveness), and recursively RCA has a positive effect on RTA (learning by exporting). We also analyse how diffusion and RD policy interfere with these performances.

### **3. Theoretical framework and hypotheses**

The main objective of this chapter is to study the interdependencies between the relative innovation performance and the relative export performance of countries. In this section, we present the arguments in favour of a potential endogeneity problem between the two measures of relative performance. In addition, our study aims at taking into account the potential impact of climate policies supporting innovation and supporting diffusion on relative performance. These policies are potentially endogenous with the relative performances. Therefore, our model will take into account the potential endogeneity problems between all these variables.

#### **3.1. Possible endogeneity between innovation and exports: the coexistence of two hypotheses**

In this subsection, we describe two hypotheses regarding the possible endogeneity between innovation performance and export performance of a country. More precisely, we will refer to two hypotheses:

- i. The 'learning-by-exporting' hypothesis, *i.e.* exports encourage more innovation, in particular by promoting knowledge transfer and promoting the profitability of new products.
- ii. The self-selection hypothesis, which stipulates that the most "productive" firms are more inclined to export

##### **3.1.1. The learning-by exporting hypothesis**

The learning-by-exporting thesis argues that contact with foreign partners drives firms to improve their technological capabilities and their innovation performance. The main reason is that exporting is an important source of income, information, competitive pressures, and other comparative advantages for firms, leading to significant performance improvements (Baldwin and Gu, 2003; Garcia et al., 2012; Yang and Mallick, 2014). Wagner (2007) and in Martins and Yang (2009) provide a literature review on the learning by exporting hypothesis.

Some scholars have shown that variables related to demand affect RD efforts (see for instance Piva and Vivarelli, 2007, Popp et al. 2010). In advanced countries, export is the most dynamic component of demand. In particular, it leads to demand for new knowledge and new

competences required to succeed in an international competitive market (Dosi et al, 1990; Carlin, 2001).

Moreover, export success plays a key role to provide the financial resources required for RD investments. Indeed, a large literature has shown that RD activities are financially constrained (Hall, 2002; Cincera and Ravet, 2010; Bogliacino and Gomez, 2010) mainly because RD is difficult to collateralize (i.e. return on RD investment is subject to uncertainty) and suffers from informational problems (asymmetric distribution of information) (Stiglitz and Weiss, 1981). Consequently, successful economic performance – through both exports and profits – represents a vital source of resources for financing RD activities.

Furthermore, according to the Costantini and Melitz model (2008), firms anticipate trade liberalization by making investments to upgrade the production process through innovation. The reason is that higher expected profits from internationalization are contingent on higher productivity. Thus, not only income from export activities improves the innovation performance of companies, but also the expected profitability related to technology improvements.

Some scholars also argue that the positive connection between exposure to foreign market and firm technological knowledge is due to highly competitive pressure of international market, as this constantly forces firms to upgrade their technologies (Wagner, 2007).

Finally, by participating in international trade, a firm becomes aware of other technologies available on the market, taps into knowledge that is more diverse and is exposed to best practice technologies (Girma et al. 2003). On average, the effect from learning by exporting on firm productivity could be higher for firms in developing countries, because of their greater distance to the technological frontier compared to those in developed countries (Martins & Yang, 2009).

However, the impact of the knowledge acquired from the international market on innovation performance may take time, as highlighted by Salomon and Shaver (2005) who carry out a case study of Spanish firms. They conclude that it takes two years after the export market entry for the learning-by-exporting effect to have an impact on product innovation.

### **3.1.2. Self-selection hypothesis**

The literature on learning by exporting essentially considers this phenomenon as an exogenous variable to explain firm productivity improvements, but does not take into account the fact that learning may be an outcome of the strategic decision of the firm, and could also act as an endogenous variable. This problem gives rise to the “sample selection” hypothesis (Wagner, 2002). This hypothesis postulates that the firm innovative activity intensifies its export performance. A wide literature has already investigated, both theoretically and empirically, the relation between technology and international competitiveness (see among others Dosi et al. 1990; Amendola et al., 1993, Carlin et al., 2001; Landesmann and Pfaffermayr 1997). In particular, the Melitz’ model (2003), starting from the observation that exporters within an

industry are the most productive firms<sup>26</sup>, has revolutionized the theoretical developments in the field of international trade.

This theory rests on several arguments. First, the most productive firms are more likely to export because the level of competition is more intense in the export markets. Moreover, these markets have higher costs than the domestic markets (Helpman et al., 2004; Clerides et al. 1998). Indeed, some sunk costs are associated with entrance and exploitation in foreign markets, and therefore only the most productive firms find profitable to adopt an ‘exportation strategy’, as emphasized in Roberts and Tybout (1997). Exporting firms face significant start-up costs in order to get information and develop marketing channels in foreign markets, and to learn how to deal with new bureaucratic procedures (Greenaway et al., 2007).

Second, innovations able the firm to differentiate and therefore is a source of international competitive advantage (Filipescu et al., 2009; López Rodríguez and García Rodríguez, 2005). Furthermore, competitors may not have the necessary resources to imitate, reproduce the innovation (Miller and Shamsie, 1996). Finally, by innovating, firms adjust their products to the needs of foreign customers and reduce their operational cost through process innovation (Lachenmaier and Wößmann, 2006).

Third, according to Pla-Barber and Alegre (2007), innovation leads to export because the local market alone may not be large enough to make innovation investments profitable.

### **3.2. The possible endogeneity of public policies**

In addition to the potential problem of endogeneity of performance variables, we must take into account the possible endogeneity of public policy variables. Lobbying strategies of incumbent firms may explain this endogeneity. In fact, the entrance of new product in the market may harm the profit of these firms. This may be particularly true for energy markets and the entrance of new renewable technologies. The historical firms are specialized in fossil fuels. High fixed costs make the fossil fuel market oligopolistic. This situation allows actors to generate substantial rents if public authorities do not regulate their activities or do not internalise the negative externalities of pollution they generate. If the action of public authorities is to favour renewable energies, this will potentially, reduce their market share and market power. From this point of view, the increase of innovation and export performance in renewable energies may increase lobbying actions by incumbents and thus may have a negative effect on the implementation of public policies (Gürtler et al., 2019). Nevertheless, lobbying can come from actors specialised in renewable energies. The more their innovation and export performance increases, the greater the influence they can have on governments (Suhlsen and Alisschemoller, 2014; Strunz et al., 2016; Gullberg, 2013).

---

<sup>26</sup> This observation is shared by other studies in the 1990’s (see for instance Bernard et al. (1995) who showed that among US manufacturing plants, exporters are larger, more skill-intensive, more capital intensive, and more productive, or Clerides et al., 1998; Roberts and Tybout, 1997).

Finally, endogeneity may be due to studies evaluating the impact of implemented policies. Let us imagine a policy supporting innovation and therefore seeking to increase the innovation performance of economic agents. The evaluation of the policy will try, for example, to compare the innovation performance of agents who have benefited from the policy with the performance of other agents. If the evaluation concludes that the policy increased innovation performance, this may provide an incentive for the government to intensify their actions (Bini et al., 2017; Broc et al, 2019).

## 4. Variables and data

### 4.1. Relative export performance

Like mentioned in the previous chapter, in the empirical trade literature, it is common to measure the relative export performance with the Balassa index (1965) of revealed comparative advantage (RCA) which represents the success in exporting of countries relative to the rest of the world<sup>27</sup>.

Chapter 2 presents the formula for the relative innovative performance (RTA). The formula for RCA is similar, except we replace patents by the value of exports:

$$RCA_{ij} = \frac{\frac{X_{ij}}{\sum_{i'} X_{i'j}}}{\frac{\sum_{j'} X_{ij'}}{\sum_{i'} \sum_{j'} X_{i'j'}}}$$

$X_{ij}$  are annual exports of product  $i$  from country  $j$ . A comparative advantage is "revealed" if  $RCA > 1$ . If RCA is less than unity, the country has a comparative disadvantage in the corresponding commodity or industry.

For the same reasons as for RTA in chapter 2, we calculate a symmetrical RCA indicator around 0:  $Symmetric\ RCA = \frac{RCA-1}{RCA+1}$ . The values of this symmetrical indicator range between -1 and 1, the neutral value is now 0. This means that the country is over-specialized in exports if its symmetric RCA is between 0 and 1.

We retrieve international trade data from the UN-COMTRADE<sup>28</sup> (United Nations International Trade Statistics) database. The HS (Harmonized System) classification, an international nomenclature for the classification of products, allows filtering the database to retrieve data for a specific commodity.

In order to get data only on wind trade exchanges we use the classification of the Harmonized System (HS). We use the following codes (Table 15):

---

<sup>27</sup> Although, strictly speaking, the Balassa index is a measure of specialization, we will use it as a measure of relative export performance.

<sup>28</sup> <https://comtrade.un.org/data/>, data retrieved the 05/05/2019



Code	Meaning
850231	Electric generating sets; wind-powered, (excluding those with spark-ignition or compression-ignition internal combustion piston engines)
850230	Electric generating sets (removed in 1996)

Table 15: Two HS codes wind technologies

Nevertheless, in many papers (*e.g.* Wind, 2008; Sung and Song, 2014; Jha, 2009; Kuik et al., 2019), the authors use more HS codes to be as exhaustive as possible. Therefore, besides the wind core technologies, they also consider all wind complementary technologies. The main advantage of considering a larger number of HS codes is that it provides a more exhaustive measure of export performance. Thus, this reduces the risk of not including an export flow relevant for the analysis. Moreover, this may be relevant because of the synergies between all the technologies represented by all these codes. A country may specialize in the products at the core of the technology only, or only in complementary products that have more generic uses, or in all products. Interactions with innovations can therefore take place at several levels.

Therefore, in addition to the RCA indicator with two HS codes, we build an alternative RCA covering exports tagged with all the following HS codes (Table 16). These codes represent several technologies such as electrical machinery and equipment, all or roller bearing, electric generators and transformers, instruments for measuring.

Code	Meaning	Code	Meaning
850231	Electric generating sets; wind-powered, (excluding those with spark-ignition or compression-ignition internal combustion piston engines)	850421	Electrical transformers; liquid dielectric, having a power handling capacity not exceeding 650kVA
850230	Electric generating sets (removed in 1996)	850422	Electrical transformers; liquid dielectric, having a power handling capacity exceeding 650kVA but not exceeding 10,000kVA
730820	Iron or steel; structures and parts thereof, towers and lattice masts	850423	Electrical transformers; liquid dielectric, having a power handling capacity exceeding 10,000kVA
841290	Engines; parts, for engines and motors of heading no. 8412	850431	Electrical transformers; n.e.s. in item no. 8504.2, having a power handling capacity not exceeding 1kVA
848220	Bearings; tapered roller bearings, including cone and tapered roller assemblies	850432	Transformers; n.e.s. in item no. 8504.2, having a power handling capacity exceeding 1kVA but not exceeding 16kVA
848230	Bearings; spherical roller bearings	850433	Transformers; n.e.s. in item no. 8504.2, having a power handling capacity exceeding 16kVA but not exceeding 500kVA
848240	Bearings; needle roller bearings	850434	Transformers; n.e.s. in item no. 8504.2, having a power handling capacity exceeding 500kVA
848250	Bearings; cylindrical roller bearings n.e.s. in heading no. 8482	854459	Insulated electric conductors; for a voltage exceeding 80 volts but not exceeding 1000 volts, not fitted with connectors
848280	Bearings; n.e.s. in heading no. 8482, including combined ball/roller	854460	Insulated electric conductors; for a voltage exceeding 1000 volts
848340	Gears and gearing; (not toothed wheels, chain sprockets and other transmission elements presented separately); ball screws; gear boxes and other speed changers, including torque converters	902830	Meters; electricity supply or production meters, including calibrating meters thereof
850161	Generators; AC generators, (alternators), of an output not exceeding 75kVA	903020	Cathode-ray oscilloscopes and cathode-ray oscillographs
850162	Electric generators; AC generators, (alternators), of an output exceeding 75kVA but not exceeding 375kVA	903031	Multimeters; for measuring or checking voltage, current, resistance or power, without a recording device
850163	Electric generators; AC generators, (alternators), of an output exceeding 375kVA but not exceeding 750kVA	903081	Instruments and apparatus; with a recording device, specially designed for telecommunications (eg cross-talk meters, gain measuring instruments, distortion factor meters, psophometers)
850164	Electric generators; AC generators, (alternators), of an output exceeding 750kVA	848210	Ball bearings
850300	Electric motors and generators; parts suitable for use solely or principally with the machines of heading no. 8501 or 8502	848340	Gears and gearing; (not toothed wheels, chain sprockets and other transmission elements presented separately); ball or roller screws; gear boxes and other speed changers, including torque converters

Table 16: All HS codes- wind technologies

For solar PV technologies, we also build two RCA covering two different set of HS codes. A first RCA include only two HS codes (Table 17) and the other all the potential codes (Table 18). All these codes cover several technologies such as mirrors, water heaters, electrical components (batteries, transformers ...), optical technologies (lenses ...).

Code	Meaning
854140	Electrical apparatus; photosensitive, including photovoltaic cells, whether or not assembled in modules or made up into panels, light-emitting diodes (LED)
854150	Electrical apparatus; photosensitive semiconductor devices n.e.c. in heading no. 8541, including photovoltaic cells, whether or not assembled in modules or made up into panels

Table 17: Two HS codes - solar PV technologies

Code	Meaning	Code	Meaning
854140	Electrical apparatus; photosensitive, including photovoltaic cells, whether or not assembled in modules or made up into panels, light emitting diodes	841989	Machinery, plant and laboratory equipment; for treating materials by change of temperature, other than for making hot drinks or cooking or heating food
854150	Electrical apparatus; photosensitive semiconductor devices n.e.s. in heading no. 8541, including photovoltaic cells, whether or not assembled in modules or made up into panels	841990	Machinery, plant and laboratory equipment; parts of equipment for treating materials by a process involving a change of temperature
700991	Glass mirrors; unframed, excluding rear-view mirrors for vehicles	850440	Electrical static converters
700992	Glass mirrors; framed, excluding rear-view mirrors for vehicles	850720	Electric accumulators; lead-acid, (other than for starting piston engines), including separators, whether or not rectangular (including square)
711590	Metal; precious or metal clad with precious metal, other than that of item no. 7115.10	900190	Optical elements; lenses n.e.c. in heading no. 9001, prisms, mirrors and other optical elements, unmounted, of any material (excluding elements of glass not optically worked)
830630	Photograph, picture or similar frames, mirrors; of base metal	900290	Optical elements; n.e.c. in heading no. 9002 (e.g. prisms and mirrors), mounted, being parts or fittings for instruments or apparatus, of any material (excluding elements of glass not optically worked)
841280	Engines; pneumatic power engines and motors, n.e.s. in heading no. 8412	900580	Monoculars; other optical telescopes and astronomical instruments, excluding instruments for radio-astronomy
841919	Heaters; instantaneous or storage water heaters, non-electric, other than gas		

Table 18: All HS codes – solar PV technologies

## 4.2. Relative technological advantage

We use an unweighted and a weighted symmetric RTA indicator as introduced in chapter 2.

## 4.3. Public policies indicators

We consider two variables representing two types of public policies. Firstly, as a measure of policies supporting innovation we use public RD expenditures directed towards the technology under study. These data on Government Energy Technology RD Budgets are from the IEA Energy Technology RD Statistics<sup>29</sup>. In order to take into account size effects at the country level we divide RD expenditures by the GDP of the country. It should be noted that our study does not take into account indirect innovation support specific to enterprises, such as subsidies and research tax credits, whereas decisions to patent are most often made by firms. Nevertheless,

<sup>29</sup> [https://www.oecd-ilibrary.org/energy/data/iea-energy-technology-r-d-statistics/r-d-budget\\_data-00488-en](https://www.oecd-ilibrary.org/energy/data/iea-energy-technology-r-d-statistics/r-d-budget_data-00488-en)

as we showed in the first chapter, public RD expenditures has a positive effect on innovation in wind and solar PV technologies.

We also include a variable measuring policies supporting diffusion (*share cap*). In the literature, scholars use various proxies for this type of policy: dummy variables equal to one when the policy is in force and zero otherwise; environmental severity indicators (EPS) developed by the OECD; feed-in tariff amount; installed production capacity.... Given our methodological constraint related to the presence of endogeneity between all our variables of interest, we have to use specific econometric methods. We detail the methodology in section 6. It is nevertheless necessary to mention that categorical variables (like dummy variables) are not very suitable for this type of model. Thus, we will use as a proxy for diffusion policies the ratio of installed production capacity in the renewable technology under study over the total installed production capacity. Sung (2015), Boehringer et al. (2014) and Dalmazzone and Corsatea (2012) use this proxy.

## 5. Descriptive statistics

### 5.1. Data coverage and label of variables

Our panel covers 24 countries mainly European: Austria, Australia, Belgium, Canada, Switzerland, Germany, Denmark, Spain, Finland, France, United Kingdom, Greece, Ireland, Italy, Japan, Republic of Korea, Luxembourg, The Netherlands, Norway, New Zealand, Portugal, Sweden, Turkey, United States of America.

Unfortunately, we could not include China in our panel because of the unavailability of data (in particular public policy data). In solar PV technologies, nine of the twelve main PV exporters (in terms of market share) are Chinese (Figure 38) and in total China accounts for 78% of the solar PV module production in 2017 (Yu and Geoffron, 2020). In wind technologies, China has a less predominant role: seven of the top fifteen firms in terms of total installed capacities were Chinese in 2017 (Figure 39).

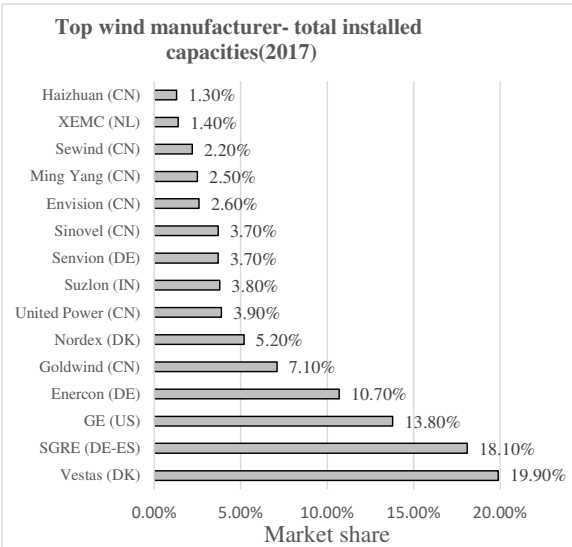

Figure 39: Main manufacturer wind industry (2017)  
Source: Yusta and Lacal-Arántegui (2020)

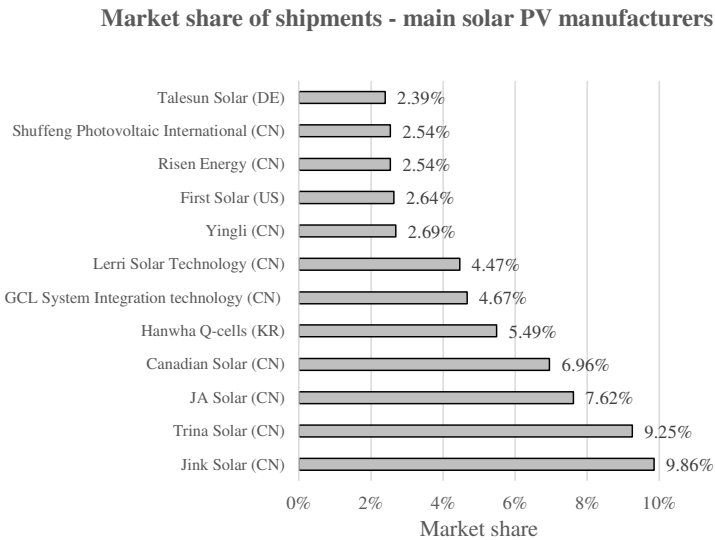

Figure 38: Main manufacturer solar PV industry (2017)  
Source: Statista

Thus, without China in our panel, we do not directly consider in our study a large part of total export in wind and solar PV. However, the weight of China in international trade is taken into account thanks to our relative performance indicators, as the reference group (in the denominator) is all countries in the world. The figure below represents, for each year, the share of the exports of the 24 countries in our panel in the total exports of all countries (Figure 40). First, we notice that all the lines except the one for "wind 2 codes" are decreasing. This reflects the increasing weight of countries that we did not include in our panel, in particular China as shown in the figures in appendix B-2. Only the line for “wind 2 codes” does not have this downward trend, in part because the weight of China in total wind core technologies exports did not increase dramatically<sup>30</sup>. This figure shows that our panel is less representative for solar technologies than for wind technologies, this lack of completeness should lead us to be cautious about the results we draw from our analysis.

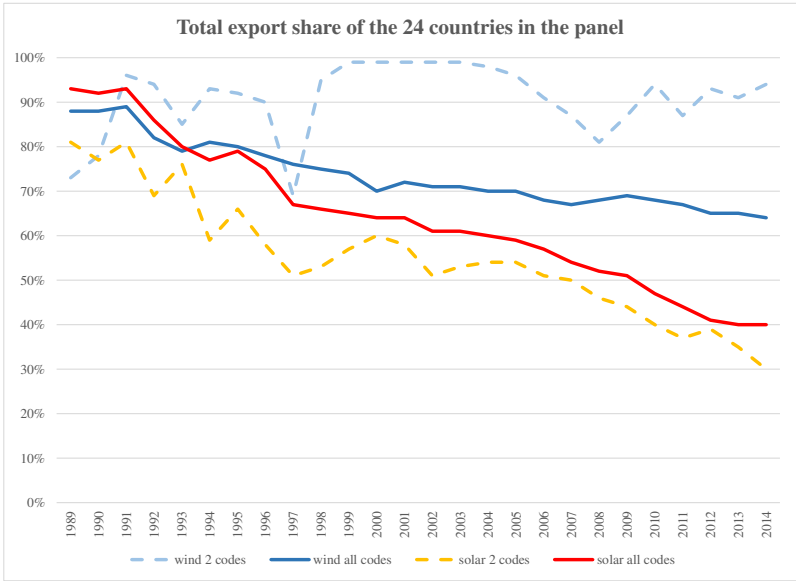

Figure 40: share of the exports of the 24 countries in our panel (source: author)

The table below (Table 19) gives the meaning of each variable name as well as their data source. We retrieve data on installed production capacities from ENERDATA, which itself creates, centralises and reprocesses data from several sources. The main external sources used by ENERDATA are in the last column.

<sup>30</sup> For a large number of countries, graphs on the evolution of the country's share in global exports are available upon request.

Variable name	Label	Source of data
Unweighted RTA	Unweighted symmetric RTA	PATSTAT (autumn 2017 version)
Weighted RTA	Symmetric RTA weighted by the size of the patent family	PATSTAT (autumn 2017 version)
RCA all codes	Symmetric RCA based on all potential HS codes (covering both core and complementary technologies)	UN-COMTRADE
RCA 2 codes	Symmetric RCA based on the two most relevant HS codes (covering only core technologies)	UN-COMTRADE
Share cap	Share of electricity production capacities over total production capacities	EurObserver; US department of energy; Ministry of Business, Innovation and employment; ENERDATA
RD per GDP	Public RD expenditures per GDP	OECD
GDP	Gross domestic product (2019 USD)	OECD

Table 19: Label and source of data for wind technologies

## 5.2. Missing data leading to two different models

For both wind and solar PV technologies, our panel including all the variables of interest is unbalanced as we lack data for RD variables. The IEA (International Energy Agency) makes available these RD data after gathering information from the competent institutions in each country that have collected information through national surveys in order to retrieve RD expenditures. However, some countries do not carry out these surveys every year. Therefore, for these countries, we face some missing data. We have thus an unbalanced panel, which is problematic for our econometric study. To address this issue, we distinguish two types of models. The first one does not include the RD expenditure variable and therefore will cover all 24 countries. The second includes the RD variable and covers a smaller number of countries in order to keep a balanced panel.

Details of the missing data for wind technologies, country by country, are as follows (Table 20). The left side of the table shows the countries for which we lack data on public RD expenditures. Thus, in the models including the RD variable, our panel covers only the 15 countries (those on the right side of the table). This leads to 390 observations.

Country	Number of missing values RD per GDP variable	Country	Number of missing values RD per GDP variable
Greece	14	Austria	0
Luxembourg	14	Canada	0
Republic of Korea	13	Denmark	0
Ireland	12	Finland	0
Belgium	10	France	0
Australia	8	Germany	0
Turkey	6	Japan	0
Italy	3	Netherlands	0
Portugal	3	New Zealand	0
		Norway	0
		Spain	0
		Sweden	0
		Switzerland	0
		United Kingdom	0
		USA	0

Table 20: Missing data RD variable - wind technologies

The figure shows countries included in the model with the RD variable for wind technologies (in green, Figure 41)

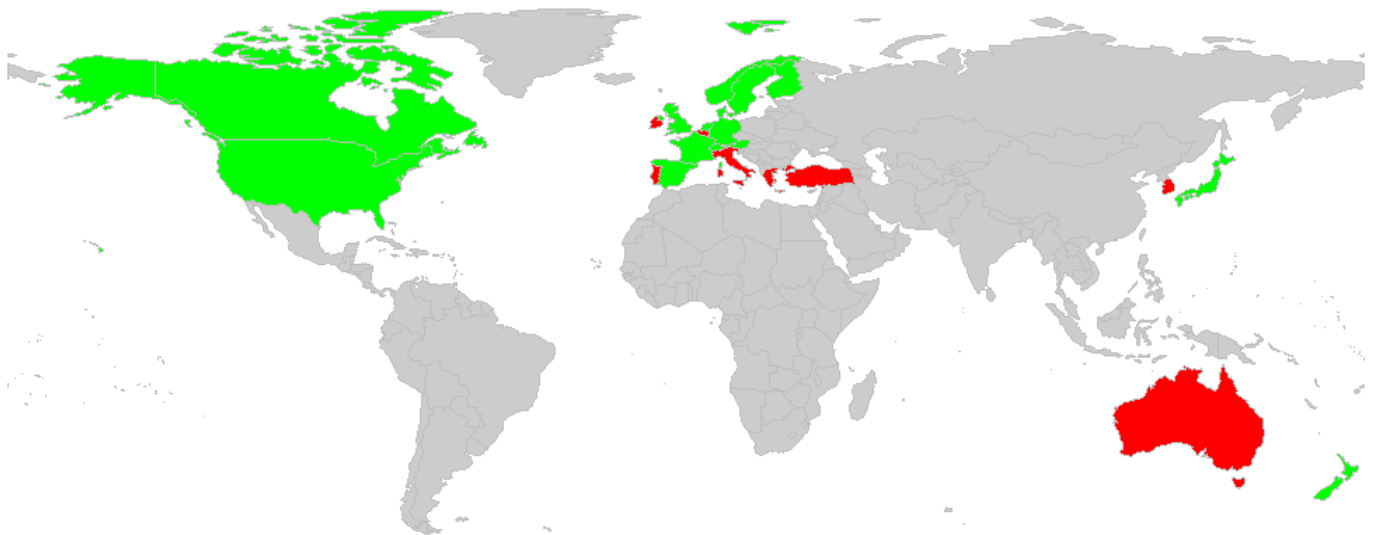

Figure 41: Wind: countries included in the RD model (green) and those excluded (red)

Table 21 gives the same information for solar photovoltaic technologies. There are more missing data for PV compared to wind technologies. Models with the variable RD include fewer countries for PV than for wind: only 11.

Country	Number of missing values RD per GDP variable	Country	Number of missing values RD per GDP variable
Republic of Korea	20	Austria	0
Greece	14	Canada	0
Ireland	14	Denmark	0
Luxembourg	14	France	0
Belgium	10	Germany	0
Australia	9	Japan	0
Finland	9	Netherlands	0
Italy	7	New Zealand	0
Turkey	7	Portugal	0
United Kingdom	7	Sweden	0
USA	6	Switzerland	0
Spain	4		
Norway	1		

Table 21: Missing data RD variable - solar PV technologies

The figure shows countries included in the model with the RD variable for solar PV technologies (in green, Figure 42)

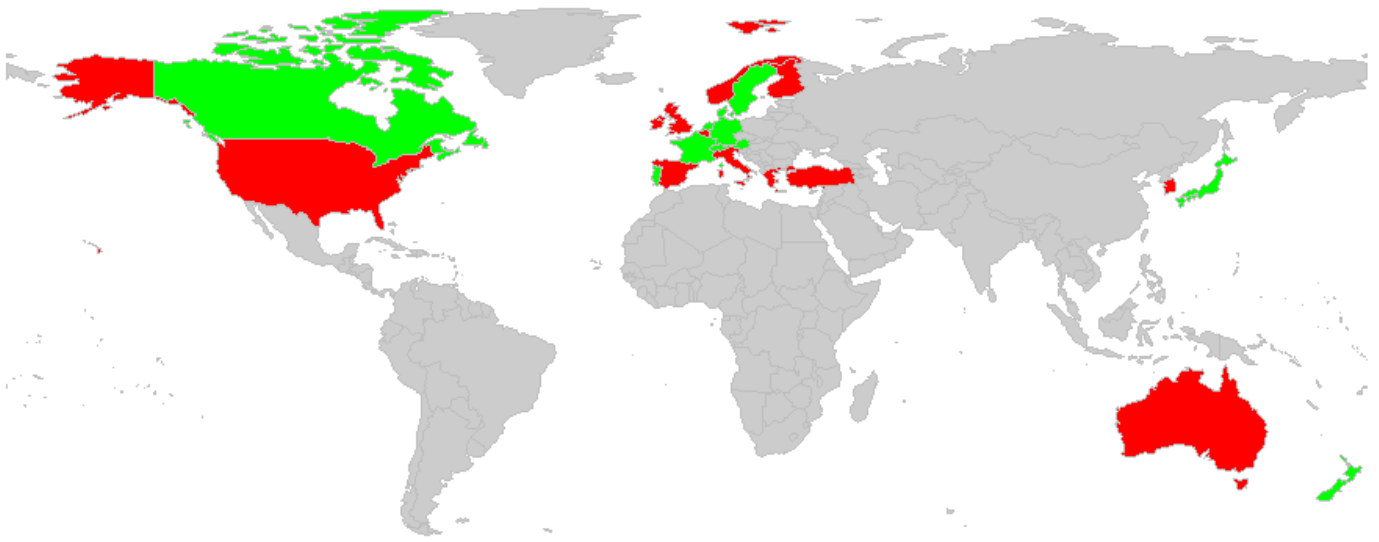

Figure 42: Solar PV: countries included in the RD model (green) and those excluded (red)

Since we consider two models with a different number of countries, our conclusions may differ between the models if the characteristics of the countries are heterogeneous. In the next subsection, we will study the difference between the descriptive statistics of the two sets of countries, for each of the technologies. Then, we will detail innovation and export performance within countries in order to establish a typology of the most and least performing countries. In addition, we will analyse the co-evolution of the two types of performance within each country. These descriptive analyses will shed light on the need for carrying out an econometric analysis and could fuel the discussion to interpret possible different results between the two models (the one including a RD variable and the one not including this variable).

### 5.3. Main descriptive statistics for each set of countries

First, we report for each technology the main descriptive statistics of the variables: minimum, maximum, mean, median, standard deviation, and coefficient of variation. The latter, equal to the absolute value of the ratio between the standard deviation and the mean, is useful to compare the dispersion of two series. Descriptive statistics by country are available in appendix B-3.

To be able to read the results, we multiply the value of the share cap variables by 100. The GDP variable is in thousands of billions of euros ( $1.10^{12}$ ). We adjust the scale of RD expenditures per GDP point but differently between wind and solar technologies: the initial value is multiplied by 10000 for wind and by 100000 for solar.

If we compare the sub-panels for the models with the RD variable, we find important differences between the two technologies. We note that the average GDP level of the solar sub-panel is much lower than the average GDP of the wind sub-panel. For solar technologies, the countries from the sub-panel have also a lower innovation relative performance. These differences between the two sub-panels limit the extent to which the results of the model with the RD variable can be compared between the two technologies.



Main statistics - 24 countries - wind technologies						
Variable	Minimum	Maximum	Mean	Median	St. dev	Coef. of variation
Unweighted RTA	-1	0.93	-0.09	-0.06	0.55	6.37
Weighted RTA	-1	0.98	-0.15	-0.15	0.55	3.61
RCA 2 codes	-1	0.98	-0.66	-0.95	0.55	0.83
RCA all codes	-1	0.80	-0.14	-0.06	0.41	2.97
Share cap (%)	0	33.01	3.33	0.54	5.85	1.76
GDP (10 <sup>12</sup> )	0.01	17.50	1.29	0.40	2.44	1.90

Table 22: Main statistics over the 24 countries - wind technologies

Main statistics - 15 countries - wind technologies						
Variable	Minimum	Maximum	Mean	Median	St. dev	Coef. of variation
Unweighted RTA	-1	0.93	0.00	0.04	0.50	107.11
Weighted RTA	-1	0.93	-0.06	-0.08	0.52	8.43
RCA 2 codes	-1	0.98	-0.57	-0.91	0.62	1.09
RCA all codes	-1	0.80	-0.07	-0.02	0.39	5.26
Share cap (%)	0	33.01	3.60	0.63	6.19	1.72
GDP (10 <sup>12</sup> )	0.04	17.50	1.78	0.57	2.96	1.67
RD per GDP (10 <sup>4</sup> )	0	1.22	0.12	0.05	0.17	1.42

Table 23: Main statistics over 15 countries - wind technologies

Main statistics - 24 countries - solar PV technologies						
Variable	Minimum	Maximum	Mean	Median	St. dev	Coef. of variation
Unweighted RTA	-1	0.88	-0.29	-0.20	0.52	1.80
Weighted RTA	-1	0.92	-0.35	-0.28	0.49	1.39
RCA 2 codes	-1	0.62	-0.56	-0.68	0.41	0.73
RCA all codes	-1	0.49	-0.29	-0.26	0.38	1.30
Share cap (%)	0	19.75	0.74	0.02	2.44	3.29
GDP (10 <sup>12</sup> )	0.01	17.50	1.29	0.40	2.44	1.90

Table 24: Main statistics over the 24 countries - solar PV technologies

Main statistics - 11 countries - solar PV technologies						
Variables	Minimum	Maximum	Mean	Median	St. dev	Coef. of variation
Unweighted RTA	-1	0.73	-0.21	-0.12	0.49	2.31
Weighted RTA	-1	0.75	-0.29	-0.24	0.48	1.63
RCA 2 codes	-1	0.62	-0.48	-0.61	0.43	0.91
RCA all codes	-1	0.49	-0.16	-0.11	0.35	2.21
Share cap (%)	0	19.75	0.69	0.02	2.41	3.49
GDP (10 <sup>12</sup> )	0.04	6.20	1.13	0.42	1.42	1.27
RD per GDP (10 <sup>5</sup> )	0	7.69	1.62	1.08	1.62	1.00

Table 25: Main statistics over 11 countries - solar PV technologies

The descriptive statistics we have just presented are based on aggregated data at the country group level and do not allow a detailed study of the differences between countries. The objective of the next sub-section is therefore to detail comparison of performances between countries to

better grasp the characteristics of the countries and the patterns of the co-evolution of performance within each country.

## **5.4. Countries typology by RTA and RCA**

This section analyses the evolution across time of RTA and RCA by country. We separate the analysis into two sub-periods: before 1998 and after 1998 as this year marks a turning point in the fight against climate change since it corresponds to the signing of the Kyoto Protocol (signed in December 1997). In addition, the graphical representations of the series (see appendix B-4 and B-5) show a change in the trend of the RTA and RCA curves for several countries (*e.g.* for Austria's wind RTA).

Our aim is to classify countries according to their performance on each indicator. Moreover, we compare, for each country, the trend of the evolution of RTA with the trend of RCA. We also chose not to display in the main document the results for weighted RTA, as the conclusions are not significantly different from unweighted RTA, for both wind and solar PV technologies. We start by analysing the series for wind technologies.

### **5.4.1. Wind technologies: Denmark leader, no clear relation between RTA and RCA**

From the three graphs below (Figure 43), it stands out that Denmark is by far the leading country in term of relative innovation performance and relative export performance, particularly after 1998. It is the only country, with Switzerland, to have a positive average “RCA 2 codes” during the 1989-1998 sub-period. In addition, its performance increases between the two sub periods for all the indicators. Not surprisingly, it is the country with the highest average amount of “share cap” and RD expenditures per GDP over the entire period among all countries.

Norway, Spain, Germany and Finland are the other countries with strong relative innovation performance. These countries are among those that have invested the most in public diffusion and innovation policies toward wind energy, according to the average values over the whole period of their “share cap” and “RD expenditures per GDP” variables (see appendix B-4). We can note the strong increase in the relative innovation performance of Norway and Spain where the average value of their unweighted RTA becomes positive over the second sub-period (1998-2014). For Norway, this average value increases from -0.04 to 0.59 and for Spain from -0.11 to 0.53. Conversely, Luxembourg, New Zealand, the Republic of Korea and Japan are among the least performing countries in terms of RTA and these countries do not seem to have made much effort in terms of public policies to support their innovation and export performance. We can also emphasise the case of Portugal. Its innovation performance was equal to -1 during the first sub-period, which means that no patent was filed by a Portuguese inventor during this period. Then the country becomes over-specialized, as the average value of its unweighted RTA over the second is 0.23. Finally, we note that only three countries out of 24 suffer a loss of RTA between the two sub-periods: Austria, Canada, and Finland.

Regarding the relative export performance on the core products of wind technology (RCA 2 codes), Denmark is the country with the best relative performance in both sub-periods. We also note that for Spain and Germany the average value of "RCA 2 codes" is positive over the second period. In particular, Spain experienced a strong increase in its relative export performance as it went from an average of -0.7 over the period 1989-1997 to +0.23 over the period 1998-2014. Furthermore, Switzerland's relative performance drops dramatically from +0.17 on average in the first sub-period to -1 in the second sub-period. This means that Switzerland did not export wind technology at all during the second sub-period. Finally, the countries with the lowest overall export performance, according to "RCA 2 codes", are New Zealand, Norway, the Republic of Korea, Turkey and Luxembourg. Some of these countries like New Zealand, Luxembourg, and the Republic of Korea were also among the least performant in terms of innovation. Moreover, the relative export performance declined for 13 countries according to this indicator, including the three that experienced a decline in innovation performance. Finally, the comparison between leaders and laggards for RTA and RCA 2 codes highlights the case of Norway where we observe a dichotomy between the two performance measures (RTA/RCA 2 codes). Indeed, while this country is one of the best performing country in terms of RTA, it is one of the worst performing countries in terms of RCA. This therefore indicates that despite the large number of innovations carried out by this country, it has not chosen (or has not managed) to strengthen its position on international markets. The averages of public policy variables could possibly shed some light on this observation: on average, wind energy represents only 0.66% of its total production capacity, even though it is one of the countries with the highest RD expenditures per GDP. Thus, Norway has mainly focused its policies toward innovation rather than diffusion of wind technologies. It would be relevant to conduct a specific study of the mechanisms at stake in this country in order to understand this situation.

We observe that the dynamics are very different between the two measures of export performance. Thus, according to the "RCA all codes" indicator (which considers all products related to wind technologies), the average export performance becomes positive during the second period for several countries (Denmark, Greece, Italy for instance). Furthermore, it is key to note that for half of the countries the trends are different between the two relative export performance indicators (*e.g.* France, Finland, USA). According to "RCA all codes" the best performing countries are Denmark, Finland, Japan, Germany and Portugal, while the worst performing countries are Norway, New Zealand, Australia, Ireland and Luxembourg. We can see the strong increase in "RCA all codes" for Italy, Belgium and Denmark. Finally, only two countries saw their "RCA all codes" decrease between the two periods: Switzerland and Australia.

In addition, for several countries among the most performance, the share-cap variable grew quite early, around 1996 (*e.g.* Denmark, Germany, Spain). Conversely, for some countries with a low performance, their « share cap » started to increase later, around 2005 (*e.g.* France, Italy, Belgium, Australia). Thus, we may postulate that early implementation of diffusion policies could help foster good innovation and export performance of countries.

We complete the analysis for wind technologies with the comparison of trends in innovation performance and export performance within countries (Table 26). For the countries that performed best on both innovation and export (Denmark, Germany and Spain) we find an increase between the sub-periods for every performance indicators. Nevertheless, for Spain, the

statistics show that the gain in innovation performance mainly benefited to the export of core wind energy products (RCA2 codes). The case of Japan shows also interesting trends: Japan has a high “all codes RCA” while its RTA and “2 codes RCA” remained low during the whole period. For other countries, it is difficult to identify specific patterns. Therefore, we could conclude that it seems difficult to understand how RTA and RCA in wind technologies influence each other. For 10 countries, we find an opposite trend between RTA and "RCA 2 codes": France, Japan, Netherlands, New Zealand, Norway, Sweden, Switzerland, Turkey, United Kingdom, and USA. For these 10 countries, the increase in RTA between the two sub-periods, did not allow to increase their export performance on the core wind technologies. On the other hand, if we compare the evolution of RTA and "RCA all codes", the trends are opposite for only five countries (Australia, Austria, Canada, Finland, Switzerland). Thus, although the results are heterogeneous across countries, it seems that the positive relationship between relative innovation and export performance is more robust when we look at all goods related to wind technology (rather than only the core goods). In particular, we can notice an opposite trend between RTA and RCA for Finland for which both RTA and 2 codes RCA decrease but all codes RCA increases. Furthermore, Table 26 shows that for all countries the average values of share cap increased between the two sub-periods. Therefore, for several countries, there is a variation in the opposite direction between share cap and RCA 2 codes. Almost all of these countries are in the model with the RD variable. We can therefore expect differences in results between the two models.

### Mean unweighted RTA - wind technologies

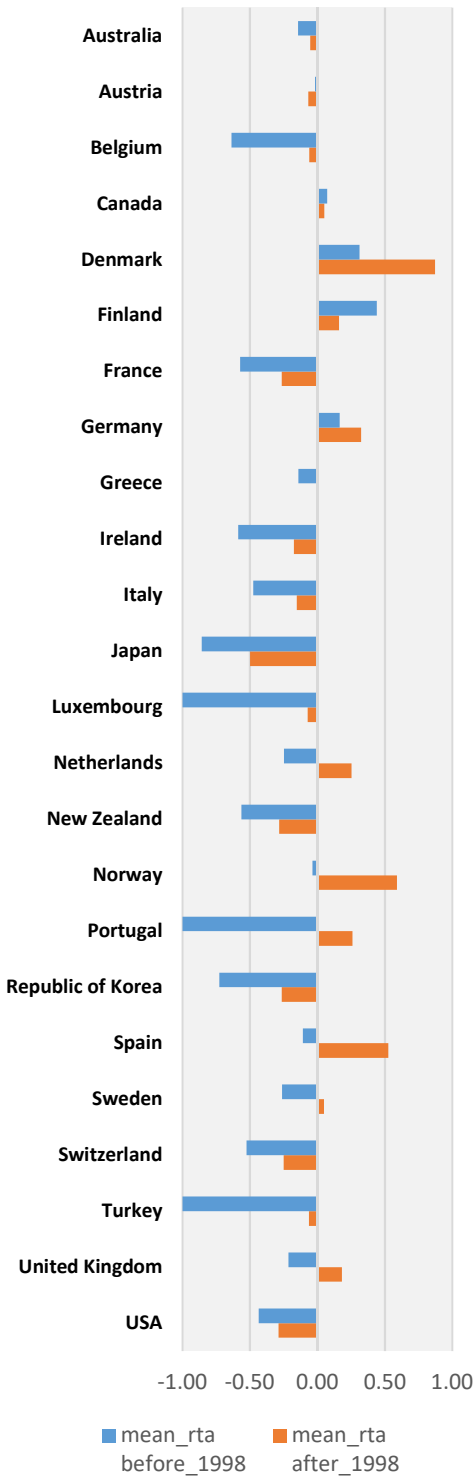

### Mean RCA 2 codes - wind technologies

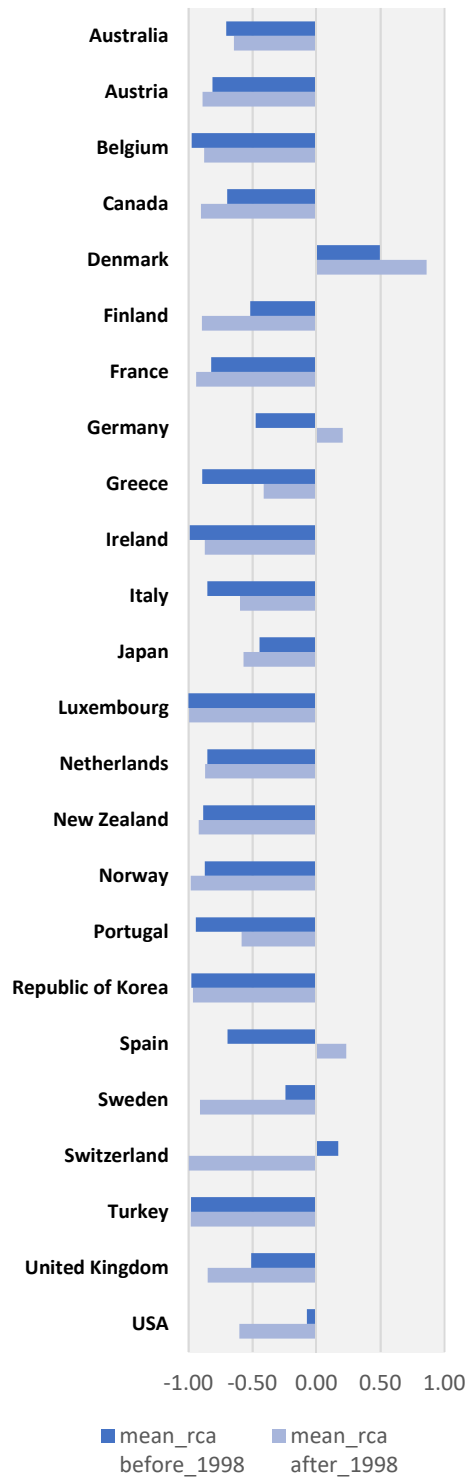

### Mean RCA all codes - wind technologies

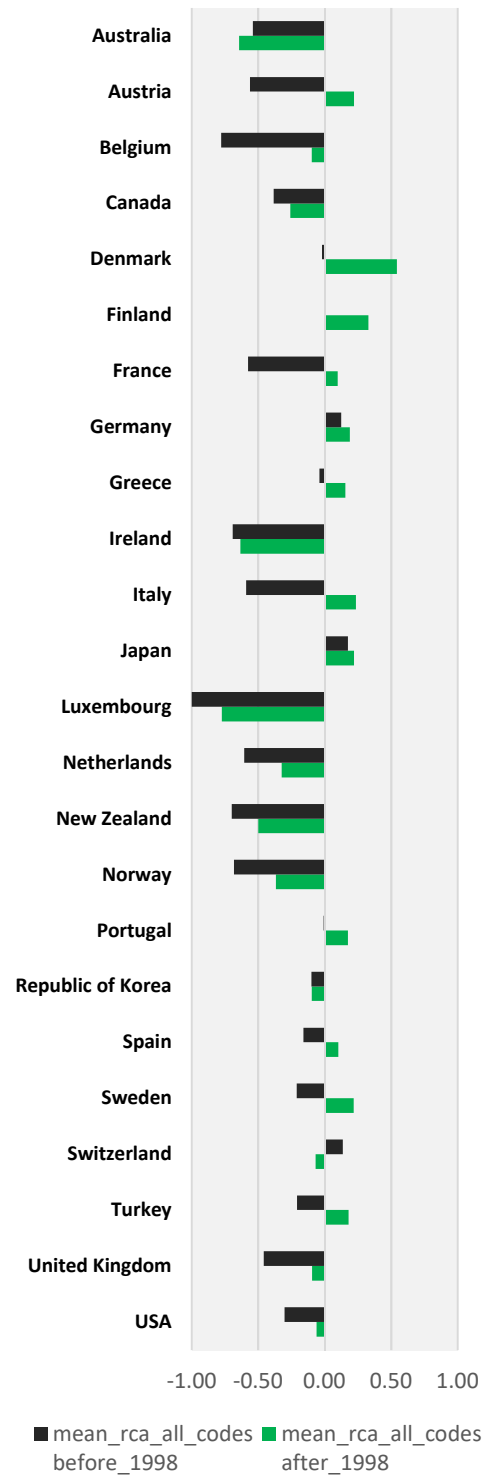

Figure 43: Mean of performance variable over each sub period - wind technologies

Country	Unweighted RTA	Weighted RTA	RCA 2 codes	RCA all codes	Share cap	RD
Australia	Increase	Decrease	Increase	Decrease	Increase	
Austria	Decrease	Decrease	Decrease	Increase	Increase	Increase
Belgium	Increase	Increase	Increase	Increase	Increase	
Cada	Decrease	Decrease	Decrease	Increase	Increase	Increase
Denmark	Increase	Increase	Increase	Increase	Increase	Increase
Finland	Decrease	Decrease	Decrease	Increase	Increase	Increase
France	Increase	Increase	Decrease	Increase	Increase	Increase
Germany	Increase	Increase	Increase	Increase	Increase	Decrease
Greece	Increase	Decrease	Increase	Increase	Increase	
Ireland	Increase	Increase	Increase	Increase	Increase	
Italy	Increase	Increase	Increase	Increase	Increase	
Japan	Increase	Increase	Decrease	Increase	Increase	Increase
Luxembourg	Increase	Increase	Increase	Increase	Increase	
Netherlands	Increase	Increase	Decrease	Increase	Increase	Decrease
New Zealand	Increase	Increase	Decrease	Increase	Increase	Increase
Norway	Increase	Increase	Decrease	Increase	Increase	Increase
Portugal	Increase	Increase	Increase	Increase	Increase	
Republic of Korea	Increase	Increase	Increase	Increase	Increase	
Spain	Increase	Increase	Increase	Increase	Increase	Increase
Sweden	Increase	Increase	Decrease	Increase	Increase	Decrease
Switzerland	Increase	Increase	Decrease	Decrease	Increase	Increase
Turkey	Increase	Increase	Decrease	Increase	Increase	
United Kingdom	Increase	Increase	Decrease	Increase	Increase	Decrease
USA	Increase	Increase	Decrease	Increase	Increase	Increase

Table 26: Evolution of the mean of the variable between the two sub periods - wind technologies

#### 5.4.2. Solar PV technologies: Japan leader, no clear relation between RTA and RCA

Japan, Australia and Germany are the countries with the best relative performance in innovation (Figure 44). In particular, Germany and Japan are among the countries that have invested the most in innovation policies (see appendix B-5). Conversely, Portugal, Ireland, New Zealand, Finland and Turkey are the countries with the lowest unweighted RTA. In particular, inventors in Turkey, Ireland and Portugal did not file any patents throughout the first sub-period. We can nevertheless note the strong increase between the two sub-periods in the relative innovation performance of France (-0.4 to -0.04), Belgium (-0.57 to +0.12) and Italy (-0.83 to -0.14). Germany experienced a significant decline, although its RTA remained positive. Only four countries faced a decline in their relative innovation performance: Germany, Japan, USA, and Denmark. Despite its high RD expenditures over the whole period, the relative innovation performance of the Netherlands is rather weak over the two sub-periods (-0.35 and 0.01). Moreover, the Netherlands did not invest much in diffusion policies, as their average “share cap” over the whole period is 0.38. This could explain why their efforts towards innovation did not lead to a good innovation performance and we could therefore wonder about the complementarity (or substitutability) of the two types of policies (demand-pull and techno-push policies).

Regarding the "RCA 2 codes" indicator, Japan is the only country to show a positive relative export performance during both periods. We can add the Republic of Korea and Denmark in

the first sub-period. Ireland, New Zealand, Finland, Greece and Turkey are the countries with the lowest relative export performance according to this indicator. Their performance is particularly weak during the first sub-period (1989-1998), as most of them did not export at all during this period. Overall, we find among the worst performing countries those that are also the worst performers in innovation (similar to what we find with wind technologies). Moreover, we note the dramatic decrease between the two sub-periods for Denmark (+0.01 to -0.8). For the majority of countries, relative export performance increases between the two sub-periods; only five countries did not follow this trend: Switzerland, Netherlands, Republic of Korea, Canada, and Denmark.

Compared to "RCA 2 codes", more countries show a positive export performance on average over the sub-periods with the indicator "RCA all codes". The best performing countries are Japan, Denmark (especially during the first sub-period), Finland, Switzerland and Germany. Conversely, Luxembourg, Ireland, Norway, Australia and Turkey are the worst performers. We can see the strong performance increase between the two sub-periods for Austria (-0.63 to -0.05) and Luxembourg (-1 to -0.35). Finally, seven countries saw their relative export performance decrease between the two sub-periods: Australia, Germany, Switzerland, Republic of Korea, Canada, Denmark, and New Zealand.

Compared to wind technologies, a larger number of countries have the same trends for both measures of RCA. Indeed, for only four countries the trends are different between the two RCA indicators (Australia, Germany, Netherlands, New Zealand).

According to the literature (see section 1 of this chapter), we can expect a positive relationship between the two performances (innovation and export). Nevertheless, by comparing performances within countries, we identify several special cases. Although Finland's relative innovation performance is low, as well as its relative export performance measured with the "RCA 2 codes" indicator, its "RCA all codes" is positive over all periods. We observe a similar situation for wind technologies (see above). Therefore, this shows that even though the relative innovation and export performance in core solar PV technologies of Finland decreased over the studied period it was able to maintain its performance regarding export of solar PV complementary technologies.

In Germany, the great performance in innovation is concomitant with a great export performance for all goods related to photovoltaic solar technologies (RCA all codes). However, its relative export performance on core technology remained negative although it increased between the two sub-periods. Thus, Germany's high RCA all codes is related to its great export performance on technologies complementary to those at the core of solar photovoltaic technologies. Finally, in Australia, the relatively good performance in innovation did not lead to a strong export performance. It would perhaps be relevant to carry out an analysis specifically on this country to understand this dichotomy between innovation and export performance.

If we compare trends between our measures of relative performance (Table 27), we find that for seven countries the trends are different between innovation performance and export performance (for both export performance indicators). Japan, Switzerland, the USA and the Republic of Korea are ones of these seven countries. Finally, as for wind technologies, it is difficult to establish a clear relation between relative innovation performance and relative export performance. Moreover, the results may depend on the version of RCA. All this

reinforces the need for an econometric study to investigate the relationship between the two types of performance. This econometric study would also allow measuring the potential effect of public policies supporting innovation and diffusion on both performances. In addition, this table shows that for all countries the average value of the share cap variable increased between the two sub-periods (as for wind technologies). As for wind technologies, most of the countries whose average innovation or export performance fell between the two sub-periods are in the model with the RD variable. We can therefore expect to have different results on the effect of the share cap variable on performance between the two models.



### Mean unweighted RTA - solar PV technologies

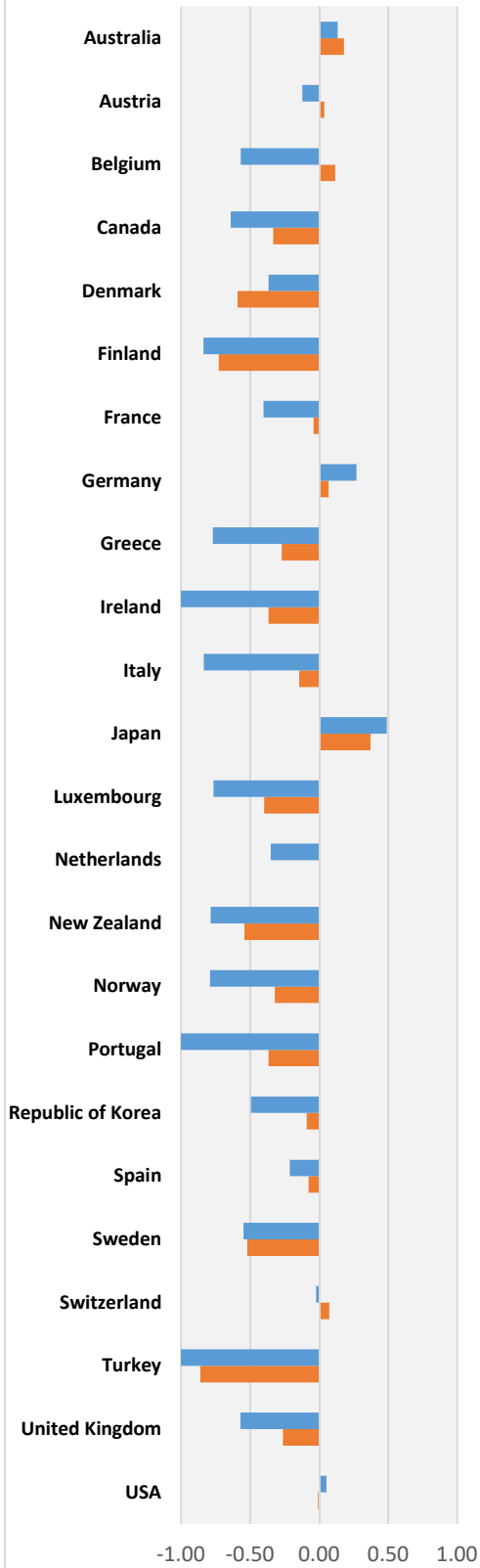

### Mean RCA 2 codes - solar PV technologies

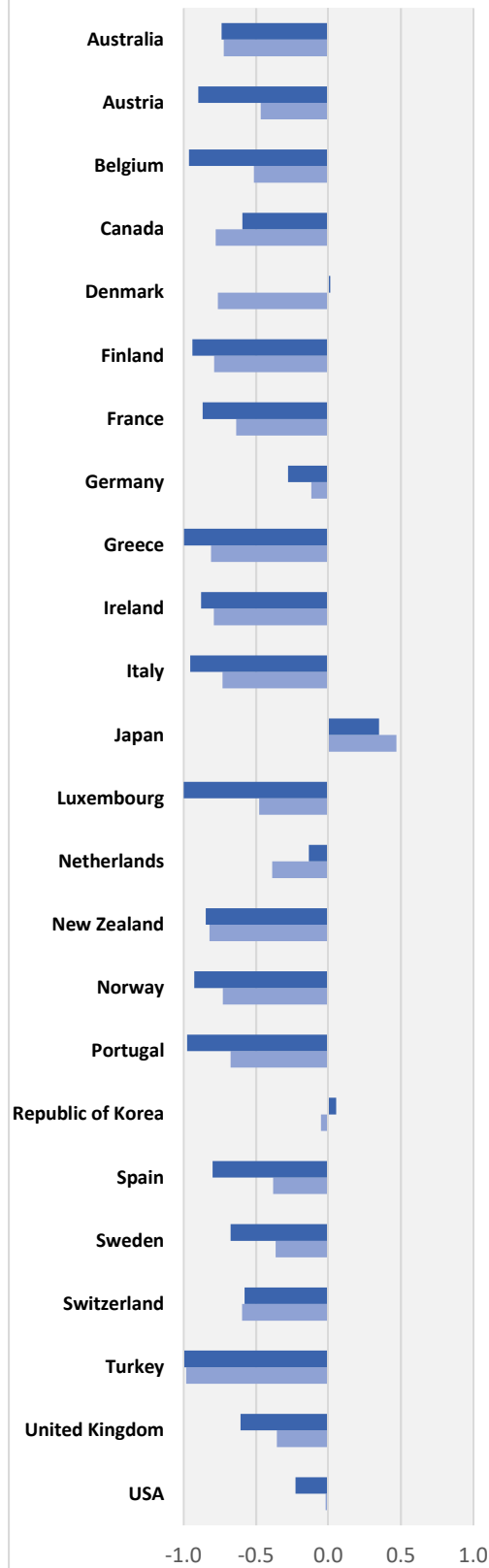

### Mean RCA all codes - solar PV technologies

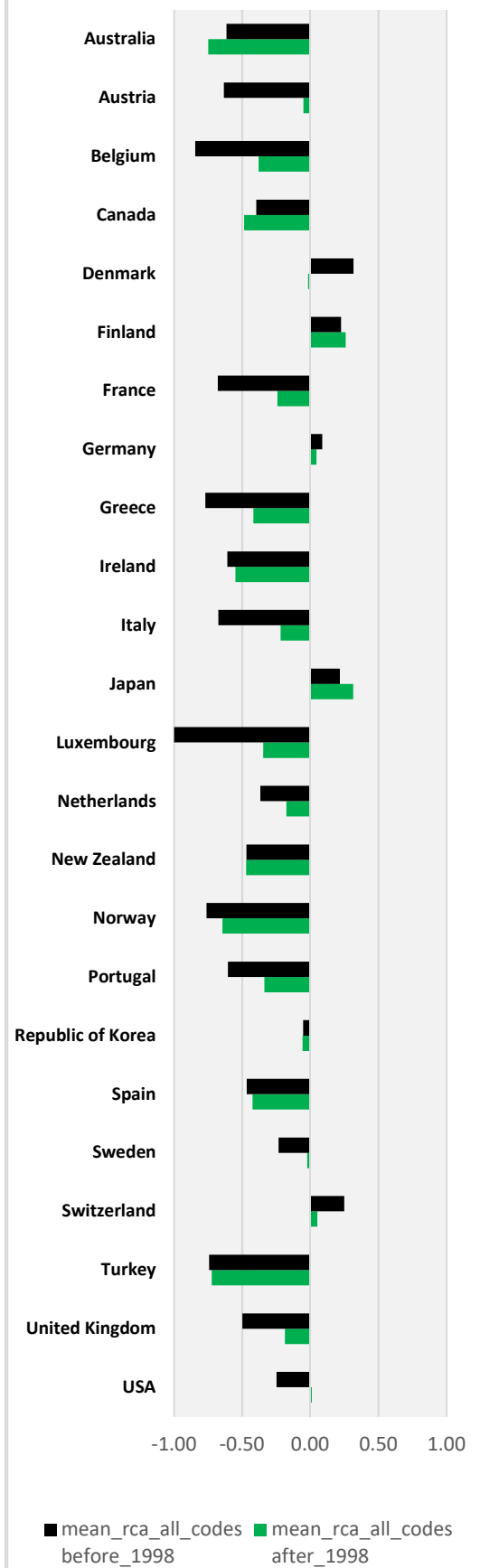

Figure 44: Mean of performance variable over each sub period - solar PV technologies

Country	Unweighted RTA	Weighted RTA	RCA 2 codes	RCA all codes	Share cap	RD
Australia	Increase	Increase	Increase	Decrease	Increase	
Austria	Increase	Increase	Increase	Increase	Increase	Increase
Belgium	Increase	Increase	Increase	Increase	Increase	
Canada	Increase	Increase	Decrease	Decrease	Increase	Increase
Denmark	Decrease	Decrease	Decrease	Decrease	Increase	Increase
Finland	Increase	Increase	Increase	Increase	Increase	
France	Increase	Increase	Increase	Increase	Increase	Increase
Germany	Decrease	Decrease	Increase	Decrease	Increase	Decrease
Greece	Increase	Increase	Increase	Increase	Increase	
Ireland	Increase	Increase	Increase	Increase	Increase	
Italy	Increase	Increase	Increase	Increase	Increase	
Japan	Decrease	Decrease	Increase	Increase	Increase	Increase
Luxembourg	Increase	Increase	Increase	Increase	Increase	
Netherlands	Increase	Increase	Decrease	Increase	Increase	Increase
New Zealand	Increase	Increase	Increase	Decrease	Increase	Increase
Norway	Increase	Increase	Increase	Increase	Increase	
Portugal	Increase	Increase	Increase	Increase	Increase	Decrease
Republic of Korea	Increase	Increase	Decrease	Decrease	Increase	
Spain	Increase	Increase	Increase	Increase	Increase	
Sweden	Increase	Increase	Increase	Increase	Increase	Increase
Switzerland	Increase	Decrease	Decrease	Decrease	Increase	Decrease
Turkey	Increase	Increase	Increase	Increase	Increase	
United Kingdom	Increase	Increase	Increase	Increase	Increase	
USA	Decrease	Increase	Increase	Increase	Increase	

Table 27: Evolution of the mean of the variable between the two sub periods - solar PV technologies

## 6. Estimation strategy and pre-estimation investigations

In order to study the relationships between relative innovation and relative export performance, as well as the effect of climate policies, while taking into account the problems of endogeneity between the variables, we use a PVAR (Panel Vector AutoRegression) model. A PVAR model is a combination of classical VAR models and panel models. A panel VAR model thus allows considering a set of endogenous variables while including individual heterogeneity. We denote  $p$  as the number of lags to consider for endogenous variables and  $l$  as a specific lag such that  $l=1, \dots, p$ . The reduced form of our PVAR model is as follows:

$$\mathbf{Y}_{i,t} = \mu_i + \sum_{l=1}^p \mathbf{A}_l \mathbf{Y}_{i,t-l} + \mathbf{B}\mathbf{X}_{i,t} + \boldsymbol{\varepsilon}_{i,t}$$

$\mathbf{Y}_{i,t}$  is a vector ( $m \times 1$ ) of endogenous variables, where  $m$  is the number of endogenous variables included in the model. Thus for our study this vector regroups the RTA variables (weighted or unweighted), the RCA variables (with 2 HS codes or the set of potential codes) and the public policies variables (share cap, RD public expenditures per GDP) for individual  $i$  at period  $t$ .  $\mathbf{Y}_{i,t-1}$  is thus the vector ( $m \times 1$ ) of the lagged endogenous variables.  $\mu_i$  is a time-invariant parameter representing the heterogeneous individual effects.  $\mathbf{X}_{i,t}$  is the vector of dimensions ( $n \times 1$ ) of the exogenous variables (i.e. uncorrelated with the error term regardless  $t$ ), where  $n$  is the number of exogenous variables. For our analysis, this vector includes GDP variable and dummy variables representing potential temporal shock.  $\boldsymbol{\varepsilon}_{i,t}$  is a vector ( $m \times 1$ ) of errors. The errors are independently and identically distributed such that the mean of error is zero, they are homoscedastic and they do not suffer from serial correlation. Finally,  $\mathbf{A}_l$  and  $\mathbf{B}$  are the matrices of estimated coefficients.  $\mathbf{A}_l$  is of dimension ( $m \times m$ ) and  $\mathbf{B}$  is ( $m \times n$ ). In a panel VAR model, we assume parameter homogeneity for all  $i$ .

Therefore, if we assume a one lag model with three endogenous variables and two exogenous variable the developed form of the model is:

$$\begin{bmatrix} Y_{1i,t} \\ Y_{2i,t} \\ Y_{3i,t} \end{bmatrix} = \mu_i + \begin{bmatrix} a_{1,1}^1 & a_{1,2}^1 & a_{1,3}^1 \\ a_{2,1}^1 & a_{2,2}^1 & a_{2,3}^1 \\ a_{3,1}^1 & a_{3,2}^1 & a_{3,3}^1 \end{bmatrix} \begin{bmatrix} Y_{1i,t-1} \\ Y_{2i,t-1} \\ Y_{3i,t-1} \end{bmatrix} + \begin{bmatrix} b_{1,1} & b_{1,2} \\ b_{2,1} & b_{2,2} \\ b_{3,1} & b_{3,2} \end{bmatrix} \begin{bmatrix} X_{1i,t} \\ X_{2i,t} \end{bmatrix} + \begin{bmatrix} \varepsilon_{1i,t} \\ \varepsilon_{2i,t} \\ \varepsilon_{3i,t} \end{bmatrix}$$

As explained previously, since we have a large number of missing values for public RD expenditure, we consider two separate models: one without the RD expenditures variable and one with it. Due to the different version of the relative performance measures, we evaluate four specifications per model and thus eight specifications in total (Table 28). In the specifications 5 to 8, the GDP variable is no longer included as an exogenous variable but taken into account via the variable RD per GDP.

Specification	Endogenous variables	Exogenous variables
1	Unweighted RTA - RCA all codes - share capacities	GDP - year dummy variables
2	Weighted RTA - RCA all codes - share capacities	GDP - year dummy variables
3	Unweighted RTA - RCA 2 codes - share capacities	GDP - year dummy variables
4	Weighted RTA - RCA 2 codes - share capacities	GDP - year dummy variables
5	Unweighted RTA - RCA all codes - share capacities - RD per GDP	year dummy variables
6	Weighted RTA - RCA all codes - share capacities - RD per GDP	year dummy variables
7	Unweighted RTA - RCA 2 codes - share capacities - RD per GDP	year dummy variables
8	Weighted RTA - RCA 2 codes - share capacities - RD per GDP	year dummy variables

Table 28: The eight specifications of our analysis

Before estimating the model through Generalized method of moments (GMM), we have to implement several tests in order to define the right specification: temporal shock, cross sectional dependence, unit root and cointegration tests. The following sub sections give a short description of each of these pre estimation tests and the corresponding results (more details on the technical aspects are available in appendix B-6).

The following figure summarizes the whole procedure (Figure 45). The grey items represent the path we follow in this analysis.

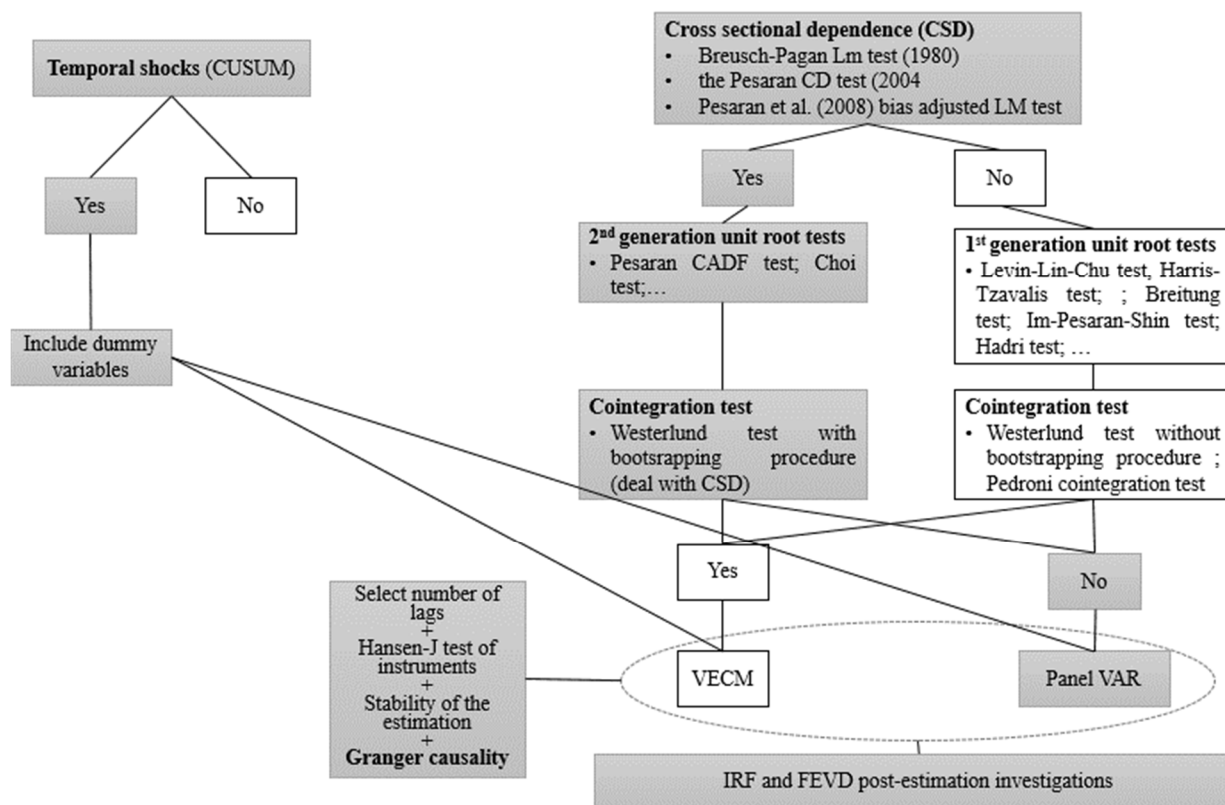

Figure 45: Visual summary of the estimation strategy

## 6.1. Temporal shocks: CUSUM (CUMulative SUM)

A temporal shock is a significant change in the values of a time series. In econometric estimation, it is a change over time in the estimated parameters of the model. Thus, if we do not take into account this change in the model, it may increase forecast errors. One solution may be to split the time analysis into several sub-periods, each ending with the occurrence of a temporal shock. However, this requires having relatively long time series initially in order to not obtain too short sub-periods. Our panel covers 26 years (1989-2014). At most, if only one temporal shock occurs in 2002, we would have two 13-year sub-periods. This seems a bit short, especially to study the stationarity of the series (see below). Another solution is to include dummy variables equal to 1 for the year corresponding to a temporal shock and 0 otherwise. However, we have to be careful with not including too many dummies so as not to lose too many degrees of freedom. We choose this second option.

In order to identify the years corresponding to temporal shock we use a CUSUM test for each country. The graphs presenting the results of the CUSUM tests for both wind and solar PV technologies are in appendix B-7. Nevertheless, beyond statistic tests, it is crucial to justify factually the existence of temporal shocks. These shocks may be due to global shocks on the world economy such as financial crises. For our analysis on renewable energies, several years are potential temporal shocks:

- 1992: Earth summit in Rio
- 1998: Adoption of the Kyoto Protocol (happened in December 1997)

- 2000: International financial crisis following the burst of the internet bubble
- 2005: Implementation of the European Union Emissions Trading System (EU ETS), Kyoto protocol entered into force
- 2009:
  - EU climate and Energy package (three key objectives: a 20% reduction in EU greenhouse gas emissions from 1990 levels; Raising the share of EU energy consumption produced from renewable resources to 20%; A 20% improvement in the EU's energy efficiency).
  - 2009: 15<sup>th</sup> conference of the parties in Copenhagen
  - 2009: Subprime mortgage crisis

On the CUSUM graphs there are three curves: the curve representing the cumulative sum and the straight lines presenting the confidence interval bounds. When the curve representing the cumulative sum goes outside the confidence interval, this indicates that the corresponding year (read on the x-axis) potentially corresponds to a temporal shock. For both technologies, we observe that the CUSUM tests highlight the years around 1998, 2005 and 2009.

Thus, in the econometric estimations we integrate three exogenous dummy variables representing these three years for both wind and solar PV.

## **6.2. Cross sectional dependence**

Cross sectional dependence (CSD) refers to the lack of independence among units. In macro panels, cross sectional dependence is common as dynamic in a specific country often depends on the dynamic in other countries due to global economic and financial cycle through the globalization of economic activity, trade agreements, cross border spillovers, etc...

It is essential to test for the presence of cross sectional dependence first, as one of the key assumption of some unit root and cointegration tests is the independence of unit. This independence is a condition to obtain test statistics converging to the correct distribution (normal, ...).

The null hypothesis of the CSD tests is the absence of dependence across the units. We use three CSD semi-parametric tests in our analysis: the Breusch-Pagan LM test (1980); the Pesaran CD test (2004) and the Pesaran et al. (2008) bias adjusted LM test.

The results of the cross sectional dependence tests for wind technologies are in the two tables below: Table 29 for the model without the RD variable and Table 30 for the model with the RD variable. We perform these tests on each of the eight different specifications (Table 28). We indicate the variables considered in the first column of the tables, where the first variable represents the dependent variable and the following variables the independent variables. In the tables, we indicate the test statistics and the stars represent the level of the first type error.

Model	LM	LM adj	CD
Unweighted RTA/ RCA all codes / share cap	381.5***	9.273***	4.538***
Weighted RTA / RCA all codes / share cap	379.4***	9.056***	-0.2048
Unweighted RTA / RCA 2 codes / share cap	537.7***	27.52***	10.83***
Weighted RTA / RCA 2 codes / share cap	449.2***	17.39***	3.392***
RCA all codes / Unweighted RTA / share cap	1006***	81.09***	18.66***
RCA all codes / Weighted RTA / share cap	1080***	89.57***	18.13***
RCA 2 codes / Unweighted RTA / share cap	413.7***	13.22***	6.164***
RCA 2 codes / Weighted RTA / share cap	425.5***	14.62***	7.155***
Share cap / RCA all codes / Unweighted RTA	2378***	241.7***	42.39***
Share cap / RCA all codes / Weighted RTA	2498***	256***	43.6***
Share cap / RCA 2 codes / Unweighted RTA	2572***	265.9***	47.52***
Share cap / RCA 2 codes / Weighted RTA	2756***	287.5***	49.63***

\*\*\*: p-value<0.1%

Table 29: Cross sectional dependence test - wind technologies model without RD variable

Model	CD
Unweighted RTA/ RCA all codes / share cap / RD	5.727***
Weighted RTA / RCA all codes / share cap / RD	1.164
Unweighted RTA / RCA 2 codes / share cap / RD	8.653***
Weighted RTA / RCA 2 codes / share cap / RD	3.507***
RCA all codes / Unweighted RTA / share cap / RD	4.689***
RCA all codes / Weighted RTA / share cap / RD	5.835***
RCA 2 codes / Unweighted RTA / share cap / RD	9.632***
RCA 2 codes / Weighted RTA / share cap / RD	9.806***
Share cap / RCA all codes / Unweighted RTA / RD	19.257***
Share cap / RCA all codes / Weighted RTA / RD	17.709***
Share cap / RCA 2 codes / Unweighted RTA / RD	24.265***
Share cap / RCA 2 codes / Weighted RTA / RD	24.905***
Unweighted RD / RTA/ RCA all codes / share cap	4.466***
Weighted RD / RTA / RCA all codes / share cap	4.294***
Unweighted RD / RTA / RCA 2 codes / share cap	4.350***
Weighted RD / RTA / RCA 2 codes / share cap	4.309***

\*\*\*: p-value<0.1%

Table 30: Cross sectional dependence test - wind technologies model with RD variable

For solar PV technologies, the results of the cross sectional dependence tests are in Table 31 for the model without the RD variable and in Table 32 for the model with the RD variable

Model	LM	LM adj	CD
Unweighted RTA/ RCA all codes / share cap	377.1***	8.901***	4.868***
Weighted RTA / RCA all codes / share cap	384.7***	9.771***	2.322***
Unweighted RTA / RCA 2 codes / share cap	350.3***	5.807***	1.98*
Weighted RTA / RCA 2 codes / share cap	348.9***	5.64***	0.37
RCA all codes / Unweighted RTA / share cap	1075***	89.28***	13.15***
RCA all codes / Weighted RTA / share cap	1133***	95.99***	11.98***
RCA 2 codes / Unweighted RTA / share cap	963.7***	76.57***	7.5***
RCA 2 codes / Weighted RTA / share cap	1063***	88.05***	6.9***
Share cap / RCA all codes / Unweighted RTA	3403***	361.6***	56.34***
Share cap / RCA all codes / Weighted RTA	3549***	378.7***	58.02***
Share cap / RCA 2 codes / Unweighted RTA	3416***	363.2***	56.55***
Share cap / RCA 2 codes / Weighted RTA	3553***	379.3***	58.18***

Table 31: Cross sectional dependence test - solar PV technologies model without RD variable

Model	LM	LM adj	CD
Unweighted RTA/ RCA all codes / share cap	377.1***	8.901***	4.868***
Weighted RTA / RCA all codes / share cap	384.7***	9.771***	2.322***
Unweighted RTA / RCA 2 codes / share cap	350.3***	5.807***	1.98*
Weighted RTA / RCA 2 codes / share cap	348.9***	5.64***	0.37
RCA all codes / Unweighted RTA / share cap	1075***	89.28***	13.15***
RCA all codes / Weighted RTA / share cap	1133***	95.99***	11.98***
RCA 2 codes / Unweighted RTA / share cap	963.7***	76.57***	7.5***
RCA 2 codes / Weighted RTA / share cap	1063***	88.05***	6.9***
Share cap / RCA all codes / Unweighted RTA	3403***	361.6***	56.34***
Share cap / RCA all codes / Weighted RTA	3549***	378.7***	58.02***
Share cap / RCA 2 codes / Unweighted RTA	3416***	363.2***	56.55***
Share cap / RCA 2 codes / Weighted RTA	3553***	379.3***	58.18***

Table 32: Cross sectional dependence test - solar PV technologies model with RD variable

Therefore, for both wind and solar PV technologies, the results of the cross sectional dependence tests are almost all in favour of the presence of cross sectional dependence. Therefore, this will influence the unit root and cointegration tests that we will implement

### 6.3. Unit root

Like mentioned before the presence of cross-sectional dependence influences the unit root tests to implement. For our analysis, we find CSD for both wind and solar PV technologies, therefore we have to use second-generation unit root test. For our analysis, we chose to use the Pesaran CADF (Cross-sectional Augmented Dickey-Fuller) unit root test which is the most common test dealing with the presence of CSD (Pesaran, 2007). The null hypothesis states that the series have a unit root.

If the series is stationary in level we say that it is integrated of order 0. Otherwise, in order to obtain stationary series, generally, we differentiate them. If after one differentiation the series is stationary, it is integrated of order 1.

Table 33 and Table 34 report the test statistics, and stars indicate the level of the type I error (). The results show that the relative performance measures are all stationary without differentiation (they are integrated of order 0). We have to differentiate the “share cap” series twice to make it stationary (it is integrated of order 2). The variable measuring RD expenditures is integrated of order 1. In order to avoid spurious regressions, we include all these stationary series in our estimations.

variable	t-bar	Z[t-bar]
Unweighted RTA	-3.262***	-7.559***
Weighted RTA	-3.191***	-7.204***
RCA all codes	-2.837***	-5.434***
RCA 2 codes	-2.96***	-6.048***
share cap	-1.502	1.23
D.share cap	-1.768	-0.091
D2.share cap	-3.728***	-9.89***

\*\*\*: p-value < 0.1%

Table 34: Pesaran CADF unit root test – wind technologies model without RD

variable	t-bar
Unweighted RTA	-4.581***
Weighted RTA	-4.374***
RCA all codes	-2.603***
RCA 2 codes	-5.004***
share cap	3.07
D.share cap	1.497
D2.share cap	-8.270***
RD	-0.889
D.RD	-9.304***

Table 33: Pesaran CADF unit root test – wind technologies model with RD

For solar PV technologies, the results of panel unit tests are in Table 23 and 24 below. We notice some differences between the two models. In the model without the variable RD (Table 36) the share cap variable is the only one that is not level stationary: we have to differentiate it once to make it stationary. In the model with the variable RD (**Erreur ! Source du renvoi introuvable.**), we must differentiate the variable "RCA 2 codes" once to make it stationary while the variable "share cap" is stationary in level. Finally, the variable measuring public RD expenditures is integrated of order 1.

variable	t-bar	Z[t-bar]
Unweighted RTA	-3.08***	-6.647***
Weighted RTA	-3.287***	-7.682***
RCA all codes	-2.526***	-3.877***
RCA 2 codes	-2.477***	-3.634***
share cap	-0.882	4.34
D.share cap	-2.465***	-3.574***

Table 35: Pesaran CADF unit root test – solar PV technologies with RD:



variable	t-bar	Z[t-bar]
Unweighted RTA	-2.656***	-3.03***
Weighted RTA	-2.925***	-3.951***
RCA all codes	-2.416***	-2.21***
RCA 2 codes	-2.098	-1.122
D.RCA 2 codes	-3.657***	-6.451***
share cap	-2.271*	-1.171*
RD	-1.419	1.202
D.RD	-4.067***	-7.853***

Table 36: Pesaran CADF unit root test – solar PV technologies without RD

## 6.4. Cointegration

Cointegration is a statistical characteristic of temporal series that we need to test before estimating the model in order to avoid spurious regressions. Two variables are cointegrated if they share the same stochastic trend and they cannot deviate from each other in the long term. Thus, even if we observe an opposite trend in the short run they tend to follow the same trend in the long term. If two variables  $X$  and  $Y$  are integrated of order  $d$ , and if we are able to find  $(a,b)$  such that  $aX+bY$  is integrated of order less than  $d$ , then  $X$  and  $Y$  are cointegrated. If two variables are cointegrated, it is necessary to estimate their relation with a specific model: a vector error correction model (VECM) (Engle and Granger, 1987), otherwise, we can use a panel VAR estimation.

To test for presence of cointegration between our variables of interest, given the presence CSD, we use a Westerlund (2007) test with a bootstrapping procedure<sup>31</sup>. The null hypothesis is the absence of cointegration. The alternative hypothesis is different between the group mean and the panel test statistics, and therefore four tests statistics are computed. While the group mean tests (Ga and Gt statistics) require that at least one  $\alpha_i < 0$  for one  $i$ , panel tests (Pa and Pt statistics) require that  $\alpha_i < 0$  for all  $i$ .

Moreover, this test allows us to take into account the presence of cross sectional dependence through a bootstrap approach. We apply 400 bootstrap repetitions. The tables below (Table 37 and Table 38) provide the p-values associated with each of the test statistics for the different models. The null hypothesis being the absence of cointegration, if the p-value is higher than 5% then we do not reject this null hypothesis. In this case, we conclude to the probable absence of cointegration between the variables. We use a color code: the cells are in red when the p-value is higher than 5% indicating therefore the absence of cointegration. They are in green when the p-value is lower than 5%, indicating the presence of cointegration.

---

<sup>31</sup> For more details about the bootstrapping procedure see Chang (2004)

Not surprisingly, most of the results show the absence of cointegration between the series. This means that it is not relevant to evaluate long-term relationships between our variables. Therefore, we can focus on short-term relationships via a panel VAR estimation.

Model	Gt	Ga	Pt	Pa
Unweighted RTA / RCA all codes / share cap	0.083	0.72	0.18	0.273
Weighted RTA / RCA all codes / share cap	0	0.415	0.23	0.458
Unweighted RTA / RCA 2 codes / share cap	0.603	0.925	0.158	0.388
Weighted RTA / RCA 2 codes / share cap	0.108	0.54	0.133	0.423

Table 37: Westerlund cointegration test - wind without RD (p-values)

Model	Gt	Ga	Pt	Pa
Unweighted RTA/ RCA all codes / share cap / RD	0.443	0.945	0.718	0.77
Weighted RTA / RCA all codes / share cap / RD	0.003	0.158	0.33	0.223
Unweighted RTA / RCA 2 codes / share cap / RD	0.465	0.808	0.247	0.023
Weighted RTA / RCA 2 codes / share cap / RD	0.068	0.22	0.21	0.04

Table 38: Westerlund cointegration test - wind with RD (p-values)

Our conclusions are similar for solar PV technologies (Table 39 and Table 40):

Model	Gt	Ga	Pt	Pa
Unweighted RTA / RCA all codes / share cap	0.74	0.99	0.99	1
Weighted RTA / RCA all codes / share cap	0.79	0.97	1	1
Unweighted RTA / RCA 2 codes / share cap	0.71	0.97	0.99	0.98
Weighted RTA / RCA 2 codes / share cap	0.75	0.93	0.99	0.98

Table 39: Table 16: Westerlund cointegration test - solar PV without RD (p-values)

Model	Gt	Ga	Pt	Pa
Unweighted RTA/ RCA all codes / share cap / RD	0.405	0.95	0.6	0.86
Weighted RTA / RCA all codes / share cap / RD	0.01	0.5	0.03	0.2
Unweighted RTA / RCA 2 codes / share cap / RD	0.47	0.46	0.66	0.54
Weighted RTA / RCA 2 codes / share cap / RD	0.22	0.39	0.65	0.56

Table 40: Table 16: Westerlund cointegration test - solar PV with RD (p-values)

## 6.5. Number of lags

It is worth noticing that the choice of the number of lags to include in the model is not straightforward as it is the results of a trade-off. At first glance, introducing more lags in the model seems beneficial as it allows to measure effects lagged by several periods and thus to take into account the reaction times of the endogenous variables to a shock of another endogenous variable. This would therefore refine the analysis. However, including a larger number of lags also means reducing the number of observations for the estimation of the model and thus reducing the degrees of freedom.

In order to obtain the best trade-off, Andrews and Lu (2001) developed three moment model selection criteria (MMSC): the MMSC-Bayesian information criterion (MBIC), the MMSC-Akaike information criterion (MAIC) and the MMSC-Hannan and Quinn information criterion (MQIC). The idea is to keep the number of lags associated with the lowest information criteria.

We test on each of the eight specifications 1 to 3 lags, because we consider that beyond we lose too much information. The results for wind and solar PV technologies are available in appendix B-8. They show that we have to retain only one lag for all the specifications. In particular, we note that all the information criteria lead to the same conclusion.

## 6.6. PVAR estimation

Like in standard panel estimation, in order to be able to estimate the PVAR model we presented at the beginning of the section, we have to deal with the presence of heterogeneous individual effect ( $\mu_i$ ). To do so, two strategies are available: first difference and forward orthogonal transformation. When applying the first difference transformation  $Y_{it}$  becomes  $Y_{it} - Y_{i,t-1}$ . With the forward orthogonal transformation,  $Y_{it}$  becomes:  $y_{i,t}^* = (y_{i,t} - \bar{y}_{i,t}) \sqrt{\frac{T_{i,t}}{(T_{i,t}+1)}}$ , where  $T_{it}$  is the number of available future observations for panel  $i$  at time  $t$  and  $\bar{y}_{i,t} = \frac{1}{T_{i,t}} \sum_{s>t} y_{i,s}$  is the average of all future observations.

However, the first difference transformation has a significant drawback as it magnifies the gap in unbalanced panels. For instance, if  $Y_{i,t-1}$  is missing, then it is not possible to apply the transformation to get the transformed  $Y_{it}$ . Arellano and Bover (1995) suggest the orthogonal transformation to minimize data losses due to data gaps. Therefore, for this analyse we apply a forward orthogonal transformation, as suggested by Arellano and Bover (1995). For all the details on the GMM estimation of the model see Sigmund and Ferst (2019). Note that GMM estimation uses instruments to address endogeneity problems. The instruments are the lagged values of the variable itself. It is then crucial to test the validity of these instruments by a Hansen test. The results of these tests are in appendix B-9.

All the tests we have conducted allow us to define precisely which variables we should estimate by GMM. In particular, the unit root tests tell us whether the variables should be estimated in level or in difference. Information criteria tell us what number of lags we should consider in the estimates. Thus, for wind technologies, the estimated models are composed of the following variables (where D. indicates a variable differentiated once and D2. a variable differentiated twice):

Specification for the PVAR GMM estimation - wind technologies			
Specification	Endogenous variables	Exogenous variables	Number of lags
1	Unweighted RTA - RCA all codes - D2.share capacities	GDP - 1998 - 2005 - 2009 (year dummy variables)	1
2	Weighted RTA - RCA all codes - D2.share capacities	GDP - 1998 - 2005 - 2009 (year dummy variables)	1
3	Unweighted RTA - RCA 2 codes - D2.share capacities	GDP - 1998 - 2005 - 2009 (year dummy variables)	1
4	Weighted RTA - RCA 2 codes - D2.share capacities	GDP - 1998 - 2005 - 2009 (year dummy variables)	1
5	Unweighted RTA - RCA all codes - D2.share capacities - D.RD	1998 - 2005 - 2009 (year dummy variables)	1
6	Weighted RTA - RCA all codes - D2.share capacities - D.RD	1998 - 2005 - 2009 (year dummy variables)	1
7	Unweighted RTA - RCA 2 codes - D2.share capacities - D.RD	1998 - 2005 - 2009 (year dummy variables)	1
8	Weighted RTA - RCA 2 codes - D2.share capacities - D.RD	1998 - 2005 - 2009 (year dummy variables)	1

Table 41: 8 Specifications for wind technologies

For the solar PV technologies, we consider the following specifications for the PVAR estimation:

Specification for the PVAR GMM estimation - solar PV technologies			
Specification	Endogenous variables	Exogenous variables	Number of lags
1	Unweighted RTA - RCA all codes - D.share capacities	GDP - 1998 - 2005 - 2009 (year dummy variables)	1
2	Weighted RTA - RCA all codes - D.share capacities	GDP - 1998 - 2005 - 2009 (year dummy variables)	1
3	Unweighted RTA - RCA 2 codes - D.share capacities	GDP - 1998 - 2005 - 2009 (year dummy variables)	1
4	Weighted RTA - RCA 2 codes - D.share capacities	GDP - 1998 - 2005 - 2009 (year dummy variables)	1
5	Unweighted RTA - RCA all codes - share capacities - D.RD	1998 - 2005 - 2009 (year dummy variables)	1
6	Weighted RTA - RCA all codes - share capacities - D.RD	1998 - 2005 - 2009 (year dummy variables)	1
7	Unweighted RTA - RCA 2 codes - share capacities - D.RD	1998 - 2005 - 2009 (year dummy variables)	1
8	Weighted RTA - RCA 2 codes - share capacities - D.RD	1998 - 2005 - 2009 (year dummy variables)	1

Table 42: 8 Specifications for solar PV technologies

## 6.7. Granger causality test

Given that we do not find cointegration between our variables, we estimate a Panel VAR model by GMM with forward orthogonal deviation (Arellano and Bover, 1995). The aim of the Granger causality test is to know whether past values of a variable  $x$  have a significant effect on current value of a variable  $y$ . If we consider more than one lag in the model, then it is necessary to test the joint significance of the coefficients associated with the lags of the variable  $x$ . If we have only one lag in the model then Granger causality can be inferred directly from the significance of the coefficient of the lagged variable  $x$ . As indicated in the two tables above, we consider a single lag for all specifications, for both technologies. Thus, we can infer Granger causality between the variables with the results of the GMM estimation of the PVAR. Nevertheless, in order to ensure the robustness of the conclusions we will perform the causality tests whose results will be in the appendix B-10.

Please note that to be able to go further in the analysis we must first make sure that the VAR Panel is stable (more details available in appendix B-6 and in Lütkepohl, 2005). Results of the PVAR stability test are available in appendix B-11.

## 6.8. Post estimation investigations

### 6.8.1. Impulse response functions (IRF)

As all variables in a VAR model depend on each other, estimated coefficients only provide limited information on the reaction of the system to a shock on a variable. In order to deepen the model's dynamic analysis we use impulse responses. The main aim of an impulse-response analysis is to describe the evolution of an endogenous variable of the model along a specified time horizon after a shock in one endogenous variable. This allows tracing the transmission of a single shock in one variable to another variable. Moreover, with an IRF analysis we determine whether the transmission of a shock is transitory or permanent. However, this approach assumes that a shock occurs only in one variable at a time. This assumption may hold if the shocks in different variables are independent. If they are dependent, this may bias the IRF investigation. Therefore, according to Sims (1980) we have to apply a Cholesky decomposition in order to orthogonalise the shocks. The assumption of the Cholesky decomposition is that series are listed from the more exogenous to the less exogenous. This means that we suppose that series listed earlier in the model impact the other variables contemporaneously, while series listed later in the model impact those listed earlier only with one or several lags.

We suggest the following order, for the model without the RD expenditures variable: 1) Policies supporting diffusion 2) RTA 3) RCA.

In models with RD variable, we suggest the following order: 1) Policies supporting diffusion 2) RD public expenditures 3) RTA 4) RCA. The following table synthetizes our arguments (Table 43).

<b>Relation</b>	<b>Main arguments</b>
Politiques(t) → RTA(t)	Even surprising as it may take time to develop innovations, empirical econometric literature finds a contemporaneous effect (Bourgeois et al., 2017)
Politiques(t) → RCA(t)	Public policies supporting diffusion of renewable technologies reduce market failures, ensure the profitability of economic agents in the industry and reduce uncertainty
RD(t) → RTA(t)	Again, the empirical literature highlights this phenomenon. Public RD expenditures reduce market failures such as the lack of funding or uncertainty
RD(t-k) → Politiques(t)	In line with the innovation process. Public RD expenditures are able to deal with market failures inherent to upstream step of the innovation process.
RTA(t) → RCA(t)	Self-selection hypothesis and the description we give above. Technological advantage leads to better relative endowment and thus leads to better export performance (Ohlin, 1933)
RCA(t-k) → RTA(t)	It may take time before observing the effects of learning by exporting (through financial flows from sales on the international market, technology transfers, etc.), as it requires adequate absorption capacities. After acquiring knowledge, master it may be time consuming.

Table 43: Cholesky decomposition – variable ordering explanations

### 6.8.2. Forecast Error Variance Decomposition (FEVD)

Like the IRF analysis, the variance decomposition analysis intends to deepen the dynamic analysis of the PVAR estimation. It determines how much of the forecast error variance of each of the variables is explained by exogenous shocks to the other variables. Generally, the FEVD analysis considers a 10-year horizon to study the explanatory power of shocks. As for IRF, we assume that the shock in different variables are independent. Therefore, we also have to apply the Cholesky decomposition to carry out the FEVD analysis. We use the same Cholesky decomposition as for IRF investigations.

## 7. Results

The aim of this section is to present the main results of our analyses, for wind and solar photovoltaic technologies, based on PVAR model estimations, IRF analyses and variance decomposition analyses (FEVD). In particular, we will study the interdependences between performance measures, the self-reinforcement of these performances, and the effect of public policies on them. We discuss these points by jointly studying the results of the three main analyses (estimation, IRF and FEVD). Full details on these analyses are available in the appendix. The results of the Granger tests are in appendix B-10. Since our specifications include only one lag, the results of the econometric regressions are directly interpretable in terms of causality. The results of the Granger causality tests allow controlling the results of our regressions.

Please note that given that we include in the analysis two measures of RTA and RCA this leads to four specifications four each model. Because of the missing data for some countries for the RD variable, we distinguish two models: one without the RD variable on 24 countries, the other with the RD variable based on a smaller number of countries. Thus, the wind model with RD covers 15 countries, and for the solar model 11 countries. We will thus discuss the robustness of our results depending on whether or not the model includes a variable representing public RD expenditures.

### 7.1. Results of the econometric analysis: wind technologies

Overall, the results of the estimation of the PVAR model by GMM are confirmed by the IRF and FEVD analyses. The results of the PVAR estimations are in appendix B-12, those of the IRF analysis in appendix B-13 and for the FEVD result refer to appendix B-14. It is worth to notice that when our results differ from the literature, we must be cautious in comparing results because the methodologies, data and variables used are not the same.

#### 7.1.1. Self-reinforcement for both RTA and RCA

First, our analysis shows the self-reinforcement for both relative performance variables. This is in line with the studies we have described previously in the literature review.

The self-reinforcement for the variable RTA is not robust because it appears only when RCA is measured with the two most relevant HS codes (otherwise the result is not significant). The estimated coefficients are about 0.45 and the IRF analysis shows that the transmission last during one to two years. To explain this we can refer to the relationship between RCA and RTA (results in the next sub-section). We find that RTA has a positive effect on RCA but that RCA has a negative impact on RTA. Thus, we have a kind of negative feedback loop that could explain the not robust self-reinforcement of RTA.

For the two measures of RCA, the performance at  $t-1$  affects positively the performance at  $t$ , whatever the model. This is consistent with the results highlighted in our literature review. This self-reinforcement can be explained by the crucial role reputation plays in international markets and by the possible existence of trade agreements over several years between countries. The results nevertheless indicate that this self-reinforcement is stronger and more durable for the

variable "RCA all codes". The estimated coefficients are about 0.8 for RCA all codes and about 0.6 for RCA 2 codes. Furthermore, the IRF analysis indicates that the shock transmission lasts about 5 years for RCA all codes versus 3 years for RCA 2 codes. Regarding the variance decomposition, a shock of RCA all codes explains 95% of its variance at t+10 versus 80% for RCA 2 codes. We could explain that by the fact that in "RCA all codes" we include more mature technologies than those at the core of wind technologies, for which market situations are potentially more stable.

Thus, even if we observe a self-reinforcement for both types of relative performance this self-reinforcement is stronger for relative export performance than for relative innovation performance. This is potentially due to the existence of high entry costs and high sunk costs in international wind markets as the transport of wind turbines is difficult. This creates barriers to entry in these international markets and allows some countries like Denmark to enjoy a dominant position. Wind technologies have rapidly seen the emergence of a technological standard (three-bladed wind turbines rotating perpendicularly to the ground) and the dominant market position of some players may have led to lobbying actions in order to limit the emergence of alternative technologies. This could explain the lower self-reinforcement for relative innovation performance.

#### **7.1.2. Bidirectional relation between RTA and RCA (not robust to all specifications)**

We find that the higher a country's relative export performance, the lower its relative innovation performance. In particular, in the model without the RD variable, the FEVD analysis shows that RCA all codes explains about 20% of the variance of RTA at t+10, compared to 11% for RCA 2 codes. Also in this model, the estimated coefficients show a greater effect of RCA all codes than RCA 2 codes (-1.302 versus -0.365). Despite some disparities, we can conclude that the shock transmission is significant during 4 years. We could explain this negative effect by the small impact of learning-by-exporting on innovation for mature technologies (Claeson, 1999). Therefore, we reject the learning-by-exporting hypothesis for wind technologies.

Moreover, the results show a positive effect of RTA on RCA 2 codes only when patent quality is taken into account. The estimation shows that an increase of one unit of weighted RTA leads to an increase of about 0.3 of RCA 2 codes. According to the IRF analysis, the transmission of the shock is significant up to two years and the FEVD investigations show that a choc of weighted RTA explains 31% of the variance of RCA 2 codes at t+10 in the model without the RD variable and 17% in the model with this variable. The positive influence of the weighted RTA on RCA 2 codes, in line with the literature (Brunel, 2019), is not surprising. In fact, taking into account the patents quality allows to include in the model the fact that some patents never had any commercial application because their aim is to impede innovation by other firms or because this innovation quickly became obsolete due to a new technical solution emerging

shortly afterwards<sup>32</sup>. Therefore, for weighted RTA and RCA 2 codes we do not reject the self-selection hypothesis.

However, we find no significant impact of RTA on RCA all codes. This shows that innovations in wind energy do not promote exports of wind complementary products. Thus, the cross-sectorial knowledge spillovers (like those studied in the second chapter of the thesis) are not sufficient to enhance exports of complementary technologies. Probably, this is due to the stronger self-reinforcement of RCA all codes compared to RCA 2 codes, which indicates that it is hard to modify market positions on these complementary technologies. In the existing literature, we mainly find a positive effect of innovation performance on export performance (*e.g.* Rodil et al., 2016; Azar and Ciabushi, 2017; Belderbos et al., 2009), but these studies did not take into account the dynamic effects between the different variables of the model. This reinforces the interpretation of the results of our study.

### **7.1.3. Effect of policies on RTA: positive effect of “share cap” and “RD expenditures” for some specifications**

Concerning the effect of the proxy “share cap” on RTA the results seem to differ between the two models (with and without the RD variable). We find a positive influence only in the model including the RD variable, otherwise we do not find a significant influence. More specifically, the estimated coefficients show that an increase of one percentage point in the share of wind energy in production capacities increases relative innovation performance by about 0.05. The transmission of the shock is significant during two years and a shock of the “share cap” variable explains from 4.6% to 8.3% of the variance of RTA at  $t+10$ . This shows the positive effect of learning-by-doing on the innovation performance of countries. We think that these differences between models may indicate heterogeneous effects between countries. In order to test this, we estimated our PVAR model without the variable RD and on the 15 countries included in the model with RD. Thus, if in these regressions we also find a positive effect of the share cap variable on RTA, then this is in line with our argument on the heterogeneity between countries. However, if we do not find an effect, as in the estimates with 24 countries, then the positive effect found in the model with RD could come from the specification itself and the insertion of this variable in the model. The results of these regressions, as well as the IRF and FEVD analyses are available in appendix. Our results show that with the model without the RD variable estimated over 15 countries, share cap does have a positive effect on relative innovation performance. Indeed, we find a positive significant effect for all specifications and the IRF analysis indicates that the shock transmission is significant for two year, whatever the specification. Maybe, further econometric estimations taking into account the heterogeneity between individuals are relevant to deepen the analysis (Konya, 2006). Thus, this seems to show that diffusion policies favour technological development in a heterogeneous way: we potentially observe a positive relationship in countries where the diffusion of technologies is

---

<sup>32</sup> To go further, it might be relevant to include in the model a variable measuring the stock of knowledge of the technology (weighted sum of the number of patents filed over the years, with a discount rate that takes into account the rate of obsolescence of innovations). Our measure of RTA only considers the flow of patent during a specific year. However, the technologies available for export are not only those patented during year “ $t$ ” but also those patented up until “ $t$ ”



already consequent. Therefore, we may observe a significant positive effect on innovation when wind penetration is above a specific threshold.

Regarding the influence of “RD expenditures by GDP” on RTA, we find a positive effect only when this innovation performance is weighted by patent quality (proxy with the size of the patent family) according to the GMM estimation of the PVAR models. The estimated coefficients are about 0.43. This shows the key role of public research funding in boosting high quality research with commercial prospects. However, given the IRF and FEVD analyses we should be cautious regarding this result. Indeed, the IRF analysis shows that the transmission of the shock is significant over one year only in the specification with weighted RTA and RCA all codes. We could hypothesize that this reflects the existence of short-term research projects financed by public spending. According to the FEVD analysis a shock of the RD variable explains 3.51% or 1.52% of the variance at t+10, depending on the specification. The explanatory power of public RD on RTA thus seems rather weak.

#### **7.1.4. Effects of policies on RCA: negative impact of share cap on RCA all codes, no influence of public RD expenditures**

We find that the “share cap” does not have a significant effect on RCA except a negative effect on RCA all codes in the model with the RD variable. Based on the estimated coefficients, one percentage point increase in share cap leads to a 0.009 decrease in RCA. The influence therefore seems rather small. Nevertheless, the IRF analysis shows that the shock is transmitted during 4 years and the FEVD analysis shows that a shock of the share variable explains 13.3% and 16.7% of the variance of RCA all codes at t+10. Probably, the fact that diffusion policies had enhanced innovation and the development of the domestic market at the expense of business development at the international level explains this negative effect. Moreover, if domestic supply cannot meet local demand, then the country will import the corresponding products. Diffusion policies can thus enhance imports rather than exports (Ogura, 2020). We can also compare this negative result on RCA all codes with the strong self-reinforcement of this variable: even if the country specializes and improves its competitiveness in wind technologies, market positions are difficult to change. The difference in the results between the two models perhaps highlights the heterogeneity between countries of the influence of “share cap” on RCA. The results of our analyses of the model without RD variables on the 15 countries of the model with RD confirm this (see appendix B-15). Although the estimated coefficients show a significant effect on RCA all codes only for unweighted RTA, the IRF analysis shows that the transmission of a shock of RTA on RCA all codes is significant during 4 to 5 years. According to the FEVD analysis, a shock of RTA explains about 15% of the variance of RCA all codes at t+10. We had mainly found in the existing literature that diffusion policies have a positive effect on the value of exports.

Finally, we find that public RD expenditures does not have a significant influence on export performance. This result is robust to both models and all three analyses. According to the variance decomposition, a shock of the RD variable explains between 0.5 and 1.7% of the variance of RCA. This is in line with the results of Sung and Song (2014).

### **7.1.5. Endogeneity of diffusion policies with export performance in the model with the RD variable**

The results of the estimation of the PVAR models show that no performance variable significantly influences the proxy of diffusion policies (share cap) in the model with all 24 countries (without the RD variable). However, our conclusions are different for the model with 15 countries (including public RD expenditures). Here, the export performance has a significantly negative effect on the share of wind generation capacity. The IRF and FEVD analyses confirm this result. This may be another sign that it is difficult for producers to satisfy both the domestic and international markets. Thus, we can conclude that there is no endogeneity between policies and relative innovation performance but not between policies and relative export performance.

### **7.1.6. Exogenous variables**

We will quickly comment the results concerning exogenous variables. As a reminder, we have included as exogenous variables GDP and dummies of years to take into account temporal shocks. The estimation results show a positive effect of GDP on relative innovation performance. This is in line with the environmental Kuznets' curve that states that climate change technologies are superior goods.

There is also a significantly negative effect of 1998 on relative innovation performance. The graphs in appendix B-4 show a decrease in RTA for some countries such as France or Belgium, but also a strong increase in RTA for other countries such as Korea or Portugal.

Concerning the relative export performance, we find no effect of exogenous variables.

## **7.2. Results of the econometric analysis: solar PV technologies**

All the results are available in the appendix: estimated coefficients (appendix B-19), IRF analysis (appendix B-20) and FEVD analysis (appendix B-21). The results of the Hansen are in appendix B-16, those for PVAR stability in appendix B-17, Granger causality tests are in appendix B-18.

### **7.2.1. Self-reinforcement of RTA and RCA: robust in the model without RD – not robust in the model with RD**

For the model estimated over the 24 countries, not including the public RD expenditures variable, the results show a self-reinforcement of RTA, whether this indicator is weighted or not. According to the GMM estimation, a one-unit increase in the value of RTA at period  $t-1$  leads to an increase in RTA of 0.5 to 0.7 at period  $t$ . The transmission of the shock is significant for two years and a shock in RTA at  $t-1$  explains between 70 and 98 per cent of the variance in RTA at  $t+10$ . This highlights the need for countries to ensure good innovation performance as early as possible, for example by implementing adequate public policies. We do not find this result in the model with the RD variable, covering 11 countries. Although the analysis of variance decomposition (FEVD) shows an explanatory power between 72% and 90%, the estimated coefficients and the IRF analysis show no self-reinforcement in this model. This

difference between the two models may be due to a heterogeneity in the dynamics of relative innovation performance of countries. As for wind technologies, to argue on the existence of heterogeneity of effects between countries, we estimated the model without RD variable on the 11 countries considered in the model with this variable. The results are available in appendix B-22. The estimated coefficients show a self-reinforcement of RTA only in the specifications with the variable "RCA all codes". However, the IRF analysis does not show shock transmission over time for all specifications. We thus find that the results are different from those obtained in the model without the RD variable on all countries. We can therefore think of a heterogeneity of results across countries. In addition, the sub-panel corresponding to the model with the RD variable excludes rich countries such as the United States, where self-reinforcement trajectories are probably stronger. It would therefore be relevant, for further analysis, to use an estimation method that considers this heterogeneity and that gives results for each country separately. This non-robust self-reinforcement is also probably due to the fact that the technological trajectories of solar technologies are still not clearly defined, as we have seen in the second chapter of this thesis (monocrystalline vs polycrystalline vs organic vs amorphous silicon technologies ...).

We also find different results between the two main models regarding the self-reinforcement of the relative export performance. Nevertheless, we can also conclude to a self-reinforcement of the export performance. This self-reinforcement, albeit not robust to all specifications, is in line with the results in our literature review. In the model without RD, the estimated coefficients are significant and vary between 0.6 and 0.75 and the transmission of the shock is significant for 3 to 4 years. Moreover, the explained variance is slightly higher for RCA all codes than for RCA 2 codes (63%; 79%). Thus, it is crucial for countries to have a good export performance as early as possible in order to benefit from this self-reinforcement. However, in the model with RD, we observe this self-reinforcement only for the variable "RCA all codes". As with wind technologies, this is related to the fact that RCA all codes covers more mature technologies than those at the heart of solar technologies, where market positions are established and stable. Nevertheless, the explanatory powers (FEVD analysis) are not very different between the two variants of RCA: around 80%. The IRF analysis indicates that the shock transmission is significant for two years. The lack of self-reinforcement for the core solar technology may be due to the lack of maturity of these technologies. This lack of maturity implies the absence of a technological standard for this industry. Therefore, the demand in one country may be less stable, as the demand could go to another country sending a different solar technology. Thus, the leaders are not yet established and therefore it is more difficult to maintain a good relative export performance over several years. As for RTA, to understand these differences between the two models, it would first be necessary to study the heterogeneity of the dynamics of relative export performance between countries. The results of the estimation of the model without RD for the 11 countries (appendix B-22) show a self-reinforcement only for the variable RCA all codes (like for the model with the RD variable). This then reinforces the possible heterogeneity of results between countries and the need to use a methodology that considers this heterogeneity. As for the self-reinforcement of RTA, the differences between the two models could come from the fact that the sub-panel corresponding to the model with the RD variable excludes rich countries such as the United States, where self-reinforcement trajectories are probably stronger.

### **7.2.2. RTA and RCA: no unidirectional or reverse causality**

Overall, we find no impact of the relative export performance on RTA apart from a negative effect of RCA 2 codes in the model with RD. In the specifications where RCA 2 codes has a significantly negative effect on RTA, we find that the effect is larger when the relative innovation performance is weighted. The estimated coefficients are respectively -0.55 and -1.11 on the unweighted RTA and weighted RTA variables. The explanatory power of a shock of “RCA 2 codes” is then 18.49% on weighted RTA and 6.04% on unweighted RTA. Therefore, the role of learning-by-exporting is not significant for solar energies.

Relative innovation performance does not have a significant impact on relative export performance even when we take into account the quality of innovations (unlike the results for wind technologies). This insignificant effect may be due to lower sunk costs on international markets for solar energy compared to wind technologies, especially for freight transport. Indeed, it is easier to export solar panels than wind turbines, in particular because their packaging is easier. Due to the lower sunk costs, there is less self-selection. Thus, having a technological advantage over other countries is less crucial than for wind technologies.

The absence of self-selection and learning-by-exporting contrasts with the overall trend in the literature review, where the majority of studies have concluded that both phenomena exist (*e.g.* Neves et al., 2016; Esteve-Pérez and Rodriguez, 2013; Zhao and li, 1997).

### **7.2.3. Public RD expenditures: no effect on RTA but a significant positive effect on RCA**

The results indicate that policies supporting innovation do not have a significant effect on RTA, whether this indicator is weighted or not. This is quite surprising, given the conclusions of our literature review in chapter 1. We may think that this insignificant result comes from the fact that we have removed some of the richest countries from our panel to estimate the model with the RD variable. In addition, we considered a one-year delay in our PVAR. This delay may not be the most relevant for measuring the effect of RD policies on innovation. Indeed, some studies consider a delay of two years (*e.g.* Braun et al., 2010; Klaassen et al., 2005).

Besides, it seems that public RD expenditures have a positive impact on relative export performance. We can explain this result by the low level of maturity of solar technologies: there is no technological standard unlike wind energy, so if a country offers a more efficient technology the demand can move to that country. Moreover, public RD expenditures may not be sufficient to encourage the patent filings, but may encourage other forms of innovation that are a source of commercial competitiveness (know-how, etc.). This is in line with our argument explaining the lack of self-reinforcement for relative export performance. While GMM estimations show a significantly positive effect, with estimated coefficients ranging from 0.47 to 0.98, we have to moderate our conclusions because of the IRF. Indeed, according to the IRF the transmission of a RD shock on RCA is significant during a period, but only for RCA 2 codes. Finally, the FEVD analysis shows that a RD shock explains 10% to 20% of the variance of RCA at  $t+10$ .

#### **7.2.4. Share of installed capacities: no effect on RTA, no robust negative effect on RCA**

According to the results, diffusion policies (proxy with the share cap variable) do not have a significant effect on RTA, whether this indicator is weighted or not. Thus, the explanatory power of a "share cap" shock on RTA at t+10 is low, around 3%. This may show that solar PV technologies have not sufficiently penetrated the energy mix to allow significant learning effects (learning by doing and learning by using). Indeed, we found a positive share cap effect on the relative innovation performance of wind technologies, for some specifications. Yet, the penetration in the energy mix is on average higher for wind technologies than for solar PV technologies for the majority of the countries in our panel (see appendix B-4). We could then ask whether there is a threshold at which diffusion policies have a significant effect on relative innovation performance<sup>33</sup>.

In the model with the RD variable, we find that "share cap" has a significantly negative effect on "RCA 2 codes" only. A one-percentage point increase in the share of solar energy in total generation capacity results in a 0.01 decrease in "RCA 2 codes". As for wind energy, we could justify this potential negative effect by the competition between domestic and international markets: diffusion policies favour the development of domestic markets at the expense of exports. Diffusion policies could even encourage more imports if they lead to more competition between countries (Ibenholt, 2002 ; Söderholm and Klaassen, 2007). However, we do not find this result in the IRF analysis where for all specifications we find no significant transmission of a RD shock on RCA. Finally, the FEVD analysis also moderates our conclusions: a RD shock explains a very small part of the variance of "RCA 2 codes" at t+10 (0.52% to 1.18%). This negative influence is not consistent with the results of our literature review as these studies mainly found that diffusion policies have a positive impact on the value of exports.

#### **7.2.5. No effect of both performances on public policies**

The results of the GMM estimations and other analyses show that RTA and RCA, whatever their variant, do not have a significant effect on the "share cap" variable. Nevertheless, in the model with the RD variable, we find that the explanatory power of RCA on "share cap" ranges from 0.2% to 22.18% at t+10, which may suggest a relationship between the two variables after several years.

The results are more homogeneous between the three analyses concerning the effect of RTA and RCA on public RD expenditures. The estimations as well as the IRF analysis show no significant effect of a relative performance shock on RD expenditures. Finally, according to the FEVD analysis the explanatory power of both performances is less than 9%, whatever the specification.

---

<sup>33</sup>As a first step, to test this hypothesis, we could include in a panel econometric model a categorical/factor variable representing different levels of solar energy penetration in the energy mix, with a step of 5% for example.

### **7.2.6. Exogenous variables**

Contrary to the predictions of the environmental Kuznets' curve, GDP has no effect on the relative innovation and export performance of solar PV technologies. As for wind technologies, the year 1998 seems to have a negative effect on RTA. Finally, in some specifications, there is a positive effect of the year 2005 and the year 2009 on RCA.

### **7.3. Comparison of results between the two technologies**

In this sub-section, we summarize the main results of the PVAR model analysis and compare them between the two technologies. Since the subpanels for the models with the variable RD are very different between the two technologies, we will only comment on the differences in results between the two full panels.

For both technologies, we observe a self-reinforcement of export and innovation performance. Nevertheless, the self-reinforcement of RCA is more robust to the different specifications for wind than for solar PV maybe because the technological trajectories of solar technologies are not yet clearly defined. Although Japan is a historical leader in the international photovoltaic technology markets, the lower maturity of these technologies and the existence of low entry and sunk costs (compared to wind technologies) has allowed the emergence of new players such as Spain (or China, a country not included in our panel). As wind technologies are more mature, the hierarchy in international markets is more stable.

Regarding the relationship between the two performances, we conclude that there is reverse causality for wind technologies but not for solar PV technologies. This is in line with the differences between the two technologies regarding their maturity, barriers to entry and cost structures.

In the models without the RD variable, we find that diffusion policies do have a significant negative impact on relative export performance for both technologies. This highlights the fact that dissemination policies are not the best solution to encourage exports, maybe because they favour the expansion of domestic markets at the expense of global markets. The results also show insignificant effects of diffusion policies on innovation performance in models without RD.

## **8. Conclusion and discussion**

This chapter investigates, with a Panel VAR model, the interactions between RTA and RCA for wind and solar PV technologies. Our panel covers 24 countries from 1989 to 2014. Methodologically, our main contribution to the existing literature is the consideration of endogeneity between performance measures, and between these performances and public policies. In existing studies, the non-consideration of endogeneity can bias the results of econometric studies.

Our results show that public RD expenditures appears to be more appropriate than diffusion policies to improve export performance. On the one hand, for both technologies, we find that diffusion policies have no effect on exports or even a negative effect. On the other hand, for solar technologies, RD expenditures have a significantly positive effect on export performance. This is explained by the low level of maturity of these technologies. For wind technologies, the effect of RD expenditures on exportations is indirect, through the support of relative innovation performance. Indeed, we find that RD expenditures help the development of relative innovation performance, which has a positive influence on relative export performance. Our results for wind technologies also highlight the necessity to take into account the heterogeneity of patent values.

This result is different from the conclusions of the existing literature, where there seems to be a positive link between diffusion policies and the amount of exports on the one hand, and an ambiguous effect of RD expenditures on exports, on the other hand.

The second key result concerns the relations between the two performance measures in each technologies. For both technologies, we reject the learning-by-exporting hypothesis. Moreover, we find a self-selection effect for wind only. Differences in barriers to entry and higher sunk costs for the wind industry explain these disparities between technologies.

These two main results have consequences for countries that wish to support national green growth and internationalize their renewable industries. For both technologies, it is necessary to focus on innovation support rather than diffusion support. The latter can indeed promote the development of domestic markets at the expense of exports and even enhance imports (Ogura, 2020). Given their cost structure and the barriers to entry into international markets, wind energy requires a strong innovation performance to improve export performance.

We note the importance of reputation effects on international markets and the need for players to enter these markets as soon as possible. Indeed, we observe a strong self-reinforcement of the relative export performance for both technologies.

Our study deepens the literature on several aspects, in particular on the consideration of endogeneity between variables. Nevertheless, we could discuss some interpretations. In particular, we find in several situations different results between the model with the variable RD and the model without this variable. Further econometric investigations suggest that these differences between the two models are due to heterogeneous results between countries. The "classical" PVAR model we used does not allow us to measure different effects for each country. Therefore, for future studies, it would be relevant to use an econometric method able to estimate coefficients for each country, while considering the "overall structure" of our panel. Firstly, we could refine the typology of countries that we defined in section 5 of this chapter. Then, we could estimate PVAR models on coherent subsets of countries characterized by similar behaviours (technology leader countries, export leaders, pioneers in the implementation of public policies, etc.). Secondly, the approach developed by Konya (2006) seems particularly appropriated to deepen the analysis as it allows the estimation of different coefficients for each country. We could also use quantile regressions, as they allow estimating different coefficients according to the quantiles of the explained variables. For example, with quantile regressions we could test whether the determinants of innovation performance are the same for over-specialized/leaders countries as for under-specialized/leaders countries.

The different results between the two technologies regarding the effect of diffusion policies on relative innovation performance raise the question of the existence of a threshold at which diffusion policies begin to have a significant effect on technological development. Indeed, we can think that it is necessary to send a sufficiently strong signal to economic agents to create confidence in the good profitability of their investments in innovation. Moreover, learning effects are not necessarily linear, especially for renewable energies (Criqui et al., 2015). Future studies could deal with this point. The penetration rate of REN in the country could be a relevant criterion to create sub-panels and study PVAR models on these sub-panels.

While our export performance indicator takes into account the technology studied as well as complementary technologies (via RCA 2 codes and RCA all codes), we have not included these complementary technologies in the measures of RTA. We chose to do so in order not to overload the analysis and because it requires rather consequent and time-consuming processing on the PATSTAT database. However, we observe different results depending on whether or not the RCA variable takes into account the complementary technologies. Thus, a research avenue could be to integrate in an econometric model the innovations developed in the complementary technologies to solar PV and wind identified in chapter two. This would allow characterizing countries under-specialised in REN technology but with a technological advantage in complementary technologies. These countries specialised in complementary technologies could more easily gain a technological advantage in renewable technology. In addition, we could integrate into an econometric model the knowledge stocks of complementary technologies identified in chapter two in order to highlight knowledge externality effects (knowledge spillovers) and to fuel the debate on the most relevant policy mix to implement and in order to tackle climate change and ensure green growth.

We generally distinguish between two main types of climate policies (see Chapter 1): innovation policies (*e.g.*, public RD expenditures) and diffusion policies (*e.g.*, feed-in tariffs). Each of these types of policy is designed to address specific market failures and are therefore complementary. Thus, the effect of diffusion policies on innovation may be stronger if the country also implemented innovation policies. In this study, we used two variables (share cap and RD) without ever crossing them. We could test the complementarity between these two types of policies and their joint effects on relative innovation and export performance in future econometric investigations. This could be done through the introduction of a variable multiplying the value of RD expenditures per GDP by the penetration rate of REN in the energy mix (RD x share cap).

Finally, our panel includes 24 countries, mostly European. Unfortunately, due to a lack of available data we could not include China in this panel, although this country has played a leading role in the development of renewable solar photovoltaic and wind energy. We can therefore wonder to what extent this may have changed our conclusions.



# Conclusion générale

---

## 1. Rappel du contexte et des principaux enjeux

Depuis la révolution industrielle du début du 19<sup>ème</sup> siècle nos économies et nos sociétés sont fortement dépendantes des énergies fossiles, fortement émettrices de GES. Selon les statistiques annuelles publiées par BP, en 2017 environ 85% de la consommation d'énergie primaire était d'origine fossile. Au contraire, les énergies renouvelables (hors hydraulique) représentaient 3.5% du mix mondial. Différents travaux de prospectives mettent en évidence qu'en l'absence d'efforts pour réduire nos émissions de GES nous pourrions connaître une augmentation moyenne des températures supérieure à 5°C (IEA, 2014 ; GIEC, 2015). Pour faire face à cette urgence climatique, 195 pays ont signé un accord juridiquement contraignant sur le climat au cours de la 21<sup>ème</sup> Conférence des Parties (COP) tenue à Paris en 2015 (Accord de Paris). L'objectif principal est de limiter le réchauffement climatique à +2°C par rapport à l'ère préindustrielle. Sous l'impulsion d'ONGs et de petits Etats insulaires, en première ligne face aux conséquences du changement climatique, l'accord fixe un objectif plus ambitieux visant à limiter la hausse des températures en dessous de 2°C et le plus proche possible de +1.5°C. Pour respecter l'Accord de Paris, les émissions de CO<sub>2</sub> du système énergétique mondial devront être nulles dès le courant de la seconde moitié du 21<sup>ème</sup> siècle.

La réduction des émissions de GES nécessite une diminution de l'intensité énergétique du PIB et de l'intensité carbone de l'énergie consommée (Criqui et Kitous, 2012). La croissance économique doit désormais se baser sur une utilisation sobre et raisonnée des ressources énergétiques et matérielles. L'agence internationale de l'énergie en 2010 identifiait 3 principaux leviers pour la réduction des émissions de GES : adoption rapide et à grande échelle des énergies renouvelables (ENR) ; développement des technologies de capture et de stockage du carbone ; amélioration du rendement des centrales thermiques électriques (AIE, 2010).

Néanmoins l'innovation et la diffusion des technologies renouvelables se heurtent à plusieurs défaillances de marché qui nécessitent que des politiques publiques soient mises en œuvre. Nous distinguons généralement deux grands types de politique de soutien aux énergies renouvelables : les politiques de soutien à l'innovation (dépenses publiques de recherche et développement par exemple) et les politiques de soutien à la diffusion (tarifs d'achat garanti par exemple).

L'objectif général de cette thèse est d'étudier l'efficacité des politiques mises en œuvre dans ce domaine de manière à mieux comprendre les mécanismes en jeu, mais aussi de façon à éclairer la décision publique et constituer un mix de politiques à même de répondre à l'enjeu de décarbonation totale des systèmes techniques.

Il existe aujourd'hui un débat sur le bon équilibre à établir entre le soutien à la diffusion et le soutien à l'innovation des ENR. Certains auteurs ont ainsi mis en évidence un déséquilibre important en faveur des politiques de diffusion (Zachmann *et al.*, 2014) qui pose la question de la pérennité du processus de changement technologique en cours et de la nécessité, ou non, d'un redéploiement par l'innovation (Dechezleprêtre *et al.*, 2016; Fischer *et al.*, 2013). Afin d'éclairer ce débat il est crucial dans un premier temps de se demander quelle est l'efficacité de

chacune de ces politiques. Afin de répondre à cette question, tout en apportant une contribution significative à la littérature, nous avons réalisé une revue de la littérature des études économétriques s'intéressant à l'effet des politiques climatiques sur l'innovation et la diffusion des énergies renouvelables. Cette revue a permis de poser les jalons pour les chapitres suivants en identifiant deux principaux points qui ne semblaient pas suffisamment abordés.

L'innovation dans les énergies renouvelables est dépendante de l'innovation dans d'autres secteurs technologiques, du fait de l'existence de *spillovers* de connaissance intersectoriels. Ces *spillovers* ont potentiellement un rôle crucial dans les dynamiques d'innovation des ENR et peuvent conduire à des effets indirects de politiques publiques. Or, l'effet de ces *spillovers* ne semble pas suffisamment abordé dans la littérature. L'enjeu est donc ici d'avoir une meilleure compréhension des dynamiques d'innovations dans les énergies éoliennes et solaires PV grâce à l'identification des technologies complémentaires à chacune de ces ENR. Au-delà de cette caractérisation des complémentarités technologiques, l'enjeu est également de déterminer les relations entre les performances en innovation dans les ENR et dans leurs technologies complémentaires au sein des pays. Cela permet alors d'identifier des pays où nous retrouvons une cohérence entre les deux niveaux de performance (par exemple bonne performance à la fois dans l'ENR et dans les technologies complémentaires) ou bien une incohérence (par exemple, faible performance dans les technologies complémentaires et forte pour l'ENR). Cette approche permet alors de mettre en exergue des pays qui auraient un intérêt à innover davantage dans les ENR du fait le bon positionnement en innovation dans les technologies complémentaires. Les disparités des résultats entre les technologies ENR permettent également de justifier des effets différenciés des politiques climatiques suivant les ENR.

Au-delà des incitations au développement technologique, les politiques climatiques de soutien aux ENR peuvent également avoir pour objectif de soutenir la croissance du marché domestique mais également d'encourager l'entrée des agents économiques sur les marchés internationaux. L'évaluation des politiques climatiques doit donc cibler à la fois le soutien à l'innovation et le soutien à l'exportation, en considérant qu'il peut exister des interactions mutuelles entre ces deux objectifs (*feedbacks*). Or, la littérature existante n'aborde pas ces effets de *feedbacks* ce qui peut biaiser les résultats des estimations économétriques notamment. La thèse a ainsi adressé cet enjeu.

## **2. Principaux résultats**

Le premier objectif de cette thèse est d'éclairer le débat sur l'équilibre entre les deux types de politiques (*demand-pull* et *techno-push*) en réalisant une revue de la littérature des études économétriques évaluant l'effet des politiques climatiques sur l'innovation et la diffusion dans les énergies renouvelables.

Globalement, les résultats montrent que l'effet des politiques varie selon le type de politique (politiques d'offre de soutien à l'innovation, politiques de diffusion basée sur les prix, politique de diffusion basée sur les quantités) et selon la technologie renouvelable (en particulier selon le niveau de maturité de la technologie). Ces résultats confirment ceux des études non économétriques, basées sur des études de cas ou des enquêtes par exemple. Les politiques indifférenciées quant aux technologies ciblées (quotas par exemple), stimulent l'innovation

dans les technologies matures et proches de la compétitivité comme les énergies éoliennes alors que les prix garantis (tarifs d'achat par exemple) sont plus appropriés pour les technologies plus coûteuses comme les énergies solaires PV. Ainsi, la revue de la littérature met en évidence le besoin de différencier les différentes technologies renouvelables pour l'évaluation des politiques publiques.

Plus précisément les investissements de RD ont un effet positif sur l'innovation dans les énergies éoliennes et solaires. Concernant l'effet des politiques de diffusion basées sur les prix sur l'innovation, nous observons des effets très contrastés entre l'éolien et le solaire. Tandis qu'une nette majorité d'études conclue à un effet positif pour les technologies solaires, ce n'est pas le cas pour les technologies éoliennes. La littérature tend à montrer que les politiques basées sur les quantités sont plus efficaces pour inciter à l'innovation dans l'éolien que dans le solaire. Concernant le soutien à la diffusion les politique prix semblent être plus efficaces que les politiques quantités.

Cette synthèse de la littérature fait ressortir deux principaux aspects encore peu étudiés.

Le premier concerne le manque de prise en compte des flux de connaissances (*spillovers*) vers les énergies renouvelables. Or, ces relations intersectorielles dans les dynamiques d'innovation peuvent créer de potentiels effets indirects des politiques publiques.

Le deuxième aspect concerne le manque d'étude sur la diffusion des ENR entre les pays ainsi que des effets de rétroactions entre l'innovation et la diffusion des ENR, avec des modèles économétriques adéquats.

Ainsi, dans le deuxième chapitre, afin d'étudier l'effet des *spillovers* de connaissance intersectoriels sur la performance en innovation des pays, j'ai identifié les principales technologies complémentaires aux énergies éoliennes et solaires PV. Mon approche empirique originale est basée sur une analyse réseau dynamique. Les résultats montrent que les innovations dans le domaine des transports, de la mécanique et du bâtiment jouent un rôle central pour l'innovation dans l'énergie éolienne. Les innovations en matière d'optique, de revêtement et de chimie sont essentielles pour le solaire PV. Puis j'ai étudié la cohérence entre les niveaux de performance relative en innovation au sein des pays entre les ENR éoliennes et solaires PV et leurs technologies complémentaires. Cette approche a permis d'identifier des pays qui semblent bien positionnés en terme de performance en innovation dans les technologies complémentaires et auraient un intérêt à innover davantage dans les ENR. Pour les technologies solaires PV, le Japon domine largement les autres pays si bien que seules la Belgique et l'Inde disposent d'une base de connaissances solide pour innover dans les nouvelles technologies solaires telles que les cellules organiques et les cellules à colorant. Pour les technologies éoliennes, les incohérences entre les niveaux de spécialisation sont plus prononcées. En particulier, la France bénéficie d'une très bonne performance dans les technologies aéronautiques mais cela ne s'est pas concrétisé par une surspécialisation dans l'innovation en matière d'énergie éolienne. La Grande-Bretagne, la Suède et l'Australie sont dans une situation similaire.

Dans le chapitre 3, je me suis intéressé à l'impact des politiques climatiques sur les performances en innovation et à l'export, au niveau national, pour les technologies éoliennes et solaires PV. L'originalité de l'approche développée repose sur le recours à des indicateurs de performance relative qui permet de prendre en compte la compétition entre les pays au niveau

international et de mesurer indirectement le poids de certains acteurs clé que nous n'avons pas pu intégrer dans l'analyse par manque de données disponibles (*e.g.* Chine). L'intérêt de cette étude par rapport à la littérature tient également à l'utilisation d'un modèle économétrique permettant de contrôler les biais d'estimations liés aux boucles d'interactions entre les différentes variables du modèle. Nos résultats montrent que les dépenses publiques de RD semblent être plus appropriées que les politiques de diffusion pour améliorer les performances à l'exportation. Nous constatons une influence de la performance relative de l'innovation sur la performance relative des exportations pour les technologies éoliennes uniquement. Nous ne mesurons aucune interaction mutuelle entre les deux mesures de performance relative, à la fois pour les technologies éoliennes et les technologies solaires PV. Les résultats montrent également une possible hétérogénéité des résultats entre les pays.

### **3. Perspectives de recherche**

#### **3.1. Politiques climatiques, performances relatives en innovation et à l'export : causalités hétérogènes selon les pays**

Dans le chapitre trois de cette thèse, nous avons étudié les causalités entre les politiques climatiques de soutien à l'innovation et à la diffusion, et les performances relatives en innovation et à l'export. Cette étude porte sur un panel de 24 pays de 1989 à 2014. La méthode employée (Panel VAR) est basée sur une hypothèse forte qui stipule que les causalités sont valables pour l'ensemble des pays. Il n'est en effet pas possible de pouvoir estimer des coefficients pays par pays, en considérant la structure globale du panel et la dépendance potentielle des effets entre les pays. Nous ne sommes donc pas en mesure de saisir l'hétérogénéité due aux caractéristiques spécifiques des pays (Breitung, 2005). Or, d'après les résultats obtenus dans le chapitre trois, plusieurs éléments nous permettent de penser qu'il existe des résultats hétérogènes selon les pays. Tout d'abord, nous avons analysé l'évolution des performances relatives des pays sur deux sous-périodes (avant et après 1998), afin d'identifier les pays les plus performants et au contraire ceux qui sont le moins performants. Nous nous sommes également efforcé de comparer ces performances relatives avec les efforts en terme de politiques publiques engagés par les pays. Nous avons constaté une grande hétérogénéité dans les performances relatives des pays et dans l'évolution de celles-ci entre les deux sous-périodes. Nous avons également observé des évolutions contraires des deux mesures de performance au sein des pays (par exemple en Finlande pour les technologies solaires photovoltaïques), alors que la théorie économique prédit que les deux performances évoluent dans le même sens. Enfin, certaines analyses économétriques, réalisées sur le même modèle mais avec des pays différents (certains ont été retirés), aboutissent à des conclusions différentes. Cela, pourrait s'expliquer par des résultats hétérogènes selon les pays.

La nouvelle théorie du commerce international fournit quelques intuitions pouvant expliquer l'existence d'effets différents selon les pays. Ces nouvelles théories partent notamment du constat qu'en réalité nous observons du commerce intra-branche entre deux pays, ce qui n'est pas prédit par les théories classiques (*e.g.* modèle Heckscher-Ohlin-Samuelson). Krugman justifie ce commerce intra-branche par la préférence pour la diversité des consommateurs et les rendements d'échelle croissant. Cela renforce l'idée, déjà évoquée par Posner (1961) de l'effet des efforts de RD sur les exportations qui permettent à un pays de proposer un nouveau bien

différent aux yeux des consommateurs de celui proposé par un autre pays. La performance en exportation va ainsi dépendre des efforts de RD. Mais il est nécessaire que ces efforts aboutissent à la mise sur le marché international d'un bien différencié. Or, il a été montré que certaines innovations n'aboutissent pas à des applications commerciales (*cf. technology death valley*). Il faut également que les budgets de recherche soient suffisamment conséquents pour aboutir à une différenciation significative. De plus, ces théories mettent en évidence l'avantage qu'ont les pays à rentrer les premiers sur les marchés internationaux. L'innovation va créer un nouveau marché pour le pays qui la possède. Celui-ci va se retrouver dans une situation monopolistique loin des hypothèses de concurrence parfaite des modèles classiques. Grâce à cette situation de monopole, le pays va pouvoir bénéficier de rendements croissants et donc d'économies d'échelle. La théorie prédit donc un auto renforcement des avantages au fil du temps. Les dynamiques d'exportation sont ainsi susceptibles d'être assez différentes entre les pays entrés les premiers sur les marchés et les pays suivants ainsi que les pays qui cherchent à y rentrer. Pour ces derniers, il sera probablement nécessaire de consentir à plus d'efforts pour soutenir les industries afin d'améliorer la performance à l'export. Notons néanmoins que ces avantages donnés aux pionniers peuvent disparaître avec l'amélioration du niveau de maturité des technologies et leur standardisation (*cf. cycle de vie de Vernon*).

Etant donné que ce projet se place en prolongement du chapitre trois de cette thèse, nous nous utiliserons le même jeu de données que pour ce chapitre (couvrant 24 pays de 1989 à 2014). Notre objectif est de pouvoir capter des effets hétérogènes selon les pays. Nous pouvons distinguer trois grandes méthodes économétriques pour capter cette hétérogénéité en données de panel. La première approche est basée sur l'estimation d'un modèle à correction d'erreurs (VECM) au moyen d'un estimateur de la méthode généralisée des moments (GMM). Cependant, cette approche ne peut prendre en compte ni la dépendance transversale entre les individus du panel (i.e. un choc dans un pays va avoir des conséquences sur d'autres pays) ni l'hétérogénéité. Même si la deuxième approche proposée par Hurlin (2008) contrôle l'hétérogénéité, elle ne peut pas tenir compte de la dépendance transversale. En revanche, la troisième approche proposée par Kónya (2006) est suffisante pour tenir compte à la fois de la dépendance transversale et de l'hétérogénéité. Cette approche est basée sur l'estimation SUR (*Seemingly Unrelated Regressions*) qui permet de prendre en compte la dépendance transversale entre les membres du panel. Réaliser des tests de causalité par pays est possible grâce à une méthode *bootstrap*. Enfin, la procédure de test ne nécessite aucun test de racine unitaire ou de cointégration au préalable.

Cette méthode économétrique a été utilisée dans bon nombre de papiers (*e.g.* Sen et al., 2018; Chang et al., 2015; Chen and Perng, 2017). Mais à notre connaissance notre papier sera le premier à utiliser cette méthode pour mesurer des résultats différents selon les pays sur les relations de causalité entre les performances relatives en innovation/à l'export et les politiques climatiques de soutien à l'innovation et à la diffusion. Une fois les résultats de l'estimation économétrique obtenus, une analyse des caractéristiques des pays pour lesquels les résultats sont identiques nous permettra d'améliorer notre compréhension des déterminants des performances en innovation et à l'export des ENR.

### 3.2. Innovation et productivité des entreprises françaises, une application au secteur des énergies renouvelables avec un modèle CDM

Ce projet de recherche se pose également comme un complément du troisième chapitre. Là où ce chapitre apporte une analyse macro-économique au niveau des pays, l'objectif de cette recherche est d'exploiter des données micro-économiques, au niveau des firmes, et en se focalisant sur la France. Alors que l'approche macroéconomique permet de prendre en compte le poids de chaque pays dans les échanges commerciaux internationaux, une approche micro-économique permet de se placer au niveau des firmes, là où les stratégies de protection intellectuelle (et donc les décisions de breveter) sont prises. Ce projet permet également d'exploiter nos résultats du chapitre deux sur la complémentarité entre les technologies ENR et les technologies provenant d'autres secteurs.

Théoriquement, l'hypothèse de Porter suggère que la réglementation environnementale peut encourager l'innovation technologique des entreprises, ce qui contribue *in fine* à accroître leur compétitivité (Porter et van der Linde, 1995). Plus précisément, la politique va inciter à plus d'innovation et donc à l'émergence de nouvelles technologies et de procédés de production. Cela va alors potentiellement rendre le processus de production plus efficace, permettant ainsi de réaliser des économies suffisantes pour surcompenser le coût lié à la mise en conformité de la réglementation environnementale. Selon cette hypothèse, la réglementation environnementale induit donc une situation " gagnant-gagnant " où la qualité environnementale et la productivité des entreprises sont améliorés.

Crépon, Duguet et Mairesse (1998) (ci-après CDM) proposent un système d'équations récursives qui lie la fonction de production de connaissances à la performance de l'entreprise. Le modèle CDM introduit un modèle structurel qui explique la productivité par l'innovation et par l'investissement dans la recherche. De plus, il suggère une méthode de correction de la sélectivité et de l'endogénéité inhérentes au modèle. De nombreuses études empiriques ont utilisé et étendu le cadre du modèle CDM pour étudier la relation entre l'innovation et la performance dans les entreprises. La plupart de ces études trouvent une relation positive significative (van Leeuwen et Mohnen, 2017 ; Hall et Sena, 2017 ; Bartelsman et al. 2017 ; Broström et Karlsson, 2016). Pour une revue de la littérature plus approfondie, voir Lööf et al (2017). Baum *et al.* (2017) montrent en particulier que les résultats d'une étude basée sur un modèle CDM diffèrent en fonction du secteur industriel. Les résultats de l'analyse CDM varient également d'un pays à l'autre (Griffith *et al.* 2006 ; Bartelsman *et al.* 2017), et en fonction de la période considérée (Aw *et al.*, 2008 ; Bond et Guceri, 2017).

Peu d'études ont tenté d'inclure l'effet des *spillovers* de connaissances dans le modèle CDM, et ne l'ont fait que partiellement. Ben Hassine *et al.* (2017) n'incluent les *spillovers* que dans l'équation de productivité, mais ne prennent pas en compte l'endogénéité entre les deux fonctions. Goya *et al.* (2013) n'incluent pas les *spillovers* dans l'équation d'innovation. Lhuillery (2011) inclut le stock de connaissances des concurrents dans l'équation de recherche mais ne tient pas compte du rôle des retombées dans l'équation de productivité. Antonelli et Colombelli (2017) proposent une intégration plus précise des *spillovers* dans le modèle CDM en tenant compte des connaissances internes et externes à la fois dans l'équation de productivité et dans

l'équation d'innovation. Néanmoins, ils ne font pas de distinction entre les différents champs de connaissances impliqués dans les *spillovers*.

Dans ce projet, nous proposons de développer une extension du modèle CDM prenant en compte l'effet des *spillovers* de connaissances dans l'équation de productivité et l'équation d'innovation. En nous basant sur les résultats du deuxième chapitre, nous incluons les *spillovers* provenant des différents champs technologiques identifiés comme jouant un rôle clé dans les dynamiques d'innovation des ENR. Comme la nature et la structure des *spillovers* dans le secteur des énergies renouvelables varient dans le temps, nous utiliserons une approche dynamique. Nous examinerons également l'effet possible des politiques climatiques sur l'innovation et la productivité afin de formuler des recommandations à l'intention des décideurs politiques.

Ce travail de recherche utilisera des données de brevets issues de la base de données internationale sur les brevets (PATSTAT) ainsi que des données sur la performance économique des entreprises françaises ou européennes.

# Bibliographie

---

- Abernathy, W.J., Utterback, J.M., (1978). Patterns of industrial innovation. *Technology review* 80, 40–47.
- Adelaja, A., Hailu, Y.G., McKeown, C.H., and Tekle, A.T. (2010). Effects of Renewable Energy Policies on Wind Industry Development in the US. *Journal of Natural Resources Policy Research* 2, 245–262.
- Aghion, P., Dechezleprêtre, A., Hémous, D., Martin, R., Van Reenen, J., (2012). Carbon Taxes, Path Dependency and Directed Technical Change: Evidence from the Auto Industry. INSEAD Working Papers Collection 1–74.
- Aoki, R., (1991). R&D competition for product innovation: An endless race. *The American Economic Review* 81, 252–256.
- Arrow, K., (1962). Economic welfare and the allocation of resources for invention, in: *The Rate and Direction of Inventive Activity: Economic and Social Factors*. Princeton University Press, pp. 609–626.
- Baldwin, W.L., Childs, G.L., (1969). The Fast Second and Rivalry in Research and Development. *Southern Economic Journal* 36, 18. <https://doi.org/10.2307/1056804>
- Bassecoulard, E., Zitt, M., (2004). Patents and publications, in: *Handbook of Quantitative Science and Technology Research*. Springer, pp. 665–694.
- Battke, B., Schmidt, T.S., Stollenwerk, S., Hoffmann, V.H., (2016). Internal or external spillovers—Which kind of knowledge is more likely to flow within or across technologies. *Research Policy* 45, 27–41. <https://doi.org/10.1016/j.respol.2015.06.014>
- Baye, M.R., Hoppe, H.C., (2003). The strategic equivalence of rent-seeking, innovation, and patent-race games. *Games and Economic Behavior* 44, 217–226. [https://doi.org/10.1016/S0899-8256\(03\)00027-7](https://doi.org/10.1016/S0899-8256(03)00027-7)
- Boehringer, C., Cuntz, A.N., Harhoff, D., and Asane-Otoo, E. (2014). *The Impacts of Feed-In Tariffs on Innovation: Empirical Evidence from Germany* (Rochester, NY: Social Science Research Network).
- Bolkesjø, T.F., Eltvig, P.T., and Nygaard, E. (2014). An Econometric Analysis of Support Scheme Effects on Renewable Energy Investments in Europe. *Energy Procedia* 58, 2–8.
- Bonaccorsi, A., Thoma, G., (2007). Institutional complementarity and inventive performance in nano science and technology. *Research Policy* 36, 813–831.
- Bourgeois, G., Mathy, S., Menanteau, P., (2017). L’effet des politiques climatiques sur les énergies renouvelables : une revue des études économétriques. *Innovations* 54, 15. <https://doi.org/10.3917/inno.054.0015>
- Bowen, E., and Lacombe, D.J. (2015). Spatial interaction of renewable portfolio standards and their effect on renewable generation within NERC regions (Morgantown, W Va. : West Virginia Univ., Dep. of Economics).
- Braun, F.G., Schmidt-Ehmcke, J., and Zloczysti, P. (2010). Innovative Activity in Wind and Solar Technology: Empirical Evidence on Knowledge Spillovers Using Patent Data. *SSRN Electronic Journal*.
- Breitung, J., (2005). A parametric approach to the estimation of cointegration vectors in panel data. *Econometric Reviews* 24, 151–173.



- Breschi, S., Catalini, C., (2010). Tracing the links between science and technology: An exploratory analysis of scientists' and inventors' networks. *Research Policy* 39, 14–26. <https://doi.org/10.1016/j.respol.2009.11.004>
- Bürer, M.J., and Wüstenhagen, R. (2009). Which renewable energy policy is a venture capitalist's best friend? Empirical evidence from a survey of international cleantech investors. *Energy Policy* 37, 4997–5006.
- Bush, V., (1945). *Science the endless frontier: a report to the President by Vannevar Bush*. Director of the Office of Scientific Research and Development, United States Government Printing Office, Washington.
- Butler, L., and Neuhoff, K. (2008). Comparison of feed-in tariff, quota and auction mechanisms to support wind power development. *Renewable Energy* 33, 1854–1867.
- Canton, J., and Lindén, Å. (2010). *Support schemes for renewable electricity in the EU* (Brussels: European Commission, Directorate-General for Economic and Financial Affairs).
- Carley, S. (2009). State renewable energy electricity policies: An empirical evaluation of effectiveness. *Energy Policy* 37, 3071–3081.
- Carley, S., Baldwin, E., MacLean, L.M., and Brass, J.N. (2016). *Global Expansion of Renewable Energy Generation: An Analysis of Policy Instruments*. *Environmental and Resource Economics*.
- Carnabuci, G., Bruggeman, J., (2009). Knowledge specialization, knowledge brokerage and the uneven growth of technology domains. *Social forces* 88, 607–641.
- Chang, T., Chu, H.-P., Deale, F.W., Gupta, R., (2015). The Causal Relationship Between Happiness and Smoking: A Bootstrap Panel Causality Test. *Journal of Happiness Studies* 17, 1327–1336. <https://doi.org/10.1007/s10902-015-9645-5>
- Chen, M.Y., Perng, Y.S., (2017). Application of the bootstrap panel method an empirical study of the granger causality between carbon dioxide emissions and economic growth in emerging countries. *BULGARIAN CHEMICAL COMMUNICATIONS* 49, 42–46.
- Choe, H., Lee, D.H., Kim, H.D., Seo, I.W., (2016). Structural properties and inter-organizational knowledge flows of patent citation network: The case of organic solar cells. *Renewable and Sustainable Energy Reviews* 55, 361–370. <https://doi.org/10.1016/j.rser.2015.10.150>
- Choi, H., and Anadón, L.D. (2014). The role of the complementary sector and its relationship with network formation and government policies in emerging sectors: The case of solar photovoltaics between 2001 and 2009. *Technological Forecasting and Social Change* 82, 80–94.
- CNEPI, (2016). *Quinze ans de politiques d'innovations en France*.
- Cohen, W.M., Levinthal, D.A., (1990). Chapter 3–Absorptive Capacity: A New Perspective on Learning and Innovation. *Strategic Learning in A Knowledge Economy* 35, 128–152.
- Criqui, P., Kitous, A., (2012). 2010-2020: a decisive decade for our climate.
- Criqui, P., Martin, J.-M., Schratzenholzer, L., Kram, T., Soete, L., and Zon, A. (2000). Energy technology dynamics. *International Journal of Global Energy Issues* 14, 65–103.
- Dalmazzone, S., and Corsatea, T.D. (2012). *A Regional Analysis of Renewable Energy Patenting in Italy*. *SSRN Electronic Journal*.
- Davies, A., (1997). The life cycle of a complex product system. *International Journal of Innovation Management* 1, 229–256.

- Dechezleprêtre, A., and Glachant, M. (2014). Does foreign environmental policy influence domestic innovation? Evidence from the wind industry. *Environmental and Resource Economics* 58, 391–413.
- Dechezleprêtre, A., Bassi, S., and Martin, R. (2016). *Climate Change Policy, Innovation and Growth*.
- Dechezleprêtre, A., Bassi, S., Martin, R., (2016). *Climate Change Policy, Innovation and Growth Green Growth Knowledge Platform*.
- Dechezleprêtre, A., Glachant, M., Ménière, Y., (2013). What Drives the International Transfer of Climate Change Mitigation Technologies? Empirical Evidence from Patent Data. *Environmental and Resource Economics* 54, 161–178. <https://doi.org/10.1007/s10640-012-9592-0>
- Dechezleprêtre, A., Martin, R., Mohnen, M., (2014). Knowledge spillovers from clean and dirty technologies.
- del Río, P., and Bleda, M. (2012). Comparing the innovation effects of support schemes for renewable electricity technologies: A function of innovation approach. *Energy Policy* 50, 272–282.
- del Río, P., and Gual, M.A. (2007). An integrated assessment of the feed-in tariff system in Spain. *Energy Policy* 35, 994–1012.
- del Río, P., and Tarancón, M.-Á. (2012). Analysing the determinants of on-shore wind capacity additions in the EU: An econometric study. *Applied Energy* 95, 12–21.
- Delmas, M.A., and Montes-Sancho, M.J. (2011). U.S. state policies for renewable energy: Context and effectiveness. *Energy Policy* 39, 2273–2288.
- Dijkgraaf, E., van Dorp, T., and Maasland, E. (2014). On the Effectiveness of Feed-In Tariffs in the Development of Photovoltaic Solar. *SSRN Electronic Journal*.
- Dinica, V. (2006). Support systems for the diffusion of renewable energy technologies—an investor perspective. *Energy Policy* 34, 461–480.
- Dong, C.G. (2012). Feed-in tariff vs. renewable portfolio standard: An empirical test of their relative effectiveness in promoting wind capacity development. *Energy Policy* 42, 476–485.
- Dosi, G., (1982). Technological paradigms and technological trajectories. *Research Policy* 11, 147–162. [https://doi.org/10.1016/0048-7333\(82\)90016-6](https://doi.org/10.1016/0048-7333(82)90016-6)
- Dosi, G., (1988). The Nature of the Innovative Process, in: Dosi, G., Freeman, C., Nelson, R.R., Silverberg, G., Soete, L. (Eds.), *Technical Change and Economic Theory*.
- Duguet, E., MacGarvie, M., (2005). How well do patent citations measure flows of technology? Evidence from French innovation surveys. *Economics of Innovation and New Technology* 14, 375–393. <https://doi.org/10.1080/1043859042000307347>
- Dutra, R.M., and Szklo, A.S. (2008). Incentive policies for promoting wind power production in Brazil: Scenarios for the Alternative Energy Sources Incentive Program (PROINFA) under the New Brazilian electric power sector regulation. *Renewable Energy* 33, 65–76.
- EC (2008). European Commission Staff Working Document “The support of electricity from renewable energy sources”, accompanying document to the proposal for a directive of the European Parliament and the Council on the promotion of the use of energy from renewable sources.
- Emodi, N.V., Shagdarsuren, G., and Tiky, A.Y. (2015). Influencing Factors Promoting Technological Innovation in Renewable Energy. *International Journal of Energy Economics and Policy* 5, 889–900.
- Fay, M., Hallegatte, S., Vogt-Schilb, A., Rozenberg, J., Narloch, U., Kerr, T., 2015. Decarbonizing development: Three steps to a zero-carbon future. *The World Bank*.

- Fischer, C., Newell, R.G., and Preonas, L. (2014). Environmental and Technology Policy Options in the Electricity Sector: Interactions and Outcomes. SSRN Electronic Journal.
- Fischer, C., Parry, I.W., Pizer, W.A., (2003). Instrument choice for environmental protection when technological innovation is endogenous. *Journal of environmental economics and management* 45, 523–545.
- Fleming, L., Sorenson, O., (2001). Technology as a complex adaptive system: evidence from patent data. *Research Policy* 30, 1019–1039. [https://doi.org/10.1016/S0048-7333\(00\)00135-9](https://doi.org/10.1016/S0048-7333(00)00135-9)
- Fouquet, D., and Johansson, T.B. (2008). European renewable energy policy at crossroads—Focus on electricity support mechanisms. *Energy Policy* 36, 4079–4092.
- Frietsch, R., Schmoch, U., (2006). Technological structures and performance as reflected by patent indicators, in: *National Systems of Innovation in Comparison*. Springer, pp. 89–105.
- Gavard, C. (2016). Carbon price and wind power support in Denmark. *Energy Policy* 92, 455–467.
- Geroski, P., (1995). Markets for technology: knowledge, innovation and appropriability. *Handbook of the economics innovation and technological change*.
- GIEC, 2015. Climate Change (2014): Synthesis Report. Contribution of Working Groups I, II and III to the Fifth Assessment Report of the Intergovernmental Panel on Climate Change. IPCC, Geneva, Switzerland.
- Gilfillan, S., (1935). Social Principles of Invention-Part VIII. *J. Pat. Off. Soc’y* 17, 216.
- Grafström, J., and Lindman, Å. (2017). Invention, innovation and diffusion in the European wind power sector. *Technological Forecasting and Social Change* 114, 179–191.
- Griliches, Z., (1990). Patent statistics as economic indicators: a survey. National Bureau of Economic Research.
- Grossman, G., Helpman, E., (1992). *Innovation and growth in the global economy*/MIT Press. Cambridge (MA); London (UK).
- Grubb, M., (2004). Technology innovation and climate change policy: an overview of issues and options. *Keio economic studies* 41, 103–132.
- Grübler, A., Nakićenović, N., and Victor, D.G. (1999). Dynamics of energy technologies and global change. *Energy Policy* 27, 247–280.
- Guivarch, C., Monjon, S., (2017). Identifying the main uncertainty drivers of energy security in a low-carbon world: The case of Europe. *Energy economics* 64, 530–541.
- Haas, R., Resch, G., Panzer, C., Busch, S., Ragwitz, M., and Held, A. (2011). Efficiency and effectiveness of promotion systems for electricity generation from renewable energy sources—Lessons from EU countries. *Energy* 36, 2186–2193.
- Hajdukiewicz, A., Pera, B., (2020). International Trade Disputes over Renewable Energy—the Case of the Solar Photovoltaic Sector. *Energies* 13, 500. <https://doi.org/10.3390/en13020500>
- Hicks, J.R., (1932). The Theory of Wages. *The Economic Journal* 43, 460. <https://doi.org/10.2307/2224288>
- Hitaj, C. (2013). Wind power development in the United States. *Journal of Environmental Economics and Management* 65, 394–410.
- Hitaj, C., Schymura, M., and LLSchel, A. (2014). The Impact of a Feed-In Tariff on Wind Power Development in Germany. SSRN Electronic Journal.

- Huenteler, J., Ossenbrink, J., Schmidt, T.S., Hoffmann, V.H., (2016). How a product's design hierarchy shapes the evolution of technological knowledge—Evidence from patent-citation networks in wind power. *Research Policy* 45, 1195–1217. <https://doi.org/10.1016/j.respol.2016.03.014>
- Hvelplund, F.K. (2001). Political prices or political quantities?: A comparison of renewable energy support systems.
- IPCC (2012). Renewable energy sources and climate change mitigation: summary for policymakers and technical summary : special report of the intergovernmental panel on climate change. (New York?): [Cambridge University Press?].
- IPCC (2014). Climate change 2014: synthesis report. Contribution of Working Groups I, II and III to the fifth assessment report of the Intergovernmental Panel on Climate Change. IPCC.
- IRENA, I., (2020). Renewable power generation costs in 2019. Report. International Renewable Energy Agency, Abu Dhabi.
- Jacobs, J., (1969). The economy of cities, Vintage books. Vintage Books, New York.
- Jaffe, A.B., Newell, R.G., Stavins, R.N., (2005). A tale of two market failures: Technology and environmental policy. *Ecological economics* 54, 164–174.
- Jaffe, A.B., Trajtenberg, M., and Henderson, R. (1993). Geographic Localization of Knowledge Spillovers as Evidenced by Patent Citations. *The Quarterly Journal of Economics* 108, 577–598.
- Jamasb, T. (2007). Technical change theory and learning curves: patterns of progress in electricity generation technologies. *The Energy Journal* 51–71.
- Jenner, S., Groba, F., and Indvik, J. (2013). Assessing the strength and effectiveness of renewable electricity feed-in tariffs in European Union countries. *Energy Policy* 52, 385–401.
- Johnstone, N., Haščič, I., and Popp, D. (2010). Renewable Energy Policies and Technological Innovation: Evidence Based on Patent Counts. *Environmental and Resource Economics* 45, 133–155.
- Kahouli-Brahmi, S. (2008). Technological learning in energy–environment–economy modelling: A survey. *Energy Policy* 36, 138–162.
- Kamien, M.I., Muller, E., Zang, I., (1992). Research joint ventures and R&D cartels. *The American Economic Review* 1293–1306.
- Kapoor, R., Karvonen, M., Ranaei, S., Kässi, T., 2015. Patent portfolios of European wind industry: New insights using citation categories. *World Patent Information* 41, 4–10.
- Karvonen, M., Kässi, T., (2013). Patent citations as a tool for analysing the early stages of convergence. *Technological Forecasting and Social Change* 80, 1094–1107. <https://doi.org/10.1016/j.techfore.2012.05.006>
- Kavlak, G., McNERNEY, J., Trancik, J.E., (2018). Evaluating the causes of cost reduction in photovoltaic modules. *Energy Policy* 123, 700–710. <https://doi.org/10.1016/j.enpol.2018.08.015>
- Kilinc-Ata, N. (2016). The evaluation of renewable energy policies across EU countries and US states: An econometric approach. *Energy for Sustainable Development* 31, 83–90.
- Kim, K., and Kim, Y. (2015). Role of policy in innovation and international trade of renewable energy technology: Empirical study of solar PV and wind power technology. *Renewable and Sustainable Energy Reviews* 44, 717–727.
- Kim, K., Heo, E., and Kim, Y. (2017). Dynamic Policy Impacts on a Technological-Change System of Renewable Energy: An Empirical Analysis. *Environmental and Resource Economics* 66, 205–236.

- Klessmann, C., Held, A., Rathmann, M., and Ragwitz, M. (2011). Status and perspectives of renewable energy policy and deployment in the European Union—What is needed to reach the 2020 targets? *Energy Policy* 39, 7637–7657.
- Kouvaritakis, N., Soria, A., and Isoard, S. (2000). Modelling energy technology dynamics: methodology for adaptive expectations models with learning by doing and learning by searching. *International Journal of Global Energy Issues* 14, 104–115.
- Krafft, J., Quatraro, F., Saviotti, P.P., (2011). The knowledge-base evolution in biotechnology: a social network analysis. *Economics of Innovation and New Technology* 20, 445–475.
- Krasko, V.A., and Doris, E. (2013). State distributed PV policies: Can low cost (to government) policies have a market impact? *Energy Policy* 59, 172–181.
- Kruse, J., and Wetzel, H. (2014). Energy prices, technological knowledge and green energy innovation: A dynamic panel analysis of patent counts.
- Kulve, H. te, Smit, W.A., (2003). Civilian–military co-operation strategies in developing new technologies. *Research Policy* 32, 955–970. [https://doi.org/10.1016/S0048-7333\(02\)00105-1](https://doi.org/10.1016/S0048-7333(02)00105-1)
- Lallement, R., (2011). L'aide publique aux entreprises en matière de RD et d'innovation: quelle efficacité. Document de travail du Centre d'analyse Stratégique 1983–2011.
- Lanzi, E., Hašič, I., and Johnstone, N. (2012). The determinants of innovation in electricity generation technologies: A patent data analysis. In OECD, *Energy and Climate Policy: Bending the Technological Trajectory*
- Laursen, K., (2015). Revealed comparative advantage and the alternatives as measures of international specialization. *Eurasian Business Review* 5, 99–115. <https://doi.org/10.1007/s40821-015-0017-1>
- Lewis, J., and Wiser, R. (2005). Fostering a renewable energy technology industry: An international comparison of wind industry policy support mechanisms. Lawrence Berkeley National Laboratory.
- Leydesdorff, L., (2004). The university–industry knowledge relationship: Analyzing patents and the science base of technologies. *Journal of the American Society for Information Science and Technology* 55, 991–1001.
- Li, S.-J., Chang, T.-H., and Chang, S.-L. (2017). The policy effectiveness of economic instruments for the photovoltaic and wind power development in the European Union. *Renewable Energy* 101, 660–666.
- Liang, J., and Fiorino, D.J. (2013). The Implications of Policy Stability for Renewable Energy Innovation in the United States, 1974-2009: Implications of Policy Stability. *Policy Studies Journal* 41, 97–118.
- Lindman, Å., and Söderholm, P. (2016). Wind energy and green economy in Europe: Measuring policy-induced innovation using patent data. *Applied Energy* 179, 1351–1359.
- Lipp, J. (2007). Lessons for effective renewable electricity policy from Denmark, Germany and the United Kingdom. *Energy Policy* 35, 5481–5495.
- Luo, S., Lovely, M.E., Popp, D., (2017). Intellectual returnees as drivers of indigenous innovation: Evidence from the Chinese photovoltaic industry. *The World Economy*. <https://doi.org/10.1111/twec.12536>
- Lüthi, S., and Wüstenhagen, R. (2012). The price of policy risk—Empirical insights from choice experiments with European photovoltaic project developers. *Energy Economics* 34, 1001–1011.

- Markard, J., (2011). Transformation of infrastructures: sector characteristics and implications for fundamental change. *Journal of Infrastructure Systems* 17, 107–117.
- Marshall, A., (1890). *Principles of political economy*. Maxmillan, New York.
- Masini, A., and Menichetti, E. (2012). The impact of behavioural factors in the renewable energy investment decision making process: Conceptual framework and empirical findings. *Energy Policy* 40, 28–38.
- Meadows, D.H., Meadows, D.L., Randers, J., Behrens, W.W., (1972). *The limits to growth*. New York 102, 27.
- Menanteau, P., Finon, D., and Lamy, M.-L. (2003). Prices versus quantities: choosing policies for promoting the development of renewable energy. *Energy Policy* 31, 799–812.
- Menz, F.C., and Vachon, S. (2006). The effectiveness of different policy regimes for promoting wind power: Experiences from the states. *Energy Policy* 34, 1786–1796.
- Meyer, M., (2006a). Are patenting scientists the better scholars?: An exploratory comparison of inventor-authors with their non-inventing peers in nano-science and technology. *Research Policy* 35, 1646–1662.
- Meyer, M., (2006b). Knowledge integrators or weak links? An exploratory comparison of patenting researchers with their non-inventing peers in nano-science and technology. *Scientometrics* 68, 545–560.
- Michel, J., Bettels, B., (2001). Patent citation analysis. A closer look at the basic input data from patent search reports. *Scientometrics* 51, 185–201.
- Mina, A., Ramlogan, R., Tampubolon, G., Metcalfe, J.S., (2007). Mapping evolutionary trajectories: Applications to the growth and transformation of medical knowledge. *Research policy* 36, 789–806.
- Mitchell, C., Bauknecht, D., and Connor, P.M. (2006). Effectiveness through risk reduction: a comparison of the renewable obligation in England and Wales and the feed-in system in Germany. *Energy Policy* 34, 297–305.
- Montecchi, T., Russo, D., Liu, Y., (2013). Searching in Cooperative Patent Classification: Comparison between keyword and concept-based search. *Advanced Engineering Informatics* 27, 335–345. <https://doi.org/10.1016/j.aei.2013.02.002>
- Neij, L. (2008). Cost development of future technologies for power generation—A study based on experience curves and complementary bottom-up assessments. *Energy Policy* 36, 2200–2211.
- Nemet, G.F., (2012). Inter-technology knowledge spillovers for energy technologies. *Energy Economics* 34, 1259–1270. <https://doi.org/10.1016/j.eneco.2012.06.002>
- Nemet, G.F., (2012). Subsidies for New Technologies and Knowledge Spillovers from Learning by Doing: Subsidies and Learning by Doing. *Journal of Policy Analysis and Management* 31, 601–622. <https://doi.org/10.1002/pam.21643>
- Nemet, G.F., Johnson, E., (2012). Do important inventions benefit from knowledge originating in other technological domains? *Research Policy* 41, 190–200. <https://doi.org/10.1016/j.respol.2011.08.009>
- Nesta, L., Vona, F., and Nicolli, F. (2014). Environmental policies, competition and innovation in renewable energy. *Journal of Environmental Economics and Management* 67, 396–411.
- Newman, M.E.J., (2010). *Networks: an introduction*. Oxford University Press, Oxford ; New York.
- Nicolini, M., and Tavoni, M. (2017). Are renewable energy subsidies effective? Evidence from Europe. *Renewable and Sustainable Energy Reviews* 74, 412–423.

- Nicolli, F., and Vona, F. (2016). Heterogeneous policies, heterogeneous technologies: The case of renewable energy. *Energy Economics* 56, 190–204.
- Noailly, J., Shestalova, V., (2017). Knowledge spillovers from renewable energy technologies: Lessons from patent citations. *Environmental Innovation and Societal Transitions* 22, 1–14. <https://doi.org/10.1016/j.eist.2016.07.004>
- OECD (2010). *Measuring Innovation*. OECD Publishing. <https://doi.org/10.1787/9789264059474-en>
- Pavitt, K., (1999). *Technology, management and systems of innovation*. Edward Elgar Publishing.
- Percebois, J., (2014). Les mécanismes de soutien aux énergies renouvelables, leurs forces et leurs faiblesses respectives. *Cahier de recherche n 14*, 107.
- Peters, M., Schneider, M., Griesshaber, T., and Hoffmann, V.H. (2012). The impact of technology-push and demand-pull policies on technical change – Does the locus of policies matter? *Research Policy* 41, 1296–1308.
- Pigou, A., (1920). *The economics of welfare*. The economics of welfare.
- Polzin, F., Migendt, M., Täube, F.A., and von Flotow, P. (2015). Public policy influence on renewable energy investments—A panel data study across OECD countries. *Energy Policy* 80, 98–111.
- Popp, D., Hascic, I., and Medhi, N. (2011). Technology and the diffusion of renewable energy. *Energy Economics* 33, 648–662.
- Popp, D., Newell, R., (2012). Where does energy R&D come from? Examining crowding out from energy R&D. *Energy Economics* 34, 980–991. <https://doi.org/10.1016/j.eneco.2011.07.001>
- Porter, M.E., (1990). The competitive advantage of nations. *Harvard business review* 68, 73–93.
- Porter, M.E., Van der Linde, C., (1995). Toward a new conception of the environment-competitiveness relationship. *Journal of economic perspectives* 9, 97–118.
- Ragwitz, M., Held, A., Resch, G., Faber, T., Haas, R., Huber, C., Coenraads, R., Voogt, M., Reece, G., and Morthorst, P.E. (2007). Assessment and optimisation of renewable energy support schemes in the European electricity market.
- Ram, M., Aghahosseini, A., Breyer, C., (2020). Job creation during the global energy transition towards 100% renewable power system by 2050. *Technological Forecasting and Social Change* 151, 119682.
- Resch, G., Faber, M., Grenna Jensen, S., Haas, R., Held, A., Huber, C., Jaworski, L., Konstantinaviciute, I., Morthorst, P., and Panzer, C. (2009). *future-e-Deriving a future European Policy for Renewable Electricity; Final report of the research project future-e, with support from the European Commission*,
- Rexhäuser, S., and Löschel, A. (2015). Invention in energy technologies: Comparing energy efficiency and renewable energy inventions at the firm level. *Energy Policy* 83, 206–217.
- Romano, A.A., Scandurra, G., Carfora, A., and Fodor, M. (2017). Renewable investments: The impact of green policies in developing and developed countries. *Renewable and Sustainable Energy Reviews* 68, 738–747.
- Romer, P.M., (1986). Increasing returns and long-run growth. *Journal of political economy* 94, 1002–1037.
- Rosenberg, N., (1982). *Inside the black box: technology and economics*. Cambridge University Press, Cambridge [Cambridgeshire] ; New York.

- Rübbelke, D.T.G., and Weiss, P. (2011). Environmental Regulations, Market Structure and Technological Progress in Renewable Energy Technology - A Panel Data Study on Wind Turbines. SSRN Electronic Journal.
- Sagar, A.D., and van der Zwaan, B. (2006). Technological innovation in the energy sector: R&D, deployment, and learning-by-doing. *Energy Policy* 34, 2601–2608.
- Samadi, S., (2017). The Social Costs of Electricity Generation—Categorising Different Types of Costs and Evaluating Their Respective Relevance. *Energies* 10, 356. <https://doi.org/10.3390/en10030356>
- Sarzynski, A., Larrieu, J., and Shrimali, G. (2012). The impact of state financial incentives on market deployment of solar technology. *Energy Policy* 46, 550–557.
- Sawin, J. (2006). National policy instruments: Policy lessons for the advancement & diffusion of renewable energy technologies around the world. *Renewable Energy. A Global Review of Technologies, Policies and Markets*.
- Sawin, J.L. (2001). The role of government in the development and diffusion of renewable energy technologies: Wind power in the United States, California, Denmark and Germany, 1970--2000.
- Schilling, M.A., Green, E., (2011). Recombinant search and breakthrough idea generation: An analysis of high impact papers in the social sciences. *Research Policy* 40, 1321–1331. <https://doi.org/10.1016/j.respol.2011.06.009>
- Schmid, G. (2012). The development of renewable energy power in India: Which policies have been effective? *Energy Policy* 45, 317–326.
- Schmookler, J., (1962). Economic sources of inventive activity. *The Journal of Economic History* 22, 1–20.
- Schmookler, J., (1966). *Invention and Economic Growth*. Harvard University Press, Cambridge.
- Schoenmakers, W., Duysters, G., (2010). The technological origins of radical inventions. *Research Policy* 39, 1051–1059. <https://doi.org/10.1016/j.respol.2010.05.013>
- Şen, H., Kaya, A., Alpaslan, B., (2018). Education, Health, and Economic Growth Nexus: A Bootstrap Panel Granger Causality Analysis for Developing Countries. *Sosyoekonomi* 26.
- Shrimali, G., and Jenner, S. (2013). The impact of state policy on deployment and cost of solar photovoltaic technology in the U.S.: A sector-specific empirical analysis. *Renewable Energy* 60, 679–690.
- Shrimali, G., and Kniefel, J. (2011). Are government policies effective in promoting deployment of renewable electricity resources? *Energy Policy* 39, 4726–4741.
- Shrimali, G., Chan, G., Jenner, S., Groba, F., and Indvik, J. (2015). Evaluating Renewable Portfolio Standards for In-State Renewable Deployment: Accounting for Policy Heterogeneity. *Economics of Energy & Environmental Policy* 4.
- Shrimali, G., Jenner, S., Groba, F., Chan, G., and Indvik, J. (2012). Have State Renewable Portfolio Standards Really Worked? Synthesizing Past Policy Assessments to Build an Integrated Econometric Analysis of RPS effectiveness in the U.S. SSRN Electronic Journal.
- Smith, M.G., and Urpelainen, J. (2014). The Effect of Feed-in Tariffs on Renewable Electricity Generation: An Instrumental Variables Approach. *Environmental and Resource Economics* 57, 367–392.
- Söderholm, P., and Klaassen, G. (2007). Wind power in Europe: a simultaneous innovation–diffusion model. *Environmental and Resource Economics* 36, 163–190.



- Stern, N.H. (2007). *The economics of climate change: the Stern review* (Cambridge University Press).
- Turner, G.M., (2008). A comparison of *The Limits to Growth* with 30 years of reality. *Global environmental change* 18, 397–411.
- Usher, A.P., (1954). *A history of mechanical inventions: revised edition*. Courier Corporation.
- Utterback, J.M., Abernathy, W.J., (1975). A dynamic model of process and product innovation. *Omega* 3, 639–656.
- van den Bergh, J.C.J.M., (2008). Optimal diversity: Increasing returns versus recombinant innovation. *Journal of Economic Behavior & Organization* 68, 565–580. <https://doi.org/10.1016/j.jebo.2008.09.003>
- Van der Linden, N.H., Uytterlinde, M., Vrolijk, C., Ericsson, K., Khan, J., Nilsson, L., Astrand, K., and Wisser, R. (2005). Review of international experience with renewable energy obligation support mechanisms (Energy research Centre of the Netherlands ECN).
- Varian, H.R., Varian, H.R., (1992). *Microeconomic analysis*. Norton New York.
- Verbruggen, A., and Lauber, V. (2012). Assessing the performance of renewable electricity support instruments. *Energy Policy* 45, 635–644.
- Verspagen, B., (2007). Mapping technological trajectories as patent citation networks: A study on the history of fuel cell research. *Advances in Complex Systems* 10, 93–115.
- Vincenzi, M., and Ozabaci, D. (2017). The Effect of Public Policies on Inducing Technological Change in Solar Energy. *Agricultural and Resource Economics Review* 46, 44–72.
- Walz, R., Schleich, J., and Ragwitz, M. (2011). Regulation, Innovation and Wind Power Technologies: An Empirical Analysis for OECD Countries. In DIME Final Conference, p. 8.
- Weitzman, M.L. (1974). Prices vs. quantities. *The Review of Economic Studies* 41, 477–491.
- Weitzman, M.L., (1998). Recombinant Growth. *The Quarterly Journal of Economics* 113, 331–360. <https://doi.org/10.1162/003355398555595>
- Wiesenthal, T., Leduc, G., Haegeman, K., Schwarz, H.-G., (2012). Bottom-up estimation of industrial and public R&D investment by technology in support of policy-making: The case of selected low-carbon energy technologies. *Research Policy* 41, 116–131.
- Williams, J.H., DeBenedictis, A., Ghanadan, R., Mahone, A., Moore, J., Morrow, W.R., Price, S., Torn, M.S., (2012). The technology path to deep greenhouse gas emissions cuts by 2050: the pivotal role of electricity. *science* 335, 53–59.
- Wisser, R., Barbose, G., and Holt, E. (2011). Supporting solar power in renewables portfolio standards: Experience from the United States. *Energy Policy* 39, 3894–3905.
- World Energy Council, 2016. *World Energy Scenarios 2016 - The Grand Transition*.
- Yin, H., and Powers, N. (2010). Do state renewable portfolio standards promote in-state renewable generation?. *Energy Policy* 38, 1140–1149.
- Zachmann, G., Serwaah-Panin, A., and Peruzzi, M. (2015). When and How to Support Renewables?—Letting the Data Speak. In *Green Energy and Efficiency*
- Zachmann, G., Serwaah-Panin, A., Peruzzi, M., (2014). When and How to Support Renewables?—Letting the Data Speak, in: Ansuategi, A., Delgado, J., Galarraga, I. (Eds.), *Green Energy and Efficiency*. Springer International Publishing, Cham, pp. 291–332. [https://doi.org/10.1007/978-3-319-03632-8\\_12](https://doi.org/10.1007/978-3-319-03632-8_12)

Zhang, F. (2013). How Fit are Feed-in Tariff Policies? Evidence from the European Wind Market (The World Bank).

Zhao, Y., Tang, K.K., and Wang, L. (2013). Do renewable electricity policies promote renewable electricity generation? Evidence from panel data. *Energy Policy* 62, 887–897.

# Annexes

## Annexes du chapitre 2

### A-1: Not structuring spillovers: should not bias our analysis

Our network approach is based on the co-occurrence of CPC codes among the spillovers. Nevertheless, some spillovers do not influence the technological structure of knowledge spillovers as they do not contain several distinct technological codes (at the 3-digits level). The figure below reports the share of such “not structuring spillovers” over all the spillovers. It stands out that more spillovers are concerned for solar PV backward than for wind backward spillovers. Nevertheless, the percentage does not seem so high, particularly for the last periods.

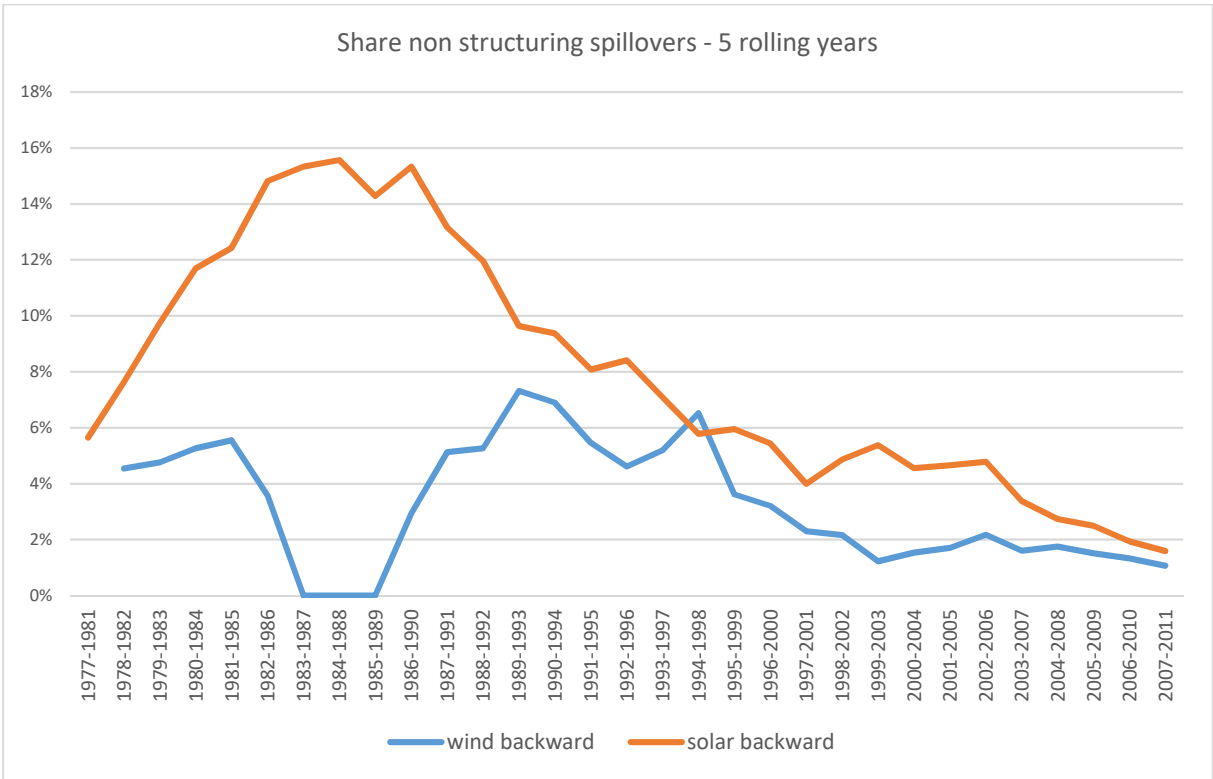

If such unobserved spillovers are too numerous, it could bias our network analysis. After computing the share of such “non-structuring” spillovers it stands out that more spillovers are concerned for solar PV backward than for wind backward spillovers. Nevertheless, the percentage does not seem so high, particularly for the last periods.

## A-2: Details about the methodology for the network centrality analysis

For our co-occurrence networks, we have to be careful with the fact that the number of distinct CPC codes is different between spillovers. Moreover, the mean number of distinct CPC codes within spillovers tend to increase steadily along the years (figure below).

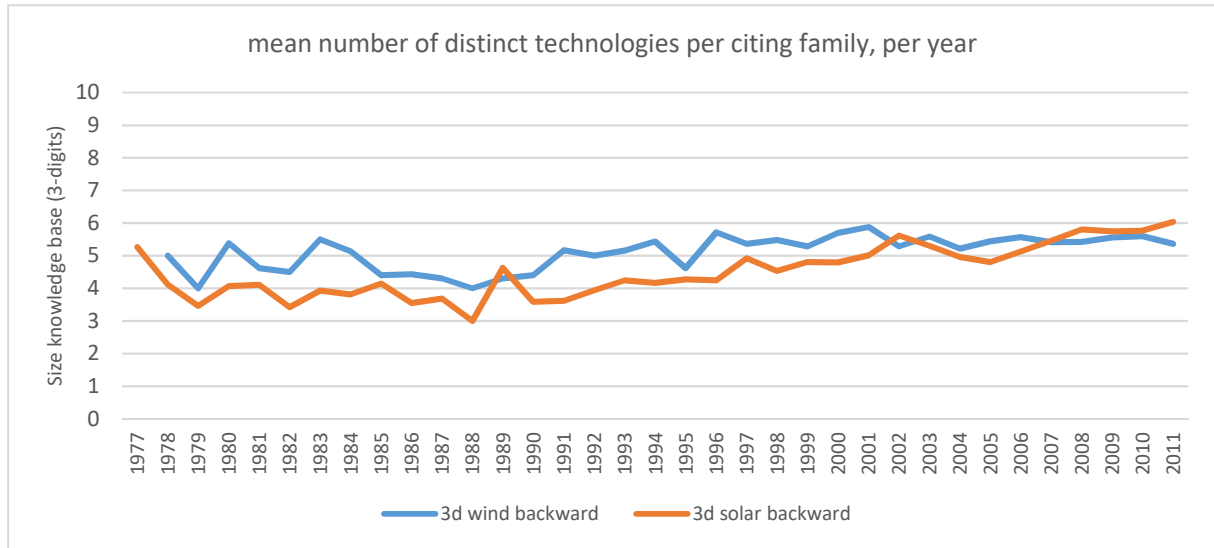

To avoid this potential bias induced by generic technologies, i.e. technologies used in many other sectors, we apply the so-called “Jaccard coefficient” to the weight of each link:

$$v_{ij} = \frac{a}{a + b + c}$$

Where  $a$  is the number of spillovers with both technologies  $i$  and  $j$ ,  $b$  is the total number of spillovers with technology  $i$  but without  $j$ , and  $c$  is the number of spillovers with technology  $j$  but without  $i$ . This weight captures the strength of the interaction between two technologies. It ranges from 0 ( $i$  and  $j$  never appear in the same spillover) to 1 ( $i$  and  $j$  appear in spillovers only together) (Yayavaram and Ahuja, 2008).

After applying the Jaccard coefficient to the initial weight of the links, we compute the degree and betweenness centrality indicators to the nodes of all the networks.

Finally, to retain the most important technologies we use the following procedure:

- First, we compute the betweenness centrality value (shorten as Betw.) for all the nodes (n nodes), for all the networks, (we consider only 3 periods for our example: P<sub>1</sub>, P<sub>2</sub>, P<sub>3</sub>).

Technological field (cpc code)	Degree value P <sub>1</sub> [1978-1982]	Degree value P <sub>2</sub> [1979-1983]	Degree value P <sub>3</sub> [1980-1984]
CPC <sub>1</sub>	Betw <sub>1,P1</sub>	Betw <sub>1,P2</sub>	Betw <sub>1,P3</sub>
CPC <sub>2</sub>	Betw <sub>2,P1</sub>	Betw <sub>2,P2</sub>	Betw <sub>2,P3</sub>
...	...	...	...
CPC <sub>n</sub>	Betw <sub>n,P1</sub>	Betw <sub>n,P2</sub>	Betw <sub>n,P3</sub>

Given that we calculate this measure repeatedly over different periods, with a varying number of nodes and edges, we normalized the betweenness and degree value of the nodes:

$$normalized_{betw} = \frac{betw(e_k) - \min[betw(e)]}{\max[betw(e)] - \min[betw(e)]}, k = a \text{ specific node}$$

(same for the normalized degree)

Where  $\min[betw(e)]$  and  $\max[betw(e)]$  are, respectively, the minimum and maximum values of edge betweenness in the network. Thus, the normalized value of edge betweenness ranges from 0, when  $betw(e_k)$  is equal to its minimum observed value, to 1, when  $betw(e_k)$  is equal to its maximum observed value.

- Then, for each periods, we compute the value of the 90% percentile of the betweenness centrality.

Betw. value P <sub>1</sub>	Betw. value P <sub>2</sub>	Betw. value P <sub>3</sub>
1978-1982	1979-1983	1980-1984
Betw.percentile.90 <sub>p1</sub>	Betw.percentile.90 <sub>p2</sub>	Betw.percentile.90 <sub>p3</sub>

- Then, we calculate the mean of all these percentile:

$$\text{Mean}(\text{Betw.percentile.90}_{p1}, \text{Betw.percentile.90}_{p2}, \text{Betw.percentile.90}_{p3})$$

This mean value of the percentile 90% gives a threshold above which we consider a technology as 'key'.

Finally, we retain all the technologies with a betweenness value above this threshold for at least one period.

### A-3: Procedure to draw the graph for analysing the evolution of the innovation efforts in wind and solar PV patents

First, we keep the distinct CPC codes of each wind and solar PV patent family. Then, we filter this sub sample to keep only “Y\* codes” corresponding to wind or solar PV knowledge (respectively codes starting by Y02E 10/7\* and Y02E 10/5\*). Finally, for all patent family of a given priority year we compute the share of a specific code over all the codes retained previously.

Code	Denomination	Number of occurrence	Concentration effort
Y02E 10/721	Blades or Rotors	10	12.50%
Y02E 10/725	Generator or configuration	5	6.25%
Y02E 10/728	Onshore towers	20	25.00%
Y02E 10/722	Components or gearbox	10	12.50%
Y02E 10/763	Electronic aspects - grid connected applications	15	18.75%
Y02E 10/727	Offshore towers	5	6.25%
Y02E 10/726	Nacelles	5	6.25%
Y02E 10/766	Electronic aspects - power management inside the plant	10	12.50%
TOTAL		80	100%

#### **A-4: Centrality Analysis: wind spillovers**

This appendix gives more information about the social network analysis, in particular the evolution of the degree and betweenness centrality values.

The graphs display the temporal evolution of the normalised value of the centrality indicators for each key technologies (grey lines), and the linear trend (green lines). The horizontal dotted red line represents the threshold value. As seen before, innovation in wind technologies focused on different components over the years, the dotted vertical lines separate these sub periods (1= rotor ; 2= Power train ; 3 = Emergence Grid Connection ; 4= Emergence Mounting and encapsulation, 5 = decrease Grid Connection / Mounting and encapsulation, more rotor).

The following table gives the meaning of the key cpc codes for wind technologies

<b>Code CPC</b>	<b>Description</b>
wind	Wind technologies
F05	Indexing schemes relating to engines or pumps
B63	Ships or other waterborne vessels
B64	Aircraft aviation cosmonautics
H02	Generation conversion or distribution of electric power
F16	Engineering elements and units
F01	Machines or engines in general
E02	Hydraulic engineering
E04	Structure of building
G01	Measuring, Testing
B66	Hoisting lifting hauling

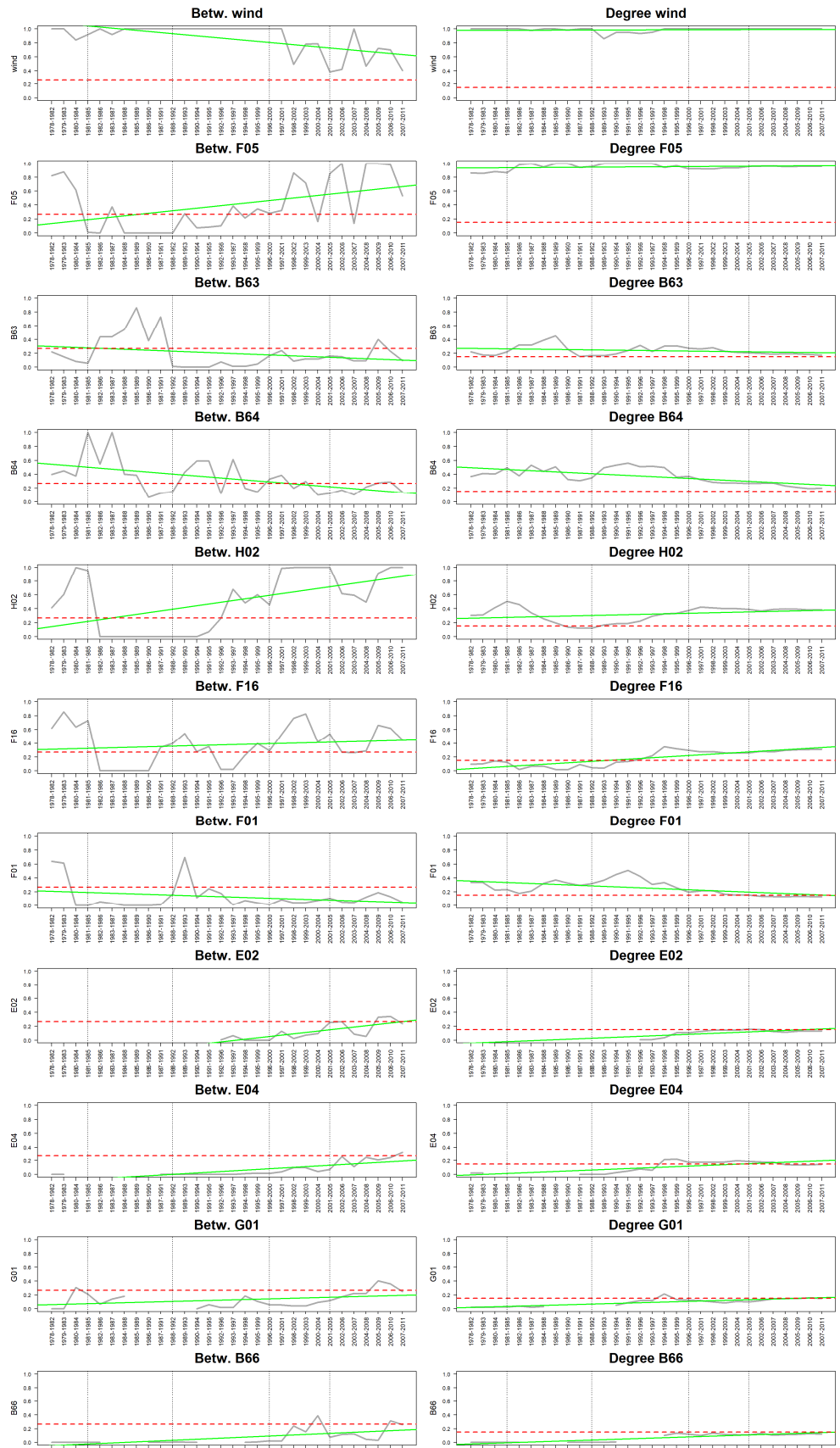

The following table gives the coefficient of the linear trend line for the betweenness and degree centrality values of key technologies in wind spillovers:



Code CPC	Wind backward			
	Betweenness		Degree	
	Intercept	Slope	Intercept	Slope
wind	1,104	-0,016	0,98	0
F05	0,118	0,018	0,933	0,001
B63	0,305	-0,007	0,273	-0,002
B64	0,561	-0,014	0,505	-0,009
H02	0,118	0,025	0,259	0,004
F16	0,308	0,005	0,023	0,01
F01	0,214	-0,006	0,364	-0,007
E02	-0,313	0,019	-0,047	0,007
E04	-0,11	0,01	-0,012	0,007
G01	0,055	0,005	0,016	0,005
B66	-0,052	0,008	-0,026	0,006

## A-5: Centrality Analysis: solar PV spillovers

In this appendix, we give the evolution of the betweenness and degree centrality values of key technologies in spillovers toward solar PV innovations.

The table below gives the description of the different CPC code.

CPC code	Description
Solar PV	Solar PV technologies
H01	Basic electric elements
C09	Dyes; paints; polishes; natural resins; adhesives
H02	Generation; conversion or distribution of electric power
C23	Coating metallic materials
C30	Crystal growth
F24	Heating, range, ventilating
G02	Optics
G03	Photography, cinematography, holography
B32	Layered products
H05	Other electric techniques
C07	Organic chemistry
C08	Organic macromolecular compounds
B82	Nanotechnology
G05	Controlling, regulating

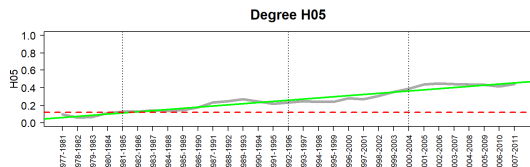
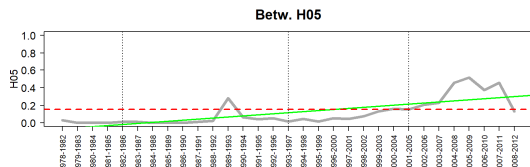
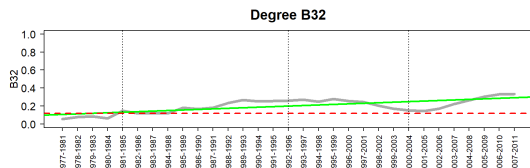
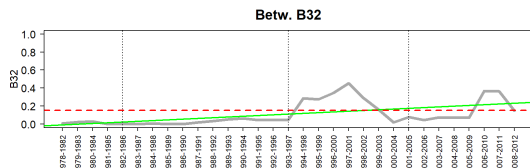
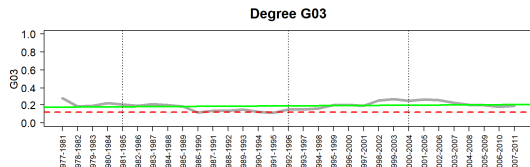
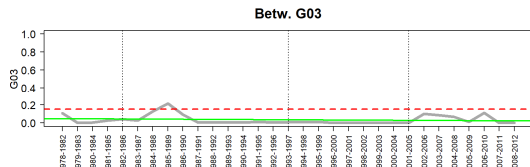
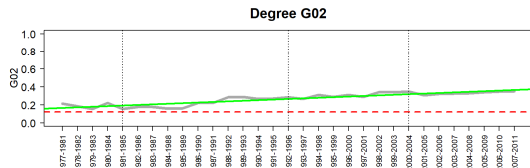
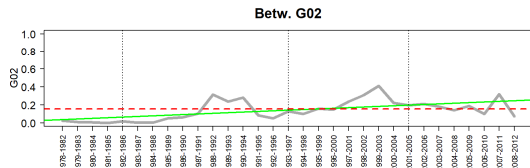
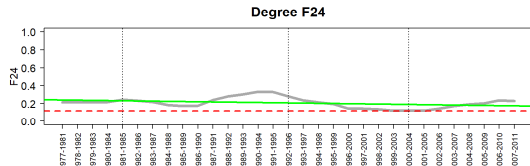
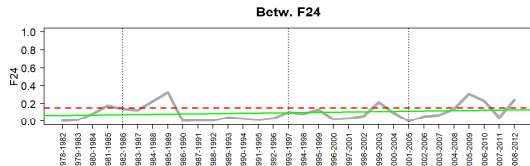
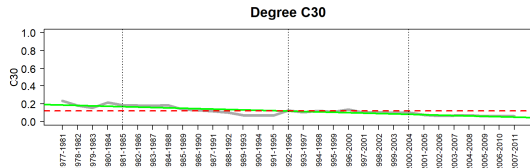
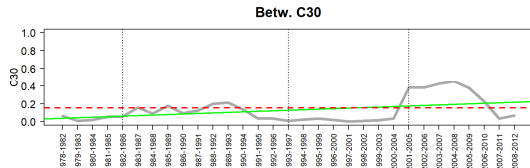
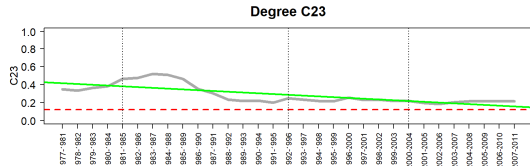
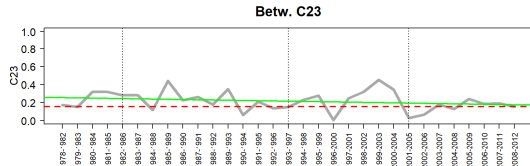
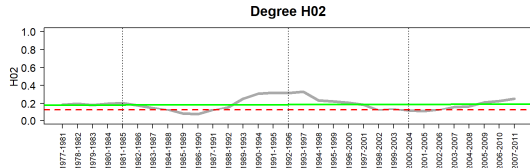
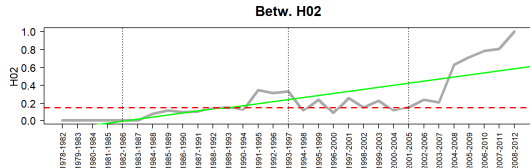
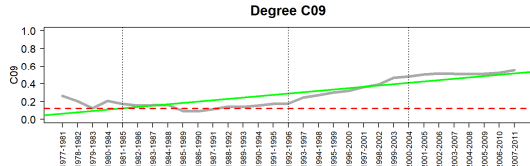
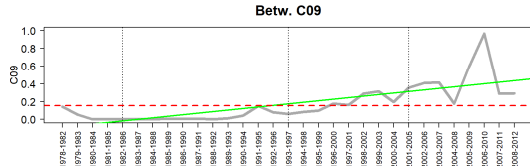
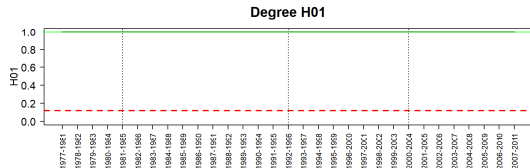
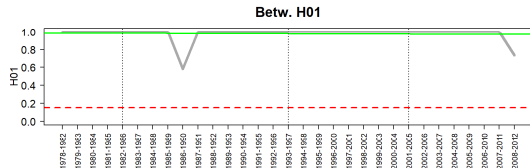
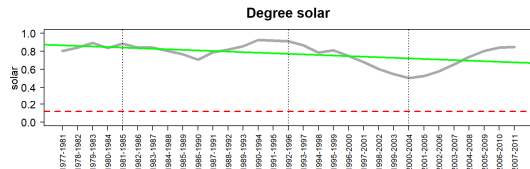
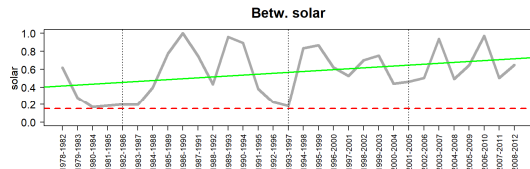

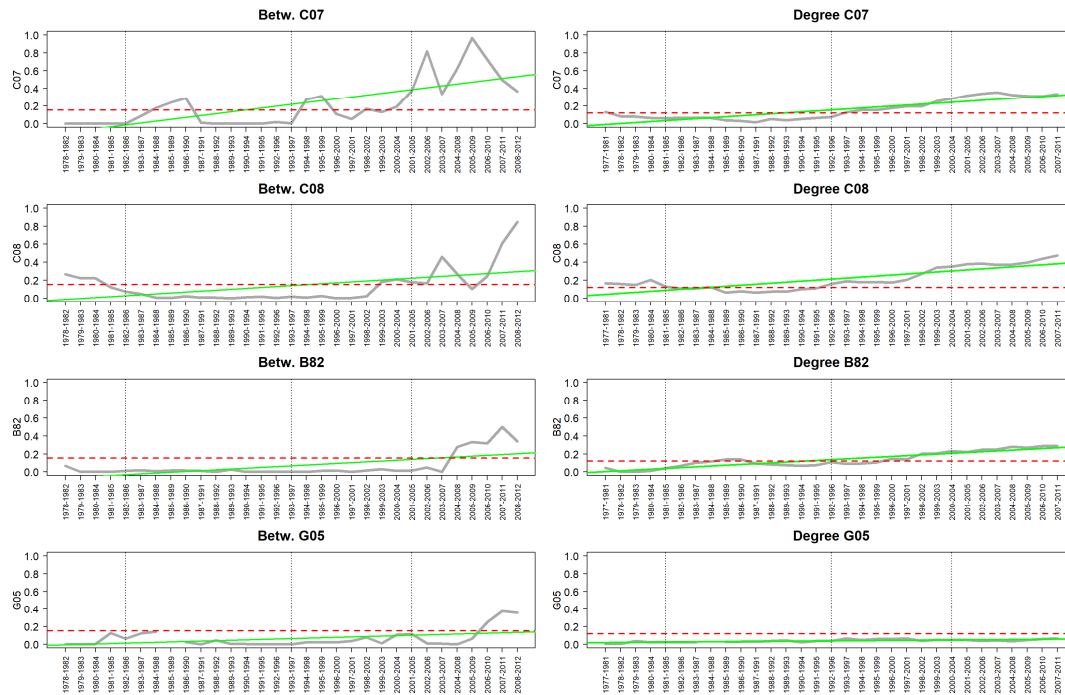

The following table displays the coefficients of the linear trend lines for the betweenness and degree centrality values of the key technologies in solar PV spillovers.

Code CPC	Solar PV backward			
	Betweenness		Degree	
	Intercept	Slope	Intercept	Slope
solar PV	0,405	0,01	0,874	-0,006
H01	0,985	0	1	0
C09	-0,104	0,017	0,048	0,015
H02	-0,123	0,023	0,182	0
C23	0,259	-0,003	0,424	-0,009
C30	0,031	0,006	0,19	-0,004
F24	0,067	0,002	0,244	-0,002
G02	0,028	0,007	0,159	0,007
G03	0,049	-0,001	0,176	0,001
B32	-0,019	0,008	0,1	0,006
H05	-0,077	0,012	0,05	0,013
C07	-0,117	0,021	-0,019	0,011
C08	-0,025	0,01	0,029	0,011
B82	-0,076	0,009	-0,004	0,009
G05	-0,01	0,005	0,017	0,001

**A-6: Correspondence between iso2 codes and country name**

iso2	Country name	iso2	Country name
AL	Albania	IR	Iran
AR	Argentina	IT	Italy
AT	Austria	JP	Japan
AU	Australia	KR	Rep. of Korea
BE	Belgium	KZ	Kazakhstan
BG	Bulgaria	LU	Luxembourg
BR	Brazil	LV	Latvia
BY	Belarus	MD	Rep. of Moldova
CA	Canada	NL	Netherlands
CH	Switzerland	NO	Norway
CL	Chile	NZ	New Zealand
CN	China	PL	Poland
CZ	Czechia	PT	Portugal
DE	Germany	RO	Romania
DK	Denmark	RU	Russian Federation
ES	Spain	SE	Sweden
FI	Finland	SG	Singapore
FR	France	SI	Slovenia
GB	United Kingdom	SK	Slovakia
GR	Greece	TH	Thailand
HK	Hong Kong	TR	Turkey
HR	Croatia	TW	Taiwan
HU	Hungary	UA	Ukraine
IE	Ireland	US	USA
IL	Israel	ZA	South Africa
IN	India		

## A-7: Wind technologies: world map of mean weighted RTA over 1977-2011

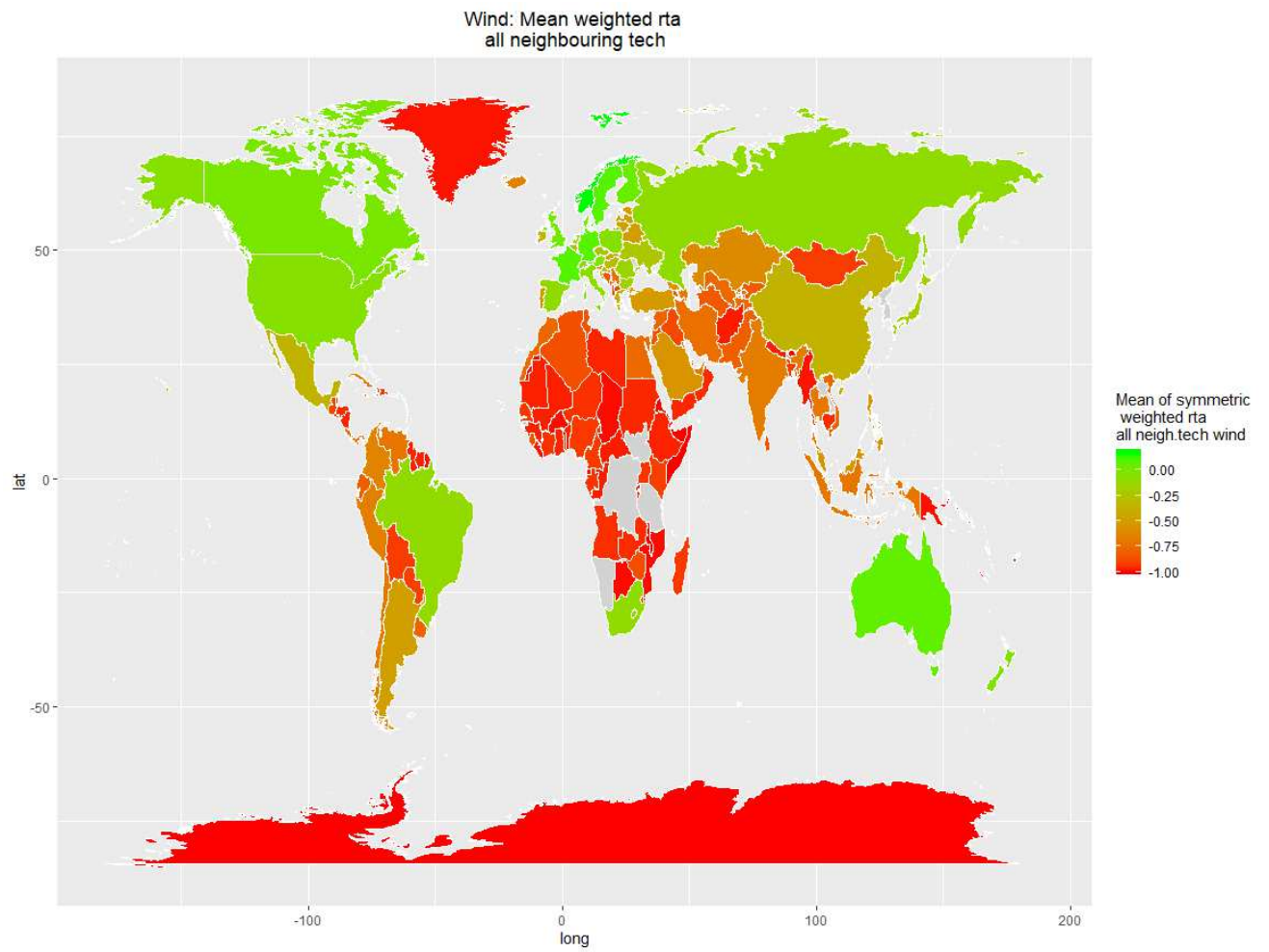

## A-8: Weighted RTA in complementary technologies for each country – wind technologies

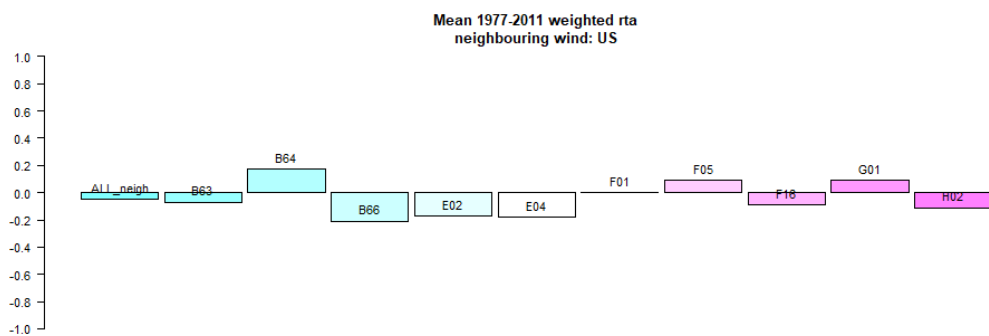
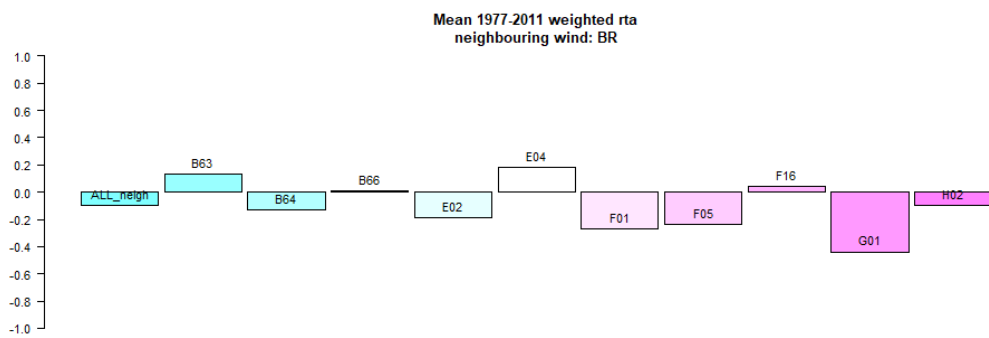
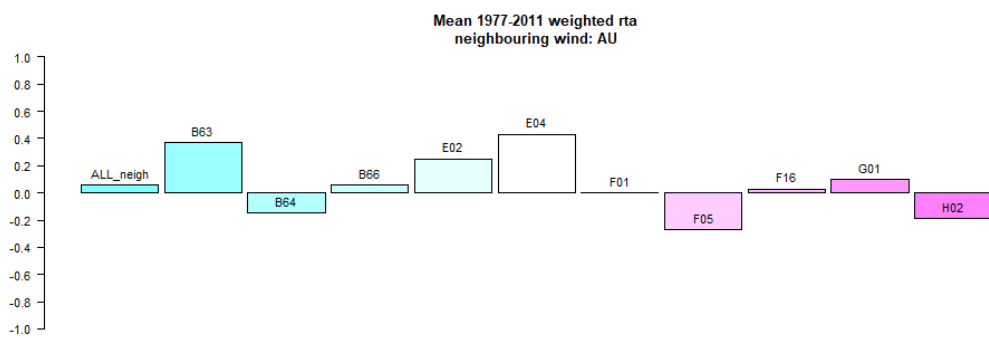
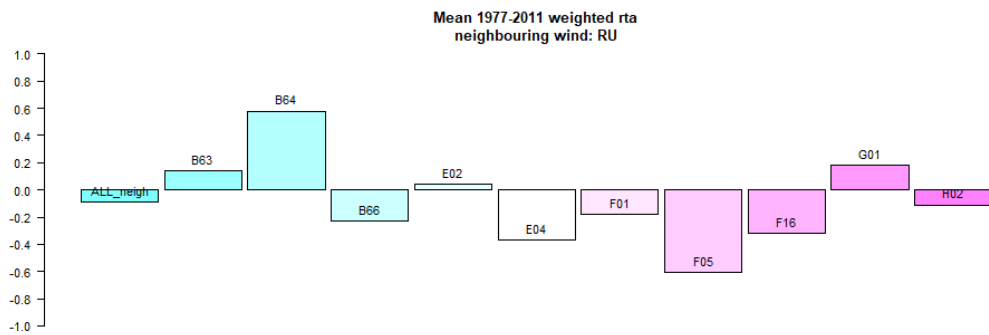

Mean 1977-2011 weighted rta  
neighbouring wind: CA

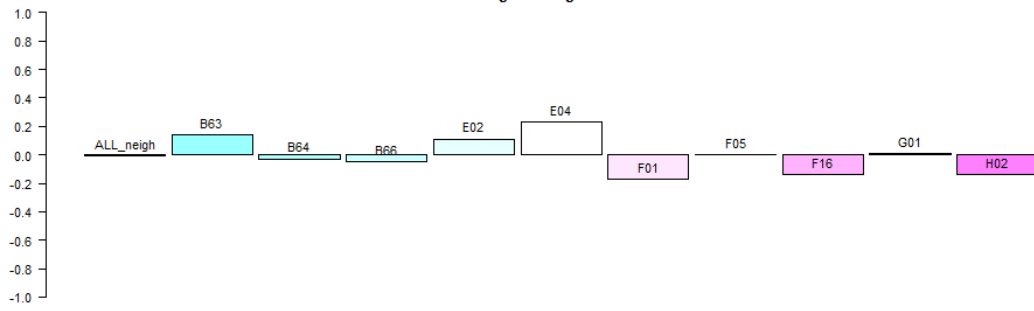

Mean 1977-2011 weighted rta  
neighbouring wind: NO

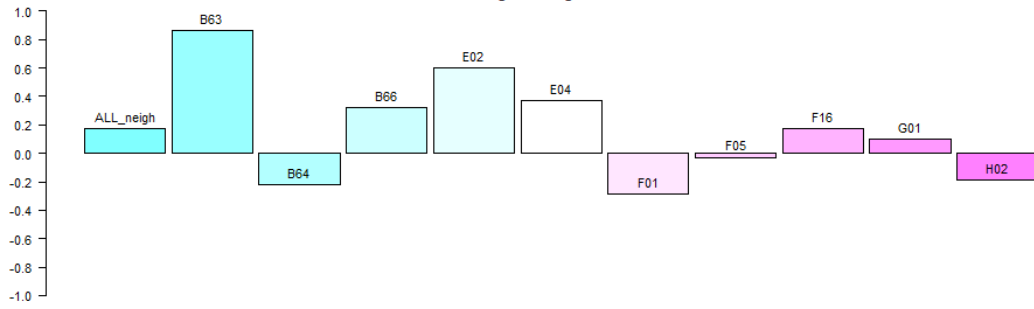

Mean 1977-2011 weighted rta  
neighbouring wind: SE

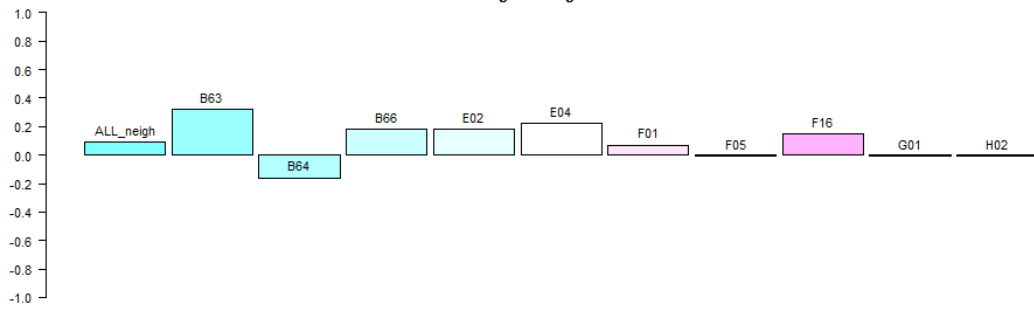

Mean 1977-2011 weighted rta  
neighbouring wind: FI

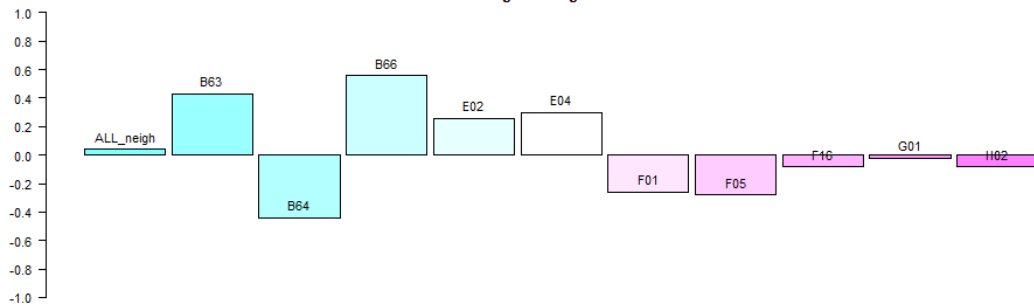



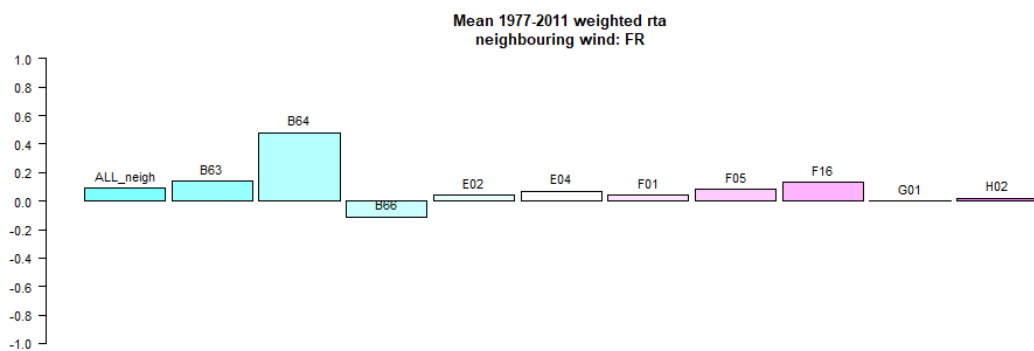
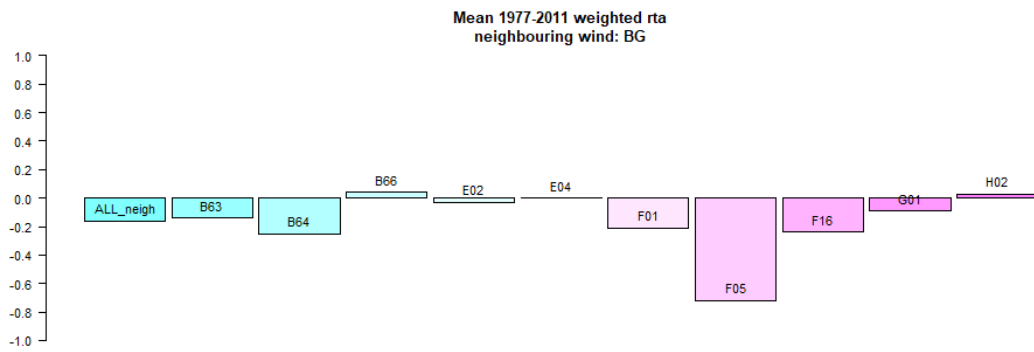
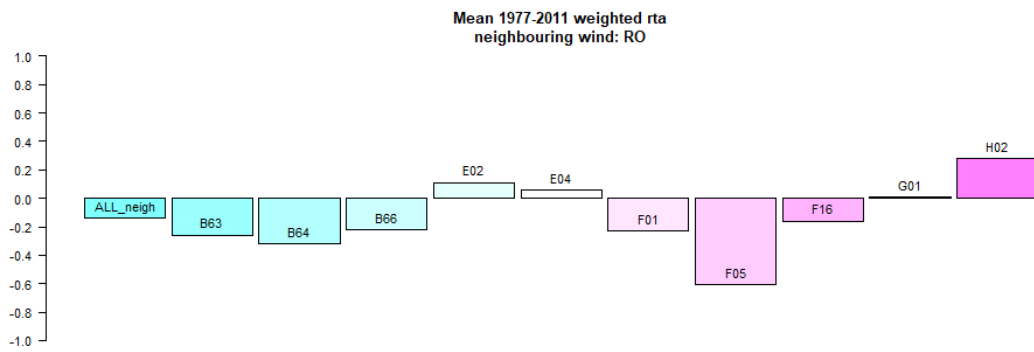
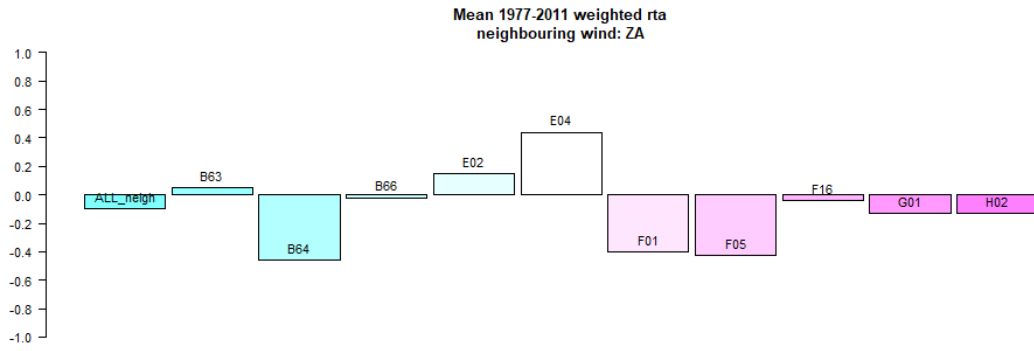

Mean 1977-2011 weighted rta  
neighbouring wind: ES

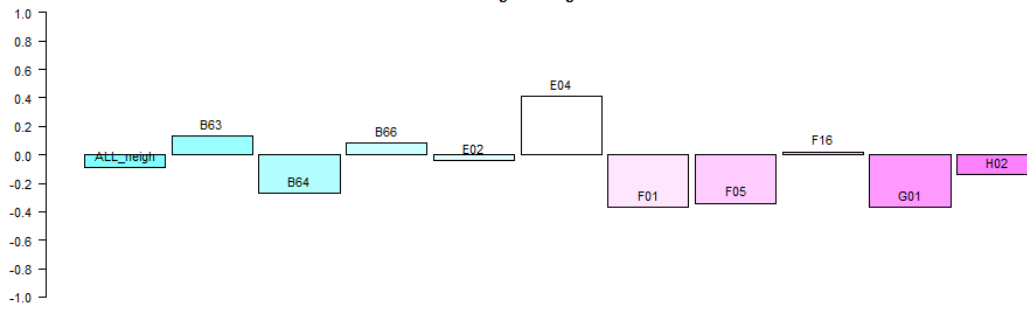

Mean 1977-2011 weighted rta  
neighbouring wind: GB

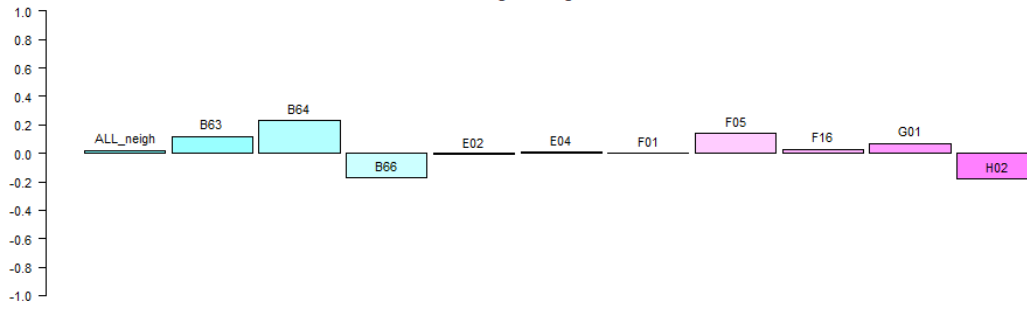

Mean 1977-2011 weighted rta  
neighbouring wind: DK

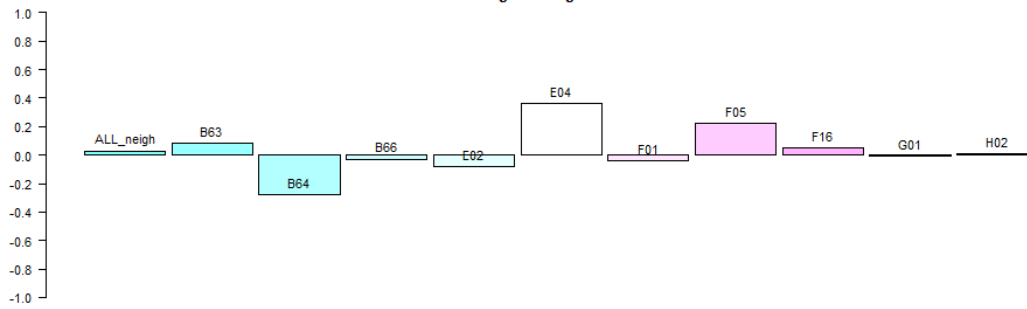

Mean 1977-2011 weighted rta  
neighbouring wind: IT

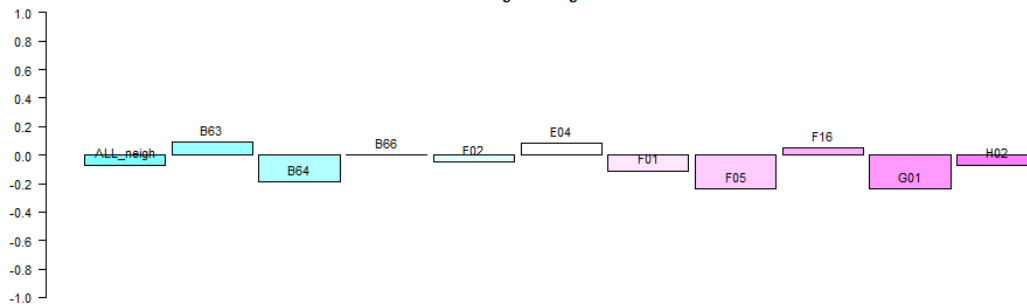

Mean 1977-2011 weighted rta  
neighbouring wind: DE

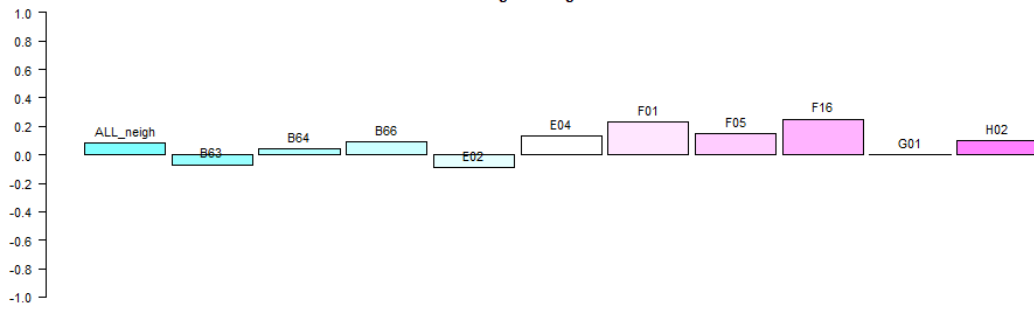

Mean 1977-2011 weighted rta  
neighbouring wind: AT

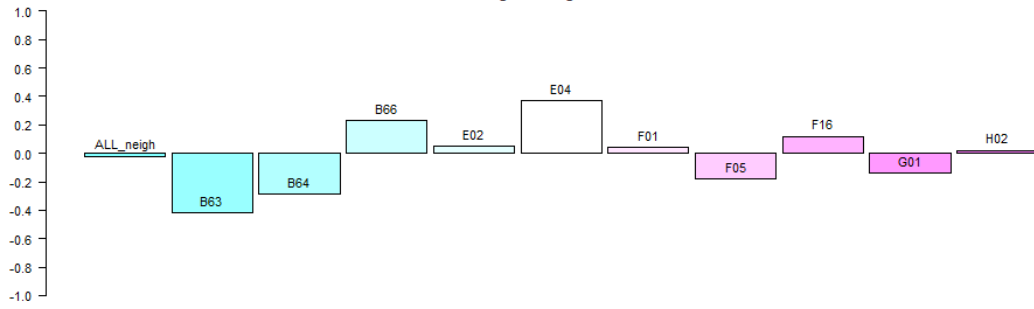

Mean 1977-2011 weighted rta  
neighbouring wind: NZ

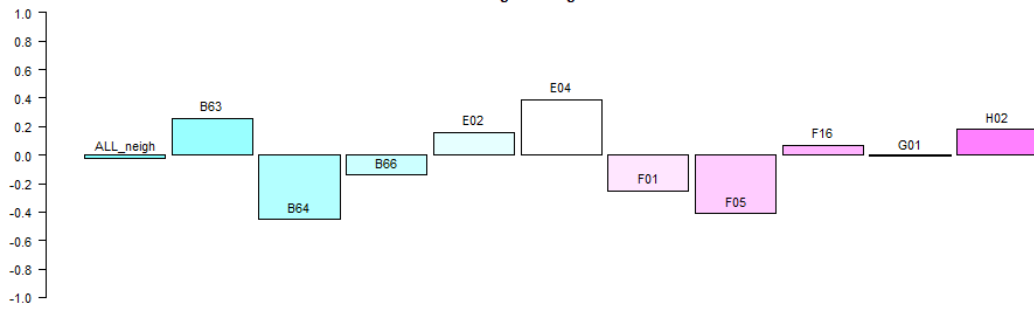

Mean 1977-2011 weighted rta  
neighbouring wind: JP

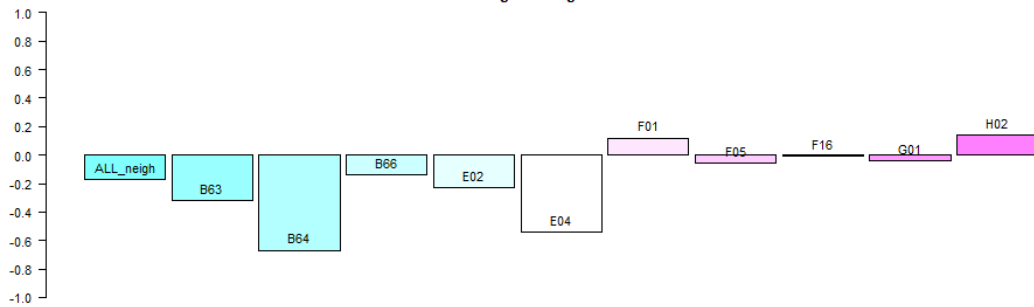

Mean 1977-2011 weighted rta  
neighbouring wind: BE

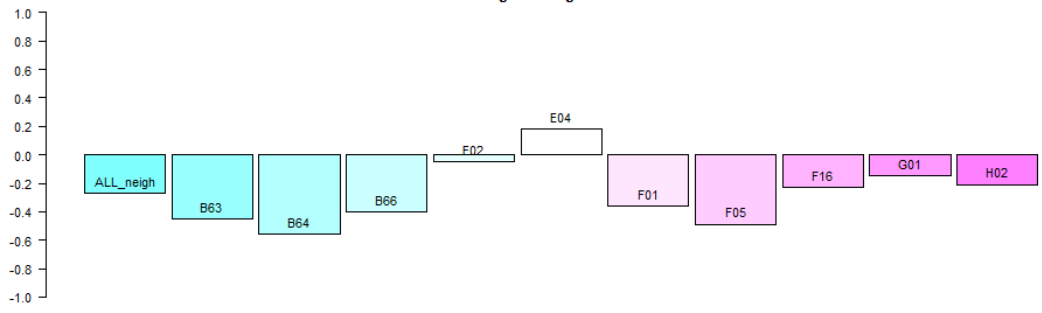

## A-9: solar PV technologies: world map of relative innovation performance

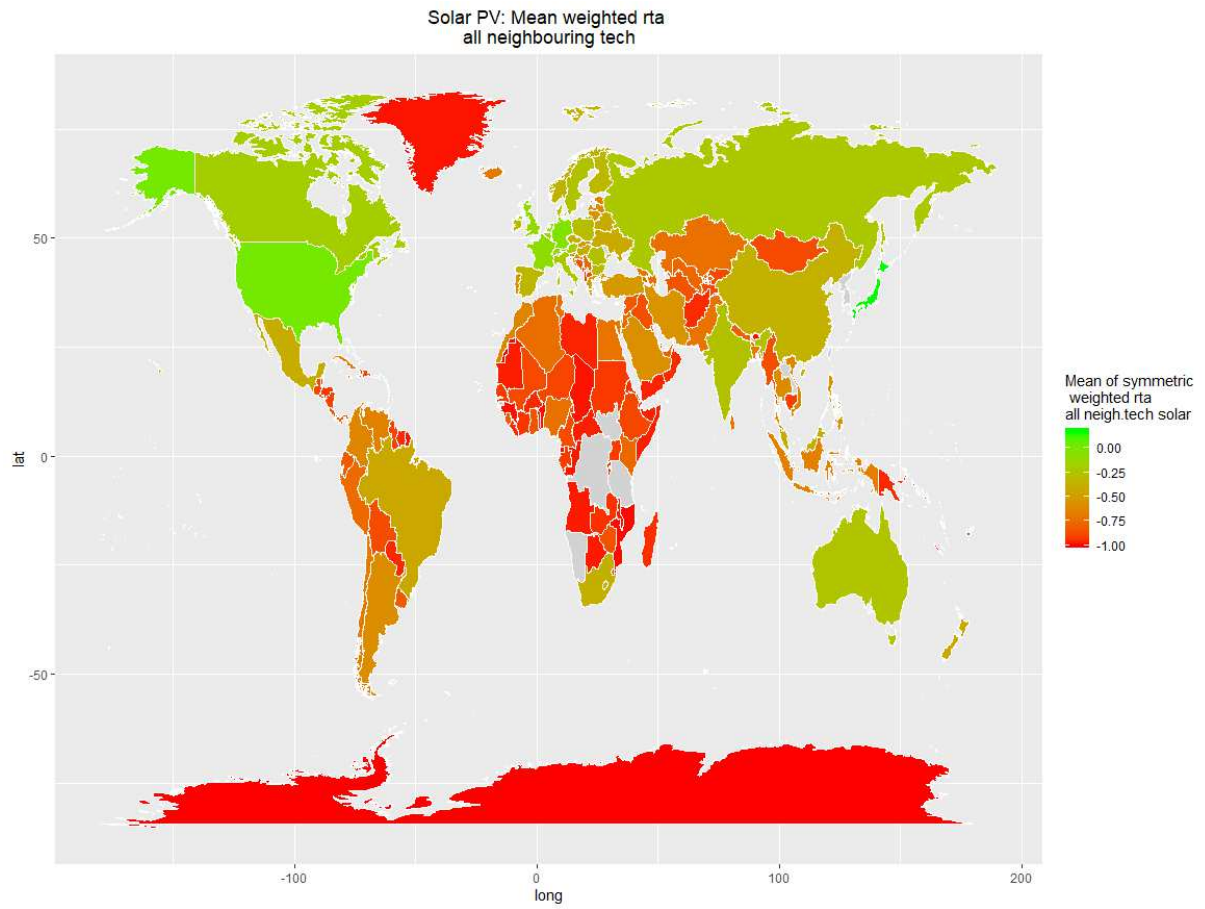

# A-10: Weighted RTA in complementary technologies for each country – solar PV technologies

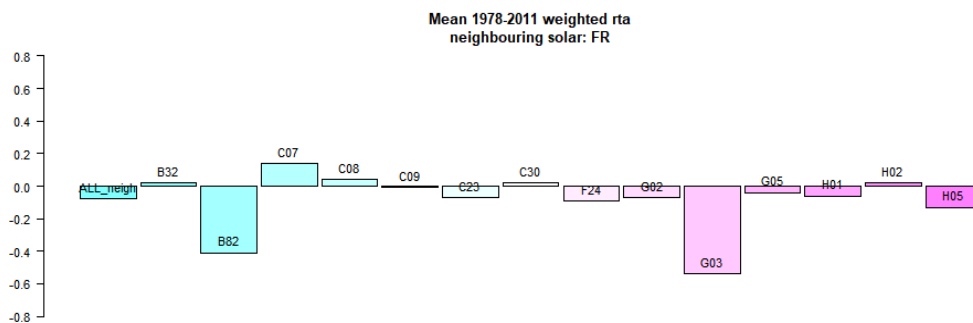
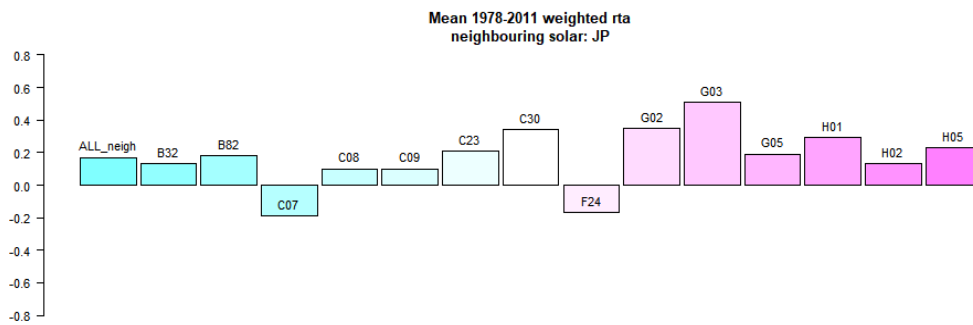
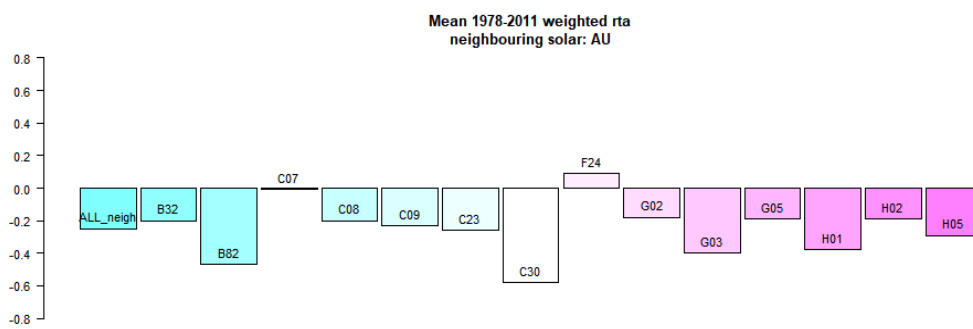
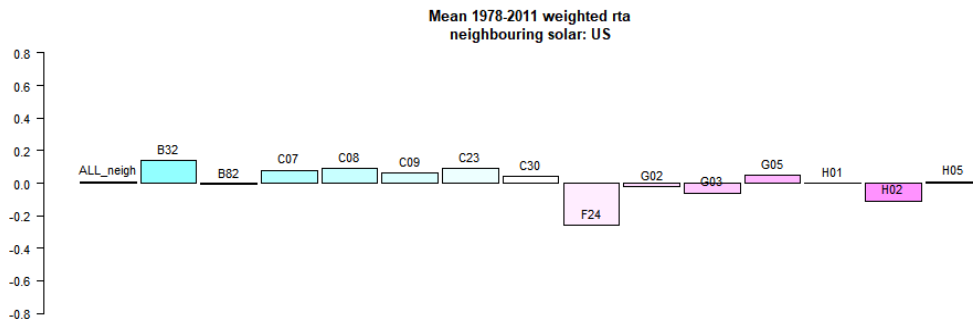

Mean 1978-2011 weighted rta  
neighbouring solar: IT

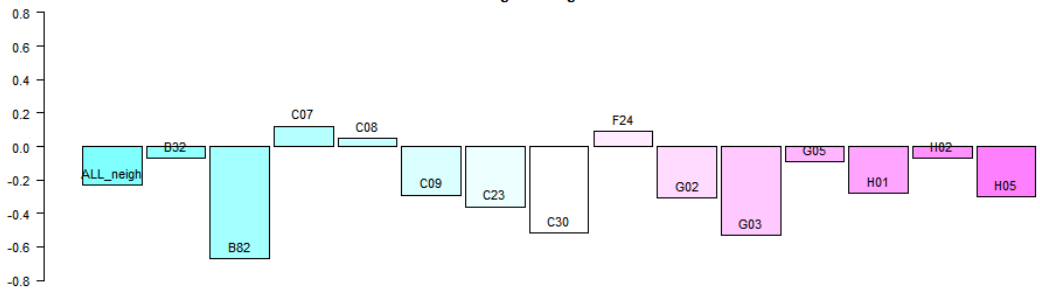

Mean 1978-2011 weighted rta  
neighbouring solar: DE

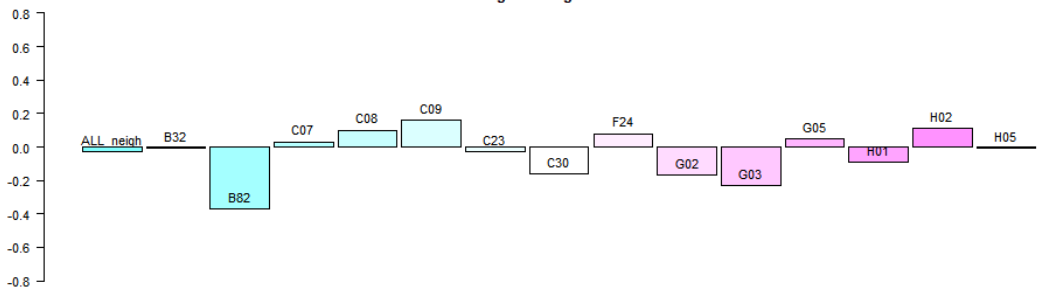

Mean 1978-2011 weighted rta  
neighbouring solar: GB

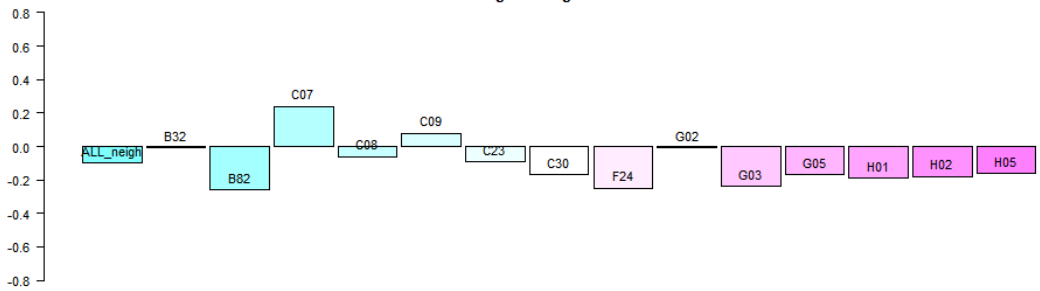

Mean 1978-2011 weighted rta  
neighbouring solar: BE

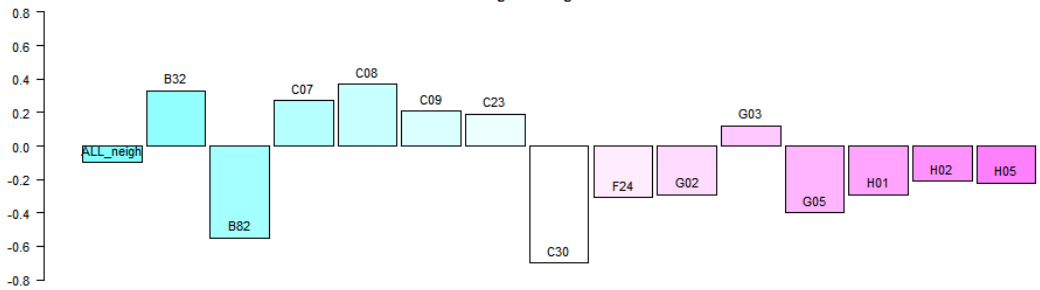

Mean 1978-2011 weighted rta  
neighbouring solar: NL

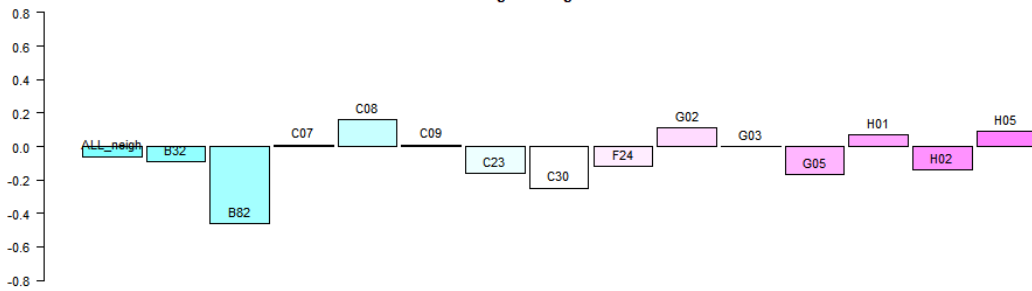

Mean 1978-2011 weighted rta  
neighbouring solar: RU

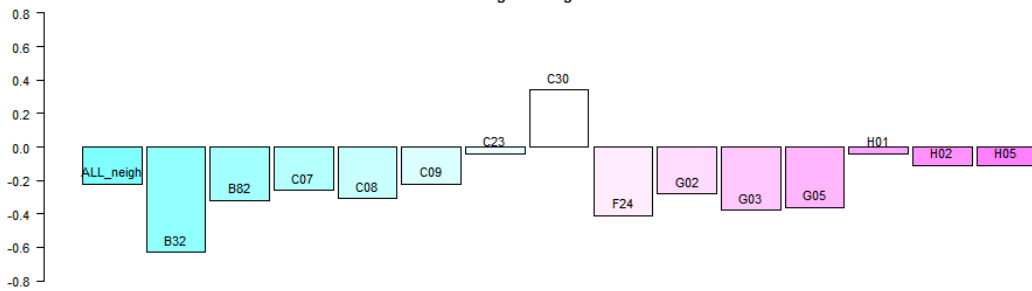

Mean 1978-2011 weighted rta  
neighbouring solar: CN

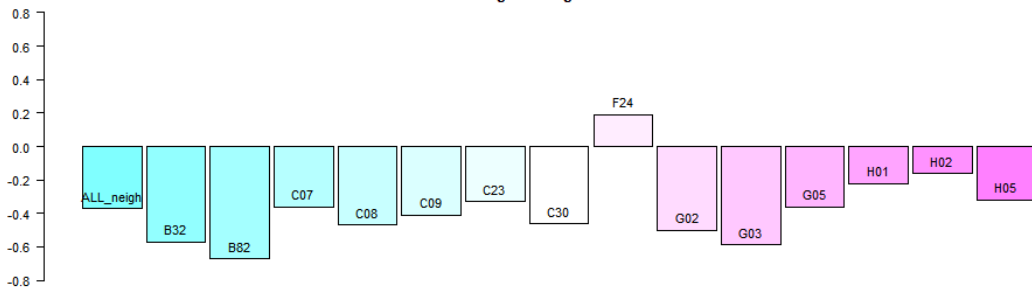

Mean 1978-2011 weighted rta  
neighbouring solar: IN

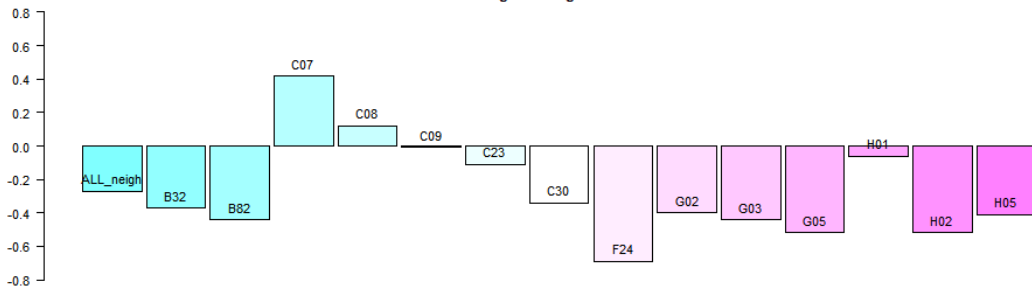



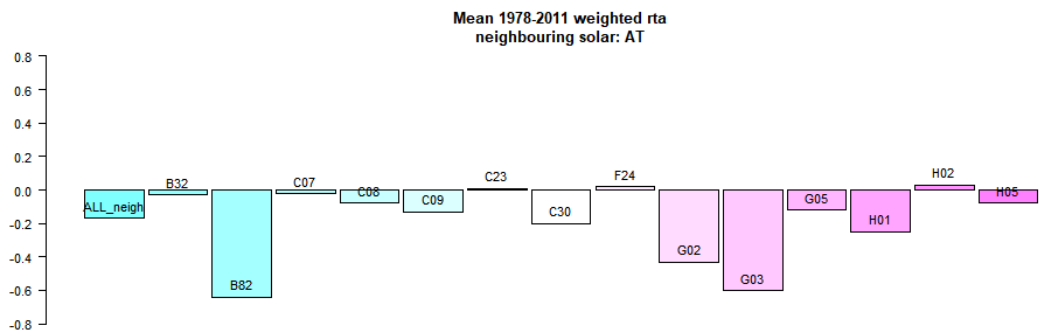
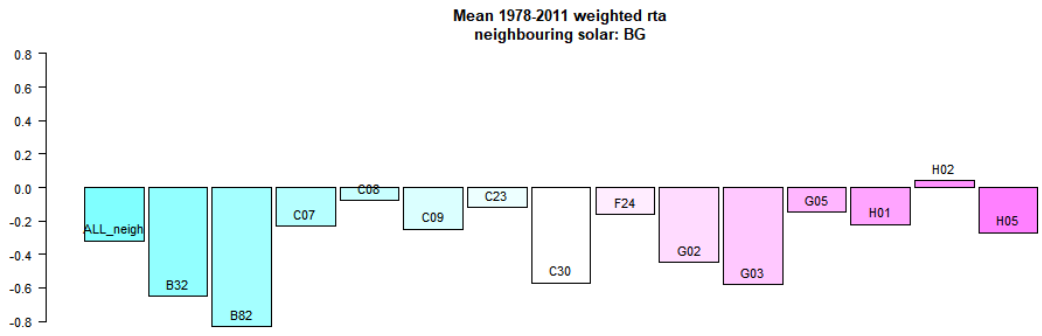
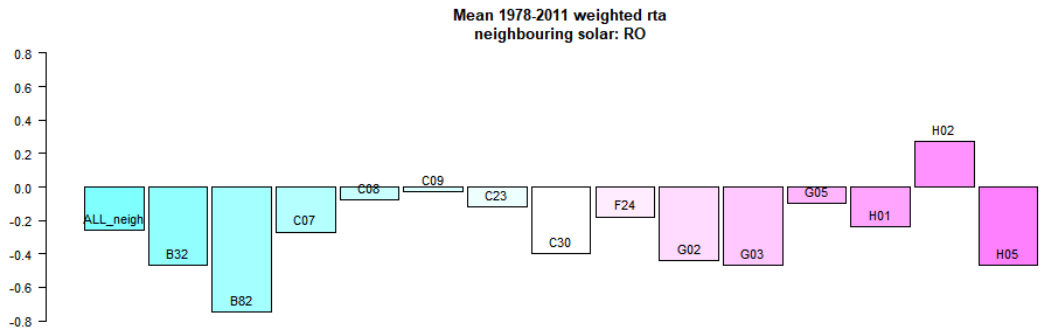
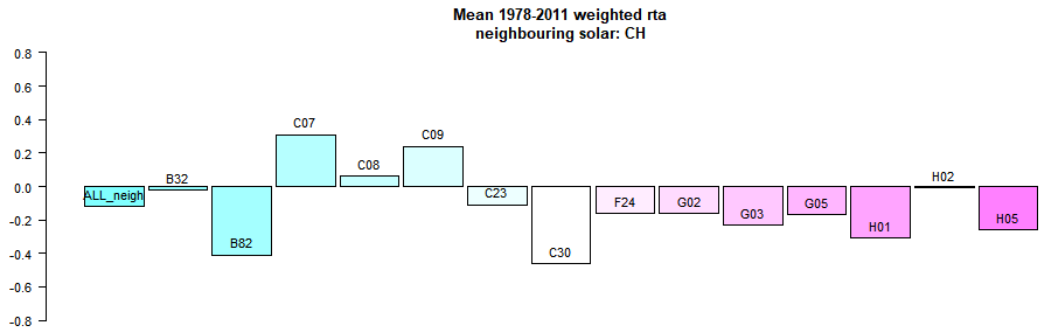

## **Annexes du chapitre 3**

### **B-1: Literature review**

Reference	Research question	Geographic scope – Micro/macro level	Time frame	Methodology	Results	Main variables - Comments
Cieřlik and Michałek (2018)	Innovation → Export	Poland / Czech republic / Hungary / Slovak republic ; firm level	2011-2014	Probit	Process I → +E, other type of innovation have no significant impact on Export  RD → +E	RD, Innovation (Product Innovation; management innovation; marketing innovation), Export = Dummy
Belderbos et al. (2009)	Innovation → Export	Flanders ; firm level	2000, 2004 and 2006	Tobit	Product I; process I → + Exports	Export = % sales, Innovation = Dummy,
Wu et al. (2019)	Innovation → Export	China ; firm level	2005-2007	Tobit–Heckit Model  Tobit–2SLS–Heckit Model	RD→+E in term of extensive margins but negative effect on intensive margins.  Self-reinforcement export (Et-1→+Et)	Export = Dummy, logarithm of export values  RD = natural logarithm of RD expenditures  Results robust to several specification (productivity level of firms ; private vs public firms ; labour intensive industries vs capital intensive ones ...
Falk, de Lemos (2019)	Innovation → Export	Austria ; firm level	1995–2011	Probit and GLM	RD → - E for old firms (0 for young firms, overall negative effect)	Export = % sales  RD = % sales and Dummy
Reęica et al (2019)	Innovation → Export	29 countries ; firm level	2002, 2005 and 2008	Tobit	I → + E	Export = %sales  Innovation = Dummy
Brunel (2019)	Innovation → Export	31 OECD countries ; Country level	1988 - 2003	PPML (Pseudo Poisson Maximum likelihood)	<u>no distinction between REN technologies</u> : I→+ E, domestic I → - E <sup>(*)</sup> , foreign I→ +E  <u>Wind technologies</u> : I → + E	Innovation = patent stock filed in the country weighted by the size of the patent family  Export = logarithm of export value

Reference	Research question	Geographic scope – Micro/macro level	Time frame	Methodology	Results	Main variables - Comments
					Solar technologies: I → 0 E	(*) : “domestic patents might be geared towards domestic production for domestic consumption”
Azar, Ciabuschi (2017)	Innovation → Export	Sweden ; firm level	Sweden February → April 2012	Structural equation model (SEM)	Organizational I → + E I radicalness → 0 E I extensiveness → + E	Industry scope = forestry, fishing, food product, beverage, garment, and furniture industries  Innovation radicalness = degree to which innovations depart from existing structural and technological principles (scale 1 → 7)  innovation extensiveness = refers to the number of innovations that a firm adopts within a given period ((scale 1 → 7)  Export = scale 1 → 7  RD = % GDP
Cieřlik et al. (2018)	Innovation → Export	China ; firm level	2 years : 2003 and 2012	Probit	New product, product I → 0 E (2003)  Process I → + E (2003)  New product, product I → + E (2012)  Process I → 0 E (2012)	Export and Innovation (new product introduction; Patent granted; innovation engagement) = Dummy
Blyde et al. (2015)	Innovation → Export	Chile – firm level	2009	2 SLS (stage least squares)	I → +E for differentiated goods  I → 0 E for non-differentiated goods	Differentiated goods = good neither traded in organized exchanges nor have reference prices

Reference	Research question	Geographic scope – Micro/macro level	Time frame	Methodology	Results	Main variables - Comments
						Export = logarithm of value Innovation = Dummy
Elliott et al. (2019)	Innovation → Export	France ; firm level	1999–2007	Propensity score matching (PSM) and difference-in-differences (DiD) approach with	I → + E driven primarily through the intensive margin.	Export and RD = % sales Intensive margin = export value by exporting firms
Rodil et al. (2016)	Innovation → Export	Spain (Galicia) ; firm level	2004 - 2005	Logit Tobit	I → + E	Innovation = Dummy Export = Dummy, % sales
Yang (2018)	Export → Innovation	China ; firm level	2005-2007	Probit and Tobit	E, E variety, E quality → + RD Export process → - RD	RD = Dummy Export = logarithm of trade values
Di Cintio et al. (2020)	Export → Innovation	27 transition economies; firm level	Merged 2002, 2005, 2008–2009 and 2011–2014	Radius Matching (RM) and Inverse-Probability Weighted with Regression Adjustment (IPWRA)	Direct E → + Product Innovation (probability higher compared to non-exporters and indirect exporters)	Export and Innovation = Dummy Indirect exporter = firm choosing a trade intermediary instead of directly exporting to consumers abroad.
Trachuk and Linder (2018)	Export → Innovation	Russia ; firm level	2004 - 2016	Probit	E → + I	Export and Innovation = Dummy
Trachuk and Linder (2019)	Export → Innovation	Russia ; firm level	2015-2017	Probit	E → + I ; E → + RD	Export, innovation, RD = Dummy Innovation = New technology implementation; Product Innovation ; Marketing Innovation

Reference	Research question	Geographic scope – Micro/macro level	Time frame	Methodology	Results	Main variables - Comments
Love and Ganotakis (2013)	Export → Innovation	United Kingdom ; firm level	2001 - 2004	Tobit Probit With Heckman procedure	E → + I	Export and RD = Dummy and % sales
Olabisi (2017)	Export → Innovation	China ; firm level	2005-2007	• Difference in differences • Tobit	E → + product I E → + RD	Export and Innovation = Dummy RD = logarithm value
Salomon and Shaver (2005)	Export → Innovation	Spain ; firm level	1990-1997	Nonlinear GMM estimator Windmeijer (2002)	E dummy → + product I (but only with a two periods lag)  E volume → + product I with one lag and two lags  E → + patent applications with one, two or three lags	Export = Dummy Innovation = number of patent applications
Salomon and Jin (2010)	Export → Innovation	Spain ; firm level	1990–1997	Negative binomial (count data model)	E → + I for both technologically leading and lagging firms; but the magnitude of the effect is higher for technologically leading firms	Export = Dummy RD = number of patent applications
Caldera (2010)	Export → Innovation	Spain ; firm level	1991-2002	Probit - GMM	E → + I	Export = Dummy RD = Dummy, % sales Innovation = Dummy (Product Innovation, process Innovation)

Reference	Research question	Geographic scope – Micro/macro level	Time frame	Methodology	Results	Main variables - Comments
Véganzonès-Varoudakis and Plane (2019)	Innovation ⇔ Export	India ; firm level	2013 - 2014	Univariate estimations with instruments	I → + E E → 0 I E → + RD	Export = % of sales RD and Innovation = Dummy (product/process/management/ marketing)
Damijan and Kostevc (2015)	Innovation ⇔ Export (sequencing)	Spain ; firm level	1990 - 2008	Probit	RD → + I → + E	Export and Innovation = Dummy RD = % sales
Sener and Delican (2019)	Innovation ⇔ Export	31 developed and 26 developing countries ; Country level	2007 - 2017	PVAR	I → 0 E E → I (granger causality, so sign is unknown) For both developed and developing countries	Innovation = Global innovation index Export = Logarithm of export value
Salim and Bloch (2009)	Innovation ⇔ Export	Australia ; country level	1975 - 2002.	VAR- Granger – VECM-IRF-FEVD	Long-run relationship between export and RD RD → E but E → 0RD (Granger causality)	RD and Export = logarithm of value
Rehman (2017)	Innovation ⇔ Export	29 countries (Eurasian and CEE countries) ; firm level	2011	3SLS – 2SLS - probit	E → + I I → + E Self-reinforcement of export and innovation Results robust across Eurasian and CEE firms	Innovation = Dummy Export = value per employee
Neves et al. (2016)	Innovation ⇔ Export	Portugal ; firm level	2006 - 2012.	Bivariate Probit model	E → + RD RD → + E	Export and RD = Dummy

Reference	Research question	Geographic scope – Micro/macro level	Time frame	Methodology	Results	Main variables - Comments
					Self-reinforcement export and RD	
Alarcón and Sánchez (2016)	Innovation ⇔ Export	Spain ; agricultural and food firms	2006 - 2011	Bivariate probit	Product I → + E Process I → + E E → +I only for food firms (0 for agricultural firms)	Export and Innovation = Dummy
Golovko and Valentini (2011).	Innovation ⇔ Export	Spain ; firm level	1990 - 1999	Dynamic panel, Arellano-Bond estimation (GMM)	I → 0E ; RD → +E E → +I ; E → + RD  Self-reinforcement export and innovation	Export and Innovation = Dummy RD = logarithm value
Esteve-Pérez Rodriguez (2013)	Innovation ⇔ Export	Spain ; firm level	1990–2006	Dynamic bivariate probit model	E → +RD RD → + E  Self-reinforcement export and RD	Export and RD = Dummy
Zhao and li (1997)	Innovation ⇔ Export	China ; Spain ; firm level	1992	Logit 2 SLS	E → +RD RD → + E	Export and RD = Dummy
Kim and Kim (2015)	Innovation ⇔ Export	16 countries using solar PV and 14 countries using wind power ;Country level	1991 - 2008	3SLS	<u>For wind technologies:</u> E → +I I → + E  <u>For solar PV technologies:</u>	Export = value (USD)  Innovation = number of patent applications/total applications , RD expenditures



Reference	Research question	Geographic scope – Micro/macro level	Time frame	Methodology	Results	Main variables - Comments
					E → 0 I I → + E	
Girma et al. (2008)	Innovation ⇔ Export	Great Britain and the Republic of Ireland ; firm level	1996-2003	Bivariate probit estimation	RD → +E British firms, 0 for Irish firms E → 0 RD for British firms,+ for Irish firms Self-reinforcement for export and RD for both British and Irish firms.	Export and RD = Dummy Heterogeneity among countries
Ayllón and Radic (2019)	Innovation ⇔ Export	Spain ; firm level	2001 - 2014	Dynamic Probit estimated with maximum likelihood	<u>Product I</u> : + E(t); 0 E(t-1) <u>Process I</u> : +E(t) ; -E(t-1) <u>Exports</u> + product I(t) ; + process I (t) 0 product I (t-1) ; - process I (t-1) Self-reinforcement for these 3 variables	Innovation and Export = Dummy
Kuik et al. (2019)	Public policies → export wind and solar PV	49 countries for wind and 40 countries for solar PV ; country level	1995 - 2013	Gravity model - Poisson Pseudo-Maximum Likelihood (PPML) estimation	Policy → + Export wind and solar PV	Export = value (USD) Policy = installed capacities
Zhao (2011)	Public policies → export	21 OECD countries and 9 sample energy intensive industries ; country level	1992-2008	Gravity model - GLS estimation	Carbon tax → - E	Export = value (USD) Carbon tax = Dummy

Reference	Research question	Geographic scope – Micro/macro level	Time frame	Methodology	Results	Main variables - Comments
Costantini and Mazzanti (2012)	Public policies → export	14 exporting countries 145 importing countries  Five manufacturing sectors (High tech Medium-high tech Medium-low tech Low tech) + environmental sector ; country level	1996–2007	Gravity model – System GMM estimation	Environmental tax → +E for high tech sector and medium-low tech sector otherwise 0.  Energy tax → +E for high tech sector otherwise 0  E(t-1) → E(t)  ETS → - E for high tech and Medium-high sectors ; + E for low tech sector	Export = value (USD)  Environmental tax and energy tax = revenues as percentage of total tax revenues  ETS (Emission Trading System) = Dummy
Groba (2014)	Public policies → export solar PV	21 OECD countries exporting SETCs to 118 importing countries ; country level	1999-2007	Gavity model – PPML estimation	RD → + E  Duration fit & Dummy → + E  Duration tax measure → +E  Obligations → 0 E  Incentives tariffs → +/0 E	Export = value (USD)  FIT (feed-in tariffs) = Dummy, duration  Obligations (renewable portfolio standard, ...) = Dummy, duration  ETS = Dummy  Tax measure= Dummy  RD = budget (USD)
Groba and Cao (2015)	Public policies → export wind and solar PV	43 developed and developing countries that imported from China ; country level	1996-2008	Gravity trade model – PPML estimation	<u>Solar PV</u>  Incentives tariffs → + imports  Obligation → - imports  Tax measures → 0 imports  Electricity prod. → + imports    <u>Wind</u>	Export = value (USD)  Electricity prod. = Contribution to total electricity production  Incentives tariffs= Dummy  Obligations = Dummy  Tax measure = Dummy

Reference	Research question	Geographic scope – Micro/macro level	Time frame	Methodology	Results	Main variables - Comments
					Incentives tariffs → - imports Obligation → 0 imports Tax measures → - imports Electricity prod. → - imports	
Ogura (2020)	Public policies → export wind and solar PV	33 OECD member nations and BRICS countries	1999-2011	Gravity model - PPML estimation	<u>Exporting country</u> Electricity prod. → +E solar PV, 0E wind FIT → -E solar and wind RPS → -E solar and wind  <u>Importing country</u> Electricity prod. → +/- E solar PV, 0 E wind FIT → 0 E solar, +E wind RPS → 0 E solar, +E wind	Export = value (USD) Electricity prod = contribution to total electricity production FIT = Dummy and price RPS (renewable portfolio standard) = Dummy and objective
Sung and Wen (2018)	Public policies → export all renewable energies	19 OECD countries	1991-2012	Panel vector autoregressive (PVAR) - first difference GMM estimation	Electricity prod. → + E E(t-1) → +E(t) RD → - E	Export = value (USD) Electricity prod = contribution to total electricity production RD = budget
Sung and Song (2014)	Public policies → export wind, solar PV and biomass	18 countries	1992-2008	VECM (wind and biomass) because of cointegration PVAR (solar)	<u>Wind</u> E(t-1) → +E(t) Electricity prod → +E	Export = value (USD) RD = budget (USD)

Reference	Research question	Geographic scope – Micro/macro level	Time frame	Methodology	Results	Main variables - Comments
					RD → 0 E  <u>Solar</u> E(t-1) → +E(t) RD → -E Electricity prod → +E  <u>Biomass</u> E(t-1) → +E(t) RD → 0 E Electricity prod → 0 E	Electricity prod = contribution to total electricity production
Sung and Song (2013)	Public policies → export all renewable energies	18 countries	1991-2007	PVAR – GMM estimation	RD → 0 E Electricity prod(t-1) → 0 E Electricity prod(t-2) → - E E → + Electricity prod. E → 0 RD E(t-1) → -E(t)	Export = value (USD) RD = budget (USD) Electricity prod = contribution to total electricity production
Sung et al. (2017)	Public policies → export bionergy	16 OECD countries :	1995-2012	PVAR – GMM estimation	ECOE → 0 E E(t-1) → + E(t)	Export = value (USD) ECOE (Eco efficiency) = indicator that considers the number of patent granted, the contribution of bionergy to energy supply and total CO2 emissions

Reference	Research question	Geographic scope – Micro/macro level	Time frame	Methodology	Results	Main variables - Comments
Kim and Kim (2015)	Innovation ⇔ Export	16 countries using solar PV and 14 countries using wind power ;Country level	1991 - 2008	3SLS	<u>Solar PV</u> Tariff incentives → +E Obligations → +E Environmental taxes → +E Public investment → +E RD → +E  <u>Wind</u> Tariff incentives → +E Obligations → -E Environmental taxes → 0 E Public investment → -E RD → +E	Export = value (USD)  Innovation = number of patent applications/total applications , RD expenditures
Hwang and Kim (2017)	Public policies → export manufacturing sectors (Distinction between high, medium and low energy intensity manufacturing sector)	19 OECD countries	1996-2009	Gravity model	Energy tax → - E Environmental tax → - E ETS → + E	Export = value (USD) ETS = Dummy Energy tax = Dummy Environmental tax = Dummy

## B-2: China's share in global exports of wind and solar PV technologies

Source: COMTRADE

Wind 2 codes:

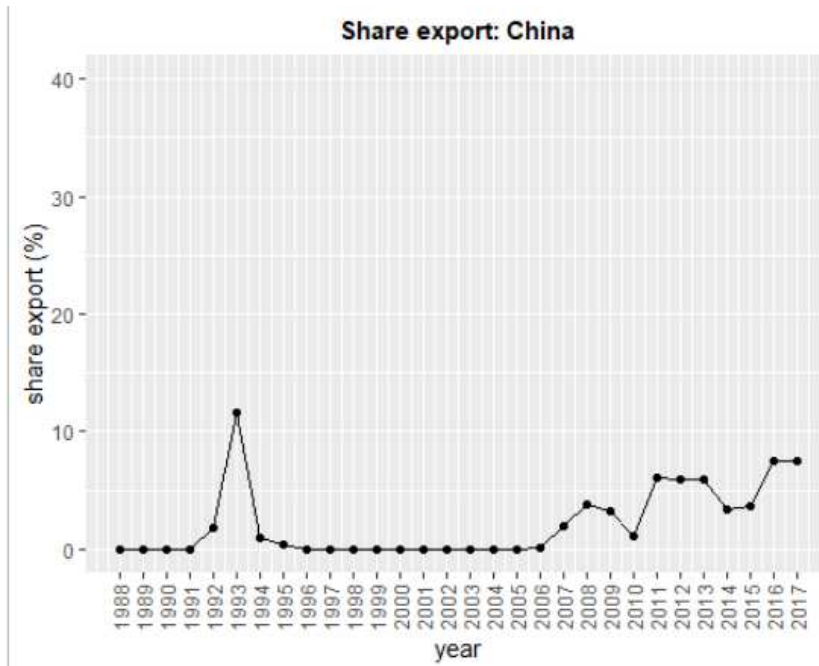

Wind all codes:

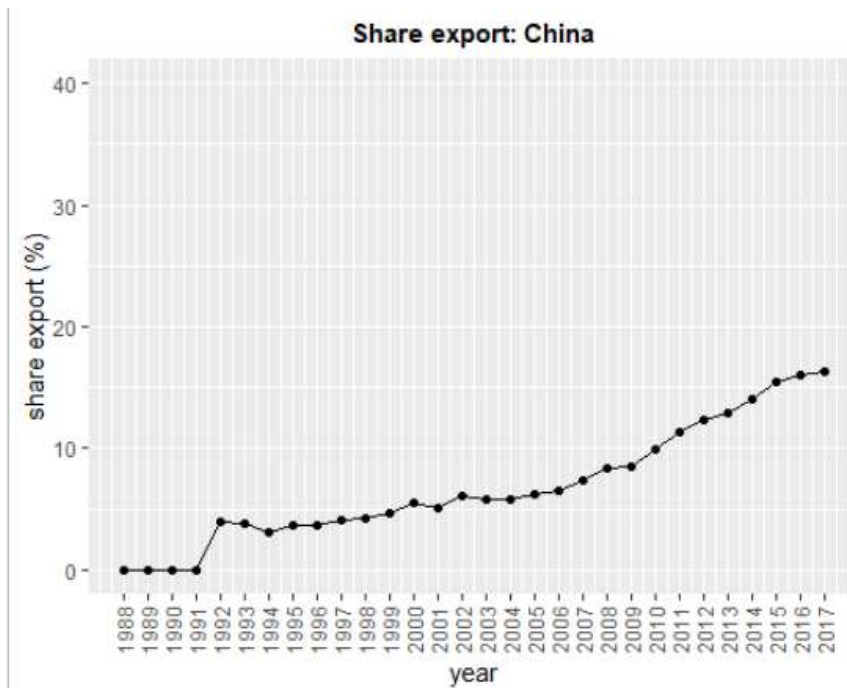

**Solar 2 codes:**

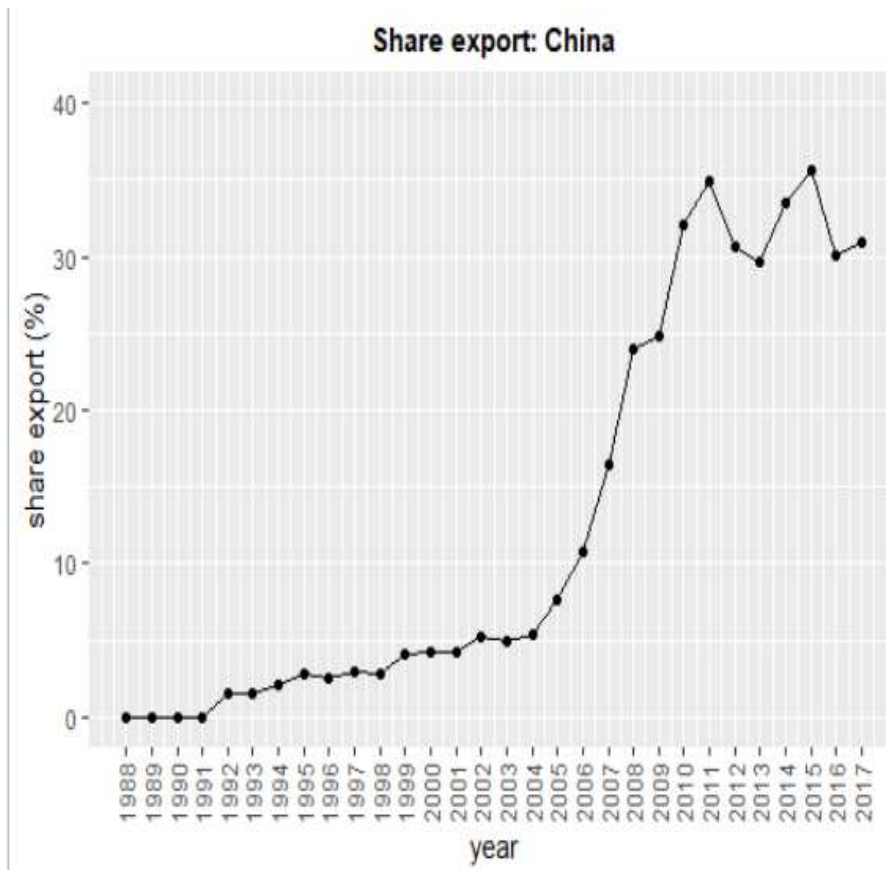

**Solar all codes:**

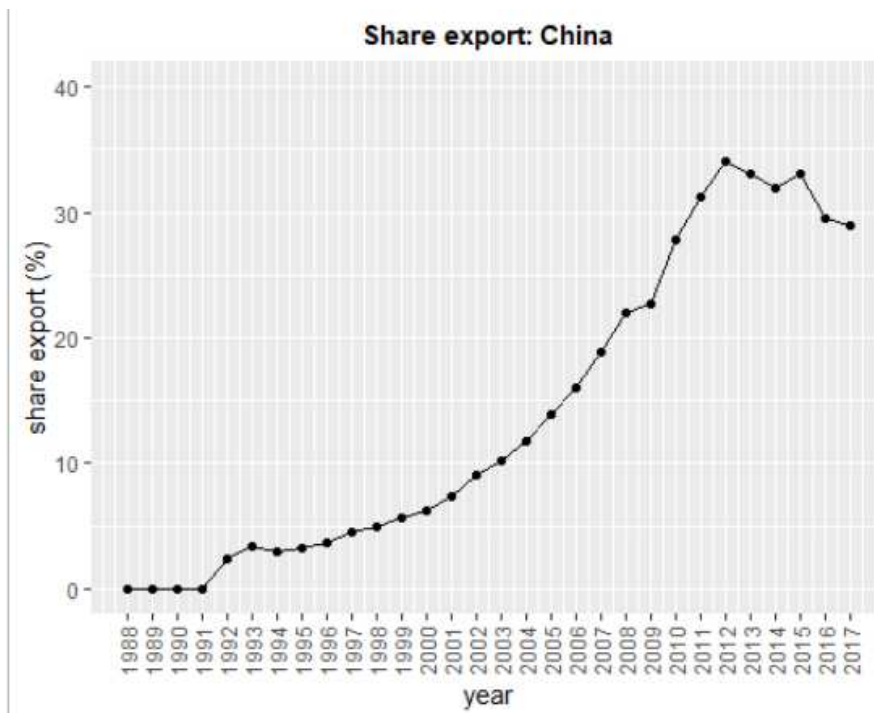

### B-3: Mean of variables for each country, wind technologies and solar PV

Mean of variables for each country, wind technologies:

Country	Unweighted RTA	Weighted RTA	RCA 2 codes	RCA all codes	share cap	GDP	RD per GDP
Australia	-0.08	-0.11	-0.66	-0.61	1.35	0.67	0.02
Austria	-0.05	-0.13	-0.87	-0.02	2.25	0.28	0.02
Belgium	-0.24	-0.29	-0.91	-0.31	1.71	0.34	0.03
Canada	0.06	-0.09	-0.84	-0.3	1.34	1.02	0.05
Denmark	0.7	0.74	0.75	0.37	16.95	0.23	0.61
Finland	0.25	0.04	-0.78	0.23	0.53	0.18	0.15
France	-0.36	-0.4	-0.9	-0.11	1.59	1.93	0.01
Germany	0.28	0.31	0	0.17	8.71	2.67	0.13
Greece	-0.04	-0.17	-0.56	0.1	3.71	0.19	0.2
Ireland	-0.3	-0.4	-0.91	-0.65	7.19	0.15	0.06
Italy	-0.25	-0.28	-0.68	-0.02	2.04	1.59	0.09
Japan	-0.61	-0.58	-0.53	0.21	0.31	4.66	0.03
Luxembourg	-0.36	-0.44	-1	-0.84	1.28	0.03	0.06
Netherlands	0.1	0.01	-0.86	-0.41	4.15	0.58	0.26
New Zealand	-0.37	-0.49	-0.91	-0.56	2.02	0.09	0.01
Norway	0.4	0.32	-0.95	-0.46	0.66	0.27	0.15
Portugal	-0.13	-0.24	-0.69	0.12	7.56	0.16	0.02
Republic of Korea	-0.41	-0.39	-0.97	-0.1	0.19	0.73	0.3
Spain	0.33	0.36	-0.05	0.02	8.73	0.93	0.11
Sweden	-0.05	-0.11	-0.71	0.09	2.62	0.36	0.13
Switzerland	-0.33	-0.53	-0.64	0	0.07	0.4	0.03
Turkey	-0.35	-0.44	-0.98	0.06	0.91	0.42	0.01
United Kingdom	0.06	-0.04	-0.75	-0.2	2.67	1.95	0.09
USA	-0.33	-0.34	-0.44	-0.13	1.39	11.11	0.04

Mean of variables for each country, solar PV technologies:

Country	Unweighted RTA	Weighted RTA	RCA 2 codes	RCA all codes	Share cap	RD per GDP	GDP
Australia	0.17	0.11	-0.73	-0.71	0.73	1.3	0.67
Austria	-0.01	-0.11	-0.6	-0.23	0.36	1.18	0.28
Belgium	-0.09	-0.2	-0.65	-0.52	2.32	0.74	0.34
Canada	-0.43	-0.43	-0.72	-0.46	0.15	0.56	1.02
Denmark	-0.52	-0.62	-0.52	0.09	0.41	1.07	0.23
Finland	-0.76	-0.7	-0.83	0.25	0.02	0.05	0.18
France	-0.15	-0.28	-0.71	-0.38	0.58	0.99	1.93
Germany	0.13	0.03	-0.17	0.06	3.88	2.69	2.67
Greece	-0.42	-0.57	-0.87	-0.53	1.62	0.92	0.19
Ireland	-0.56	-0.66	-0.82	-0.57	0	0.56	0.15
Italy	-0.36	-0.42	-0.8	-0.36	2.26	2.12	1.59
Japan	0.41	0.35	0.43	0.28	0.86	2.01	4.66
Luxembourg	-0.51	-0.58	-0.64	-0.55	1.22	0.05	0.03
Netherlands	-0.1	-0.22	-0.31	-0.23	0.38	3.88	0.58
New Zealand	-0.62	-0.65	-0.83	-0.47	0.02	0.35	0.09
Norway	-0.46	-0.51	-0.79	-0.68	0.02	0.82	0.27
Portugal	-0.56	-0.64	-0.77	-0.42	0.35	0.43	0.16
Republic of Korea	-0.21	-0.16	-0.02	-0.06	0.33	1.76	0.73
Spain	-0.12	-0.23	-0.51	-0.44	1.11	0.71	0.93
Sweden	-0.53	-0.56	-0.46	-0.09	0.02	0.76	0.36
Switzerland	0.04	-0.1	-0.59	0.11	0.57	3.88	0.4
Turkey	-0.9	-0.87	-0.99	-0.73	0.01	0.29	0.42
United Kingdom	-0.36	-0.43	-0.43	-0.28	0.44	0.16	1.95
USA	0.01	-0.04	-0.08	-0.07	0.09	1.23	11.11



## B-4: Graphical representation of performance within countries – wind technologies

Legend:

- Green line = Unweighted RTA
- Red line = RCA 2 codes
- Orange line = RCA all codes
- Vertical dotted red line = year 1998 (Year after the adoption of the Kyoto Protocol)

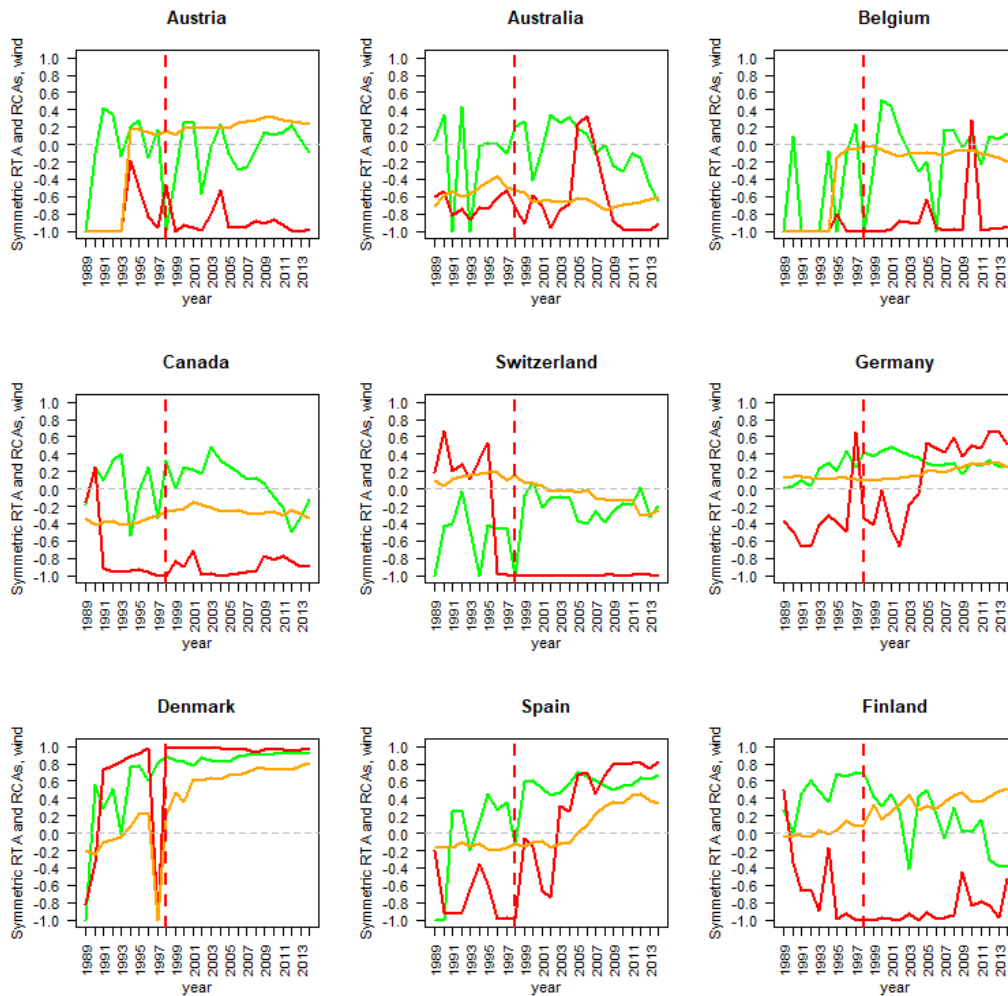

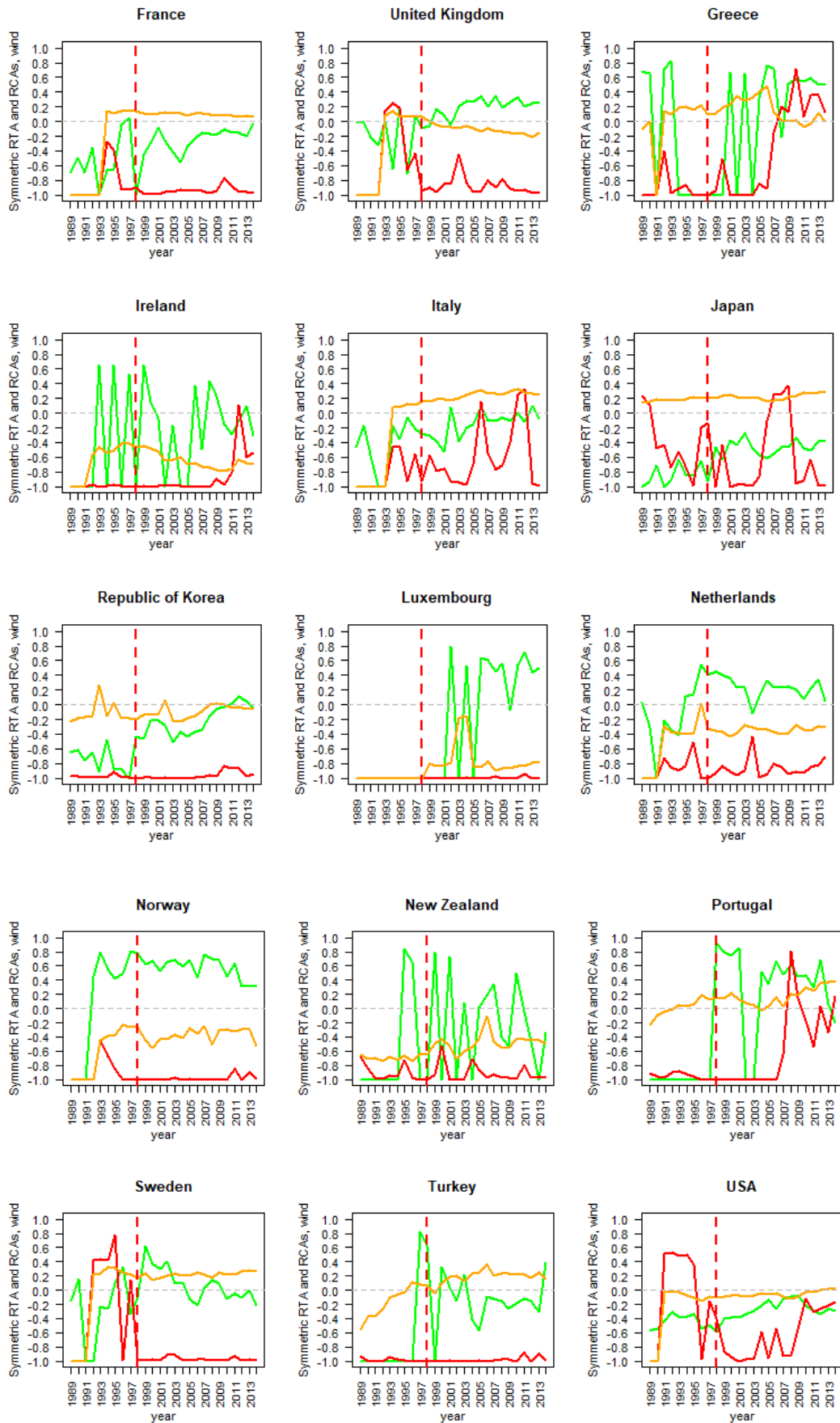

# B-5: Graphical representation of performance within countries – solar PV technologies

Legend:

- Green line = Unweighted RTA
- Red line = RCA 2 codes
- Orange line = RCA all codes
- Vertical dotted red line = year 1998 (Year after the adoption of the Kyoto Protocol)



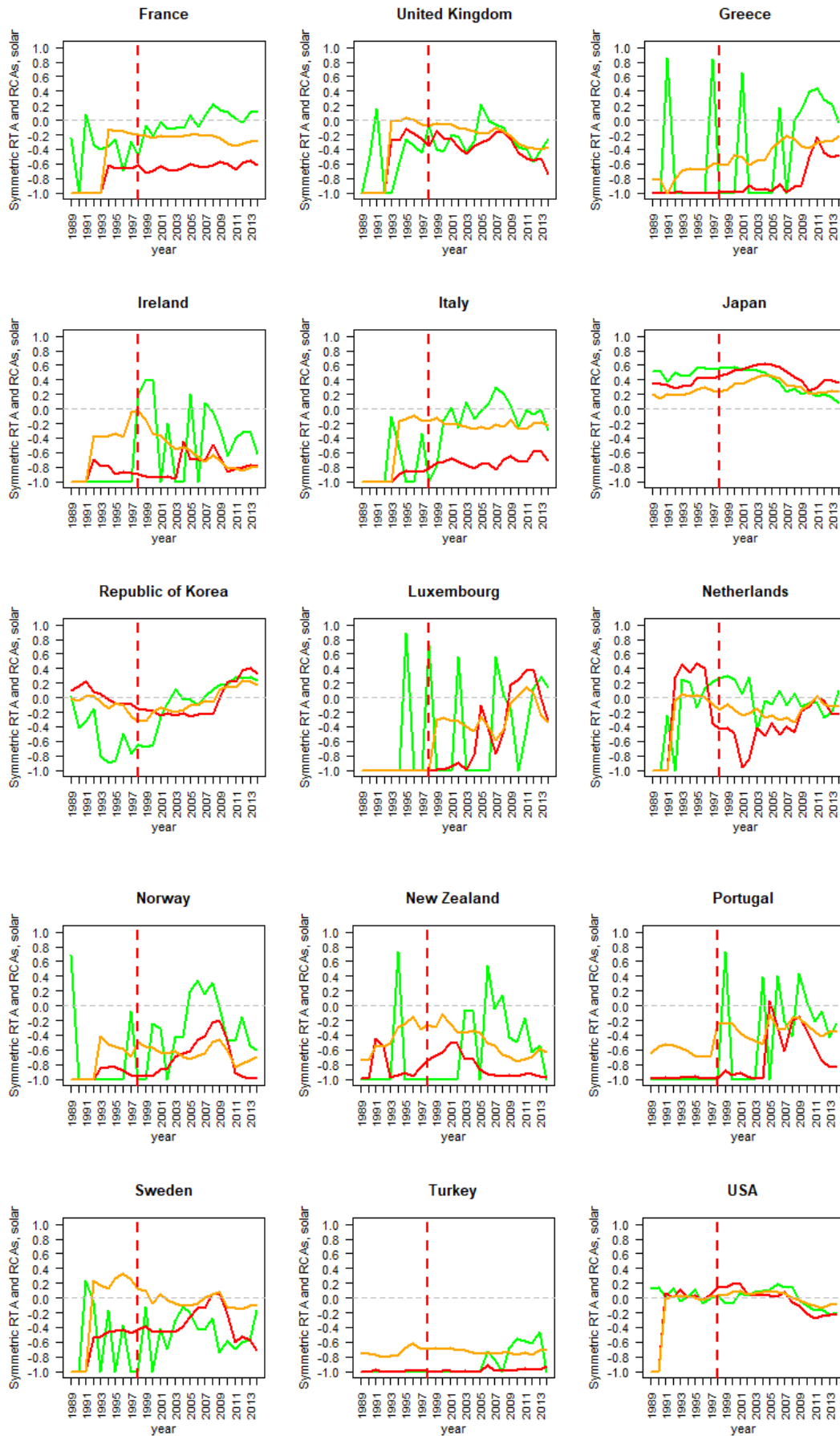

## B-6: Estimation strategy: technical econometric aspects

### Temporal shock CUSUM

Starting with a model  $Y_t = X_t\beta_t + \varepsilon_t$  estimated with OLS, Brown et al. (1975) proposed the following recursive residual as the component of the test statistic:

$$w_t = \frac{y_t - x_t'\hat{\beta}_{t-1}}{\sqrt{1 + [x_t'(X_{t-1}'X_{t-1})^{-1}x_{t-1}]}}$$

Then, in order to run the CUSUM test we compute:

$$W_t = \sum_{t=K+1}^m \frac{w_t}{\hat{\sigma}_w}$$

With:

$$\sigma_w^2 = \frac{1}{T-K-1} \sum_{t=K+1}^m (w_t - \bar{w})^2 ; \bar{w} = \frac{1}{T-K} \sum_{t=K+1}^m w_t \text{ and } m=K+1, \dots, T \text{ (K is the number of coefficients varying over time)}$$

Under the null hypothesis “there is no temporal shock at time m” we must have:  $-L_m \leq W_m \leq L_m$  where  $L_m = \frac{a(2m+T-3K)}{\sqrt{T-K}}$  where  $a$  is a constant depending on the threshold of type I error: 1.143 for 1%; 0.948 for 5% and 0.850 for 10% (Farhani, 2012)

The objective of temporal shock test is to identify the period(s) (*i.e.* year(s)) corresponding to a significant change in the estimated coefficient. If we assume that the year  $m$  corresponds to a temporal shock, and if  $\beta_t$  are the estimated coefficients we test  $\beta_0 = \beta_1 = \dots = \beta_{m-1} \neq \beta_m$

In order to deal with this issue we include in the model dummy exogenous variables equal to one if the years correspond to a temporal shock and zero instead.

### Cross sectional dependence

Let us consider a panel model:  $y_{it} = \alpha_i + \beta x_{it} + u_{it}$  and  $\hat{\rho}_{ij}^2$  the pair-wise correlation coefficient based on residuals of the estimation of the model:  $\hat{\rho}_{ij} = \hat{\rho}_{ji} = \frac{\sum_{t=1}^T \hat{u}_{it}\hat{u}_{jt}}{(\sum_{t=1}^T \hat{u}_{it}^2)^{1/2}(\sum_{t=1}^T \hat{u}_{jt}^2)^{1/2}}$

. Breusch-Pagan (1980) constructed a LM statistic  $\sum_{i=1}^{N-1} \sum_{j=i+1}^N \hat{\rho}_{ij}^2$  which follows a chi-squared distribution with  $\frac{N(N-1)}{2}$  degree of freedom.

The Pesaran CD test statistic is  $\sqrt{\frac{2T}{N(N-1)}} (\sum_{i=1}^{N-1} \sum_{j=i+1}^N \hat{\rho}_{ij}) \sim N(0,1)$  as  $N$  tends to infinite for sufficiently large  $T$ . Pesaran (2004) showed with Monte Carlo simulations that his test is stronger than the LM test for small  $T$  and that the power of this test grows rapidly with  $T$  and  $N$ .

However, the Pesaran CD test has low power when the pair-wise correlations ( $\hat{\rho}_{ij}$ ) are equal to zero. In order to solve this problem, Pesaran et al. (2008) proposed the following LM bias

adjusted statistic:  $\sqrt{\frac{2T}{N(N-1)}} \left( \sum_{i=1}^{N-1} \sum_{j=i+1}^N \hat{\rho}_{ij} \frac{(T-k)\hat{\rho}_{ij}^2 - \mu_{Tij}}{v_{Tij}} \right)$  which tends to a normal distribution  $N(0,1)$  as T and N tend to the infinity.

In the formulas N is the number of units, T is the time period k is the number of regressors,  $\mu_{Tij}$  is the mean of  $(T-k)\hat{\rho}_{ij}^2$ ,  $v_{Tij}$  is the standard deviation of  $(T-k)\hat{\rho}_{ij}^2$

### **Second-generation panel unit root (Pesaran CADF)**

The Pesaran CADF (Cross-sectional Augmented Dickey-Fuller) unit root test is based on an augmented Dickey fuller type regression:

$$\Delta y_{it} = \alpha_i + b_i y_{i,t-1} + c_i \bar{y}_{t-1} + d_i \Delta \bar{y}_t + e_{it}$$

Where:  $\bar{y}_{t-1} = \frac{1}{N} \sum_{i=1}^N y_{i,t-1}$  and  $\Delta \bar{y}_t = \frac{1}{N} \sum_{i=1}^N \Delta y_{i,t}$

This regression looks like the standard Dickey Fuller one but with cross section averages of lagged levels ( $\bar{y}_{t-1}$ ) and first differences of the individual series ( $\Delta \bar{y}_t$ ) which are proxy for the common factor and allow thus to deal with CSD.

Under the null hypothesis of unit root in the series, the statistic test is based on the average of the Im, pesaran and Shin t-bar (Im et al., 2003) test computed for each estimated  $\hat{b}_i$ .<sup>34</sup>

$$\bar{t} = \frac{1}{N} \sum_{i=1}^N t_i$$

The null hypothesis states that  $\hat{b}_i = 0 \forall i$ , *i.e.* each series has a unit root and the alternative hypothesis states that at least one series is stationary: “ $\hat{b}_i < 0$  for at least one *i*”.

### **Cointegration (Westerlund)**

The underlying idea of the Westerlund test is to examine the absence of cointegration by determining if error correction exists among the individual panel members or among the whole panel. The Westerlund test is based on the estimation of the following model:

$$\Delta Y_{i,t} = \delta_i' d_i + \alpha_i (Y_{i,t-1} - \beta_i' X_{i,t-1}) + \sum_{j=1}^{pi} \alpha_{ij} \Delta Y_{i,t-j} + \sum_{j=1}^{pi} \theta_{ij} \Delta X_{i,t-j} + \varepsilon_{i,t}$$

In this model,  $\alpha_i$  gives the speed at which the model gets back to the equilibrium. When  $\alpha_i < 0$  this means that there is error correction, therefore  $y_{it}$  and  $x_{it}$  are cointegrated. Therefore, we can write the null hypothesis as  $H_0 : \alpha_i = 0 \forall i$ .

### **PVAR stability**

The standard stability condition of the panel VAR coefficients is based on the modulus of each eigenvalue of the estimated model. Lütkepohl (2007) and Hamilton (1994) both show that a VAR model is stable if all moduli of the companion matrix are strictly less than one.

---

<sup>34</sup> For further information please refer to Hurlin and Mignon (2007)

We give the theory for VAR model, as the application to a pvar is quite straightforward.

$$(I - \mathbf{B}_1L - \mathbf{B}_2L^2 - \dots - \mathbf{B}_pL^p)I\mathbf{Y}_t = \mathbf{B}_0 + \mathbf{u}_t$$

$$\Leftrightarrow B(L)\mathbf{Y}_t = \mathbf{B}_0 + \mathbf{u}_t$$

Where L is the lag operator (for instance,  $LY_t = Y_{t-1}$ )

Let us assume that  $B(L)$  is invertible, and  $B(L)^{-1}$  be the inverse of  $B(L)$ . Then we get:  $\mathbf{Y}_t = B(L)^{-1}\mathbf{B}_0 + B(L)^{-1}\mathbf{u}_t$  as  $B(L)^{-1}B(L) = I$  where I is the identity matrix

AS, by definition,  $B(L)^{-1} = \left( \frac{1}{|B(L)|} \times \mathbf{adj}(B(L)) \right)$ , we can write:

$$\mathbf{Y}_t = \left( \frac{1}{|B(L)|} \times \mathbf{adj}(B(L)) \right) (\mathbf{B}_0 + \mathbf{u}_t)$$

$$\Leftrightarrow |B(L)|\mathbf{Y}_t = (\mathbf{adj}(B(L))) (\mathbf{B}_0 + \mathbf{u}_t)$$

With :

- $|B(L)|$  = Determinant fo the matrix  $B(L)$ . For instance, for a bivariate VAR (i.e. a VAR with two endogenous variables)  $|B(L)|$  is a polynomial of degree 2
- $\mathbf{adj}(B(L))$  = adjoint matrix of the matrix  $B(L)$

In order to have a stable VAR, the root of  $|B(L)|$  must be greater than 1. This is a necessary condition for  $B(L)$  to be invertible. Said differently, the eigenvalues of  $B(L)$  must have modulus less than one.

### Panel Granger causality

This test works as follows. Let us consider two stationary time series  $x_t$  and  $y_t$  and the following model:

$$y_{i,t} = \alpha_i + \sum_{k=1}^K \beta_{ik}y_{i,t-k} + \sum_{k=1}^K \gamma_{ik}x_{i,t-k} + \varepsilon_{i,t}$$

where x and y are two stationary variables. Coefficients may differ across individuals but not across time periods. We assume that the lag order K is identical for all individuals.

The null hypothesis is the absence of causality for all individuals in the panel.

$$H_0: \gamma_{i1} = \dots = \gamma_{ik} = 0 \quad \forall i = 1, \dots, N$$

The alternative hypothesis assumes there can be causality for some individuals but not necessarily for all:

$$H_1: \gamma_{i1} = \dots = \gamma_{ik} = 0 \quad \forall i = 1, \dots, N_1$$

$$\gamma_{i1} \neq 0 \text{ or } \dots \text{ or } \gamma_{ik} = 0 \quad \forall i = N_1 + 1, \dots, N$$

## **B-7: CUSUM graphs**

CUSUM graphs are available in a separate file: [link](#)



## B-8: Information criteria: relevant number of lags

### Wind - Model without RD

Specification	Lag	MBIC	MAIC	MQIC
1	1	-229.48	-51.70	-122.22
	2	-180.26	-38.04	-94.45
	3	-134.75	-28.08	-70.39
2	1	-235.04	-57.26	-127.78
	2	-188.95	-46.72	-103.13
	3	-142.16	-35.49	-77.80
3	1	-226.93	-49.16	-119.67
	2	-175.47	-33.25	-89.66
	3	-129.43	-22.76	-65.07
4	1	-229.72	-51.94	-122.46
	2	-187.45	-45.23	-101.64
	3	-136.95	-30.28	-72.59

### Wind - Model with RD

Specification	Lag	MBIC	MAIC	MQIC
5	1	-288.57	-62.18	-153.25
	2	-214.81	-45.02	-113.32
	3	-152.42	-39.22	-84.76
6	1	-292.70	-66.31	-157.38
	2	-222.81	-53.02	-121.33
	3	-155.46	-42.26	-87.80
7	1	-278.92	-52.53	-143.61
	2	-214.38	-44.59	-112.90
	3	-145.95	-32.76	-78.30
8	1	-283.47	-57.08	-148.15
	2	-222.29	-52.50	-120.80
	3	-144.16	-30.97	-76.51

For solar PV technologies we also select one lag, whatever the specification:

### Solar PV – model without RD

Specification	Lag	MBIC	MAIC	MQIC
1	1	-240.01	-59.50	-130.93
	2	-188.50	-44.10	-101.24
	3	-144.53	-36.22	-79.08
2	1	-243.66	-63.16	-134.58
	2	-192.09	-47.68	-104.82
	3	-144.99	-36.68	-79.54
3	1	-230.28	-47.20	-119.48
	2	-187.05	-40.58	-98.41
	3	-142.39	-32.55	-75.91
4	1	-237.92	-57.41	-128.84
	2	-192.87	-48.47	-105.61
	3	-149.85	-41.54	-84.40

### Solar PV – model with RD

Specification	Lag	MBIC	MAIC	MQIC
5	1	-325.16	-66.68	-171.42
	2	-274.90	-68.11	-151.90
	3	-208.90	-53.81	-116.66
6	1	-337.07	-78.58	-183.32
	2	-273.89	-67.10	-150.89
	3	-211.59	-56.50	-119.34
7	1	-330.44	-71.96	-176.69
	2	-267.74	-60.95	-144.74
	3	-203.40	-48.31	-111.15
8	1	-334.42	-75.93	-180.67
	2	-273.12	-66.33	-150.12
	3	-210.67	-55.57	-118.42

### **B-9: Hansen’s J-test for wind technologies**

The aim is to test the overidentification of our model and therefore the validity of our instruments. The null hypothesis states “the over-identifying restrictions are valid”. Therefore, if we do not reject the null hypothesis this means that our instruments are valid.

For each specification, we do not reject the null hypothesis, as the p-value is greater than 5%. We can conclude that the instruments are valid.

Model without RD		
Specification	J statistic	P-value
1	38.7	0.74
2	31.6	0.94
3	41.75	0.61
4	31.86	0.76

Model with RD		
Specification	J statistic	P-value
5	83.18	0.38
6	83.91	0.36
7	89.26	0.22
8	85.14	0.33

## B-10: Panel Granger causality tests – wind technologies

In the tables below, we test if the series in the third column influences significantly the series in the second column. The null hypothesis is the absence of Granger-causality between the two series. Therefore, if the p-value (last column) is lower than 5% there is a granger causality between the variables (green p-value). Otherwise, we conclude on the absence of Granger-causality between the two series (red p-value).

### Model without RD

Specification	Equation \ Excluded	chi2	df	P-value
1	Unweighted RTA			
	RCA all codes	10.016	1	0.002
	Share cap	1.545	1	0.214
	RCA all codes			
	Unweighted RTA	0.053	1	0.818
	Share cap	0.26	1	0.61
	Share cap			
	Unweighted RTA	3.343	1	0.067
RCA all codes	0.341	1	0.559	
2	Weighted RTA			
	RCA all codes	7.626	1	0.006
	Share cap	2.242	1	0.134
	RCA all codes			
	Weighted RTA	0.456	1	0.5
	Share cap	0.465	1	0.495
	Share cap			
	Weighted RTA	0.084	1	0.772
RCA all codes	1.967	1	0.161	
3	Unweighted RTA			
	RCA 2 codes	5.003	1	0.025
	Share cap	1.521	1	0.218
	RCA 2 codes			
	Unweighted RTA	0.947	1	0.331
	Share cap	0.046	1	0.83
	Share cap			
	Unweighted RTA	1.078	1	0.299
RCA 2 codes	0.098	1	0.754	
4	Weighted RTA			
	RCA 2 codes	2.068	1	0.15
	Share cap	0.916	1	0.338
	RCA 2 codes			
	Weighted RTA	4	1	0.045
	Share cap	0.11	1	0.74
	Share cap			
	Weighted RTA	0.244	1	0.621
RCA 2 codes	0.526	1	0.468	

## Model with RD – wind technologies

Specification	Equation \ Extended	chi2	df	P-value	
5	Unweighted RTA	RCA all codes	50.77	1	0
		RD	1.935	1	0.164
		Share cap	8.527	1	0.003
	RCA all codes	Unweighted RTA	6.2	1	0.013
		RD	0.832	1	0.362
		Share cap	6.457	1	0.011
	RD	Unweighted RTA	0.518	1	0.472
		RCA all codes	4.864	1	0.027
		Share cap	30.996	1	0
	Share cap	Unweighted RTA	0.246	1	0.62
		RCA all codes	21.326	1	0
		RD	7.847	1	0.005
6	Weighted RTA	RCA all codes	21.843	1	0
		RD	11.991	1	0.001
		Share cap	12.848	1	0
	RCA all codes	Weighted RTA	0.399	1	0.528
		RD	0.591	1	0.442
		Share cap	3.802	1	0.051
	RD	Weighted RTA	1.582	1	0.208
		RCA all codes	4.192	1	0.041
		Share cap	25.22	1	0
	Share cap	Weighted RTA	0.978	1	0.323
		RCA all codes	20.086	1	0
		RD	4.623	1	0.032
7	Unweighted RTA	RCA 2 codes	19.447	1	0
		RD	0.699	1	0.403
		Share cap	7.694	1	0.006
	RCA 2 codes	Unweighted RTA	0.409	1	0.523
		RD	2.615	1	0.106
		Share cap	0.705	1	0.401
	RD	Unweighted RTA	0.355	1	0.551
		RCA 2 codes	3.417	1	0.065
		Share cap	0.394	1	0.53
	Share cap	Unweighted RTA	10.109	1	0.001
		RCA 2 codes	24.178	1	0
		RD	0.025	1	0.875
8	Weighted RTA	RCA 2 codes	39.969	1	0
		RD	7.571	1	0.006
		Share cap	3.806	1	0.051
	RCA 2 codes	Weighted RTA	7.862	1	0.005
		RD	1.146	1	0.284
		Share cap	0.897	1	0.343
	RD	Weighted RTA	0.99	1	0.32
		RCA 2 codes	0.012	1	0.913
		Share cap	0	1	0.998
	Share cap	Weighted RTA	1.642	1	0.2
		RCA 2 codes	13.413	1	0
		RD	0.732	1	0.392

### **B-11: Panel VAR stability, wind technologies**

Panel VAR is a prerequisite to IRF and FEVD investigations. A panel VAR is stable if its modulus is lower than one. In the two table below all the modulus are lower than one. Therefore, all our PVAR are stable and are able to run IRF and FEVD investigations.

#### **Model without RD**

Specification	Eigenvalue		Modulus
	Real	Imaginary	
1	0.83	0.00	0.83
	-0.59	0.00	0.59
	0.18	0.00	0.18
2	0.85	0.00	0.85
	-0.46	0.00	0.46
	0.28	0.00	0.28
3	0.59	-0.16	0.61
	0.59	0.16	0.61
	-0.43	0.00	0.43
4	0.55	0.27	0.62
	0.55	-0.27	0.62
	-0.39	0.00	0.39

**Model with RD – wind technologies**

Specification	Eigenvalue		Modulus
	Real	Imaginary	
5	0.74	0.00	0.74
	-0.43	0.00	0.43
	0.29	0.00	0.29
	0.01	0.00	0.01
6	Eigenvalue		Modulus
	Real	Imaginary	
	0.74	0.00	0.74
	-0.43	0.00	0.43
	0.29	0.00	0.29
0.01	0.00	0.01	
7	Eigenvalue		Modulus
	Real	Imaginary	
	0.71	0.00	0.71
	-0.42	0.00	0.42
	0.41	0.00	0.41
-0.22	0.00	0.22	
8	Eigenvalue		Modulus
	Real	Imaginary	
	0.60	-0.34	0.69
	0.60	0.34	0.69
	-0.29	0.00	0.29
-0.26	0.00	0.26	

## B-12: PVAR estimations – wind technologies

### Model without RD

	Unweighted RTA	Weighted RTA	Unweighted RTA	Weighted RTA
L.Unweighted RTA	0.0294 (0.13)		0.429* (2.55)	
L.Weighted RTA		0.0565 (0.24)		0.467+ (1.93)
L.RCA all codes	-1.302** (-3.16)	-1.098** (-2.76)		
L.RCA 2 codes			-0.365* (-2.24)	-0.290 (-1.44)
L.D2.share cap	0.0435 (1.24)	0.0643 (1.50)	0.0351 (1.23)	0.0362 (0.96)
GDP	0.0296+ (1.71)	0.0471* (2.16)	0.0293 (1.55)	0.0405+ (1.70)
year_1998	-0.320* (-2.26)	-0.289* (-2.23)	-0.267* (-2.16)	-0.184 (-1.53)
year_2005	-0.0990 (-1.40)	-0.106 (-1.56)	-0.0299 (-0.40)	-0.0135 (-0.17)
year_2009	-0.00402 (-0.12)	-0.0132 (-0.35)	0.0215 (0.66)	0.0181 (0.38)
Number of obs.	384	384	384	384

*t statistics in parentheses*

+  $p < 0.10$ , \*  $p < 0.05$ , \*\*  $p < 0.01$ , \*\*\*  $p < 0.001$

	RCA all codes	RCA all codes	RCA 2 codes	RCA 2 codes
L.Unweighted RTA	0.00722 (0.23)		0.0830 (0.97)	
L.Weighted RTA		0.0212 (0.67)		0.259* (2.00)
L.RCA all codes	0.832*** (10.45)	0.866*** (11.03)		
L.RCA 2 codes			0.608*** (4.40)	0.564*** (3.51)
L.D2.share cap	-0.00307 (-0.51)	-0.00457 (-0.68)	-0.00634 (-0.21)	-0.0122 (-0.33)
GDP	0.00262 (0.66)	0.00149 (0.36)	0.0431 (1.49)	0.0413 (1.41)
year_1998	0.00808 (0.43)	0.0177 (0.82)	-0.140+ (-1.91)	-0.0626 (-0.82)
year_2005	0.0154 (1.03)	0.0128 (0.89)	-0.0253 (-0.42)	0.0425 (0.76)
year_2009	0.0133 (1.34)	0.0152 (1.52)	0.0367 (0.94)	0.0277 (0.62)
Number of obs.	384	384	384	384

*t statistics in parentheses*

+  $p < 0.10$ , \*  $p < 0.05$ , \*\*  $p < 0.01$ , \*\*\*  $p < 0.001$



	<b>D2.share cap</b>	<b>D2.share cap</b>	<b>D2.share cap</b>	<b>D2.share cap</b>
L.Unweighted RTA	0.734+ (1.83)		0.283 (1.04)	
L.Weighted RTA		-0.167 (-0.29)		-0.176 (-0.49)
L.RCA all codes	0.555 (0.58)	-1.508 (-1.40)		
L.RCA 2 codes			-0.111 (-0.31)	-0.215 (-0.73)
L.D2.share cap	-0.549*** (-3.80)	-0.383* (-2.14)	-0.416*** (-3.40)	-0.382*** (-3.30)
GDP	-0.0784 (-1.38)	-0.0190 (-0.26)	-0.0426 (-0.77)	-0.0327 (-0.64)
year_1998	0.112 (0.85)	-0.240 (-0.96)	-0.00941 (-0.13)	-0.157* (-1.98)
year_2005	0.141 (1.26)	-0.0542 (-0.31)	0.162 (1.43)	0.0416 (0.40)
year_2009	0.111 (0.72)	0.0737 (0.41)	0.0453 (0.30)	0.0552 (0.37)
Number of obs.	384	384	384	384

*t statistics in parentheses*

+  $p < 0.10$ , \*  $p < 0.05$ , \*\*  $p < 0.01$ , \*\*\*  $p < 0.001$

**Model with RD – wind technologies**

	Unweighted RTA	Weighted RTA	Unweighted RTA	Weighted RTA
L.Unweighted RTA	0.0952 (1.01)		0.452*** (3.95)	
L.Weighted RTA		0.128 (0.98)		0.321* (2.03)
L.RCA all codes	-0.753*** (-7.13)	-0.500*** (-4.67)		
L.RCA 2 codes			-0.399*** (-4.41)	-0.437*** (-6.32)
L.D.RD	0.125 (1.39)	0.439*** (3.46)	0.0937 (0.84)	0.427** (2.75)
L.D2.share cap	0.0387** (2.92)	0.0611*** (3.58)	0.0556** (2.77)	0.0407+ (1.95)
year_1998	-0.394*** (-4.68)	-0.425*** (-6.43)	-0.132 (-1.25)	-0.329*** (-4.35)
year_2005	0.0184 (0.44)	0.0108 (0.28)	0.0464 (0.85)	0.0306 (0.65)
year_2009	0.0203 (0.67)	0.0543 (1.51)	0.0580+ (1.84)	0.0742+ (1.84)
N	239	239	239	239

*t statistics in parentheses*

*+ p<0.10, \* p<0.05, \*\* p<0.01, \*\*\* p<0.001*

	RCA all codes	RCA all codes	RCA 2 codes	RCA 2 codes
L.Unweighted RTA	0.0577* (2.49)		-0.0432 (-0.64)	
L.Weighted RTA		0.0187 (0.63)		0.308** (2.80)
L.RCA all codes	0.791*** (20.27)	0.788*** (19.38)		
L.RCA 2 codes			0.595*** (7.24)	0.730*** (7.33)
L.D.RD	-0.0277 (-0.91)	-0.0253 (-0.77)	-0.160 (-1.62)	-0.116 (-1.07)
L.D2.share cap	-0.00984* (-2.54)	-0.00836+ (-1.95)	0.0124 (0.84)	0.0147 (0.95)
year_1998	0.0279* (2.52)	0.00747 (0.60)	-0.259*** (-3.62)	-0.154* (-2.06)
year_2005	0.00991 (0.87)	0.00483 (0.43)	-0.0124 (-0.31)	-0.0248 (-0.55)
year_2009	0.0105 (1.11)	0.0142 (1.51)	0.129*** (3.45)	0.0740* (2.19)
N	239	239	239	239

*t statistics in parentheses*

*+ p<0.10, \* p<0.05, \*\* p<0.01, \*\*\* p<0.001*

	D2.share cap	D2.share cap	D2.share cap	D2.share cap
L.Unweighted RTA	-0.0940 (-0.50)		-0.715** (-3.18)	
L.Weighted RTA		-0.294 (-0.99)		-0.533 (-1.28)
L.RCA all codes	-1.405*** (-4.62)	-1.474*** (-4.48)		
L.RCA 2 codes			-1.051*** (-4.92)	-0.702*** (-3.66)
L.D.RD	-1.004** (-2.80)	-0.837* (-2.15)	-0.0691 (-0.16)	0.368 (0.86)
L.D2.share cap	-0.0515 (-0.62)	-0.0698 (-0.77)	-0.173+ (-1.80)	-0.198* (-2.07)
year_1998	-0.0911+ (-1.76)	-0.0887 (-1.12)	-0.173+ (-1.76)	-0.185+ (-1.94)
year_2005	0.0668 (0.67)	0.0552 (0.53)	0.0893 (0.87)	0.0294 (0.33)
year_2009	0.258 (1.49)	0.287+ (1.67)	0.506*** (3.33)	0.469** (3.26)
N	239	239	239	239

*t statistics in parentheses*

*+ p<0.10, \* p<0.05, \*\* p<0.01, \*\*\* p<0.001*

	D.RD	D.RD	D.RD	D.RD
L.Unweighted RTA	0.0193 (0.72)		0.0188 (0.60)	
L.Weighted RTA		0.0749 (1.26)		-0.0361 (-0.99)
L.RCA all codes	0.120* (2.21)	0.117* (2.05)		
L.RCA 2 codes			0.0485+ (1.85)	-0.00285 (-0.11)
L.D.RD	-0.304** (-3.06)	-0.467*** (-4.72)	-0.474*** (-4.11)	-0.519*** (-5.07)
L.D2.share cap	-0.0332*** (-5.57)	-0.0362*** (-5.02)	-0.00393 (-0.63)	0.0000165 (0.00)
year_1998	0.0551** (3.17)	0.0576** (2.65)	0.0829*** (3.94)	0.0654** (3.15)
year_2005	-0.0195 (-1.32)	-0.0169 (-1.05)	-0.0157 (-1.04)	-0.00416 (-0.31)
year_2009	0.0585** (2.77)	0.0541* (2.44)	0.0610** (2.84)	0.0575** (2.69)
N	239	239	239	239

*t statistics in parentheses*

*+ p<0.10, \* p<0.05, \*\* p<0.01, \*\*\* p<0.001*

### B-13: IRF analysis – wind technologies

Variable names in the following figures are those used in STATA. The following table gives the meaning of each variable:

Stata variable name	Label
rta_sw	Unweighted RTA
rta_sw_fw	Weighted RTA
rca_sw	RCA all codes
rca_sw_2c	RCA 2 codes
d2_sh-w-cap	Share capacities differentiated twice
d_rd_gdp_w	Public RD expenditures per GDP, differentiated once

We present the results for each specification. We number them from 1 to 8 as follows:

Specification	Endogenous variables	Exogenous variables
1	Unweighted RTA - RCA all codes - share capacities	GDP - year dummy variables
2	Weighted RTA - RCA all codes - share capacities	GDP - year dummy variables
3	Unweighted RTA - RCA 2 codes - share capacities	GDP - year dummy variables
4	Weighted RTA - RCA 2 codes - share capacities	GDP - year dummy variables
5	Unweighted RTA - RCA all codes - share capacities - RD	year dummy variables
6	Weighted RTA - RCA all codes - share capacities - RD	year dummy variables
7	Unweighted RTA - RCA 2 codes - share capacities - RD	year dummy variables
8	Weighted RTA - RCA 2 codes - share capacities - RD	year dummy variables

#### Model without RD

1)

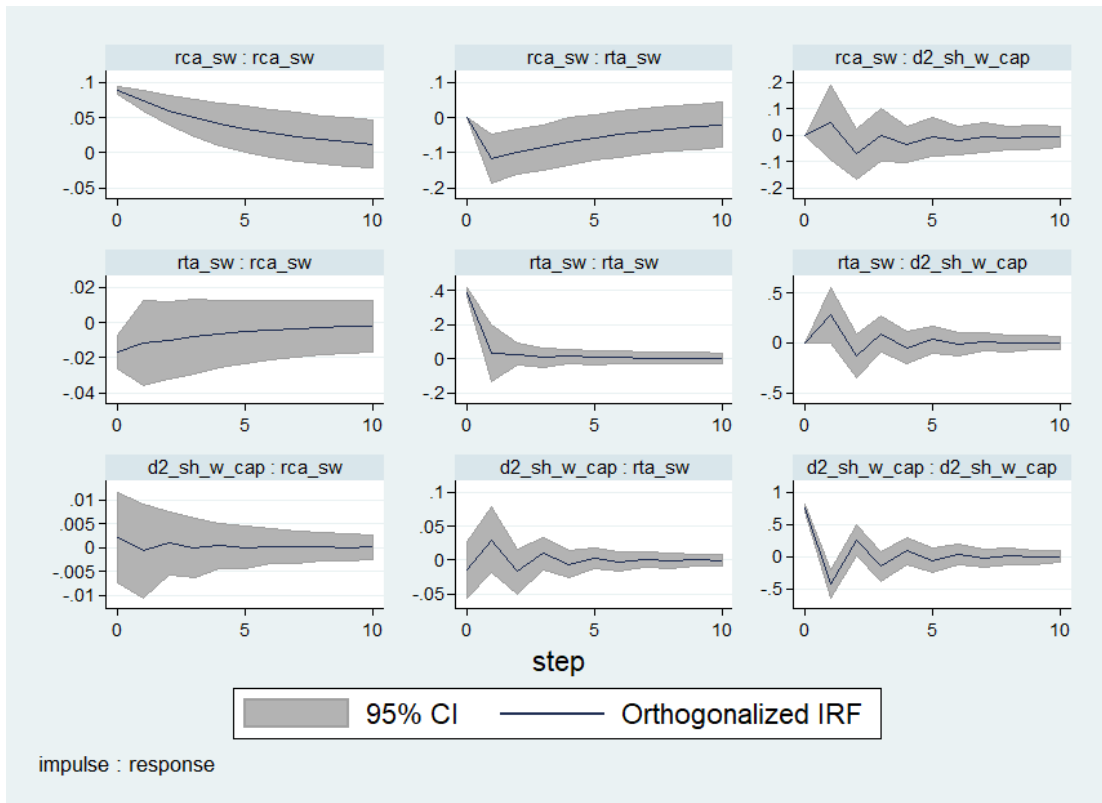

2)

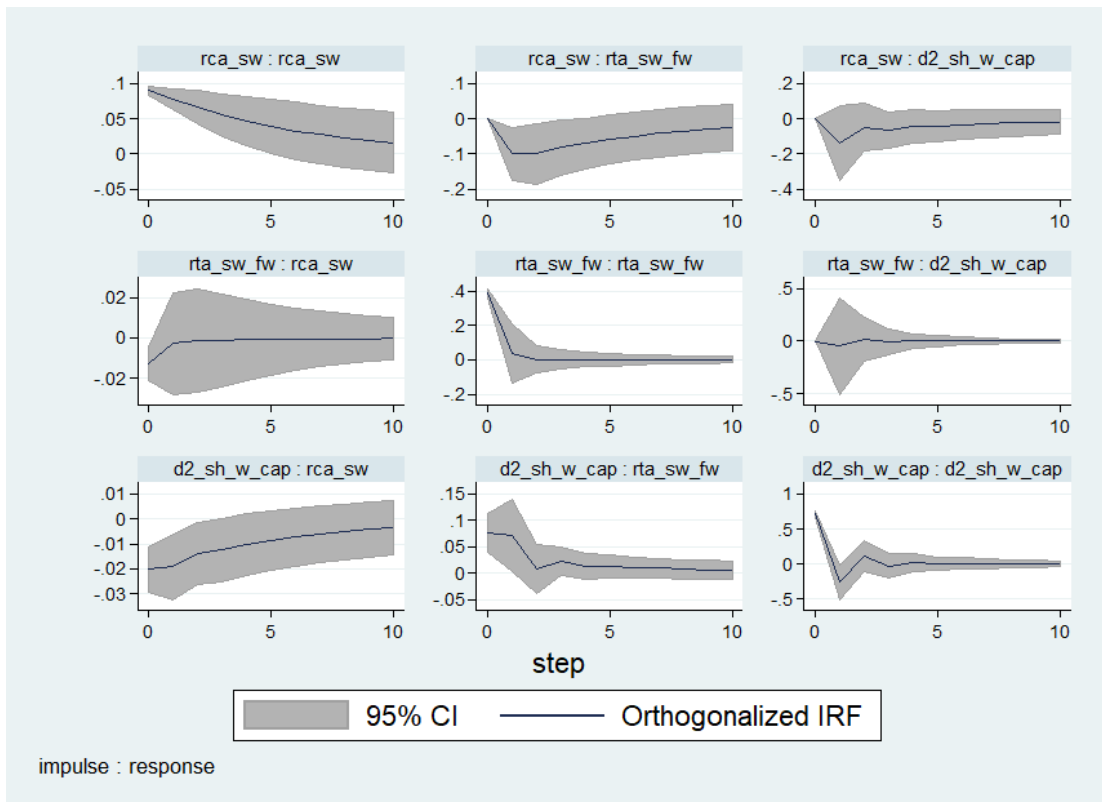

3)

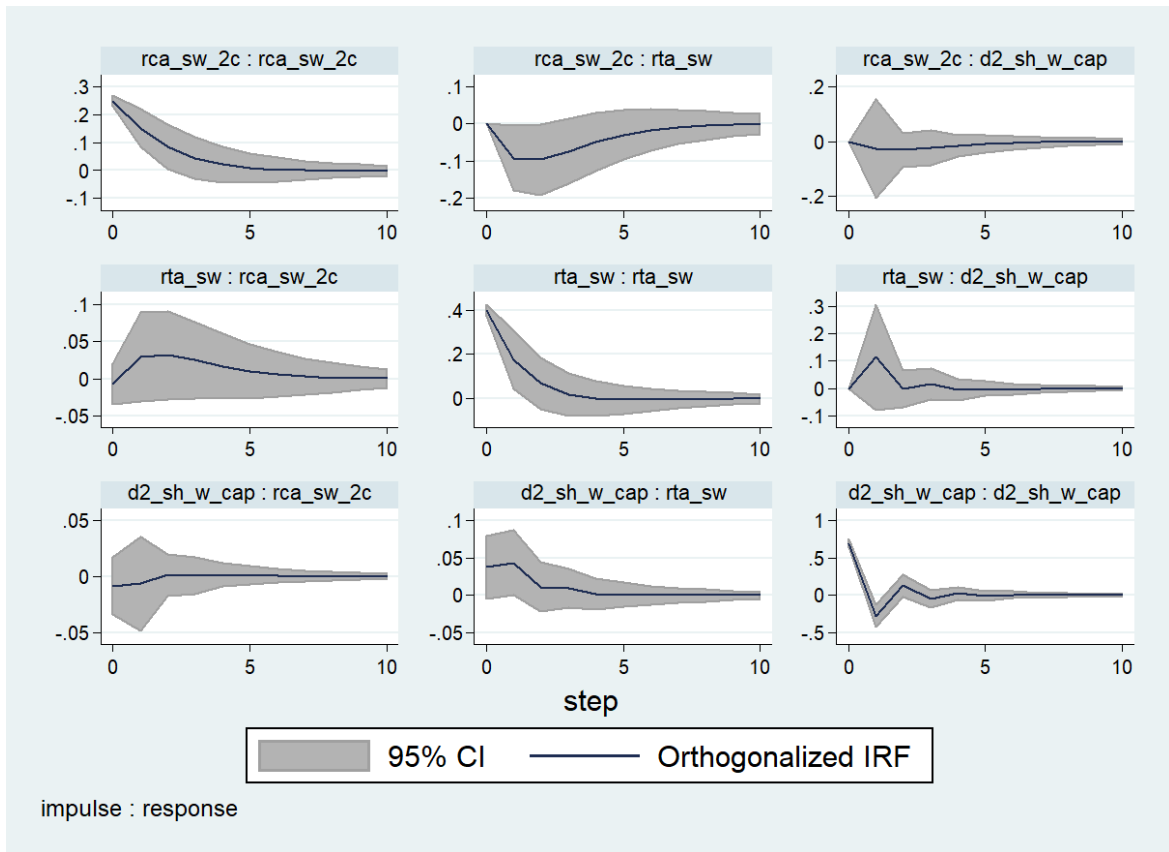

4)

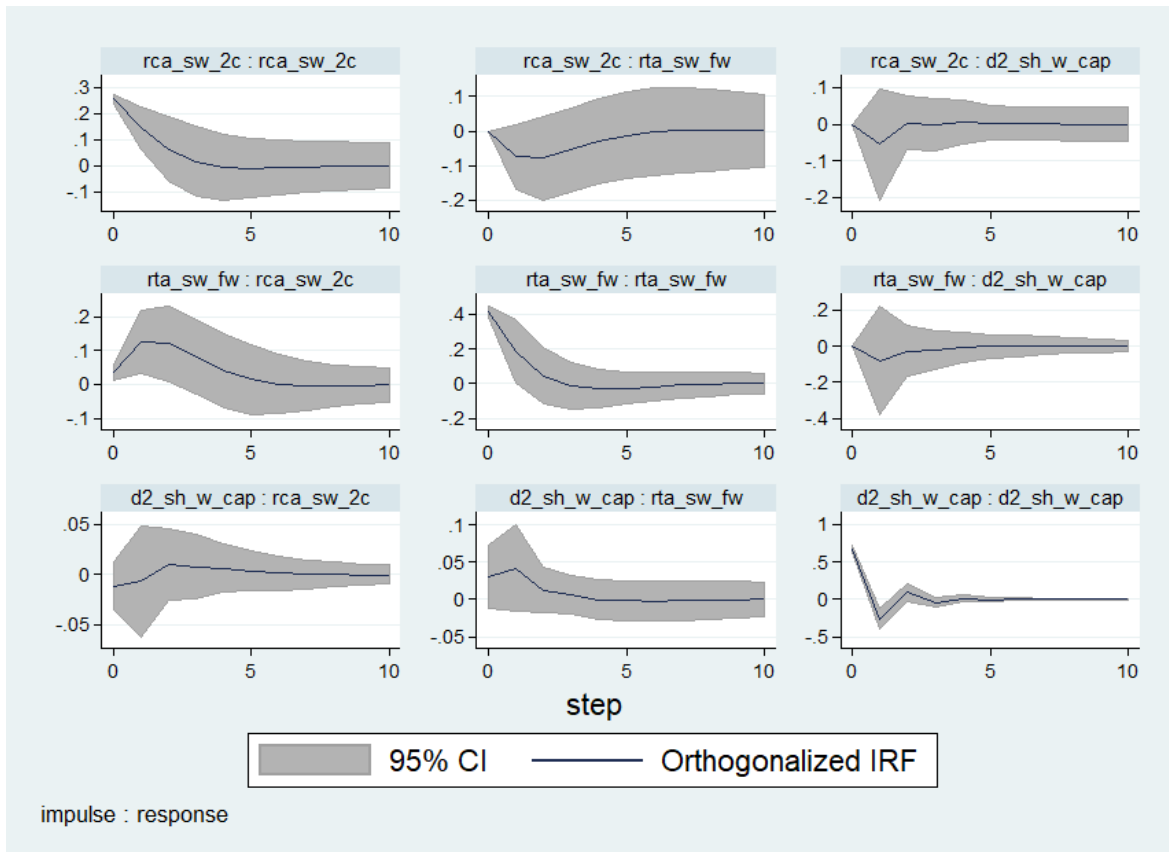



## Model with RD – wind technologies

5)

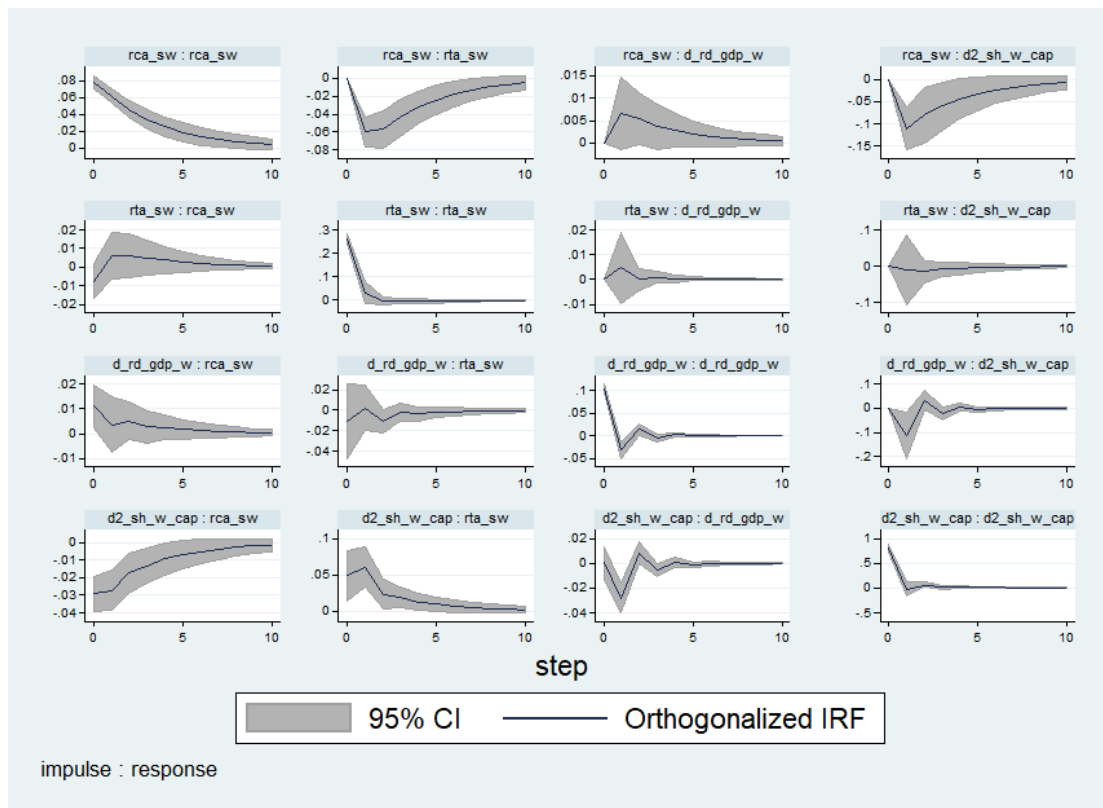

6)

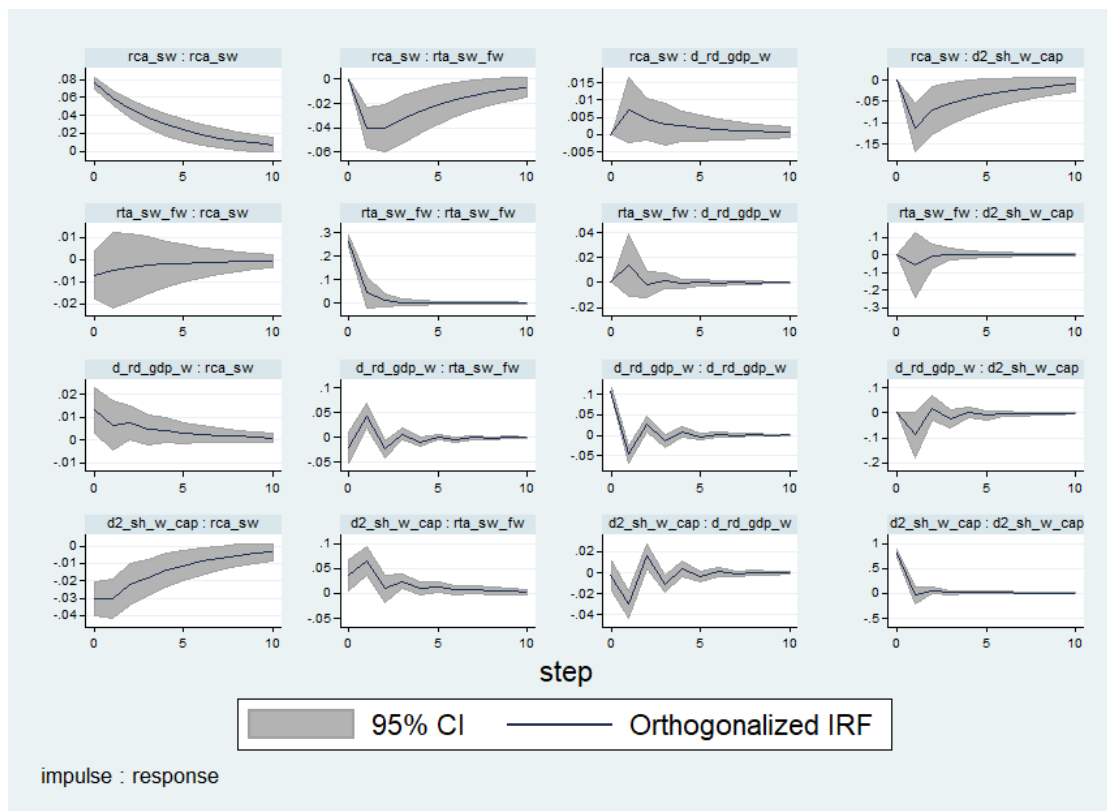

7)

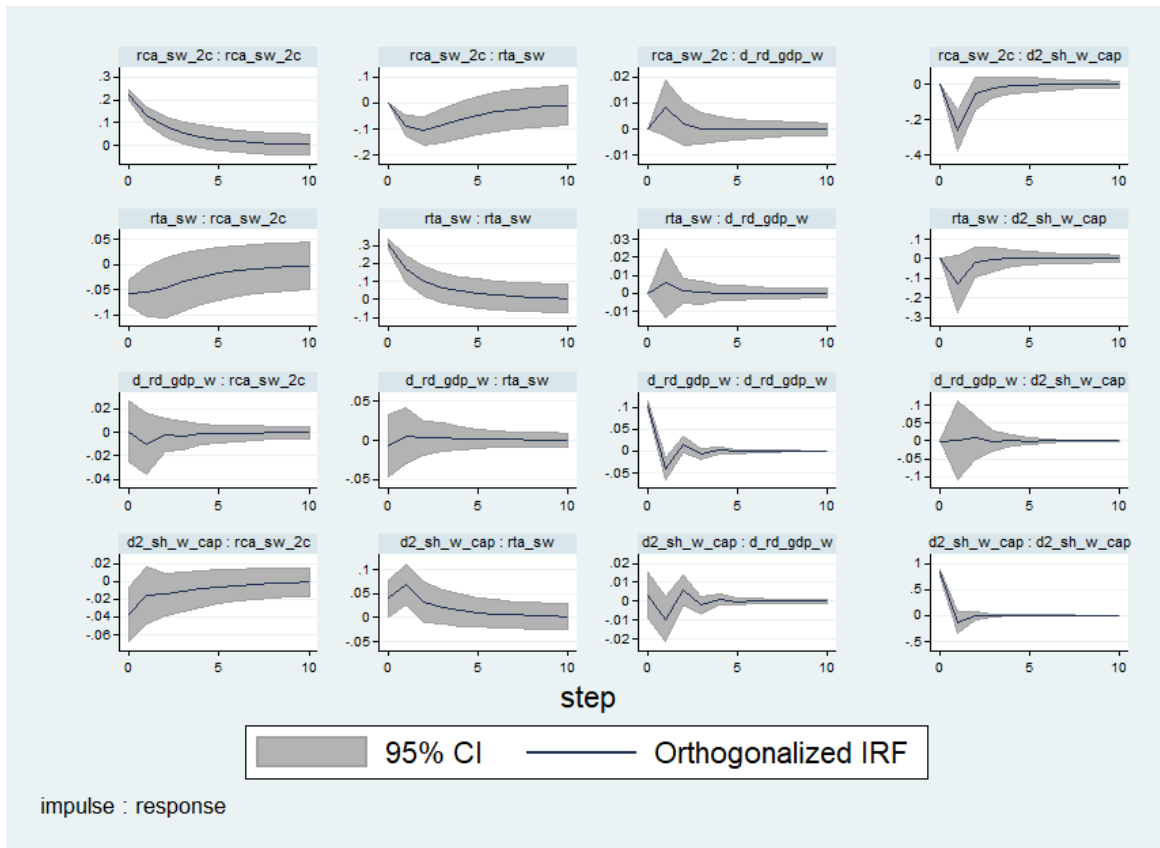

8)

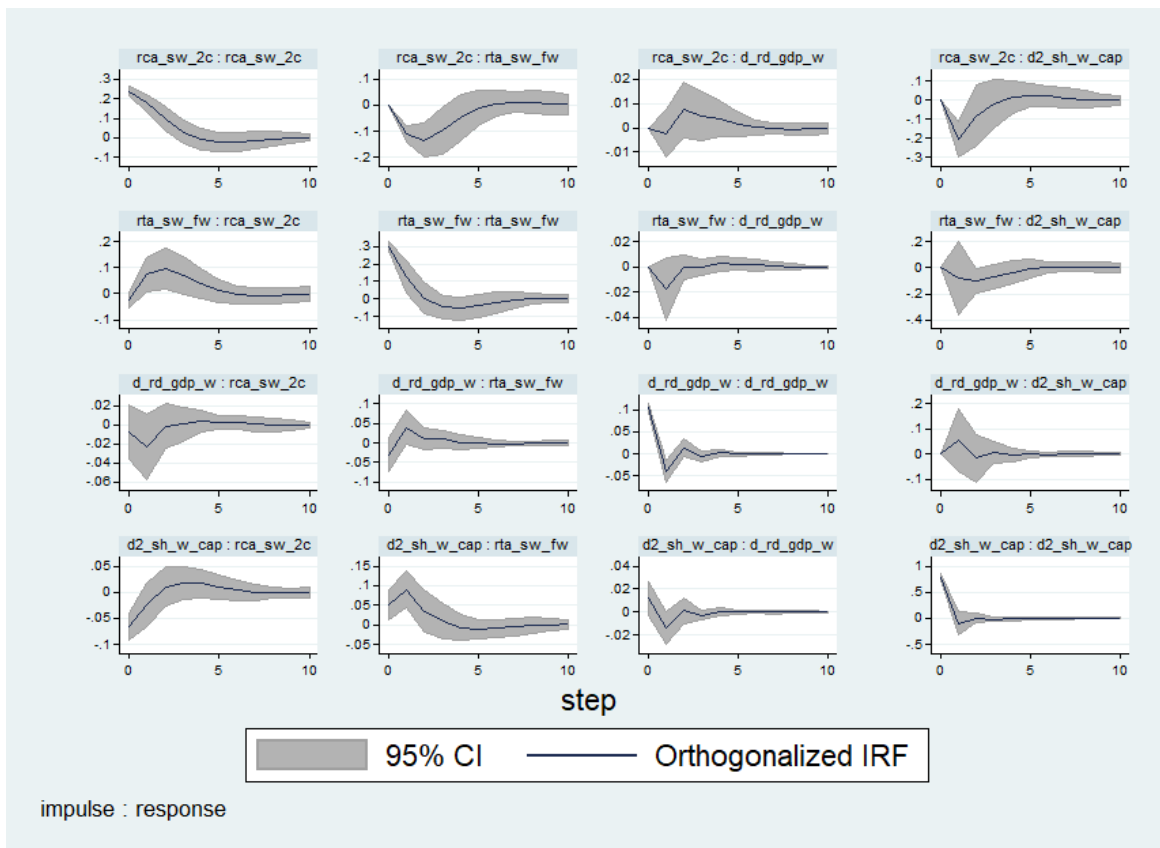

## B-14: FEVD analysis – wind technologies

Reminder :

Specification	Endogenous variables	Exogenous variables
1	Unweighted RTA - RCA all codes - share capacities	GDP - year dummy variables
2	Weighted RTA - RCA all codes - share capacities	GDP - year dummy variables
3	Unweighted RTA - RCA 2 codes - share capacities	GDP - year dummy variables
4	Weighted RTA - RCA 2 codes - share capacities	GDP - year dummy variables
5	Unweighted RTA - RCA all codes - share capacities - RD	year dummy variables
6	Weighted RTA - RCA all codes - share capacities - RD	year dummy variables
7	Unweighted RTA - RCA 2 codes - share capacities - RD	year dummy variables
8	Weighted RTA - RCA 2 codes - share capacities - RD	year dummy variables

### Model without RD – wind technologies

1)

step	D2.share cap	RCA all codes	Unweighted RTA
D2.share cap			
1	100.00%	0.00%	0.00%
5	88.10%	0.90%	11.00%
10	<b>87.96%</b>	0.96%	11.08%
RCA all codes			
1	0.05%	96.40%	3.55%
5	0.03%	97.11%	2.87%
10	0.02%	97.16%	2.82%
Unweighted RTA			
1	0.13%	0.00%	99.87%
5	0.78%	17.96%	81.26%
10	0.75%	21.36%	77.89%

2)

step	D2.share cap	RCA all codes	Weighted RTA
D2.share cap			
1	100.00%	0.00%	0.00%
5	95.24%	4.38%	0.38%
10	94.54%	5.08%	0.37%
RCA all codes			
1	4.72%	93.43%	1.86%
5	4.86%	94.45%	0.69%
10	4.82%	94.59%	0.59%
Weighted RTA			
1	3.83%	0.00%	96.17%

5	6.18%	16.10%	77.72%
10	6.11%	19.93%	73.96%

3)

step	D2.share cap	RCA 2 codes	Unweighted RTA
D2.share cap			
1	100.00%	0.00%	0.00%
5	97.33%	0.43%	2.24%
10	97.30%	0.45%	2.25%
RCA 2 codes			
1	0.11%	99.82%	0.07%
5	0.12%	97.05%	2.83%
10	0.12%	96.91%	2.97%
Unweighted RTA			
1	0.86%	0.00%	99.14%
5	1.55%	11.23%	87.22%
10	1.55%	11.68%	86.77%

4)

step	D2.share cap	RCA 2 codes	Weighted RTA
D2.share cap			
1	100.00%	0.00%	0.00%
5	97.99%	0.57%	1.45%
10	97.98%	0.57%	1.45%
RCA 2 codes			
1	0.19%	97.97%	1.84%
5	0.29%	69.07%	30.64%
10	0.30%	68.98%	30.73%
Weighted RTA			
1	0.53%	0.00%	99.47%
5	1.25%	6.85%	91.90%
10	1.25%	6.88%	91.87%

### Model with RD – wind technologies

5)

step	D2.share cap	D.RD	RCA all codes	Unweighted RTA
D2.share cap				
1	100.00%	0.00%	0.00%	0.00%
5	94.41%	2.08%	3.45%	0.06%
10	94.11%	2.08%	3.74%	0.07%
D.RD				
1	0.00%	100.00%	0.00%	0.00%
5	6.81%	92.30%	0.71%	0.17%
10	6.82%	92.22%	0.78%	0.18%
RCA all codes				
1	12.05%	1.72%	85.44%	0.80%
5	13.35%	1.08%	84.51%	1.06%
10	13.31%	1.06%	84.53%	1.10%
Unweighted RTA				
1	3.40%	0.17%	0.00%	96.43%
5	8.26%	0.30%	11.42%	80.02%
10	8.33%	0.31%	12.61%	78.75%

6)

step	D2.share cap	D.RD	RCA all codes	Weighted RTA
D2.share cap				
1	100.00%	0.00%	0.00%	0.00%
5	94.90%	1.27%	3.31%	0.52%
10	94.50%	1.28%	3.70%	0.52%
D.RD				
1	0.07%	99.93%	0.00%	0.00%
5	7.89%	90.35%	0.54%	1.22%
10	7.96%	90.23%	0.59%	1.22%
RCA all codes				
1	13.05%	2.47%	83.76%	0.72%
5	16.56%	1.80%	81.09%	0.56%
10	16.72%	1.77%	80.97%	0.54%

Weighted RTA				
1	1.79%	0.60%	0.00%	97.61%
5	7.12%	3.54%	5.89%	83.44%
10	7.33%	3.51%	7.03%	82.13%

7)

step	D2.share cap	D.RD	RCA 2 codes	Unweighted RTA
D2.share cap				
1	100.00%	0.00%	0.00%	0.00%
5	88.84%	0.01%	9.04%	2.12%
10	88.83%	0.01%	9.04%	2.12%
D.RD				
1	0.09%	99.91%	0.00%	0.00%
5	1.12%	98.02%	0.58%	0.28%
10	1.12%	98.02%	0.58%	0.28%
RCA 2 codes				
1	2.56%	0.00%	91.29%	6.14%
5	2.29%	0.13%	86.18%	11.40%
10	2.32%	0.13%	85.72%	11.84%
Unweighted RTA				
1	1.63%	0.05%	0.00%	98.32%
5	4.66%	0.07%	17.15%	78.12%
10	4.61%	0.07%	18.91%	76.41%

8)

step	D2.share cap	D.RD	RCA 2 codes	Weighted RTA
D2.share cap				
1	100.00%	0.00%	0.00%	0.00%
5	89.36%	0.44%	7.10%	3.10%
10	89.19%	0.44%	7.24%	3.13%
D.RD				
1	1.39%	98.61%	0.00%	0.00%
5	2.61%	94.35%	0.71%	2.34%

10	2.61%	94.28%	0.73%	2.38%
RCA 2 codes				
1	7.04%	0.10%	91.77%	1.09%
5	4.47%	0.47%	78.24%	16.82%
10	4.51%	0.48%	78.16%	16.85%
Weighted RTA				
1	2.85%	0.94%	0.00%	96.21%
5	7.32%	1.54%	24.77%	66.37%
10	7.34%	1.52%	24.71%	66.43%

**B-15: Results for wind model without RD on 15 countries**

All the results are available online ([link](#))

### B-16 : Hansen J-test for solar PV technologies

Model without RD		
Specification	J statistic	P-value
1	31.54	0.94
2	27.04	0.98
3	32.53	0.92
4	32.33	0.92

Model with RD		
Specification	J statistic	P-value
5	90.56	0.2
6	82.67	0.4
7	98.86	0.09
8	85.38	0.317

### B-17: Panel stability – solar PV technologies

#### Model without RD

Specification	Eigenvalue		Modulus
	Real	Imaginary	
1	0.89	0.00	0.89
	0.69	0.00	0.69
	0.34	0.00	0.34
2	0.90	0.00	0.90
	0.65	0.00	0.65
	0.46	0.00	0.46
3	0.82	0.00	0.82
	0.64	0.11	0.64
	0.64	-0.11	0.64
4	0.87	0.00	0.87
	0.67	-0.16	0.68
	0.67	0.16	0.68



**Model with RD**

	Eigenvalue		Modulus
	Real	Imaginary	
5	0.82	0.02	0.82
	0.82	-0.02	0.82
	0.33	0.00	0.33
	-0.20	0.00	0.20
	Eigenvalue		Modulus
	Real	Imaginary	
6	0.85	0.00	0.85
	0.76	0.00	0.76
	0.24	0.00	0.24
	-0.14	0.00	0.14
	Eigenvalue		Modulus
	Real	Imaginary	
7	0.81	0.00	0.81
	0.37	0.13	0.39
	0.37	-0.13	0.39
	-0.23	0.00	0.23
	Eigenvalue		Modulus
	Real	Imaginary	
8	0.81	0.00	0.81
	0.40	0.00	0.40
	-0.04	-0.13	0.14
	-0.04	0.13	0.14

## B-18: Panel Granger causality – solar PV technologies

### Model without RD

Specification	Equation \ Excluded	chi2	df	P-value
1	Unweighted RTA			
	RCA all codes	0.91	1	0.34
	Share cap	0.83	1	0.363
	RCA all codes			
	Unweighted RTA	1.77	1	0.184
	Share cap	1.84	1	0.175
	Share cap			
	Unweighted RTA	0.08	1	0.78
	RCA all codes	4.16	1	0.041
2	Weighted RTA			
	RCA all codes	0.18	1	0.672
	Share cap	2.19	1	0.139
	RCA all codes			
	Weighted RTA	1.64	1	0.2
	Share cap	3.03	1	0.082
	Share cap			
	Weighted RTA	0.33	1	0.564
	RCA all codes	0.01	1	0.932
3	Unweighted RTA			
	RCA 2 codes	0.03	1	0.854
	Share cap	0.25	1	0.618
	RCA 2 codees			
	Unweighted RTA	3.58	1	0.058
	Share cap	0.11	1	0.737
	Share cap			
	Unweighted RTA	0.77	1	0.381
	RCA 2 codes	1.99	1	0.159
4	Weighted RTA			
	RCA 2 codes	1.04	1	0.307
	Share cap	2.07	1	0.15
	RCA 2 codes			
	Weighted RTA	0.17	1	0.682
	Share cap	2.03	1	0.154
	Share cap			
	Weighted RTA	2.30	1	0.13
	RCA 2 codes	2.93	1	0.087

## Model with RD - solar PV technologies

Specification	Equation \ Excluded	chi2	df	P-value	
5	Unweighted RTA	RCA all codes	0.17	1	0.681
		Share cap	2.85	1	0.092
		RD	14.36	1	0
	RCA all codes	Unweighted RTA	4.78	1	0.029
		Share cap	4.64	1	0.031
		RD	21.28	1	0
	Share cap	Unweighted RTA	4.83	1	0.028
		RCA all codes	2.91	1	0.088
		RD	4.77	1	0.029
	RD	Unweighted RTA	1.12	1	0.29
		RCA all codes	20.16	1	0
		Share cap	0.01	1	0.928
6	Weighted RTA	RCA all codes	15.31	1	0
		Share cap	12.00	1	0.001
		RD	0.44	1	0.505
	RCA all codes	Weighted RTA	4.64	1	0.031
		Share cap	5.00	1	0.025
		RD	8.58	1	0.003
	Share cap	Weighted RTA	1.31	1	0.252
		RCA all codes	11.91	1	0.001
		RD	0.02	1	0.903
	RD	Weighted RTA	0.73	1	0.392
		RCA all codes	0.47	1	0.492
		Share cap	3.05	1	0.081
7	Unweighted RTA	d_RCA 2 codes	0.41	1	0.521
		Share cap	25.70	1	0
		RD	19.05	1	0
	RCA 2 codes	Unweighted RTA	2.42	1	0.12
		Share cap	44.78	1	0
		RD	1.91	1	0.167
	Share cap	Unweighted RTA	2.95	1	0.086
		d_RCA 2 codes	7.20	1	0.007
		RD	4.04	1	0.044
	RD	Unweighted RTA	0.00	1	0.981
		d_RCA 2 codes	1.15	1	0.285
Share cap		2.44	1	0.118	
8	Weighted RTA	d_RCA 2 codes	0.09	1	0.77
		Share cap	17.44	1	0
		RD	10.28	1	0.001
	RCA 2 codes	Weighted RTA	0.00	1	0.986
		Share cap	44.78	1	0
		RD	0.26	1	0.613
	Share cap	Weighted RTA	7.42	1	0.006
		d_RCA 2 codes	5.02	1	0.025
		RD	2.20	1	0.138
	RD	Weighted RTA	0.01	1	0.934
		RCA 2 codes	6.35	1	0.012
Share cap		5.07	1	0.024	

## B-19: PVAR estimations – solar PV technologies

### Model without RD

	Unweighted RTA	Weighted RTA	Unweighted RTA	Weighted RTA
L.Unweighted RTA	0.715*** (3.89)		0.682*** (3.69)	
L.Weighted RTA		0.510* (2.22)		0.618** (2.70)
L.RCA all codes	0.632 (1.16)	0.0199 (0.04)		
L.RCA 2 codes			-0.0418 (-0.16)	-0.226 (-0.82)
L.D.share cap	0.0205 (0.28)	0.112 (1.28)	-0.0136 (-0.25)	0.0682 (1.20)
GDP	-0.00676 (-0.15)	-0.0445 (-1.02)	-0.0182 (-0.67)	-0.0403 (-1.38)
year_1998	-0.00274 (-0.03)	0.0116 (0.12)	0.0192 (0.17)	-0.000622 (-0.01)
year_2005	0.0818 (0.90)	0.0156 (0.21)	0.0980 (1.22)	0.0384 (0.53)
year_2009	-0.0560 (-0.64)	0.0622 (0.66)	-0.0731 (-1.05)	0.0366 (0.48)
Number of obs.	432	432	432	432

	<b>RCA all codes</b>	<b>RCA all codes</b>	<b>RCA 2 codes</b>	<b>RCA 2 codes</b>
L.Unweighted RTA	-0.0165 (-0.37)		0.0999+ (1.70)	
L. Weighted RTA		-0.0241 (-0.39)		0.0253 (0.34)
L.RCA all codes	0.604*** (4.61)	0.641*** (4.34)		
L.RCA 2 codes			0.750*** (6.16)	0.697*** (6.24)
L.D.share cap	0.000870 (0.05)	0.0129 (0.50)	-0.00413 (-0.18)	0.0381 (1.62)
GDP	-0.0121 (-1.06)	-0.0147 (-1.14)	-0.0116 (-0.93)	-0.0307* (-2.23)
year_1998	0.0535+ (1.95)	0.0389 (1.55)	0.0228 (0.88)	0.00507 (0.22)
year_2005	0.0416** (2.64)	0.0495** (3.24)	0.0597+ (1.72)	0.0962** (2.82)
year_2009	0.0478* (2.17)	0.0567* (2.34)	0.0292 (0.83)	0.0796* (2.46)
Number of obs.	432	432	432	432

*t statistics in parentheses*

+  $p < 0.10$ , \*  $p < 0.05$ , \*\*  $p < 0.01$ , \*\*\*  $p < 0.001$

	D.share cap	D.share cap	D.share cap	D.share cap
L.Unweighted RTA	0.00673 (0.05)		-0.190 (-1.02)	
L. Weighted RTA		-0.162 (-0.28)		-0.126 (-0.50)
L.RCA all codes	0.270 (0.66)	-0.0960 (-0.12)		
L.RCA 2 codes			0.594 (1.53)	0.538 (1.48)
L.D.share cap	0.865*** (7.88)	0.975** (3.27)	0.778*** (9.65)	0.815*** (8.50)
GDP	0.150* (2.51)	0.105 (0.82)	0.175** (3.26)	0.179** (3.04)
year_1998	0.0359 (0.73)	0.0349 (0.36)	0.0256 (0.53)	0.0256 (0.50)
year_2005	-0.0856+ (-1.70)	-0.0580 (-0.99)	-0.0939* (-1.97)	-0.0883+ (-1.83)
year_2009	-0.0466 (-0.26)	0.142 (0.43)	-0.0244 (-0.15)	-0.0743 (-0.44)
Number of obs.	432	432	432	432

*t statistics in parentheses*

+  $p < 0.10$ , \*  $p < 0.05$ , \*\*  $p < 0.01$ , \*\*\*  $p < 0.001$

**Model with RD - solar PV technologies**

	<b>Unweighted RTA</b>	<b>Weighted RTA</b>	<b>Unweighted RTA</b>	<b>Weighted RTA</b>
L.Unweighted RTA	0.500* (2.05)		0.428 (1.59)	
L.Weighted RTA		0.451+ (1.78)		0.391 (1.44)
L.RCA all codes	-0.507 (-1.16)	-0.400 (-0.83)		
L.D.RCA 2 codes			-0.552+ (-1.67)	-1.119** (-2.82)
L.Share cap	-0.0112 (-1.47)	-0.00944 (-1.40)	-0.0117 (-1.36)	-0.0175* (-2.34)
L.D.RD	0.924 (1.54)	1.343+ (1.81)	0.639 (1.05)	0.0265 (0.04)
year_1998	-0.155* (-2.25)	-0.130 (-1.54)	-0.261** (-2.60)	-0.312* (-2.50)
year_2005	0.0114 (0.09)	-0.0154 (-0.14)	0.0498 (0.45)	-0.0976 (-1.09)
year_2009	-0.0180 (-0.21)	0.0748 (0.73)	-0.0392 (-0.45)	0.116 (1.28)
Number of obs.	209	209	209	209

*t statistics in parentheses*

+  $p < 0.10$ , \*  $p < 0.05$ , \*\*  $p < 0.01$ , \*\*\*  $p < 0.001$

	RCA all codes	RCA all codes	D.RCA 2 codes	D.RCA 2 codes
L.Unweighted RTA	0.0274 (0.43)		-0.00505 (-0.06)	
L.Weighted RTA		-0.0301 (-0.36)		0.0566 (0.52)
L.RCA all codes	0.798*** (5.90)	0.640*** (3.57)		
L.D.RCA 2 codes			0.0286 (0.19)	-0.0287 (-0.18)
L.Share cap	-0.00168 (-0.64)	-0.00565 (-1.25)	-0.0109** (-3.02)	-0.00528+ (-1.68)
L.D.RD	0.463* (2.15)	0.953** (2.61)	0.785* (2.02)	0.979* (2.45)
year_1998	0.0821+ (1.83)	0.0701 (1.63)	0.0462 (1.08)	0.0565 (1.22)
year_2005	0.0499 (1.49)	0.0772+ (1.67)	0.159+ (1.83)	0.221* (2.49)
year_2009	0.00655 (0.32)	0.0252 (1.07)	0.0199 (0.48)	0.0254 (0.69)
Number of obs.	209	209	209	209

*t statistics in parentheses*

+  $p < 0.10$ , \*  $p < 0.05$ , \*\*  $p < 0.01$ , \*\*\*  $p < 0.001$



	Share cap	Share cap	Share cap	Share cap
L.Unweighted RTA	-0.111 (-0.32)		-0.267 (-0.69)	
L.Weighted RTA		0.525 (1.07)		0.792 (1.56)
L.RCA all codes	0.909 (1.29)	-1.340 (-1.58)		
L.D.RCA 2 codes			-0.339 (-0.41)	-1.294+ (-1.69)
L.Share cap	0.890*** (10.60)	0.848*** (8.54)	0.909*** (9.09)	0.851*** (11.07)
L.D.RD	-1.107 (-0.62)	-6.027* (-2.19)	-2.297 (-1.49)	0.00813 (0.00)
year_1998	-0.378* (-2.18)	-0.127 (-0.42)	-0.447+ (-1.89)	-0.427 (-1.60)
year_2005	-0.738** (-3.06)	-1.055*** (-3.32)	-0.827** (-3.08)	-0.793** (-3.12)
year_2009	-0.622** (-2.85)	-0.574* (-2.55)	-0.293 (-1.13)	-0.500* (-2.35)
Number of obs.	209	209	209	209

*t statistics in parentheses*

+  $p < 0.10$ , \*  $p < 0.05$ , \*\*  $p < 0.01$ , \*\*\*  $p < 0.001$

	<b>D.RD</b>	<b>D.RD</b>	<b>D.RD</b>	<b>D.RD</b>
L.Unweighted RTA	0.0647 (1.29)		0.0277 (0.65)	
L.Weighted RTA		0.0532 (1.00)		-0.0623 (-1.15)
L.RCA all codes	0.107 (0.99)	0.0453 (0.49)		
L.D.RCA 2 codes			0.0392 (0.60)	-0.103 (-1.47)
L.Share cap	0.000341 (0.13)	-0.000606 (-0.26)	-0.000569 (-0.27)	-0.00314 (-1.46)
L.D.RD	-0.204 (-0.80)	-0.182 (-0.81)	-0.240 (-1.28)	-0.297 (-1.34)
year_1998	0.0295 (1.09)	0.0297 (1.16)	0.0349 (1.25)	-0.0154 (-0.53)
year_2005	-0.0207 (-0.91)	-0.0116 (-0.56)	-0.0126 (-0.66)	-0.0183 (-1.20)
year_2009	0.0141 (0.61)	0.0158 (0.69)	0.0402* (2.04)	0.0657*** (3.83)
Number of obs.	209	209	209	209

*t statistics in parentheses*

+  $p < 0.10$ , \*  $p < 0.05$ , \*\*  $p < 0.01$ , \*\*\*  $p < 0.001$

## B-20: IRF analysis – solar PV technologies

### Model without RD

1)

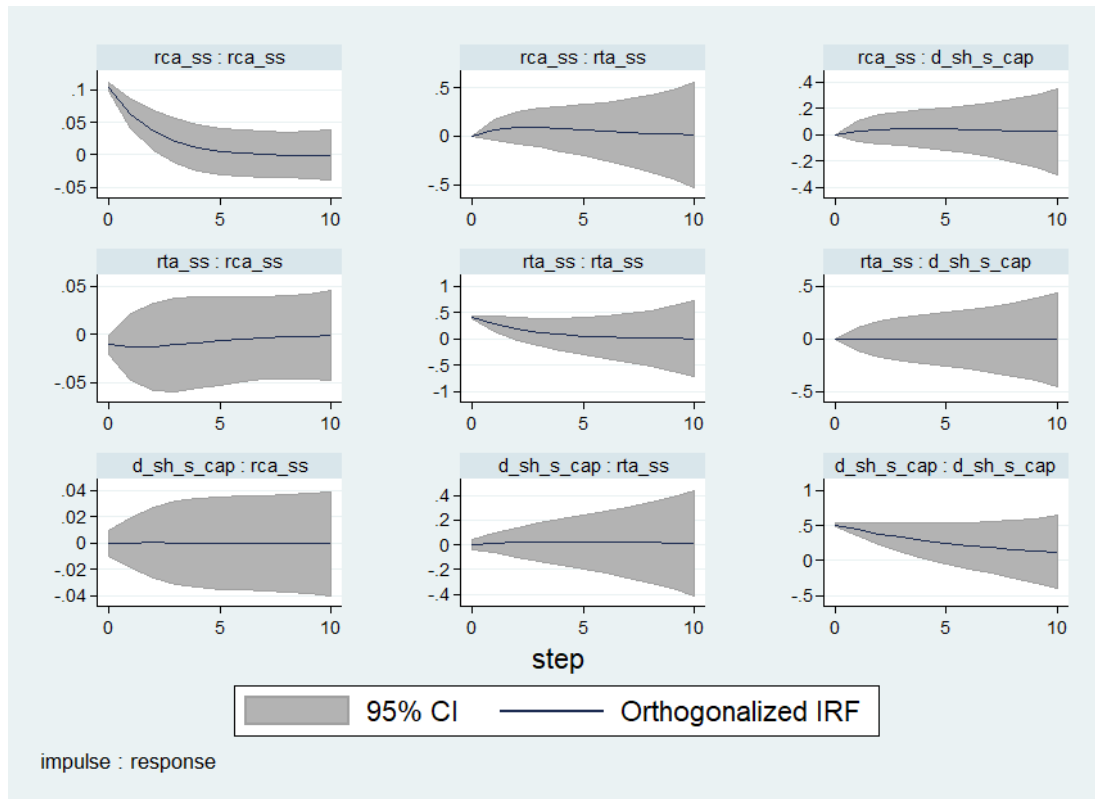

2)

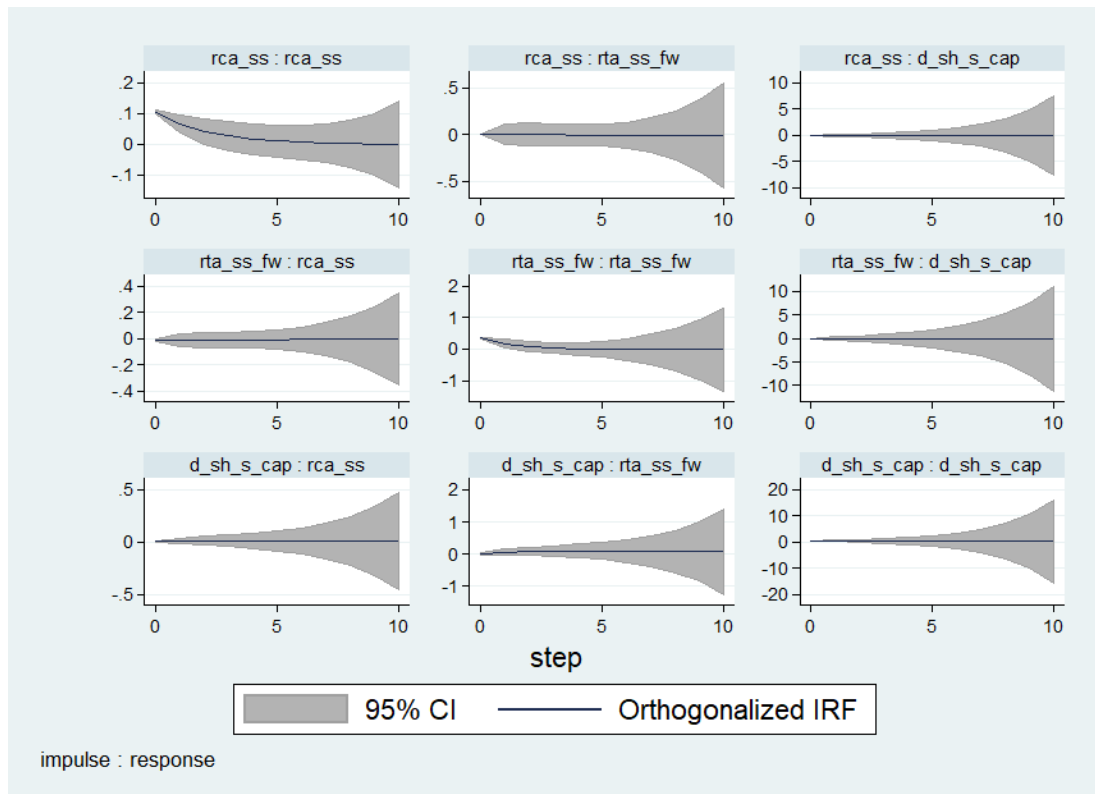

3)

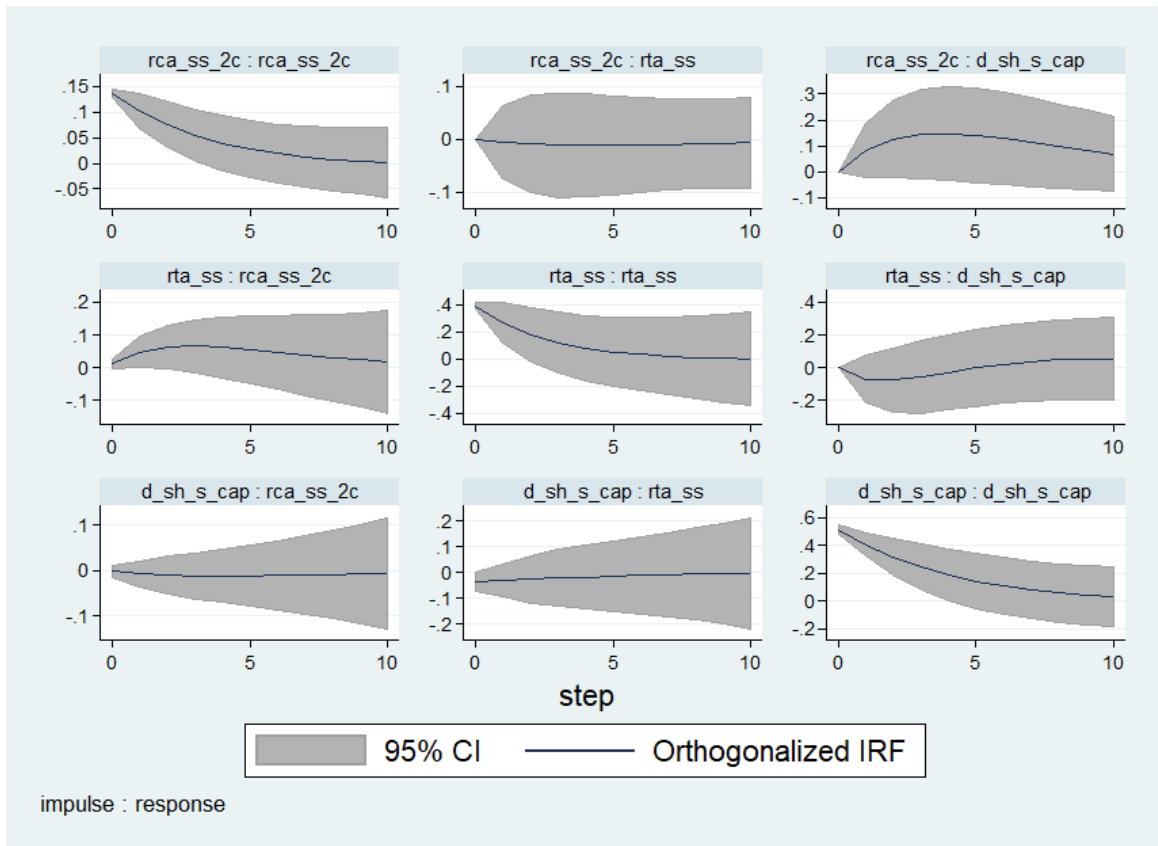

4)

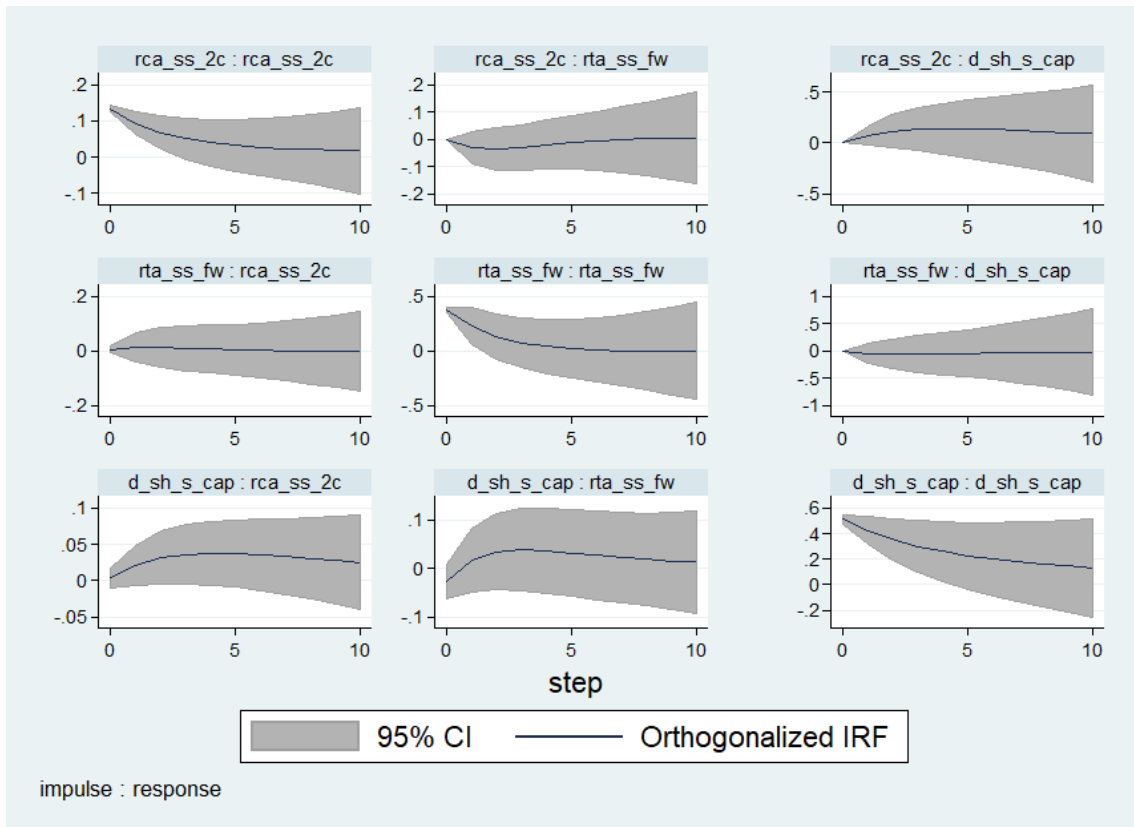

## Model with RD - solar PV technologies

5)

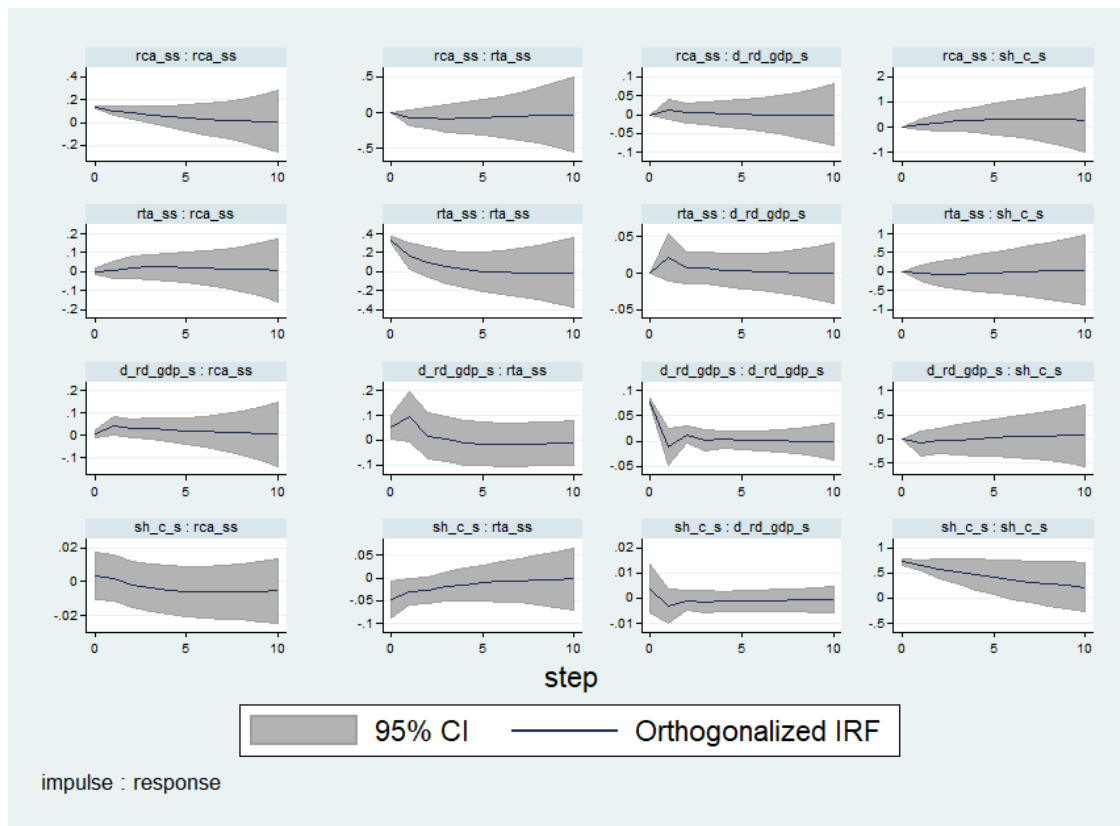

6)

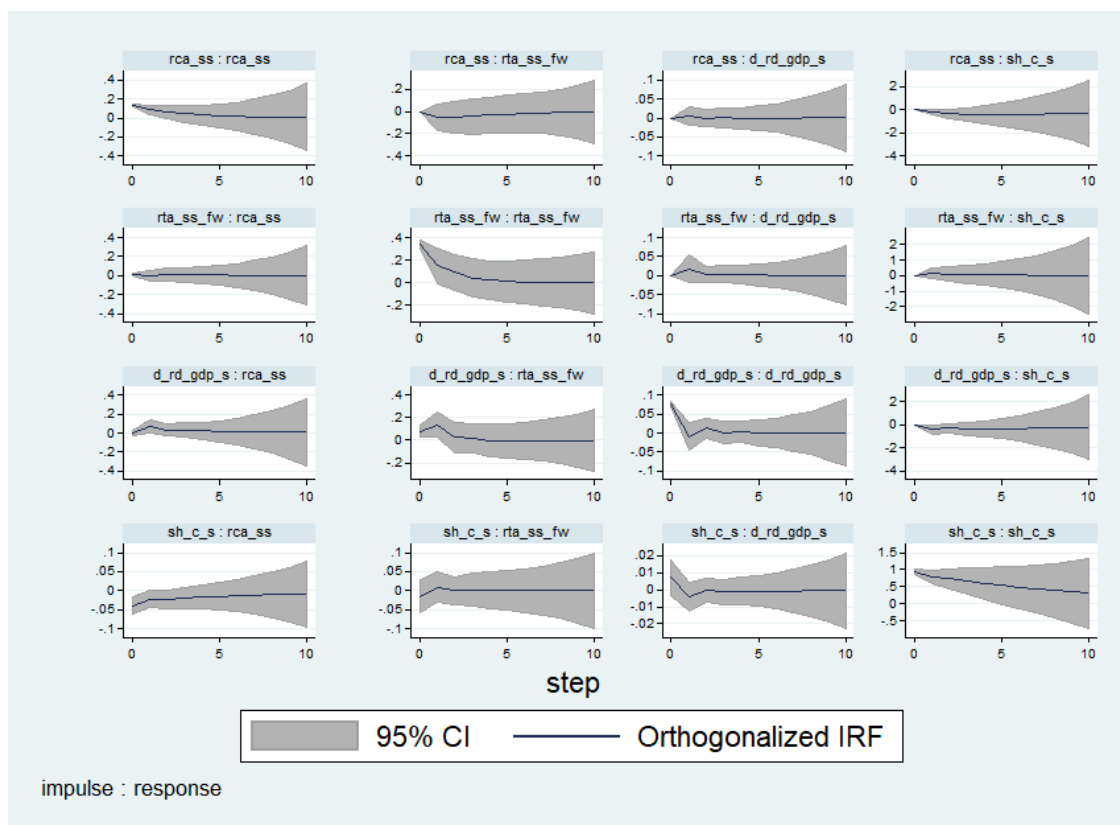

7)

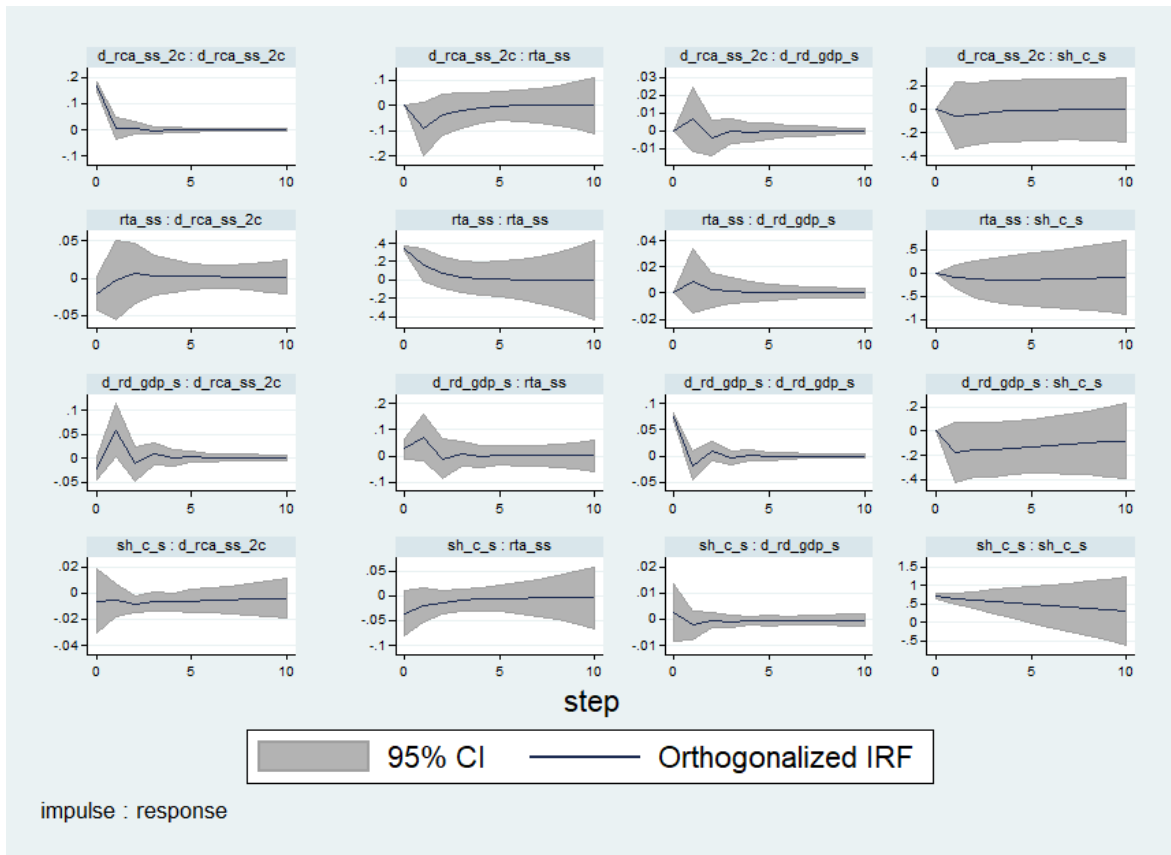

8)

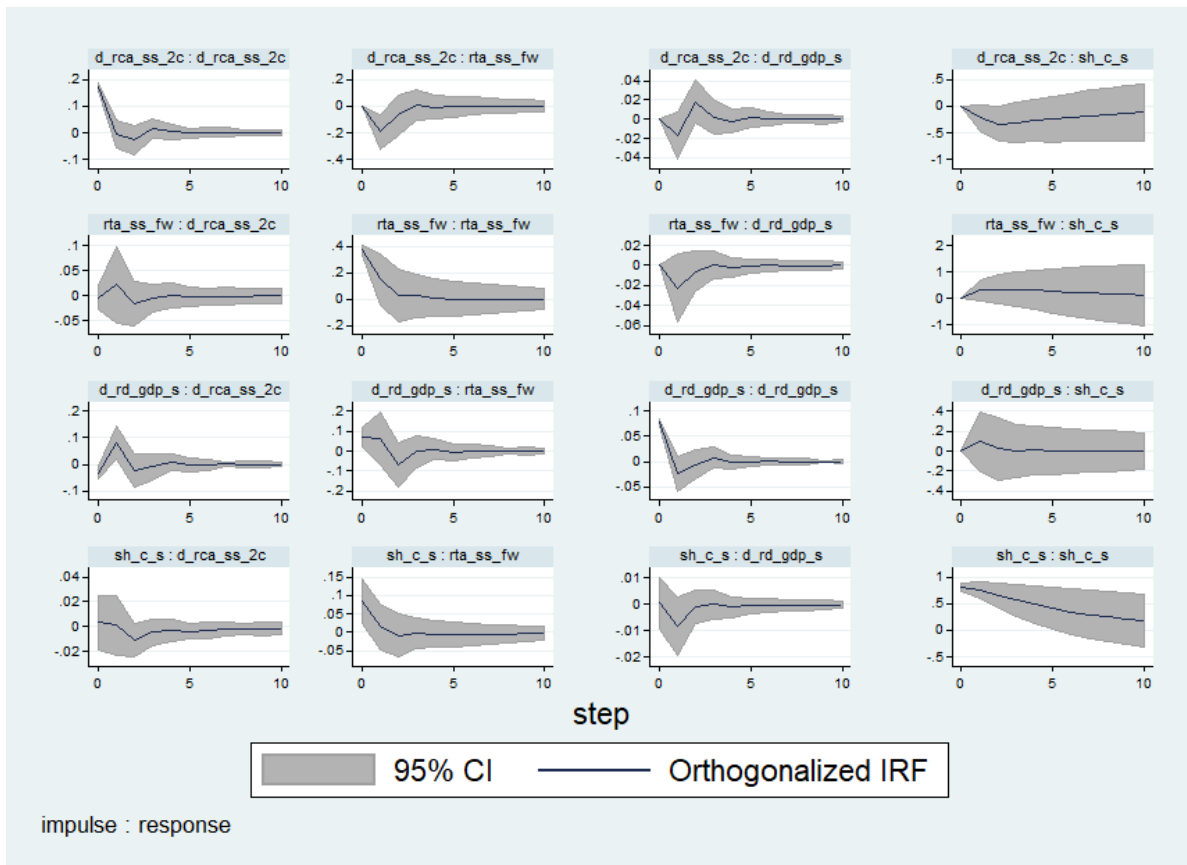

## B-21: FEVD analysis – solar PV technologies

Reminder :

Specification for the PVAR GMM estimation - solar PV technologies			
Specification	Endogenous variables	Exogenous variables	Number of lags
1	Unweighted RTA - RCA all codes - D.share capacities	GDP - 1998 - 2005 - 2009 (year dummy variables)	1
2	Weighted RTA - RCA all codes - D.share capacities	GDP - 1998 - 2005 - 2009 (year dummy variables)	1
3	Unweighted RTA - RCA 2 codes - D.share capacities	GDP - 1998 - 2005 - 2009 (year dummy variables)	1
4	Weighted RTA - RCA 2 codes - D.share capacities	GDP - 1998 - 2005 - 2009 (year dummy variables)	1
5	Unweighted RTA - RCA all codes - Share capacities - D.RD	1998 - 2005 - 2009 (year dummy variables)	1
6	Weighted RTA - RCA all codes - Share capacities - D.RD	1998 - 2005 - 2009 (year dummy variables)	1
7	Unweighted RTA - D.RCA 2 codes - Share capacities - D.RD	1998 - 2005 - 2009 (year dummy variables)	1
8	Weighted RTA - D.RCA 2 codes - Share capacities - D.RD	1998 - 2005 - 2009 (year dummy variables)	1

### Model without RD – solar PV technologies

1)

step	D.Share cap	RCA all code	Unweighted RTA
D.Share cap			
1	100.00%	0.00%	0.00%
5	99.13%	0.87%	0.01%
10	98.62%	1.35%	0.03%
RCA all codes			
1	0.00%	98.96%	1.04%
5	0.00%	96.38%	3.62%
10	0.00%	95.89%	4.11%
Unweighted RTA			
1	0.00%	0.00%	100.00%
5	0.42%	7.77%	91.81%
10	0.92%	10.03%	89.05%

2)

step	D.Share cap	RCA all code	Weighted RTA
D.Share cap			
1	100.00%	0.00%	0.00%
5	97.64%	0.10%	2.26%
10	96.51%	0.20%	3.29%
RCA all codes			
1	0.11%	98.98%	0.91%
5	2.41%	93.46%	4.12%
10	4.21%	91.10%	4.69%
Weighted RTA			
1	0.00%	0.00%	100.00%
5	16.12%	0.00%	83.87%
10	30.85%	0.04%	69.11%

3)

step	D.Share cap	RCA 2 codes	Unweighted RTA
D.Share cap			
1	100.00%	0.00%	0.00%
5	88.89%	9.11%	1.99%
10	81.65%	15.76%	2.59%
RCA 2 codes			
1	0.01%	99.23%	0.76%
5	0.77%	72.25%	26.98%
10	1.36%	63.25%	35.40%
Unweighted RTA			
1	0.83%	0.00%	99.17%
5	1.34%	0.13%	98.53%
10	1.48%	0.30%	98.22%

4)

step	D.Share cap	RCA 2 codes	Weighted RTA
D.Share cap			
1	100.00%	0.00%	0.00%
5	91.61%	6.99%	1.40%
10	86.04%	12.43%	1.53%
RCA 2 codes			
1	0.07%	99.79%	0.14%
5	10.38%	88.34%	1.28%
10	19.61%	79.29%	1.10%
Weighted RTA			
1	0.53%	0.00%	99.47%
5	2.24%	1.52%	96.24%
10	3.42%	1.59%	94.99%



### Model with RD - solar PV technologies

5)

step	d_rd_gdp_s	RCA all code	Unweighted	Share cap
d_rd_gdp_s				
1	99.76%	0.00%	0.00%	0.24%
5	88.14%	3.17%	8.28%	0.42%
10	87.91%	3.18%	8.44%	0.47%
RCA all codes				
1	0.26%	99.67%	0.00%	0.07%
5	9.21%	87.32%	3.35%	0.12%
10	10.31%	83.98%	5.28%	0.43%
Unweighted RTA				
1	2.32%	0.00%	95.71%	1.98%
5	6.26%	11.19%	80.17%	2.38%
10	6.49%	16.41%	74.77%	2.33%
Share cap				
1	0.00%	0.00%	0.00%	100.00%
5	0.45%	10.08%	0.61%	88.85%
10	0.82%	22.98%	0.47%	75.73%

6)

step	d_rd_gdp_s	RCA all code	Weighted RTA	Share cap
d_rd_gdp_s				
1	99.12%	0.00%	0.00%	0.88%
5	92.48%	0.57%	5.80%	1.14%
10	92.42%	0.58%	5.82%	1.19%
RCA all codes				
1	0.00%	91.85%	0.43%	7.73%
5	17.86%	73.98%	0.63%	7.54%
10	18.79%	71.78%	0.68%	8.75%
Weighted RTA				
1	5.05%	0.00%	94.75%	0.20%
5	14.24%	4.59%	80.98%	0.18%
10	14.19%	5.13%	80.49%	0.18%
Share cap				
1	0.00%	0.00%	0.00%	100.00%
5	13.91%	12.06%	1.45%	72.58%
10	17.04%	18.94%	1.04%	62.97%

7)

step	d_rd_gdp_s	D.RCA 2 code	Unweighted	Share cap
d_rd_gdp_s				
1	99.90%	0.00%	0.00%	0.10%
5	97.47%	0.94%	1.40%	0.20%
10	97.44%	0.94%	1.41%	0.21%
D.RCA 2 codes				
1	1.59%	96.84%	1.43%	0.13%
5	12.44%	85.32%	1.49%	0.76%
10	12.41%	84.88%	1.53%	1.18%
Unweighted RTA				
1	0.66%	0.00%	98.29%	1.05%
5	3.62%	6.04%	89.22%	1.13%
10	3.62%	6.04%	89.16%	1.18%
Share cap				
1	0.00%	0.00%	0.00%	100.00%
5	4.84%	0.29%	3.74%	91.13%
10	5.35%	0.20%	5.34%	89.11%

8)

step	d_rd_gdp_s	D.RCA 2 code	Weighted RT	Share cap
d_rd_gdp_s				
1	100.00%	0.00%	0.00%	0.00%
5	84.01%	8.25%	6.85%	0.89%
10	83.96%	8.28%	6.86%	0.90%
D.RCA 2 codes				
1	3.23%	96.67%	0.06%	0.03%
5	20.72%	76.97%	1.88%	0.42%
10	20.69%	76.86%	1.94%	0.52%
Weighted RTA				
1	3.03%	0.00%	92.16%	4.80%
5	5.94%	18.49%	72.21%	3.36%
10	5.94%	18.49%	72.15%	3.42%
Share cap				
1	0.00%	0.00%	0.00%	100.00%
5	0.33%	10.97%	14.20%	74.50%
10	0.25%	12.95%	16.68%	70.12%

## B-22: Results for solar PV model without RD on 11 countries

All the results are available online ([link](#))