



**HAL**  
open science

# Design of resilient networked control systems

Rongyao Ling

► **To cite this version:**

Rongyao Ling. Design of resilient networked control systems. Automatic. Ecole nationale supérieure Mines-Télécom Atlantique; Zhejiang University (Hangzhou, Chine), 2020. English. NNT : 2020IMTA0193 . tel-03299347

**HAL Id: tel-03299347**

**<https://theses.hal.science/tel-03299347v1>**

Submitted on 26 Jul 2021

**HAL** is a multi-disciplinary open access archive for the deposit and dissemination of scientific research documents, whether they are published or not. The documents may come from teaching and research institutions in France or abroad, or from public or private research centers.

L'archive ouverte pluridisciplinaire **HAL**, est destinée au dépôt et à la diffusion de documents scientifiques de niveau recherche, publiés ou non, émanant des établissements d'enseignement et de recherche français ou étrangers, des laboratoires publics ou privés.

# THESE DE DOCTORAT DE

L'ÉCOLE NATIONALE SUPÉRIEURE MINES-TELECOM ATLANTIQUE  
BRETAGNE PAYS DE LA LOIRE - IMT ATLANTIQUE

ET ZHEJIANG UNIVERSITY OF TECHNOLOGY, HANGZHOU,  
CHINA

ÉCOLE DOCTORALE N° 601  
*Mathématiques et Sciences et Technologies  
de l'Information et de la Communication*  
Spécialité : Automatique, productique et robotique

Par

**Rongyao LING**

## Design of Resilient Networked Control Systems

Thèse présentée et soutenue à Hangzhou, le 10/12/2020  
Unité de recherche : IMT Atlantique, LS2N UMR CNRS 6004, Nantes, F-44000.  
Thèse N° : 2020IMTA0193

### Rapporteurs avant soutenance :

James WHIDBORNE	Professeur, Cranfield University
Zhengguang WU	Professeur, Zhejiang University

### Composition du Jury :

Président :	Christophe AUBRUN	Professeur, Université de Lorraine
Examineurs :	James WHIDBORNE	Professeur, Cranfield University
	Zhengguang WU	Professeur, Zhejiang University
	Thibault HILAIRE	Maître de conférence, Université Paris VI
Directeurs de Thèse :	Philippe CHEVREL	Professeur, IMT Atlantique
Co-encadrant de Thèse :	Wen-an ZHANG	Professeur, Zhejiang University of Technology
	Fabien CLAVEAU	Maître de conférences, IMT Atlantique
	Yu FENG	Professeur, Zhejiang University of Technology

# Synthèse de Lois de Commande Résilientes vis-à-vis de l'Implémentation par Réseau

## Résumé

On parle de lois de commande implémentée par réseau, dénommées “Networked control systems” (NCSs) dans la littérature anglo-saxonne, quand le système à piloter, les capteurs, les actionneurs, et le(s) régulateur(s) interagissent par l’intermédiaire d’un réseau numérique de communication. Ceci permet alors la mise en place d’une unique boucle de rétroaction multi-entrées / multi-sorties, ou l’implémentation de plusieurs boucles locales pouvant toutefois interagir, aboutissant dans tous les cas à des performances d’asservissement du système inatteignables avec des boucles locales isolées (par exemple avec des PID). De plus, en comparaison à l’implémentation « point-à-point » traditionnelle, la mise en œuvre de lois de commande par réseau peut permettre de réduire les coûts, d’améliorer la fiabilité, la maintenabilité et l’évolutivité de la solution de commande. C’est ainsi que les NCSs sont de plus en plus employés dans de nombreux secteurs tels que les « smart grids » (réseaux électriques intelligents), les transports intelligents, les réseaux de capteurs, la téléopération, etc... Depuis leur émergence, les NCSs font l’objet de l’intérêt de plus en plus d’académiques et d’industriels. La littérature sur le sujet est abondante, et c’est ainsi que les plus grandes revues ont édité des numéros spéciaux à ce sujet. La « Control Systems Association » (CSS) de l’institut IEEE « Institute of Electrical Engineering » a par exemple lancé en 2013 un nouveau journal intégralement dédié à ce domaine, le « IEEE Transactions on Control of Network Systems », portant sur l’analyse, la conception et l’implémentation des lois de commande par réseau.

En y regardant de plus près toutefois, les réseaux digitaux de communication ne sont pas non plus parfaitement fiables et parfaits, et la mise en place de tels moyens de communication entre le système à piloter et le(s) régulateur(s) apporte son lot de

nouveaux challenges techniques ; on citera par exemple les problèmes d'atténuation, de saturation de la bande passante, des pertes de paquets, des retards, des effets de quantification... Sachant que ces trois dernières dégradations sont peut-être celles engendrant le plus de pertes de performance, pouvant amener à l'instabilité du système ainsi régulé. Une chose est certaine ; quelles que soient les dégradations citées ci-dessus, la plupart des outils méthodologiques de contrôle – commande usuels doivent être adaptés à ce nouveau contexte. Globalement, les travaux portant sur la commande implémentée par réseau peuvent être classés en deux grandes catégories ; la première regroupe les approches synthétisant le(s) régulateur(s) sans prendre en compte les défauts intrinsèques au réseau, en utilisant les outils classiques de la théorie de la commande, puis cherchant à dimensionner ou adapter le protocole de communication afin de minimiser l'occurrence et l'impact des défauts de communication. La seconde catégorie prend en considération ces défauts explicitement dans la formulation du problème de commande à résoudre. Ils existent déjà un certain nombre de travaux se focalisant sur ces nouveaux problèmes d'analyse ou de synthèse pour les NCSs, soumis aux dégradations citées précédemment. Toutefois, de nombreux verrous techniques existent encore. A notre connaissance, les difficultés majeures en lien avec l'analyse et la commande des NCSs sont concentrées sur les aspects suivants ; 1/ on peut montrer que trouver une solution analytique au problème de synthèse multi-entrées multi-sorties impliquant un NCS revient à résoudre un problème dit de «  $\mu$ -synthèse », qui ne peut être résolu que par une approche algorithmique itérative, 2/ la prise en compte de plusieurs dégradations du réseau complique exponentiellement les problèmes de synthèse, et des méthodologies systématiques pour traiter ceux-ci font encore défaut, 3/ lors de la présence de plusieurs dégradations ou incertitudes sur les capacités du réseau, les performances voire la stabilité du système en boucle fermée sont sensibles au choix même de la réalisation choisie pour l'implémentation de la loi de commande.

Partant de ce constat, les travaux de thèse présentés ici apportent des contributions méthodologiques pour l'analyse et la commande des NCSs, considérant tour-à-tour des problèmes concrets comme celui du suivi de trajectoire, du filtrage robuste ou du choix de réalisations robustes aux effets de la quantification en lien avec le codage en virgule fixe. Le premier défi est adressé au chapitre 3, où une commande LQ stochastique est mise-en-œuvre pour assurer le suivi de trajectoire asymptotique pour les systèmes MIMO (multi-entrées multi-sorties) à temps discret, via un réseau de communication subissant des pertes de paquets. Le problème de filtrage robuste est quant à lui traité

dans le chapitre 4, toujours en considérant le problème des pertes de paquets. Le troisième problème est abordé dans le chapitre 5 ; on y traite le choix de la bonne réalisation du NCS soumis à la fois au problème d'approximation numérique en lien avec le codage par virgule fixe des coefficients de la représentation d'état, et aussi au problème de retards de communication entre les différentes entités implémentant de manière distribuée la loi de commande. Ces trois problématiques sont reliés ainsi ; dans le chapitre 3, pour traiter le problème de suivi de trajectoire, la connaissance complète de l'état du système est nécessaire pour mettre en place le régulateur LQ. Si l'état ne peut être mesuré convenablement, la conception d'un filtre s'avère alors nécessaire (résultat du chapitre 4). Les résultats du chapitre 5 peuvent être utile à la fois pour les régulateurs ou les filtres conçus dans les deux chapitres précédents. Leur implémentation via un réseau numérique, de manière centralisée ou distribuée, va potentiellement engendrer des soucis de quantification et / ou de retards internes. Il peut être intéressant d'apporter de la robustesse ou résilience en jouant sur le choix de la réalisation de la représentation d'état permettant « d'incarner » la loi à implémenter. Les autres chapitres de la thèse s'organisent ainsi ; le chapitre 1 introduit le contexte de la thèse et fait un état de l'art sur les thématiques abordés par la thèse. Un bilan des difficultés types pour l'analyse et la commande des NCS est notamment proposé. Le chapitre 2 se présente comme un glossaire étendu, regroupant les définitions et lemmes fondamentaux utiles à la thèse. Le chapitre 6 prend appui quant à lui sur un benchmark de deux robots mobiles coopératifs, permettant d'illustrer la mise en œuvre des différents résultats de commande, filtrage, et choix de réalisation des chapitres 3, 4 et 5. Différentes simulations sont ainsi proposées afin de démontrer l'efficacité des méthodologies proposées. Finalement, un bilan et quelques perspectives de ces travaux de thèse sont proposés dans le chapitre 7.

Détaillons maintenant un peu plus précisément les résultats clés des chapitres 3 à 6 au cœur de cette thèse. Comme dit précédemment, une loi de commande LQ stochastique est proposée dans le chapitre 3 afin de résoudre un problème de suivi de trajectoire asymptotique, pour un système multivariable modélisé à temps discret, soumis à des pertes de paquets au niveau des signaux de commande. Un problème de co-conception est en fait traité, supposant la mise en place d'un canal de communication « MIMO » (multi-entrées multi-sorties) entre le régulateur centralisé et le système, la communication des signaux de commande étant certes soumise à des pertes de paquets, mais l'architecture MIMO permet toutefois d'avoir plus de voies de communication

(multiplexées) que de signaux de commande à transmettre. Cela implique l'implémentation et donc le dimensionnement d'un codeur et d'un décodeur statiques aux entrées et sorties de ce canal MIMO, qui peuvent être vus comme des degrés de liberté salutaires. Les difficultés techniques majeures de ce problème de co-conception peuvent être résumées ainsi ; en premier lieu, trouver une solution analytique au problème de commande des NCSs multi-entrées revient à résoudre un problème dit de  $\mu$ -synthèse. Deuxièmement, le problème de co-conception des gains de retour d'état, du codeur et du décodeur n'est pas simple et aucune méthodologie classique n'est encore disponible dans la littérature pour le traiter. Une condition suffisante est proposée dans ce chapitre permettant d'assurer les performances LQ stochastique pour le suivi de trajectoire. Plus précisément, une condition de stabilité formulée via des LMI sert de fondement, basée sur une condition de performance reliant la norme  $H_2$  entrée – sortie du système à piloter et le taux de transmission des paquets. L'expression des matrices de codage et décodage est alors dérivée au sens « Mean Square ». A cette condition de stabilité est rajoutée un objectif LQ stochastique. Cela aboutit à une équation de Riccati modifiée à temps-discret (MDARE). Afin de passer d'un problème de régulation à un problème de suivi de trajectoire, la reformulation classique du problème passant par l'ajout d'une équation de Sylvester à résoudre est enfin effectué. Nous proposons finalement de résoudre l'équation de Riccati modifiée par une résolution itérative numérique, l'algorithme proposé ayant été conçu de façon à réduire le conservatisme associé. Les contributions de ce chapitre 3 peuvent être résumées ainsi ; dans un cadre méthodologique unifié, nous proposons de résoudre un problème complet de suivi de trajectoire, pour un système multivariable, via un support de communication MIMO présentant des pertes de paquet. Il ne s'agit donc pas d'un simple problème « académique » mais bien d'un problème pouvant être rencontré en vrai, se confrontant à plusieurs difficultés. D'un point de vue technique, nous considérons ici des matrices de codage et décodage pleines et non purement diagonales comme cela se voit habituellement dans la littérature ; ceci a le mérite de réduire le conservatisme en performance de la solution proposée. Nous avons rajouté aussi certains degrés de liberté comparativement aux résultats de la littérature, comme un nombre de canaux de communication supérieur aux nombres de signaux de commande, ou encore la capacité de transmission de chaque canal qui est considérée comme réglable, et non la capacité totale de tous les canaux.

Dans le chapitre 4, en lien avec le problème de filtrage robuste soumis à des pertes

de paquets, l'hypothèse est faite que chaque signal de mesure est transmis au filtre par son propre canal indépendant, soumis à des pertes de paquets modélisables par une loi stochastique. Dans ce contexte, on cherche à concevoir le filtre de telle façon à ce que le modèle aux écarts est stable au sens des Moindres Carrés (Mean Square stability), tout en satisfaisant un certain niveau de performance  $H_\infty$ . Afin de pouvoir analyser la stabilité et ces performances  $H_\infty$ , un « opérateur adjoint » associé est introduit. Celui-ci permet d'en déduire une équation de Riccati modifiée menant à la solution de ce problème de filtrage  $H_\infty$ , associée à toute une méthodologie de synthèse. De plus, une condition nécessaire et suffisante est proposée en lien avec la stabilité au sens des moindres carrés du modèle aux écarts, établie sur la base du taux de transmission des paquets de chaque canal. Les contributions de ce chapitre 4 sont ; en comparaison du problème de filtrage robuste  $H_\infty$  dans le cas déterministe, une extension a été proposée pour le cas stochastique, se basant sur l'opérateur adjoint et une équation de Riccati modifiée. Une autre contribution réside dans la relation proposée reliant la stabilité au sens des moindres carrés du modèle aux écarts, le taux de transmission des paquets et la mesure de Mahler caractérisant le système.

Des outils traitant des problèmes concrets de suivi de trajectoire et de filtrage robuste sont donc proposés dans les chapitre 3 et 4. Dans la continuité de nos développements pour une mise en œuvre « pratique » des NCSs, il nous paraissait intéressant de traiter les problèmes d'implémentation sur mono ou multi-calculateur(s). C'est l'objet du chapitre 5, qui s'intéresse au choix de la meilleure réalisation de la loi de commande ou de filtrage à implémenter, meilleur au sens de la robustesse (résilience) vis-à-vis d'une part des retards inter-calculateurs support d'une implémentation potentiellement distribuée de cette loi, d'autre part des problèmes de quantification des coefficients, très souvent incontournables lors d'une implémentation sur une architecture CPU de type virgule fixe. Afin d'aborder ce problème, une représentation d'état de type descripteur est tout d'abord proposée, permettant d'explicitier, dans un même formalisme, les retards internes et les effets de quantifications des coefficients de l'algorithme de commande ou de filtrage. Sur la base de cette forme descripteur fondamentale, une condition de stabilité est déduite. Celle-ci peut être mise à profit de manière à trouver la réalisation optimale permettant de garantir la stabilité avec la précision minimale pour coder tous les coefficients. Cette forme descripteur universelle (modélisation des retards mais aussi des quantifications), ainsi que la condition de stabilité du NCS ainsi représentée constituent deux résultats originaux dans cette thèse.

Le chapitre 6 est un chapitre d'application, reposant sur un démonstrateur, sous forme d'un simulateur dans cette thèse, composé de deux robots mobiles devant coopérer pour transporter une charge commune tout en assurant un suivi de trajectoire. Suivant le schéma d'implémentation choisi pour une loi de commande ou de filtrage, via un superviseur ou distribuée sur les deux robots directement, la topologie et les perturbations associées du réseau de communication sont alors différents. Cet exemple simple mais reflétant des problèmes concrets a permis de montrer l'efficacité des outils et méthodologies produits dans les chapitres 3 à 5. Pour commencer, le problème de suivi de trajectoire a pu être traité à l'aide des outils du chapitre 3 (commande LQ stochastique et co-conception de la communication MIMO). Les hypothèses de travail étaient les suivantes ; nous supposons que la position et la vitesse dans le plan des deux robots étaient disponibles, sans retard, à l'aide d'un système de caméras. Ces mesures arrivent au niveau d'un ordinateur superviseur, assurant l'implémentation centralisée de la loi de commande. Les signaux de commande qu'il génère sont ensuite transmis par un réseau digital MIMO, soumis à des pertes de paquets mais présentant une paire de codeur - décodeur. Les objectifs de commande sont ; 1/ le barycentre des deux robots doit suivre une trajectoire prédéfinie, 2/ une interdistance constante doit être respectée entre les deux. La mise en œuvre de la méthodologie de co-conception a ainsi permis d'obtenir différentes lois de commande, en prenant en compte seulement la condition de stabilité ou bien en considérant aussi un critère LQ de performance et les degrés de liberté supplémentaires apportés par les codeurs et décodeurs, et les gains en terme de performances atteignables ont pu être caractérisés en simulation. Par la suite, les résultats du chapitre 4 ont pu être mis en application en cherchant à estimer la vitesse du barycentre des deux robots, en supposant n'avoir accès qu'à la mesure de la position de deux robots. Ceci a donc permis de valider la méthodologie de synthèse de filtre robuste, toujours sous l'hypothèse de pertes de paquets. Un autre exemple de filtre (reconstruction de tout l'état du système, *i.e.* des deux robots) est pris en considération afin d'illustrer les travaux sur la recherche de réalisations robustes du chapitre 5. On suppose ici que l'ordinateur superviseur n'est plus disponible, et que l'on cherche à implémenter ce filtre de manière distribuée sur les deux robots ; chaque robot estime ses propres états, et partage les résultats de sa propre estimation avec l'autre robot. La communication est supposée perturbée par des retards de communication en plus des dégradations liées à la quantification. L'application des résultats obtenus au chapitre 5 permet de trouver la forme la plus robuste à cette distribution et aux dégradations



internes (retards et quantification), et de connaître aussi le nombre de bits minimum nécessaire pour le codage des coefficients de la représentation d'état.

En conclusion, cette thèse s'est intéressée au traitement des trois grands types de dégradations inhérentes à l'implémentation des lois de commande ou de filtrage via un réseau numérique ; les pertes de paquets, les phénomènes de retards ou les problèmes de quantification des données. Différents outils méthodologiques ont été proposés, afin de les prendre en considération, pour différents problèmes classiques de commande ; le suivi de trajectoire (chapitre 3), le filtrage ou l'estimation (chapitre 4), et l'implémentation de ces lois de commande ou de filtrage de façon distribuée (chapitre 5). Ces différentes méthodologies, pouvant avoir des retombées pratiques claires, prennent appui sur différents outils théoriques de modélisation ou de synthèse ; l'approche stochastique de la commande LQ, la notion de stabilité aux moindres carrés, l'utilisation des normes  $H_2$  ou  $H_\infty$  ainsi que la forme descripteur. Des améliorations ou des évolutions de ces différentes contributions sont encore possibles. Par exemple sur la base de la forme descripteur proposée au chapitre 5, il serait intéressant de pouvoir modéliser d'autres types de dégradations intrinsèques aux NCSs ; comme par exemple les pertes de paquets ou les retards variables, ou la prise en compte d'autres lois modélisant l'évolution de ces dégradations (lois stochastiques, markoviennes, voire déterministes fondées sur les connaissances acquises sur certains protocoles de communication). De même, pour le moment seule la stabilité est prise en considération par exemple pour le choix de la réalisation, il serait intéressant d'étendre cet outil d'analyse à certains critères de performance. Le concept de co-conception régulateur – réseau de communication nous semble aussi pertinent, est demandée certainement à être poussé plus en avant. D'autres lois reliant les caractéristiques intrinsèques du système à piloter et les capacités du réseau sont à trouver. Celles-ci pourraient servir de base alors à d'autres outils guidant la conception à la fois du régulateur (ou filtre) et le dimensionnement du réseau digital support de celui-ci. Pour finir, tous les aspects « sécurité réseau » ouvrent tout un nouveau champ d'étude. D'autres perturbations de communication réseau non abordées dans cette thèse sont celles issues d'actions malveillantes types déniés de service, usurpations d'adresses, etc... Ces perturbations, en général plus intelligentes que les perturbations « naturelles », nécessitent le développement d'autres solutions pour rendre les algorithmes de commande ou de filtrage à implémenter plus robustes ou résilients.

# 网络化控制系统的弹性设计问题研究

## 摘 要

相比于传统的点对点控制系统，网络化控制系统具有成本低，可靠性高，易于维护和扩展的优势。凭借这些特有的优势，网络化控制系统在众多领域具有广泛的适用性，目前已成为工业界和学术界研究的热点之一。另一方面，随着通信网络的引入，各种网络诱导因素也带来了一系列前所未有的问题和挑战。丢包、网络诱导时延和量化是最常见的三个问题，也是导致网络化控制系统性能恶化甚至失稳的主要原因。

针对网络化控制系统，已经有大量的研究致力于网络诱导因素影响下的系统分析与综合问题，特别是针对上述三个因素。然而，仍然有许多极具挑战性的问题有待解决。目前，网络化控制系统分析与综合的难点主要集中在以下几个方面。首先，多入多出网络化控制系统的综合问题难以求得解析解，通常只能通过迭代算法求解。其次，多耦合因素下的网络化控制系统的综合问题十分复杂，并缺乏系统性的方法来进行处理。第三，在存在网络诱导因素的情况下，进一步考虑求得的网络化控制系统的实现问题将带来进一步的复杂性和难度。针对这些难点，本文提出了一套网络化控制系统的分析与综合方法，分别考虑了轨迹跟踪控制、鲁棒滤波和有限字长效应下的系统实现问题。具体来说，本文主要进行了以下几个方面的研究。

首先，针对丢包约束下的多输入多输出网络化系统的渐近跟踪问题。通过控制器、编码器和解码器的协同设计，充分利用网络资源，实现多信道下控制系统的均方镇定。相应控制器的综合条件揭示了被控对象的  $H_2$  范数、信道传输成功率和编解码矩阵之间的相互制约关系。并通过一组西尔维斯特方程构建结构化控制器，实现了丢包下的渐近跟踪控制。为提升闭环系统的跟踪品质，进一步考虑了丢包环境中的随机线性二次性能指标约束。借助修正的离散时间代数黎卡提方程来构造相应的反馈控制器。

其次，研究了多信道丢包约束下的鲁棒滤波问题。引入伴随算子对误差系统的稳定性和  $H_\infty$  性能进行分析。然后，导出了用于求解  $H_\infty$  滤波问题的修正代数黎卡提方程，并给出了相应滤波器的设计方法。进一步给出了滤波器存在的充要条件，推导并讨论了误差方程均方稳定性与信道参数之间的关系。

再次，考虑了有限字长效应下网络化控制系统的实现问题，其中的状态反馈

控制器与滤波器在实现过程中，其系数会受到有限精度字长效应的影响，同时，系统内部信息交互所引入的时延也会对系统的整体性能造成影响。针对此问题，提出了一种采用广义模型的方法，在统一的框架内表示包含有限精度字长效应和内部时延的控制器和滤波器的等价实现形式并推导了系统稳定的判别条件。基于此，进一步给出了实现镇定所需字长最小的最佳实现的搜索算法。

为了验证上述控制、滤波和系统实现方法的有效性，本文借助两个协同移动机器人组成的系统作为算例，进行了相应的仿真。

**关键词：**网络化控制系统，丢包，有限字长效应，时延，弹性鲁棒控制， $H_\infty$ 滤波，系统实现

# DESIGN OF RESILIENT NETWORKED CONTROL SYSTEMS

## ABSTRACT

Compared with the conventional point-to-point systems, the main features of networked control systems are low cost, high reliability, ease of maintenance and expansion. For these distinctive advantages, networked control system has a wide applicability in numerous fields and has now been a top research focus in both industry and academia. On the other hand, with the introduction of network come a series of unprecedented problems and challenges. Packet dropout, network-induced delay and quantization are three most common issues of these network-induced problems, and are also generally regarded as the primary causes for the performance deterioration or even instability of networked control systems.

A great deal of research has focused on the analysis and synthesis problem for networked control systems subject to network-induced factors, especially on the three above-mentioned issues. However, there are still lots of challenging problems to be resolved. As far as is known, the difficulties in analysis and synthesis of networked control systems mainly concentrate on the following aspects. To begin with, analytical solutions to the synthesis problems of multi-input-multi-output systems are difficult to solve, which can usually only be solved by iterative algorithms. Secondly, synthesis problem for systems with multiple coupled factors is significantly complicated, and still lacks of systematical methodologies to cope with. Thirdly, it brings additional complexity and difficulty for further considering the realization for networked control systems obtained in existing of network-induced factors. Focusing on these difficulties, this thesis presents a methodology for analysis and synthesis of networked control systems, including trajectory tracking control, robust filtering and system realization subject finite word length effects. Specifically, the following researches are considered in this thesis.

Firstly, the asymptotic tracking problem is considered for multi-input-multi-output networked control systems subject to packet dropouts. The co-design approach of controller, encoder and decoder is adopted in order to take full advantage of the network resource and to achieve the MS stabilization of the control system under multi-channel. The synthesis condition of the corresponding controller reveals the fundamental limitation among the  $H_2$  norm of the plant, the data arrival rates and the

coding matrices. For asymptotic tracking control under packet dropouts, a structured controller is further obtained by solving a Sylvester equation. In order to improve the tracking performance of the closed-loop system, the stochastic linear quadratic constraint under packet dropouts is further considered. And the modified discrete-time algebraic Riccati equation is deduced to construct the corresponding feedback controller.

Secondly, the robust filtering problem is studied over multiple channels with packet dropouts. The adjoint operator is introduced to analyze the stability and  $H_\infty$  performance of the error system. Then, the modified algebraic Riccati equation is derived to solve the  $H_\infty$  filtering problem, and the design method is also proposed for the corresponding filter. Furthermore, the necessary and sufficient conditions for the existence of the filter are given, and the relationships between the MS stability of the error equation and the channel parameters are derived and discussed.

Thirdly, the realization problem subject to finite word length effects is sympathetically addressed for networked control systems. In the process of implementation, the coefficients of state feedback controller and filter are affected by finite word length effects, and the internal time delays in the information interaction will also affect the overall performance of the system. A corresponding descriptor model-based approach is thus constructed to describe the internal time delays and equivalent realizations of the controller and filter with finite word length effects in a unifying framework. And a stability analysis condition is deduced. Based on this, an algorithm is further proposed to find the optimal realization requiring the minimum word length for stabilization.

Finally, in order to verify the effectiveness of the proposed control, filtering and realization methods mentioned above, two cooperative mobile robots are introduced as an illustrative example, while a series of simulations are presented.

**KEY WORDS:** networked control system, packet dropout, finite word length effect, time delay, robust and resilient control,  $H_\infty$  filtering, system realization

# Contents

摘要 .....	I
ABSTRACT .....	III
Contents .....	V
List of Figures .....	VIII
List of Tables .....	VIII
Notations .....	IX
Chapter 1 Introduction .....	1
1.1 Research background and significance .....	1
1.2 Main constraints in NCSs .....	2
1.2.1 Quantization .....	2
1.2.2 Network-induced delay .....	4
1.2.3 SNR constraint .....	5
1.2.4 Fading channel .....	6
1.2.5 Lossy channel .....	6
1.3 Relevant concepts .....	8
1.3.1 Trajectory tracking control .....	8
1.3.2 Linear quadratic control .....	9
1.3.3 System realization .....	9
1.3.4 Singular system .....	10
1.4 Research motivations and contents .....	10
1.4.1 Research motivations .....	11
1.4.2 Research contents .....	11
1.5 Conclusion .....	12
Chapter 2 Preliminaries Results .....	13
2.1 Bounded power signals .....	13
2.2 System norms .....	14
2.3 System stability .....	15
2.4 Matrices lemmas .....	16

2.5	Conclusion.....	17
Chapter 3 Stochastic Asymptotic Tracking Over Lossy Channels .....		18
3.1	Introduction .....	18
3.2	Problem formulation.....	18
3.3	Controller design .....	21
3.3.1	MS stabilization.....	21
3.3.2	Stochastic LQ control .....	24
3.3.3	Asymptotic tracking.....	27
3.4	Conclusion .....	29
Chapter 4 Robust Filtering Over Lossy Channels .....		30
4.1	Introduction .....	30
4.2	Problem formulation.....	30
4.3	Filtering method .....	32
4.3.1	Adjoint operator.....	32
4.3.2	Filter design .....	36
4.4	Conclusion .....	43
Chapter 5 Realization of Network-based Systems .....		44
5.1	Introduction .....	44
5.2	Problem formulation.....	44
5.3	Delay and FWL .....	46
5.4	Problem formulation.....	48
5.5	Realization method .....	49
5.5.1	Descriptor model representation.....	49
5.5.2	Stability analysis.....	52
5.5.3	Special case: filters implemented on one SOC.....	57
5.6	Conclusion .....	59
Chapter 6 Illustration: Cooperative Robots .....		60
6.1	Introduction .....	60
6.2	System description.....	60
6.3	Trajectory tracking control .....	62
6.3.1	Control strategy formulation .....	62
6.3.2	Simulation results .....	64

6.4	Robust filtering .....	70
6.4.1	Filtering strategy formulation .....	70
6.4.2	Simulation results .....	71
6.5	Filter realization.....	72
6.5.1	Realization strategy formulation .....	72
6.5.2	Simulation results .....	73
6.6	Conclusion .....	75
Chapter 7 Summary .....		76
7.1	Concluding remarks.....	76
7.2	Future research directions.....	76
Reference .....		78
Acknowledgements .....		83
Introduction to the Ph.D. Candidate .....		84
1	Brief Introduction .....	84
2	Papers published .....	84
3	Projects participated .....	84
4	Patents for inventions .....	84



## List of Figures

Figure 1-1 Structure of typical NCSs .....	1
Figure 1-2 Quantizers with infinite levels: logarithmic quantizer (a) and uniform quantizer (b).....	3
Figure 1-3 Channel with time delays.....	5
Figure 1-4 Common channel models: SNR channel (a), fading channel (b) and lossy channel (c) .....	5
Figure 1-5 Relationships among chapters .....	12
Figure 2-1 System with stochastic perturbation .....	15
Figure 3-1 System setup .....	19
Figure 3-2 Coding scheme.....	20
Figure 4-1 Filtering problem setup.....	31
Figure 5-1 Problem setup .....	45
Figure 6-1 Setup of the cooperative robots .....	60
Figure 6-2 Control implementation for the robots .....	62
Figure 6-3 Tracking performance without LQ performance .....	65
Figure 6-4 Tracking performance with LQ performance to Case 1 .....	67
Figure 6-5 Tracking performance with LQ performance to Case 2 .....	67
Figure 6-6 Filtering performance .....	71
Figure 6-7 Filtering error.....	71
Figure 6-8 State evolution of the filter realized by the $\delta$ -operator with $\beta=3$ .....	74
Figure 6-9 State evolution of the filter realized by the shift operator with $\beta=5$ .....	74
Figure 6-10 State evolution of the filter realized by the shift operator with $\beta=6$ .....	75

## List of Tables

Table 6-1 Tracking errors of different strategies .....	69
Table 6-2 Minimum word length for stability .....	74

## Notations

$\mathbb{R}$	---	Field of real numbers
$\mathbb{Z}$	---	Field of integer numbers
$\mathbb{C}$	---	Field of complex numbers
$\mathbb{N}$	---	Field of natural numbers
$\mathbb{N}^+$	---	Field of Positive integer numbers
$\mathbb{R}^n$	---	n-dimensional real Euclidean space
$\mathbb{R}^{n \times m}$	---	Set of $n \times m$ real matrix
$I$	---	Identity matrix with appropriate dimensions
$A^{-1}$	---	Inverse of square matrix $A$
$A > 0$	---	Symmetric positive definite matrix $A$
$A \geq 0$	---	Symmetric positive semi-definite matrix $A$
*	---	Symmetric terms in a symmetric matrix
$diag\{A_1, \dots, A_n\}$	---	Block diagonal matrix with $A_i$ on the diagonal
Superscript $H$	---	Complex conjugate transpose
Superscript $T$	---	Transpose
$\mathcal{RH}_2$	---	Space of all strictly proper and real rational stable matrices
$H_\infty$	---	H-infinity
$\in$	---	Belong to
$\otimes$	---	Kronecker product
$\odot$	---	Hadamard product
$\  \cdot \ $	---	Vector or matrix norm

$\triangleq$	---	Define
$\text{Prob}\{ \cdot \}$	---	Occurrence probability of event
$E\{ \cdot \}$	---	Mathematical expectation
$\text{Tr}\{ \cdot \}$	---	Trace of a square matrix
$\rho\{ \cdot \}$	---	Spectral radius
$\sigma_{\max}\{ \cdot \}$	---	Maximum singular value
$\ P\ _1$	---	Matrix 1-norm for $P \in \mathbb{C}^{m \times n}$ as $\max_{1 \leq j \leq m} \sum_{i=1}^n  P_{ij} $
$\mathcal{M}(A)$	---	Mahler measure of $A \in \mathbb{R}^{n \times n}$ as $\prod_{i=1}^n \max\{1,  \lambda_i(A) \}$
$G \triangleq (A, B, C, D)$	---	State space realization of system $G(z)$
LMI	---	Linear matrix inequality
MDARE	---	Modified discrete-time algebraic Riccati equation
MIMO	---	Multi-input-multi-output
MS	---	Mean square
NCSs	---	Networked control systems
SISO	---	Single-input-single-output
SNR	---	Signal-to-noise ratio

# Chapter 1 Introduction

## 1.1 Research background and significance

Over the past decade, the rapid development of computer, network and information technology has significantly changed the structure of control systems. In contrast with traditional point-to-point control structures, plants, sensors, actuators and controllers are now frequently coordinated through communication networks. Such feedback control systems are called networked control systems (NCSs) [1-3]. Figure 1-1 shows a typical structure of NCSs, wherein communications between devices deployed in different locations are realized through a shared digital network. In this case, devices such as controllers and sensors combine to form one or more closed-control loops to enable cooperating for completing work that cannot be done by partial devices. Such network-based structure further promotes the system's overall function and performance. Compared with traditional control systems, NCSs provide advantages of having low costs, low power consumption, high flexibility, strong expansibility, simple installation and maintenance [4-6], and they also enable resource sharing and remote operation. As a result, NCSs currently represent a research focus with wide applications in numerous fields, such as smart grids [7, 8], intelligent transportations [9, 10], sensor networks [11, 12], remote control systems [13, 14] etc.

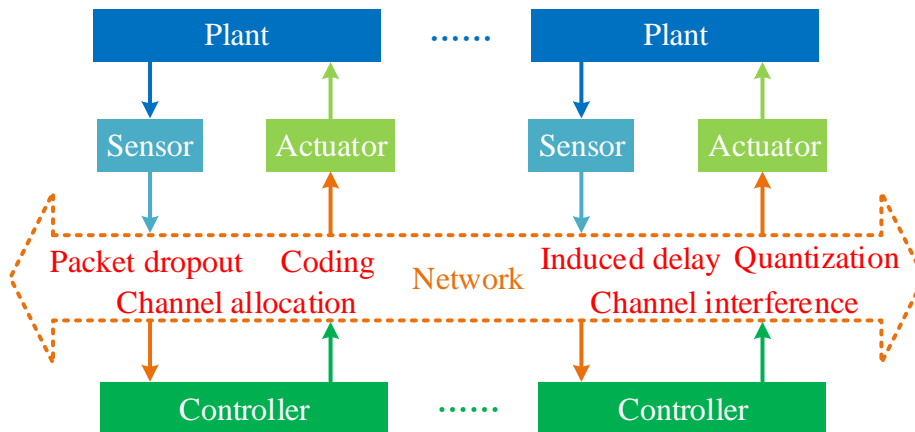

**Figure 1-1 Structure of typical NCSs**

Since the concept of NCSs arose [1], the research on NCS has attracted extensive attention from industry and academia. Numerous NCS-based research results have been published and special issues related to NCSs established by a series of well-known

journals. A new journal ‘IEEE Transactions on Control of Network Systems’ was also launched in 2013 by the control systems association (CSS) of the institute of electrical and electronic engineers (IEEE) to address research into the analysis, design and implementation of NCSs.

The digital communication network, however, is not a completely reliable transmission medium, and in NCSs, the imperfect channels can introduce constraints and uncertainties such as packet dropouts [15, 16], time delays [17, 18], fading [19], limited data rates [20], quantization [21, 22], among which random packet dropouts, fading and time delays are more likely to occur in wireless networks caused by factors such as multi-hop or multi-path data transmissions, channel interferences and so on. These network constraints pose challenges during the analysis and synthesis of NCSs. Inserting unreliable communication networks into the sensor-to-controller and/or controller-to-actuator loop will inevitably reduce system performance or even lead to unstable NCSs. Therefore, many traditional control theories and design methods must be re-evaluated before they can be applied to NCSs, especially DNCSs (distributed networked control systems), which assume that the information interaction process between the plant, actuator(s), sensor(s) and controller(s) is “perfect.”

In summary, the benefits of NCSs make them widely studied and applied by academia and industry; however, they require additional investigation for analysis and synthesis. Further research on NCS aims to aid integrating and developing control and communication technologies to provide theoretical significance and practical value.

## 1.2 Main constraints in NCSs

All research on NCSs into accommodating numerous network-induced constraints can be divided into two categories [2]: One method is to apply traditional control theories without regarding these constraints but then design a communication protocol that minimizes the occurrence of these issues. The other approach is to address network-unfavorable events as given conditions and then design ad hoc control strategies that explicitly consider them. Regardless of approach, the characteristics or mathematical expressions of the network constraints require discussion first. And this section thus introduces several common constraints in NCSs and some corresponding results.

### 1.2.1 Quantization

From a control perspective, quantizer is regarded as a class of nonlinear systems that converts the input to an element in a presupposed set. The elements of the presupposed set are called the quantitative levels of quantizers. Quantizers can be uniform or non-uniform according to the quantitative levels. One representative non-uniform

quantizer is called the logarithmic quantizer with exponential quantization levels [23]. The uniform quantizer and logarithmic quantizer with infinite levels are shown in Figure 1-2, where  $v$  is the input of the quantizers and  $u$  is the quantized output. In Figure 1-2 (b), the lengths of each quantization level are equal for the uniform quantizer. Such quantizers are easy to be described by mathematical models, and their quantization error is often uniformly distributed and regarded as additive disturbance [24]. Therefore, when the input signal is small, the output signal is greatly affected by the quantization noise. For comparison, the SNR of each quantization level is equal for the logarithmic quantizer in Figure 1-2 (a), and when the input signal is small, its quantization levels are dense, and when the input signal is large, the quantization levels are sparse. In practice however, the quantitative levels of quantizers are always limited, and thus the practical application will also limit the values of the input and output signals.

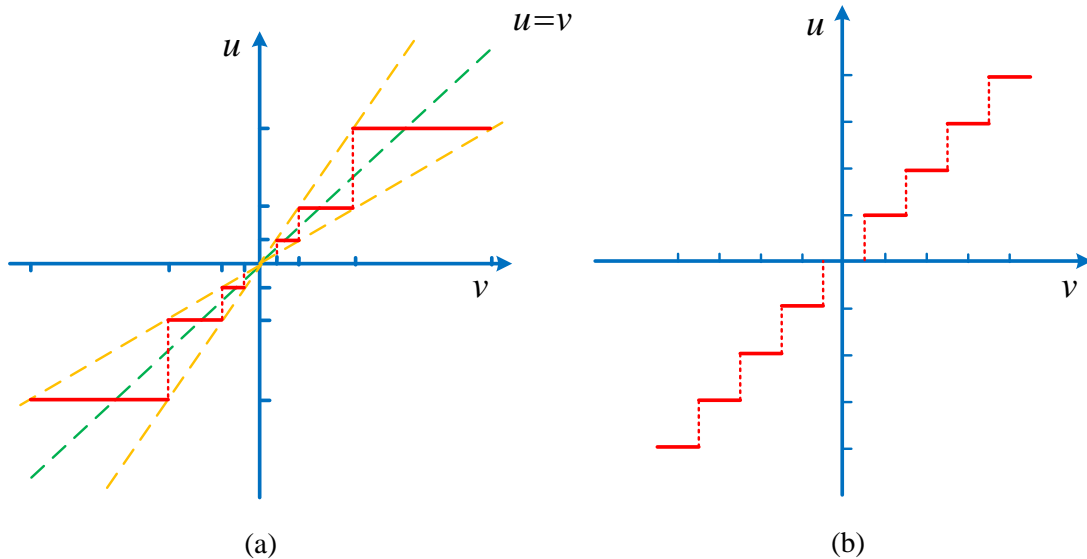

**Figure 1-2 Quantizers with infinite levels: logarithmic quantizer (a) and uniform quantizer (b)**

In the field of digital control or digital signal processing, signal quantization represents a problem requiring consideration. Because the bandwidth resources are limited in networked systems, the data transmitted through the network must be transmitted with as few bits as possible. Reducing the number of bits and quantization accuracy will inevitably increase the quantization error. It will affect the system performance and even lead to system instability; therefore, the quantizer influence on the performance of NCSs has attracted attention. The authors in [23] studied the stabilization problem of single-input systems with logarithmic quantized state feedback, where the coarsest quantization density required for quadratic stabilization was obtained regarding the Mahler measure of the plant, i.e., the absolute product of the unstable poles. The logarithmic quantizer proposed in [24], where the quantized data have

uniform upper and lower bounds of relative error, is further described by a sector nonlinear approach in [25]. Then, the coarsest quantization is studied in [26] in the multiple input case using the Lyapunov function approach, whereby the system can be stabilized using a one-dimensional subspace of the input space. Instead of a single quantizer, the authors in [27] use separate quantizers at different inputs and obtain a sufficient condition for stabilization in terms of Linear matrix inequalities (LMIs). [28] proposed a class of uniform quantizers with time-varying characteristics, which can use only a few quantization levels under specific circumstances. In contrast, the authors in [29] modeled the quantization errors of the logarithmic quantizer as uniformly distributed random noise, and further consider the output feedback stabilization in the mean square (MS) sense.

Quantization is also a problem requiring consideration in coefficients' representation for digital devices. Such devices entail finite precision, leading to some finite word length (FWL) effects that can influence the stability and performance of the system. In a decentralized architecture, these effects include: 1) computing devices embedded in such architecture often have reduced computing capabilities; 2) potentially numerous processors can be involved. There are two categories of FWL effects: 1) the roundoff noise due to the rounding of variables in mathematical operations [30] and 2) the distortion of parameters resulting from coefficients' representation [31]. The FWL effects depend on the arithmetic format (floating point, fixed-point etc.) and chosen type of realization.

### 1.2.2 Network-induced delay

Time delays represent key indicators to measure the performance of networks. As shown in Figure 1-3, time delays can be introduced in the processing, sending and transmission of the data packets. Numerous factors such as network protocol, network topology, packet length and sending rate affect the characteristics of the network-induced delays. For example, TCP/IP protocols provide reliable transmission of data packets, regardless of possible collisions that might occur on the physical transmission medium, and thus TCP/IPs will result in packet delays but no packet dropouts. Network-induced delays take various forms in different studies: 1) Regarding the length, network-induced delays are divided into long time delays (larger than one sampling period) and short time delays; 2) regarding the time-varying characteristics of the network-induced delays, they are divided into fixed delays and time-varying delays.

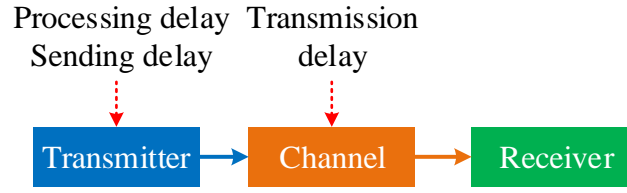
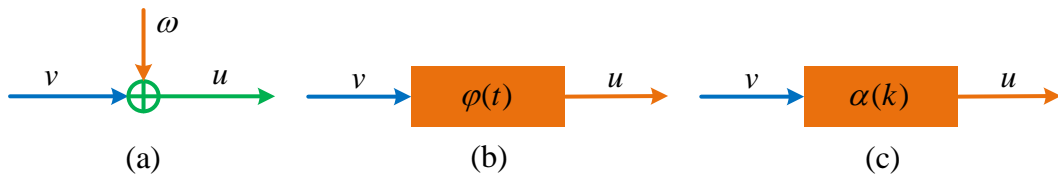

**Figure 1-3 Channel with time delays**

Time delays have received considerable attention in the field of networked systems, and thus researchers have developed different types of modeling and analysis methods for networks with time delays. For fixed time delays, the influence of time delays on system performance was studied in [32]. While in [33], a buffer with appropriate length was established to offset the impact of delays on system performance. For time-varying delays, [34] proposed to use time-driven samplers and event-driven actuators to regard the delays as a state. In [35], robust control approach was used to treat the time-varying delay as an uncertain parameter of the system. In [36], the stability analysis and controller design of NCSs with long time delays were studied using stochastic optimal methods. In [37], a time-delay system method was proposed to study the  $H_\infty$  control of NCSs with continuous time delays. It is worth noting that many results in the literature notably address delays only on the control and measurement signals between the controller and plant, while few papers handle internal delays inside a controller or filter.

### 1.2.3 SNR constraint

The signal-to-noise ratio (SNR) constraint is frequently used in information and communication theory. As shown in Figure 1-4 (a),  $v$  is the input of the channel, and  $u$  is the output and  $\omega$  the disturbance. For such models, the channel input signal  $v$  is often assumed to be a stationary process with given predetermined admissible power level  $P_v$ , and the transmission process is supposed to be disturbed by a zero-mean white Gaussian noise  $\omega$  with known power spectral density  $P_\omega$ . In this case, the signal-to-noise ratio of the channel in Figure 1-4 (a) is defined as  $P_v / P_\omega$ , which can also be regarded as a given signal-to-noise ratio constraint on the channel. A large SNR implies that more reliable information can be transmitted through the channel.



**Figure 1-4 Common channel models: SNR channel (a), fading channel (b) and lossy channel (c)**

Stabilization under SNR constraints represents a fundamental issue in NCSs and is investigated in different studies. For instance, [38] provided a method to obtain the



minimum SNR that ensures stabilization using static-state feedback for the single-input case regarding the topological entropy of the plant. On this basis, [39, 40] demonstrated that such requirements between the SNR and the topological entropy of the plant are necessary for stabilization even given the adoption of nonlinear control laws. In contrast, authors in [41] investigated the stabilization via a linear time-invariant (LTI) controller over the additive white Gaussian noise channel, where the minimum total transmission power required for stabilization is given in terms of the  $H_2$  norm of certain transfer functions. For the MIMO case, necessary and sufficient conditions for stabilization were obtained in [42] regarding the SNRs of the channels for both state and output feedback architectures.

#### 1.2.4 Fading channel

Fading represents a common issue in communication, especially in wireless networks. As shown in Figure 1-4 (b), the channel input signal  $v$  is subject to a stochastic multiplicative noise  $\varphi(t)$  instead of an additive white Gaussian noise as in the SNR channel model, where  $\varphi(t) \in [0, 1]$  is a continuous-time random process.

In recent years with the wide application of wireless network, the fading effect has received significant research. Considering feedback control over fading channels, author in [43] presented the minimal capacity for MS stabilizing in terms of the Mahler measure of the plant. Following the work in [43], [44] focused on the network requirement for both state feedback and output feedback stabilization of MIMO plants over multiple fading channels and provided necessary and sufficient conditions for triangularly decoupled MIMO systems. In addition to stabilization problems, [45] investigated probabilistic stability of Kalman filtering over fading channels and established stability conditions for upper and lower almost-sure stability. Authors in [46] considered distributed filtering problems over wireless sensor networks subject to fading measurements and deduced the matrix difference equations to pursue an upper bound for the filtering error covariance.

#### 1.2.5 Lossy channel

Packet dropout means that one or more packets cannot successfully reach the destination through the network [15, 47]. As depicted in Figure 1-4 (c), the lossy channel subject to packet dropouts is regarded as a particular case of a fading channel, where stochastic multiplicative noise  $\alpha(k)$  takes value in set  $\{0, 1\}$ . The causes of packet dropouts include signal degradation, channel blocking, packet corruption and damage to the hardware or driver. In most network protocols, if the packet is sent and cannot be delivered to the receiver after a certain period, then it is judged as lost. Some

network protocols, such as transmission control protocols (TCPs), provide reliable packet delivery schemes, so that in cases of packet dropout, the TCP will request the sender to retransmit the packets to the receiver repeatedly until they are correctly received. Other protocols such as the user datagram protocols (UDPs) do not provide for the recovery of lost packets and thus requires defining its own mechanism to deal with packet loss. For communication protocols with retransmission mechanisms, the frequent retransmission of lost packets may lead to larger transmission delays, and therefore some retransmission mechanisms cannot be applied in some real-time networked systems. What should the controller (or filter) do when packet dropout occurs? There are three categories: 1) if the input information is missing, then the input is set to zero (Zero-input) [48],  $u(k) = 0$ ; 2) before the arrival of the new information, retain the previous input information (Hold-input) [49],  $u(k) = u(k-1)$ ; 3) make predictions for the information and use it as the input information (Predictive-input) [50],  $u(k) = \hat{u}(k)$ , where  $\hat{u}(k)$  is the estimation of  $u(k)$ . Scheme 1 is relatively simple, but the non-smooth switch of input signal caused by the input to be suddenly set to zero may cause adverse system effects; scheme 2 can guarantee the smooth transition of the input signal but does not ensure a favorable system performance; scheme 3 can achieve ideal performance but requires extra costs of storage and computing. Choosing the above schemes thus depends on the situation.

Packet dropouts have received significant research. Based on the stochastic system approach, in [51], an optimal control problem was considered for NCSs with Bernoulli packet dropouts in both actuating and feedback channel by adopting UDP and TCP protocols respectively. The authors in [52] considered a stabilization problem with actuating channels subject to Bernoulli packet dropout, where the necessary and sufficient conditions are determined regarding the packet dropout probability and spectral radius of the system matrix. The stabilization problem for single-input single-output systems with Bernoulli packet dropouts was solved in [53] by computing two algebraic Riccati equations and a Riccati inequality, which reveals the tradeoff between robust stability and performance. Furthermore, [54] provides the solution for the multi-input multi-output case. For NCSs with packet dropouts driven by Markov chains in both actuating and feedback channels, the sufficient conditions for the system's stochastic stability as well as the design method of the controller are given in [55] for both SISO and MIMO channel cases. Another method to analyze NCSs with packet dropout regards the switched system approach, whereby the NCSs subject to the packet dropout is regarded as a switched system within several subsystems to describe the status of the system with successful or failed data transfer. The Lyapunov function

must be found and the switched system approach can be further adopted to perform stability analysis and controller design for NCSs. In [56], the switched system approach is adopted to introduce the weakly hard real-time constraints to describe the packet dropout process in a non-probabilistic manner, and NCSs with packet dropout are modeled as a non-arbitrary switching system with a limited number of subsystems. Despite failures in updating the control input, this method guarantees the stability of the entire system in the classical sense of Lyapunov. In [57, 58], the authors described the closed-loop system with packet dropouts as a discrete-time switched system composed of four subsystems. The average dwell-time method is adopted to request the sufficient conditions for exponential stability of closed-loop systems as well as the design method for the observer-based output feedback controller. The relationship between system stability and packet dropout rate is also shown. Other approaches to addressing packet dropouts include the event-triggered method [59], predictive control method [60] and improved transmission protocol [61]. Many studies are also devoted to the filtering problem [62-64], control of multi-agents [65, 66] and distributed control and filtering of sensor networks [67-69] over lossy channels.

Among the issues that lead to unreliable communication networks, the packet dropouts and network-induced delays are regarded as the main indexes to measure network performance and are known to primarily cause performance deterioration or the instability of NCSs [2, 70]. Many studies of NCSs have considered the influence of both factors; for example, the consensus problem of multi-agent systems with random communication delay and packet loss were considered in [71], where a queuing mechanism was applied and the switching process of the interaction topology of the network was modeled as a Bernoulli random process. In [72], a discrete-time controller with time-varying sampling periods was considered and is assumed to switch between different values in a random manner with given probability. A model was developed to describe the possible multiple random transmission delays and data packet losses by employing a group of Bernoulli distributed random variables in [73, 74] extended a state-feedback approach to event-based control to cope with communication delays and packet losses in the feedback link.

### 1.3 Relevant concepts

In this thesis, Chapters 3, 4 and 5 focus on trajectory tracking control, robust filtering and system realization, respectively. Therefore, some essential concepts related to these research contents are given in this section for better understanding.

#### 1.3.1 Trajectory tracking control

The output regulation or trajectory tracking control problem is defined as allowing the

controlled output of a system to track a reference signal, which is generated by a trajectory generator called an exogenous system. It is known that if a controller achieves exact tracking, then it must contain a copy of the exo-system.

The classical output regulation problem has been systematically investigated for continuous-time linear systems [75, 76] and discrete-time linear systems [77] respectively. Some studies over the past dozen years have focused on the output regulation problem in networked environments with transmission uncertainties. The output regulation problem for continuous linear time delay systems is studied in [78] using the operator approach and in [79] using the finite-dimensional linear state space techniques. Moreover, the output regulation problem is extended to a cooperative and distributed scheme with constraint as switching network topology [80]. Output regulation is alternatively addressed using input/output weighting estimators, and the classical internal model principle is extended to the so-called comprehensive admissibility [81].

### 1.3.2 Linear quadratic control

Linear quadratic (LQ) control regards an indispensable role in systems and control theory since it can obtain the optimal control law for feedback control to realize the closed-loop optimal control and is widely used as an optimal control method.

Such problems for deterministic systems have been investigated and reached a mature state in the 1970s [82]. The optimal control problem for systems subject to stochastic perturbations and network-induced constraints has received equally considerable attention from the control community; for example, [83] addressed the LQ control problem for NCSs subject to data rate constraints by employing a state feedback control scheme to achieve the minimum data rate for the MS stabilization of the system. To address the LQ problem for Itô-type stochastic systems with input delays, the authors in [84] introduced a forward-backward stochastic differential equation-based approach to obtain the optimal controller. [85] was concerned with the stochastic LQ control for Markovian jumping systems and used the averaging approach to aggregate states according to their jump rates. [86] studied the LQ performance of systems where control signals are subject to packet dropout, and both zero-control and hold strategies are discussed. The authors in [87] studied the LQ control problem for discrete-time linear systems over single packet-dropping link and proposed a controller-coding co-design method to address the lost packets, where estimated values are used to replace the missing measurements.

### 1.3.3 System realization

A given system can be expressed using equivalent realization forms with different coefficients, such as direct-form I, direct-form II, balanced realization,  $\delta$ -operator

realization, etc. When subject to coefficients' representation with FWL effects, these realizations are no longer equivalent, and it is therefore necessary to select the appropriate realization form based on the scenario.

The  $\delta$ -operator generally has favorable FWL properties with coefficients' representation [88]. The state-space form can represent most realizations, and many realization problems are considered in the state-space framework [89, 90]; however, such representation is generally insufficient and entails several limitations. The descriptor model was thus introduced in [91] to analyze deteriorations caused by FWL effects. In [92], a new  $\rho$ -modal realization was constructed motivated by the  $\delta$ -operator for implementing the filters or controllers with distinct poles in the descriptor model framework. [93] adopted the same descriptor framework to address the implementation problem of controllers/filters by involving time delays in the network among subsystems.

#### 1.3.4 Singular system

Singular systems can be called generalized state space systems, implicit systems and descriptor systems [94, 95]. The applicability of singular systems is greater than that of normal state space system. The author in [96] first proposed the concept of singular system to describe the current transient phenomenon before and after failure in the power grid.

The descriptor/implicit model [97, 98] regards an important tool for analyzing and synthesizing control systems. [95] proposed a general framework in descriptor form to analyze the FWL effects of linear time-invariant digital filter implementations. [93] adopted the same descriptor framework to address the implementation of controllers/filters over NCSs, where communication delay is involved in the channel among subsystems. Moreover, control under unstable and nonproper input/output weight is addressed using descriptor models, while a structured controller with an extended internal model principle was derived in [81].

### 1.4 Research motivations and contents

This thesis proposes methodologies for analyzing and synthesizing NCSs subject to network-induced factors. Resilient NCSs are required to be designed, i.e., the given performance of NCSs can be guaranteed subject to network-induced factors such as packet dropouts and time delays. This section lists the motivations and research contents to facilitate discussion.

#### 1.4.1 Research motivations

This thesis is motivated by the following difficulties in NCSs-related research: 1) determining an analytical solution to the synthesis problem of multi-input-multi-output NCSs regards an essential  $\mu$ -synthesis problem, which can usually only be solved via iterative algorithms; 2) the synthesis problem with multiple coupled factors becomes significantly complicated to handle and more systematical methodologies need to be established; 3) in the presence of coupled multiple uncertainties, it becomes necessary to select the appropriate realization form for NCSs based on the scenario. Focusing on the above difficulties, several studies are considered in this thesis and the main research contents are introduced in the following subsection.

#### 1.4.2 Research contents

According to the three difficulties in NCSs-related research mentioned in Subsection 1.4.1, in this thesis the following studies are carried out:

1) Regarding difficulties 1 and 2, the stochastic LQ control under asymptotic tracking is considered for MIMO discrete-time system with packet dropouts in Chapter 3. A pair of linear encoder and decoder is introduced in the transmitting side and receiving side of the channels to fully utilize the communication resource and achieve a better signal transmission. Some sufficient conditions are deduced to co-design the controller and coding matrices so that the tracking problem is solved and the stochastic LQ performance is guaranteed.

2) Regarding difficulty 1, the  $H_\infty$  filtering problem is studied over lossy channels in Chapter 4. A MDARE-based solution is first derived to solve the filtering problem by introducing an adjoint operator for the error system, and to design the corresponding filter. Some necessary and sufficient conditions are further deduced for the error system to be MS stable. Finally, the relationships are clarified between the obtained modified discrete-time algebraic Riccati equation (MDARE) condition and the MS stability of the error system.

3) Regarding difficulty 3, Chapter 5 handles the realization problem of NCSs subject to deteriorations caused by both coefficients' representation with FWL effects and internal transmission delays. A descriptor model-based method is proposed to describe the realization problem subject to both internal time delays and FWL effects in a unified framework. Based on the descriptor model, the stability analysis condition for the controller/filter is deduced.

In Chapter 6, the control, filtering and realization methods proposed in Chapters 3-5 are applied to the cooperative robots and a series of simulations are presented to illustrate the effectiveness of the results. Finally, a summary of the research in this thesis is provided in Chapter 7.

The relationships among the above three studies are depicted in Figure 1-5. In

Chapter 3, the trajectory tracking control is studied over lossy channels, where the system state is required for feedback stabilization to ensure the tracking performance of the closed-loop system. When the state signals cannot be accurately obtained or the measurement process is disturbed by disturbance, the filtering problem needs to be considered. In Chapter 4, the robust filtering problem is also considered over multiple lossy channels. In Chapter 5, the realization problem of controller or filter is considered. When the state feedback controller and filter obtained are required to be further implemented in a centralized or decentralized manner, the realization method proposed in Chapter 5 can be adopted to deal with FWL effects and internal time delays.

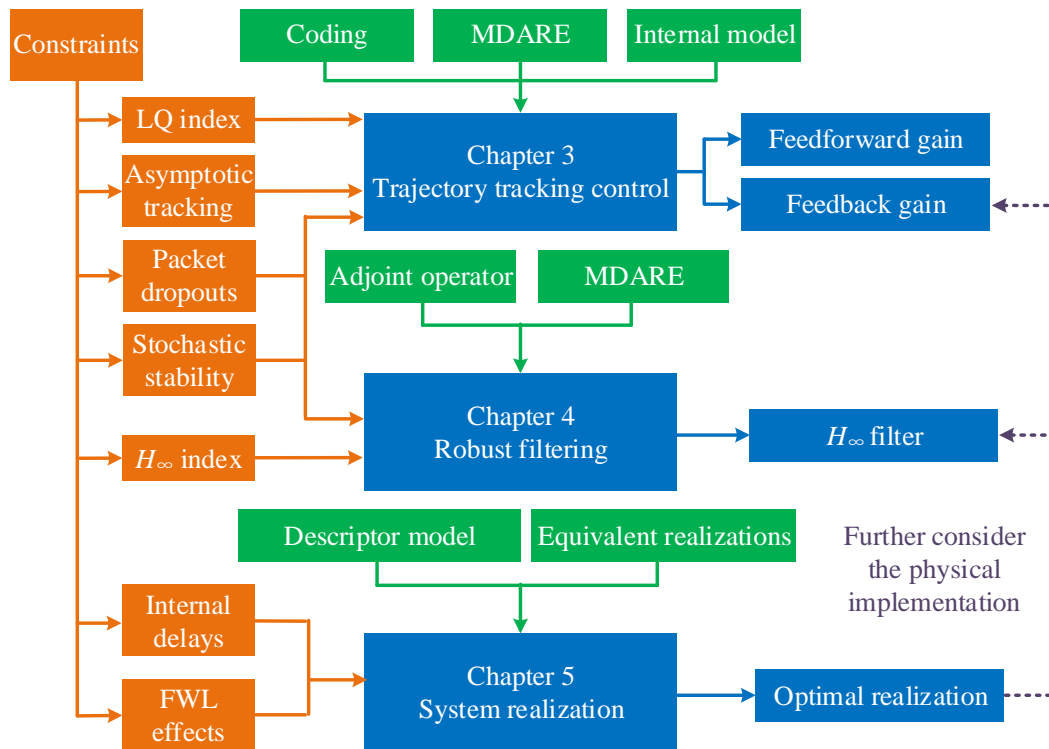

**Figure 1-5 Relationships among chapters**

## 1.5 Conclusion

This chapter introduces the research background of the thesis and presents some existing research related to this thesis. On this basis, this chapter also summarizes the difficulties in the analysis and synthesis problem for NCSs. Then the main research content of this thesis and the relationships between chapters are discussed in the last section of this chapter.

## Chapter 2 Preliminaries Results

This thesis is concentrated to networked-based systems with constraints such as packet dropouts and time delays, where several methodological contributions for analysis and synthesis are proposed. In this chapter, a brief introduction to some basic definitions and lemmas related to the research contents of this thesis is given to facilitate the further discussion.

### 2.1 Bounded power signals

Consider the following discrete-time real vector stochastic signal

$$u(k) = [u_1(k) \quad u_2(k) \quad \cdots \quad u_m(k)]^T \in \mathbb{R}^m, \quad (2-1)$$

where  $u_i(k)$ ,  $i=1, 2, \dots, m$  are real discrete random processes. The mean and autocorrelation matrices are defined respectively as

$$E[u(k)] \triangleq [E\{u_1(k)\} \quad E\{u_2(k)\} \quad \cdots \quad E\{u_m(k)\}]^T, \quad (2-2)$$

$$R_{uu}(\tau) = \lim_{N \rightarrow \infty} \frac{1}{N} \sum_{k=0}^{N-1} E\{u(k+\tau)u^T(k)\}, \quad (2-3)$$

The power spectral density of  $u(k)$  is

$$S_{uu}(\omega) = \frac{1}{2\pi} \sum_{k=-\infty}^{\infty} R_{uu}(k) e^{-j\omega k}. \quad (2-4)$$

A stationary stochastic vector signal is said to have bounded power if

1. both  $R_{uu}(\tau)$  and  $S_{uu}(\omega)$  exist;
2.  $\lim_{N \rightarrow \infty} \frac{1}{N} \sum_{k=0}^{N-1} E\{\|u(k)\|_2^2\} < \infty$ .

For bounded power signal  $u(k)$ , the following definition is introduced.

**Definition 2-1. (Power norm)** [99] For a vector stationary stochastic signal

$$u(k) = [u_1(k) \quad u_2(k) \quad \cdots \quad u_m(k)]^T \in \mathbb{R}^m, \quad (2-5)$$

which is power bounded, the semi-norm can be defined on  $\mathcal{P}$  as

$$\|u(k)\|_{\mathcal{P}} = \sqrt{\lim_{N \rightarrow \infty} \frac{1}{N} \sum_{k=0}^{N-1} E\{\|u(k)\|_2^2\}} = \sqrt{\text{Tr}\{R_{uu}(0)\}}, \quad (2-6)$$

where  $\mathcal{P}$  is the set of all signals with bounded power.



## 2.2 System norms

Consider a LTI system described by

$$\begin{cases} x(k+1) = Ax(k) + Bu(k), \\ y(k) = Cx(k) + Du(k), \end{cases} \quad (2-7)$$

where  $x(k) \in \mathbb{R}^n$  is the state vector,  $u(k) \in \mathbb{R}^m$  is the control input, and  $y(k) \in \mathbb{R}^p$  is the output measurement, respectively.  $A$ ,  $B$ ,  $C$  and  $D$  are known matrices with appropriate dimensions. The system transfer function is defined as

$$G(z) = \begin{bmatrix} A & B \\ C & D \end{bmatrix} = C(zI - A)^{-1}B + D, \quad (2-8)$$

and the following system norms are defined for  $G(z)$ .

**Definition 2-2. ( $H_2$  and  $H_\infty$  norms)** [99, 100] For a stable discrete-time system  $G(z)$  with state space realization  $G = (A, B, C, 0)$ , denote  $w \in \mathbb{R}^m$  and  $z \in \mathbb{R}^p$  as the input and output signals of the system, respectively. The  $H_2$  and  $H_\infty$  norms of this system are defined as

$$\|G\|_2 = \sqrt{\frac{1}{2\pi} \int_{-\pi}^{\pi} \text{Tr}\{G(e^{j\omega})G^H(e^{j\omega})\}d\omega}, \quad (2-9)$$

$$\|G\|_\infty = \sup_{\omega} \sigma_{\max}[G(e^{j\omega})]. \quad (2-10)$$

Note that if  $w$  is a bounded power signal, it can be shown that

$$\|G\|_\infty = \sup_w \frac{\|z\|_{\mathcal{P}}}{\|w\|_{\mathcal{P}}}. \quad (2-11)$$

And it is easy to validate that

$$\|G\|_\infty < \gamma \Leftrightarrow 0 < \gamma^2 \|w\|_{\mathcal{P}}^2 - \|z\|_{\mathcal{P}}^2, \forall w \neq 0. \quad (2-12)$$

Moreover, if  $w$  is a white disturbance signal, it can be shown that  $\|G\|_2 = \|z\|_{\mathcal{P}}$ .

In the study of the following chapters, packet dropouts will be considered and the stability of stochastic system is required to be analyzed. Therefore, the mixed norm for  $G(z)$ , which is related to stability of such systems, is defined as

$$\|G\|_{2,1} = \sqrt{\max_{1 \leq j \leq m} \sum_{i=1}^p \|G_{ij}(z)\|_2^2}, \quad (2-13)$$

where  $G_{ij}(z)$  denotes the element of  $G(z)$  in  $i^{\text{th}}$  row and  $j^{\text{th}}$  column.

## 2.3 System stability

Different from the internally stability for deterministic systems, the MS stability is considered for stochastic systems in this thesis and the following definition is therefore introduced.

**Definition 2-3. (MS stability)** [43] Consider a closed-loop system

$$x(k+1) = Ax(k) + B\Delta(k)Kx(k), \quad (2-14)$$

where  $x(k) \in \mathbb{R}^n$  is the state vector and  $\Delta(k) = \text{diag}[\Delta_1(k), \dots, \Delta_p(k)] \in \mathbb{R}^{p \times p}$  is a random process with  $E\{\Delta_i(k)\} = 0$ ,  $E\{\Delta_i^2(k)\} = \tau_i^2$ ,  $A \in \mathbb{R}^{n \times n}$ ,  $B \in \mathbb{R}^{n \times p}$  and  $K \in \mathbb{R}^{p \times n}$  are all known matrices with appropriate dimensions. System (2-14) is said to be MS stable if for any bounded initial state  $x(0)$ ,  $E\{x(k)x^T(k)\}$  is well defined for all  $k$  and

$$\lim_{k \rightarrow \infty} E\{x(k)x^T(k)\} = 0. \quad (2-15)$$

For analyzing the MS stability of stochastic systems, the following stochastic small gain theorem is introduced here.

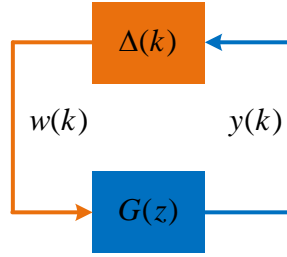

Figure 2-1 System with stochastic perturbation

**Lemma 2-1. (Stochastic small gain theorem)** [43] For an internally stable system  $G$  with dimension  $p \times p$  and a structured random process

$$\Delta(k) = \text{diag}[\Delta_1(k), \dots, \Delta_p(k)] \quad (2-16)$$

such that  $E\{\Delta_i(k)\} = 0$ ,  $E\{\Delta_i^2(k)\} = \tau_i^2$ ,  $i = 1, 2, \dots, p$ , the feedback interconnection in Figure 2-1 is MS stable if and only if the condition  $\rho\{\phi\{G\}\Psi\} < 1$  holds, where  $\Psi = \text{diag}[\tau_1^2, \dots, \tau_p^2]$ , and the operator  $\phi\{G(z)\}$  for  $G(z)$  is defined as

$$\phi\{G(z)\} = \begin{bmatrix} \|G_{11}\|_2^2 & \cdots & \|G_{1m}\|_2^2 \\ \vdots & \ddots & \vdots \\ \|G_{m1}\|_2^2 & \cdots & \|G_{mm}\|_2^2 \end{bmatrix}. \quad (2-17)$$

The relation between the above Lemma 2-1 and the mixed norm defined in (2-13) will be further explained by Lemma 3-1 in Chapter 3.

The discrete-time singular systems is considered in Chapter 5 and the related definitions are therefore first given here.

**Definition 2-4.** [101] For a discrete-time singular system

$$Ex(k+1) = Ax(k), \quad (2-18)$$

where  $x(k) \in \mathbb{R}^n$  is the state vector,  $A \in \mathbb{R}^{n \times n}$ ,  $E \in \mathbb{R}^{n \times n}$  are known matrices and  $E$  maybe singular. The following definitions are introduced for system (2-18)

1. It is said to be regular if  $\det(zE - A)$  is not identically zero;
2. It is said to be causal if  $\deg[\det(zE - A)] = \text{rank}(E)$ ;
3. It is said to be stable if  $\rho(E, A) < 1$ ;
4. It is said to be admissible if it is regular, causal and stable.

## 2.4 Matrices lemmas

At the end of this chapter, some lemmas related to matrices are given for further study in Chapters 3, 4 and 5.

**Lemma 2-2. (Schur complement)** [102] For any real matrices  $S_1$ ,  $S_2$  and  $S_3$  with appropriate dimensions that  $S_1 = S_1^T$ ,  $S_3 > 0$ . Then there holds

$$S_1 - S_2 S_3^{-1} S_2^T < 0, \quad (2-19)$$

if and only if

$$\begin{bmatrix} S_1 & S_2 \\ S_2^T & -S_3 \end{bmatrix} < 0, \quad (2-20)$$

or equivalently

$$\begin{bmatrix} -S_3 & S_2^T \\ S_2 & S_1 \end{bmatrix} < 0. \quad (2-21)$$

**Lemma 2-3. (Block matrix inversion)** [103] If a matrix is partitioned into four blocks, it can be inverted blockwise as follows

$$\begin{bmatrix} A & B \\ C & D \end{bmatrix}^{-1} = \begin{bmatrix} A^{-1} + A^{-1}B(D - CA^{-1}B)^{-1}CA^{-1} & -A^{-1}B(D - CA^{-1}B)^{-1} \\ -(D - CA^{-1}B)^{-1}CA^{-1} & (D - CA^{-1}B)^{-1} \end{bmatrix}, \quad (2-22)$$

where  $A$ ,  $B$ ,  $C$  and  $D$  have arbitrary size and  $A$  and  $D$  must be square, so that they can be inverted. Furthermore,  $A$  and  $D - CA^{-1}B$  must be invertible. Equivalently, by permuting the blocks

$$\begin{bmatrix} A & B \\ C & D \end{bmatrix}^{-1} = \begin{bmatrix} (A - BD^{-1}C)^{-1} & -(A - BD^{-1}C)^{-1}BD^{-1} \\ -D^{-1}C(A - BD^{-1}C)^{-1} & D^{-1} + D^{-1}C(A - BD^{-1}C)^{-1}BD^{-1} \end{bmatrix}. \quad (2-23)$$

Here,  $D$  and  $A - BD^{-1}C$  must be invertible.

**Lemma 2-4. (Projection lemma)** [104] For a symmetric matrix  $Z \in \mathbb{R}^{m \times m}$ , two matrices  $U$  and  $V$  of column dimension  $m$ , there exists an unstructured matrix  $X$

that satisfies

$$U^T X V + V^T X^T U + Z < 0, \quad (2-24)$$

if and only if the following projection inequalities with respect to  $X$  are satisfied

$$N_U^T Z N_U < 0, \quad N_V^T Z N_V < 0, \quad (2-25)$$

where  $N_U$  and  $N_V$  are arbitrary matrices whose columns form a basis of the null spaces of  $U$  and  $V$ , respectively.

**Lemma 2-5.** [105] Let  $\Lambda$  and  $\Pi$  be any real matrices with appropriate dimensions. Then, for any scalar  $\varepsilon > 0$ ,

$$\Lambda^T \Pi + \Pi^T \Lambda \leq \varepsilon^{-1} \Lambda^T \Lambda + \varepsilon \Pi^T \Pi. \quad (2-26)$$

## 2.5 Conclusion

In this chapter, as preliminaries results, some basic definitions for signals, systems and matrices are first introduced. On this basis, some lemmas related to the research contents in the following chapters are further given to facilitate the following discussion.

## Chapter 3 Stochastic Asymptotic Tracking Over Lossy Channels

### 3.1 Introduction

As previously mentioned in Subsection 1.4.1, the difficulties in designing NCSs mainly focus on the following aspects. First, an analytical solution to controller synthesis of multi-input NCSs turns out to be an essential  $\mu$ -synthesis problem [54, 106]. Secondly, controller synthesis problem with multiple coupled factors becomes significantly complicated and harder to cope with [81, 107]. Motivated by the above discussion, in this chapter, the stochastic LQ control under asymptotic tracking is considered for MIMO discrete-time system over lossy channels. To solve this objective control problem, the controller-coding co-design approach is adopted, i.e., a pair of linear encoder and decoder is introduced respectively in the transmitting side and the receiving side of the channels, in order to take full advantage of the communication resource and to achieve a better signal transmission. Sufficient conditions are deduced for co-designing of the controller and the coding matrices such that the tracking problem is solved and the stochastic LQ performance is guaranteed.

The contributions of this chapter are briefly discussed here. In the current tracking problem, multiple constraints as MIMO lossy channels, LQ performance requirement and coding strategy are investigated at the same time under a unified framework. Such multi-objective problem brings considerable difficulties during controller synthesis. This chapter presents a complete solution to the aforementioned problem. Moreover, different from the resource allocation technique reported in [44, 106] where diagonal coding matrices are adopted, full dimensional coding matrices are applied here to achieve less conservative performance of the closed-loop system.

### 3.2 Problem formulation

The overall setup of the control problem is depicted in Figure 3-1, where the controller connects to the discrete-time plant through the encoder, the multiple channels subject to packet dropouts and the decoder. The plant is described by the following discrete-time state-space representation

$$\begin{cases} x(k+1) = Ax(k) + Bu(k), \\ z(k) = Cx(k) + Du(k), \end{cases} \quad (3-1)$$

where  $x(k) \in \mathbb{R}^n$  is the state vector,  $u(k) \in \mathbb{R}^m$  is the control input, and  $z(k) \in \mathbb{R}^p$  is the controlled output for tracking some given reference, respectively.  $A$ ,  $B$ ,  $C$  and  $D$  are known matrices with appropriate dimensions. It is assumed that the matrix pair  $(A, B)$  is stabilizable.

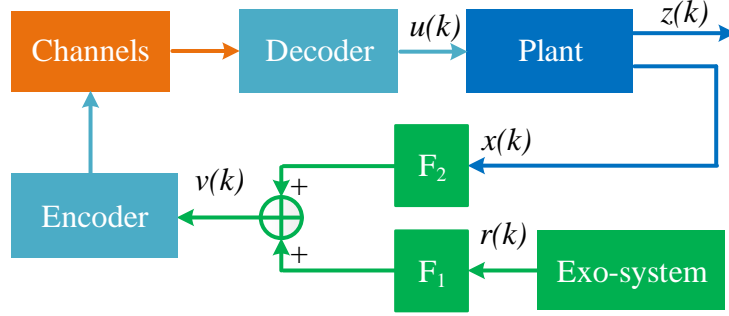

**Figure 3-1 System setup**

The control law  $v(k)$  is given by

$$v(k) = F_1 r(k) + F_2 x(k), \quad (3-2)$$

where  $F_1 \in \mathbb{R}^{m \times q}$  is the feedforward gain related to the tracking reference, and  $F_2 \in \mathbb{R}^{m \times n}$  is the state feedback gain related to the LQ performance defined later, respectively. The signal  $r(k) \in \mathbb{R}^q$  is the states vector of the following exo-system

$$\begin{cases} r(k+1) = A_r r(k), \\ z_r(k) = C_r r(k), \end{cases} \quad (3-3)$$

with  $z_r(k) \in \mathbb{R}^q$  being the reference signal. The exo-system (3-3) is introduced here as an autonomous system that generates the reference signal to be tracked. More detailed descriptions about exo-systems may be found in [108, 109]. Hence, the tracking error can be defined as

$$e(k) = z(k) - z_r(k). \quad (3-4)$$

Moreover,  $l$  unreliable communication channels are placed in the path from the controller to the plant. In some existing results, e.g. [44, 106], the number of channels is equal to the number of control signals, and the capacity of each sub-channel subject to certain lower bound is assumed to be flexible under total capacity constraint. Instead, in this chapter the capacity of each sub-channel is fixed a priori with an appropriate coding strategy to improve the efficiency of the network resource. Therefore, different from the above works, the lower bounds of sub-channels' capacities are decreased, and relatively less expensive sub-channels may therefore be used. In this case, the number of channels is assumed to be more than the number of control signals, i.e.  $l > m$ .

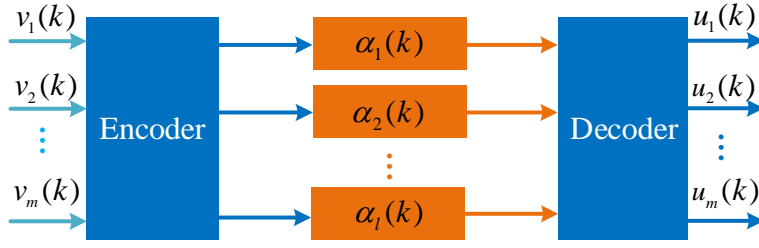

**Figure 3-2 Coding scheme**

As shown in Figure 3-2, a pair of encoder  $\mathcal{E} \in \mathbb{R}^{l \times m}$  and decoder  $\mathcal{D} \in \mathbb{R}^{m \times l}$  is introduced on each side of the  $l$  channels to give a degree of freedom for fully utilizing the resource of all the multiple channels. This transmission process is specified by the input  $v(k)$  and output  $u(k)$  as

$$u(k) = \mathcal{D}\alpha(k)\mathcal{E}v(k), \quad (3-5)$$

where  $\alpha(k) = \text{diag}[\alpha_1(k), \dots, \alpha_l(k)]$  with  $\alpha_i(k)$ ,  $i=1, 2, \dots, l$  being Bernoulli variables to specify the unreliable transmission process of each channel. Here  $\alpha_i(k)$  take value in  $\{0, 1\}$  at any time instant  $k$ .  $\alpha_i(k)=1$  indicates that the transmission succeeds, otherwise  $\alpha_i(k)=0$ . The probability of successful transmission is given as  $E\{\alpha_i(k)\} = \bar{\alpha}_i$  with  $\bar{\alpha}_i \in (0, 1]$ . That is to say, the situation that the channel being completely blocked is not considered in this chapter. As known, encoder and decoder are generally viewed as a pair of invertible operators. Hence the design requirement on  $\mathcal{E}$  and  $\mathcal{D}$  is to satisfy the following constraint

$$\mathcal{D}\Xi\mathcal{E} = I, \quad (3-6)$$

where  $\Xi = \text{diag}[\bar{\alpha}_1, \dots, \bar{\alpha}_l]$ .

Combining (3-1), (3-3) and (3-5), the closed-loop system is obtained as

$$\begin{cases} x(k+1) = [A + B\mathcal{D}\alpha(k)\mathcal{E}F_2]x(k) + B\mathcal{D}\alpha(k)\mathcal{E}F_1r(k), \\ e(k) = [C + D\mathcal{D}\alpha(k)\mathcal{E}F_2]x(k) + [D\mathcal{D}\alpha(k)\mathcal{E}F_1 - C_r]r(k). \end{cases} \quad (3-7)$$

Furthermore, we define the cost functional

$$J(x, u) = \lim_{N \rightarrow \infty} \frac{1}{N} \sum_{k=0}^{N-1} E\{x^T(k)Qx(k) + u^T(k)Ru(k)\}, \quad (3-8)$$

where the matrices  $Q \geq 0$  and  $R > 0$ .

Now the problem under consideration is described as follows.

**Problem 3-1.** Find the feedforward gain  $F_1$ , the feedback gain  $F_2$  in (3-2) and a pair of encoder  $\mathcal{E}$  and decoder  $\mathcal{D}$  in (3-5) such that the closed-loop system (3-7) meets the following requirements

- **R1** (MS stability): the closed-loop system (3-7) is MS stable according to Definition

2-3;

- **R2** (LQ performance): the cost functional in (3-8) is minimized when  $r(k) = 0$ ;
- **R3** (Tracking performance): for any bounded initial state  $x(0)$ ,  $r(0)$ , the tracking error defined in (3-4) satisfies

$$\lim_{k \rightarrow \infty} E\{e(k)\} = 0. \quad (3-9)$$

Problem 3-1 is defined as a multi-objective control problem when the requirements detailed in **R1-R3** are considered. In the next section, corresponding solvability conditions are successively given to fulfill the aforementioned requirements, and based on them, a complete solution to Problem 3-1 is further presented.

### 3.3 Controller design

In this section, some results are derived to solve Problem 3-1. Firstly, a LMI-based stabilization condition is derived in the MS sense. Then, to consider the additional stochastic LQ control objective, a MDARE is conducted. Finally, relied on the stabilization results, the asymptotic tracking constraint is further fulfilled through solving a Sylvester equation.

#### 3.3.1 MS stabilization

In this subsection, let us focus on MS stabilization. In other words, we consider Problem 3-1 with the requirements **R2** and **R3** being removed.

**Theorem 3-1.** **R1** in Problem 3-1 is satisfied, if there exist matrices  $X > 0$ ,  $W > 0$ ,  $Y$ , and  $U \in \mathbb{R}^{l \times m}$  with  $U^T U = I$ , such that the following conditions hold

$$\{UWU^T\}_{ii} < \frac{1}{\bar{\alpha}_i^{-1} - 1}, \quad (3-10)$$

$$\begin{bmatrix} W & Y \\ * & X \end{bmatrix} > 0, \quad (3-11)$$

$$\begin{bmatrix} X & AX + BY & B \\ * & X & 0 \\ * & * & I \end{bmatrix} > 0. \quad (3-12)$$

Then the state feedback gain  $F_2$  in (3-2), encoder  $\mathcal{E}$  and decoder  $\mathcal{D}$  in (3-5) are constructed respectively as

$$F_2 = YX^{-1}, \quad (3-13)$$

$$\mathcal{E} = \Xi^{-1/2}U, \quad \mathcal{D} = U^T \Xi^{-1/2} \quad (3-14)$$

with  $\Xi = \text{diag}[\bar{\alpha}_1, \dots, \bar{\alpha}_l]$ .



The following lemma is introduced here for the derivation of Theorem 3-1.

**Lemma 3-1.** Given an internally stable system  $G$  with dimension  $p \times p$ , there holds

$$\rho\{\phi\{G\}\} = \inf_Y \|\Upsilon^{-1}G\Upsilon\|_{2,1}^2, \quad (3-15)$$

where  $Y$  is a diagonal matrix with all diagonal elements being positive.

**Proof of Lemma 3-1:** As represented by Lemma 2.2 in [110], for nonnegative matrix  $M$ , there holds

$$\rho\{M\} = \inf_Y \|\Upsilon^{-1}M\Upsilon\|_q, \quad (3-16)$$

for  $1 \leq q \leq \infty$ . Thus, there holds

$$\rho\{\phi\{G\}\} = \inf_Y \|\Upsilon^{-1}\phi\{G\}\Upsilon\|_1, \quad (3-17)$$

where  $\phi\{G\}$  is defined in (2-17). And by the definition of  $\|\cdot\|_{2,1}$  in (2-13), there holds

$$\|\Upsilon^{-1}\phi\{G\}\Upsilon\|_1 = \|\Upsilon^{-1}G\Upsilon\|_{2,1}^2. \quad (3-18)$$

Then, it is obvious that

$$\rho\{\phi\{G\}\} = \|\Upsilon^{-1}G\Upsilon\|_{2,1}^2. \quad (3-19)$$

Therefore, the proof is completed.  $\square$

Now, we are in the position to prove Theorem 3-1.

**Proof of Theorem 3-1:** Note that for the Bernoulli process  $\alpha_i(k)$ ,  $i=1, 2, \dots, l$  given in (3-5), we have

$$E\{\alpha_i(k)\} = \bar{\alpha}_i \neq 0, \quad E\{(\alpha_i(k) - \bar{\alpha}_i)^2\} = \bar{\alpha}_i(1 - \bar{\alpha}_i). \quad (3-20)$$

Setting new random variables as  $\phi_i(k) = [\alpha_i(k) - \bar{\alpha}_i] / \bar{\alpha}_i$ , yields

$$E\{\phi_i(k)\} = 0, \quad E\{\phi_i^2(k)\} = \bar{\alpha}_i^{-1} - 1, \quad i=1, 2, \dots, l. \quad (3-21)$$

Then the closed-loop system in (3-7) is rewritten as

$$x(k+1) = [A + BF_2 + B\mathcal{D}\Xi\Phi(k)\mathcal{E}F_2]x(k) \quad (3-22)$$

where  $\Xi = \text{diag}[\bar{\alpha}_1, \dots, \bar{\alpha}_l]$ ,  $\Phi(k) = \text{diag}[\phi_1(k), \dots, \phi_l(k)]$ .

The above closed-loop system can be rewritten as

$$x(k+1) = (A + BF_2)x(k) + B\mathcal{D}\Xi w(k), \quad (3-23)$$

$$y(k) = \mathcal{E}F_2x(k), \quad (3-24)$$

$$w(k) = \Phi(k)y(k). \quad (3-25)$$

Then it can be seen as the interconnection of two parts in Figure 2-1 with

$$G = (A + BF_2, B\mathcal{D}\Xi, \mathcal{E}F_2, 0), \quad \Delta(k) = \Phi(k). \quad (3-26)$$

With the help of Lemma 2-1 (Stochastic small gain theorem), it is easy to indicate

that the closed-loop system (3-7) is MS stable if there exists a feedback gain  $F_2$ , an encoder/decoder pair  $\mathcal{E}$  and  $\mathcal{D}$  such that

$$\rho\{\tilde{T}\bar{\beta}^2\} < 1 \quad (3-27)$$

where

$$\begin{aligned} T(z) &= \mathcal{E}F_2(zI - A - BF_2)^{-1}B\mathcal{D}\Xi, \\ \bar{\beta} &= \text{diag}[(\bar{\alpha}_1^{-1} - 1)^{1/2}, \dots, (\bar{\alpha}_l^{-1} - 1)^{1/2}], \quad \tilde{T} = \phi\{T(z)\}. \end{aligned}$$

Next, we will show that under the conditions (3-10)-(3-12), (3-27) holds with  $F_2$ ,  $\mathcal{E}$  and  $\mathcal{D}$  given in (3-13) and (3-14). To this end,  $T(z)$  is first rewritten as

$$T(z) = \Xi^{-1/2}UF_2(zI - A - BF_2)^{-1}BU^T\Xi^{1/2}. \quad (3-28)$$

Then, it is observed by Lemma 3-1 that

$$\rho\{\tilde{T}\bar{\beta}^2\} = \inf_Y \left\| \Upsilon^{-1}T(z)\bar{\beta}\Upsilon \right\|_{2,1}^2. \quad (3-29)$$

Next, we will show

$$\rho\{\tilde{T}\bar{\beta}^2\} < \left\| \Upsilon^{-1}T(z)\bar{\beta}\Upsilon \right\|_{2,1}^2 < 1, \quad (3-30)$$

with  $\Upsilon$  being selected as  $\Upsilon = \Xi^{-1/2}$ .

By the definition,  $\left\| \Xi^{1/2}T(z)\bar{\beta}\Xi^{-1/2} \right\|_{2,1}^2$  can be rewritten as

$$\begin{aligned} \left\| \Xi^{1/2}T(z)\bar{\beta}\Xi^{-1/2} \right\|_{2,1}^2 &= \max_i \frac{1}{2\pi} \int_{-\pi}^{\pi} \{ \bar{\beta}\Xi^{-1/2}T^H(e^{j\omega})\Xi T(e^{j\omega})\Xi^{-1/2}\bar{\beta} \}_{ii} d\omega \\ &= \max_i \{ \bar{\beta}U \left( \frac{1}{2\pi} \int_{-\pi}^{\pi} \bar{T}^H(e^{j\omega})\bar{T}(e^{j\omega}) d\omega \right) U^T \bar{\beta} \}_{ii}, \end{aligned}$$

where  $\bar{T}(z) = F_2(zI - A - BF_2)B$  satisfies

$$\frac{1}{2\pi} \int_{-\pi}^{\pi} \bar{T}^H(e^{j\omega})\bar{T}(e^{j\omega}) d\omega = F_2W_0F_2^T \quad (3-31)$$

with  $W_0$  being the solution to equation

$$(A + BF_2)^T W_0 (A + BF_2) - W_0 + BB^T = 0. \quad (3-32)$$

By Schur complement, (3-12) and (3-13) indicate that

$$(A + BF_2)^T X (A + BF_2) - X + BB^T < 0, \quad (3-33)$$

and (3-11) and (3-13) indicate that

$$W > F_2 X F_2^T. \quad (3-34)$$

According to III. C in [111], it can be concluded that

$$W > F_2 X F_2^T > F_2 W_0 F_2^T = \frac{1}{2\pi} \int_{-\pi}^{\pi} \bar{T}^H(e^{j\omega})\bar{T}(e^{j\omega}) d\omega. \quad (3-35)$$

Therefore, it can be concluded with (3-10) that

$$\begin{aligned}\|\Xi^{1/2}T(z)\bar{\beta}\Xi^{-1/2}\|_{2,1}^2 &= \max_i \{\bar{\beta}U(\frac{1}{2\pi}\int_{-\pi}^{\pi}\bar{T}^H(e^{j\omega})\bar{T}(e^{j\omega})d\omega)U^T\bar{\beta}\}_{ii} \\ &= \max_i \{\bar{\beta}UWU^T\bar{\beta}\}_{ii} < 1.\end{aligned}$$

Then, it is clear that

$$\rho\{\tilde{T}\bar{\beta}^2\} \leq \|\Xi^{1/2}T(z)\bar{\beta}\Xi^{-1/2}\|_{2,1}^2 < 1. \quad (3-36)$$

Consequently, (3-27) holds. Therefore, the closed-loop system (3-7) is MS stable.  $\square$

It can be seen from the proof that the controller synthesis problem of multi-input NCSs with packet dropout turns out to be a  $\mu$ -synthesis problem. Compared with the resource allocation technique [44, 106], where diagonal coding matrices are adopted, full dimensional coding matrices are applied here to achieve less conservative performance. However, the solvability conditions (3-10)-(3-12) given in Theorem 3-1 result in a nonlinear matrix inequality problem. One can of course take a specific  $U$  to render the problem convex. However, proceeding with a specific  $U$  may lead to a conservative synthesis. It is essential to provide an iterative algorithm to find a less conservative solution (see Subsection 3.3.3).

### 3.3.2 Stochastic LQ control

In this subsection, we are concerned with LQ performance under MS stability, that is, Problem 3-1 with the requirement **R3** being removed. Before proceeding, we rewrite the closed-loop system (3-7) with  $r(k)$  been removed as

$$x(k+1) = Ax(k) + B\mathcal{D}\Xi[I + \Phi(k)]\mathcal{E}F_2x(k), \quad (3-37)$$

where  $\Phi(k) = \text{diag}[\phi_1(k), \dots, \phi_l(k)]$ ,  $\phi_i(k) = [\alpha_i(k) - \bar{\alpha}_i] / \bar{\alpha}_i$ ,  $i = 1, 2, \dots, l$ . And the control law  $v(k)$  in (3-2) is rewritten as

$$v(k) = F_2x(k). \quad (3-38)$$

**Theorem 3-2.** **R1** and **R2** in Problem 3-1 are satisfied if there exist solution  $P > 0$  and  $U \in \mathbb{R}^{l \times m}$  with  $U^T U = I$  to the following MDARE

$$P = A^T P A + Q - A^T P B U^T \Xi^{1/2} \bar{\Sigma}^{-1} \Xi^{1/2} U B^T P A, \quad (3-39)$$

where

$$\begin{aligned}\bar{\Sigma} &= [(\Xi \mathcal{H} \Xi + \Sigma) \odot (R + \Xi^{1/2} U B^T P B U^T \Xi^{1/2})], \\ \Sigma &= \text{diag}[\bar{\alpha}_1(1 - \bar{\alpha}_1), \dots, \bar{\alpha}_l(1 - \bar{\alpha}_l)], \quad \Xi = \text{diag}[\bar{\alpha}_1, \dots, \bar{\alpha}_l],\end{aligned}$$

$\mathcal{H}$  denotes a constant matrix with all elements being 1. Then the feedback gain  $F_2$  is given by

$$F_2 = -U^T \Xi^{1/2} \bar{\Sigma}^{-1} \Xi^{1/2} U B^T P A, \quad (3-40)$$

the encoder and decoder are given as

$$\mathcal{E} = \Xi^{-1/2}U, \quad \mathcal{D} = U^T\Xi^{-1/2}. \quad (3-41)$$

**Proof of Theorem 3-2:** First let us consider the MS stability of the closed-loop system (3-7) with the feedback gain  $F_2$  given in (3-40), encoder  $\mathcal{E}$  and decoder  $\mathcal{D}$  given in (3-41). To this end, we define

$$V[x(k)] = \text{Tr}\{E[x(k)x^T(k)]P\}. \quad (3-42)$$

For the closed-loop system

$$x(k+1) = Ax(k) + B\mathcal{D}\Xi[I + \Phi(k)]\mathcal{E}F_2x(k), \quad (3-43)$$

it can be concluded that

$$\begin{aligned} V[x(k+1)] &= \text{Tr}\{E[x(k+1)x^T(k+1)]P\} \\ &= \text{Tr}\{E\{x(k)x^T(k)[(A + B\mathcal{D}\Xi\mathcal{E}F_2)^T P(A + B\mathcal{D}\Xi\mathcal{E}F_2)]\} \\ &\quad + \text{Tr}\{E\{x(k)x^T(k)[(B\mathcal{D}\Xi\Phi(k)\mathcal{E}F_2)^T P(B\mathcal{D}\Xi\Phi(k)\mathcal{E}F_2)]\} \\ &= \text{Tr}\{E[x(k)x^T(k)]A^T P A\} + \text{Tr}\{E[x(k)x^T(k)][(\mathcal{E}F_2)^T \hat{\Sigma}^{-1} \mathcal{E}F_2]\}, \end{aligned}$$

where  $\hat{\Sigma} = [(\Xi\mathcal{H}\Xi + \Sigma) \odot (\Xi^{1/2}UB^T PBU^T\Xi^{1/2})]$ .

Substituting (3-39), (3-40) and (3-41) into the above formula, yields

$$\begin{aligned} V[x(k+1)] &= V[x(k)] - \text{Tr}\{E[x(k)x^T(k)]Q\} \\ &\quad - \text{Tr}\{E[x(k)x^T(k)][(\mathcal{E}F_2)^T [(\Xi\mathcal{H}\Xi + \Sigma) \odot R]^{-1} \mathcal{E}F_2]\} \\ &< V[x(k)]. \end{aligned}$$

Therefore, it can be obtained that  $\lim_{k \rightarrow \infty} E\{x(k)x^T(k)\} = 0$ , which indicates that the

closed-loop system (3-7) is MS stable.  $\square$

For further considering the functional  $J(x, u)$  in (3-8), we define

$$V_1[x(k)] = x^T(k)Px(k), \quad (3-44)$$

$$z_1(k) = \begin{bmatrix} Q^{1/2}x(k) \\ R^{1/2}u(k) \end{bmatrix}. \quad (3-45)$$

Noticing

$$z_1(k) = \begin{bmatrix} Q^{1/2}x(k) \\ R^{1/2}\mathcal{D}\Xi[I + \Phi(k)]\mathcal{E}F_2x(k) \end{bmatrix}, \quad (3-46)$$

there holds

$$\begin{aligned} &\|z_1(k)\|^2 + V_1(k+1) - V_1(k) \\ &= x^T(k)Qx(k) + v^T(k)\mathcal{E}^T\Xi\mathcal{D}^T\mathcal{R}\mathcal{D}\Xi\mathcal{E}v(k) + v^T(k)\Phi(k)\mathcal{E}^T\Xi\mathcal{D}^T\mathcal{R}\mathcal{D}\Xi\mathcal{E}\Phi(k)v(k) \\ &\quad + 2v^T(k)\mathcal{E}^T\Xi\mathcal{D}^T\mathcal{R}\mathcal{D}\Xi\mathcal{E}\Phi(k)v(k) + x^T(k)A^T P A x(k) + v^T(k)\mathcal{E}^T\Xi\mathcal{D}^T B^T P B \mathcal{D}\Xi\mathcal{E}v(k) \\ &\quad + v^T(k)\Phi(k)\mathcal{E}^T\Xi\mathcal{D}^T B^T P B \mathcal{D}\Xi\mathcal{E}\Phi(k)v(k) + 2v^T(k)\mathcal{E}^T\Xi\mathcal{D}^T B^T P B \mathcal{D}\Xi\mathcal{E}\Phi(k)v(k) \\ &\quad + 2x^T(k)A^T P B \mathcal{D}\Xi\mathcal{E}v(k) + 2x^T(k)A^T P B \mathcal{D}\Xi\mathcal{E}\Phi(k)v(k) - x^T(k)Px(k). \end{aligned}$$

Note that the random variable  $\Phi(k)$  is independent of the control law  $v(k)$ , which is a static linear function of the state  $x(k)$ . Hence, taking expectations from both sides, together with (3-39), yields

$$\begin{aligned} & E\{\|z_1(k)\|^2\} + E\{V_1(k+1)\} - E\{V_1(k)\} \\ &= E\{x^T(k)F_2^T \mathcal{E}^T \bar{\Sigma} \mathcal{E} F_2 x(k)\} + E\{2x^T(k)A^T PBU^T \Xi^{1/2} \mathcal{E} F_2 x(k)\} \\ & \quad + E\{x^T(k)A^T PBU^T \Xi^{1/2} \bar{\Sigma}^{-1} \Xi^{1/2} UB^T PAx(k)\}. \end{aligned}$$

where  $\bar{\Sigma} = [(\Xi \mathcal{H} \Xi + \Sigma) \odot (R + \Xi^{1/2} UB^T PBU^T \Xi^{1/2})]$ . Note that

$$\begin{aligned} J(x, u) &= E\{\|z_1(k)\|^2\} \\ &= \lim_{N \rightarrow \infty} \frac{1}{N} \sum_{k=0}^{N-1} E[x^T(k)Qx(k) + u^T(k)Ru(k)], \end{aligned}$$

Then, it can be obtained that

$$J(x, u) = \|\bar{\Sigma}^{1/2} [\mathcal{E} F_2 + \bar{\Sigma}^{-1} \Xi^{1/2} UB^T PA]x(k)\|_{\mathcal{P}}^2 + x^T(0)Px(0). \quad (3-47)$$

It is easy to conclude that  $J(x, u)$  is minimized if

$$\mathcal{E} F_2 = -\bar{\Sigma}^{-1} \Xi^{1/2} UB^T PA. \quad (3-48)$$

Noticing that  $\mathcal{D}\Xi \mathcal{E} = I$ ,  $\mathcal{E} = \Xi^{-1/2}U$  and  $\mathcal{E} = U^T \Xi^{-1/2}$ , multiply  $\mathcal{D}\Xi$  at both sides of (3-48) and the state feedback gain  $F_2$  is given by

$$F_2 = -U^T \bar{\Sigma}^{-1} \Xi^{1/2} UB^T PA. \quad (3-49)$$

And, the proof is completed.  $\square$

---

### Algorithm 3-1

---

Step 1: give the number of the iteration  $N_1$ . Set  $k=0$  and the initial condition

$$P(0) = 0;$$

Step 2: solve conditions (3-10)-(3-12) and obtain a feasible matrix  $U$ ;

Step 3: update  $P(k)$  as  $P(k+1) = A^T P(k)A + Q - A^T PBU^T \Xi^{1/2} \bar{\Sigma}^{-1} \Xi^{1/2} UB^T PA$ ,

where  $\bar{\Sigma} = [(\Xi \mathcal{H} \Xi + \Sigma) \odot (R + \Xi^{1/2} UB^T PBU^T \Xi^{1/2})]$ ;

Step 4: set  $k = k+1$ , go to Steps 3. If  $\|P(k+1) - P(k)\| < \varepsilon$  with  $\varepsilon$  being a small positive number, stop. If  $k > N_1$ , stop.

---

The MDARE (3-39) in Theorem 3-2 is solvable, if there exists a state feedback gain  $F_2$  such that the system (3-37) is MS stable [44, 112]. It is well known that solving modified Riccati equation in the stochastic setting with close-form solution is still an open problem [44, 112]. To be worse, the MDARE (3-39) also includes the matrix  $U$ ,

which makes the corresponding solvability condition even harder. In Algorithm 3-1, an iterative method is proposed for numerical solution to MDARE (3-39) with a fixed  $U$ .

### 3.3.3 Asymptotic tracking

In this subsection, a sufficient condition is given for designing the feedforward gain  $F_1$  in (3-2) such that the tracking requirement **R3** defined in Problem 3-1 is fulfilled.

**Theorem 3-3.** **R3** in Problem 1 is satisfied if there exist matrices  $X_r$  and  $Y_r$  such that the following Sylvester equation holds

$$\begin{aligned} X_r A_r &= A X_r + B Y_r, \\ 0 &= C X_r + D Y_r - C_r. \end{aligned} \quad (3-50)$$

Moreover, the feedforward gain  $F_1$  is given as

$$F_1 = Y_r - F_2 X_r, \quad (3-51)$$

where  $F_2$  can be chosen as any feedback gain that ensures the MS stability of the following closed-loop system

$$x(k+1) = (A + B F_2)x(k) + B \mathcal{D} \Xi \Phi(k) \mathcal{E} F_2 x(k). \quad (3-52)$$

**Proof of Theorem 3-3:** Substitute (3-51) into (3-50), yields

$$\begin{aligned} X_r A_r &= (A + B F_2) X_r + B F_1, \\ 0 &= (C + D F_2) X_r + D F_1 - C_r. \end{aligned} \quad (3-53)$$

By defining  $\bar{x}(k) = x(k) - X_r r(k)$  for the closed-loop system (3-7), it is observed that

$$\begin{aligned} &x(k+1) - X_r r(k+1) \\ &= A_c x(k) + B_c r(k) - X_r r(k+1) \\ &= (A + B F_2)x(k) + B F_1 r(k) + B \mathcal{D} \Xi \Phi(k) \mathcal{E} F_2 x(k) \\ &\quad + B \mathcal{D} \Xi \Phi(k) \mathcal{E} F_1 r(k) - X_r A_r r(k), \end{aligned}$$

where  $A_c = B \mathcal{D} \alpha(k) \mathcal{E} F_2$ ,  $B_c = B \mathcal{D} \alpha(k) \mathcal{E} F_1$ . Substituting (3-51) and (3-53) into the above formula, yields

$$\begin{aligned} \bar{x}(k+1) &= x(k+1) - X_r r(k+1) \\ &= (A + B F_2)[x(k) - X_r r(k)] + B \mathcal{D} \Xi \Phi(k) \mathcal{E} F_2 r(k) + B \mathcal{D} \Xi \Phi(k) \mathcal{E} F_1 r(k) \\ &= (A + B \mathcal{D} \alpha(k) \mathcal{E} F_2) \bar{x}(k) + B \mathcal{D} \Xi \Phi(k) \mathcal{E} Y_r r(k). \end{aligned}$$

Note that  $E[B \mathcal{D} \Xi \Phi(k) \mathcal{E} F_2 r(k)] = 0$ , then is observed that

$$\lim_{k \rightarrow \infty} E[\bar{x}(k)] = 0. \quad (3-54)$$

According to (3-6) and  $e(k)$  defined in (3-7), it can be obtained that

$$\begin{aligned} \lim_{k \rightarrow \infty} [e(k)] &= \lim_{k \rightarrow \infty} E[(C + D \mathcal{D} \alpha(k) \mathcal{E} F_2)x(k) + (D \mathcal{D} \alpha(k) \mathcal{E} F_1 - C_r)r(k)] \\ &= \lim_{k \rightarrow \infty} E[(C + D F_2)x(k) + (D F_1 - C_r)r(k)]. \end{aligned}$$

By defining  $\bar{x}(k) = x(k) - X_r r(k)$ , the above equation can be rewritten as

$$\begin{aligned} \lim_{k \rightarrow \infty} E[e(k)] &= \lim_{k \rightarrow \infty} E[(C + DF_2)x(k) - (C + DF_2)X_r r(k)] \\ &\quad + \lim_{k \rightarrow \infty} E[(C + DF_2)X_r r(k) + (DF_1 - C_r)r(k)] \\ &= \lim_{k \rightarrow \infty} E[(C + DF_2)\bar{x}(k) + (CX_r + DF_2X_r + DF_1 - C_r)r(k)]. \end{aligned}$$

Note that

$$CX_r + DF_2X_r + DF_1 - C_r = 0 \quad (3-55)$$

according to (3-53). Thus, according to (3-54) and (3-55),

$$\lim_{k \rightarrow \infty} E[e(k)] = 0 \quad (3-56)$$

holds, and the tracking requirement **R3** is satisfied.  $\square$

Theorem 3-3 presents the conditions for satisfying the requirement **R3** in Problem 3-1. The corresponding feedforward gain  $F_1$  given in (3-51) is structured with  $X_r$ ,  $Y_r$  and  $F_2$ , among which  $F_2$  is the state feedback gain that can be previously computed by Theorem 3-1 or Theorem 3-2. So far, all the conditions needed to solve the Problem 3-1 have already been presented. Therefore, the following complete conditions are given to solve the Problem 3-1.

**Theorem 3-4.** Problem 3-1 is solvable if there exist matrices  $U \in \mathbb{R}^{l \times m}$  satisfying  $U^T U = I$ ,  $X > 0$ ,  $W > 0$ ,  $P > 0$ ,  $Y$ ,  $X_r$ ,  $Y_r$ , such that the conditions (3-10)-(3-12), (3-39) and (3-50) hold. Then the feedforward gain  $F_1$  is given in (3-51), the feedback gain  $F_2$  is given in (3-40), the encoder  $\mathcal{E}$  and decoder  $\mathcal{D}$  are given in (3-41).

**Proof of Theorem 3-4:** The proof can be obviously obtained by combination of Theorem 3-1, Theorem 3-2 and Theorem 3-3.  $\square$

Theorem 3-4 is a synthesis of Theorems 3-1, 3-2 and 3-3, which gives a complete solution to Problem 3-1. In other words, the system (3-7) with the feedforward gain  $F_1$ , feedback gain  $F_2$ , the corresponding encoder  $\mathcal{E}$  and decoder  $\mathcal{D}$  obtained by Theorem 3-4 can achieve minimum LQ performance under MS stabilization when  $r(k) = 0$ . At the same time, when  $r(k) \neq 0$ , it can also fulfill asymptotic tracking for the reference  $z_r(k)$ .

In the section 3.3.2, a simple and efficient Algorithm 3-1 is provided to solve the MDARE (3-39) provided in Theorem 3-2. However, the certain solution of MDARE (3-39) by directly applying a specific  $U$  matrix may lead to a conservative synthesis. Therefore, an iterative process taking benefits from Theorems 3-1 and Theorems 3-2 is proposed as Algorithm 3-2 to design iteratively the matrix  $U$  and feedback gain  $F_2$  in order to reduce the conservatism of the results.

---

**Algorithm 3-2**

---

- Step 1: give the number of the iteration  $N_1$ . Set  $i=0$ ,  $k=0$ . Get a feasible  $U$  by solving inequalities (3-10)-(3-12);
- Step 2: compute MDARE (3-39) with  $U$  obtained in Step 1 by Algorithm 3-1 and structure the feedback gain  $F_2$  as in (3-40);
- Step 3: calculate  $W_0$  by solving equation (3-32) with  $F_2$  obtained in Step 2 and set  $W = W_0$ ;
- Step 4: find  $U = U(0), U(1), \dots, U(N)$  satisfying (3-10) with  $W$  obtained in Step 3 and set  $c=0$ ,  $j=0$ ,  $P(0)=0$ . If  $N=0$ , stop;
- Step 5: update  $P(k)$  as Step 3 in Algorithm 3-1 with  $U = U(c)$ ;
- Step 6: set  $k=k+1$ , and go to Step 5. If  $|P(k+1) - P(k)| < \varepsilon$  with  $\varepsilon$  being a small positive number, set  $P_j = P(k+1)$ ,  $U_j = U(c)$ ,  $j = j+1$ ,  $c = c+1$ ,  $k=0$  and go to Step 5. If  $k > N_1$ , set  $k=0$ ,  $c = c+1$  and go to Step 5;
- Step 7: find the matrix  $P_{j^*}$  that minimizing  $x^T(0)P_{j^*}x(0)$ , where  $j^* = 1, 2, \dots, j$  and set  $P_i = P_{j^*}$ ,  $U_i = U_{j^*}$ ;
- Step 8: if  $\|x^T(0)(P_i - P_{i-1})x(0)\| < \varepsilon$  with  $\varepsilon$  being a small positive number, obtain the feedback gain  $F_2$  with  $P = P_i$ ,  $U = U_i$  as in (3-40), stop;
- Step 9: set  $i = i+1$ , go to Step 3.
- 

### 3.4 Conclusion

In this chapter, the stochastic LQ control problem under asymptotic tracking is considered for linear discrete-time systems over lossy channels. In order to solve this problem, a theorem that reveals the fundamental limitation among the  $H_2$  norm of the plant, data arrival rates and coding matrices is first derived such that the closed-loop system is MS stable. To further consider the LQ performance objective, a new condition is proposed that gives way to the controller synthesis for minimizing the stochastic LQ criterion under the MS stability constraint. Finally, a Sylvester equation is appealed for the asymptotic tracking issue and the resulting feedforward gain is structured. The methods proposed in this chapter will be verified by the simulation in Subsection 6.3.

For the control method proposed in this chapter, the state of the plant are required for feedback control to ensure the tracking performance of the closed-loop system. When the accurate state values are not directly available, instead the filtering problem needs to be considered to obtain the estimated state values. And the next chapter will focus on the robust filtering problem.



## Chapter 4 Robust Filtering Over Lossy Channels

### 4.1 Introduction

In this chapter, the robust filtering problem is considered over multiple lossy channels. In order to analyze the stability and  $H_\infty$  performance of the error system, a corresponding adjoint operator is therefore introduced. Then, the modified algebraic Riccati equation is derived to solve the  $H_\infty$  filtering problem, and the design method for the corresponding filter is also given. Furthermore, the necessary and sufficient conditions are deduced for the existence of the filter such that the error system is MS stable, while the relationships between the MS stability of the error system and the channel parameters are derived.

The contribution of this chapter is detailed here. Different from the  $H_\infty$  filtering method for deterministic systems, an adjoint-operator-based approach is proposed in this chapter and the traditional Riccati-equation-based  $H_\infty$  filtering method [113] is therefore extended. On the other hand, the relationships among the MS stability of the error system, data arrival rates of the channels and the mahler measure of the plant are also deduced.

### 4.2 Problem formulation

Consider the following LTI discrete-time system

$$\begin{cases} x(k+1) = Ax(k) + Bw(k), \\ y(k) = C_1x(k) + Dw(k), \\ z(k) = C_2x(k), \end{cases} \quad (4-1)$$

where  $x(k) \in \mathbb{R}^n$  is the state vector,  $y(k) \in \mathbb{R}^p$  is the output measurement,  $w(k) \in \mathbb{R}^m$  is the external power bounded disturbance representing the uncertainty of system parameters, and  $z(k) \in \mathbb{R}^l$  is the weighted state information of the system to be estimated, respectively.  $A$ ,  $B$ ,  $C_1$ ,  $C_2$ ,  $D$  are known matrices with appropriate dimensions. It is assumed that  $(A, C_1)$  is observable.

The filtering problem is shown in Figure 4-1, where each component of the measurement output  $y(k)$  is transmitted to the filter through an independent single channel, where packet dropouts may occur stochastically during the transmission of

$y_i(k)$ ,  $i = 1, 2, \dots, m$ . In this case, the information received by the filter can be given as  $\hat{y}_i(k) = \alpha_i(k)y_i(k)$ , where  $\alpha_i(k) \in \{0,1\}$  is a Bernoulli random variable with the following characteristics

$$\begin{cases} \text{Prob}\{\alpha_i(k) = 1\} = E\{\alpha_i(k)\} = \bar{\alpha}_i, \\ \text{Prob}\{\alpha_i(k) = 0\} = 1 - E\{\alpha_i(k)\} = 1 - \bar{\alpha}_i, \end{cases} \quad (4-2)$$

where  $\bar{\alpha}_i \in (0,1]$  is the data arrival rate of each channel. Under the above transmission strategy, the input of the filter can be expressed as

$$\hat{y}(k) = \alpha(k)y(k), \quad (4-3)$$

where  $\alpha(k) = \text{diag}\{\alpha_1(k), \alpha_2(k), \dots, \alpha_p(k)\}$ ,  $\hat{y}(k) = [\hat{y}_1(k) \ \hat{y}_2(k) \ \dots \ \hat{y}_p(k)]^T$ .

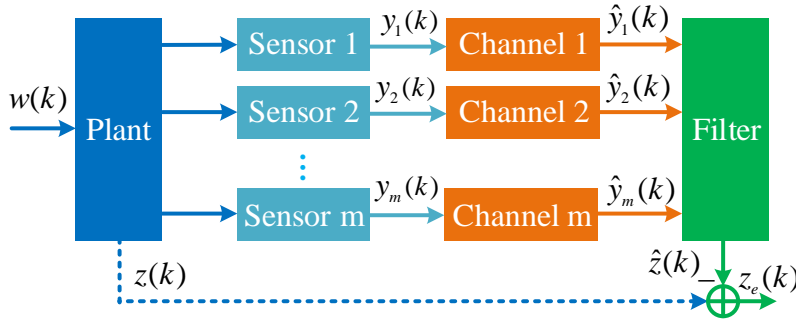

**Figure 4-1 Filtering problem setup**

In this chapter, the filter with the following structure is considered

$$\begin{cases} \hat{x}(k+1) = A\hat{x}(k) + L\alpha(k)[y(k) - C_1\hat{x}(k)], \\ \hat{z}(k) = C_2\hat{x}(k), \end{cases} \quad (4-4)$$

where  $\hat{x}(k) \in \mathbb{R}^n$  is the state vector of the filter and  $L$  is the filter gain to be designed.

Defining  $e(k) = x(k) - \hat{x}(k)$ , and by combination of (4-1), (4-3), (4-4), the error system can be obtained as

$$\begin{cases} e(k+1) = [A - L\alpha(k)C_1]e(k) + [B - L\alpha(k)D]w(k), \\ z_e(k) = C_2e(k). \end{cases} \quad (4-5)$$

Note that the error system (4-5) contains the random variable  $\alpha(k)$ . By further defining  $\phi_i(k) = [\alpha_i(k) - \bar{\alpha}_i] / \bar{\alpha}_i$ , it is obtained that

$$E\{\phi(k)\} = 0, \quad E\{\phi^2(k)\} = \bar{\alpha}^{-1} - I, \quad (4-6)$$

where  $\phi(k) = \text{diag}\{\phi_1(k), \phi_2(k), \dots, \phi_p(k)\}$ ,  $\bar{\alpha} = \text{diag}\{\bar{\alpha}_1, \bar{\alpha}_2, \dots, \bar{\alpha}_p\}$ . Based on  $\phi(k)$  defined above, the error system (4-5) can be rewritten as

$$\begin{cases} e(k+1) = [\bar{A} - L\phi(k)\bar{C}_1]e(k) + [\bar{B} - L\phi(k)\bar{D}]w(k), \\ z_e(k) = C_2e(k), \end{cases} \quad (4-7)$$

where  $\bar{A} = A - L\bar{C}_1$ ,  $\bar{B} = B - L\bar{D}$ ,  $\bar{C}_1 = \bar{\alpha}C_1$ ,  $\bar{D} = \bar{\alpha}D$ .

It is noticed that the rewritten error system (4-7) is a stochastic system with the disturbance  $w(k)$  and random variable  $\phi(k)$ . In order to better detail the filtering problem under consideration and to further analyze the considered performance of the error system (4-7), the following definitions are first given.

**Definition 4-1.** The error system (4-7) is said to satisfy the  $H_\infty$  performance index  $\gamma$  if it is MS stable and satisfies the following performance requirement

$$\sup_{\|w(k)\|_{\mathcal{D}} \neq 0} \frac{\|z_e(k)\|_{\mathcal{D}}^2}{\|w(k)\|_{\mathcal{D}}^2} < \gamma^2. \quad (4-8)$$

**Definition 4-2. (N-point inner product)** For vector stationary stochastic signals

$$u(k) = [u_1(k) \quad u_2(k) \quad \cdots \quad u_m(k)]^T \in \mathbb{R}^m, \quad (4-9)$$

$$v(k) = [v_1(k) \quad v_2(k) \quad \cdots \quad v_m(k)]^T \in \mathbb{R}^m, \quad (4-10)$$

the N-point inner product is defined as

$$\langle u(k), v(k) \rangle_N = E \left\{ \frac{1}{N} \sum_{k=0}^{N-1} u^T(k) v(k) \right\}. \quad (4-11)$$

**Definition 4-3. (Adjoint operator)** For a linear operator  $\mathcal{J} : \mathbb{R}^q \rightarrow \mathbb{R}^l$ , its adjoint operator  $\mathcal{J}_a$  is defined as  $\mathcal{J}_a : \mathbb{R}^l \rightarrow \mathbb{R}^q$  and for any vectors  $\mathcal{Z} \in \mathbb{R}^q$ ,  $\mathcal{Y} \in \mathbb{R}^l$  there holds

$$\langle \mathcal{J}\{\mathcal{Z}\}, \mathcal{Y} \rangle_N = \langle \mathcal{Z}, \mathcal{J}_a\{\mathcal{Y}\} \rangle_N. \quad (4-12)$$

Now the filtering problem considered in this chapter can be summarized as the following problem 4-1.

**Problem 4-1.** Design the filter gain  $L$  in (4-4) such that the error system (4-7) is MS stable and satisfies the  $H_\infty$  performance index  $\gamma$ .

### 4.3 Filtering method

In this section, some solvability conditions are derived to solve Problem 4-1. For this purpose, an adjoint operator-based approach is first proposed. The relationships between the MS stability of the error system (4-7) and the data arrival rate  $\bar{\alpha}_i$  are also derived.

#### 4.3.1 Adjoint operator

In this subsection, an operator for error system (4-7) is first defined and its adjoint operator is further obtained. Based on the obtained operators, a related Lemma 4-1 is proposed, which will be adopted to analyze the  $H_\infty$  performance of error system (4-7) in

Subsection 4.3.2.

It can be obtained from (4-7) that

$$z_e(k) = \begin{cases} \sum_{j=0}^{k-1} C_2 \Phi(k, j+1) [\bar{B} - L\phi(k)\bar{D}] w(j) + C_2 \Phi(k, 0) e(0), & k > 0, \\ C_2 e(0), & k = 0, \end{cases} \quad (4-13)$$

where

$$\Phi(k, j) = \begin{cases} [\bar{A} - L\phi(k-1)\bar{C}_1] \times \cdots \times [\bar{A} - L\phi(j)\bar{C}_1], & k > j, \\ I, & k = j. \end{cases}$$

Note that equation (4-13) represents the input-output characteristic of (4-7) from  $w(k)$  and  $e(0)$  to  $z_e(k)$ . A linear mapping operator can be defined based on (4-13) as

$$\mathcal{T} : [w(k), e(0)] \rightarrow z_e(k), \quad (4-14)$$

and it is further defined that

$$\mathcal{T}_a : z_e(k) \rightarrow [w_a(k), e_a(0)] \quad (4-15)$$

is the adjoint operator of (4-14).

It is obvious that (4-7) is the state space representation of  $\mathcal{T}$  defined in (4-14). And for further discussion of the MS stability of error system (4-7) in Subsection 4.3.2, the state space representation of  $\mathcal{T}_a$  in (4-15) also needs to be acquired. Now, we are in the position to obtain it.

Based on Definition 4-3, it is observed that the operator (4-14) satisfies the following equation

$$\langle \mathcal{T} \{ [w(k), e(0)] \}, z_e(k) \rangle_N = \langle [w(k), e(0)], \mathcal{T}_a \{ z_e(k) \} \rangle_N. \quad (4-16)$$

By Definition 4-2, each side of equation (4-16) can be rewritten as

$$\begin{aligned} \langle [w(k), e(0)], \mathcal{T}_a \{ z_e(k) \} \rangle_N &= \langle [w(k), e(0)], [w_a(k), e_a(0)] \rangle_N \\ &= \mathbf{E} \left\{ \frac{1}{N} \sum_{k=0}^{N-1} w^T(k) w_a(k) \right\} + \mathbf{E} \left\{ \frac{1}{N} e^T(0) e_a(0) \right\}, \end{aligned} \quad (4-17)$$

and

$$\langle \mathcal{T} \{ [w(k), e(0)] \}, z_e(k) \rangle_N = \langle z_e(k), z_e(k) \rangle_N = \mathbf{E} \left\{ \frac{1}{N} \sum_{k=0}^{N-1} z_e^T(k) z_e(k) \right\}. \quad (4-18)$$

By substituting (4-13) into (4-18), it can be obtained that

$$\begin{aligned} \mathbf{E} \left\{ \frac{1}{N} \sum_{k=0}^{N-1} z_e^T(k) z_e(k) \right\} &= \mathbf{E} \left\{ \frac{1}{N} \sum_{k=0}^{N-1} \sum_{j=0}^{k-1} \{ C_2 \Phi(k, j+1) [\bar{B} - L\phi(k)\bar{D}] w(j) \}^T z_e(k) \right\} \\ &\quad + \mathbf{E} \left\{ \frac{1}{N} \sum_{k=0}^{N-1} \{ C_2 \Phi(k, 0) e(0) \}^T z_e(k) \right\} \\ &= \mathbf{E} \left\{ \frac{1}{N} \sum_{k=0}^{N-1} w^T(k) w_a(k) \right\} + \mathbf{E} \left\{ \frac{1}{N} e^T(0) e_a(0) \right\}. \end{aligned}$$

In the above equation, noticing for formula

$$\sum_{k=0}^{N-1} \sum_{j=0}^{k-1} \{C_2 \Phi(k, j+1) [\bar{B} - L\phi(k)\bar{D}] w(j)\}^T z_e(k),$$

$k$  can take values as  $k = j+1, k = j+2, \dots, k = N-1$  for  $j = 1, 2, \dots, N-2$ , respectively. After reclassification, it is obtained that

$$\begin{aligned} & \sum_{k=0}^{N-1} \sum_{j=0}^{k-1} \{C_2 \Phi(k, j+1) [\bar{B} - L\phi(k)\bar{D}] w(j)\}^T z_e(k) \\ &= \sum_{k=0}^{N-1} \sum_{j=k+1}^{N-1} w^T(k) [\bar{B} - L\phi(k)\bar{D}]^T \Phi^T(j, k+1) C_2^T z_e(j). \end{aligned}$$

According to equation (4-17),  $e_a(0)$  and  $w_a(k)$  can be selected as

$$\begin{cases} e_a(0) = \sum_{j=0}^{N-1} \Phi^T(j, 0) C_2^T z_e(j), \\ w_a(k) = \sum_{j=k+1}^{N-1} [\bar{B} - L\phi(k)\bar{D}]^T \Phi^T(j, k+1) C_2^T z_e(j). \end{cases} \quad (4-19)$$

Defining  $x_a(k) = \sum_{j=k+1}^{N-1} \Phi^T(j, k+1) C_2^T z_e(j)$ , there holds

$$\begin{aligned} w_a(k) &= [\bar{B} - L\phi(k)\bar{D}]^T x_a(k), \\ x_a(k-1) &= \sum_{j=k}^{N-1} \Phi^T(j, k) C_2^T z_e(j) \\ &= \sum_{j=k+1}^{N-1} \Phi^T(j, k) C_2^T z_e(j) + \Phi^T(k, k) C_2^T z_e(k) \\ &= \Phi^T(k+1, k) \sum_{j=k+1}^{N-1} \Phi^T(j, k+1) C_2^T z_e(j) + C_2^T z_e(k) \\ &= [\bar{A} - L\phi(k)\bar{C}_1] x_a(k) + C_2^T z_e(k). \end{aligned}$$

According to  $w_a(k)$  and  $x_a(k)$  obtained, the following state space representation is given as

$$\begin{cases} x_a(k-1) = [\bar{A} - L\phi(k)\bar{C}_1]^T x_a(k) + C_2^T z_e(k), \\ w_a(k) = [\bar{B} - L\phi(k)\bar{D}]^T x_a(k). \end{cases} \quad (4-20)$$

Defining  $\bar{k} = N - k$ , the above system (4-20) can be rewritten as

$$\begin{cases} \tilde{x}_a(\bar{k}+1) = [\bar{A} - L\tilde{\phi}(\bar{k})\bar{C}_1]^T \tilde{x}_a(\bar{k}) + C_2^T \tilde{z}_e(\bar{k}), \\ \tilde{w}_a(\bar{k}) = [\bar{B} - L\tilde{\phi}(\bar{k})\bar{D}]^T \tilde{x}_a(\bar{k}). \end{cases} \quad (4-21)$$

where

$$\tilde{x}_a(\bar{k}) = x_a(N - \bar{k}), \quad \tilde{w}_a(\bar{k}) = w_a(N - \bar{k}), \quad \tilde{z}_e(\bar{k}) = z_e(N - \bar{k}), \quad \tilde{\phi}(\bar{k}) = \phi(N - \bar{k}).$$

It is obvious that (4-21) is the state space representation of the operator  $\mathcal{T}_a$  defined in (4-15).

Next, the following lemma 4-1 is given for operator  $\mathcal{T}$  in (4-14) and its adjoint

operator  $\mathcal{T}_a$  in (4-15), which will be used in discussing the  $H_\infty$  performance of the error system (4-7) in the next subsection.

**Lemma 4-1.** When  $e(0) = 0$ ,  $e_a(0) = 0$ , for the operator (4-14) and its adjoint operator (4-15), there holds

$$\sup_{\|w(k)\|_{\mathcal{P}} \neq 0} \frac{\|z_e(k)\|_{\mathcal{P}}^2}{\|w(k)\|_{\mathcal{P}}^2} = \sup_{\|z_e(k)\|_{\mathcal{P}} \neq 0} \frac{\|w_a(k)\|_{\mathcal{P}}^2}{\|z_e(k)\|_{\mathcal{P}}^2}. \quad (4-22)$$

**Proof of Lemma 4-1:** In order to prove (4-22), an operator is defined as

$$\mathcal{H}(z_e(k), [w(k), e(0)]) = \left\langle z_e(k), \mathcal{T} \{ [w(k), e(0)] \} \right\rangle_N. \quad (4-23)$$

And the following norm for operator (4-23) is defined as

$$\|\mathcal{H}\| \triangleq \lim_{N \rightarrow \infty} \sup_{\|w(k)\|_{\mathcal{P}} \neq 0} \frac{\left| \left\langle z_e(k), \mathcal{T} \{ [w(k), e(0)] \} \right\rangle_N \right|}{\|z_e(k)\|_{\mathcal{P}} \| [w(k), e(0)] \|_{\mathcal{P}}}. \quad (4-24)$$

Noticing  $\mathcal{T} \{ [w(k), e(0)] \} = z_e(k)$ , (4-24) can be rewritten as

$$\begin{aligned} \|\mathcal{H}\| &= \lim_{N \rightarrow \infty} \sup_{\|w(k)\|_{\mathcal{P}} \neq 0} \frac{\left| \left\langle z_e(k), z_e(k) \right\rangle_N \right|}{\|z_e(k)\|_{\mathcal{P}} \| [w(k), e(0)] \|_{\mathcal{P}}} \\ &= \sup_{\|w(k)\|_{\mathcal{P}} \neq 0} \frac{\|z_e(k)\|_{\mathcal{P}}^2}{\|z_e(k)\|_{\mathcal{P}} \| [w(k), e(0)] \|_{\mathcal{P}}} \\ &= \sup_{\|w(k)\|_{\mathcal{P}} \neq 0} \frac{\|z_e(k)\|_{\mathcal{P}}}{\| [w(k), e(0)] \|_{\mathcal{P}}}. \end{aligned}$$

When  $e(0) = 0$ , it indicates that

$$\|\mathcal{H}\| = \sup_{\|w(k)\|_{\mathcal{P}} \neq 0} \frac{\|z_e(k)\|_{\mathcal{P}}}{\|w(k)\|_{\mathcal{P}}}. \quad (4-25)$$

On the other hand, (4-23) can be rewritten according to Definition 4-3 as

$$\begin{aligned} \mathcal{H}(z_e(k), [w(k), e(0)]) \\ = \left\langle z_e(k), \mathcal{T} \{ [w(k), e(0)] \} \right\rangle_N &= \left\langle \mathcal{T}_a \{ z_e(k) \}, [w(k), e(0)] \right\rangle_N. \end{aligned} \quad (4-26)$$

For (4-26), it can be further deduced by Cauchy-Schwarz inequality [103] that

$$\begin{aligned} \|\mathcal{H}\| &= \lim_{N \rightarrow \infty} \sup_{\|w(k)\|_{\mathcal{P}} \neq 0} \frac{\left| \left\langle \mathcal{T}_a \{ z_e(k) \}, [w(k), e(0)] \right\rangle_N \right|}{\|z_e(k)\|_{\mathcal{P}} \| [w(k), e(0)] \|_{\mathcal{P}}} \\ &= \lim_{N \rightarrow \infty} \sup_{\|w(k)\|_{\mathcal{P}} \neq 0} \frac{\left| \left\langle [w_a(k), e_a(0)], [w(k), e(0)] \right\rangle_N \right|}{\|z_e(k)\|_{\mathcal{P}} \| [w(k), e(0)] \|_{\mathcal{P}}} \\ &= \sup_{\|w(k)\|_{\mathcal{P}} \neq 0} \frac{\| [w_a(k), e_a(0)] \|_{\mathcal{P}} \| [w(k), e(0)] \|_{\mathcal{P}}}{\|z_e(k)\|_{\mathcal{P}} \| [w(k), e(0)] \|_{\mathcal{P}}}. \end{aligned}$$

The above equation indicates that

$$\|\mathcal{H}\| = \sup_{\|z_e(k)\|_{\mathcal{P}} \neq 0} \frac{\|[w_a(k), e_a(0)]\|_{\mathcal{P}}}{\|z_e(k)\|_{\mathcal{P}}}. \quad (4-27)$$

When  $e_a(0) = 0$ , (4-27) yields

$$\|\mathcal{H}\| = \sup_{\|z_e(k)\|_{\mathcal{P}} \neq 0} \frac{\|w_a(k)\|_{\mathcal{P}}}{\|z_e(k)\|_{\mathcal{P}}}. \quad (4-28)$$

By combination of (4-25) and (4-28), it is obvious that

$$\|\mathcal{H}\|^2 = \sup_{\|w(k)\|_{\mathcal{P}} \neq 0} \frac{\|z_e(k)\|_{\mathcal{P}}^2}{\|w(k)\|_{\mathcal{P}}^2} = \sup_{\|z_e(k)\|_{\mathcal{P}} \neq 0} \frac{\|w_a(k)\|_{\mathcal{P}}^2}{\|z_e(k)\|_{\mathcal{P}}^2}. \quad (4-29)$$

Therefore, equation (4-22) holds.  $\square$

### 4.3.2 Filter design

Based on the adjoint operator (4-21) obtained in Section 4.3.1, a MDARE-based solution is proposed in this section to solve the filtering problem 4-1 such that the error system (4-7) is MS stable while satisfying the given  $H_\infty$  performance index  $\gamma$  and the design method for the corresponding filter in (4-4) is also proposed.

**Theorem 4-1.** For a given constant  $\gamma > 0$ , if there exists a matrix  $P > 0$ , such that the following MDARE holds

$$P = APA^T + BB^T + [AP\hat{C}_2^T + B\hat{D}^T][\hat{C}_2P\hat{C}_2^T + \hat{D}\hat{D}^T - \hat{S}_1 + \hat{\Phi} \odot (\hat{C}_1P\hat{C}_1^T + \hat{D}\hat{D}^T)]^{-1}[AP\hat{C}_2^T + B\hat{D}^T]^T. \quad (4-30)$$

Then the error system (4-7) meets the following requirements

1. when  $w(k) = 0$ , the error system (4-7) is MS stable;
2. when  $w_0(k) \neq 0$ , the error system (4-7) satisfies the performance requirement

$$\sup_{\|w(k)\|_{\mathcal{P}} \neq 0} \frac{\|z_e(k)\|_{\mathcal{P}}^2}{\|w(k)\|_{\mathcal{P}}^2} < \gamma^2. \quad (4-31)$$

Moreover, the filter gain  $L$  in (4-4) is given as

$$L = [AP\hat{C}_2^T + B\hat{D}^T][\hat{C}_2P\hat{C}_2^T + \hat{D}\hat{D}^T - \hat{S}_1 + \hat{\Phi} \odot (\hat{C}_1P\hat{C}_1^T + \hat{D}\hat{D}^T)]^{-1}\hat{S}_2 \quad (4-32)$$

where

$$\hat{C}_1 = \begin{bmatrix} 0 \\ \bar{C}_1 \end{bmatrix}, \quad \hat{C}_2 = \begin{bmatrix} \gamma^{-1}C_2 \\ \bar{C}_1 \end{bmatrix}, \quad \hat{D} = \begin{bmatrix} 0 \\ \bar{D} \end{bmatrix}, \quad \hat{S}_1 = \begin{bmatrix} I & 0 \\ 0 & 0 \end{bmatrix}, \quad \hat{S}_2 = \begin{bmatrix} 0 \\ I \end{bmatrix}, \quad \hat{\Phi} = \begin{bmatrix} H_1 & H_2 \\ H_2^T & \bar{\phi} + H \end{bmatrix},$$

$\bar{\phi} = \bar{\alpha}^{-1} - I$ , and  $H_1$ ,  $H_2$ ,  $H$  are matrices of proper dimensions with all elements being 1.

**Proof of Theorem 4-1:** The proof for the MS stability is first given. It is known that the error system (4-7) is MS stable if and only if system (4-20) is MS stable [114].

Noticing that (4-20) and (4-21) represent the same system. the MS stability of system (4-21) is therefore considered here, and the following Lyapunov function is defined for it as

$$V(\bar{k}) = \tilde{x}_a^T(\bar{k})P\tilde{x}_a(\bar{k}). \quad (4-33)$$

By combination of (4-21) and (4-33), it can be obtained that

$$\begin{aligned} & E\{\Delta V(\bar{k})\} \\ &= E\{V(\bar{k}+1) - V(\bar{k})\} \\ &= \tilde{x}_a^T(\bar{k})\bar{A}P\bar{A}^T\tilde{x}_a(\bar{k}) + \tilde{x}_a^T(\bar{k})\bar{A}P\bar{C}_2^T\tilde{z}_e(\bar{k}) + \tilde{z}_e^T(\bar{k})\bar{C}_2P\bar{A}^T\tilde{x}_a(\bar{k}) \\ &\quad + \tilde{z}_e^T(\bar{k})\bar{C}_2P\bar{C}_2^T\tilde{z}_e(\bar{k}) - \tilde{x}_a^T(\bar{k})P\tilde{x}_a(\bar{k}) + \tilde{x}_a^T(\bar{k})L[\bar{\phi} \odot (\bar{C}_1P\bar{C}_1^T)]L^T\tilde{x}_a(\bar{k}), \end{aligned}$$

where  $\bar{\phi} = \bar{\alpha}^{-1} - I$ . When  $\tilde{z}_e(\bar{k}) = 0$  for the system (4-21), the above equation can be rewritten as

$$E\{V(\bar{k}+1) - V(\bar{k})\} = E\{\tilde{x}_a^T(\bar{k})[\bar{A}P\bar{A}^T + L[\bar{\phi} \odot (\bar{C}_1P\bar{C}_1^T)]L^T - P]\tilde{x}_a(\bar{k})\}. \quad (4-34)$$

With the help of Lemma 2-3, the MDARE (4-30) and the equation (4-32) can be rewritten respectively as

$$P = APA^T + BB^T + APC_2U_1^{-1}C_2^TPA^T - U_3^TU_2^{-1}U_3, \quad (4-35)$$

$$L = U_3U_2^{-1}, \quad (4-36)$$

where

$$\begin{aligned} U_1 &= \gamma^2I - C_2PC_2^T > 0, \quad U_3 = \bar{C}_1PA^T + \bar{D}B^T + \bar{C}_1PC_2^TU_1^{-1}C_2PA^T, \\ U_2 &= (\bar{\phi} + H) \odot (\bar{C}_1P\bar{C}_1^T + \bar{D}\bar{D}^T) + \bar{C}_1PC_2^TU_1^{-1}C_2P\bar{C}_1^T. \end{aligned}$$

Substituting equation (4-36) into equation (4-35), it can be calculated that

$$\begin{aligned} P &= APA^T + BB^T + APC_2U_1^{-1}C_2^TPA^T - U_3^TU_2^{-1}U_3 - U_3^TU_2^{-1}U_3 + U_3^TU_2^{-1}U_3 \\ &= APA^T + BB^T + APC_2U_1^{-1}C_2^TPA^T - LU_3 - U_3^TL^T + LU_2L^T \\ &= \bar{A}P\bar{A}^T + \bar{B}\bar{B}^T + L[\bar{\phi} \odot (\bar{C}_1P\bar{C}_1^T + \bar{D}\bar{D}^T)]L^T + \bar{A}P\bar{C}_2^TU_1^{-1}C_2P\bar{A}^T, \end{aligned}$$

which indicates that

$$\bar{A}P\bar{A}^T + L[\bar{\phi} \odot (\bar{C}_1P\bar{C}_1^T)]L^T - P < 0 \quad (4-37)$$

with  $U_1 > 0$  holding.

Substituting (4-37) into (4-34), it can be observed that  $E\{V(\bar{k}+1) - V(\bar{k})\} < 0$  holds, which means

$$E\{\tilde{x}_a^T(\bar{k}+1)P\tilde{x}_a(\bar{k}+1)\} < E\{\tilde{x}_a^T(\bar{k})P\tilde{x}_a(\bar{k})\}. \quad (4-38)$$

Hence, there holds

$$Tr\{E[\tilde{x}_a(\bar{k}+1)\tilde{x}_a^T(\bar{k}+1)]P\} < Tr\{E[\tilde{x}_a(\bar{k})\tilde{x}_a^T(\bar{k})]P\}, \quad (4-39)$$

which indicates that

$$\lim_{\bar{k} \rightarrow \infty} E\{\tilde{x}_a(\bar{k})\tilde{x}_a^T(\bar{k})\} = 0. \quad (4-40)$$

Therefore, the system (4-21) is MS stable, and the error system (4-7) is thus MS stable.

For further considering the  $H_\infty$  performance of the error system (4-7), it can be obtained by (4-21) and (4-33) that



$$\begin{aligned}
\mathbf{E}\{\Delta V(\bar{k})\} &= \mathbf{E}\{\Delta V(\bar{k})\} - \mathbf{E}\{\gamma^2 \tilde{z}_e^T(\bar{k}) \tilde{z}_e(\bar{k})\} \\
&\quad + \mathbf{E}\{\tilde{w}_a^T(\bar{k}) \tilde{w}_a(\bar{k})\} + \mathbf{E}\{\gamma^2 \tilde{z}_e^T(\bar{k}) \tilde{z}_e(\bar{k}) - \tilde{w}_a^T(\bar{k}) \tilde{w}_a(\bar{k})\} \\
&= \mathbf{E}\{\gamma^2 \tilde{z}_e^T(\bar{k}) \tilde{z}_2(\bar{k}) - \tilde{w}_a^T(\bar{k}) \tilde{w}_a(\bar{k})\} + \tilde{x}_a^T(\bar{k}) \Pi_{11} \tilde{x}_a(\bar{k}) + \tilde{x}_a^T(\bar{k}) \Pi_{12} \tilde{z}_e(\bar{k}) \\
&\quad + \tilde{z}_e^T(\bar{k}) \Pi_{21} \tilde{x}_a(\bar{k}) + \tilde{z}_e^T(\bar{k}) \Pi_{22} \tilde{z}_e(\bar{k}) \\
&= \mathbf{E}\{\gamma^2 \tilde{z}_e^T(\bar{k}) \tilde{z}_e(\bar{k}) - \tilde{w}_a^T(\bar{k}) \tilde{w}_a(\bar{k})\} + \tilde{x}_a^T(\bar{k}) [\Pi_{11} - \Pi_{12} \Pi_{22}^{-1} \Pi_{21}] \tilde{x}_a(\bar{k}) \\
&\quad + [\tilde{z}_e(\bar{k}) + \Pi_{22}^{-1} \Pi_{21}(\bar{k}) \tilde{x}_a(\bar{k})]^T \Pi_{22} [\tilde{z}_e(\bar{k}) + \Pi_{22}^{-1} \Pi_{21} \tilde{x}_a(\bar{k})],
\end{aligned}$$

where

$$\begin{aligned}
\Pi_{11} &= \bar{A} \bar{P} \bar{A}^T + \bar{B} \bar{B}^T + L[\bar{\phi} \odot (\bar{C}_1 \bar{P} \bar{C}_1^T + \bar{D} \bar{D}^T)] L^T - P, \\
\Pi_{21} &= \Pi_{12}^T, \quad \Pi_{22} = C_2 P C_2^T - \gamma^2 I < 0, \quad \Pi_{12} = \bar{A} P C_2^T.
\end{aligned}$$

Under the zero-initial condition, there holds

$$\begin{aligned}
\sum_{\bar{k}=0}^{N-1} \mathbf{E}\{\Delta V(\bar{k})\} &= V(N) - V(0) \\
&= \sum_{\bar{k}=0}^{N-1} \mathbf{E}\{\gamma^2 \tilde{z}_e^T(\bar{k}) \tilde{z}_e(\bar{k}) - \tilde{w}_a^T(\bar{k}) \tilde{w}_a(\bar{k})\} + \sum_{\bar{k}=0}^{N-1} \mathbf{E}\{\tilde{x}_a^T(\bar{k}) [\Pi_{11} - \Pi_{12} \Pi_{22}^{-1} \Pi_{21}] \\
&\quad \times \tilde{x}_a(\bar{k})\} + \sum_{\bar{k}=0}^{N-1} \mathbf{E}\{[\tilde{z}_e(\bar{k}) + \Pi_{22}^{-1} \Pi_{21} \tilde{x}_a(\bar{k})]^T \Pi_{22} [\tilde{z}_e(\bar{k}) + \Pi_{22}^{-1} \Pi_{21} \tilde{x}_a(\bar{k})]\}.
\end{aligned}$$

From the above formula, it can be obtained

$$\begin{aligned}
\sum_{\bar{k}=0}^{N-1} \mathbf{E}\{\tilde{w}_a^T(\bar{k}) \tilde{w}_a(\bar{k}) - \gamma^2 \tilde{z}_e^T(\bar{k}) \tilde{z}_e(\bar{k})\} \\
&= -V(N) + \sum_{\bar{k}=0}^{N-1} \mathbf{E}\{[\tilde{z}_e(\bar{k}) + \Pi_{22}^{-1} \Pi_{21} \tilde{x}_a(\bar{k})]^T \Pi_{22} [\tilde{z}_e(\bar{k}) + \Pi_{22}^{-1} \Pi_{21} \tilde{x}_a(\bar{k})]\} \\
&\quad + \sum_{\bar{k}=0}^{N-1} \mathbf{E}\{\tilde{x}_a^T(\bar{k}) [\Pi_{11} - \Pi_{12} \Pi_{22}^{-1} \Pi_{21}] \tilde{x}_a(\bar{k})\}.
\end{aligned}$$

By substituting equation (4-36) into equation (4-35), there holds

$$P = \bar{A} \bar{P} \bar{A}^T + \bar{B} \bar{B}^T + L[\bar{\phi} \odot (\bar{C}_1 \bar{P} \bar{C}_1^T + \bar{D} \bar{D}^T)] L^T + \bar{A} P C_2^T U_1^{-1} C_2 P \bar{A}^T,$$

which means that

$$\Pi_{11} - \Pi_{12} \Pi_{22}^{-1} \Pi_{21} = 0. \quad (4-41)$$

Therefore, it can be further obtained

$$\begin{aligned}
\sum_{\bar{k}=0}^{N-1} \mathbf{E}\{\tilde{w}_a^T(\bar{k}) \tilde{w}_a(\bar{k}) - \gamma^2 \tilde{z}_e^T(\bar{k}) \tilde{z}_e(\bar{k})\} \\
&= -V(N) + \sum_{\bar{k}=0}^{N-1} \mathbf{E}\{[\tilde{z}_e(\bar{k}) + \Pi_{22}^{-1} \Pi_{21} \tilde{x}_a(\bar{k})]^T \Pi_{22} [\tilde{z}_e(\bar{k}) + \Pi_{22}^{-1} \Pi_{21} \tilde{x}_a(\bar{k})]\} < 0,
\end{aligned}$$

which means that  $\lim_{N \rightarrow \infty} \sum_{\bar{k}=0}^{N-1} \mathbf{E}\{\tilde{w}_a^T(\bar{k}) \tilde{w}_a(\bar{k}) - \gamma^2 \tilde{z}_e^T(\bar{k}) \tilde{z}_e(\bar{k})\} < 0$ . Therefore,

$$\sup_{\|\tilde{z}_e(\bar{k})\| \neq 0} \frac{\|\tilde{w}_a(\bar{k})\|_{\mathcal{P}}^2}{\|\tilde{z}_e(\bar{k})\|_{\mathcal{P}}^2} = \sup_{\|z_e(k)\| \neq 0} \frac{\|w_a(k)\|_{\mathcal{P}}^2}{\|z_e(k)\|_{\mathcal{P}}^2} < \gamma^2. \quad (4-42)$$

By lemma 4-1 and (4-42), there holds

$$\sup_{\|w(k)\| \neq 0} \frac{\|z_e(k)\|_{\mathcal{P}}^2}{\|w(k)\|_{\mathcal{P}}^2} = \sup_{\|z_e(k)\| \neq 0} \frac{\|w_a(k)\|_{\mathcal{P}}^2}{\|z_e(k)\|_{\mathcal{P}}^2} < \gamma^2. \quad (4-43)$$

Therefore, (4-7) is MS stable with satisfying the given  $H_\infty$  performance index  $\gamma$ .  $\square$

Theorem 4-1 details the design method for the filter gain  $L$  such that the error

system (4-7) is MS stable and satisfies the given  $H_\infty$  performance index  $\gamma$ . It is obvious  $H_\infty$  performance indicates MS stability of the error system. And the conditions need to be further discussed for the existing of the filter gain  $L$  such that the error system (4-7) is MS stable. Therefore, the stabilizability conditions are given in the next subsection, which reveals certain relationships among the MS stability of the error system (4-7), data arrival rate  $\bar{\alpha}_i$  in (4-2) and the Mahler measure of system matrix  $A$  in (4-1).

Before further discussion, a useful technique called Wonham decomposition is briefly reviewed first. It was proposed in [115] to solve the multi-input pole placement problem.

**Definition 4-4. (Wonham decomposition)** Given a stabilizable multi-input system  $G$  with state matrix  $A \in \mathbb{R}^{n \times n}$  and input matrix  $B \in \mathbb{R}^{n \times m}$ , we can carry out the controllable-uncontrollable decomposition with respect to the first column of  $B$  by a similarity transformation such that the matrix pair  $(A, B)$  is equivalent to

$$\left( \begin{bmatrix} A_1 & * \\ 0 & \tilde{A}_2 \end{bmatrix}, \begin{bmatrix} b_1 & * \\ 0 & \tilde{B}_2 \end{bmatrix} \right). \quad (4-44)$$

Then we proceed to do the controllable-uncontrollable decomposition on the matrix pair  $(\tilde{A}_2, \tilde{B}_2)$  with respect to the first column of  $\tilde{B}_2$ . Continuing this process yields to the following Wonham decomposition

$$\left( \begin{bmatrix} A_1 & * & \dots & * \\ 0 & A_2 & \ddots & \vdots \\ \vdots & \ddots & \ddots & * \\ 0 & \dots & 0 & A_m \end{bmatrix}, \begin{bmatrix} b_1 & * & \dots & * \\ 0 & b_2 & \ddots & \vdots \\ \vdots & \ddots & \ddots & * \\ 0 & \dots & 0 & b_m \end{bmatrix} \right). \quad (4-45)$$

that is equivalent to  $(A, B)$ , where each pair  $(A_i, b_i)$ ,  $i = 1, 2, \dots, m$  is stabilizable, and the symbol  $*$  represents the entry irrelevant to the discussion proceeded subsequently.

**Theorem 4-2.** The error system (4-7) is MS stable only if

$$\mathcal{M}^2(A) < \prod_{i=1}^p (1 - \bar{\alpha}_i)^{-1} \quad (4-48)$$

where  $\mathcal{M}(A)$  is the Mahler measure of matrix  $A$ . Conversely, if

$$\mathcal{M}^2(A_i) < (1 - \bar{\alpha}_i)^{-1} \quad (4-49)$$

then there exists a filter gain  $L$  such that the error system (4-7) is MS stable.

**Proof of Theorem 4-2:** The error system (4-7) is MS stable if and only if the following system

$$e(k+1) = [\bar{A} - L\phi(k)\bar{C}_1]^T e(k) \quad (4-50)$$

is MS stable [114], which can be rewritten as

$$\begin{cases} e(k+1) = \bar{A}^T e(k) + C_1^T d(k), \\ f(k) = -L^T e(k), \\ d(k) = \bar{\alpha} \phi(k) f(k), \end{cases} \quad (4-51)$$

where  $\bar{A} = A - L\bar{C}_1$ ,  $\bar{C}_1 = \bar{\alpha}C_1$ .

We first show the necessity. We will show that if system (4-51) is MS stable, then the condition (4-48) holds. From (4-51), there holds  $d(k) = \mathcal{I}_1(q)\bar{\alpha}\phi(k)f(k)$ , where  $q^{-1}$  is the shift operator and

$$\mathcal{I}_1 = \left[ \begin{array}{c|c} \bar{A}^T & C_1^T \\ \hline -L^T & 0 \end{array} \right]. \quad (4-52)$$

Let  $f_i(k)$  and  $R_d(\tau)$  be the  $i^{\text{th}}$  element of  $f(k)$  and the auto-correlation matrix of  $d(k)$ , respectively. Then we have

$$R_d(\tau) = \lim_{N \rightarrow \infty} \frac{1}{N} \sum_{k=0}^{N-1} \{\phi(k+\tau)f(k+\tau)f^T(k)\phi^T(k)\} = \delta(\tau)(\bar{\alpha} - \bar{\alpha}^2)D_f(\tau) \quad (4-53)$$

with  $D_f(\tau) = \text{diag}\{R_{f_1}(\tau), R_{f_2}(\tau), \dots, R_{f_p}(\tau)\}$ ,  $\delta(\tau)$  being the impulse function, and the PSD (power spectral density) of  $d(k)$  is thus given by  $S_d(\omega) = (\bar{\alpha} - \bar{\alpha}^2)D_f(0)$ .

Hence

$$\|f\|_p^2 = \text{Tr}\{D_f(0)\} = \frac{1}{2\pi} \int_{-\pi}^{\pi} \text{Tr}\{\mathcal{I}_1(e^{j\omega})S_d(\omega)\mathcal{I}_1^H(e^{j\omega})d\omega\} = \text{Tr}\{\Upsilon D_f(0)\}, \quad (4-54)$$

where

$$\Upsilon = (\bar{\alpha} - \bar{\alpha}^2) \frac{1}{2\pi} \int_{-\pi}^{\pi} \mathcal{I}_1^H(e^{j\omega})\mathcal{I}_1(e^{j\omega})d\omega.$$

Since system (4-51) is MS stable, the diagonal entries of  $\Upsilon$  are all less than 1. On the other hand,  $\Upsilon$  can be rewritten as

$$\Upsilon = (\bar{\alpha}^{-1} - I) \frac{1}{2\pi} \int_{-\pi}^{\pi} \mathcal{I}_2^H(e^{j\omega})\mathcal{I}_2(e^{j\omega})d\omega \quad (4-55)$$

with

$$\mathcal{I}_2 = \left[ \begin{array}{c|c} \bar{A}^T & \bar{C}_1^T \\ \hline -L^T & 0 \end{array} \right]. \quad (4-56)$$

Denote

$$J = \Upsilon + (\bar{\alpha}^{-1} - I) = (\bar{\alpha}^{-1} - I) \left[ I + \frac{1}{2\pi} \int_{-\pi}^{\pi} \mathcal{I}_2^H(e^{j\omega})\mathcal{I}_2(e^{j\omega})d\omega \right]. \quad (4-57)$$

Since  $\Upsilon_{i,i} < 1$ , then  $J_{i,i} < \bar{\alpha}_i^{-1}$ . Moreover,  $\mathcal{I}_2(z)$  is the complementary sensitivity of the form  $\mathcal{I}_2(z) = \mathcal{F}(zI - \mathcal{A} - \mathcal{B}\mathcal{F})^{-1}\mathcal{B}$  with  $\mathcal{A} = A^T$ ,  $\mathcal{B} = \bar{C}_1^T$  and  $\mathcal{F} = -L^T$ , hence there holds

$$\det\left\{ \left[ I + \frac{1}{2\pi} \int_{-\pi}^{\pi} \mathcal{T}_2^H(e^{j\omega}) \mathcal{T}_2(e^{j\omega}) d\omega \right] \right\} \geq \mathcal{M}(A). \quad (4-58)$$

Since the matrix  $J$  is positive definite, Hadamard's inequality [103] gives

$$\det\{J\} \leq \prod_{i=1}^p J_{i,i}. \quad (4-59)$$

Therefore, we have

$$\mathcal{M}^2(A) \prod_{i=1}^p (1 - \bar{\alpha}_i) \bar{\alpha}_i^{-1} < \prod_{i=1}^p \bar{\alpha}_i^{-1}, \quad (4-60)$$

which leads to inequality (4-48).

Now, the sufficiency is shown. According to Lemma 2-1, the error system (4-7) is MS stable if there exists a scaling matrix  $\mathcal{D}$  and an estimation gain  $L$  such that

$$(\bar{\alpha} - \bar{\alpha}^2) \left\| \mathcal{D}^{-1} \mathcal{T}_1 \mathcal{D} \right\|_{2,1} < 1. \quad (4-61)$$

Set  $\mathcal{D} = \text{diag}\{1, \varepsilon, \dots, \varepsilon^{p-1}\}$ ,  $U = \text{diag}\{I_{n_1}, \varepsilon I_{n_2}, \dots, \varepsilon^{p-1} I_{n_p}\}$ , where  $\varepsilon > 0$  is sufficiently small. Then with the Wonham decomposition (4-47), we have

$$\mathcal{D}^{-1} \mathcal{T}_1(z) \mathcal{D} = -\mathcal{D}^{-1} L^T U (zI - U^{-1} A^T U + U^{-1} \bar{C}_1 \mathcal{D} \mathcal{D}^{-1} L U)^{-1}, \quad (4-62)$$

where  $U^{-1} A^T U = \text{diag}\{A_1^T, \dots, A_p^T\} + o(\varepsilon)$ ,  $U^{-1} \bar{C}_1^T U = \text{diag}\{c_1^T, \dots, c_p^T\} + o(\varepsilon)$ , and  $o(\varepsilon)/\varepsilon$  approaches to a finite constant when  $\varepsilon$  approaches to zero. Hence, there holds

$$\mathcal{D}^{-1} \mathcal{T}_1(z) \mathcal{D} = \text{diag}\{\mathcal{T}_{11}(z), \dots, \mathcal{T}_{1p}(z)\} + o(\varepsilon, z), \quad (4-63)$$

where  $\mathcal{T}_{1i}(z) = l_i^T (zI_{n_i} - A_i^T - c_i^T \bar{\alpha}_i l_i^T)^{-1} c_i^T$ .

Take

$$l_i = -\bar{\alpha}_i A_i P_i c_i^T (1 + \bar{\alpha}_i^2 c_i P_i c_i^T)^{-1} \quad (4-64)$$

with  $P_i$  being the stabilizing solution to the ARE

$$P_i = A_i P_i A_i^T - \bar{\alpha}_i^2 A_i P_i c_i^T (1 + \bar{\alpha}_i^2 c_i P_i c_i^T)^{-1} c_i P_i A_i^T. \quad (4-65)$$

Then, we have [106]

$$\left\| \mathcal{T}_{1i}(z) \right\|_2^2 < \bar{\alpha}_i^{-2} \mathcal{M}_2(A_i) - \bar{\alpha}_i^{-2}. \quad (4-66)$$

Note

$$\mathcal{M}^2(A_i) < (1 - \bar{\alpha}_i)^{-1} \quad (4-67)$$

as given in inequality (4-49), which indicates

$$\left\| \mathcal{T}_{1i}(z) \right\|_2^2 < 1 / (\bar{\alpha}_i - \bar{\alpha}_i^2). \quad (4-68)$$

Hence, by choosing  $L = -\text{diag}\{l_1, \dots, l_p\}$ , we have

$$(\bar{\alpha} - \bar{\alpha}^2) \left\| \mathcal{D}^{-1} \mathcal{T} \mathcal{D} \right\|_{2,1} < 1 \quad (4-69)$$

for sufficiently small  $\varepsilon$ . □

When  $p=1$ , i.e.,  $\bar{\alpha} = \bar{\alpha}_1$ , Theorem 4-2 can be further simplified. Therefore, the following corollary is derived based on Theorem 4-2.

**Corollary 4-1.** When  $p=1$ , the error system (4-7) is MS stable if and only if

$$\mathcal{M}^2(A) < (1 - \bar{\alpha})^{-1}. \quad (4-70)$$

**Proof of Corollary 4-1:** Corollary 4-1 is straight forward from Theorem 4-2.  $\square$

As detailed in Theorem 4-1, the error system (4-7) is MS stable if the MDARE (4-30) holds. And according to Theorem 4-2, the condition (4-48) must be ensured when error system (4-7) is MS stable. Therefore, the following Remark 4-1 further discusses the relationships between the MDARE (4-30) given in Theorem 4-1 and the condition (4-48) given in Theorem 4-2.

**Remark 4-1.** When  $p = 1$ ,  $w(k) = 0$ , the error system (4-7) can be rewritten as

$$e(k+1) = (A - L\bar{\alpha}C_1 - L\phi(k)\bar{\alpha}C_1)e(k). \quad (4-71)$$

System (4-71) is MS stable if and only if the following system

$$\begin{cases} e(k+1) = (A - L\bar{\alpha}C_1)^T e(k) + C_1^T d(k), \\ f(k) = -L^T e(k), \\ d(k) = \phi(k)z(k), \end{cases} \quad (4-72)$$

is MS stable. Denote  $V(k) = e^T(k)Pe(k)$ , it can be obtained that

$$\begin{aligned} & V(k+1) - V(k) \\ &= e^T(k)[(A - L\bar{\alpha}C_1)P(A - L\bar{\alpha}C_1)^T - P]e(k) \\ & \quad + d^T(k)C_1PC_1^T d(k) + 2e^T(k)(A - L\bar{\alpha}C_1)PC_1^T d(k). \end{aligned}$$

By (4-35), we have

$$(A - L\bar{\alpha}C_1)P(A - L\bar{\alpha}C_1)^T + L[(\bar{\alpha} - \bar{\alpha}^2)C_1PC_1^T]L^T - P < 0. \quad (4-73)$$

Hence,

$$\begin{aligned} & \|f(k)\|_2^2 + V(k+1) - V(k) \\ & < e^T(k)[1 - L(\bar{\alpha} - \bar{\alpha}^2)C_1PC_1^T L^T]e(k) \\ & \quad + d^T(k)C_1PC_1^T d(k) + 2e^T(k)(A - L\bar{\alpha}C_1)PC_1^T d(k). \end{aligned}$$

Since  $e(k)$  is independent of  $d(k)$ , it can be obtained that

$$(\bar{\alpha} - \bar{\alpha}^2)C_1PC_1^T \|f(k)\|_2^2 < C_1PC_1^T. \quad (4-74)$$

That is  $\|f(k)\|_2^2 < 1/(\bar{\alpha} - \bar{\alpha}^2)$ . On the other hand, by the same method in the proof of Theorem 4-2, it can be obtained that

$$\|f(k)\|_2^2 < \bar{\alpha}^{-2}\mathcal{M}^2(A) - \bar{\alpha}^{-2}. \quad (4-75)$$

Then, we have

$$\mathcal{M}^2(A) < (1 - \bar{\alpha})^{-1}, \quad (4-76)$$

which is a special case of (4-48). In this case, the sufficiency condition in (4-48), which ensures the error system (4-7) to be MS stable is also implied in the MDARE (4-30).

## 4.4 Conclusion

In this chapter, the robust filtering problem is considered over lossy channels. To consider the  $H_\infty$  performance of the error system, an adjoint operator is introduced. A MDARE-based solution is further proposed to solve the filtering problem, and the design method for the corresponding filter is simultaneously proposed. Then, the necessary and sufficient conditions are deduced for the existence of the filter such that the error system is MS stable subject to packet dropouts. Meanwhile, the relationships between the obtained MDARE and the MS stability of the error system are also discussed. The effectiveness of the filtering method proposed in this chapter will be verified by the simulation in Subsection 6.4.

## Chapter 5 Realization of Network-based Systems

### 5.1 Introduction

The trajectory tracking control problem and robust filtering problem are respectively considered in Chapter 3 and Chapter 4. For practical application, the controller and filter need further implementation. This chapter addresses the realization problem of the filter/controller. Implementation on a digital process entails finite word length effects on the coefficients' representation, and the multiple-subsystem architecture of the filter also introduces internal time delays in the information interaction. Dealing with these intrinsic defects requires finding a realization, which is resilient to them. For this purpose, a corresponding descriptor model-based approach is thus constructed to describe the internal time delays and equivalent realizations with finite word length effects in a unifying framework.

The contribution of this chapter mainly focus on the following two aspects: 1) a descriptor model-based method is proposed to describe the realization problem subject to both fixed internal time delays and FWL effects in a unified framework; 2) Based on this descriptor model obtained, a stability analysis condition is deduced and an algorithm is also proposed to find the optimal realization requiring the minimum word length for stabilization.

### 5.2 Problem formulation

This chapter deals with the realization problem for controllers/filters. Consider the plant described by following LTI discrete-time system

$$\begin{cases} x(k+1) = Ax(k) + Bu(k), \\ y(k) = Cx(k), \end{cases} \quad (5-1)$$

where  $x(k) \in \mathbb{R}^n$  is the state vector,  $u(k) \in \mathbb{R}^m$  is the control input,  $y(k) \in \mathbb{R}^p$  is the output measurement, respectively.  $A$ ,  $B$  and  $C$  are known matrices with appropriate dimensions. The matrix pair  $(A, C)$  is assumed to be observable. There is a high similarity between the realization of the controller and the filter. Therefore, in the chapter, we focus on the filter described by the following LTI discrete-time model

$$\hat{x}(k+1) = A\hat{x}(k) + Bu(k) + L[y(k) - C\hat{x}(k)], \quad (5-2)$$

where  $\hat{x}(k) \in \mathbb{R}^n$  is the state vector of the filter, and  $L \in \mathbb{R}^{n \times p}$  is the given filter gain.

**Remark 5-1.** As said just above, the realization of the static state feedback controller can be regarded as a special case of the realization method proposed for the filter in this chapter. More specifically, for a controller described by the following LTI discrete-time model

$$x_c(k+1) = A_c x_c(k) + B_c K_c x_c(k), \quad (5-3)$$

where  $x_c(k) \in \mathbb{R}^n$  is the state vector, and  $A_c$ ,  $B_c$ ,  $K_c$  are known matrices with appropriate dimensions. (5-3) can be rewritten as the form in (5-2) by replacing  $A_c = A$ ,  $B_c = L$ ,  $K_c = C$  and  $u(k) = 0$ ,  $y(k) = 0$ .

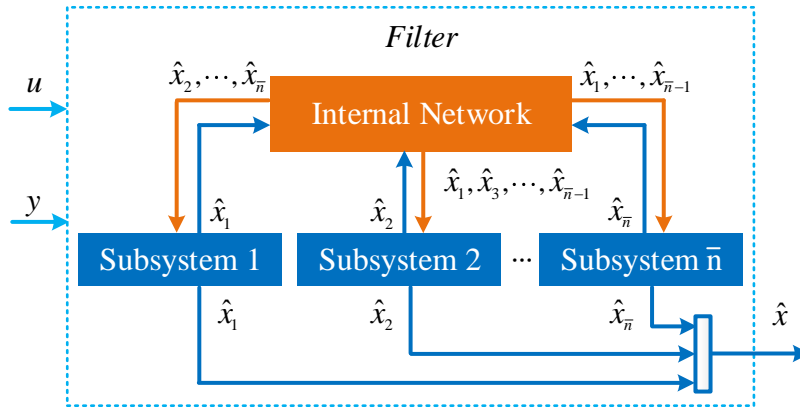

**Figure 5-1 Problem setup**

As depicted in Figure 5-1, due to the limitation of processing capacity for single SOC (system on chip), it is assumed that the filter given in (5-2) requires digital implementation using  $\bar{n}$  SOCs with finite precision, in which case the FWL effects should be considered for the parameter matrices involved in (5-2). Therefore, (5-2) is partitioned into  $\bar{n}$  subsystems according to the following partition

$$A = \begin{bmatrix} A_{11} & \cdots & A_{1\bar{n}} \\ \vdots & \ddots & \vdots \\ A_{\bar{n}1} & \cdots & A_{\bar{n}\bar{n}} \end{bmatrix}, \quad B = \begin{bmatrix} B_{11} & \cdots & B_{1\bar{n}} \\ \vdots & \ddots & \vdots \\ B_{\bar{n}1} & \cdots & B_{\bar{n}\bar{n}} \end{bmatrix},$$

$$C = \begin{bmatrix} C_{11} & \cdots & C_{1\bar{n}} \\ \vdots & \ddots & \vdots \\ C_{\bar{n}1} & \cdots & C_{\bar{n}\bar{n}} \end{bmatrix}, \quad L = \begin{bmatrix} L_{11} & \cdots & L_{1\bar{n}} \\ \vdots & \ddots & \vdots \\ L_{\bar{n}1} & \cdots & L_{\bar{n}\bar{n}} \end{bmatrix},$$

$$\hat{x}^T(k) = [\hat{x}_1^T(k) \quad \hat{x}_2^T(k) \quad \cdots \quad \hat{x}_{\bar{n}}^T(k)], \quad u^T(k) = [u_1^T(k) \quad u_2^T(k) \quad \cdots \quad u_{\bar{n}}^T(k)],$$

$$y^T(k) = [y_1^T(k) \quad y_2^T(k) \quad \cdots \quad y_{\bar{n}}^T(k)],$$

where

$$\hat{x}_i(k) \in \mathbb{R}^{n_i}, \quad u_i(k) \in \mathbb{R}^{m_i}, \quad y_i(k) \in \mathbb{R}^{p_i}, \quad \sum_{i=1}^{\bar{n}} n_i = n, \quad \sum_{i=1}^{\bar{n}} m_i = m, \quad \sum_{i=1}^{\bar{n}} p_i = p.$$



And the matrices  $A_{ij}$ ,  $B_{ij}$ ,  $C_{ij}$ ,  $L_{ij}$  are defined accordingly to the partition of the signals  $\hat{x}(k)$ ,  $u(k)$ ,  $y(k)$ .

In the considered realization problem, the filter is required to be stable after implementation by  $\bar{n}$  SOCs. Therefore, the signals  $u(k)$  and  $y(k)$  are omitted in the following discussion. According to the above partition, the centralized system (5-2) can be further rewritten as the following subsystems

$$\hat{x}_i(k+1) = A_{ii}\hat{x}_i(k) + L_{ii}z_i(k) + \sum_{j=1; j \neq i}^{\bar{n}} [A_{ij}\hat{x}_j(k) + L_{ij}z_j(k)], \quad (5-4)$$

where  $z_i(k) = C_{ii}\hat{x}_i(k) + \sum_{j=1; j \neq i}^{\bar{n}} C_{ij}\hat{x}_j(k)$ .

The subsystem (5-4) represents a filter realized by the shift operator in the state-space form. The implementation strategy with multiple subsystems depicted in Figure 5-1 introduces time delays in the information interaction among the subsystems, and the matrices  $A_{ij}$ ,  $C_{ij}$ ,  $L_{ij}$ ,  $i=1, 2, \dots, \bar{n}$ ,  $j=1, 2, \dots, \bar{n}$  in (5-4) requires digital representation by each SOC with finite precision. In this case, the stability of the filter (5-4) cannot be strictly guaranteed following such implementation scheme even if it is designed to be stable. This is due to FWL effects and a common method against FWL effects is the equivalent realization. More specifically, the filter (5-4) can be described using different operators and thus leading to equivalent realizations. When their parameters are affected by FWL effects, the realizations are no longer equivalent. Therefore, the FWL effects should be considered along with the equivalent realizations of (5-4), whose resilience to these defects must be determined. To gain a detailed description of the problem, the characteristics of the internal time delays as well as arithmetic format for coefficients' representation must be described. In addition, the equivalent realizations for (5-4) should be further discussed and considered in a general unifying framework, which will be detailed in the following subsections.

### 5.3 Delay and FWL

In the considered realization problem, the internal communication network of all subsystems is represented as  $\bar{\mathcal{A}}$ , and the communication channel from the  $i^{\text{th}}$  subsystem to  $j^{\text{th}}$  subsystem is represented as  $\bar{\mathcal{A}}_{ij}$ . (5-4) shows that the evolution of the state  $\hat{x}_i(k+1)$  requires  $\hat{x}_j(k)$ ,  $j=1, 2, \dots, \bar{n}$ ,  $j \neq i$  from the  $j^{\text{th}}$  subsystem. It is assumed that single-packet transmission is adopted by the  $j^{\text{th}}$  subsystem to send  $\hat{x}_j(k)$  to the  $i^{\text{th}}$  subsystem, while the packet dropouts are not considered in the transmission

process. To describe the network  $\bar{\mathcal{X}}$ , the input and output of the channel  $\bar{\mathcal{X}}_{ij}$  are defined as  $v_{ij}(k) \in \mathbb{R}^{n_j}$  and  $\eta_{ij}(k) \in \mathbb{R}^{n_i}$ , respectively. The time delay of each individual communication channel  $\bar{\mathcal{X}}_{ij}$  is assumed to be independent and it is fixed as  $\tau_{ij}T_s$ ,  $\tau_{ij} \in \mathbb{N}$ , where  $T_s$  is the period of the discrete-time system (5-2). And it is undoubtedly that  $\tau_{ii} = 0$  for  $i = 1, 2, \dots, \bar{n}$ . In this case, the input-output characteristic of  $\bar{\mathcal{X}}_{ij}$  is given as  $\eta_{ij}(k) = v_{ij}(k - \tau_{ij})$ . By considering the time delays, (5-4) can be rewritten as

$$\hat{x}_i(k+1) = A_{ii}\hat{x}_i(k) + L_{ii}z_i(k) + \sum_{j=1; j \neq i}^{\bar{n}} [A_{ij}\hat{x}_j(k - \tau_{ij}) + L_{ij}z_j(k)], \quad (5-5)$$

where  $z_i(k) = C_{ii}\hat{x}_i(k) + \sum_{j=1; j \neq i}^{\bar{n}} C_{ij}\hat{x}_j(k - \tau_{ij})$ .

For each subsystem (5-5), the representation of its coefficients  $A_{ij}$ ,  $C_{ij}$  and  $L_{ii}$ ,  $i, j = 1, 2, \dots, \bar{n}$  should be considered, which depends on both the arithmetic format and word length for representation.

In this chapter, the fixed-point representation scheme is introduced [116]. A real number  $a \in \mathbb{R}$  can be represented in fixed-point format with a total word length  $\gamma = \alpha + \beta + 1$  by assigning 1 bit for the sign,  $\alpha$  bits for the integer part and  $\beta$  bits for the fraction part of  $a$ . In this case, the integer part of a real number can be represented by a sufficiently large word length without overflow as  $\alpha = \log_2 \lfloor a \rfloor$ , while its fraction part cannot be exactly represented and the representation error of  $a$  is related to the word length  $b \in \mathbb{N}^+$ . More specifically, after fixed-point representation,  $b$  is given as

$$\varphi(a) = a + \Delta, \quad |\Delta| < 2^{-(\beta+1)}, \quad (5-6)$$

where  $\varphi(\cdot)$  denotes the function for fixed-point representation.

To consider a real matrix  $X$ , let  $d(X)$  represent the matrix of the same dimension with elements

$$d(X)_{ij} = \begin{cases} 0, & X_{ij} \in \mathbb{Z}, \\ 1, & X_{ij} \notin \mathbb{Z}, \end{cases} \quad (5-7)$$

where  $d(X)_{ij}$  denotes the element of  $d(X)$  in  $i^{\text{th}}$  row and  $j^{\text{th}}$  column and  $X_{ij}$  denotes the element of  $X$  in  $i^{\text{th}}$  row and  $j^{\text{th}}$  column. Then after fixed-point representation  $\varphi(\cdot)$  with finite word length  $\beta$ ,  $X$  is given as

$$\varphi(X) = X + d(X) \odot \Delta_{ij}, \quad |\Delta_{ij}| < 2^{-(\beta+1)}. \quad (5-8)$$

In this chapter, the parameter matrices involved in each subsystem (5-5) are represented by the same fixed-point scheme with the same bits for the fraction part.

Under this assumption, and assuming also that all uncertainties  $|\Delta_{ij}|$  have the common bound  $2^{-(\beta+1)}$ , it can be obtained that

$$|\varphi(X)_{ij} - X_{ij}| < 2^{-(\beta+1)}, \quad (5-9)$$

where  $\varphi(X)_{ij}$  denotes the element of  $\varphi(X)$  in  $i^{\text{th}}$  row and  $j^{\text{th}}$  column. In the stability analysis method proposed in the next section, the bound is considered. Therefore,  $\varphi(X)$  can be simplified as

$$\varphi(X) = X + d(X)\Delta, \quad |\Delta| < 2^{-(\beta+1)}. \quad (5-10)$$

With the above-mentioned fixed-point representation scheme, the integer part of all the coefficients  $A_{ij}$ ,  $C_{ij}$ ,  $L_{ij}$ ,  $i=1, 2, \dots, \bar{n}$ ,  $j=1, 2, \dots, \bar{n}$  are assumed to be precisely represented without overflow, while the fraction part of the coefficients is represented with word length  $\beta$ . In this case, the result of coefficients' representation is related only to  $\beta$ , while the word length  $\alpha$  for the integer part as well as the bit for the sign are subsequently omitted.

#### 5.4 Problem formulation

As discussed in Subsection 5.3, the coefficients in (5-5) cannot be precisely represented with finite word length  $\beta$ , and thus equivalent realizations may result in different properties against the FWL effects. For illustration, we consider an example of realizing the coefficients  $A_{ij}$ ,  $C_{ij}$  and  $L_{ij}$ ,  $i=1, 2, \dots, \bar{n}$ ,  $j=1, 2, \dots, \bar{n}$  in (5-5) with the  $\delta$ -operator as

$$\delta[\hat{x}_i(k)] = A_{ii}^\delta \hat{x}_i(k) + L_{ii}^\delta z_i(k) + \sum_{j=1; j \neq i}^{\bar{n}} [A_{ij}^\delta \hat{x}_j(k - \tau_{ij}) + L_{ij}^\delta z_j(k)], \quad (5-11)$$

where  $z_i(k) = C_{ii}^\delta \hat{x}_i(k) + \sum_{j=1; j \neq i}^{\bar{n}} C_{ij}^\delta \hat{x}_j(k - \tau_{ij})$ ,  $A_{ii}^\delta = (A_{ii} - I) / \Delta_\delta$ ,  $A_{ij}^\delta = A_{ij} / \Delta_\delta$ ,  $C_{ii}^\delta = C_{ii}$ ,  $C_{ij}^\delta = C_{ij}$ ,  $L_{ii}^\delta = L_{ii} / \Delta_\delta$ ,  $L_{ij}^\delta = L_{ij} / \Delta_\delta$ ,  $\delta = (q - 1) / \Delta_\delta$  with  $\Delta_\delta$  being a positive constant and  $q^{-1}$  being the shift operator [89].

Noticing that (5-5) and (5-11) are equivalent realizations with different coefficients. However, with coefficients' representation subject to FWL effects, they may lead to different properties of stability. Moreover, with  $\delta[\hat{x}_i(k)]$  in expression (5-11), the classical state-space model is insufficient to describe the form of (5-11), and thus a more generalized model is introduced in the next section.

The problem under consideration can be paraphrased as finding an appropriate equivalent realization for (5-5) which is resilient to FWL effects using the fixed-point

representation to guarantee the stability of the filter, which is summarized as the following Problem 5-1.

**Problem 5-1.** For given word length  $\beta$  for coefficients' representation and network  $\bar{\mathcal{A}}$  with internal time delay  $\tau_{ij}$ ,  $i, j = 1, 2, \dots, \bar{n}$ , find an appropriate realization for system (5-5) to be stable after implementation.

## 5.5 Realization method

This section details the method to solve Problem 1. In subsection 5.5.1, the descriptor model is first adopted to consider the internal time delays, coefficients representation and the equivalent realizations in the unifying framework. Based on the above modeling method, an analysis condition is then deduced in subsection 5.5.2 to evaluate the stability resilience of a given realization against the FWL effects.

### 5.5.1 Descriptor model representation

To describe the equivalent realizations of (5-5) within a general unifying framework, the following descriptor model [91] is introduced with the specialized form given as

$$\begin{bmatrix} \check{J} & 0 & 0 \\ -\check{K} & I & 0 \\ -\check{L} & 0 & I \end{bmatrix} \begin{bmatrix} \check{T}(k+1) \\ \check{X}(k+1) \\ \check{Y}(k+1) \end{bmatrix} = \begin{bmatrix} 0 & \check{M} & \check{N} \\ 0 & \check{P} & \check{Q} \\ 0 & \check{R} & \check{S} \end{bmatrix} \begin{bmatrix} \check{T}(k) \\ \check{X}(k) \\ \check{U}(k) \end{bmatrix}, \quad (5-12)$$

where  $\check{X}(k) \in \mathbb{R}^n$  is the state vector,  $\check{U}(k) \in \mathbb{R}^m$  is the control input,  $\check{Y}(k) \in \mathbb{R}^p$  is the output measurement,  $\check{T}(k) \in \mathbb{R}^l$  is the intermediate variable and  $\check{J}$  is a lower triangular matrix with 1 on the diagonal. The general state-space model can be regarded as a special case of the above model and the above model can also be used to express the state-space system. On the other hand, the intermediate variable  $\check{T}(k)$  in the above model makes it possible to represent the system (5-11) realized by the  $\delta$ -operator. Thus model provides an explicit description of the parametrization and allows the analysis of FWL effects in a unifying framework.

The above model takes the form of an implicit state-space system [101]. In (5-12),  $\check{X}(k+1)$  is the stored state vector and  $\check{X}(k)$  is effectively stored from one step to the next, in order to compute  $\check{X}(k+1)$  at step  $k$ .  $\check{T}(k)$  plays a particular role as  $\check{T}(k+1)$  is independent of  $\check{T}(k)$  and  $\check{T}(k)$  is not used for the calculation at step  $k$ , which characterizes the concept of an intermediate variable. The particular structure of  $\check{J}$  allows to express how the computations are decomposed with intermediates results that could be reused. The computations associated with the above realization are

executed in row order, giving the following algorithm

$$\begin{cases} \tilde{J}\tilde{T}(k+1) = \tilde{M}\tilde{X}(k) + \tilde{N}\tilde{U}(k), \\ \tilde{X}(k+1) = \tilde{K}\tilde{T}(k+1) + \tilde{P}\tilde{X}(k) + \tilde{Q}\tilde{U}(k), \\ \tilde{Y}(k+1) = \tilde{L}\tilde{T}(k) + \tilde{R}\tilde{X}(k) + \tilde{S}\tilde{U}(k). \end{cases} \quad (5-13)$$

Note that the computations are executed in row order and  $\tilde{J}$  is lower triangular with 1 on the diagonal. Hence, there is no need to compute  $\tilde{J}^{-1}$ . See [117] for practical examples taking benefits from this descriptor model

The descriptor model (5-12) is equivalent in infinite precision to the classical state-space form as

$$\begin{bmatrix} \tilde{T}(k+1) \\ \tilde{X}(k+1) \\ \tilde{Y}(k+1) \end{bmatrix} = \begin{bmatrix} 0 & \tilde{J}^{-1}\tilde{M} & \tilde{J}^{-1}\tilde{N} \\ 0 & \tilde{A} & \tilde{B} \\ 0 & \tilde{C} & \tilde{D} \end{bmatrix} \begin{bmatrix} \tilde{T}(k) \\ \tilde{X}(k) \\ \tilde{U}(k) \end{bmatrix}, \quad (5-14)$$

where  $\tilde{A} \in \mathbb{R}^{n \times n}$ ,  $\tilde{B} \in \mathbb{R}^{n \times m}$ ,  $\tilde{C} \in \mathbb{R}^{p \times n}$ ,  $\tilde{D} \in \mathbb{R}^{p \times m}$  with

$$\tilde{A} = \tilde{K}\tilde{J}^{-1}\tilde{M} + \tilde{P}, \quad \tilde{B} = \tilde{K}\tilde{J}^{-1}\tilde{N} + \tilde{Q}, \quad \tilde{C} = \tilde{L}\tilde{J}^{-1}\tilde{M} + \tilde{R}, \quad \tilde{D} = \tilde{L}\tilde{J}^{-1}\tilde{N} + \tilde{S}. \quad (5-15)$$

The finite-precision implementation of the above model will cause different numerical deterioration compared with (5-14).

To match the structure of the above descriptor model, (5-5) and (5-11) are rewritten into a general unifying framework as

$$\begin{cases} J_i T_i(k+1) = M_{ii} \hat{x}_i(k) + N_{ii} z_i(k) + \sum_{j=1; j \neq i}^{\bar{n}} [M_{ij} \hat{x}_j(k - \tau_{ij}) + N_{ij} z_j(k)], \\ \hat{x}_i(k+1) = K_i T_i(k+1) + P_{ii} \hat{x}_i(k) + \sum_{j=1; j \neq i}^{\bar{n}} P_{ij} \hat{x}_j(k - \tau_{ij}), \end{cases} \quad (5-16)$$

where  $z_i(k) = C_{ii} \hat{x}_i(k) + \sum_{j=1; j \neq i}^{\bar{n}} C_{ij} \hat{x}_j(k - \tau_{ij})$ ,  $T_i(k) \in \mathbb{R}^{l_i}$  are intermediate variables. In (5-16),  $J_i$ ,  $K_i$ ,  $M_{ii}$ ,  $M_{ij}$ ,  $P_{ii}$ ,  $P_{ij}$ ,  $N_{ii}$ ,  $N_{ij}$  are known matrices satisfying

$$\begin{aligned} A_{ii} &= K_i J_i^{-1} M_{ii} + P_{ii}, \quad A_{ij} = K_i J_i^{-1} M_{ij} + P_{ij}, \\ L_{ii} &= K_i J_i^{-1} N_{ii}, \quad L_{ij} = K_i J_i^{-1} N_{ij}, \quad i, j = 1, 2, \dots, \bar{n}. \end{aligned}$$

Compared to the state-space form (5-5), the representation (5-16) is more general and provides more detailed information on the implementation. The intermediate variables  $T_i(k)$  typically enable describing the  $\delta$ -operator in (5-11). Specifically, (5-16) is equivalent in infinite precision to the classical state-space form (5-5) by selecting parameters in (5-16) as

$K_i = I$ ,  $J_i = I$ ,  $P_{ii} = A_{ii}$ ,  $P_{ij} = A_{ij}$ ,  $L_{ii} = N_{ii}$ ,  $L_{ij} = N_{ij}$ ,  $M_{ii} = 0$ ,  $M_{ij} = 0$ , (5-16) is similarly equivalent in infinite precision to the realization (5-11) with  $\delta$ -operator by selecting parameters as

$$J_i = I, \quad M_{ii} = \Delta_\delta^{-1}(A_{ii} - I), \quad M_{ij} = \Delta_\delta^{-1}A_{ij}, \quad P_{ii} = I, \\ P_{ij} = 0, \quad K_i = \Delta_\delta^{-1}I, \quad N_{ii} = \Delta_\delta^{-1}L_{ii}, \quad N_{ij} = \Delta_\delta^{-1}L_{ij}.$$

For the convenience of the following discussion, denote

$$T^T(k) = [T_1^T(k) \quad \cdots \quad T_{\bar{n}}^T(k)], \quad \bar{P}_1 = \text{diag}[P_{11}, P_{22}, \dots, P_{\bar{m}\bar{m}}], \quad \bar{M}_1 = \text{diag}[M_{11}, M_{22}, \dots, M_{\bar{m}\bar{m}}], \\ N = \begin{bmatrix} N_{11} & \cdots & N_{1\bar{n}} \\ \vdots & \ddots & \vdots \\ N_{\bar{n}1} & \cdots & N_{\bar{m}\bar{m}} \end{bmatrix}, \quad \bar{M}_2 = \begin{bmatrix} M_{11} & \cdots & M_{1\bar{n}} \\ \vdots & \ddots & \vdots \\ M_{\bar{n}1} & \cdots & M_{\bar{m}\bar{m}} \end{bmatrix} - \bar{M}_1, \quad \bar{P}_2 = \begin{bmatrix} P_{11} & \cdots & P_{1\bar{n}} \\ \vdots & \ddots & \vdots \\ P_{\bar{n}1} & \cdots & P_{\bar{m}\bar{m}} \end{bmatrix} - \bar{P}_1, \\ \bar{C} = \text{diag}[\bar{C}_1, \bar{C}_2, \dots, \bar{C}_{\bar{n}}], \quad \bar{C}_i = [a_{i1}C_{i1} \quad a_{i2}C_{i2} \quad \cdots \quad a_{i\bar{m}}C_{i\bar{m}}], \quad i = 1, 2, \dots, \bar{n}.$$

The item  $\hat{x}_j(k - \tau_{ij})$  in (5-16) with time delays  $\tau_{ij}$  does not yet match the form of descriptor model (5-12), which can be overcome by adopting the similar modeling method proposed in [93]. In this case, each communication path  $\bar{\mathcal{X}}_{ij}$  is represented by the following state-space system

$$\begin{cases} \kappa_{ij}(k+1) = \Gamma_{ij}\kappa_{ij}(k) + \Pi_{ij}v_{ij}(k), \\ \eta_{ij}(k+1) = \Psi_{ij}\kappa_{ij}(k) + \Sigma_{ij}v_{ij}(k), \end{cases} \quad (5-17)$$

where  $\kappa_{ij}(k) \in \mathbb{R}^{(\tau_{ij}+1)n_i}$ ,  $v_{ij}(k) \in \mathbb{R}^{n_j}$ ,  $\eta_{ij}(k) \in \mathbb{R}^{n_j}$  are the state, input, output vectors, respectively,

$$\Gamma_{ij} = \begin{bmatrix} 0 & & (0) \\ I_{n_i} & \ddots & \\ & \ddots & \ddots & 0 \\ (0) & & & I_{n_i} \end{bmatrix}, \quad \Pi_{ij} = \begin{bmatrix} I_{n_i} \\ 0 \\ \vdots \\ 0 \end{bmatrix}, \quad \Psi_{ij} = \begin{bmatrix} 0 \\ \vdots \\ 0 \\ I_{n_i} \end{bmatrix}, \quad \Sigma_{ij} = \begin{cases} 0_{n_i} & (\text{if } \tau_{ij} \neq 0), \\ I_{n_i} & (\text{if } \tau_{ij} = 0). \end{cases}$$

(5-17) shows that  $\eta_{ij}(k) = v_{ij}(k - \tau_{ij})$ , and therefore, (5-17) can be adopted to describe the input-output characteristic of the channel  $\bar{\mathcal{X}}_{ij}$ .

By combination all the individual communication models (5-17) for  $\bar{\mathcal{X}}_{ij}$ , the model of the whole communication network  $\bar{\mathcal{X}}$  is defined as

$$\begin{cases} \kappa(k+1) = \Gamma\kappa(k) + \Pi v(k), \\ \eta(k+1) = \Psi\kappa(k) + \Sigma v(k), \end{cases} \quad (5-18)$$

where

$$\kappa^T(k) = [\kappa_{11}^T(k) \quad \cdots \quad \kappa_{1\bar{n}}^T(k) \quad \kappa_{21}^T(k) \quad \kappa_{22}^T(k) \quad \cdots \quad \kappa_{ij}^T(k) \quad \cdots \quad \kappa_{\bar{m}\bar{m}}^T(k)], \\ v(k) = [v_{11}^T(k) \quad \cdots \quad v_{1\bar{n}}^T(k) \quad v_{21}^T(k) \quad v_{22}^T(k) \quad \cdots \quad v_{ij}^T(k) \quad \cdots \quad v_{\bar{m}\bar{m}}^T(k)], \\ \eta(k) = [\eta_{11}^T(k) \quad \cdots \quad \eta_{1\bar{n}}^T(k) \quad \eta_{21}^T(k) \quad \eta_{22}^T(k) \quad \cdots \quad \eta_{ij}^T(k) \quad \cdots \quad \eta_{\bar{m}\bar{m}}^T(k)], \\ \Gamma = [\Gamma_{11} \quad \cdots \quad \Gamma_{1\bar{n}} \quad \Gamma_{21} \quad \Gamma_{22} \quad \cdots \quad \Gamma_{ij} \quad \cdots \quad \Gamma_{\bar{m}\bar{m}}], \\ \Pi = [\Pi_{11} \quad \cdots \quad \Pi_{1\bar{n}} \quad \Pi_{21} \quad \Pi_{22} \quad \cdots \quad \Pi_{ij} \quad \cdots \quad \Pi_{\bar{m}\bar{m}}],$$

$$\Psi = [\Psi_{11} \quad \cdots \quad \Psi_{1\bar{n}} \quad \Psi_{21} \quad \Psi_{22} \quad \cdots \quad \Psi_{ij} \quad \cdots \quad \Psi_{\bar{m}}],$$

$$\Sigma = [\Sigma_{11} \quad \cdots \quad \Sigma_{1\bar{n}} \quad \Sigma_{21} \quad \Sigma_{22} \quad \cdots \quad \Sigma_{ij} \quad \cdots \quad \Sigma_{\bar{m}}], \quad i, j = 1, 2, \dots, \bar{n}, i \neq j.$$

By combining (5-18) and (5-16), (5-16) can be rewritten as the following autonomous system in the form of the descriptor model (5-14) as

$$\begin{bmatrix} \bar{J} & 0 \\ -\bar{K} & I \end{bmatrix} \begin{bmatrix} \bar{T}(k+1) \\ \bar{x}(k+1) \end{bmatrix} = \begin{bmatrix} 0 & \bar{M} \\ 0 & \bar{P} \end{bmatrix} \begin{bmatrix} \bar{T}(k) \\ \bar{x}(k) \end{bmatrix}, \quad (5-19)$$

where

$$\bar{T}^T(k) = [T^T(k) \quad v^T(k)], \quad \bar{x}^T(k) = [\eta^T(k) \quad \kappa^T(k) \quad \hat{x}^T(k)],$$

$$\bar{J} = \begin{bmatrix} J & 0 \\ 0 & I \end{bmatrix}, \quad \bar{M} = \begin{bmatrix} \bar{M}_2 & 0 & \bar{M}_1 + N\bar{C} \\ 0 & 0 & M^r \end{bmatrix}, \quad \bar{K} = \begin{bmatrix} 0 & \Sigma \\ 0 & \Pi \\ K & 0 \end{bmatrix}, \quad \bar{P} = \begin{bmatrix} 0 & \Psi & 0 \\ 0 & \Gamma & 0 \\ \bar{P}_2 & 0 & \bar{P}_1 \end{bmatrix},$$

$$M^r = [M_{11}^r \quad \cdots \quad M_{1\bar{n}}^r \quad M_{21}^r \quad M_{22}^r \quad \cdots \quad M_{ij}^r \quad \cdots \quad M_{\bar{m}}^r]^T,$$

$$M_{ij}^r = [0_{n_j \times n_{i_1}} \quad \cdots \quad 0_{n_j \times n_{j-1}} \quad I_{n_j} \quad 0_{n_j \times n_{j+1}} \quad \cdots \quad 0_{n_j \times n_{\bar{n}}} ]^T.$$

Noticing that (5-16) has been rewritten as (5-19) and they are equivalent. Therefore, (5-16) and (5-19) can be only determined by the set of matrices  $\bar{J}$ ,  $\bar{K}$ ,  $\bar{M}$  and  $\bar{P}$ , leading to the following definition.

**Definition 5-1.** A realization  $\aleph$  of (5-16) is defined by the specific set of matrices  $\bar{J}$ ,  $\bar{K}$ ,  $\bar{M}$ ,  $\bar{P}$  as  $\aleph \triangleq (\bar{J}, \bar{K}, \bar{M}, \bar{P})$ .

With Definition 5-1, Problem 1 can be formed as the following Problem 5-2.

**Problem 5-2.** Find a realization  $\aleph \triangleq (\bar{J}, \bar{K}, \bar{M}, \bar{P})$  such that (5-16) is stable with its coefficients represented by given word length  $\beta$ .

### 5.5.2 Stability analysis

In this subsection, the condition is derived to solve Problem 5-2, where (5-16) is rewritten as the descriptor model in (5-19). Therefore, Problem 5-2 is solved if system (5-19) is stable subject to coefficients' representation with given word length  $\beta$ .

In (5-19), the representation of its coefficients  $\bar{J}$ ,  $\bar{K}$ ,  $\bar{M}$  and  $\bar{P}$  should be considered. It shows that analyzing the FWL effects on the stability of (5-19) is equivalent to analyze the stability of the following system

$$\begin{bmatrix} \bar{J} + d(\bar{J})\Delta & 0 \\ -\bar{K} + d(\bar{K})\Delta & I \end{bmatrix} \begin{bmatrix} \bar{T}(k+1) \\ \bar{x}(k+1) \end{bmatrix} = \begin{bmatrix} 0 & \bar{M} + d(\bar{M})\Delta \\ 0 & \bar{P} + d(\bar{P})\Delta \end{bmatrix} \begin{bmatrix} \bar{T}(k) \\ \bar{x}(k) \end{bmatrix},$$

where the function  $d(\cdot)$  is defined in (5-7),  $|\Delta| < 2^{-(\beta+1)}$  with  $\beta$  being word length for representing the fraction part of the coefficients. For the above system, it is difficult

to analyze its stability due to the uncertainties  $\Delta$  coupled on both sides, and thus the above system is further augmented and rewritten as

$$\hat{E}\tilde{x}(k+1) = \hat{A}\tilde{x}(k) + \hat{N}[\hat{C} + d(\hat{C})\Delta]\tilde{x}(k), \quad (5-20)$$

where

$$\begin{aligned} \tilde{x}^T(k) &= [\bar{T}^T(k) \quad \bar{x}^T(k) \quad \varepsilon_1^T(k) \quad \varepsilon_2^T(k) \quad \varepsilon_3^T(k)], \quad \hat{A} = \hat{A}_1 + d(\hat{A}_2)\Delta, \\ \bar{A} &= \begin{bmatrix} 0 & \bar{M} \\ 0 & \bar{P} \end{bmatrix}, \quad \bar{E} = \begin{bmatrix} \bar{J} & 0 \\ -\bar{K} & I \end{bmatrix}, \quad \hat{A}_1 = \begin{bmatrix} \bar{A} & 0 & I & 0 \\ 0 & -I & 0 & 0 \\ 0 & 0 & -I & 0 \\ 0 & 0 & 0 & -I \end{bmatrix}, \quad \hat{E} = \begin{bmatrix} \bar{E} & I & 0 & 0 \\ 0 & 0 & 0 & 0 \\ 0 & 0 & 0 & 0 \\ 0 & 0 & 0 & 0 \end{bmatrix}, \\ \hat{N} &= \begin{bmatrix} \bar{N} \\ 0 \\ 0 \\ I \end{bmatrix}, \quad \hat{A}_2 = \begin{bmatrix} \bar{A} & 0 & 0 & 0 \\ \bar{E} & 0 & 0 & 0 \\ 0 & 0 & 0 & \bar{N} \\ 0 & 0 & 0 & 0 \end{bmatrix}, \quad \hat{C}^T = \begin{bmatrix} \hat{C}_1^T \\ 0 \\ 0 \\ 0 \end{bmatrix}, \quad \bar{N} = \begin{bmatrix} N \\ 0 \\ 0 \\ 0 \\ 0 \end{bmatrix}, \quad \hat{C}_1^T = \begin{bmatrix} 0 \\ 0 \\ \bar{C}^T \\ 0 \end{bmatrix}. \end{aligned}$$

The above system (5-20) is a singular system with known singular matrix  $\hat{E}$ , and to analyze its stability, the following singular value decomposition [101] can be introduced for  $\hat{E}$  as

$$\hat{E} = M_d \hat{E} N_d = \begin{bmatrix} I & 0 \\ 0 & 0 \end{bmatrix},$$

where  $M_d$  and  $N_d$  are upper triangular and lower triangular nonsingular matrices such that

$$\tilde{A}_1 = M_d \hat{A}_1 N_d, \quad \tilde{N} = M_d \hat{N}, \quad \tilde{C} = \hat{C} N_d,$$

and

$$\tilde{A} = M_d \{\hat{A} + \hat{N}[\hat{C} + d(\hat{C})\Delta]\} N_d = \begin{bmatrix} \tilde{A}_{11} & \tilde{A}_{12} \\ \tilde{A}_{21} & \tilde{A}_{22} \end{bmatrix}. \quad (5-21)$$

The above decomposition allows rewriting singular the systems (5-20) as

$$\tilde{E}\tilde{x}(k+1) = \tilde{A}\tilde{x}(k) + \tilde{N}[\tilde{C} + d(\tilde{C})\Delta]\tilde{x}(k), \quad (5-22)$$

(5-22) shows that the proposed descriptor model-based method explicitly describes equivalent realizations of the filter (5-16) with internal time delays and can also deal with the coupled uncertainties. Therefore, the analysis of FWL effects is achieved via a unifying framework.

The stability analysis is considered for (5-22), where all parameters in (5-22) are known besides the representation error  $\Delta$ . The following Theorem 5-1 is given for



solving this stability analysis problem.

Different from state-space systems, analyzing singular systems requires considering not only stability but also regularity and causality. As previously defined in Definition 2-4, a singular system is said to be admissible if it is regular, causal and stable.

**Theorem 5-1.** For given scalars  $\beta \in \mathbb{N}^+$ ,  $\tau_{ij}$ ,  $i, j = 1, 2, \dots, \bar{n}$ , the system (5-22) is admissible if there exist matrices  $\bar{Q}$ ,  $\bar{R}$ ,  $\bar{S}$ ,  $\bar{Z} > 0$  and a scalar  $\varepsilon > 0$ , such that

$$\begin{bmatrix} -\frac{1}{2}\bar{Q}-\frac{1}{2}\bar{Q}^T & * & * & * \\ \bar{\Phi}_{21} & \bar{\Phi}_{22} & * & * \\ \bar{Z}-\bar{Q}-\frac{1}{2}\bar{Q}^T & \bar{\Phi}_{32} & -\bar{Q}-\bar{Q}^T & * \\ \bar{\Phi}_{41} & \bar{\Phi}_{42} & \bar{\Phi}_{43} & \bar{\Phi}_{44} \end{bmatrix} < 0, \quad (5-23)$$

where  $\bar{\Phi}_{21} = \bar{\Phi}_4 \bar{\Phi}_1^T$ ,  $\bar{\Phi}_{32} = \bar{\Phi}_1 \bar{\Phi}_4^T$ ,  $\bar{\Phi}_{42} = [\bar{\Phi}_5 \quad \bar{\Phi}_2]$ ,  $\bar{\Phi}_{22} = \bar{\Phi}_2 \bar{\Phi}_4^T + \bar{\Phi}_4 \bar{\Phi}_2^T - \bar{\Phi}_3$ ,  $\bar{\Phi}_{41}^T = [0 \quad \bar{\Phi}_1]$ ,  $\bar{\Phi}_{43} = \bar{\Phi}_{41}$ ,  $\bar{\Phi}_1 = [\bar{Q} \quad \bar{R}]$ ,  $\bar{\Phi}_2 = \begin{bmatrix} 0 & 0 \\ 0 & \bar{S} \end{bmatrix}$ ,  $\bar{\Phi}_3 = \begin{bmatrix} \bar{Z} & 0 \\ 0 & 0 \end{bmatrix}$ ,  $\bar{\beta} = 2^{-(\beta+1)}$ ,  $\bar{\Phi}_{44} = -\varepsilon I$ ,  $\bar{\Phi}_4^T = (\hat{A}_1 + \tilde{N}\tilde{C})$ ,  $\bar{\Phi}_5^T = \bar{\beta}\varepsilon[M_d d(\hat{A}_2)N_d + \tilde{N}d(\tilde{C})]$ .

**Proof of Theorem 5-1:** Suppose that the inequality (5-23) holds. By Schur complement, one has

$$\bar{\Phi}_4 + \varepsilon^{-1}\bar{\Phi}_5\bar{\Phi}_5^T + \varepsilon\bar{\Phi}_6\bar{\Phi}_6^T < 0. \quad (5-24)$$

$$\text{where } \bar{\Phi}_4 = \begin{bmatrix} -\frac{1}{2}\bar{Q}-\frac{1}{2}\bar{Q}^T & * & * \\ \bar{\Phi}_{21} & \bar{\Phi}_{22} & * \\ \bar{Z}-\bar{Q}-\frac{1}{2}\bar{Q}^T & \bar{\Phi}_{32} & -\bar{Q}-\bar{Q}^T \end{bmatrix}, \quad \bar{\Phi}_5 = \begin{bmatrix} 0 \\ \bar{\beta}[M_d d(\hat{A}_2)N_d + \tilde{N}d(\tilde{C})] \\ 0 \end{bmatrix},$$

$$\bar{\Phi}_6 = \begin{bmatrix} \bar{\Phi}_1 \\ \bar{\Phi}_2 \\ \bar{\Phi}_1 \end{bmatrix}. \text{ Then applying Lemma 2-5 leads to}$$

$$\begin{aligned} & \bar{\Phi}_4 + \Delta / \bar{\beta}\bar{\Phi}_5\bar{\Phi}_5^T + \Delta / \bar{\beta}\bar{\Phi}_6\bar{\Phi}_6^T \\ & \leq \bar{\Phi}_4 + \varepsilon^{-1}\bar{\Phi}_5\bar{\Phi}_5^T + \varepsilon\Delta^2 / \bar{\beta}^2\bar{\Phi}_6\bar{\Phi}_6^T \\ & < \bar{\Phi}_4 + \varepsilon^{-1}\bar{\Phi}_5\bar{\Phi}_5^T + \varepsilon\bar{\Phi}_6\bar{\Phi}_6^T < 0, \end{aligned}$$

where  $\Delta < \bar{\beta}$  is the representation error. By Schur complement, it is obtained from the above inequality that

$$\begin{bmatrix} -\frac{1}{2}\bar{Q}-\frac{1}{2}\bar{Q}^T & * & * \\ \tilde{A}^T\Phi_1^T & \Phi_2\tilde{A}+\tilde{A}^T\Phi_2^T-\Phi_3 & * \\ \bar{Z}-\bar{Q}-\frac{1}{2}\bar{Q}^T & \Phi_1\tilde{A} & -\bar{Q}-\bar{Q}^T \end{bmatrix} < 0. \quad (5-25)$$

With the decompositions given in (5-21), one has

$$\begin{bmatrix} -\frac{1}{2}\bar{Q}-\frac{1}{2}\bar{Q}^T & * & * & * \\ \Phi_{21} & -\bar{Z} & * & * \\ \Phi_{31} & \bar{S}[\tilde{A}_{21}+\Delta d(\tilde{A}_{21})] & \Phi_{33} & * \\ \bar{Z}-\bar{Q}-\frac{1}{2}\bar{Q}^T & \Phi_{42} & \Phi_{43} & -\bar{Q}-\bar{Q}^T \end{bmatrix} < 0, \quad (5-26)$$

where

$$\begin{aligned} \Phi_{21} &= \tilde{A}_{11}^T\bar{Q}^T + \tilde{A}_{21}^T\bar{R}^T, \quad \Phi_{31} = \tilde{A}_{12}^T\bar{Q}^T + \tilde{A}_{22}^T\bar{R}^T, \\ \Phi_{33} &= \bar{S}\tilde{A}_{22} + \tilde{A}_{22}^T\bar{S}^T, \quad \Phi_{42} = \bar{Q}\tilde{A}_{11} + \bar{R}\tilde{A}_{21}, \quad \Phi_{43} = \bar{Q}\tilde{A}_{12} + \bar{R}\tilde{A}_{22}. \end{aligned}$$

Left- and right-multiplying the above inequality by

$$T = \begin{bmatrix} I & 0 & 0 & 0 \\ 0 & I & 0 & 0 \\ 0 & 0 & 0 & I \\ 0 & 0 & I & 0 \end{bmatrix} \quad (5-27)$$

and its transpose, respectively, lead to

$$W + W^T < 0 \quad (5-28)$$

with

$$W = \begin{bmatrix} -\frac{1}{2}\bar{Q} & 0 & 0 & 0 \\ W_{21} & -\frac{1}{2}\bar{Z} & W_{23} & \tilde{A}_{21}^T\bar{S}^T \\ W_{31} & 0 & -\bar{Q} & 0 \\ W_{41} & 0 & W_{43} & \tilde{A}_{22}^T\bar{S}^T \end{bmatrix} \quad (5-29)$$

where

$$\begin{aligned} W_{21} &= \tilde{A}_{11}^T\bar{Q}^T + \tilde{A}_{21}^T\bar{R}^T, \quad W_{24} = \tilde{A}_{11}^T\bar{Q}^T + \tilde{A}_{21}^T\bar{R}^T, \quad W_{31} = \bar{Z} - \bar{Q} - \frac{1}{2}\bar{Q}^T, \\ W_{41} &= \tilde{A}_{12}^T\bar{Q}^T + \tilde{A}_{22}^T\bar{R}^T, \quad W_{43} = \tilde{A}_{12}^T\bar{Q}^T + \tilde{A}_{22}^T\bar{R}^T. \end{aligned}$$

Note that  $\tilde{A}_{22}^T\bar{S}^T + \bar{S}\tilde{A}_{22} < 0$  in the above inequality. Using the matrix measurement properties [118], one can claim that the matrices  $\tilde{A}_{22}$  and  $\bar{S}$  are both non-singular. Hence, the singular system (5-22) is regular and causal [101]. And it can be reduced to a

state-space system

$$\hat{x}(k+1) = A_r \hat{x}(k), \quad (5-30)$$

where  $A_r = \tilde{A}_{11} - \tilde{A}_{12} \tilde{A}_{22}^{-1} \tilde{A}_{21}$ .

The above system is stable, if and only if there exists a matrix  $\bar{Z} > 0$ , such that  $A_r^T \bar{Z} A_r - \bar{Z} < 0$ . By Schur complement, the inequality  $A_r^T \bar{Z} A_r - \bar{Z} < 0$  is equivalent to

$$\begin{bmatrix} -\bar{Z} & * \\ A_r^T \bar{Z} & -\bar{Z} \end{bmatrix} < 0. \quad (5-31)$$

The above inequality can be rewritten as  $\Xi_r^T \Xi \Xi_r < 0$ , where

$$\Xi = \begin{bmatrix} 0 & 0 & \bar{Z} \\ 0 & \bar{Z} & 0 \\ \bar{Z} & 0 & 0 \end{bmatrix}, \quad \Xi_r = \begin{bmatrix} I & 0 \\ 0 & I \\ -\frac{1}{2}I & A_r \end{bmatrix}. \quad (5-32)$$

Noting  $\bar{Z} > 0$ , a trivial constraint is introduced as

$$\begin{bmatrix} -\bar{Z} & 0 \\ 0 & -2\bar{Z} \end{bmatrix} < 0. \quad (5-33)$$

And this constraint can be rewritten as  $\Xi_\Psi^T \Xi \Xi_\Psi < 0$ , where

$$\Xi_\Psi^T = \begin{bmatrix} 0 & I & 0 \\ -I & 0 & I \end{bmatrix}. \quad (5-34)$$

Then the following matrices can be defined as

$$\Psi = [I \ 0 \ I], \quad \Gamma = \begin{bmatrix} -\frac{1}{2}I & A_r & -I \end{bmatrix}. \quad (5-35)$$

where  $\Psi \Xi_\Psi = 0$ ,  $\Gamma \Xi_r = 0$ .

With inequalities  $\Xi_r^T \Xi \Xi_r < 0$  and  $\Xi_\Psi^T \Xi \Xi_\Psi < 0$ , applying Lemma 2-4 (Projection Lemma) leads to

$$\Xi + \Gamma^T \bar{Q}^T \Psi + \Psi^T \bar{Q} \Gamma < 0. \quad (5-36)$$

On the other hand, inequality (5-28) gives

$$\begin{bmatrix} -\frac{1}{2}\bar{Q} - \frac{1}{2}\bar{Q}^T & * & * \\ A_r^T \bar{Q}^T & -\bar{Z} & * \\ \bar{Z} - \bar{Q} - \frac{1}{2}\bar{Q}^T & \bar{Q} A_r & -\bar{Q} - \bar{Q}^T \end{bmatrix} < 0, \quad (5-37)$$

which is equivalent to inequality (5-36). Then, it is observed that  $A_r$  is stable.

Therefore, the singular system (5-22) is admissible.  $\square$

Theorem 5-1 provides the stability analysis condition for the filter in (5-16) with a given

realization. However, in practical application, it may be significant to find the realization which is most resilient to the FWL effects. Therefore, Algorithm 5-1 is further proposed to identify realizations that minimize the FWL effects.

---

**Algorithm 5-1**

---

**Input:** A set of  $\hat{n}$  alternative realizations  $\aleph(i)$ ,  $i = 1, 2, \dots, \hat{n}$ .

**Output:** Realization  $\aleph^*$ ; The smallest word length  $\beta^*$ ;

- 1: Initialize  $\beta$ ;
- 2: For  $i = 1 : \hat{n}$ ;
- 3: Solve the inequality (5-23) for  $\aleph(i)$  and  $\beta$ ;
- 4: If (5-23) is solvable;
- 5: Set  $\beta = \beta - 1$ ,  $\beta^* = \beta$ ,  $\aleph^* = \aleph(i)$ , go to step 3;
- 6: end;
- 7: end;

**Return:**  $\aleph^*$ ,  $\beta^*$ .

---

### 5.5.3 Special case: filters implemented on one SOC

If the filter is implemented by only one SOC, it can be regarded as a simplified special case of the results proposed in Section 5.5.2, in which case the internal information interaction of the filter and internal network with time delays no longer require consideration. In this situation, the stability analysis method for the corresponding filter is provided.

By implementation in only one SOC, the information interaction of the filter is not considered. Therefore, (5-2) is rewritten as

$$\hat{x}(k+1) = A\hat{x}(k) + LC\hat{x}(k) \quad (5-38)$$

with  $y(k) = 0$ ,  $u(k) = 0$  and the descriptor model (5-16) is correspondingly rewritten as

$$\begin{cases} JK(k+1) = Mx(k) + NC\hat{x}(k), \\ \hat{x}(k+1) = KT(k+1) + P\hat{x}(k), \end{cases} \quad (5-39)$$

where  $T(k)$  is the intermediate variable. Matrices  $K$ ,  $J$  and  $P$  satisfy

$$A = KJ^{-1}M + P, \quad (5-40)$$

and  $N$  is the matrix satisfying

$$L = KJ^{-1}N. \quad (5-41)$$

Then, (5-39) is further rewritten as

$$\begin{bmatrix} J & 0 \\ -K & I \end{bmatrix} \begin{bmatrix} T(k+1) \\ \hat{x}(k+1) \end{bmatrix} = \begin{bmatrix} 0 & M \\ 0 & P \end{bmatrix} \begin{bmatrix} T(k) \\ \hat{x}(k) \end{bmatrix}. \quad (5-42)$$

To analyze the FWL effects on the stability of the above system is equivalent to analyze the stability of the system

$$\begin{bmatrix} J + d(J)\Delta & 0 \\ -K + d(K)\Delta & I \end{bmatrix} \begin{bmatrix} T(k+1) \\ \hat{x}(k+1) \end{bmatrix} = \begin{bmatrix} 0 & M + d(M)\Delta \\ 0 & P + d(P)\Delta \end{bmatrix} \begin{bmatrix} T(k) \\ \hat{x}(k) \end{bmatrix}. \quad (5-43)$$

For (5-43), the singular value decomposition is given as

$$\tilde{E}_c = M_{dc} \hat{E}_c N_{dc} = \begin{bmatrix} I & 0 \\ 0 & 0 \end{bmatrix}, \tilde{N}_c = M_{dc} \hat{N}_c, \tilde{C}_c = \hat{C}_c N_{dc},$$

$$\tilde{A}_{c1} = M_{dc} \hat{A}_{c1} N_{dc}, \tilde{A}_c = M_{dc} \{ \hat{A}_c + \hat{N}_c [\hat{C}_c + d(\hat{C}_c)\Delta] \} N_{dc}.$$

The above decomposition allows rewriting singular the systems (5-43) as

$$\tilde{E}_c \tilde{x}_c(k+1) = \tilde{A}_c \tilde{x}_c(k) + \tilde{N}_c [\tilde{C}_c + d(\tilde{C}_c)\Delta] \tilde{x}_c(k), \quad (5-44)$$

where

$$\hat{A}_c = \hat{A}_{c1} + d(\hat{A}_{c2})\Delta, \quad \bar{E}_c = \begin{bmatrix} J & 0 \\ -K & I \end{bmatrix}, \quad \bar{N}_c = \begin{bmatrix} N \\ 0 \end{bmatrix}, \quad \bar{A}_c = \begin{bmatrix} 0 & M \\ 0 & P \end{bmatrix}, \quad \bar{C}_c^T = \begin{bmatrix} 0 \\ C^T \end{bmatrix},$$

$$\tilde{x}_c(k) = \begin{bmatrix} T(k) \\ \hat{x}(k) \\ \varepsilon_1(k) \\ \varepsilon_2(k) \\ \varepsilon_3(k) \end{bmatrix}, \quad \hat{E}_c = \begin{bmatrix} \bar{E}_c & I & 0 & 0 \\ 0 & 0 & 0 & 0 \\ 0 & 0 & 0 & 0 \\ 0 & 0 & 0 & 0 \end{bmatrix}, \quad \hat{A}_{c1} = \begin{bmatrix} \bar{A}_c & 0 & I & 0 \\ 0 & -I & 0 & 0 \\ 0 & 0 & -I & 0 \\ 0 & 0 & 0 & -I \end{bmatrix},$$

$$\hat{N}_c = \begin{bmatrix} \bar{N}_c \\ 0 \\ 0 \\ I \end{bmatrix}, \quad \hat{A}_{c2} = \begin{bmatrix} \bar{A}_c & 0 & 0 & 0 \\ \bar{E}_c & 0 & 0 & 0 \\ 0 & 0 & 0 & \bar{N}_c \\ 0 & 0 & 0 & 0 \end{bmatrix}, \quad \hat{C}_c^T = \begin{bmatrix} \bar{C}_c^T \\ 0 \\ 0 \\ 0 \end{bmatrix}.$$

$M_{dc}$  and  $N_{dc}$  are upper triangular and lower triangular nonsingular matrices. By adopting the similar method proposed in section 5.5.2, the following corollary is further proposed to show the analysis condition for stability of (5-44).

**Corollary 5-1.** For given scalars  $\beta \in \mathbb{N}^+$ , the system in (5-44) is admissible if there exist matrices  $\bar{Q}_c, \bar{R}_c, \bar{S}_c, \bar{P}_c > 0$  and a scalar  $\varepsilon > 0$ , such that

$$\begin{bmatrix} -\frac{1}{2}\bar{Q}_c - \frac{1}{2}\bar{Q}_c^T & * & * & * \\ \check{\Phi}_{21} & \check{\Phi}_{22} & * & * \\ \bar{P}_c - \bar{Q}_c - \frac{1}{2}\bar{Q}_c^T & \check{\Phi}_{32} & -\bar{Q}_c - \bar{Q}_c^T & * \\ \check{\Phi}_{41} & \check{\Phi}_{42} & \check{\Phi}_{43} & \check{\Phi}_{44} \end{bmatrix} < 0, \quad (5-45)$$

where  $\check{\Phi}_{21} = \check{\Phi}_4 \check{\Phi}_1^T$ ,  $\check{\Phi}_{32} = \check{\Phi}_1 \check{\Phi}_4^T$ ,  $\check{\Phi}_{42} = [\check{\Phi}_5 \quad \check{\Phi}_2]$ ,  $\check{\Phi}_{22} = \check{\Phi}_2 \check{\Phi}_4^T + \check{\Phi}_4 \check{\Phi}_2^T - \check{\Phi}_3$ ,  
 $\check{\Phi}_{41}^T = [0 \quad \check{\Phi}_1]$ ,  $\check{\Phi}_{43} = \check{\Phi}_{41}$ ,  $\check{\Phi}_1 = [\bar{Q}_c \quad \bar{R}_c]$ ,  $\check{\Phi}_2 = \begin{bmatrix} 0 & 0 \\ 0 & \bar{S}_c \end{bmatrix}$ ,  $\check{\Phi}_3 = \begin{bmatrix} \bar{P}_c & 0 \\ 0 & 0 \end{bmatrix}$ ,  
 $\bar{\beta} = 2^{-(\beta+1)}$ ,  $\check{\Phi}_{44} = -\varepsilon I$ ,  $\check{\Phi}_4^T = (\tilde{A}_{c1} + \tilde{N}_c \tilde{C}_c)$ ,  $\check{\Phi}_5^T = \beta \varepsilon [M_{dc} d(\hat{A}_{c2}) N_{dc} + \tilde{N}_{dc} d(\tilde{C}_c)]$ .

**Proof of Corollary 5-1:** The proof can be simply achieved according to Theorem 5-1 by replacing  $\bar{Q}$ ,  $\bar{R}$ ,  $\bar{S}$ ,  $\bar{Z}$ ,  $\tilde{A}$ ,  $\tilde{A}_1$ ,  $\tilde{A}_2$ ,  $\tilde{C}$ ,  $\tilde{N}$ ,  $\tilde{M}_d$ ,  $\tilde{N}_d$  in it with  $\bar{Q}_c$ ,  $\bar{R}_c$ ,  $\bar{S}_c$ ,  $\bar{P}_c$ ,  $\tilde{A}_c$ ,  $\tilde{A}_{c1}$ ,  $\tilde{A}_{c2}$ ,  $\tilde{C}_c$ ,  $\tilde{N}_c$ ,  $\tilde{M}_{dc}$ ,  $\tilde{N}_{dc}$  and is omitted.  $\square$

For searching the realization that minimize the FWL effects, the method proposed in Algorithm 5-1 can also be adopted for the special case in this section by further replacing the inequality (5-23) in step 3 and 4 of Algorithm 5-1 with (5-45).

## 5.6 Conclusion

This chapter is concerned with the realization problem for filter and controller. To implement all the subsystems in a digital way, coefficients' representation with FWL are considered and this architecture also introduce the internal time delays. To solve this problem, a descriptor model is adopted to describe the system subject to both internal time delays and FWL effects in a general unifying way. Then a condition for stability analysis of the filter/controller is deduced based on the descriptor model. The effectiveness of the realization method proposed in this chapter will be verified simulation in Section 6.5.

## Chapter 6 Illustration: Cooperative Robots

### 6.1 Introduction

In this chapter, a system based on two cooperative robots is introduced. Depending on the chosen implementation scheme for the controller or filter, which is centralized on a supervisor, or decentralized directly on the two robots, this system involves different kind of networked communication with the associated damage. And based on these robots, the simulations are presented to show the detail process as well as the effectiveness of the methods proposed in Chapter 3, Chapter 4 and Chapter 5.

### 6.2 System description

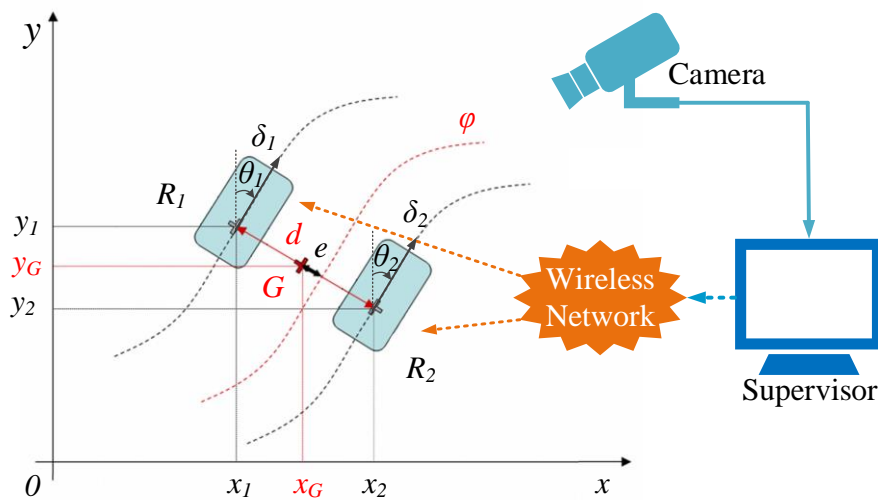

**Figure 6-1 Setup of the cooperative robots**

As depicted in Figure 6-1, the control system consists of two cooperative mobile robots, one camera and a supervisor. The objective is to drive the two cooperative mobile robots in order to complete tasks. For modeling, the volume and shape of the robots are ignored. In other words, they are seen as two points with position  $(x_1, y_1)$  and  $(x_2, y_2)$  as depicted in Figure 6-1.

The barycenter of the robots is defined as  $G(x_G, y_G)$ . The distance  $d$  of the two robots are defined as the Euclidian norm between centers of the robot 1  $(x_1, y_1)$  and

the robot 2  $(x_2, y_2)$ . Therefore,  $x_G$ ,  $y_G$  and  $d$  are given as

$$\begin{cases} x_G = (x_1 + x_2) / 2, \\ y_G = (y_1 + y_2) / 2, \\ d = \sqrt{(x_1 - x_2)^2 + (y_1 - y_2)^2}. \end{cases} \quad (6-1)$$

And the control objectives for the two robots can be formulated as:

1. The barycenter  $G(x_G, y_G)$  of the robots must be driven along a pre-defined path;
2. The constant interdistance  $d$  between the two robots must be ensured.

To meet with  $x_G$ ,  $y_G$  and  $d$  given in (6-1), the control objectives can be defined through the 4 following signals to be controlled

$$\begin{cases} x_G = (x_1 + x_2) / 2, \\ y_G = (y_1 + y_2) / 2, \\ \Delta_x = x_1 - x_2, \\ \Delta_y = y_1 - y_2. \end{cases} \quad (6-2)$$

Each robot can be modeled by a classic kinematic unicycle model

$$\begin{cases} v_{xi} = \delta_i \cos(\theta_i), \\ v_{yi} = \delta_i \sin(\theta_i), \\ \dot{\theta}_i = \hat{\eta}_i, \\ \dot{\delta}_i = \hat{v}_i, \end{cases} \quad (6-3)$$

where  $(x_i, y_i)$  are the position of the  $i^{\text{th}}$  robot,  $\delta_i$  and  $\theta_i$  are its velocity and its angular orientation,  $(v_{xi}, v_{yi})$  are its velocity on  $x$  and  $y$  axle,  $\dot{\theta}_i$  is its angular velocity, and  $\hat{\eta}_i$ ,  $\hat{v}_i$  are the plant input of the  $i^{\text{th}}$  robot,  $i=1, 2$ . In each robot a classical linearizing feedback control law is implemented [119], leading to a new input-output mapping based on two decoupled integrator chains

$$\begin{cases} x_i / a_i^x = 1 / s^2, \\ y_i / a_i^y = 1 / s^2. \end{cases} \quad (6-4)$$

The two new control inputs for each robots  $(a_i^x, a_i^y)$  are homogeneous to the acceleration of the robot. Finally, the plant model including the two robots is given by

$$\dot{x} = A_p x + B_p u_p \quad (6-5)$$

with

$$\begin{aligned} x^T &= [x_1 \quad v_{x1} \quad y_1 \quad v_{y1} \quad x_2 \quad v_{x2} \quad y_2 \quad v_{y2}]^T, \\ u_p^T &= [u_1^p \quad u_2^p \quad u_3^p \quad u_4^p]^T = [a_1^x \quad a_1^y \quad a_2^x \quad a_2^y]^T, \\ A_p &= \text{diag}[A_1 \quad A_2 \quad \dots \quad A_4], \quad B_p = \text{diag}[b_1 \quad b_2 \quad \dots \quad b_4], \end{aligned}$$



$$A_i = \begin{bmatrix} 0 & 1 \\ 0 & 0 \end{bmatrix}, \quad b_i = \begin{bmatrix} 0 \\ 1 \end{bmatrix}, \quad i = 1, 2, 3, 4.$$

After exact discretization at  $T_{samp} = 0.1s$ , (6-5) can be rewritten as the following system

$$x(k+1) = Ax(k) + Bu(k) \quad (6-6)$$

with parameters

$$A = \text{diag}[A_{d1} \quad A_{d2} \quad \cdots \quad A_{d4}], \quad B = \text{diag}[b_{d1} \quad b_{d2} \quad \cdots \quad b_{d4}],$$

$$A_{di} = \begin{bmatrix} 1 & 0.1 \\ 0 & 1 \end{bmatrix}, \quad b_{di} = \begin{bmatrix} 0.005 \\ 0.100 \end{bmatrix}, \quad i = 1, 2, 3, 4.$$

### 6.3 Trajectory tracking control

In this section, the main results proposed in Chapter 3 is applied to the cooperative control system with two robots to show the specific co-design process and to verify the effectiveness of the results. More specifically, the tracking control problem is considered over lossy channels. And it is assumed that the supervisor can obtain the state values of the equation (6-6) for state feedback stabilization.

#### 6.3.1 Control strategy formulation

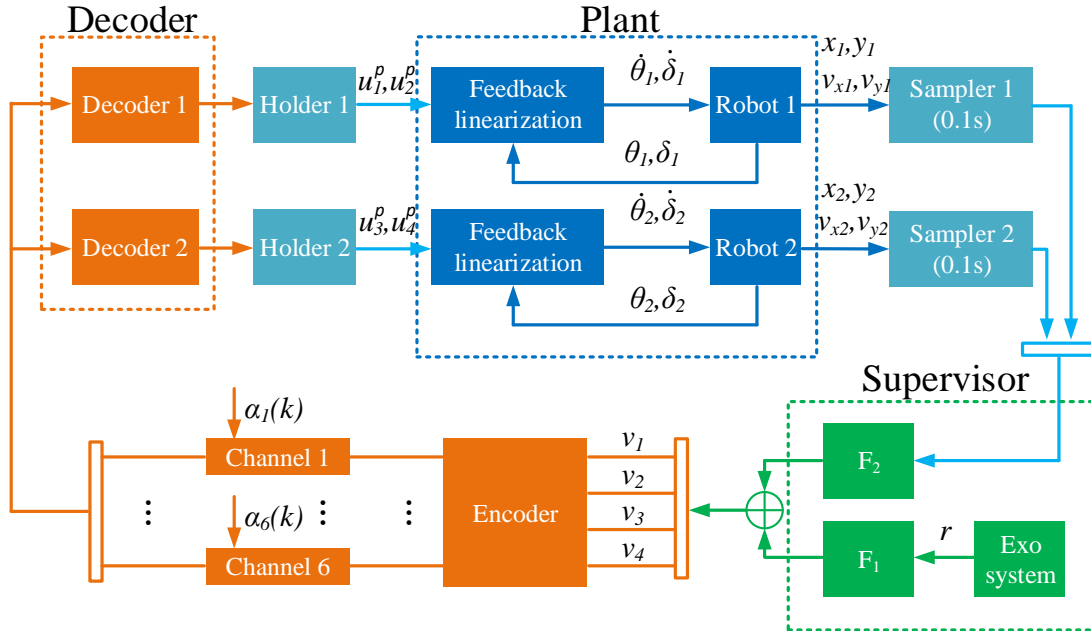

Figure 6-2 Control implementation for the robots

The whole control implementation is depicted in Figure 6-2. The two robots with their local feedback linearization law are set as the plant. The camera send the measured

absolute position and velocity of each robot to the supervisor with a sampling period tuned at 0.1s. The controller implemented by the supervisor consists of a static feedback gain  $F_2$  and a static feedforward gain  $F_1$  generating the control signals  $v_1, v_2, v_3$  and  $v_4$  to drive the two robots.

The four control signals  $v_1, v_2, v_3$  and  $v_4$  are first encoded and then transmitted via  $l=6$  independent wireless lossy channels. After transmission, the signals are decoded and sent to the two robots, respectively. The encoder (static matrix  $\mathcal{E} \in \mathbb{R}^{6 \times 4}$ ) can be implemented directly in the supervisor. While, the decoder (static matrix  $\mathcal{D} \in \mathbb{R}^{4 \times 6}$ ) should be implemented separately in the two robots as

$$\mathcal{D} = \begin{bmatrix} \mathcal{D}_1 \\ \mathcal{D}_2 \end{bmatrix}, \quad \mathcal{D}_1 \in \mathbb{R}^{2 \times 6}, \quad \mathcal{D}_2 \in \mathbb{R}^{2 \times 6}. \quad (6-7)$$

The standard model defined in (3-1) is linked to the plant model (6-6). The matrices  $A$  and  $B$  are given as in (6-6). According to the controlled output of the two robots defined in (6-2), the matrices  $C$  and  $D$  in (3-1) are given as

$$C = \begin{bmatrix} 0.5 & 0 & 0 & 0 & 0.5 & 0 & 0 & 0 \\ 0 & 0 & 0.5 & 0 & 0 & 0 & 0.5 & 0 \\ 1 & 0 & 0 & 0 & -1 & 0 & 0 & 0 \\ 0 & 0 & 1 & 0 & 0 & 0 & -1 & 0 \end{bmatrix}, \quad D = 0.$$

The trajectory tracking control problem for the two robots is considered here and it is reformulated to fit with the theoretical results proposed in Chapter 3. In this simulation, the reference trajectory  $z_r(k)$  for the barycenter  $G$  of the robots is a circle with radius  $10m$ , and the robots should travel around this trajectory with a fixed inter-distance of  $2m$ , at a fixed velocity of  $1m/s$ . The travel period is thus around  $62.8s$ . This leads to

$$z_r(k) = C_r r(k) = \begin{cases} x_G^r(k) = 10 \sin(0.1\pi k / 20), \\ y_G^r(k) = 10 \cos(0.1\pi k / 20), \\ \Delta_x^r(k) = 2 \sin(0.1\pi k / 20), \\ \Delta_y^r(k) = 2 \cos(0.1\pi k / 20). \end{cases} \quad (6-8)$$

The 4 reference signals are clearly coupled, and thus a discrete-time state-space representation based on (3-3) can be designed with parameters

$$A_r = \begin{bmatrix} 0.99995 & -0.00800 \\ 0.01250 & 0.99995 \end{bmatrix}, \quad C_r = \begin{bmatrix} 0 & 10 & 0 & 2 \\ 8 & 0 & -1.6 & 0 \end{bmatrix}^T.$$

### 6.3.2 Simulation results

In this subsection, some simulations are considered for the two robots. As detailed in Chapter 3, multiple lossy channels are adopted to transmit the control signals. And the number of channels is assumed to be more than the number of control signals. Therefore, relatively less expensive sub-channels may be used. Without loss of generality, 6 channels are adopted with different data arrival rates  $\bar{\alpha}_1 = 0.9$ ,  $\bar{\alpha}_2 = 0.7$ ,  $\bar{\alpha}_3 = 0.5$ ,  $\bar{\alpha}_4 = 0.5$ ,  $\bar{\alpha}_5 = 0.3$ ,  $\bar{\alpha}_6 = 0.1$  to transmit the 4 control signals  $v_1$ ,  $v_2$ ,  $v_3$  and  $v_4$ .

To fit with the theoretical results proposed in Section 3.3, three different control strategies are considered for the robots to design the feedback gain  $F_2$ , coding matrix  $U$  and the feedforward gain  $F_1$ .

1. the controller set  $(F_2 = F_2^{MS}, U = U^{MS}, F_1 = F_1^{MS})$  is obtained thanks to Theorem 3-1 and Theorem 3-3 without considering the LQ performance requirement, i.e., only MS stabilization and tracking control are considered;
2. the LQ performance are further considered when designing the feedback gain and the sets  $(F_2 = F_2^{LQ1}, U = U^{LQ1}, F_1 = F_1^{LQ1})$  and  $(F_2 = F_2^{LQ2}, U = U^{LQ2}, F_1 = F_1^{LQ2})$  corresponding to two different weights for LQ functional (3-8) are obtained by Theorem 3-4;
3. the sets  $(F_2 = F_2^{IT1}, U = U^{IT1}, F_1 = F_1^{IT1})$ ,  $(F_2 = F_2^{IT2}, U = U^{IT2}, F_1 = F_1^{IT2})$  are obtained by solving Theorem 3-4 with different weights for LQ functional (3-8), and the iterative design method proposed in Algorithm 3-2 is adopted to reduce the conservatism of the results.

#### Tracking over lossy channels

In this part, the MS stabilization feedback gain  $F_2 = F_2^{MS}$  is designed for the cooperative robots by Theorem 3-1 without considering the LQ performance, and the corresponding feedforward gain  $F_1 = F_1^{MS}$  is computed by Theorem 3-3. With  $F_2^{MS}$  and  $F_1^{MS}$ , a simulation is introduced to show the tracking performance.

For Theorem 3-1, the coding matrix  $U$  is given as

$$U = U^{MS} = \begin{bmatrix} -0.2823 & -0.4024 & -0.5113 & -0.2098 \\ -0.4515 & -0.1390 & 0.5950 & 0.3477 \\ -0.6033 & -0.0440 & 0.2043 & -0.0217 \\ -0.3672 & 0.7786 & -0.3976 & 0.2797 \\ -0.4164 & -0.3496 & -0.3614 & -0.0106 \\ -0.2103 & 0.2973 & 0.2327 & -0.8696 \end{bmatrix}.$$

Then the feedback gain  $F_2^{MS}$  associated to the matrix  $U^{MS}$  is obtained by solving LMIs (3-10)-(3-12) as

$$F_2^{MS} = \text{diag}[f_1, \dots, f_4] \text{ with } f_1 = f_2 = f_3 = f_4 = [-0.3397 \quad -1.1151].$$

The feedforward gain  $F_1^{MS}$  corresponding to  $F_2^{MS}$  and  $U^{MS}$  is obtained by Theorem 3-3 as

$$F_1^{MS} = \begin{bmatrix} 1.2341 & 2.9099 \\ 3.6374 & -0.9873 \\ 1.0097 & 2.3808 \\ 2.9761 & -0.8078 \end{bmatrix}.$$

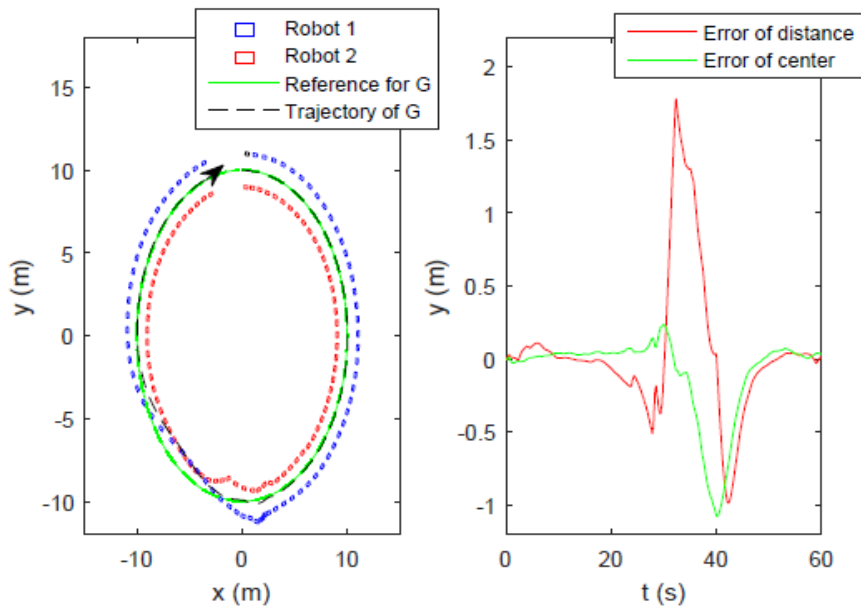

**Figure 6-3 Tracking performance without LQ performance**

For the simulation, a unit step signal is added to the position  $x_1$  of robot 1 as defined in (6-5) from time 30s to 42s to simulate disturbance factors. The initial positions of robot 1 and robot 2 are (0, 11) and (0, 9) respectively, and the two robots are asked to follow a circular trajectory with diameter 10m, an inter-distance of 2 meters and a fixed velocity 1m/s.

Based on  $F_2^{MS}$ ,  $U^{MS}$  and  $F_1^{MS}$ , Figure 6-3 shows the tracking performance and the evolution of the tracking error. As depicted in Figure 6-3, the set  $(F_2 = F_2^{MS}, U = U^{MS}, F_1 = F_1^{MS})$  can ensure an acceptable tracking performance. However, the two robots are decoupled due to the diagonal feedback gain  $F_2^{MS}$ . Therefore, when the robot 1 is affected by the disturbance from 30s to 42s, the robot 2 will not respond accordingly. Therefore, we can see in Figure 6-3 that both the center

error and the distance error have greatly increased. This problem will be solved in the next part by further considering the LQ performance.

### Tracking over lossy channels with LQ performance

In this part, Theorem 3-4 is adopted to solve the tracking problem for the cooperative robots and the LQ index is considered to improve the tracking performance. To this end, two different sets of parameters are defined for the cost functional (3-8) as

1. Case 1: more weights are given on center error as  $Q_1 = C^T \text{diag}[100,100,1,1]C$ ,  $R_1 = I$ . This indicates that we pay more attention to reduce the center error.
2. Case 2: more weights are given on distance error as  $Q_2 = C^T \text{diag}[1,1,100,100]C$ ,  $R_2 = I$ . In this case, we pay more attention to keep the distance between the robots.

For the same coding matrix  $U$  given as  $U^{LQ1} = U^{LQ2} = U^{MS}$ , the set  $(F_2^{LQ1}, U^{LQ1}, F_1^{LQ1})$  associated to weight matrices  $(Q_1, R_1)$  as well as the set  $(F_2^{LQ2}, U^{LQ2}, F_1^{LQ2})$  associated to weight matrices  $(Q_2, R_2)$  is obtained by solving Theorem 3-4

$$F_2^{LQ1} = \begin{bmatrix} -2.7396 & 0.0344 & -1.6725 & 0.0975 \\ -2.0847 & 0.1264 & -0.6345 & 0.1643 \\ 0.2188 & -3.1688 & -0.1692 & -1.2658 \\ 0.1356 & -2.4344 & 0.0313 & -0.6619 \\ -1.6302 & 0.0840 & -2.8591 & -0.2314 \\ -0.6324 & 0.0440 & -2.1721 & -0.1826 \\ 0.3509 & -2.1336 & -0.4160 & -1.6617 \\ 0.1770 & -0.7053 & -0.1918 & -1.3351 \end{bmatrix}^T, \quad F_1^{LQ1} = \begin{bmatrix} -2.7036 & 36.0047 \\ 53.7705 & -3.5574 \\ 8.2581 & 35.1215 \\ 28.7722 & -0.7348 \end{bmatrix},$$

$$F_2^{LQ2} = \begin{bmatrix} -1.8522 & -0.1214 & 1.2829 & 0.5351 \\ -1.6998 & -0.1218 & 0.6285 & 0.2763 \\ -0.2653 & -1.5930 & 0.3348 & 0.0889 \\ -0.1290 & -1.5037 & 0.1945 & 0.0404 \\ 1.2526 & 0.1468 & -1.9160 & -0.5503 \\ 0.6270 & 0.1852 & -1.7560 & -0.2897 \\ 0.3319 & 0.8771 & -0.3924 & -0.5732 \\ 0.2661 & 0.0798 & -0.2818 & -1.0543 \end{bmatrix}^T, \quad F_1^{LQ2} = \begin{bmatrix} 1.2361 & 7.2705 \\ 9.4861 & -1.2535 \\ 0.7370 & 2.4018 \\ 4.0478 & -1.4697 \end{bmatrix}.$$

For simulation, the same unit step signal as mentioned in the above simulation is added to the position  $x_1$  of robot 1 from time 30s to 42s. Figures 6-4 and 6-5 show the tracking performance and the evolution of the tracking error for simulation with  $(F_2^{LQ1}, U^{LQ1}, F_1^{LQ1})$  and  $(F_2^{LQ2}, U^{LQ2}, F_1^{LQ2})$ , respectively. Compared with Figure 6-3,

we can see in Figure 6-4 that the two robots cooperate to minimize the error between the center of robots and the reference trajectory. When the robot 1 is affected by the disturbance and moves outward, the robot 2 moves inward correspondingly to reduce the center error. Therefore, the center error in Figure 6-4 is relatively small and this is consistent with the parameters we selected in Case 1. On the contrary, we can see in Figure 6-5 that the two robots cooperate to minimize the distance error. When the robot 1 moves outward, the robot 2 moves outward correspondingly. It is consistent with the parameters we selected in Case 2. For both simulations, we can see that a better cooperation can be achieved by taking the LQ performance into consideration, and the impact of different weights can be clearly seen.

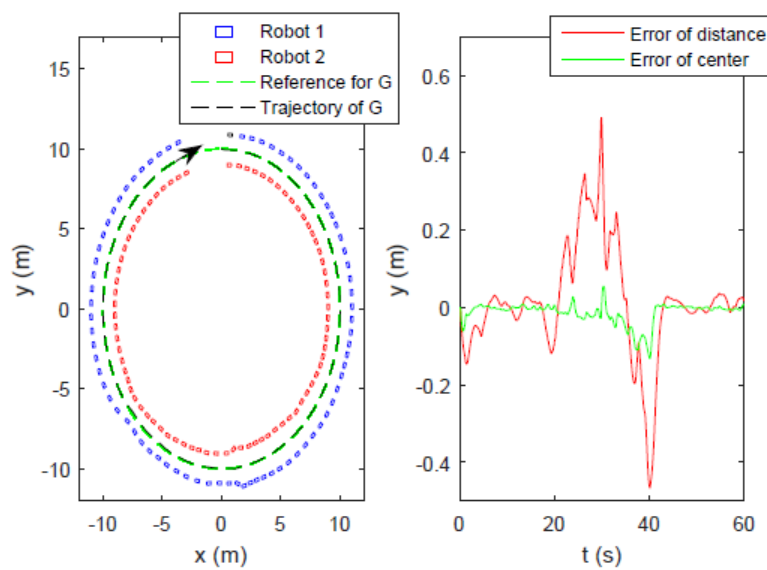

**Figure 6-4 Tracking performance with LQ performance to Case 1**

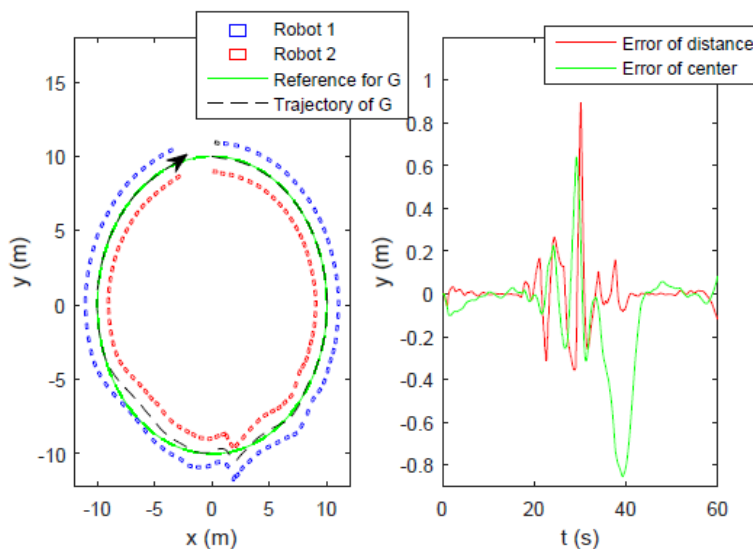

**Figure 6-5 Tracking performance with LQ performance to Case 2**

## Iterative solution

In the above simulations, the coding matrix  $U$  is given and fixed. This will inevitably affect the design of the controller. Next, we will further use the freedom of coding matrix to reduce the conservatism of the design. In this part, Algorithm 3-2 is applied to reduce the conservatism of the results obtained by Theorem 3-4. The less conservative solutions  $U^{I1}$  and  $U^{I2}$  are computed by the Algorithm 3-2. Then, by solving Theorem 3-4, sets  $(F_2^{I1}, U^{I1}, F_1^{I1})$  for Case1 and  $(F_2^{I2}, U^{I2}, F_1^{I2})$  for Case2 are obtained as

$$U^{I1} = \begin{bmatrix} -0.4756 & 0.3525 & -0.2949 & 0.7469 \\ -0.3994 & -0.5220 & -0.6550 & -0.2430 \\ -0.2469 & -0.6592 & 0.3571 & 0.2601 \\ -0.4012 & 0.3929 & -0.1263 & -0.5330 \\ -0.4326 & 0.1196 & 0.4352 & -0.0938 \\ -0.4530 & -0.0127 & 0.3887 & -0.1501 \end{bmatrix}^T,$$

$$U^{I2} = \begin{bmatrix} -0.3321 & 0.4088 & 0.7094 & -0.4485 \\ -0.3162 & -0.4452 & 0.5267 & 0.6500 \\ -0.3013 & 0.6568 & -0.1845 & 0.4510 \\ -0.4313 & -0.4338 & -0.1275 & -0.4144 \\ -0.5817 & 0.0651 & -0.2971 & -0.0319 \\ -0.4178 & -0.1044 & -0.2841 & 0.0116 \end{bmatrix}^T,$$

$$F_1^{I1} = \begin{bmatrix} -2.6140 & 42.3516 \\ 54.0542 & -2.9927 \\ 4.6939 & 42.3949 \\ 52.8992 & -5.9123 \end{bmatrix}^T, \quad F_1^{I2} = \begin{bmatrix} 0.6232 & 5.9630 \\ 9.3562 & -1.4436 \\ 0.8339 & 1.6239 \\ 2.6789 & -0.5191 \end{bmatrix}^T,$$

$$F_2^{I1} = \begin{bmatrix} -2.9862 & 0.0577 & -2.2707 & 0.3126 \\ -2.0796 & 0.0544 & -1.0517 & 0.2310 \\ 0.2290 & -3.2311 & -0.0816 & -2.1212 \\ 0.0630 & -2.3418 & -0.0654 & -0.8447 \\ -2.2135 & -0.0252 & -3.1356 & 0.0977 \\ -1.0488 & -0.0626 & -2.2072 & -0.0391 \\ 0.3696 & -2.0695 & -0.0726 & -3.3194 \\ 0.2338 & -0.8421 & -0.0476 & -2.3821 \end{bmatrix}^T,$$

$$F_2^{IT2} = \begin{bmatrix} -1.8739 & 0.0791 & 1.6055 & -0.0467 \\ -1.6072 & 0.0644 & 0.8574 & -0.0240 \\ 0.0890 & -2.0718 & -0.0244 & 1.4986 \\ 0.0649 & -1.8398 & 0.0015 & -0.7777 \\ 1.4554 & -0.0433 & -2.1979 & 0.0333 \\ 0.8499 & 0.0006 & -1.9238 & -0.0018 \\ -0.0667 & 1.4724 & 0.0247 & -2.1361 \\ -0.0250 & 0.7764 & 0.0022 & -1.9095 \end{bmatrix}^T.$$

**Table 6-1 Tracking errors of different strategies**

Strategy	$x^T(0)Px(0)$	Average error of center (m)	Average error of distance (m)
MS stabilization	-	1.9934	3.9880
Case 1 (with $U^{LQ1}$ )	65488	0.8344	2.0884
Case 1 (with $U^{IT1}$ )	42341	0.3014	1.8041
Case 2 (with $U^{LQ2}$ )	59172	1.4403	0.5545
Case 2 (with $U^{IT2}$ )	35277	1.1918	0.4323

With the sets  $(F_2^{IT1}, U^{IT1}, F_1^{IT1})$  and  $(F_2^{IT2}, U^{IT2}, F_1^{IT2})$  obtained above, the average tracking errors of one hundred sets of stochastic simulation are given in Table 6-1. It can be seen in Table 6-1 that compared with the given matrix  $U^{LQ1}$ , the iterative solution  $U^{IT1}$  by solving Algorithm 3-2 greatly reduces the center error by 63.9% and also reduces the distance error by 13.6%. And compared with the given matrix  $U^{LQ2}$ , the iterative solution  $U^{IT2}$  reduces the center error and distance error by 17.2% and 22%, respectively. Therefore, it is clear that Algorithm 3-2 can reduce the conservatism of the results by iterative computation of coding matrix  $U$ . It is observed from Table 6-1 that the controller synthesis and coding design (equivalently channel design) are of equal importance for such network-based systems.

In this section, the controller coding co-design method proposed in Chapter 3 is adopted and applied to the control system with two cooperative robots. According to the research results in Chapter 3, different control strategies are adopted for trajectory tracking control over lossy channels. Several simulations are thus given and the effectiveness of the co-design method proposed in Chapter 3 is further verified by these simulation results.



## 6.4 Robust filtering

In this section, the results proposed in Chapter 4 are applied to the control system with two cooperative robots to verify the effectiveness. For the two robots shown in Figure 6-1, a filter is required to be implemented on the supervisor. Differ from Section 6.3, it is assumed that the supervisor can only measure the position of the two robots and the filter is required to be designed to estimate the velocity of the robots' barycenter  $G$  as defined in (6-2).

### 6.4.1 Filtering strategy formulation

In order to resolve the problem mentioned above, the robust filtering method proposed in Chapter 4 is adopted. The plant in (4-1) is linked to the two robots' model (6-6) and the matrices  $A$  and  $B$  in (4-1) are given as the same in (6-6). The parameter matrices  $C_1$ ,  $C_2$  and  $D$  in (4-1) are given as

$$D = \begin{bmatrix} 1 & 0 & 0 & 0 \\ 0 & 0 & 1 & 0 \\ 0 & 1 & 0 & 0 \\ 0 & 0 & 0 & 1 \end{bmatrix}, \quad C_1 = \begin{bmatrix} 0.5 & 0 & 0 & 0 & 0.5 & 0 & 0 & 0 \\ 0 & 0 & 0.5 & 0 & 0 & 0 & 0.5 & 0 \\ 1 & 0 & 0 & 0 & -1 & 0 & 0 & 0 \\ 0 & 0 & 1 & 0 & 0 & 0 & -1 & 0 \end{bmatrix},$$

$$C_2 = \begin{bmatrix} 0 & 0.5 & 0 & 0 & 0 & 0.5 & 0 & 0 \\ 0 & 0 & 0 & 0.5 & 0 & 0 & 0 & 0.5 \end{bmatrix}.$$

With the parameters  $C_1$  given above, it is defined that the measurement output  $y(k)$  sent to the filter is given as the controlled output in (6-2). And according to  $C_2$  given above, the weighted state information  $z(k) = C_2 x(k)$  to be estimated is defined as the velocities of the robots' barycenter on  $x$  and  $y$  axle, respectively. The estimation error is further defined as  $z_e(k) = z(k) - \hat{z}(k)$ , where  $\hat{z}(k)$  is the estimated value for  $z(k)$  generated by the filter.

For the robust filtering problem considered, the bounded disturbance  $w(k)$  in (4-1) is given as

$$w(k) = 0.75 [\sin(0.01k) \quad \cos(0.01k) \quad \sin(0.01k) \quad \cos(0.01k)]^T. \quad (6-9)$$

In the simulation, four different channels are considered to transmit the output measurement  $y(k)$ . The data arrival rate of each channel is given as  $\bar{\alpha}_1 = 0.8$ ,  $\bar{\alpha}_2 = 0.9$ ,  $\bar{\alpha}_3 = 0.7$ ,  $\bar{\alpha}_4 = 0.6$ . The disturbance suppression rate of the error system is given as  $\gamma = 4$ . The filter gain  $L$  in form of (4-4) is calculated by solving MDARE (4-30) and is given by equation (4-32) with parameters

$$L = \begin{bmatrix} 0.0530 & 0.0825 & -0.0341 & -0.0005 & 0.1012 & 0.0761 & -0.0287 & -0.0023 \\ -0.0243 & -0.0024 & 0.1395 & 0.0876 & -0.0402 & -0.0188 & 0.1568 & 0.0829 \\ 0.0661 & 0.0676 & -0.0066 & -0.0063 & -0.1445 & -0.0842 & 0.0202 & -0.0037 \\ -0.0147 & -0.0003 & 0.1245 & 0.0724 & 0.0057 & -0.0014 & -0.1597 & -0.0840 \end{bmatrix}^T.$$

#### 6.4.2 Simulation results

The simulation results are shown in Figure 6-6 and Figure 6-7. In Figure 6-6,  $z_1(k)$ ,  $z_2(k)$  are the velocities of the robots' barycenter on  $x$  and  $y$  axle, respectively.  $\hat{z}_1(k)$ ,  $\hat{z}_2(k)$  are the estimated values for  $z_1(k)$  and  $z_2(k)$  generated by the filter. Figure 6-7 shows the estimation error. The results in Figure 6-6 and Figure 6-7 show the estimated values  $\hat{z}_1(k)$ ,  $\hat{z}_2(k)$  can track the values of  $z_1(k)$  and  $z_2(k)$ , and the filter can also achieve the given disturbance suppression rate.

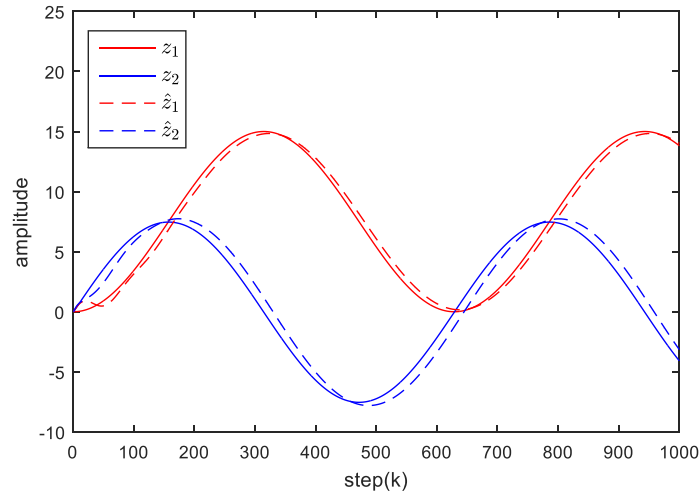

**Figure 6-6 Filtering performance**

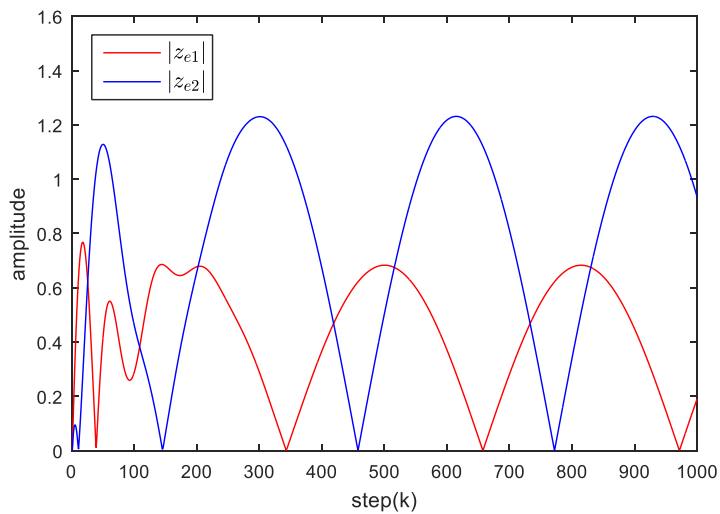

**Figure 6-7 Filtering error**

In this section, the robust filtering over lossy channels is considered and the filter design method proposed in Chapter 4 is adopted. The system with two robots is considered as the plant and the simulation is presented based on such system. The simulation results presented in Subsection 6.4.2 show the effectiveness of the robust filtering method proposed in Chapter 4.

## 6.5 Filter realization

In this section, the realization methods detailed in Chapter 5 are applied to the cooperative robots to verify the effectiveness. In this section, we focus on the realization of the given filter. Differ from Section 6.4, packet dropouts and  $H_\infty$  performance are not considered in this section. A new filter is given and required to be implemented with two subsystems, where one subsystem is embedded in each robot. To focus on the results proposed in Chapter 5, only the FWL effects and the internal communication delays between the subsystems are considered in this section.

### 6.5.1 Realization strategy formulation

Same as Sections 6.3 and 6.4, the two robots is regarded as the plant. For the plant, a filter with the standard model defined in (5-2) is proposed as

$$\hat{x}(k+1) = A\hat{x}(k) + Bu(k) + L[y(k) - C\hat{x}(k)]. \quad (6-11)$$

The matrices  $A$  and  $B$  in (6-11) are given as the same in (6-6) and  $y(k) = Cx(k)$  is the measurement from the two robots with

$$C = \begin{bmatrix} 0.5 & 0 & 0 & 0 & 0.5 & 0 & 0 & 0 \\ 0 & 0 & 0.5 & 0 & 0 & 0 & 0.5 & 0 \\ 1 & 0 & 0 & 0 & -1 & 0 & 0 & 0 \\ 0 & 0 & 1 & 0 & 0 & 0 & -1 & 0 \end{bmatrix}.$$

In this section, we focus on the realization problem for a given filter. Packet dropouts and  $H_\infty$  performance are not considered for the filter (6-11). In this case, the filter gain  $L$  in (6-11) is given as

$$L = \begin{bmatrix} -0.1374 & -0.0924 & 0.0295 & -0.0010 & -0.0626 & -0.0679 & 0.0646 & 0.0014 \\ 0.1392 & 0.2901 & -0.1695 & -0.0728 & 0.0664 & 0.0931 & -0.1337 & -0.0696 \\ -0.1666 & -0.1671 & 0.0352 & 0.1028 & 0.1307 & 0.0928 & -0.0238 & 0.0900 \\ 0.0353 & 0.0005 & -0.1371 & -0.1759 & -0.1370 & 0.0322 & 0.1556 & 0.0805 \end{bmatrix}^T,$$

such that (6-11) is stable when  $u(k) = 0$  and  $y(k) = 0$ .

For further implementation, the filter (6-11) is required to be partitioned into two subsystems and embedded in each robot. The matrices  $A$ ,  $C$ ,  $L$  in (6-11) are

therefore partitioned as

$$A_{cl} = \begin{bmatrix} A_{11} & A_{12} \\ A_{21} & A_{22} \end{bmatrix}, \quad C = \begin{bmatrix} C_{11} & C_{12} \\ C_{21} & C_{22} \end{bmatrix}, \quad L = \begin{bmatrix} L_{11} & L_{12} \\ L_{21} & L_{22} \end{bmatrix},$$

$$A_{11} \in \mathbb{R}^{4 \times 4}, \quad A_{12} \in \mathbb{R}^{4 \times 4}, \quad A_{21} \in \mathbb{R}^{4 \times 4}, \quad A_{22} \in \mathbb{R}^{4 \times 4}, \quad C_{11} \in \mathbb{R}^{2 \times 4}, \quad C_{12} \in \mathbb{R}^{2 \times 4},$$

$$C_{21} \in \mathbb{R}^{2 \times 4}, \quad C_{22} \in \mathbb{R}^{2 \times 4}, \quad L_{11} \in \mathbb{R}^{4 \times 2}, \quad L_{12} \in \mathbb{R}^{4 \times 2}, \quad L_{21} \in \mathbb{R}^{4 \times 2}, \quad L_{22} \in \mathbb{R}^{4 \times 2}.$$

It is assumed the time delay  $\tau_{12}T_{samp} = 0.1s$  and  $\tau_{21}T_{samp} = 0s$ , i.e., the time delay in the channel  $\bar{\mathcal{A}}_{12}$  is fixed as  $0.1s$  and there is no time delay in the channel  $\bar{\mathcal{A}}_{21}$ .

Omitting  $u(k)$  and  $y(k)$  in (6-11), a filter in form of (5-16) can be obtained as

$$\begin{cases} J_1 T_1(k+1) = M_{11} \hat{x}_1(k) + N_{11} z_1(k) + M_{12} \hat{x}_2(k - \tau_{12}) + N_{12} z_2(k), \\ \hat{x}_1(k+1) = K_1 T_1(k+1) + P_{11} \hat{x}_1(k) + P_{12} \hat{x}_2(k - \tau_{12}), \\ J_2 T_2(k+1) = M_{22} \hat{x}_2(k) + N_{22} z_2(k) + M_{21} \hat{x}_1(k) + N_{21} z_1(k), \\ \hat{x}_2(k+1) = K_2 T_2(k+1) + P_{22} \hat{x}_2(k) + P_{21} \hat{x}_1(k), \end{cases} \quad (6-12)$$

where

$$A_{ii} = K_i J_i^{-1} M_{ii} + P_{ii}, \quad A_{ij} = K_i J_i^{-1} M_{ij} + P_{ij},$$

$$L_{ii} = K_i J_i^{-1} N_{ii}, \quad L_{ij} = K_i J_i^{-1} N_{ij}, \quad i, j = 1, 2,$$

$$z_1(k) = C_{11} x_1(k) + C_{12} x_2(k-1), \quad z_2(k) = C_{22} x_2(k) + C_{21} x_1(k), \quad \hat{x}^T(k) = \begin{bmatrix} \hat{x}_1^T(k) & \hat{x}_2^T(k) \end{bmatrix},$$

$$\hat{x}_1^T(k) = \begin{bmatrix} \bar{x}_1(k) & \bar{x}_2(k) & \bar{x}_3(k) & \bar{x}_4(k) \end{bmatrix}, \quad \hat{x}_2^T(k) = \begin{bmatrix} \bar{x}_5(k) & \bar{x}_6(k) & \bar{x}_7(k) & \bar{x}_8(k) \end{bmatrix}.$$

In the simulation, (6-12) is supposed to be digital implemented with word length  $\beta$  for coefficients' representation. And two realization forms are considered respectively for (6-12):

1. **Realization 1:** (6-12) realized by the shift operator;
2. **Realization 2:** (6-12) realized by the  $\delta$ -operator with  $\Delta_\delta = 2^{-3}$ .

As mentioned above, the time delay for communication channel  $\bar{\mathcal{A}}_{12}$  is given as  $\tau_{12}T_{samp} = 0.1s$ . To describe this communication channel, the following state-space model in form of (5-17) are constructed for the channel  $\bar{\mathcal{A}}_{12}$  as

$$\begin{cases} \kappa_{12}(k+1) = \begin{bmatrix} 0 & 0 \\ I & 0 \end{bmatrix} \kappa_{12}(k) + \begin{bmatrix} I \\ 0 \end{bmatrix} \nu_{12}(k), \\ \eta_{12}(k) = \begin{bmatrix} 0 & I \end{bmatrix} \kappa_{12}(k). \end{cases}$$

### 6.5.2 Simulation results

With the channel model obtained, system (6-12) can be rewritten as the descriptor model in (5-22) respectively for Realization 1 and Realization 2 according to the method proposed in Subsection 5.5.2. By applying Algorithm 5-1, the minimum word

length  $\beta^*$  for stability is calculated for Realization 1, 2 and the results are shown in Table 6-2. According to Table 6-2, the filter implemented by  $\delta$ -operator with  $\Delta_\delta = 2^{-3}$  requires 3 bits at least for stability and the filter implemented with the shift operator requires at least 6 bits for stability. Therefore, Algorithm 5-1 proposed in Chapter 5 can be adopted for choosing an appropriate realization to reduce the minimum word length required for keeping the stability of the filter after implementation. Such result can lead to practical consequences. Considering the total word length to be manipulated, e.g. cheaper SOCs based on an 8 bits architecture with 4 bits for the fraction part could be used instead of 16 bits with 8 bits for the fraction part.

**Table 6-2 Minimum word length for stability**

Realizations	By shift operator	By $\delta$ -operator ( $\Delta_\delta = 2^{-3}$ )
Minimum word length	$\beta^* = 6$	$\beta^* = 3$

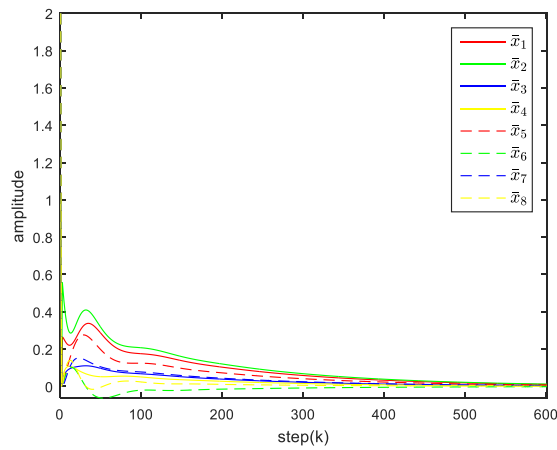

**Figure 6-8 State evolution of the filter realized by the  $\delta$ -operator with  $\beta=3$**

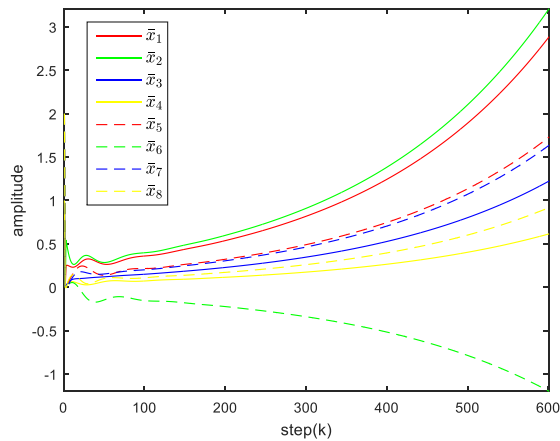

**Figure 6-9 State evolution of the filter realized by the shift operator with  $\beta=5$**

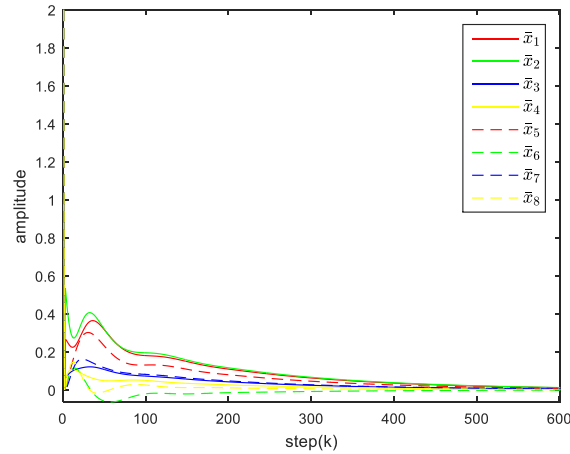

**Figure 6-10 State evolution of the filter realized by the shift operator with  $\beta=6$**

Then, several simulations are given to estimate the stability of (6-12) realized by Realization 1 and Realization 2, respectively. With the same initial states  $\hat{x}_1(0)=[1 \ 1 \ 1 \ 1]^T$ ,  $\hat{x}_2(0)=[2 \ 2 \ 2 \ 2]^T$  for system (6-12), the evolution of the filter states are depicted in Figure 6-8, Figure 6-9 and Figure 6-10. In Figure 6-8, it can be seen that (6-12) realized by the  $\delta$ -operator can remain stable subject to coefficients' representation with bit length  $\beta=3$ . As shown in Figure 6-9 and Figure 6-10, the stability of the system (6-12) realized by the shift operator can only be ensured at least with  $\beta=6$ . The simulation results verify the effectiveness of the proposed realization method and also show that the  $\delta$ -operator has better FWL properties with coefficients representation compared with the shift operator.

In this section, the realization method proposed in Chapter 5 is applied to the cooperative robots to verify the effectiveness. The shift operator and the  $\delta$ -operator are adopted to represent the filter, respectively. The corresponding simulations are given and the results show the effectiveness of the results given in Chapter 5.

## 6.6 Conclusion

In this chapter, a system with two robots is introduced. And based on this system, several illustrative simulations are given to show the detail process of applying the methods proposed in Chapter 3, Chapter 4 and Chapter 5. For this system, a tracking control scheme is first adopted by applying the design method proposed in Chapter 3. The robust filtering method proposed in Chapter 4 is then adopted to estimate the velocity of the robots' barycenter. Moreover, a filter is implemented and embedded in each robot to show the effectiveness of the results proposed in Chapter 5.

## Chapter 7 Summary

### 7.1 Concluding remarks

This thesis focuses on several difficult problems concerning NCSs. Several methodological contributions for analysis and synthesis of NCSs are proposed to provide solutions to some of them.

1) A controller-coding co-design approach is adopted in Chapter 3 to solve the stochastic LQ control problem under asymptotic tracking for discrete-time systems over multiple lossy channels. A stabilizability condition for the state feedback gain is first derived in the MS sense that reveals the fundamental limitations among the  $H_2$  norm of the plant, data arrival rates and coding matrices. Then, a MDARE-based solvability condition is conducted to handle the additional stochastic LQ control objective. Relied on such design, the asymptotic tracking constraint is further fulfilled. The Sylvester equation and the feedforward gain related to tracking are parameterized.

2) In Chapter 4, the robust filtering problem is considered over multiple lossy channels. The adjoint operator is introduced to analyze the MS stability and  $H_\infty$  performance of the error system. Then, a MDARE-based solution is proposed for solving the  $H_\infty$  filtering problem and the design method for the corresponding filter is also proposed. The necessary and sufficient conditions are further deduced for the existence of the filter and the relationships between MS stability of error system and channel parameters are derived.

3) The realization problem for networked-based systems is considered in Chapter 5, where the coefficients of controllers/filters are affected by the FWL effects. At the same time, the time delays caused by the information exchange within the system also affect the overall performance. To solve these problems, a descriptor model is first constructed to describe the internal time delays and the equivalent realizations in a unifying framework. A stability analysis condition for the controller and filter is obtained. Based on this, an algorithm is further proposed to find the optimal realization requiring the minimum word length for stabilization.

### 7.2 Future research directions

The analysis and synthesis problem for systems subject to network-induced factors has always been a hot topic. Aiming at several difficulties in it, this thesis presents a series

of solutions. However, there are still some problems deserved further consideration.

1) The descriptor model is an effective tool for system analysis and synthesis. And it is adopted in Chapter 5 to deal with the realization problem subject to FWL effects and fixed time delays. What worth further consideration is considering and analyzing more performance indexes of NCSs in such descriptor model-based framework. It is also a follow-up study to apply this framework to analyze systems with network-induced factors such as packet dropouts and time-varying delays.

2) It is worth noting that only stability is considered in the realization problem in Chapter 5. More specifically, additional performance of the closed-loop system or the error system such as tracking performance and disturbance suppression performance are not considered. Therefore, it is worth further researching the co-design of synthesis and realization to meet more system performance constraints.

3) Different from the traditional system, the most important feature of NCSs is the introduction of networks in it. Therefore, how to analyze the impact of network-induced factors on system performance is an important research objective. In Chapters 3 and 4, some preliminary results are proposed to show the relationships between the MS stability of the system and the data arrival rates of the channels. In the follow-up studies, more relationships between the performance of system and the network parameters are required to be further established.

4) Security for NCSs is another important topic which attracts extensive attention. Common network attacks such as denial of service, address resolution protocol spoofing can affect the transmission of the signals in NCSs. And unlike traditional channel constraints, network attacks usually have certain intelligence. Thus, the effectiveness of the networked control strategy cannot be guaranteed under network attacks and it is a challenging research direction to design control strategy for NCSs, which is resilient to network attacks.



## Reference

- [1] G. C. Walsh, H. Ye, L. G. Bushnell. Stability analysis of networked control systems. American Control Conference, 1999: 2876-2880.
- [2] W. Zhang, M. S. Branicky, S. M. Phillips. Stability of networked control systems. IEEE Control Systems Magazine, 21(1): 84-99, 2001.
- [3] G. C. Walsh, H. Ye, L. G. Bushnell. Stability analysis of networked control systems. IEEE Transactions on Control Systems Technology, 10(3): 438-446, 2002.
- [4] J. Baillieul, P. J. Antsaklis. Control and communication challenges in networked real-time systems. Proceedings of the IEEE, 95(1): 9-28, 2007.
- [5] L. X. Zhang, H. J. Gao, O. Kaynak. Network-induced constraints in networked control systems-a survey. IEEE Transactions on Industrial Informatics, 9(1): 403-416, 2013.
- [6] L. D. Xu, W. He, S. C. Li. Internet of things in industries: a survey. IEEE Transactions on Industrial Informatics, 10(4): 2233-2243, 2014.
- [7] W. Yao, L. Jiang, J. Y. Wen, Q. H. Wu, S. J. Cheng. Wide-area damping controller for power system interarea oscillations: a networked predictive control approach. IEEE Transactions on Control Systems Technology, 23(1): 27-36, 2015.
- [8] M. Li, Y. Chen. A wide-area dynamic damping controller based on robust  $H_\infty$  control for wide-area power systems with random delay and packet dropout. IEEE Transactions on Power Systems, 33(4): 4026-4037, 2018.
- [9] Y. H. Li, L. M. Yang, G. L. Yang. Network-based coordinated motion control of large-scale transportation vehicles. IEEE/ASME Transactions on Mechatronics, 12(2): 208-215, 2007.
- [10] X. Chen, F. Hao, B. L. Ma. Periodic event-triggered cooperative control of multiple non-holonomic wheeled mobile robots. IET Control Theory and Applications, 11(6): 890-899, 2017.
- [11] D. Zhang, G. Li, K. Zheng, X. Ming, Z. H. Pan. An energy-balanced routing method based on forward-aware factor for wireless sensor networks. IEEE Transactions on Industrial Informatics, 10(1): 766-773, 2014.
- [12] D. R. Ding, Z. D. Wang, B. Shen, H. L. Dong. Event-triggered distributed H-infinity state estimation with packet dropouts through sensor networks. IET Control Theory and Applications, 9(13): 1948-1955, 2015.
- [13] H. Y. Wu, L. Lou, C. C. Chen, S. Hirche, K. Kuhnlenz. Cloud-based networked visual servo control. IEEE Transactions on Industrial Electronics, 60(2): 554-566, 2013.
- [14] Y. Q. Xia. Cloud control systems. IEEE/CAA Journal of Automatica Sinica, 2(2): 134-142, 2015.
- [15] B. Sinopoli, L. Schenato, M. Franceschetti, K. Poolla, M. Jordan, S. Sastry. Kalman filtering with intermittent observations. IEEE Transactions on Automatic Control, 49(9):1453-1464, 2004.
- [16] J. Wu, T. W. Chen. Design of networked control systems with packet dropouts. IEEE Transactions on Automatic Control, 52(7): 1314-1319, 2007.
- [17] E. Fridman, U. Shaked. Delay-dependent stability and H-infinity control: constant and time-varying delays. International Journal of Control, 76(1): 48-60, 2003.
- [18] J. P. Richard. Time-delay systems: an overview of some recent advances and open problems. Automatica, 39(10): 1667-1694, 2003.
- [19] G. J. Foschini, M. J. Gans. On limits of wireless communications in a fading environment when using multiple antennas. Wireless Personal Communications, 6(3): 311-335, 1998.
- [20] G. Nair, R. Evans. Stabilizability of stochastic linear systems with finite feedback data rate. SIAM Journal on Control and Optimization, 43(2): 413-436, 2004.
- [21] N. Elia, S. K. Mitter. Stabilization of linear systems with limited information. IEEE Transactions on Automatic Control, 46(9): 1384-1400, 2001.
- [22] S. L. Hu, D. Yue. Event-triggered control design of linear networked systems with

- quantizations. *ISA Transactions*, 51(1): 153-162, 2012.
- [23] D. Liberzon. Hybrid feedback stabilization of systems with quantized signals. *Automatica*, 39(9): 1543-1554, 2003.
- [24] B. Widrow, I. Kollar, M. C. Liu. Statistical theory of quantization, *IEEE Transactions on Instrumentation and Measurement*, 45(2): 353-361, 1996.
- [25] M. Y. Fu, L. H. Xie. The sector bound approach to quantized feedback control. *IEEE Transactions on Automatic Control*, 50(11): 1698-1711, 2005.
- [26] H. Haimovich, M. M. Seron. On infimum quantization density for multiple-input systems. *IEEE Conference on Decision and Control*, 2005: 7692-7697.
- [27] H. Gao, T. Chen. A new approach to quantized feedback control systems. *Automatica*, 44(2): 534-542, 2008.
- [28] R. W. Brockett, D. Liberzon. Quantized feedback stabilization of linear systems. *IEEE Transactions on Automatic Control*, 45(7): 1279-1289, 2000.
- [29] A. J. Rojas, F. Lotero. Signal-to-noise ratio limited output feedback control subject to channel input quantization. *IEEE Transactions on Automatic Control*, 60(2): 475-479, 2015.
- [30] J. X. Hao, G. Li. An efficient controller structure with minimum roundoff noise gain. *Automatica*, 43(5): 921-927, 2007.
- [31] T. Hilaire, P. Chevrel, J. F. Whidborne. Finite wordlength controller realisations using the specialised implicit form. *International Journal of Control*, 83(2): 330-346, 2010.
- [32] K. J. Astrom, B. Wittrnmark. *Computer controlled systems: theory and design*. New Jersey: Prentice-Hall, 1997.
- [33] B. Luck, A. Ray. An observer-based compensator for distributed delays. *Automatica*, 26(5): 903-908, 1990.
- [34] L. W. Liou, A. Ray. A stochastic regulator for integrated communication and control systems: part I-formulation of control law. *ASME Journal of Dynamic Systems, Measurement and Control*, 113(4): 604-611, 1991.
- [35] E. T. Jeung, D. C. Oh, J. H. Kim, H. B. Park. Robust controller design for uncertain systems with time delays: LMI approach. *Automatica*, 32(8): 1229-1311, 1996.
- [36] S. S. Hu, Q. X. Zhu. Stochastic optimal control and analysis of stability of networked control systems with long delay. *Automatica*, 39(11): 1877-1884, 2003.
- [37] H. J. Gao, T. W. Chen, J. Lam. A new delay system approach to network-based control. *Automatica*, 44(1): 39-52, 2008.
- [38] J. H. Braslavsky, R. H. Middleton, J. S. Freudenberg. Feedback stabilization over signal-to-noise ratio constrained channels. *IEEE Transactions on Automatic Control*, 52(8): 1391-1403, 2007.
- [39] J. S. Freudenberg, R. H. Middleton, V. Solo. Stabilization and disturbance attenuation over a Gaussian communication channel. *IEEE Transactions on Automatic Control*, 55(3): 795-799, 2010.
- [40] J. S. Freudenberg, R. H. Middleton, J. H. Braslavsky. Minimum variance control over a Gaussian communication channel. *IEEE Transactions on Automatic Control*, 56(11): 1751-1765, 2011.
- [41] Y. Li, E. Tuncel, J. Chen, W. Su. Optimal tracking performance of discrete-time systems over an additive white noise channel. *IEEE Conference on Decision and Control*, 2009: 2070-2075.
- [42] F. J. Vargas, E. I. Silva, J. Chen. Stabilization of two-input two-output systems over SNR-constrained channels. *Automatica*, 49(10): 3133-3140, 2013.
- [43] N. Elia. Remote stabilization over fading channels. *Systems and Control Letters*, 54(3): 237-249, 2005.
- [44] N. Xiao, L. H. Xie, L. Qiu. Feedback stabilization of discrete-time networked systems over fading channels. *IEEE Transactions on Automatic Control*, 57(9): 2176-2189, 2012.
- [45] J. F. Wu, G. D. Shi, B. D. O. Anderson, K. H. Johansson. Kalman filtering over fading channels: zero-one laws and almost sure stabilities. *IEEE Transactions on Information Theory*, 64(10): 6731-6742, 2018.
- [46] C. B. Wen, Z. D. Wang, Q. Y. Liu, F. E. Alsaadi. Recursive distributed filtering for a class of state-saturated systems with fading measurements and quantization effects. *IEEE Transactions on Systems, Man, and Cybernetics: Systems*, 48(6): 930-941, 2018.

- [47] J. L. Xiong, J. Lam. Stabilization of linear systems over networks with bounded packet loss. *Automatica*, 43(1): 80-87, 2007.
- [48] L. Zhang, D. Hristu-Varsakelis. Communication and control codesign for networked control systems. *Automatica*, 2006, 42(6): 953-958.
- [49] A. Ray, Y. Halevi. Integrated communication and control systems: part II-Design considerations. *ASME Journal of Dynamic Systems, Measurement and Control*, 110(4): 374-381, 1988.
- [50] G. P. Liu. Predictive controller design of networked systems with communication delays and data loss. *IEEE Transactions on Circuits and Systems II*, 57(6): 481-485, 2010.
- [51] O. C. Imer, S. Yüksel, T. Başar. Optimal control of LTI systems over unreliable communication links. *Automatica*, 42(9): 1429-1439, 2006.
- [52] V. Gupta, N. C. Martins. On stability in the presence of analog erasure channel between the controller and the actuator. *IEEE Transactions on Automatic Control*, 55(1): 175-179, 2010.
- [53] Y. Feng, X. Chen, G. X. Gu. Observer-based stabilizing controllers for discrete-time systems with quantized signal and multiplicative random noise. *SIAM Journal on Control and Optimization*, 54(1): 251-265, 2016.
- [54] Y. Feng, X. Chen, G. X. Gu. Output feedback stabilization for discrete-time systems under limited communication. *IEEE Transactions on Automatic Control*, 62(4): 1927-1932, 2017.
- [55] J. Wu, T. W. Chen. Design of networked control systems with packet dropout. *IEEE Transactions on Automatic Control*, 52(7): 1314-1319, 2007.
- [56] B. Rainer, A. Frank, Towards networked control systems with guaranteed stability: using weakly hard real-time constraints to model the loss process, *IEEE Conference on Decision and Control*, 2015: 7510-7515.
- [57] W. A. Zhang, L. Yu. Output feedback stabilization of networked control systems with packet dropouts. *IEEE Transactions on Automatic Control*, 52(9): 1705-1710, 2007.
- [58] W. A. Zhang, L. Yu. Modelling and control of networked control systems with both network-induced delay and packet-dropout. *Automatica*, 44(12): 3206-3210, 2008.
- [59] X. F. Wang, M. D. Lemmon. Event-triggering in distributed networked control systems, *IEEE Transactions on Automatic Control*, 56(3): 586-601, 2011.
- [60] H. B. Li, Z. Q. Sun, M. Y. Chow. Predictive observer-based control for networked control systems with network-induced delay and packet dropout. *Asian Journal of Control*, 10(6): 638-650, 2008.
- [61] D. Georgiev, D. M. Tibury. Packet-based control: the  $H_2$ -optimal solution. *Automatica*, 42(1): 137-144, 2006
- [62] Y. Liang, T. W. Chen, Q. Pan. Optimal linear state filter with multiple packet dropouts. *IEEE Transactions on Automatic Control*, 55(6): 1428-1433, 2010.
- [63] M. Moayedi, Y. K. Foo, Y. C. Soh. Adaptive Kalman filtering in networked systems with random sensor delays, multiple packet dropouts and missing measurements. *IEEE Transactions on Signal Processing*, 58(3): 1577-1588, 2010.
- [64] X. He, Z. D. Wang, X. F. Wang, D. H. Zhou. Networked strong tracking filtering with multiple packet dropouts: algorithms and applications. *IEEE Transactions on Industrial Electronics*, 61(3): 1454-1463, 2014.
- [65] H. L. Dong, Z. D. Wang, H. J. Gao. Distributed filtering for a class of time-varying systems over sensor networks with quantization errors and successive packet dropouts. *IEEE Transactions on Signal Processing*, 60(6): 3164-3173, 2012.
- [66] P. Ray, P. K. Varshney. Estimation of spatially distributed processes in wireless sensor networks with random packet loss. *IEEE Transactions on Wireless Communications*, 8(6): 3162-3171, 2009.
- [67] W. B. Zhang, Y. Tang, T. W. Huang, J. Kurths. Sampled-data consensus of linear multi-agent systems with packet losses. *IEEE Transactions on Neural Networks and Learning Systems*, 28(11): 2516-2527, 2017.
- [68] E. Garcia, Y. C. Cao, D. W. Casbeer. Decentralised event-triggered consensus of double integrator multi-agent systems with packet losses and communication delays. *IET Control Theory and Applications*, 10(15): 1835-1843, 2016.
- [69] N. Bof, R. Carli, G. Notarstefano. Multiagent newton-raphson optimization over lossy

- networks. *IEEE Transactions on Automatic Control*, 64(7): 2983-2990, 2019.
- [70] Z. D. Wang, F. W. Yang. Robust  $H_\infty$  control for networked systems with random packet losses. *IEEE Transactions on Systems, Man, and Cybernetics: Cybernetics*, 37(4): 916-924, 2007.
- [71] Y. Zhang, Y. P. Tian. Consensus of data-sampled multi-agent systems with random communication delay and packet loss. *IEEE Transactions on Automatic Control*, 55(4): 939-943, 2010.
- [72] R. Rakkiyappan, N. Sakthivel, J. D. Cao. Stochastic sampled-data control for synchronization of complex dynamical networks with control packet loss and additive time-varying delays. *Neural Networks*, 66: 46-63, 2015.
- [73] S. L. Sun, G. H. Wang. Modeling and estimation for networked systems with multiple random transmission delays and packet losses. *Systems and Control Letters*, 73: 6-16, 2014.
- [74] D. Lehmann, J. Lunze. Event-based control with communication delays and packet losses. *International Journal of Control*, 85(5): 563-577, 2012.
- [75] E. J. Davison. The robust control of a servomechanism problem for linear time-invariant multivariable systems. *IEEE Transactions on Automatic Control*, 21(1): 25-34, 1976.
- [76] B. A. Francis, W. M. Wonham. The internal model principle of control theory. *Automatica*, 12(5): 457-465, 1976.
- [77] J. Huang. *Nonlinear output regulation: theory and applications*, Philadelphia: Society for Industrial and Applied Mathematics, 2004.
- [78] C. I. Byrnes, I. G. Lauko, D. S. Gilliam, V. I. Shubov. Output regulation for linear distributed parameter systems. *International Journal of Control*, 45(12): 2236-2252, 2000.
- [79] M. Lu, J. Huang. Robust output regulation problem for linear time delay systems. *International Journal of Control*, 88(6): 1236-1245, 2015.
- [80] Y. F. Su, J. Huang. Cooperative output regulation with application to multi-agent consensus under switching network. *IEEE Transactions on Systems, Man, and Cybernetics*, 42(3): 864-875, 2012.
- [81] Y. Feng, M. Yagoubi. Comprehensive admissibility for descriptor systems. *Automatica*, 66(C): 271-275, 2016.
- [82] B. D. O. Anderson, J. B. Moore. *Linear optimal control*. New Jersey: Prentice-Hall, 1971.
- [83] Q. Q. Liu, F. Jin. LQG control of networked control systems with limited information. *Mathematical Problems in Engineering*, 206391: 1-12, 2014.
- [84] H. X. Wang, H. S. Zhang. LQ control for Ito-type stochastic systems with input delays. *Automatica*, 49(12): 3538-3549, 2013.
- [85] Q. Zhang, G. Yin. On nearly optimal controls of hybrid LQG problems. *IEEE Transactions on Automatic Control*, 44(12): 2271-2282, 1999.
- [86] L. Schenato. To zero or to hold control inputs with lossy links?. *IEEE Transactions on Automatic Control*, 54(5): 1093-1099, 2009.
- [87] V. Gupta, B. Hassibi, R. M. Murray. Optimal LQG control across packet dropping links. *Systems and Control Letters*, 56(6): 439-446, 2007.
- [88] M. Gevers, G. Li, G. Parametrizations in control, estimation and filtering problems. London: Springer, 1993.
- [89] G. Li, Z. Zhao. On the generalized DFLLT structure and its state-space realization in digital filter implementation. *IEEE Transactions on Circuits and Systems*, 51(1): 769-778, 2004.
- [90] J. Wu, S. Chen, J. F. Whidborne, J. Chu. A unified closed-loop stability measure for finite-precision digital controller realizations implemented in different representation schemes. *IEEE Transactions on Automatic Control*, 48(5): 921-927, 2003.
- [91] T. Hilaire, P. Chevrel, J. F. Whidborne. A unifying framework for finite wordlength realizations. *IEEE Transactions on Circuits and Systems*, 54(8): 1765-1774, 2007.
- [92] Y. Feng, P. Chevrel, T. Hilaire. Generalised modal realisation as a practical and efficient tool for FWL implementation. *International Journal of Control*, 84(1): 66-77, 2011.
- [93] F. Claveau, P. Chevrel. Modeling and analysis of networked control algorithms using descriptor models. *International Conference on System Theory, Control and Computing*, 2013: 131-138.
- [94] H. Xu, K. Mizukami. Linear-quadratic zero-sum differential games for generalized state space systems. *IEEE Transactions on Automatic Control*, 39(1): 143-147, 1994.

- [95] T. Iwasaki, G. Shibata. LPV system analysis via quadratic separator for uncertain implicit systems. *IEEE Transactions on Automatic Control*, 46(8): 1195-1208, 2001.
- [96] D. G. Luenberger, A. Arbel. Singular dynamic Leontief systems. *Econometrica*, 45(4): 991-995, 1977.
- [97] L. Dai. *Singular control systems*. Berlin: Springer, 1989.
- [98] Y. Feng, M. Yagoubi. *Robust control of linear descriptor systems*. Singapore: Springer, 2017.
- [99] K. Zhou, J. Doyle, K. Glover. *Robust and Optimal Control*. New Jersey: Prentice Hall, 1996.
- [100] T. Chen, B. A. Francis. *Optimal sampled-data control systems*. Berlin: Springer, 1996.
- [101] S. Xu, J. Lam. *Robust control and filtering of singular systems*. New York: Springer, 2006.
- [102] S. Boyd, L. E. Ghaoui, E. Feron, V. Balakrishnan. *Linear matrix inequalities in systems and control theory*. Philadelphia: SIAM, 1994.
- [103] D. S. Bernstein. *Matrix mathematics: Theory, facts, and formulas with application to linear systems theory*. Princeton: Princeton University Press, 2005.
- [104] P. Gahinet, P. Apkarian. A linear matrix inequality approach to  $H_\infty$  control. *International Journal of Robust and Nonlinear Control*, 4(4): 421-448, 1994.
- [105] P. P. Khargonekar, I. R. Petersen, K. Zhou. Robust stabilization of uncertain linear systems: quadratic stabilizability and  $H_\infty$  control theory. *IEEE Transactions on Automatic Control*, 35(3): 356-361 1990.
- [106] L. Qiu, G. X. Gu, W. Chen. Stabilization of networked multi-input systems with channel resource allocation. *IEEE Transactions on Automatic Control*, 58(3): 59-63, 2013.
- [107] K. Tsumura, H. Ishii, H. Hoshina. Tradeoffs between quantization and packet loss in networked control of linear systems. *Automatica*, 45(12): 2963-2970, 2009.
- [108] A. A. Stoorvogel, A. Saberi, P. Sannuti. Performance with regulation constraints. *Automatica*, 36(10): 1443-1456, 2000.
- [109] A. A. Stoorvogel, A. Saberi, P. Sannuti. *Control of linear systems with regulation and input constraints*. London: Springer, 2000.
- [110] S. M. Rump. Optimal scaling for p-norms and componentwise distance to singularity. *IMA Journal of Numerical Analysis*, 23(1): 1-9, 2003.
- [111] C. Scherer, P. Gahinet, M. Chilali. Multiobjective output-feedback control via LMI optimization. *IEEE Transactions on Automatic Control*, 42(7): 896-911, 1997.
- [112] J. M. Zhou, G. X. Gu, X. Chen. Distributed Kalman filtering over wireless sensor networks in the presence of data packet drops. *IEEE Transactions on Automatic Control*, 64(4): 1603-1610, 2019.
- [113] C. E. De Souza, L. H. Xie. On the discrete-time bounded real lemma with application in the characterization of static state feedback  $H_\infty$  controllers. *Systems and Control Letters*, 18(1): 61-71, 1992.
- [114] Y. Feng, X. H. Nie, X. Chen. Robust optimal filtering over lossy networks. *IEEE Transactions on Automatic Control*, 65(5): 2272-2277, 2020.
- [115] W. M. Wonham. On pole assignment in multi-input controllable linear systems. *IEEE Transactions on Automatic Control*, 12(12): 660-665, 1967.
- [116] A. V. Oppenheim, R. W. Schaffer. *Discrete-time signal processing*. New Jersey: Prentice-Hall, 2009.
- [117] T. Hilaire, P. Chevrel, Y. Trinquet. Implicit state-space representation: a unifying framework for FWL implementation of LTI systems. *IFAC World Congress*, 2005: 285-290.
- [118] C. Desoer, M. Vidyasagar. *Feedback systems: input-output properties*. New York: Academic Press, 1975.
- [119] G. Conte, C. H. Moog, A. M. Perdon. *Algebraic methods for nonlinear control system*. London: Springer, 2007.

## Acknowledgements

The completion of this thesis is attributed to the support and encouragement from many people. Therefore, I would like to extend my deep gratitude to all those who have offered me practical, cordial and selfless support in writing this thesis.

Firstly, I am extremely grateful to my supervisors, Prof. Philippe CHEVREL, Dr. Fabien CLAVEAU, Prof. Wen-an ZHANG and Prof. Yu FENG. They gave me great help by providing me with necessary materials, advices of great value and inspiration of new ideas. It is their suggestions that draw my attention to several deficiencies and make many things clearer. Without their strong support, this thesis could not be the present form.

Secondly, my heartfelt thanks go to the reviewers of my thesis, for their help in making the quality of the thesis much higher. And, I am also pleased to acknowledge all the members in my thesis defense committee, including Prof. James WHIDBORNE, Prof. Zhengguang WU, Prof. Christophe AUBRUN and Dr. Thibault HILAIRE. They graciously make considerable comments and sound suggestions to the final revision of this thesis.

Thirdly, I would like to express my gratitude to my family for their support. Their understanding and support are of great help for me to finish this thesis successfully.

Finally, I am much obliged to all teachers who ever taught me during the years of my Ph.D. studies and I would like to express my gratitude to all those who helped me during my pursuing the Ph.D. degree. Most of all, I would like to thank Zhejiang University of Technology and IMT Atlantique for providing me the opportunity for further study.

# Introduction to the Ph.D. Candidate

## 1 Brief Introduction

February 1989, born in Shaoxing, Zhejiang Province.

September 2012—July 2015, received the M.S. degree in control science and engineering from Zhejiang University of Technology, Hangzhou, China.

September 2015—Now, pursuing the jointed Ph.D. degree in control science and engineering at IMT Atlantique, Nantes, France and Zhejiang University of Technology, Hangzhou, China.

## 2 Papers published

- [1] **R. Y. Ling**, Y. Feng, F. Claveau, P. Chevrel. Design and realizations of networked filters: a descriptor model approach. *IEEE Access*, 8: 156394-156407, 2020.
- [2] **R. Y. Ling**, Y. Feng, F. Claveau, P. Chevrel. Stochastic LQ control under asymptotic tracking for discrete systems over multiple lossy channels. *IET Control Theory and Applications*, 13(18): 3107-3116, 2019.
- [3] **R. Y. Ling**, Y. Feng. Discrete-time robust filtering with limited information, *Journal of Chinese Computer Systems*, Accepted. (Written in Chinese)
- [4] **R. Y. Ling**, F. Claveau, Y. Feng, P. Chevrel. Output regulation of multi-input systems under packet dropout with application to trajectory tracking of cooperative robots, *European Control Conference*, 2018: 1938-1944.

## 3 Projects participated

- [1] Natural Science Foundation of China under Grant 61973276
- [2] Zhejiang Provincial Natural Science Foundation of China for Distinguished Young Scholars under Grant LR17F030003

## 4 Patents for inventions

- [1] Y. Feng, **R. Y. Ling**, Y. J. Guo, W. A. Zhang, Y. Y. Huang. A master-slave formation control method for wheeled mobile robots based on the integral sliding mode algorithm. China, ZL201610041201.5[P]. 2018-03-02.
- [2] Y. Feng, **R. Y. Ling**, D. Zhang, W. A. Zhang, Y. Y. Huang. A distributed control method for the multiple-stage stirred reactor. China, ZL201511008202.1[P]. 2018-02-13.

---

**Titre:** Synthèse de Lois de Commande Résilientes vis-à-vis de l'Implémentation par Réseau

**Mots clés:** Commande par Réseau, Commande Robuste, Méthodologie de Co-conception, Commande LQ Stochastique, Filtre  $H_\infty$ , Forme Descripteur

**Résumé:** Cette thèse apporte des contributions méthodologiques pour l'analyse et la synthèse systématiques de lois de commande implémentée par réseau, confrontées à plusieurs dégradations induites comme les pertes de paquets, les retards ou bien encore les effets de quantification. Plus précisément, les problématiques suivantes sont abordées : 1) sur la base d'un critère LQ stochastique, le problème de suivi de trajectoire pour un système discret multivariable, piloté via un réseau avec pertes de paquets est d'abord considéré. Une solution de co-conception régulateur-codeur/décodateur est proposée, permettant d'exploiter au mieux les capacités du réseau ; 2) le problème de filtrage robuste implémenté aussi sur un réseau avec pertes de paquets est ensuite traité. Une solution à base d'opérateur adjoint est proposée pour résoudre le problème

de filtrage  $H_\infty$ , faisant appel à la résolution d'une équation de Riccati discrète modifiée; 3) se focalisant ensuite sur la problématique des estimateurs implémentés de manière distribuée, une méthodologie permettant en une fois de les concevoir et de choisir la réalisation la plus résiliente est ensuite présentée. Cette méthodologie tire profit d'une forme d'état descripteur spécifique, permettant de décrire et analyser les réalisations équivalentes, en explicitant notamment les retards internes et l'impact des phénomènes de quantification. Afin de valider ces différents outils méthodologiques, un exemple basé sur deux robots mobiles coopératifs est introduit. Cet exemple, traité simulation, permet de confronter ces développements méthodologiques sur un problème concret et réaliste.

---

**Title:** Design of Resilient Networked Control Systems

**Keywords:** Networked Control System, Robust Control, Co-design Methodology, Stochastic LQ Control,  $H_\infty$  Filtering, Descriptor Model

**Abstract:** This thesis presents several methodological contributions for the analysis and synthesis of networked control systems subjected to multiple network-induced factors, such as packet dropouts, time delays, finite word length effects. Specifically, the following researches are considered in the thesis: 1) the stochastic LQ control under asymptotic tracking is considered for multiple-input-multiple-output discrete-time system over lossy channels, where the controller-coding co-design approach is adopted to take full advantage of the network resources; 2) the robust filtering problem is considered also over lossy channels, where an adjoint operator-based approach is proposed to solve the considered  $H_\infty$  filtering problem and a modified discrete-time algebraic Riccati equation-based solution is further proposed to design the corresponding  $H_\infty$  filter; 3) taking into

consideration the networked estimators, implemented in a multi-subsystem way, a methodology making possible both their design and the choice of the most resilient realization is introduced. This methodology is based on a descriptor model used to describe in a unifying framework all the equivalent realizations, with the internal time delays and finite word length effects. Based on this descriptor model, the design and realization optimization for the estimator is thus achieved. To verify the effectiveness of the proposed design and realization methods mentioned above, a system with two cooperative mobile robots is introduced as an illustrative example. Several simulations permit us to test and validate our different methodological contributions on a concrete and realistic problem.