



HAL
open science

Arsyad al-Banjari's approaches to rationality : argumentation and sharia

Muhammad Iqbal

► **To cite this version:**

Muhammad Iqbal. Arsyad al-Banjari's approaches to rationality : argumentation and sharia. Philosophy. Université de Lille, 2021. English. NNT : 2021LILUH011 . tel-03333823

HAL Id: tel-03333823

<https://theses.hal.science/tel-03333823>

Submitted on 3 Sep 2021

HAL is a multi-disciplinary open access archive for the deposit and dissemination of scientific research documents, whether they are published or not. The documents may come from teaching and research institutions in France or abroad, or from public or private research centers.

L'archive ouverte pluridisciplinaire **HAL**, est destinée au dépôt et à la diffusion de documents scientifiques de niveau recherche, publiés ou non, émanant des établissements d'enseignement et de recherche français ou étrangers, des laboratoires publics ou privés.



UNIVERSITE DE LILLE
ÉCOLE DOCTORALE SCIENCES DE L'HOMME ET DE LA SOCIÉTÉ
UMR STL 8163

**ARSYAD AL-BANJARI'S APPROACHES TO RATIONALITY:
ARGUMENTATION AND SHARIA**

LES APPROCHES DE LA RATIONALITÉ PAR ARSYAD AL-BANJARI:
ARGUMENTATION ET CHARIA

Muhammad Iqbal

Thèse présentée en vue de l'obtention du grade de
Docteur en Philosophie

Le 14 janvier 2021

Composition du Jury :

Michel CRUBELLIER	Professeur émérite (Université de Lille)	Président du jury
Shahid RAHMAN	Professeur (Université de Lille)	Directeur de thèse
Farid ZIDANI	Professeur (Université Alger 2)	Rapporteur/Examineur
Juan REDMOND	Professeur (Universidad de Valparaíso)	Rapporteur
Tutik HAMIDAH	Professeure (UIN Malang)	Examinatrice
Siti AISYAH	Professeure (UIN Alauddin Makassar)	Examinatrice
MUJIBURRAHMAN	Professeur (UIN Antasari Banjarmasin)	Examineur
Walter Edward YOUNG	Chercheur associé (McGill University)	Examineur

ABSTRACT

The thesis provides an epistemological study of the great Islamic scholar of Banjarese origin, Syeikh Muhammad Arsyad al-Banjari (1710-1812) who contributed to the development of Islam in Indonesia and, in general, Southeast Asia. Moreover, we will focus on Arsyad al-Banjari's dialectical use and understanding of *qiyās* or correlational inference, a model of parallel reasoning or analogy in Islamic jurisprudence, that constituted the most prominent instrument he applied in his effort of integrating Islamic law into the Banjarese society. It is, so we claim, this interactive and epistemological stance on the cultural integration of social practices that led Arsyad al-Banjari to cast *qiyās* into the dialectical framework of "questions and responses" where meaning and knowledge are featured by a suitable balance of competitive and cooperative moves of reciprocal understanding. According to our view, this describes one of the main epistemological features at work in Arsyad al-Banjari's thought and constitutes the main general aim of our research.

This work includes a study of one of the main theoretical sources of Arsyad al-Banjari's dialectical stance on legal reasoning, namely, the books by Abū Ishāq al-Shīrāzī (393H/1003 CE-476H/1083 CE), one of the most prominent Shāfi'ī legal theorists of the 5thH/11th century, whose developments on *qiyas* and dialectic (*jadāl*) constituted a paradigm in the field. Let us mention that al-Shīrāzī classifies *qiyās* into three kinds: *qiyās al-'illa* (correlational inference by occasioning factor), *qiyās al-dalāla* (correlational inference by indication) and *qiyās al-shabah* (correlational by resemblance). Precisely it is this classification that shapes Arsyad al-Banjari own work, particularly so in his *magnum opus Sabīl al-Muhtadīn*. In *Sabīl al-Muhtadīn* Arsyad al-Banjari does not only display a very large use of these main forms of *qiyas* but he also adds some structural variants to al-Shīrāzī's three-folded classification .

In order to delve into the dialectical system of *qiyās*, we developed an analysis based on a dialogical approach to Per Martin-Löf's *Constructive Type Theory*. This

approach provides both a natural understanding and a fine-tuned instrument capable of stressing two of the hallmarks of this form of reasoning: 1) the interaction of hermeneutic, heuristic and epistemological processes with logical steps; 2) the dialectical dynamics underlying the meaning-explanation of the terms involved.

One of the epistemological results emerging from the present study is that the *different* forms of *qiyās* applied by Arsyad al-Banjari represent an innovative and sophisticated form of reasoning. A reasoning that not only provides new epistemological insights into legal reasoning in general, but also furnishes a refined pattern for *parallel reasoning* which can be deployed in a wide range of problem-solving contexts and does not seem to reduce to the standard forms of analogical argumentation that are studied in contemporary philosophy of science.

Keywords: Arsyad al-Banjari, *qiyās*, dialogue, *jadal*, argumentation, Islamic law.

RÉSUMÉ

La thèse propose une étude épistémologique de certains travaux du grand savant islamique d'origine banjaraise, Syeikh Muhammad Arsyad al-Banjari (1710-1812), lequel a contribué au développement de l'islam en Indonésie et, en général, en Asie du Sud-Est. Nous nous concentrerons sur l'utilisation dialectique et la compréhension par Arsyad al-Banjari du *qiyās* ou de l'inférence corrélationnelle - un modèle de raisonnement parallèle ou d'analogie dans la jurisprudence islamique - qui a constitué l'instrument principal en vue de son effort d'intégration de la loi islamique à la société banjaraise. C'est, comme nous le prétendons, cette position interactive et épistémologique sur l'intégration culturelle des pratiques sociales qui a conduit Arsyad al-Banjari à replacer les *qiyās* dans le cadre dialectique des « questions et réponses », où le sens et la connaissance sont caractérisés par un équilibre approprié de mouvements compétitifs et coopératifs de compréhension réciproque. Selon nous, cette approche permet de décrire l'une des principales caractéristiques épistémologiques à l'œuvre dans la pensée d'Arsyad al-Banjari et constitue l'objectif principal de nos recherches.

Ce travail comprend une étude de l'une des principales sources théoriques de l'approche dialectique d'Arsyad al-Banjari relative au raisonnement juridique, à savoir les livres d'Abū Ishāq al-Shīrāzī (393H / 1003 - 476H / 1083), l'un des les plus éminents théoriciens du droit shāfi'i du 11^{ème} siècle, dont les développements sur les *qiyas* et la dialectique (*jadāl*) constituaient un paradigme dans le domaine. Mentionnons que al-Shīrāzī classe les *qiyās* en trois types : *qiyās al-'illa* (inférence corrélationnelle par facteur occasionnel), *qiyās al-dalāla* (inférence corrélationnelle par indication) et *qiyās al-shabah* (corrélation par ressemblance). C'est précisément cette classification qui façonne l'œuvre d'Arsyad al-Banjari, en particulier dans son magnum opus *Sabīl al-Muhtadīn*. Dans cette œuvre Arsyad al-Banjari n'indique pas seulement une très large

utilisation de ces principales formes de *qiyas*, mais il ajoute également quelques variantes structurelles à la classification en trois volets d'al-Shīrāzī.

Afin d'examiner le système dialectique des *qiyās*, nous avons développé une analyse basée sur une approche dialogique de la *théorie constructive des types* de Per Martin-Löf. Cette approche fournit à la fois une compréhension naturelle et un instrument adéquat capable de souligner deux des caractéristiques de cette forme de raisonnement : 1) l'interaction des processus herméneutiques, heuristiques, épistémologiques et des étapes logiques ; 2) la dynamique dialectique sous-jacente à l'explication du sens des termes impliqués.

L'un des résultats épistémologiques émergeant de la présente étude est que les différentes formes de *qiyās* appliquées par Arsyad al-Banjari représentent une forme de raisonnement innovante et sophistiquée. Un raisonnement qui, non seulement, fournit de nouvelles perspectives épistémologiques sur le raisonnement juridique en général, mais également un modèle raffiné de raisonnement parallèle pouvant être déployé dans un large éventail de contextes de résolution de problèmes, mais qui, de plus, ne semble pas pouvoir être réduit aux formes standard de l'argumentation analogique étudiées dans la philosophie contemporaine de la science.

Mots clés : Arsyad al-Banjari, *qiyās*, dialogue, *jadal*, argumentation, loi islamique.

ACKNOWLEDGEMENTS

My PhD studies in Lille have been not only my intellectual journey, but also an important part of my family's life journey and mine. So, firstly, I would like to acknowledge the immense debt that I feel we owe to the City and to its people.

I would also like to admit that I owe a great deal to many people and many institutions not all of which are mentioned here, and I want to apologize for that. My principal gratitude must certainly go to my *directeur de thèse*, Professor Shahid Rahman. The thesis presented here could not have been written were it not for his assistance in its planning, execution and writing. His enthusiasm and intellectual energy for the project both encouraged me and animated the research. His wisdom and patience have been a foundation for my studies. His incredible care and generosity have provided comfort and serenity for my years with the family in Lille. He has taught me more than I could ever give him credit for here. He has shown me, by his example, what a good scholar and person should be. It has been a blessing for me learning and working with him.

I would also like to thank to the members of the jury, Professor Michel Crubellier, Professor Tutik Hamidah, Professor Siti Aisyah, Professor Farid Zidani, Professor Mujiburrahman, Professor Juan Redmond and Dr. Walter Edward Young for agreeing to read the manuscript and to participate in the defence of this thesis. I would especially like to thank to Dr. Walter E. Young who not only inspired this work by his impressive work on juridical disputation and the evolution of Islamic law, but also assisted with fruitful relevant remarks.

I gratefully acknowledge the funding of *Indonesian Ministry of Religious Affairs* (MoRA) through the *5000 doctors Scholarship Program* that made it possible to develop my research at the University of Lille and the Laboratory STL (*Savoirs, Textes, Langage*). I am grateful to the support of Campus France through the *bourse de couverture sociale*. I am also deeply thankful for the conference and travel grants I was

awarded throughout my Ph.D studies from the *École doctorale Sciences de l'Homme et de la Société* and *Laboratoire Savoirs, Textes, Langage*.

I extend my sincere thanks to all members of the *École doctorale Sciences de l'Homme et de la Société* (EDSHS). Thanks to the support of EDSHS, I could follow the intensive French course, organised by DEFI (*Département de l'Enseignement de Français à l'International*) for one semester during the first year of my research at the University of Lille. I wish to say a special thank you to Claudine Schneider for helping me to find a room in a *résidence universitaire* for my stay during my first year in Lille. I would also like to thank to Sabrina Abed for helping me to resolve administrative issues.

To all members of the *Laboratoire Savoirs, Textes, Langage* whose comments and response have helped me in many ways, I am truly grateful, specially to Leone Gazziero, Claudio Majolino, Giuliano Bacigalupo, Simon Brunin, Christian Berner, Patrice Canivez, Pierre Cardascia, Michel Crubellier, Hanna Karpenko, Sébastien Magnier, Raffaele Pisano, Juliette Senechal, Juliele Sievers, Ruth Webb and Sequoya Yiaueki. I am also grateful to Alain Lernould, Justin Duquesnoy, Marie-Christine Ismaiel and Édouard Neidenberger.

To leaders, past and present, and to all colleagues and friends in the *Universitas Islam Negeri Antasari Banjarmasin* for their support and assistance in various ways before and during my studies at the University of Lille, I would like to express my gratitude, specially to Prof. Dr. H. Fauzi Aseri, Prof. Dr. H. Mujiburrahman, Prof. Dr. H. Syaifuddin Sabda, Dr. Hidayat Ma'ruf, Prof. Dr. H. Juairiah, Dr. Inna Muthmainnah, Dr. Hairul Hudaya, Dr. M. Noor Fuady, Dr. Fahmi Riady, Dr. H. Faisal Mubarak Seff, Fathullah Munadi, Rusnadi Ali Kasan, Pak Arbani and Baidah. Very special thanks to Dr. Muhammad Rusydi and Ka Samdani who aided me by providing me with manuscripts.

I am indebted to all my friends in Lille, or in general France, who were always so helpful in numerous ways, specially to Ali Taqi, Moussa, Hanaa Beldjerd, Promise Kofi Dodzi, Clément Lion, Zoe McConaughy, Steephen Rossy Eckoubili, Kamil,

Ratih, Pipit, Wahyu, Aji, Rahmad, Mas Iib, Mbak Lisma, Bu Prie and Pak Armand. A very special thank you to Mas Fahrur Rozi who is more than a friend and always there for me and family, specially, for assisting me to take care of my children while I had to accompany my wife to give birth to a baby boy (Abed), our third child, at the end of 2017. I am also very grateful to Petrus and Shanty for helping to take care of my children when, again, I had to be present beside my wife giving birth to Shahid, our fourth child, in a tough situation during the covid-19 pandemic in 2020.

Finally, my gratitude to my partner on this journey of life, Mairita Inderiani, my beloved wife, for everything she did, that cannot be expressed in plain words, in order to overcome all difficulties without complaining. I am also grateful to all members of our extended family for their boundless support and assistance. My warmest thanks to my dear children, specially to Rameika and Semaisyqa, who, in spite of having to feel longing for home and the extended family in Indonesia, have never complained; and to Abed and Shahid whose presence in the midst of my struggling with the studies provided an opportunity to reflect longer on this work. Ultimately, this work is dedicated to my mother, Nuriah, and my late father, Nur Muhammad, two lights that never went out of my life.

TABLE OF CONTENTS

ABSTRACT	i
RÉSUMÉ	iii
ACKNOWLEDGEMENTS	v
CHAPTER 1	
INTRODUCTION	1
References	12
CHAPTER 2	
A GENERAL VIEW OF <i>QIYĀS</i> : A DIALECTICAL READING	13
2.1. Brief remarks on some relevant terms	13
2.1.1. On <i>al-aṣl</i> , <i>al-far'</i> and <i>al-'illa</i>	13
2.1.2. On <i>ḥukm</i>	14
2.2. Typology of <i>qiyās</i>	16
2.2.1. <i>Qiyās al-'illa</i>	18
2.2.2. On classification of <i>qiyās al-dalāla</i> and <i>qiyās al-shabah</i>	20
2.2.3. <i>Qiyās al-dalāla</i>	22
2.2.4. <i>Qiyās al-shabah</i>	24
References	26
CHAPTER 3	
DIALECTICAL SYSTEM OF <i>QIYĀS AL-'ILLA</i>	28
3.1. Motivating the deployment of a CTT-framework	29
3.1.1. The meaning-explanation of juridical rulings in <i>qiyās al-'illa</i>	31
3.1.1.1. Elements of CTT in the context of <i>qiyās al-'illa</i> : the specificity of <i>waṣf</i>	31
3.1.1.2. More elements of CTT in the context of <i>qiyās al-'illa</i> : on <i>ta'thīr</i> , <i>ṭard</i> and <i>'aks</i>	38
3.2. Towards the interactive stance	43
3.2.1. Epistemic-assumptions, the formal rule and epistemic strength	44
3.2.2. The choice of the dialogical framework, the termination of <i>jadāl</i> session and the aims of <i>qiyās al-'illa</i>	48
3.2.3. Dialectical elements of <i>qiyās al-'illa</i>	52
3.2.3.1. Requiring justification: <i>muṭālaba</i>	52

3.2.3.2. <i>Mu'āraḍa</i>	53
3.2.3.3. Forms of destructive criticism.....	54
3.3. A dialogical framework for <i>qiyās al- 'illa</i>	58
3.3.1. The dialogical approach to logic	59
3.3.2. Local meaning	60
3.3.3. Global meaning	67
3.3.3.1. Structural rules	67
3.3.3.2. The constitution of strategies	83
3.3.4. Examples of dialogues for <i>qiyās al- 'illa</i>	87
3.3.4.1. Example of a <i>qiyās al- 'illa (al-jalī bi-al-naṣṣ)</i>	89
3.3.4.2. Examples of <i>qiyās al- 'illa al-khaḍī</i>	89
References	99
 CHAPTER 4	
DIALECTICAL SYSTEM OF <i>QIYĀS AL-DALĀLA</i> AND <i>QIYĀS AL-SHABAH</i>	
4.1. <i>Qiyās al-dalāla</i>	102
4.1.1. <i>Qiyās al-dalāla I</i>	103
4.1.1.1. <i>Shahādat al-uṣūl</i> for <i>qiyās al-dalāla I</i>	104
4.1.2. <i>Qiyās al-dalāla II</i>	111
4.1.2.1. <i>Shahādat al-uṣūl</i> for <i>qiyās al-dalāla II</i>	117
4.2. <i>Qiyās al-shabah</i>	118
4.2.1. The inferential structure of <i>qiyās al-shabah</i>	119
4.3. A dialogical framework for <i>qiyās al-dalāla</i> and <i>qiyās al-shabah</i>	121
4.3.1. The dialogical approach to logic	121
4.3.2. Local Meaning.....	122
4.3.3. Global meaning	128
4.3.3.1. Structural rules	128
4.3.4. Examples of dialogues for <i>qiyās al-dalāla</i> and <i>al-shabah</i>	140
4.3.4.1. A dialogue for <i>qiyās al-dalāla I</i> : the deployment of <i>khaṣṣa</i>	141
4.3.4.2. A dialogue for <i>qiyās al-dalāla II</i> : the deployment of <i>naẓīr</i>	144
4.3.4.3. A dialogue for <i>qiyās al-shabah</i>	146
References	148
 CHAPTER 5	
ARSYAD AL-BANJARI: A BANJARESE SHĀFI'Ī SCHOLAR	
5.1. Banjar and Islam	150
5.2. Arsyad al-Banjari's life and journey with the Shāfi'ī School	153

5.2.1. Arsyad al-Banjari's studies in Mecca: jurisprudence, transmitted and rational sciences	153
5.2.2. Arsyad al-Banjari's studies in Medina: sufism, religious thought and practice, and further studies on Shāfi'ī thought.	155
5.3. Re-Islamization of Banjar and the employment of <i>qiyās</i>	158
References.....	162
CHAPTER 6	
SYSTEMS OF <i>QIYĀS</i> IN ARSYAD AL-BANJARI'S WORKS	164
6.1. A general overview of the system of <i>qiyās</i> implemented in Arsyad al-Banjari's works	164
6.2. <i>Qiyās</i> in <i>Kitāb al-Nikāh</i>	168
6.3. <i>Qiyās</i> in <i>Luqṭa al-'Ajlān</i>	177
6.4. <i>Qiyās</i> in <i>Sabīl al-Muhtadīn</i>	183
6.4.1. Example of <i>qiyās al-'illa</i>	184
6.4.2. Example of <i>qiyās al-dalālā</i>	191
6.4.3. Example of <i>qiyās al-shabah</i>	200
6.4.4. Two non-canonical forms of <i>qiyās</i>	211
6.4.4.1. <i>Non-canonical qiyās type A</i>	212
6.4.4.2. <i>Non-canonical qiyās type B</i>	224
References.....	235
CHAPTER 7	
ARSYAD AL-BANJARI'S <i>QIYĀS</i> FOR INTEGRATING BANJARESE TRADITIONS INTO ISLAMIC LAW.....	237
7.1. Basics on <i>qiyās</i>	239
7.2. Arsyad al-Banjari's framework.....	241
7.3. <i>Qiyās al-shabah</i> on <i>manyanggar</i> and <i>mambuang pasilih</i>	242
7.3.1. Brief remarks on the cultural and philosophical background	242
7.3.2. An overall view of the argument.....	243
7.3.3. The dialogue on <i>manyanggar</i> and <i>mambuang pasilih</i>	247
7.3.4. Elements for a dialectical analysis of the argument	252
7.4. <i>Qiyās al-'illa</i> on <i>lahang</i>	261
7.4.1. An overall view of the argument.....	261
7.4.2. The dialogue on fermented <i>lahang</i>	262
7.4.3. Elements for a dialectical analysis of the argument.....	263
7.5. <i>Qiyās al-shabah</i> on <i>harta perpantangan</i>	266
7.5.1. Brief remarks on the background of <i>harta perpantangan</i>	266

7.5.2. An overall view of the argument.....	268
7.5.3. The dialogue on <i>harta perpantangan</i>	269
7.5.4. Elements for a dialectical analysis of the argument.....	271
Appendix 7.A. The original texts.....	275
References.....	284
CHAPTER 8	
CONCLUDING REMARKS.....	287
8.1. Arsyad al-Banjari’s <i>qiyās</i> : between argumentation and Sharia.....	287
8.2. The forms of <i>qiyās</i> deployed in Arsyad al-Banjari’s work.....	288
8.3. Dialogical framework.....	289
8.4. Beyond the legal context: Articulation Model of <i>qiyās</i> ?.....	290
8.5. Toward a general reasoning schema for parallel reasoning in law.....	296
8.5.1. <i>Qiyās</i> and two contemporary accounts of parallel reasoning in law.....	296
8.5.2. Analogy-warranting rule and <i>ta’thīr</i>	304
8.5.3. Dialectical approach to parallel reasoning: a lesson of the Elders.....	308
References.....	314
BIBLIOGRAPHY.....	316

CHAPTER 1

INTRODUCTION

The Banjarese or *urang Banjar*, the native ethnic group in South Kalimantan, is one of the largest ethnic groups in Indonesia. They are generally identified as Muslims. According to Daud (1997, p. 5), Islam has long been the feature of the Banjarese, so that when one of the Dayak people, recognised as the indigenous people in Kalimantan, converted to Islam, he was said to be “converting to Banjarese”. The Islamisation of Banjar started around the sixteenth century when the Banjarese Kingdom was converted to Islam by the Sultanate of Demak. However, the process of Islamisation became more intense by the eighteenth century through the efforts of Syeikh Muhammad Arsyad al-Banjari (1710-1812) after his return from studying in the Muslim holy cities of Mecca and Medina. So, no doubt, Arsyad al-Banjari is the most important figure in the Islamisation of Banjar. Moreover, he also contributed to the development of Islam in Indonesia or, in general, Southeast Asia.

His contribution is undeniable particularly in regards to Islamic law. Indeed, as pointed out by Steenbrink (1984, p. 91), there were no other figures who produced books or manuscripts in Islamic law in the Indonesian language so widespread and systematic as Arsyad al-Banjari. This is, certainly, one of the reasons for the recent revival of research involving his rich work. Up to date, however, such research is rather restricted to the study of some problems involving his role in the Islamisation and the education of the society of his day. Nevertheless, so we claim, the task of elucidating the epistemological background underlying his work is crucial for the understanding of his thought.

Notice that, since the earliest periods of the development of Islamic jurisprudence, the main epistemological problem is the fact that sharia (God’s law) must be applicable in whatever condition (*ṣāliḥ likulli zamān wa makān*), while the sources, the Qur’ān

and the Sunna do not cover, at least not literally so, all the problems arising during the development of a society through time and place. Thus, in order to do both, to accept the universality of the juridical sources and to deal with the synchronic development of society, a special intellectual endeavour, called *ijtihād* (اجتهاد) is required which allows one to make legal decisions for new cases or contexts from the epistemological understanding of the sources. Let us quote the beautiful paragraph on *ijtihād* by Wael B. Hallaq in his landmark work *A History of Islamic Legal Theories*:

In his Mustasfā Ghazali depicts the science of legal theory in terms of a tree cultivated by man. The fruits of the tree represent the legal rules that constitute the purpose behind planting the tree; the stem and the branches are the textual materials that enable the tree to bear the fruits and to sustain them. But in order for the tree to be cultivated, and to bring it to bear fruits, human agency must play a role. [...]. We shall now turn to the “cultivator,” the human agent whose creative legal reasoning is directed toward producing the fruit, the legal norm. The jurist (faqīh) or jurisconsult (muftī) who is capable of practising such legal reasoning is known as the mujtahid, he who exercises his utmost effort in extracting a rule from the subject matter of revelation while following the principles and procedures established in legal theory. The process of this reasoning is known as ijtihād, the effort itself.¹

In his mission for the Islamisation of Banjar, Arsyad al-Banjari encountered some legal issues or cases, particularly in relation to local traditions and empirical conditions proper of the region that casted doubt on the legal validity of certain practices. Since the setting of these cases were not to be found already in the juridical sources, *ijtihād* or the intellectual endeavour for inferring the right legal decisions, was needed. Such intellectual endeavour, as pointed by Hallaq (1997, p. 82), requires the knowledge of hermeneutical principles, legal epistemology and the governing rules of consensus. This strongly indicates that the conception of legal reasoning developed within Islamic jurisprudence requires an epistemic framework where deductive moves are combined with interpretative and heuristic ones. Indeed, in the particular case of Arsyad al-Banjari, before inferring rulings concerning legal decisions on local traditions, he had to verify the meaning of the texts involved in the juridical decisions and their links with other texts. Notice that the intertextual relationship may be one of specification

¹ Hallaq (1997, p.117).

(*takhsīṣ*), corroboration (*tafsīr*) or abrogation (*naskh*). Moreover, Arsyad al-Banjari had to further verify that the inferred rulings did not yield results contrary to the established consensus within the Shāfi‘ī school of law to which he belonged. In order to do so he deployed a pattern of reasoning within Islamic Law called *qiyās* (قياس).

Qiyās, which constitutes one of the forms of carrying out *ijtihād* (intellectual effort or endeavour), is regularly put into effect by the Shāfi‘ī school of law. More precisely, *qiyās* is a particular method of drawing inferences for new cases not considered by the scriptural sources, i.e. the Qur’ān and the Sunna, based on its parallelism with cases that had already been considered.

Indeed, Abū ‘Abdillah Muḥammad Idrīs al-Shāfi‘ī (150H/767 CE–204H/820 CE), the Imām and founder of the Shāfi‘ī school of law (hereafter called al-Shāfi‘ī), in his *Risāla*² included *qiyās* into what he calls *bayān*; which, in general, can be understood as the clarification and declaration of legal rulings occurring in the scriptural sources (again, the Qur’ān and the Sunna).³ Al-Shāfi‘ī (Shākir, Ed. (1940)) pointed out further that legal rulings are clarified and declared, in the scriptural sources, to humankind in one of five ways⁴: 1) only by the Qur’ān; 2) by the Qur’ān and the Sunna together, each expressing the same rule; 3) by the Qur’ān and the Sunna together, whereby the Sunna explains what is in the Qur’ān; 4) by the Sunna alone; 5) by *ijtihād*, and more specifically by *qiyās* when legal rulings are stated neither by the Qur’ān or the Sunna. However, the application of *ijtihād* or *qiyās* is rooted in the epistemological

² Hallaq (1987a) reported that it is only in this work that *uṣūl al-fiqh* was treated for the first time as an independent discipline.

³ Al-Shāfi‘ī in his *Risāla* (Shākir, Ed. (1940)) explains *bayān* as follows:

والبيان اسم جامع لمعاني مجتمعة الأصول، متشعبة الفروع: فأقل ما في تلك المعاني المجتمعة المتشعبة: أنها بيان لمن خوطب بها من نزل القرآن بلسانه، متقاربة، الاستواء عنده، وإن كان بعضها أشد تأكيداً بيان من بعض. ومختلفة عند من يجهل لسان العرب.

“*Al-Bayan is a collective term for a variety of meanings which have common roots but differing ramifications. The least [common denominator] of these linked but diverging meanings is that they are [all] a perspicuous declaration for those to whom they are addressed, and in whose tongue the Qur’an was revealed; they are of almost equal value for these persons, although some declarations were made emphatically clearer than others, though they differed [in clarity] to persons ignorant of the Arab tongue.*” Translated by Majid Khadduri (1987, p. 67).

⁴ Cf. Lowry (2007).

understanding of these two textual sources. Accordingly, the Shāfi‘ī school claims that for every legal problem a suitable declaration and/or elucidation of a ruling can be found in the Qur’ān or the Sunna.

In this context, al-Shāfi‘ī (Shākir, Ed. (1940)) stresses the fact that *qiyās* is a particular form of implementing *bayān*, which, when confronted with new cases, makes use of indications that these cases are in conformity (*muwāfaqa*) with precedently revealed information, to be found either in the Book or in the Sunna (*mā tuliba bi al-dalā’il ‘alā muwāfaqāt al-khabar al-mutaqaddim, min al-Kitāb aw al-Sunna*). Such indications might establish conformity with precedent cases because 1) the meaning (*ma’nā*) that grounds the legal ruling of the precedently revealed information (*khabar*) covers the cases not considered by the scriptural sources; or 2) there is a close resemblance between the precedently revealed information and the cases not considered by the sources in relation to some properties relevant for the legal ruling at stake. This two-folded way to be in conformity with a precedent case led to the classification of *qiyās* into the so-called *qiyās al-‘illa* and *qiyās al-shabah*. Thus, whereas *qiyās al-‘illa*, i.e. *qiyās* by *occasioning factor* is rooted in examining the meaning of a ruling, its *ratio legis* or constitutive rationale; *qiyās al-shabah* is rooted in finding relevant affinities between the new case and the one of the sources. What needs to be noticed is that making such conformity a condition for the clarification and declaration of legal rulings presupposes that the Qur’ān and the Sunna are the only authoritative sources of the truth. Moreover, it presupposes the universality of God’s law (sharia) that is presented by these two scriptural sources.

Thus, this approach has the consequence of a trade-off between the rationality of arguments and the universality of God’s law (sharia) in making a legal decision. This trade-off is a way to counter the objections against the use of *qiyas* as being a purely hypothetical method that moves us away from certainty.

Furthermore, in the Islamic context, the method of argumentation by means of which legal decisions are achieved requires the involvement of both legal theory (*uṣūl al-fiqh*) and dialectic (*jadāl*). So, in the particular case of *qiyas*, inferring that a juridical

ruling applies to some case not considered by the sources belongs to the realm of legal theory, but establishing the validity of both the material evidences for the ruling and the inference is achieved by means of a dialectic process. The dynamic relationship between legal theory and dialectic in the process of legal reasoning eventually led jurists to conceive a dialectical framework where – to put it in Young’s (2017) apt terminology— an *ijtihādīc* anticipation of a given opponent’s critique is put into action.

Actually, *qiyās* constitutes a system of juridical reasoning that is in the middle of two other (sometimes contested) forms of rational juridical change deployed in *fiqh* called, respectively, (i) *the doctrine of rational juridical preference* or *istiḥsān* (استحسان), which might produce the withdrawal of a conclusion achieved by a *qiyās*-procedure, and (ii) *the theory of public welfare* or *maṣlaḥa* (مصلحة), which could trigger the production of a new juridical ruling or *ḥukm* (حكم). More precisely, while the use of *qiyās* might extend the scope of applying a particular juridical ruling, it does not actually refute the ruling nor the occasioning factor that the juridical source explicitly declares as the grounds for that ruling. The changes made possible by the use of *qiyās* are, in some sense, of a more semantic or inferential nature.

Coming back to the work of Arsyad al-Banjari, it is fair to say that, despite the fact that the *qiyās* applied in Arsyad al-Banjari’s works generally were inherited from the Shāfi‘ī school of law – he was a Shāfi‘ī scholar after all, a number of *qiyās* deployed by Arsyad al-Banjari in order to achieve legal decisions concerning specific problems he encountered in the society during his life can be considered as his own *qiyās*. As we will see below some of al-Banjari’s own *qiyās* take a very sophisticated dialectical form, often because of his constant effort to discuss the integration or rejection of the local traditions by means of a rational dialogical interaction.

This is certainly what Arsyad al-Banjari put into practice in his effort to make legal decisions concerning the specific problems in the society of his time. Moreover, in order to find solutions to the legal problems that he was confronted with, Arsyad al-Banjari took the following as conditions: 1) legal decisions must be achieved by means

of argumentation; and 2), this argumentation should be based on an epistemological approach to the juridical sources so that the argumentation will lead to the knowledge and understanding of God's universal law (sharia).

It is this interactive and epistemological stance on cultural integration that led Arsyad al-Banjari to cast *qiyās* into the dialectical framework of "questions and responses". According to our view, this describes the epistemological feature of Arsyad al-Banjari's thought and constitutes the main general aim of our research.

More precisely, we will investigate the system of *qiyās* occurring in his work and study its application in the context of the Banjarese society of his time. This should provide on the one hand the particular way he adapted the system to the contextual circumstances, and on the other it should suggest the general epistemological features of how contextualisation processes are carried out. Therefore, our project focuses on the two following questions:

1. How do the systems of *qiyās* developed in Arsyad al-Banjari's work?
2. How does Arsyad al-Banjari apply *qiyās* in the context of the Banjarese society of his time?

Our study focuses on the *qiyās* as applied by Arsyad al-Banjari in *Sabīl al-Muhtadīn*, *Tuḥfat al-Rāghibīn*, *Kitāb al-Nikāḥ*, *Kitāb al-Farā'id* and *Luqṭat al-'Ajlān*. It is curious to note, however, that despite the widespread acknowledgement of Arsyad al-Banjari's employment of *qiyās*, no exclusive study is yet known to have been made on his work concerning this specific epistemological aspect.

Two reasons can, perhaps, be suggested for the absence of such studies. One is the fact that his works were written in the Banjarese-Malay language so that it is difficult for foreign researchers who do not speak Malay to elaborate on his rich work. The second reason is that epistemological research on Islamic jurisprudence is indeed still not attracting much attention for Islamic researchers, particularly those who speak Malay.

However, let us mention two publications that may be considered as the initial studies concerning epistemological aspects of Arsyad al-Banjari's work. First, we

should mention the study of Darliansyah Hasdi (2009): “*Fatwa-fatwa Spesifik Syeikh Muhammad Arsyad al-Banjari*”, which discusses Arsyad al-Banjari’s opinions about the legal rulings of some specific issues. In the last chapter, Hasdi focuses on the method of legal reasoning employed in al-Banjari’s magnum opus *Sabīl al-Muhtadīn*. However, Hasdi’s work is restricted to the theory of deductive and inductive reasoning as applied by Arsyad al-Banjari in his attempt to tackle specific issues, and does not delve into the theory of *qiyās*.

The second study is that of Muhammad Rusydi’s 2014 doctoral dissertation: “*Kitab Tuhfat al-Rāghibīn Karya Muhammad Arshad al-Banjari: Studi Ideologi dan Epistemologi*”. This work deals with the ideology and epistemology of Arsyad al-Banjari in his *Tuhfat al-Rāghibīn*. In terms of epistemology, the most important point of its findings is that Arsyad al-Banjari’s thought in the *Tuhfat al-Rāghibīn* articulates the stance that the sources constitute the authoritative texts, and the view that *qiyās* is the pattern of reasoning to be applied in the context of legal issues. Now, since the author’s purpose is to portray in general al-Banjari’s epistemology, he does not provide the particular epistemological features of the *qiyās* deployed by al-Banjari while developing his arguments.

Thus, our research, so we claim, will provide the first systematic epistemological study of *qiyās* as used by this great Islamic scholar of Banjarese origin.

Moreover, one of the epistemological results emerging from the present study is that the *different* forms of *qiyās*, which are inherited from the Shāfi‘ī and applied by Arsyad al-Banjari, represent an innovative and sophisticated form of reasoning. A reasoning that not only provides new epistemological insights into legal reasoning in general, but also furnishes a fine-tuned pattern for *parallel reasoning*⁵ which can be deployed in a wide range of problem-solving contexts and does not seem to reduce to the standard forms of analogical argumentation that are studied in contemporary philosophy of science.

⁵ We have borrowed the term “*parallel reasoning*” from Bartha (2010).

Now, in focusing attention on the systems of *qiyās* and its interface with *jadāl*, we will require a more efficient tool to better analyse such systems. With regard to this problem, we developed an analysis based on a dialogical approach to Per Martin-Löf's (1984) *Constructive Type Theory*, or CTT. According to our view, such an approach provides both a natural understanding and a fine-tuned instrument capable of stressing the two hallmarks of this form of reasoning:

- (a) the interaction of hermeneutic, heuristic and epistemological processes with logical steps,
- (b) the dialectical dynamics underlying the meaning-explanation of the terms involved,

What the dialogical framework adds to the standard natural-deduction presentation of CTT is that this approach not only provides insights into the dynamics of meaning underlying the notion of *qiyās*, but it also leads to a conception of logic where logical rules too are understood as emerging from dialectical interaction. In other words, the dialogical reconstruction of the different forms of correlational inference is not to be conceived of as the concatenation of a dialogical structure + logical rules + semantics + knowledge + jurisprudence, but rather as a unifying system where all these levels are constituted, or *forged* at once by an argumentative interaction, they are *immanent* to a dialogue that makes reason and knowledge happen.

Before an analysis of Arsyad al-Banjari's *qiyās* can be launched, a proper understanding of systems of *qiyās* and its interface with *jadāl* theory, as previously developed by Islamic jurists, is required. We will focus on the systems that were developed by the jurists belonging to the 5th H/11th century since this is the period where *qiyās* and *jadāl* reached their maturity.

Up to now, the system of *qiyās* and its interface with dialectic has been an issue that has attracted very little attention from researchers in Islamic studies. However, a number of studies on this issue has been realised. Let us mention some important works on this issue.

The first is the article of Josef van Ess: “The Logical Structure of Islamic Theology” first published in 1970.⁶ In fact, the main thesis underlying his work is that the logical structure of Islamic theology, including *fiqh*, originated from Stoic philosophy. Yet, in this work van Ess already demonstrated that *‘ilm al-kalām* (theology) and *fiqh* were developed through dialectic. In relation to *qiyās*, van Ess showed that the dialectic was centralised in the notion of *‘illa* (occasioning factor).

The work which is indispensable in this field is Larry Miller’s 1984 doctoral dissertation: “Islamic Disputation Theory”, a work that deals with the evolution of dialectical theory in Islamic tradition.⁷ Following van Ess, Miller claims that Islamic jurists took the theological teaching on dialectics and applied it to jurisprudence. Apart from that issue, this work, to our knowledge, is the first comprehensive and detailed work that provides the dialectical features of *qiyās* in the process of legal reasoning.

Wael Hallaq’s (1987) introduction to his translation of Abū al-Ḥusayn al-Basrī’s (d. 436/1044) *Kitāb al-Qiyās al-Shar‘ī*: “A Tenth-Eleventh Century Treatise on Juridical Dialectic” is a further publication that has to be mentioned since it highlights the dynamic relationship between legal theory and dialectic in the process of legal reasoning. The remarkable point in this work is that juridical dialectic was viewed as an efficient means to reach the truth about a particular legal question and constituted the final stage in the process of legal reasoning. As the primary method of legal reasoning in *fiqh*, *qiyās* is cast as the focal point of juridical dialectic with *‘illa* being the central discussion. Hallaq provides some elements employed in dialectic in order to verify the validity of *‘illa*.

The last work we would like to mention is Walter Edward Young’s (2017) *Dialectical Forge* which motivated and animated our study on *qiyās* and *jadal*. First,

⁶ After the first publication in *Logic in classical Islamic culture*, ed. by G.E. von Grunebaum. Wiesbaden: Harrassowitz 1970, 21–50, the article was reprinted several times: in *Islamic philosophy and theology: critical concepts in Islamic thought*. Vol. 2: *Revelation and reason*, ed. by Ian Richard Netton. London, New York: Routledge 2007, 31–62; in *An Anthology of Islamic Studies*, Ed. Issa J. Boullata, Montreal: Canada: McGill-Indonesia IAIN Development Project, 1992; more recently, in *Kleine Schriften by Josef van Ess*, Ed. Hinrich Biesterfeldt, Leiden; Boston: Brill, 2018, pp. 238-271.

⁷ This work just published by Springer, see Miller (2020).

Young contests Miller’s claim that juridical dialectic was taken from theological teachings by showing that a parallel development between theological and juridical systems of dialectic took place. Yet the main point of this work is that it further develops the dynamic relationship between legal theory and dialectic that was formerly highlighted by Hallaq. In fact, the main claim underlying the work of Young is that legal theory and *jadāl* theory have been continuously forged, refined and systematized in a venue and an engine, both of which he calls a “Dialectical Forge”. However, this presupposes that *fiqh* is dynamic in nature. This dynamic nature is put into action by both the dialectical understanding and the dialectical practice of legal reasoning. Indeed, since dialectic constitutes the final stage in the practice of *ijtihād*, the process of legal reasoning in *fiqh* takes the form of an interrogative enquiry where the intertwining of giving and asking for reasons features the notion of meaning that grounds legal rationality.

We will not deal with the evolution of legal theory and dialectic discussed by the authors above. Rather we will focus on the system of *qiyās* in Arsyad al-Banjari’s work that is based on dialectical understanding and practice. Therefore, we will develop our study by providing a logical framework for the system of *qiyās* as used by one of the most prominent Shāfi’ī jurists of the 5thH/11th century, namely, Abū Ishāq al-Shīrāzī (393H/1003 CE-476H/1083 CE) whose crucial works on *qiyās* and *jadāl* constitute a paradigm in the field.⁸ Accordingly, we will rely upon the systems of *qiyās* and *jadāl* from al-Shīrāzī as discussed in his *al-Mulakhkhaṣ fī al-Jadāl (Epitome on Dialectical Disputation)*, *al-Ma’ūna fī al-Jadāl (Aid on Dialectical Disputation)* and *al-Luma’ fī Uṣūl al-Fiqh (Refulgence of Islamic Legal Theory)*.

In fact, during the research of our thesis we managed to provide a logic reconstruction that highlights the epistemological and dialectical features of al-Shīrāzī’s system of *qiyās*. This reconstruction yielded the paper “*Unfolding Parallel*

⁸ Notice that, as pointed out by Miller (1984, p. 89; 2020, p. 48), the works of two important authors on *jadāl*-theory, the Mālikī scholar Abū al-Walīd al-Bājī (d.474/1081) and the Ḥanbalī scholar Abū al-Wafā’ ‘Alī b. ‘Aqīl (d.513/1119), are dependent very much on al-Shīrāzī’s studies.

Reasoning in Islamic Jurisprudence; Epistemic and Dialectical Meaning in Abū Ishāq al-Shīrāzī's System of Co-Relational Inferences of the Occasioning Factor” by Shahid Rahman and Muhammad Iqbal (2018), published by the *Cambridge Journal of Arabic Sciences and Philosophy*; and the book “*Inferences by Parallel Reasoning in Islamic Jurisprudence. Al-Shīrāzī's Insights into the Dialectical Constitution of Meaning and Knowledge*” by Shahid Rahman, Muhammad Iqbal and Youcef Soufi (2019), published by Springer.

Two separate chapters of the present dissertation (Chapter 3 and 4) provide an analysis of al-Shīrāzī's system of *qiyās* as already developed in those two publications.

Our study consists of eight chapters that are structured as follows:

- a) The first chapter, the present introduction, introduces the background, the problems, and the objectives of our study, as well as the method of analysis we have developed.
- b) The second chapter speaks of a general view of *qiyās* including the typology and specific terms used in this form of inference.
- c) The next two chapters (Chapters 3 and 4) discuss al-Shīrāzī's system of *qiyās* as developed in our earlier publications. Chapter 3 deals with the system of correlational inferences of the occasioning factor (*qiyās al-illa*). Chapter 4 deals with the system of correlational inferences by indication and resemblance (*qiyās al-dalāla, qiyās al-shabah*).
- d) Chapter 5 deals with the historical background and context of Banjar, as well as the life and the education of Arsyad al-Banjari relevant to the present study.
- e) The next two chapters (Chapters 6 and 7) deal with the *qiyās* of Arsyad al-Banjari. Chapter 6 discusses in general the systems of *qiyās* in his works. Chapter 7 discusses the *qiyas* he applied for integrating Banjarese traditions into Islamic law. In fact, some parts of Chapter 6 are based on our paper: “Arsyad al-Banjari's Dialectical Model for Integrating Indonesian Traditional Uses into Islamic Law; Arguments on *Manyanggar, Membuang Pasilih and Lahang*” by Muhammad

Iqbal and Shahid Rahman (2020) published by the Springer Journal of Argumentation.

f) Chapter 8 outlines some remarks as conclusions of the present study.

References

- Al-Shāfi'ī, Muḥammad Idrīs. (1987). *Al-Shāfi'ī's Risāla ; Treatise on the Foundations of Islamic Jurisprudence*. Trans. Majid Khadduri. The Text Islamic Society.
- Al-Shāfi'ī, Muḥammad Idrīs. (1940). *Al-Risāla*. (Ed. Aḥmad Shākir). Cairo: Maktaba al-Ḥalabī.
- Bartha, P. (2010). *By Parallel Reasoning; The Construction and Evaluation of Analogical Arguments*. Oxford: Oxford University Press.
- Daud, A. (1997). *Islam & masyarakat Banjar: diskripsi dan analisa kebudayaan Banjar*. Jakarta: RajaGrafindo Persada.
- Hallaq, W. B. (1987a). A Tenth-Eleventh Century Treatise on Juridical Dialectic. *The Muslim World*, 77 3-4, 151-282.
- Hallaq, W. B. (1997). *A History of Islamic Legal Theories: An Introduction to Sunnī Uṣūl al-Fiqh*. Cambridge; New York: Cambridge University Press.
- Hasdi, D. (2009). *Fatwa-Fatwa Spesifik Syeikh Muhammad Arsyad Al-Banjari*. Banjarmasin: Antasari Press.
- Lowry, J. E. (2007). *Early Islamic Legal Theory: The Risāla of Muḥammad ibn Idrīs al-Shāfi'ī*. Leiden: Brill.
- Martin-Löf, P. (1984). *Intuitionistic Type Theory. Notes by Giovanni Sambin of a Series of Lectures given in Padua, June 1980*. Naples: Bibliopolis.
- Miller, L. B. (1984). *Islamic Disputation Theory*. PhD dissertation, Pinceton University.
- Miller, L. B. (2020). *Islamic Disputation Theory*. Cham: Springer.
- Rusydi, M. (2014). *Kitab Tuhfat Al-Raghibin Karya Muhammad Arshad Al Banjari: Studi Ideologi dan Epistemologi*. PhD thesis, UIN Sunan Ampel Surabaya.
- Steenbrink, K. A. (1984). *Beberapa Aspek tentang Islam di Indonesia Abad ke19*. Jakarta: Bulan Bintang.
- van Ess, J. (2018). The Logical Structure of Islamic Theology. In H. Biesterfeldt, *Kleine Schriften by Josef van Ess* (pp. 238-271). Leiden; Boston: Brill.
- Young, W. E. (2017). *The Dialectical Forge; Juridical Disputation and the Evolution of Islamic Law*. Dordrecht: Springer.

CHAPTER 2

A GENERAL VIEW OF *QIYĀS*: A DIALECTICAL READING

2.1. Brief remarks on some relevant terms

In the contexts of Islamic Law, *qiyās* is a model of parallel reasoning which is employed in order to make legal decisions concerning some issues when lacking scriptural sources. This form of reasoning is composed mainly of four parts: *al-aṣl*, *al-farʿ*, *al-illa* and *al-ḥukm*. In order to facilitate the reading, let us first have a very brief introduction of these terms.

2.1.1. On *al-aṣl*, *al-farʿ* and *al-illa*

Within *qiyās*, a source-case whose legal ruling is already established by the juridical sources and to which a new case not covered by sources is linked is called *aṣl* (أصل) or *root-case*. On the other hand, the new case is called *farʿ* (فرع) or *branch-case*. The Arabic terminology makes use of the botanic metaphor of, respectively, a *root* and a *branch* in order to express the relation between the *aṣl* and the *farʿ*. The idea is not that the *farʿ* is a subcase of the *aṣl*, but that the ruling claimed to apply to the *farʿ* is rooted in that of the *aṣl*.

The root-case and the branch-case in principle are correlated with regard to the fact that they both share a property, called *waṣf* (وصف) or *ṣifa* (صفة), that qualifies as the factor occasioning the ruling of the *aṣl* which the proponent seeks to extend to the *farʿ*. A property with such qualification is known as *illa* (علة) or occasioning factor.¹ In fact,

¹ “Occasioning factor” is used as the translation of “illa” by Young (2017) who afterwards in his personal email to Prof. Shahid Rahman indicated that this translation is based on the one by Bernard G. Weiss (1992, 1998). The term is also translated as *effective cause*, *operative cause*, *ratio legis* and *ratio decidendi*. Some of these translations do not seem to bear the causal significance of the term. The term *illa* is derived from ancient Syriac, where it means a “fault” or “blame” constituting the cause for returning articles or property. The term penetrated from Syriac into the lexicon of rational thought even

uṣūliyyūn (Islamic legal theorists) sometimes also use the term ‘*illa*’ referring to some feature shared by the *aṣl* and the *far‘* without specifying it as the factor occasioning the ruling at stake.² However, in our study we use the term ‘*illa*’ referring specifically to the occasioning factor.

2.1.2. On *ḥukm*

The ruling of an *aṣl* which is sought to be extended to a *far‘* in *qiyās* is called *ḥukm* (حكم). It is important to note that *ḥukm* (pl. *aḥkām*) takes the form of *heteronomous imperatives* (Rahman, Granström & Farjami, 2019; Rahman, Zidani & Young, 2020). Indeed, *ḥukm* is defined by most of legal theorists as communication from Lawgiver in relation to some acts to a *mukallaf* (مكلف), that is, the person who is legally considered liable for those acts. The communication may take the form of a command, option (to do or not to do) or declaration relating to the acts.³

In terms of the command and option, the ruling basically may be *wājib* (واجب) or obligatory, *mandūb* (مندوب) or recommended, *mubāḥ* (مباح) or indifferent, *makrūh* (مكروه) or reprehensible and *ḥarām* (حرام) or forbidden. These five deontic modalities, as heteronomous imperatives, are classified with the qualifications “reward and sanction”.

before Aristotelianism penetrated Arabic culture (we owe the remark on the etymology of the term ‘*illa*’ to Joseph E. David (2010; 2014)). In a general context, a distinction is drawn between providing a *ground* (‘*illa*’) and providing a *factual cause* or *reason* (*sabab*): while grounding is a rational endeavour, providing a *sabab* might be limited to an empirical task. It seems to be related to St. Thomas’ (*Summa Theologiae* 2.2c:) distinction between *propter quid* and *quia* that stems from Aristotle’s distinction in *Posterior Analytics* 13 (for a discussion in the context of CTT see J. Granström (2011, p. 157)). In fact, we should also mention the notion *ḥikma* that stands for the underlying higher purpose of the ‘*illa*’. Moreover, the notion of *ḥikma* underlies the *doctrine of rational juridical preference* or *istiḥsān*, and the *theory of public welfare* or *maṣlaḥa* mentioned before. However, this notion does not seem to play a role in the inferential processes deployed by the use of a *qiyās*.

² For example, as will be shown shortly later, when legal theorists provide a broad definition of *qiyās*, they usually use the term ‘*illa*’ to say simply the feature shared by the root-case and the branch-case.

³ See al-Ghazālī (1324H/1906, p. 55); Ibn Qudāma (1998, p. 97); and Ṣadr Shari‘a (1357H/1938, p. 7).

In this context, majority of legal theorists generally define the five deontic modalities as follows⁴:

- 1) The obligatory is that which is rewarded when performed and sanctioned when omitted.
- 2) The recommended is that which is rewarded when performed and neither rewarded nor sanctioned when omitted.
- 3) The indifferent is that which is neither rewarded nor sanctioned when performed or omitted.
- 4) The reprehensible is that which is rewarded when omitted and neither rewarded nor sanctioned when performed.
- 5) The forbidden is that which is rewarded when omitted and sanctioned when performed.

In the present study we will not display the logical form of the deontic modalities we just mentioned, but the reader should take into consideration that expressions such as *fasting during Ramaḍān is obligatory* should be read that fasting during Ramaḍān is rewarded when performed and sanctioned when omitted.⁵

⁴ See, Ibn Ḥazm (1926-1930, vol. 3, p. 77); and al-Juwaynī (1955, p. 4)

⁵ A logical analysis for these five deontic modalities is provided by Rahman, Granström & Farjami (2019) and Rahman, Zidani & Young (2020) by using the following formulation:

$$b(x): [(\forall y: A_1) \mathbf{left}^{\vee}(y)_{=\{H\}}x \supset R(y)] \wedge [(\forall z: \neg A) \mathbf{right}^{\vee}(z)_{=\{H\}}x \supset S_1(z)] \quad (x: A \vee \neg A)$$

whereby $\{H\}$ is a short-form for the hypothesis $A \vee \neg A$.

that can be glossed as follows:

All those performances of an action of type A identical to the ones chosen (by agent g) to be performed (i.e., if the left side of the disjunction has been chosen to be performed), are to be rewarded; and all those cases omitting to perform an action of type A identical to the ones chosen (by agent g) to be omitted (i.e., if the right side of the disjunction $\neg A$ has been chosen to be performed), are to be sanctioned.

This formulation yields the followings:

wājib (obligatory): If we do it, we are rewarded. If we do not do it, we are sanctioned.

$$b_1(x): [(\forall y: A_1) \mathbf{left}^{\vee}(y)_{=\{H_1\}}x \supset R_1(y)] \wedge [(\forall z: \neg A_1) \mathbf{right}^{\vee}(z)_{=\{H_1\}}x \supset S_1(z)] \quad (x: A_1 \vee \neg A_1).$$

mandūb(recommended): If we do it, we are rewarded. If we do not do it, we are neither sanctioned nor rewarded.

$$b_2(x): [(\forall y: A_2) \mathbf{left}^{\vee}(y)_{=\{H_2\}}x \supset R_2(y)] \wedge [(\forall z: \neg A_2) \mathbf{right}^{\vee}(z)_{=\{H_2\}}x \supset (\neg S_2(z) \wedge \neg R_2(z))] \quad (x: A_2 \vee \neg A_2).$$

As for the communication taking the form of declaration, rulings deal principally with the cause (*sabab*), condition (*shart*) and impediment (*māni* ') for the performance of a legal act.⁶ The performance of an act becomes, saying, obligatory due to the presence of the *sabab* and the absence of the *māni* ' . For instance, the noon prayer (*ṣalāt al-zuhr*) becomes obligatory when the sun moves from its zenith at midday, and those who perform it (specially women) are not in the menstrual period. While *shart* is a condition without which a religious act is rendered legally invalid. Thus, in this context, the ruling may be *ṣahīh* (legally valid) or *bāṭil* (legally invalid). Let us say that the noon prayer has been becoming obligatory, when it has been performed, and the performance is considered legally valid, then the obligation is accomplished in the sense that the performer is rewarded and not punished. In contrast, when the performance is legally invalid, then the obligation is not fulfilled and the noon prayer should be reperformed. Otherwise, instead of being rewarded, the performer will be punished.

2.2. Typology of *qiyās*

As indicated in the introduction of the present study, in order to elaborate Arsyad al-Banjari's *qiyās* we focus on Abū Ishāq al-Shīrāzī's classification of *qiyās* as developed in *al-Mulakhkhaṣ fī al-Jadal* (*Epitome on Dialectical Disputation*), *al-Ma'ūna fī al-Jadal* (*Aid on Dialectical Disputation*) and *al-Luma' fī Uṣūl al-Fiqh* (*Refulgence of Islamic Legal Theory*).

***mubāh* (indifferent):** If we do it, we are neither sanctioned nor rewarded. If we do not do it, we are neither sanctioned nor rewarded.

$b_3(x): [(\forall y: A_3) \text{left}^\vee(y)_{=\{H3\}x} \supset (\neg S_3(y) \wedge \neg R_3(y))] \wedge [(\forall z: \neg A_3) \text{right}^\vee(z)_{=\{H3\}x} \supset (\neg S_3(z) \wedge \neg R_3(z))]$ ($x: A_3 \vee \neg A_3$).

***makrūh* (reprehensible):** If we do not do it, we are rewarded. If we do it, we are neither sanctioned nor rewarded.

$b_4(x): [(\forall y: A_4) \text{left}^\vee(y)_{=\{H4\}x} \supset (\neg S_4(y) \wedge \neg R_4(y))] \wedge [(\forall z: \neg A_4) \text{right}^\vee(z)_{=\{H4\}x} \supset R_4(z)]$ ($x: A_4 \vee \neg A_4$).

***ḥarām* (forbidden):** If we do it, we are sanctioned. If we do not do it, we are rewarded.

$b_5(x): [(\forall y: A_5) \text{left}^\vee(y)_{=\{H5\}x} \supset S_5(y)] \wedge [(\forall z: \neg A_5) \text{right}^\vee(z)_{=\{H5\}x} \supset R_5(z)]$ ($x: A_5 \vee \neg A_5$).

⁶ For more details about legal rulings in Islamic law, including particularly the five deontic modalities, see al-Ghazālī (1324H/1906, pp. 55-99).

Before exploring the classification of *qiyās*, let us first consider the definition of *qiyās* by al-Shīrāzī. In fact, as pointed out by Ahmad Hasan (1986) in his landmark “*Analogical Reasoning in Islamic Jurisprudence*”, *qiyās* is defined diversely by Islamic jurists. Al-Shīrāzī himself defines *qiyās* as the correlation of a case not yet covered by juridical sources, a branch-case or *far‘*, to a case already covered, a root-case or *aṣl*, by means of some feature unifying the two of them in order to extend the application of the ruling of the *aṣl* to the *far‘*. Within this frame Young (2017) is likely to translate *qiyās* as *correlational inference*.⁷

والقياس حمل فرع على أصل بعلّة جامعة بينهما واجراء حكم الأصل على الفرع⁸

“*Qiyās* is the linking of a branch-case to a root-case with an ‘*illa*’⁹ [i.e. feature] unifying the two of them, and the application of the root-case’s ruling to the branch-case.”¹⁰

If we give a dialectical reading to such definition, a *qiyās* involves bringing forward a branch-case to which, according to the claim of the thesis, a particular *ḥukm* applies. The point is to ground this claim by linking it with the application of such

⁷ Cf. Young (2017, p. 10). The term has quite often a broader meaning encompassing legal reasoning in general. However, Young’s choice for its translation renders a narrower sense that stems from al-Shīrāzī’s approach.

⁸ In the *Mulakhkhaṣ* edited by Niyāzī (al-Shīrāzī, 1407 H/1986) that is quoted by Young (2017), it is written “*بعلّة* (with an ‘*illa*’)” rather than “*بعلّة جامعة بينهما*” (with an ‘*illa* unifying the two of them)”. However, in the manuscript of *Mulakhkhaṣ* we confronted with and the *Ma ‘ūna* edited by al-‘Umayrīnī, it is written as quoted. See al-Shīrāzī (2016, fol. 2a) and al-Shīrāzī (1987, p. 36).

⁹ The term ‘*illa*’ here, as alluded to previously, refers simply to some feature the root-case and the branch-case share. More precisely, the feature which is not (yet) ascertained to be the occasioning factor. In this context, as will be seen in the discussion of *qiyās al-‘illa*, for occasioning factor, al-Shīrāzī indicates it by the words “*العلّة التي علق الحكم عليها في الشرع*” (the ‘*illa* upon which the ruling is juristically made dependent).” Similarly, in *al-Waraqāt*, al-Juwaynī (1955), when defining *qiyās* in general, uses the term ‘*illa*’ which refers not to the occasioning factor, but to the feature shared by the *aṣl* and the *far‘*. Furthermore, he distinguishes the ‘*illa*’ in *qiyās al-‘illa* from that in *qiyās al-dalāla*. He asserts that in the first form of *qiyās* the ‘*illa*’ is the cause for the ruling (*موجبة للحكم*), whereas in the second form, the ‘*illa*’ is the indicator for the ruling (*دالة للحكم*). In the other work, *al-Luma‘*, al-Shīrāzī makes use of the term *ma‘nā* (معني), that literally means *meaning or sense*, rather than ‘*illa*’. Like the term ‘*illa*’, the term *ma‘nā* employed here refers to some feature joining the *aṣl* and the *far‘*.

¹⁰ In the *Luma‘*, al-Shīrāzī provides a similar definition though with a different redaction. More precisely, in this work he defines *qiyās* as “*the correlating of a branch case to a root-case, in some of its legal rulings, with a ma‘nā that joins the two of them, and the application of the root-case’s ruling to the branch-case.*” See al-Shīrāzī (1995, p. 208; 2003, p. 100).

ruling to a root-case that is acknowledged by legal sources. Accordingly, the grounding is carried out in two main steps:

The first step. It starts by bringing forward a root-case which the juridical sources have already established that it falls under the scope of the same juridical ruling as the one claimed to apply to the branch-case.

The second step. It involves two alternative developments:

- 1) (*First alternative*). It proceeds by the assumptions that the property (*wasf*) constituting the *ground* or *occasioning factor* (*'illa*) for the ruling of the root-case can be found, and that this property also applies to the branch-case. Moreover, the proceeding assumes that the relevant property is to be found either by inspecting the sources or by epistemological considerations.
- 2) (*Second alternative*). It proceeds by finding some way to relate the branch-case to the root-case *in absence of knowledge of the occasioning factor* by developing a parallel reasoning based on some kind of similarity.

2.2.1. *Qiyās al-'illa*

The first alternative to the second step yields the so-called *qiyās al-'illa* (*correlational inference by the occasioning factor*) that is considered to be the strongest in terms of epistemic strength.

فأما قياس العلة فهو أن يحمل الفرع على الأصل بالعلة التي علق الحكم عليها في الشرع.¹¹

“As for *Qiyās al-'illa*, it is that the branch-case is linked to the root-case by way of the *'illa*¹² upon which the ruling is juristically made dependent [i.e. the occasioning factor]”.

Al-Shīrāzī distinguishes three main cases classified by the strength of the evidence for the *'illa*:

¹¹ See al-Shīrāzī (1407 H/1986, p. 76). Cf. al-Shīrāzī (1987; 1995; 2003)

¹² Beside the term *'illa*, al-Shīrāzī employs different terms in his other works. He uses the term *ma'nā* in the *Ma'ūna* (al-Shīrāzī, 1987, p. 36); *nukta* (point) in the *Luma'* edited by Muḥyī al-Dīn Dīb Mustū and Yūsuf 'Alī Badīwī (al-Shīrāzī, 1995, p. 204); and *bayyina* (evidence) in the other edition of the *Luma'* (al-Shīrāzī, 2003, p. 99). However, these terms are unified by the words following them, namely “that upon which the ruling is juristically made dependent” that makes all of these terms signifying the *occasioning factor*.

- 1) the evidence for the identification of the *‘illa* stems from unambiguous and explicit passages in the texts (*naṣṣ*) of the Qur’ān and of the prophetic tradition (*al-jalī bi-al-naṣṣ*), or from a consensus of the jurists (*al-jalī bi-al-ijmā’*)
- 2) the identification of the *‘illa* stems from some hermeneutical process of the texts (*al-wāḍiḥ bi-al-nuṭq*) or it is based upon some historical background reported by the Companion of the Prophet (*al-wāḍiḥ bi-al-sabab*)¹³
- 3) the *‘illa* is identified by positing some suitable hypothesis (*al-khaḥḥ*) about the general law occasioning the ruling of the root-case.¹⁴ The latter looks similar to Aristotle’s *argument from example* (*paradeigma*) described in the *Rhetoric* (1402b15) and the *Prior Analytics* (*Pr. An.* 69a1).

The logical structure of *qiyās al-‘illa* will be examined in the next chapter. However, before delving into the logical structure, let us motivate the underlying dialectical processes of this kind of parallel reasoning with the help of an informal diagram. The diagram presents the most general form of the *qiyās al-‘illa*, without (for the moment) drawing a distinction between subdivisions inside each type of this correlational inference.

Schema 2.1. *Qiyās al-‘Illa*¹⁵

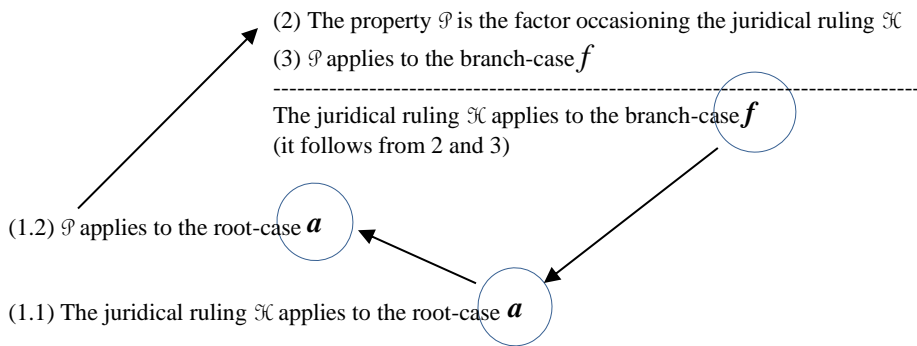

¹³ If we examine al-Shīrāzī’s example it seems that *al-sabab* here signifies *sabab al-nuzūl* and *sabab al-wurūd*, that is, the historical cause of revelations for the Qur’ān and Ḥadīth respectively.

¹⁴ See al-Shīrāzī (1407 H/1986, pp. 76-79). In *al-Luma’*, the second and the third are set as a single type, that is, the type of *khaḥḥ*, see al-Shīrāzī (1995, pp. 207-208; 2003, pp. 99-100).

¹⁵ The diagram has been adapted from Bartha’s (2010, p. 36) figure for Aristotle’s reasoning by *paradeigma*.

The point of the *al-‘illa*-form of correlational inference is to find a general law and a property, shared by both the branch- and root-cases, which allows the inference of the ruling we are looking to ground. It is not really a case of analogy by resemblance, but a kind of what is nowadays called *deductive parallel reasoning*, since it combines some kind of *symmetric* reasoning with inferential moves. Notice that in the diagram neither of the assertions gathered in the steps 1.1. and step 1.2 are premises for the last inferential step. Indeed, steps 1.1 and 1.2 have the heuristic role of obtaining assertions that should lead to the required general rule. In order to extract from the diagram the underlying *jadāl*-structure, we need to read the arrows as dialectical actions or argumentative moves, whereby the first action (the arrow on the right of the diagram) amounts to the heuristic move of finding a suitable root-case, then the short arrow from 1.1 to 1.2 indicates the result of finding out the property that provides the occasioning factor specific to the ruling of the root-case, and the last arrow stresses the core of the process, namely: *to learn from the ruling of the root-case that it instantiates a general juridical norm*. Once this has been achieved, a simple logical mechanism leads us to the conclusion sought.

2.2.2. On classification of *qiyās al-dalāla* and *qiyās al-shabah*

The second alternative to the second step described above is divided in general into two cases: 1) both the root-case and the branch-case share some other juridical ruling which is in parallel with the ruling under consideration; 2) both the root-case and the branch-case share some properties. Al-Shīrāzī calls the first case *qiyās al-dalāla* (*correlational inference of indication*) and the second case *qiyās al-shabah* or (*correlational inference of resemblance*).

Actually, in his *Mulakhkhaṣ*, *qiyās al-shabah* is set as a particular case of *qiyās al-dalāla* that, in this setting, is understood as the type of *qiyās* applied generally in the absence of knowledge of the occasioning factor. However, in his further work al-Shīrāzī distinguishes between *qiyās al-dalāla* and *qiyās al-shabah* as two separate forms. The distinction deepens in *al-Luma‘* (al-Shīrāzī, 2003, pp. 99-101) where clearly

he classifies *qiyas al-shabah* as a third type of *qiyās* which is considered to be the weakest in terms of the epistemic strength.

In fact, though both *qiyās al-dalāla* and *qiyas al-shabah* are based on establishing parallelisms, the notion of resemblance deployed by *qiyās al-dalāla* is quite different from that one deployed by *qiyās al-shabah*. Indeed, whereas the notion of resemblance deployed by *qiyās al-dalāla* requires making it apparent that a root-case and a branch-case share some structural parallelism, in the sense that each of both cases falls under the scope of a pair of *rulings* linked by some structural relation, the kind of resemblance deployed by *qiyas al-shabah* amounts to pointing out one or more relevant *properties* shared by the root-case and the branch-case. In short, whereas the conclusion drawn in an inference of *qiyās al-dalāla* is based on the **parallelism between two rulings**, the conclusion drawn by an inference of *qiyas al-shabah* is based on the **resemblance between *aṣl* and *far'***.

We took the option to follow the approach adopted in *al-Luma'* and, therefore, in the present study, we classify *qiyās al-shabah* as the form of inference different from *qiyās al-dalāla*. In our view this strategy provides a fertile ground for a close examination of the epistemological notions involved in the systems of *qiyas al-dalāla* and *al-shabah*.¹⁶

In fact, one way to express the rationale behind al-Shīrāzī's typology (not shared by all of the other authors) is that he conceives *qiyās* as a system of parallel reasoning that deploys arguments by

- a) exemplification (of a general law): *qiyās al-illa*;
- b) symmetry between structures: *qiyās al-dalāla*;
- c) resemblance between the root-case and the branch-case: *qiyās al-shabah*.

¹⁶ The same classification can be found in al-Juwaynī's (1955) *Waraqāt*.

2.2.3. *Qiyās al-dalāla*

وأما الضرب الثاني من القياس: وهو قياس الدلالة فهو أن ترد الفرع إلى الأصل بمعنى غير المعنى الذي علق عليه الحكم في الشرع إلا أنه يدل على وجود علة الشرع¹⁷

“As for the second type of *qiyās*: *qiyās al-dalāla*, it is that the branch-case is associated to the root-case by way of a *ma'nā* other than the *ma'na* upon which the ruling is juristically made dependent [i.e. by way of a feature other than the occasioning factor], except that it indicates the existence of the [unknown] occasioning factor.”

Qiyās al-dalāla amounts to the task of pointing out what, by extending the original terminology, we might call *indicators*, where these indicators support transferring some specific juridical ruling applied to a root-case to the branch-case. Al-Shīrāzī, who is well aware of the difficulty of establishing a form of inference that lies between one where the occasioning factor is known and one exclusively based on some form of resemblance or analogy, provides an example that should highlight the fine distinction (al-Shīrāzī, 1988, p. 806). His example can be put in the following way:

That some being is a living being (*al-hayā*) can be inferred by observing that this being experiences senses (*al-iḥsās*), suffers pain (*ta'allum*) and undergoes processes of growth (*al-numuww*).

Clearly, senses, pain and growth are **not** actually the factors occasioning the living, but one can recognize that a certain being is a living one because of these three *life-indicators*. Those indicators are dependent upon some *'illa*, which though it is unknown, is the source of their efficiency for indicating the presence of life.

Thus, in the absence of the knowledge of *'illa* we might deploy those indicators when we have to decide if some being is or not a living one. If a being fails to have one of those indicators, it cannot be said (in principle) to be a living one; and if it has the properties described by the indicators, then the claim that it is indeed a living being is plausible. Another example is that some peculiar smell is always present when alcohol (intoxication) is; this smell in principle does not occasion the interdiction of wine, but it indicates the existence of intoxication which is the factor occasioning the interdiction.

If the indicators are close together, in the sense that both always occur together, then the hypothesis that both are linked to a common occasioning factor wins support.

¹⁷ See al-Shīrāzī (1995, p. 100; 2003, p. 208). Cf. al-Shīrāzī (1407 H/1986, p. 81).

Thus, the closer the indicators are, the stronger the justification for the transference from the known case to the new case is. Now, when we move to the juridical case the idea is that the *indicators* in *qiyās al-dalāla* are rulings. Indeed, the form of inference typical of *dalāla* is based on the idea of establishing a relationship between the ruling under consideration, let us say \mathcal{K} , and a second ruling, say \mathcal{K}^* , such that both apply to the root-case.

Moreover, the relationship of these two rulings demonstrates that whatever the *'illa* for the ruling \mathcal{K}^* is, it must be the same as the one occasioning \mathcal{K} . So, it can be assumed that the ruling \mathcal{K}^* indicates the existence of the (unknown) factor that occasions the ruling \mathcal{K} ; such that, bear in mind that the ruling and its *'illa* should be present together, the presence of the ruling \mathcal{K}^* can further *indicate* (rather than *occasion*) that the ruling \mathcal{K} applies to the branch-case. Thus, we can say that the application of the ruling \mathcal{K} to the *far'* in *qiyās al-dalāla* is caused *indirectly* by an (unknown) *'illa* through the presence of the ruling \mathcal{K}^* as its indicator; as opposed to the application of the ruling \mathcal{K} in *qiyās al-'illa* that is caused *directly* by a (known) *'illa*. Furthermore, in their relationship, the ruling \mathcal{K}^* may be either the particular (*khaṣīṣa*) or the parallel (*naẓīr*) of the ruling \mathcal{K} . The first model of relationship is considered to be stronger than the second one because, according to al-Shīrāzī, the fact that the particular entails its general is stronger than that one of two parallel things entails the other. The following schema displays the structure underlying *qiyās al-dalāla*:

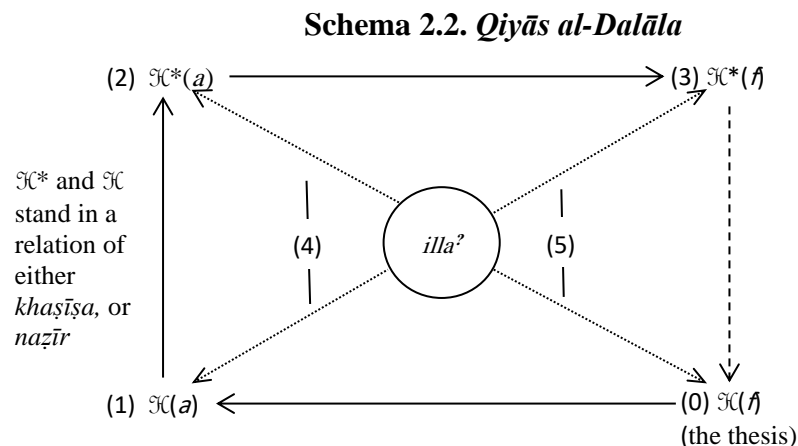

Notational keys:

" $\mathfrak{C}^*(a)$ " can be glossed as " Ruling \mathfrak{C}^* applies to the root-case"

" $\mathfrak{C}(a)$ " can be glossed as " Ruling \mathfrak{C} applies to the root-case"

" $\mathfrak{C}^*(f)$ " can be glossed as " Ruling \mathfrak{C}^* applies to the branch-case"

" $\mathfrak{C}(f)$ " can be glossed as " Ruling \mathfrak{C} applies to the branch-case"

"*illa*" can be glossed as " Rulings \mathfrak{C} and \mathfrak{C}^* are both dependent upon an unknown occasioning factor *illa* " The pointed arrows express the dependence of the indicators (i.e., the rulings \mathfrak{C} and \mathfrak{C}^*) upon the *illa*.

In order to extract the dialectical process of this type of inference, we need to read the arrows in the diagram as dialectical actions or argumentative moves. Let us now spell out each of those moves:

- the first and second actions (the arrow linking 0 with 1 and 1 with 2) express the *heuristic moves* of finding both a suitable root-case relevant for the sought ruling \mathfrak{C} and a second ruling \mathfrak{C}^* linked by some common (not identified) occasioning factor;
- the third action (the arrow linking 2 with 3) represents the result of establishing that the second ruling \mathfrak{C}^* also applies to the branch-case.
- despite the fact that the occasioning factor of the root-case is unknown, we have nevertheless the indication that the application of the rulings \mathfrak{C}^* and \mathfrak{C} to the root-case are close together (dash 4). Moreover, since the second ruling also applies to the branch-case, we can infer by this indication – rather than with certainty (dotted arrow from 3 to 0) – that the first ruling also applies to the branch-case. Dash 5 expresses that the inference from 3 to 0 replicates the link (dash 4) established between the two rulings for the root-case.

2.2.4. *Qiyās al-shabah*

والضرب الثالث هو قياس الشبه وهو أن يحمل فرع على أصل بضرب من الشبه.¹⁸

“The third type is *qiyās al-shabah*, and it is that a branch-case is linked to a root-case, by way of a type of resemblance.”

¹⁸ See al-Shīrāzī (2003, p. 209). Cf. al-Shīrāzī (2016, fol. 5a).

Unlike *qiyās al-dalāla*, the targeted conclusion is inferred by establishing a resemblance (*al-shabah*) between the root-case and the branch-case in relation to some relevant set of properties or rulings (al-Shīrāzī, 1988, p. 812).¹⁹

Notice that identifying the relevant properties (or rulings) does not amount here to establishing the efficiency (*ta'thīr*) required to become an occasioning factor; the only role of these properties (or rulings) is to provide a set in relation to which *aṣl* and *far'* can be said to be similar. Thus, if the set is a pair of rulings, those rulings are structured neither by a *khaṣīṣa*-relation nor by a *naẓīr*-relation.²⁰ Briefly, parallel reasoning displayed by *qiyās al-shabah* is based on a mere resemblance without any association, directly or indirectly, with the occasioning factor (*'illa*).

The dialectical moves underlying *qiyās al-shabah* can be schematized by means of the following informal diagram:

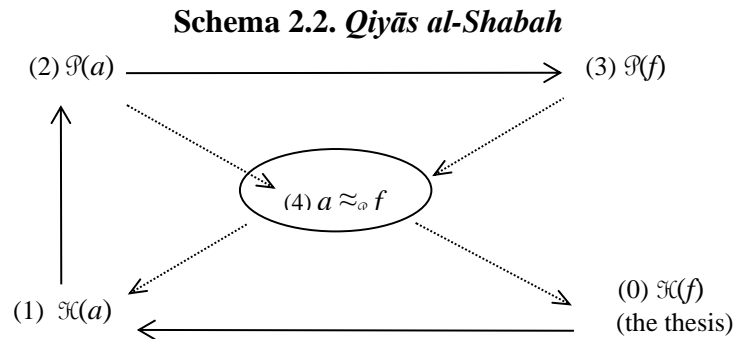

Let us spell out the main moves as depicted in the diagram:

- the first action (the solid arrow linking 0 with 1) amounts to the heuristic move of finding a suitable root-case;
- the second and the third (the solid arrows linking 1 with 2 and 2 with 3) indicate the result of finding out a set of properties or ruling(s) shared by the root-case and the branch-case. Let " \mathcal{P} " stand for the selected set of properties (or ruling(s));

¹⁹ See also the examples for this type of *qiyās* in *al-Luma'* (al-Shīrāzī, 2003, p. 101).

²⁰ It looks as if this type of *qiyās* is very close to Aristotle's *argument from likeness (homoiotes)*.

- The fourth action (two dash arrows linking 2 and 3 with 4) indicates the result of establishing the similarity of the root-case and the branch-case in relation to the set \mathcal{P} – the notation " $a \approx_{\mathcal{P}} f$ " expresses this similarity;
- The next (two dash arrows linking 4 with 1 and 0) indicates the result of inferring by analogy by means of substituting the root-case with the branch-case in (1) based on the similarity established in (4).

References

- Bartha, P. (2010). *By Parallel Reasoning; The Construction and Evaluation of Analogical Arguments*. Oxford: Oxford University Press.
- David, J. E. (2014). *Jurisprudence and Theology*. Dordrecht: Springer.
- Granström, J. G. (2011). *Treatise on Intuitionistic Type Theory*. Dordrecht: Springer.
- Hasan, A. (1986). *Analogical Reasoning in Islamic Jurisprudence: A Study of the Juridical Principle of Qiyas*. Islamabad: Islamic Research Institute.
- al-Ghazālī, Abū Hāmid. (1324 H/1906). *Al-Mustaṣfā min 'Ilm al-Uṣūl*. Būlāq: al-Maṭba'a al-Amīriyya.
- Ibn Ḥazm. (1926-1930). *Al-Ihkām fī Uṣūl al-Ahkām*. (Ed. Aḥmad Muḥammad Shākir). Cairo: Maṭba'at al-Sa'āda.
- Ibn Qudāma. (1998). *Rauḍa al-Nāzir wa-Jannat al-Munāzir*. Beirut: Mu'assasa al-Rayyān.
- al-Juwaynī, Imām al-Ḥaramayn. (1955). *Al-Waraqāt fī Uṣūl al-Fiqh*. On the margin of al-Maḥallī's Sharḥ al-Waraqāt. Hyderabad: Markaz Tau'iyya al-Fiqh al-Islāmī.
- Rahman, S., Granström, J. G., & Farjami, A. (2019). Legal Reasoning and Some Logic After All. The Lessons of the Elders. In D. Gabbay, L. Magnani, W. Park, & A.-V. Pietarinen, *Natural Arguments. A Tribute to John Woods* (pp. 743-780). London: CollegePublications.
- Rahman, S., Zidani, F., & Young, W. E. (2020). Ibn Hazm on Heteronomous Imperative. Landmark in the History of the Logical Analysis of Legal Norms. In P. McNamara, A. Jones, & M. Brown, *Deontic Logic*. Synthese Library-Springer. In print.
- Sharī'a, Ṣadr. (1357 H/1938). *Tanqīḥ al-Uṣūl*. Cairo: al-Maṭba'a al-Maḥmūdiyya al-Tijāriyya bi-l-Azhar.
- al-Shīrāzī, Abū Ishāq. (1407 H/1986). *Mulakhkhaṣ fī al-Jadal fī Uṣūl al-Fiqh*. (Ed. Muḥammad Yūsuf Ākhund Jān Niyāzī). MA Thesis, Umm al-Qura University.

- al-Shīrāzī, Abū Ishāq. (1987). *Al-Ma'ūna fī al-Jadal*. (Ed. 'Alī b. 'Abd al-'Azīz al-'Umayrīnī). Al-Şafāh, Kuwait: Manshūrāt Markaz al-Makhṭūṭāt wa-al-Turāth.
- al-Shīrāzī, Abū Ishāq. (1988). *Sharḥ al-Luma' fī Uşūl al-Fiqh*. (Ed. 'Abd al-Majīd Turkī). Beirut: Dār al-Gharb al-Islāmī.
- al-Shīrāzī, Abū Ishāq. (1995). *Al-Luma' fī Uşūl al-Fiqh*. (Ed. Muḥyī al-Dīn Dīb Mustū and Yūsuf 'Alī Badīwī). Damascus; Beirut: Dār al-Kalam al-Ṭayyib; Dār Ibn Kathīr.
- al-Shīrāzī, Abū Ishāq. (2003). *Al-Luma' fī Uşūl al-Fiqh*. Beirut: Dār al-Kutub al-'Ilmiyah.
- al-Shīrāzī, Abū Ishāq. (2016, February). *Mulakhkhaş fī al-Jadal*. Retrieved from https://upload.wikimedia.org/wikisource/ar/e/ea/الملخص_في_الجدل_خ.pdf
- Weiss, B. G. (1992). *Search for God's Law, Islamic Jurisprudence in the Writings of Sayf al-Dīn al-Amīdī*. Salt Lake City: University of Utah Press.
- Weiss, B. G. (1998). *The Spirit of Islamic Law*. Athens; London: The University of Georgia Press.
- Young, W. E. (2017). *The Dialectical Forge; Juridical Disputation and the Evolution of Islamic Law*. Dordrecht: Springer.

CHAPTER 3

DIALECTICAL SYSTEM OF *QIYĀS AL-‘ILLA*

As pointed out in the introduction, our study on Arsyad al-Banjari’s *qiyās* based on the systems of *qiyās* and its interface with *jadāl* theory as developed by al-Shīrāzī in his work. For that purpose, we employ an analysis that is based on a dialectical framework. However, we are not claiming (yet) that the framework we propose in the present study is either a literal description or a complete formalization of the *jadāl* disputation form in which the *qiyās* is carried out.

Our study provides a *dialectical meaning-explanation* of the main notion of correlational inference relevant for the development of al-Shīrāzī’s system of *qiyās*.¹ In other words, what we are aiming at is to set out a kind of interactive language game that makes apparent the dialectical meaning of the main notions involved in these forms of reasoning. Actually, since all of the steps prescribed by our dialogical framework are based on moves involved in al-Shīrāzī’s dialectical conception of *qiyās al-‘illa*, we think that our proposal can be further developed into a system for actual juridical disputation that provides a full reconstruction of *jadāl* as deployed in Islamic jurisprudence.²

Before delving into the dialectical structure, let us motivate the use of a notation inspired by Constructive Type Theory. In fact, we only deploy very basic features of the CTT-framework; a deep and thorough development is still due.

¹ The notion of *dialectical meaning-explanation* is the dialogical counterpart of Martin-Löf’s (inferential) *meaning-explanation* mentioned above. The dialectical meaning-explanation of an expression amounts to setting rules that establish how to challenge and defend that expression. These rules also indicate how to produce a local reason for a claim and how to analyze such a reason – see Sect. 3.3. in the present chapter.

² It is also worth mentioning that, to the best of our knowledge, there is no systematic study yet comparing the theory of juridical argumentation as developed within the Islamic tradition with the dialectical form of medieval disputations known as *Obligationes*. Such a study, that will fill up some flagrant gaps in the history of the development of rational argumentation, is certainly due.

3.1. Motivating the deployment of a CTT-framework

The expressive power of Per Martin L f's Constructive Type Theory³ allows the following features underlying the *qiyās* to be expressed at the object language level:

- 1) The stress on assertions (or judgements) rather than on propositional sentences. The dialectical process underlying correlational inferences is triggered by both an assertion concerning the identification of the factor occasioning the relevant ruling and the process of justifying such an assertion. In the specialized literature these assertions are called *ta 'līl* (affirmation of the relevance of a particular property for the determination of the *'illa*), or more generally *ithbāt* (affirmation).
- 2) The intensional rather than extensional understanding of the sets underlying the semantics of the *qiyās*.
- 3) The deployment of hypothetical judgements. This dovetails with the *qiyās*-notion of dependence of a given juridical ruling on a particular occasioning factor.
- 4) The restrictive form of the substitution rules.

The last point will be discussed in the next chapter since it relates to correlational inferences by resemblance.

Certainly, other formal reconstructions are possible, and in particular, we might not need an intensional framework in order to deal with changing extensions. However,

- 1) the deployment of intensional frameworks seems to be a natural approach in historical contexts⁴;
- 2) CTT provides a solid theory for the deployment of intensionally grounded **sets**⁵;
- 3) CTT seems to match well with dialectical approaches to meaning and normative approaches to logic, such as the dialogical one. This is particularly so in a CTT-

³ For a systematic presentation of CTT see Martin-L f (1984; 1996), Nordstr m, Petersson & Smith (1990; 2000), Ranta (1994), Granstr m (2011). For philosophical and historical insights into CTT see Ranta (1988), Primiero (2008), Sundholm (2009; 2012).

⁴ See for example, Marion & R ckert (2015) and Martin-L f (2012).

⁵ From now on we write "**set**" (boldface) instead of "set" in order to indicate that we deploy intensional sets as developed within CTT.

framework where non-mathematical propositions are understood as language-games, as suggested for the first time by Ranta.⁶

The main idea to be developed in the following two sections is that our framework allows to isolate within the general notion of occasioning factor its causal feature. Indeed, according to our approach, implementing the causal feature of the occasioning factor is reconstructed as the application of a method (function) that triggers a particular juridical decision $\mathfrak{H}(x)$, whenever a given action or event qualifies as being, let us say, a case of \mathcal{P} . For example, the factor that **occasions or causes** the interdiction $\mathfrak{H}(x)$ of entering someone else's house without permission is the application of a method or process that triggers the interdiction of those acts that qualify as cases of *Violation of Privacy* (i.e. to those acts that are elements of the set \mathcal{P} of cases of *Violation of Privacy*) and exempts of that interdiction those cases that do not constitute a case of *Violation of Privacy*. Thus, our reconstruction renders the implementation of the causal feature of the occasioning factor as having a purely dynamic nature, namely that of an act that causes some juridical sanction based on a qualification identified as relevant for that sanction. This allows us to distinguish the property relevant for some specific juridical sanction, from the actual procedure of triggering that sanction for some particular case. It is the triggering procedure that provides the notion of occasioning factor with its causal force.

In fact, the notion of occasioning factor as deployed in Islamic jurisprudence includes the following three main components:

- 1) *Wasf*, the property \mathcal{P} relevant for a juridical sanction \mathfrak{H} , such that the latter is defined as being specific to the set of cases defined by \mathcal{P} (e.g. those interdictions $\mathfrak{H}(x)$ that apply to consuming those drinks that instantiate the set \mathcal{P} of drinks inducing intoxication).
- 2) The efficiency feature or *ta'thīr*, that provides the means to test whether the property \mathcal{P} purported to be relevant for the juridical sanction at stake is indeed so.

⁶ Ranta (1994, pp. 55–7).

The test declines into two complementary procedures: testing *ṭard*, co-extensiveness or co-presence (if the property is present then the sanction too) and testing *‘aks*, co-exclusiveness or co-absence (if the property is absent, then so is the juridical sanction – the consumption of vinegar is in principle not forbidden). While co-extensiveness examines whether sanction \mathcal{K} follows from the verification of the presence of the property \mathcal{P} , co-exclusiveness examines whether exemption from the sanction \mathcal{K} follows from the verification of the absence of \mathcal{P} .

- 3) The causal feature, i.e., the legal method encoded by the function $b(x)$, that when applied to some instance a of the relevant property \mathcal{P} renders the ruling $\mathcal{K}(a)$ specific to that property. More precisely, when we focus on the causal feature of the occasioning factor, the function will be written as *‘illa*(x). The function *‘illa*(x) admits the substitution *‘illa*(a) for some case a (that satisfies the *wasf*), only after the efficiency of the property \mathcal{P} has been verified by the test *ta’thīr*.

3.1.1. The meaning-explanation of juridical rulings in *qiyās al-‘illa*

We first furnish the main formal elements of Martin-Löf’s theory which are relevant for our logical analysis.

3.1.1.1. Elements of CTT in the context of *qiyās al-‘illa*: the specificity of *wasf*

Per Martin-Löf’s (1984) Constructive Type Theory (CTT) provides a thorough formal framework whereby categorical and hypothetical judgements can be explicitly distinguished at the object-language level without conflating judgements with the propositions that constitute them.⁷

- **On Categorical Judgements.** In the CTT framework it is possible to express at the object-language level

⁷ More details on CTT can be found in the short introductory survey by Ansten Klev in Rahman, McConaughy, Klev & Clerbout (2018, chapter II).

A true,

which, when asserted by some individual **g**, conveys the information that this individual is in possession of some proof-object for *A*. Moreover, it can be rendered explicit by means of the **categorical judgement**

d: A,

which reads: *there is a proof-object d of A* – or the individual **g** can bring forward the proof-object *d* in support of his claim that *A* is *true*.

More generally, within CTT a proposition is interpreted as a **set** the elements of which represent the proofs of the proposition, the solution to a problem, and the fulfilments of an expectation. Accordingly,

d: A

A true

can be read as

d is an element of the **set** *A*

A has an element

d is a proof of the proposition *A*

A is *true*

d is a solution to the problem *A*

A has a solution

d fulfils the expectation *A*

A is fulfilled

Ranta (1994, p. 54) combines CTT with Davidson's (1980, essays 6-10) idea that an action makes an action-proposition *true*. Accordingly, the proposition:

(that) al-Fārābī read Aristotle's *Analytica Posteriora*

is made *true* by individual readings of al-Fārābī performing actions of that type. This interpretation is not far from the interpretation mentioned above of expectations as propositions and fulfilments as proof-objects. We will here follow Ranta's suggestion and assume that we have action-propositions that are made *true* by some evidence that some action of the type expressed by those propositions has been performed.

• **On Hypothetical Judgements.** One of the characteristic features of CTT is that it also allows, at the object-language level, the expression of a hypothetical judgements as a form of statement distinguishable from the assertion of the truth of an implicational

proposition. Hypothetical judgements give rise to dependency structures in CTT, such as

$B \text{ true } (x: A)$

or, in its explicit form:

$b(x): B (x: A),$

which reads: $b(x)$ is a (dependent) proof-object of B , provided x is a proof-object of the **set** A . Or, the function b takes elements from the **set** A , and yields proof-objects for B .⁸

In other words, in this frame the dependence of the truth of B upon the truth of A amounts to the dependence of the proof-object of B upon the proof-object of A . And the dependence of the proof-object of B upon the proof-object of A is expressed by means of the function $b(x)$ (from A to B), where x is a proof-object of A and where the function $b(x)$ itself constitutes the dependent proof-object of B .

In our context, we have the **set** of (evidences of) performances of actions qualified by a property \mathcal{P} (such, as say, *acts of Violation of Privacy*) and the **set** \mathcal{K} of juridical decisions **specific** to that property (*forbidding Violation of Privacy*). Thus, given the assertion $b(x): \mathcal{K}(x) (x: \mathcal{P})$, and the assertion that there is a performance a that qualifies as \mathcal{P} , then we can infer that performing action a (such as entering the house of someone else without permission), is forbidden.

In plain words, from the premises

- 1) Performances x of an action of the type *of Violation of Privacy* \mathcal{P} trigger the juridical process $b(x)$ by means of which those performances are sanctioned as forbidden ($b(x): \mathcal{K}(x) (x: \mathcal{P})$);
- 2) a is such a performance ($a: \mathcal{P}$);

we can infer that

Performance a is forbidden ($b(a): \mathcal{K}(a)$).

⁸ For example, intuitively, if A is the **set** of natural numbers and B is the **set** of whole numbers, then the function takes one natural number and yields an element of the **set** of whole numbers B , e.g. $b(x) = 2x$.

In short,

$$\frac{a: \mathcal{P} \quad b(x): \mathfrak{K}(x) (x: \mathcal{P})}{b(a): \mathfrak{K}(a)}$$

According to this analysis, the juridical meaning of a given ruling is rendered by the rules that establish its **dependence** upon a property identified as being relevant for that ruling. The identified property, as mentioned above, is called *wasf* (in our example the **set** \mathcal{P}) and determines the occasioning factor (the causal link) relevant to that ruling.⁹ Thus, assertions such as *Entering someone else's house without permission is forbidden* obtain their juridical meaning from those rules that establish how to justify this interdiction. The required form of justification is rooted in the **causal link** (implemented by the function $b(x)$) between the interdiction and the relevant property, in our case qualifying as an act of *Violation of Privacy*. In fact, as mentioned above, in order to isolate the causal agent, we will call the function $b(x)$ the '*illa*-function. It yields

$$\frac{a: \mathcal{P} \quad \textit{illa}(x): \mathfrak{K}(x) (x: \mathcal{P})}{\textit{illa}(a): \mathfrak{K}(a)}$$

Actually, the property occasioning the juridical rule is more naturally conceived as a predicate defined over a **set** rather than an independent **set**. For example, the property of *constituting an act of Violation of Privacy*, is naturally formulated as a subset of some **set** \mathcal{D} of *performances of acts*, "*separated*" by the *villa* property \mathcal{P} (i.e. we separate within \mathcal{D} the **subset** of those acts that qualify as acts of privacy-violation–

⁹ Hallaq (1985, pp. 88-91; 1987b, pp-50-58). See also Young (2017, p. 162).

a construction extensively discussed by the commentators of Aristotle).¹⁰ In CTT this alternative form of characterizing the relevant property yields the following:

Forbidden(x): prop ({x: Act | *Violation of Privacy(x)*})
 (subset-separation: the **set** of those elements of the **set** of acts that constitute violations of privacy)

The general abstract notation for arbitrary **set** \mathfrak{D} , and arbitrary property $\mathfrak{P}(x)$ qualifying elements of \mathfrak{D} is:

$\mathfrak{K}(x): \textit{prop} (\{x: \mathfrak{D} \mid \mathfrak{P}(x)\})$

In order to avoid a too heavy notation we will use the following formal notation:

Abstract abbreviated notation:

$\mathfrak{K}(x): \textit{prop} (\{x: \mathfrak{P}_{\mathfrak{D}}\})$

Abbreviated notation with explicit content:

Forbidden(x): prop (x: *Violation of Privacy*_{acts}).

According to the proposed abbreviation the specificity of the juridical decision $\mathfrak{K}(x)$ to those elements of the **set** \mathfrak{D} qualified as being $\mathfrak{P}(x)$ will carry the notation

'illa(x): $\mathfrak{K}(x)$ (x: $\mathfrak{P}_{\mathfrak{D}}$)

where *'illa(x)* is a legal procedure that yields some juridical decision $\mathfrak{K}(x)$ (such as *Forbidden(x)*) concerning elements of the **set** $\mathfrak{P}_{\mathfrak{D}}$ (in our example, acts that qualify as constituting cases of *Violation of Privacy*, such as inspecting the bags of someone else without permission, reading the correspondence of someone else without permission, ...).

This displays the relations of content linking ruling and property: the **relevance** of the property for the ruling. What we need now is to make it apparent that *Privacy-Violation* has the efficiency required to occasion the relevant juridical ruling. As

¹⁰ Alexander of Aphrodisias called such a form of construction *proseptic proposition* – see L. Gili (2015).

mentioned above, Islamic legal theorists identified three general conditions to be met by the *wasf* occasioning a ruling:

- 1) Efficiency (*ta`thīr*).
- 2) Co-extensiveness or co-presence (*tard*) – the presence of the property when the judgement is present.
- 3) Co-exclusiveness or co-absence (*‘aks*) – the absence of the property when the judgement is absent.

Arguments for endorsing some proposed property as efficient are based on showing both that when the property is present (*wujūd*) the ruling at stake is present, and that when the property is absent (*salb*) so is the property. It is quite often the case that an argument for endorsing a property as constitutive of the occasioning factor ends with the formulation:

Therefore, the presence of the ḥukm is due to the presence of the property, and the absence of the ḥukm is due to its absence.

Thus, a property is efficient (*ta`thīr*) in relation to a given ruling **if the ruling is defined in terms of this property** (relevance has been established) and the property satisfies both co-extensiveness (*tard*) and co-exclusiveness (*‘aks*). Let us then analyze

Privacy-Violation occasions the juridical ruling sanctioning its proscription – given the efficiency of Privacy-Violation in relation to that proscription.

as the construction

Cases of Privacy-Violation ($\mathcal{P}_v(x)$) occasion the interdiction $\mathcal{H}(x)$ – given the efficiency of $\mathcal{P}(x)$ in relation to $\mathcal{H}(x)$.

Furthermore, if the property $\mathcal{P}(x)$ is efficient in relation to the ruling $\mathcal{H}(x)$, then there is a method that provides the justification of applying the ruling to every case qualified as $\mathcal{P}_v(x)$ – and dually, it provides the justification of applying $\neg\mathcal{H}(x)$, given instances of $\neg\mathcal{P}_v(x)$. In the argumentative practice, the efficiency of a proposed property is tested by *choosing an arbitrary element a_i of the same set*, and showing that

If a_i has the tested property, then the juridical sanction follows.

If a_i is an element of \mathcal{D} but does not have the tested property $\mathcal{P}_{\mathfrak{D}}(x)$, then the juridical sanction $\mathfrak{K}(x)$ does not follow

The efficiency is said to have been established if it can be shown that this holds *for any arbitrary choice* of elements of $\mathcal{P}_{\mathfrak{D}}(x)$.

Example

Entering someone else's house without permission (a_1)

Entering someone else's house with the permission of the owner (a_2)

The first case, which constitutes a case of privacy-violation ($\mathcal{P}_{\mathfrak{D}}(a_1)$), is forbidden: $\mathfrak{K}(a_1)$. The second case, which does not constitute a case of privacy-violation ($\neg\mathcal{P}_{\mathfrak{D}}(a_1)$), is not forbidden: $\neg\mathfrak{K}(a_2)$. Therefore, acts of privacy-violation are forbidden because of the property $\mathcal{P}_{\mathfrak{D}}(x)$.

In such a context the factor occasioning the application of the ruling $\mathfrak{K}(x)$ to some case a is conceived as procedure of substitution *'illa*(x/a): $\mathfrak{K}(x/a)$, given $a: \mathcal{P}_{\mathfrak{D}}$. More generally, each particular instance of *Privacy-Violation* occasions the proscription of that instance. *E.g. entering the house of someone else without permission*, an instance of *Privacy-Violation*, provides the *'illa* occasioning the proscription of such an action. In other words, the occasioning factor in relation to a juridical ruling $\mathfrak{K}(x)$ defined over the set $\mathcal{P}_{\mathfrak{D}}$ is the function *'illa*(x) that for any instance of $\mathcal{P}_{\mathfrak{D}}$ it produces an instance of the ruling $\mathfrak{K}(x)$. However, this assumes that *tard* and co-exclusiveness (*'aks*) have been verified before.

Thus, establishing that a given ruling applies to the branch-case of the thesis involves two main steps:

- 1) Recognizing that the ruling $\mathfrak{K}(x)$ at stake is defined in terms of a property $\mathcal{P}_{\mathfrak{D}}$ and that there is a root-case exemplifying how a given normative method (specific to that ruling and property) occasions that every case that satisfies the property falls under the ruling (and dually, for the absence of that property). In other words, the

root-case exemplifies the application of the function that verifies the universal norm *Every x that is a \mathcal{P}_0 falls under the ruling $\mathfrak{C}(x)$* (and its dual),

2) Recognizing that this general norm also applies to the branch-case.

The point is that the construction underlying the meaning of application of the ruling to the root-case is, to put it in Bartha's terms, *precursor to a generalization*.¹¹ However, the idea is quite different from what is nowadays called *one-step induction*.¹² Indeed, identifying the occasioning factor for the root-case under consideration amounts to grasping it as exemplifying (the application of) a general law: this is what the notion of causality in *uṣūl al-fiqh* comes down to.

The generality of the norm results from a typical dialogical understanding of universal quantification, namely, that the challenger can choose an arbitrary element of the **set** at stake in order to test the efficiency of the property for triggering the legal sanction under scrutiny. If the efficiency claim resists the test of any arbitrary choice of the challenger, then the generality of the norm has been justified – for the dialogical interpretation of universal quantifiers see Rahman, Iqbal, & Soufi (2019, Chapter IV); Rahman, McConaughey, Klev, & Clerbout (2018).

Let us now have a closer look at the logical structure of the notion of efficiency.

3.1.1.2. More elements of CTT in the context of *qiyās al-illa*: on *ta'thīr*, *ṭard* and *'aks*

In the context of *jadāl* and dialectical frameworks, there are moves aimed at testing if the selected property is actually the one occasioning the juridical ruling. Let us take this time the widely discussed example of the *prohibition of consuming wine*. Let us further assume that the property selected as relevant was *being red*. The refusal to accept *being a red drink* as the factor occasioning the relevant ruling is not only a refusal to endorse the generalization *Every red drink is to be forbidden*. The refusal lies

¹¹ Bartha (2010, p. 109).

¹² See *e.g.* Bartha (2010, pp. 36–40).

deeper in the structure. It is about denying that *being a red drink* is legally relevant to the *prohibition of consuming wine*.¹³ This is what our formulation $\text{'illa}(x): \mathfrak{H}(x) (x: \mathcal{P}_\mathfrak{D})$ in the precedent section brings to the fore.

Accordingly, the logical form of the method $ta' th\bar{ir}^\mathfrak{P}$ that establishes the efficiency of the property $\mathcal{P}_\mathfrak{D}$ in relation to the ruling $\mathfrak{H}(x)$ is structured as follows:

$ta' th\bar{ir}^\mathfrak{P}$

{

ṭard: If x is a drink where toxicity is present (*wujūd*), then its consumption is forbidden. Thus, “*ṭard*” is the function that when applied to a drink inducing intoxication, yields a legal sanction forbidding its consumption.

ʿaks: if x is a drink where toxicity is absent (*salb*), then its consumption is not forbidden. Thus, “*ʿaks*” is the function that when applied to a drink that does not induce intoxication, yields a legal sanction allowing its consumption.

While *ṭard* triggers the sanction if the relevant property is present, *ʿaks* assures that the case under consideration *does not build an exception*.

In fact, the fully explicit formulation is: given the disjunction $\mathcal{P}_\mathfrak{D} \vee \neg \mathcal{P}_\mathfrak{D}$, of toxic drinks ($\mathcal{P}_\mathfrak{D}$) and non-toxic ones ($\neg \mathcal{P}_\mathfrak{D}$); and given that interdiction and non-interdiction for consumption have been defined in terms of this disjunction interdiction and non-interdiction distributes as follows:

*All those drinks inducing toxicity, if identical to the ones identified as the wujūd, are **forbidden for consumption** – i.e., they are forbidden if they are identical to the drinks instantiating the **left** side of the disjunction $\mathcal{P}_\mathfrak{D} \vee \neg \mathcal{P}_\mathfrak{D}$. Furthermore,*

*All those drinks not inducing toxicity, if identical to the ones identified as the salb, are **allowed for consumption** – i.e., they are allowed if they are identical to the drinks instantiating the **right** side of the disjunction $\mathcal{P}_\mathfrak{D} \vee \neg \mathcal{P}_\mathfrak{D}$.*

¹³ We borrowed the example from Hallaq (1985, pp. 88–9).

Technically speaking, “*wujūd*” and “*salb*” stand for functions (injections) that render the disjunction $\mathcal{P}_{\mathfrak{D}} \vee \neg \mathcal{P}_{\mathfrak{D}}$ *true*.¹⁴ Recall that in constructive logic, the truth of a disjunction requires not only some proof-object for the disjunction, but also an indication signaling which side of the disjunction is made *true* by that proof-object. Accordingly, while *wujūd* stands for the injective function from the **set** $\mathcal{P}_{\mathfrak{D}}$ to the **set** $\mathcal{P}_{\mathfrak{D}} \vee \neg \mathcal{P}_{\mathfrak{D}}$, *salb* stands for the injective function from the **set** $\neg \mathcal{P}_{\mathfrak{D}}$ to the **set** $\mathcal{P}_{\mathfrak{D}} \vee \neg \mathcal{P}_{\mathfrak{D}}$.

Thus, *wujūd* indicates that the disjunction $\mathcal{P}_{\mathfrak{D}} \vee \neg \mathcal{P}_{\mathfrak{D}}$ is *true* since its **left** side is made *true* by some element of $\mathcal{P}_{\mathfrak{D}}$; and *salb* indicates that the disjunction $\mathcal{P}_{\mathfrak{D}} \vee \neg \mathcal{P}_{\mathfrak{D}}$ is *true* since its **right** side is made *true* by some element of $\neg \mathcal{P}_{\mathfrak{D}}$; and $ta' th\bar{ir}^{\mathfrak{P}}(x)$ is the function:

$$ta' th\bar{ir}^{\mathfrak{P}}(x): \{ [(\forall y: \mathcal{P}_{\mathfrak{D}}) wuj\bar{u}d^{\vee}(y) =_{\{\mathcal{P}_{\mathfrak{D}} \vee \neg \mathcal{P}_{\mathfrak{D}}\}} x \supset \mathfrak{K}(y)] \wedge [(\forall z: \neg \mathcal{P}_{\mathfrak{D}}) salb^{\vee}(z) =_{\{\mathcal{P}_{\mathfrak{D}} \vee \neg \mathcal{P}_{\mathfrak{D}}\}} x \supset \neg \mathfrak{K}(z)] \} (x: \mathcal{P}_{\mathfrak{D}} \vee \neg \mathcal{P}_{\mathfrak{D}})$$

In other words, the function $ta' th\bar{ir}^{\mathfrak{P}}(x)$ provides the proof-object of the following hypothetical:

$$\{ [(\forall y: \mathcal{P}_{\mathfrak{D}}) wuj\bar{u}d^{\vee}(y) =_{\{\mathcal{P}_{\mathfrak{D}} \vee \neg \mathcal{P}_{\mathfrak{D}}\}} x \supset \mathfrak{K}(y)] \wedge [(\forall z: \neg \mathcal{P}_{\mathfrak{D}}) salb^{\vee}(z) =_{\{\mathcal{P}_{\mathfrak{D}} \vee \neg \mathcal{P}_{\mathfrak{D}}\}} x \supset \neg \mathfrak{K}(z)] \} true (x: \mathcal{P}_{\mathfrak{D}} \vee \neg \mathcal{P}_{\mathfrak{D}})$$

If we pull all this together and write it as a universal expression we obtain the following formalization, where the lambda-abstract of the function $ta' th\bar{ir}^{\mathfrak{P}}(x)$ constitutes the proof-object of the universal.¹⁵ In a dialectical framework the lambda-abstract $\lambda x.ta' th\bar{ir}^{\mathfrak{P}}(x)$ corresponds to those reasons that, at the strategic level, justify the universal assertion that co-extensiveness and co-exclusiveness are being satisfied –

¹⁴ In the notation of CTT *wujūd* and *salb* stand for special cases of the injections $\mathbf{i}(x)$ and $\mathbf{j}(x)$ – see Rahman, Iqbal, & Soufi (2019, Chapter IV); Rahman, McConaughy, Klev, & Clerbout (2018).

¹⁵ The proof-object of a universal such as $(\forall x: A) B$ *true* is $\lambda x. b: (\forall x: A) B$. Since in our case the function $b(x): B (x: A)$ is actually $ta' th\bar{ir}^{\mathfrak{P}}(x): [(\forall y: \mathcal{P}_{\mathfrak{D}}) wuj\bar{u}d^{\vee}(y) =_{\{\mathcal{P}_{\mathfrak{D}} \vee \neg \mathcal{P}_{\mathfrak{D}}\}} x \supset \mathfrak{K}(y)] \wedge [(\forall z: \neg \mathcal{P}_{\mathfrak{D}}) salb^{\vee}(z) =_{\{\mathcal{P}_{\mathfrak{D}} \vee \neg \mathcal{P}_{\mathfrak{D}}\}} x \supset \neg \mathfrak{K}(z)] (x: \mathcal{P}_{\mathfrak{D}} \vee \neg \mathcal{P}_{\mathfrak{D}})$, the proof-object of the universal is $\lambda x. ta' th\bar{ir}^{\mathfrak{P}}$. Note that $\lambda x.ta' th\bar{ir}^{\mathfrak{P}}(x)$ and $ta' th\bar{ir}^{\mathfrak{P}}(x)$ are entities of different types: while the latter is a function (i.e. a dependent object); we may conceive $\lambda x.ta' th\bar{ir}^{\mathfrak{P}}(x)$ as an (independent) individual that codes this function (see Rahman, Iqbal, & Soufi, 2019, Chapter IV; Rahman, McConaughy, Klev, & Clerbout, 2018).

in a nutshell: they stand for those objects that instruct the proponent of the universal to sanction the ruling $\mathfrak{K}(x)$ for any element (chosen by the antagonist) that enjoys the relevant property $\mathcal{P}_\mathfrak{D}$, and to sanction the non-application of the ruling if the chosen element does not enjoy that property (see Sect. 3.3.3. below; Rahman, Iqbal, & Soufi, 2019, Chapter IV; Rahman, McConaughey, Klev, & Clerbout, 2018).

$$\lambda x.ta' th\bar{r}^{\mathcal{P}}: (\forall x: \mathcal{P}_\mathfrak{D} \vee \neg \mathcal{P}_\mathfrak{D}) \{ [(\forall y: \mathcal{P}_\mathfrak{D}) wuj\bar{u}d^\vee(y) =_{\{\mathcal{P}_\mathfrak{D} \vee \neg \mathcal{P}_\mathfrak{D}\}} x \supset \mathfrak{K}(y)] \wedge [(\forall z: \neg \mathcal{P}_\mathfrak{D}) salb^\vee(z) =_{\{\mathcal{P}_\mathfrak{D} \vee \neg \mathcal{P}_\mathfrak{D}\}} x \supset \neg \mathfrak{K}(z)] \}.$$

In the dialectical framework to be developed in the next sections, one of the players, the Proponent **P**, claims that since the property \mathcal{P} satisfies efficiency in relation to sanction \mathfrak{K} , he can show that applying the branch-case to this property **causes** the juridical sanction \mathfrak{K} . This claim engages him to force **O** to endorse first the assertion

$$ta' th\bar{r}^{\mathcal{P}\mathbf{X}}[[p_i^{\mathbf{Y}}]]: (\forall x: \mathcal{P}_\mathfrak{D} \vee \neg \mathcal{P}_\mathfrak{D}) \{ [(\forall y: \mathcal{P}_\mathfrak{D}) wuj\bar{u}d^\vee(y) =_{\{\mathcal{P}_\mathfrak{D} \vee \neg \mathcal{P}_\mathfrak{D}\}} x \supset \mathfrak{K}(y)] \wedge [(\forall z: \neg \mathcal{P}_\mathfrak{D}) salb^\vee(z) =_{\{\mathcal{P}_\mathfrak{D} \vee \neg \mathcal{P}_\mathfrak{D}\}} x \supset \neg \mathfrak{K}(z)] \}$$

Generally speaking, the player **X** (**P** or **O**), who endorses such an assertion, claims that he has a reason for justifying the universal and that this *reason*, called *strategic reason*, has the form $ta' th\bar{r}^{\mathcal{P}\mathbf{X}}[[p_i^{\mathbf{Y}}]]$. The notation of the strategic reason stands for the following:

- $p_i^{\mathbf{Y}}$ is the value (object or performance of an action) chosen by the challenger to test the universal quantifier $(\forall x: \mathcal{P}_\mathfrak{D} \vee \neg \mathcal{P}_\mathfrak{D})$ – i.e., the challenger asks the defender to show that some arbitrary case p_i at stake p_i satisfies co-presence and co-absence. In the context of the debates under study the cases chosen by both of the players are precisely the branch-case and the root-case.
- $ta' th\bar{r}^{\mathcal{P}\mathbf{X}}$ is the process launched by **X** in order to test the efficiency of the property \mathcal{P} in relation to sanction \mathfrak{K} , with the help of the case p_k (chosen by the challenger). In the terminology of the dialogical framework (see Sect. 3.3.3. below) $ta' th\bar{r}^{\mathcal{P}\mathbf{X}}$

stands for the *instruction* to bring forward a *local reason* for the proposition (the conjunction) under the scope of the quantifier, given the antagonist's choice of p_k .¹⁶

- $ta' th\bar{r}^{\mathfrak{X}}[[p_i^{\mathfrak{Y}}]]$ encodes the process $ta' th\bar{r}^{\mathfrak{P}}$ for **any** p_i chosen by the challenger \mathfrak{Y} . In other words, it conveys the relevant moves by the means of which \mathfrak{X} succeeds in showing that any case p_i chosen by \mathfrak{Y} satisfies co-presence and co-absence.¹⁷

Accordingly, when we apply the process $ta' th\bar{r}^{\mathfrak{P}}$ to a concrete case a we verify if the property under consideration is or not relevant for the juridical sanction recorded by the sources. Coming back to our example, if *wine* (*grape-juice* in a state that induces intoxication) is chosen as the element that makes the disjunction *true*, and it is identified as one of those elements of the set of toxic drinks $\mathfrak{P}_{\mathfrak{D}}$ (that is, if $wine: \mathfrak{P}_{\mathfrak{D}}$) then, the sanction \mathfrak{K} interdicting its consumption follows. We can then say that the consumption of wine is forbidden **because** it induces intoxication.¹⁸

Technically speaking, the choice of wine triggers an **application** of the proof-object of the universal to wine which yields its interdiction for consumption – that is, the value of the function $ta' th\bar{r}^{\mathfrak{P}}(wine): \mathfrak{P}_{\mathfrak{D}}$ makes the proposition $\mathfrak{I}nterdiction(wine)$ true.¹⁹ In short, the application of $ta' th\bar{r}^{\mathfrak{P}}(x)$ to wine constitutes the **verification of the efficiency of property \mathcal{P}** for causing the proscription of wine-consumption. This leads us to deploy the following expression in order to indicate that the consumption of grape-juice, in the state of wine, is forbidden:

¹⁶ Within the language of CTT $ta' th\bar{r}^{\mathfrak{P}}$ stands for the **function** $ta' th\bar{r}^{\mathfrak{P}}(x): \{ [(\forall y: \mathfrak{P}_{\mathfrak{D}}) wuj\bar{u}d^{\vee}(y) =_{\{\mathfrak{P}_{\mathfrak{D}} \vee \neg \mathfrak{P}_{\mathfrak{D}}\}} x \supset \mathfrak{K}(y)] \wedge [(\forall z: \neg \mathfrak{P}_{\mathfrak{D}}) salb^{\vee}(z) =_{\{\mathfrak{P}_{\mathfrak{D}} \vee \neg \mathfrak{P}_{\mathfrak{D}}\}} x \supset \neg \mathfrak{K}(z)] \} (x: \mathfrak{P}_{\mathfrak{D}} \vee \neg \mathfrak{P}_{\mathfrak{D}})$.

¹⁷ While in the framework of CTT *encoding of a process* is a way to understand the role of a lambda operator on a function, in the dialogical framework the encoding is understood as a *recapitulation* or *reprise* of the moves constituting plays won by \mathbf{P} (see *strategic reason* in Rahman, Iqbal, & Soufi (2019, Chapter IV).

¹⁸ Dually, if grape-juice in a state that does not induce intoxication is the element that makes the (right side of the) disjunction *true*, then this substance is exempted from the interdiction.

¹⁹ More generally, if $c: (\forall x: \mathfrak{P}) \mathfrak{K}(x)$, $b(x): \mathfrak{K}(x)$ ($x: \mathfrak{P}$) and $a: \mathfrak{P}$, the application **ap** of c to a (i.e. **ap**(c, a), amounts to applying the lambda abstract of the function $b(x)$ to a (recall that the proof-object of a universal involving the function $b(x)$ is (or must be equal to) the lambda-abstract of that function) ; that is, **ap**(c, a) is equal to the value of $b(a)$ – see Rahman, Iqbal, & Soufi (2019, Chapter IV); Rahman, McConaughy, Klev, & Clerbout (2018).

$$ap(\lambda x.ta' th\bar{r}^{\mathfrak{P}}, wine): \mathfrak{K}(wine)$$

The point is that **applying** $\lambda x.ta' th\bar{r}^{\mathfrak{P}}$ to the case of *wine* amounts to the assertion that the function $ta' th\bar{r}^{\mathfrak{P}}(wine)$ provides the **verification** that the property \mathfrak{P} causes its interdiction:

$$ap(\lambda x.ta' th\bar{r}^{\mathfrak{P}}, wine) = ta' th\bar{r}^{\mathfrak{P}}(wine): \mathfrak{K}(wine)$$

The dialogical formulation of the strategic reason (i.e. the object that instructs how to develop a winning strategy for **P**) when **O** asserted the universal is the following:

$$ap[wine.ta' th\bar{r}^{\mathfrak{P}}]: \mathfrak{K}(wine)$$

This indicates that the strategic reason brought forward by **P** in order to justify the interdiction of wine amounts to launching the process of verification $ta' th\bar{r}^{\mathfrak{P}}$ for the case of wine (asserted to be one of the substances prone inducing intoxication).

Let us now develop the first steps towards the interactive stance.

3.2. Towards the interactive stance²⁰

In order to provide meaning-explanations to the basic notions of *qiyās* we deployed CTT which is rooted on natural deduction, whereas *qiyās*, as pointed out previously, is developed in a dialectical framework (*jadal*). Thus, we need now to motivate the interface of CTT with a dialectical framework. We will develop this motivation in three main steps, namely

- 1) by a (brief) discussion of the interface of *epistemic-assumption*, *formal rule* and the notion of *epistemic strength*;
- 2) by the distinction of play and strategic level and the notion of winning and losing within the dialectical framework underlying the system of *qiyās al- 'illa*;
- 3) by a brief explanatory note elucidating dialectical elements of *qiyās al- 'illa*.

²⁰ We owe the expression “*Interactive Stance*” to the title of Ginzburg (2012).

Yet, let us first remark that the dialectical framework we developed is not a specific logical system but rather a framework rooted in a rule-based approach to meaning in which *qiyās* can be developed. More precisely, *qiyās* is set in a dialogical framework where two parties argue about a thesis respecting certain fixed rules –that will be spelled out thoroughly in Sect. 3.3.3. The player that states the thesis is called Proponent (**P**), and his rival, who contests the thesis, is called Opponent (**O**).

3.2.1. Epistemic-assumptions, the formal rule and epistemic strength

In recent lectures in Paris, Per Martin-Löf (2015) advanced some important motivations for linking CTT with a dialectical conception of logic. They mainly involve the normative approaches to logic in general and to CTT in particular. The main proposal of Martin-Löf involves the deployment of the so-called *formal rule* of dialogical logic in order to provide a normative understanding of Göran Sundholm’s²¹ notion of *epistemic assumption*.²² Indeed, one of the main features of the dialogical framework is the so-called *formal rule*, nowadays more aptly named the *Socratic Rule*, by Marion & Rückert (2015), by the means of which:

the Proponent is entitled to use the Opponent’s moves in order to develop the defence of his own thesis.

Moreover, when the Proponent challenges some statement of the Opponent, such as a universal quantified one, he might ask the Opponent to concede that the selected individual falls under the kind of individuals about which the predicate is said to universally apply. This, as pointed out by Marion & Rückert (2015), is at the roots of

²¹ Sundholm (2013, p. 17).

²² “The solution [...], it seems to me now, comes naturally out of this **dialogical analysis** (not in bold in the original text). [...] the premises here should not be assumed to be known in the qualified sense, that is, to be demonstrated, but we should simply assume that they have been asserted, which is to say that others have taken responsibility for them, and then the question for me is whether I can take responsibility for the conclusion. So, the assumption is merely that they have been asserted, not that they have been demonstrated. That seems to me to be the appropriate definition of epistemic assumption in Sundholm’s sense.” Transcription by Ansten Klev of Martin-Löf’s talk in May 2015.

Aristotle's meaning-explanation of the universal quantifier in the *Prior Analytics* (A 24b28–29) as discussed in the *Topics* (© 157a34–37 and 160b1–6.), and has evident roots in Plato's dialogues (Cooper (1997)). The general point is that the Socratic Rule induces the players to bring explicitly all the premises to the fore in order to integrate them as part of the debate at stake:

*It is also worth emphasizing that the Socratic Rule is not merely projected on Plato's text: it has clear motivation within his dialogues, since it explains both Socrates' 'avowals of ignorance', as well as the 'doxastic' or 'say what you believe' constraint on Answerer's answers, for example, at **Protagoras** 331c–d or **Charmides** 166d–e.63. Indeed, it is of the utmost importance for Socrates qua Questioner that he does not introduce a premise of his own in Answerer's scoreboard, if he is convincingly to infer a contradiction from Answerer's beliefs. Otherwise, one would simply counter the charge of inconsistency by pointing out that one had not agreed to this or that premise. It is therefore important that the premises are put in Answerer's scoreboard only once Answerer has granted them—this is the 'say what you believe' constraint—but also that Socrates insists on his having no view on any given matter during the exchange—this being the 'avowal of ignorance', for example, in the middle of the game in **Lesser Hippias** 372b–e. As it turns out, Socrates very often introduces premises, but he always requests assent from the respondent. For that reason, readers often complain that Answerer is merely a sort of 'yes-man' to Socrates or whoever else is playing Questioner, for example, Parmenides in the second half of *Parmenides*, but this complaint misses the need for Answerer to be explicitly committed to all premises in his scoreboard.*

As we will see below, the Socratic Rule is crucial for the dialectical reconstruction of the logic underlying the *qiyās*. However, in such a context, the Socratic Rule needs to be refined and levelled: it must be extended to a context where content is at the basis of any concession of the Opponent.²³ In fact, the epistemological aims of the dialectical structure of the *qiyās* require the claims to be backed either by the sources or by some arguments. Only after this has been achieved will he (the Opponent) be prepared to provide a concession upon which the logical argument will rely.

Within the framework of the *qiyās* the Socratic Rule is given an additional new role, namely to structure the level of epistemic strength attained by its deployment, in relation to the ways the claim requested to be conceded is grounded:

- 1) If a player backs his claim with a reference to the sources, it has the maximal authoritative force and it must be conceded.

²³ Such kinds of dialogue are related to what is referred to as *material dialogues*. See E. C. Krabbe (2006), Keiff (2009).

- 2) If the Proponent backs his claim by appealing to the Opponent's own concessions during the dialectical process, then it has a logical force. *Logical force* underlies the logical fragments of a *qiyās*-process. However, Opponent's concessions (leaving aside the sources) might be the result of a cooperative move by the means of which the Opponent brings forward some kind of justification for the selection of a particular property, based on its efficiency in relation to the relevant ruling. More generally, Opponent's concessions, when not rooted in the sources, usually assume some underlying (often empirical) process leading to those concessions, particularly in the case of the branch-case (see below).
- 3) The deployment of concessions based on similarities and/or resemblances, has less authoritative and epistemic force than all the previous ones. This form of justification involves the deployment of *qiyās al-dalāla* and *qiyās al-shabah* that will be discussed in the next chapter.

Furthermore, one crucial step for the successful ending of the play by the Proponent is to force the Opponent to concede that the branch-case under consideration instantiates the proposed property \mathcal{P} as being the *wasf* relevant for occasioning the sanction \mathcal{K} . Before responding, the Opponent might ask for some kind of justification that this is the case. Take the example of acknowledging that the branch-case *date-wine* is a *toxic drink* – in a sense that causes its interdiction. The Proponent might need to bring some factual evidence of the presence of toxicity. There are several forms to implement this, for example assuming some sort of sub argument, by the means of which the players acknowledge the deployment of some kind of measurement or empirical test that provides the required evidence. In fact, we will keep only those plays where it is assumed that there is evidence that the branch-case instantiates the relevant property. In other words, we will assume that, once the general law expressing the occasioning factor has been identified and acknowledged by the Opponent, he will respond positively to the further request to acknowledge that the branch-case is an

instance of the relevant property.²⁴ In short, such kinds of assertions will be given the status of *epistemological assumptions*.

We will proceed in a similar way with requests concerning the acknowledgement that the root-case is an instance of the proposed property. However, notice that this move *does not* amount to recognizing the property as relevant for the determination of the occasioning factor: the Opponent can concede that the root-case satisfies some property (e.g. being a red drink) and at the same time refuse that this property is relevant for the juridical sanction under consideration (forbidden for consumption).

The point of such a way of proceeding is that if the Opponent rejects such kind of requests, there is something fundamentally wrong in the way the Proponent is developing his argumentation: if the property does not apply at all to either the root-case or the branch-case it is not really relevant for carrying out a *qiyās*-process (e.g. take the case where the Proponent asks the Opponent to acknowledge that *wine* is an animal product). If the proposed property does not apply, then the dialogues should start from scratch. This strategy has the desirable effect that the whole dialectical process focuses on the central point of *qiyās al-illa*, namely identifying the occasioning factor and deciding if it does or not apply to the branch-case: victory and defeat will be determined by the achievement or not of these main tasks. This is a consequence of inserting the deployment of the Socratic Rule to the branch-case within the sequence of moves that define a dialogical play for *qiyās al-illa*.

²⁴ If we examine closely many of al-Baṣrī's and al-Shīrāzī's own examples of debates, it is clear that their dialectical procedure assumes that, when this point of the debate has been achieved, the issue has been settled positively – that is, the empirical test has been carried out and the result is that the branch-case indeed satisfies property \mathcal{P} . It is interesting to note that Aristotle's dialectic games have a similar way of dealing with challenges on universals, by the means of which the challenger brings forward one individual in order to test the generality of the universal. The defender of the universal must accept that the individual instantiates the antecedent of a universal unless he can produce some evidence that this is not the case. This point is being worked out by Zoe McConaughey in her PhD thesis and has been implemented in Crubellier, McConaughey, Marion, & Rahman (2019).

3.2.2. The choice of the dialogical framework, the termination of *jadal* session and the aims of *qiyās al-‘illa*

As mentioned above, it is not our intention to develop a complete formalization of the *jadal*-structure underlying the *qiyās al-‘illa* but to provide the dialectical meaning-explanations of the main notions involved in this form of reasoning. This does not mean that we are not aiming at a formalization of the *jadal* theory at all. It is rather the case that in the present study we are engaged with the more modest target of setting the basic conceptual elements for such a development.

Today there are numerous dialectical frameworks to choose from for our task. Our choice is the dialogical framework of Paul Lorenzen and Kuno Lorenz²⁵ which seems natural given that we made the choice to deploy the formal language of CTT, and as argued in the preceding sections there are some good motivations for linking the epistemic perspectives of CTT with the dialogical approach to logic in general. We should now explain our choice of the dialogical conception of logic as our instrument for the study of dialectical structure underlying the theory of *qiyās* – leaving aside the important fact that Miller’s work, that sets a landmark in the understanding of *jadal*, deploys for his reconstruction notions stemming precisely from the dialogical framework of Lorenzen and Lorenz.

Let us recall that the very idea of developing a general system of *qiyās* was to achieve knowledge in an interactive setting that engaged hermeneutical, heuristic and logical moves.²⁶ One important feature of the objectives of deploying *qiyās* is that attaining victory by the use of linguistic traps or fallacies is absolutely excluded. In other words, what distinguishes the dialectical framework of the *jadal* from Sophistical dialectics is its ambition of pursuing truth. This feature of the *qiyās* dovetails nicely with the main normative tenets of the dialogical approach to logic. Indeed, the dialogical approach was developed in order to implement an epistemic and pragmatist

²⁵ P. Lorenzen and K. Lorenz (1978).

²⁶ See Miller (1984, pp. 9–14; 2020, pp. 5-8), Hallaq (1997, pp. 136–7), and Young (2017, p. 1).

conception of logic where meaning and knowledge are constituted by interaction, not in order to describe the logic of a dialogue. This is the main idea behind the Socratic Rule mentioned above: epistemological assumptions and textual data are internalized within a dialectical frame in such a way that all notions are cast into what Young calls the *dialectical forge*.

Furthermore, most (but not necessarily all) of the developments within the dialogical framework define plays as being finite and ending with the victory or defeat of one of the players. This feature of Lorenzen-Lorenz's dialogical framework, which provides the notion of proposition (Rahman, McConaughey, Klev, & Clerbout, 2018), makes good sense in the context of *jadal* since it is crucial that juridical debate ends, given that the final aim is to come to a juridical decision. In fact, in the theory of *jadal* the termination of a disputation (*inqiṭā'*) may be either *ilzām* or *ifhām*. There has been some evolution in relation to the meaning of these terms: in the early times it looks as if *ilzām* described the general situation of the defeat of one of the contenders, whereas later on it was attached to the Questioner's (Opponent's) concession of defeat. While developing our own dialogical reconstruction we adopted the following usage:

- 1) We describe the end of a debate where the Proponent has been brought to silence with the term *ifhām*.
- 2) We describe the end of a debate where the Opponent concedes defeat with the term *ilzām*.

In the context of *qiyās al-'illa*, the finiteness of the debates is assured by the fact that challenges to the efficiency of a proposed property amount to finding a counterexample within the sources (including the consensus of the experts). Certainly, a new debate might start later on; but then data and assumptions will have changed and we will be in the presence of a new cycle of the dialectical forge.

Still, it might look as if the terminology *winning* and *losing* a play and the resulting notion of *winning strategy*, an important feature of standard games within this dialogical framework, works against the *jadal* conception of a *cooperative endeavour*

towards the pursuit of truth²⁷. In our view, one of the epistemological results gathered by the examination of *jadal* is that it suggests a novel perspective on how to integrate cooperative and revision moves in a dialectical framework: a winning strategy is to be thought of as a kind of *recapitulation* of the different attempts to attain truth. According to our reconstruction, the existence of a winning strategy in this context includes the following steps:

- 1) *internal cooperation*: keeping only the successful moves (including sub-arguments) of the actual plays developed;
- 2) *external or metalogical cooperation*: including moves and plays that have not actually been played but that due to the background of existing factual and logical knowledge should have been considered.

The second step assumes the perspective of an expert in the field that prescribes how the debate should have proceeded.

What is at stake here is a particular form of what Kuno Lorenz calls *dialogische Geltung*,²⁸ or legitimacy, instead of logical validity. More precisely it is *material legitimacy*. In the context of *qiyās al-illa* legitimacy amounts to establishing whether there is or not enough evidence to decide about the application of a juridical ruling to the case at stake, given the epistemological circumstances involving the thesis and the logical features of the framework. So, the real target is to achieve a conclusion in relation to some particular legitimacy claim (*Geltungsanspruch*). Legitimacy claims are not to be thought of as bounded by the particular identity of a player: it is an intersubjective notion. If a claim is legitimate it is independent of the particular skills of the player who sustains it. Moreover, the existence of a winning strategy does not amount to the victory of any particular player. However, it is not about claims of logical universality either, but about content-based truth. A winning strategy within a debate structured by a system of *qiyās* displays the collective effort towards pursuing truth.

²⁷ Young (2017, p. 15).

²⁸ K. Lorenz (2000, pp 87–106).

As we will illustrate below, the development of a debate includes cooperative moves, called *mu'āraḍa*, by means of which a player might collaborate, with the task of grounding the main claim. As just explained, at the strategy level (the level at which the result of the whole dialectical procedure is evaluated), only the outcome of the collaboration will be displayed. This indicates that the normativity of the dialectical process underlying the *qiyās* admits the following stages:

- 1) conceptual normativity: the dialectical framework provides the notions by means of which the reasoning involving the legitimacy of the claims underlying a debate is to be developed;
- 2) heuristic normativity: the inclusion of cooperative moves allows correction and revision during a play in order to obtain the optimal moves for selecting the relevant property;
- 3) strategic normativity: the optimal moves in order to test the legitimacy of the main claim.

Summing up, while the first level involves the core of what normativity is, by providing us with what Jaroslav Peregrin calls the *material for reasoning*, the second and the third level correspond to normativity in the sense of *tactics*, or on *how to move*.²⁹ Al-Shīrāzī's dialectical framework leaves the precise description of the optimal moves open, since the inclusion of means for cooperation intends to provide a contextually dependent instrument for heuristic normativity. We will illustrate this point with some examples below.

Notice that revision takes place at the play level. If it is the main claim that must be revised by adding some fresh information, then strictly speaking there is no revision but rather a new start – because the original claim was thought to be knowledge but has been shown to be ungrounded. Thus, the dynamics underlying al-Shīrāzī's dialectical system of *qiyās* seems to be closer to what we nowadays call epistemic approaches rather than to non-monotonic reasoning.

²⁹ J. Peregrin (2014, pp. 228–9).

3.2.3. Dialectical elements of *qiyās al-‘illa*

3.2.3.1. Requiring justification: *muṭālaba*

The conditions of co-extensiveness and co-exclusiveness determine the way to challenge and defend the assertion that links property and ruling. A counterexample to the condition of *efficiency* amounts to bringing up a case where the purported property is not present and absent together with the ruling. In the context of a debate structured by the *qiyās*, if there is no evidence from the sources of a property $\mathcal{P}_\mathfrak{D}$ being the relevant one for the ruling $\mathfrak{K}(a\mathfrak{s}l)$ of the root-case, then $\mathcal{P}_\mathfrak{D}$ is only assumed to constitute the *‘illa* of the *aṣl*. So, we indicate this fact by

‘illa(*aṣl*): $\mathfrak{K}^\mathfrak{P}$ (*aṣl*)

instead of

‘illa(*aṣl*): $\mathfrak{K}_\mathfrak{S}^\mathfrak{P}$ (*aṣl*),

which indicates evidence from the sources.

Sometimes, we use the abbreviated forms

‘illa(*a*): $\mathfrak{K}^\mathfrak{P}$ (*a*)

‘illa(*a*): $\mathfrak{K}_\mathfrak{S}^\mathfrak{P}$ (*a*)

If the context makes it clear that the ruling has been defined to be specific for the property \mathcal{P} , we may leave it tacit. This yields the notations:

‘illa(*a*): \mathfrak{K} (*a*), and

‘illa(*a*): $\mathfrak{K}^\mathfrak{S}$ (*a*)

For the sake of notational simplicity, when occurring within a formula we write \mathcal{P} instead of $\mathcal{P}_\mathfrak{D}$

In the case where *‘illa*(*a*): $\mathfrak{K}^\mathfrak{P}$ (*a*) has been asserted rather than *‘illa*(*a*): $\mathfrak{K}_\mathfrak{S}^\mathfrak{P}$ (*a*), a justification for selecting the property $\mathcal{P}_\mathfrak{D}$ can be required: the request is called *muṭālaba*, more precisely *muṭālaba bi taṣhīḥ al-‘illa*. The justification process involves showing that the proposed property satisfies co-extensiveness and co-exclusiveness. This suggests the following dialectical structure:

- 1) the original claim on the applicability of a ruling to a case not recorded by the sources presupposes singling out a particular property;
- 2) a *qiyās al-‘illa* process contemplates the possibility of making explicit the reasons that led to select one property rather than a different one: this is what *muṭālabā* is about.

3.2.3.2. *Mu‘āraḍa*

The Opponent might counter the Proponent’s proposal by bringing up a competing argument; this kind of critique is called *mu‘āraḍa*.³⁰ For *qiyās al-‘illa*, the competing argument is related to the *‘illa* for the ruling at stake. In this context, the Opponent comes up with another property (*wasf*) challenging the property proposed by the Proponent as the factor occasioning the ruling under consideration and shows that the property proposed by him to constitute the *‘illa* is sounder than that proposed by the Proponent. The point here is that the Opponent is willing to collaborate with the task of searching for the relevant property. For this reason, Young calls it *constructive criticism*³¹ which is opposed to *destructive criticism*.

The *mu‘āraḍa* is launched in the dialogue when the Opponent thinks that the thesis is correct but he also thinks that the Proponent made wrong choices during his argumentation in support for it. For example, **thesis**: date-wine (*far‘*) is forbidden (⊗); **claim**: it is forbidden because, like grape-wine (*aṣl*), it is a fermented beverage (Ⓟ); **mu‘āraḍa**: grape-wine is forbidden because of its intoxicating nature (Ⓟ*), not because it is a fermented beverage since vinegar (*aṣl**) is fermented and not forbidden; however, like grape-wine, date-wine is intoxicating (Ⓟ*), so it is true that it should be forbidden (⊗).

On the other hand, if the Opponent assumes that the new *‘illa* he proposes for the root-case does not apply to the branch-case and, furthermore, entails the distinction

³⁰ See al-Shīrāzī (1092). The first part of this material is missing from *al-Ma‘ūna* which is edited by al-‘Umayrīnī.

³¹ Young (2017, p. 151).

between the root-case and the branch-case concerning the application of the ruling under consideration, then it is called *farq* or invalidating distinction. So, *farq*, according to al-Shīrāzī, is a special type of *mu'āraḍa*. Al-Bājī (2001, p. 101) points out that *farq* will lead the branch-case to fall under the opposite ruling ('*aks*) to that applied to the root-case. For example, **thesis**: fermented tea (*far'*) is forbidden (\mathfrak{C}); **claim**: it is forbidden because, like grape-wine (*aṣl*), it is a fermented beverage; **farq**: grape-wine is forbidden because of its intoxicating nature (\mathfrak{P}^*), not because it is a fermented beverage since vinegar (*aṣl^**) is fermented and not forbidden; therefore, given the fact that the fermented tea is not intoxicating ($\neg\mathfrak{P}^*$), it should not be forbidden ($\neg\mathfrak{C}$).

3.2.3.3. Forms of destructive criticism

The Opponent might react by *strongly* rejecting the Proponent's proposal. We distinguish two cases that we call (1) *Destruction of the thesis*; (2) *Destruction of the 'illa*.

The main target of the form of objection we call *destruction of the thesis* is the thesis rather than only objecting to the Proponent's proposal for determining the *'illa*. In such a case it is he, the Opponent, who has to bring forward a counterexample from the sources. This will trigger a sub-play where the Opponent develops his counter argumentation. In practice, the Opponent launches such a form of destructive criticism when he thinks that the claim of the thesis is incorrect and that the only way to correct it is to start from scratch.

This form of criticism declines into different kinds of objections distinguished by the type of counterexample brought forward. We will restrict ourselves to only five main forms of non-cooperative criticism. Let us point out that we decided to include the third one as implementing the destruction of the thesis, because of the examples found in the texts, but in principle it does not need to be classified in that way. Thus, according to our classification destruction of the thesis amounts to:

- 1) Bringing forward a root-case of which it is recorded that exactly the opposite of the claimed ruling applies, despite the fact that the property itself applies.³² It is called *qalb* (reversal). The counterexample undermines the *ṭard*-condition of the purported property – the property applies but the opposite of the ruling is the case. For example, **thesis**: saliva of beasts of prey (*far`*) is impure (س); **claim**: “being an animal whose meat is not eaten” determines the *illa*; **qalb**: the saliva of cats, which are animal whose meat is not eaten, is not impure.³³
- 2) Bringing forward a root-case of which it is recorded that a ruling different from the claimed ruling applies and that it has been acknowledged that both rulings are incompatible, despite the fact that the property itself applies. It is called, *naqd* (*inconsistency*).³⁴ The counterexample can also be seen as undermining the *ṭard*-condition (provided both rulings are incompatible). For example, **thesis**: killing (*far`*) should be punished with jail (س); **claim**: “having committed homicide” determines the *illa*; **naqd**: Some forms of homicide neither lead to jail nor to being set free but to the obligation of carrying out certain specific social services.³⁵
- 3) Bringing forward a root-case of which it is recorded that a ruling different to the claimed ruling applies despite the fact that the property, in fact a compound of properties, itself is present but with some qualifications. The point is that one component of the proposed compound property is not efficient in the sense that the claimed ruling applies inspite of the absence of that component; and the other(s) do not induce the expected ruling. It is called, *kasr* (*breaking apart*).³⁶ The

³² Our formulation is slightly more general than that of Young (2017, p. 166), since according to our setting the root-case that triggers the counterargument does not need to be the same as that chosen by the Proponent. The point is that if we follow Young’s restriction to only one root-case, then it all comes down to accepting or not that the ruling of the thesis applies to that root-case. This assumes that the Proponent either misinterprets the sources or misses some relevant evidence that can be found in those sources. Our formulation might be closer to a specific form of reversal called *reversal and oppositeness* (*al-qalb wa-al-‘aks*) – see Young, (2017, pp. 166–167).

³³ Young (2017, p. 166).

³⁴ See al-Shīrāzī (1987, p. 104)

³⁵ The example is in fact reconstructed from al-Baṣrī’s example quoted by Young (2017, p. 170).

³⁶ See al-Shīrāzī (1987, p. 107). Cf. Al-Baṣrī (1964, p. 821).

counterexample can also be understood as a particular form of *naqd*. This rule involved many discussions, and rightly so, since it looks as it comes close to committing the fallacy of compound and divided sense. The defender might reject the objection by insisting that his claim is about the *compound* taken as unity; not that each property taken separately, is efficient by their own to induce the judgment.³⁷ For example, *thesis*: interdiction (\mathfrak{C}) of trading merchandises which the buyer did not see at the time of the transaction-contract (*far`*); *claim*: “the merchandises (\mathfrak{P}_1) inaccessible to the beneficiary at the time of contract (\mathfrak{P}_2)” determines the *illa*; *kasr*: the property of being merchandise (\mathfrak{P}_1) is not efficient to occasion the interdiction since non-merchandise can also lead to such ruling; in addition, it seems that the remaining property (\mathfrak{P}_2) cannot induce the ruling since marriage is not forbidden even if at the time of contract the woman is closed before the future husband. Clearly, in this case, the defender might respond by pointing out that his claim involved the *compound of merchandise and its inaccessibility to the consumer*. It is about having no access in the context of transaction-contracts like purchasing or renting (*bay`*), not about inaccessibility of the subject of contract to the beneficiary in general.³⁸

One crucial feature of destructive criticisms of the thesis is that the counterexample must involve a root-case that is closely related to the branch-case proposed. In fact

³⁷ In fact expressions such as “the merchandises (\mathfrak{P}_1) inaccessible to the beneficiary at the time of contract (\mathfrak{P}_2)”, have either a *compound* understanding or a *divided* understanding. The compound understanding requires that if we isolate one of the components, it always carries information about the second component – technically speaking the way to isolate one component is to use the function *left-* and *right-projection*. In the divided understanding one can isolate one component that does not carry information about the other – technically speaking it amounts to the use of *injections*. One of the difficulties of *kasr* is that the Opponent seems to understand the construction in its divided sense, but the Proponent might insist that his claim assumes a compound sense.

³⁸ Young (2017, p. 175) points out that al-Juwaynī in the *Kāfiya* (1979, p. 211-213), pays a special attention to arguments against the validity of *kasr*. The contemporary author ‘Abd al-Karīm b. ‘Ālī b. Muḥammad al-Namla provided in his work *al-Muḥadhdhab fī ‘Ilm Uṣūl al-Fiqh al-Muqārin* (1999, pp 2287-2288) the following reconstruction of *kasr*. The Opponent starts by presenting a counterexample to the claim that the compound property at stake is inefficient for the relevant juridical ruling. The Proponent defends his claim by breaking the component and claim that the other part is the efficient one. If he succeeds, he justified the main claim if not it is the antagonist’s objection the one that is justified.

quite often, the counterexamples brought forward by a destructive criticism involve a root-case that is some subset of the branch-case. Thus, the criticism will proceed by forcing the Proponent to concede that the counterexample shows that the ruling to be applied contradicts the one claimed to hold for the branch-case.

The second form of objection, *destruction of the ‘illa*, will trigger a sub-play where the Opponent brings forward objections to the efficiency of the proposed *wasf*. Destruction of the *‘illa* is implemented by one of the following two criticisms:

- 4) Bringing forward a root-case to which the opposite ruling to the one proposed by the Proponent in the thesis applies, and, in fact, it is the property which defines the branch-case that is considered by the sources to be the factor occasioning that ruling. It is called *fasād al-waḍ’* (invalidity of occasioned status) and unlike the next criticism it amounts to producing evidence for a new *‘illa*. In short, the Opponent brings forward an *‘illa* that invalidates the one deployed by the Proponent and leads to the destruction of the thesis. For example, **thesis**: saliva of beasts of prey (*far’*) is impure (ﻓﻮﺣ); **claim**: “having canine teeth” determines the *‘illa*; **fasād al-waḍ’**: according to the sources, it is *being beast of prey* that is actually the factor occasioning the ruling *that saliva of cats is not impure*.³⁹
- 5) Bringing forward a root-case of which it is recorded that the claimed ruling applies despite the absence of the property claimed to specify the occasioning factor. It is called *‘adam al-ta’thīr* (lack of efficiency).⁴⁰ The counterexample undermines the *‘aks* condition.⁴¹ For example, **thesis**: the consumption of cherry red wine (*far’*) is forbidden; **claim**: “being a red intoxicating beverage” determines the *‘illa*; **‘adam al-ta’thīr**: grape white wine is forbidden, despite the fact that it is not a red intoxicating drink.⁴²

³⁹ al-Shīrāzī (1987, pp. 111-112). Cf. Young (2017, pp. 158–159).

⁴⁰ al-Shīrāzī (1987, pp. 100-101)

⁴¹ Young (2017, p. 162).

⁴² Hallaq (1985, pp. 88–89).

3.3. A dialogical framework for *qiyās al-‘illa*

One distinctive feature of dialogues for *qiyās* is that, though they involve the development of **plays**, the main aim of the Proponent is to provide a **winning strategy** for the thesis. More precisely, the main aim is to develop an argument in such a way that it forces the Opponent to concede that there is a winning strategy for the claim that the branch-case falls under the scope of the juridical sanction \mathfrak{K} . In other words, by running one or more relevant plays **P** will try to force **O** to concede that there is a strategic reason justifying his claim $\mathfrak{K}(\text{far}')$, and more precisely that the justification of the assertion takes the form

‘illa(far'): $\mathfrak{K}(\text{far}')$,

given **O**'s endorsement of far' : \mathcal{P} ;

and of **O ap**[far' : $\text{ta}'\text{thīr}^{\mathcal{P}}$]: $\mathfrak{K}(\text{far}')$.

i.e. **O**'s endorsement that the efficiency of the property \mathcal{P} has been verified.

Actually, the main claim is to be grounded by **running the plays** relevant for constituting a winning strategy. Furthermore, in real-life situations the running of a play might not provide the moves suitable for building a winning strategy. The winning strategy has to be understood as a kind of recapitulation of the relevant moves, including revisions (of weak moves) taking place at the play level (see introduction to 3.3.3 below). Accordingly, the prescriptions for the development of a dialogue for *qiyās* leave room for a move that it is not optimal and for its possible correction by the cooperative criticism of the Opponent. So, at the start of a dialogue, the strategic reason for the thesis is left tacit until the relevant plays have been run and the sequence of moves constituting the winning strategy has been described (see our remark on the strategic reason for such an assertion in 3.3.3.2).

Before developing a systematic presentation of the dialogical framework for *qiyās al-‘illa*, in order to facilitate the reading, let us present first the overall argumentative schema of a dialogue for *qiyās al-‘illa* with the following diagram. We also advise the reader to see the examples of dialogues provided at the end of this section.

Development of a play for *qiyās al-illa*

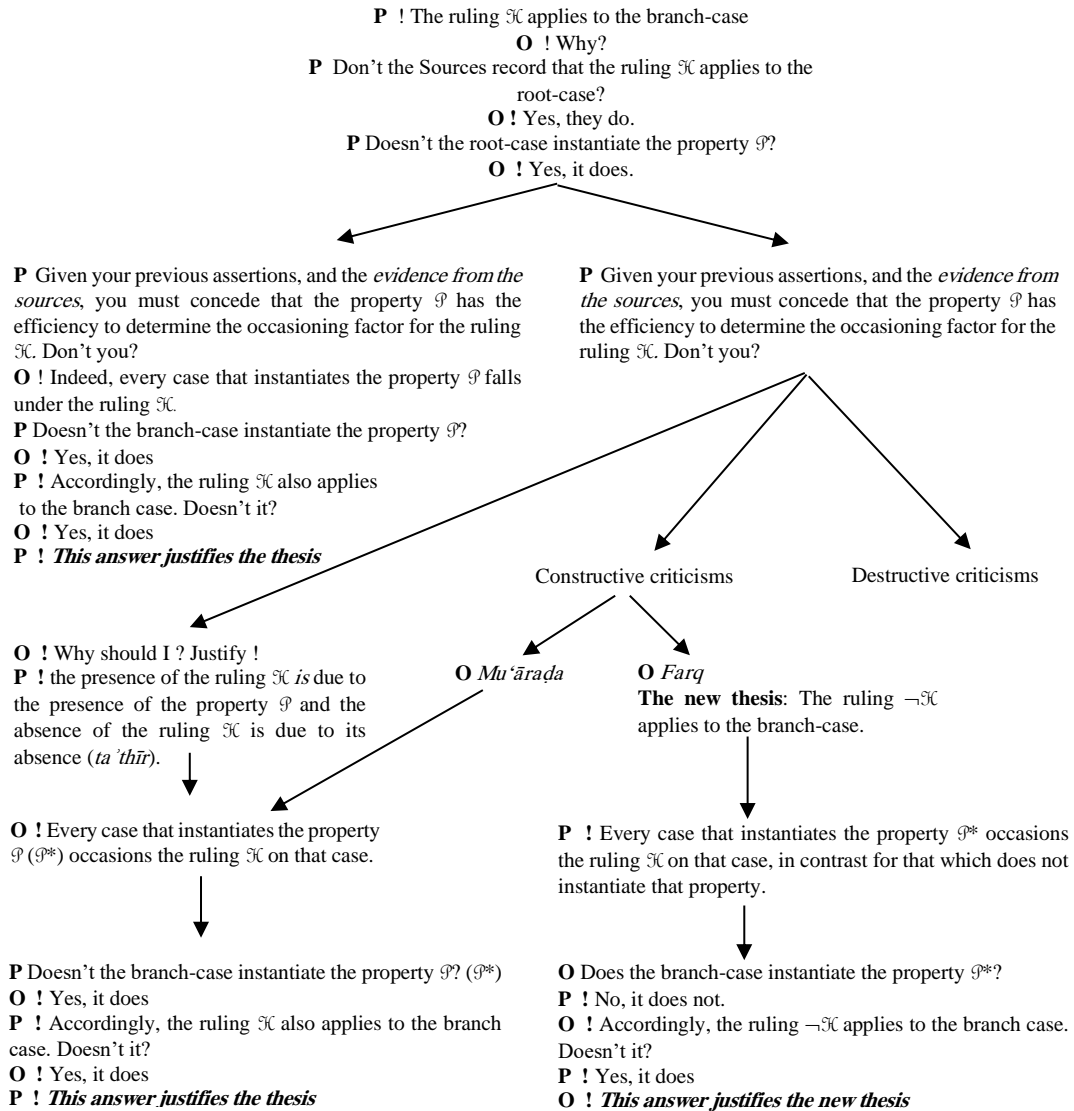

3.3.1. The dialogical approach to logic

The dialogical approach to logic is not a specific logical system but rather a framework rooted on a rule-based approach to meaning in which different logics can be developed, combined and compared.⁴³ More precisely, in a dialogue two parties argue about a

⁴³ In the following sections we present only a simplified and adapted form of the Dialogical Framework, called *Immanent Reasoning* – see Rahman, McConaughy, Klev, & Clerbout (2018). The main original

thesis respecting certain fixed rules. The player that states the thesis is called Proponent (**P**), and his rival, who contests the thesis, is called Opponent (**O**). Dialogues are designed in such a way that each of the plays end after a finite number of moves with one player winning, while the other loses. Actions or moves in a dialogue are often understood as speech-acts involving *declarative utterances or statements* and *interrogative utterances or requests*.

The point is that the rules of the dialogue do not operate on expressions or sentences isolated from the act of uttering them. The rules are divided into particle rules or rules for logical constants (*Partikelregeln*) and structural rules (*Rahmenregeln*). Particle rules provide an abstract description of how the game can proceed locally: they specify the way a formula can be challenged and defended according to its main logical constant. In this way the particle rules govern the local level of meaning (of logical constants – but it can be extended to non-logical ones). Strictly speaking, the expressions occurring in the table above are not actual moves because they feature formula schemata and the players are not specified. Moreover, these rules are indifferent to any particular situations that might occur during the game. For these reasons we say that the description provided by the particle rules is abstract. The structural rules determine the development of a dialogue game and they govern the moves involving elementary statements.

3.3.2. Local meaning

It is presupposed in standard dialogical systems that the players use well-formed formulas. The well formation can be checked at will, but only with the usual meta reasoning by which the formula is checked to indeed observe the definition of a wff. We want to enrich the system by first allowing players to enquire on the status of

papers are collected in Lorenzen & Lorenz (1978) – see too Lorenz (2010a, b), Felscher (1985), Krabbe (2006). For an account of recent developments see Rahman & Keiff (2005), Keiff (2009), Rahman & Tulenheimo (2009), Rückert (2011), Clerbout (2014a, b). The most recent work links dialogical logic and Constructive Type Theory, see Clerbout & Rahman (2015) and Rahman, Clerbout, & Redmond (2017).

expressions and in particular to ask if a certain expression is a proposition. We thus start with dialogical rules explaining the formation of propositions. Moreover, we extend the first-order language assumed in standard dialogical logic by adding two labels **O** and **P**, standing for the players of the game, and the two symbols ‘!’ and ‘?’. When the identity of the player does not matter, we use the variables **X** or **Y** (with $X \neq Y$). A move **M** is an expression of the form ‘**X**-*e*’, where *e* is one of the forms specified by the particle rules.

Local meaning: Formation

Statement	Challenge	Defence
X $A \vee B$: prop	Y $?_{F\vee 1}$ Or Y $?_{F\vee 2}$	X A : prop X B : prop
X $A \wedge B$: prop	Y $?_{F\wedge 1}$ Or Y $?_{F\wedge 2}$	X A : prop X B : prop
X $A \supset B$: prop	Y $?_{F\supset 1}$ Or Y $?_{F\supset 2}$	X A : prop X B : prop
X $\neg A$: prop	Y $?_{F\neg}$	X A : prop
X $(\forall x:A) B(x)$: prop	Y $?_{F\forall 1}$ Or Y $?_{F\forall 2}$	X A : set X $B(x)$: prop ($x:A$)
X $(\exists x:A) B(x)$: prop	Y $?_{F\exists 1}$ Or Y $?_{F\exists 2}$	X A : set X $B(x)$: prop ($x:A$)

Because our deployment expressions come from Constructive-Type Theory, the language contains expressions such as the following (further expressions are provided in the section on terminology in the main text):

- X** ! A Player **X** claims that he *can produce* some *local reason* for A .
- X** p : A Player **X** states that p instantiates A . In other words, player **X** states that p provides a *local reason* for A .

$\mathbf{X} p_i: B(p_j)$ Player \mathbf{X} states that p_i provides a *local reason* for B given that *the antagonist* \mathbf{Y} states that p_j provides a *local reason* for A , and given that $\mathbf{B}(x): \mathbf{prop}(x:A)$.

Similarly

$\mathbf{X} p_i: B(p_j)$ Player \mathbf{X} states that p_i provides a *local reason* for B given that it is *he himself* (\mathbf{X}), who states that p_j provides a *local reason* for A , and given that $\mathbf{B}(x): \mathbf{prop}(x:A)$.

Sometimes, when the context requires it, we add the indications $p_i^{\mathbf{X}}: B(p_j^{\mathbf{Y}})$ or $p_i^{\mathbf{X}}: B(p_j^{\mathbf{X}})$

Synthesis of local reasons

The **synthesis rules** of local reasons determine how to produce a local reason for a statement; they include rules of interaction indicating how to produce the local reason that is required by the proposition (or set) in play, that is, they indicate what kind of dialogical action –what kind of move – must be carried out, by whom (challenger or defender), and what reason must be brought forward.

Synthesis rules for local reasons

	Move	Challenge	Defence
Conjunction	$\mathbf{X} ! A \wedge B$	$\mathbf{Y} ? L^\wedge$ or $\mathbf{Y} ? R^\wedge$	$\mathbf{X} p_1: A$ (resp.) $\mathbf{X} p_2: B$
Existential quantification	$\mathbf{X} ! (\exists x: A)B(x)$	$\mathbf{Y} ? L^\exists$ or $\mathbf{Y} ? R^\exists$	$\mathbf{X} p_1: A$ (resp.) $\mathbf{X} p_2: B(p_1)$
Disjunction	$\mathbf{X} ! A \vee B$	$\mathbf{Y} ?^\vee$	$\mathbf{X} p_1: A$ or $\mathbf{X} p_2: B$
Implication	$\mathbf{X} ! A \supset B$	$\mathbf{Y} p_1: A$	$\mathbf{X} p_2: B$
Universal quantification	$\mathbf{X} ! (\forall x: A)B(x)$	$\mathbf{Y} p_1: A$	$\mathbf{X} p_2: B(p_1)$
Negation	$\mathbf{X} ! \neg A$ Also expressed as $\mathbf{X} ! A \supset \perp$	$\mathbf{Y} p_1: A$	$\mathbf{X} p_2: \perp$

Analysis of local reasons

Apart from the rules for the synthesis of local reasons, we need rules that indicate how to parse a complex local reason into its elements: this is the *analysis* of local reasons. In order to deal with the complexity of these local reasons and formulate general rules for the analysis of local reasons (at the play level), we introduce certain operators that we call *instructions*, such as $L^\vee(p)$ or $R^\wedge(p)$. To the standard particle rules (the local rules for logical constants) we also add rules for the operators \mathbb{F} and \mathbb{V} adapted to the purposes of our present study.

Let us introduce these instructions and the analysis of local reasons with an example: player \mathbf{X} states the implication $(A \wedge B) \supset A$. According to the rule for the synthesis of local reasons for an implication, we obtain the following:

Move	$\mathbf{X} ! (A \wedge B) \supset B$
Challenge	$\mathbf{Y} p_1: A \wedge B$

Recall that the synthesis rule prescribes that \mathbf{X} must now provide a local reason for the consequent; but instead of defending his implication (with $\mathbf{X} p_2: B$ for instance), \mathbf{X} can choose to parse the reason p_1 provided by \mathbf{Y} in order to force \mathbf{Y} to provide a local reason for the right-hand side of the conjunction that \mathbf{X} will then be able to copy. In other words, \mathbf{X} can force \mathbf{Y} to provide the local reason for B out of the local reason p_1 for the antecedent $A \wedge B$ of the initial implication. The analysis rules prescribe how to carry out such a parsing of the statement by using *instructions*.

The rule for the analysis of a local reason for the conjunction $p_1: A \wedge B$ will thus indicate that its defence includes expressions such as

- the left instruction for the conjunction, written $L^\wedge(p_1)$, and
- the right instruction for the conjunction, written $R^\wedge(p_1)$.

These instructions can be informally understood as carrying out the following step: for the defence of the conjunction $p_1: A \wedge B$ separate the local reason p_1 in its left (or right)

component so that this component can be adduced in defence of the left (or right) side of the conjunction.

Let us now proceed to present the **Analysis rules** for the usual logical constants.

Analysis rules for local reasons

	Move	Challenge	Defence
Conjunction	$X p: A \wedge B$	$Y ? L^\wedge$ or $Y ? R^\wedge$	$X L^\wedge(p): A$ (resp.) $X R^\wedge(p): B$
Existential quantification	$X p: (\exists x: A)B(x)$	$Y ? L^\exists$ or $Y ? R^\exists$	$X L^\exists(p): A$ (resp.) $X R^\exists(p): B(L^\exists(p))$
Disjunction	$X p: A \vee B$	$Y ?^\vee$	$X L^\vee(p): A$ or $X R^\vee(p): B$
Implication	$X p: A \supset B$	$Y L^\supset(p): A$	$X R^\supset(p): B$
Universal quantification	$X p: (\forall x: A)B(x)$	$Y L^\forall(p): A$	$X R^\forall(p): B(L^\forall(p))$
Negation	$X p: \neg A$ Also expressed as $X p: A \supset \perp$	$Y L^\neg(p): A$ $Y L^\supset(p): A$	$X R^\neg(p): \perp$ $X R^\supset(p): \perp$ Which amounts to stating $X ! \perp$ ⁴⁴

Special denominations for *qiyās al-illa*

Expressions “ p ” in “ $p: A$ ” stand for either some branch-case *far‘* or some root-case *aṣl*

⁴⁴ The general point of deleting the instruction in $X R^\supset(p): \perp$ is that instructions occurring in expressions stating **falsum** keep un-resolved – see below structural rule SR3 on resolutions, item 3.

Statement	Challenge	Defence
Synthesis $\mathbf{X} ! \mathcal{P}_2 \vee \neg \mathcal{P}_2$	$\mathbf{Y} ?^\vee$	$\mathbf{X} p_1: \mathcal{P}_2$ or $\mathbf{X} p_2: \neg \mathcal{P}_2$
Analysis $\mathbf{X} p: \mathcal{P}_2 \vee \neg \mathcal{P}_2$	$\mathbf{Y} ?^\vee$	$\mathbf{X} wujūd^\vee(p): \mathcal{P}_2$ or $\mathbf{X} salb^\vee(p): \neg \mathcal{P}_2$
Synthesis $\mathbf{X} ! (\forall x: \mathcal{P}_2) \mathfrak{K}(x)$ $\mathbf{X} ! (\forall x: \neg \mathcal{P}_2) \neg \mathfrak{K}(x)$	$\mathbf{Y} p_1: \mathcal{P}_2$ $\mathbf{Y} q_1: \neg \mathcal{P}_2$	$\mathbf{X} p_2: \mathfrak{K}(p_1)$ $\mathbf{X} q_2: \neg \mathfrak{K}(q_1)$
Analysis $\mathbf{X} p: (\forall x: \mathcal{P}_2) \mathfrak{K}(x)$ $\mathbf{X} q: (\forall x: \neg \mathcal{P}_2) \neg \mathfrak{K}(x)$	$\mathbf{Y} L^\vee(p): \mathcal{P}_2$ $\mathbf{Y} L^\vee(q): \neg \mathcal{P}_2$	$\mathbf{X} \text{'}tard(p): \mathfrak{K}(L^\vee(p))$ $\mathbf{X} \text{'}aks(q): \neg \mathfrak{K}(L^\vee(q))$
Synthesis $\mathbf{X} ! (\forall x: \mathcal{P}_2 \vee \neg \mathcal{P}_2) \{ [(\forall y: \mathcal{P}_2) wujūd^\vee(y) =_{\{\mathcal{P}_2 \vee \neg \mathcal{P}_2\}} x \supset \mathfrak{K}(y)] \wedge [(\forall z: \neg \mathcal{P}_2) salb^\vee(z) =_{\{\mathcal{P}_2 \vee \neg \mathcal{P}_2\}} x \supset \neg \mathfrak{K}(z)] \}$	$\mathbf{Y} p_1: \mathcal{P}_2$	$\mathbf{X} ta' thīr^\mathfrak{P}$: $\{ [(\forall y: \mathcal{P}_2) wujūd^\vee(y) =_{\{\mathcal{P}_2 \vee \neg \mathcal{P}_2\}} p_1 \supset \mathfrak{K}(y)] \wedge [(\forall z: \neg \mathcal{P}_2) salb^\vee(z) =_{\{\mathcal{P}_2 \vee \neg \mathcal{P}_2\}} p_1 \supset \neg \mathfrak{K}(z)] \}$ (similar for $\mathbf{Y} q_1: \neg \mathcal{P}_2$)
Analysis $\mathbf{X} p: (\forall x: \mathcal{P}_2 \vee \neg \mathcal{P}_2) \{ [(\forall y: \mathcal{P}_2) wujūd^\vee(y) =_{\{\mathcal{P}_2 \vee \neg \mathcal{P}_2\}} x \supset \mathfrak{K}(y)] \wedge [(\forall z: \neg \mathcal{P}_2) salb^\vee(z) =_{\{\mathcal{P}_2 \vee \neg \mathcal{P}_2\}} x \supset \neg \mathfrak{K}(z)] \}$	$\mathbf{Y} L^\vee(p): \mathcal{P}_2$	$\mathbf{X} . L^\vee(p). ta' thīr^\mathfrak{P}$: $\{ [(\forall y: \mathcal{P}_2) wujūd^\vee(y) =_{\{\mathcal{P}_2 \vee \neg \mathcal{P}_2\}} L^\vee(p) \supset \mathfrak{K}(y)] \wedge [(\forall z: \neg \mathcal{P}_2) salb^\vee(z) =_{\{\mathcal{P}_2 \vee \neg \mathcal{P}_2\}} L^\vee(p) \supset \neg \mathfrak{K}(z)] \}$ (similar for $\mathbf{Y} L^\vee(q): \neg \mathcal{P}_2$)

Actually, in the dialogues we write $\mathbf{X} . ap[L^\vee(p). ta' thīr^\mathfrak{P}]$ instead of $\mathbf{X} . [L^\vee(p). ta' thīr^\mathfrak{P}]$. Strictly speaking; the former expression corresponds to the strategy level (see section on strategies below), whereas the latter corresponds to the play level. This use assumes that the player \mathbf{X} has indeed a winning strategy.

Tanāquḍ

Statement	Challenge	Defence
$X ! A$ (or $p_i: A$) move m ... $X ! \neg A$ (or $p_j: \neg A$) move n	$Y ! \textit{tanāquḍ } m-n$ The antagonist indicates the contradiction	$X !$ I concede

The operator F ⁴⁵

In uttering the formula FA the argumentation partner X claims that he can find a counterexample during a play where the antagonist Y asserts A . The antagonist Y challenges FA by asserting that A can be challenged successfully. Thus, through this challenge Y obliges X to open a *sub-play* where he (X) states A .

- The rules for synthesis and analysis follow those of

$Y ! \neg A$

fulfilling the distribution of duties and rights prescribed for the role of Y in the sub-play.

In other words, the local meaning of the operator FA reduces to stating the negation of the proposition under its scope. However, this statement might change his duties in relation to the Socratic Rule

$X ! FA$	Challenge	Defence
	$Y ?F$	
	<i>Sub-play</i> \mathcal{D}_1	<i>Sub-play</i> \mathcal{D}_1
	$Y ! A$ Y must play under the restriction of the <i>Socratic-Rule</i> in the sub-play	$X ?_A$ (he challenges A) The local reason for the operator is the local reason that encodes a play for the negation of A .

⁴⁵ Cf. Rahman & Rückert (2001, pp. 113-116).

The operator \forall

In uttering the formula $\forall A$ the argumentation partner \mathbf{X} claims that he can win a play where he (\mathbf{X}) asserts A . The antagonist \mathbf{Y} responds by challenging \mathbf{X} to open a *sub-play* where he (\mathbf{X}) defends A .

- The rules for synthesis and analysis follow those of

$\mathbf{X} ! A$

fulfilling the distribution of duties and rights prescribed for the role of \mathbf{X} in the sub-play.

$\mathbf{X} ! \forall A$	Challenge	Defence
	$\mathbf{Y} : ?\forall$	
	<i>Sub-play</i> \mathcal{D}_1	<i>Sub-play</i> \mathcal{D}_1
	$\mathbf{Y} ?_A$ (he challenges A) \mathbf{Y} must play under the restriction of the <i>Socratic Rule</i>	<p style="text-align: center;">$\mathbf{X} ! A$</p> <p>The local reason for the operator is the local reason that encodes a play for A.</p>

3.3.3. Global meaning

3.3.3.1. Structural rules

In the dialogical approach, validity is defined via the notion of *winning strategy*, where winning strategy for \mathbf{X} means that for any choice of moves by \mathbf{Y} , \mathbf{X} has at least one possible move at his disposal such that he (\mathbf{X}) wins:

- Validity (definition)*: A proposition is valid in a certain dialogical system if and only if \mathbf{P} has a winning strategy for this proposition.

In the present context we will deploy a variant of the structural rules. Before providing them, let us fix the following notions:

- Play*: A *play* is a legal sequence of moves, *i.e.*, a sequence of moves which observes the game rules. Particle rules are not the only rules which must be observed in this respect. In fact, it can be said that the second kind of rules, namely, the *structural*

rules are those giving the precise conditions under which a given sequence is a play.

- **Dialogical game:** The *dialogical game* for φ , written $D(\varphi)$, is the set of all plays with φ being the *thesis* (see the Starting rule below).⁴⁶

The *structural rules* are the following:

SR0 (Starting rule)

Any dialogue starts with the Opponent stating initial concessions, if any, and the Proponent stating the thesis. After that the players each choose a positive integer called *repetition rank*. The *repetition rank* of a player restricts the number of challenges he can play in reaction to a single move.

SR1 (Game-playing rule)

SR1.1 (Classical game-playing rule)

Players move alternately. After the repetition ranks have been chosen, each move is a challenge or a defence in reaction to a previous move and in accordance with the particle rules.

SR1.2 (Intuitionistic game-playing rule)

Players move alternately. After the repetition ranks have been chosen, each move is a challenge or a defence in reaction to a previous move and in accordance with the particle rules. Players can only answer against the *last non-answered* challenge by the adversary.⁴⁷

SR2 (Socratic Rule)⁴⁸

⁴⁶ For a formal formulation see Clerbout (2014a, b).

⁴⁷ This last clause is known as the *Last Duty First* condition, and is the clause which makes dialogical games suitable for Intuitionistic Logic, hence the name of this rule.

⁴⁸ This, rule, as extensively discussed in Sect. 3.2.1. is one of the most salient characteristics of dialogical logic. In previous literature on dialogical logic this rule has been called the *copy-cat rule* or *Socratic rule* and it introduces a kind of asymmetry in the distribution of roles. Clearly, if the ultimate grounds of a dialogical thesis are elementary statements and if this is implemented by the use of the copy-cat rule, then the development of a dialogue is in this sense necessarily asymmetric. Indeed, if both

P cannot make an elementary statement if **O** has not stated it before, except in the thesis. An elementary statement is either an elementary proposition with implicit local reason, or an elementary proposition and its local reason (not an instruction).

SR2.1 Challenging elementary sentences

Challenges against elementary statements with implicit local reasons take the form:

$$\begin{array}{l} \mathbf{X} ! A \\ \mathbf{Y} ?_{reason} \\ \mathbf{X} a: A \end{array}$$

where A is an elementary proposition and a is a local reason.⁴⁹ In the context of dialogues for *qiyās* it can take the form:

$$\begin{array}{l} \mathbf{X} ! A \\ \mathbf{Y}_{why} ? \\ \mathbf{X} a: A \end{array}$$

SR2.1.2 Responses to challenges against elementary statements.

If **O** endorsed a statement of the form $\mathbf{O} ! A$ at move n , **P** can state " $you(i): A$ " which expresses that **P**'s reason for endorsing B is "you, the Opponent, have already endorsed B at move n ". It can also take the form

$$\begin{array}{l} \mathbf{P} ! A \\ \mathbf{O} Why ? \\ \mathbf{P} you(n): A \text{ (assuming } \mathbf{O} a: A \text{ at } n) \end{array}$$

SR2.1.3 Responses to challenges against the thesis of a *qiyās*

O's challenge to the thesis of a *qiyās al-'illa* is described by SR3.

SR2.1.4 Resolution of Instructions

- 1) A player may ask his adversary to carry out the prescribed instruction and thus bring forward a suitable local reason in defence of the proposition at stake. Once

contenders were restricted by the copy-cat rule no elementary statement can ever be uttered. Thus, we implement the copy-cat rule by designating one player, called the *Proponent*, whose utterances of elementary statements are restricted by this rule. It is the win of the Proponent that provides the dialogical notion of validity.

⁴⁹ For more details see structural rules for Immanent Reasoning SR5 in Rahman, Iqbal, & Soufi (2019, Chapter IV); Rahman, McConaughy, Klev, & Clerbout (2018).

the defender has replaced the instruction with the required local reason, we say that the instruction has been resolved.

- 2) The player index of an instruction determines which of the two players has the right to choose the local reason that will resolve the instruction.

For example:

$\mathbf{X} L_{\wedge}(p): A$
 $\mathbf{Y} ? \dots / L_{\wedge}(p)$
 $\mathbf{X} p_1: A$

The choice of a local reason for resolving an instruction is restricted by the distribution of rights and duties prescribed by the local rules.

Instructions occurring in expressions stating **falsum** have no resolution. In fact, the player stating $\mathcal{S}(p): \perp$ gives up and therefore loses the play. For more details see structural rules for Immanent Reasoning in Rahman, Iqbal, & Soufi (2019, Chapter IV); Rahman, McConaughey, Klev, & Clerbout (2018).

SR2.1.5 Requests and endorsements for *qiyās al-‘illa*.

Qiyās al-‘illa also requires the following moves prescribed by the **development rules** specific to the dialectical framework underlying this form of *qiyās*.

SR2.1.5.1 Requests based on sources.

If the request has a form that indicates sources, it **must** be endorsed by the respondent:

$$\begin{array}{ll} \mathbf{X} p^{\mathfrak{s}}: A? & \mathbf{X} ! A^{\mathfrak{s}}? \\ \mathbf{Y} p^{\mathfrak{s}}: A & \mathbf{Y} ! A^{\mathfrak{s}} \end{array}$$

(Since in the glosses of the examples, the backing from the sources is made explicit, we often do not add them explicitly to the notation).

SR2.1.5.2 Principal request in *qiyās al-‘illa*

The concern of *qiyās al-‘illa* is the efficiency of a property as required to be an occasioning factor. Therefore, the principal request of the Proponent in *qiyās al-‘illa* is to ask the Opponent to endorse that the property he proposed is the one that constitutes

the relevant occasioning factor.⁵⁰ The request is expressed by the following notation:

$$\mathbf{P} \text{ 'illa}(a\text{ṣl}): \mathfrak{K}^{\mathcal{P}}(a\text{ṣl})?$$

This principal request might trigger different forms of answer. The following responses are possible:

$$\mathbf{X} \text{ 'illa}(a\text{ṣl}): \mathfrak{K}^{\mathcal{P}}(a\text{ṣl})?$$

Cooperative criticism	Destructive Criticisms	Asking for Justification	Endorsing the request by asserting the efficiency of the property \mathcal{P}
$\mathbf{Y} ! \text{ mu 'āraḍa}$	$\mathbf{Y} ! \text{ qalb};$ $\mathbf{Y} ! \text{ naqḍ};$ $\mathbf{Y} ! \text{ kasr};$ $\mathbf{Y} ! \text{ fasād al-waḍ'}$; or $\mathbf{Y} ! \text{ 'adam al -ta 'thīr}$	$\mathbf{Y} ! \text{ muṭālaba}$	$\mathbf{Y} ! (\forall x: \mathcal{P}_{\mathfrak{D}} \vee \neg \mathcal{P}_{\mathfrak{D}}) \{ [(\forall y: \mathcal{P}_{\mathfrak{D}}) \text{ wujūd}^{\vee}(y) =_{\{\mathcal{P}_{\mathfrak{D}} \vee \neg \mathcal{P}_{\mathfrak{D}}\}} x \supset \mathfrak{K}(y)] \wedge [(\forall z: \neg \mathcal{P}_{\mathfrak{D}}) \text{ salb}^{\vee}(z) =_{\{\mathcal{P}_{\mathfrak{D}} \vee \neg \mathcal{P}_{\mathfrak{D}}\}} x \supset \neg \mathfrak{K}(z)] \}$

Which of the options are available is determined by the rules prescribing the overall development of a play for *qiyās al- 'illa*. We proceed to describe the development of the first three responses, the development of the fourth one (the universal) having already been described above.

SR2.1.5.3 *Muṭālaba*

$\mathbf{P} \text{ 'illa}(a\text{ṣl}): \mathfrak{K}^{\mathcal{P}}(a\text{ṣl})?$	\mathbf{P} asks \mathbf{O} to endorse that the property \mathcal{P} is the relevant one for occasioning the ruling of the root-case.
$\mathbf{O} \text{ muṭālaba} !$	\mathbf{O} asks \mathbf{P} for the justification.
$\mathbf{P} ! (\forall x: \mathcal{P}) \mathfrak{K}(x)$ $\mathbf{P} ! (\forall x: \neg \mathcal{P}) \neg \mathfrak{K}(x)$ $\mathbf{P} ! (\forall x: \mathcal{P}_{\mathfrak{D}} \vee \neg \mathcal{P}_{\mathfrak{D}}) \{ [(\forall y: \mathcal{P}_{\mathfrak{D}}) \text{ wujūd}^{\vee}(y) =_{\{\mathcal{P}_{\mathfrak{D}} \vee \neg \mathcal{P}_{\mathfrak{D}}\}} x \supset \mathfrak{K}(y)] \wedge [(\forall z: \neg \mathcal{P}_{\mathfrak{D}}) \text{ salb}^{\vee}(z) =_{\{\mathcal{P}_{\mathfrak{D}} \vee \neg \mathcal{P}_{\mathfrak{D}}\}} x \supset \neg \mathfrak{K}(z)] \}$	\mathbf{P} must be able to bring forward arguments showing that the property satisfies <i>ṭard</i> and <i>'aks</i> . If he succeeds, he can state the efficiency (<i>ta 'thīr</i>) of the property as required to be the occasioning factor.

⁵⁰ In the context of *jadal* this move is called “*ta 'līl*” by the means of which the Proponent asserts that a given property determines the factor occasioning the relevant ruling. See Young (2017, pp. 24–25)

SR2.1.5.4 *Mu‘āraḍa*

As already mentioned, the Opponent might react by deciding to cooperate by proposing a more precise formulation of the property advanced or by proposing a new property for the constitution of the occasioning factor. This will trigger a sub-play where the Opponent will defend the choice of an alternative property.

P <i>‘illa</i> ($a\mathfrak{A}l$): $\mathfrak{K}^{\mathcal{P}}(a\mathfrak{A}l)$?	P asks O to endorse that the property \mathcal{P} is the relevant one for occasioning the ruling of the root-case.
O ! \forall <i>‘illa</i> ($a\mathfrak{A}l$): $\mathfrak{K}^{\mathcal{P}^*}(a\mathfrak{A}l)$	O refuses to endorse the requested assertion and starts by asserting that the relevant factor for the root-case at stake is the property \mathcal{P}^* rather than \mathcal{P} .
P <i>muḥālabā</i> !	If the assertion of O is rooted in the sources, P must accept it and the play will continue. If it is not based on the sources P responds by challenging O to open a <i>sub-play</i> where the latter must defend his thesis.

Before providing the required justification, O might first choose to force P to accept that there is a root-case that contradicts P’s choice of P as relevant for the ruling at stake.

Start of a sub-play; P’s contradiction

O $a\mathfrak{A}l^*$: \mathcal{P} ? P $a\mathfrak{A}l^*$: \mathcal{P}	O searches for a new root-case to which \mathcal{P} applies.
O ! $(\forall x: \mathcal{P}_{\mathfrak{D}} \vee \neg \mathcal{P}_{\mathfrak{D}}) \{ [(\forall y: \mathcal{P}_{\mathfrak{D}}) wujūd^{\vee}(y) =_{\{\mathcal{P}_{\mathfrak{D}} \vee \neg \mathcal{P}_{\mathfrak{D}}\}} x \supset \mathfrak{K}(y)] \wedge [(\forall z: \neg \mathcal{P}_{\mathfrak{D}}) salb^{\vee}(z) =_{\{\mathcal{P}_{\mathfrak{D}} \vee \neg \mathcal{P}_{\mathfrak{D}}\}} x \supset \neg \mathfrak{K}(z)] \}$?	O forces P to agree that according to the presupposition \mathcal{P} has the efficiency required for producing the ruling
P ! $(\forall x: \mathcal{P}_{\mathfrak{D}} \vee \neg \mathcal{P}_{\mathfrak{D}}) \{ [(\forall y: \mathcal{P}_{\mathfrak{D}}) wujūd^{\vee}(y) =_{\{\mathcal{P}_{\mathfrak{D}} \vee \neg \mathcal{P}_{\mathfrak{D}}\}} x \supset \mathfrak{K}(y)] \wedge [(\forall z: \neg \mathcal{P}_{\mathfrak{D}}) salb^{\vee}(z) =_{\{\mathcal{P}_{\mathfrak{D}} \vee \neg \mathcal{P}_{\mathfrak{D}}\}} x \supset \neg \mathfrak{K}(z)] \}$	
O $a\mathfrak{A}l^*$: \mathcal{P} P <i>ap</i> [$a\mathfrak{A}l^*.f^{\mathcal{P}}$]: $\mathfrak{K}(a\mathfrak{A}l^*)$ (move <i>n</i>) O $\neg \mathfrak{K}^{\mathfrak{C}}(a\mathfrak{A}l^*)$? P ! $\neg \mathfrak{K}^{\mathfrak{C}}(a\mathfrak{A}l^*)$ (move <i>m</i>)	O then forces P to contradict himself in relation to the applicability of the ruling to the new-root case by forcing P to concede that, based the endorsement, the ruling should apply to the new root-case, however according to sources, the other way round.
O ! <i>tanāquḍ n-m</i>	O indicates the contradictory moves and P must concede.

At this point of the dialogue, the sub-play might continue with two alternatives.

1st alternative: Start of the constructive contribution within the sub-play

$\mathbf{P} ! (\forall x: \mathcal{G}^*) \vee \neg \mathcal{G}^*) \{ [(\forall y: \mathcal{G}^*) w^\vee(y) = \{ \mathcal{G}^* \vee \neg \mathcal{G}^* \} \mathcal{X} \supset \mathfrak{K}^{\mathcal{C}^{\mathcal{S}}}(y)] \wedge (\forall z: \neg \mathcal{G}^*) s^\vee(z) = \{ \mathcal{G}^* \vee \neg \mathcal{G}^* \} \mathcal{X} \supset \neg \mathfrak{K}^{\mathcal{C}^{\mathcal{S}}}(z)] \}$	After P 's contradiction, O starts his constructive contribution by displaying the efficiency of a new property. Herewith he answers to the request of justification.
--	---

End of the 1st alternative sub-play

P accepts the suggestion developed in the constructive fragment of the sub-play and deploys it for the justification of the thesis so far as the branch-case instantiates \mathcal{G}^* .

The tree displaying the winning strategy will delete the unsuccessful attempts and also the justification of the sub-play.

2nd Alternative (*al-farq*): New start of the dialogue within the sub-play

$\mathbf{O} ! \neg \mathfrak{K}(\textit{far}')$	O starts his constructive contribution by proposing a new thesis that it is the opposite ruling that should apply to the branch-case; and P ask for the reason.
$\mathbf{P} \textit{Why} ?$	
$\mathbf{O} ! (\forall x: \mathcal{G}^*) \vee \neg \mathcal{G}^*) \{ [(\forall y: \mathcal{G}^*) w^\vee(y) = \{ \mathcal{G}^* \vee \neg \mathcal{G}^* \} \mathcal{X} \supset \mathfrak{K}^{\mathcal{C}^{\mathcal{S}}}(y)] \wedge (\forall z: \neg \mathcal{G}^*) s^\vee(z) = \{ \mathcal{G}^* \vee \neg \mathcal{G}^* \} \mathcal{X} \supset \neg \mathfrak{K}^{\mathcal{C}^{\mathcal{S}}}(z)] \}$	O then displays the efficiency of a new property; and P concedes it.
$\mathbf{O} \textit{far}' : \neg \mathcal{G}^* ?$	O ask P to acknowledge that the new property does not apply to the branch-case; and P acknowledges it.
$\mathbf{P} ! \textit{far}' : \neg \mathcal{G}^*$	
$\mathbf{O} \textit{far}' : \neg \mathcal{G}^*$	O challenges the ' <i>aks</i> ' component of the <i>ta'thīr</i> previously conceded by P ; and P is forced to concede that it is the opposite ruling that applies to the branch-case. This justifies the new thesis proposed by O .
$\mathbf{P} \textit{ap}[\textit{far}' . \textit{t}^{-\mathcal{G}^*}] : \neg \mathfrak{K}(\textit{far}')$	
$\mathbf{O} \neg \textit{illa}(\textit{far}') : \neg \mathfrak{K}(\textit{far}')$	
$\mathbf{P} \textit{Iḥām}$	P concedes defeat.

End of the 2nd alternative sub-play

After the objection and the constructive contribution of **O**, the *qiyās* is rewritten with the new thesis proposed by **O** (New Proponent), namely $\neg \mathfrak{K}(\textit{far}')$. The tree displaying the winning strategy will delete the unsuccessful attempts.

SR2.1.5.4 Destructive criticisms

The Opponent might also react by simply destroying the causal link between the property and the ruling as proposed by the Opponent. This will trigger a sub-play where the Opponent develops his counter argumentation. This form of criticism declines into

different kinds of objections distinguished by the type of counterexample brought forward.

1) *Qalb*

The Opponent is committed to a sub-play where he brings forward a root-case of which it is recorded that an opposite ruling to the claimed ruling applies. Hence the root-case is presented as a counterexample to the Proponent's claim that every \mathcal{P} falls under the ruling \mathcal{K} and in particular to the claim that this ruling applies to the branch-case.

P <i>'illa(aṣl):</i> $\mathcal{K}^{\mathcal{P}}(aṣl)$?	P asks O to endorse that the property \mathcal{P} is the relevant one for occasioning the ruling of the root-case.
O ! F $(\forall x:\mathcal{P}) \mathcal{K}(x)$	Instead of endorsing P 's assertion, O rejects it completely and launches a sub-play where he is committed to show that the property \mathcal{P} does not satisfy the requirement to be the factor occasioning the ruling.
P ! $(\forall x:\mathcal{P})\mathcal{K}(x)$	P insists that the property \mathcal{P} does satisfy the conditions to be the factor occasioning the ruling.
O $a^*:\mathcal{P}$	O challenges P 's assertion by bringing forward a^* that instantiates \mathcal{P} .
P ! $\mathcal{K}(a^*)$	P is forced to concede that a^* falls under the ruling \mathcal{K} .
O $\neg\mathcal{K}^{\mathcal{O}}(a^*)$?	O comes with evidence from the sources that it is the ruling $\neg\mathcal{K}$ (i.e. the opposite ruling to the claimed ruling) that actually applies to a^* .
P ! $\neg\mathcal{K}^{\mathcal{O}}(a^*)$	Since the evidence from the sources, P is forced to concede that the ruling $\neg\mathcal{K}$ applies to a^* .
O ! <i>tanāqud</i>	O indicates P 's contradiction.
P <i>Ifhām</i>	P concedes defeat.

2) *Naqd*

The Opponent is committed to a sub-play where he brings forward a root-case of which it is recorded that a different ruling to the claimed ruling applies and both rulings are incompatible. Hence the root-case is presented as a counterexample to the Proponent's assertion that every \mathcal{P} falls under the ruling \mathcal{K} and in particular to the claim that this ruling applies to the branch-case.

P <i>'illa(aṣl):</i> $\mathcal{K}^{\mathcal{P}}(aṣl)$?	P asks O to endorse that the property \mathcal{P} is the relevant one for occasioning the ruling of the root-case.
O ! F $(\forall x:\mathcal{P}) \mathcal{K}(x)$	Instead of endorsing P 's assertion, O rejects it completely and launches a sub-play where he is committed to show

	that the property \mathcal{P} does not satisfy the requirement to be the factor occasioning the ruling.
P! $(\forall x: \mathcal{P})\mathcal{K}(x)$	P insists that the property \mathcal{P} does satisfy the conditions to be the factor occasioning the ruling.
O $a^*: \mathcal{P}$	O challenges P 's assertion by bringing forward a^* that instantiates \mathcal{P} .
P! $\mathcal{K}(a^*)$	P is forced to concede that a^* falls under the ruling \mathcal{K} .
O $\mathcal{K}^{\circ\circ}(a^*)$?	O comes with evidence from the sources that the ruling \mathcal{K}° (the ruling other than the claimed ruling) applies to a^* .
P! $\mathcal{K}^{\circ\circ}(a^*)$	Since the evidence from the sources, now, P is forced to concede that the ruling \mathcal{K}° applies to a^* .
O! $(\mathcal{K}(a^*) \wedge \mathcal{K}^{\circ}(a^*)) \supset \perp$	O indicates P 's inconsistency that leads to the invalidation of P 's argument.
P <i>Iḥām</i>	P concedes defeat.

3) *Kasr*

Given the Proponent's claim that the relevant property is in fact the compound (it could be also composed by more than two properties), then the Opponent is committed to a sub-play where he brings forward a root-case to which the ruling applies despite the absence of one of the properties, that is to say that this property is inefficient in relation to the ruling. Moreover, it is the case that the remaining property (or cluster of properties) cannot induce the ruling.⁵¹

P <i>'illa(aṣl):</i> $\mathcal{K}^{\mathcal{P}_1 \wedge \mathcal{P}_2}(aṣl)$?	P asks O to endorse that the conjunction of $\mathcal{P}_1 \wedge \mathcal{P}_2$ is the relevant one for occasioning the ruling of the root-case.
O ! F $(\forall x: \mathcal{P}_1 \wedge \mathcal{P}_2) \mathcal{K}(x) \wedge (\forall x: \neg(\mathcal{P}_1 \wedge \mathcal{P}_2)) \neg\mathcal{K}(x)$	Instead of endorsing P 's assertion, O rejects it completely and launches a sub-play where he is committed to show that the conjunction of $\mathcal{P}_1 \wedge \mathcal{P}_2$ does not satisfy to be the factor occasioning the ruling.
P! $(\forall x: \mathcal{P}_1 \wedge \mathcal{P}_2) \mathcal{K}(x) \wedge (\forall x: \neg(\mathcal{P}_1 \wedge \mathcal{P}_2)) \neg\mathcal{K}(x)$	P insists that the conjunction of $\mathcal{P}_1 \wedge \mathcal{P}_2$ does satisfy the conditions to be the factor occasioning the ruling.
O $a^*: \neg\mathcal{P}_1$	O challenges P 's assertion by firstly bringing forward a^* that instantiates $\neg\mathcal{P}_1$ (not \mathcal{P}_1).
P! $\neg\mathcal{K}(a^*)$	P is forced to concede that a^* falls under the ruling $\neg\mathcal{K}$ (not \mathcal{K}).
O $\mathcal{K}^{\circ}(a^*)$?	O comes with evidence from the sources that the ruling \mathcal{K} applies to a^* .
P! $\mathcal{K}^{\circ}(a^*)$	Since the evidence from the sources, P is forced to concede that the ruling \mathcal{K} applies to a^* .

⁵¹ See our comments on the doubts on the validity of this rule in Sect. 3.2.3.3.

O $!(\neg\mathfrak{K}(a^*) \wedge \mathfrak{K}(a^*)) \supset \perp$	O indicates P 's contradiction due to the inefficiency of \mathcal{P}_1 for constituting the factor occasioning the ruling. The complete notation would be $\{[(\forall x: \mathcal{P}_1) \mathfrak{K}(x) \wedge (\forall x: \neg\mathcal{P}_1) \neg\mathfrak{K}(x)] \wedge [(a^*: \neg\mathcal{P}_1) \mathfrak{K}(x)]\} \supset \perp$
P $!(\forall x: \mathcal{P}_2) \mathfrak{K}(x) \wedge (\forall x: \neg\mathcal{P}_2) \neg\mathfrak{K}(x)$	Now, P insists that the remaining property \mathcal{P}_2 is efficient as required to be the factor occasioning the ruling.
O $a^\circ: \mathcal{P}_2$	O challenges P 's assertion by bringing forward a° that instantiates \mathcal{P}_2 .
P $!\mathfrak{K}(a^\circ)$	P is forced to concede that a° falls under the ruling \mathfrak{K} .
O $\mathfrak{K}^*(a^\circ) ?$	O comes with evidence from the sources that it is the ruling \mathfrak{K}^* (the ruling other than the claimed ruling, and both are incompatible) that actually applies to a° .
P $!\mathfrak{K}^*(a^\circ)$	Since the evidence from the sources, P is forced to concede that the ruling \mathfrak{K}^* applies to a° .
O $!(\mathfrak{K}^*(a^\circ) \wedge \mathfrak{K}(a^\circ)) \supset \perp$	O indicates P 's inconsistency that leads to the invalidation of P 's argument.
P <i>Ifhām</i>	P concedes defeat.

4) *Fasād al-waḍ'*

The Opponent is committed to a sub-play where he brings forward a root-case to which the opposite ruling to the one proposed by the Proponent in the thesis applies, and, in fact, it is the property which defines the branch-case that is considered by the sources to be the factor occasioning that ruling. In short, the Opponent brings forward an *'illa* that invalidates the one deployed by the Proponent and leads to the destruction of the thesis. For the complication of this form of objection, we present the schema using an example, namely the problem concerning the purity of the saliva of beasts prey.

P $!\mathfrak{K}(far')$, precisely P $!\mathfrak{K}(f,b,c)$	P proposes a thesis that the ruling \mathfrak{K} (impurity) applies to the branch-case f [precisely, to f (e.g. the saliva of a tiger) that is the saliva (c) of the beast prey (b) having canine teeth].
P <i>'illa(aṣl):</i> $\mathfrak{K}^{\mathcal{P}}(aṣl)?$	P asks O to endorse that <i>having canine-teeth</i> (\mathcal{P}) is the relevant one for occasioning impurity of the root-case.
O $!F \mathfrak{K}(x,y,z)$ (x : canine teeth, y : beast of prey(x), z : $saliva(x,y)$)	Instead of endorsing P 's assertion, O rejects it completely and launches a sub-play where he is committed to show that saliva of those x that are beasts of prey having canine teeth does not fall under the ruling \mathfrak{K} (i.e. is not impure). (The point is that if the saliva of beasts of prey having canine teeth is not impure , then this invalidates P 's claim

	that having canine teeth in general determines the factor occasioning the impurity (of saliva.)
P! $\exists(x,y,z) (x: \text{canine teeth}, y: \text{beast of prey}(x), z: \text{saliva}(x,y))$	Following up his previous assertion, P insists that saliva of those x that are beasts of prey having canine teeth is impure .
O a^* : canine teeth, b : beast of prey(canine teeth), c : saliva(canine, b)	O challenges P 's assertion by bringing forward a^* (e.g. the saliva of a cat) that is the saliva of a beast of prey having canine teeth.
P! $\exists(a^*,b,c)$	P is forced to concede that a^* falls under the ruling \exists .
O! $\neg\exists^{\circ}(a^*,c)^{\circ}$ (a^* : beast of prey, c : saliva(beast of prey) ?	Then, O comes with evidence from the sources showing that a^* is not impure —i.e. the opposite ruling to the claimed ruling ($\neg\exists$) that actually applies to a^* . Moreover, O asks P to acknowledge that it is ‘being beast of prey’, according to the sources, that occasions the application of this opposite ruling ($\neg\exists$) to a^* .
P! $\neg\exists^{\circ}(a^*,b)^{\circ}$	P concedes it.
O! $(\exists(a^*,b,c) \wedge \neg\exists^{\circ}(a^*,c)^{\circ}) \supset \perp$	O makes the point showing P 's <i>fasād al-waḍ'</i> or false construction ⁵² of the occasioning factor that leads to the invalidation of P 's argument. The complete notation would be the following: $\{[\exists(a^*,b,c) (a^*: \text{canine teeth}, b: \text{beast of prey}(\text{canine teeth}), c: \text{saliva}(\text{canine}, b)] \wedge [\neg\exists^{\circ}(a^*,c)^{\circ} (a^*: \text{beast of prey}, c': \text{saliva}(\text{beast of prey}))]\} \supset \perp$
P Ifhām	P concedes defeat.

5) ‘Adam al-ta’thīr

The Opponent is committed to a sub-play where he brings forward a root-case which constitutes a counterexample to the efficiency of the proposed property asserted by the Proponent. More precisely, the Opponent puts on the table a root-case where the ruling applies despite the absence of the purported property.

P ‘illa($a\mathcal{P}$): $\exists^{\circ}(a\mathcal{P})?$	P asks O to endorse that the property \mathcal{P} is the relevant one for occasioning the ruling of the root-case.
O! F $(\forall x:\mathcal{P}) \exists(x) \wedge (\forall x:\neg\mathcal{P}) \neg\exists(x)$	Instead of endorsing P 's assertion, O rejects it completely and launches a sub-play where he is committed to show that the property \mathcal{P} does not satisfy to be the factor occasioning the ruling.
P! $(\forall x:\mathcal{P}) \exists(x) \wedge (\forall x:\neg\mathcal{P}) \neg\exists(x)$	P insists that the property \mathcal{P} does satisfy to be the factor occasioning the ruling.
O a^* : $\neg\mathcal{P}$	O challenges P 's assertion by firstly bringing forward a^* that instantiates $\neg\mathcal{P}$ (not \mathcal{P}).

⁵² We owe the translation of *fasād al-waḍ'* to Miller (2020)

P ! $\neg\mathfrak{K}(a^*)$	P is forced to concede that a^* falls under the ruling $\neg\mathfrak{K}$ (not \mathfrak{K}).
O $\mathfrak{K}(a^*)$?	O comes with evidence from the sources that the ruling \mathfrak{K} applies to a^* .
P ! $\mathfrak{K}(a^*)$	Since the evidence from the sources, P is forced to concede that the ruling \mathfrak{K} applies to a^* .
O ! $(\neg\mathfrak{K}(a^*) \wedge \mathfrak{K}(a^*)) \supset \perp$	O indicates P 's contradiction due to the inefficiency of \mathcal{P} for constituting the factor occasioning the ruling. The complete notation would be $\{[(\forall x:\mathcal{P}) \mathfrak{K}(x) \wedge (\forall x:\neg\mathcal{P}) \neg\mathfrak{K}(x)] \wedge [(a^*:\neg\mathcal{P}) \mathfrak{K}(a^*)]\} \supset \perp$
P <i>Ifhām</i>	P concedes defeat.

SR3 The overall development of a dialogue for *qiyās al-`illa*

The overall development of a dialogue for <i>qiyās al-`illa</i>	
Preliminary Remark:	
Recall our discussion in the introduction to Sect. 3.3. regarding the strategic aims of the dialogue <i>qiyās</i> . The main point of that discussion is that, despite the strategic aims of the debate, the development of such dialogues is based on running of actual plays . Accordingly, the strategic reason of the main assertion on the efficiency of the proposed property is left implicit. In short, the strategic reason can be specified only after the plays have been run and the sequence of moves constituting the winning strategy has been described. We call such a procedure <i>recapitulation</i> (see the introduction to Sect. 3.3.3 and particularly our remark on the strategic reason for the main assertion in Sect. 3.3.3.2).	
1.	A dialogical play for <i>qiyās al-`illa</i> starts with the Proponent claiming that some specific legal ruling applies to a certain branch-case. P ! $\mathfrak{K}(far')$
2.	After agreement on the finiteness of the argument to be developed, the Opponent will launch a challenge to the assertion by asking for justification. O Why? The Proponent's aim is to develop an argument in such a way that it forces the Opponent to concede the justification of the challenged assertion (see step 13). In other words P will try O to concede O <i>ap</i> [<i>far' . ta`thīr^q</i>]: $\mathfrak{K}(far')$ which will allow P to make the move P <i>`illa</i> (<i>far'</i>): $\mathfrak{K}(far')$, that justifies the main thesis.

<p>3. In order to develop his argument, the Proponent will start by choosing (to the best of his juridical knowledge) a suitable root-case from the sources for which the ruling at stake has been applied. The move consists in the Proponent forcing the Opponent to acknowledge this fact.</p>
<p>4. Since the evidence comes from sources the Opponent is forced to concede it.</p> <p style="text-align: center;">Steps 3 and 4 yield: P $\mathfrak{K}^{\text{e}}(a\text{ṣ}l)?$ O $! \mathfrak{K}^{\text{e}}(a\text{ṣ}l)$</p> <p>The "e" in "$\mathfrak{K}^{\text{e}}$" indicates that there is evidence from the <i>sources</i> that the ruling \mathfrak{K} applies to the root-case.</p>
<p>5. Once conceded, the Proponent will start by choosing (to the best of his juridical and epistemological knowledge) a suitable property (that should lead to the relevant occasioning factor). The move consists in the Proponent forcing the Opponent to acknowledge that the root-case instantiates that property. As already pointed out, here we will keep only those plays where the Opponent responds positively to this form of request.</p> <p style="text-align: center;">P $a\text{ṣ}l: \mathcal{P}?$ O $a\text{ṣ}l: \mathcal{P}$</p>
<p>6. Once the Opponent concedes that both the ruling and the selected property apply to the root-case, the Proponent will ask the Opponent to concede that the property just selected is the one that constitutes the relevant occasioning factor. The request can indicate the sources or not.</p> <p style="text-align: center;">P <i>illa</i>($a\text{ṣ}l$): $\mathfrak{K}(a\text{ṣ}l)?$</p> <p>If the <i>illa</i> has been determined by the sources the Opponent must accept by endorsing the efficiency of the property. This endorsement commits the Opponent to assert the universal O $! (\forall x: \mathcal{P}_{\text{e}} \vee \neg \mathcal{P}_{\text{e}}) \{ [(\forall y: \mathcal{P}_{\text{e}}) wujūd^{\vee}(y) = \{_{\mathcal{P}_{\text{e}} \vee \neg \mathcal{P}_{\text{e}}} x \supset \mathfrak{K}(y)] \wedge [(\forall z: \neg \mathcal{P}_{\text{e}}) \text{salb}^{\vee}(z) = \{_{\mathcal{P}_{\text{e}} \vee \neg \mathcal{P}_{\text{e}}} x \supset \neg \mathfrak{K}(z)] \}$⁵³. If there is no explicit backing from the sources the Opponent can ask for justification (<i>muṭālabā</i>), cooperate in such a justification or <i>strongly</i> reject it.</p>

⁵³ Recall our remark in Sect. 3.1.1.1. concerning the fact that identifying an occasioning factor amounts to characterizing it as a general law.

<p>7. If the Opponent asks for a justification, the Proponent will switch to the development of a dialogue of the form <i>qiyās al-‘illa al-khafī</i> and will develop an argument towards establishing its efficiency. In other words, the Proponent must be able to bring forward arguments showing that the property satisfies <i>ṭard</i> and <i>‘aks</i>. These duties commit the Proponent to assert $\mathbf{P} ! (\forall y: \mathcal{P}_D) \mathfrak{K}(y)$ and $\mathbf{P} ! (\forall z: \neg \mathcal{P}_D) \neg \mathfrak{K}(z)$. Both assertions lead to the further assertion $\mathbf{O} ! (\forall x: \mathcal{P}_D \vee \neg \mathcal{P}_D) \{ [(\forall y: \mathcal{P}_D) wujūd^V(y) =_{\{\mathcal{P}_D \vee \neg \mathcal{P}_D\}} x \supset \mathfrak{K}(y)] \wedge [(\forall z: \neg \mathcal{P}_D) salb^V(z) =_{\{\mathcal{P}_D \vee \neg \mathcal{P}_D\}} x \supset \neg \mathfrak{K}(z)] \}$, that establishes <i>ta’thīr</i> (the efficiency of the property \mathcal{P} for causing the juridical decision \mathfrak{K}, for any concrete case satisfying \mathcal{P}).</p>
<p>8. If the Proponent does not succeed, the play stops unless the Opponent decides to cooperate as described in the next step.</p>
<p>9. The Opponent might react by deciding to cooperate by first proposing a more precise formulation of the property advanced or by proposing a new property for the constitution of the occasioning factor. This will trigger a sub-play where the Opponent will defend the choice of an alternative property following the procedure prescribed for a <i>mu‘āraḍa</i>-move or constructive criticism. Once the sub-play ended, the play proceeds to step 12. A <i>mu‘āraḍa</i>-move assumes (1) that the choice of the root-case and the choice of ruling are relevant for the thesis, despite the fact that the Proponent chooses the wrong property for determining the occasioning factor, and (2) that the branch-case instantiates the “right” (newly proposed) property. The launching of a constructive criticism by \mathbf{O} will be indicated with the following notation</p> $\mathbf{O} ! V \text{‘illa}(a\mathfrak{K}l): \mathfrak{K}^{\mathcal{P}^*}(a\mathfrak{K}l)$ <p>where the “V” indicates that \mathbf{O} proposes to develop an argument for establishing \mathcal{P}^* rather than \mathcal{P} as the relevant property.</p> <p>In case the Opponent thinks that the branch-case does not instantiate the new property, the sub-play turns into <i>farq</i>-move. In such a move the Opponent proposes a new thesis concerning the branch-case. At this stage, practically a new start of the dialogue takes place. The Opponent, then, becomes the New Proponent and must defend his arguments following the procedure prescribed for a <i>farq</i>-move. Therefore, once the sub-play ends and the Proponent concedes defeat, the whole argument is rewritten with the thesis justified by the sub-play, which is proposed by the Opponent or New Proponent.</p>
<p>10. The Opponent might also react by <i>strongly</i> rejecting the Proponent’s proposal. We distinguish two cases that we call (1) <i>Destruction of the thesis</i>. The main target of this form of objection is the thesis rather than only objecting to the Proponent’s proposal for determining the <i>‘illa</i>. In such a case it is he, the Opponent, who has to bring forward a counterexample from the sources. This</p>

will trigger a sub-play where the Opponent develops his counter argumentation, following the prescriptions for one of the forms of destructive criticism, namely: *qalb* (reversal), *naqd* (inconsistency), or *kasr* (breaking apart). (2) *Destruction of the 'illa*. The counter-argument involves bringing forward objections against the proposed *wasf* proposed as determining the *'illa*, following the prescriptions for attacks of the forms *fasād al-waḍ'* (false construction) or *'adam al-ta'thīr* (lack of efficiency). If the Opponent succeeds, the play stops.

11. If, after the justification, the Opponent concedes that the property determines the occasioning factor for the ruling of the root-case, then the same moves as in step 7 follow. In other words, the Opponent commits himself to assert the universal

$$\mathbf{O} ! (\forall x: \mathcal{P}_\mathfrak{Q} \vee \neg \mathcal{P}_\mathfrak{Q}) \{ [(\forall y: \mathcal{P}_\mathfrak{Q}) wujūd^\vee(y) =_{\{\mathfrak{Q} \vee \neg \mathfrak{Q}\}} x \supset \mathfrak{K}(y)] \wedge [(\forall z: \neg \mathcal{P}_\mathfrak{Q}) salb^\vee(z) =_{\{\mathfrak{Q} \vee \neg \mathfrak{Q}\}} x \supset \neg \mathfrak{K}(z)] \}.$$

12. After the Opponent's assertion of the universal stated in the previous step, the Proponent will ask the Opponent to acknowledge that the property also applies to the branch-case – recall (again) that we keep only those plays where the Opponent responds positively to this form of request. Request and answer will be expressed by means of the following notation:

P *far'*: $\mathcal{P}?$ (or \mathcal{P}^*)

O *far'*: \mathcal{P} (or \mathcal{P}^*)

13. After the Opponent concedes that the property does apply to the branch case, and since the Opponent also concedes that the property is the one that characterizes the relevant occasioning factor, the Proponent will ask the Opponent to acknowledge that the branch-case falls under the ruling at stake. This move forces the Opponent to concede the challenged thesis. A play ends if there are no other moves allowed. If the Proponent's defence is successful the play will end by a move where he indicates that the Opponent has finished by endorsing the thesis under scrutiny.

P *far'*: \mathcal{P}

(challenging the universal that expresses the *tard* -condition)

O *ap[far'.ta'thīr^Q]:* $\mathfrak{K}(far')$

P *'illa(far')*: $\mathfrak{K}(far')$

(answer to the request for justification of the thesis that can be glossed as: you just stated the justification of the thesis you asked for)

Schema of the development of a dialogue for *qiyās al-‘illa*

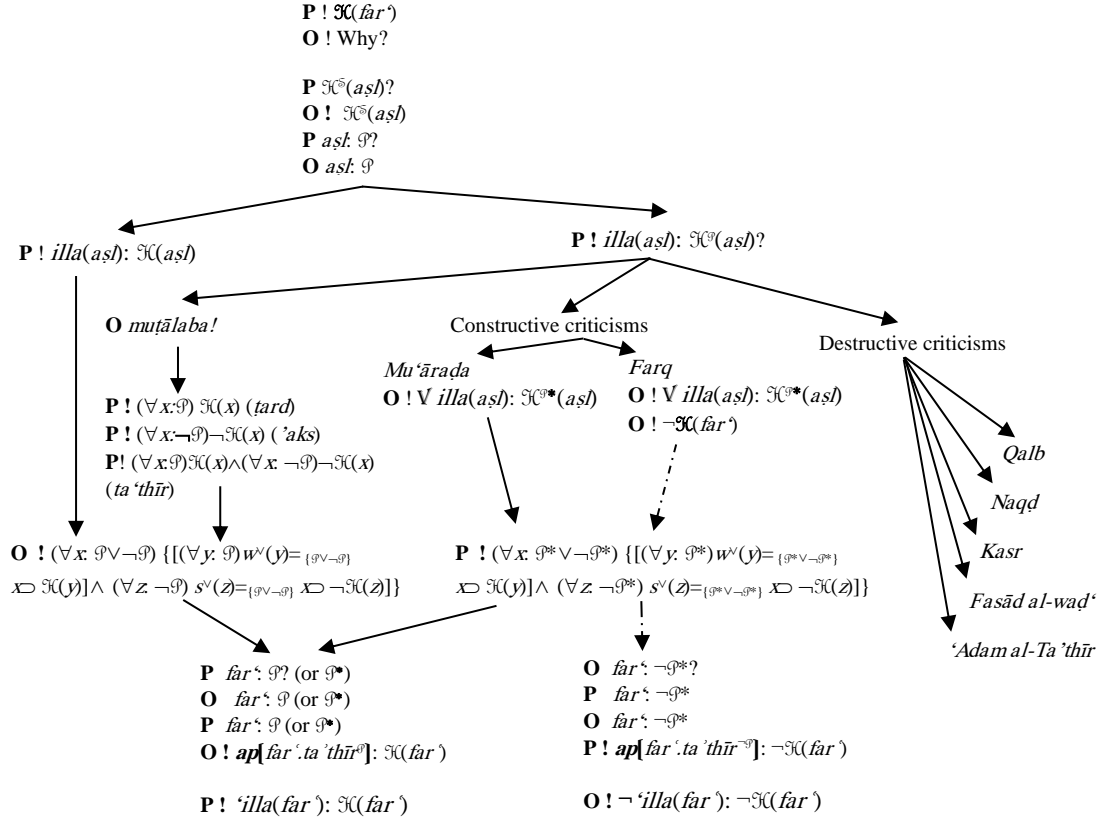

SR4 Winning rule.

This structural rule requires some additional terminology:

- **Terminal play:** A play is called *terminal* when it cannot be extended by further moves in compliance with the rules.
- **X-terminal:** We say it is *X-terminal* when the last move in the play is an **X**-move. Player **X** wins the play ζ only if it is **X**-terminal, unless he states \perp . The player who states **falsum** loses the play.
- **Strategy:** A *strategy* for player **X** in $D(\varphi)$ is a function which assigns an **X**-move **M** to every non terminal play ζ having a **Y**-move as last member such that extending ζ with **M** results in a play.
X-winning-strategy: An *X-strategy* is *winning* if playing according to it leads to **X**-terminal play no matter how **Y** moves.

- **Winning-strategy resulting from a cooperative move:** Winning strategies constituted by plays where cooperative moves took place will disregard the unsuccessful attempts and also the justification of the sub-play. More precisely, it will proceed as if the Proponent has chosen the property resulting from the sub-play. Accordingly, the winning strategy will include moves where the Proponent rather than the Opponent asserted the efficiency of the relevant property.

3.3.3.2. The constitution of strategies

While building the core of a *winning P*-strategy, local reasons are linked not only to the local meaning of expressions but also to their justification. This cannot be achieved while considering single plays. Consider, for example, the case of a **P**-conjunction such that the Proponent claims that it has a (winning) strategic reason for it. Single plays cannot provide a way to check if a conjunction is justified; this would require **P** to win the play for the two conjuncts. However, if the repetition rank chosen by the Opponent is 1, then in no single play can **P** bring forward the strategic reason for the whole conjunction. It is only within the tree that displays the winning-strategy that both plays can be brought together as two branches with a common root. Indeed, if we think of the tree as developed through the plays, the root of the tree will not explicitly display the information gathered while developing the plays. When a play starts it is just a *claim*. Only at the end of the construction-process of the relevant plays will **P** be able to have the knowledge required to *assert* the thesis.

Similarly, in the case of a disjunction, we will only be able to display the strategic reason correspondent to the choice that yielded the canonical argumentation form of the strategic reason after the choices involving the defence have been made. More generally, the *assertion* of the thesis that makes explicit the reason resulting from the plays is a *recapitulation* of the result achieved after running the relevant plays, after **P**'s initial statement of that thesis. This is what the canonical argumentation form of a reason is at the strategic level, and this is what renders the dialogical formulation of a

canonical proof-object. We call those reasons that constitute a winning strategy *global reasons*.

In the case of material implication (and universal quantification), a winning **P**-strategy literally displays the procedure by which the Proponent chooses the local reason for the consequent *depending* on the local reason chosen by the Opponent for the antecedent. What the canonical argumentation form of a global reason does is to make explicit the relevant *choice-dependence* by means of a *recapitulation* of the thesis. This corresponds to the general description of proof-objects for material implications and universally quantified formulas in CTT: a method which, given a proof-object for the antecedent, yields a proof-object for the consequent. The dialogical interpretation of this functional dependence amounts to rendering the canonical argumentation form of a strategic reason for $\mathbf{P} \ ! \ A \supset B$ as $\mathbf{P} \ p_j \llbracket p_i^{\mathbf{O}} \rrbracket : A \supset B$ that expresses that if **P** is looking to make his claim legitimate he must be able to assert the consequent for any reason that the Opponent brings forward to back his (the Opponent's) own assertion of the antecedent. Thus, the global reason for the material implication $A \supset B$ is the “strategic-reason” $\mathbf{P} \ p_j \llbracket p_i^{\mathbf{O}} \rrbracket$. In fact, the CTT-framework prescribes the notation $\lambda(x^{\mathbf{O}})b^{\mathbf{P}}(x) : A \supset B$, that is, the lambda-abstract of the function $p(x) : B$ (see Rahman, Iqbal, & Soufi, 2019, Chapter IV; Rahman, McConaughy, Klev, & Clerbout, 2018). However, here we use instead $p_j \llbracket p_i^{\mathbf{O}} \rrbracket : A \supset B$ in order to stress the dialogical interdependence.

Similar holds for a universal. **P**-strategic reasons must be built (*synthesis* of **P**-strategic reasons); they constitute the justification of a statement by providing certain information—choice-dependences—that are essential to the relevant plays issuing from the statement: strategic reasons are a recapitulation of the building of a winning strategy, directly inserted into a play. Thus, a strategic reason for a **P**-statement on the universal $\mathbf{P} \ ! \ (\forall x : A) B(x)$ has the form $p_j^{\mathbf{P}} \llbracket p_i^{\mathbf{O}} \rrbracket$ (where $p_j^{\mathbf{P}} : B(p_i^{\mathbf{O}})$ and $p_i^{\mathbf{O}} : A$) and indicates that **P**'s choice p_j for defending the right constituent of the universal, is dependent upon **O**'s choice of p_i .

Strategic reasons for **P** are the dialogical formulation of CTT proof-objects, and the canonical argumentation form of strategic reasons correspond to canonical proof-objects. Since in this section we are seeking a notion of winning strategy that corresponds to that of a CTT-demonstration, and since these strategies have been identified to be those where **P** wins, we will only describe the synthesis of strategic reasons for **P** – for a complete presentation of all the rules see Rahman, Iqbal, & Soufi (2019, Chapter IV); Rahman, McConaughey, Klev, & Clerbout (2018).

Synthesis of strategic reasons for **P**

	Move	Synthesis of local reasons		Synthesis of strategic reasons Canonical Argumentation form
		Challenge	Defence	
Conjunction	$\mathbf{P} ! A \wedge B$	$\mathbf{O} ? L^\wedge$ or $\mathbf{O} ? R^\wedge$	$\mathbf{P} p_1 : A$ (resp.) $\mathbf{P} p_2 : B$	$\mathbf{P} \langle p_1, p_2 \rangle : A \wedge B$
Existential quantification	$\mathbf{P} ! (\exists x : A) B(x)$	$\mathbf{O} ? L^\exists$ or $\mathbf{O} ? R^\exists$	$\mathbf{P} p_1 : A$ (resp.) $\mathbf{P} p_2 : B(p_1)$	$\mathbf{P} \langle p_1, p_2 \rangle : (\exists x : A) B(x)$
Disjunction	$\mathbf{P} ! A \vee B$	$\mathbf{O} ? V$	$\mathbf{P} p_1 : A$ or $\mathbf{P} p_2 : B$	$\mathbf{P} p_1 : A \vee B$ or $\mathbf{P} p_2 : A \vee B$
Implication	$\mathbf{P} ! A \supset B$	$\mathbf{O} p_1 : A$	$\mathbf{P} p_2 : B$	$\mathbf{P} p_j^{\mathbf{P}} \llbracket p_i^{\mathbf{O}} \rrbracket : A \supset B$ (where $p_j^{\mathbf{P}} : B$ and $p_i^{\mathbf{O}} : A$)
Universal quantification	$\mathbf{P} ! (\forall x : A) B(x)$	$\mathbf{O} p_1 : A$	$\mathbf{P} p_2 : B(p_1)$	$\mathbf{P} p_j^{\mathbf{P}} \llbracket p_i^{\mathbf{O}} \rrbracket : (\forall x : A) B(x)$ (where $p_j^{\mathbf{P}} : B(p_i^{\mathbf{O}})$ and $p_i^{\mathbf{O}} : A$)
Negation	$\mathbf{P} ! A \supset \perp$	$\mathbf{O} p_1 : A$... $\mathbf{O} ! \perp$ (stating the antecedent leads eventually to \mathbf{O} giving up)	—————	$\mathbf{P} p_j^{\mathbf{P}} \llbracket p_i^{\mathbf{O}} \rrbracket \llbracket p_i^{\mathbf{O}} \rrbracket : A \supset \perp$ The method encoded by $p_j^{\mathbf{P}} \llbracket p_i^{\mathbf{O}} \rrbracket$ will never be carried out. Indeed, since this method provides a winning strategy, P will force O to state falsum himself (on the grounds of the move $\mathbf{O} p_1 : A$), before $p_j^{\mathbf{P}}$ comes into play.

Strategic Reasons for the Main Assertion

The notation $ta' th\bar{r}^{\mathcal{P}} \llbracket p_i^{\mathbf{Y}} \rrbracket$ indicates that the process (the function) $ta' th\bar{r}^{\mathcal{P}}$ is dependent upon the p_i chosen by \mathbf{Y} ; and $\mathbf{X} ap[p_1, ta' th\bar{r}^{\mathcal{P}}]: \mathfrak{K}(p_1)$ indicates that when p_1 is chosen by the challenger $ta' th\bar{r}^{\mathcal{P}}$ confirms the efficiency of property \mathcal{P} .

Statement	Challenge	Defence
<p>Synthesis</p> $\mathbf{X} ! (\forall x: \mathcal{P}_{\mathcal{D}} \vee \neg \mathcal{P}_{\mathcal{D}}) \{ [(\forall y: \mathcal{P}_{\mathcal{D}}) wuj\bar{u}d^{\vee}(y) =_{\{\mathcal{P}_{\mathcal{D}} \vee \neg \mathcal{P}_{\mathcal{D}}\}} x \supset \mathfrak{K}(y)] \wedge [(\forall z: \neg \mathcal{P}_{\mathcal{D}}) salb^{\vee}(z) =_{\{\mathcal{P}_{\mathcal{D}} \vee \neg \mathcal{P}_{\mathcal{D}}\}} x \supset \neg \mathfrak{K}(z)] \}$	$\mathbf{Y} p_i: \mathcal{P}_{\mathcal{D}}$	$' ta' th\bar{r}^{\mathcal{P}} \llbracket p_i^{\mathbf{Y}} \rrbracket:$ $\{ [(\forall y: \mathcal{P}_{\mathcal{D}}) wuj\bar{u}d^{\vee}(y) =_{\{\mathcal{P}_{\mathcal{D}} \vee \neg \mathcal{P}_{\mathcal{D}}\}} p_i \supset \mathfrak{K}(y)] \wedge [(\forall z: \neg \mathcal{P}_{\mathcal{D}}) salb^{\vee}(z) =_{\{\mathcal{P}_{\mathcal{D}} \vee \neg \mathcal{P}_{\mathcal{D}}\}} p_i \supset \neg \mathfrak{K}(z)] \}$ <p>(similar for $\mathbf{Y} q_i: \neg \mathcal{P}_{\mathcal{D}}$)</p>
<p>Analysis</p> $\mathbf{X} p: (\forall x: \mathcal{P}_{\mathcal{D}} \vee \neg \mathcal{P}_{\mathcal{D}}) \{ [(\forall y: \mathcal{P}_{\mathcal{D}}) wuj\bar{u}d^{\vee}(y) =_{\{\mathcal{P}_{\mathcal{D}} \vee \neg \mathcal{P}_{\mathcal{D}}\}} x \supset \mathfrak{K}(y)] \wedge [(\forall z: \neg \mathcal{P}_{\mathcal{D}}) salb^{\vee}(z) =_{\{\mathcal{P}_{\mathcal{D}} \vee \neg \mathcal{P}_{\mathcal{D}}\}} x \supset \neg \mathfrak{K}(z)] \}$ <p>Notice that in the development of a play "p" will be left implicit (see remark below)</p>	$\mathbf{Y} L^{\supset}(p)^{\mathbf{Y}} = p_1: \mathcal{P}_{\mathcal{D}}$	$R^{\supset}(p) = p_1.ta' th\bar{r}^{\mathcal{P}}$ \Downarrow $\mathbf{X} ap[p_1.ta' th\bar{r}^{\mathcal{P}}]: \mathfrak{K}(p_1):$ $\{ [(\forall y: \mathcal{P}_{\mathcal{D}}) wuj\bar{u}d^{\vee}(y) =_{\{\mathcal{P}_{\mathcal{D}} \vee \neg \mathcal{P}_{\mathcal{D}}\}} p_1 \supset \mathfrak{K}(y)] \wedge [(\forall z: \neg \mathcal{P}_{\mathcal{D}}) salb^{\vee}(z) =_{\{\mathcal{P}_{\mathcal{D}} \vee \neg \mathcal{P}_{\mathcal{D}}\}} p_1 \supset \neg \mathfrak{K}(z)] \}$ <p>(similar for $\mathbf{Y} q_1: \neg \mathcal{P}_{\mathcal{D}}$)</p> <p>In practice we skip the equality steps.</p>

Remark:

As discussed above, the strategic reason of the main assertion on the efficiency of the proposed property is left implicit – it will be made explicit through the equality that “resolves” the instruction to apply the process $ta' th\bar{r}^{\mathcal{P}}$ to p_1 only after the winning strategy has been developed. The point is that during a play, the player who brings forward such an assertion *claims* to be able to provide a strategic reason rather than committing himself to be already in possession of one. In short, the strategic reason can be specified only after the plays have been run and the sequence of moves constituting the winning strategy has been described.

3.3.4. Examples of dialogues for *qiyās al-‘illa*

Most of the examples discussed in the present section are based on textual sources, with the exception of the branch-case of our first example (on reading the emails of someone else). The point of the anachronism is to illustrate how to apply an ancient juridical rule to a new branch-case. However, the root-case and the identification of the property determining the relevant occasioning factor are based on textual sources to which we refer.

We will only display the tree of the resulting winning strategy for the last example, since the other examples follow basically the same pattern. Let us first provide the general schema that determines the development of our examples.

Notational Conventions

We slightly changed the usual notation of the dialogical framework and added some further indications specific to the *qiyās*. More precisely:

- 1) Proponent’s moves are numbered with even numbers starting from **0**. Those moves are recorded at the outmost right column.
- 2) Opponent’s moves are numbered with odd numbers starting from **1**. Those moves are recorded at the outmost left column.
- 3) The inner columns record the form (challenge or defence) of response and the line to which the move responds. So, while “? 0” indicates that the corresponding move is a challenge (by the Opponent) to line 0 of the Proponent; “! 3” indicates that the corresponding move is a defence of a challenge launched by the Opponent in move 3.
- 4) Formal expressions with a preceding **exclamation mark** such as ! ‘ $\mathcal{K}(a\dot{s}l)$ ’ indicate the assertion that there is some (not yet specified) evidence in the sources for the fact that the ruling \mathcal{K} applies to the root-case. Similarly, expressions such as ! ‘ $\mathcal{K}(far\dot{’})$ ’ indicate the assertion that there is some (not yet specified) evidence for the fact that the ruling \mathcal{K} applies to the branch-case.

- 5) Formal expressions **without** a **preceding exclamation mark** such as ‘*illa(far)*’: $\mathfrak{K}(far)$ asserted by the Proponent indicate that the justification for the application of the ruling to the branch-case follows from applying that branch-case to the universal

$$(\forall x: \mathcal{P}_\mathfrak{D} \vee \neg \mathcal{P}_\mathfrak{D}) \{ [(\forall y: \mathcal{P}_\mathfrak{D}) wujūd^\vee(y) =_{\{\mathfrak{D} \vee \neg \mathfrak{D}\}} x \supset \mathfrak{K}(y)] \wedge [(\forall z: \neg \mathcal{P}_\mathfrak{D}) salb^\vee(z) =_{\{\mathfrak{D} \vee \neg \mathfrak{D}\}} x \supset \neg \mathfrak{K}(z)] \}$$

which is precisely the universal the Proponent tries to force the Opponent to endorse.

- 6) For the sake of notational simplicity, we did not include the moves related to the repetition rank (for the notion of *repetition rank* see Sec. 3.3.3.1.)

More notational conventions

- The dialectical framework for *qiyās al-‘illa* deploys not only the usual challenges and defences but also requests. With a request a player brings forward an assertion and asks the contender to endorse it.
- The notation deployed for a request has the form “ $!n, !m$ ”, where “ n ” and “ m ” stand for natural numbers (that reads: the Proponent responds to move n of the Opponent by requesting him to endorse the assertion brought forward in move m).
- Sometimes a request formulated in move k responds to move n of the antagonist \mathbf{X} , given a previous move m of \mathbf{X} . This request will be indicated with the notation “ $!n(m), !k$ ”.
- Before endorsing the requested assertion brought forward with move m the requested contender might himself ask for justification of the assertion requested to be endorsed. This response will be indicated with the notation “ $?m!$ ”.
- We will also deploy

$$(\forall x: \mathcal{P} \vee \neg \mathcal{P}) \{ [(\forall y: \mathcal{P}) w^\vee(y) =_{\{\mathcal{P} \vee \neg \mathcal{P}\}} x \supset \mathfrak{K}(y)] \wedge [(\forall z: \neg \mathcal{P}) s^\vee(z) =_{\{\mathcal{P} \vee \neg \mathcal{P}\}} x \supset \neg \mathfrak{K}(z)] \}$$

instead of

$$(\forall x: \mathcal{P}_\mathfrak{D} \vee \neg \mathcal{P}_\mathfrak{D}) \{ [(\forall y: \mathcal{P}_\mathfrak{D}) wujūd^\vee(y) =_{\{\mathfrak{D} \vee \neg \mathfrak{D}\}} x \supset \mathfrak{K}(y)] \wedge [(\forall z: \neg \mathcal{P}_\mathfrak{D}) salb^\vee(z) =_{\{\mathfrak{D} \vee \neg \mathfrak{D}\}} x \supset \neg \mathfrak{K}(z)] \}$$

- We will not write explicitly the strategic reason $ta' thir^{pX}[[p_i^Y]]$ justifying the main assertion of the efficiency-verification, but deploy the implicit form

$$\mathbf{X} ! (\forall x: \mathcal{P} \vee \neg \mathcal{P}) \{[(\forall y: \mathcal{P})w^\vee(y)_{\{\mathcal{P} \vee \neg \mathcal{P}\}x} \supset \mathfrak{K}(y)] \wedge [(\forall z: \neg \mathcal{P})s^\vee(z)_{\{\mathcal{P} \vee \neg \mathcal{P}\}x} \supset \neg \mathfrak{K}(z)]\}$$

(for a justification of this convention see our discussion introducing Sect. 3.3. above and the remark on strategic reason in 3.3.3.2).

However, the defence is written in its explicit though abbreviated form:

$$\mathbf{X} ! ap[p_i, t^{\mathcal{P}}]: \mathfrak{K}(p_i) - \text{given } \mathbf{Y} p_i: \mathcal{P}.$$

The defence is a short-cut of the following moves: (1) replacing x with p_i , and (2) defending the left side of the conjunction.

3.3.4.1. Example of a *qiyās al-illa* (*al-jalī bi-al-naṣṣ*)

See Tab. 3.1 below. The importance of this form of *qiyās al-illa*, despite its simplicity, is that it has a canonical form. Moreover, it is related to Aristotle's *reasoning by exemplification* or *paradigmatic inference*,⁵⁴ though, as pointed out before it is not to be understood as involving one-step induction – it might be even argued that Aristotle's notion does not involve one-step induction either.

3.3.4.2. Examples of *qiyās al-illa al-khaṭī*

The following example, in Tab. 2 below, is a reconstruction that constitutes a variant of al-Shīrāzī's⁵⁵ refutation of Ḥanafī's analysis of the argument on the *purity status of beasts of prey*. As pointed out by Young⁵⁶, al-Shīrāzī himself thought that the argument should be developed following a *fasād al-waḍ'* (invalidity of the occasioned status) –

⁵⁴ Cf. Aristotle, *Pr. An.* 69a1; Bartha (2010, pp. 36–40).

⁵⁵ Shīrāzī (1987, p. 112).

⁵⁶ Young (2017, p. 159).

move.⁵⁷ Indeed, al-Shīrāzī sees the argument as indicating that the main thesis is fundamentally false since it assumes that beasts of prey are impure, but there is direct evidence from the sources contradicting this. Thus, according to al-Shīrāzī we do not need to be involved in a discussion about the suitability or not of the property chosen by the Proponent. Our take on the example corresponds rather to Miller’s presentation of *qalb* or *destructive criticism by reversal*.⁵⁸ Moreover, it corresponds to a particular form of *qalb* called *reversal* and *oppositeness* (*al-qalb wa-al-‘aks*).⁵⁹ Notice that in the sub-play the opponent is changing the roles and defending the claim that he has a winning strategy in order to reject \mathcal{P} as the determining occasioning factor. This move, *a switch of roles*, was pointed out by scholars such as Hallaq (“The logic of legal reasoning”) and Young (*The Dialectical Forge*).

The second example, the *wine example* in Tab. 3 below, is one that has received very much attention in the specialized literature. Finally, Tab. 4 below develops a variant of the wine example. This variant deploys a *mu‘āraḍa*-move. As already mentioned, *mu‘āraḍa*-moves assume a cooperative attitude of the challenger. Here we assume that the original argument in favour of choosing the property of being a drink made of pressed fruit-juice as relevant for determining the relevant property, misses one of those conditions, namely co-presence (the counterexample is vinegar):

Tab. 3.1. Dialogue for *qiyās al-‘illa* (*al-jalī bi-al-naṣṣ*)

O			P		
		responses	responses	Main Thesis Reading (without permission) letters of someone else is forbidden ! $\mathcal{K}(\text{far}')$	0
1	Why?	? 0	¿1, ¿! 2	Entering (without permission) into a house of someone else is	2

⁵⁷ Different to Young’s (2017, p. 159) analysis, Miller (1984, p. 119; 2020, p. 63) concludes that al-Shīrāzī’s presentation suggests that the two forms of destructive criticism, namely *qalb* and *fasād al-waḍ‘*, are indistinguishable.

⁵⁸ Miller (1984, p. 119; 2020, p. 63).

⁵⁹ See Young (2017, pp. 166–7).

				forbidden by the Quran (sources \mathfrak{S}), isn't it? $\mathfrak{K}^{\mathfrak{S}}(a\mathfrak{I})?$	
3	Yes $! \mathfrak{K}^{\mathfrak{S}}(a\mathfrak{I})$! 2	$\mathfrak{I}3, \mathfrak{I}! 4$	Entering (without permission) into a house of someone else violates privacy. Don't you agree? $a\mathfrak{I}: \mathfrak{P}?$	4
5	I do. $a\mathfrak{I}: \mathfrak{P}$! 4	$\mathfrak{I}5(3), \mathfrak{I}! 6$	Given your own moves 3 and 5, and the evidence from the sources, you must concede that Violation of Privacy has the efficiency to determine the 'illa of that <i>hukm</i> . Do you? $'illa(a\mathfrak{I}): \mathfrak{K}_{\mathfrak{S}}^{\mathfrak{P}}(a\mathfrak{I})?$	6
7	Indeed, I endorse it since it comes from the sources of the assertion $! (\forall x: \mathfrak{P} \vee \neg \mathfrak{P}) \{[(\forall y: \mathfrak{P})w^{\vee}(y) =_{\{\mathfrak{P} \vee \neg \mathfrak{P}\}} x \supset \mathfrak{K}(y)] \wedge (\forall z: \neg \mathfrak{P}_{\mathfrak{S}}) s^{\vee}(z) =_{\{\mathfrak{P} \vee \neg \mathfrak{P}\}} x \supset \neg \mathfrak{K}(z)]\}$! 6	$\mathfrak{I}7, \mathfrak{I}! 8$	Does reading (without permission) personal letters of someone else violate the privacy of that person? $far': \mathfrak{P}?$	8
9	Yes, it does $far': \mathfrak{P}$! 8	? 7	So, since reading (without permission) personal letters of someone else violates the privacy of that person, it instantiates the antecedent of the <i>ṭard</i> -component of your assertion linking privacy-violation and interdiction. You should now assert the consequent. Right? $far': \mathfrak{P}$	10
11	Indeed, I endorse this interdiction to the branch-case too $'ap[far': t_{\mathfrak{S}}^{\mathfrak{P}}]: \mathfrak{K}(far')$! 10	! 1	So, this provides the justification for the thesis you were asking for with your first move: the branch-case falls under the ruling because it instantiates the property you just endorsed as relevant for determining the occasioning factor. $'illa(far'): \mathfrak{K}_{\mathfrak{S}}^{\mathfrak{P}}(a\mathfrak{I})$	12
	<i>Ilzām</i>				

Tab. 3.2. Dialogue for deployment of *qalb* and *fasād al-waḍ'*

O			P		
		responses	responses	Main Thesis The saliva of the beast of prey qualifies as impure (<i>najīs</i>) ! $\mathcal{K}(\text{far } \cdot)$	0
1	Why?	? 0	! 1, ! 2	Does the saliva of pigs qualify as impure (<i>najāsa</i>)? $\mathcal{K}^{\circ}(a\mathcal{S}l)$?	2
3	Yes, it does ! $\mathcal{K}^{\circ}(a\mathcal{S}l)$! 2	! 3, ! 2	Does the saliva of pigs come from an animal that has canine teeth (<i>dhū nābin</i>)? <i>a\mathcal{S}l</i> : \mathcal{P}° ⁶⁰	4
5	Yes, it does <i>a\mathcal{S}l</i> : \mathcal{P}	! 4	! 5(3), ! 6	Given 3 and 5 it seems plausible to conclude that the saliva of animals with canines has the required efficiency for determining the relevant <i>'illa</i> for its impurity. Don't you agree? <i>'illa(a\mathcal{S}l)</i> : $\mathcal{K}^{\circ}(a\mathcal{S}l)$?	6
7	<i>qalb</i> ! Do not agree! I have a counterexample to the assertion that impurity applies to the saliva of any animal possessing canines ! $\mathbf{F}(\forall x: \mathcal{P})\mathcal{K}(x)$ START OF THE SUB-PLAY -----	? 6	? 7	 START OF THE SUB-PLAY ----- Still I stick to the following assertion: Impurity applies to the saliva of any animal possessing canines ! $(\forall x: \mathcal{P})\mathcal{K}(x)$	8

⁶⁰ For the sake of simplicity, we do not reflect in our formalization the mereological relation between animals and their saliva.

9	Cats possess canine teeth. Thus, according to your characterization of \mathcal{P} (<i>saliva of animals possessing canines</i>), their saliva is impure. ! <i>cat-saliva</i> : \mathcal{P}	?8	! 9	Indeed, I have to concede this ! $\mathcal{K}(\textit{cat-saliva})$	10
11	We know (from the sources) that the saliva of cats is not impure. Do you agree? $\neg\mathcal{K}^{\circ}(\textit{cat-saliva})?$	ζ 10, ζ ! 11	! 11	I must agree. It comes from the sources ! $\neg\mathcal{K}^{\circ}(\textit{cat-saliva})$	12
13	! <i>tanāquḍ</i> 10-12. You asserted before that according to your view on the relevant property, it follows that the saliva of cats is impure. You contradict yourself! ⁶¹ Therefore, possessing canine teeth is not the relevant property for determining saliva's impurity.	? 12		I concede.	14
15	Moreover, cats are beasts of prey. So, their saliva is the saliva of a beast of prey. Furthermore, the saliva of a beast of prey is a case of the saliva of animals with canines. Right? ⁶² <i>far</i> ': \mathcal{P} ?	ζ 14, ζ ! 15	! 15	Yes, it is <i>far</i> ': \mathcal{P}	16
17	So, you must also concede that their saliva is not impure either? $\neg\mathcal{K}^{\circ}(\textit{far}'?)$	ζ 16, ζ ! 17	! 17	Indeed. $\neg\mathcal{K}^{\circ}(\textit{far}'?)$	18
19	! <i>tanāquḍ</i> 0-18 This contradicts your main thesis.	?18		I give up <i>ifhām</i> .	

⁶¹ The player that brings up the expression *tanāquḍ*, accuses the antagonist of self-contradiction – for a thorough discussion on this notion see Young (2017, pp. 537–43).

⁶² In order to focus on the main argumentation thread, we did not include (formally) the moves that lead from *saliva of animals of prey* to *saliva of the cats*.

Tab. 3.3. Dialogue for *qiyās al-‘illa al-khafī*

O			P		
		responses	responses	Main Thesis (Consuming) Date-wine (<i>nabīdh</i>) is forbidden (<i>ḥarām</i>). ! $\mathfrak{K}(\text{far})$	0
1	Why?	? 0	! 1, ! 2	Isn't drinking grape-wine (<i>khamr</i>) forbidden by the Quran? $\mathfrak{K}(a\mathfrak{S}l)$?	2
3	Yes, it is forbidden. ! $\mathfrak{K}(a\mathfrak{S}l)$! 2	! 3, ! 4	Isn't grape-wine a drink made of fruit-juice which contains <i>euphoric intensity</i> (<i>shiddat</i> <i>muṭriba</i>)? <i>aṣl</i> : \mathfrak{P} ?	4
5	Yes <i>aṣl</i> : \mathfrak{P}	! 4	! 3(5), ! 6	So, according to your moves 3 and 5, the presence of euphoric intensity occasions the proscription of consuming grape- wine. Right? <i>‘illa(aṣl)</i> : $\mathfrak{K}(\mathfrak{P})$?	6
7	<i>muṭālaba</i> ! Justify !	? 6	! 7	<i>‘aks</i> : Before the occurrence of the euphoric intensity, the lawfulness of consuming a drink made of fruit-juice is the object of consensus. ! $(\forall x: \neg \mathfrak{P}) \rightarrow \neg \mathfrak{K}(x)$ <i>tard</i> : After the euphoric intensity occurs [<i>i.e.</i> , when it becomes wine] and nothing else occurs, the proscription of consuming a drink made of fruit-juice is the object of consensus. (ratification of) <i>‘aks</i> : When the euphoric intensity of a drink made of fruit-juice falls away [<i>i.e.</i> , when it becomes vinegar] and nothing else falls away, it is the object of consensus that it should not be forbidden. ! $(\forall x: \mathfrak{P}) \mathfrak{K}(x)$ <i>ta`thīr</i> : Therefore, the presence of the <i>ḥukm</i> is due to the presence of	8

				the <i>wasf</i> , and the absence of the <i>hukm</i> is due to its absence $!(\forall x: \mathcal{P} \vee \neg \mathcal{P}) \{[(\forall y: \mathcal{P}_\mathcal{Q}) w^\vee(y) =_{\{\mathcal{P} \vee \neg \mathcal{P}\}} x \supset \mathfrak{K}(y)] \wedge (\forall z: \neg \mathcal{P}_\mathcal{Q}) s^\vee(z) =_{\{\mathcal{P} \vee \neg \mathcal{P}\}} x \supset \neg \mathfrak{K}(z)]\}$	
9	Given these arguments I concede your previous request $!(\forall x: \mathcal{P} \vee \neg \mathcal{P}) \{[(\forall y: \mathcal{P}) w^\vee(y) =_{\{\mathcal{P} \vee \neg \mathcal{P}\}} x \supset \mathfrak{K}(y)] \wedge (\forall z: \neg \mathcal{P}) s^\vee(z) =_{\{\mathcal{P} \vee \neg \mathcal{P}\}} x \supset \neg \mathfrak{K}(z)]\}$! 6 (8)	¿9, ¿! 10	Isn't <i>nabīdh</i> a drink made of fruit-juice which contains 'euphoric intensity'? <i>far</i> ': \mathcal{P} ?	10
11	Yes, I agree <i>far</i> ': \mathcal{P}	! 10	? 9	If it is the case that date-wine contains euphoric intensity, and, given 9, should this not lead you to endorse as a consequence its interdiction? <i>far</i> ': \mathcal{P}	12
13	Indeed, the presence of euphoric intensity should occasion its interdiction. <i>ap</i> [<i>far</i> ': \mathcal{P}]: $\mathfrak{K}(far')$! 10	! 1	So, this provides the justification for the thesis you were asking for with your first move: the branch-case falls under the ruling because it instantiates the property you just endorsed as constituting the occasioning factor. ' <i>illa</i> (<i>far</i> '): $\mathfrak{K}^\mathcal{Q}(far')$	14
	<i>Ilzām</i>				

Tab. 3.4. Dialogue for deployment of *mu'ārada*

O		P			
		responses	responses	Main Thesis (Consuming) Date-wine is forbidden. $! \mathfrak{K}(far')$	0
1	Why?	? 0	¿1, ¿! 2	Isn't drinking grape-wine forbidden by the Quran? $\mathfrak{K}^\mathcal{Q}(ašl)$?	2
3	Yes, it is <i>ḥarām</i> .	! 2	¿3, ¿! 4	Isn't grape-wine made of pressed fruit-juice	4

	! $\mathfrak{C}^{\circ}(a\mathfrak{S}l)$			$a\mathfrak{S}l: \mathfrak{P}?$	
5	Yes $a\mathfrak{S}l: \mathfrak{P}$! 4	$\dot{\iota}3, (5), ! 6$	So, according to your moves 3 and 5, the proscription of consuming grape-wine is caused by the fact that it is made of pressed fruit-juice. Right? $'illa(a\mathfrak{S}l): \mathfrak{C}^{\circ}(a\mathfrak{S}l)?$	6
7	I am far from being convinced. I rather think that the cause of its interdiction is that it is one of the drinks containing euphoric intensity (\mathfrak{P}^*) $! \forall 'illa(a\mathfrak{S}l): \mathfrak{C}^{\circ}(a\mathfrak{S}l)$? 6	?7	$mu\mathfrak{t}\bar{a}laba !$ Justify !	8
	START OF THE SUB-PLAY -----			START OF THE SUB-PLAY -----	
9	Vinegar is made of pressed juice-fruit. Isn't it? $a\mathfrak{S}l^*: \mathfrak{P}?$	$\dot{\iota} 8, \dot{\iota}! 9$! 9	Indeed. $a\mathfrak{S}l^*: \mathfrak{P}$	10
11	Given 6, you must agree that being a pressed juice is efficient property for sanctioning pressed juices as $\mathfrak{h}\bar{a}r\bar{a}m$. Right? $(\forall x: \mathfrak{P}\vee\neg\mathfrak{P}) \{[(\forall y: \mathfrak{P})w^{\vee}(y)=_{\{\mathfrak{P}\vee\neg\mathfrak{P}\}} x \supset \mathfrak{C}(y)] \wedge (\forall z: \neg\mathfrak{P}) s^{\vee}(z)=_{\{\mathfrak{P}\vee\neg\mathfrak{P}\}} x \supset \neg\mathfrak{C}(z)]\}?$	$\dot{\iota} 6, \dot{\iota}! 11$! 11	Yes $! (\forall x: \mathfrak{P}\vee\neg\mathfrak{P}) \{[(\forall y: \mathfrak{P})w^{\vee}(y)=_{\{\mathfrak{P}\vee\neg\mathfrak{P}\}} x \supset \mathfrak{C}(y)] \wedge (\forall z: \neg\mathfrak{P}) s^{\vee}(z)=_{\{\mathfrak{P}\vee\neg\mathfrak{P}\}} x \supset \neg\mathfrak{C}(z)]\}$	12
13	But, given that you just agreed that vinegar is made of pressed juice, (according to the $\mathfrak{t}\bar{a}r\bar{d}$ - component of your assertion) it should be $\mathfrak{h}\bar{a}r\bar{a}m$ $a\mathfrak{S}l^*: \mathfrak{P}$! 12	! 13	Indeed $ap[a\mathfrak{S}l^*.t^{\circ}]: \mathfrak{C}(a\mathfrak{S}l^*)$	14
15	But its consumption is not forbidden. Is it? $! \neg\mathfrak{C}^{\circ}(a\mathfrak{S}l^*)?$	$\dot{\iota} 14, \dot{\iota}! 15$! 15	Yes, it is not $\mathfrak{h}\bar{a}r\bar{a}m$ $! \neg\mathfrak{C}^{\circ}(a\mathfrak{S}l^*)$	16
17	! $\mathfrak{t}\bar{a}n\bar{a}q\bar{u}d$ 14-16 You contradict yourself	? 16		I concede!	18
19	Herewith my argument for the relevance of \mathfrak{P}^*	! 8			

	<p>‘<i>aks</i>: Before the occurrence of the euphoric intensity, the lawfulness of consuming a drink made of fruit-juice is the object of consensus. $!(\forall x:\neg\mathcal{P}^*)\neg\mathfrak{C}(x)$</p> <p><i>ṭard</i>: After the euphoric intensity occurs [<i>i.e.</i>, when it becomes wine] and nothing else occurs, the proscription of consuming a drink made of fruit-juice is the object of consensus. (ratification of) ‘<i>aks</i>: When the euphoric intensity of a drink made of fruit-juice falls away [<i>i.e.</i>, when it becomes vinegar] and nothing else falls away it is the object of consensus that it should not be forbidden. $!(\forall x:\mathcal{P}^*)\mathfrak{C}(x)$</p> <p><i>ta`thīr</i>: Therefore, the presence of the <i>ḥukm</i> is due to the presence of the \mathcal{P}, and the absence of the <i>ḥukm</i> is due to its absence $!(\forall x:\mathcal{P}^*)\vee\neg\mathcal{P}^*) \{[(\forall y:\mathcal{P}^*)w^{\vee}(y)=_{\{\mathcal{P}^*\vee\neg\mathcal{P}^*\}} x\supset\mathfrak{C}^{\mathcal{C}}(y)]\wedge(\forall z:\neg\mathcal{P}^*)s^{\vee}(z) =_{\{\mathcal{P}^*\vee\neg\mathcal{P}^*\}} x\supset\neg\mathfrak{C}^{\mathcal{C}}(z)]\}$ And it certainly applies to our root-case: ‘<i>ap</i>[<i>aṣl.t^{\mathcal{P}^*}</i>]: $\mathfrak{C}^{\mathcal{C}}(aṣl)$</p>				
	END OF THE SUB-PLAY -----			END OF THE SUB-PLAY -----	
21	Yes, it does. <i>far</i> ‘: \mathcal{P}^*	! 20	‘ 19, ‘! 20	I concede your argument in favour of singling out euphoric intensity as the relevant property, but then you should admit that our branch-case <i>nabīdh</i> in fact instantiates this property. Does it? <i>far</i> ‘: \mathcal{P}^* ?	20

23	Indeed! $ap[far', t^{\mathcal{P}^*}]: \mathcal{H}(far')$! 22	? 19	If it is the case that date-wine contains euphoric intensity, and, given your endorsement at move 19 of $!(\forall x: \mathcal{P}^*) \vee \neg \mathcal{P}^*) \{[(\forall y: \mathcal{P}^*) w^\vee(y) =_{\{\mathcal{P}^* \vee \neg \mathcal{P}^*\}} x \supset \mathcal{H}^\ominus(y)] \wedge (\forall z: \neg \mathcal{P}^*) s^\vee(z) =_{\{\mathcal{P}^* \vee \neg \mathcal{P}^*\}} x \supset \neg \mathcal{H}^\ominus(z)]\}$ Should this not lead to the interdiction of our branch-case? $far': \mathcal{P}^*$	22
			! 1	So, this provides the justification for the thesis you were asking for with your first move: the branch-case falls under the ruling because it instantiates the property you just helped to identify as the one determining the occasioning factor. $'illa(far'): \mathcal{H}^{\mathcal{P}^*}(far')$	24
	<i>Ilzām</i>				

This yields the following tree displaying the winning-strategy. Since as explained in the following section, the strategy is being conceived as a recapitulation of the “correct” moves, the unsuccessful attempts are deleted:

1. **P** ! $\mathcal{H}(far')$
2. **O** Why [?0]
3. **P** $\mathcal{H}^\ominus(a\mathcal{S}l)?$
4. **O** ! $\mathcal{H}^\ominus(a\mathcal{S}l)$
5. **P** $a\mathcal{S}l: \mathcal{P}^*?$
6. **O** $a\mathcal{S}l: \mathcal{P}^*$
7. **P** $'illa(a\mathcal{S}l): \mathcal{H}^{\mathcal{P}^*}(a\mathcal{S}l)?$
8. **O** ! $(\forall x: \mathcal{P}^*) \vee \neg \mathcal{P}^*) \{[(\forall y: \mathcal{P}^*) w^\vee(y) =_{\{\mathcal{P}^* \vee \neg \mathcal{P}^*\}} x \supset \mathcal{H}^\ominus(y)] \wedge (\forall z: \neg \mathcal{P}^*) s^\vee(z) =_{\{\mathcal{P}^* \vee \neg \mathcal{P}^*\}} x \supset \neg \mathcal{H}^\ominus(z)]\}$
9. **P** $far': \mathcal{P}^*?$
10. **O** $far': \mathcal{P}^*$
11. **P** $far': \mathcal{P}^* [?7]$
12. **O** $ap[far', t^{\mathcal{P}^*}]: \mathcal{H}^\ominus(far')$
13. **P** $'illa(far'): \mathcal{H}^{\mathcal{P}^*}(far')$ (! 1. answer to the request of justification in the second move)

References

- al-Bājī, Abū al-Walīd Sulaymān. (2001). *Kitāb al-Minhāj fī Tartīb al-Ḥijāj*. (Ed. 'Abd al-Majīd Turkī). Beirut: Dār al-Gharb al-Islāmī.
- Barnes, J. (1984). *The Complete Works of Aristotle. The Revised Oxford Translation*. Princeton NJ: Princeton University Press.
- Bartha, P. (2010). *By Parallel Reasoning; The Construction and Evaluation of Analogical Arguments*. Oxford: Oxford University Press.
- al-Baṣrī, Abū al-Ḥusayn. (1964). *Kitāb al-Qiyās al-Sharī*. In *idem, Kitāb al-Mu'tamad fī Uṣūl al-Fiqh*. (Eds. Muḥammad Ḥamīd Allāh, Muḥammad Bakīr, & Ḥasan Ḥanafī). Damascus: Al-Ma'had al-'ilmī al-Faransī li'l-Dirāsāt al-'Arabiyya bi-Dimash.
- Clerbout, N. (2014a). First-Order Dialogical Games and Tableaux. *Journal of Philosophical Logic*, 43(4), 785-801.
- Clerbout, N. (2014b). *Étude sur quelques sémantiques dialogiques : Concepts fondamentaux et éléments de métathéorie*. London: College Publications.
- Clerbout, N., & Rahman, S. (2015). *Linking Game-Theoretical Approaches with Constructive Type Theory: Dialogical Strategies as CTT-Demonstrations*. Dordrecht: Springer.
- Crubellier, M., Marion, M., McConaughey, Z., & Rahman, S. (2019). Dialectic, The Dictum de Omni and Ecthesis. *History and Philosophy of Logic*, 40/3, 207-233.
- Davidson, D. (1980). *Essays on Actions and Events*. Oxford: Clarendon Press.
- Felscher. (1985). Dialogues as a Foundation for Intuitionistic Logic. (D. Gabbay, & G. F. Eds.) *Handbook of Philosophical Logic*, 3, 341-372.
- Gili, L. (2015). Alexander of Aphrodisias and the Heterodox dictum de omni et de nullo. *History and Philosophy of Logic*, 36/2, 114–128.
- Ginzburg, J. (2012). *The Interactive Stance*. Oxford: Oxford University Press.
- Hallaq, W. B. (1997). *A History of Islamic Legal Theories: An Introduction to Sunnī Uṣūl al-Fiqh*. Cambridge; New York: Cambridge University Press.
- Hallaq, W. B. (1985). The Logic of Legal Reasoning in Religious and Non-Religious Cultures: The Case of Islamic Law and Common Law. *Cleveland State Law Review*, 34, 79-86.
- Hallaq, W. B. (1987b). The Development of Logical Structure in Islamic Legal Theory. *Der Islam*, 64/1, 42-67.
- al-Juwaynī, Imām al-Ḥaramayn. (1979). *al-Kāfiya fī al-Jadal*. (Ed. Fawqīya Ḥusayn Maḥmūd). Cairo: Maṭba'at 'Isā al-Bābī al-Ḥalabī.
- Keiff, L. (2009). *Dialogical Logic*. (E. N. Zalta, Ed.) Retrieved from The Stanford Encyclopedia of Philosophy: <http://plato.stanford.edu/entries/logic-dialogical>
- Krabbe, E. C. (2006). Dialogue Logic. In D. Gabbay, & J. Woods (Eds.), *Handbook of the History of Logic* (Vol. 7, pp. 665-704). Amsterdam: Elsevier.

- Lorenz, K. (2000). Sinnbestimmung und Geltungssicherung. In G.-L. Lueken, *Formen der Argumentation* (pp. 87-106). Leipzig: Akademisches Verlag.
- Lorenz, K. (2010a). *Logic, Language and Method: On Polarities in Human Experiences*. Berlin / New York: De Gruyter.
- Lorenz, K. (2010b). *Philosophische Variationen: Gesammelte Aufsätze unter Einschluss gemeinsam mit Jürgen Mittelstrass greschriebener Arbeiten zu Platon und Leibniz*. Berlin / New York: De Gruyter.
- Lorenzen, P., & Lorenz, K. (1978). *Dialogische Logik*. Damstadt: Wissenschaftliche Buchgesellschaft.
- Marion, M., & Rückert, H. (2015). Aristotle on universal quantification: a study from the perspective of game semantics. *History and Philosophy of Logic*, 37(3), 201-209.
- Martin-Löf, P. (1984). *Intuitionistic Type Theory. Notes by Giovanni Sambin of a Series of Lectures given in Padua, June 1980*. Naples: Bibliopolis.
- Martin-Löf, P. (1996). On the Meanings of the Logical Constants and the Justifications of the Logical Laws. *Nordic Journal of Philosophical Logic*, 1, 11-60.
- Martin-Löf, P. (2012, March). *Aristotle's distinction between apophansis and protasis in the light of the distinction between assertion and proposition in contemporary logic*. Paper presented at the Workshop "Sciences et Savoirs de l'Antiquité à l'Age classique" held at the laboratory SPHERE-CHSPAM, Paris VII, Paris.
- Martin-Löf, P. (2015, May). *Is Logic Part of Normative Ethics?* Paper presented at the research Unity Sciences, Normes, Décisions (FRE 3593), Paris.
- Miller, L. B. (1984). *Islamic Disputation Theory*. PhD dissertation, Pinceton University.
- Miller, L. B. (2020). *Islamic Disputation Theory*. Cham: Springer.
- al-Namla, 'Abd al-Karīm b. 'Alī b. Muḥammad. (1999). *al-Muhadhdhab fī 'Ilm Uṣūl al-Fiqh al-Muqārīn*. Riyadh: Maktabat al-Rushd.
- Nordström, B., Petersson, K., & Smith, J. M. (1990). *Programming in Martin-Löf's Type Theory: An Introduction*. Oxford: Oxford University Press.
- Nordström, B., Petersson, K., & Smith, J. M. (2000). Martin-Löf's Type Theory. In S. Abramsky, D. Gabbay, & T. S. Maibaum (Eds.), *Handbook of Logic in Computer Science* (Vol. 5 : Logic and Algebraic Methods, pp. 1-37). Oxford: Oxford University Press.
- Peregrin, J. (2014). *Inferentialism. Why Rules Matter*. New York: Plagrave MacMillan.
- Plato. (1997). *Plato. Complete Works*. (J. M. Cooper, Trans.) Indianapolis IN: Hackett.
- Primiero, G. (2008). *Information and Knowledge*. Dordrecht: Springer.
- Rahman, S., & Keiff, L. (2005). On How to be a Dialogician. In D. Vanderveken (Ed.), *Logic, Thought and Action* (pp. 359-408). Dordrecht: Kluwer.
- Rahman, S., & Rückert, H. (Eds.). (2001). Special Volume Synthese 127. *New Perspectives in Dialogical Logic*. Dordrecht: Springer.
- Rahman, S., & Tulenheimo, T. (2009). From Games to Dialogues and Back: Towards a General Frame for Validity. In O. Majer, A. Pietarinen, & T. Tulenheimo

- (Eds.), *Games: Unifying Logic, Language and Philosophy* (pp. 153-208). Dordrecht: Springer.
- Rahman, S., Clerbout, N., & Redmond, J. (2017). Interacción e Igualdad La interpretación dialógica de la Teoría Constructiva de Tipos Interaction and Equality Dialogical interpretation of Constructive type Theory. *Critica, Revista Hispanoamericana de Filosofía, UNAM*, 49 (145), , 49-89.
- Rahman, S., Iqbal, M., & Soufi, Y. (2019). *Inference by Parallel Reasoning in Islamic Jurisprudence*. Cham: Springer.
- Rahman, S., McConaughy, Z., Klev, A., & Clerbout, N. (2018). *Immanent Reasoning or Equality in Action. A Plaidoyer for the Play Level*. Dordrecht: Springer.
- Ranta, A. (1988). Propositions as Games as Types. *Syntese*, 76, 377-395.
- Ranta, A. (1994). *Type-Theoretical Grammar*. Oxford: Clarendon Press.
- Rückert, H. (2011). *Dialogues as a Dynamic Framework for Logic*. London: College Publications.
- al-Shīrāzī, Abū Ishāq. (1092). *Al-Ma'ūna*. Princeton University Digital Library. <http://publ.princeton.edu/objects/2f75r807h>.
- al-Shīrāzī, Abū Ishāq. (1987). *Al-Ma'ūna fī al-Jadal*. (Ed. 'Alī b. 'Abd al-'Azīz al-'Umayrīnī). Al-Şafāh, Kuwait: Manshūrāt Markaz al-Makḥṭūṭāt wa-al-Turāth.
- Sundholm, G. (2009). A century of judgement and inference, 1837-1936: Some strands in the development of logic. In L. Haaparanta, *The Development of Modern Logic* (pp. 264-317). Oxford: Oxford University Press.
- Sundholm, G. (2012). Inference versus Consequence Revisited: Inference, Conditional, Implication. *Syntese*, 187, 943-956.
- Sundholm, G. (2013). *Inference and Consequence as an Interpreted Language*. Paper presented at the Workshop "Proof Theory and Philosophy" Groningen, Desember 2-3, 2013.
- Young, W. E. (2017). *The Dialectical Forge; Juridical Disputation and the Evolution of Islamic Law*. Dordrecht: Springer.

CHAPTER 4

DIALECTICAL SYSTEM OF *QIYĀS AL-DALĀLA* AND *QIYĀS AL-SHABAH*

As already discussed, correlational inferences by indication (*qiyās al-dalāla*) and resemblance (*qiyās al-shabah*), sometimes broadly referred to as arguments by analogy (or better by the Latin denomination arguments *a pari*), are put into action when there is absence of knowledge of the occasioning factor grounding the application of a given ruling. These forms of *qiyās* relate the branch-case to the root-case by developing a parallel reasoning based on some kind of similarity. However, though both *qiyās al-dalāla* and *qiyās al-shabah* are based on establishing resemblance, the notion of resemblance deployed by *qiyās al-dalāla* is quite different from that one deployed by *qiyās al-shabah*. Thus, before developing a dialogical framework for these forms of correlational inferences, we should first examine the notion of resemblance employed by each of these forms.

4.1. *Qiyās al-dalāla*

It is worth mentioning that al-Shīrāzī can be identified as the main developer if not the inventor of the system of *qiyās al-dalāla* based on drawing parallelisms between rulings. The point in correlational inferences by indication is that a root-case and a branch-case share some structural parallelism, in the sense that each of both cases falls under the scope of a pair of *rulings* linked by some structural relation. Recall that the idea to link two rulings by a structural relation is not only to justify that the presence of one ruling entails the presence of the other, but also to indicate that the two rulings as a set are certainly occasioned by an (unknown) identical *'illa*. To put it in another way, given \mathfrak{C}^* and \mathfrak{C} are a pair of rulings, the factor that occasions the ruling \mathfrak{C}^* should as well occasion the ruling \mathfrak{C} , such that whenever the ruling \mathfrak{C}^* applies, the ruling \mathfrak{C} should apply. By doing so, it validates the main thesis in *qiyās*: *the presence*

of the *ḥukm* is due to the presence of the ‘*illa*, and the absence of the *ḥukm* is due to its absence.

In fact, al-Shīrāzī emphasizes in several texts, such as in the *Sharḥ al-Luma’*, that *ṭard* and ‘*aks*, usually linked to the efficiency test underlying *qiyās al-‘illa*, are to be included as parts of the process of finding in the sources the suitable set of rulings. However, in the context of *qiyās al-dalāla* the logical structure of *ṭard* and ‘*aks* is quite different to the one they have in *qiyās al-‘illa*, since the juridical sanction at work cannot be defined as a function from an (occasioning) property to that sanction.

Intuitively, the idea is that in order to test if the ruling \mathcal{K} applies to the branch-case, evidence from the sources should witness that when this ruling applies to the root-case then another ruling \mathcal{K}^* also applies to the branch-case, whereby the first and the second stand in a structural relation of either specification or bi-implication.

The different structural relations between both rulings, specification and bi-implication, feature the subdivision of *qiyās al-dalāla* into two types which have a different degree in terms of epistemic strength. Given two rulings, \mathcal{K}^* and \mathcal{K} , as applied to the root-case, it is said that the relation is one of specification, when \mathcal{K}^* is the particularity or special characteristic (*khaṣīṣa*) of \mathcal{K} ; and the relation is one of bi-implication, when \mathcal{K}^* is the parallel (*naẓīr*) of \mathcal{K} (i.e. both can be seen as subsets of a same set). Arguments based on specification have epistemically a higher degree than those based on bi-implication since, as discussed in the following section, the specification indicates a semantic dependence of the ruling \mathcal{K} upon its counterpart \mathcal{K}^* .

4.1.1. *Qiyās al-dalāla I*

احدها ان يستدلّ بخصيصة من خصائص الشيء عليه¹

One of them [i.e. types of qiyās al-dalāla] is that one infers a thing [i.e. a ruling] by way of one of the particularities of that thing [i.e. ruling].²

¹ al-Shīrāzī (1987, p. 37).

² al-Ghazālī (1971, pp. 441-444) calls this kind of inference *al-istidlāl bi al-khāṣṣiya* (inference by particularity).

When one ruling \mathfrak{C}^* is said to be a *khaṣīṣa* of a second ruling \mathfrak{C} , the indication that the second ruling can be transferred from the root-case to the branch-case is based on the fact, suppose \mathfrak{C}^* applies to the branch-case, that \mathfrak{C}^* can be shown to be a specification of \mathfrak{C} by means of a specific additional qualification. This leads us to speak of *particular* and *general ruling*. For example, given the set: 1) *Witr prayer is supererogatory*; 2) *Witr prayer is allowed to be performed in sitting position without excuse*, the second ruling is to be considered *particular* in relation to the first due to the specific additional qualification “in sitting position without excuse” which specifies the general supererogation of a prayer. In other words, *khaṣīṣa* can be conceived as a **restriction of the domain of application of the general rule**. Thus, particular-general applies in the first place to the domain of application.

Recall that the closer the relationship between both rulings, the stronger the indication grounding the transference from the root-case to the branch-case. This is precisely what motivates looking for a general-particular relationship between the two rulings required for the application of *qiyās al-dalāla*. Indeed, when one ruling can be established as the particular (*khaṣīṣa*) of the other, then the relation is so close that it is likely that the (unknown) factor occasioning the former is the same as the one that occasions the latter. This brings to the fore one crucial condition for applying *qiyās al-dalāla* based on *khaṣīṣa*, namely the *interdependency of the rulings*. Let us discuss this point in detail.

4.1.1.1. *Shahādat al-uṣūl* for *qiyās al-dalāla I*

In the context of *qiyās al-dalāla* in general al-Shīrāzī and al-Baghdādī speak of the *sources as (providing) testimony (shahādat al-uṣūl)* of the relationship between the two rulings.³ More precisely, they point out that in order for one ruling to be either *khaṣīṣa* or *naẓīr* of the other there should be some testimony of juridical sources showing that when one ruling is present, the other is too; and when one ruling is absent, so is the

³ See al-Shīrāzī (2003, p. 112); and al-Baghdādī (1421H, p. 520).

other. This has consequences for the formulation of the conditions of co-presence (*tard*) and co-absence (*'aks*). Unfortunately, though in the *Sharḥ al-Luma'* al-Shīrāzī explicitly emphasizes *tard* and *'aks* for *qiyās al-dalāla* in general⁴, he does not explain how *tard* and *'aks* should be applied to the first type of *qiyās al-dalāla*. However, let us consider al-Shīrāzī's example below:

فأجلاها أن يستدل بخصيصة من خصائص الحكم على ثبوت ذلك الحكم، وذلك مثل أن يستدل الشافعي في سجود التلاوة أنه نفل فيقول: (سجود يجوز فعله على الراحلة من غير عذر فكان نفلا كسائر سجود النفل). فاستدل بجواز فعله على الراحلة من غير عذر على كونه نفلا لأن جواز فعله على الراحلة مع عدم العذر من خصيصة النوافل. ألا ترى أن سجود الصلاة لما كان واجبا لم يجوز فعله على الراحلة من غير عذر؟⁵

The strongest (qiyās al-dalāla) is that one infers the confirmation of a ruling by way of one of the particularities of that ruling. And that is like the argument of Shāfi'ī on prostration of Quran recital (sujūd al-tilāwa) that it is supererogatory (non-obligatory), by saying: "a prostration which is allowed to be performed on the vehicle during travelling without validating excuse is supererogatory (non-obligatory), like all prostrations during supererogatory prayers (sujūd al-nafl)." Thus, they argue its status of being supererogatory by way of its status of being allowed to be performed on the vehicle during travelling, because it (the status of being allowed to be performed on the vehicle during travelling) is the particularity of supererogations (of prostrations). Don't you see that when prostration during a prayer is obligatory, then it is not allowed to be performed on the vehicle during travelling without validating excuse?

This example describes that the particular ruling prescribes a *specific way to perform an action* of the kind that constitutes the domain of application of the general rule. Moreover, the specific way at work is a *non-canonical* way to perform an action. Certainly, if the specification of the domain of application amounts to pinpointing some canonical ways to perform the kind of action falling under the ruling, the exercise would reduce to simply subsuming the particular to the general. Thus, if we study al-Shīrāzī's own examples, co-presence and co-absence take the following form:

- *Tard*. We say that the relation of specification satisfies *co-presence* when the following holds: if the sources provide evidence that ruling \mathcal{R}^* allows some

⁴ al-Shīrāzī (1988, p. 860)

⁵ al-Shīrāzī (1988, pp. 809-810).

particular, **non-canonical way** to perform an undertaking of type @ (such as those prostrations allowed to be performed on the back of a camel), then the sources also provide evidence that the ruling \mathfrak{K} sanctions performances of this kind of action (e.g. prostrations) as non-obligatory in general, and that this includes non-canonical performances. So canonical performances \mathcal{C} and non-canonical performances \mathcal{C}° are not compatible.

- *'Aks.* We say that the relation of specification satisfies *co-absence* when the following holds: If the ruling \mathfrak{K}^* sanctions that some undertaking of type @ is **forbidden** to be performed in some specific, non-canonical way (such as those prostrations forbidden to be performed on the back of a camel), then the sources also provide evidence that the general ruling \mathfrak{K} sanctions that performing that kind of action is obligatory @ (it is not allowed not to perform it). Furthermore, the sources also make it evident that the obligation sanctioned by \mathfrak{K} entails that the non-canonical way of performing specified by \mathfrak{K}^* is forbidden.

Thus, co-presence and co-absence involve distinguishing within the domain of application @ two different subsets of actions, those that are **allowed** and those that are **forbidden** in relation to some specific form of carrying those actions out. Accordingly, showing that the condition *ṭard* is satisfied for the general ruling \mathfrak{K} and the particular ruling \mathfrak{K}^* requires: 1) finding in the sources that the particular ruling \mathfrak{K}^* **allows** (henceforth “**L**” stands for *allowed*) some root-case *a*, an action of the type @, to be carried out in a **non-canonical way** \mathcal{C}° ; 2) making it explicit that the general form of this particular ruling presupposes that its domain of application are **those actions of the type @** that, when carried out in a **non-canonical manner**, are **allowed** by the general ruling \mathfrak{K} .

$\mathfrak{K}^*(x, y, z): \text{prop } (x: @, y: \mathcal{C}(x) \vee \mathcal{C}^\circ(x), z: \mathfrak{K}(x, \mathbf{right}^\vee(y)))^6$
or with explicit modality

⁶ In plain words, ruling \mathfrak{K}^* is dependent upon ruling \mathfrak{K} which applies to cases of the type @. See the explanation of hypotheticals with multiple hypotheses in the appendix to the present book.

$\mathbf{L}^*(x, y, z): \text{prop } (x: \mathcal{A}, y: \mathcal{C}(x) \vee \mathcal{C}^\circ(x), z: \mathbf{L}(x, \mathbf{right}^\vee(y)))$

given \mathcal{A} : *set* and $y: \mathcal{C}(x) \vee \mathcal{C}^\circ(x) : \text{prop } (x: \mathcal{A})$.

(In plain words, \mathfrak{K}^* is constituted by those elements of the right side of the disjunction $\mathcal{C}(x) \vee \mathcal{C}^\circ(x)$; that is, the set of non-canonical performances \mathcal{C}° , included in the ruling \mathfrak{K} and prescribed by both rulings as non-obligatory).⁷

Thus, if the particular ruling allows some undertaking to be performed in a non-canonical form, then this presupposes that also the general ruling does. Moreover, the latter presupposes that the general ruling allows some undertaking to be carried out, it also allows the performance to be carried out in both ways, canonical and non-canonical. So in fact, strictly speaking, we should extend \mathbf{L} to both a canonical and a non-canonical of the same kind action. For the sake of simplicity, we leave this further precision out.

Showing that the ‘*aks*’ condition is satisfied concerns considering (within the domain of application \mathcal{A}) the case of forbidden actions, and this requires: 1) finding in the sources that the particular ruling \mathfrak{K}^* **forbids** (henceforth “ $\neg\mathbf{L}$ ” stands for *not-allowed* or *forbidden*) some root-case a^* , an action of the type \mathcal{A} from being carried out in a non-canonical way; 2) making it explicit that the general form of this particular ruling presupposes that its domain of application are **those actions of the type \mathcal{A}** that, when carried out in a non-canonical manner, are **forbidden** by the general ruling \mathfrak{K} .

$\mathfrak{K}^*(x, y, z): \text{prop } (x: \mathcal{A}, y: \mathcal{C}(x) \vee \mathcal{C}^\circ(x), z: \mathfrak{K}(x, \mathbf{right}^\vee(y)))$

or with explicit modality

$\neg\mathbf{L}^*(x, y, z): \text{prop } (x: \mathcal{A}, y: \mathcal{C}(x) \vee \mathcal{C}^\circ(x), z: \neg\mathbf{L}(x, \mathbf{right}^\vee(y)))$.

(In plain words, \mathfrak{K}^* is constituted by those elements of the right side of the disjunction $\mathcal{C}(x) \vee \mathcal{C}^\circ(x)$, that is, the set of non-canonical performances \mathcal{C}° included in the ruling \mathfrak{K} and prescribed by both rulings as forbidden (not-allowed).

⁷ Recall that, as mentioned in I.3.1.2, the expression “ $\mathbf{right}^\vee(x)$ ” stands for the operator that selects the right proof-object of a disjunction.

This also presupposes that when the general ruling sanctions that performing some undertaking is obligatory (henceforth “**O**” stands for *obligatory*), it also forbids this undertaking from being carried out in a non-canonical form. In other words, the task of showing that *ṭard* is satisfied also consists in making it explicit that the formation of

$\mathfrak{H}(a^*)$: or with explicit modality $\mathbf{O}(a^*)$, whereby $a^* : \mathcal{A}$,

presupposes the formation rules

$\mathbf{O}(x, y)$: *prop* $((x : \mathcal{A}, y : \mathcal{C}(x)), \text{ given } \mathcal{A} : \text{set and } y : \mathcal{C}(x) : \text{prop } (x : \mathcal{A})$

$\neg \mathbf{L}(x, z)$: *prop* $((x : \mathcal{A}, z : \mathcal{C}^\circ(x))$.

If we come back to the general structure, the formal steps underlying a correlational inference by *khaṣīṣa* can thus be described in the following way:

- Establishing by examining the sources that one ruling, that applies to both branch-case and root-case, is a specification of a more general one (that applies to the root-case).
- Establishing by examining the sources that there is enough evidence for asserting that both the deontic force (being allowed, obligatory or forbidden) and the juridical consequences of the particular ruling stem from the general one. This amounts to establishing that both co-presence and co-absence are satisfied.
- The establishment of *ṭard* and *‘aks* allows (1) concomitance (*jarayān*) to be assessed of the *khaṣīṣa* –link between both rulings, (2) making it explicit that the concrete applications of the particular ruling to the root- and branch-cases, and of the general ruling to the root-case, instantiate a general form linking both rulings. This crucial move amounts to the act of *grasping the universal* in the concrete applications recorded by the sources. In other words, by examining the formation rules underlying the concrete applications of the ruling, the general form of the rulings becomes apparent.⁸

⁸ This move can be seen as related to Averroes’ notion of *ibdāl* or substitution of the general by the particular (see Bou Akl, 2018, pp. 50-62). However, as discussed in our preface, al-Shīrāzī’s general conception of *qiyās* (*not only of the kind al-dalāla*) goes the other way round: while examining the form of the substituted instance, the general substitutional form comes to the fore.

- Establishing that whatever the occasioning factor of the general ruling is, it must be the same as that of the particular ruling. That is,

if \mathfrak{K}^* is a specification of \mathfrak{K} and

if there is some (unknown) occasioning factor for the latter, i.e.

$z: (illa(x): \mathfrak{K})$

then this occasioning factor also causes the ruling

$z: (illa(x):: \mathfrak{K}^*)$

whereby the expression “ z ” indicates that there is a *hypothesis* or *open assumption*, as explained in the preceding chapter. However, we actually do not know what the occasioning factor is.

- Justifying ! $\mathfrak{K}(far^*)$ ⁹

The main thesis is just the claim that the general ruling applies to the branch-case.

It requires a justification, that is, a proof-object for the proposition $\mathfrak{K}(far^*)$.

Moreover, the justification will require it to be shown that the branch-case encodes some inner structure. One way to think about the branch-case occurring in $\mathfrak{K}(far^*)$

is as its being a non-canonical proof-object that will be brought to its canonical form during the inferential moves. Implementing this requires some more notation.

In order to limit this, when occurring in an inference, we will deploy the notation “ far^* ” for its non-canonical form and “ f, y, \dots, z ” for its canonical form. The same applies to the root-case.

Given

$z: (illa(x): \mathfrak{K})$

$z: (illa(x): \mathfrak{K}): \mathfrak{K}^*$

$\mathbf{L}^*(x, y, z): prop(x: \mathcal{A}, y: \mathcal{C}(x) \vee \mathcal{C}^\circ(x), z: \mathbf{L}(x, \mathbf{right}^\vee(y)))$

the following holds:

! $\mathbf{L}^*(f, b, c)$

for

⁹ An alternative reconstruction would stress the fact that both the root- and the branch-case are identical in relation to the rulings, and then conclude by substitution. However, this option makes the distinction between *qiyas al-dalāla* and *qiyas al-shabah* less clear-cut.

$b: \mathcal{C}(f) \vee \mathcal{C}^\circ(f)$
 $c: \mathbf{L}(f, \mathbf{right}^\vee(b))$

The latter is the explicit justified form of the thesis, which is encoded by the expression

$dalāla_{\mathfrak{K}^*khaṣīṣa-\mathfrak{K}} = c: \mathbf{L}(f,b)^{10}$

(In plain words, the justification of the thesis is the proof-object c , which is equal to the proof-object that encodes a demonstration of the proposition that the branch-case is allowed to be carried out in a non-canonical way. The demonstration encoded deploys the correlational inference of *khaṣīṣa* to the pair of rulings \mathfrak{K} and \mathfrak{K}^* .)

The following diagram expresses one typical example for this form of *qiyās al-dalāla* – the graphical presentation is based on that of Young (2017, p. 116). The example requires the richer structure discussed above.

<p>The root-case <i>aṣl</i>: <i>Prostration of Supererogatory prayer</i></p>		<p>The branch-case <i>far'</i>: <i>Prostration of Qu' rān recital</i>¹¹</p>
<p>$\mathbf{L}^*(a, b, c)$ <i>It (prostration of supererogatory prayer) is allowed to be performed on the back of a camel while travelling without validating excuse ('udhr)</i> $c: \mathbf{L}(a, b)$ <i>Prostration of supererogatory prayer is non-obligatory</i></p>	<p>↔</p> <p>→</p>	<p>$\mathbf{L}^*(f, b, c)$ <i>It (prostration of Qu' rān recital) is allowed to be performed on the back of a camel while travelling without validating excuse ('udhr)</i> $c: \mathbf{L}(f, b)$ <i>Prostration of Qu' rān recital is non-obligatory</i></p>

The particular specification $\mathfrak{K}^*(x, y, z): \mathit{prop}(x: \mathcal{A}, y: \mathcal{C}(x) \vee \mathcal{C}^\circ(x), z: \mathfrak{K}(x, \mathbf{right}^\vee(y)))$

at stake in this example is the following:

- “ $\mathbf{L}(x)$ ” (which presupposes “ $\mathbf{L}(x): \mathit{prop}(x: \mathcal{A})$ ”) stands for “*non-obligatory undertakings of the type \mathcal{A} (prostration).*”

¹⁰ Recall that the injection $\mathbf{right}^\vee(b): \mathcal{C}(f) \vee \mathcal{C}^\circ(f)$ yields $b: \mathcal{C}(f)$.

¹¹ The branch-case *Sujūd al-tilāwa* – sanctioned as non-obligatory by the ruling \mathfrak{K} – is the prostration performed after reciting “*the verses of prostration*”. There are 14 verses of prostration in the Qur’an.

- “ $\mathbf{L}^*(x, y, z)$ ” stands for “*undertakings of the type @ (x) to be performed on the back of a camel while travelling without validating excuse (y), are allowed (z)*”
- “*a*” stands for the root-case “*sujūd-prostration of supererogatory prayer*”, which is one of actions allowed to be performed in a non-canonical way. The term *supererogatory* corresponds to the modality *recommendable action (mustahabb)* and applies to actions that are rewarded if performed but neither sanctioned nor rewarded if not performed (see our remark on deontic modalities below).
- “*f*” stands for the branch-case “*sujūd-prostration of Qwrān recital*”.
- “*b*” stands for some evidence from the sources that undertakings of the type @ can be performed either in canonical or non-canonical form.
- “*c*” stands for some evidence from the sources that the general ruling, which allows actions of the type @, includes non-canonical undertakings of that type.

The analysis of Young (2017, pp. 116-117) is slightly different from ours. Indeed, while discussing this example, Young (2017, p. 116) underlines the resemblance of $\mathfrak{K}^*(a)$ and $\mathfrak{K}^*(f)$ and thus also the similarity of $\mathfrak{K}(a)$ and $\mathfrak{K}(f)$, instead of relying on the force of the inference in the relation of specification.¹² The resemblance is, of course, important, but in the further elucidations of *al-Luma’ al-Shīrāzī* completes the explanation by stressing that the transference obtains its epistemic force from the fact that the second ruling $\mathfrak{K}^*(a)$ specifies the first $\mathfrak{K}(a)$ in some particular way, and that the resemblance is rooted in such particular form of specification:

*[the first type of qiyās al-dalāla] is that one infers a ruling by way of one of the particularities (khaṣāṣa min khaṣāṣ al-ḥukm) of that ruling.*¹³

4.1.2. *Qiyās al-dalāla II*

ويليه ما يستدل بنظير الحكم على الحكم¹⁴

The next type [of qiyās al-dalāla] is that one infers a ruling by way of the parallel of that ruling.

¹² However, in other parts of Young's book there is a discussion of this point but not in relation to that example, such as Young (2017, pp. 94-95 and p. 105).

¹³ al-Shīrāzī (2003, p. 100).

¹⁴ al-Shīrāzī (2003, p. 100). al-Ghazālī (1971, pp. 446) calls this form *al-istidlāl bi al-naẓīr*.

If we follow al-Shīrāzī's description on this second type of *qiyās al-dalāla* as provided in the *Mulakhkhaṣ*¹⁵, the procedure might be expressed as follows:

- (1) We wish to find out if some ruling applies to the branch-case $\mathfrak{K}(\textit{far}'$), but no occasioning factor can be learned from the sources. However, by reviewing the sources we discover that there is another ruling $\mathfrak{K}^*(\textit{far}'$) that resembles very closely the ruling considered to apply to the *far'* (*ḥukm yushākil ḥukm al-far'*).
- (2) A new visit into the sources shows that, in relation to some relevant root-case, we also discover that the two rulings mentioned above, i.e., $\mathfrak{K}(x)$ and $\mathfrak{K}^*(x)$, can be seen as different specifications of a general ruling from which their deontic force and juridical consequence stem (take the example of two different valid forms of divorce-declarations of a Muslim; though different, they can be seen as subsets of the set of divorce-declarations – so that their juridical consequences stem from the fact that they are divorce-declarations). In other words, both rulings can be said to be of the same juridical type and always run together (*yajriyān majran wāḥidan*); and thus, one of the rulings can be said to be the parallel (*naẓīr*)¹⁶ of the other.
- (3) Actually, from the sources we learn that there is evidence that this parallelism can be generalized beyond the one established for the root-case. The parallelism between $\mathfrak{K}(a)$ and $\mathfrak{K}^*(a)$ is so close that they can thus be considered as almost equal (*taswiya*) – or more precisely, one of the two rulings holds if and only if the other one does.
- (4) Establishing that whatever the occasioning factor of one of the rulings is, it must be the same as that of the other.
- (5) Hence, if there is indeed enough evidence that (i) from the point of view of their juridical effect both rulings $\mathfrak{K}(x)$ and $\mathfrak{K}^*(x)$ run together, and (ii) given $\mathfrak{K}(a)$, $\mathfrak{K}^*(a)$, and $\mathfrak{K}^*(f)$, it follows that $\mathfrak{K}(x)$ also applies to the branch-case *f*.

¹⁵ See al-Shīrāzī (1407 H/1986, p. 81).

¹⁶ In fact, like the term *khaṣīṣa* in the first type, al-Shīrāzī does not employ the term *naẓīr* in the *Mulakhkhaṣ*, however, he does use it in the *Ma'ūna* and in the *al-Luma'*.

Step 4 hinges on the assumption of the *sameness* of both rulings in *general*, not only in relation to the root-case. If we formulate this in the language of CTT, the formal steps underlying the process just described is roughly the following:

- Establishing that both rulings involve the same underlying *set*.

$\mathfrak{K}^*(x): \text{prop } (x:\mathfrak{D})$.

$\mathfrak{K}(x): \text{prop } (x:\mathfrak{D})$

- Establishing by examining the root-case and the sources that (in relation to the deontic force and juridical effects determined by the underlying set) there is enough evidence for asserting that if one is the case then so is the second and vice-versa.¹⁷

$(\forall x:\mathfrak{D}) \mathfrak{K}(x) \supset\subset \mathfrak{K}^*(x)$

Notice that the task of showing the bi-implication amounts to showing that *ṭard* and *ʿaks* are satisfied.

- Inferring the ruling under consideration for the branch-case

$(\forall x:\mathfrak{D}) \mathfrak{K}(x) \supset\subset \mathfrak{K}^*(x) \text{ true} \qquad \mathfrak{K}^*(f) \text{ true}$

 $\mathfrak{K}(f) \text{ true}$

The standard example of al-Shīrāzī requires special care. On one hand, the example suggests that both the root-case and the branch-case involve a kind of general terms such as “Muslim” and “non-Muslim”, while on the other the rulings involved are constituted by some specific forms of divorce-declarations sanctioned as valid irrespective of whether they are performed by a Muslim or a non-Muslim.

Indeed, the main example of ‘al-Shīrāzī concerns deciding about the legal validity of an old form of divorce-declaration called *zihār*¹⁸ when performed by a non-Muslim (*Dhimmī*)¹⁹ given that it is known from the sources that a standard form of divorce-declaration called *ṭalāq* is legally valid when performed by both Muslims and non-Muslims. If we follow the texts of our author, it looks as if the example involves

¹⁷ This again involves the process of grasping the universal by examining the particular

¹⁸ See Fyzee (1964, p. 154).

¹⁹ *Dhimmī* is a historical term referring to non-Muslim citizens of an Islamic state.

root-case: *Muslim*,
branch-case: *(some) Non-Muslim*

Parallel rulings for the root-case

Base-ruling established by the sources
'Ṭalāq-declaration-is-valid' of Muslim

Naẓīr-ruling established by the sources
'Ẓihār-declaration-is-valid' of Muslim

Parallel rulings for the branch-case

Base-ruling established by the sources
'Ṭalāq-declaration-is-valid of' non-Muslim

Naẓīr-ruling; thesis to be grounded
'Ẓihār-declaration-is-valid' of non-Muslim

Now, as mentioned above, the general structure of this form of *qiyās* requires both forms of divorce to be understood as being specifications of an underlying set. In this example, the idea is that the propositional function *valid ṭalāq-declaration* is a subset of the set *divorce-declarations* \mathfrak{D} . The same applies to the formation of *Ẓihār(x)*.

<i>divorce-declaration: set</i>	(<i>x:divorce-declaration</i>)
	...
	<i>ṭalāq(x) ∧ Valid (x): prop</i>

<i>divorce-declaration: set</i>	(<i>x:divorce-declaration</i>)
	...
	<i>ẓihār (x) ∧ Valid (x): prop</i>

Moreover, we should also bring to the fore that *divorce-declarations* are brought forward by Humans, instances of which include *Muslims* and *non-Muslims*, so that the fully explicit formation of

valid divorce-declaration of the kind ṭalāq brought forward by x;
valid divorce-declaration of the kind ẓihār brought forward by x,
 if written in linear form, is:

valid (x, y, z) *prop* (x : *Human*, y : *divorce-declaration*(x), z : *ṭalāq*(x, y)).
valid (u, v, w) *prop* (u : *Human*, v : *divorce-declaration*(u), w : *ḡihār* (u, v)).

In plain words, *valid* qualifies *ṭalāq-declarations* that are *divorce-declarations* brought forward by some *Human* (the same applies to *ḡihār-declarations*).²⁰

If we use our usual notation of juridical rulings we obtain:

$\mathfrak{C}(x, y, z)$ “*ṭalāq-declaration of x is a valid divorce-declaration*”
 $\mathfrak{C}^*(u, v, w)$ “*ḡihār-declaration of u is a valid divorce-declaration*”

Hence, as expected, the whole point is to establish the relevant parallelism. This, as mentioned above, requires two complementary steps:

- (1) Establishing that both are subsets specifying an underlying set – in our case-study, the set of *valid divorce-declarations*. This amounts to the examination of the formation rules involved.
- (2) Establishing that whenever one of the rulings is legally valid, so is the other.²¹

The second step relates to co-presence and co-absence, which we will discuss in the following section. However, before going into that issue let us briefly discuss an alternative possible reconstruction. Despite the fact that in the *al-Luma‘ al-Shīrāzī* indicates that the branch-case and the root-case are *Non-Muslim* and *Muslim*, the formulation, particularly in the *Mulakhkhaṣ*, might lead one to conceive that both the root-case and the branch-case split in two subcases, rendering a four-folded structure:

Root-cases

ṭalāq-declaration of Muslim
ḡihār-declaration of Muslim

Branch-cases

ṭalāq-declaration of non-Muslim
ḡihār-declaration of non-Muslim

Parallel rulings for the root-case:

ṭalāq-declaration of Muslim is legally-valid
ḡihār-declaration of Muslim is legally-valid

²⁰ See the explanation of hypotheticals with multiple hypotheses in the appendix to the present book.

²¹ Notice that in the case of *khaṣīṣa* both steps have the same objective, namely establishing a formation rule that makes it apparent that one of the rulings is a specification of the other.

Parallel rulings for the branch-case:

ṭalāq-declaration of non-Muslim is legally-valid
ḡihār-declaration of non-Muslim is legally-valid

This is, in essence, the interpretation followed by Young (2017, p. 117), who bases his reconstruction on the *Mulakkhaṣ* rather than on the *al-Luma'*. Notice that this reconstruction also requires establishing a resemblance between the "twin root-cases". This brings *qiyas al-dalāla* closer to *qiyas al-shabah*. Since, as discussed above, we prefer to keep *qiyas al-dalāla* and *al-shabah* apart, and because of our reconstruction of the deployment of *naḡīr* in *al-Luma'*, we stick with the two-fold structure.

The following diagram condenses our two-fold view on the main moves behind a *qiyas al-dalāla* by means of *naḡīr*:

The root-case <i>aṣl</i> : <i>Muslim</i>		The branch-case <i>far'</i> : <i>non-Muslim</i>
$\mathfrak{C}^*(a, q, r)$: <i>ṭalāq is valid (of Muslim)</i> <i>(ṭalāq-declaration of a Muslim is a valid divorce-declaration)</i>	\longleftrightarrow	$\mathfrak{C}^*(f, d, t)$: <i>ṭalāq is valid (of non-Muslim)</i> <i>(ṭalāq-declaration of a non-Muslim is a valid divorce-declaration)</i>
$\mathfrak{C}(a, q', r')$: <i>ḡihār is valid (of Muslim)</i> <i>(ḡihār-declaration of a Muslim is a valid divorce-declaration)</i>	\longrightarrow	$\mathfrak{C}(f, d', t')$: <i>ḡihār is valid (of non-Muslim)</i> <i>(ḡihār-declaration of a non-Muslim is a valid divorce-declaration)</i>

The formation assumed is the following:

$\mathfrak{C}^*(f, d, t)$:

valid (x, y, z) *prop* (x : *Human*, y : *divorce-declaration*(x), z : *ṭalāq*(x, y)).
non-Muslim: Human, d: divorce-declaration(non-Muslim), t: ṭalāq(non-Muslim, d)

$\mathfrak{C}^*(a, q, r)$:

valid (x, y, z) *prop* (x : *Human*, y : *divorce-declaration*(x), z : *ṭalāq*(x, y)).
Muslim: Human, q: divorce-declaration(Muslim), r: ṭalāq(Muslim, q)

$\mathfrak{C}(f, d', t')$:

valid (u, v, w) *prop* (u : *Human*, v : *divorce-declaration*(u), w : *ḡihār* (u, v)).
non-Muslim: Human, d': divorce-declaration(non-Muslim), t': ḡihār (non-Muslim, d')

$\mathfrak{C}(a, d', t')$:

valid (u, v, w) *prop* (u : Human, v : divorce-declaration(u), w : zihār (u, v)).

Muslim: Human, d' : divorce-declaration(Muslim), t' : zihār (Muslim, d')

4.1.2.1. *Shahādat al-uṣūl for qiyās al-dalāla II*

In the case where the indication is based on *nazīr*, the *mujtahid* must verify that the sources provide evidence that if the ruling \mathfrak{C} applies, then \mathfrak{C}^* also does (co-presence), and that if the first does not apply, then neither does the second (co-absence). Only then can the equality (*taswiya*) of the ruling be considered. Thus, in this form of correlational inference, establishing the equality (*taswiya*) between both rulings amounts to establishing their concomitance (*jarayān*).

In our example, the point is to show that

- for all whose *ṭalāq*-declarations are valid-divorce-declarations, then their performances of *zihār*-declarations also are (*tard*) (*man ṣahḥa ṭalāquhu ṣahḥa zihāruhu*); and that dually,
- for all whose performances of *ṭalāq*-declarations are not valid-divorce-declarations, then their performances of *zihār*-declarations are not valid either (*'aks*). For example: if a *ṭalāq*-declaration is performed by a mad-man, and is therefore not legally valid, then neither is the *zihār*-declaration performed by a mad-man.

Let us assume that the examination of various cases like that of a mad-man, a child and so on, leads to generalizing the parallelism of the rulings not only in relation to the root-case but also in general, so that we obtain the fully explicit notation:

It is **true** that all those humans who perform a valid *ṭalāq*-declaration also perform a valid *zihār* one, and it is also **true** that all those humans who perform a valid *zihār*-declaration also perform a *ṭalāq*-declaration.

For the sake of simplicity, let us further assume that some *divorce-declarations*, *ṭalāq-declarations* and *zihār-declarations*, have been fixed for the debate.

d, d' : divorce-declaration

t : *ṭalāq*-declaration

t': *zihār* -declaration

Hence, once the following have been established:

$$\begin{aligned} &!(\forall x: \textit{Human})\{ \textit{valid}(x,d,t) \supset \textit{valid}(x,d',t')\} \textit{true} && (\textit{tard}) \\ &!(\forall x: \textit{Human})\{ \neg \textit{valid}(x,d,t) \supset \neg \textit{valid}(x,d',t')\} \textit{true} && (\textit{aks}) \end{aligned}$$

then the main premise holds:

$$(\forall z: \textit{Human}) (\textit{valid}(z,d,t) \supset \textit{valid}(z,d',t')) \textit{true} \quad (\textit{jarayān})$$

Let us also further assume that *non-Muslim* has been selected to eliminate the quantifier:

non-Muslim: Human

The main final step of the inference that leads to the searched conclusion is then:

$$\begin{array}{l} (\forall z: \textit{Human}) (\textit{valid}(z,d,t) \supset \textit{valid}(z,d',t')) \textit{true} \\ \textit{valid}(\textit{non-Muslim},d,t) \textit{true} \\ \hline \textit{valid}(\textit{non-Muslim},d',t') \textit{true} \end{array}$$

In the dialectical practice, the way to show that two pair of rulings are associated by a *naẓīr*-relation requires finding some root-case and then make explicit the relation by displaying the logical of form of both rulings and asserting their bi-implication.

4.2. *Qiyās al-shabah*

The procedure of deploying similarity in *qiyās al-shabah* might be described as follows.

1. We wish to find out if some branch-case-ruling $\mathfrak{K}(f)$ applies, but no occasioning factor can be learned from the sources, nor is there a way to identify some kind of indication. However, by reviewing the sources we discover that this ruling applies to a root-case $\mathfrak{K}(a)$.
2. A close inspection of both the root-case and the branch-case shows that they share a set of properties or rulings that are juridically relevant.
3. Given this set and its juridical relevance, root-case and branch-case are taken to be identical (within the set).

4. Given the (assumed) identity of *aṣl* and *far'*, the occurrence of the root-case in $\mathfrak{C}(a)$ can be substituted with the branch-case and the searched conclusion $\mathfrak{C}(f)$ is obtained.

Step 4 hinges on the assumption of identifying a suitable set that provides the sameness-condition required by the substitution. The problem is that, on one hand, applying *qiyās al-shabah* requires identifying a relevant set of properties, while on the other hand, those properties are not sufficient to provide the occasioning factor.

Thus, the selected properties must be somehow relevant for ruling albeit the fact that they provide neither enough elements for identifying the juridical ground underlying the ruling, nor a way to assume that some common juridical ruling (even if not known) is at work.

This underlies the rejection of this form of inference by many jurists including al-Shīrāzī. Indeed, although, as mentioned above, al-Shīrāzī followed the Shāfi'ī school in acknowledging and studying the application of *qiyās al-shabah*, his own opinion was that it is not a valid (*lā yaṣiḥḥ*) form of inference because it is based neither on an 'illa nor on an indication (*dalāla*) of the 'illa.²²

Notice that, despite the problem of singling out a suitable set of properties (or rulings) required by *qiyās al-shabah*, the study of the examples existing in the literature shows that this system imposes quite strong conditions for its application: the properties grounding the analogy must be **exactly the same** for both the root- and the branch-case.²³

4.2.1. The inferential structure of *qiyās al-shabah*

The inferential structure of this form of *qiyās* deploys substitution of identicals. However, the *epistemic weakness* of this form of *qiyās* is that we do not really know if

²² Cf. al-Shīrāzī (2003, p. 101).

²³ This is different to the main conceptions of analogy nowadays where the properties on both sides (the target case and the known case) might be *similar* rather than exactly the same – see e.g. Bartha (2010) – we come back to this issue at the end chapter of the present book.

they are identicals, but only taken to be so in relation to the property (or properties) \mathcal{P} . We indicate this weak form of identity with the notation $a \approx_{\mathcal{P}} f$.

Within the formal framework of CTT the inference of the conclusion is reached by applying a version of what is nowadays known as *Leibniz's substitution rule*:

$$\begin{array}{c}
 \mathcal{P}(x): \text{prop } (x: \mathcal{D}) \\
 \dots \\
 a, f: \mathcal{D} \qquad \mathcal{P}(a) \text{ true} \qquad \mathcal{P}(f) \text{ true} \qquad a \approx_{\mathcal{P}} f \text{ true} \qquad \mathcal{K}(a) \text{ true} \\
 \hline
 \text{shabah } \mathcal{K}^*: a \approx_{\mathcal{P}} f: \mathcal{K}(f)
 \end{array}$$

Remarks

1. The main CTT notion deployed is a variant of *propositional identity*. Propositional identity is distinguished from *judgemental equality*: whereas the latter establishes (at the ontological level) a *real definition*, the former establishes identity in the form of a proposition and in relation to a set. For example, while a slave and a free person can be seen as identical in relation to some juridical properties that lead one to infer that the slave is allowed to own property, slave is not a definition of free person! ²⁴
2. Notice that the form of the ruling is **not** $\mathcal{K}(x,y): \text{prop } (x: \mathcal{D}, y: \mathcal{P}(x))$, which would establish the dependence of the ruling upon the property. The point is that, in the context of *qiyās al-shabah*, we really do not know if that property is sufficient for determining the occasioning factor. The main inferential step is actually a substitution based on an assumed identity between the root-and the branch-case.

Let us see very briefly one classical example of *qiyās al-shabah*, which deploys three properties. The diagram speaks for itself:²⁵

²⁴ More precisely, within the framework of CTT real definitions establish what something is in relation to some canonical element of the set, and thus if two entities are definitionally equal a true proposition establishing the identity of both can be asserted. However, the inverse is not assured – see Ranta (1994, p. 52).

²⁵ See al-Shīrāzī (1407 H/1986, p. 81). Cf. Young (2017, p. 118).

The root-case <i>aṣl</i> : <i>The free person</i>		The branch-case <i>far'</i> : <i>The slave</i>
$\mathfrak{P}_1(a)$ <i>(the free person) is a human being to whom instructive communication is addressed (mukhāṭab)</i> – where $\mathfrak{P}_1(x)$: <i>prop (x:Human being)</i>	↔	$\mathfrak{P}_1(f)$ <i>(the slave) is a human being to whom instructive communication is addressed (mukhāṭab)</i> – where $\mathfrak{P}_1(x)$: <i>prop (x:Human being)</i> .
$\mathfrak{P}_2(a)$ <i>(the free person) is a human being who is rewarded (muthāb)</i> – where $\mathfrak{P}_2(x)$: <i>prop (x:Human being)</i>	↔	$\mathfrak{P}_2(f)$ <i>(the slave) is a human being who is rewarded (muthāb)</i> – where $\mathfrak{P}_2(x)$: <i>prop (x:Human being)</i>
$\mathfrak{P}_3(a)$ <i>(the free person) is a human being who is punished ((mu'āqab)</i> – where $\mathfrak{P}_3(x)$: <i>prop (x:Human being)</i>	↔	$\mathfrak{P}_3(f)$ <i>(the slave) is a human being who is punished (mu'āqab)</i> – where $\mathfrak{P}_3(x)$: <i>prop (x:Human being)</i>
$\mathfrak{K}(a)$ <i>(the free person) is a human being who is legally permitted to own</i> – where $\mathfrak{K}(x)$: <i>prop (x:Human being)</i>	→	$\mathfrak{K}(f)$, given $a \approx_{\mathfrak{P}} f$ – where “ \mathfrak{P} ” stands for the conjunction $\mathfrak{P}_1(x) \wedge \mathfrak{P}_2(x) \wedge \mathfrak{P}_3(x)$: <i>prop (x:Human being)</i> <i>(the slave) is a human being who is legally permitted to own</i> – where $\mathfrak{K}(x)$: <i>prop (x:Human being)</i>

4.3. A dialogical framework for *qiyās al-dalāla* and *qiyās al-shabah*

In our aim to facilitate the overview of the different chapters of this study, we will repeat the general introduction to dialogical logic as presented in the last section of the preceding chapter.

For a simple overview, we advise the reader to see first the presentation of the overall development of a dialogue for *qiyās al-dalāla* and *qiyās al-shabah* in Sect. 4.3.3.1 (without looking at the formulae); and also observe the examples of dialogues provided at the end of this section.

4.3.1. The dialogical approach to logic

As already indicated, our analysis of the dialectical structure of *qiyās* deploys a version of the dialogical approach to logic. The dialogical approach to logic is not a specific logical system but rather a framework rooted on a rule-based approach to meaning in

which different logics can be developed, combined and compared.²⁶ More precisely, in a dialogue two parties argue about a thesis respecting certain fixed rules. The player that states the thesis is called Proponent (**P**), and his rival, who contests the thesis, is called Opponent (**O**). Dialogues are designed in such a way that each of the plays end after a finite number of moves with one player winning, while the other loses. Actions or moves in a dialogue are often understood as speech-acts involving *declarative utterances or statements* and *interrogative utterances or requests*.

The point is that the rules of the dialogue do not operate on expressions or sentences isolated from the act of uttering them. The rules are divided into particle rules or rules for logical constants (*Partikelregeln*) and structural rules (*Rahmenregeln*). Particle rules provide an abstract description of how the game can proceed locally: they specify the way a formula can be challenged and defended according to its main logical constant. In this way the particle rules govern the local level of meaning (of logical constants – but it can be extended to non-logical ones). Strictly speaking, the expressions occurring in the table above are not actual moves because they feature formula schemata and the players are not specified. Moreover, these rules are indifferent to any particular situations that might occur during the game. For these reasons we say that the description provided by the particle rules is abstract. The structural rules determine the development of a dialogue game and they govern the moves involving elementary statements.

4.3.2. Local Meaning

It is presupposed in standard dialogical systems that the players use well-formed formulas. The well formation can be checked at will, but only with the usual meta

²⁶ In the following sections we present only a simplified and adapted form of the Dialogical Framework, called *Immanent Reasoning* – see Rahman, McConaughy, Klev, & Clerbout (2018). The main original papers are collected in Lorenzen & Lorenz (1978) – see too Lorenz (2010a, b), Felscher (1985), Krabbe (2006). For an account of recent developments see Rahman & Keiff (2005), Keiff (2009), Rahman & Tulenheimo (2009), Rückert (2011), Clerbout (2014a, b). The most recent work links dialogical logic and Constructive Type Theory, see Clerbout & Rahman (2015) and Rahman, Clerbout, & Redmond (2017).

reasoning by which the formula is checked to indeed observe the definition of a wff. We want to enrich the system by first allowing players to enquire on the status of expressions and in particular to ask if a certain expression is a proposition. We thus start with dialogical rules explaining the formation of propositions. Moreover, we extend the first-order language assumed in standard dialogical logic by adding two labels **O** and **P**, standing for the players of the game, and the two symbols ‘!’ and ‘?’. When the identity of the player does not matter, we use the variables **X** or **Y** (with $X \neq Y$). A move **M** is an expression of the form ‘**X**-*e*’, where *e* is one of the forms specified by the particle rules.

Local meaning: Formation

Statement	Challenge	Defence
X $A \vee B$: prop	Y $?_{F\vee 1}$ Or Y $?_{F\vee 2}$	X A : prop X B : prop
X $A \wedge B$: prop	Y $?_{F\wedge 1}$ Or Y $?_{F\wedge 2}$	X A : prop X B : prop
X $A \supset B$: prop	Y $?_{F\supset 1}$ Or Y $?_{F\supset 2}$	X A : prop X B : prop
X $\neg A$: prop	Y $?_{F\neg}$	X A : prop
X $(\forall x:A) B(x)$: prop	Y $?_{F\forall 1}$ Or Y $?_{F\forall 2}$	X A : set X $B(x)$: prop ($x:A$)
X $(\exists x:A) B(x)$: prop	Y $?_{\exists 1}$ Or Y $?_{F\exists 2}$	X A : set X $B(x)$: prop ($x:A$)

Because our deployment expressions come from Constructive-Type Theory, the language contains expressions such as the following (further expressions are provided in the section on terminology in the main text):

X ! A Player **X** claims that he *can produce* some *local reason* for A .

$\mathbf{X} p: A$ Player \mathbf{X} states that p instantiates A . In other words, player \mathbf{X} states that p provides a *local reason* for A .

$\mathbf{X} p_i: B(p_j)$ Player \mathbf{X} states that p_i provides a *local reason* for B given that the antagonist \mathbf{Y} states that p_j provides a *local reason* for A , and given that $\mathbf{B}(x): \mathbf{prop}(x:A)$.

Similarly

$\mathbf{X} p_i: B(p_j)$ Player \mathbf{X} states that p_i provides a *local reason* for B given that it is *he himself* (\mathbf{X}), who states that p_j provides a *local reason* for A , and given that $\mathbf{B}(x): \mathbf{prop}(x:A)$.

Sometimes, when the context requires it, we add the indications $p_i^{\mathbf{X}}: B(p_j^{\mathbf{Y}})$ or $p_i^{\mathbf{X}}: B(p_j^{\mathbf{X}})$

Synthesis of local reasons

The **synthesis rules** of local reasons determine how to produce a local reason for a statement; they include rules of interaction indicating how to produce the local reason that is required by the proposition (or set) in play, that is, they indicate what kind of dialogical action –what kind of move – must be carried out, by whom (challenger or defender), and what reason must be brought forward.

Synthesis rules for local reasons

	Move	Challenge	Defence
Conjunction	$\mathbf{X} ! A \wedge B$	$\mathbf{Y} ? L^\wedge$ or $\mathbf{Y} ? R^\wedge$	$\mathbf{X} p_1: A$ (resp.) $\mathbf{X} p_2: B$
Existential quantification	$\mathbf{X} ! (\exists x: A)B(x)$	$\mathbf{Y} ? L^\exists$ or $\mathbf{Y} ? R^\exists$	$\mathbf{X} p_1: A$ (resp.) $\mathbf{X} p_2: B(p_1)$
Disjunction	$\mathbf{X} ! A \vee B$	$\mathbf{Y} ?^\vee$	$\mathbf{X} p_1: A$ or $\mathbf{X} p_2: B$
Implication	$\mathbf{X} ! A \supset B$	$\mathbf{Y} p_1: A$	$\mathbf{X} p_2: B$
Universal quantification	$\mathbf{X} ! (\forall x: A)B(x)$	$\mathbf{Y} p_1: A$	$\mathbf{X} p_2: B(p_1)$
Negation	$\mathbf{X} ! \neg A$ Also expressed as $\mathbf{X} ! A \supset \perp$	$\mathbf{Y} p_1: A$	$\mathbf{X} p_2: \perp$

Analysis of local reasons

Apart from the rules for the synthesis of local reasons, we need rules that indicate how to parse a complex local reason into its elements: this is the *analysis* of local reasons. In order to deal with the complexity of these local reasons and formulate general rules for the analysis of local reasons (at the play level), we introduce certain operators that we call *instructions*, such as $L^\vee(p)$ or $R^\wedge(p)$. To the standard particle rules (the local rules for logical constants) we also add rules for the operators \mathbb{F} and \mathbb{V} adapted to the purposes of our present study.

Let us introduce these instructions and the analysis of local reasons with an example: player \mathbf{X} states the implication $(A \wedge B) \supset A$. According to the rule for the synthesis of local reasons for an implication, we obtain the following:

Move	$\mathbf{X} ! (A \wedge B) \supset B$
Challenge	$\mathbf{Y} p_1: A \wedge B$

Recall that the synthesis rule prescribes that \mathbf{X} must now provide a local reason for the consequent; but instead of defending his implication (with $\mathbf{X} p_2: B$ for instance), \mathbf{X} can choose to parse the reason p_1 provided by \mathbf{Y} in order to force \mathbf{Y} to provide a local reason for the right-hand side of the conjunction that \mathbf{X} will then be able to copy. In other words, \mathbf{X} can force \mathbf{Y} to provide the local reason for B out of the local reason p_1 for the antecedent $A \wedge B$ of the initial implication. The analysis rules prescribe how to carry out such a parsing of the statement by using *instructions*.

The rule for the analysis of a local reason for the conjunction $p_1: A \wedge B$ will thus indicate that its defence includes expressions such as

- the left instruction for the conjunction, written $L^\wedge(p_1)$, and
- the right instruction for the conjunction, written $R^\wedge(p_1)$.

These instructions can be informally understood as carrying out the following step: for the defence of the conjunction $p_1: A \wedge B$ separate the local reason p_1 in its left (or right)

component so that this component can be adduced in defence of the left (or right) side of the conjunction.

Let us now proceed to present the **Analysis rules** for the usual logical constants.

Analysis rules for local reasons

	Move	Challenge	Defence
Conjunction	$\mathbf{X} p: A \wedge B$	$\mathbf{Y} ? L^\wedge$ or $\mathbf{Y} ? R^\wedge$	$\mathbf{X} L^\wedge(p): A$ (resp.) $\mathbf{X} R^\wedge(p): B$
Existential quantification	$\mathbf{X} p: (\exists x: A)B(x)$	$\mathbf{Y} ? L^\exists$ or $\mathbf{Y} ? R^\exists$	$\mathbf{X} L^\exists(p): A$ (resp.) $\mathbf{X} R^\exists(p): B(L^\exists(p))$
Disjunction	$\mathbf{X} p: A \vee B$	$\mathbf{Y} ?^\vee$	$\mathbf{X} L^\vee(p): A$ or $\mathbf{X} R^\vee(p): B$
Implication	$\mathbf{X} p: A \supset B$	$\mathbf{Y} L^\supset(p): A$	$\mathbf{X} R^\supset(p): B$
Universal quantification	$\mathbf{X} p: (\forall x: A)B(x)$	$\mathbf{Y} L^\forall(p): A$	$\mathbf{X} R^\forall(p): B(L^\forall(p))$
Negation	$\mathbf{X} p: \neg A$ Also expressed as $\mathbf{X} p: A \supset \perp$	$\mathbf{Y} L^\neg(p): A$ $\mathbf{Y} L^\supset(p): A$	$\mathbf{X} R^\neg(p): \perp$ $\mathbf{X} R^\supset(p): \perp$ Which amounts to stating $\mathbf{X} ! \perp$ ²⁷

The operator \mathbf{F} ²⁸

In uttering the formula $\mathbf{F}A$ the argumentation partner \mathbf{X} claims that he can find a counterexample during a play where the antagonist \mathbf{Y} asserts A . The antagonist \mathbf{Y} challenges $\mathbf{F}A$ by asserting that A can be challenged successfully. Thus, through this challenge \mathbf{Y} obliges \mathbf{X} to open a *sub-play* where he (\mathbf{X}) states A .

²⁷ The general point of deleting the instruction in $\mathbf{X} R^\supset(p): \perp$ is that instructions occurring in expressions stating **falsum** keep un-resolved – see below structural rule SR3 on resolutions, item 3.

²⁸ Cf. Rahman & Rückert (2001, pp. 113-116).

- The rules for synthesis and analysis follow those of

$Y ! \neg A$

fulfilling the distribution of duties and rights prescribed for the role of Y in the sub-play.

In other words, the local meaning of the operator FA reduces to stating the negation of the proposition under its scope. However, this statement might change his duties in relation to the Socratic Rule

$X ! FA$	Challenge	Defence
	$Y ?F$	
	<i>Sub-play</i> \mathcal{D}_1	<i>Sub-play</i> \mathcal{D}_1
	$Y ! A$ Y must play under the restriction of the <i>Socratic-Rule</i> in the sub-play	$X ?_A$ (he challenges A) The local reason for the operator is the local reason that encodes a play for the negation of A.

The operator V

In uttering the formula VA the argumentation partner X claims that he can win a play where he (X) asserts A . The antagonist Y responds by challenging X to open a *sub-play* where he (X) defends A .

- The rules for synthesis and analysis follow those of

$X ! A$

fulfilling the distribution of duties and rights prescribed for the role of X in the sub-play.

$X ! VA$	Challenge	Defence
	$Y : ?V$	
	<i>Sub-play</i> \mathcal{D}_1	<i>Sub-play</i> \mathcal{D}_1
	$Y ?_A$ (he challenges A) Y must play under the restriction of the <i>Socratic Rule</i>	$X ! A$ The local reason for the operator is the local reason that encodes a play for A.

4.3.3. Global meaning

4.3.3.1. Structural rules

In the dialogical approach, validity is defined via the notion of *winning strategy*, where winning strategy for **X** means that for any choice of moves by **Y**, **X** has at least one possible move at his disposal such that he (**X**) wins:

- *Validity (definition)*: A proposition is valid in a certain dialogical system if and only if **P** has a winning strategy for this proposition.

In the present context we will deploy a variant of the structural rules. Before providing them, let us fix the following notions:

- *Play*: A *play* is a legal sequence of moves, *i.e.*, a sequence of moves which observes the game rules. Particle rules are not the only rules which must be observed in this respect. In fact, it can be said that the second kind of rules, the *structural rules* are those giving the precise conditions under which a given sequence is a play.
- *Dialogical game*: The *dialogical game* for φ , written $D(\varphi)$, is the set of all plays with φ being the *thesis* (see the Starting rule below).²⁹

The *structural rules* are the following:

SR0 (Starting rule)

Any dialogue starts with the Opponent stating initial concessions, if any, and the Proponent stating the thesis. After that the players each choose a positive integer called *repetition rank*. The *repetition rank* of a player restricts the number of challenges he can play in reaction to a single move.

SR1 (Game-playing rule)

SR1.1 (Classical game-playing rule)

Players move alternately. After the repetition ranks have been chosen, each move is a challenge or a defence in reaction to a previous move and in accordance with the particle rules.

²⁹ For a formal formulation see Clerbout (2014a, b).

SR1.2 (Intuitionistic game-playing rule)

Players move alternately. After the repetition ranks have been chosen, each move is a challenge or a defence in reaction to a previous move and in accordance with the particle rules. Players can only answer against the *last non-answered* challenge by the adversary.³⁰

SR2 (Socratic Rule)³¹

P cannot make an elementary statement if **O** has not stated it before, except in the thesis. An elementary statement is either an elementary proposition with implicit local reason, or an elementary proposition and its local reason (not an instruction).

SR2.1 Challenging elementary sentences

Challenges against elementary statements with implicit local reasons take the form:

$$\begin{array}{l} X! A \\ Y?_{reason} \\ X a: A \end{array}$$

where A is an elementary proposition and a is a local reason.³² In the context of dialogues for *qiyās* it can take the form:

$$\begin{array}{l} X! A \\ Y_{why}? \\ X a: A \end{array}$$

SR2.1.2 Responses to challenges against elementary statements.

³⁰ This last clause is known as the *Last Duty First* condition, and is the clause which makes dialogical games suitable for Intuitionistic Logic, hence the name of this rule.

³¹ This, rule, as extensively discussed in Sect. 3.2.1. is one of the most salient characteristics of dialogical logic. In previous literature on dialogical logic this rule has been called the *copy-cat rule* or *Socratic rule* and it introduces a kind of asymmetry in the distribution of roles. Clearly, if the ultimate grounds of a dialogical thesis are elementary statements and if this is implemented by the use of the copy-cat rule, then the development of a dialogue is in this sense necessarily asymmetric. Indeed, if both contenders were restricted by the copy-cat rule no elementary statement can ever be uttered. Thus, we implement the copy-cat rule by designating one player, called the *Proponent*, whose utterances of elementary statements are restricted by this rule. It is the win of the Proponent that provides the dialogical notion of validity.

³² For more details see structural rules for Immanent Reasoning SR5 in Rahman, Iqbal, & Soufi (2019, Chapter IV); Rahman, McConaughy, Klev, & Clerbout (2018).

If **O** endorsed a statement of the form **O** ! A at move n , **P** can state " $you(i): A$ " which expresses that **P**'s reason for endorsing B is "you, the Opponent, have already endorsed B at move n ". It can also take the form

P ! A
O *Why* ?
P $you(n): A$ (assuming **O** $a: A$ at n)

SR2.1.3 Responses to challenges against the thesis of a *qiyās*

O's challenge to the thesis of a *qiyās al-dalāla* and *al-shabah* is described by SR3.

SR2.1.4 Resolution of Instructions

- 3) A player may ask his adversary to carry out the prescribed instruction and thus bring forward a suitable local reason in defence of the proposition at stake. Once the defender has replaced the instruction with the required local reason, we say that the instruction has been resolved.
- 4) The player index of an instruction determines which of the two players has the right to choose the local reason that will resolve the instruction.

For example:

X $L_{\wedge}(p): A$
Y ?.../ $L_{\wedge}(p)$
X $p_1: A$

The choice of a local reason for resolving an instruction is restricted by the distribution of rights and duties prescribed by the local rules.

Instructions occurring in expressions stating **falsum** have no resolution. In fact, the player stating $\mathcal{S}(p): \perp$ gives up and therefore loses the play.³³

SR2.1.5 Requests and endorsements for *qiyās al-dalāla* and *al-shabah*

Qiyās al-dalāla and *al-shabah* also require the following moves prescribed by the **development rules** specific to the dialectical framework underlying these forms of

³³ For more details see structural rules for Immanent Reasoning in Rahman, Iqbal, & Soufi (2019, Chapter IV); Rahman, McConaughy, Klev, & Clerbout (2018).

qiyās.

SR2.1.5.1 Requests based on sources.

If the request has a form that indicates sources, it **must** be endorsed by the respondent:

$$\begin{array}{ll} \mathbf{X} p^{\mathfrak{s}}: A? & \mathbf{X} ! A^{\mathfrak{s}}? \\ \mathbf{Y} p^{\mathfrak{s}}: A & \mathbf{Y} ! A^{\mathfrak{s}} \end{array}$$

(Since in the glosses of the examples, the backing from the sources is made explicit, we often do not add them explicitly to the notation).

SR2.1.5.2 The principal requests

Qiyās al-dalāla aims at establishing a structural relation between two rulings. Therefore, the followings are the principal requests proposed by the Proponent to the Opponent:

$$\begin{array}{l} \mathbf{P} \mathfrak{C}^*[x_1, \dots, x_n]\text{-khaṣīṣa-}\mathfrak{C}[x] ? \\ (\mathbf{P} \text{ asks } \mathbf{O} \text{ to endorse that specification } \mathfrak{C}^* \text{ specifies } \mathfrak{C}) \\ \mathbf{P} (\forall x: \mathfrak{D}) \mathfrak{C}(x) \supset \mathfrak{C}^*(x) ? \\ (\mathbf{P} \text{ asks } \mathbf{O} \text{ to endorse that both rulings are in a } \textit{naẓīr}\text{-relation}) \end{array}$$

For *qiyās al-shabah*, the Proponent asks the Opponent to endorse that the root-case and the branch-case are identical in relation to the property \mathfrak{P} . This is expressed with the following notation:

$$\mathbf{P} a \approx_{\mathfrak{P}} f?$$

SR2.1.5.3 *Muṭālaba (qiyās al-dalāla)*

The Opponent might ask the Proponent for the justification of linking the ruling \mathfrak{C}^* to the ruling \mathfrak{C} .

$\mathbf{X} \mathfrak{C}^*[x_1, \dots, x_n]\text{-khaṣīṣa-}\mathfrak{C}[x] ?$	\mathbf{X} asks \mathbf{Y} to endorse that specification \mathfrak{C}^* specifies \mathfrak{C} .
$\mathbf{Y} \textit{muṭālaba} !$	asking for argumentation
$\mathbf{X} @_1. \dots @_n$	argumentation of \mathbf{X} in order to show 1) that the particular-general relationship holds between $\mathfrak{C}^*(a)$ and $a: \mathfrak{C}$; and 2) that according to the <i>sources</i> \mathfrak{C} applies iff \mathfrak{C}^* applies.
$\mathbf{Y}! \mathfrak{C}^*[x_1, \dots, x_n]\text{-khaṣīṣa-}\mathfrak{C}[x]$	\mathbf{Y} endorses the request.

X ($\forall x:\mathcal{D}$) $\mathfrak{C}(x) \supset \mathfrak{C}^*(x)$?	X asks Y to endorse that both rulings are in a <i>nazīr</i> -relation
Y <i>muṭālaba</i> !	asking for argumentation
X $\mathcal{Q}_1, \dots, \mathcal{Q}_n$	argumentation of X in order to show 1) that both \mathfrak{C} and \mathfrak{C}^* are particular rulings that specify some underlying set \mathcal{D} , and thus, that both can be said to be equal in relation to the deontic force and juridical effects of the underlying general ruling; and 2) that according to the <i>sources</i> \mathfrak{C} applies iff \mathfrak{C}^* applies.
Y ! ($\forall x:\mathcal{D}$) $\mathfrak{C}(x) \supset \mathfrak{C}^*(x)$	Y endorses the request.

SR2.1.5.4 *Mu ‘āraḍa* deployed in *qiyās al-dalāla*³⁴

The Opponent might refuse the link between \mathfrak{C}^* and \mathfrak{C} proposed by the Proponent. The refusal amounts to drawing a distinction (*al-farq*) between the application of \mathfrak{C}^* to the root-case and the branch-case so that this ruling can be seen neither as a specification nor a parallel of \mathfrak{C} , since there is another alternative pair $\mathfrak{C}^{\bullet\bullet}$, \mathfrak{C}^{\bullet} , that (according to some sources s^{\bullet} which have priority in relation to the sources (that ground **P**'s main thesis) applies to some root-case a^{\bullet} but that contradicts the thesis $\mathfrak{C}(f)$. We will assume that a refusal will be brought forward after the Proponent has developed his own argument. If such an objection has been raised, a sub-play starts and a role reversal takes place where the Opponent must defend his arguments.

P $\mathfrak{C}^*[x_1, \dots, x_n]$ - <i>khaṣīṣa</i> - $\mathfrak{C}[x]$?	P asks O to endorse that \mathfrak{C}^* is <i>khaṣīṣa</i> of \mathfrak{C} .
O <i>muṭālaba</i> !	asking for argumentation
P $\mathcal{Q}_1, \dots, \mathcal{Q}_n$	argumentation of P in order to show 1) that the particular-general relationship holds between $\mathfrak{C}^*(a)$ and a : \mathfrak{C} ; 2) that according to the <i>sources</i> \mathfrak{C} applies iff \mathfrak{C}^* applies.
O $\forall \mathfrak{C}^{\bullet\bullet} [x_1, \dots, x_n]$ - <i>khaṣīṣa</i> - $\mathfrak{C}^{\bullet}[x]$ (<i>al-farq</i>)	Instead of endorsing the requested assertion, O states that a distinction is due and launches a sub-play where he proposes as his thesis the alternative pair of rulings \mathfrak{C}^{\bullet} , $\mathfrak{C}^{\bullet\bullet}$
P <i>muṭālaba</i> ?	P asks for justification

³⁴ See al-Shīrāzī (1987, pp. 116-117)

O $\mathcal{K}^{\bullet\bullet}(f)?$	O asks P to acknowledge that, according to the sources s^{\bullet} , the branch-case falls under the ruling $\mathcal{K}^{\bullet\bullet}$. Whereas, the root-case a does not fall under this ruling (i.e. O indicates the distinction of the root-case a to the branch-case f with regard to this ruling).
P! $\mathcal{K}^{\bullet\bullet}(f)$	P concedes it.
O $\mathcal{K}^{\bullet\bullet}(a^*)?$	O asks P to acknowledge that, according to the sources, a^* (the new root-case) falls under the ruling $\mathcal{K}^{\bullet\bullet}$
P! $\mathcal{K}^{\bullet\bullet}(a^*)$	P acknowledges it.
O $\mathcal{K}^{\bullet}(a^*)?$	O asks P to acknowledge that, according to the sources, a^* falls under the ruling \mathcal{K}^{\bullet}
P! $\mathcal{K}^{\bullet}(a^*)$	P acknowledges it.
O $\mathcal{K}^{\bullet\bullet} [x_1, \dots, x_n]$ - <i>khaṣīṣa</i> - $\mathcal{K}^{\bullet}[x]$?	O asks P to endorse that $\mathcal{K}^{\bullet\bullet}$ is <i>khaṣīṣa</i> of \mathcal{K}^{\bullet} .
P <i>muṭālaba?</i>	P asks for justification
O $\mathcal{Q}_1, \dots, \mathcal{Q}_n$	argumentation of O in order to show 1) that the particular-general relationship holds between $\mathcal{K}^{\bullet\bullet}(a^*)$ and a^* : \mathcal{K}^{\bullet} ; and 2) that according to the <i>sources</i> \mathcal{K}^{\bullet} applies iff $\mathcal{K}^{\bullet\bullet}$ applies.
P! $\mathcal{K}^{\bullet\bullet} [x_1, \dots, x_n]$ - <i>khaṣīṣa</i> - $\mathcal{K}^{\bullet}[x]$	P endorses it, and the sub-play continues in a standard play.
O $\mathcal{K}^{\bullet}(f, b, c)?$	O asks P to acknowledge that according to the endorsement the branch-case falls under the scope of the general ruling \mathcal{K}^{\bullet} .
P! $\mathcal{K}^{\bullet}(f, b, c)$	P concedes it.
O $(\mathcal{K}^{\bullet}(f, b, c) \wedge \mathcal{K}^{\bullet}(f, b, c)) \supset \perp$	O makes the point that the branch-case cannot fall under two incompatible rulings (since this leads to a contradiction).
P <i>Iḥḩām</i>	P concedes defeat.
	After the objection and the constructive contribution of O , the <i>qiyās</i> is rewritten with the thesis: $\mathcal{K}^{\bullet}(far)$ The tree displaying the winning strategy will delete the unsuccessful attempts.

Similar sub-plays will be triggered by objections to the arguments in support of *naẓīr*.

SR2.1.5.5 *Farq* and *mu'āraḩa-farq* deployed in *qiyās al-shabah*

For *qiyās al-shabah*, the Opponent might refuse to accept that the branch-case and the root-case are identical despite the fact that they both share the property \mathcal{P} since the branch-case is distinguished from the root-case in relation to the property \mathcal{P}^* — a specification of \mathcal{P} ; and the Opponent is required to show that the distinction does not support transferring the ruling of the root-case to the branch-case. We distinguish two

forms: *farq* and *mu'āraḍa-farq*.³⁵ For the second form, the play continues where the Opponent brings forward a new root-case and proposes a new *qiyās* (between the branch-case and the new root-case with regard to the property \mathcal{P}^*) competing the Proponent's *qiyās*. If *farq* or *mu'āraḍa-farq* has been launched, a sub-play starts and a role reversal takes place where the Opponent must defend his arguments.

$\mathbf{P} \ a \approx_{\mathcal{P}} f?$	\mathbf{P} asks \mathbf{O} to endorse that the root-case and the branch-case are identical with regard to \mathcal{P} such that whatever in correlation with \mathcal{P} in the root-case should be in correlation with \mathcal{P} in the branch-case.
$\mathbf{O} \ ! \ \forall \ a \not\approx_{\mathcal{P}^*} f$ (where \mathcal{P}^* induces a subset in \mathcal{P} namely, the set “all those instances of \mathcal{P} , that satisfy \mathcal{P}^* ”)	Instead of endorsing the requested assertion, \mathbf{O} states that a distinction is due and launches a sub-play where he brings forward the specific property \mathcal{P}^* that both imposes the distinction of the root-case to the branch-case and undermines the extending of the application of the ruling of the root-case to the branch-case.
$\mathbf{P} \ \text{muḥālaba}?$	\mathbf{P} asks for justification
$\mathbf{O} \ \neg \mathcal{P}^*(a)?$	\mathbf{O} asks \mathbf{P} to concede that the root-case does not enjoy the specific property \mathcal{P}^* .
$\mathbf{P} \ ! \ \neg \mathcal{P}^*(a)$	\mathbf{P} concedes it.
$\mathbf{O} \ \mathcal{P}^*(f) ?$	\mathbf{O} asks \mathbf{P} to acknowledge that the branch-case enjoys that property.
$\mathbf{P} \ ! \ \mathcal{P}^*(f)$	\mathbf{P} acknowledges it.
$\mathbf{O} \ a \not\approx_{\mathcal{P}^*} f?$	Then, \mathbf{O} asks \mathbf{P} to endorse that the root-case and the branch-case are not identical with regard to \mathcal{P}^* .
$\mathbf{P} \ ! \ a \not\approx_{\mathcal{P}^*} f$	\mathbf{P} endorses the request.
$\mathbf{O} \ ! \ \{(a \not\approx f) [\mathfrak{K}(a) \wedge \mathfrak{K}(f)]\} \supset \perp$	Based on the endorsement, \mathbf{O} states that the root-case and the branch-case should be distinguished in relation to the ruling \mathfrak{K} .
For <i>farq</i> , the play stops (\mathbf{P} concedes defeat [<i>ifḥām</i>]). As for <i>mu'āraḍa-farq</i> , the sub-play continues where \mathbf{P} endorses \mathbf{O} 's last assertion; and, then, \mathbf{O} proposes a new thesis.	

³⁵ Al-Bājī (2001, p. 202) provides two different opinions of legal theorist (*uṣūliyyūn*) concerning *farq*. Some legal theorist, such as Abū al-Ḥasan b. al-Quṣṣār, say that *farq* does not require a counterexample (i.e. a new root-case competing the root-case proposed by the Proponent)—that is to say, it is enough for the Opponent to distinguish the root-case from the branch-case in relation to a specific property which is a specification of the proposed property (let us call \mathcal{P}^*) in order to invalidate the Proponent's analogy. While the others, including al-Bājī, argue that *farq* requires a counterexample that shares with the branch-case that specific property \mathcal{P}^* . With that said, the Opponent proposes another analogy competing the Proponent's analogy. In fact, so far as we understood, al-Bājī speaks of *farq* within the frame of *mu'āraḍa*, whereas al-Quṣṣār, perhaps, describes *farq* in general. Therefore, we distinguish two forms of *farq*, namely *farq* and *mu'āraḍa-farq*.

O ! $\mathfrak{C}^*(f)$	O proposes the new thesis that the ruling \mathfrak{C}^* (where \mathfrak{C}^* and \mathfrak{C} are incompatible) applies to the branch-case.
P Why ?	P asks for the reason.
O $\mathfrak{C}^*(a^*)$?	O asks P to acknowledge that the ruling \mathfrak{C}^* applies to a^*
P ! $\mathfrak{C}^*(a^*)$	P concedes it.
O $\mathcal{P}^*(a^*)$?	O asks P to concede that the new root-case a^* enjoys \mathcal{P}^*
P ! $\mathcal{P}^*(a^*)$	P concedes it.
O $a^* \approx_{\mathcal{P}^*} f$?	O asks P to endorse a^* and the branch-case are identical with regard to \mathcal{P}^* .
P $a^* \approx_{\mathcal{P}^*} f$	P endorse the request.
O $\mathfrak{C}^*(a^*/f)$?	O asks P to replace a^* by the branch-case.
P ! $\mathfrak{C}^*(f)$	P implements the requested substitution.
O $(\mathfrak{C}(f) \wedge \mathfrak{C}^*(f)) \supset \perp$	O makes the point that the branch-case cannot fall under two incompatible rulings.
P <i>Iḥām</i>	P concedes defeat.
	After the objection and the constructive contribution of O , the <i>qiyās</i> is rewritten with the thesis: $\mathfrak{C}^*(f)$ The tree displaying the winning strategy will delete the unsuccessful attempts.

SR2.1.5.6 *Naqđ* for *qiyās al-shabah*³⁶

The Opponent might also react by simply destroying the Proponent’s argument that the similarity with regard to \mathcal{P} leads to the similarity in relation to the ruling \mathfrak{C} . In order to do so, the Opponent must be able to demonstrate the inconsistency (*naqđ*) of that assertion. This will trigger a sub-play where the Opponent is committed to bring forward a case of which it is recorded that a different ruling to the claimed ruling

³⁶ For *qiyās al-dalāla*, theoretically, the Opponent has the option of rejecting completely the Proponent’s assertion by drawing a *naqđ*-objection in order to show the inconsistency of the Proponent’s assertion linking the rulings \mathfrak{C}^* to \mathfrak{C} . This, again, theoretically, will trigger a sub-play where the Opponent is committed to bring forward a new root-case to which the ruling \mathfrak{C}^* applies, but the ruling \mathfrak{C} does not apply. However, so far as we know, legal theorists never provide an example of the deployment of this form of objection for *qiyās al-dalāla* because it is difficult, not to say impossible, to find a counterexample used to draw a *naqđ*-objection, for there are limited cases of this form of *qiyās*. Therefore, we do not deploy the *naqđ*-objection in our framework for *qiyās al-dalāla*. As for the other forms of destructive criticism such as *qalb*, *kasr*, ‘*adam al-ta’tihir*’ and *fasād al-wađ*’, they cannot be employed in *qiyās al-dalāla* because they deal exclusively with an ‘*illa* (occasioning factor).

applies (whereas both rulings are incompatible), despite the fact that the new case and the root-case share the property \mathcal{P} .

P $a \approx_{\mathcal{P}} f$?	P asks O to endorse that the root-case and the branch-case are identical with regard to \mathcal{P} such that whatever in correlation with \mathcal{P} in the root-case should be in correlation with \mathcal{P} in the branch-case.
O! $\mathbf{F} a \approx_{\mathcal{P}} f$	Instead of endorsing P 's assertion, O rejects it completely and launches a sub-play where he is committed to show that the branch-case and the root-case cannot be seen to be identical despite sharing the property \mathcal{P} , such that whatever in correlation with \mathcal{P} in one case should not be in correlation with \mathcal{P} in the other.
P! $a \approx_{\mathcal{P}} f$	P insists his previous assertion.
O $\mathcal{K}(a^*)$?	O asks P to concede that a new root-case a^* enjoys \mathcal{P} .
P! $\mathcal{K}(a^*)$	P concedes it.
O $a \approx_{\mathcal{P}} a^*$?	Following up P 's previous assertion, O asks P to endorse that a and a^* are identical with regard to \mathcal{P} such that whatever in correlation with \mathcal{P} in a should be in correlation with \mathcal{P} in a^* .
P! $a \approx_{\mathcal{P}} a^*$	P should endorse the request.
O $\mathcal{K}(a/a^*)$?	O asks P to replace a by a^* – given P 's previous assertion on the identical relation.
P! $\mathcal{K}(a^*)$	P is forced to concede that a^* falls under the ruling \mathcal{K} .
O $\mathcal{K}^{\circ}(a^*)$?	O comes with an evidence from the sources showing that a^* actually falls under the ruling \mathcal{K}° , the ruling different from and not compatible with the claimed ruling.
P! $\mathcal{K}^{\circ}(a^*)$	Since the evidence from the sources, P is forced to concede that the ruling \mathcal{K}° applies to a^* .
O! $(\mathcal{K}(a^*) \wedge \mathcal{K}^{\circ}(a^*)) \supset \perp$	O indicates P 's inconsistency that leads to the invalidation of P 's argument.
P! <i>Ifhām</i>	P concedes defeat

SR3 The overall development of a dialogue for *qiyās al-dalāla* and *al-Shabah*.

<p>1) A dialogical play starts with the Proponent setting the thesis that some specific legal ruling (\mathcal{K}) applies to a certain branch-case.</p> <p style="text-align: center;">P ! $\mathcal{K}(far)$</p> <p>The Proponent's aim is to develop an argument in such a way that it forces the Opponent to concede the justification of the thesis.</p>
--

Remark: As pointed out before, the main thesis is just the claim that the general ruling applies to the branch-case. It requires a justification, that is, a proof-object for the proposition $\mathfrak{K}(far')$. Moreover, the justification will require it to be shown that the branch-case encodes some inner structure. One way to think about the branch-case occurring in $\mathfrak{K}(far')$ is as its being a non-canonical proof-object that will be brought to its canonical form during the inferential moves. Implementing this requires some more notation. In order to limit this, when occurring in an inference, we will deploy the notation “*far*” for its non-canonical form and “*f, y, ..., z*” for its canonical form. The same applies to the root-case.

- 2) After agreement on the finiteness of the argument to be developed, the Opponent will launch a challenge to the assertion by asking for the occasioning factor justifying the thesis:

O *illa?*

- 3) The Proponent’s aim is to develop an argument in such a way that it forces the Opponent to concede the thesis. In case of *dalāla* but not *shabah* the Proponent will try to show that there are sufficient elements to *assume* that there is some underlying occasioning factor, *despite the fact that no precise occasioning factor can be found*. In order to develop his argument, the Proponent will start by choosing (to the best of his juridical knowledge) a root-case from the sources for which the ruling \mathfrak{K} has been applied and will ask the Opponent to endorse it.

P $\mathfrak{K}(a\mathfrak{s}l)$?

Remark: The main aim behind this move that motivates the whole argumentation consists in the Proponent forcing the Opponent to endorse the thesis because of some specific indications (in the case of *qiyās al-dalāla*) or resemblances (in the case of *qiyās al-shabah*) brought forward by the Proponent himself. The endorsement of the Opponent, at the **end** of the play – if such an endorsement takes place –, allows the Proponent to justify his thesis by bringing forward one of the following statements:

dalāla $\mathfrak{K}^*-kha\mathfrak{s}\mathfrak{i}\mathfrak{s}a-\mathfrak{K}$: $\mathfrak{K}(f,b)$

($\mathfrak{K}(f,b)$ is justified by the *khaṣīṣa*-relation between both rulings)

dalāla $\mathfrak{K}^*-naz\mathfrak{i}\mathfrak{r}-\mathfrak{K}$: $\mathfrak{K}(f,d,t)$

($\mathfrak{K}(f)$ is justified by a *nazīr*-relation between both rulings)

shabah $\mathfrak{K}^*-a\mathfrak{s}f-\mathfrak{K}$: $\mathfrak{K}(f,b)$

($\mathfrak{K}()$ is justified by a *shabah*-relation between root- and branch-case).

- 4) Since the evidence backing $\mathfrak{K}(a\mathfrak{s}l)$ comes from the sources, the Opponent is forced to concede it.

O ! $\mathfrak{K}(a\mathfrak{s}l)$

<p>5) Once the Opponent has endorsed $\mathfrak{K}(a\mathfrak{s}l)$, and given that the occasioning factor cannot be learned, the Proponent will look in the sources for another suitable ruling (\mathfrak{K}^*). This new ruling also applies to the root-case. The Proponent will proceed by forcing the Opponent to acknowledge this.</p>
<p>6) If the Opponent concedes that both of the rulings \mathfrak{K}^* and \mathfrak{K} apply to the root-case, the Proponent will look to associate \mathfrak{K}^* with \mathfrak{K} when applied to the root-case by asking the Opponent to acknowledge that the ruling \mathfrak{K}^* is either a specification (<i>khaṣīṣa</i>) of the ruling \mathfrak{K} or a parallel (<i>naẓīr</i>) of the ruling \mathfrak{K}. This launches a <i>qiyās</i> by indication (<i>dalāla</i>) – since indication by <i>khaṣīṣa</i> is a stronger indication than one by <i>naẓīr</i>, we will assume that the Proponent will start with the former. The <i>qiyās al-dalāla</i> will thus be launched by a move either of the form</p> <p style="text-align: center;"> P $\mathfrak{K}^*[x_1, \dots, x_n]$-<i>khaṣīṣa</i>-$\mathfrak{K}[x]$? (requesting O to endorse a <i>khaṣīṣa-link</i>) or P $\mathfrak{K}[x]$-<i>naẓīr</i>-$\mathfrak{K}^*[x]$? (requesting O to endorse a <i>naẓīr-link</i>) </p>
<p>7) The Opponent might ask for justification (<i>muṭālaba</i>) of the proposed link or refuse it. The refusal amounts of drawing a distinction (<i>al-farq</i>) between the application of \mathfrak{K}^* to the root-case and the branch-case so that this ruling cannot be seen as a specification (or a parallel) of \mathfrak{K}. If such an objection has been raised, a sub-play starts and a role reversal takes place where the Opponent must defend his arguments following the prescriptions of step 8 (or 9 in the case of <i>naẓīr</i>). Once the sub-play ends and the Proponent concedes defeat, the whole argument is re-written with the thesis justified by the sub-play.</p>
<p>8) If the Opponent asks for a justification of the claim that a <i>khaṣīṣa-relation</i> links both rulings, the Proponent must, <i>first</i>, be able to show that the particular-general relationship holds and <i>second</i>, bring forward evidence from the sources (<i>shahādat al-uṣūl</i>) that co-presence and co-exclusiveness apply to the link between those rulings – recall the formulation of co-presence and co-exclusiveness for the <i>khaṣīṣa-relation</i> given above. If the Proponent does not succeed and if the indication is not one of <i>naẓīr</i>, the play stops, unless it switches to <i>qiyās al-shabah</i>.</p>
<p>9) If the Opponent asks for a justification of the claim that a <i>naẓīr-relation</i> links both rulings, the Proponent must fulfil two main tasks. <i>First</i>, the Proponent must prove that both \mathfrak{K} and \mathfrak{K}^* are particular rulings that specify some underlying set \mathfrak{D} – and thus, that both can be taken to be equal in relation to the deontic force and juridical effects of the underlying general rule. <i>Second</i>, the Proponent must bring forward evidence from the sources (<i>shahādat al-uṣūl</i>) that the ruling \mathfrak{K}^* applies if and only if the ruling \mathfrak{K} does. In doing so, it is also established that,</p>

<p>whatever the occasioning factor of one of the rulings is, it must be the same as that of the other. If the Proponent does not succeed, the play stops, unless, it switches to <i>qiyās al-shabah</i>.</p>
<p>10) Once the Opponent concedes that the ruling \mathcal{K}^* stands in either a <i>khaṣīṣa</i> or a <i>naẓīr</i> relationship with \mathcal{K}, and since the ruling \mathcal{K}^* does apply to the branch-case, the Proponent will ask the Opponent to acknowledge that the branch-case too falls under the ruling \mathcal{K}. So, while conceding this the Opponent concedes the main thesis brought forward by the Proponent. This concession of the Opponent leads him to also concede that whatever the <i>illa</i> for the ruling \mathcal{K}^* is, it must be the same as that one occasioning \mathcal{K}.</p>
<p>11) If at the start (step 5) the play already applies <i>qiyās al-shabah</i>, or after unsuccessful attempts to apply <i>qiyās al-dalāla</i> switches to <i>qiyās al-shabah</i>, then the Opponent will be asked to concede that the set (of properties or ruling(s)) \mathcal{P} which applies to the root-case also applies to the branch-case.</p>
<p>12) If conceded, the Proponent can ask the Opponent to acknowledge that the root-case and the branch-case can be taken to be identical in relation to \mathcal{P}, such that whatever in correlation with \mathcal{P} in the root-case should be in correlation with that in the branch-case (the move of this request being: $\mathbf{P} a \approx_{\mathcal{P}} f?$). If the Opponent concedes it, this will lead to the Opponent conceding the main thesis.</p>
<p>13) The Opponent might refuse to accept that the branch-case and the root-case can be taken to be identical despite the fact that they both share the property \mathcal{P}. In this case, the Opponent must be able to draw a distinction (<i>al-farq</i>) between the root-case and the branch-case. This move will trigger a sub-play where the Opponent is committed to bring forward a specific property \mathcal{P}^* that distinguishes the root-case from the branch-case, despite the fact that both cases share some general property \mathcal{P}. Furthermore, the Opponent is required to show that the distinction does not support transferring the ruling of the root-case to the branch-case. We distinguish two forms: <i>farq</i> and <i>mu'āraḍa-farq</i>. For the second form, the play continues where the Opponent brings forward a new root-case in order to propose a new <i>qiyās</i> between the branch-case and the new root-case. The sub-play then continues in a standard play for <i>qiyās al-shabah</i>.</p>
<p>14) The Opponent might also react by simply destroying the Proponent's argument that the similarity with regard to \mathcal{P} leads to the similarity in relation to the ruling \mathcal{K}. In order to do so, the Opponent must be able to demonstrate the inconsistency (<i>naqd</i>) of that assertion. This will trigger a sub-play where the Opponent is committed to bring forward a case of which it is recorded that a different ruling to the claimed ruling applies (whereas both rulings are incompatible), despite</p>

the fact that the new case and the root-case share the property \wp . If the Opponent succeeds, the Proponent must concede defeat, and the play stops.

SR4 Winning rule

This structural rule requires some additional terminology:

- **Terminal play:** A play is called *terminal* when it cannot be extended by further moves in compliance with the rules.
- **X-terminal:** We say it is *X-terminal* when the last move in the play is an **X**-move. Player **X** wins the play ζ only if it is **X**-terminal, unless he states \perp . The player who states **falsum** loses the play.
- **Strategy:** A *strategy* for player **X** in $D(\varphi)$ is a function which assigns an **X**-move M to every non terminal play ζ having a **Y**-move as last member such that extending ζ with M results in a play.
X-winning-strategy: An *X-strategy* is *winning* if playing according to it leads to **X**-terminal play no matter how **Y** moves.
- **Winning-strategy resulting from a cooperative move:** Winning strategies constituted by plays where cooperative moves took place will disregard the unsuccessful attempts and also the justification of the sub-play. More precisely, it will proceed as if the Proponent has chosen the property resulting from the sub-play. Accordingly, the winning strategy will include moves where the Proponent rather than the Opponent asserted the efficiency of the relevant property.

4.3.4. Examples of dialogues for qiyās al-dalāla and al-shabah

The notation, terminology and moves to be deployed in the following dialogues will be disclosed in the context of the plays. In the following section we will present a generalization of such kinds of dialogue.

4.3.4.1. A dialogue for *qiyās al-dalāla I* : the deployment of *khaṣīṣa*

Here we deploy the same notational conventions as those of the schematic diagram above. The particular specification $\mathfrak{K}^*(x, y, z): \text{prop } (x: \mathcal{Q}, y: \mathcal{C}(x) \vee \mathcal{C}^\circ(x), z: \mathfrak{K}(x, \text{right}^\vee(y)))$ at stake in this example is the following:

- “ $\mathbf{L}(x)$ ” (which presupposes “ $\mathbf{L}(x): \text{prop } (x: \mathcal{Q})$ ”) stands for “*non-obligatory undertakings of the type \mathcal{Q} (prostration).*”
- “ $\mathbf{L}^*(x, y, z)$ ” stands for “*undertakings of the type \mathcal{Q} (x) to be performed on the back of a camel while travelling without validating excuse (y) are allowed (z).*”
- “ a ” stands for the root-case “*sujūd-prostration of supererogatory prayer*”, which is one of the actions allowed to be performed in a non-canonical way. The term *supererogatory* corresponds to the modality *recommendable action (mustahabb)* and applies to actions that are rewarded if performed but neither sanctioned nor rewarded if not performed.
- “ f ” stands for the branch-case “*sujūd-prostration of Qur’ān recital*”.
- “ b ” stands for some evidence from the sources that undertakings of the type \mathcal{Q} can be performed either in canonical or non-canonical form.
- “ c ” stands for some evidence from the sources that the general ruling, which allows actions of the type \mathcal{Q} , includes non-canonical undertakings of that type.

Table 4.1. Dialogue for *qiyās al-dalāla I*

O			P		
		responses	responses	Main Thesis <i>Sujūd al-tilāwa (far’)</i> is not an obligatory undertaking ! $\mathfrak{K}(\text{far’})$	0
1	Why? What is the ‘illa? ‘illa ?	? 0 (challenges move 0)	! 1, ! 2 (responds to 1 with the request of endorsing 2)	According to the sources, supererogatory prayer (<i>aṣl</i>) is not an obligatory undertaking, is it? $\mathfrak{K}(\text{aṣl}) ?$	2
3	Yes, it is non-obligatory. ! $\mathfrak{K}(\text{aṣl})$! 2 (responds to the request of move 2)	! 3, ! 4	Is supererogatory prayer one of those undertakings that are allowed to be performed on the back of a camel while travelling, without a validating excuse?	4

				$\exists C^*(a\text{ṣl}) ?$	
5	Yes, it is. ! $\exists C^*(a\text{ṣl})$! 4	ḥ5, ḥ! 6	Is <i>sujūd al tilāwa</i> also allowed to be performed on the back of a camel while travelling, without a validating excuse? $\exists C^*(far\text{ }?) ?$	6
7	Yes, it is. ! $\exists C^*(far\text{ }?)$! 6	ḥ7(3,5), ḥ!8	Don't you see that the relation of the allowed status of an undertaking to be performed on the back of a camel while travelling, without a validating excuse, to the non-obligatory status of that undertaking has the form particular-general? If we return to your assertions 3 and 5, can't we say that the second ruling is a specification of the first one? $\exists C^*[x_1, \dots, x_n] - kha\text{ṣ}i\text{ṣ}a - \exists C[x] ?$	8
9	Justify! <i>muḥālaba !</i>	? 8	! 9	1) According to the sources (<i>shahādat al-uṣūl</i>), supererogatory prayers (<i>a</i>) are one of those undertakings allowed to be performed on the back of a camel while travelling, without a validating excuse, and the sources testimony too that all those kinds of undertakings are non-obligatory. ! $L^*(a,b,c)$ is the case and this presupposes that $L^*(x,y,z): prop(x: \mathcal{A}, y: \mathcal{C}(x) \vee \mathcal{C}^\circ(x), z: L(x, \mathbf{right}^\vee(y)))$ 2) At the same time, according to the sources, obligatory undertakings, such as obligatory prayers (<i>a*</i>), are not allowed to be performed on the back of a camel while travelling, without a validating excuse. ! $\neg L^*(a^*,b^*,c^*)$ is the case. That is, those obligatory prayers <i>a*</i> , that when carried out in a non-canonical manner are forbidden by	10

				<p>$\mathfrak{C} (=:\mathbf{L})$, are also forbidden by \mathfrak{C}^* ($(=:\mathbf{L}^*)$). This presupposes that $\neg\mathbf{L}^*(x^*,y^*,z^*): \text{prop } (x^*: @, y^*: @ (x) \vee @^\circ(x), z^*: \neg\mathbf{L}(x, \mathbf{right}^\vee(y^*)))$.</p> <p>This also presupposes the formation of $\mathbf{O}(a^*)$, where $a^*: @$ is actually $\mathbf{O}(x, y)$: prop $(x: @, y: @ (x))$</p> <p>$\neg\mathbf{L}(x, y): \text{prop } (x: @, y: @^\circ(x))$</p>	
11	<p>Given these arguments I concede your previous request</p> <p>! $\mathfrak{C}^*[x_1, \dots, x_n]$-<i>khaṣīṣa</i>-$\mathfrak{C}[x]$</p>	! 8, (10). O endorses 8 after the sub-arguments developed in 10	? 11	<p>If it is the case, and given that according to 7 <i>sujūd al tilāwa</i> is allowed to be performed on the back of a camel while travelling, without a validating excuse, and given your endorsement of the <i>khaṣīṣa</i>-relation between both rulings, should not this lead to the conclusion that branch- and root-case share the same 'illa?</p> <p><i>you</i>(7): $\mathfrak{C}^*(\text{far } ^\circ)$ <i>z</i>: (<i>illa</i>(<i>x</i>): \mathfrak{C}?) <i>z</i>: (<i>illa</i>(<i>x</i>): \mathfrak{C}^*?)</p>	12
13	<p>I do endorse that whatever the 'illa is, it must apply for both rulings.</p> <p><i>z</i>: (<i>illa</i>(<i>x</i>): \mathfrak{C}) <i>z</i>: (<i>illa</i>(<i>x</i>): \mathfrak{C}^*)</p>	! 12	! 13, 14	<p>But then you should also acknowledge that the general form of the <i>khaṣīṣa</i>-relation between both rulings also applies to <i>f</i>: @, and that it can be carried out in a non-canonical way, according to the general ruling, which allows those kinds of actions to also be performed non-canonically. Hence you should endorse</p> <p>$\mathbf{L}^*(f,b,c)?$</p>	14
15	<p>I agree.</p> <p>! $\mathbf{L}^*(f,b,c)$</p>	! 14	! 15, 16	<p>Fine. Now, given this and your endorsement of the <i>khaṣīṣa</i>-relation, you should also endorse</p> <p>$\mathbf{L}(f, b)?$</p>	16
17	<p>Indeed, its allowed status to be performed on the back of a camel while travelling, without a validating excuse is the indication (<i>dalāla</i>) of the fact that it instantiates the factor occasioning the non-obligatory status.</p>	! 16	! 1	<p>So, this provides the justification for the thesis you were asking for with your first move: <i>sujūd al tilāwa</i> is not an obligatory undertaking. Thus, the relation of <i>khaṣīṣa</i> provides an indication that whatever the occasioning factor behind both rulings is, it is the</p>	18

	! $L(f, b)$			same. Summing up; the justification of my thesis is grounded on an indication by <i>khaṣīṣa</i> . $dalāla^{\mathfrak{C}^*khaṣīṣa-\mathfrak{C}} = c: L(f, b)$.	
	<i>Ilzām</i> (I concede defeat)				

4.3.4.2. A dialogue for *qiyās al-dalāla II* : the deployment of *naẓīr*

Table 4.2 Dialogue for *qiyās al-dalāla II*

O			P		
		responses	responses	<i>Dhimmī's zihār</i> is legally valid. ³⁷ ! $\mathfrak{C}(far')$	0
1	Why? What is the <i>illa</i> ? <i>illa</i> ?	? 0	! 1, ! 2	Is Muslim's <i>zihār</i> legally valid? $\mathfrak{C}(aṣl)$?	2
3	Yes, it is. ! $\mathfrak{C}(aṣl)$! 2	! 3, ! 4	Is Muslim's <i>ṭalāq</i> legally valid? ³⁸ $\mathfrak{C}^*(aṣl)$?	4
5	Yes, it is. ! $\mathfrak{C}^*(aṣl)$! 4	! 5, ! 6	Is <i>Dhimmī's ṭalāq</i> legally valid? $\mathfrak{C}^*(far')$?	6
7	Yes, it is. ! $\mathfrak{C}^*(far')$! 6	! 5 (3), ! 8	If we return to your assertion 3 and 5, it is clear that the validity of <i>ṭalāq</i> and the validity of <i>zihār</i> are parallel (<i>naẓīr</i>) cases that run together. Right? $(\forall x:\mathfrak{D}) \mathfrak{C}(x) \supset \mathfrak{C}^*(x)$?	8
9	Justify! <i>muṭālaba</i> !	? 8	! 9	@ ¹ : Don't you see that both the validity of the Muslim's <i>ṭalāq</i> and the validity of its <i>zihār</i> are two kinds of divorce-declarations in matrimony with the same deontic force and juridical consequences?	10

³⁷ Al already mentioned, the term "*zihār*" –a component of the ruling \mathfrak{C} : "*zihār* is legally valid"– is an ancient form of divorce-statement by the husband.

³⁸ The term "*ṭalāq*" – a component of the ruling \mathfrak{C}^* : "*ṭalāq* is legally valid" – is the standard form of divorce-statement by the husband.

				<p>So, both are applications of different forms of legally valid divorce-declarations?</p> <p>In other words, don't you see that $\mathfrak{H}^*(dhimmī')$, and $\mathfrak{H}^*(muslim)$ $\mathfrak{H}(Muslim)$, share the following structure?</p> <p><i>valid</i> (x,y,z) <i>prop</i> (x: Human, y: divorce-declaration(x), z: ṭalāq(x, y)).</p> <p><i>valid</i> (x,y,z) <i>prop</i> (x: Human, y: divorce-declaration(x), z: zihār(x, y)).</p>	
11	<p>Can you develop your argument?</p> <p>muṭālaba !</p>	? 10 (8)	! 11	<p>@²: More generally, according to the sources, for all those whose <i>ṭalāq-declaration</i> is valid, their <i>zihār</i> is valid, such as the declaration of mature Muslims.</p> <p>In other words, the following holds:</p> <p>! $(\forall x: Human)\{valid(x,d,t) \supset valid(x,d',t')\}$ true</p> <p>Assuming <i>d, d'</i>: divorce-declaration <i>t</i>: ṭalāq-declaration <i>t'</i>: zihār -declaration</p> <p>@³: According to the sources, for all those whose <i>ṭalāq</i> is not valid, their <i>zihār</i> is not valid either, such as the declarations of children and madmen.</p> <p>Thus, the following holds (under the same assumptions as before):</p> <p>! $(\forall x: Human)\{\neg valid(x,d,t) \supset \neg valid(x,d',t')\}$ true</p> <p>@⁴: Therefore, by evidence of the sources (<i>shahādat al-uṣūl</i>) we can conclude that for those whose <i>ṭalāq</i> is valid, their <i>zihār</i> is valid, and for those whose <i>ṭalāq</i> is not valid, their <i>zihār</i> is not valid (<i>man ṣahḥa ṭalāquhu ṣahḥa zihāruhu</i>).</p>	12

				! $(\forall x: Human)\{ valid(x,d,t) \supset valid(x,d',t') \}$ true.	
13	Given these arguments I concede your previous request. ! $(\forall x: \mathcal{D}) \mathfrak{K}(x) \supset \mathfrak{K}^*(x)$! (8) 12	? 13(7), ! 14	If it is the case, and, given 7 that <i>Dhimmī's ṭalaq</i> is legally valid, should not this lead to validity of his <i>ḡihār</i> ? Moreover, we must also conclude that the relation of <i>naẓīr</i> provides an indication that whatever the occasioning factor behind both rulings is, it is the same. <i>you</i> (7): $\mathfrak{K}^*(far')$ <i>z</i> : $(illa(x): \mathfrak{K}?)$ <i>z</i> : $(illa(x): \mathfrak{K}^*?)$	14
15	Indeed, the validity of <i>Dhimmī's ṭalaq</i> is an indication (<i>dalāla</i>) that the factor occasioning its validity is the same as that occasioning the validity of its <i>ḡihār</i> . <i>z</i> : $(illa(x): \mathfrak{K}?)$ <i>z</i> : $(illa(x): \mathfrak{K}^*?)$! 14	? 13, ! 16	Hence, given this and your endorsement of the <i>naẓīr</i> -relation between both rulings, you should also endorse $\mathfrak{K}(f,d',t')$?	16
17	I agree. The branch-case can be concluded as falling under ruling \mathfrak{K} . ! $\mathfrak{K}(f,d',t')$! 16		So, this provides the justification for the thesis you were asking for with your first move: <i>Dhimmī's ḡihār</i> is valid because of the validity of his <i>ṭalaq</i> that you just endorsed. <i>dalāla</i> ^{\mathfrak{K}-<i>naẓīr</i>-\mathfrak{K}^*} : $\mathfrak{K}(f,d',t')$	18
19	<i>Ilzām</i>				

4.3.4.3. A dialogue for *qiyās al-shabah*

Table 4.3. Dialogue for *qiyās al-shabah*

O		P			
		responses	responses	The slave is legally permitted to own. ! $\mathfrak{K}(far')$	0
1	Why? What is the <i>illa</i> ? <i>illa</i> ?	? 0	! 1, ! 2	Is the free person legally permitted to own? $\mathfrak{K}(aṣl)$?	2

3	Yes, it is. ! $\mathfrak{K}(a\mathfrak{s}l)$! 2	$\mathfrak{c}3, \mathfrak{c}! 4$	But a free person and a slave can be seen as being equal in relation to their right to own. Right? $a \approx_{\mathfrak{P}} f?$ (where " \mathfrak{P} " stands for the conjunction of properties $\mathfrak{P}_1(x) \wedge \mathfrak{P}_2(x) \wedge \mathfrak{P}_3(x)$ (x : <i>Human</i>)) establishing the right to own.	4
5	Justify! <i>muṭālaba !</i>	? 4	$\mathfrak{c} 5, \mathfrak{c}! 6$	The free person is a human being to whom instructive communication is addressed (<i>mukhāṭab</i>) (\mathfrak{P}_1); and he can be rewarded (<i>muthāb</i>) (\mathfrak{P}_2) and be punished (<i>mu'āqab</i>) (\mathfrak{P}_3). Is that right? $\mathfrak{P}_1(a) \wedge \mathfrak{P}_2(a) \wedge \mathfrak{P}_3(a) ?$	6
7	Yes, it is. ! $\mathfrak{P}_1(a) \wedge \mathfrak{P}_2(a) \wedge \mathfrak{P}_3(a)$! 6	$\mathfrak{c} 7, ! 8$	The slave is also a human being to whom instructive communication is addressed; and is rewarded and punished. Is it right? $\mathfrak{P}_1(f) \wedge \mathfrak{P}_2(f) \wedge \mathfrak{P}_3(f) ?$	8
9	Indeed. ! $\mathfrak{P}_1(f) \wedge \mathfrak{P}_2(f) \wedge \mathfrak{P}_3(f)$! 8	$\mathfrak{c} 9, \mathfrak{c}! 10$	According to these endorsements, it seems reasonable to consider them identical in relation to \mathfrak{P}_1 - \mathfrak{s} , right? Given: <i>you(7)</i> : $\mathfrak{P}_1(a) \wedge \mathfrak{P}_2(a) \wedge \mathfrak{P}_3(a)$ <i>you(9)</i> : $\mathfrak{P}_1(f) \wedge \mathfrak{P}_2(f) \wedge \mathfrak{P}_3(f)$ $a \approx_{\mathfrak{P}_1, \mathfrak{s}} f?$	10
11	I agree. ! $a \approx_{\mathfrak{P}_1, \mathfrak{s}} f$! 10	$\mathfrak{c} 11, \mathfrak{c}! 12$	If that is the case, and given 3 that the free person is legally permitted to own, should not this be similar to permission for the slave to own? $\mathfrak{K}(a/f)?$	12
13	Indeed, according to their resemblance, the permission of the free person to own yields its analogous permission for the slave. ! $\mathfrak{K}(f)$! 12	! 1	So, this provides the justification for the thesis you were asking for with your first move: the slave is permitted to own because it is analogous to such permission of the free person based their resemblance in relation to the set of properties \mathfrak{P} . ! <i>shabah</i> ^{$\mathfrak{P}-a \approx f-\mathfrak{K}$} : $\mathfrak{K}(f)$	14
	<i>Ilzām</i>				

References

- al-Baghdādī, al-Khaṭīb. (1421 H). *Al-Faqīh wa al-Mutaḥḥiqh*. (Ed. Abū ‘Abd al-Raḥmān). Saudi: Dār ibn Jauzī.
- al-Bājī, Abū al-Walīd Sulaymān. (2001). *Kitāb al-Minhāj fī Tartīb al-Ḥijāj*. (Ed. ‘Abd al-Majīd Turkī). Beirut: Dār al-Gharb al-Islāmī.
- Bartha, P. (2010). *By Parallel Reasoning; The Construction and Evaluation of Analogical Arguments*. Oxford: Oxford University Press.
- Bou Akl, Z. (2019). Averroes on Juridical Reasoning. In P. & Adamson, *Interpreting Averroes: Critical Essays* (pp. 45-63). Cambridge: Cambridge University Press.
- Clerbout, N. (2014a). First-Order Dialogical Games and Tableaux. *Journal of Philosophical Logic*, 43(4), 785-801.
- Clerbout, N. (2014b). *Étude sur quelques sémantiques dialogiques : Concepts fondamentaux et éléments de métathéorie*. London: College Publications.
- Clerbout, N., & Rahman, S. (2015). *Linking Game-Theoretical Approaches with Constructive Type Theory: Dialogical Strategies as CTT-Demonstrations*. Dordrecht: Springer.
- Felscher. (1985). Dialogues as a Foundation for Intuitionistic Logic. (D. Gabbay, & G. F, Eds.) *Handbook of Philosophical Logic*, 3, 341-372.
- Fyze, A. A. (1964). *Outlines of Muhammadan Law*. Oxford: Oxford University Press.
- al-Ghazālī, Abū Ḥāmid. (1971). *Shifā’ al-Ghalīl*. (Ed. Aḥmad Al-Kabīsī). Baghdad: Maṭba‘a al-Irshād.
- Keiff, L. (2009). *Dialogical Logic*. (E. N. Zalta, Ed.) Retrieved from The Stanford Encyclopedia of Philosophy: <http://plato.stanford.edu/entries/logic-dialogical>
- Krabbe, E. C. (2006). Dialogue Logic. In D. Gabbay, & J. Woods (Eds.), *Handbook of the History of Logic* (Vol. 7, pp. 665-704). Amsterdam: Elsevier.
- Lorenz, K. (2010a). *Logic, Language and Method: On Polarities in Human Experiences*. Berlin / New York: De Gruyter.
- Lorenz, K. (2010b). *Philosophische Variationen: Gesammelte Aufsätze unter Einschluss gemeinsam mit Jürgen Mittelstrass geschriebener Arbeiten zu Platon und Leibniz*. Berlin / New York: De Gruyter.
- Lorenzen, P., & Lorenz, K. (1978). *Dialogische Logik*. Damstadt: Wissenschaftliche Buchgesellschaft.

- Rahman, S., & Keiff, L. (2005). On How to be a Dialogician. In D. Vanderveken (Ed.), *Logic, Thought and Action* (pp. 359-408). Dordrecht: Kluwer.
- Rahman, S., & Rückert, H. (Eds.). (2001). Special Volume Synthese 127. *New Perspectives in Dialogical Logic*. Dordrecht: Springer.
- Rahman, S., & Tulenheimo, T. (2009). From Games to Dialogues and Back: Towards a General Frame for Validity. In O. Majer, A. Pietarinen, & T. Tulenheimo (Eds.), *Games: Unifying Logic, Language and Philosophy* (pp. 153-208). Dordrecht: Springer.
- Rahman, S., Clerbout, N., & Redmond, J. (2017). Interacción e Igualdad La interpretación dialógica de la Teoría Constructiva de Tipos Interaction and Equality Dialogical interpretation of Constructive type Theory. *Critica, Revista Hispanoamericana de Filosofía, UNAM, 49 (145)*, 49-89.
- Rahman, S., Iqbal, M., & Soufi, Y. (2019). *Inference by Parallel Reasoning in Islamic Jurisprudence*. Cham: Springer.
- Rahman, S., McConaughey, Z., Klev, A., & Clerbout, N. (2018). *Immanent Reasoning or Equality in Action. A Plaidoyer for the Play Level*. Dordrecht: Springer.
- Ranta, A. (1994). *Type-Theoretical Grammar*. Oxford: Clarendon Press.
- Rückert, H. (2011). *Dialogues as a Dynamic Framework for Logic*. London: College Publications.
- al-Shīrāzī, Abū Ishāq. (1407 H/1986). *Mulakhkhaṣ fī al-Jadal fī Uṣūl al-Fiqh*. (Ed. Muḥammad Yūsuf Ākhund Jān Niyāzī). MA Thesis, Umm al-Qura University.
- al-Shīrāzī, Abū Ishāq. (1987). *Al-Ma'ūna fī al-Jadal*. ('Alī b. 'Abd al-'Azīz al-'Umayrīnī. Al-Ṣafāh, Ed.). Kuwait: Manshūrāt Markaz al-Makhṭūṭāt wa-al-Turāth.
- al-Shīrāzī, Abū Ishāq. (1988). *Sharḥ al-Luma' fī Uṣūl al-Fiqh*. (Ed. 'Abd al-Majīd Turkī). Beirut: Dār al-Gharb al-Islāmī.
- al-Shīrāzī, Abū Ishāq. (2003). *Al-Luma' fī Uṣūl al-Fiqh*. Beirut: Dār al-Kutub al-'Ilmiyah.
- Young, W. E. (2017). *The Dialectical Forge; Juridical Disputation and the Evolution of Islamic Law*. Dordrecht: Springer.

CHAPTER 5

ARSYAD AL-BANJARI: A BANJARESE SHĀFI'Ī SCHOLAR

5.1. Banjar and Islam

The Banjarese, or as they like to call themselves, *urang Banjar* (Banjar people), is the native ethnic group in South Kalimantan, Indonesia. It is one of the largest ethnic groups in Indonesia. According to the 2010 statistics data (Badan Pusat Statistik, 2011), the number of the Banjarese in Indonesia reached 4,127,124 persons and most of them live in South Kalimantan with the total population reached 2,686,627 persons, in Central Kalimantan with 464,260 persons and in East Kalimantan with 440,453 persons. Nevertheless, the term Banjar at first was not used to describe an ethnic group. Mary Hawkins (2000) argues that the term *urang Banjar* (Banjarese) emerged as a term of ethnic identification in the 1930s. 'Banjar' was formerly only connected with the Banjar Sultanate that was historically the continuation of Negara Daha and Negara Dipa, the Hindu Kingdoms established by immigrants from Java around the thirteenth century. Previously, the Buddhist Kingdom of Tanjung Pura was established by Malay immigrants from Sumatera around the fifth to sixth in South Kalimantan.¹

The research conducted by Regional Research and Development Agency of South Kalimantan (Badan Penelitian dan Pengembangan Daerah Propinsi Kalimantan Selatan) in 2007 provides the fact that the Banjarese at least consists of some original ethnicities: the Malays as the majority and some local Dayaks such as Bukit, Ngaju and Maanyan.² Moreover, if we include the Sultanate of Banjar as the continuation of the previous Hindu-Buddhist kingdoms founded by the Malay and Javanese, Banjarese certainly also comprises the Javanese ethnic. These various ethnicities, with their cultural backgrounds, constituted the elements that create the Banjarese culture. In

¹ More detail about the history of Banjar, see Ras (1968); Ideham et al. (2007a).

² See Ideham et al. (2007b)

other words, the Banjarese was formed through cultural interaction between the different ethnic groups. The Banjar language (*Basa Banjar*) is a better example of how ‘Banjar’ was created by such cultural interaction. J.J. Ras (1968) in his introduction of *Hikajat Bandjar* indicates that the Banjar language which was used in everyday life at the time the *Hikajat* was written is rather an ancient type of Malay³ that is covered by some Dayak dialects and mixed with Javanese. It was confirmed later by the research conducted by Regional Research and Development Agency of South Kalimantan in 2007. According to the research, most of the Banjar language vocabularies are taken from Malay and a small number of them are found similar to Javanese and Dayak languages such as Ngaju, Maanyan, and Deyah. The word “Banjarmasin”, for example, is originated from the word “*banjarmasih*” which consists of “*banjar*” and “*masih*”. The word “*banjar*” is originally from Malay and it means village. While the word “*masih*” is the term used in the Ngaju language for Malay people. Thus, the word “*banjarmasih*” means the village of Malay people.⁴

The Banjarese have the reputation of being practicing Muslims in the sense that they perform the so-called five pillars of Islam. They pray five times a day, they fast in the days of Ramadān, they pay *zakāt* (alms-giving), they intend to perform *hajj* (pilgrimage). Islam indeed animates and has an important impact on the way of life of the Banjarese. The Banjarese also apply Islamic teachings for commercial and civil acts such as trade, marriage, divorce and distribution of inheritance. Islam shapes too the construction of the city of Banjarmasin and its villages, in such a way that every village of the city has its own *langgar* (prayer house). This led Banjarmasin to be known not only as “*kota seribu sungai*” or “a thousand rivers city”, but also “*kota seribu langgar*” or “a thousand prayer house city”. Islamic events are also very often carried out by the Banjarese, particularly when it comes to the special Islamic days. In the month of the Prophet’s birth (*Rabi’ al-awwal*), for example, the commemoration of

³ Given this fact, Alfani Daud maintains that ancestors of the Banjarese probably came from Malay Sumatra. See Daud (1997, pp. 1-4).

⁴ See Ideham et al. (2007b)

the Prophet's birth carried out by the Muslim communities can be found almost every day in every village of Banjar land. In a nutshell, Islam is the reference for the Banjarese norms and social lives.

Moreover, Islam seems to have become the identity of the Banjarese. As pointed out by Hawkins (2000), "So what do people mean when they call themselves 'Banjar'? The term Banjar does not relate to common occupation, or common language, but there is one context in which people of southern Kalimantan will invariably identify themselves as Banjar, and that is in reference to religion". Even, Dayak people who convert to Islam will "become *urang* Banjar". In other words, as stated by Chalmers (2007), to be an ethnic Banjarese is, by definition, to be a Muslim.

When Islam first came in Banjarmasin is still questionable, though some say that it was probably by the end of the 15th century through trade activities. What is certain is that the Islamic Kingdom or the Sultanate of Banjar was established in the 16th century as the compensation for assistance provided by the Demak Sultanate to Prince Samudra in the seizure of the Negara Daha Kingdom's throne against his uncle, Prince Temanggung. Prince Samudra was appointed the first Sultān and was given the name of Sultān Surian Shāh or Surian Allāh by an Arab. With the establishment of the Sultanate of Banjar, Islam became the official religion of the state.⁵ However, Mujiburrahman (2017) points out that it was a formal conversion without a deep understanding of beliefs and practices of Islam. Hence, as indicated by Azyumardi Azra (2004), during the earlier period of Islamization, adherents to Islam, by and large, were confined to the Malay population; Islam only very slowly made inroads among the Dayaks. Even among Malay Muslims, the adherence to Islam was evidently nominal and did not go beyond the utterance of the confession of faith. The process of

⁵ See Azra (2004). In relation to Pangeran Samudra's conversion to Islam, Ian Chalmers (2007) pointed out that there are various interpretations of the way this process took place, differing chiefly on the timing. One possibility is that the conversion was the outcome of a deal he had made with the Demak Sultanate for the latter's military aid as mentioned in *Hikajat Bandjar*. On the other hand, there is evidence that Pangeran Samudra had already converted to Islam: the letter seeking Demak's support was written using Arabic script, which may be an indication that Muslim scholars were already established at court.

Islamization became more intense by the eighteenth century after the return of Muhammad Arsyad ibn Abdullah al-Banjari (1122–1227H/1710–1812), the figure of our research, from studying in Mecca and Medina.

5.2. Arsyad al-Banjari's life and journey with the Shāfi'ī School

Arsyad al-Banjari was born on Şafar 1122H/March 1710 in Lok Gabang, Martapura, south Kalimantan. He passed away on Shawwāl 1227H/October 1812 in Dalampagar Village, and was buried in Kalampayan. For this reason, he is called by the Banjarese *Datu Kalampayan*. His basic religious education was probably obtained from his parents and local teacher in his own village, as there is no evidence that a formal school or an Islamic school existed in Banjar during his childhood. When he was seven years old, Arsyad al-Banjari was famous for his intelligence and his impressive paintings that led Sultān Tahlīl Allāh (1112–58/1700–45) to take him to live in the court of the Sultanate where Arsyad al-Banjari got further education, especially in religious knowledge.

There is no specific information about the lessons he obtained at the court, as well as the teachers who taught him. However, if we take into consideration the way Islam developed in Indonesia at that time, there is a strong indication that what Arsyad al-Banjari acquired was the Islam attached to both the school of Ahl al-Sunnah wa al-Jamā'ah and the Shāfi'ī as the school of law. Furthermore, in relation to the latter, let us recall that the Banjar Sultanate had a close relation with the Demak Sultanate which was affiliated to the Shāfi'ī School of law.

5.2.1. Arsyad al-Banjari's studies in Mecca: jurisprudence, transmitted and rational sciences

When Arsyad al-Banjari was about 30 years old, he went to Mecca in order to pursue further studies at the expense of the Sultanate. In the eighteenth century, Mecca was

apparently dominated by Shāfi'ī scholars, three of whom had a decisive influence on Arsyad al-Banjari.

In Mecca, as mentioned by Azra (2004), Arsyad al-Banjari and his fellow students from the Archipelago (Nusantara) such as 'Abd al-Ṣamad al-Palimbani and Dāwūd al-Fatānī learned with the Egyptian Shāfi'ī scholar 'Aṭā' Allāh al-Maṣrī al-Azharī al-Makkī. Regarding the biography of al-Maṣrī, the relevant biographical dictionaries⁶ do not provide an accurate information on the dates of his birth and death, though it is reported that he died after 1188H/1774.⁷ Al-Maṣrī studied in al-Azhar University Cairo, because of that he carried the surname, *laqab*, al-Azharī. Having completed his study in al-Azhar, al-Maṣrī migrated to Mecca and taught at Masjid al-Harām.

Crucial for completing the picture on Arsyad al-Banjari intellectual background is that his teacher al-Maṣrī was a Shāfi'ī scholar, known as an accomplished expert in literature and logic. In fact, al-Maṣrī wrote several works on literature and logic, among them are *Nihāya al-'Arab fī sharḥ Lāmiya al-'Arab* and *Manṭiq al-Ḥādir wa al-Bādī*.

Arsyad al-Banjari also had occasion to listen and learn from 'Abd al-Mun'im al-Damanhūrī (1101H/1690-1192H/1778). Al-Damanhūrī was an Egyptian scholar proficient in both transmitted sciences (*'ilm al-naqlī*) and rational sciences (*'ilm al-'aqlī*) including logic, rhetoric, rational theology, jurisprudence, Qur'ān recitation, medicine, anatomy and arithmetic. In terms of jurisprudence, al-Damanhūrī was very known for his knowledge on the four schools of Sunni Islamic law.⁸ He was Shaykh in al-Azhar university; and became the rector in the year 1768 and occupied the position until his death ten years later. It has been said that he visited Mecca in 1177H/1763 in order to perform the pilgrimage.⁹ During al-Damanhūrī visit to Mecca, some students, including Arsyad al-Banjari and his fellow students from the Archipelago, came to study with him.

⁶ See Kaḥāla (1993, p. 379); 'Āyish and Qaiṣar (2003, p. 222); al-Zarkalī (2002, p. 236).

⁷ See 'Abd Allah Muḥammad 'Īsā al-Ghazālī (1991/1992).

⁸ On al-Damanhūrī, see al-Jabartī (1998, vol.1, 2725); Kaḥāla (1993, vol. 1, p. 303); al-Zarkalī (2002, vol. 1, 163).

⁹ See Moshe Perlmann (1971)

At the time of his studies in Mecca, that lasted for about thirty years, Arsyad al-Banjari lived in a house he bought in Shamiyyah Village (financially supported by the Banjar Sultanate). The house was called *Barhat Banjar*, which is still nowadays how it is called. In the last years of his living in Mecca, it is reported that he was delegated by his teacher, ‘Aṭā’ Allāh al-Maṣrī, to teach students in the Ḥarām Mosque of Mecca – an important recognition of his proficiency and mastery in religious sciences.

5.2.2. Arsyad al-Banjari’s studies in Medina: sufism, religious thought and practice, and further studies on Shāfi’ī thought.

Still wishing to extend and deepen his knowledge, together with his fellow students from the Archipelago, Arsyad al-Banjari continued his studies in Medina. In Medina, Arsyad al-Banjari studied with Muḥammad ibn ‘Abd al-Karīm al-Sammānī al-Madanī, the comrade of ‘Aṭā’ Allāh al-Maṣrī. Al-Sammānī was born at Medina around 1130H/1718 and died there around 1179H/1775.¹⁰

Al-Sammānī was the founder and the leader of the Sannāniyya Sufi order, *Tarīqa al-Sammāniyya*, affiliated to the Sufi orders of Khalwatiyya, al-Qādiriyya and Shādhiliyya. His grave is in the Baqī, the oldest cemetery in Medina, close to the graves of the Prophet wives and the celebrities of yore. As pointed out by Drewes (1992), the very location of the grave already indicates the degree of respect he enjoyed in his native town. Al-Sammānī was raised by his father in Medina and studied with some great scholars. After a thorough study of the Shāfi’ī school of jurisprudence, in 1174H/1760 al-Sammānī was sent to Egypt where he was respectfully received by former students of his father. Al-Jabartī reported that in Egypt, al-Sammānī organized a *dhikr* forum, *ḥalaqat al-dhikr*, (a forum for the repetitive utterances of short sentences glorifying God) at the Mashhad al-Ḥusainī, which drew a lot of people. After his visit to Egypt, al-Sammānī, returned to Medina, where later on after his father passed away, he was appointed as the leader of scholars (*shaikh*) (replacing his father’s place). Al-

¹⁰ See Kaḥāla (1993).

Sammānī wrote some known works on sufism, among them are *al-futūḥāt al-ilāhiyya fī al-tawajjuhāt al-rūḥiyya* and *al-naḥḥāt al-ilāhiyya fī kaiḥiyya sulūk al-ṭarīqa al-muḥammadiyya*.¹¹

Al-Sammānī had a great influence on Arsyad al-Banjari's religious thought and practice, particularly on Sufism (*taṣawwuf*). In fact, al-Banjari was considered the *khalifa* of this Sufi order, that is to say that he was master of this Sufi order.¹²

Let us point out that the spread of the Sammāniyya Sufi order in Kalimantan cannot be separated from Arsyad al-Banjari's role in its promulgation. This role of Arsyad al-Banjari contributed to al-Sammānī reputation among the Banjarese who call him the late *Syekh Seman*. Even nowadays, every year, Banjarese commemorate his death by means of a remembrance act called *haul* in Indonesian. Moreover, his *manāqib* (encomium) containing the praise and short biography is often read by the Banjarese in ritual meetings or religious teachings.

In Medina, in addition to his learnings on Sufism Arsyad al-Banjari continued to delve more deeply into Shāfi'ī thought. Particularly so by studying with Sulaymān al-Kurdī (1715-1780), the colleague of al-Sammānī. Al-Kurdī was known as a great scholar who mastered transmitted religious sciences (*'ilm al-naqlī*) and rational sciences (*'ilm al-'aqlī*), even he was described to have been one of the mountains of sciences (*jabalan min jibāl al-'ilmi*). He was born in Damascus, and when he was one year old his father brought him to Medina, where he grew up and spent most of his life. He was one of the most prominent Shāfi'ī scholars of his time and became the Shāfi'ī *mufī* (jurist consult) in Medina.¹³ Al-Kurdī wrote several important works on Islamic jurisprudence. As pointed out by van Bruinessen (1998), in Indonesia the best-known work on Jurisprudence of al-Kurdī is his *al-Ḥawāshī al-Madaniyya* (still reprinted in Indonesia). The *al-Ḥawāshī al-Madaniyya* constitutes an extensive commentary on Bā-

¹¹ See al-Jabartī (1998, vol. 1, p. 480) and al-Di'bāsī (2014).

¹² See Abu Daudi (1996); and Zaid Ahmad (2015).

¹³ See al-Jābī (2011).

Faḍl's *al-Muqaddima al-Ḥaḍramiyya* — or rather a supercommentary on an earlier commentary by Ibn Ḥajar, *Minhāj al-Qawīm*.

Sulaymān al-Kurdī is known as being the teacher who had the greatest influence on Arsyad al-Banjari. Al-Kurdī's influence to Arsyad al-Banjari is made apparent by the fact, among others, that Arsyad al-Banjari's works, such as *Sabīl al-Muhtadīn*, *Kitāb al-Nikāḥ* and *Luqṭat al-'Ajlān* rely on the commentaries (*shurūḥ*) of Ibn Ḥajar al-Haytamī and Shams al-Dīn al-Ramlī, two sixteenth-century jurists who commented on al-Nawawī's *Minhāj al-Ṭālibīn*. This is most likely due to the suggestion of al-Kurdī that all Shāfi'ī scholars must rely on these two works because of an overwhelming, though seemingly not unanimous, agreement among scholars that al-Nawawī is one of the highest authorities in the Shāfi'ī school.¹⁴

Another indication of the influence of al-Kurdī on Arsyad al-Banjari is that the latter often consulted his teacher not only in theoretical but also in practical matters in his own homeland. One of these occasions relates to the Sultān of Banjar decision to fine those subjects who fail to perform the Fridays prayer (in order to improve public attendance). It is likely in this context that Arsyad al-Banjari asked his teacher Sulaymān al-Kurdī to explain the differences between *zakāh* (obligatory 'alms') and tax – for the Sultān of Banjar fine were categorized as tax rather than as *zakāh*.¹⁵ Al-Kurdī's responses were recorded by Arsyad al-Banjari in his work *Fatāwā Shaykh Sulaymān al-Kurdī* (فتاوى شيخ سليمان الكردي) which is written in Arabic, unfortunately, it has not been found.

Besides the mentors of Mecca and Medina mentioned above, some Arsyad al-Banjari biographers report the influence of other important teachers, one of them was Ibrāhīm al-Ra'īs al-Zamzamī, from whom Arsyad al-Banjari studied *'ilm al-falak* (astronomy), a field in which he became a leading authority among other scholars in the Archipelago. In fact, Arsyad al-Banjari wrote two treatises in this field, namely

¹⁴ See al-Kurdī (2011, pp. 37-38). Cf. El Shamsy (2013, p. 292).

¹⁵ See Abu Daudi (1996).

Risālat 'Ilm Falak (رسالة علم الفلك), which is written in Arabic, and *Kar Dunia dan Khatulistiwa* (كار دنيا دان خط الإستوى), which is written in Malay. Beyond these theoretical outcomes of his study on Astronomy there is evidence on the practical implementation of this knowledge such as correcting the position of *qibla* (the direction to Ka'ba), in the mosques Jembatan Lima, Pakojan and Luar Batang in Jakarta.

Having studied 30 years in Mecca and 5 years in Medina Arsyad al-Banjari still had the intention to advance his knowledge in Egypt and conveyed his intention to his mentor, al-Kurdī. The teacher appreciated his intention, but suggested him to return to Banjar, as the teacher believed that he had already mastered various branches of Islamic knowledge, and therefore it would be more useful for him to start teaching Islam in his homeland.¹⁶ Arsyad al-Banjari accepted the teacher's suggestion and left Mecca and Medina in 1186H/1772 heading to Banjar.

5.3. Re-Islamization of Banjar and the employment of *qiyās*

Arsyad al-Banjari arrived at Banjar in Ramaḍān of 1186H or the end of 1772. He was welcomed by Sulṭān Tamjīd Allāh with a royal ceremony. After his arrival, he started the process of re-Islamization of Banjar, in the sense of intensifying the integration of Islamic teachings into the Banjarese society. Besides his writing activities which yielded some manuscripts that became a reference for the Banjarese norms and social lives¹⁷, Arsyad al-Banjari carried out some important practical projects toward re-

¹⁶ See Halidi (1968) and Abu Daudi (1996).

¹⁷ Arsyad al-Banjari was a productive writer. He wrote many works relating to various branches of Islamic knowledge. Apart from those already mentioned, he also wrote the followings: *Uṣūl al-Dīn* (كتاب الدين), *Parūkunan Basar* (فركونان بسار), *Luqṭat al-'Ajlān* (لقطة العجلان), *Kitāb al-Nikāḥ* (كتاب النكاح), *Kitāb al-Farā'id* (كتاب الفرائض), *Sabīl al-Muhtadīn* (سبيل المهتدين), *Hāshiyā Fath al-Jawād* (حاشية فتح الجواد), *al-Qawl al-Mukhtaṣar* (القول المختصر), *Tuḥfat al-Rāghibīn* (تحفة الراغبين), *Madzhab Ahlu Sunnah wal Jama'ah*, *Qadariyah dan Jabariyah* (مذهب اهل السنة و الجماعة), *Risālat Fath al-Rahmān* (رسالة فتح الرحمان), *Risālat Kanz al-Ma'rifah* (رسالة كنز المعرفة), *Khuṭbah Muṭlaqah Pakai Makna* (خطبة مطلقة فاكي معنى), *Awwal al-Din Ma'rifat Allāh* (اول الدين معرفة الله), *Bidāyat al-Mubtadī wa 'Umdat al-Aulādī* (بداية المبتدى و (عمدة الاولادى), *Muṣḥaf al-Qur'ān al-Karīm* (مصحف القرآن الكريم), *Arkān Ta'līm al-Ṣibyān* (اركان تعليم الصبيان), *Bulūgh al-Marām* (بلوغ المرام), *Fī Bayān al-Qaḍhā' wa al-Qadar wa al-Wabā'* (في بيان القضاء و القدر و الوباء), and *Tuḥfat al-Albāb* (تحفة الأحياب).

Islamization. One of the earlier projects implemented after his arrival was to create a learning forum where he delivered lectures concerning Islamic teachings to his relatives and the people around him. It has been said that the lectures were constantly attended by a massive number of students. As more and more people came to study, Arsyad al-Banjari wished to establish an Islamic school. Coincidentally, Sulṭān Tamḥīd Allāh, the successor of Sulṭān Tamjīd Allāh, granted to him land located outside Martapura. On this land he built the family houses, a prayer house and an Islamic education centre similar to *pesantren* in Java, which consisted of lecture halls, students' dormitory, and library. A fence surrounded the area, this led the village to be known as "*Kampung Dalampagar*" which means "village inside fence". It has been claimed that this education centre was the first Islamic school in Kalimantan that had a significant contribution for the re-Islamization of Banjar since it became the vital place for the education of students. The contribution of the *Kampung Dalampagar* to re-Islamization continued with Arsyad al-Banjari's descendants, who later became leading scholars in South Kalimantan and the surroundings.

It is worth noting that Arsyad al-Banjari, as pointed out by his biographer, Yusuf Halidi (1968), undertook an action that might have been unpopular for the people of his time, namely, the involving of women in his education centre. One of Arsyad al-Banjari motivations for such a perspective that nowadays we would qualify as revolutionary; was that, on his view, women had a crucial role in re-Islamization namely, integrating Islamic teachings within family life. In fact, his education centre later produced female religious scholars, one of them is Fatimah, his granddaughter who was delegated by Arsyad al-Banjari to be the teacher for female students in the education centre.

Halidi (1968) and Abu Daudi (1996) claims that Fatimah is the actual author of the very known work *Parukunan*, a treatise dealing with basic knowledge on *fiqh*, despite the fact that it is his uncle's name Jamaluddin, who appears as author of the treatise. The claim still needs further research since some reported that the treatise was

authored by Jamaluddin, nevertheless this strongly suggest the intellectual reputation of Fatimah within the Banjarese society.

In addition to his significant contribution in education, Arsyad al-Banjari played an important role in the reforms of the administration of justice in the Sultanate of Banjar. Indeed, Arsyad al-Banjari, with the support of the Sultān, established *Mahkamah Syari'ah* (Sharia Court). With the establishment of this Court, Islamic law, particularly according to the Shāfi'ī school, was put into action in civil as well as in criminal matters. It was perhaps the most remarkable achievement of Arsyad al-Banjari towards the re-Islamization of Banjar. The *Mahkamah Syari'ah* was managed by the *Muftī* and the *Qāḍī*. The former is the head of the court who is in charge of issuing legal rulings (*fatwā*), while the latter is a judge who renders decision for an actual case according to Islamic law. Muhammad As'ad, Arsyad al-Banjari's grandson, was appointed as the first *Muftī* and Abu Su'ud, his son, was appointed as the first *Qāḍī*.

Yet despite the achievements made, the process of re-Islamization was not without challenges. New cases not considered by scriptural sources, particularly relative to Banjarese culture, came out regularly and required legal certainty regarding their status according to Islamic doctrines.

Some of those new cases involved practices of local traditions associated to previous existing religions. As mentioned above, Banjar was constituted by the cultural interactions between different ethnic groups that existed in South Kalimantan. In the process of Islamization, tug of war between local religions and Islam was unavoidable. Consequently, the cultural transformation of Banjarese society from local religions to Islam took the feature of an overlapping transformation rather than of a linear transformation, in the sense that local religions were not totally replaced by Islam.¹⁸ One striking example of this overlapping is the case of the local beliefs and practices associated to the traditional offerings to (ancient) spirits and rituals *manyanggar* and *mambuang pasilih*, that were carried out by some Banjarese despite their conversion to

¹⁸ Cf. Iqbal Noor (2011).

Islam,. The question was whether those local beliefs and practices are lawful according to Islamic law.

Some new cases also emerged because of the different role that nature had in the Arabic and in the Banjarese environment. Notice that the Islamic sources, the Qur'ān and Ḥadīth, deal with nature, in some respect, in a way specific to the Arab world. Therefore, some problems specific to nature in the region of Banjar are not (explicitly) included in the sources. Regarding, for example, foods and drinks consumed by Banjarese, some of them are produced from the flora and the fauna typical of Banjar, so legal decisions concerning such foods and drinks cannot be found literally in the Qur'ān and Ḥadīth. For instance, some Banjarese eat snails that live in swamp areas in Banjar such as *haliling* and *kalimbuai*. *Haliling* is a small snail that lives normally in water, while *kalimbuai* is a big snail that lives mostly outside water. Another example is the consumption of *lahang*, a traditional Banjarese fermented beverage made from a sugar-palm tree that is usually produced in a bamboo container. Since the scriptural sources dealing with these kinds of snails and drink were not found, the lawfulness of consuming them was put into question.

Similarly, different socio-cultural conditions between Arab and Banjar was a factor contributing to emergence of new cases. As the Qur'ān and Ḥadīth cover explicitly social problems in Arabic society in the first development of Islam, certain issues in the Banjarese society are not covered by the scriptural sources, such as marital property. Unlike the case of the traditional Arabic society where wives do not contribute (by means of a remunerated work) to the economy of the household, in Banjar, wives work together with their husbands to support the family finance. The problem is what happens with the property that has been gathered by their joint work in the case of divorce or the death of one of a couple.

More generally, the emergence of new cases activated an encounter between Islam and Banjarese culture that led to, on one side, cultural integration by dynamic interaction and, on the other, cultural isolation. The system of *qiyās*, known as the dialectical argumentation system of *correlational inference*, offered a paramount

method for implementing the dynamic process of cultural integration. The point is that, if the rulings for the new cases cannot be found in the scriptural sources, *ijtihād* or rational endeavour was needed to achieve their legal decisions. *Qiyās* was developed by the Shāfi‘ī school of jurisprudence into a particular dialectical argumentation form of *ijtihād* by parallel reasoning that should provide a method for finding which ruling should apply to those new cases. So it is not a surprise that Arsyad al-Banjari, educated by the Shāfi‘ī school of jurisprudence, used this form of dialectic inference as the prominent instrument for tackling this issue.

This already indicates the deep insights into the Shāfi‘ī’s conceptions gathered by Arsyad al-Banjari, who perceived, implemented and developed further with the same positive energy as creativity the interactive perspective on Islamic thought, society, culture and education, launched by his teachers.

References

- Ahmad, Z. (2015). Al-Banjari, Muhammad Arshad (1122-1233/1710-1812). In O. Leaman, *The Biographical Encyclopedia of Islamic Philosophy*. London/Newyork: Bloomsbury.
- ‘Āyish, ‘Abd al-Fattāḥ. & Qaiṣar. (2003). *Mu‘jam al-Adibbā’ min ‘Asr al-Jāhilī ḥattā sana 2002*. Vol. 4. Beirut: Dār al-Kutub al-‘Ilmiyya.
- Azra, A. (2004). *The Origins of Islamic reformism in Southeast Asia: networks of Malay-Indonesian and Middle Eastern ‘Ulamā’ in the seventeenth and eighteenth centuries*. Crows Nest; Honolulu: Allen & Unwin; University of Hawai’i Press.
- Chalmers, I. (2007). The Islamization of Southern Kalimantan: Sufi Spiritualism, Ethnic Identity, Political Activism. *Studia Islamika*, 14/3, 371-417.
- Daud, A. (1997). *Islam & masyarakat Banjar: diskripsi dan analisa kebudayaan Banjar*. Jakarta: RajaGrafindo Persada.
- Daudi, A. (1996). *Maulana Syekh Muhammad Arsyad al-Banjari (Tuan Haji Besar)*. Dalam Pagar Martapura: Madrasah Sullam al-Ulum.
- al-Di‘bāsī, Aḥmad ‘Abd al-Nabiī Farghal. (2014). *al-Sulāla al-Bakriyya al-Ṣiddīqiyya*. Cairo: al-Mu’assasa al-‘Umma al-‘Arabiyya li al-Nashr wa al-Tauzī‘.

- Drewes, G. (1992). A note on Muhammad al-Samman, his writings, and 19th century Sammāniyya practices, chiefly in Batavia, according to written data. *Archipel*, 43, 73-87.
- al-Ghazālī, ‘Abd Allah Muḥammad ‘Īsā. (1991/1992). Muqaddima. In Atā’ Allāh al-Maṣrī, *Nihāya al-‘Arab fī sharḥ Lāmiya al-‘Arab lī al-Shanfarā ibn Mālik al-Azdī*. Majlis al-Naṣr al-‘Ilmī Kuwait University.
- Halidi, Y. (1968). *Ulama Besar Kalimantan Selatan Syekh Arsyad al-Banjari*. Surabaya: al-Ikhsan.
- Hawkins, M. (2000). Becoming Banjar. *The Asia Pacific Journal of Anthropology*, 1:1, 24-36. DOI: 10.1080/14442210010001705830
- Ideham, M. S. et al. (2007a). *Sejarah Banjar*. Banjarmasin: Balitbangda Kalimantan Selatan.
- Ideham, M. S. et al. (2007b). *Urang Banjar dan Kebudayaanannya*. Banjarmasin: Balitbangda Kalimantan Selatan.
- al-Jabartī, ‘Abd al-Raḥman. (1998). *Tārikh ‘Ajā’ib al-Āthār fī al-Tarājum wa al-Akhbār*. Beirut: Dār al-Jīl.
- al-Jābī, Bassām ‘Abd al-Wahāb. (2011). Tarjama Muḥammad ibn Sulaymān al-Kurdī/al-Kardī. In Muḥammad b. al-Kurdī, *al-Fawā’id al-Madaniyya*. Libanon: Dār Nūr al-Ṣabāḥ and al-Jaffān wa al-Jābī.
- Kaḥāla, ‘Umar Riḍā. (1993). *Mu’jam al-Mu’allifīn; Tarājum Mu’allifī al-Kutub al-‘Arabiyya*. Vol.2. Beirut: Mu’assasa al-Risāla.
- al-Kurdī, Muḥammad b. Sulaymān. (2011). *al-Fawā’id al-Madaniyya*. (Ed. Bassām ‘Abd al-Wahāb al-Jābī). Libanon: Dār Nūr al-Ṣabāḥ and al-Jaffān wa al-Jābī.
- Mujiburrahman. (2017). Historical Dynamic of Inter-Religious Relations in South Kalimantan. *Journal of Indonesian Islam*, 11/1, 145-174.
- Noor, M. I. (2011). Nalar Keislaman Urang Banjar. *Al-Banjari*, 10/2, 185-204.
- Perlmann, M. (1971). Shaykh al-Damanhūrī against the churches of Cairo (1739). *Actas IV Congresso de Estudos Arabes e Islâmicos: Coimbra-Lisboa, 1 a 8 de setembro de 1968* (pp. 27–32). Leiden: Brill.
- Ras, J. J. (1968). *Hikajat Bandjar: A Study in Malay Historiography*. The Hague: Martinus Nijhoff.
- Shamsy, A. E. (2013). The Ḥāshiya in Islaimic Law: A Sketch of Shāfi’ī Literature. *Oriens*, 41, 289-315.
- van Bruinessen, M. (1998). Kurdish `Ulama and their Indonesian disciples" [revised version of: "The impact of Kurdish `ulama on Indonesian Islam"]. *Les annales de l'autre islam*, 5, 83-106.
- al-Zarkalī, Khair al-Dīn. (2002). *al-A’lām*. vol.4. Beirut: Dār al-‘Ilm li al-Malāyīn.

CHAPTER 6

SYSTEMS OF *QIYĀS* IN ARSYAD AL-BANJARI'S WORKS

6.1. A general overview of the system of *qiyās* implemented in Arsyad al-Banjari's works

Arsyad al-Banjari learned the theory and practice of *qiyās*, without a doubt, from the Shāfi'ī school of law. The development of the system of *qiyās* took most mature form by the work of one of the finest masters of that school, namely, Abū Ishāq al-Shīrāzī (393H/1003-476H/1083CE). It seems that al-Banjari also integrated some further developments of the *qiyās* such as the ones of al-Ghazālī.¹ Accordingly, before studying and pondering the concrete examples discussed by Arsyad al-Banjari, it seems useful to have a look at the basics of this form of inference as developed by al-Shīrāzī.²

The aim of *qiyās* is to provide a rational ground for the application of a juridical ruling to a given case not yet considered by the original juridical sources. It proceeds by combining heuristic (and/or hermeneutic) moves with logical inferences. The simplest form follows the following pattern:

- In order to establish if a given juridical ruling applies or not to a branch-case (*far'*), we look for a root-case (*aṣl*) we already know that it falls under that ruling. Then we search for a property or set of properties upon which the application of the ruling to the root-case is grounded (the *ratio legis* or *legal cause* for that juridical decision).

¹ Whereas al-Ghazālī defended vehemently the use of *qiyās*, he did not share the opinion that the occasioning factor can be identified by pure epistemological means. Epistemological methods must be coupled with insights coming from additional hermeneutical procedures. Cf. al-Ghazālī (1324H/ 1906, pp. 307-308) and Hallaq (1987b, pp. 61-62). It seems that the interpretation of al-Ghazālī is followed by al-Banjari. Perhaps, one way to put al-Ghazālī's point is as stressing the fact that the epistemological means provided by *qiyās* pave the way for understanding the intention of the norms given by the Lawgiver.

² See al-Shīrāzī (1986, 1987, 1988, 1995, 2003).

- If that grounding property (or set of them) is known, we ponder if it can also be asserted of the new case under consideration. In the case of an affirmative answer, it is inferred that the new case also falls under the juridical ruling at stake, and so the range of its application is extended. When the legal cause is explicitly known (by the sources) or made explicit by specifying a relevant set of properties, we are in the presence of an inference by *qiyās al-‘illa* or correlational inference by the *occasioning factor*.
- When the grounds behind a given juridical ruling are neither explicit nor can they be made explicit we are in the presence of correlational inferences by indication (*qiyās al-dalāla*) or by resemblance (*qiyās al-shabah*). Whereas the former is based on pinpointing at specific relevant parallelisms between rulings (*qiyās al-dalāla*), the latter are based on resemblances between properties (*qiyās al-shabah*).

Thus, *qiyās al-dalāla* and *qiyās al-shabah* are put into action in the absence of knowledge of the occasioning factor grounding the application of a given ruling. The plausibility of a conclusion attained by *parallelism between rulings* (*qiyās al-dalāla*) is considered to be epistemically stronger than of the conclusion obtained by *resemblance of the branch-case and the root-case* in relation to some set of (relevant) properties (*qiyās al-shabah*). However, conclusions obtained by either *qiyās al-dalāla* or *qiyās al-shabah* have a lower degree than conclusions inferred by the deployment of *qiyās al-‘illa*, where the occasioning factor can be pinpointed.

Our scrutiny of Arsyad al-Banjari’s works shows that the application of *qiyās* can be traced in his works dealing with Islamic law (*fiqh*), such as *Kitāb al-Nikāḥ* (كتاب النكاح), *Luqṭat al-‘Ajlān* (لقطة العجلان) and mainly his magnum opus, *Sabīl al-Muhtadīn* (سبيل المهتدين). Additionally, *qiyās* is applied in *Tuḥfat al-Rāghibīn* (تحفة الراغبين) which is actually deals with the doctrines of Sunni theology, but *qiyās* is employed for the issue related to Islamic law. However, in the present chapter we are discussing only the application of *qiyās* in the first three works since, in our view, they are sufficient to demonstrate the systems of *qiyās* in Arsyad al-Banjari’s works, our focus in this

chapter. Moreover, for its relevance, the *qiyās* applied in *Tuḥfat al-Rāghibīn* will be discussed in the next chapter that focuses on how this form of inference takes a significant part in the process of cultural integration of Islam into the Banjarese society.

Let us remark that most of the *qiyās* applied in Arsyad al-Banjari's works, in fact, were inherited from Shāfi'ī scholars' works, including *Tuḥfat al-Muḥtāj fī Sharḥ al-Minhāj* by Ibn Hajar al-Haytamī (909-974H/1504-1567) and *Nihāyat al-Muḥtāj ilā Sharḥ al-Minhāj* by al-Ramlī (919-1004H/1513-1596).

Regarding their types, the application of the three forms of *qiyās* can be found particularly in *Sabīl al-Muhtadīn*. Even so, the majority of *qiyās* applied in Arsyad al-Banjari's works are *qiyās al-shabah* or *correlational inference by resemblance*.³ As acknowledged by al-Ghazālī (1324H/1906, p. 312), the great majority of *qiyās* applied by jurists are indeed the form of *al-shabah*, due to the complications in demonstrating the efficiency of occasioning factor by means of either the scriptural texts (*naṣṣ*), consensus (*ijmā'*) or investigation of relevant properties.⁴ Arsyad al-Banjari, as do most jurists, applies *qiyās al-shabah* chiefly in the sphere of religious rituals where the ground for their rulings is indeed not intelligible.

Moreover, we also find two forms of *qiyās* other than the three forms just mentioned that were applied by Arsyad al-Banjari in his *Sabīl al-Muhtadīn*. Yet, whereas *qiyās* is normally applied in order to establish legal decisions for new cases when lacking the scriptural sources, these two types of *qiyās* are applied purely to show the coherence of juridical rulings that have already been confirmed as legitim. Accordingly, these two types of *qiyās* can be considered as non-canonical forms of *qiyās*, where the three forms acknowledged in Islamic jurisprudence are considered as canonical forms. Structurally, as will be discussed later, what distinguishes these two forms of parallel reasoning from the three canonical forms of *qiyās* is that they are

³ It seems that Arsyad al-Banjari also followed al-Ghazālī in the issue of legality of this form of *qiyās*.

⁴ Cf. Hallaq (1987b).

based not in a set of common properties or rulings, but simply on a symmetrical structure.

The systems of *qiyās* in the manuscripts we just mentioned will be presented by the following procedures:

- 1) After an overall view of the application of *qiyās* in each manuscript, we will present a relevant text, together with its translation into English, which shows an example of the application of this form of inference. Notice that all works we are studying were written in Banjarese-Malay using the so-called Jāwī script, a modified form of the Arabic script that was used commonly for the writing of Malay and other Indonesian languages in that period. In order to maintain their originality, the texts will be written in Jāwī.
- 2) From the example provided by the manuscript, then, we will examine what Hesse (1966) calls horizontal relations and vertical relations between properties (*waṣf* pl. *awṣāf*) and rulings (*ḥukm* pl. *aḥkām*) within the *qiyās* using Per Martin Löff's Constructive Type Theory in order to spell out the construction of some crucial elements within the structure of the *qiyās*.
- 3) Those elements, furthermore, will be set in the dialogical framework as developed in Chapters 3 and 4 so that it provides the means to include the dialectical system of *qiyās* that combines heuristic and logical moves, and sometimes even involves attacks and counterattacks.
- 4) At the end, the argument developed within the dialogue will be displayed briefly in a schematic structure in order to highlight three consecutive elements in the argument by *qiyās*, namely precondition, generalization and application. The precondition consists of demonstrating what Bartha (2010) calls *prior association* and *potential for generalization*. In *qiyās*, the former is the relation between some property (or ruling) with the ruling under consideration (or its analogue) in the root-case; the ruling under consideration is the ruling that is anticipated to be applied to the branch-case. While the latter is the fact that the property (or ruling) that is in relation with the ruling under consideration has an analogue in the branch-

case such that the prior association in the root-case is potential to be generalized. That allows us then to establish the second element, that is, generalization which is a general rule established from the prior association. Hence, the general rule varies according to the model of the prior association. As for the application, the last element of the argument by *qiyās*, it is the application of the general rule to the branch-case, so the conclusion that the ruling under consideration applies to the branch-case can be achieved.

6.2. *Qiyās in Kitāb al-Nikāh*⁵

There is only one application of *qiyās* found in this short treatise, as it explains mainly procedures and regulations in relation to marriage and divorce which are mostly already provided by scriptural sources. The following passage shows the *qiyās* application in this treatise.

<p>A woman whose husband is <i>manfūd</i>, that is, it is unknown whether he is living or dead, is forbidden to get married unless the husband's death or divorce has been recognised.</p>	<p>برمول سوامی یغ منفود یعنی تیاد کتهوان ماتین دان هیدوفن تیاداله هارس باکی استرین برسوامی هغک پات ماتین اتو طلاقن</p>
<p>That is similar to a person who sells the father's property, while assuming the father has died. The selling is legally valid in condition that the father's death has been recognised.</p>	<p>ادله بندیغش یغ دمکین ایت سفرتی سؤراغ منجوال ارت بفان فد حال دسغکان بفان سوده ماتی مک پات کادان بفان ایت سوده ماتی دهول درفد منجوال ارتان مک یایت صح جوالث⁶</p>

⁵ It is a treatise that deals with issues pertaining to marriage and divorce. Aswadié Syukur (2004) reported that *Kitāb al-Nikāh* was published in Istanbul and Singapore. In Indonesia, the treatise was copied from its original text by Abu Daudi, the descendant of Arsyad al-Banjari, and has been published by YAPIDA Martapura.

⁶ See Arsyad al-Banjari (2005, p. 67)

General structure of the *qiyās*

As mentioned in the text above, the *qiyās* is employed for refuting the legality of the marriage of a woman whose husband is unknown whether he is living or dead. The refutation is based on the similarity of such marriage to selling the property belonging to a father we do not know whether he is living or dead. The claim is that, since the selling is legally invalid, the marriage is also legally invalid unless the death has been recognised. Within the frame of *uṣūl fiqh* (Islamic jurisprudence), the marriage is the branch-case (*far‘*) and the selling the root-case (*aṣl*).

Marry B. Hesse (1966) introduced an analysis model of analogical argument – developed later by Bartha (2010)– that is based on horizontal and vertical relations. The horizontal relation is concerned with similarities between domains or, more specifically in Islamic jurisprudence, between a root-case and a branch-case. The point of establishing such relation is, roughly, to rationalize the parallel between the root- and branch-cases, despite their differences. While the vertical relation displays association between objects or properties within each case by means of which co-occurrence of those objects or properties can be justified. In our case, the horizontal relation is the relation between the root-case and the branch-case with regard to the fact that both are *kinds of contract carried out by representative while the actual owner’s death is unknown*; let us call this aspect the property \mathcal{P} . While the vertical relation is the relation between the property \mathcal{P} and the status of being legally invalid; let us call this aspect the ruling \mathcal{K} . The text states evidently that the relation between the property \mathcal{P} and the ruling \mathcal{K} in the root-case⁷ is that the latter dependent upon the former, as it is said, “*the selling is legally valid in condition that the father’s death has been recognised*”. In other words, the fact that the root-case instantiates the property \mathcal{P} , in CTT it is expressed by *aṣl*: \mathcal{P} , is claimed having relevance or appropriateness

⁷ The vertical relation in the root-case or source domain is called by Bartha (2010, p. 25) *prior association*.

(*munāsaba*) to the application of the ruling \mathfrak{K} to the root-case, expressed by $\mathfrak{K}(a\mathfrak{s}l)$. So, the relations in this *qiyās* can be described by the following diagram:

The diagram 6.1. *Qiyās* in *Kitāb al-Nikāh*

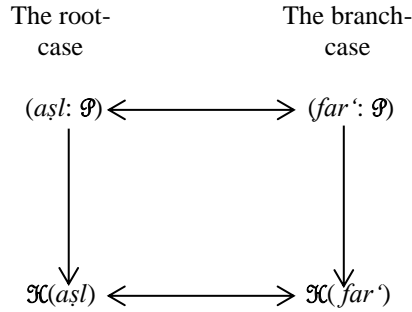

The downwards arrow from $a\mathfrak{s}l: \mathcal{P}$ to $\mathfrak{K}(a\mathfrak{s}l)$ within the domain of the root-case defines that the former is prior to the latter in the association.⁸ Thus, the relation between the two can be expressed by the following:

$$\mathfrak{K}(a\mathfrak{s}l) (a\mathfrak{s}l: \mathcal{P})$$

“Selling property of a father whose death is in question is legally invalid, given the fact that it is an instance of contracts carried out by representative while the actual owner’s death is unknown.”

The dependence of the ruling \mathfrak{K} upon the property \mathcal{P} assumes that the latter is the factor occasioning the former. So, it is obvious that this *qiyās* takes the form of *‘illa* or correlational inference by occasioning factor. However, that does not suffice to project that the similar relation between $far': \mathcal{P}$ and $\mathfrak{K}(far')$ holds in the branch-case. For that purpose, it is necessary first to generalize the association between $a\mathfrak{s}l: \mathcal{P}$ and $\mathfrak{K}(a\mathfrak{s}l)$ in the root-case. The generalization, more precisely, amounts to considering that such association in the root-case as an instance of a general formation. The following schema might be the general formation of such association:

$$\mathfrak{K}(x) \text{ true } (x: \mathcal{P})$$

⁸ Bartha (2010, p. 96) calls the analogy that is based on this kind of prior association *predictive analogy*.

“invalid status (the ruling \mathcal{K}) applies to x , provided x instantiates contracts carried out by representative while the actual owner’s death is unknown (the property \mathcal{P})”

At this point, this schema not only signifies that the invalid status of a contract is grounded upon the property \mathcal{P} , that is, the fact that it is a contract carried out by representative while the actual owner’s death is unknown, but also signifies that the invalid status is an invalid status specific to contracts instantiating the property \mathcal{P} . Hence, the generalization in *qiyās al-illa*, as pointed out in the previous chapter, is in the form of *exemplification*, whereby one instance is grasped as exemplifying the whole.

Now, in order to confirm that the property \mathcal{P} is indeed the factor that occasions the ruling \mathcal{K} , according Islamic jurisprudence, the property \mathcal{P} must satisfy the condition of *ta’thīr* (efficiency) in relation to the ruling \mathcal{K} . The *ta’thīr* is tested by two complementary procedures: testing *ṭard* or co-extensiveness (i.e. if the property is present, then the ruling is too); and testing *‘aks* or co-exclusiveness (i.e. if the property is absent, then so is the ruling). In this case, as indicated in the text, such condition is verified by the fact that:

- Selling the property of a father whose death is unknown is legally invalid, so it can be introduced that contracts carried out by representative while the actual owner’s death is unknown are legally invalid. (*Ṭard*)

$$!(\forall x: \mathcal{P}) \mathcal{K}(x)$$

- Selling the property of a father whose death is recognised is legally valid, so it can be introduced that contracts carried out by representative while the actual owner’s death is recognised are legally valid. (*‘Aks*)

$$!(\forall x: \neg\mathcal{P}) \neg\mathcal{K}(x)$$

- So, the presence of the ruling \mathcal{K} is due to the presence of the property \mathcal{P} , and the absence of the ruling \mathcal{K} is due to the absence of the property. (*Ta’thīr*)

$$! (\forall x: \mathcal{P} \vee \neg \mathcal{P}) \{[(\forall y: \mathcal{P}) w^\vee(y) =_{\{\mathcal{P} \vee \neg \mathcal{P}\}} x \supset \mathcal{K}(y)] \wedge$$

$$(\forall z: \neg \mathcal{P}) s^\vee(z) =_{\{\mathcal{P} \vee \neg \mathcal{P}\}} x \supset \neg \mathcal{K}(z)]\}^9$$

Since the efficiency of the property \mathcal{P} in relation to the ruling \mathcal{K} has been verified, the *'illa* quality of that property has been fulfilled such that the causal link between the property \mathcal{P} and the ruling \mathcal{K} is established, where the former is the cause of the latter. Naturally, the causal link is a system that when applied to some case, saying b that instantiates \mathcal{P} , ($b: \mathcal{P}$), renders the specific ruling $\mathcal{K}(b)$. In our notation it is encoded by the function *'illa*(x) in the formation *'illa*(x): $\mathcal{K}(x)$ ($x: \mathcal{P}$), that when it is applied, coming back to our case, to *selling property of a father whose death is in question (aʃl)* that is an instance of *contracts carried out by representative while the actual owner's death is unknown* (the property \mathcal{P}) renders *such selling invalid* [$\mathcal{K}(aʃl)$] or, more precisely, makes it become an invalid contract.

$$'illa(aʃl): \mathcal{K}^\mathcal{P}(aʃl)$$

The same occurs when the function *'illa*(x) is applied to the branch-case, namely the marriage of a woman whose husband is unknown whether he is dead is an instance of the property \mathcal{P} , it renders the marriage invalid [$\mathcal{K}(far')$].

$$'illa(far'): \mathcal{K}^\mathcal{P}(far')$$

Dialogue for the *qiyās*

The table 6.1. Dialogue for the *qiyās* in *Kitāb al-Nikāḥ*

O		P	
	response	response	The marriage of a woman whose husband is <i>manfūd</i> is legally invalid. ! $\mathcal{K}(far')$
			0

⁹ Denotations of these formalisations can be consulted in Rahman & Iqbal (2018) and Rahman, Iqbal, & Soufi (2019).

1	Why?	? 0 (challenge s move 0)	! 1, ! 2 (responds to 1 with the request of endorsing 2)	Selling property of a father whose living is in question is legally invalid, isn't it? $\mathfrak{K}(a\mathfrak{s}l)$?	2
3	Yes, it is. $! \mathfrak{K}(a\mathfrak{s}l)$! 2	! 3, ! 4	Such selling is a contract carried out by representative where the actual owner's death is unknown. Right? $a\mathfrak{s}l: \mathfrak{P} ?$	4
5	Yes. $a\mathfrak{s}l: \mathfrak{P}$! 4	! 3(5), ! 6	So, according to your moves 3 and 5, being a contract carried out by representative where the actual owner's death is unknown occasions the invalidity of such selling. Is that right? $'illa(a\mathfrak{s}l): \mathfrak{K}^{\mathfrak{P}}(a\mathfrak{s}l)?$	6
7	Justify! <i>muṭālaba !</i>	? 6	! 7	'aks: Selling the property of the father whose death is recognised is legally valid. $! (\forall x: \neg \mathfrak{P}) \rightarrow \mathfrak{K}(x)$ ṭard: Selling the property of the father whose death is unknown is legally invalid. $! (\forall x: \mathfrak{P}) \mathfrak{K}(x)$ ta`thīr: Therefore, the presence of the <i>ḥukm</i> is due to the presence of the <i>wasf</i> , and the absence of the <i>ḥukm</i> is due to its absence $! (\forall x: \mathfrak{P} \vee \neg \mathfrak{P}) \{[(\forall y: \mathfrak{P}) w^{\vee}(y) =_{\{\mathfrak{P} \vee \neg \mathfrak{P}\}} x \supset \mathfrak{K}(y)] \wedge (\forall z: \neg \mathfrak{P}) s^{\vee}(z) =_{\{\mathfrak{P} \vee \neg \mathfrak{P}\}} x \supset \neg \mathfrak{K}(z)]\}$	8

9	<p>Given these arguments I concede your previous request</p> <p>! $(\forall x: \mathcal{P} \vee \neg \mathcal{P}) \{[(\forall y: \mathcal{P}) w^v(y) =_{\{\mathcal{P} \vee \neg \mathcal{P}\}} x \supset \mathcal{K}(y)] \wedge (\forall z: \neg \mathcal{P}) s^v(z) =_{\{\mathcal{P} \vee \neg \mathcal{P}\}} x \supset \neg \mathcal{K}(z)]\}$</p>	! 6 (8)	! 9, ! 10	<p>Is the marriage of a woman whose husband is <i>manfūd</i> is an instance of contracts carried out by representative where the death of “the actual owner” is unknown?</p> <p><i>far'</i>: \mathcal{P}?</p>	10
11	<p>Yes, I agree.</p> <p><i>far'</i>: \mathcal{P}</p>	! 10	! 11, ! 12	<p>If it is the case that such marriage is a contract carried out by representative where the death of “the actual owner” is unknown, and, given 9, should this not lead you to endorse as a consequence its invalidity?</p> <p><i>far'</i>: \mathcal{P}</p>	12
13	<p>Indeed, the fact that it is a contract carried out by representative where the death of “the actual owner” is unknown should occasion its invalidity.</p> <p><i>ap[far'.t⁹]: $\mathcal{K}(far')$</i></p>	! 10	! 1	<p>So, this provides the justification for the thesis you were asking for with your first move: the branch-case falls under the ruling because it instantiates the property you just endorsed as constituting the occasioning factor.</p> <p><i>'illa(far')</i>: $\mathcal{K}^9(far')$</p>	14
	<i>Ilzām</i>				

Structure of the argument

In this part, we are not aiming at describing step by step how the argument established by the Proponent using *qiyās al-'illa* for refuting the legality of the marriage of a woman whose husband is *manfūd*, since that is already described by the dialogue above. The point is to highlight some crucial steps with the aim of articulating the

model of argument developed within this form of parallel reasoning. In order to do so, the argument will be expounded with the help of the following schema:

The schema 6.1. The argument of the *qiyās* in *Kitāb al-Nikāḥ*

Thesis $\mathcal{K}(far')$: The marriage of a woman whose husband is <i>manfūd</i> is legally invalid
--	---

The branch-cases (*far'*) : The marriage of a woman whose husband is *manfūd*
The root-case (*aṣl*) : Selling property of a father whose death is in question
The shared property \mathcal{P} : Being a contract carried out by representative in which the actual owner's death is unknown
Inferred Ruling \mathcal{K} : legally invalid

Argument:

- (1) $\mathcal{K}(aṣl)$: The root-case falls under the ruling \mathcal{K} .
(2) $aṣl: \mathcal{P}$: The root-case instantiates the property \mathcal{P} .
(3) $far': \mathcal{P}$: The branch-case instantiates the property \mathcal{P}

Because,

- (4) $'illa(x): \mathcal{K}(x) (x: \mathcal{P})$: *'illa*-link between the property \mathcal{P} and the ruling \mathcal{K} confirms the ruling \mathcal{K} for those that instantiate the property \mathcal{P}

(4.1) $(\forall x: \mathcal{P} \vee \neg \mathcal{P}) \{[(\forall y: \mathcal{P})$: since it has been verified that the property \mathcal{P} satisfies the efficiency (*ta'thīr*) in relation to the ruling \mathcal{K} , in the sense that if the property \mathcal{P} is present then the ruling \mathcal{K} too, and if the property \mathcal{P} is absent, then so is the ruling \mathcal{K} .
 $w^\vee(y) = \{ \mathcal{P} \vee \neg \mathcal{P} \}$
 $x \supset \mathcal{K}(y) \} \wedge (\forall z: \neg \mathcal{P})$
 $s^\vee(z) = \{ \mathcal{P} \vee \neg \mathcal{P} \}$
 $x \supset \neg \mathcal{K}(z) \}$

Hence,

- (5) $\mathcal{K}(far')$: given (3), the branch-case *f* falls under the ruling \mathcal{K} .
-

The schema above shows that the argument developed within this form of *qiyās* is not based on identical relations between the root-case and the branch-case, despite the

fact that they share some identical property. In fact, the argument is established on a sophisticated method of linking objects in the root-case, namely the property \mathcal{P} and the ruling \mathcal{K} by means of which the presence of the property \mathcal{P} in the branch-case entails the application of the ruling \mathcal{K} for it.

In general, the establishment of the argument in this form of *qiyās* can be divided into three main steps as follows:

- i) Establishing the causal link between *al-waṣf* (the property) and *al-ḥukm* (the ruling) in the root-case while indicating the similarity between the root-case and the branch case in relation to the property that is in causal link with the ruling. That shows the potential of that causal link to be generalized. In the schema, it is presented by (1), (2) and (3) where *aṣl*: \mathcal{P} and $\mathcal{K}(aṣl)$ signify the dependence of the ruling \mathcal{K} upon the property \mathcal{P} such that it can be said that the former is the cause of the latter, and at the same time, and *far'*: \mathcal{P} shows that the root-case and the branch-case share the property \mathcal{P} , so the causal link between the property \mathcal{P} and the ruling \mathcal{K} in the root-case is potential for generalization.
- ii) Generalising the causal relation. It is presented by (4) where *'illa*(x): $\mathcal{K}(x)$ (x : \mathcal{P}) is the general rule obtained from the generalisation of the causal link between the property \mathcal{P} and the ruling \mathcal{K} in the root-case. For this type of *qiyās*, the generalisation has to be followed by the justification showing the efficiency (*ta'thīr*) of the property \mathcal{P} in relation to the ruling \mathcal{K} in the sense that the presence of the ruling \mathcal{K} is due to the presence of the property \mathcal{P} and the absence of the ruling \mathcal{K} is due to its absence, as presented by (4.1). Concerning the generalisation, it should be noticed that even though procedurally it follows the causal link in the root-case, but epistemologically it precedes that causal link, for this reason, (1), (2) and (3) are connected to (4) with the conjunction “*because*”.
- iii) Applying the general rule to the branch-case. Given that the branch-case is an instance of the property \mathcal{P} , if we apply the general rule established in the second step, then we conclude at (5) that the branch-case falls under the ruling \mathcal{K} . In fact,

in the dialogue, the last is expressed by ‘*illa(far)*’: $\mathfrak{K}^{\mathfrak{P}}(\textit{far})$ that signifies that the ‘*illa*’ link between \mathfrak{P} and \mathfrak{K} is the proof for the application of the ruling \mathfrak{K} to the branch-case which is an instance of \mathfrak{P} .

6.3. *Qiyās in Luqṭa al-‘Ajlān*¹⁰

Like *Kitāb al-Nikāḥ*, this treatise deals with a specific matter in Islamic law. It explains especially regulations in relation to woman’s health issues whose rulings are generally already provided by juridical sources. So, there is no much application of *qiyās* in this treatise. More precisely, only two applications of *qiyās* can be found in this work where they both take the form of *shabah*. One of them, as quoted below, will be discussed in this section.

<p><i>Istihāda</i>, namely the bleeding occurring out of menstrual and puerperal periods, is a continuous state of <i>ḥadath</i>¹². It is similar to urine, <i>wadī</i>¹³ and <i>madhī</i>¹⁴ that come out continuously, that is, it neither prevents (a woman) from performing prayers, practicing fasting, having sexual intercourse (with her husband), and so on.</p>	<p>ادفون داره استحاضة يات يغ كلوار فد ماس لاین درفد ماس حیض دان نفاس مک یات حدث یغ سننتیاس اداله بندیشن سفرت کمه دان ودي دان مذي یغ سننتیاس کلوار یات تیاد منکهن ای اکن سمبیغ دان فواس دان وطی دان بارغسباکین¹¹</p>
--	---

¹⁰ This manuscript discusses legal decisions concerning the issues on women’s reproductive health such as *ḥaid* (menstruation), *nifās* (puerperal period) and *istihāda* (dysfunctional uterine bleeding). The treatise was published for the first time in Banjar in 1992. It has been transliterated into Latin script by Abu Daudi and Abu ‘Adi and published by YAPIDA Martapura.

¹¹ See Arsyad al-Banjari (2013, p. 11)

¹² *Ḥadath* is a state of dirtiness, ritual impurity that prevents a person from performing some kinds of worshipping. There two kind of *ḥadath*, the minor impurity (*ḥadath aṣghar*) and the mayor impurity (*ḥadath akbar*). Purification from *ḥadath* is accomplished by *wuḍū’* (ablution) or *ghuṣl* (full-body ablution) depending on the type of *ḥadath*. A continuous state of *ḥadath* signifies a condition where what renders *ḥadath*, such as passing urine, stool or wind, cannot be controlled.

¹³ It is a thick white fluid that comes after urinating. It is also considered impure.

¹⁴ It is a thin white sticky fluid which is discharged due to sexual stimulation.

General structure of the *qiyās*

The *qiyās* is applied in order to argue that woman suffering dysfunctional uterine bleeding (*istihāḍa*) is not prevented from performing any prayers. The argument, as stated in the text, is grounded in the resemblance between *istihāḍa*, the branch-case (*far'*), and urinary incontinence and the like, the root-case (*aṣl*), in relation to the fact that all of those things are considered continuous states of ritual impurity (*ḥadath*). Since the urinary incontinence and the like do not prevent someone from performing any prayers, so, *istihāḍa* should not prevent too.

Let us begin with discussing the vertical relation between the continuous state of ritual impurity (the property \mathcal{P}) and the prevention from performing prayers (the ruling \mathcal{K}) that both apply to the root-case (*aṣl*); expressed respectively by $\mathcal{P}(aṣl)$ and $\mathcal{K}(aṣl)$. It is not like the relation between *aṣl*: \mathcal{P} and $\mathcal{K}(aṣl)$ in the previous *qiyās*, that signifies the dependence of the ruling \mathcal{K} upon the property \mathcal{P} . In this case, we do not know how the property \mathcal{P} connects to the ruling \mathcal{K} apart from the fact that both apply to the root-case.

Indeed, it is common in Islamic jurisprudence that mostly when it comes to the area of religious rituals, like this case, the ground or the meaning (*ma'nā*) of the ruling is unknown. We do not know, for instance, why urinary incontinence does not prevent someone from performing prayers, just as we do not know why passing urine invalidates ablution so that we are prevented from performing prayers.

Nevertheless, in the horizontal relation, the root-case and the branch-case belong to a common identity in relation to the property \mathcal{P} . More explicitly, urinary incontinence and dysfunctional uterine bleeding are identical with regard to the fact that they both are continuous states of ritual impurity. This can be formulated by the following notation:

$$\mathcal{P}(aṣl) \mathcal{P}(far') \quad (aṣl, far' : \mathcal{D}) \text{ --where } \mathcal{P}(x): prop(x : \mathcal{D})$$

The vertical and horizontal relations in this *qiyās* can be displayed by the following diagram:

The diagram 6.2. *Qiyās* in *Luqta al-‘Ajlān*

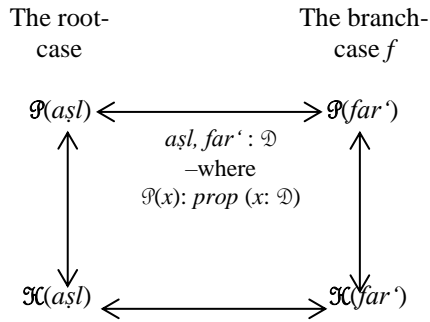

The up down arrow connecting $\mathcal{P}(a\mathfrak{s}l)$ and $\mathfrak{K}(a\mathfrak{s}l)$ indicates the unknown direction that links the property \mathcal{P} and the ruling \mathfrak{K} in the root-case. In other words, the relation between the property \mathcal{P} and ruling \mathfrak{K} is no more than a statistical correlation.¹⁵ However, the root-case and the branch-case can be unified in a common identity corresponding to the property \mathcal{P} , such that whatever in correlation with the property \mathcal{P} in the root-case should be in correlation with the property \mathcal{P} in the branch-case. This is expressed by the following notation:

$$a \approx_{\mathcal{P}} f$$

–where a stands for $a\mathfrak{s}l$ (the root-case), and f for far' (the branch-case)

It says: “the root-case and the branch-case are identical in relation to the property \mathcal{P} , such that whatever in correlation with the property \mathcal{P} in the root-case should be in correlation with that in the branch-case.”

Now, given the fact that the branch-case enjoys the property \mathcal{P} and the correlation between the property \mathcal{P} and the ruling \mathfrak{K} in the root-case, the same correlation in the branch-case should be. So, the ruling \mathfrak{K} should apply to the branch-case. For this

¹⁵ Bartha (2010, p. 96) calls the analogy that is based on this kind of association *correlative analogy*.

reason, it is believed or, borrowing al-Ghazālī's term, most likely (*ghalaba al-zann*) that the property \mathcal{P} is relevant (*munāsib*) to the ruling \mathcal{K} .

Dialogue for the *qiyās*

The table 6.2. Dialogue for the *qiyās* in *Luqta al-'Ajlān*

O		P			
		response	response	<i>Istihāda</i> (dysfunctional uterine bleeding) does not prevent from performing any prayers. ! $\mathcal{K}(\textit{far}')$	0
1	Why? What is the <i>illa</i> ? <i>illa</i> ?	? 0	$\mathcal{I}1, \mathcal{I}! 2$	Urinary incontinence does not prevent from performing any prayers. Is that right? $\mathcal{K}(\textit{aṣl})$?	2
3	Yes, it is. ! $\mathcal{K}(\textit{aṣl})$! 2	$\mathcal{I}3, \mathcal{I}! 4$	<i>Istihāda</i> and urinary incontinence can be seen as being equal in relation to the authorisation to perform any prayers. Right? $a \approx_{\mathcal{P}} f$? $\mathcal{P}(x)$ (x : ritual impurity)	4
5	Justify! <i>muṭālaba</i> !	? 4	$\mathcal{I} 5, \mathcal{I}! 6$	Urinary incontinence is a continuous state of <i>ḥadath</i> . Is that right? $\mathcal{P}(\textit{aṣl})$? (<i>aṣl</i> : ritual impurity)	6
7	Yes, it is. ! $\mathcal{P}(\textit{aṣl})$! 6	$\mathcal{I} 7, ! 8$	<i>Istihāda</i> is a continuous state of <i>ḥadath</i> . Is it right? $\mathcal{P}(\textit{far}')$? (<i>far'</i> : ritual impurity)	8
9	Indeed.	! 8	$\mathcal{I} 9, \mathcal{I}! 10$	According to these endorsements, it seems reasonable to consider them identical in relation to \mathcal{P} ,	10

	! $\mathcal{P}(\textit{far}')$			such that they should also be similar in relation to the ruling \mathcal{K} which is in correlation with \mathcal{P} . Do you agree? Given: <i>you(7)</i> : $\mathcal{P}(\textit{a}\mathcal{S}l)$ <i>you(9)</i> : $\mathcal{P}(\textit{far}')$ $a \approx_{\mathcal{P}} f$? $\mathcal{P}(x)$ (x : ritual impurity)	
11	I agree. ! $a \approx_{\mathcal{P}} f$! 10	! 11, ! 12	If that is the case, and given 3 that urinary incontinence does not prevent from performing any prayers, should not this be similar to the authorisation to perform any prayers in case of <i>istiḥāḍa</i> ? $\mathcal{K}(\textit{a}\mathcal{S}l/\textit{far}')$?	12
13	Indeed, according to their resemblance, the authorisation to perform any prayers in case of urinary incontinence yields its analogous authorisation in case of <i>istiḥāḍa</i> . ! $\mathcal{K}(\textit{far}')$! 12	! 1	So, this provides the justification for the thesis you were asking for with your first move: <i>istiḥāḍa</i> does not prevent from performing any prayers, because it is analogous to such authorisation in case of urinary incontinence, based on their resemblance in relation to the property \mathcal{P} . ! <i>shabah</i> $\mathcal{P} \approx f \mathcal{K}$: $\mathcal{K}(\textit{far}')$	14
	<i>Ilzām</i>				

Structure of the argument

The argument developed by the Proponent using *qiyās al-shabah*, as described in the dialogue, in order to argue that dysfunctional uterine bleeding does not prevent from performing any prayers can be structured as follows:

The schema 6.2. The argument of the *qiyās* in *Luqṭa al-‘Ajlān*

Thesis $\mathfrak{K}(far')$: <i>Dysfunctional uterine bleeding does not prevent from performing any prayers.</i>
---	---

The branch-cases (*far'*) : Dysfunctional uterine bleeding
The root-case (*aṣl*) : Urinary incontinence
The shared property \mathcal{P} : being a continuous state of *ḥadath* (ritual impurity)
Inferred Ruling \mathfrak{K} : authorises to perform any prayers
The set \mathcal{D} : Ritual impurity

Argument:

- (1) $\mathfrak{K}(aṣl)$: The ruling \mathfrak{K} applies to the root-case
(2) $\mathcal{P}(aṣl)$ ($aṣl: \mathcal{D}$) : The root-case enjoys the property \mathcal{P}
(3) $\mathcal{P}(far')$ ($far': \mathcal{D}$) : The branch-case enjoys the property \mathcal{P}

Given these facts,

- (4) $a \approx_{\mathcal{P}} f$: the root-case and the branch-case are identical in
–where relation to the property \mathcal{P} , such that whatever in
 $\mathcal{P}(x)prop (x: \mathcal{D})$ correlation with the property \mathcal{P} in the root-case
should be in correlation with that in the branch-
case.



- (5) $\mathfrak{K}(far')$: Hence,
the application of the ruling \mathfrak{K} to the root-case, at
number (1), should be extended to the branch-
case, so we conclude that the ruling \mathfrak{K} applies to
the branch-case.

Unlike *qiyās al-‘illa* where the application of the ruling \mathfrak{K} to the branch-case is based on the generalisation of a causal link between the property \mathcal{P} and the ruling \mathfrak{K} in the root-case, the argument developed within *qiyās al-shabah* is based merely on identical relations between the root-case and the branch-case with regard to the property \mathcal{P} . However, it does not simply say, “*aṣl* is \mathcal{P} and \mathfrak{K} , given the fact that *far'* is

\mathcal{P} , then it is plausible that *far'* is \mathcal{K} .” The schema shows that the establishment of the argument is quite complex and consists of three main stages:

- (i) Establishing a correlation between some property and the ruling at stake in the root-case, while corresponding the root-case and the branch-case in relation to that property such that the correlation is potential to be applied to the branch-case. In the schema, it is presented by (1), (2) and (3) where $\mathcal{K}(a\mathcal{S}l)$, $\mathcal{P}(a\mathcal{S}l)$ ($a\mathcal{S}l: \mathcal{D}$) and $\mathcal{P}(far')$ ($far': \mathcal{D}$) indicate that the root-case and the branch-case share the property \mathcal{P} , and moreover, it also indicates a correlation between the property \mathcal{P} and the ruling \mathcal{K} .
- (ii) Generalising the correlation between the property \mathcal{P} and the ruling \mathcal{K} which amounts to establishing resemblance (*shabah*) between the root-case and the branch-case by unifying them in a common identity, corresponding to the property \mathcal{P} such that the correlation between the property \mathcal{P} and the ruling \mathcal{K} in the root-case entails the same correlation in the branch-case. It is expressed by $a \approx_{\mathcal{P}} f$ at (4).
- (iii) Applying $a \approx_{\mathcal{P}} f$ to the branch-case at (5) so that it provides evidence that the ruling \mathcal{K} applies to the branch-case [$\mathcal{K}(far')$]. If we want to be more explicit, as in the dialogue, it would be signified by “*shabah* $\mathcal{P}-a \approx_{\mathcal{P}} f-\mathcal{K}: \mathcal{K}(far')$ ” that means that the application of the ruling \mathcal{K} to the branch-case is based on the resemblance between the root- and branch-cases in relation to the property \mathcal{P} , where \mathcal{P} in the root-case is in correlation with the ruling \mathcal{K} .

6.4. *Qiyās in Sabīl al-Muhtadīn*¹⁶

¹⁶ *Sabīl al-Muhtadīn*, as mentioned by Arsyad al-Banjari (1957, fol. 2b) in the introduction of this work, was composed upon the request of Sultān Tamjīd Allāh because of lacking book of Islamic law in Malay language. Aswadi Syukur (2016) points out that this work has been well known and read by Muslim communities in Southeast Asia where the people use Malay language in their daily conversations, such as Indonesia, Malaysia, Singapore, Brunei Darussalam and some regions in Thailand, Philippines and Cambodia, since there was no other book in Malay language that discuss Islamic law comprehensively and profoundly as *Sabīl al-Muhtadīn*. Arsyad al-Banjari began writing the manuscript in 1193H/1779 and finished it two years later, in 1195H/1781. It was edited for the first time by Ahmad ibn Muhammad

Sabīl al-Muhtadīn is Arsyad al-Banjari’s masterpiece that is considered the most important Malay work in Islamic law. In this manuscript, we can find a huge use of *qiyās*. The manuscript was composed in two volumes that consist of eight chapters (*kitāb*), that discuss different matters of Islamic law, and twenty-six subchapters (*bāb*), that discusses more specific problem of the matters. The *qiyās* application can be traced in every chapter and almost every subchapter of this work. Even in some chapters, such as Chapters on Purification (*al-Ṭahāra*), Fasting (*al-Ṣiyām*) and Pilgrimage (*al-Hajj wa al-‘Umra*), *qiyās* is employed enormously.

Moreover, the application of three forms of *qiyās*, namely *al-‘illa*, *al-dalāla* and *al-shabah*, can be found in this manuscript. Additionally, as already mentioned, two kinds of parallel reasoning other than the three forms of *qiyās* recognised in *uṣūl al-fiqh* are also applied in this manuscript. We will discuss the application of every forms of *qiyās* in this masterpiece by analysing examples provided for each form.

6.4.1. Example of *qiyās al-‘illa*

The second one that causes *hadath*¹⁷ is loss of consciousness because of sleep or other things like mental illness, apoplexy, drunkenness or sickness, as the Prophet said: (*al-‘aynāni wikā’ al-sāh faman nāma falyatawaḍḍa’*), that means: “two eyes are the string that ties anal sphincter, consequently, whoever has fallen asleep is obliged to take ablution”. “Two (open) eyes” are metaphor of awakening in the sense that the awakening (open eyes) keeps someone aware when a thing comes out

(يشكدوا) درفد سكل سبب حدث هيلغ عقل
سبب تيدر اتو لايث سفره كيلا اتو فيتم اتو مابق
اتو ساكت كارن سبدا نبي صلى الله عليه وسلم
(العينان وكاء الساه فمن نام فليتوضأ) ارتين برمولى
دوا متا ايت مملهاكن دبر درفد كلور سوات
درفدان مك برغسياف تيدر اي مك هندقله اي
مغمبل وضوء (دان) دوا متا ايت كناية درفد جاك

Zain al-Fathani and published almost simultaneously in Mecca and Istanbul around 1882. Munadi (2020) indicates that the manuscript was also edited by Muhammad Ilyas al-Azhari and published in Cairo in 1307H/1889. In fact, *Sabīl al-Muhtadīn* was translated into Indonesian language by Aswadie Syukur and has been published by Bina Ilmu Surabaya since 1985. In Malaysia, it was transcribed by Mohamad Haidzir bin Hussin bin Ibrahim, edited by Fuad Ismail and has been published by Telaga Biru since 2010; and it was also transcribed by Jahabersa Team and has been published since 2013 by Jahabersa, Johor Baru.

¹⁷ See the previous note on this issue.

<p>of the anus. A person who sleeps normally does not recognise that something comes out of the anus due to the loss of consciousness.</p>	<p>يعني بهوشن جاگ دوا متا ايت مملهاكن اي درفد كلور سوات درفد دبرن دان اورغيغ تيدر ايت تركدغ كلور سوات درفد دبرن فد حال تباد كرسانن سبب هيلغ عقلن</p>
<p>Since ablution is nullified by sleep, so it should be nullified too by mental illness, apoplexy and drunkenness for the reason that the loss of consciousness because of such conditions is stronger than because of sleep.</p>	<p>دان افبيل ثابتله بطل وضوء سبب تيدر مك دهبوغكن دغندي كيلا دان فيتم دان مابق ترليه ساعة درفد هيلغن سبب تيدر</p>
<p>However, it is different to the sleep of a person who sits firmly. It does not invalidate ablution regardless of whether she sits on floor or the back of a mount or others, or even if she sleeps by leaning on an object such that if it is taken up, she will tumble, because such sleep let nothing come out of the anus. Accordingly, it is not the most likely place for a thing to come out from the anus.</p>	<p>(مليكن) تيدر اورغيغ دودق يغ منتفكن اي اكن مقعدن فد تمفت كدودوقكنن مك تيداله بطل وضوء دغندي سم ادا تمفت كدودوقكنن ايت بوم اتو بلاكغ تغكاغنن اتو لايث دان جكلو تيدر اي دغن برسندر فد سوات سكير ۲ جك دهيلغن تمفت كسندرث ايت نسچاي رهله اي سكايفون كارن دامانكن درفد كلور سوات درفد دن مك تيداله اي تمفت ظن بگ كلور سوات درفد دن كتيك ايت</p>
<p>As for the sleep of a person who does not sit firmly; and the sleep of a person who sits firmly but she is so thin that there is space between her bottom and the seat because of thinness or she is not thin but her bottom is raised surely from the seat before awakening; and the sleep of a person lying on the back, all those sleeps invalidate ablution.</p>	<p>(ادافون) تيدر اورغيغ تباد منتفكن اي اكن مقعدن فد تمفت كدودوقكنن اتو منتفكن اي دكندي تناف اداله اي كورس سكير ۲ اداله انتار مقعدن دان تمفت كدودوقكنن ايت رغكغ سبب كورسن اتو تباد اي كورس تناف تراغكت مقعدن درفد تمفت كدودوقكنن دهول درفد جكان دغن يقين دان تيدر اورغيغ برتلننغ مك بطالله دغندي وضوء¹⁸</p>

¹⁸ See Arsyad al-Banjari (n.d., vol. 1, pp. 94-95)

General structure of the *qiyās*

In this example, *qiyās al-‘illa* is employed in order to argue that the branch-case (*far‘*), namely mental illness, apoplexy and drunkenness invalidates ablution. As indicated by the text, the reason is that the root-case (*aṣl*), namely sleep invalidates ablution due to loss of consciousness such that the person who sleeps does not recognise when something comes out of the anus. Accordingly, the factor that occasions the invalidation of ablution for sleep in the sense of sleep lying down is *loss of consciousness* coupled with possibility of something coming out of the anus; hereinafter abbreviated as *possibility of coming out*. Since loss of consciousness and possibility of coming out occur in the conditions of mental illness, apoplexy and drunkenness, so, these conditions also invalidate ablution.

In general, the structure of this *qiyās* is similar to that applied in *Kitāb al-Nikāḥ* previously since they share the same form of *qiyās*. What distinguishes them is that in this *qiyās* there are a couple of properties, namely *loss of consciousness* (\mathcal{P}_1) and *possibility of coming out* (\mathcal{P}_2), that constitute the *‘illa*.

The diagram 6.3. *Qiyās al-‘illa* in *Sabīl al-Muhtadīm*

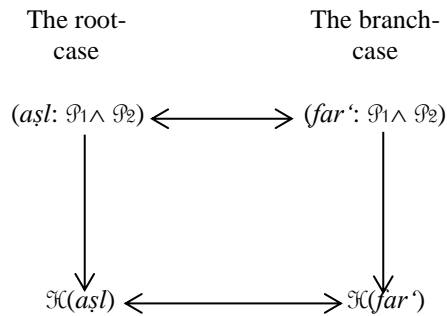

Another difference between this *qiyās al-‘illa* and that in *Kitāb al-Nikāḥ* is in the method of determining the occasioning factor. Let us recall that the occasioning factor can be learned either: (1) because the sources explicitly (*jalī*) identify the relevant

property; or (2) because, though the sources do not contain an explicit description of the property determining the *'illa*, it comes out as *evident* (*wāḍiḥ*), by hermeneutical examination of the texts; or (3) because, when it is neither explicit nor apparent after a hermeneutical study, but hidden or *latent* (*khafī*), it is made apparent by an epistemological enquiry. For this *qiyās al-'illa*, different from that is applied in *Kitāb al-Nikāḥ*, the fact that *loss of consciousness* (\mathcal{P}_1) and *possibility of coming out* (\mathcal{P}_2) occasion *invalidation of ablution* (the ruling \mathcal{K}) is confirmed evidently by hermeneutical examination of the scriptural source, that is, the Prophet's saying that awakening (open eyes) keeps someone aware of something coming out of the anus. This is expressed by the following notation:

$$\begin{aligned} & \text{'illa}(a\mathcal{K}): \mathcal{K}_{\mathcal{S}}^{\mathcal{P}}(a\mathcal{K}) \\ & \text{—where } \mathcal{P} = \mathcal{P}_1 \wedge \mathcal{P}_2 \end{aligned}$$

§ indicates that the evidence confirming the property \mathcal{P} to be the occasioning factor of the ruling \mathcal{K} is from the source.

The confirmation of the source for the set of properties \mathcal{P}_1 and \mathcal{P}_2 to be the *'illa* of the ruling \mathcal{K} amounts to establishing the relevance and the efficiency of those set of properties in relation to the ruling \mathcal{K} . Therefore, in fact, the efficiency of the property \mathcal{P} in relation to the ruling \mathcal{K} is not necessary to be tested. However, in the text, the efficiency is demonstrated by taking two cases: (1) the sleep of a person lying on the back; and (2) the sleep of a person who sits tightly on the seat. The first case instantiates the set of properties \mathcal{P}_1 (*loss of consciousness*) and \mathcal{P}_2 (*possibility of coming out*). So, the invalidation of ablution applies. As for the second case, though it constitutes a state of *loss of consciousness* (\mathcal{P}_1), but it does not constitute, at least according to the text, a state of *possibility of coming out* (\mathcal{P}_2). So, it does not satisfy the conjunction of \mathcal{P}_1 and \mathcal{P}_2 , and the invalidation of ablution does not apply.

Dialogue for the *qiyās*

The table 6.3. Dialogue for *qiyās al-‘illa* in *Sabīl al-Muhtadīn*

O		P			
		response	response	Main Thesis Mental illness, apoplexy and drunkenness invalidate ablution. $\mathfrak{K}(far)$	0
1	Why?	? 0	! 1, ! 2	Falling asleep invalidates ablution, doesn't it? $\mathfrak{K}(a\mathfrak{s}l)$?	2
3	Yes $\mathfrak{K}(a\mathfrak{s}l)$! 2	! 3, ! 4	When someone falls asleep, he loses consciousness such that he does not recognise whether a thing comes out from the anus. Don't you agree? $a\mathfrak{s}l: \mathcal{P}?$ Note: $\mathcal{P} = (\mathcal{P}_1 \wedge \mathcal{P}_2)$ \mathcal{P}_1 : <i>loss of consciousness</i> \mathcal{P}_2 : <i>possibility of something coming out of the anus</i>	4
5	I do. $a\mathfrak{s}l: \mathcal{P}$! 4	! 5(3), ! 6	Given your own moves 3 and 5, and the evidence from the source, you must concede that loss of consciousness in which someone does not feel something coming out of the anus has the efficiency to determine the <i>‘illa</i> of that <i>ḥukm</i> . Do you agree? $‘illa(a\mathfrak{s}l): \mathfrak{K}_{\mathfrak{s}}^{\mathcal{P}}(a\mathfrak{s}l)?$	6
7	Indeed, I endorse it since it comes from the source.	! 6	! 7, ! 8	When someone suffers mental illness or apoplexy	8

	$!(\forall x: \mathcal{P} \vee \neg \mathcal{P}) \{[(\forall y: \mathcal{P}) w^\vee(y) =_{\{\mathcal{P} \vee \neg \mathcal{P}\}} x \supset \mathfrak{K}(y)] \wedge (\forall z: \neg \mathcal{P}) s^\vee(z) =_{\{\mathcal{P} \vee \neg \mathcal{P}\}} x \supset \neg \mathfrak{K}(z)]\}$			<p>or was drunk, he loses consciousness such that he does not feel whether a thing comes out from the anus. Is it true?</p> <p><i>far'</i>: \mathcal{P}?</p>	
9	<p>Yes, it is.</p> <p><i>far'</i>: \mathcal{P}</p>	! 8	? 7	<p>So, mental illness, apoplexy and drunkenness cause loss of consciousness such that a person who suffers such conditions does not feel something coming out of the anus, this instantiates the antecedent of the <i>ṭard</i>-component of your assertion linking loss of consciousness coupled with possibility of coming out and invalidation of ablution. You should now assert the consequent. Right?</p> <p><i>far'</i>: \mathcal{P}</p>	10
11	<p>Indeed, I endorse this ruling to the branch-case too.</p> <p>'<i>ap</i>[<i>far'</i>: $\mathfrak{K}_{\mathcal{S}}^{\mathcal{P}}$]: $\mathfrak{K}(far')$</p>	! 10	! 1	<p>So, this provides the justification for the thesis you were asking for with your first move: the branch-case falls under the ruling because it instantiates the property you just endorsed as relevant for determining the occasioning factor.</p> <p>'<i>illa</i>(<i>far'</i>): $\mathfrak{K}_{\mathcal{S}}^{\mathcal{P}}(far')$</p>	12
	<i>Ilzām</i>				

Structure of the argument

The argument developed by the Proponent using *qiyās al-‘illa* in order to argue that mental illness, apoplexy and drunkenness invalidate ablution can be described by the following schema:

The schema 6.3. The argument of *qiyās al-‘illa* in *Sabīl al-Muhtadīn*

Thesis $\mathfrak{K}(far')$: <i>Mental illness, apoplexy and drunkenness invalidate ablution.</i>
------------------------------------	--

The branch-cases (*far'*) : Mental illness, apoplexy and drunkenness
The root-case (*aṣl*) : Sleep
The shared property \mathcal{P} : loss of consciousness (\mathcal{P}_1) and possibility of coming out (\mathcal{P}_2)
Inferred Ruling \mathfrak{K} : invalidating ablution

Argument:

- (1) $\mathfrak{K}(aṣl)$: The root-case falls under the ruling \mathfrak{K} .
(2) *aṣl*: \mathcal{P}° : The root-case instantiates the property \mathcal{P} .
(3) *far'*: \mathcal{P} : The branch-case instantiates the property \mathcal{P}

Because,

- (4) *‘illa*(x): $\mathfrak{K}(x)$ (x : \mathcal{P}°) : According to the source, the *‘illa*-link between the property \mathcal{P} and the ruling \mathfrak{K} confirms the ruling \mathfrak{K} for those that instantiate the property \mathcal{P}



- (5) $\mathfrak{K}(far')$: the branch-case falls under the ruling \mathfrak{K} .
-

The structure of the argument of this *qiyās* is similar to that of the previous *qiyās al-‘illa* except that in this *qiyās*, since the generalisation in (4) is confirmed by the source, so the verification of its efficiency (*ta‘thīr*) is not needed.

6.4.2. Example of *qiyās al-dalāla*

In fact, the example we are presenting is the second type of *qiyās al-dalāla*, which is based on a parallel (*naẓīr*) relationship between two rulings. The application of the first type of this form of *qiyās*, which is based on a particular-general relationship (*khaṣīṣa*) between two rulings, cannot be found in Arsyad al-Banjari's works.

<p>It is obligatory to release an animal that is forbidden to be killed such as <i>Hudhud</i> (Hoopoe) and <i>Khuṭāf</i> (a variety of Swallow), because when it is forbidden to catch or to kill it, then it is forbidden too to cage it, like the ruling (<i>ḥukm</i>) for game in <i>Ḥarām</i> land.²⁰</p>	<p>(دان واجب) ملفسکن بناتغ یعدتکهن درفد مبونهدی سفره هدهد دان خطاف کارن بهوسن تتکال اداله ای دتکهن درفد منغکفدی دان مبونهدی حرامله مغورغدی سفره حکم فربروان فد تانه حرام¹⁹</p>
--	---

General structure of *qiyās*

Qiyās is employed here in order to argue the prohibition of caging the species of hoopoe and swallow based on the prohibition of killing them. Precisely, the argument is grounded on the parallelism between *the prohibited killing* and *the prohibited caging* as that apply to wild animals of *Ḥarām* land (the sacred zone in Mecca).

The paragraph above designates that in the horizontal relation the branch-case (*far'*), the species of hoopoe and swallow, and the root-case (*aṣl*), wild animals of *Ḥarām* land, share some ruling (*ḥukm*), that is, the prohibited killing. Nonetheless, the point here is the vertical link between two rulings, the prohibited killing and the prohibited caging, that apply in the root-case. These two rulings, as stated in the text, can be considered a pair of rulings (*naẓīrain*) where the presence of one implies the

¹⁹ See Arsyad al-Banjari (n.d., vol. 2, pp. 252-253)

²⁰ It is the sacred zone in Mecca where some prohibitions, such as killing animal and damaging plants or trees, apply. For boundaries of *Ḥarām* land, see 'Abd al-Malik ibn 'Abd Allāh ibn Dahīsh (1995). *Al-Ḥarām al-Makkī al-Sharīf wal-A'lām al-Muhīta bih*. Mecca.

presence of the other so that the prohibition of caging these two species can be deduced from the prohibition of killing them that is already confirmed by juridical sources.

In fact, as pointed out by al-Shīrāzī (1988), the rationale underlying that one ruling can be confirmed from the confirmation of its parallel (*naẓīr*), is that whatever the factor occasioning its parallel must be the same as the one occasioning it. However, in order to confirm that those two rulings are indeed a pair, it requires, *first*, that both rulings involve the same underlying set, and *second*, that some source cases provide evidence (*shahada al-uṣūl*) that if one applies, then the other also does (*tard/co-extensiveness*), and that if one does not apply, then neither does the other (*'aks/co-exclusiveness*).

The first requirement, that *the prohibited killing* and *the prohibited caging* involve the same underlying set, is confirmed by the fact that these two rulings can be seen as subsets of the set of *actions*.

	(<i>x</i> : <i>action</i>)
	...
<i>action: set</i>	<i>killing(x) ∧ Prohibited(x): prop</i>
	(<i>x</i> : <i>action</i>)
	...
<i>action: set</i>	<i>caging(x) ∧ Prohibited(x): prop</i>

To go more explicit, we should also bring to the fore that *actions* are oriented toward *animals*, instances of which include *wild animals of Ḥarām land* and *the species of hoopoe and swallow*, so that the fully explicit formation of

Prohibited action of killing toward x,
Prohibited action of caging toward x,

if written in a linear form, is:

prohibited (x, y, z) prop (x: animal, y: action(x), z: killing(x, y)).
prohibited (u, v, w) prop (u: animal, v: action(u), w: caging (u, v)).

In plain words, *prohibited* qualifies *killing* that are *actions* toward some *animal* (the same applies to *caging*). However, for the sake of simplicity, we use the following formations:

- $\mathfrak{K}^*(x)$ (x : *animal*)
- $\mathfrak{K}(x)$ (x : *animal*)
- Assuming
- \mathfrak{K}^* : *prohibited killing*
- \mathfrak{K} : *prohibited caging*

The first, $\mathfrak{K}^*(x)$ (x : *animal*), can be read, “the prohibited killing applies to animal x , or it is forbidden to kill animal x ”. The same applies to the second, it can be read, “the prohibited caging applies to animal x , or it is forbidden to cage animal x ”. If we apply to our case, those yield the following rulings:

- $\mathfrak{K}^*(a\mathfrak{s}l)$ (x : \mathfrak{D})
- $\mathfrak{K}(a\mathfrak{s}l)$ (x : \mathfrak{D})
- $\mathfrak{K}^*(far')$ (x : \mathfrak{D})
- $\mathfrak{K}(far')$ (x : \mathfrak{D})
- Assuming
- \mathfrak{D} is the set of animals

The relations between those rulings can be described by the following diagram:

The diagram 6.4. *Qiyās al-dalāla* in *Sabīl al-Muhtadīn*

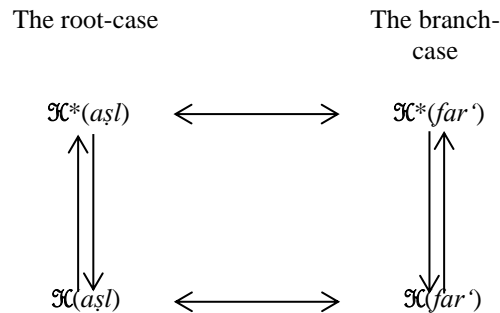

The pair of upwards and downwards arrows that link vertically the rulings \mathfrak{K}^* and \mathfrak{K} signify two possible directions, as they are assumed a pair of rulings. That, however, does not suffice yet to confirm $\mathfrak{K}(far')$ from $\mathfrak{K}^*(far')$. As asserted above, it still needs

some source-cases confirming co-extensiveness and co-exclusiveness of the rulings \mathfrak{K}^* and \mathfrak{K} . In this case, the point is to show that *all animals forbidden to be killed is forbidden to be caged*; and, *all animals not forbidden to be killed is not forbidden to be caged*. The first point is confirmed by the case of *wild animals of Ḥarām land*, but for the second point no confirming case is given.²¹ However, in order to examine further the validation of the argument, mainly in a *jadāl* practice as will be developed in the dialogue, we need the case confirming the co-exclusiveness. So, let us take example the case of fishes. Fishes are not forbidden animals to be killed, so they are not forbidden to be caged. Now we have established the following:

$$\begin{aligned} &!(\forall x: \text{animal}) \mathfrak{K}^*(x) \supset \mathfrak{K}(x) \text{ true (} \textit{tard}) \\ &!(\forall x: \text{animal}) \neg \mathfrak{K}^*(x) \supset \neg \mathfrak{K}(x) \text{ true (} \textit{aks}) \end{aligned}$$

This leads to the generalization of the pair (*naẓīr*) relationship between $\mathfrak{K}^*(x)$ and $\mathfrak{K}(x)$, so that we obtain:

$$!(\forall x: \text{animal}) \mathfrak{K}^*(x) \supset \mathfrak{K}(x) \text{ true.}$$

“It is **true** that for all animals to which the prohibited killing applies, then the prohibited caging also applies, and it is also **true** that for all animals to which the prohibited killing does not apply, then the prohibited caging does not apply too.”

Now, given the fact that the prohibited killing applies to the species of hoopoe and swallow [$\mathfrak{K}^*(\textit{far}')$], so its parallel, the prohibited caging [$\mathfrak{K}(\textit{far}')$], should also apply to them.

²¹ This was probably because Arsyad al-Banjari focused particularly on justifying his argument concerning the prohibition of caging Hoopoe and Swallow, so it is sufficient for him showing the *tard*. This is what actually happens for most of jurists, not only for *qiyās al-dalāla*, but also for *qiyās al-'illa*. They often provide no confirming case for the co-exclusiveness when they focus on justifying the argument which is in accordance with the co-extensiveness. For example, when al-Shīrāzī established the parallelism between the ruling of *zihār* (ancient form of divorce-declaration) and the ruling of *ṭalāq* (standard form of divorce-declaration) in his works, he did not give the source-case with regards to the co-exclusiveness of the rulings of *zihār* and *ṭalāq* in his earlier works, such as *al-Mulakhkhaṣ*, *al-Ma'ūna*, and *al-Luma'*. Since he focused on justifying the validity of *zihār* for some non-Muslim, so it looks sufficient for him to show the co-extensiveness. He provided it later in his *Sharḥ al-Luma'* for a *jadāl* practice.

Dialogue for the *qiyās*

The table 6.4. Dialogue for *qiyās al-dalāla* in *Sabīl al-Muhtadīn*

O		P			
		response	Response	It is forbidden to cage the species of hoopoe and swallow. ! $\mathfrak{C}(far')$	0
1	Why? What is the <i>illa</i> ? <i>illa</i> ?	? 0	! 1, ! 2	It is forbidden to kill a wild animal of <i>Harām</i> land, isn't it? $\mathfrak{C}(a\mathfrak{s}l)$?	2
3	Yes, it is. ! $\mathfrak{C}(a\mathfrak{s}l)$! 2	! 3, ! 4	It is forbidden to cage the wild animal of <i>Harām</i> land, isn't it? $\mathfrak{C}^*(a\mathfrak{s}l)$?	4
5	Yes, it is. ! $\mathfrak{C}^*(a\mathfrak{s}l)$! 4	! 5, ! 6	Is it forbidden to kill the species of hoopoe and swallow? $\mathfrak{C}^*(far')$?	6
7	Yes, it is. ! $\mathfrak{C}^*(far')$! 6	! 5 (3), ! 8	If we return to your assertion 3 and 5, it is clear that the prohibition of killing animals and the prohibition of caging animals are parallel (<i>naẓīr</i>) cases that run together. Right? $(\forall x:\mathfrak{D}) \mathfrak{C}^*(x) \supset \mathfrak{C}(x)$?	8
9	Justify! <i>muṭālaba</i> !	? 8	! 9	@ ¹ : Don't you see that both the prohibition of killing and the prohibition of caging animals are two kinds of actions toward animal with the same deontic force and juridical consequences?	10

				<p>So, both are applications of different forms of forbidden actions towards animal? In other words, don't you see that $\mathfrak{H}^*(far')$, and $\mathfrak{H}^*(a\mathfrak{s}l)$ $\mathfrak{H}(a\mathfrak{s}l)$, share the following structure?</p> <p><i>prohibited</i> (x, y, z) <i>prop</i> (x: animal, y: action(x), z: killing(x, y)).</p> <p><i>prohibited</i> (x, y, z) <i>prop</i> (x: animal, y: action(x), z: caging(x, y)).</p>	
11	<p>Can you develop your argument? <i>muṭālaba</i> !</p>	10 (8)	11	<p>@²: More generally, according to the sources, for all animal that is forbidden to be killed, it is forbidden to be caged, such as wild animals of <i>Ḥarām</i> land.</p> <p>In other words, the following holds:</p> <p>! $(\forall x: animal) \mathfrak{H}^*(x) \supset \mathfrak{H}(x)$ true</p> <p>@³: According to the sources, for all animal that is not forbidden to be killed, it is not forbidden to be caged, such as fishes. Thus, the following holds (under the same assumptions as before):</p> <p>! $(\forall x: animal) \neg \mathfrak{H}^*(x) \supset \neg \mathfrak{H}(x)$ true</p> <p>@⁴: Therefore, by evidence of the sources (<i>shahādat al-uṣūl</i>) we can conclude that the animal that is forbidden</p>	12

				to be killed is forbidden to cage it, and the animal that is not forbidden to be killed is not forbidden to cage it. ! $(\forall x: animal) \mathfrak{K}^*(x) \supset \mathfrak{K}(x)$ <i>true</i>	
13	Given these arguments I concede your previous request. ! $(\forall x: \mathcal{D}) \mathfrak{K}^*(x) \supset \mathfrak{K}(x)$! (8) 12	? 13(7), ! 14	If it is the case, and, given 7 that it is forbidden to catch and to kill the species of hoopoe and swallow, should this not lead to the prohibition of caging? Moreover, we must also conclude that the relation of <i>nazīr</i> provides an indication that whatever the occasioning factor behind both rulings is, it is the same. <i>you(7):</i> $\mathfrak{K}^*(far')$ <i>z:</i> $(illa(x): \mathfrak{K}?)$ <i>z:</i> $(illa(x): \mathfrak{K}^?)$	14
15	Indeed, the prohibition of catching and killing the species of hoopoe and swallow is an indication (<i>dalāla</i>) that the factor occasioning that prohibition is the same as that occasioning the prohibition of caging them. <i>z:</i> $(illa(x): \mathfrak{K})$ <i>z:</i> $(illa(x): \mathfrak{K}^*)$! 14	? 13, ! 16	Hence, given this and your endorsement of the <i>nazīr</i> -relation between both rulings, you should also endorse that it is forbidden to cage the species of hoopoe and swallow. $\mathfrak{K}(far')$?	16
17	I agree. The branch-case can be concluded as falling under ruling \mathfrak{K} . ! $\mathfrak{K}(far')$! 16	! 1	So, this provides the justification for the thesis you were asking for with your first move: it is forbidden to cage the species of hoopoe and swallow because of the prohibition of catching and killing them that you just endorsed.	18

					$dalāla^{\mathfrak{C}\text{-}na\mathfrak{z}\mathfrak{i}\mathfrak{r}\text{-}\mathfrak{C}^*} : \mathfrak{C}(far^{\text{'}})$
	<i>Ilzām</i>				

Structure of the argument

The argument developed by the Proponent using *qiyās al-dalāla* in order to argue that the species of hoopoe and swallow are forbidden to be caged, as described in the dialogue, takes the following structure:

The schema 6.4. The argument of *qiyās al-dalāla* in *Sabīl al-Muhtadīn*

Thesis $\mathfrak{C}(f)$: <i>the species of hoopoe and swallow are forbidden to cage.</i>
--	---

The branch-cases f : The species of hoopoe and swallow
The root-case a : The animal of *Harām* land
The shared ruling \mathfrak{C}^* : The prohibited killing
Inferred Ruling \mathfrak{C} : The prohibited caging
The set \mathfrak{D} : Animal

Argument:

- (1) $\mathfrak{C}(a\mathfrak{s}l)$ ($a\mathfrak{s}l : \mathfrak{D}$) : The ruling \mathfrak{C} applies to the root-case that is the subset of the set of animals.
- (2) $\mathfrak{C}^*(a\mathfrak{s}l)$ ($a\mathfrak{s}l : \mathfrak{D}$) : The ruling \mathfrak{C}^* applies to the root-case that is the subset of the set of animals.
- (3) $\mathfrak{C}^*(far^{\text{'}})$ ($far^{\text{'}} : \mathfrak{D}$) : The ruling \mathfrak{C}^* applies to the branch-case that is the subset of the set of animals.

Given these facts,

- (4) $(\forall x : \mathfrak{D}) \mathfrak{C}^*(x) \supset \mathfrak{C}(x)$: The rulings \mathfrak{C}^* and \mathfrak{C} that both apply to the set of animals are associated by *naẓīr*-relation,

- (4.1) $(\forall x: \mathcal{D}) \mathcal{K}^*(x) \supset \mathcal{K}(x)$: since the sources also provide evidence that if the ruling \mathcal{K}^* applies, then the ruling \mathcal{K} also does; (*tard*)
- (4.2) $(\forall x: \mathcal{D}) \neg \mathcal{K}^*(x) \supset \neg \mathcal{K}(x)$: and if the ruling \mathcal{K}^* does not apply, then neither does the ruling \mathcal{K} . (*'aks*)



(5) $\mathcal{K}(f)$: given (3) and *nazīr*-relationship between \mathcal{K}^* and \mathcal{K} , the branch-case f falls under the ruling \mathcal{K} .

The schema shows that the argument developed within this type of *qiyās dalāla* is established by pairing two rulings by means of which the application of the ruling under consideration can be inferred from the application of the other ruling which is considered its pair. The argument developed in this type of *qiyās* generally consists of three elements:

- i) Corresponding the root-case and the branch-case in relation to the ruling \mathcal{K}^* while indicating that this ruling and the ruling \mathcal{K} constitute a pair (*nazīrain*) since the two rulings involve the same underlying set. In the schema, it is presented by (1), (2) and (3) where “ $\mathcal{K}(a\text{ṣ}l)$ ($a\text{ṣ}l: \mathcal{D}$)”, “ $\mathcal{K}^*(a\text{ṣ}l)$ ($a\text{ṣ}l: \mathcal{D}$)” and “ $\mathcal{K}^*(far')$ ($far': \mathcal{D}$)” signify that \mathcal{K}^* and \mathcal{K} are two prohibitions applied to *an instance* of the set \mathcal{D} such that they would be a pair.
- ii) Generalising the pair relationship between the two rulings \mathcal{K}^* and \mathcal{K} . It is presented by (4) where “ $(\forall x: \mathcal{D}) \mathcal{K}^*(x) \supset \mathcal{K}(x)$ ” is the general rule established by the generalisation of the pair relationship between the rulings \mathcal{K}^* and \mathcal{K} . For this type of *qiyās*, the generalisation must be justified by the evidence provided by source cases (*shahada al-uṣūl*) confirming that if the ruling \mathcal{K}^* applies, then the ruling \mathcal{K} also does –presented at (4.1); and if the ruling \mathcal{K}^* does not apply, then neither does the ruling \mathcal{K} – presented at (4.2).

iii) Applying the general rule of the pair relationship between the rulings \mathcal{K}^* and \mathcal{K} . Given the fact that the ruling \mathcal{K}^* applies to the branch-case, according to the general rule, this provides evidence for the application of the ruling \mathcal{K} to the branch-case, expressed by $\mathcal{K}(f)$ at (5). If we want a more complete notation, it can be expressed by “*dalāla* ^{\mathcal{K} -*naẓīr*- \mathcal{K}^*} : $\mathcal{K}(f)$ ”, as in the dialogue, that signifies that the pair (*naẓīr*) relationship between \mathcal{K} and \mathcal{K}^* provides indication (*dalāla*) that both rulings are occasioned by the same factor (*‘illa*) such that, given \mathcal{K}^* applies to the branch-case, \mathcal{K} should also apply.

6.4.3. Example of *qiyās al-shabah*

The third condition is that soil which is used for *tayammum* (dry ablution)²² is not *musta‘mal*²³, that is, the soil that has been used for another *tayammum*, more precisely, the soil that is left on body parts of *tayammum*, or that has fallen from the body parts after being used for *tayammum*, even if it is taken from air, but there is a sign indicating that it has been touched by the body parts, as well as the soil that has been used for purifying an object contaminated by a heavy impurity (*najāsah mughallazah*).²⁴ Such soil can no longer be used for *tayammum*, because what is meant with pure (*tāhir*), or interpreted as good (*tayyiban*), is *tahūr* that means pure and purifying. As for the soil which is *musta‘mal*, although it is pure, it is not purifying. Thus, *tayammum*

(شرط یغ کتیک) بهو تیاد ادا تانه یغ اکن تیمم ایت مستعمل یعنی یغ سوده ترفاکی فد تیمم یائت یغ تشکل ای فد اغکوتا تیمم اتو یغ کوکور ای درفد اغکوتا کمین درفد ترسننه ای دغندی دان جک تیاد برفالغ ای درفد سکلیفون مک جک دامبلن اکن تانه ایت درفد هواء کمین درفد برچری ای درفد اغکوتان یغ ترسننه ای دغندی نسجای تیداله ممدای اکندی دان تانه یغ مستعمل فد منسوجیکن یغ کنا نحاسه مغلظة سفرة یغ مستعمل فد تیمم جو کارن یغدکهنداک دغن طاهر یغ فد تفسیر طیبیا ایت طهور ارتین یغ سوچ لاک مپیچیکن دان تانه یغ مستعمل ایت تیاد مپیچیکن دان جک ادا ای سوچ سکلیفون مک تیاد صح

²² It is dry ablution using a pure soil or the like.

²³ It literally means “being used”. The term refers to water or anything else that has already been used for an ablution and it can no longer be used for another ablution.

²⁴ It is the type of impurity which is considered as the severest, such as saliva of dog and pig. It is named as *mughallazah* since the body that is contaminated by such impurity must be washed seven times, one of which is with soil.

<p>using that soil is legally invalid, like ablution with a <i>musta'mal</i> water. Moreover, invalidity that is caused by <i>musta'mal</i> soil is severer than that is caused by <i>musta'mal</i> water, as the soil is more inferior than the water.</p>	<p>تیمم دغن تانه یغ مستعمل سفره تیاد صح وضوء دغن ایر یغ مستعمل تناف تانه یغ مستعمل ترلیه اتام دغن تیاد صح درفد ایر مستعمل کارن تانه یغ مستعمل اداله ای ترضعیف درفد ایر مستعمل</p>
<p>Question: if someone questions that, soil of <i>tayammum</i> does not remove <i>hadath</i>, consequently, it will not become <i>musta'mal</i> only because of the use that makes it inferior. It is different from the water that is used for ablution (i.e. the water does purify <i>hadath</i>).²⁵</p>	<p>(سؤال) جك دتیا اورغ بهوشن تانه تیمم ایت تیاد مغثکتکن ای اکن حدث مك تیاد ای جدی مستعمل یعنی دغن استعمال یغ منجدیکن ضعیف برسلاهن ایر یغ ترفاکی فد افما وضوء</p>
<p>Response: concerning the cause that results the using (i.e. that makes water <i>musta'mal</i> or not), it is nothing to do with removing <i>hadath</i>. In fact, the real cause is removal of what prevents us, for example, from performing prayers, for the reason that the water which is used for ablution by someone who has a continuous <i>hadath</i> becomes <i>musta'mal</i>, even though it does not remove <i>hadath</i>. Thus, soil should be similar to water.</p>	<p>(جواب) بهوشن سبب یغ مغحاصلکن استعمال ایت بوکن ای خصوص مغثکتکن حدث جوا هان سبب ایت هیلیغ تکه درفد افما سمبیغ دغن دلیل بهوشن ایر وضوء دار اورغیغ سننیاس حدث ایت مستعمل ای دغن استعمال یغ منجدیکندی ضعیف سرتا بهوشن تیاد ای مغثکتکن حدث مك برسمانله تانه دغن ایر²⁶</p>

General structure of the *qiyās*

For this example, *qiyās al-shabah* is employed for arguing that the soil already used for another *tayammum* or purification becomes the so-called *musta'mal*, so it can no longer be used for a novel *tayammum*. This *qiyās* involves attack and counterattack in

²⁵ Let us be clear on this issue. In fact, ablution in Islamic law should use a pure water. *Tayammum* (dry ablution) is an exception. It is performed in case of lack of pure water or the impossibility of using water due to an illness. *Tayammum* is valid only for one obligatory prayer, the same *tayammum* cannot be used for another obligatory prayer. So, we should perform this kind of ablution every time when we want to perform the obligatory prayers, because, unlike *wuḍū'* (standard ablution that uses water), it does not remove *hadath* (ritual impurity) though it authorises us to perform the prayer.

²⁶ Arsyad al-Banjari (n.d., vol. 1, pp. 124-125)

such a way that displays a dialectical argument. In general, the argument is grounded on analogy between that used soil [the branch-case (*far'*)] and the water that is already used for another ablution (*wuḍū'*) or purification [the root-case (*aṣl*)]. Let us describe it more explicit with the help of the following diagram:

The diagram 6.5. *Qiyās al-shabah* in *Sabīl al-Muhtadīn*

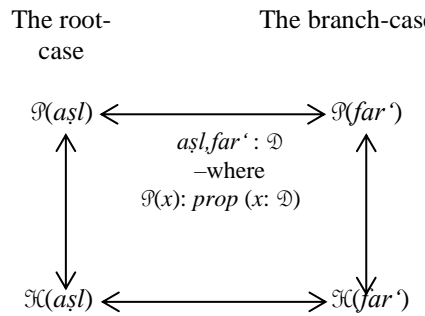

As the preceding example of correlational inference by resemblance in *Luqta al-‘Ajlān*, the extension of the ruling \mathfrak{K} that is applied to the root-case to the branch-case is achieved by establishing the unification of the root- and branch-cases in a common identity corresponding to the property \mathfrak{P} (horizontal relation), such that the ruling \mathfrak{K} that is in correlation with the property \mathfrak{P} in the root-case (vertical link) should be in correlation too with the property \mathfrak{P} in the branch-case. This is expressed by the following notation:

$$a \approx_{\mathfrak{P}} f$$

More explicitly, in our case, it says that the root-case and the branch-case have a common identity corresponding to the fact that they both are substances for purification that have been used for another purification by means of which performing any worship are authorised (the property \mathfrak{P}). Since in the root-case that state of *having been used for another purification* is in correlation with the state of being *musta‘mal* (the ruling \mathfrak{K}), there must be the same correlation in the branch-case. In other words, the branch-case,

the soil already used for another purification, is musta‘mal and can no longer be used for a novel tayammum, for its having been used for another purification.

Attack and counterattack

As already said, the deployment of *qiyās al-shabah* in developing the argument for the invalidity of using the soil already used for another purification involves attack and counterattack. The attack and counterattack take two forms of objection (*i‘tirāḍ*), namely:

- 1) ***Farq* (invalidating distinction)**. In this form of objection, one of contenders, let us say the Questioner (*Sā‘il*), brings forward a specific property that distinguishes the root-case and the branch-case in relation to the ruling at stake, despite the fact that they both share some general property. For *qiyās al-shabah*, the point of this form of objection is to assume that what is in correlation with the ruling under consideration is *the specific property* brought forward by the Questioner, not the general property.
- 2) ***Naqd* (inconsistency)**. In this form of objection, the Questioner brings forward another source-case to which the ruling under consideration does not apply, despite the fact that the new source-case enjoys the property that is claimed by the contender in correlation with the ruling at stake. Thus, this invalidates the correlation between the property and the ruling at stake as claimed by the contender.

The first form of objection, *farq*, is launched by Opponent in order to attack the argument of the Proponent. The attack is established on the fact that the root-case and the branch-case are different with regard to the fact that the former removes *ḥadath*, on the other hand, the latter does not. The main claim of the Opponent is that the distinction with regard to this specific property, removing *ḥadath* (call this aspect the property \mathfrak{P}^*), should lead to the distinction in relation to the state of being *musta‘mal* (the ruling \mathfrak{C}). In other words, the Opponent assumes that what is actually in correlation

with the ruling \mathfrak{K} is the property \mathfrak{P}^* , not \mathfrak{P} . Thus, in spite of sharing the general property \mathfrak{P} , that is, *the state of being used for purifications*, the root-case and the branch-case cannot be seen being equal in relation to the ruling \mathfrak{K} because, different from the root-case, the branch-case does not enjoy the specific property \mathfrak{P}^* . Therefore, the branch-case does not become *musta‘mal* and can still be used for purification.

Using the *naqd*-form of objection, the Proponent counterattacks the Opponent’s claim that associates the state of being *musta‘mal* (the ruling \mathfrak{K}) with the aspect of removing *hadath* (property \mathfrak{P}^*). For this, the Proponent brings forward the case of water having been used by a person in a continuous state of *hadath* (ritual impurity); let us call this aspect the counter-case (*asl**). Such water is considered by the source being *musta‘mal* (\mathfrak{K}) despite the fact that it does not remove *hadath* ($\neg\mathfrak{P}$). Subsequently, this forces the Opponent to concede the contrary of his own earlier claim, that is, the distinction with regard to the specific property \mathfrak{P}^* , should not lead to the distinction in relation to the ruling \mathfrak{K} because the counter-case provides evidence that there is no correlation between the property \mathfrak{P}^* and the ruling \mathfrak{K} . By doing so, the Opponent becomes inconsistent so that it invalidates his earlier claim. Finally, the Proponent succeeds in defending the argument that the soil already used for another *tayammum* or purification can no longer be used for a different purification because it becomes *musta‘mal*.

Dialogue for the *qiyās*

The table 6.5. Dialogue for *qiyās al-shabah* in *Sabīl al-Muhtadīn*

O		P	
	response	response	<p>The soil already used for another <i>tayammum</i> or purification is <i>musta‘mal</i> (no longer allowed to use for purification).</p> <p>! $\mathfrak{K}(far')$</p>

1	Why? What is the <i>illa</i> ?	? 0	ı̇1, ı̇! 2	The water already used for another <i>wuḍū'</i> or purification is <i>musta'mal</i> , isn't it?	2
	<i>illa</i> ?			$\mathfrak{C}(a\mathfrak{s}l)$?	
3	Yes, it is. ! $\mathfrak{C}(a\mathfrak{s}l)$! 2	ı̇3, ı̇! 4	Such soil (let us call it the used soil) and such water (let us call it the used water) can be seen as being equal in relation to the state of being <i>musta'mal</i> . Right?	4
				$a \approx_{\mathfrak{P}} f$?	
5	Justify! <i>muḥālaba</i> !	? 4	ı̇ 5, ı̇! 6	The used water has been used for purification by means of which performing any worship are authorised. Is that right?	6
				$\mathfrak{P}(a\mathfrak{s}l)$?	
7	Yes, it is. ! $\mathfrak{P}(a\mathfrak{s}l)$! 6	ı̇ 7, ı̇! 8	The used soil has been used for purification that authorizes the performance of religious worship. Is it right?	8
				$\mathfrak{P}(far')$?	
9	Indeed. ! $\mathfrak{P}(far')$! 8	ı̇ 9, ı̇! 10	According to these endorsements it seems reasonable to consider them identical in relation to \mathfrak{P} such that they should also be similar in relation to the ruling \mathfrak{C} . Do you agree?	10
				Given: <i>you(7)</i> : $\mathfrak{P}(a\mathfrak{s}l)$ <i>you(9)</i> : $\mathfrak{P}(far')$ $a \approx_{\mathfrak{P}} f$?	
11	(<i>Farq-objection</i>) No, I do not agree. The used soil must be distinguished from the used water in relation to the	? 10	? 11	Justify! <i>muḥālaba</i> !	12

	<p>ruling \mathfrak{K}, since they are different with regard to the property \mathcal{P}^* which I assume the real property being in correlation with the ruling \mathfrak{K}.</p> <p>$! \forall a \not\approx_{\mathcal{P}^*} f$</p>				
	START OF THE SUB-PLAY 1			START OF THE SUB-PLAY 1	
13	<p>The used water removes <i>ḥadath</i>, doesn't it?</p> <p>$\mathcal{P}^*(a\mathfrak{s}l)$?</p> <p>note: \mathcal{P}^* induces a subset in \mathcal{P}, namely, the set "all those instances of \mathcal{P}. that satisfy \mathcal{P}^*".</p>	\mathfrak{c} 12, \mathfrak{c} ! 13	$!$ 13	<p>Yes, it does.</p> <p>$! \mathcal{P}^*(a\mathfrak{s}l)$</p>	14
15	<p>The used soil does not remove <i>ḥadath</i>. Is that right?</p> <p>$\neg \mathcal{P}^*(far')$?</p>	\mathfrak{c} 14, \mathfrak{c} ! 15	$!$ 15	<p>Yes, it is.</p> <p>$! \neg \mathcal{P}^*(far')$</p>	16
17	<p>According to the distinction between the used water and the used soil with regard to the property \mathcal{P}^*, it seems reasonable to distinguish them in relation to the ruling \mathfrak{K}. Do you agree?</p> <p>Given: <i>you(14)</i>: $\mathcal{P}^*(a\mathfrak{s}l)$ <i>you(16)</i>: $\neg \mathcal{P}^*(far')$ $a \not\approx_{\mathcal{P}^*} f$?</p>	\mathfrak{c} 16, \mathfrak{c} ! 17	$?$ 17	<p><i>(Naqd-objection)</i> No, I do not agree. I have a counterexample to your assertion that the distinction with regard to the property \mathcal{P}^* leads to the distinction in relation to the ruling \mathfrak{K}.</p> <p>$! \mathbf{F} a \not\approx_{\mathcal{P}^*} f$</p>	18
	START OF THE SUB-PLAY 2			START OF THE SUB-PLAY 2	
19	<p>Still I stick the following assertion: the distinction in relation to the property \mathcal{P}^* leads to the distinction in relation to the ruling \mathfrak{K}.</p> <p>$! a \not\approx_{\mathcal{P}^*} f$</p>	$?$ 18	\mathfrak{c} 19, \mathfrak{c} ! 20	<p>The water having been used by a person in a continuous state of <i>ḥadath</i> is <i>musta'mal</i>. Is that right?</p> <p>$\mathfrak{K}(a\mathfrak{s}l^*)$?</p>	20

21	Yes, it is. ! $\mathfrak{K}(a\text{ṣ}l^*)$! 20	! 21, ! 22	Such water does not remove <i>ḥadath</i> . Is that right? $\neg \mathfrak{P}^*(a\text{ṣ}l^*) ?$	22
23	Yes, it is. ! $\neg \mathfrak{P}^*(a\text{ṣ}l^*)$! 22	! 23, ! 24	According to the assertions 3, 14, 21 and 23, the distinction in relation to the property \mathfrak{P}^* does not lead to the distinction in relation to the ruling \mathfrak{K} . In other words, there is no correlation between the property \mathfrak{P}^* and the ruling \mathfrak{K} . Given: (3): ! $\mathfrak{K}(a\text{ṣ}l)$ (14): ! $\mathfrak{P}^*(a\text{ṣ}l)$ (21): ! $\mathfrak{K}(a\text{ṣ}l^*)$ (23): ! $\neg \mathfrak{P}^*(a\text{ṣ}l^*)$ $\neg(a \not\approx_{\mathfrak{P}^*} a^*) ?$	24
25	Given those assertions, I concede that the distinction with regard to the property \mathfrak{P}^* does not lead to the distinction in relation to the ruling \mathfrak{K} because there is no correlation between the property \mathfrak{P}^* and the ruling \mathfrak{K} . ! $\neg(a \not\approx_{\mathfrak{P}^*} a^*)$! 24	? 25	<i>Tanāquḍ</i> 19-25. Before, you asserted that the distinction in relation to the property \mathfrak{P}^* leads to the distinction in relation to the ruling \mathfrak{K} . Now, you contradict yourself.	26
	END OF THE SUB-PLAY			END OF THE SUB-PLAY	
27	Well, I made mistake. Now, I concede your previous request. ! $a \approx_{\mathfrak{P}} f$! 10	! 27, ! 28	If it is the case, and given 3 that the water already used for another <i>wuḍū'</i> or purification is <i>musta'mal</i> , should not the soil already used for another <i>tayammum</i> or purification be <i>musta'mal</i> ? $\mathfrak{K}(a\text{ṣ}l/\text{far}')$?	28

29	Indeed, according to their resemblance, the state of being <i>musta‘mal</i> of the used water yields its analogous state of being <i>musta‘mal</i> for the used soil. ! $\mathfrak{K}(\text{far}')$! 28	! 1	So, this provides the justification for the thesis you were asking for with your first move: the soil already used for another <i>tayammum</i> or purification is <i>musta‘mal</i> because it is analogous to the state of being <i>musta‘mal</i> of the used water, based on their resemblance in relation to the property \mathfrak{P} . ! <i>shabah</i> $\mathfrak{P} \text{---} a \text{---} f \text{---} \mathfrak{K} : \mathfrak{K}(\text{far}')$	30
	<i>Ilzām</i>				

Structure of the arguments

The argument developed by the Proponent using *qiyās al-shabah* in order to argue that the soil already used for another *tayammum* or purification is *musta‘mal* (no longer allowed to use for purification) can be structured as follows:

The schema 6.5. The argument of *qiyās al-shabah* in *Sabīl al-Muhtadīn*

Thesis $\mathfrak{K}(\text{far}')$: The soil already used for another <i>tayammum</i> or purification is <i>musta‘mal</i> (no longer allowed to use for purification).
--	--

The branch-cases (*far'*) : The soil already used for another *tayammum* or purification
The root-case (*aṣl*) : The water already used for another *wuḍū'* (ablution) or purification
The shared property \mathfrak{P} : having been used for the purification that authorizes the performance of religious worship
Inferred Ruling \mathfrak{K} : *musta‘mal* (no longer allowed to use for purification)
The set \mathfrak{D} : substances for purification

Argument:

(1) $\mathfrak{K}(\text{aṣl})$: The ruling \mathfrak{K} applies to the root-case

- (2) $\mathcal{P}(a\mathcal{S}l)$ ($a\mathcal{S}l: \mathcal{D}$) : The root-case enjoys the property \mathcal{P}
- (3) $\mathcal{P}(far')$ ($far': \mathcal{D}$) : The branch-case enjoys the property \mathcal{P}

Given these facts,

- (4) $a \approx_{\mathcal{P}} f$
 –where
 $\mathcal{P}(x)prop (x: \mathcal{D})$: the root-case and the branch-case are identical in relation to the property \mathcal{P} which is specific to the set \mathcal{D} where the two cases are in common, such that the ruling \mathcal{K} that is in correlation with the property \mathcal{P} in the root-case should be in correlation too with the property \mathcal{P} in the branch-case.



- (5) $\mathcal{K}(far')$: Hence,
 : the application of the ruling \mathcal{K} to the root-case, at number (1), should be extended to the branch-case, so we conclude that the ruling \mathcal{K} applies to the branch-case.

At this point, the structure of the argument in this *qiyās* is the same as in the *qiyās al-shabah* in *Luqta al-'Ajlān*. However, as described in the dialogue, the Opponent attacks the argument by launching the *farq*-objection that distinguishes the root-case and the branch-case in relation to the ruling \mathcal{K} based on their difference with regard to the specific property \mathcal{P}^* .



The Opponent's <i>farq</i> (distinction)	: <i>The soil already used for another tayammum or purification is different to the water already used for another wuḍū' (ablution) or purification.</i>
---	--

The Opponent's thesis : The distinction in relation to the specific property \mathcal{P}^* leads to the distinction in relation to the ruling \mathcal{K}

The distinctive property \mathcal{P}^* : Removing *ḥadath* (ritual impurity).

note:

\mathcal{P}^* induces a subset in \mathcal{P} , namely, the set “all those instances of \mathcal{P} , that satisfy \mathcal{P}^* ”.

- (1) $\mathfrak{K}(a\mathfrak{s}l)$: The ruling \mathfrak{K} applies to the root-case
- (2) $\mathfrak{P}^*(a\mathfrak{s}l)$ ($a\mathfrak{s}l: \mathfrak{D}$) : The root-case enjoys the property \mathfrak{P}^*
- (3) $\neg\mathfrak{P}^*(far')$ ($far': \mathfrak{D}$) : The branch-case does not enjoy the property \mathfrak{P}^*

Given these facts,

- (4) $a \not\approx_{\mathfrak{P}^*} f$: the root-case is different to the branch-case f in relation to the property \mathfrak{P}^* such that the root-case and the branch-case should be distinguished in relation to the ruling \mathfrak{K} , because of its correlation with the property \mathfrak{P}^* .



Hence,

- (5) $\neg\mathfrak{K}(far')$: The ruling \mathfrak{K} does not apply to the branch-case.
-

The Proponent then counters the objection made by the Opponent by bringing forward the counter-case ($a\mathfrak{s}l^*$) where the ruling \mathfrak{K} applies despite the absence of the property \mathfrak{P}^* . In other words, the $a\mathfrak{s}l^*$ is an antithesis (*naqīd*) of the Opponent's claim that the ruling \mathfrak{K} is in correlation with the property \mathfrak{P}^* . The proponent's *naqd* for the Opponent's *farq* can be schematized as follows:



The Proponent's <i>naqd</i>	: <i>The claim that the distinction in relation to the specific property \mathfrak{P}^* leads to the distinction in relation to the ruling \mathfrak{K} is invalid.</i>
------------------------------------	---

The Proponent's thesis : The distinction in relation to the specific property \mathfrak{P}^* does not lead to the distinction in relation to the ruling \mathfrak{K}

The counter-case ($a\mathfrak{s}l^*$) : The water that has been used by a person in a continuous state of *hadath* (ritual impurity).

- (1) $\mathfrak{K}(a\mathfrak{s}l)$: The ruling \mathfrak{K} applies to the root-case
- (2) $\mathfrak{K}(a\mathfrak{s}l^*)$: The ruling \mathfrak{K} applies to the counter-case
- (3) $\mathfrak{P}^*(a\mathfrak{s}l)$ ($a\mathfrak{s}l: \mathfrak{D}$) : The root-case enjoys the property \mathfrak{P}^*

(4) $\neg\mathcal{P}^*(a\mathcal{S}l^*) (a\mathcal{S}l^*: \mathcal{D})$: The counter-case does not enjoy the property \mathcal{P}^*

Given these facts,

(5) $\neg(a \not\approx_{\mathcal{P}^*} a^*)$: The distinction in relation to the specific property \mathcal{P}^* does not lead to the distinction in relation to the ruling \mathcal{H} .

By using *naqd* to counterattack the Opponent's *farq*, the Proponent forces the Opponent to concede that the distinction in relation to the property \mathcal{P}^* should not lead to the distinction in relation to the ruling \mathcal{H} , however, this is in contrary with his earlier claim. So, the Opponent becomes inconsistent and the claim that the distinction with regard to property \mathcal{P}^* leads to the distinction in relation to the ruling \mathcal{H} is made invalid. Finally, the Proponent succeeds in defending the argument that the soil already used for another *tayammum* or purification can no longer be used for a different purification because it becomes *musta'mal*.

6.4.4. Two non-canonical forms of *qiyās*

As already mentioned, there are two non-canonical forms of *qiyās* applied in *Sabīl al-Muhtadīn*. What these two forms of *qiyās* have in common is that, unlike the three canonical forms, they are based not in a set of common properties or rulings, but merely on a symmetrical structure. What distinguishes one form to the other, let us call them respectively type A and type B, is that the former reflects some structure in the root-case to the branch-case, while the latter involves parallel cases of the root- and branch-cases by means of which the structure linking the root-case and its parallel is replicated to the branch-case and its parallel.

These two types of *qiyās*, as marked by the term “non-canonical”, are applied not in order to establish legal decisions for new cases or circumstances, but purely in order to grasp rationality behind the application of rulings that are already confirmed. To our knowledge, these two non-canonical forms of *qiyās* are not discussed in Islamic

jurisprudence in a theoretical way. The theory of these two forms of *qiyās* thus cannot be traced in some masterpieces of *uṣūl fiqh* such as the ones of al-Shīrāzī and al-Ghazālī. Be that as it may, they were put into practice by some Shāfi‘ī scholars. So, Arsyad al-Banjari actually inherited the practice of these two forms of parallel reasoning from Shāfi‘ī school of law. Despite that fact, this shows that *qiyās* takes a significant part in Arsyad al-Banjari’s approach to rationality, particularly when it comes to rationalizing applications of juridical rulings.

6.4.4.1. Non-canonical *qiyās* type A

Two example cases are provided for this type of non-canonical *qiyās* in *Sabīl al-Muhtadīn*, namely the case of sleeping and that of vinegar, but even so, we will focus more on the first case in order to provide a clear account of the structure of this type of parallel reasoning.

The text on sleeping

This is due to the fact that sleep and the conditions associated to it (i.e. mental illness, apoplexy, drunkenness) are the most likely place (in Malay: *tempat zann*) for a thing to come out of the anus without feeling because of loss of consciousness. Then, it is determined that, in such conditions, indeed a thing does come out of the anus in such a way that loss of consciousness (i.e. the condition that constitutes loss of consciousness such as sleep) is established as one of causes of ritual impurity that invalidates ablution, even though during the time of loss of consciousness nothing comes out of the anus. It follows the well-known legal principle (*qā‘idah*) that says: (*inna mā nīṭa bi al-mazīnah lā farqa baina*

(برمول) کپتائش یغدمکین ایت کارن بهوسش تیدر دان برغیغدهوبغکن دغندي سکلین ایت تمفت ظن بک کلور سوات درفد دبرن فدحال تیاد کراسائش کارن هیلغ عقلن مک ددیریکن ظن اکن کلور سوات درفدان فد کتیک ایت فد تمفت یقین اکن کلورن هتک دجدیکن دیرین هیلغ عقل دغن سالا سوات درفد یغترسبت ایت سبب حدث یغ مبطلکن وضوء دان جک تیاد کلور سوات درفد دبرن فد کتیک ایت سکلیفون کارن مغلکین قاعدة یغته مشهور (ان ما نیط بالمظنة لا فرق بین وجوده و عدمه) یغنی بهوسش برغیغدفرتمتکن دغن تمفت ظن ایت تیاد بیزا اتار اداش دان تیادش

<p><i>wujūdihi wa ‘adamihi</i>), that means “what is associated with the most likely place (i.e. what is likely to happen in a state) is not different between its presence and absence.”</p>	
<p>That is similar to the hardship in a travel. Since the hardship is likely to happen in a travel, so it is established that indeed it does happen. It is hence permissible while traveling to break the obligatory fasting of Ramaḍān and to shorten (<i>qasr</i>) the prayers even though the hardship might be absent while traveling. So are sleep and the conditions associated to it.</p>	<p>مک بندغ یغدمکین ایت سفره مشقه ددالم سفر کو اداله سفر ایت تمفت ظن بک ادا مشقه فد غالب مک ددیریکن ظن اکن ادا مشقه ددالم سفر فد تمفت یقین اکن ادا هغک افبیل دفراوله سفر نسچای دهارسکن دالم بربوک فواس فرض رمضان فد سیغ هاری دان مقتصر سمبیه دان برغسباکین دان جک تیاد ادا مشقه سکلیفون مک سفره دمکین ایتوله تیدر دان برغیغ دهبوغکن دغندی²⁷</p>

The text on vinegar

<p>However, if the substance is impure (i.e. the substance being added into juice while producing vinegar is impure), then the vinegar is not pure even if that substance is taken out before it turns into vinegar. Some jurists say that this is due to hastening the process of obtaining what is intended by performing the prohibition, so it is punished with being prevented from obtaining what is intended. It is similar to the one who kills his relative with the intention to inherit the property of the victim, in this case the</p>	<p>(أدافون) جک ادا عین ایت نجس مک تیداله چوک ایت سوچ دان جک دکلورکن عین نجس ایت درفدان دهول درفدان جدی چوک سکلیفون (دان کتا) ستغه علماء بهوسن علة یغدمکین ایت کارن بهوسن میکراکن ای کفد معجاصلکن مقصودن دغن بریوة یغ دحرامکن مک دشکسا ای دغن دتکهکن ای درفد ممفراوله مقصودن اداله بندغن سفره ممبونه سورغ اکن اورغ یغ دوارثین اگندی سفیا سکرا موارث ای اکن ارتاٹ مک دشکسا</p>
---	--

²⁷ See Arsyad al-Banjari (n.d., vol. 1, pp. 94-95)

<p>killer is hindered to inherit from the victim. Thus, it is said: (<i>man ista'jala shay'an qabla 'awānihi 'ūqiba biḥirmānihi</i>). It means: “whoever has hastened to get something prematurely is punished with being prevented from it”.</p>	<p>اي دغن دتکه کن درفد موارثدي مک درکارن اینله دکنا (من استعجل شيئاً قبل اوانه عوقب بحرمانه) اړتین برغسیاف میکران سوات دهول درفد وقتون دشکساله اي دغن منکهکندي درفدان²⁸</p>
---	--

General structure of the *qiyās*

In fact, the first text that we are focusing more on is an integral part of that discussed in Sect. 6.4.1 concerning *qiyās al-'illa* in *Sabīlal-Muhtadīn*. Recall, sleeping invalidates ablution, as confirmed by juridical source, because in such condition it is most likely that something comes out of the anus without feeling due to loss of consciousness. Something coming out of the anus (hereinafter called “something coming out”) indeed invalidates ablution, but one might question, why sleep invalidates ablution, whereas we cannot ensure that something comes out during sleeping. So, it is rather to legally rationalize that sleep invalidates ablution.

The rationalization starts with a heuristic move by means of which a suitable root-case is proposed. In this case, the ruling that travelling excuses to not perform the obligatory fasting and to shorten the obligatory prayers is brought forward as the root-case. The reason is, as indicated in the text, because hardship that excuses those acts is most likely to happen in a travel. So, either hardship is present or absent, the travelling allows to not perform the obligatory fasting and to shorten the obligatory prayers.

If we use the technical terms of *qiyās* theory, the root-case (the travel) is most likely to bring about some property (*wasf*), that is, hardship. Furthermore, that property is the factor occasioning (*'illa*) the ruling (*ḥukm*) of the permission to break the fasting and to shorten the prayers. So, let us formulate that formation by the following notation:

$$a\text{ṣl}: P\mathbb{Q} . (x: \mathbb{Q}) \mathbb{Q}(x)$$

Assuming

the superscript of the letter *P* indicates the more probability;

²⁸ See Arsyad al-Banjari (n.d., vol. 1, p. 40)

\mathcal{Q} : hardship; and
 \mathcal{A} : the permission to not perform the fasting and to shorten the prayers;
 then, the notation can be glossed, “*the root-case is most likely to instantiate hardship, whereas the one that instantiates hardship authorises to break the fasting and to shorten the prayers.*”

The similar formation belongs to the branch-case (sleeping). The branch-case is most likely to bring about some property, that is, something coming out that constitutes the factor occasioning the invalidation of ablution. Following the notation before, this formation can be expressed by:

$$far': {}^P\mathcal{R} . (x: \mathcal{R}) \mathcal{B}(x)$$

Assuming
 \mathcal{R} : something coming out; and
 \mathcal{B} : the invalidation of ablution;
 then, the notation can be glossed, “*the branch-case is most likely to instantiate something coming out, whereas the one that instantiates something coming out invalidates ablution.*”

Now, the formation that belongs to the root-case is followed by the application of the ruling \mathcal{A} to the root-case, $\mathcal{A}(a\mathcal{S}l)$. Then, it seems rational that the formation that belongs to the branch-case is also followed by the application of the ruling \mathcal{B} to the branch-case, $\mathcal{B}(far')$. For a clear description, let us set them in the schematic diagram as follows:

The diagram 6.6. Non-canonical *qiyās* type A

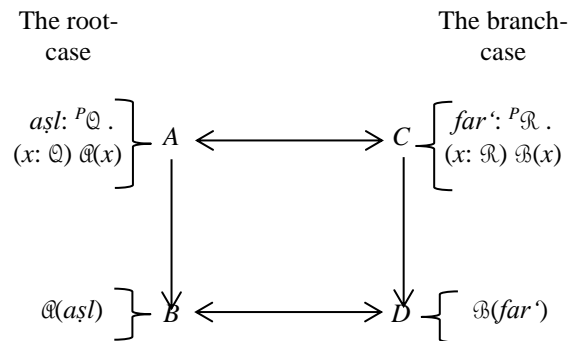

Notice, the root-case and the branch-case do not have common property and ruling as in the canonical *qiyās*. In the horizontal relation, the properties \mathcal{Q} and \mathcal{R} , as well as the rulings \mathcal{A} and \mathcal{B} , are not the same, nor even similar. What they have in common is the formal structure that configures each of their properties and rulings.²⁹ More precisely, the configuration of the property \mathcal{Q} and the ruling \mathcal{A} in formation A of the root-case is the same as that of the property \mathcal{R} and the ruling \mathcal{B} in formation C of the branch-case.

Again, in the root-case, A is followed by B , so it seems plausible that in the branch-case, C is also followed by D . However, there must be some rationale connecting the formation in the upper part (A/C) and that in the lower part (B/D) by means of which D can be inferred from C . To that end, we must establish a general rule based on the association between A and B in the root-case. If we delve into the structure connecting the formation A , namely $a\mathcal{S}l: {}^P\mathcal{Q} . \mathcal{A}(x) (x: \mathcal{Q})$, to the formation B , namely $\mathcal{A}(a)$, it is evident that the association of A to B assumes that

$$\begin{aligned} & {}^P\mathcal{Q} \text{ is equal to } \mathcal{Q} \\ & ({}^P\mathcal{Q} = \mathcal{Q}). \end{aligned}$$

In plain words, the association of A to B assumes that there is no difference between what is likely to enjoy some property and what does enjoy that property. This is exactly what is said by legal principle (*qā'idah*) quoted by Arsyad al-Banjari: “*inna mā nīṭa bi al-mazinnah lā farqa baina wujūdihi wa 'adamihī*”, that in general means, “what is likely to be present is not different between its presence and absence.” So, if we use CTT, the general rule made from the association of A to B , can be formulated as follows:

$$\begin{aligned} & (\forall x: \mathcal{P} \vee {}^P\mathcal{P}) [(\forall y: \mathcal{P}) L^\vee = \{P\}x \supset \mathfrak{H}(y)] \wedge [(\forall z: {}^P\mathcal{P}) R^\vee = \{P\}x \supset \mathfrak{H}(z)] \\ & \text{whereby } \{P\} \text{ is short-form for the hypothesis } \mathcal{P} \vee {}^P\mathcal{P}. \end{aligned}$$

It can be glossed, “in case that all those that does instantiate some property, saying \mathcal{P} (the left side of the disjunction occurs) fall under some ruling, saying

²⁹ This is a kind of parallel reasoning that is developed typically in science and mathematics. It is called *formal analogy* that is contrasted with *material analogy*. See Hesse (1966, pp. 68-69) and Bartha (2010, pp. 207-210).

∩; then all those that are likely to instantiate that property (the right side of the disjunction occurs) fall under the same ruling.”

Let us call this general rule as $qā'idah^{P\mathcal{P}}$. Now, given the fact that it is most likely that something comes out of the anus while sleeping, where something coming out does invalidate ablution, [far' : $P\mathcal{R} \cdot \mathcal{B}(x) (x: \mathcal{R})$], if we apply the $qā'idah^{P\mathcal{P}}$, then we can conclude that sleep invalidates ablution [$\mathcal{B}(far')$].

$$ap(far': qā'idah^{P\mathcal{P}}): \mathcal{B}(far')$$

In other words, the equality between \mathcal{R} and $P\mathcal{R}$, where the one that instantiates \mathcal{R} falls under the ruling \mathcal{B} , justifies that the ruling \mathcal{B} applies to the branch-case (far') that instantiates $P\mathcal{R}$. The justification of the application of the ruling \mathcal{B} to the branch-case can be written:

$$\mathcal{R} = P\mathcal{R} \mathcal{B}(x) (x: \mathcal{R}): \mathcal{B}^{P\mathcal{R}}(far')$$

However, we should notice that in Islamic jurisprudence it is not the standard justification for the ruling that sleeping invalidates ablution. It can be considered as a non-canonical justification for that ruling, since, as discussed in the section 5.4.1, the canonical justification is actually the fact that sleeping instantiates *loss of consciousness* and *possibility of coming out* that constitute the occasioning factor of that ruling. This canonical justification, if we follow the notation used in this section, can be written:

$$'illa(far'): \mathcal{B}^{\mathcal{P}}(far')$$

Assuming

\mathcal{P} : *loss of consciousness* and *possibility of coming out*.

Now, let us compare this case briefly with the second case as described by the second text without, for the present, providing a formalization. The second case deals with the purity of the vinegar. Notice, the terms “pure” and “impure” mean legally pure and impure according to Islamic law that refer to the terms “*tāhir*” and “*najis*”. As stated in the text, the vinegar that is produced by adding an impure substance with the intention of accelerating the process of the production is impure (*najis*), even though,

vinegar is basically pure (*tāhir*). For example, the vinegar from the fruit juice that is produced by adding wine into the juice, according to Shāfi‘ī school to which Arsyad al-Banjari belonged, is impure based on hermeneutic reading of some prophetic tradition. Wine is indeed impure due to intoxicating, but one might question, why such vinegar is considered impure, whereas the wine has turned together with the juice into vinegar, and the intoxicating nature that renders wine impure has been disappeared. To answer this question, the parallel case is brought forward, that is, the case of parricide because of inheritance. Basically, someone obtains the inheritance from his relative who has been died. However, if he murders his relative with the aim of obtaining the inheritance from the victim, he will not obtain the inheritance. These two cases are unified, as pointed out in the text, by the following general rule:

“*Man ista’jala shay’an qabla ’awānihi ’uqiba biḥirmānihi.*”

It means: “whoever has been hastened to get something prematurely is punished with being prevented from it.”

Let us see the following schema:

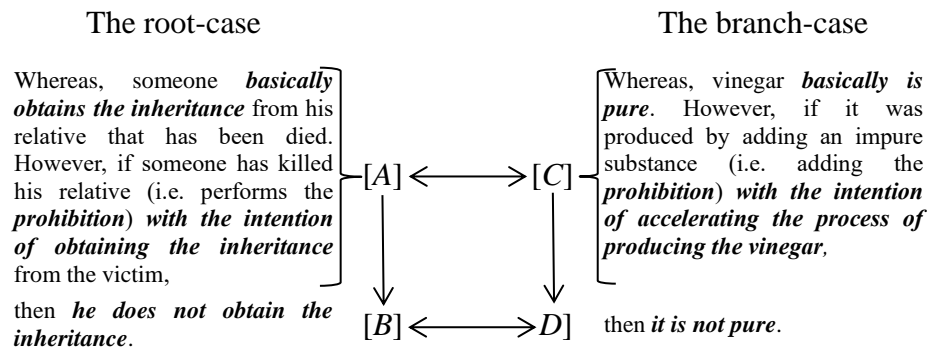

Similar to the case of sleeping, the root-case and the branch-case do not have common property and ruling. See the difference between “*obtaining the inheritance*” and “*being pure*”; and “performing the *prohibition with the intention of obtaining the inheritance*” and “adding the *prohibition with the intention of accelerating the process of producing the vinegar*”. Nevertheless, the root-case and the branch-case share a similar formation. The formation A in the root-case resembles the formation C in the branch-case. Therefore, the association of A to B in the root-case is the same as

that of *C to D* in the branch-case, because they both articulate the general rule we just mentioned. Roughly speaking, that general rule justifies the impurity of such vinegar. However, in Islamic jurisprudence, it is the non-canonical justification, while hermeneutic reading of some prophetic traditions is the canonical one.

Dialogue for the *qiyās*

The dialogue for the non-canonical *qiyās* follows in general the dialogical framework that is developed in the previous chapter. However, we should clarify that this *qiyās* applied not for legal decision making but rather for the rationalization of the ruling, so we include the standard justification of the ruling (canonical justification) in the beginning of the dialogue. Moreover, in order to emphasize that the non-canonical *qiyās* particularly deals with the coherence of ruling, it is indicated by the subscript *C*. For example, in the following dialogue it is written $\mathfrak{B}_C(\textit{far}')$ to stress the coherence of the ruling \mathfrak{B} for the branch-case.

The table 6.6. Dialogue for non-canonical *qiyās* type A

O		P			
		response	response	Sleeping invalidates ablution. ! $\mathfrak{B}(\textit{far}')$	0
1	Indeed, as discussed previously, according to the source it is because in such condition something is likely to come out of anus without feeling due to loss of consciousness. <i>'illa(far')</i> : $\mathfrak{B}_S(\textit{far}')$ Assuming	! 0	? 1	It is true, that is the factor occasioning the ruling. Yet, one might question why sleeping invalidates ablution, whereas it cannot be warranted that something coming out of the anus that invalidates ablution happens while sleeping. So, it deals with the coherence of this ruling. ! $\mathfrak{B}_C(\textit{far}')$	2

	<p>\mathcal{P}: <i>loss of consciousness and possibility of coming out.</i></p> <p>Recall \mathcal{S} indicates that the relevance of the property \mathcal{P} to the ruling \mathcal{B} is provided by juridical source.</p>				
3	<p>Ok. Now, show the coherence!</p> <p><i>Reason?</i></p>	? 2(0)	$\mathcal{I}3, \mathcal{I}! 4$	<p>Travelling allows to not perform the obligatory fasting and to shorten the obligatory prayers. Is that right?</p> <p>$\mathcal{A}(a\mathcal{S}l) ?$</p>	4
5	<p>Yes, it is.</p> <p>$! \mathcal{A}(a\mathcal{S}l)$</p>	! 4	$\mathcal{I}5, \mathcal{I}! 6$	<p>The ruling that sleeping invalidates ablution is structurally similar to the ruling that travelling allows to not perform the obligatory fasting and to shorten the obligatory prayers.</p> <p>$\mathcal{A}(a\mathcal{S}l) \approx \mathcal{B}(far')$</p>	6
7	<p>Justify!</p> <p><i>muṭālabā !</i></p>	? 6	$\mathcal{I} 7, \mathcal{I}! 8$	<p>It is hardship that allows to not perform the obligatory fasting and to shorten the obligatory prayers. However, hardship is most likely to occur while travelling. Right?</p> <p>$a\mathcal{S}l: {}^P\mathcal{Q} . \mathcal{A}(x) (x: \mathcal{Q})?$</p>	8
9	<p>Yes, it is.</p> <p>$! a\mathcal{S}l: {}^P\mathcal{Q} . \mathcal{A}(x) (x: \mathcal{Q})$</p>	! 8	$\mathcal{I} 9(5), ! 10$	<p>According to your endorsements, it is evident that what is most likely to enjoy hardship is assumed really enjoying hardship. Do you agree?</p> <p>Given: $you(5): ! \mathcal{A}(a\mathcal{S}l)$ $you(9): ! a\mathcal{S}l: {}^P\mathcal{Q} . \mathcal{A}(x) (x: \mathcal{Q})$ ${}^P\mathcal{Q} = \mathcal{Q} ?$</p>	10

11	<p>Indeed.</p> <p>$!^P Q = Q$</p>	! 10	<p>¿ 11, ¿! 12</p>	<p>If it is the case, then it assumes that there is no difference between what is likely to enjoy some property and what does enjoy that property, as the legal principle that says: “<i>inna mā nīṭa bi al-mazīnnah lā farqa baina wujūdihi wa ‘adamihi</i> (what is likely to be present is not different between its presence and absence)”. So, if all those that does instantiate some property, saying \mathcal{P} fall under some ruling, saying \mathfrak{K}; then all those that are likely to instantiate that property fall under the same ruling. Do you agree?</p> <p>$(\forall x: \mathcal{P} \vee {}^P\mathcal{P}) [(\forall y: \mathcal{P}) L^\vee = \{P\}x \supset \mathfrak{K}(y)] \wedge [(\forall z: {}^P\mathcal{P}) R^\vee = \{P\}x \supset \mathfrak{K}(z)] ?$</p> <p>whereby $\{P\}$ is short-form for the hypothesis $\mathcal{P} \vee {}^P\mathcal{P}$</p>	12
13	<p>I agree.</p> <p>$! (\forall x: \mathcal{P} \vee {}^P\mathcal{P}) [(\forall y: \mathcal{P}) L^\vee = \{P\}x \supset \mathfrak{K}(y)] \wedge [(\forall z: {}^P\mathcal{P}) R^\vee = \{P\}x \supset \mathfrak{K}(z)]$</p>	! 12	<p>¿ 13, ¿! 14</p>	<p>Something coming out is most likely to occur while sleeping, whereas something coming out invalidates ablution. Is that right?</p> <p><i>far’</i>: ${}^P\mathcal{R} . \mathfrak{B}(x) (x: \mathcal{R})?$</p>	14
15	<p>Yes, it is.</p> <p>$! far’: {}^P\mathcal{R} . \mathfrak{B}(x) (x: \mathcal{R})$</p>	! 14	? 13	<p>If it is the case that something coming out is most likely to occur while sleeping, whereas something coming out invalidates ablution, this instantiates the antecedent of the right side of your hypothetical assertion at 13.</p>	16

				You should now assert the consequent. Right? <i>far'</i> : ${}^P\mathcal{R}$	
17	Indeed, the fact that something coming out is most likely to occur while sleeping, where something coming out indeed invalidates ablution, coherently should lead sleeping to invalidate ablution. <i>ap(far' .qā'idah^{PQ=Q}):</i> <i>ℬ_c(far')</i>	! 16	! 3	So, this provides the justification for the thesis you were asking for with your third move: it is <i>coherent</i> that sleeping invalidates ablution because it is most likely to bring about the property \mathcal{R} that occasions the ruling \mathcal{B} based on the legal principle that there is no difference between what is likely to enjoy some property and what does enjoy that property. $\mathcal{R} = {}^P\mathcal{R}(\mathcal{B}(x) (x: \mathcal{R})): \mathcal{B}_c({}^{P\mathcal{R}}(far'))$	18
	<i>Ilzām</i>				

Structure of the arguments

The argument developed by the Proponent using non-canonical *qiyās* type A, particularly in order to show the coherence of the ruling that sleeping invalidates ablution, can be structured as follows:

The schema 6.6. The argument of non-canonical *qiyās* type A

Thesis $\mathcal{B}_c(far')$: <i>It is coherent that sleep invalidates ablution.</i>
-------------------------------------	--

The branch-cases (*far'*) : Sleeping
The root-case (*aṣl*) : Travelling
The superscript *P* : more probability
The property \mathcal{Q} : hardship
The property \mathcal{R} : something coming out
The ruling \mathcal{Q} : allowing to not perform the obligatory fasting and to shorten the obligatory prayers
The ruling \mathcal{B} : invalidating ablution

Argument:

- (1) $@(a\bar{s}l)$: The ruling $@$ applies to the root-case
- (2) $a\bar{s}l: {}^P\mathcal{Q} . @(\bar{x}) (\bar{x}: \mathcal{Q})$: The root-case is most likely to instantiate the property \mathcal{Q} , where one that instantiates the property \mathcal{Q} falls under the ruling $@$
- (3) $far': {}^P\mathcal{R} . \mathcal{B}(\bar{x}) (\bar{x}: \mathcal{R})$: The branch-case is most likely to instantiate the property \mathcal{R} , where one that instantiates the property \mathcal{R} falls under the ruling \mathcal{B}

Given these facts,

- (4) $(\forall \bar{x}: \mathcal{P} \vee {}^P\mathcal{P}) [(\forall \bar{y}: \mathcal{P})$: in case that all those that does instantiate some property, saying \mathcal{P} (the left side of the disjunction
 $L^\vee = \{\bar{P}\bar{x} \supset \mathcal{H}(\bar{y})\} \wedge$ occurs) fall under some ruling, saying \mathcal{H} ; then all
 $[(\forall \bar{z}: {}^P\mathcal{P}) R^\vee = \{\bar{P}\bar{x} \supset$ those that are likely to instantiate that property
 $\mathcal{H}(\bar{z})]$ (the right side of the disjunction occurs) fall under
the same ruling.



Hence,

- (5) $\mathcal{B}_c(far')$: given (3), it is coherent that the branch-case falls under the ruling \mathcal{B} .

The schema shows that the root-case and the branch-case do not have common property and ruling, but they share some formation on which the application of the ruling at stake to the branch-case can be inferred. As displayed by the schema, the establishment of the argument consists of three general steps:

- i. Corresponding the branch-case and the root-case in relation to some formation that configures each of their properties and rulings while indicating that such formation in the root-case is followed by the application of some ruling with the aim of establishing the association between the shared formation and the application of some ruling. In other words, showing that the root-case and the branch-case share such formation amounts to indicating that the association of such formation and

the application of some ruling in the root-case is potential for generalization. In the case of sleeping, as can be seen in the schema, it is presented by (1), (2) and (3) where the formation $a\dot{s}l: {}^P\mathcal{Q} . \mathcal{A}(x) (x: \mathcal{Q})$ is indicated to be in association with $\mathcal{A}(a\dot{s}l)$, and $far': {}^P\mathcal{R} . \mathcal{B}(x) (x: \mathcal{R})$ shows that, despite the difference of property and ruling, the branch-case and the root-case share the formation that configures each of their rulings and properties such that the formal structure that associates the formation $a\dot{s}l: {}^P\mathcal{Q} . \mathcal{A}(x) (x: \mathcal{Q})$ and $\mathcal{A}(a\dot{s}l)$ is potential to be generalized.

- ii. Generalizing the structure that associates the shared formation and the application of some ruling in the root-case by means of which the application of the ruling under consideration to the branch-case will be grounded. In our case, it is generalizing the structure that links the formation $a\dot{s}l: {}^P\mathcal{Q} . \mathcal{A}(x) (x: \mathcal{Q})$ and $\mathcal{A}(a\dot{s}l)$ where the application of the ruling \mathcal{B} to the branch-case [$\mathcal{B}(far')$] will be grounded on that generalization. In the schema, it is presented by (4) where $(\forall x: \mathcal{P} \vee {}^P\mathcal{P})$ $[(\forall y: \mathcal{P}) L^\vee = \{P\}x \supset \mathcal{H}(y)] \wedge [(\forall z: {}^P\mathcal{P}) R^\vee = \{P\}x \supset \mathcal{H}(z)]$ is the generalization established from the association of the formation $a\dot{s}l: {}^P\mathcal{Q} . \mathcal{A}(x) (x: \mathcal{Q})$ and $\mathcal{A}(a\dot{s}l)$ in the root-case.
- iii. Applying the general rule. Given the formation $far': {}^P\mathcal{R} . \mathcal{B}(x) (x: \mathcal{R})$, if we apply the general rule, then the application of the ruling \mathcal{B} to the branch-case [$\mathcal{B}(far')$] can be achieved as presented at (5).

6.4.4.2. Non-canonical qiyās type B

<p>There are two <i>taḥallul</i> for <i>ḥajj</i>-pilgrimage due to the long process and a lot of required actions to perform. It is similar to <i>ḥaid</i> (menstruation), due to the long period of time, there are two <i>taḥallul</i> established for it, first, the end of bleeding; and second, bathe (i.e. <i>ghuṣl</i> or grand ablution). Different from <i>ʿumrah</i>-pilgrimage, there is only one <i>taḥallul</i> for it, namely after</p>	<p>(برمول) أداله بک حج ایت دو تحلل کارن لنجت مسان دان کارن بابق فربواتن بندهن سفره حیض تتکال أداله حیض ایت لنجت مسان دجديکن بکین دوا تحلل فرتام فوتس داره کدوا مندي برسلاهن دغن عمره مک تیاد بکین تحلل هان</p>
---	--

accomplishing all requirements, because it does not take a long time, similar to *janābah* (i.e. ritual impurity due to sexual intercourse or seminal discharge).

سات جوا دان يائت سلسي درفد مفرجاکن
سکلين رکنن کارن تياد لنجت مسان سفره جنابه³⁰

Brief remarks on *taḥallul* in pilgrimage and ritual impurity

Taḥallul is actually a technical term used in Islamic pilgrimage that refers to dissolution or ending the state of *ihrām* by virtue of which all prohibitions of pilgrimage return lawful. Once a Muslim, woman or man, starts performing the pilgrimage and enters the *ḥarām land* in Mecca where the pilgrimage takes place, she or he is in the state of *ihrām* and some prohibitions or restrictions apply, such as removing hair and nails from the body, use of perfume, killing game, sexual intercourse, etc.

There are two pilgrimages in Islam, namely *‘umrah*, that can be undertaken at any time of the year, and *ḥajj*, that has specific dates according to the Islamic lunar calendar. The latter requires more ritual acts than the former, so it takes more time. There is only one *taḥallul* for *‘umrah* that occurs after accomplishing all required acts. So, all prohibitions of *ihrām* are no longer applicable after *taḥallul* that is symbolized by cutting or shaving hair. As for *ḥajj*, as Arsyad al-Banjari argues, there are two *taḥalluls*, the first *taḥallul* occurs when almost all required acts have been undertaken, normally after cutting or shaving hair. After the first *taḥallul*, all prohibitions of *ihrām* other than sexual intercourse are repealed. The second *taḥallul* occurs when all required acts have been completed, normally after performing the so-called *ṭawāf al-ifādah*, the last ritual of going around the Ka‘bah seven times. After the second *taḥallul*, all prohibitions of *ihrām* including sexual intercourse are repealed.

The term *taḥallul* is also used by Shāfi‘ī school of law for the case of major ritual impurity (*ḥadath akbar*). In this case, it refers to disengagement from the state of major

³⁰ See Arsyad al-Banjari (n.d., vol. 2, p. 202)

ritual impurity by virtue of which all preventions due to ritual impurity are authorised. The state of major ritual impurity can be caused by sexual intercourse or ejaculation (*janābah*) and vaginal bleeding such as menstruation (*ḥaid*). When a Muslim, woman or man, in the state of *janābah*, she or he is prevented from performing several worships such as prayer, going around the Ka‘bah, stay in Mosque and touching the Qur’ān. The same applies for a woman in the state of *ḥaid*, she is prevented from performing those worships and, additionally, from fasting and being divorced by the husband. There is only one *taḥallul* for *janābah* that is put into action by performing grand ablution (*ghuṣl*), that is, washing the entire body using a pure water. Once grand ablution performed, all prevented worships are authorised. As for *ḥaid*, there are two *taḥalluls*. The first one occurs at the end of bleeding and the second one occurs when grand ablution has been performed. After the first *taḥallul*, fasting and being divorced are allowed. Then, after the second one, all prevented worships due to ritual impurity are allowed.

General structure of the *qiyās*

Let us recall that this type of *qiyās* is applied not to achieve a legal decision, but rather to rationalize it. Indeed, while the legal decision that there are two *taḥalluls* in *ḥajj* is already established by juridical source, the *qiyās* is applied to prove that the decision is legally rational. Rationalization process involves some parallel rulings that are put on the table in order to show the coherence of that decision. Accordingly, this entails some creative moves that require both hermeneutic and heuristic skills.

If we give a dialectical reading to Arsyad al-Banjari’s text above, it starts by bringing forward the analogue ruling that applies to the root-case. In our case, the ruling that menstruation enjoys two *taḥalluls* is brought forward since both *ḥajj* and menstruation can be seen similar in relation to the fact that they both involve some prohibitions that are ended up by *taḥallul*, despite their sharp differences in practice. Still, the question is: why should *ḥajj* enjoy two *taḥalluls* like menstruation? The

justification process begins with proposing a parallel case of the branch-case (call this case *far* ‘*’) to which a parallel ruling of that applies to the branch-case already applies. In this case, it is brought forward that ‘*umrah* (*far* ‘*’), another kind of pilgrimage beside *hajj* (*far* ‘), enjoys one *tahallul* and its performance takes less time than *hajj*. This is subsequently followed by bringing forward a parallel case of the root-case (call this case *aṣl**) which takes less time than the *aṣl*, and, moreover, the analogue ruling to that applies to the *far* ‘*’ applies. In this case, it is presented that *janābah* (*aṣl**), the other kind of major ritual impurities beside menstruation (*aṣl*), enjoys one *tahallul* and its occurrence takes less time than menstruation. That is to say, though the *tahallul* of ‘*umrah* is practically different to that of *janābah*, the ruling that ‘*umrah* enjoys one *tahallul* is structurally similar to the ruling that *janābah* also enjoys one *tahallul* since both take less time relative to their parallels.

The idea is to establish correlation between the time of performance or occurrence and the number of *tahallul*. More precisely, the parallelism between menstruation (*aṣl*) and *janābah* (*aṣl**) shows that *tahallul* of those that takes a long time, menstruation, is double and of those that takes a brief time, *janābah*, is single. Hence, given parallel relation between *hajj* (*far* ‘) and ‘*umrah* (*far* ‘*’), and the fact that the former takes more time than the latter that enjoys one *tahallul*, so it seems rational that *hajj* enjoys two *tahalluls*. The general rules established from the relationship between the *aṣl* and *aṣl** can be formulated as follows:

Single (x, y, z) *prop* ($x: \mathcal{D}, y: \text{long}(x) \vee \text{brief}(x), z: \text{tahallul}(x, R^{\vee}(y))$)

Double (x, y, z) *prop* ($x: \mathcal{D}, y: \text{long}(x) \vee \text{brief}(x), z: \text{tahallul}(x, L^{\vee}(y))$)

In plain words, the first can be read, “*tahallul* of the brief type (the right side of the disjunction y) of the set \mathcal{D} is single”. As for the second, “*tahallul* of the long type (the left side of the disjunction y) of the set \mathcal{D} is double”. If we apply those formation to our case, those yield the followings:

Single(a^*, m, t)

(a^* : major impurity, m : $\text{long}(a^*) \vee \text{brief}(a^*)$, t : $\text{tahallul}(a^*, R^{\vee}(m))$)

Double(a, m', t')

$(a: \text{major impurity}, m': \text{long}(a) \vee \text{brief}(a), t': \text{taḥallul}(a, L^\vee(m)))$

$\text{Single}(f^*, p, t)$

$(f^*: \text{pilgrimage}, p: \text{long}(f^*) \vee \text{brief}(f^*), t: \text{taḥallul}(f^*, R^\vee(p)))$

$\text{Double}(f, p', t')$

$(f: \text{pilgrimage}, p': \text{long}(f) \vee \text{brief}(f), t': \text{taḥallul}(f, L^\vee(p)))$

Assuming

$a: \text{aṣl}$ (menstruation)

$a^*: \text{aṣl}^*$ (*janābah*)

$f: \text{far}'$ (*ḥajj*)

$f^*: \text{far}'^*$ (*'umrah*)

If we use our usual notation of juridical rulings, we obtain the following rulings:

$\mathfrak{C}_1(a^*, m, t)$

“one *taḥallul* applies to *janābah* that is the brief kind of major impurity”

$\mathfrak{C}_2(a, m', t')$

“two *taḥalluls* apply to menstruation that is the long kind of major impurity”

$\mathfrak{C}_1^*(f^*, p, t)$

“one *taḥallul* applies to *'umrah* that is the brief kind of pilgrimage”

$\mathfrak{C}_2^*(f, p', t')$

“two *taḥalluls* apply to *ḥajj* that is the long kind of pilgrimage”

We distinguish the notations between the rulings of the root-cases (i.e. \mathfrak{C}_1 and \mathfrak{C}_2 for major ritual impurities) and the branch-cases (i.e. \mathfrak{C}_1^* and \mathfrak{C}_2^* for pilgrimages), because, as already pointed out, the prohibitions and the *taḥalluls* in pilgrimages and major ritual impurities are different. The relations between those rulings can be displayed by the following diagram:

The diagram 6.7. Non-canonical *qiyās type B*

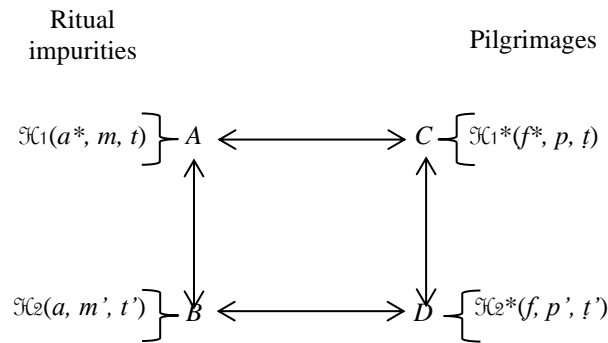

Regarding the relationship between two rulings in the vertical relation, it looks like that this *qiyās* resembles *qiyās al-dalāla* that is discussed in the section 5.4.2. What distinguishes them is that in this type of non-canonical *qiyās* two parallel rulings apply respectively to two parallel cases [$\mathfrak{K}_1(x^*)$ and $\mathfrak{K}_2(x)$], whereas in *qiyās al-dalāla* two parallel rulings apply to one case [$\mathfrak{K}_1(x)$ and $\mathfrak{K}_2(x)$]. Moreover, while in the *qiyās al-dalāla* the two rulings are a pair where the presence of one entails the presence of the other, in this *qiyās* the two rulings are no more than that they both are considered in correlation like in *qiyās al-shabah*.

However, they differ sharply in the horizontal relation. They are indeed similar regarding that they both involve some prohibitions that are ended up by *tahallul*, but notice, as pointed out above, the prohibitions and the *tahallul* in pilgrimages differ practically from those in major ritual impurities. Thus, in the horizontal relation the branch-cases (pilgrimages) and the root-cases (major ritual impurities) do not share the same ruling as in the *qiyās al-dalāla*. Moreover, the similarity in the horizontal relation is dependent on the vertical relation. In our case, it is said that *hajj* takes a long time is relative to its parallel, namely ‘*umrah*, as well as that menstruation takes a long time is relative to *janābah*. In short, this type of *qiyās* is based on proportionality of two rulings in the vertical relation. Thus, in this type of parallel reasoning there is no horizontal relation independent of vertical relation.

Accordingly, the reason that *hajj* enjoys two *tahalluls* is because it takes more time than its parallel (‘*umrah*) that enjoys only one *tahallul* based on their resemblance (*shabah*) to major ritual impurity where *tahallul* of that takes a long time, menstruation, is two and of that takes a brief time, *janābah*, is one. So, the justification that *hajj* enjoys two *tahalluls* can be written:

$$\text{Shabah } \mathfrak{K}_1(a^*)\text{-nazīr- } \mathfrak{K}_2(a): \mathfrak{K}_2^*(f, p', t')$$

However, we should notice that this justification is a non-canonical justification since the ruling that *hajj* enjoys two *tahalluls* is already established by juridical source.

Regarding its structure, this type B of non-canonical *qiyās* is similar to the type A in relation to the fact that in the horizontal relation the branch-case and the root-case share merely some structure. More precisely, they share the formal structure that links them to each of their parallel cases. If we look at the diagram above, like in the type A of non-canonical *qiyās*, *A to B* is the same as *C to D*. However, in the type A the vertical relation cannot be inverted (presented by the downward arrow from *A to B*—see the diagram 5.6), while in this type B it can be inverted (presented by the up down arrow connecting *A* and *B*—see the diagram 5.7), so we can say that *B to A* is also the same as *D to C*. In other words, as already indicated, this type of *qiyās* is based on some proportionality.

Dialogue for the *qiyās*

The table 6.7. Dialogue for non-canonical *qiyās* type B

O		P			
		response	response	There are two <i>taḥalluls</i> for <i>ḥajj</i> . ! $\mathfrak{K}_2^*(far')$	0
1	Indeed, it is confirmed by juridical source. $\mathfrak{K}_2^*(far')$! 0	? 1	It is true, but what I want to say that this ruling is coherent with some rulings. ! $\mathfrak{K}_2^*(far')$	2
3	Ok. Now, show the coherence! <i>Reason?</i>	? 2(0)	¿ 3, ¿! 4	Menstruation enjoys two <i>taḥalluls</i> . Is that right? $\mathfrak{K}_2(aṣl)$?	4
5	Yes, it is. ! $\mathfrak{K}_2(aṣl)$! 4	¿ 5, ¿! 6	' <i>Umrah</i> enjoys one <i>taḥallul</i> , doesn't it? $\mathfrak{K}_1^*(far'^*)$	6
7	Yes, it does.	? 6	¿ 7, ¿! 8	<i>Janābah</i> enjoys one <i>taḥallul</i> . Right? $\mathfrak{K}_1(aṣl^*)$	8

9	Yes.	! 8	¿ 9(5), ! 10	The ruling that menstruation enjoys two <i>taḥalluls</i> is structurally similar to the ruling that <i>ḥajj</i> enjoys two <i>taḥalluls</i> . $\mathfrak{K}_2(aṣl) \approx \mathfrak{K}_2^*(far')$	10
11	Justify! <i>muṭālabā !</i>	! 10	¿ 11, ¿! 12	@ ¹ : Don't you see that ' <i>umrah</i> that is a brief type of pilgrimage enjoys one <i>taḥallul</i> ? $\mathfrak{K}_1^*(f^*, p, t)$ (f^* : pilgrimage, p : long(f^*) \vee brief(f^*), t : <i>taḥallul</i> (f^* , $R^\vee(p)$)) ? Assuming f^* is <i>far</i> '*	12
13	Indeed. $\mathfrak{K}_1^*(f^*, p, t)$ (f^* : pilgrimage, p : long(f^*) \vee brief(f^*), t : <i>taḥallul</i> (f^* , $R^\vee(p)$))	! 12	¿ 13, ¿! 14	@ ² : Moreover, menstruation, the major ritual impurity that takes a long time, enjoys two <i>taḥalluls</i> , while <i>janābah</i> , the major ritual impurity that takes a brief time, enjoys one <i>taḥallul</i> . $\mathfrak{K}_2(a, m', t')$ (a : major impurity, m' : long(a) \vee brief(a), t' : <i>taḥallul</i> (a , $L^\vee(m)$)) $\mathfrak{K}_1(a^*, m, t)$ (a^* : major impurity, m : long(a^*) \vee brief(a^*), t : <i>taḥallul</i> (a^* , $R^\vee(m)$)) Assuming: a : <i>aṣl</i> a^* : <i>aṣl</i> '* @ ³ : So, <i>taḥallul</i> of those that takes a long time is double and of those that takes a brief time is single. Do you agree?	14

				<p><i>Single</i> (x, y, z) <i>prop</i> $(x: \mathcal{D}, y: \text{long}(x) \vee \text{brief}(x), z: \text{taḥallul}(x, R^\vee(y)))$</p> <p><i>Double</i> (x, y, z) <i>prop</i> $(x: \mathcal{D}, y: \text{long}(x) \vee \text{brief}(x), z: \text{taḥallul}(x, L^\vee(y))) ?$</p>	
15	<p>I agree.</p> <p><i>Single</i> (x, y, z) <i>prop</i> $(x: \mathcal{D}, y: \text{long}(x) \vee \text{brief}(x), z: \text{taḥallul}(x, R^\vee(y)))$</p> <p><i>Double</i> (x, y, z) <i>prop</i> $(x: \mathcal{D}, y: \text{long}(x) \vee \text{brief}(x), z: \text{taḥallul}(x, L^\vee(y)))$</p>	! 14	? 15	<p>According to these endorsements, there should be two <i>taḥalluls</i> for <i>ḥajj</i> because it takes more time than <i>‘umrah</i>. Like the case of major ritual impurities. Do you agree?</p> <p>$f: \text{pilgrimage}, p': \text{long}(f) \vee \text{brief}(f), t': \text{taḥallul}(f, L^\vee(p))$</p> <p>Assuming <i>f</i> is <i>far</i>‘</p>	16
17	<p>Indeed, the fact that <i>ḥajj</i> takes more time than <i>‘umrah</i> should coherently lead <i>ḥajj</i> to enjoy two <i>taḥalluls</i>. Like menstruation that enjoys two <i>taḥalluls</i> because it takes more time than <i>janābah</i> that enjoys one <i>taḥallul</i>.</p> <p>! $\mathfrak{H}_{\mathcal{Q}^*}(f, p', t')$</p>	! 16	! 3	<p>So, this provides the justification for the thesis you were asking for with your third move: it is <i>coherent</i> that <i>ḥajj</i> enjoys two <i>taḥalluls</i> because it takes more time than its parallel (<i>‘umrah</i>) that enjoys only one <i>taḥallul</i> based on their resemblance (<i>shabah</i>) to major ritual impurity where <i>taḥallul</i> of that takes a long time is two and of that takes a brief time is one.</p> <p><i>Shabah</i>$^{\mathfrak{H}_1(a^*)-nazīr-\mathfrak{H}_3(a)}$: $\mathfrak{H}_{\mathcal{Q}^*}(f, p', t')$</p>	18
	<i>Ilzām</i>				

Structure of the arguments

The argument developed by the Proponent using non-canonical *qiyās* type B in order to show the coherence of the ruling that *ḥajj* enjoys two *taḥalluls* can be structured as follows:

The schema 6.7. The argument of non-canonical *qiyās* type B

Thesis $\mathfrak{C}_2^*(far')$: <i>It is coherent that ḥajj enjoys two taḥalluls.</i>
--	---

The branch-cases (f)	: <i>ḥajj</i>
The root-case (a)	: menstruation
The parallel of <i>far'</i> (f^*)	: <i>'umrah</i>
The parallel of <i>aṣl</i> (a^*)	: <i>janābah</i>
$\mathfrak{C}_1, \mathfrak{C}_1^*$: single
$\mathfrak{C}_2, \mathfrak{C}_2^*$: double
m, m'	: brief and long types of major impurity, respectively
p, p'	: brief and long types of pilgrimage, respectively
$t, t', \mathfrak{t}, \mathfrak{t}'$: <i>taḥallul</i>

Argument:

- | | |
|--|---|
| (1) $\mathfrak{C}_2(a, m', t')$ | : <i>Taḥallul</i> of the root-case that is the long type of major ritual impurity is double. |
| (2) $\mathfrak{C}_1(a^*, m, t)$ | : <i>Taḥallul</i> of the parallel of the root-case that is the brief type of major ritual impurity is single. |
| (3) $\mathfrak{C}_1^*(f^*, p, \mathfrak{t})$ | : <i>Taḥallul</i> of the parallel of the branch-case that is the brief type of pilgrimage is single. |

Given these facts,

- | | |
|--|--|
| (4) (4.1) $\mathfrak{D}_{double}(x, y', t')$ | : <i>Taḥallul</i> of those that are the long types of some set of states is double. |
| (4.2) $\mathfrak{S}_{single}(x^*, y, t)$ | : <i>Taḥallul</i> of those that are the brief types of some set of states is single. |



Hence,

- | | |
|--|---|
| (5) $\mathfrak{C}_2^*(f, p', \mathfrak{t}')$ | : It is coherent that <i>taḥallul</i> of the branch-case is double since it is the long type of pilgrimage. |
|--|---|

As can be seen in the schema, this type of non-canonical *qiyās* is based on proportionality of some rulings. The establishment of the argument consists of three main steps as follows:

- i. Establishing parallelism between two rulings that are applied respectively to the root-case and its parallel, while corresponding the ruling that is applied to the parallel of the root-case and the ruling that is applied to the parallel of the branch-case in relation to some formation such that the correlation between two rulings applied respectively to the root-case and its parallel is potential to be applied to the branch-case and its parallel. It is presented by (1), (2) and (3) where $\mathfrak{K}_2(a, m', t')$ and $\mathfrak{K}_1(a^*, m, t)$ shows parallelism between two rulings that are applied respectively to the root-case and its parallel, and $\mathfrak{K}_1^*(f^*, p, t)$ indicates that the ruling that is applied to the parallel of the root-case is structurally similar to the ruling that is applied to the parallel of the branch-case. So, the structure that links the two parallel rulings applied respectively to the root-case and its parallel is potential to be generalized and applied to the branch-case and its parallel.
- ii. Generalizing the structure that links two rulings applied to the root-case and its parallel, respectively. It is presented by (4.1) and (4.2), where $\mathfrak{D}_{double}(x, y', t')$ and $\mathfrak{S}_{single}(x^*, y, t)$ are the general rules established from $\mathfrak{K}_2(a, m', t')$ and $\mathfrak{K}_1(a^*, m, t)$.
- iii. Applying the general rules. Given the fact that the branch-case takes more time relative to its parallel [$\mathfrak{K}_1^*(f^*, p, t)$], as presented at (3), if we apply the general rules established in the second step, then we can conclude that it is legally rational that the branch-case enjoys two *tahalluls* [$\mathfrak{K}_2^*(f, p', t')$], as presented at (5).

References

- al-Banjari, Muhammad Arsyad. (1957). *Sabīl al-Muhtadīn*. Riyadh: King Saud University.
- al-Banjari, Muhammad Arsyad. (2005). *Kitāb al-Nikāh*. Banjarmasin: Comdes.
- al-Banjari, Muhammad Arsyad. (2009). *Pemikiran-pemikiran Syeh Muhammad Arsyad al Banjari dalam bidang tauhid dan tasawuf*. (Ed. Aswadie Syukur). Banjarmasin: Comdes.
- al-Banjari, Muhammad Arsyad. (2013). *Luq̄at al-'Ajlān*. Martapura: Yapida.
- al-Banjari, Muhammad Arsyad. (n.d.). *Sabīl al-Muhtadīn*. al-Ḥaramayn.
- Bartha, P. (2010). *By Parallel Reasoning; The Construction and Evaluation of Analogical Arguments*. Oxford: Oxford University Press.
- Dahīsh, ‘Abd al-Malik ibn ‘Abd Allāh ibn. (1995). *Al-Ḥarām al-Makkī al-Sharīf wal-A‘lām al-Muhīta bih*. Mecca.
- al-Ghazālī, Abū Hāmid. (1324 H/1906). *Al-Mustaşfā min ‘Ilm al-Uşūl*. Būlāq: al-Maṭba’a al-Amīriyya.
- Hallaq, W. B. (1987b). The Development of Logical Structure in Islamic Legal Theory. *Der Islam*, 64/1, 42-67.
- Hesse, M. B. (1966). *Models and Analogies in Science*. Notre Dame, Indiana: University of Notre Dame Press.
- Munadi, F. (2020). *Teks dan Naskah Sabīl al-Muhtadīn: Kajian Filologi atas Karya Syekh Muhammad Arsyad*. Retrieved from https://www.academia.edu/41958304/TEKS_DAN_NASKAH_SAB% C4% A AL_AL_MUHTAD% C4% AAN_KAJIAN_FILOLOGI_ATAS_KARYA_SYEKH_MUHAMMAD_ARSYAD
- Rahman, S., & Iqbal, M. (2018). Unfolding parallel reasoning in islamic jurisprudence: Epistemic and Dialectical Meaning within Abū Ishāq al-Shīrāzī’s System of Co-Relational Inferences of the Occasioning Factor. *Arabic Sciences and Philosophy*, 28, 67-132.
- Rahman, S., Iqbal, M., & Soufi, Y. (2019). *Inference by Parallel Reasoning in Islamic Jurisprudence*. Cham: Springer.
- al-Shīrāzī, Abū Ishāq. (1407 H/1986). *Mulakhkhaş fī al-Jadal fī Uşūl al-Fiqh*. (Ed. Muḥammad Yūsuf Ākhund Jān Niyāzī). MA Thesis, Umm al-Qura University.
- al-Shīrāzī, Abū Ishāq. (1987). *Al-Ma’ūna fī al-Jadal*. (Ed. ‘Alī b. ‘Abd al-‘Azīz al-‘Umayrīnī). Al-Şafāh, Kuwait: Manshūrāt Markaz al-Makhṭūṭāt wa-al-Turāth.
- al-Shīrāzī, Abū Ishāq. (1988). *Sharḥ al-Luma’ fī Uşūl al-Fiqh*. (Ed. ‘Abd al-Majīd Turkī). Beirut: Dār al-Gharb al-Islāmī.
- al-Shīrāzī, Abū Ishāq. (1995). *Al-Luma’ fī Uşūl al-Fiqh*. Beirut; Damascus: Dār Ibn Kathīr; Dār al-Kalam al-Ṭayyib.
- al-Shīrāzī, Abū Ishāq. (2003). *Al-Luma’ fī Uşūl al-Fiqh*. Beirut: Dār al-Kutub al-‘Ilmiyah.

- Syukur, A. (2009). Kata Pengantar. In Muhammad Arsyad al-Banjari, *Pemikiran-pemikiran Syeh Muhammad Arsyad al Banjari dalam bidang tauhid dan tasawuf*. (Ed. Aswadie Syukur). Banjarmasin: Comdes.
- Syukur, A. (2016). Pemikiran Syeikh Muhammad Arsyad al-Banjari dalam Bidang Fiqh (1); Kitab Sabil al-Muhtadin. In Abdul Rahman Abdullah, *Biografi Agung Sheikh Arshad al-Banjari* (pp. 290-302). Shah Alam, Selangor: Karya Bestari.

CHAPTER 7
**ARSYAD AL-BANJARI'S *QIYĀS* FOR INTEGRATING BANJARESE
TRADITIONS INTO ISLAMIC LAW**

As pointed out in the Chapter 5, the process of re-Islamization of Banjar carried out by Arsyad al-Banjari after his arrival in Banjar from his studying in Mecca and Medina was challenged by the emergence of new cases related to the Banjarese culture that required legal certainty regarding their status according to Islamic law. This galvanized a dynamic interaction between Islam and Banjarese culture that led to, on one side, cultural integration and, on the other, cultural isolation between the two. *Qiyās* or *correlational inference* played a paramount role in this process since Arsyad al-Banjari applied a model of integration based on a dialectical understanding of this legal theory of parallel reasoning.

Let us point out that Arsyad al-Banjari endorsement of a dialectical understanding of drawing inferences by *qiyās* is not only crucial for the model of integration he puts into practice but it also relates to two main hallmarks of legal reasoning within Islamic Law highlighted and developed by Walter Edward Young (2017) in his work *The Dialectical Forge*. In a nutshell: the shaping of *qiyās* by means of *jadal*, the Islamic framework for argumentation, allows to implement the stances that (1) legal reasoning is largely a matter of practice, and that (2) the openness of the domain of application of a law requires a dynamic instrument for extending this domain.

In this context, one cannot overestimate the work of Arsyad al-Banjari, who sets a paradigm on how to apply a dialectical constitution of *qiyās* in order to integrate new cultural contexts into the scope of Islamic Law. We will illustrate the method of integration applied by Arsyad al-Banjari with the help of three applications of *qiyās* related to the local belief and practice, the local natural environment and the local socio-culture, respectively:

- 1) the argument for the interdiction of the traditional Banjarese offering-rituals for avoiding disease or calamities called respectively *manyanggar* and *mambuang pasilih*.¹
- 2) the argument for the allowance of consuming the traditional drink called *lahang* (even when fermented) made of the juice of sugar-palm.²
- 3) the argument for the equal distribution of marital property called *harta perpantangan* in Banjar.³

¹ This issue is discussed in *Tuḥfat al-Rāghibīn*, the treatise that deals with the doctrines of Sunni theology. This treatise was composed two years after Arsyad al-Banjari's return to the Banjarese Sultanate (1772), namely in 1188H/1774. It was published several times in Istanbul, Mecca, Cairo, Singapore, and Surabaya. The treatise was printed for the first time in 1887 in Istanbul by al-Maṭba'ah al-Ḥāj Muḥarram Afandī. Its authorship, in fact, triggers a controversy since the author's name is not mentioned in some manuscripts (Hasan, 2007). Some scholars have argued that this treatise was composed by Abdul Samad al-Palimbani. However, the arguments of the researchers compiled by Mujiburrahman (2014) –including the one of Hasan (2007)– provide strong evidence that the treatise was authored by Arsyad al-Banjari, mainly regarding the similar dictions of the doxology to some works of Arsyad al-Banjari, the use of some Banjarese words and the mention of the Banjarese traditions. Moreover, the publication by Maṭba'ah al-Aḥmadiyyah Singapore and al-Ihsan Surabaya in 1929 mentioned clearly Arsyad al-Banjari as the author of the treatise.

² This issue is discussed in *Sabīl al-Muhtadīn*. As discussed in the previous chapter, it is Arsyad al-Banjari's magnum opus that was composed upon the request of Sulṭān Tamjīd Allāh because of lacking book of Islamic law in Malay language. This request is mentioned by Arsyad al-Banjari (1957) in his introduction of this work. Aswadie Syukur (2016) points out that this work has been well known and read by Muslim communities in Southeast Asia where the people use Malay language in their daily conversations, such as Indonesia, Malaysia, Singapore, Brunei Darussalam and some regions in Thailand, Philippines and Cambodia, since there was no other book in Malay language that discuss Islamic law comprehensively and profoundly as *Sabīl al-Muhtadīn*. Arsyad al-Banjari began writing the manuscript in 1193H/1779 and finished it two years later, in 1195H/1781. It was edited for the first time by Ahmad ibn Muhammad Zain al-Fathani and published almost simultaneously in Mecca and Istanbul around 1882. Munadi (2020) indicates that the manuscript was also edited by Muhammad Ilyas al-Azhari and published in Cairo in 1307H/1889. In fact, *Sabīl al-Muhtadīn* was translated into Indonesian language by Aswadie Syukur and has been published by Bina Ilmu Surabaya since 1985. In Malaysia, it was transcribed by Mohamad Haidzir bin Hussin bin Ibrahim, edited by Fuad Ismail and has been published by Telaga Biru since 2010; and it was also transcribed by Jahabersa Team and has been published since 2013 by Jahabersa, Johor Baru.

³ As information circulated in the Banjarese society, this issue is mentioned by Arsyad al-Banjari in his work *Kitāb al-Farāid* which deals with Islamic law of inheritance. Unfortunately, this treatise has never been found. Guru Irshad Zein, Arsyad al-Banjari's descendant who use nom de plume of Abu Daudi, told that the original book is probably saved by Abd al-Rahman Siddiq, one of Arsyad al-Banjari's offspring, who was appointed Mufti in Siak Sultanate, Indera Giri (Sapat) Riau (Dakhoir, 2010; Irfan Noor, 2015). Aswadie Syukur, as mentioned by Dakhoir et al (2017), reported that in his visit to Malaysia he found the book *Kitāb al-Farāid* mentioning Abd al-Rahman as the author. It is possible that when published the name of Abd al-Rahman is mentioned as the author, even though the book is originally written by Arsyad al-Banjari. In addition, it is reported that this concept of marital property was likely

Whereas the first and third arguments take the form of *qiyās al-shabah* (argument by analogy), the second one is shaped by *qiyās al-‘illa* – argumentation-schemes based on establishing the *occasioning factor* (or *ratio legis*) that grounds the juridical decision at stake. As we shall see from our dialogical reconstruction, the debate concerning *manyanggar* and *mambuang pasilih* is quite sophisticated, with the opponent that does not surrender easily to the rejection of his use of those rituals.

In order to facilitate the reading of Arsyad al-Banjari’s model of argumentation, in the next section, once more, we will briefly recall the main notions involving the objectives and features of the dialectical structure of *qiyās*, as well as its classification as developed by al-Shīrāzī in his works.⁴

7.1. Basics on *qiyās*

Let us recall that the aim of correlational inferences is to provide a rational ground for the application of a juridical ruling to a given case not yet considered by the original juridical sources. It proceeds by combining heuristic (and/or hermeneutic) moves with logical inferences. The simplest form follows the following pattern:

- In order to establish if a given juridical ruling applies or not to a branch-case (*far’*), we look for a root-case (*aṣl*) we already know that it falls under that ruling. Then we search for the property or set of properties upon which the application of the ruling to the root-case is grounded (the *ratio legis* or *legal cause* for that juridical decision).
- If that grounding property (or set of them) is known, we ponder if it can also be asserted of the new case under consideration. In the case of an affirmative answer, it is inferred that the new case also falls under the juridical ruling at stake, and so the range of its application is extended. When the legal cause is explicitly known (by the sources) or made explicit by specifying a relevant set of properties, we are

to be delivered orally by Arsyad al-Banjari to his students who then became *Qadis* (Judges); and they applied it in the society so that it becomes the tradition of the Banjarese society (Zamzam, 1979)

⁴ See al-Shīrāzī (1986, 1987, 1988, 1995, 2003).

in presence of an inference by *qiyās al-‘illa* or correlational inference by the *occasioning factor*.

- When there is absence of knowledge of the occasioning factor grounding the application of a given ruling, we are in presence of correlational inferences by indication (*qiyās al-dalāla*) or by resemblance (*qiyās al-shabah*). Whereas the former is based on pinpointing at specific relevant parallelisms between rulings (*qiyās al-dalāla*), the latter are based on resemblances between properties (*qiyās al-shabah*).

The plausibility of a conclusion attained by *parallelism between rulings* (*qiyās al-dalāla*) is considered, in terms of epistemic strength, stronger than the conclusion obtained by *resemblance of the branch-case and the root-case* in relation to some set of (relevant) properties (*qiyās al-shabah*). Yet conclusions obtained by either *qiyās al-dalāla* or *qiyās al-shabah* have a lower degree of epistemic plausibility as conclusions inferred by the deployment of *qiyās al-‘illa*, where the *occasioning factor* can be pinpointed.

One cardinal feature of al-Shīrāzī’s take on *qiyās al-‘illa* is the development of the test of efficiency or *ta’thīr*, that provides the means to test whether the property \mathcal{P} purported to be relevant for the juridical sanction at stake is indeed so. The test declines into two complementary procedures:

- testing co-extensiveness or *ṭard* (if the property is present then the sanction too), and
- testing co-exclusiveness or *‘aks* (if the property is absent then so is the juridical sanction. While co-extensiveness examines whether sanction \mathcal{K} follows from the verification of the presence of the property \mathcal{P} , co-exclusiveness examines whether exemption from the sanction \mathcal{K} follows from the verification of the absence of \mathcal{P} – see Chapter 3.

The method of efficiency is largely used by Arsyad al-Banjari, particularly so in his argument for the legal validity of consuming *Lahang*.

Let us now display the dialogues based on the arguments of the texts and shaped by the structure of the Islamic argumentation form.

7.2. Arsyad al-Banjari's framework

Arsyad al-Banjari often presents his arguments in a question-response framework. Indeed, texts with the headings “question and response” are ubiquitous in Arsyad al-Banjari's work. They can be found almost in every chapter of his works such as *Sabīl al-Muhtadīn*, *Tuḥfat al-Rāghibīn*, *Kitāb al-Nikāh* and *Luḡtat al-'Ajlān*. However, at many cases they are not set in the schema of “Proponent and Opponent” as usually deployed within the framework of *jadāl*. This makes Arsyad al-Banjari's arguments more difficult to follow, particularly so when counter-attacks trigger a change of roles between respondent and challenger.

However, one advantage of the style of the original texts, presented and translated in the appendix, is that it stresses how one argument defeats another one, rather than the victory or defeat of the contenders. The disadvantage, of Arsyad al-Banjari's style is that it makes it hard to distinguish the main thesis from the sub-arguments. Since our aim is to provide an overall view of the structure of the debate, we will reconstruct the argument within a dialogical framework, though we also stick closely to the original text in the sense that, by identifying the precise challenges and responses we will make it patent how one argument defeats another one.

In order to facilitate the reading, before providing the dialogical reconstruction of the texts, we will first sketch the argumentation pattern, mention briefly the cultural background and outline the most relevant philosophical assumptions.

After presenting the dialogue we will provide a detailed analysis commenting the main moves from the point of view of Islamic argumentation theory. This will require that we introduce before the main dialectical forms of objection deployed by Arsyad

al-Banjari. However, in the present chapter, we will refrain of providing a formalization—a formalization of the relevant notions can be consulted in previous chapters.⁵

7.3. *Qiyās al-shabah* on *manyanggar* and *mambuang pasilih*

7.3.1. Brief remarks on the cultural and philosophical background

On the rituals

Manyanggar and *mambuang pasilih* are offering-rituals practised within the Banjarese tradition in order to attain some purpose and carried out as acts of propitiation. The *manyanggar* –ceremony of offering is practiced in order appease evil spirits and their influences. The *mambuang pasilih*-offerings seek to appease the so-called *hidden family*. The hidden family can refer to an ancient king that passed away and to some his descendants or followers believed to be still alive but hidden. It is believed that if these rituals are not carried out, the evil or the hidden family will do harm such as bringing in disaster or disease – see Syukur (2002) and Mujiburrahman (2014; 2017).

On causation

The complexity of the argument does not only stem from its argumentative structure but it is also generated by important philosophical matters. Moreover, the strongest passages of the argument set up analogies involving epistemological and theological issues concerning causation. Indeed, in order to follow the argument it is necessary to take into consideration that Arsyad al-Banjari follows here the notion of causation of the Ash‘arī theological school according to whom Allah is the only agent of effects. Let us take the example of al-Ghazālī (1966, pp. 239-240), the prominent figure of that school. According to him, the burning of cotton is neither inherent to fire (it is not *in the nature of fire* by itself, to put in the terminology of Arsyad al-Banjari), nor did Allah constituted fire in such a way that once it contacts cotton, it burns. Cotton burns when in contact with fire because Allah constituted fire in such a way that when in

⁵ See also Rahman & Iqbal (2018) and Rahman, Iqbal, & Soufi (2019).

contact with cotton, it is He Himself who enacts the burning.⁶ In the dialogue both Opponent and Proponent share this view on causation.

7.3.2. An overall view of the argument

As already mentioned, Arsyad al-Banjari's argument for the rejection of those rituals, is quite sophisticated and involves counterattacks which induce change of burden of the proof. The general structure of the argument has the form of *qiyās al-shabah* and it is therefore grounded on establishing an analogy based on the similarity of the branch-case and the root-case. Actually, the argument displays the intertwining of several analogies.

The argument starts by attempting to ground the thesis (the interdiction) in the resemblance of the **branch-case**, the rituals of *manyanggar* and *mambuang pasilih*, and the practice of idolatry. The analogy is based on the fact that those ceremonies and the practice of idolatry share some relevant property, namely, the belief that it is not Allah the efficient cause for the avoiding of disaster or disease, but carrying out such rituals.

This is contested by another analogy brought forward by the clever Opponent who compares the resemblance of the belief on the healing and preventing powers of the contested rituals with the (established) belief that the power of fire to burn dry objects and the power of food to satiate is in fact due to Allah's power to enact those effects. Thus, carrying out the contested rituals is not idolatry, in the same way as it is not idolatry to believe that hunger is satiated by taking food and that dry objects can be

⁶ See Marmura (1965). Peter Adamson (2019, April 1), who has a slightly less occasionalist reading as the one of Marmura expresses the point as follows:

his [Al-Ghazālī] critique here imputes a very strong notion of causality to the philosophers: namely that given the existence of a cause, the existence of its effect is necessary. Al-Ghazālī holds that, on such a notion of causality, only God is a cause. This is because, given the existence of miracles, and accepting the proposition that God can do anything, no cause other than God can necessitate its effect. It is always possible that God might will the expected effect not to proceed, or will an entirely different effect to proceed. Al-Ghazālī defends this view against both philosophers who claim that a natural cause, such as the fire which causes the burning of cotton, is the sole and sufficient cause for its effect.

burned by ignition, provided the ones carrying out those rituals endorse the Islamic theory of causation which establishes Allah as the true agent of efficiency (see remark on causation below).

This allows the Opponent to force his antagonist to concede that, under these conditions, practicing the rituals under consideration does not entail idolatry. Moreover, since deploying fire and food is not forbidden, so must *manyanggar* and *mambuang pasilih* be integrated into Law as permissible acts.

The Proponent accepts that under these conditions the practices of *manyanggar* and *mambuang pasilih* do not entail idolatry. However, he refuses that this should lead to their permissibility. The Opponent's argument on the permissibility of *manyanggar* and *mambuang pasilih* is based on an irrelevant similarity between the belief entailed by deploying fire and food and the belief entailed by the practice of those rituals. The grounds for refusing the proposed similarity are subtle and deeply entrenched in the Islamic theory of causation endorsed by Arsyad al-Banjari just mentioned. In a nutshell, while burning and satiation are enacted by Allah through the natural beings food and fire (in that derivative sense we can speak of them of being *natural causes*), the contested rituals are not present in nature and cannot be said to be in that sense natural causes of healing and prevention of danger enacted by Allah. Therefore, food and fire are different to *manyanggar* and *mambuang pasilih* and hence, the deployment of food and fire in order to attain their effects (by the enacting of Allah) is also different to carrying out those rituals.

At this point of the debate, the argumentation seems to get stuck. On one hand the Opponent managed to convince the Proponent that there is no idolatry behind the practices in question; on the other the Proponent forces the Opponent to concede that the analogies brought so far into the debate do not justify their permissibility. Nevertheless, the Proponent, who has the burden of the proof, did not prove yet his thesis on the interdiction of *manyanggar* and *mambuang pasilih*. Accordingly, the Proponent starts developing another angle of attack. Actually, the moves of both

Opponent and Proponent, that follow this attack, seem to be grounded in less convincing analogies.

The Proponent claims now that *manyanggar* and *mambuang pasilih* are similar to the act of wasting and following Satan since they entail offering food to Satan.

The Opponent refuses to accept that these rituals are similar to the act of wasting and following Satan by comparing feeding his own family or friends with feeding the hidden family.

The response of the Proponent is clear as it can be. What is the evidence for the hidden family profiting of the offers? The Opponent's reference to the story of Elders and of a possessed person as witnesses of the existence of the hidden family does not provide evidence that the offers have not been wasted.

The Opponent ends up accepting that practicing *manyanggar* and *mambuang pasilih* entails wasting and following the footsteps of Satan. However, surprisingly, the Opponent claims that though the practices entail following Satan, this does not make those practices forbidden acts. The reason he brings in is that the objective of the practice is still a permissible one, namely being healed. Moreover, the Opponent proposes the following: while feeding Satan with the aim of healing we can do as if we were feeding a dog. Feeding a dog is permissible after all and so is the aim of practicing these rituals, namely, being healed.

The response displays three forms of objection:

- 1) *Naqđ (inconsistency)*: The Proponent uses this form of objection in order to attack the very idea of excusing a despicable act in the way suggested by the Opponent. It amounts to forcing the Opponent to concede that, when confronted to another case that shares the same inferential pattern as the one brought forward, the conclusion of both arguments (the ruling drawn from the premises) leads to either contradiction or to incompatibility.
- 2) *Farq (invalidating distinction)*: The second form of objection targets the Opponent's claim that feeding a dog and feeding Satan can be considered to be similar, due to the fact that both are feedings. The Proponent shows that both cases

are to be distinguished and this distinction invalidates the similarity claimed by the Opponent.

- 3) *Man' (denial)*: The third form of objection denies that the contested rituals are to be considered as medical practices.

In relation to the first group the Proponent observes that not only engaging in a despicable act in order to attain some permissible objective does not change the interdiction, but by doing as if the being addressed by the act (Satan) is something else (the dog) does not help in erasing despicability of that act (and corresponding interdiction) either. The Proponent's counter-examples are almost shocking: killing a person with the belief that this killing will bring relief to the heartache of the perpetrator makes it not less despicable if while during the killing the murderer does as if he is killing a mouse. He adds a second example of the same kind: committing adultery with the belief that the intercourse will heal his rheumatism does not become acceptable, even if during the intercourse the man does as if he is with his wife. Since the Opponent accepts that the counterexamples share the same general property as the one of his own argument; and since he endorses too the inferred conclusion, namely: that this kind of acts are to be forbidden, he must concede the inconsistency of his own position.

The Proponent implements the second form of objection in order to pinpoint at the dissimilarity between feeding a dog and feeding Satan. According to the Proponent, the fact that feeding a dog and feeding Satan are different is made patent by the ways the offerings are carried out, leftovers for the dog, and the finest food for Satan.

The application of the third form of objection seems to be more convincing to the modern reader: Medicine is practiced by treating the body of the sick person by inducing ingestion or by smearing or spraying it with some substance. This treatment impacts the body in such a way that it can be felt to be either cold or warm. Clearly, this does not liken the purported healing practice of *manyanggar* and *mambuang pasilih*. These practices are not acknowledged medical healing practices.

Finally, these last objections lead the Opponent to concede defeat.

7.3.3. The dialogue on *manyanggar* and *mambuang pasilih*

The table 7.1. Dialogue on *manyanggar* and *mambuang pasilih*

O		P	
		<i>Manyanggar</i> and <i>mambuang pasilih</i> are forbidden	0
1	Why?	According to the sources, <i>tabdhīr</i> ⁷ or wasting is forbidden, isn't it?	2
3	Yes, it is forbidden	According to the sources, following the footsteps of Satan is also forbidden, isn't it?	4
5	Yes, it is also forbidden	Moreover, according to the sources, <i>shirk</i> (idolatry or polytheism) and <i>bid'a sayyi'a</i> (heretical innovations) are forbidden, aren't they? ⁸	6
7	Yes, they are forbidden	<i>Manyanggar</i> and <i>mambuang pasilih</i> in their practice entail the belief that sick people cannot be cured or danger cannot be avoided except only by carrying them out. That amounts to the belief that the ceremonies have the causal power of curing or avoiding danger. So, they are similar to the practice of idolatry. Indeed, they assume that Allah is not the only agent of healing and avoiding danger, but that Allah has a partner for enacting the desired effects. So, they should be forbidden, aren't they?	
9	No, they are not forbidden because we do not believe that the power to cure or to avoid danger is in the nature of the ceremonies themselves.	Well, even if it is believed that they have not such a power by their own nature, but it is believed that it is Allah who gave them the power to enact healing and prevention of danger, then they are still impious heretic practices (<i>bid'a fisq</i>). So, they are forbidden, aren't they?	10
11	No, they are not forbidden because we do not have the belief that Allah gave them the power to enact those beneficial effects.	So, what is your view?	12

⁷ Literally, *tabdhīr* means wasting or squandering.

⁸ Literally, *shirk* means ascribing a partner for God in lordship and worship.

13	Well, it is not in the nature of fire and food by themselves to have the power to burn or to satiate. Moreover, it is not the case that Allah gave them the power to burn or to satiate. Indeed, it is rather the case that Allah is the one who burns and satiates by enacting the burning of something dry when it is touched by fire, and by enacting in the same way that we become satiated when we have food. Is it right?	Yes, it is.	14
15	So, there is no <i>shirk</i> and <i>bid'a</i> in such belief involving the power of Allah to enact the effects of fire and food, right?	Yes, I concede.	16
17	Likewise, the acts of <i>manyanggar</i> and <i>mambuang pasilih</i> have no power either by their own nature or given by Allah to cure or avoid danger. It is Allah who has the power to cure and avoid danger by enacting that if those acts are carried out then, he himself, Allah, cures and avoids the danger in the time of carrying out these rituals. So, there is no <i>shirk</i> and <i>bid'a</i> in such a belief, right?	Yes, there is no <i>shirk</i> and <i>bid'a</i> in such belief.	18
19	So, if deploying fire and food are not forbidden, so must also the practice of <i>manyanggar</i> and <i>mambuang pasilih</i> be not forbidden. Is it right?	No, I don't agree. It is true that there is no <i>shirk</i> and <i>bid'a</i> in your belief about <i>manyanggar</i> and <i>mambuang pasilih</i> . But, you cannot argue their permissibility based on the similarity between your belief about their effects and your belief about the effects of deploying food and fire. Certainly, food and fire are different to <i>manyanggar</i> and <i>mambuang pasilih</i> . Satiation is enacted by Allah through Food, a natural entity; and similiary burning is enacted through the natural entity fire – we can say then that in this sense fire and food are natural causes of the effects of burning and satiation enacted by Allah. However, <i>manyanggar</i> and <i>mambuang pasilih</i>	20

		are not present in nature– we cannot say therefore that these rituals are the natural causes of the effects of healing and prevention enacted by Allah. Thus, while the deploying fire and food in order to attain their effects involves natural "causes", the effects of the practice of the contested rituals does not involve natural causes at all. Furthermore, although according to the belief associated to your practice of <i>manyanggar</i> and <i>mambuang pasilih</i> they are not to be considered <i>shirk</i> , they are still forbidden practices.	
21	Why?	The act of wasting (<i>tabdhīr</i>) is forbidden, isn't it?	22
23	Yes, it is.	Following Satan is also forbidden. Right?	24
25	Yes, it is right.	The act of wasting is spending resources improperly, isn't it?	26
27	Yes, it is.	Following Satan entails accomplishing the demands of Satan. Right?	28
29	Yes, it is right.	<i>Manyanggar</i> and <i>mambuang pasilih</i> are offering food to Satan, so they entail spending resources improperly in order to accomplish the demand of Satan. So, they are similar to the act of wasting and following Satan in regard to such properties (spending resources improperly and accomplishing the demands of Satan). Given the fact that wasting and following Satan are forbidden, the ceremonies of <i>manyanggar</i> and <i>mambuang pasilih</i> must also be forbidden.	30
31	I do not share at all the view that <i>manyanggar</i> and <i>mambuang pasilih</i> entail wasting. Accordingly their practice does not entail either following the footsteps of Satan. In fact, those who practice these rituals should not be likened to devils.	Can you develop your argument?	32

33	Sharing food with (living) family members with the intention of helping each other is not forbidden, right?	Yes	34
35	<i>Manyanggar</i> and <i>mambuang pasilih</i> consists in sharing food with the invisible men who lived in the old days with the intention that they would relieve our troubles. So, they are similar to sharing food with (living) family members with the intention of helping each other. Hence, they do not entail wasting.	How do you know that the invisible men who lived in the old days are still alive and need to eat?	36
37	We have two evidences confirming that who demands the offering of food are the invisible men: first, from the story the elders told us about from generations to generations; second, the words of a possessed person who at the moment of possession said: “O my descendants give me food so that I will help you to relieve your difficulties and to cure your illness”.	The story told by the elders constitutes no valid justification for the permissibility of <i>manyanggar</i> and <i>mambuang pasilih</i> because it is merely based on prejudice and delusion without evidence (<i>dalil</i>) confirming its truth. Moreover, the words of a possessed person do not constitute a legally valid evidence for asserting that who possesses the possessed person is a man. On the contrary there is evidence from the sources that who possesses the possessed person is Satan because some verses of Quran and Hadith, and what jurists say prove that only angels and devils can enter into the body of a human [...]. The difference between them is that angels only suggest (God’s) guidance and goodness while Satan only suggest the wrong path and evil. So, following the requests of a possessed does not provide evidence that Satan is not behind after all. ⁹	38
39	Ok, I concede <i>manyanggar</i> and <i>mambuang pasilih</i> consists in feeding Satan with the intention of curing illness, but the rituals themselves should be permissible.	Why?	40
41	Feeding a dog is permissible, right?	Yes.	42

⁹ The text uses sometimes, but not always uses “Satan” in plural, “demons” – this might be due to the edition of the manuscript.

43	Healing is also permissible, right?	Yes.	44
45	So, we suppose Satan likens a dog. Accordingly, we feed Satan with the intention of curing illness and in doing so we do as if Satan is a dog. So, the feeding of Satan should not be forbidden. Don't you agree?	No, I do not agree. That does not eliminate the <i>tabdhīr</i> and the concomitant act of following the footsteps of Satan. This kind of feeding is forbidden.	46
47	Why?	I can bring three arguments backing the interdiction.	48
49	Let us examine each of them	Killing a mouse or having sexual intercourse with your own wife is permissible, right?	50
51	Yes.	Curing heartache or rheumatism is also permissible, right?	52
53	Yes.	Is it permissible to kill someone with the intention of healing heartache even if while killing we do as if he is a mouse? Is it permissible to commit adultery in order to cure rheumatism even if during the intercourse the adulterous does as if he is with his wife?	54
55	No, it is not permissible	So, contrary to your claim feeding Satan with the intention of healing, even if when feeding you do as if you were feeding a dog, is still a despicable act, that must be forbidden.	56
57	What is your second argument?	Feeding Satan is not similar at all to feeding a dog. What you do when practicing <i>manyanggar</i> and <i>mambuang pasilih</i> indicates that you venerate Satan. The feeding of Satan contrasts strongly to the feeding of a dog.	58
59	What is the difference?	You do not give Satan leftover foods, but you provide beautiful foods, and you deliver it by putting it in decorated trays. Right?	60
61	Yes, it's right.	Mostly, you give a dog despicable food that is put haphazardly in any place. Right?	62
63	Yes, it's right.	So, what you do for Satan indicates that you venerate Satan. This shows	64

		that both kinds of feeding contrast each other very sharply.	
65	You said you have a third?	Medicine is practiced by treating the body of the sick person by inducing ingestion or by smearing or spraying it. This treatment impacts the body in such a way that it can be felt to be either cold or warm. Right?	66
67	Yes, it's right.	Thus, is the body of a sick person treated in the same way in Medicine as by means of <i>manyanggar</i> and <i>mambuang pasilih</i> ?	68
69	No, they are not.	Furtermore; is there any juridical indication establishing that <i>manyanggar</i> and <i>mambuang pasilih</i> are practices that are part of legally acknowledged Medicine?	70
71	No, there is not.	So, <i>manyanggar</i> and <i>mambuang pasilih</i> neither by the way these rituals are actually practiced nor by juridical sanction can those practices be called medicine. [Summing up, though <i>manyanggar</i> and <i>mambuang pasilih</i> do not involve idolatry they are not different to wasteful practices and therefore, who practices them is following the footsteps of Satan. Every such an act is to be thus forbidden].	72

7.3.4. Elements for a dialectical analysis of the argument

The main moves of the dialogue involve three forms of objection (*i'tirād*), namely: *naqđ*, *farq* and *man'*. As already discussed, what these three forms of objection have in common is that the player who makes use of them, let us call him the *questioner* (*al-sā'il*), is committed to a sub-dialogue where he must display the grounds for his objection. What distinguishes them is the nature of the commitments engaged in the

respective sub-dialogues (for more details on these forms of objection, see Chapter 4, Sect. 4.3.3.1.).

a. *Man‘* (denial)

This move constitutes the rejection to one of the contender’s assertion. According to al-Shīrāzī (1987), this form of objection can be applied to deny the application of the ruling in the root-case or the existence of the property in the root-case, the branch-case, or in both. In the dialogue, this form of objection is applied only to deny the existence of some specific property or belief in the branch-case. In this case, the questioner is committed to a sub-dialogue where he shows that some specific property or belief (call it \mathcal{P}) does not apply to the case at stake, contrary to the claim of his antagonist. In fact, the dialogue also involves an objection which combines *man‘* with a competing analogy. In addition to denying that the property or belief \mathcal{P} applies to the branch-case, the questioner also brings forward a new root-case with which the branch-case shares some other property. That is to say, the questioner proposes another analogy for the branch-case competing the proposed analogy. Moreover, this competing analogy leads the branch-case to fall under the opposite ruling to that claimed by the rival. Al-Baṣrī (1964, Vol. 2, p. 770) calls this competing analogy “*mu‘āraḍa al-qiyās bi al-qiyās*”. For this reason we call this combination of objections *man‘-mu‘āraḍa*.

b. *Naqḍ* (inconsistency)

As discussed in Chapter 4, the questioner is committed to bring forward (in a sub-dialogue) a case of which it is recorded (or is of general acceptance) that a different ruling to the claimed ruling applies (whereas both rulings are incompatible), despite the fact that the new case and the case under scrutiny share the same property or belief \mathcal{P} . This allows the questioner to indicate that the position of the antagonist is inconsistent.¹⁰

¹⁰ Notice that the rulings leading to *naqḍ* are not always based on producing two contradictory rulings or sanctions, it is sufficient to bring forward two incompatible ones. Let us recall the example of this form of objection in Chapter 3 – though this example involves *qiyās al-‘illa* rather than *qiyās al-shabah*,

c. *Farq* (invalidating distinction)

The questioner is committed to a sub-play where he brings forward a specific property or belief that distinguishes the root-case and the branch-case in relation to the ruling at stake, despite the fact that both cases share some general property. In this case the questioner is required to show that the distinction does not support transferring the ruling of the root-case to the branch-case.¹¹

The following table displays schematically the uses of the objections occurring in the dialogue.

The table 7.2. The Forms of Objection in the Dialogue

Notational Conventions:

“*a* is \mathcal{K} ”, stands for “the root-case *a*, *al-aṣl*, falls under the ruling \mathcal{K} ”.

“*a* is \mathcal{P} ”, stands for “the root-case *a* enjoys or instantiates the property/belief \mathcal{P} ”.

“*f* is \mathcal{K} ”, stands for “the branch-case *f*, *al-far‘*, falls under the ruling \mathcal{K} ”.

“*f* is \mathcal{P} ”, stands for the branch-case *f* enjoys or instantiates and the property/belief \mathcal{P} ”.

“*a* $\approx_{\mathcal{P}}$ *f*”, stands for “the root-case and the branch-case are similar, *shabah*, with regard to the property/belief \mathcal{P} ”

“*a**” stands for a new root-case

X's <i>qiyās al-shabah</i>	Y's objection Sub-dialogue	Form of objection
a is \mathcal{K} a is \mathcal{P} f is \mathcal{P} $a \approx_{\mathcal{P}} f$ \downarrow f is \mathcal{K}	f is not \mathcal{K} or a is not \mathcal{P} or f is not \mathcal{P} or a and f are not \mathcal{P}	<i>Man‘</i>
	f is not \mathcal{P} , but \mathcal{R} a^* is \mathcal{R} a^* is not \mathcal{K} \downarrow f is not \mathcal{K}	<i>Man‘-mu‘āraḍa</i>

some forms of homicide neither lead to jail nor to being set free but to the obligation of carrying out certain specific social services.

¹¹ This, in fact, can be seen as countering the criticisms of the anti-analogists that say that it is always possible to find some property to distinguish two cases (or some general one to make them similar).

<p>The conclusion f is \mathcal{K} is obtained by substituting the root-case a by the branch-case f in “a is \mathcal{K}”.</p> <p>Notice, the rationale behind this substitution is that since a and f are identical with regard to \mathcal{P}, whatever in correlation with \mathcal{P} in the root-case a should be in correlation with that in the branch-case f.</p>	<p>a^* is \mathcal{P}; a^* is \mathcal{K}^* \downarrow inconsistency (\mathcal{K} and \mathcal{K}^*)</p> <p>note: recall that \mathcal{K} and \mathcal{K}^* might be incompatible rather than contradictory</p>	<i>Naqd</i>
	<p>f is not similar to a in relation to \mathcal{Q} \downarrow f is \mathcal{P} is not sufficient for inferring f is \mathcal{K}</p> <p>Thus, though a and f can be considered to be similar in relation to \mathcal{P}, they are different in relation to \mathcal{Q}.</p> <p>note: \mathcal{Q} induces a subset in \mathcal{P}, namely, the set “all those instances of \mathcal{P} that satisfy \mathcal{Q}”.</p>	<i>Farq</i>

Let us now insert content to the schema. The dialogue starts by the Proponent claiming that practicing *manyanggar* and *mambuang pasilih* should be forbidden, due to the fact that they are similar to both, *wasting resources and following Satan* and to *idolatry*. However; though the dialogue starts by claiming that the rituals amounts to *wasting resources and following Satan*, in the order of justification it starts by stating that the practices of these rituals can be likened to the practice of idolatry.

In fact, the justifications for each of the main claims structures the dialogue in two main sub-arguments, one involving idolatry and the other wasting resources and following Satan. The rhetorical device of mentioning wasting resources first, is effective, since as displayed in the dialogue above, the Proponent concedes that the practice of those rituals is not idolatry after all. So, the main reason for their interdiction is that of wasting and following Satan.

The schema 7.1. The argument on *manyanggar* and *mambuang pasilih*

I. First sub-argument: Idolatry

Proponent's thesis: Practicing *manyanggar* and *mambuang pasilih* is forbidden

The branch-cases f :

manyanggar and *mambuang pasilih*

The root-case a :

practicing idolatry

The shared belief \mathcal{P} :

The belief that practicing some ritual is the cause that enacts a desired effect

Inferred Ruling \mathcal{K} :

Forbidden

Argument:

- (1) a is \mathcal{K} ;
- (2) a is \mathcal{P} ;
- (3) f is \mathcal{P} ;
- (4) *shabah*, $a \approx_{\mathcal{P}} f$: a and f are similar in relation to \mathcal{P} . Hence, by substituting a in “ a is \mathcal{K} ” by f , we conclude f is \mathcal{K} .



I.1. The Opponent's denial and competing analogy (*man'-mu'āraḍa*): Practicing *manyanggar* and *mambuang pasilih* is not to be likened to idolatry; rather they resemble *using fire* and *eating food*. Those practices are not forbidden.

The branch-cases f :

practicing *manyanggar* and *mambuang pasilih* in order to prevent disease, or healing, or avoid disaster.

The root-case a^* :

using fire to ignite wood, feeding (eating food) to satiate hunger

The shared belief \mathcal{Q} :

The belief that only Allah is the one who enacts one event to happen, when another, concomitant with the first, occurs.

The denied belief \mathcal{P} (to apply to f):

The belief that practicing some ritual is the cause that enacts a desired effect

Inferred Ruling \mathcal{K}^* :

permissible, not forbidden

Sub-dialogue:

- (1) f is \mathcal{Q} , not \mathcal{P} ;
- (2) a^* is \mathcal{Q} , not \mathcal{P} ;
- (3) a^* is \mathcal{K}^* ;

- (4) f is **not similar** to acts of idolatry but to those acts believed to be enacted by Allah. In other words, a^* and f are similar in relation to \mathcal{Q} , $a^* \approx_{\mathcal{Q}} f$. Hence, by substituting a in “ a^* is \mathcal{K}^* ” by f , we conclude f is \mathcal{K}^* .



I.1.1. **The Proponent’s distinction (*farq*):** Practicing *manyanggar* and *mambuung pasilih* is different to igniting and feeding. This distinction does not support the claim that the rituals at stake are to be likened to not forbidden practices

The branch-cases f :

practicing *manyanggar* and *mambuung pasilih* in order to prevent disease, or healing, or avoid disaster.

The root-case a^* :

using fire to ignite wood, feeding (deploying food) to satiate hunger.

The shared belief \mathcal{Q} :

the belief that only Allah is the one who enacts one event to happen, when another, concomitant with the first, occurs.

The property that invalidates the similarity \mathcal{R} :

natural events enacted by Allah.

Invalidated Ruling \mathcal{K}^* :

that the branch-case is permissible, cannot be validated

Sub-dialogue:

- (1) a^* is \mathcal{Q} and \mathcal{R} ;
- (2) it is **not** the case that f is \mathcal{R} ; though f is \mathcal{Q} ;
- (3) so a^* and f are *different* in relation to \mathcal{R} , $a^* \not\approx_{\mathcal{R}} f$. Hence, in the context of this distinction we cannot conclude that f is \mathcal{K}^* .



Conclusion of the first sub-argument: Practicing *manyanggar* and *mambuung pasilih* is not idolatry, but the arguments do not ground the permissibility of these practices.

II. Second sub-argument: Wasting and following Satan

Proponent’s thesis: Practicing *manyanggar* and *mambuung pasilih* is forbidden

The branch-cases f :

manyanggar and *mambuung pasilih*

The root-case a^{} :**

acts of wasting and following Satan

The shared property \mathcal{S} :

spending resources improperly and accomplishing the demands of Satan

Inferred Ruling \mathfrak{K} :

Forbidden

Sub-dialogue:

- (1) a^{**} is \mathfrak{K} ;
- (2) a^{**} is \mathfrak{S} ;
- (3) f is \mathfrak{S} ;
- (4) *shabah*, $a^{**} \approx_{\mathfrak{S}} f$: a and f are similar in relation to \mathfrak{S} . Hence, by substituing in “ a^{**} is \mathfrak{K} ” the root-case by the branch-case we conclude f is \mathfrak{K} .



II.1. **The Opponent’s denial and competing analogy (*man’-mu’āraḍa*):** Practicing *manyanggar* and *mambuang pasilih* are not to be likened to acts of wasting and following Satan, but they likened to acts of feeding one’s own family. The rituals are therefore **not** forbidden.

The branch-cases f :

practicing *manyanggar* and *mambuang pasilih* in order to prevent disease, or healing, or avoid disaster.

The root-case a^{*} :**

acts of feeding one’s own (living) family.

The shared property \mathfrak{G} :

sharing food in order to help each other.

The denied property \mathfrak{S} (to apply to f):

spending resources improperly and accomplishing the demands of Satan

Inferred Ruling \mathfrak{K}^* :

permissible, not forbidden

Sub-dialogue:

- (1) f is \mathfrak{G} , not \mathfrak{S} ;
- (2) a^{***} is \mathfrak{G} , not \mathfrak{S} ;
- (3) a^{***} is \mathfrak{K}^* ;
- (4) f is **not similar** to acts of wasting, but to acts of feeding one’s own family. In other words, $a^{***} \approx_{\mathfrak{G}} f$. Hence, by substituing in “ a^{***} is \mathfrak{K}^* ” the root-case by the branch-case we conclude f is \mathfrak{K}^* .



II.1.1. **The Proponent’s denial (*man’*).** There is no evidence that practicing *manyanggar* and *mambuang pasilih* enjoys the property of sharing food in order to help each other.

We will not develop the moves here. The point is that the Proponent forces his contender to concede that practicing *manyanggar* and *mambuang pasilih* is actually feeding Satan rather than the hidden, invisible, family.



II.1.2. The Opponent accepts that there is no evidence that practicing *manyanggar* and *mambuang pasilih* is not wasting and following Satan. However, he argues that feeding Satan is not to be forbidden.

Despite the fact that the Opponent accepts that the rituals at stake are to be likened to acts of following Satan, surprisingly, the Opponent still insists in their permissibility. His justification can be sketched as follows. The Opponent asks the Proponent to concede that feeding a dog and healing are permissible. Once conceded by the Proponent, the Opponent establishes the resemblance of offering food in order to heal the offeror by means of the contested rituals and feeding a dog (in order to heal the offeror). Based on that, and given that feeding a dog in order to heal the offeror is permissible, the Opponent concludes that offering food for Satan (in order to heal the offeror) by means of practicing *manyanggar* and *mambuang pasilih* should be permissible, under the condition that during that offering the offeror does as if he is feeding a dog.



II.1.2.1. Three objections of the Proponent.

Naqd: Opponent's claim that feeding Satan, under the condition that during the feeding the feeder does as if he is feeding a dog is inconsistent.

The branch-cases f :

practicing *manyanggar* and *mambuang pasilih* in order to prevent disease, or healing, or avoid disaster.

The root-case deployed by the Opponent a_1 :

Feeding a dog with the purpose of healing the feeder.

Opponent's assumption:

f is \mathfrak{K}^*

The new root-cases a_2, a_3 :

killing someone, having intercourse with someone other than the wife.

The shared property \mathfrak{B} :

while performing an evil action, doing as if someone different to the actual object of the action has been aimed by that action.

Inferred inconsistency \mathfrak{K} and \mathfrak{K}^* :

forbidden and permissible.

Sub-dialogue:

- (1) a_2 is \mathfrak{K} , a_3 is \mathfrak{K} ;
- (2) a_2 is \mathfrak{B} , a_3 is \mathfrak{B} ;
- (3) f is \mathfrak{B} ;
- (4) $a_2, a_3 \approx_{\mathfrak{B}} f$. Thus, by substitution the Opponent is forced to accept that f is \mathfrak{K} .
However, the Opponent also conceded f is \mathfrak{K}^* . So, the Opponent is forced to concede \mathfrak{K} and \mathfrak{K}^* . Hence the Opponent's position is inconsistent

Farq: Feeding Satan (by practicing *manyanggar* and *mambuang pasilih*) is different to feeding a dog.

The branch-case f :

Feeding Satan by practicing *manyanggar* and *mambuang pasilih*.

The root-case a_1 :

Feeding a dog.

The shared property \mathcal{U} :

Feeding.

The property that invalidates the similarity \mathcal{C} :

the feeding is carried out in a careless manner (left-overs).

Invalidated Ruling \mathfrak{K}^* :

that the branch-case is permissible, cannot be validated

Sub-dialogue:

- (1) a_1 is \mathcal{U} and \mathcal{C} ;
- (2) it is **not** the case that f is \mathcal{C} , though f is \mathcal{U} . Indeed though, feeding Satan and feeding a dog, are both feeding, the first is carried out with much effort and care, while the latter is carried without such care.
- (3) Thus, the root-case and the branch-case are *different* in relation to \mathcal{C} , $a_1 \not\approx f$. Hence, in the context of this distinction we cannot conclude that f is \mathfrak{K}^* .

Man⁴: *manyanggar* and *mambuang pasilih* are **not** to be likened to medical practices.

The branch-cases f :

practicing *manyanggar* and *mambuang pasilih* in order to prevent disease, or healing, or avoid disaster.

The root-case a_4 :

acknowledged medical practices

The specific property \mathcal{N} denied to apply to f :

Acts of healing, making use of acknowledged practices such as smearing the body with some substance; and having verifiable impact in the body.

Sub-dialogue:

- (1) a_4 is \mathcal{N} ;
- (2) f is **not** \mathcal{N} ;
- (3) f is **not similar** to acknowledged medical practices in relation to the way they are carried out, and in relation to their impact in the body. In other words, $a_4 \not\approx_{\mathcal{N}} f$. Hence, under these conditions, their permissibility cannot be concluded.



Conclusion of the whole dialogue: Practicing *manyanggar* and *mambuang pasilih* is forbidden.

7.4. *Qiyās al-‘illa* on *lahang*

7.4.1. An overall view of the argument

The aim of the argumentation is to decide about the legality of the consumption of *lahang*, a traditional drink made of the juice of the sugar-palm tree.¹² In fact, one expects to see an argument that follows the steps of the most known examples of *qiyās al-‘illa*, namely the one that leads to the interdiction of the consumption of wine.

Let us recall the classical example: date liquor intoxicates, just as (grape) wine does, so that it is prohibited like wine. The canonical analysis identifies four elements in such an argument: the branch-case, date liquor; the root-case, wine; the character they have in common, their power to intoxicate; and their common legal qualification, prohibition. The crucial step that underlies this form of argumentation is the identification of the occasioning factor, the *‘illa*, that lies behind its prohibition. The point here is that applying the general principle that *drinks that have the power to induce intoxication should be forbidden* to the case of date liquor *occasions* its interdiction.

Now, since *lahang*, even if fermented does not induce intoxication, we should conclude, quite straightforwardly, that its consumption should not be forbidden. However, as quite often Arsyad al-Banjari adds a twist to it. According to Arsyad al-Banjari, one crucial feature of wine is that if some substance is added to it, in order for example to accelerate the process of becoming vinegar, this substance is impure, even after the wine became vinegar. The point is that the added substance has been contaminated by the impurity of wine. Moreover, the contamination of the additive spreads to the vinegar making it impure too.¹³ So, as generally defended by the Shāfi’īs, Arsyad al-Banjari considers that wine-vinegar can become impure and interdicted.¹⁴

¹² More precisely *lahang* is made from the juice of *Arenga pinnata*.

¹³ See the discussion on this issue in Chapter 6, specifically on what we call *non-canonical qiyās*.

¹⁴ In relation to the contamination of wine-vinegar al-Banjari refers to *Tuḥfat al-Muḥtāj fī Sharḥ al-Minhāj* by Ibn Hajar al-Haytamī (909-974H/1504-1567), re-printed 1983 and *Nihāyat al-Muḥtāj ilā Sharḥ al-Minhāj* by al-Ramlī (919-1004H/1513-1596), re-printed 1984. Both of these jurists were Shāfi’īs.

Under this lens the intoxicating nature of wine, which occasions its interdiction and impurity qualification, also entails its capacity of contaminating with impurity whatever substance it touches. So, on Arsyad al-Banjari’s view, the capacity of wine contaminating with impurity other substances it touches is part and parcel of its interdiction.

In short, Arsyad al-Banjari’s argument for the lawfulness of the consumption of *lahang* amounts to the observation that this drink is intoxicating neither before nor after being fermented, and moreover, it does not contaminate substances added to it, not even before becoming vinegar.

In order to make it apparent that the argument follows the canonical example of *qiyās al-‘illa* for the interdiction of wine we will re-structure the order of the text so that it fits the Respondent-Questioner interaction required by the *Jadal* framework.

7.4.2. The dialogue on fermented *lahang*

The table 7.3. Dialogue on fermented *lahang*

O		P	
		The consumption of <i>lahang</i> is allowed, even if fermented. Furthermore, whatever pure substance is added to it before the <i>lahang</i> becomes vinegar rests pure and thus the resulting vinegar is pure and hence its consumption is not forbidden either.	0
1	Why?	According to the sources the consumption of wine made of fermented grape-juice is forbidden. Right?	2
3	Indeed.	In a previous debate we established that the occasioning factor for its interdiction is its intoxicating nature. Right?	4
5	We came to that conclusion before.	Isn't it the case that whatever pure substance is added to wine (made of grape juice) before it becomes	6

		vinegar, becomes contaminated by the impurity of the wine? Moreover, isn't it the case that this contamination (<i>mutanajjis</i>) makes thus the resulting vinegar to become impure and that it therefore also makes its consumption forbidden?	
7	Yes, this follows from our previous discussions on the interdiction of wine	Now, it has been verified by repeated observations that if <i>lahang</i> is left over night and ferments, it has no intoxicating nature. So, it has intoxicating nature neither before nor after it ferments. Even when it is drunk in a large amount.	8
9	This can be indeed verified	Therefore, its vinegar is intoxicating neither. Furthermore, the vinegar cannot be contaminated by any pure substance added to the <i>lahang</i> that vinegar is made of. Recall that the <i>lahang</i> is not intoxicating before becoming vinegar even if fermented.	10
11	Yes, I see.	So, clearly, <i>lahang</i> has not the factor occasioning the interdiction of wine. Right?	12
13	Yes, I concede.	Thus, its consumption in any form, before fermentation, after fermentation; after becoming vinegar is to be allowed	14
15	Yes. I concede.	So, my case has been closed and it provides the justification for the thesis you asked for with your first move	16

7.4.3. Elements for a dialectical analysis of the argument

Efficiency (*ta'thīr*) of intoxicating in relation to unlawfulness and impurity

In order to argue that the consumption of fermented *lahang* is lawful and that the drink is not impure, and that this also holds for the vinegar made from it – even if a pure solid substance is added during the process of becoming vinegar, the Proponent first brings forward the canonical case of wine. Moreover, the Proponent recalls the classical argument justifying the interdiction of the consumption of wine and its status of being

impure. The move is crucial for the argument developed by the Proponent since it will provide the justification of his thesis. In fact, wine provides the root-case of the *qiyās al-illa*.

More precisely, the point of recalling the example is **not** to infer by resemblance, but in order to identify the occasioning factor, namely the property of inducing toxicity. Arsyad al-Banjari even displays al-Shīrāzī’s test of *efficiency* that verifies that inducing toxicity is indeed the occasioning factor. This is the subject of the first section of the dialogue.

The schema 7.2. The argument on *lahang*

First sub-argument: the interdiction of consuming wine

Proponent’s thesis:

The consumption of wine is forbidden because of inducing intoxication.

The root-case *a*:

(grape) wine

The property *℘*:

inducing intoxication

The Ruling *℔*:

forbidden

a is *℔*

The rationale

- (1) The property *℘* is efficient (*ta’thīr*) in relation to *℔*.
 - (1.1) *℘* satisfies *ṭard* (the test of co-extensiveness): if the intoxicating-power is present for some *x*, then the unlawfulness is also present.
 - (1.2) *℘* satisfies *’aks* (the test of co-exclusiveness): if the intoxicating-power is absent, for some *x*, then so is the unlawfulness.
- (2) *a* is *℘*.
- (3) Hence, *a* is *℔*.

In the next section of the dialogue, the Proponent asks the Opponent to concede, that even the vinegar that is made from grape-juice becomes both unlawful and impure if a (previously) pure *solid* substance such as stone or leaf is added to the grape-juice before it turns into vinegar. The point is that by this addition the vinegar becomes contaminated since the juice will turn firstly into wine which is impure and contaminates the substance, and subsequently, that substance contaminates the resulting vinegar to become impure and that therefore also makes its consumption forbidden. The qualification *solid*, refers to an object that when added to grape-juice does not dissolve or does not mingle with it.

In other words, adding substances that mingle or dissolve with the grape-juice, such as sugar, honey or wheat do not contaminate the resulting vinegar. This leads to the next section of the dialogue that combines the efficiency of the intoxicating-power with its propensity to be contaminated.

Second sub-argument: the interdiction of consuming wine and its impurity

Proponent's thesis:

Wine (i.e. wine which turns into vinegar) is forbidden to consume and is impure due to intoxicating-power and propensity to be contaminated.

The root-case *a*:

(grape) wine

The properties $\mathcal{P}_1, \mathcal{P}_2$:

intoxicating-power, propensity to be contaminated (by addition of a pure solid substance)

Inferred Rulings \mathcal{K}, \mathcal{S} :

forbidden, having an impure status

a is \mathcal{K} and \mathcal{S} .

The rationale

- (1) Properties $\mathcal{P}_1, \mathcal{P}_2$ are efficient (*ta'thīr*) in relation to \mathcal{K} and \mathcal{S} .
 - (1.1) $\mathcal{P}_1, \mathcal{P}_2$ satisfy *tard* (the test of co-extensiveness): if the intoxicating-power and the contaminating propensity are present for some *x*, then the unlawfulness and the impurity are also present.
 - (1.2) $\mathcal{P}_1, \mathcal{P}_2$ satisfy *'aks* (the test of co-exclusiveness): if the intoxicating-power and the contaminating propensity are absent for some *x*, then the unlawfulness and the impurity are also absent.
 - (2) *a* is \mathcal{P}_1 , *a* is \mathcal{P}_2 .
 - (3) Hence, *a* is \mathcal{K} and \mathcal{S} .
-

At this point of the debate all the elements for justifying the main thesis have been set up. The idea is to use *'aks* in order to infer from the absence of the occasioning factors in *lahang*, that this beverage is not impure and its consumption is not forbidden.

The main thesis: *lahang* is not impure and its consumption is not forbidden

Proponent's thesis:

lahang (including its vinegar) is not impure and its consumption is not forbidden

The branch-case *f*:

lahang

The root-case *a*:

(grape) wine

The properties $\mathcal{P}_1, \mathcal{P}_2$:

intoxicating-power, propensity to be contaminated (by addition of a pure solid substance)

Inferred Rulings \mathcal{K}, \mathcal{S} for the root-case:

forbidden, having the status of being impure; a is \mathcal{H} and \mathcal{G}
Inferred Rulings \mathcal{H}^* , \mathcal{G}^* for the branch-case:
 allowed, not-impure

Argument

- (1) Properties \mathcal{P}_1 , \mathcal{P}_2 are efficient (*ta'thīr*) in relation to \mathcal{H} and \mathcal{G} .
 - (1.1) \mathcal{P}_1 , \mathcal{P}_2 satisfy *tard* (the test of co-extensiveness): if the intoxicating-power and the contaminating propensity are present for some x , then the unlawfulness and the impurity are also present.
 - (1.2) \mathcal{P}_1 , \mathcal{P}_2 satisfy *'aks* (the test of co-exclusiveness): if the intoxicating-power and the contaminating propensity are absent for some x , then the unlawfulness and the impurity are also absent.
- (2) a is \mathcal{P}_1 , a is \mathcal{P}_2 ;
- (3) Hence, a is \mathcal{H} and \mathcal{G} ;
- (4) f is not \mathcal{P}_1 , f is not \mathcal{P}_2 ;



(5) Hence, by *'aks*, f is \mathcal{H}^* and f is \mathcal{G}^*

7.5. Qiyās al-shabah on harta perpantangan

7.5.1. Brief remarks on the background of harta perpantangan

In the Banjarese society, women (wives) not only take care of houses and children, but also work shoulder to shoulder with men (husbands) in order to support the family finance. For instance, in a farmer family, both husband and wife work together in the farm. When it comes to planting, the husband usually clears the land and the wife plants the seeds. Waiting for the harvest, the husband works as fishermen, and the wife works as trader. In the past, when river, as the main infrastructure provided by nature, was the centre of the Banjarese activities, mainly in trading and transportation, women did transaction and trading on a small boat called *Jukung* floating on the river. Therefore, it can be witnessed in South Kalimantan until now that almost all who trade on *jukung* at floating markets on the river are women. That shows that women in the Banjarese society are not housewives who only take care of household affairs like cooking and washing clothes, but also play a significant role in supporting the family economy.

Now, the problem is what happens with the marital property in case of divorce or one of a couple die since there is no source dealing with such property. During his life in Arab, Arsyad al-Banjari did not encounter this issue since in Arabic society women do not work at all to help the household economy. It is different to what he saw in Banjar where wives work together with husbands to support the family finance as described previously. According to Guru Irshad Zein, as mentioned by Dakhoir (2010) and Irfan Noor (2015), it is for such a different culture between Arab and Banjar Arsyad al-Banjari delivered the concept of *harta perpantangan*.

Harta means property, and *perpantangan*¹⁵ means being exactly between two sides. So, the term *harta perpantangan* means the property that belongs to two equal sides (husband and wife). That is to say, when one of a couple die the marital property gained by a couple must be distributed first equally (50%-50%) to husband's and wife's parts before the deceased husband/wife's part is passed on to the heirs.¹⁶ Arsyad al-Banjari, as indicated by Dakhoir (2010) and Irfan Noor (2015), bases the equal distribution of marital property (*harta perpantangan*) on its resemblance to the earnings obtained in *shirka al-abdān* (labour partnership), namely a partnership where two persons or more work jointly and share their earning fifty-fifty.¹⁷ For example, if two workers agree to undertake home cleaning services for their customers on the condition that the income so earned will go to a joint pool which shall be distributed equally to two workers irrespective of the effort contributed by each worker.¹⁸

¹⁵ The word *perpantangan* is originated from the word *pantang* or *pintang* in Banjarese language that means to coincide or to face. See Zam-zam (1979, p. 73).

¹⁶ Concepts of marital property in fact can be found in other Indonesian society, such as *Harta Seuharkat* in Aceh; *Harta Gono Gini* in Java; *Harta Seguna Sekaya* in Sunda, *Harta Seugrabe* in Bali; and *Harta Suarang* in Jambi. See Dakhoir (2010).

¹⁷ Such a definition of *shirka al-abdān* is pointed out, for instance, by Abū Bakr al-Rāzī al-Jaṣṣāṣ (d. 370H/980), a prominent Ḥanafī jurist, in his *Sharh Mukhtaṣar at-Taḥāwī*. See al-Jaṣṣāṣ (2010, vol. 3, p. 250).

¹⁸ It presupposes that Arsyad al-Banjari concedes the legality of *shirka al-abdān*. It is interesting as the Shāfi'īs mostly refute the legality of such a partnership because it has the potential for deception and injustice, see Ibn Rushd (2004, vol. 4, p. 38). However, it should be noticed, although Arsyad al-Banjari does not follow some legal decisions of Shāfi'ī scholars, he consistently follows their methods of legal reasoning, particularly *qiyās*.

7.5.2. An overall view of the argument

The purpose of the argumentation is to decide the legality of *harta perpantangan*, the concept that the marital property gained through the joint work of husband and wife must be distributed equally. The structure of the argument has the form of *qiyās al-shabah*. Therefore, it is grounded in establishing an analogy based on the similarity of the branch-case and the root-case in relation to some property. As pointed out earlier, the concept of *harta perpantangan* is grounded on the resemblance between marital property and earnings obtained in *shirka al-abdān* (labour partnership). Even though we have no more information how the analogy established because of the disappearance of the treatise discussing this issue, it can be grasped that the analogy is based on the fact that marital property is gained by the joint work of the married partners (husband and wife) where one probably works more than the other; and the earnings in *shirka al-abdān* are obtained by the joint work of unmarried partners where, again, one probably works more than the others.

In order to delve into Arsyad al-Banjari's argument, we need to put it in comparison with other concepts of marital property as applied in Indonesian society. Some Indonesian communities allot woman only half the share of marital property given to man.¹⁹ This, for instance, is practiced in Banggai Island and some regions of central Java (Hasibuan, 2017). Such distribution of marital property is also applied by some communities in Aceh where it is called *harta seuharkat*. According to the Result of the Discussion of Ulema of North Aceh (Hasil Muzakarah Ulama Aceh Utara), this is based on allocation of inheritance in *'ilm al-farā'id* (inheritance law) that allots women half the share of inheritance available to men.²⁰ In other words, this distribution

¹⁹ See Dakhoir et al (2017).

²⁰ <http://riadybarna.blogspot.com/2009/02/harta-seuhareukat-seharkat.html>, accessed 14 January 2020. Some scholars hold that the original reasons for the differences of inheritance between men and women are the responsibilities that are allotted to spouses. A husband in Islam must use his inheritance to support his family while a wife has no support obligation. The same reason was used in Java regarding the distribution of marital property, a husband obtained $\frac{2}{3}$ and a wife $\frac{1}{3}$ of the total of marital property based on the principle of *sakgendong sakpikul*, that is, the principle that men are more likely than women to

is based on the similarity between marital property and inheritance with regard to their status as joint assets between owners including woman and man. It would be interesting to have a comparison between such concept of marital property and *harta perpantangan* since they both are based on *qiyās*.

If we follow Arsyad al-Banjari's argument on *harta perpantangan*, he would certainly object the unequal distribution of marital property which is based on its resemblance to inheritance. Although inheritance and marital property are similar in relation to the fact that they are possessed jointly between owners including woman and man, they can obviously be distinguished with regard to the way they are obtained. Inheritance is obtained by owners by means of inheritance, while marital property is earned by means of a joint work. So, marital property is rather similar to earnings obtained in *shirka al-abdān* than to inheritance.

Let us now develop a dialectical-argumentation between Arsyad al-Banjari's concept of *harta perpantangan* and the other concept of marital property we just mentioned within our dialogical framework. In this case, we assume Arsyad al-Banjari as the Opponent who objects the unequal distribution of marital property between husband and wife.

7.5.3. The dialogue on *harta perpantangan*

The table 7.4. Dialogue on *harta perpantangan*

O		P	
		Marital property should be distributed $\frac{1}{3}$ for woman (wife) and $\frac{2}{3}$ for man (husband).	0
1	Why?	According to the sources, inheritance is distributed $\frac{1}{3}$ for daughters and $\frac{2}{3}$ for sons, or in cases that inheritance is passed on to brothers and sisters, it is distributed $\frac{1}{3}$ for sisters and $\frac{2}{3}$ for brothers. In a nutshell, inheritance	2

have more responsibility for the family finance. Such principle is known in Bali with *sasuhun sarembat* (Hasibuan, 2017).

		should be distributed $\frac{1}{3}$ for woman and $\frac{2}{3}$ for man. Right?	
3	Yes.	Marital property and inheritance can be seen similar in relation to their distribution $\frac{1}{3}$ for woman and $\frac{2}{3}$ for man.	4
5	Justify!	Inheritance is a joint asset, right?	6
7	Yes	Marital property is also a joint asset, right?	8
9	Yes.	According to these endorsements, it seems reasonable to consider them identical in relation to the fact that they both are joint assets, and given your move 3 that inheritance should be distributed $\frac{1}{3}$ for woman and $\frac{2}{3}$ for man, should not this be similar to the distribution of marital property for wife (woman) and husband (man)?	10
11	No, I do not agree. Inheritance is certainly different from marital property.	Can you develop the argument?	12
13	Inheritance is joint property that is inherited by owners from someone else, isn't it?	Yes, it is.	14
15	Marital property is joint property that is not inherited from someone else, isn't it?	Yes, it is.	16
17	According to your move 14 and 16, inheritance is different from marital property in relation to the way they are obtained by owners. Inheritance is inherited by owners from someone else, while marital property is not.	Indeed.	18
19	So, joint property between owners is distributed $\frac{1}{3}$ for woman and $\frac{2}{3}$ for man provided that it is inherited. Since marital property is earned by not by inherited, the distribution $\frac{1}{3}$ for woman and $\frac{2}{3}$ for man cannot be applied.	I concede.	20
21	In fact, marital property is analogous with the earnings of <i>shirka al-abdān</i> in relation to the distribution.	Can you clarify it?	22

23	The earnings of <i>shirka al-abdān</i> are distributed equally among partners, right?	Yes	24
25	Marital property and the earnings of <i>shirka al-abdān</i> can be seen similar in relation to the equal distribution among partners.	Justify!	26
27	The earnings of <i>shirka al-abdān</i> are earned by joint work between partners where one probably works more than the other, aren't they?	Yes, they are.	28
29	Marital property is earned by joint work between wife and husband where one probably works more than the other, isn't it?	Yes, it is.	30
31	According to these endorsements, it seems reasonable to consider them identical in relation to the fact that they both are earned by joint work between some partners, either married or not, where one probably works more than the other.	I agree	32
33	If that is the case, and given your move 24 that the earnings of <i>shirka al-abdān</i> must be distributed equally among partners, should not this be similar to the distribution of marital property between husband and wife?	Indeed, according to their resemblance, equal distribution of the earnings of <i>shirka al-abdān</i> yields the analogous equal distribution for marital property (<i>harta perantangan</i>).	34
35	So, this provides the justification for the thesis you were asking for with your move 26: marital property must be distributed equally between wife and husband because it is analogous to such equal distribution of the earnings of <i>shirka al-abdān</i> . In addition, this invalidates your thesis that marital property should be distributed $\frac{1}{3}$ for woman (wife) and $\frac{2}{3}$ for man (husband).		

7.5.4. Elements for a dialectical analysis of the argument

The dialogue starts by the Proponent asking to the Opponent to concede that marital property should be distributed $\frac{1}{3}$ for woman (wife) and $\frac{2}{3}$ for man (husband) like

inheritance based on their resemblance with reference to the fact that they are joint assets between some owners including woman and man. The Opponent refutes to concede the requested assertion and launches an objection taking the form of *mu'āraḍa-farq*. Recall, as discussed in Chapter 4, in this case the Opponent is committed to a sub-play where he brings forward a specific property \mathcal{P}^* that distinguishes the root-case a and the branch-case f , despite the fact that both cases share some general property \mathcal{P} ; and this distinction does not support transferring the ruling of the root-case a (\mathcal{K}) to the branch-case f . Furthermore, the Opponent proposes a new *qiyās* between the branch-case f and the new root-case a^* competing the analogy proposed by the Proponent. More precisely, the Opponent brings forward the new root-case a^* that both shares with the branch-case f the specific property \mathcal{P}^* and that the other ruling \mathcal{K}^* applies to —notice, \mathcal{K} and \mathcal{K}^* are incompatible. In the dialogue, the Opponent argues that marital property and inheritance must be distinguished with the justification of the fact that though they both are joint assets, but inheritance is different sharply to marital property in relation to the way they are obtained by owners. Inheritance is inherited by owners from someone else, while marital property is earned by owners themselves through a joint work. This distinction does not support the claim that the distribution of marital property similar to the inheritance distribution. The Opponent, then, argues that marital property is rather similar to earnings obtained through *shirka al-abdān* with regard to the fact that the former is earned by the joint work of a married couple (husband and wife) and the latter is earned by the joint work of unmarried partners. Since the earnings of *shirka al-abdān* is distributed equally to the partners, the marital property should be distributed equally too between husband and wife.

The schema 7.3. The argument on *harta perantangan*

The Proponent's *qiyās*: marital property resembles inheritance

The Proponent's thesis: marital property is distributed $\frac{1}{3}$ for wife and $\frac{2}{3}$ for husband.

The branch-cases *f*:

marital property

The root-case *a*:

inheritance

The shared property \mathcal{P} :

joint assets

Inferred Ruling \mathcal{C} :

distributed $\frac{1}{3}$ for woman and $\frac{2}{3}$ for man

Argument:

- (1) *a* is \mathcal{C} ;
- (2) *a* is \mathcal{P} ;
- (3) *f* is \mathcal{P} ;
- (4) *shabah*, $a \approx_{\mathcal{P}} f$: *a* and *f* are similar in relation to \mathcal{P} . Hence, by substituting *a* by *f* in
(1) we conclude *f* is \mathcal{C} .



The Opponent's *mu'āraḍa-farq*: marital property is different from inheritance with regard to the way they are obtained; marital property actually is rather similar to earnings obtained in *shirka al-abdān* than to inheritance.

The Opponent's thesis: Marital property should be distributed equally between husband and wife.

The branch-cases *f*: marital property

The Proponent's root-case *a*: inheritance

The Opponent's root-case *a:** earnings of *shirka al-abdān*

The shared property between all cases (call it \mathcal{P}): joint assets

The specific property that invalidates the proposed similarity (call it \mathcal{Q}): earned by joint work of partners (i.e. to them the earnings will be distributed)

Invalidated Ruling \mathcal{C} : that the branch-case is distributed $\frac{1}{3}$ for woman and $\frac{2}{3}$ for man cannot be validated

Inferred Ruling \mathcal{C}^* : distributed equally for woman and for man

Sub-dialogue:

- (1) *a* is \mathcal{P} and \mathcal{Q} ;
- (2) it is **not** the case that *f* is \mathcal{Q} ; though *f* is \mathcal{P} ;

- (3) so, a and f are *different* in relation to \mathcal{Q} , $a \not\approx_{\mathcal{Q}} f$. Hence, in the context of this distinction we cannot conclude that f is \mathcal{H} .
- (4) actually, f is \mathcal{P} and \mathcal{R} ;
- (5) a^* is \mathcal{P} and \mathcal{R} ;
- (6) a^* is \mathcal{H}^* ;



(7) *shabah*, $a^* \approx_{\mathcal{R}} f$: a^* and f are similar in relation to \mathcal{R} . Hence, by substituting the root-case a^* by the branch-case f in (6) we conclude f is \mathcal{H}^* .

Appendix 7.A. The original texts

7.A.1. The text on *Manyanggar* and *Mambuang Pasilih*

<p>O students! You should know that some deeds that have become a custom in some “lands below the wind” (Malay: <i>negeri bawah angin</i>)²¹ such as <i>mambuang pasilih</i>, <i>manyanggar</i> and the like are innovations (<i>bid‘a</i>) which are in opposition to the quran, the hadith, companion’s opinion (<i>qawl ṣaḥāba</i>) and consensus of jurists (<i>ijmā‘</i>). Thus, they are heretical innovations (<i>bid‘at al-dalāla</i>), so that it is obligatory for those who carried them out to repent. It is also obligatory for kings and leaders to abolish them since they are immoral acts in which some evils are present; and every evil act must be interdicted and eliminated as [we find in] the command of Allah and His messenger in some verses of quran and hadith.</p>	<p>هندقله اغكوكهوى هي طالب بهوسن فكرجان يثتله ترعاتد فد ستغه نكرى باوه اغين سفرة ممبواغ فسيلاه دان مپغكر دان برغيغ سافمان يائت بدعه فد فر بواتن همب يغبرسلا ۲هن دغن قرآن دان حديث دان قول صحابة دان اجماع سكلين علماء مك يائت بدعه ضلالة يغ امت كجى واجب ائس اورغيغ مغرجاكندى سكر توبه درفدان، دان واجب ائس سكل راج ۲ دان اوراغ بسر مغيهلغكندى دركارن يقدمكن ايت درفد فكرجان معصية يغ مغندوغ براف بكي درفد يغ منكر، دان تيف ۲ فكرجان يغ منكر واجب منكهكندى دان مغيهلغكندى دغن سورة الله تعالى دان رسولن ددالم براف نص قرآن دان حديث.</p>
<p>Question: how much evil is present in the act of <i>mambuang pasilih</i> and <i>manyanggar</i>?</p>	<p>سؤال: براف باكي فكرجان يغ منكر بغتركندوغ ددالم فكرجان يغ برابواغ فسيلاه دان مپغكر ايت</p>
<p>Response: well, there are many evils contained in that act. One of them is called <i>tabdhīr</i> that means wasting by spending money/resources improperly; and a person that wastes and spends money/resources is called <i>mubadhdhir</i>. This is the evil that Allah and His Prophet prohibit in certain verses of quran and hadith as Allah’s word: “<i>wa lā tubadhdhir tabdhīrā. inna al-mubadhdhirīna kānū ikhwān al-shayāṭīn</i>”. It means: “Do not spend wastefully. Surely, the wasteful [people] are brothers of the devils”. That is to say,</p>	<p>جواب: ادفون باكي منكر يغتركندوغ ددالم فكرجان ايت امت بايق ستغه درفدن تبذير نماش ارتين ممبواغ ارت دغن مبلنجاكندى فد فكرجان يغدحرامكن، ايتله ارتى تبذير دان اورغيغ ممبواغ ارت دان مبلنجاكن دى فد فكرجان يغد جرامكن ايت دنماى مبذر مك اداله تبذير ايت سواة منكر يغدتكهكن الله تعالى دان رسولن ددالم براف نص آية قرآن دان حديث سفرقى فرمان الله تعالى: (وَلَا تُبْذِرْ تَبْذِيرًا. إِنَّ الْمُبْذِرِينَ كَانُوا إِخْوَانَ الشَّيَاطِينِ) ارتين جاغنه</p>

²¹ It is the ancient name of Southeast Asia in the Age of Commerce. See Reid (1988).

<p>do not spend your money/resources for forbidden acts, because those who spend their money/resources for a forbidden act become nothing but brothers of the devils by the fact that they are deceived and together with devils they do what is prohibited by Allah and His Messenger.</p>	<p>اغکو مبذر دری کرن سکال مریک یغ مبذر ایت اداله مریکیت سودارا سکال شیطان جوا یعنی جاغنه اغکو مبلنجاکن ارتامو فد فکرجان یغ حرام دری کرن بهواسن سکال مریکت یغ مبلنجاکن ارتان فد فکرجان یغ حرام ایت جدی سودارا سکال شیطان جوا فد فیق تفردای دغن فردایان دان برسام ۲ دغندی مخرجان یغ دتکهکن الله تعالی دان رسولن.</p>
<p>O intelligent brothers, listen to the prohibition of Allah to do <i>tabdhīr</i>; and [recall that] Allah strongly condemns those who do it so [<i>tabdhīr</i>] that they are likened to devils that are the most evil creatures. Should we appreciate the <i>tabdhīr</i>, but Allah prohibit and condemn it?</p>	<p>هی سودار یغ عاقل دغرله تکه الله تعالی دردد مخرجان تبذیر دان دچل الله تعالی سکیرا ۲ دسامکن الله تعالی اکندی دغن سکال شیطان یغ سجاهه ۲ مخلوق اداکه فاتوة تبذیر ایت دفرملیاکن دان دسرکن فد حال الله تعالی منکه دان منچلادیا.</p>
<p>One of the evils present in the act of <i>mambuang pasilih</i> and <i>manyanggar</i> is “<i>ittibā’ al-shayāṭīn wa ghurūrihim</i>” that means following the footsteps of Satans by doing what they [the devils] ask and expecting what they promised. That is a heinous evil act that Allah and His Messenger prohibits it in certain verses of quran and hadith as Allah’s word: “<i>wa lā tattabi’ū khuṭuwāt al-shayṭān innahu lakum ‘aduwwun mubīn. Innamā ya’murukum bi-l-sū’ wa al-faḥshā’</i>”. That means, do not follow the footsteps of devil, namely his deceit because he is to you a clear enemy. He only orders you to evil acts and immorality. As well, Allah’s word: “<i>wa man yattakhidhu al-shayṭāna waliyyan min dūnillāh faqad khasira khusrānan mubīnā</i>”. That means, whoever takes devil as an ally that he/she follow instead Allah has certainly sustained a clear loss. Devil</p>	<p>دان ستغه دردد منکر یغترکندوغ دالم فکرجان ربواغ فسیله دان میغکر ایت (اتباع الشیاطین و غرورهم) آرتهن میگو سکال شیطان دان میگو فدای مریکت، مک میگو سکال شیطان دغن معاصلکن بارغ فرمنتانن دان مغهارف ۲ یغدجنیکنن ای سواة منکر یغ امة کچی یغدتکهکن الله تعالی دان رسولن ددالم براف نص آیه قرآن دان حدیث سفرتی فرمان الله تعالی (وَلَا تَتَّبِعُوا خُطُوَاتِ الشَّيْطَانِ إِنَّهُ لَكُمْ عَدُوٌّ مُّبِينٌ . إِنَّمَا يَأْمُرُكُم بِالسُّوءِ وَالْفَحْشَاءِ) آرتهن دان جاغن کامو ایگو اکن سکال جانن شیطان یعنی فرهیاسنن دان فردایان دری کرن بهواسن شیطان ایت بکی کامو سترو یغ امة پات هان سن تیاد مپورهکن شیطان ایت اکن کامو ملاینکن دغن برواة کجاهتن دان سکال فکرجان یغ کچی دان لاکنی فرمان الله تعالی (وَمَنْ يَتَّخِذِ</p>

<p>promises humans and arouses desire in them. But devil does not promise them except delusion.</p>	<p>الشَّيْطَانُ وَلِيًّا مِّن دُونِ اللَّهِ فَقَدْ خَسِرَ خُسْرَانًا مُّبِينًا . يَعِدُهُمْ وَيُمَنِّيهِمْ وَمَا يَعِدُهُمُ الشَّيْطَانُ إِلَّا غُرُورًا) أرتيش بارغ سیاف یغ منجدیکن ای اکن شیطان ایت ولین یغد ایکوثن اکندی لاین درفد الله تعالی مک سان براوله کروکینله دغن روکی یغ امة پات ، منجنجیکن شیطان ایت اکن سگال مانسی دان مغارف ۲ ای اکن مریکئیت دغن یغدجنجیکئن ، دان تیاد منجنجیکن شیطان ایت اکن مریکئیت ملینکن یغدمکین ایت سفرقی اکن فردای ای جوا .</p>
<p>The other evils in the act of <i>mambuang pasilih</i> and <i>manyanggar</i> are <i>shirk</i> and <i>bid'a sayyi'a</i> (heretical innovations). Those are the very heinous evils. If it is believed that sick people cannot be cured or danger cannot be avoided except only by carrying out <i>manyanggar</i> or <i>mambuang pasilih</i>, in the sense that those acts have the power (to cure or to avoid danger) in their own nature, so the one who has such belief is heathen (<i>kāfir</i>). There is no disagreement of jurists on that case because that is going against oneness of Allah's deeds (<i>tauḥīd af'āl</i>). If it is believed that they [those acts] have no power in their nature, but it is believed that they have the power [to cure or to avoid danger] given by Allah to their nature, then the jurists agree that the one who believes so is the impious heretic (<i>bid'a fāsiq</i>); and jurists disagree on his/her heathenism (<i>kufr</i>). According to the jurists of [the region] "what lies beyond the river" (arabic: <i>mā warā' al-nahr</i>)²² he/she is also heathen (<i>kāfir</i>). If</p>	<p>دان ستغه درفد باکی منکر یغترکندوغ ددالم فکرچان بریواغ فسیله دان میغکر ایت یائت شرک دان بدعه سیئات، انیله منکر یغ ترلبه کچی . دری کرن جک داعتقدکنن بهوا تیاد سمبوه یغ ساکة درفد فپاکیت اتو تیاد ترتولق درفد بهای ملاینکن دغن میغکار اتو بریواغ فسیله مک دتیلک جک داعتقدکنن یغدمکین ایت ممبری بکس دغن طبیعتن مک اورغ ایت جادی کافر دغن تیاد برسلاهن سکالین علماء، کرن تیاد باکینن توحید فد افعال الله دان جک تیاد داعتقدکنن یغدمکین ایت ممبری بکس دغن طبیعتن هان داعتقدکنن اکندی ممبری بکس دغن قوای یغجددیکن الله تعالی ددالمئ مک اورغ ایت جدی بدعه فاسق تیاد برسلاهن سکالین علماء دان کفرن برسلاهن مریکئیت کات علماء ما وراء النهر اورغ ایت جادی کافر جو . دان جک تیاد داعتقدکنن یغدمکین ایت ممبری بکس دغن</p>

²² It is the arabic name of *Transoxania*, historical region of Turkistan in Central Asia east of the Amu Darya (Oxus River) and west of the Syr Darya (Jaxartes River), roughly corresponding to present-day Uzbekistan and parts of Turkmenistan, Tajikistan, and Kazakhstan. See The Editors of *Encyclopedia Britannica* (2018, October 5). See also Svat Soucek (2000, p. 25).

<p>it is believed that they have no power [to cure or to avoid danger] either in their own nature or given by Allah to their nature, but it is believed that only Allah who has the power to cure and avoid danger by enacting that if those acts are carried out then Allah cures and avoids the danger in that time. It is said that analogy and comparison for that is like [the deployment of] fire and food. They do not have the power in their own nature to burn or to satiate, as well they do have neither the power [to burn or to satiate] given by Allah. It is only Allah who burns and satiates enacting that when fire touches something dry, then it becomes burned, and enacting that when we eat food then we are satisfied. It is said that this is the analogy and the comparison of <i>manyanggar</i> and <i>mambuang pasilih</i>. So, someone who believes so does not become heathen by merely such a belief, but they are still heretics. However, had he/she pronounced the permissibility of <i>manyanggar</i> and <i>mambuang pasilih</i>, he/she would have been heathen (<i>kāfir</i>) with such belief; and there is no disagreement of jurists on that case.</p>	<p>طبیعتش دان تیاد ممبری بکس ای دغن قواة یغدجدیکن الله تعالی ددالمث، هان داعتقادکنث بهوسن یغ ممبری بکس فد مپمپکن دان منولقکنت بهای ایت الله تعالی جوا دغن دعادتکنث افبیل دکرچاکن سغکر اتو فسیله ایت مک دجدیکن الله تعالی سمبوه دری فپاکیت دان دتولقکنث سگال بهای فد کتیک ایت کتاث ادله قیاس دان بندغ یغدمکین ایت سفرتی افی دان مکانن تیاد ممبری بکس دی دغن طبیعتش فد مغماغسکن دان مغماغی دان تیاد ممبری بکس ای دغن قواة یغدجدیکن الله تعالی ددالمث هان یغ ممبری بکس فد مغماغسکن دان مغماغی ایت الله تعالی جوا، دغن دعادتکنث منجدیکن هاغس تتکال برسنتوه افی دغن سواة یغ کرپغ دان دعادتکنث کپیاغ تتکال ممان اکن مکانن. کتاث دمکینه قیاس دان بندغ سغکار دان فسیله، مک اورغیغ براعتقاد یغدمکین ایت تیاد جدی کافر دغن مجرد اعتقاد ایت هان جدیله بدعه جوا، تنافی جدی کافر ای جک دحلالکنث فکرجان سغکار دان فسیله دغن اعتقاد یغدمکین ایت دغن تیاد خلاف سکل علماء</p>
<p>Concerning the analogy and the comparison, it is not legally valid to pronounce the permissibility of <i>manyanggar</i> and <i>mambuang pasilih</i> based on that analogy because they have a different nature. Indeed, fire and food are natural causes [in the sense that Allah enacts being burned and being satisfied by means of the natural beings, fire and food], whereas <i>manyanggar</i> and <i>mambuang pasilih</i> certainly are not the natural cause [of being cured and being</p>	<p>. ادفون قیاس دان بندغ یغ ترسبوة ایت تیاد صح اکن جادی مغللاکنن اعتقاد یغترسبت ایت سبب برلأین لینن حکم دری کرن افی دان مکانن ایت سبزیپاله ای درفد سگال سبب یغ برعاده دغن تیاد شک دان تیاد خلاف. ادفون فکرجان سغکار دان فسیله ایت مک یائت سگال ۲ تیاد ای درفد سگال سبب یغ برعاده، دان جک دتقدیرکن برلاکو فدان کلاکوان سفرتی کلاکوان سبب یغبرعاده دغن</p>

<p>prevented from danger; in other words, since <i>manyanggar</i> and <i>mambuang pasilih</i> are not present in nature, we cannot say therefore that these rituals are the natural causes of the effects of healing and prevention enacted by Allah]. If, saying, when they are carried out, then being cured or being avoided from danger happens, it is nothing but the deceit of Satan. So, this analogy and comparison could not be legally valid.</p>	<p>مسیبین مک یائت سات ۲ فردای شیطان جوا مک بتاف کیران صح قیاس دان بندغ یغترسبت ایت.</p>
<p>O intelligent brothers, you should be aware: is there any danger bigger than the danger of heathenism (<i>kufir</i>) and blameworthy innovation (<i>bid'a sayyi'a</i>) so that those who perform them are cursed by Allah as [the] Prophet said: <i>man 'ahdatha hadathan fa'alaihi la 'natullāh ta'ālā</i>. That means, whoever commits innovation which opposes to religion, so the curse of Allah to him. O student! You should know that <i>manyanggar</i> and <i>mambuang pasilih</i> are not part of religion (Islam), but they are blameworthy innovations which are [to be] forbidden. So, those who carried them out will be cursed by Allah as told in the hadith.</p>	<p>هی سکا لین إخوان یغ عاقل فیکیرکن اولهمو دغن انصاف ادکه بهای یغترلبه بسر درفد بهای کفر دان بدعه سیئات یغرهادف آنس یغریواتدی لعنة الله تعالى سفرقی سبدا نبی صلی الله علیه وسلم (من أحدث حدثا فعليه لعنة الله تعالى) آرتین بارغسیاف مغادکن سواتو فکرجان یغ تیاد ای در فد اکام مک آنسن لعنة الله تعالى. کنهوی اولهمو هی طالب بهواسن فکرجان سغکار دان فسیله ایت تیاد ای درفد اکام اسلام هان اداله درفد فکرجان بدعه سیئات یغدتکهنکن درفدان، مک بارغسیاف مغرجاکندی آنسن لعنة الله تعالى سفرقی یغتر معلوم ددالم نص حدیث ایت.</p>
<p>Question: if they said that we carry out <i>manyanggar</i> and <i>mambuang pasilih</i> not because to share Satan food and to follow his demand, but those whom we share are the invisible men who lived in the old days. Among of them are the ancestral kings and the followers who are still alive up to now, so we share them food as a tribute with the intention that they would relieve our troubles. It is similar to sharing food with (living) families and friends with the intention of helping each other. This act is</p>	<p>سؤال: جک دکات اورغ بهوا کامی میغکار دان مبعواغ فسیله ایت تیاد کرن مبری شیطان دان مغیکوة فرمنتانن هان سن یغکامی بری ایت مانسی یغ غائب دهل کالا یائیت ستغنن للوهور راج ۲ دان ستغنن فسیسن اداله مریکئیت غایب دان هیدف سمفی سکارغ این مک کامی بری اکن مریکئیت ورنه بانکی مکان مکان کرن حورمة اکندی سفای دتلوغین اکن کامی فد بارغ فکرجان کام یغ سوسه سفرقی کامی مبری مکانن کفد</p>

<p>permissible, not forbidden, because it is not <i>tabdhīr</i> (wasting by spending money/resources) nor following Satan nor <i>shirk</i> and <i>bid'a</i>.</p>	<p>کلورکا دان صحابه یغ تیاد غایب سفای برتولوغ تولوغن کام فد بارغ فکرجان مک یایت فکرجان هارس تیاد حرام ددالمن کرن تیاد فدان تبذیر دان مغیکوة شیطان دان تیاد شرک دان بدعه</p>
<p>Response: that is simply invalid because that is purely delusion without evidence from the Quran, Hadith or what jurists say. How can we know that those who request the food are the invisible men living in the old days who are still alive up to now? So, every prejudice without evidence (<i>dalīl</i>) is not permitted to be relied upon and to be believed. Even if it is true that who request the food are the invisible men, the act (<i>manyanggar</i> and <i>mambuang pasilih</i>) is still forbidden and not permissible because it is committing <i>tabdhīr</i> and sinful innovation. Even if the food is eaten by human or animal, that does not eliminate the sin of <i>tabdhīr</i> and heretical innovation. It will be much more sinful if the food is given to Satan and its delivery containing some other evils.</p>	<p>جواب: فرکاتان ایت بطل جوا اداش دری کرن یغدمکین ایت سات ۲ دعوی دان وهم دغن تیاد دلیل درفد قرآن دان حدیث اتو قول علماء، مک دغن افا جوا کیت معتھوی بهواسن یغ منتأ سغکار ایت مانسی یغ غائب دھول کال هیدف سمفی سکارغ این. مک تیاف ۲ دعوی دغن تیاد دلیل ایت تیاد هارس دفرککاشی دان دجدیکن اعتقاد دان جکالو افمان دتریم دان دبزنکن بهوا یغ منتأسغکار ایت مانسی یغ غائب سکالیفون أداله فکرجان ایت جرام جوا تیاد هارس دکرچان کرن تیاد سوپی درفد تبذیر دان بدعه یغ حرام دان جک اوفمان دماکن اوله مانسی اتو بنانغ اکن مکان یغدانترکن کفد تمفة یغسغکار ایت سکالیفون تیاد جوا مغھیلغکن حرام تبذیر دان بدعه. استمواہ لاکئی جک ادا یغدبری مکان شیطان سرت دھمفنکن کفد فکرجان یغ منکر یغ لاین درفد ایت.</p>
<p>Question: if they said that we have two evidences confirming that who demands the food are the invisible men: first, the elders tell us about that story from generations to generations; second, the words of a possessed person who at the moment of possession said: “O my descendants give me food so that I will help you to relieve your difficulties and to cure your illness”.</p>	<p>سؤال: جک دکات اورغ بهوا دلیل کامی منونجو فکن انس بهو یغ منتأ سغکار ایت مانسی یغ غائب دوا فرکارا: فرتام چریترا اورغ توها ۲ تورن تمورون سره اد کناش جکایتش. کدوا فرکارا تتکال ای مپاروغ کفد سورغ مانسی کناش: هی انق چچوکو بری اولھمو اکنداکو مکان سفای کتولوغ اکن کامو فد بارغ فکرجان یغ سوکر اتو سفای سمبوه یغ ساکیه درفدامو. انیلہ افما فرکناش.</p>

<p>Response: the story that the elders tell about is not a legally valid justification of the permissibility of <i>manyanggar</i> and <i>mambuang pasilih</i> because it is merely prejudice and delusion without evidence (<i>dalīl</i>) confirming its truth. Moreover, the words of a possessed person are not a legally valid evidence for justifying that who possesses the possessed person is a man, but that is proof that who possesses the possessed person is Satan because some verses of Quran and Hadith, and what jurists say prove that only angels and Satans can enter into the body of a human because they are created by Allah with ability to do hard things so that they can enter into the body of a human. However, the difference between them is that angels only suggest (God's) guidance and goodness while Satans only suggest the wrong path and evil.</p>	<p>جواب: بهو چریترا اورغ توها ۲ دان فرکتان حکایه ایت تیاد صح جادی دلیل اُتس یغدمکین ایت، دری کرن ای سمات ۲ سغکا دان وهم جوا تیاد سرتان دلیل یغ منونجوقکن کبنارانن. دان دمکین لاکئی فرکتانن اورغ یغ کساروغن ایت سکال ۲ تیاد صح جدی دلیل یغ منونجوقکن اُتس بهو یغ مپاروغ ایت مانسی هان أدله بغه مکین ایت صح جادی دلیل منونجوقکن اُتس بهواسن یغ مپاروغ ایت شیطان جوا کرن یراف نص قرآن دان حدیث دان فرکتان سکال علماء یغ منونجوقکن اُتس بهواسن یغ بوله مپاروغ دان ماسق کفد بادن ایت ملایکه دان شیطان جوا دری کرن ملایکه دان شیطان ایت دجدیکن الله کواس مخرجان یغ سوکر هغکا دافه ای ماسق کدالم توبه مانسی تتافی فر بذائش بهواسن ملائکه ایت تیاد مپروای (ملائیکن) کفد جالن فتونجوق دان کباجیکن دان شیطان ایت تیاد مپروای ملایکن کفد جالن سسه دان کجاهتن.</p>
<p>It is mentioned further in the hadith that an angel called <i>mulhim</i> stays in the right side of human's heart, by Allah's command, suggesting goodness; and a Satan called <i>waswās</i> stays in the left side of human's heart, by Allah's command, suggesting evil. So, all good tendencies come from the suggestion of <i>mulhim</i> so his suggestion is called <i>ilhām</i> (inspiration); and all evil tendencies come from the suggestion of <i>waswās</i> so his suggestion is called <i>waswās</i> (evil thoughts). Therefore, if someone recites <i>dhikr</i> (remembrance) of Allah then the Satan will go far away and disappear from his heart, but if he neglects reciting <i>dhikr</i> of Allah the Satan will go back to</p>	<p>شهدان ترسبه دالم حدیث بهواسن سورغ ملائکه برنام ملهم بردیری فد هاتی انق آدم یغ فد فیق کانن دغن تینه الله تعالی فد حال مپرو ای کفد کبجیکن. دان سورغ شیطان برنام وسواس بردیری فد هاتی انق آدم یغ فد فیق کیری دغن تینه الله تعالی فد حال مپرو ای کفد کجهاتن. مک سکال خواطر کبجیکن داتغ درفد فیق سرو ملهم دان دنمای سرون ایت الهام، دان سکال خواطر کجهاتن ایت داتغ داری فیق سرو وسواس دان دنمای سرون ایت وسواس. مک أفبیل مپبوة سورغ مانسی اکن ذکر الله ترخنسیله شیطان یعنی اندورله دان پپله ای</p>

<p>his heart. This is the understanding of Allah's words: <i>min sharri al-waswās al-khannaās, alladhī yuwaswisu fī ṣudūr al-nās</i>. That is, I seek refuge with Him from the evil of Satan named <i>waswās</i>. He will go far away and disappear if <i>dhikr</i> of Allah is recited. He is the one who gives the evil thoughts in the hearts of people. Such is what al-Ghazālī said in the <i>Minhāj al-‘Ābidīn</i> and the others.</p>	<p>دردف هاتين، دان أفبيل لالي دردف مپوتدي مك داتغ فول اي، يائتوله مفهوم فرمان الله تعالى (من شَرِّ الوَسْوَاسِ الخَنَّاسِ. الَّذِي يُوسُوسُ فِي صُدُورِ النَّاسِ) يعني برلندوغ آكو دعندي دردف كجاهتن شيطان يغ برنام وسواس، اوندور اي دان په اي أفبيل دسبوة ذكر الله اپاله يغ ممبري وسواس ددالم هاتي سكال مانسي دمكينه دسبوتكن اوله امام غزالي ددالم منهاج العابدين دان لاينث.</p>
<p>Question: if someone says that whom we give the food in <i>manyanggar</i> and <i>mambuang pasilih</i> is indeed Satan, but our intention of carrying them out is only to cure. Otherwise, we suppose Satan similar to a dog, so we give the food to Satan as if we feed a dog. It was known that feeding a dog is permissible and there is no prohibition of such act. That is <i>manyanggar</i> and <i>mambuang pasilih</i> if we put them with such supposition and intention.</p>	<p>سؤال: جك بركات سورغ بهواسن يغ كامى سغكار دان يغ كامى بري فسيله ايت سببرنث شيطان جوا تنافي نية كامى فد مفرجان فكرجان ايت كرن اكن اوبه جوا، اتو كامى نيتكن شيطان ايت سفرة انجيج مك كامى بري اكندي مكان سفرة ممبري انجيج دان تله ترمعلوم بهواسن براوبه دان ممبري ماكن انجيج ايت فكرجان هارس تباد حرام دالمث سفرة دمكينه. اينله سغكار دان فسيله أفبيل دنيتكن دغن نية يغ ترسبه ايت.</p>
<p>Response: such supposition and intention are simply not helpful because they do not eliminate the prohibition of <i>tabdhīr</i>, following Satan and heretical innovation. That comparison is similar to someone who kills someone else with the intention to cure heartache and while killing he does as if the victim is a mouse. It is also similar to someone who commits adultery with the intention to cure rheumatism and during the intercourse he does as if he is with his wife. So, those suppositions and intentions do not eliminate the prohibition of killing and adultery. Furthermore, concerning what they said</p>	<p>جواب: بهوا نية يعدمكين ايت سكال ۲ تباد ممبري فائده كرن تباد مغيهلگكن حرام تبذير دان مگكوة شيطان دان حرام يدعه. مك بنديغ يعدمكين ايت سفرقي اورغيج ممبونه اورغ تباد دغن سببرنث سرت دنيتكن ممبونه تيكوس اتو دنيتكن اكن جادي اوبه ساكية هاتي دان سفرقي اورغيج زناء دنيتكن جماع دغن استرين اتو اكن جدي اوبه ساكية فغكغ اوغمان. مك نية يعدمكين ايت سكال ۲ تباد مغيهلگكن حرام ممبونه دان زناء، سبكي لاني فركتانن كام بري مكان اكن شيطان ايت سفرقي ممبري انجيج يائت سات ۲ دستا جوا تباد برسمان يغ ددالم هتين دغن</p>

<p>that giving the food to Satan is like feeding a dog, in fact what they said is different from what is in their heart. Their hearts venerate Satan, this is indicated by the fact that they do not give Satan leftovers, but they provide beautiful foods, and they server them in decorated trays and by doing so they indicate their respect for Satan. O intelligent brothers, is it similar to feeding a dog? Mostly, you do not give a dog food but despicable and leftovers that are put haphazardly in any place. Finally, <i>manyanggar</i> and <i>mambuung pasilih</i> should not be called Medicine neither by the practice involved in these rituals nor by juridical indication [there is no evidence from the sources at all indicating that these practices should be called Medicine]. Medicine is practiced by treating the body of the sick person by inducing ingestion or by semearing or spraying it. This treatment impacts the body in such a way that it can be felt to be either cold or warm [But the contested rituals do not treat the body in that way]</p>	<p>فرکتان لیداهن، أداله هاتین یغ معحرماتی دان مملیاکن اکن شیطان دغن دلیل دفریواتن بکی شیطان ایت براف باکی ماکن یغ انداه ۲ دان تیاد دبریکنن دسیسا ۲ دان لفس سرت دانترکنن کفد تمفتن دغن براف کلغکافن دان فرهیاسن دان براف فکرجان یغ منونجوکن اتس معحورماتی دان مملیاکن شیطان جوا ادا. فیکیرکن اولهم هی اخوان یغ عاقل اداکه سفرتی دمکین ایت مبری ماکن انجیغ، تیاد جوا مکان یغ دبریکن کفد انجیغ فد غالب ملینکن مکان یغ هینا لاکنی سیسا دان دبریکن فد سمبارغ تمفة اتس کلاکوان یغ تیاد مملیاکن. سبانی لاکنی سغکار دان فسیله ایت سکال ۲ تیاد فاتوة دنمای اوبه فد عادة استمیوا فول فد شرع هان یغدنمای اوبه فد عادة یائت بارغیغ دکناکن فد بدان اورغیغ داوبتی دغن دماکن اتو دمیمن اتو دبدقکن اتو دسمبورکن بارغیغ سباین سرت مملیپراکن یغ فاتوة فد طبیعه بدان اورغیغ داوباتی فد دیغنن اتو هاغنن.</p>
---	--

7.A.2. The text on *Lahang*

<p>It is understood from what has been explained above that vinegar made from <i>lahang</i> or the like is pure on the whole either it becomes vinegar automatically or because of being added with another substance which is pure because <i>lahang</i> does not turn into wine even if it is left for one night or more. So, it is different from grape juice and the like because <i>lahang</i> that is left overnight is not intoxicating. This [the fact that it is not intoxication] has</p>	<p>(شهدان) دکتهوی درفد سکلین یغ ترسبت ایت بهوسن چوک یغ جدی درفد لاهغ انو اتو برغسباکین سوچ ای اتس اطلاق یعنی سما ادا ای جدی چوک دغن سنندیرین اتو دغن دبو به سوات عین یغ سوچ کدالمث درکارن لاهغ انو ایت تیاد جدی خمر دغن دفرمالکن سالم اتو لبه برسلاهن دغن ایر بوه اغکور دان برغیغ سوغمان</p>
---	--

been observed several times even when it is drunk in a large amount. If wine is drunk in smaller amount than that, then it normally intoxicates. In the previous discussion, it was explained that the 'illa of the impurity and the unlawfulness of wine lies in its intoxicating nature. Hence, if such 'illa does not exist like in the case of *lahang* which is left overnight, then it is not impure and not unlawful. Likewise, vinegar made from it is pure and permissible to drink. Even though another substance is added within it, that does not change the ruling.

کارن لاهغ یغ تله دفرمالکن ایت تیاد ای مابوقکی
 دغن سوده ترجوبا دمیم ببراف کال هغک جکلو
 دمیم ای دغن قدر یغ بایق سکلیفون سکیرا ۲
 جک دمیم حمر دغن قدر یغ ترکورغ درفد ایت
 نسچای مابوقکیله ای (دان سن) تله تردهول
 فرکنان بهوسن علة نجس حمر دان علة حرمث یائت
 کادائش مابوقکی مک أفیل تیاده دفراولهرعلة یغ
 ترسبت ایت فد لاهغ انو یغ تله دفرمالکن تیاده
 نجس ای دان تیاد حرام (دان دمکینلاک) چوک
 یغ جدی درفدائ هان اداله ای سوچ هارس
 میندی دان جک دبو به سوات عین یغ لاین کدالمث
 مک یائت تیاد ممبری مضرة

References

- Adamson, P. (2019, April). *Al-Ghazālī, Causality, and Knowledge*. Retrieved from <https://www.bu.edu/wcp/Papers/Medi/MediAdam.htm>
- al-Baṣrī, Abū al-Ḥusayn. (1964). *Kitāb al-Qiyās al-Shar‘ī*. In *idem, Kitāb al-Mu‘tamad fī Uṣūl al-Fiqh*. (Eds. Muḥammad Ḥamīd Allāh, Muḥammad Bakīr, & Ḥasan Ḥanafī). Damascus: Al-Ma‘had al-‘Ilmī al-Faransī li’l-Dirāsāt al-‘Arabiyya bi-Dimash.
- al-Ghazālī, Abū Ḥamid. (1966). *Tahāfut al-Falāsifa*. (Ed. Sulaymān Dunyā). Cairo: Dār al-Ma‘ārif.
- al-Haytamī, Aḥmad b. Muḥammad b. ‘Alī Ibn Hajar. (1983). *Tuḥfat al-Muḥtāj fī Sharḥ al-Minhāj*. Cairo: al-Maktaba al-Tijāriyya al-Kubrā.
- al-Jaṣṣās, Abū Bakr al-Rāzī. (2010). *Sharḥ Mukhtaṣar at-Taḥāwī*. (Eds. by ‘Iṣmat Allāh et. al.). Beirut: Dār al-Bashā‘ir al-Islāmiyya.
- al-Ramlī, Shams al-Dīn b. Aḥmad. (1984). *Nihāyat al-Muḥtāj ilā Sharḥ al-Minhāj*. Beirut: Dār al-Fikr.

- al-Shīrāzī, Abū Ishāq. (1407 H/1986). *Mulakkhkhaṣ fī al-Jadal fī Uṣūl al-Fiqh*. (Ed. Muḥammad Yūsuf Ākhund Jān Niyāzī). MA Thesis, Umm al-Qura University.
- al-Shīrāzī, Abū Ishāq. (1987). *Al-Ma'ūna fī al-Jadal*. (Ed. 'Alī b. 'Abd al-'Azīz al-'Umayrīnī). Al-Ṣafāh, Kuwait: Manshūrāt Markaz al-Makhtūṭāt wa-al-Turāth.
- al-Shīrāzī, Abū Ishāq. (1988). *Sharḥ al-Luma' fī Uṣūl al-Fiqh*. (Ed. 'Abd al-Majīd Turkī). Beirut: Dār al-Gharb al-Islāmī.
- al-Shīrāzī, Abū Ishāq. (1995). *Al-Luma' fī Uṣūl al-Fiqh*. (Ed. Muḥyī al-Dīn Dīb Mustū and Yūsuf 'Alī Badīwī). Damascus; Beirut: Dār al-Kalam al-Ṭayyib; Dār Ibn Kathīr.
- al-Shīrāzī, Abū Ishāq. (2003). *Al-Luma' fī Uṣūl al-Fiqh*. Beirut: Dār al-Kutub al-'Ilmiyah.
- Dakhoir, A. (2010). Pemikiran Fiqih Shaikh Muhammad Arshad al-Banjari. *Islamica*, 4/2, 230-247.
- Dakhoir, A., Rafuan, A., & Fatihah, A. N. (2017). Legal Pluralism in Settling Shared Property Disputes in Perspective of Muhammad Arshad Al-Banjari. *Istiqro'*, 15/1, 89-118.
- Hasan, N. (2007). The Tuhfat al-Raghibin: The Work of Abdul Samad al-Palimbani or Muhammad Arsyad al-Banjari? *Bijdragen tot de Taal-, Land- en Volkenkunde (BKI) 163-1*, 67-85.
- Hasibuan, Z. (2017). Pembagian Harta Bersama pada Masyarakat Penyabungan Kota Kabupaten Mandailing Natal Ditinjau dari UUP No.1 Tahun 1974 dan KHI. *At-Tafahum*, 1/1, 9.
- Ibn Rushd. (2004). *Bidāyat al-Mujtahid wa Nihāyat al-Muqtaṣid*. Cairo: Dār al-Ḥadīth.
- Marmura, M. E. (1965). Ghazali and Demonstrative Science. *Journal of the History of Philosophy* 3/2, 183-204.
- Mujiburrahman. (2014). Islamic Theological Texts and Contexts in Banjarese Society: An Overview of the Existing Studies. *Southeast Asian Studies*, 3/3, 611-641.
- Mujiburrahman. (2017). Historical Dynamic of Inter-Religious Relations in South Kalimantan. *Journal of Indonesian Islam*, 11/1, 145-174.
- Munadi, F. (2020). *Teks dan Naskah Sabīl al-Muhtadīn: Kajian Filologi atas Karya Syekh Muhammad Arsyad*. Retrieved from https://www.academia.edu/41958304/TEKS_DAN_NASKAH_SAB%20AL_AL_MUHTAD%20AAN_KAJIAN_FILOLOGI_ATAS_KARYA_SYEKH_MUHAMMAD_ARSYAD
- Noor, I. (2015, November). *Harta Perpantangan: Sebuah Akomodasi Hukum Waris Islam atas Budaya Relasi Gender dalam Masyarakat Banjar*. Retrieved from <https://dokumen.tips/documents/harta-perpantangan.html>
- Rahman, S., Iqbal, M., & Soufi, Y. (2019). *Inference by Parallel Reasoning in Islamic Jurisprudence*. Cham: Springer.
- Reid, A. (1988). *Southeast Asia in the age of commerce, 1450-1680*. New Haven; London: Yale University Press.
- Soucek, S. (2000). *A History of Inner Asia*. Cambridge: Cambridge University Press.

- Syukur, A. (2002). *Risalah Tuhfatu al Raghabin fi Bayani Haqiqati Imani al Mu'minin wama Yufsiduhu min Riddati al Murtadin*. Lecture organised by Pusat Pengkajian Islam Kalimantan (PPIK), held at IAIN Antarasari Banjarmasin, 6 June 2002.
- Syukur, A. (2016). Pemikiran Syekh Muhammad Arsyad al-Banjari dalam Bidang Fiqh (1); Kitab Sabil al-Muhtadin. In Abdul Rahman Abdullah, *Biografi Agung Sheikh Arshad al-Banjari* (pp. 290-302). Shah Alam, Selangor: Karya Bestari.
- The Editors of Encyclopedia Britannica. (2018, October). *Transoxania (historical region, Asia)*. Retrieved from Encyclopedia Britannica: <https://www.britannica.com/place/Transoxania>
- Young, W. E. (2017). *The Dialectical Forge; Juridical Disputation and the Evolution of Islamic Law*. Dordrecht: Springer.
- Zamzam, Z. (1979). *Syekh Muhammad Arsyad Al-Banjari; Ulama Besar Juru Da'wah*. Banjarmasin: Penerbit Karya.

CHAPTER 8

CONCLUDING REMARKS

8.1. Arsyad al-Banjari's *qiyās*: between argumentation and Sharia

In Islamic jurisprudence *qiyās* or correlational inference is a pattern of reasoning applied in order to establish the legal validity of a ruling when this ruling is neither literally nor evidently sanctioned by the scriptural sources. This pattern of reasoning is one of the forms *ijtihād* can take and it assumes that legal knowledge is achieved by rational endeavour, the intellectual effort of human beings. This elucidates the meaning of the word “*fiqh*”, Islamic law/jurisprudence, which literally means “deep understanding”.

In relation to the main subject of our thesis, let us recall that in his efforts toward the cultural integration of Islam into Banjar society, Arsyad al-Banjari was challenged by new particular cases relative to Banjarese culture that came out regularly and required legal certainty regarding their status according to Islamic law. The point is that, if the rulings for the new cases could not be found in the scriptural sources, then *ijtihād* or rational endeavour was needed to achieve their legal decisions. As discussed in the previous chapter, this led Arsyad al-Banjari to deploy *qiyās* in an argumentative system.

Moreover, we should not forget that *qiyās* is a way to make explicit Sharia (God's law). Accordingly, *qiyās* should be based on hermeneutical and epistemological understandings of the scriptural sources in which Sharia is believed to be explained and declared. In other words, the practice of *qiyās* presupposes the universality of Sharia in the sense that it covers all the problems arising during the development of a society through time and place.

More precisely, in order to find solutions for those cases presented by practices stemming from the Banjarese culture, Arsyad al-Banjari applied the following general methodological principles: 1) legal decisions must be achieved by means of

argumentation, and; 2) this argumentation should lead to making explicit God's law (Sharia).

8.2. The forms of *qiyās* deployed in Arsyad al-Banjari's work

As already mentioned, according to al-Shīrāzī, in order to establish if a legal ruling applies or not to a given case, a *branch-case* (*far'*), we look for a case already known to fall under that ruling, a *root-case* (*aṣl*),— and shares with the branch-case a property (or set of properties) constituting the *'illa* (occasioning factor) of that ruling so that we can conclude – by combining heuristic (and/or hermeneutic) moves with logical inferences – that the branch-case falls under the scope of that ruling. In this case we are in the presence of *qiyās al-'illa* or correlational inference by the *occasioning factor*.

When the factor occasioning the ruling is not explicitly known or not even known at all, we are in the presence of correlational inferences by indication (*qiyās al-dalāla*) or by resemblance (*qiyās al-shabah*). Whereas the former is based on pinpointing at specific relevant parallelisms between rulings (*qiyās al-dalāla*), the latter form of inference is based on resemblances between the root-case and the branch-case in relation to some property (*qiyās al-shabah*).

This form of inference was regularly put into practice by the Shāfi'ī school of law when lacking textual sources. It is precisely this regularity that we found in the works of our author who was a Banjarese Shāfi'ī scholar. A huge number of uses of *qiyās* can be traced in his works, including *Sabīl al-Muhtadīn*, *Tuḥfat al-Rāghibīn*, *Kitāb al-Nikāḥ* and *Luqṭat al-'Ajlān*.

In fact, three forms of *qiyās* as developed by al-Shīrāzī can be found in Arsyad al-Banjari's own work. Nevertheless, the majority of *qiyās* applied in his work are *qiyās al-shabah*; a form, as indicated earlier, which is based merely on resemblance between two cases and is applied when the rationale for a ruling cannot be discerned. Indeed, this form is applied by Arsyad al-Banjari chiefly in the sphere of religious rituals where the grounds for a ruling were unintelligible or obscure.

In addition, Arsyad al-Banjari also applied two forms of *qiyas* other than the three forms classified by al-Shīrāzī. We call them *non-canonical forms of qiyās* for the reason that, unlike the three forms recognised in *uṣūl al-fiqh*, they are applied purely to show the internal coherence of some juridical rulings that have already been confirmed as legitimate, instead of deciding on the legal validity of a new case. Structurally, what distinguishes the two non-canonical forms of *qiyās* from the three standard forms is that they are based not in identifying a set of common properties or rulings between the root-case and the branch-case, but simply they are based on a study of the formal structure underlying two given rulings. The use of non-canonical *qiyās* shows that parallel reasoning in all its varieties really takes a significant part in Arsyad al-Banjari's approach to rationality, particularly so in the realm of juridical reasoning.

8.3. Dialogical framework

Notice that *qiyās* was put into practice within a dynamic relationship between legal theory and dialectic occurring in the conceptual venue that Young (2017) calls the *dialectical forge*. In such a dialectical setting, conclusions, as well as the inference by means of which the conclusions were reached, were cast within the framework of *jadāl* (dialectic). However, unlike other dialectical frameworks the focus of the dialectical forge is on developing methods of interaction aimed at gaining knowledge and meaning, beyond the rhetorical purposes of a legal trial or debate. This gave *jadāl* a crucial epistemological role in the pursuit of truth.¹

It is for this reason that we develop a general dialogical framework specific to *qiyās* as conceived and deployed in the context of Islamic jurisprudence and particularly so in the background of Arsyad al-Banjari's work. The dialogical framework we develop displays two of the hallmarks of this form of inference.

First, the interaction of heuristic, hermeneutic procedures and logical steps. This interface was displayed by two main steps: (1) finding a suitable root-case that

¹ Hallaq (1987a).

both shares with the branch-case some property/ruling and that the ruling under consideration applies to; (2) linking the branch-case logically to the root-case by means of a general schema established from the relationship between the shared property/ruling and the ruling under consideration so that the thesis that the ruling under consideration applies to the branch-case can be achieved.

Second, the dynamics underlying the extension of the legal terms involved. Such dynamics is displayed by the intertwining of confirmations and refutations that contribute to establish the most suitable conclusion in relation to the consideration of a new case.

Now, how does this framework contribute to contemporary theories of parallel reasoning in general, and to legal reasoning in particular?

Such a study is a work in progress.² Nevertheless, let us briefly discuss some of the points linked to such a generalization.³

8.4. Beyond the legal context: Articulation Model of *qiyās*?

In some parts of his book “*By Parallel Reasoning*”, Paul Bartha (2010) suggests that his *articulation model* for parallel reasoning may be presented in what he calls a rhetorical device⁴ that seems to be very close to the dialectical conception of *qiyās*.

² See, for example, Martinez-Cazalla, Menendez Martin, & Rahman (2019) and Martinez-Cazalla, Menendez Martin, Kvernenes & Rahman (2020).

³ In fact, we have discussed this issue in the final remarks of our book (Rahman, Iqbal & Soufi, 2019). In general, what we discuss here can be seen as further development of our remarks regarding the encounter between *qiyās* and the contemporary theories of parallel reasoning.

⁴ See Bartha (2010, Chapter 1 & 4). In general, he introduces the rhetorical device as one method for testing the epistemic strength of a purported analogy. To that effect Bartha (2010, p. 5) writes:

I shall introduce a rhetorical device that will be useful throughout the book.

The philosophical argument is based on the assumption that justification for analogical reasoning, or at least the sort of justification that is of primary interest, should be public. It should be based on communicable experiences, models, and assumptions. This requirement certainly supports the thesis that justifiable analogical reasoning is capable of representation in argument form. It does not rule out the inclusion of visual information, such as diagrams, in the argument. The rhetorical device is to imagine that the analogical reasoning is presented by an enthusiastic advocate to a polite but moderately skeptical interlocutor, the critic. The reasoning succeeds if it survives the critic’s scrutiny. The framework of advocate and critic helps to set a standard of justification that

This can be a starting point to develop a general framework for parallel reasoning that comprises reasoning not only in law but also in natural and social sciences.

Moreover, the system of *qiyās* presented in the present study surprisingly seems to correspond with Bartha's *articulation model*. Further research, of course, should be conducted to evaluate this statement. However, let us briefly point out some remarks where the theory of *qiyās* meets with the articulation model apart from their dialectical nature.

Recall that the articulation model, according to Bartha (2010), is in fact a response to the dissatisfaction with most philosophical theories and computational models of parallel reasoning assessing analogical arguments on the basis of overall similarity between source and target domains—what Hesse (1966) refers to as *horizontal relations* (see Chapter 6). That is why, as Bartha states further, most classifications of parallel reasoning have focused on the nature of horizontal relations (similarity).

Focusing on horizontal relations, then, most theories and models of parallel reasoning do not articulate clearly the nature of *vertical relations*; namely, relations between features known to be shared and features projected to be shared by source and target domains. Whereas the strength of analogical arguments is in fact dependent upon how the vertical relations in each domain occur. Therefore, Bartha suggests that the vertical relations in each domain should be articulated in such a way that different articulations would show different degrees of argument.

Similarly, as discussed in previous chapters, *qiyās* deals more with the vertical relations between shared properties (or rulings) and rulings under consideration (i.e. rulings applied to root-cases or sources that are anticipated to be extended in some way to branch-cases or targets). Hence, the relevance of the properties in relation to the rulings under consideration becomes the central issue and defines the epistemic strength of arguments established by this form of inference.

can be varied to reflect the demands of different settings. It also provides a vivid way to appreciate the requirement of publicity.

Bartha introduces the concept of the *prior association* to support his theory, that is, the vertical relation between P (positive similarity) and Q (hypothetical similarity) in the source domain. Accordingly, his classification of analogical arguments is generally based on the direction of the prior association between P and Q ; where the clearer the direction the stronger the analogy. As such, there are four types of analogical arguments classified according to their epistemic strength (Bartha, 2010, pp. 96-97):

1. *Predictive analogies* ($P \rightarrow Q$), where P is prior to Q in the association. Here, it may be that P causes or entails Q .
2. *Explanatory analogies* ($Q \rightarrow P$), where Q is prior to P in the association. In this context, Q explains or entails P .
3. *Functional analogies* ($P \leftrightarrow Q$), where the association runs in both directions.
4. *Correlative analogies* ($P \downarrow Q$), where the association is symmetric; there is no direction of priority. The relationship here is one of statistical correlation.

This classification, as indicated earlier, seems to be similar to that of the *qiyās* developed by al-Shīrāzī which we discussed in previous chapters. At the very least, it can be said that the typology of *qiyās* in Islamic jurisprudence fits thoroughly with this classification.

Remember the three forms of *qiyās*: *al-‘illa*, *al-dalāla* and *al-shabah*. The first form, *qiyās al-‘illa*, is considered epistemically the strongest one. Let us take the classic example of this form of *qiyās*: date liquor intoxicates just as (grape) wine does, so that drinking it, like drinking wine, is deemed unlawful; and the reason is that the intoxication is considered the factor occasioning the unlawfulness. Now, let P stand for the property of intoxicating and Q for the unlawfulness. Then, Q is dependent upon P because P is the factor occasioning Q . In this association between P and Q , P is prior to Q . So in this sense we can classify *qiyās al-‘illa* as a predictive analogy.

The second form (*qiyās al-dalāla*) is, epistemically speaking, weaker than the *‘illa* form. It is applied when the property that constitutes the factor occasioning the ruling is unknown. However, the root-case and the branch-case are known to share some

ruling and, furthermore, some ruling other than the shared ruling applies to the root-case. Then, we may conclude that the other ruling also applies to the branch-case. *Qiyās al-dalāla* is divided into two types. The first type declares that the shared ruling is a particular (*khaṣīṣa*) of the inferred ruling; the second that the shared ruling is parallel (*naẓīr*) to the inferred ruling. Of this second form of *qiyās*, the first type has a higher degree of epistemic strength than the second.

An example of the first type of *al-dalāla* is the argument of Shāfi‘ī for the non-obligatory status of Quran recital prostration (*sujūd al-tilāwa*) for the reason that, like the prostration during a supererogatory prayer (*sujūd al-nafl*), its performance on a mount while travelling without an excuse is allowed. The rationale, then, for this argument is that the allowance of being performed on a mount while travelling without an excuse (call this aspect *P*) is a particularity of the status of being non-obligatory or supererogatory (call this aspect *Q*). As such, given *P* is the particular of *Q*, *Q* would be prior to *P*; insofar as what is general, here *Q*, is prior to what is particular. Thus, if we put in Bartha’s classification, this first type of *qiyās al-dalāla* can be included in the second type of his four analogical arguments; namely, explanatory analogies.

As for the second type of *qiyās al-dalāla*, let us take the example of Arsyad al-Banjari’s *qiyās* concerning the species of hoopoe and swallow. He argues that these two varieties of birds are forbidden to be caged because they are forbidden to be killed, like the game in *Haram* land. The point is that *the prohibition of killing* and *the prohibition of caging* animals, as is applied to the wild animals in *Haram* land, are believed to be a pair of rulings (see Chapter 6). If we assume *P* is the prohibition of killing and *Q* the prohibition of caging, then the association between *P* and *Q* runs in both directions because *P* and *Q* are a pair. So, according to Bartha’s classification, this second type of *qiyās al-dalāla* is categorized as a functional analogy.

The last form of *qiyās*, *qiyās al-shabah*, is considered epistemically the weakest. Let us now take the example of one of Arsyad al-Banjari’s *qiyās* in relation to the integration of Islamic law into Banjarese culture; namely, regarding *harta perpantangan*. He argues that marital property is *harta perpantangan*, in the sense that

it should be distributed equally to husband and wife. His argument is based on the resemblance between marital property and the earnings of *shirka al-abdān* with regard to the fact that the former is earned by the joint work of a married couple (husband and wife) where one probably works more than the other; and the latter is earned by the joint work of unmarried partners where, again, one probably works more than the others. And Since the earnings of *shirka al-abdān* are distributed equally to the unmarried partners, marital property should likewise be distributed equally between husband and wife. The point is that being earned by joint work where one member probably works more than the other (call this aspect *P*) is in correlation with equal distribution (call this aspect *Q*). Here there is no direction of priority in the association of *P* and *Q*, so that the relation of *P* and *Q* is one of statistical correlation. Hence, this form of *qiyās*, according to Bartha's classification, can be included in the category of correlative analogies.

All this shows that the theory of *qiyās* comes quite close to Bartha's model. And it is not only the case that the types of *qiyās* suit Bartha's classification, but his classification classifies *qiyās* with the same hierarchy of epistemic strength.

Nevertheless, we should not forget that, according to Bartha, in order for the prior association to possibly be extended to the target domain there should be a *potential for generalization*. That means that the target domain should at least enjoy a feature relevantly similar to the feature *P* occurring in the source domain—what Bartha expresses it with *P**; and there is no crucial difference between the source and the target domain that might weaken or undermine such prior association from holding in the target domain.⁵

Accordingly, the target domain does not necessarily share the same features with the source domain; and it is here where the theory of *qiyās* can be differentiated from the articulation model. *Qiyās* assumes not only that the same kind of relation holds in both the source and target domains, but that the relations should involve the same

⁵ Bartha (2010) defines such conditions as *prima facie plausibility* for analogical arguments.

properties (or rulings). In other words, Bartha's model allows that, to put it in the context of *qiyās*, instead of identical properties we have similar properties on both sides in a horizontal relation.

In this sense, in Bartha's model, even what we called *the non-canonical qiyās type A* may be classified as a predictive analogy together with *qiyās al-'illa*. Remember the example of the non-canonical *qiyās type A* in Arsyad al-Banjari's work as discussed in Chapter 6; the structure A in the root-case is similar in some respect to the structure C in the branch-case. Furthermore, the structure A yields B, so it can be concluded that the structure C also yields D, where D is the analogue of B. The fact that A yields B, even though the relation is neither logical nor causal, indicates that A is prior to B in the association. So again, this type of non-canonical *qiyās* according to Bartha's model may be classified into predictive analogies like *qiyās al-'illa*.

In short, while *qiyās* seems to run parallel to the articulation model with regard to vertical relations, it requires a higher degree of relationship between source and target in the horizontal relations than the articulation model; except, that is, in cases of correlative analogies where the prior association is unclear. For such a type of analogy, again, correlative analogies, it appears that *qiyās* and Bartha's model share the same view in relation to horizontal relations.⁶

Looking at the horizontal relations, the difference between the articulation model, particularly its first three types and *qiyās* is probably due to the fact that *qiyās* dealing with legal questions takes material evidence as a condition to establish legal decisions, whereas the articulation model, dealing as it does with mathematical and scientific issues, considers more formal evidence. Moreover, unlike in science where the conclusion achieved by analogical arguments may become a hypothesis that leads to a further study, in law the conclusion achieved by analogy, in general, will become a

⁶ In relation to this issue, Bartha (2010, p. 198) states:

I suggest that a correlative analogical argument is cogent if it provides reason to infer that the source and target domains are likely to belong to a common kind, corresponding to a common nature that is responsible for the cited and hypothetical similarities.

legal decision such that an incorrect conclusion may lead to injustice or the punishment of an innocent party.

Let us now focus on the legal context in order to see how *qiyās* may take part in the contemporary discussions about parallel reasoning in law, or more precisely in the case of *common law*. In fact, Hallaq (1985) already pointed out the links between *common law* and *qiyās*. The following section can be seen as further developing his remarks.

8.5. Toward a general reasoning schema for parallel reasoning in law

8.5.1. *Qiyās* and two contemporary accounts of parallel reasoning in law

Scott Brewer (1996, pp. 1003-1017) and John Woods (2015, pp. 273-281) developed an approach to parallel reasoning based on extracting a general reasoning schema for parallel reasoning (GRSP) from some specific rules. Woods (2015, p. 278) calls such a schema a *generalization schema* (GS), while Brewer (1996, p. 1004) speaks of it as an *exemplary reasoning* (ERS).

The legal context of both Brewer and Woods is *reasoning by precedent*, one of the hallmarks of *common law*. So, the specific rules a GRSP generalize are precedent cases recorded by the legal sources – let us deploy GRSP as a term that comprises both a GS and an ERS).

Let us first look at the following structure of Brewer's (1996, p. 966) *exemplary reasoning schema* (ERS):

Step 1: z has characteristics F, G .

Step 2: x, y, \dots have characteristics F, G .

Step 3: x, y, \dots also have characteristic H .

Step 4: The presence in an individual of characteristics F, G provides sufficient warrant for inferring that H is also present in that individual.

Step 5: Therefore, there is sufficient warrant to conclude that H is present in z .

Brewer (1996, p. 965) points out that the most important step is *step 4*, which includes an 'analogy-warranting rule' or AWR and an 'analogy-warranting rationale' or AWRa. He clarifies that AWR states the logical relation between those

characteristics of compared items that are known to be shared and those that are inferred, while AWRa explains and justifies AWR.⁷

In fact, Woods (2015, pp. 275-277) seems to criticize such approaches. As we will discuss below, the main concerns of Woods seem to be rooted in

- (1) how to understand a GRSP,
- (2) the passage from GRSP to legal rulings; a passage that Brewer (1996, p. 1004) formulates with an AWR transforming the schematic inference into an instance of a universal elimination rule. This deductivist-approach, as acknowledged by Brewer (1996, p. 1006) himself; should, in principle, have problems in dealing with *defeasibility*.

However, if we take a closer look at the logical structure behind Woods' GS and Brewer's ERS, it comes out that both can be seen as sharing the same meaning-constitution as the one that structures *qiyās al-'illa*. Moreover, the efficiency-test embedded in the system of correlational inferences by occasioning factor explains what an AWR is about and why; despite the reluctance in *common law* to make rules explicit. An explicitation procedure such as the one displayed by *ta'thīr* is indeed a requirement for assuring the *tightness* of the properties Woods (2015, p.280) requires for a sound GS.

Actually Woods (2015) does not mention Brewer but Martin Golding. However, despite their different views on the defeasibility of analogical arguments, Brewer (1996, p. 966) acknowledges his debt to the work of Golding. The following schema proposed by Golding (2001; 2018) seems to be similar to Brewer's.

- (i) x has characteristics F, G, \dots
- (ii) y has characteristics F, G, \dots
- (iii) x also has characteristic H, \dots
- (iv) F, G, \dots , are H -relevant characteristics.
- (v) Therefore, unless there are countervailing considerations, y has characteristic H .

⁷ Perhaps, that is why in his recent publication Brewer (2018) splits *step 4* into two steps: step 4: AWR and step 5: AWRa. However, we will stick to the above schema since an AWRa, in our view, relates exclusively to an AWR. Moreover, the conclusion achieved within Brewer's deductivist approach is in fact inferred from an AWR, not an AWRa.

The crucial step in this schema is (*iv*), which asserts that some characteristic is ‘*H-relevant*’. Golding explains that a characteristic is ‘*H-relevant*’ insofar as it is *causally* related to *H*, even if indirectly. Woods (2015) highlights a serious difficulty with Golding’s ‘*H-relevant*’ which seems to play the same role as Brewer’s AWR. The main problem emerging in using such approaches is that parallel reasoning or analogy will eventually be articulated in a *modus ponens* inference that will distance it from its analogical nature.

We will focus on Brewer’s approach in order to compare, in principle, two very different GRSPs, the *deductivist*-approach of Brewer (1996) and the *naturalist*-approach of Woods (2015). In order to facilitate the comparison between an ERS and a GS let us answer the following questions:

What is a GRSP or general reasoning schema for parallel reasoning?

What is an inference within a GRSP?

What is a rule of law in reasoning by precedent?

One of Brewer’s (1996) main examples is *Adams v. New Jersey Steamboat co.* (1896)⁸; one of the most discussed cases of parallel reasoning in law.⁹ Adams, a passenger of the steamboat, locked some money in his stateroom. Thereafter, while Adams was away from the stateroom, someone stole the money. The issue in question was whether the steamboat owner was strictly liable for Adams’ loss.

Since our analysis will mostly be based on this case, let us quote the passages relevant to our discussion:

...The principle upon which innkeepers are charged by the common law as insurers of the money or personal effects of their guests originated in public policy. It was deemed to be a sound and necessary rule that this class of persons should be subjected to a high degree of responsibility in cases where an extraordinary confidence is necessarily reposed in them, and where great temptation to fraud and danger of plunder exists by reason of the peculiar relations of the parties. [Citation] The relations that exist between a steamboat company ²and its passengers, who have procured staterooms for their comfort during the journey, differ in no essential respect from those that exist between the innkeeper and his guests. The passenger procures and pays for his room for the same reasons that a guest at an inn does. There are the same opportunities for fraud and plunder on the

⁸ 151 N.Y. 163 (N.Y. 1896).

⁹ This case, for example, was discussed by various authors, including Golding (2001; 2018), Weinreb (2005), Posner (2006), and Finnis (2011).

part of the carrier that was originally supposed to furnish a temptation to the landlord to violate his duty to the guest. A steamer carrying passengers upon the water, and furnishing them with rooms and entertainment, is, for all practical purposes, a floating inn, and hence the duties which the proprietors owe to the passengers in their charge ought to be the same. No good reason is apparent for relaxing the rigid rule of the common law which applies as between innkeeper and guest, since the same considerations of public policy apply to both relations...

...It was held in *Carpenter v. N.Y., N.H. H.R.R. Co.* [Citation] that a railroad running sleeping coaches on its road was not liable for the loss of money taken from a passenger while in his berth, during the night, without some proof of negligence on its part. That case does not, we think, control the question now under consideration. Sleeping-car companies are neither innkeepers nor carriers. A berth in a sleeping car is a convenience of modern origin, and the rules of the common law in regard to carriers or innkeepers have not been extended to this new relation....

..... The relations of the carrier to a passenger occupying one of these berths are quite different with respect to his personal effects from those which exist at common law between the innkeeper and his guest, or a steamboat company that has taken entire charge of the traveler by assigning to him a stateroom....

...But aside from authority, it is quite obvious that the passenger has no right to expect, and in fact does not expect, the same degree of security from thieves while in an open berth in a car on a railroad as in a stateroom of a steamboat, securely locked and otherwise guarded from intrusion. In the latter case, when he retires for the night, he ought to be able to rely upon the company for his protection with the same faith that the guest can rely upon the protection of the innkeeper, since the two relations are quite analogous...

... The carrier by railroad does not undertake to insure the personal effects of the passenger which are carried upon his person against depredation by thieves. It is bound, no doubt, to use due care to protect the passenger in this respect, and it might well be held to a higher degree of care when it assigns sleeping berths to passengers for an extra compensation than in cases where they remain in the ordinary coaches in a condition to protect themselves. But it is only upon the ground of negligence that the railroad company can be held liable to the passenger for money stolen from his person during the journey...

... The carrier of passengers by railroad, whether the passenger be assigned to the ordinary coaches or to a berth in a special car, has never been held to that high degree of responsibility that governs the relations of innkeeper and guest, and it would perhaps be unjust to so extend the liability when the nature and character of the duties which it assumes are considered.

But the traveler who pays for his passage, and engages a room in one of the modern floating palaces that cross the sea or navigate the interior waters of the country, establishes legal relations with the carrier that cannot well be distinguished from those that exist between the hotelkeeper and his guests. The carrier in that case undertakes to provide for all his wants, including a private room for his exclusive use, which is to be as free from all intrusion as that assigned to the guest at a hotel. The two relations, if not identical, bear such close analogy to each other that the same rule of responsibility should govern. We are of the opinion, therefore, that the defendant was properly held liable in this case for the money stolen from the plaintiff without any proof of negligence.

Brewer (1996, pp. 1004-1005) presents the main argument in this case with the following schema:

Target (*y*) = *the steamboat owner.*

Source (*x*) = *the innkeeper.*

Shared characteristics:

F: has a client who procures a room for specified reasons R (privacy, etc.).

G: has a tempting opportunity for fraud and plunder of client.

Inferred characteristic:

H: is strictly liable.

Argument:

- 1) *y has F and G (target premise);*
- 2) *x has F and G (source premise);*
- 3) *x also has H (source premise)*
- 4) *AWR: if anything has F and G also has H, then everything that has F and G also has H;*
- 5) *Therefore, y has H.*

In this formulation Brewer deploys the terminology: *shared characteristics*. This might suggest, as is typical in arguments by analogy (such as al-Shīrāzī's (2003) *qiyās al-shabah*), that what is at stake here is the similarity between the target and the source case. However, notice that the argument in the quote above does **not** deploy the substitution of identicals. In fact, as we suggested already, GRSP should be associated to *qiyās al-illa*, i.e., let us recall, correlational inferences by occasioning factor, where the inference is carried out by a method (function) that *occasions* the legal ruling from some set of open assumptions (or schematic predicates).

The logical structure of Brewer's (1996) argument in the ERS quoted is based on the open assumptions *x and y have F*, *x and y have G*, and the propositional function *x also has H*. The cardinal step is to trigger an inference without assuming an identity relation. In order to do so, Brewer introduces an AWR which accomplishes the task of embedding the step *if anything has F and G also has H* into a standard deductive framework, where *any* becomes *every*, that is, a universal quantifier that binds the variables of the open assumptions. Thus, an AWR produces logically valid inferences. After all, an ERS do not rely on a similarity of cases but in subsuming both target- and source-cases into a general universal rule.

Woods (2015 p. 278), on the other hand, speaks of *instantiating* a schema; as opposed to subsuming cases under the scope of a universal. For this, Woods introduce his GS; which is a general argument schema supplying some characteristics or conditions that lead to a particular legal qualification, without specifying some

identical relation between the source and the target. Let us see an example of a GS as provided by Woods (2015, p. 276) in favour of abortion in cases of pregnancy by rape:

...suppose that X, Y and Z are three different human beings...

1. Without Y's consent, X has placed Z in a state of vital dependency on Y.
2. The period of dependency is indeterminate (perhaps nine months, perhaps nine year, or the rest of Y's life).
3. The dependency is a grievous impediment of locomotion and stationary mobility.
4. The dependency represents a grievous invasion of privacy.
5. It is also a source of great embarrassment for Y, and sometimes for Z too.
6. Therefore, it would be morally permissible for Y to terminate Z's vital dependency on Y.

Such a schema is actually established from the source case that Woods considers as a "trigger-argument" projected to hold in the target case as an analogue-argument. In fact, both the source and target are recognised as instances of this schema.

Clearly, instantiating a schema does not necessarily lead to logical validity. In fact, *anything has F and G also has H* occurring in step four of Brewer's example quoted above can also be seen as an instantiation schema. Notice that within *anything has F and G also has H* the distinction between the target *x* and the source *y* has been erased.

This suggests an initial answer to the first of our questions: "What is a general reasoning schema for parallel reasoning?" GRSPs are instantiation schemas. Now, in relation to the second question: "What is an inference within a GRSP?" It is possible to produce an inference provided these instantiation schemas are understood as making the conclusion inferentially dependent upon the premises.

Let us provide two different reconstructions of "*if anything has F and G also has H*".

- 1) *F* and *G* are understood as being linked by a conjunction within an open assumption

$H(x)$ true ($x: F \wedge G$),

this can be glossed as:

x is liable if it instantiates both having a client who rents a room and having a tempting opportunity to defraud and plunder clientele.

2) F and G are understood as being linked by a dependence relation. *Having a tempting opportunity to defraud and plunder clientele* is restricted to *having a client who rents a room*

$H(x, y)$ true ($x: F, y: G(x)$),

which can be glossed as:

Those x of whom G can be predicated ($G(x)$) are liable provided they instantiate F .

If we wish to have a more expressive structure we can go deeper into the structure:

$H(u, v)$ true ($u: \text{Individuals}, v: F(u) \wedge G(u)$)

x is liable if it instantiates an individual that is also an instance of those individuals having both F and G .

$H(x, y, z)$ true ($x: \text{Individuals}, y: F(y), z: G(x, y)$)

x is liable if it instantiates an individual that is also an instance of those individuals having G , provided they (first) instantiate F .

However, in order to facilitate reading, we use the less expressive version. Notice that even in this simpler version our analysis makes the liability dependent upon F and G . Here, it is not liability in general, but the liability is *inferentially* dependent upon F and G , and thus specific to having these properties.

How does this inferential structure of a GRSP actually produce inferences? Well, by instantiating. Where the instrument of inference is a method to go from any individual instantiating the premises F and G to that individual's liability. This method is obviously a function; i.e. a dependent object that provides instances from open assumptions.

Let us assume, for the moment, that a is an instantiation. Then we may obtain the following variants of the inference rules within the ERS underlying Brewer's example quoted above.

$$\begin{array}{c} (x: F \wedge G) \\ a: F \wedge G \quad b(x): H(x) \\ \hline \end{array}$$

$$b(a): H(a)$$

These inference rules also make explicit how to produce inferences within Woods' framework. The following quote from Woods (2015, p. 277) provides a way to link reasoning by precedent to our reconstruction above:

*We are now in a position to consider a connection with legal precedents. Suppose that we said that a ruling on a specific set of facts creates a precedent for later facts when its **ratio decendi** instantiates a generalization schema which later facts also instantiate.*

Indeed, if we link this observation of Woods with our analysis of GSs and instantiations, it emerges that the *ratio decendi* amounts to the *causative force* of the function $b(x)$ to trigger or *occasion* the legal ruling from the set of open assumptions (the condition or set of them) to the legal ruling.

It is important to keep in mind that if the process of a GS is to be considered an instantiation schema supporting inferences, the inferential structure must be based on open assumptions, and not on premises. In other words, the function $b(x)$ defines the propositional functions:

$$b(x): H(x) \text{ true } (x: F \wedge G)$$

Let us deploy the terminology of *qiyās al-‘illa* in the inference rule for GRSPs which stress the *occasioning* or causative force of the function. This yields the following schema:

$$‘illa(x): H(x) (x: F \wedge G)$$

which leads to the inferential rules described above.

At this point in the discussion, the patient reader will have the impression of *déjà vu*. Indeed, according to our analysis the inferential structure of a GRSP amounts to the structure behind *qiyās al-‘illa* as developed in our study.

The idea is that when a judge delves into the content behind one specific ruling acknowledged by the legal sources as setting a precedent, that the judge grasps the meaning as constituted by a schema which tightens inferential legal ruling and conditions. In other words, the judge presupposes that the propositional function

$$H(x): \text{prop } (x: F \wedge G),$$

unifies some set of cases that constitute a precedent—though the resulting generalization is not restricted to precedent cases.¹⁰

To put it in another way, the idea behind a GS, as is also presented in Woods' example of the GS quoted above, is to explain a rational relationship, beyond one of identity, between the characteristics *F* and *G* with the legal qualification *H*. Bear in mind that Brewer's AWRa (analogy warranting rationale) plays the role of providing a rationale for his AWR which links the characteristics *F* and *G* with the legal ruling *H*. In this respect one might think that the GS of Woods seems similar to an AWRa. Unfortunately, no AWRa appears in Brewer's example quoted above.

Nevertheless, GSs actually play a different role from AWRas. As such, while the role of the AWRa in Brewer's deductivist-approach is restricted to explain and back up an AWR, the GS in Woods' naturalist-approach, as indicated previously, is at the centre of a parallel reasoning. Moreover, according to Woods (2015, p. 279) the generalization schema, which rationally describes the relationship between certain characteristics with a legal qualification is the legal rule itself which judges are reluctant to make explicit. This yields an answer to our third question.

8.5.2. Analogy-warranting rule and *ta'thīr*

Notice that, so far, we have kept silent on Brewer's deductivist *analogy-warranting* rule, AWR. Woods would certainly take exception to it, and if we follow the inferential schema described above, we do not seem to need an AWR at all.

However, one way to understand the role of this rule is to link it with *ta'thīr*, that is, the *efficiency* that tests if the applied instantiation schema does indeed manage to unify the relevant set of precedent cases put into action. In order to do so, we need to display the inferential structure behind an AWR.

¹⁰ Notice that a GS might be based on putting together similar rather than identical properties – see Woods (2015, p. 277).

Inferentially speaking, the passage from a GS to the universal quantification is only a single step:

$$\frac{\begin{array}{l} (x: F \wedge G) \\ b(x) : H(x) \end{array}}{\lambda x.b(x): (\forall x: F \wedge G) H(x)}$$

This, in our view, is a way to formulate Brewer's (1996, p. 1004) *analogy-warranting rule* AWR as emerging from an instantiation schema.

Nevertheless, this is only half of the story. Notice, the role of an AWR in Brewer's deductivist-approach is to fill the gaps between premises and conclusions occurring generally in analogical arguments. If we remove, for instance, the AWR (step 4) from the structure of an ERS, then it is possible for all the premises to be true but the conclusion false. Whereas in order for analogical arguments to have the rational force of deduction, as suggested by Brewer (2018), *whenever all the premises are true, the conclusion must be true.*

In this context, *anything has F and G also has H* embedded in an AWR should be understood as the conjunction of *F* and *G* being *the sufficient condition* for *H*. Accordingly, in order to verify whether the characteristics *F* and *G* are indeed the sufficient conditions for the legal qualification *H*, Brewer (1996; 2018) observes that any AWR should be linked with disanalogy. Basically, disanalogy asserts that the presence of some similarity between two domains, if due to an irrelevance, does not support a further similarity. Accordingly, in principle, disanalogy is used to challenge an analogy-warranting rule by proposing a new rule called the *disanalogy-warranting rule* (DWR). In effect, this new rule offers another precedent in order to show that the claim *anything has F and G also has H*, again, as is embedded in an AWR, is actually incoherent.

However, as Brewer (1996, pp. 1014-1016) asserts, it is possible that the contrary happens and a DWR is used to confirm an AWR. In this context, Brewer reconstructs Judge O'Brien's argument concerning the sleeping-car railroad owner as follows:

Target (y) = the steamboat owner.

Source (x) = the innkeeper.

Shared characteristics:

F : has a client who procures a room for specified reasons R (privacy, etc.).

G : has a tempting opportunity for fraud and plunder of client.

Inferred characteristic:

H : is strictly liable.

Argument:

(1) y has F and G (target premise);

(2) x has F and G (source premise);

(3) x also has H (source premise)

(4) AWR: if anything has F and G also has H , then everything that has F and G also has H ;

(5) Therefore, y has H .

Let us now offer a shorthand name for the owner of the railroad sleeping car:

Secondary target: (z) = the owner of the railroad sleeping car.

Properly reconstructed, O'Brien's argument is that the secondary target, the railroad owner, *does not satisfy the sufficient conditions for the inferred characteristic* that both the (primary) target, the steam-boat owner, and the source, the innkeeper, do satisfy:

(2a). z does not have F and G .

Because, in this case, the only way to achieve H is by satisfying the jointly sufficient conditions for H - namely, F and G - one is not entitled to conclude that z has H .

Interestingly, in this reconstruction Brewer calls the sleeping car railroad owner a target (specifically a secondary target), though this is not an issue the Judge had to decide. For this case had previously been brought to court and its ruling, which set a precedent, had already been issued. However, one way to understand Brewer's thought in this reconstruction is that the confirmation of an AWR using disanalogy signifies two effects. One is the confirmation of an AWR in the sense of acknowledging that F and G are indeed *the sufficient conditions* for the inferred characteristic H , such that if F and G are absent so is H . In this context we can understand why Brewer considers the sleeping car railroad owner as a "target". To be clear, let us consider the following statement of Brewer (1996, p. 1016):

Recall that in Adams, Judge O'Brien concluded that the plaintiff steamboat passenger did satisfy the criteria for a strict liability cause of action against the steamboat owner. Using analogical reasoning in a context of doubt, the judge articulated sufficient conditions for the concept of strict

liability and inferred deductively that the steamboat owner satisfied them. Using the same analogy-warranting rule, he also was able to conclude that the railroad owner did not satisfy those sufficient conditions.

In this respect, again, AWRs are very close to the *ta'thīr*. Recall that in *qiyās* when some property is said to satisfy the efficiency (*ta'thīr*) in relation to some ruling, the absence of the property means the absence of the ruling. In fact, O'Brien's argument that the sleeping car railroad owner is not strictly liable, as reconstructed by Brewer above, shares the same structure with Arsyad al-Banjari's argument on the lawfulness of *lahang* as discussed in Chapter 7. Given the efficiency of the property of *intoxicating* in relation to the *unlawfulness of juices*, such as in the case of grape juice (wine), Arsyad al-Banjari argues for the lawfulness of *lahang* since it does not instantiate such a property even if fermented. If we put this argument in Brewer's terminology; the intoxication would be the sufficient condition for the unlawfulness of juices, and *lahang* would be lawful because it does not intoxicate—though *lahang* and wine are similar in relation in so far as both are fermented juices.

The second effect of using disanalogy to confirm an AWR – still sticking to the sleeping-car railroad case as the precedent brought forward by the defendant (the New Jersey Steamboat Co.) as a competing analogy to the innkeeper case – can be seen in the sense of complementing the sufficiency previously assumed in such a way that disanalogy confirms on the one hand, that when *F* and *G* are present *H* is too; and on the other hand, that when *F* and *G* are absent so is *H*. This is actually what O'Brien pursued in the Steamboat case. The procedure of that confirmation and drawn conclusion –if we use the same assumptions as Brewer's reconstruction above– can be described as follows:

- (1) *x* (the source) and *y* (the target) have *F* and *G*; *x* also has *H*;
- (2) AWR: anything has *F* and *G* also has *H*. (*F* and *G* are the sufficient conditions for *H*)
- (3) *z* (the other source –what Brewer calls the secondary target) does not have *F* and *G*; *z* also does not have *H*.
- (4) It confirms the AWR, *F* and *G* are indeed the sufficient conditions for *H* such that when *F* and *G* are present, then *H* is too; when *F* and *G* are absent, so is *H*.
- (5) therefore, *y* has *H*.

Here again, the system of *qiyās* as developed by al-Shīrāzī (1986; 1987; 2003) provides a way to introduce an AWR. As discussed in Chapter 3, the idea is that *ta`thīr*, the test of efficiency, provides the means to test whether the property, or set of properties, purported to be relevant or sufficient for the juridical sanction at stake is indeed so.

The test declines into two complementary procedures: testing co-extensiveness or *ṭard* (if the property is present then the sanction is too) and co-exclusiveness or *‘aks* (if the property is absent then so is the juridical sanction – the consumption of vinegar is in principle not forbidden).

While co-extensiveness examines whether the legal qualification *H* follows from the verification of the presence of the property or set of properties, co-exclusiveness examines whether exemption from the legal qualification follows from the verification of the absence.

If we formulate AWRs as such a testing procedure, we need to allow for the following expansion of AWRs:

For every *x*, if it instantiates the properties *F* and *G*, then the legal qualification *H* follows, if it does not instantiate the properties then the legal qualification does not apply (see Chapter 3).

$$\lambda x.c: (\forall x: (F \wedge G) \vee \neg(F \wedge G)) \{ [(\forall y: (F \wedge G)) \text{ left}^\vee(y) =_{\{E\}} x \supset H(y)] \wedge [(\forall z: \neg(F \wedge G)) \text{ right}^\vee(z) =_{\{E\}} x \supset \neg H(z)] \}.$$

whereby $\{E\}$ is short-form for the hypothesis $(F \wedge G) \vee \neg(F \wedge G)$.

8.5.3. Dialectical approach to parallel reasoning: a lesson of the Elders

Now, it is clearly understood that the point of Brewer (1996; 2018) in introducing his AWR, as well as his DWR, is to unify some set of precedents specific to a given ruling *H*. This is also the point of *ta`thīr* in *qiyās* as developed by al-Shīrāzī, where the testing amounts to unifying cases *recorded in the legal sources*. Recall that this was al-Shīrāzī’s way of answering to the antianalogists; a response that Brewer (1996, p. 1006)

likewise brings to the context of contemporary legal reasoning. Accordingly, a disanalogy, which is a counterexample of an analogy, should be understood as a unifying instrument to bring together all precedents in order to evaluate the claim that the presence of a property triggers the juridical ruling, and its absence the failing of that ruling.

Woods (2015, p. 193) points out that, in general, after a process the legal verdicts are closed by *fiat*. Though this does not mean that during the procedure the proposed GS cannot be contested. In our view this is related to the distinction between play level and strategy level. The latter, we claimed, should be understood as a *recapitulation* that settles the matter.¹¹

It is here that the dialogical approach comes on the scene: criticism amounts to a game of giving and asking for reasons within a fixed argumentative context. Recall that the argumentation theory of Islamic Jurisprudence included a rich set of both collaborative and destructive moves aimed at testing the relevance of some set of properties for some specific legal ruling. The dialogical approach brings to the fore the dialectical stance on legal reasoning within classical Islam by providing a framework where inferential moves, testing moves, and collaborative and destructive moves, aimed at grounding a legal qualification, can be unified.¹² More generally, the dialogical framework can even be understood as setting up a language-game in order to study the meaning-constitution of the terms involved during legal argumentation.

In fact, in order to verify whether the company was strictly liable in the Steamboat case, Judge O'Brien involved all precedents previously brought forward by both the

¹¹ Let us remark that in our framework, instantiating a GS is the way to *justify* a GS. Indeed, justifications are, in our framework, instances or tokens of a type. Moreover, as discussed in Rahman, Iqbal, & Soufi (2019) and Rahman, McConaughy, Klev, & Clerbout (2018), *local reasons*, or reasons brought forward during a play, should be distinguished from *strategic reasons*, or reasons that constitute (the justification of) a winning strategy either by establishing the validity or by establishing the truth of material inferences. Thus, despite Woods' (2015, pp. 263-272) scepticism towards justification approaches, the instantiations at work in his own GS are, after all, either (local) reasons or else justifications, that is, strategic reasons encoding a recapitulation of the process leading to the resulting legal ruling.

¹² Miller (1984; 2020) was the first to suggest the deployment of a dialogical logic in order to study Islamic argumentation theory.

plaintiff and the defendant if, that is, they were possibly related to the case. So, the dialectic between those precedents was certainly unavoidable. Indeed, if we chronologically follow the argument in this case as quoted earlier, in our view, although it does not appear literally in the argument, the Judge in fact placed all those precedents into a dialectical setting. If we provide a reconstruction of the Judge's arguments in the context of *qiyās* using our dialogical framework, we will have the following dialogue:

The table 8.1. Dialogue for the Steamboat case

O		P			
		response	response	<p>A steamboat passenger's proprietor is liable, without proof of negligence, if money is stolen from the passenger's room.</p> <p>$! H(f)$ Assuming: H is the strict liability f is the proprietor.</p>	0
1	Why?	? 0 (challenge s move 0)	! 1, ! 2 (responds to 1 with the request of endorsing 2)	<p>An innkeeper has a stringent responsibility, such that he is liable, without proof of negligence, if money is stolen from the guest's room. Is that right?</p> <p>$H(a) ?$ Assuming a is innkeeper.</p>	2
3	Yes, it is. $! H(a\&l)$! 2	! 3, ! 4	<p>The innkeeper has both a client who procures a room for personal use and a tempting opportunity to defraud and plunder clientele. Right?</p> <p>$a: F \wedge G?$ assuming: F is having a client who procures a room for personal use;</p>	4

				G is having a tempting opportunity to defraud and plunder clientele.	
5	Yes. $a: F \wedge G$! 4	! 3(5), ! 6	So, according to your moves 3 and 5, having a client who procures a room for personal use and having a tempting opportunity to defraud and plunder clientele occasions the fact that the proprietor has a stringent responsibility, such that the proprietor is liable, without proof of negligence, if money is stolen from the guest's room. Is that right? $\text{'illa}(a): H(a) (a: F \wedge G)?$	6
7	Justify! <i>muṭālaba !</i>	? 6	! 7	'aks : The owner of the railroad sleeping car does not have a client who procures a room for personal use and does not have a tempting opportunity to defraud and plunder clientele such that the owner is not liable, without proof of negligence, if money is stolen. $!(\forall x: \neg(F \wedge G))\neg H(x)$ tard : The innkeeper has both a client who procures a room for personal use, and a tempting opportunity to defraud and plunder clientele such that the proprietor is liable, without proof of negligence, if money is stolen. $!(\forall x:(F \wedge G))H(x)$	8

				<p><i>ta'thīr</i>: Therefore, the presence of the legal qualification H is due to the presence of F and G, and the absence of the legal qualification is due to their absence</p> <p>$!(\forall x: (F \wedge G) \vee \neg(F \wedge G))$ $\{ [(\forall y: (F \wedge G)) \textit{left}^\vee(y) =_{\{E\}} x \supset H(y)] \wedge [(\forall z: \neg(F \wedge G)) \textit{right}^\vee(z) =_{\{E\}} x \supset \neg H(z)] \}$.</p> <p>whereby $\{E\}$ is short-form for the hypothesis $(F \wedge G) \vee \neg(F \wedge G)$.</p>	
9	<p>Given these arguments I concede your previous request</p> <p>$!(\forall x: (F \wedge G) \vee \neg(F \wedge G))$ $\{ [(\forall y: (F \wedge G)) \textit{left}^\vee(y) =_{\{E\}} x \supset H(y)] \wedge [(\forall z: \neg(F \wedge G)) \textit{right}^\vee(z) =_{\{E\}} x \supset \neg H(z)] \}$.</p>	! 6 (8)	! 9, ! 10	<p>Does the steamboat passenger's proprietor have both a client who procures a room for personal use, and a tempting opportunity to defraud and plunder clientele?</p> <p>$f: F \wedge G?$</p>	10
11	<p>Yes.</p> <p>$f: F \wedge G$</p>	! 10	! 11, ! 12	<p>If it is the case that the steamboat passenger's proprietor has both a client who procures a room for personal use, and a tempting opportunity to defraud and plunder clientele; and, given 9, should this not lead you to endorse that he/she is liable, without proof of negligence, if money is stolen from the passenger's room?</p> <p>$f: F \wedge G$</p>	12
13	<p>Indeed, the fact that the steamboat passenger's</p>	! 10	! 1	<p>So, this provides the justification for the thesis</p>	14

<p>proprietor has both a client who procures a room for personal use, and a tempting opportunity to defraud and plunder clientele should occasion the liability of the proprietor if money is stolen from the passenger's room without proof of negligence.</p> <p>$ap[f.t^{F \wedge G}]: H(f)$</p>			<p>you were asking for with your first move: the branch-case falls under the ruling because it instantiates the property you just endorsed as constituting the occasioning factor.</p> <p>$'illa(f): H^{F \wedge G}(f)$</p>	
<p><i>Ilzām</i></p>				

At this point it seems more appropriate to place a GRSP within a dialogical framework, since it enables cases recorded in the legal sources related to the legal ruling at stake to be unified in a dialectical interaction. In fact, the general principle underlying legal reasoning is that law is largely a matter of practice, and that one of the most suitable instruments for legal practice is indeed a dialectical framework that calls for a collective act of understanding. This, perhaps, is what motivated Judge O'Brien to set all precedents related to the case under consideration in a dialectical setting. Likewise, this was also what Arsyad al-Banjari actually put into practice in his effort to integrate Islamic law into Banjarese culture by using *qiyās*.

Altogether, we can say that at the centre of Arsyad al-Banjari discursive model of integration, as well as of Judge O'Brien's reasoning in the Steamboat case, is the idea that rationality is featured in the task of bringing to the *space of games of giving and asking for reasons*, those commitments and entitlements that structure the network of implicit beliefs and notions underlying social practices.¹³ This is a general lesson of the elders we should not ignore.

¹³ Clearly, we indulge here in the anachronism of deploying Brandom's (1994) terminology in the context of a dialectical practice rather far in time and space from the one discussed by Brandom. Perhaps this also suggests that the emergence of the dialectic stance on the rational assessment of notions and beliefs implicit in social practices has quite a long and rich history behind it.

References

- al-Shīrāzī, Abū Ishāq. (1407 H/1986). *Mulakhkhaṣ fī al-Jadal fī Uṣūl al-Fiqh*. (Ed. Muḥammad Yūsuf Ākhund Jān Niyāzī). MA Thesis, Umm al-Qura University.
- al-Shīrāzī, Abū Ishāq. (1987). *Al-Ma'ūna fī al-Jadal*. (Ed. 'Alī b. 'Abd al-'Azīz al-'Umayrīnī). Al-Ṣafāh, Kuwait: Manshūrāt Markaz al-Makhṭūṭāt wa-al-Turāth.
- al-Shīrāzī, Abū Ishāq. (2003). *Al-Luma' fī Uṣūl al-Fiqh*. Beirut: Dār al-Kutub al-'Ilmiyah.
- Bartha, P. (2010). *By Parallel Reasoning; The Construction and Evaluation of Analogical Arguments*. Oxford: Oxford University Press.
- Brandom, R. (1994). *Making it Explicit*. Cambridge: Harvard University Press.
- Brewer, S. (1996). Exemplary Reasoning: Semantics, Pragmatics, and the Rational Force of Legal Argument by Analogy. *Harvard Law Review*, 109/5, 923-1028.
- Brewer, S. (2018). Undefeasible analogical argument. In H. Kaptein, & B. van der Velden, *Analogy and Exemplary Reasoning in Legal Discourse* (pp. 33-48). Amsterdam: Amsterdam University Press.
- Cazalla, M. D., Martin, T. M., & Rahman, S. (2019). *Parallel Reasoning By Ratio Legis in Contemporary Jurisprudence. Elements for a Dialogical Approach*. Retrieved from {halshs-02423507}
- Cazalla, M. D., Martin, T. M., Kvernenes, H. C., & Rahman, S. (2020). *Elements for a Dialogical Approach on Parallel Reasoning. a Case Study of Spanish Civil Law*. Retrieved from <https://hal.archives-ouvertes.fr/hal-02898073>
- Finnis, J. (2011). Analogical Reasoning in Law. In *Philosophy of Law: Collected Essays Volume IV*. Oxford University Press.
- Golding, M. (2001). *Legal Reasoning*. Petersborough; Hertfordshire; Rozelle: Broadview Press.
- Golding, M. (2018). Argument by analogy in the law. In H. Kaptein, & B. van der Velden, *Analogy and Exemplary Reasoning in Legal Discourse* (pp. 123-136). Amsterdam: Amsterdam University Press.
- Hallaq, W. B. (1987a). A Tenth-Eleventh Century Treatise on Juridical Dialectic. *The Muslim World*, 77 3-4, 151-282.
- Miller, L. B. (1984). *Islamic Disputation Theory*. PhD dissertation, Pinceton University.
- Miller, L. B. (2020). *Islamic Disputation Theory*. Cham: Springer.
- Posner, R. A. (2006). Reasoning by Analogy. *Cornell Law Review*, 91/3, 761-774.
- Rahman, S., Iqbal, M., & Soufi, Y. (2019). *Inference by Parallel Reasoning in Islamic Jurisprudence*. Cham: Springer.
- Rahman, S., McConaughy, Z., Klev, A., & Clerbout, N. (2018). *Immanent Reasoning or Equality in Action. A Plaidoyer for the Play Level*. Dordrecht: Springer.
- Weinreb, L. (2005). *Legal Reason: The Use of Analogy in Legal Argument*. Cambridge: Cambridge University Press. doi:10.1017/CBO9780511810053

- Woods, J. (2015). *Is Legal Reasoning Irrational? An Introduction to the Epistemology of Law*. London: College Publications.
- Young, W. E. (2017). *The Dialectical Forge; Juridical Disputation and the Evolution of Islamic Law* . Dordrecht: Springer.

BIBLIOGRAPHY

- Adamson, P. (2019, April). *Al-Ghazālī, Causality, and Knowledge*. Retrieved from <https://www.bu.edu/wcp/Papers/Medi/MediAdam.htm>
- Ahmad, Z. (2015). Al-Banjari, Muhammad Arshad (1122-1233/1710-1812). In O. Leaman, *The Biographical Encyclopedia of Islamic Philosophy*. London/Newyork: Bloomsbury.
- Azra, A. (2004). *The Origins of Islamic reformism in Southeast Asia: networks of Malay-Indonesian and Middle Eastern 'Ulamā' in the seventeenth and eighteenth centuries*. Crows Nest; Honolulu: Allen & Unwin; University of Hawai'i Press.
- 'Āyish, 'Abd al-Fattāḥ. & Qaiṣar. (2003). *Mu'jam al-Adibbā' min 'Asr al-Jāhilī ḥattā sana 2002*. Vol. 4. Beirut: Dār al-Kutub al-'Ilmiyya.
- al-Baghdādī, al-Khaṭīb. (1421). *Al-Faqīh wa al-Mutafaqqih*. (Ed. Abū 'Abd al-Raḥmān). Saudi: Dār ibn Jauzī.
- al-Bājī, Abū al-Walīd Sulaymān. (2001). *Kitāb al-Minhāj fī Tartīb al-Ḥijāj*. (Ed. 'Abd al-Majīd Turkī). Beirut: Dār al-Gharb al-Islāmī.
- al-Banjari, Muhammad Arsyad. (1957). *Sabīl al-Muhtadīn*. Riyadh: King Saud University.
- al-Banjari, Muhammad Arsyad. (2005). *Kitāb al-Nikāḥ*. Banjarmasin: Comdes.
- al-Banjari, Muhammad Arsyad. (2009). *Pemikiran-pemikiran Syeh Muhammad Arsyad al Banjari dalam bidang tauhid dan tasawuf*. (Ed. Aswadie Syukur). Banjarmasin: Comdes.
- al-Banjari, Muhammad Arsyad. (2013). *Luqṭat al-'Ajlān*. Martapura: Yapida.
- al-Banjari, Muhammad Arsyad. (n.d.). *Sabīl al-Muhtadīn*. al-Ḥaramayn.
- Barnes, J. (1984). *The Complete Works of Aristotle. The Revised Oxford Translation*. Princeton NJ: Princeton University Press.
- Bartha, P. (2010). *By Parallel Reasoning; The Construction and Evaluation of Analogical Arguments*. Oxford: Oxford University Press.
- al-Baṣrī, Abū al-Ḥusayn. (1964). *Kitāb al-Qiyās al-Shar'ī*. In *idem, Kitāb al-Mu'tamad fī Uṣūl al-Fiqh*. (Eds. Muḥammad Ḥamīd Allāh, Muḥammad Bakīr, & Ḥasan Ḥanafī). Damascus: Al-Ma'had al-'Ilmī al-Faransī li'l-Dirāsāt al-'Arabiyya bi-Dimash.

- Bou Akl, Z. (2019). Averroes on Juridical Reasoning. In P. & Adamson, *Interpreting Averroes: Critical Essays* (pp. 45-63). Cambridge: Cambridge University Press.
- Brandom, R. (1994). *Making it Explicit*. Cambridge: Harvard University Press.
- Brewer, S. (1996). Exemplary Reasoning: Semantics, Pragmatics, and the Rational Force of Legal Argument by Analogy. *Harvard Law Review*, 109/5, 923-1028.
- Brewer, S. (2018). Undefeasible analogical argument. In H. Kaptein, & B. van der Velden, *Analogy and Exemplary Reasoning in Legal Discourse* (pp. 33-48). Amsterdam: Amsterdam University Press.
- Cazalla, M. D., Martin, T. M., & Rahman, S. (2019). *Parallel Reasoning By Ratio Legis in Contemporary Jurisprudence. Elements for a Dialogical Approach*. Retrieved from {halshs-02423507}
- Cazalla, M. D., Martin, T. M., Kvernenes, H. C., & Rahman, S. (2020). *Elements for a Dialogical Approach on Parallel Reasoning. a Case Study of Spanish Civil Law*. Retrieved from <https://hal.archives-ouvertes.fr/hal-02898073>
- Chalmers, I. (2007). The Islamization of Southern Kalimantan: Sufi Spiritualism, Ethnic Identity, Political Activism. *Studia Islamika*, 14/3, 371-417.
- Clerbout, N. (2014a). First-Order Dialogical Games and Tableaux. *Journal of Philosophical Logic*, 43(4), 785-801.
- Clerbout, N. (2014b). *Étude sur quelques sémantiques dialogiques : Concepts fondamentaux et éléments de métathéorie*. London: College Publications.
- Clerbout, N., & Rahman, S. (2015). *Linking Game-Theoretical Approaches with Constructive Type Theory: Dialogical Strategies as CTT-Demonstrations*. Dordrecht: Springer.
- Crubellier, M., Marion, M., McConaughey, Z., & Rahman, S. (2019). Dialectic, The Dictum de Omni and Ecthesis. *History and Philosophy of Logic*, 40/3, 207-233.
- Dahīsh, ‘Abd al-Malik ibn ‘Abd Allāh ibn. (1995). *Al-Ḥarām al-Makkī al-Sharīf wal-A‘lām al-Muhīta bih*. Mecca.
- Dakhoir, A. (2010). Pemikiran Fiqih Shaikh Muhammad Arshad al-Banjari. *Islamica*, 4/2, 230-247.
- Dakhoir, A., Rafuan, A., & Fatihah, A. N. (2017). Legal Pluralism in Settling Shared Property Disputes in Perspective of Muhammad Arshad Al-Banjari. *Istiqro'*, 15/1, 89-118.
- Daud, A. (1997). *Islam & masyarakat Banjar: diskripsi dan analisa kebudayaan Banjar*. Jakarta: RajaGrafindo Persada.

- Daudi, A. (1996). *Maulana Syekh Muhammad Arsyad al-Banjari (Tuan Haji Besar)*. Dalam Pagar Martapura: Madrasah Sullam al-Ulum.
- David, J. E. (2014). *Jurisprudence and Theology*. Dordrecht: Springer.
- Davidson, D. (1980). *Essays on Actions and Events*. Oxford: Clarendon Press.
- al-Di‘bāsī, Aḥmad ‘Abd al-Nabiī Farghal. (2014). *al-Sulāla al-Bakriyya al-Ṣiddīqiyya*. Cairo: al-Mu’assasa al-‘Umma al-‘Arabiyya li al-Nashr wa al-Tauzī‘.
- Drewes, G. (1992). A note on Muhammad al-Samman, his writings, and 19th century Sammāniyya practices, chiefly in Batavia, according to written data. *Archipel*, 43, 73-87.
- Felscher. (1985). Dialogues as a Foundation for Intuitionistic Logic. (D. Gabbay, & G. F, Eds.) *Handbook of Philosophical Logic*, 3, 341-372.
- Finnis, J. (2011). Analogical Reasoning in Law. In *Philosophy of Law: Collected Essays Volume IV*. Oxford University Press.
- Fyzee, A. A. (1964). *Outlines of Muhammadan Law*. Oxford: Oxford University Press.
- al-Ghazālī, ‘Abd Allah Muḥammad ‘Īsā. (1991/1992). Muqaddima. In Aṭā’ Allāh al-Maṣrī, *Nihāya al-‘Arab fī sharḥ Lāmiya al-‘Arab lī al-Shanfarā ibn Mālik al-Azdī*. Majlis al-Naṣr al-‘Ilmī Kuwait University.
- al-Ghazālī, Abū Hāmid. (1324 H/1906). *Al-Mustaṣfā min ‘Ilm al-Uṣūl*. Būlāq: al-Maṭba‘a al-Amīriyya.
- al-Ghazālī, Abū Hāmid. (1966). *Tahāfut al-Falāsifa*. (Ed. Sulaymān Dunyā). Cairo: Dār al-Ma‘ārif.
- al-Ghazālī, Abū Hāmid. (1971). *Shifā’ al-Ghalīl*. (Ed. Aḥmad Al-Kabīsī). Baghdad: Maṭba‘a al-Irshād.
- Gili, L. (2015). Alexander of Aphrodisias and the Heterodox dictum de omni et de nullo. *History and Philosophy of Logic*, 36/2, 114–128.
- Ginzburg, J. (2012). *The Interactive Stance*. Oxford: Oxford University Press.
- Golding, M. (2001). *Legal Reasoning*. Petersborough; Hertfordshire; Rozelle: Broadview Press.
- Golding, M. (2018). Argument by analogy in the law. In H. Kaptein, & B. van der Velden, *Analogy and Exemplary Reasoning in Legal Discourse* (pp. 123-136). Amsterdam: Amsterdam University Press.
- Granström, J. G. (2011). *Treatise on Intuitionistic Type Theory*. Dordrecht: Springer.
- Halidi, Y. (1968). *Ulama Besar Kalimantan Selatan Syekh Arsyad al-Banjari*. Surabaya: al-Ikhsan.

- Hallaq, W. B. (1985). The Logic of Legal Reasoning in Religious and Non-Religious Cultures: The Case of Islamic Law and Common Law. *Cleveland State Law Review*, 34, 79-86.
- Hallaq, W. B. (1987a). A Tenth-Eleventh Century Treatise on Juridical Dialectic. *The Muslim World*, 77 3-4, 151-282.
- Hallaq, W. B. (1987b). The Development of Logical Structure in Islamic Legal Theory. *Der Islam*, 64/1, 42-67.
- Hallaq, W. B. (1997). *A History of Islamic Legal Theories: An Introduction to Sunnī Uṣūl al-Fiqh*. Cambridge; New York: Cambridge University Press.
- Hasan, A. (1986). *Analogical Reasoning in Islamic Jurisprudence: A Study of the Juridical Principle of Qiyas*. Islamabad: Islamic Research Institute.
- Hasan, N. (2007). The Tuhfat al-Raghibin: The Work of Abdul Samad al-Palimbani or Muhammad Arsyad al-Banjari? *Bijdragen tot de Taal-, Land- en Volkenkunde (BKI)* 163-1, 67-85.
- Hasdi, D. (2009). *Fatwa-Fatwa Spesifik Syekh Muhammad Arsyad Al-Banjari*. Banjarmasin: Antasari Press.
- Hasibuan, Z. (2017). Pembagian Harta Bersama pada Masyarakat Penyabungan Kota Kabupaten Mandailing Natal Ditinjau dari UUP No.1 Tahun 1974 dan KHI. *At-Tafahum*, 1/1, 9.
- Hawkins, M. (2000). Becoming Banjar. *The Asia Pacific Journal of Anthropology*, 1:1, 24-36. DOI: 10.1080/14442210010001705830
- al-Haytamī, Aḥmad b. Muḥammad b. ‘Alī Ibn Hajar. (1983). *Tuḥfat al-Muḥtāj fī Sharḥ al-Minhāj*. Cairo: al-Maktaba al-Tijāriyya al-Kubrā.
- Hesse, M. B. (1966). *Models and Analogies in Science*. Notre Dame, Indiana: University of Notre Dame Press.
- Ibn Ḥazm. (1926-1930). *Al-Iḥkām fī Uṣūl al-Aḥkām*. (Ed. Aḥmad Muḥammad Shākir). Cairo: Maṭba‘at al-Sa‘āda.
- Ibn Qudāma. (1998). *Rauḍa al-Nāẓir wa-Jannat al-Munāẓir*. Beirut: Mu’assasa al-Rayyān.
- Ibn Rushd. (2004). *Bidāyat al-Mujtahid wa Nihāyat al-Muqtaṣid*. Cairo: Dār al-Ḥadīth.
- Ideham, M. S. et al. (2007a). *Sejarah Banjar*. Banjarmasin: Balitbangda Kalimantan Selatan.
- Ideham, M. S. et al. (2007b). *Urang Banjar dan Kebudayaannya*. Banjarmasin: Balitbangda Kalimantan Selatan.
- al-Jabartī, ‘Abd al-Raḥman. (1998). *Tārīkh ‘Ajā’ib al-Āthār fī al-Tarājum wa al-Akhbār*. Beirut: Dār al-Jīl.

- al-Jābī, Bassām ‘Abd al-Wahāb. (2011). Tarjama Muḥammad ibn Sulaymān al-Kurdī/al-Kardī. In Muḥammad b. al-Kurdī, *al-Fawā'id al-Madaniyya*. Libanon: Dār Nūr al-Ṣabāḥ and al-Jaffān wa al-Jābī.
- al-Jaṣṣāṣ, Abū Bakr al-Rāzī. (2010). *Sharh Mukhtaṣar at-Taḥāwī*. (Eds. by ‘Iṣmat Allāh et. al.). Beirut: Dār al-Bashā'ir al-Islāmiyya.
- al-Juwaynī, Imām al-Ḥaramayn. (1955). *Al-Waraqāt fī Uṣūl a-Fiḥ*. On the margin of al-Maḥallī's Sharḥ al-Waraqāt. Hyderabad: Markaz Tau'iyya al-Fiḥ al-Islāmī.
- al-Juwaynī, Imām al-Ḥaramayn. (1979). *al-Kāfiya fī al-Jadal*. (Ed. Fawqiya Ḥusayn Maḥmūd). Cairo: Maṭba'at 'Isā al-Bābi al-Ḥalabī.
- Kaḥāla, ‘Umar Riḍā. (1993). *Mu'jam al-Mu'allifīn; Tarājum Mu'alifī al-Kutub al-'Arabiyya*. Vol.2. Beirut: Mu'assasa al-Risāla.
- Keiff, L. (2009). *Dialogical Logic*. (E. N. Zalta, Ed.) Retrieved from The Stanford Encyclopedia of Philosophy: <http://plato.stanford.edu/entries/logic-dialogical>
- Krabbe, E. C. (2006). Dialogue Logic. In D. Gabbay, & J. Woods (Eds.), *Handbook of the History of Logic* (Vol. 7, pp. 665-704). Amsterdam: Elsevier.
- al-Kurdī, Muḥammad b. Sulaymān. (2011). *al-Fawā'id al-Madaniyya*. (Ed. Bassām ‘Abd al-Wahāb al-Jābī). Libanon: Dār Nūr al-Ṣabāḥ and al-Jaffān wa al-Jābī.
- Lorenz, K. (2000). Sinnbestimmung und Geltungssicherung. In G.-L. Lueken, *Formen der Argumentation* (pp. 87-106). Leipzig: Akademisches Verlag.
- Lorenz, K. (2010a). *Logic, Language and Method: On Polarities in Human Experiences*. Berlin / New York: De Gruyter.
- Lorenz, K. (2010b). *Philosophische Variationen: Gesammelte Aufsätze unter Einschluss gemeinsam mit Jürgen Mittelstrass geschriebener Arbeiten zu Platon und Leibniz*. Berlin / New York: De Gruyter.
- Lorenzen, P., & Lorenz, K. (1978). *Dialogische Logik*. Damstadt: Wissenschaftliche Buchgesellschaft.
- Lowry, J. E. (2007). *Early Islamic Legal Theory: The Risāla of Muḥammad ibn Idrīs al-Shāfi'ī*. Leiden: Brill.
- Marion, M., & Rückert, H. (2015). Aristotle on universal quantification: a study from the perspective of game semantics. *History and Philosophy of Logic*, 37(3), 201-209.
- Marmura, M. E. (1965). Ghazali and Demonstrative Science. *Journal of the History of Philosophy* 3/2, 183-204.
- Martin-Löf, P. (1984). *Intuitionistic Type Theory. Notes by Giovanni Sambin of a Series of Lectures given in Padua, June 1980*. Naples: Bibliopolis.

- Martin-Löf, P. (1996). On the Meanings of the Logical Constants and the Justifications of the Logical Laws. *Nordic Journal of Philosophical Logic*, 1, 11-60.
- Martin-Löf, P. (2012, March). *Aristotle's distinction between apophansis and protasis in the light of the distinction between assertion and proposition in contemporary logic*. Paper presented at the Workshop "Sciences et Savoirs de l'Antiquité à l'Age classique" held at the laboratory SPHERE-CHSPAM, Paris VII, Paris.
- Martin-Löf, P. (2015, May). *Is Logic Part of Normative Ethics?* Paper presented at the research Unity Sciences, Normes, Décisions (FRE 3593), Paris.
- Miller, L. B. (1984). *Islamic Disputation Theory*. PhD dissertation, Pinceton University.
- Miller, L. B. (2020). *Islamic Disputation Theory*. Cham: Springer.
- Mujiburrahman. (2014). Islamic Theological Texts and Contexts in Banjarese Society: An Overview of the Existing Studies. *Southeast Asian Studies*, 3/3, 611-641.
- Mujiburrahman. (2017). Historical Dynamic of Inter-Religious Relations in South Kalimantan. *Journal of Indonesian Islam*, 11/1, 145-174.
- Munadi, F. (2020). *Teks dan Naskah Sabīl al-Muhtadīn: Kajian Filologi atas Karya Syekh Muhammad Arsyad*. Retrieved from https://www.academia.edu/41958304/TEKS_DAN_NASKAH_SAB% C4% A AL_ AL_ MUHTAD% C4% AAN_ KAJIAN_ FILOLOGI_ ATAS_ KARYA_ SY EKH_ MUHAMMAD_ ARSYAD
- al-Namla, 'Abd al-Karīm b. 'Alī b. Muḥammad. (1999). *al-Muhadhdhab fī 'Ilm Uṣūl al-Fiqh al-Muqārin*. Riyadh: Maktabat al-Rushd.
- Noor, I. (2015, November). *Harta Perpantangan: Sebuah Akomodasi Hukum Waris Islam atas Budaya Relasi Gender dalam Masyarakat Banjar*. Retrieved from <https://dokumen.tips/documents/harta-perpantangan.html>
- Noor, M. I. (2011). Nalar Keislaman Urang Banjar. *Al-Banjari*, 10/2, 185-204.
- Nordström, B., Petersson, K., & Smith, J. M. (1990). *Programming in Martin-Löf's Type Theory: An Introduction*. Oxford: Oxford University Press.
- Nordström, B., Petersson, K., & Smith, J. M. (2000). Martin-Löf's Type Theory. In S. Abramsky, D. Gabbay, & T. S. Maibaum (Eds.), *Handbook of Logic in Computer Science* (Vol. 5 : Logic and Algebraic Methods, pp. 1-37). Oxford: Oxford University Press.
- Peregrin, J. (2014). *Inferentialism. Why Rules Matter*. New York: Plagrave MacMillan.

- Perlmann, M. (1971). Shaykh al-Damanhūrī against the churches of Cairo (1739). *Actas IV Congresso de Estudos Arabes e Islâmicos: Coimbra-Lisboa, 1 a 8 de setembro de 1968* (pp. 27–32). Leiden: Brill.
- Plato. (1997). *Plato. Complete Works*. (J. M. Cooper, Trans.) Indianapolis IN: Hackett.
- Posner, R. A. (2006). Reasoning by Analogy. *Cornell Law Review*, 91/3, 761-774.
- Primiero, G. (2008). *Information and Knowledge*. Dordrecht: Springer.
- Rahman, S., & Iqbal, M. (2018). Unfolding parallel reasoning in islamic jurisprudence: Epistemic and Dialectical Meaning within Abū Ishāq al-Shīrāzī's System of Co-Relational Inferences of the Occasioning Factor. *Arabic Sciences and Philosophy*, 28, 67-132.
- Rahman, S., & Keiff, L. (2005). On How to be a Dialogician. In D. Vanderveken (Ed.), *Logic, Thought and Action* (pp. 359-408). Dordrecht: Kluwer.
- Rahman, S., & Rückert, H. (Eds.). (2001). Special Volume Synthese 127. *New Perspectives in Dialogical Logic*. Dordrecht: Springer.
- Rahman, S., & Tulenheimo, T. (2009). From Games to Dialogues and Back: Towards a General Frame for Validity. In O. Majer, A. Pietarinen, & T. Tulenheimo (Eds.), *Games: Unifying Logic, Language and Philosophy* (pp. 153-208). Dordrecht: Springer.
- Rahman, S., Clerbout, N., & Redmond, J. (2017). Interacción e Igualdad La interpretación dialógica de la Teoría Constructiva de Tipos Interaction and Equality Dialogical interpretation of Constructive type Theory. *Critica, Revista Hispanoamericana de Filosofía, UNAM*, 49 (145), 49-89.
- Rahman, S., Granström, J. G., & Farjami, A. (2019). Legal Reasoning and Some Logic After All. The Lessons of the Elders. In D. Gabbay, L. Magnani, W. Park, & A.-V. Pietarinen, *Natural Arguments. A Tribute to John Woods* (pp. 743-780). London: CollegePublications.
- Rahman, S., Iqbal, M., & Soufi, Y. (2019). *Inference by Parallel Reasoning in Islamic Jurisprudence*. Cham: Springer.
- Rahman, S., McConaughy, Z., Klev, A., & Clerbout, N. (2018). *Immanent Reasoning or Equality in Action. A Plaidoyer for the Play Level*. Dordrecht: Springer.
- Rahman, S., Zidani, F., & Young, W. E. (2020). Ibn Hazm on Heteronomous Imperative. Landmark in the History of the Logical Analysis of Legal Norms. In P. McNamara, A. Jones, & M. Brown, *Deontic Logic*. Synthese Library-Springer. In print.
- al-Ramlī, Shams al-Dīn b. Aḥmad. (1984). *Nihāyat al-Muḥtāj ilā Sharḥ al-Minhāj*. Beirut: Dār al-Fikr.

- Ranta, A. (1988). Propositions as Games as Types. *Syntese*, 76, 377-395.
- Ranta, A. (1994). *Type-Theoretical Grammar*. Oxford: Clarendon Press.
- Ras, J. J. (1968). *Hikajat Bandjar: A Study in Malay Historiography*. The Hague: Martinus Nijhoff.
- Reid, A. (1988). *Southeast Asia in the age of commerce, 1450-1680*. New Haven; London: Yale University Press.
- Rückert, H. (2011). *Dialogues as a Dynamic Framework for Logic*. London: College Publications.
- Rusydi, M. (2014). *Kitab Tuhfat Al-Raghibin Karya Muhammad Arshad Al Banjari: Studi Ideologi dan Epistemologi*. PhD thesis, UIN Sunan Ampel Surabaya.
- Al-Shāfi'ī, Muḥammad Idrīs. (1987). *Al-Shāfi'ī's Risāla ; Treatise on the Foundations of Islamic Jurisprudence* (Trans. Majid Khadduri). The Text Islamic Society.
- Al-Shāfi'ī, Muḥammad Idrīs. (1940). *Al-Risāla*. (Ed. Aḥmad Shākir). Cairo: Maktaba al-Ḥalabī.
- Shamsy, A. E. (2013). The Ḥāshiya in Islaimic Law: A Sketch of Shāfi'ī Literature. *Oriens*, 41, 289-315.
- Sharī'a, Ṣadr. (1357 H/1938). *Tanqīḥ al-Uṣūl*. Cairo: al-Maṭba'a al-Maḥmūdiyya al-Tijāriyya bi-l-Azhar.
- al-Shīrāzī, Abū Ishāq. (1092). *Al-Ma'ūna*. Princeton University Figital Library. <http://pucl.princeton.edu/objects/2f75r807h>.
- al-Shīrāzī, Abū Ishāq. (1407 H/1986). *Mulakhkhaṣ fī al-Jadal fī Uṣūl al-Fiqh*. (Ed. Muḥammad Yūsuf Ākhund Jān Niyāzī). MA Thesis, Umm al-Qura University.
- al-Shīrāzī, Abū Ishāq. (1987). *Al-Ma'ūna fī al-Jadal*. (Ed. 'Alī b. 'Abd al-'Azīz al-'Umayrīnī). Al-Ṣafāḥ, Kuwait: Manshūrāt Markaz al-Makhtūṭāt wa-al-Turāth.
- al-Shīrāzī, Abū Ishāq. (1988). *Sharḥ al-Luma' fī Uṣūl al-Fiqh*. (Ed. 'Abd al-Majīd Turkī). Beirut: Dār al-Gharb al-Islāmī.
- al-Shīrāzī, Abū Ishāq. (1995). *Al-Luma' fī Uṣūl al-Fiqh*. (Ed. Muḥyī al-Dīn Dīb Mustū and Yūsuf 'Alī Badīwī). Damascus; Beirut: Dār al-Kalam al-Ṭayyib; Dār Ibn Kathīr.
- al-Shīrāzī, Abū Ishāq. (2003). *Al-Luma' fī Uṣūl al-Fiqh*. Beirut: Dār al-Kutub al-'Ilmiyah.
- al-Shīrāzī, Abū Ishāq. (2016, February). *Mulakhkhaṣ fī al-Jadal*. Retrieved from https://upload.wikimedia.org/wikisource/ar/e/ea/الملخص_في_الجدل_خ.pdf
- Soucek, S. (2000). *A History of Inner Asia*. Cambridge: Cambridge University Press.

- Steenbrink, K. A. (1984). *Beberapa Aspek tentang Islam di Indonesia Abad ke19*. Jakarta: Bulan Bintang.
- Sundholm, G. (2009). A century of judgement and inference, 1837-1936: Some strands in the development of logic. In L. Haaparanta, *The Development of Modern Logic* (pp. 264-317). Oxford: Oxford University Press.
- Sundholm, G. (2012). Inference versus Consequence Revisited: Inference, Conditional, Implication. *Syntese*, 187, 943-956.
- Sundholm, G. (2013). *Inference and Consequence as an Interpreted Language*. Paper presented at the Workshop "Proof Theory and Philosophy" Groningen, Desember 2-3, 2013.
- Syukur, A. (2002). *Risalah Tuhfatu al Raghabin fi Bayani Haqiqati Imani al Mu'minin wama Yufsiduhu min Riddati al Murtadin*. Lecture organised by Pusat Pengkajian Islam Kalimantan (PPIK), held at IAIN Antarasari Banjarmasin, 6 June 2002.
- Syukur, A. (2009). Kata Pengantar. In Muhammad Arsyad al-Banjari, *Pemikiran-pemikiran Syeh Muhammad Arsyad al Banjari dalam bidang tauhid dan tasawuf*. (Ed. Aswadie Syukur). Banjarmasin: Comdes.
- Syukur, A. (2016). Pemikiran Syekh Muhammad Arsyad al-Banjari dalam Bidang Fiqh (1); Kitab Sabil al-Muhtadin. In Abdul Rahman Abdullah, *Biografi Agung Sheikh Arshad al-Banjari* (pp. 290-302). Shah Alam, Selangor: Karya Bestari.
- The Editors of Encyclopedia Britannica. (2018, October). *Transoxania (historical region, Asia)*. Retrieved from Encyclopedia Britannica: <https://www.britannica.com/place/Transoxania>
- van Bruinessen, M. (1998). Kurdish `Ulama and their Indonesian disciples" [revised version of: "The impact of Kurdish `ulama on Indonesian Islam"]. *Les annales de l'autre islam*, 5, 83-106.
- van Ess, J. (2018). The Logical Structure of Islamic Theology. In H. Biesterfeldt, *Kleine Schriften by Josef van Ess* (pp. 238-271). Leiden; Boston: Brill.
- Weinreb, L. (2005). *Legal Reason: The Use of Analogy in Legal Argument*. Cambridge: Cambridge University Press. doi:10.1017/CBO9780511810053
- Weiss, B. G. (1992). *Search for God's Law, Islamic Jurisprudence in the Writings of Sayf al-Din al-Amidi*. Salt Lake City: University of Utah Press.
- Weiss, B. G. (1998). *The Spirit of Islamic Law*. Athens / London: The University of Georgia Press.
- Woods, J. (2015). *Is Legal Reasoning Irrational? An Introduction to the Epistemology of Law*. London: College Publications.

- Young, W. E. (2017). *The Dialectical Forge; Juridical Disputation and the Evolution of Islamic Law* . Dordrecht: Springer.
- Zamzam, Z. (1979). *Syekh Muhammad Arsyad Al-Banjari; Ulama Besar Juru Da'wah*. Banjarmasin: Penerbit Karya.
- al-Zarkalī, Khair al-Dīn. (2002). *al-A'lām*. vol.4. Beirut: Dār al-'Ilm li al-Malāyīn.