



HAL
open science

Exploration tactile non-visuelle des graphiques : nouvelles observations comportementales et techniques d'interaction

Kaixing Zhao

► **To cite this version:**

Kaixing Zhao. Exploration tactile non-visuelle des graphiques : nouvelles observations comportementales et techniques d'interaction. Réseaux et télécommunications [cs.NI]. Université Paul Sabatier - Toulouse III, 2021. Français. NNT : 2021TOU30045 . tel-03333919

HAL Id: tel-03333919

<https://theses.hal.science/tel-03333919v1>

Submitted on 3 Sep 2021

HAL is a multi-disciplinary open access archive for the deposit and dissemination of scientific research documents, whether they are published or not. The documents may come from teaching and research institutions in France or abroad, or from public or private research centers.

L'archive ouverte pluridisciplinaire **HAL**, est destinée au dépôt et à la diffusion de documents scientifiques de niveau recherche, publiés ou non, émanant des établissements d'enseignement et de recherche français ou étrangers, des laboratoires publics ou privés.



THÈSE

**En vue de l'obtention du
DOCTORAT DE L'UNIVERSITÉ DE TOULOUSE
Délivré par l'Université Toulouse 3 - Paul Sabatier**

**Présentée et soutenue par
Kaixing ZHAO**

Le 13 juillet 2021

**Exploration tactile non-visuelle des graphiques: nouvelles
observations comportementales et techniques d'interaction**

Ecole doctorale : **EDMITT - Ecole Doctorale Mathématiques, Informatique et
Télécommunications de Toulouse**

Spécialité : **Informatique et Télécommunications**

Unité de recherche :

IRIT : Institut de Recherche en Informatique de Toulouse

Thèse dirigée par

Christophe JOUFFRAIS et Marcos SERRANO

Jury

M. Nicholas GIUDICE, Rapporteur

M. Tiago GUERREIRO, Rapporteur

Mme Florence Bara, Examinatrice

M. Thomas Pietrzak, Examineur

M. Christophe JOUFFRAIS, Directeur de thèse

M. Marcos SERRANO, Co-directeur de thèse

Contents

Contents	2
Acknowledgments.....	10
Abstract.....	12
List of tables.....	15
List of figures	16
Chapter 1 Introduction	23
1.1 Context	25
1.1.1 Accessibility issues related to graphics	25
1.1.2 Tactile exploration of graphics	26
1.1.3 Need for remote collaborative graphics learning	27
1.2 Research questions	27
1.3 Contributions.....	28
1.4 Dissertation structure.....	29
Chapter 2 Related work	32
2.1 Part I Tactile graphics	33
2.1.1 Tactile graphics for people with VI.....	33
2.1.2 Design and adaptation of tactile graphics.....	34
2.2 Part II Exploration of tactile graphics	39
2.2.1 Non-visual exploration of tactile graphics.....	39
2.2.2 Differences on recognition and identification of tactile graphics.....	45
2.2.3 Cognitive exploration strategies without vision	47
2.3 Part III Exploration of digital graphics	49
2.3.1 Interactive devices for digital graphics exploration	49

2.3.2 Interaction modalities for digital graphic exploration	53
2.3.3 Exploration strategies of digital graphics	56
2.4 Part IV Remote collaborative graphic learning.....	59
2.4.1 Collaborative activities of people with VI.....	60
2.4.2 Collaborative learning for people with VI.....	63
2.4.3 Remote online learning.....	67
2.5 Conclusion of Chapter 2.....	69
Chapter 3 VibHand: On-Hand Vibrotactile Interface Enhancing Non-Visual Exploration of Digital Graphics.....	72
3.1 Introduction	73
3.1.1 Context.....	73
3.1.2 Research questions	74
3.1.3 Motivations	74
3.1.4 Contributions	75
3.1.5 Chapter structure.....	75
3.2 Vibrotactile display	75
3.2.1 Spatiotemporal Vibrotactile Pattern	76
3.2.2 Apparent Tactile Motion	77
3.3 Participatory design.....	78
3.3.1 Phase 1: Understanding users' needs.....	78
3.3.2 Phase 2: Designing the vibrotactile interface	80
3.3.2.1 Vibrotactile factors.....	80
3.3.2.2 Optimal vibration duration.....	85
3.3.2.3 Optimal stimulation method and configuration	87
3.3.2.4 Vibrotactile progression cues.....	92

3.4 Experiment: exploring and identifying geometrical and non-figurative graphics ..	92
3.4.1 Participants	93
3.4.2 Task and instructions	95
3.4.3 Digital graphics.....	95
3.4.4 Interaction techniques.....	96
3.4.5 Experimental design	96
3.4.6 Experimental setup	97
3.4.7 Collected data and dependent variables.....	98
3.4.8 Results	99
3.4.8.1 Identification of G-Graphics	99
3.4.8.2 Pair comparison	99
3.4.8.3 Response Time (to judge same or different).....	100
3.4.8.4 Unrelated finger path for the sample graphic	101
3.4.8.5 Exploration speed.....	102
3.4.8.6 Exploration movements	103
3.4.8.7 Qualitative feedback	104
3.5 General discussion and perspectives	105
3.5.1 Vibrotactile cues improve digital graphic exploration	105
3.5.2 Impact of user’s visual status.....	105
3.5.3 Application scenarios	106
3.5.4 Limitations and Future work	107
3.6 Conclusion of Chapter 3.....	108
Chapter 4 Tactile Fixations: a behavioral marker on how people with visual impairments explore raised-line graphics	110
4.1 Introduction	111

4.1.1 Context.....	111
4.1.2 Research questions	113
4.1.3 Motivations.....	113
4.1.4 Contributions	114
4.1.5 Chapter structure.....	114
4.2 From eye fixations to tactile fixations.....	114
4.2.1 Eye fixations	114
4.2.2 I-DT for eye fixation identification	116
4.2.3 Towards to tactile fixations	117
4.3 Concept.....	118
4.4 Behavioral study.....	119
4.4.1 Participants	119
4.4.2 Raised-line graphics	120
4.4.3 Experimental setup	122
4.4.4 Task and Procedure	123
4.4.5 Methods	124
4.4.5.1 Finger Tracking Algorithm	124
4.4.5.2 Identification of tactile fixations.....	126
4.4.5.3 Statistical tests.....	127
4.4.6 Results	127
4.4.6.1 Identification rate and correct answer rate.....	127
4.4.6.2 Tactile fixations	128
4.4.6.3 Number of tactile fixations	128
4.4.6.4 Duration of tactile fixations	130
4.4.6.5 Exploration patterns.....	132

4.5 General discussion and perspectives	136
4.5.1 Can we detect tactile fixations?	136
4.5.2 Do users perform tactile fixations with both hands?	137
4.5.3 Do tactile fixations vary according to the type of graphics and the exploration task?	137
4.5.4 Can we relate tactile fixations to exploration strategies?	138
4.5.5 Lessons learned and implications for HCI and other fields.....	138
4.5.6 Limitations and future work	140
4.6 Conclusion of Chapter 4.....	141
Chapter 5 TactileLink: a remote collaborative graphics learning tool for pupils with visual impairments.....	143
5.1 Introduction	143
5.1.1 Context and motivations	143
5.1.2 Survey	144
5.1.3 Method and research questions.....	146
5.1.4 Motivations	146
5.1.5 Contributions and structure of the chapter	147
5.2 Project DERi	148
5.2.1 What is DERi?	148
5.2.2 DERi Editor and Reader	150
5.2.3 Challenges of using DERi for remote learning	152
5.3 First focus group.....	153
5.3.1 Focus group preparation	153
5.3.2 Participants	154
5.3.3 Scenario	154
5.3.4 Mockups for the focus group.....	155

5.3.5 Procedure of the focus group.....	157
5.3.6 Outcomes of the focus group.....	158
5.4 Second focus group.....	159
5.4.1 Focus group preparation.....	160
5.4.2 Participants.....	161
5.4.3 Procedure.....	161
5.4.4 Main questions of the focus group.....	161
5.4.5 Outcomes of the focus group.....	162
5.5 General discussion and perspectives.....	163
5.6 Conclusion of Chapter 5.....	166
Chapter 6 General discussion and perspectives.....	168
6.1 Dissertation summary and contributions.....	168
6.1.1 Augment human’s tactile exploration ability of digital graphics.....	168
6.1.2 Understand tactile exploration behavior at finger level.....	169
6.1.3 Design interactive tool for remote graphics learning.....	170
6.2 Perspectives.....	170
6.2.1 Perspectives of our contributions.....	170
6.2.2 Perspectives of non-visual tactile exploration of graphics.....	172
6.3 Towards a broader scope.....	174
6.3.1 Design with blindfolded sighted people.....	174
6.3.2 Expand to other domains.....	174
Chapter 7 Conclusion.....	177
7.1 Pros and cons of this dissertation.....	177
7.2 Societal impact.....	178
7.3 Decreasing the gap of graphical information access.....	179

References..... 181

Gazing on Mount Tai

岱宗夫如何？齐鲁青未了。

造化钟神秀，阴阳割昏晓。

荡胸生层云，决眦入归鸟。

会当凌绝顶，一览众山小。

O, peak of peaks, how high it stands!

One boundless green o'erspreads two states.

A marvel done by nature's hands.

O'er light and shade it dominates.

Clouds rise therefrom and lave my breast.

My eyes are strained to see birds fleet.

Try to ascend the mountain's crest.

It dwarfs all peaks under our feet.

Acknowledgments

Time flies! This is already my sixth year in France and the third year of my Ph.D. There are too many things I want to say, but I am still hesitating where to start. From a small county in China, I have been studying for 22 years. Just six years ago, I have never considered to start a new adventure in another country. But I did it! I successfully finished my Master degree in a small French city – Tours and now I am finishing my Ph.D. degree in Toulouse.

There are too many people I want to say thank you! Firstly, I want to thank two rapporteurs of my Ph.D. dissertation: Prof. Tiago Guerreiro from University of Lisbon and Prof. Nicholas A. Giudice from The University of Maine. I really appreciated your interest in my work and the time spent to review my dissertation.

I also want to say thank you to my two supervisors: Christophe and Marcos. From October 2018, they brought me into the world of research, especially the fascinating HCI world. From a novice to currently a confident HCI researcher, I have tasted too much joy and bitterness during these three years. Now I can proudly say that I entered the door of research and ready for more challenges.

Of course, I cannot forget many others in Elipse group, especially Bernard. He completely participated my Ph.D. in my past three years and also guided me in many research projects. Other members like Marc, Emmanuel, Antonio, Anthony and members who have finished their study like Sandra, Housseem, Frédéric, they all gave me lots of help. I cannot list all their help here but I will forever remember effort.

Now it's time to thank my Ph.D. colleagues Florent, Elio, Aziz, etc. We spent several years together and I really hope we can successfully get our Ph.D. degrees together!

I also really appreciate all the participants (visually impaired or sighted) for their time and efforts. I cannot finish my dissertation without your help and I am very happy to work with you to make more contributions to the Accessibility research!

Finally, I want to thank my families! Although we are 9000 kilometers far from each other, I know you think about me every day. I am excited that we can meet soon!

The last paragraph I want give it to my girlfriend Huan! We have spent together two years in Toulouse and I know you still have one year to finish your Ph.D. degree. Although we must separate temporally for one year because of my work, I am always waiting for you! Hope you can perfectly finish your study and let's get married!

To finish, I want to borrow a classical Chinese poem "The road ahead is long and has no ending but I will search with my will unbending!".

Abstract

Graphics are used as a powerful tool to present information and can provide people an easier way to understand abstract data representations. As graphical information becomes more and more pervasive in both work and daily life, it is important for people with visual impairments (VI) to be able to explore and understand them. However, despite tremendous efforts in HCI have focused on the accessibility issues of graphical information, access to maps, schemas, mathematical graphs, drawings, etc. is still a great challenge for people with VI. In fact, this issue has become more and more obvious between people with VI and sighted people, especially in current information society with rapidly growing amounts of digital graphics. Therefore, in this Ph.D. dissertation, we would like to address different difficulties during the exploration of tactile and digital graphics.

Generally, the adaptation process of tactile graphics is based on methods mastered by tactile document makers and thus difficult to conduct mass production. In addition, professionals are still not very clear about how people with VI organize their hands during the exploration of tactile graphics. However, this information may be useful for professionals to improve the accessibility of graphics.

For the first problem, with the recent developments of computing technologies, many interactive systems have been proposed to augment or replace tactile graphics. Among them, some are hybrid systems which combine physical and digital components at the same time while the others are fully digital, which graphical information is presented directly on digital devices (such as commercial mobile phones or tablets). Compared with tactile graphics, although digital graphics could provide more flexibility (easy to modify), their exploration is still very limited due to the lack of tactile cues. In this dissertation, we investigated the possibility of improving the tactile exploration experience of digital graphics by designing an on-hand vibrotactile interface called VibHand, which enables people with VI to explore digital graphics on tablets more easily. To do this, we extended the idea of using the tablet vibration and studied the use of a vibrotactile display on the back of the hand to convey directional and progression information.

For the second problem, previous researches confirmed that the design of tactile graphics usually needs to consider not only graphical elements, such as legends, textures, symbols, dots, lines, etc. but also the target users or tasks. However, there is a lack of an efficient method to evaluate users' tactile exploration behavior as well as their perceptual and cognitive capacities while exploring the tactile graphics from a more refined level. Therefore, although we had observed some special organized explorative behaviors before, they have never been systematically discussed and evaluated. Actually, there is a gap between tactile exploration experiences and the adaptation principles of tactile graphics. To tackle this problem, we conducted corresponding research focusing on understanding the tactile exploration of people with VI and proposed a behavioral marker (a novel behavioral observation) called "Tactile Fixation". A tactile fixation occurs when a finger is motionless within a spatial and temporal window during the tactile exploration. Identifying tactile fixations can provide valuable information on the salient areas of the graphics and the exploration strategies of people with VI.

Apart from the abovementioned two core foci, in this dissertation, we also explored the possibility of remote collaborative graphics learning which had an explosive demand during the global pandemic. The proposed system, which is called TactileLink, was based on an interactive graphics exploration tool and co-designed with several professionals for people with VI.

Overall, the whole dissertation contributes both theoretical and application knowledge to the non-visual tactile exploration of graphics by people with VI.

List of tables

Table 1. Demonstration of vibrotactile directional cues using different stimulation methods and with different layout shapes.	82
Table 2. Description of the VI and BF participants.	93
Table 3. Details of the participants.	119
Table 4. General comments about TactileLink.	158
Table 5. Comments about the annotations.	158
Table 6. Comments about the navigation between different levels of the graphics.	159

List of figures

Figure 1. A visual metro map of Toulouse metropolis. Such a digital map is difficult to explore and understand for people with VI.....	24
Figure 2. Tactile drawing of a flower from [87].....	24
Figure 3. A blind user exploring digital graphics displayed on a tablet.	26
Figure 4. A blind user exploring an invisible digital map based on movement tracking [13].	27
Figure 5. An example of tactile map.....	33
Figure 6. An example of tactile graphic generating by thermoforming.	33
Figure 7. The decision tree from [87] to decide if we need to produce graphics.	35
Figure 8. From left to right: the original European map and adapted tactile version [87].	36
Figure 9. Examples of areas, lines and symbols in tactile graphics from [35].	38
Figure 10. From left to right: original and adapted graphic of circulatory system [87]. ..	38
Figure 11. From left to right: original and adapted graphic of average annual rainfall of Australia [87].	39
Figure 12. A choropleth map on unemployment of USA.....	40
Figure 13. A dot distribution map on demographic statistics of Australia.	41
Figure 14. A graduated symbol map on urban population.....	41
Figure 15. A heat map on New York city.....	42
Figure 16. A cartogram on world's organic agriculture.	42
Figure 17. A bivariate choropleth map on interrelationship of educational attainment and per capita income in USA.	42
Figure 18. Exploration of a tactile map with finger tracking [13]......	43
Figure 19. Two-dimensional tactile patterns from [103]. Left: identical pairs; Right: similar pairs.....	44
Figure 20. Accurate outline following by a people with VI [105].....	45
Figure 21. Visual graphics from the image set of Snodgrass et al. [117].	46
Figure 22. An example of Cyclic strategy from [36].....	49

Figure 23. Construct a mathematical graph with proposed Tangible Graph Builder system [85].	50
Figure 24. Tangible Reels: a tangible map for people with visual impairment [30].	51
Figure 25. (left) Add annotations and paths to haptic video player by sighted people; (right) Robots are moving by following the pre-defined paths. Both from [49].	51
Figure 26. From left to right: (1) Tactile Bar Chart; (2) Tortoise and the Hare; (3) Analog Clock; (4) Braille Assistant; (5) Digestive System. Both from [50].	52
Figure 27. Digital maps exploration with smartwatch from [13].	52
Figure 28. A blind user exploring geometrical graphics using EVIAC [125].	53
Figure 29. Exploring a digital graphic using GraVVITAS [42].	55
Figure 30. Exploring a T-like digital graphic with vibro-audio mode [37].	56
Figure 31. From left to right: one-handed and two-handed path scan exploration [48].	57
Figure 32. Example of focused exploration [48].	57
Figure 33. Example of to-the-point exploration [48].	58
Figure 34. Example of freeform symmetry exploration [48].	58
Figure 35. Example of trailing finger exploration [48].	59
Figure 36. OneView interface [63]. Left: a visual, sketch-based interface; Right: a hierarchical talking menu.	61
Figure 37. The collaborative interface used during the experiment [59]. The red and blue point indicate the sighted and blind participant.	61
Figure 38. The collaborative article writing interface from [128]. Both visually impaired and sighted participants work in the same interface.	62
Figure 39. The configuration of Torino [122]. Top: Instruction beads connected to the main hub for the creation of an audio-based computer program. Bottom from left to right: play bead, pause bead, loop bead and hub.	64
Figure 40. The system McSig [104]. The teacher on the left draws on a Tablet PC to create a shape and the student on the right can feel, explore and be moved around the shape.	65
Figure 41. One sighted pupil and one pupil with VI are classifying angles using PHANTOM system [89].	66
Figure 42. The dynamic application with two users represented by a blue and red sphere respectively [89].	66

Figure 43. The primary interface of AttentiveReview [102].	67
Figure 44. Workflow of the experimental system used for online live lectures [121].	68
Figure 45. Left side: interfaces of three pupils with VI. Right side: interface of the remote instructor [80].	69
Figure 46. Simple digital graphics evaluated by Tekli et al [125].	73
Figure 47. (a) and (b): Sequential SVP [26], the arrows represent the order of activated vibrators. This stimulation gives the sensation of a moving vibration. (c) and (d): simultaneous SVP, the red points represent the activated vibrators. This stimulation gives the sensation of an intermediate “phantom” vibration generated between the two or three real vibrations.	76
Figure 48. Chronogram of an ATM [60]. d and d’: the vibration duration of the departure and arrival vibrators. T: the total duration of the movement. SOA: the time interval between two stimuli. This stimulation gives the sensation of a vibration moving between two vibrators.	77
Figure 49. People with VI interact with their smartphone using audio feedback [129].	79
Figure 50. Examples of adapted tactile graphics. Left: geographic map; Right: mathematical graph.	80
Figure 51. Four possible configurations according to the layout shapes and layout positions of vibrators on the back of the hand (A and B: square- and cross-shape on the back of the hand; C and D: square- and cross-shape on the back of the hand and fingers).	83
Figure 52. (a) Raised-line graphic exploration: tactile cues under the fingertip allow users to easily perceive line direction. (b) Digital graphic exploration: the tablet vibrates when the fingertip is over a digital line. Exploration is difficult because of the absence of fingertip tactile cues. (c) VibHand: a back-of-the-hand vibrotactile feedback that provides users with directional (d) and progression (e) cues to improve the exploration of digital graphics on tablets.	84
Figure 53. Vibrotactile prototype on the hand.	86
Figure 54. Recognition rates according to the vibration duration (ms). The error bars indicate 95% confidence intervals.	87

Figure 55. Average recognition rates according to the configurations. The error bars indicate 95% of confidence intervals. The upper bars indicate the statistical significance (* < .05, *** < .001).....	89
Figure 56. Confusion matrices with SVP for each configuration (The vertical axis represents the desired responses).....	90
Figure 57. Confusion matrices with ATM for each configuration (The vertical axis represents the desired responses).....	91
Figure 58. Subjective efficiency and satisfaction of the four configurations.	91
Figure 59. Subjective efficiency and satisfaction of the two stimulation methods.	91
Figure 60. Sets A and B: Geometrical graphic pairs; Sets C and D: Non-Figurative graphic pairs.....	95
Figure 61. Experimental setup with a NF-Graphic displayed on the tablet and the four vibrators attached to the back of the hand.	98
Figure 62. Average identification accuracy for G-Graphics (95% of CI).	99
Figure 63. Average comparison accuracy (95% of CI).	100
Figure 64. Average response time (95% of CI).	101
Figure 65. Average unrelated finger path (95% of CI).	102
Figure 66. Average exploration speed (95% of CI) by a) visual status; b) interaction technique and c) graphic type.	103
Figure 67. A and C: VI 02 finger paths when exploring a geometrical graphic with control technique and VibHand respectively; B and D: VI 06 finger paths when exploring a non-figurative graphic with control technique and VibHand respectively.	104
Figure 68. Qualitative feedback of VI participants for the VibHand technique.	104
Figure 69. A user exploring a path between two POIs on a neighborhood map (left) and a line plot on a mathematical graph (right) with VibHand.....	107
Figure 70. An example of Swell Touch Paper.....	111
Figure 71. Left and right index fingers stop often to “read” underlying information. Each stop may become a tactile fixation if it meets the conditions of tactile fixations. In this figure, the yellow point on the left hand and the orange square on the right hand represent a short and middle tactile fixation respectively.	112

Figure 72. Two eye fixations correspond to two detailed visual information retrieval processes.	115
Figure 73. A series of consecutive eye fixations reveal the user’s eye movements.	116
Figure 74. Pseudocode for the I-DT algorithm [110].	117
Figure 75. Example of raised-line graphics used for behavioral study. A: 2D Drawings; B: Drawings with Perspective; C: Mathematical Graphs; D: Geographic Maps; and E: Neighborhood-Building Maps.	122
Figure 76. The experimental setup used in this study.....	122
Figure 77. An example of real-time finger tracking and tactile fixations identification. Yellow point represents a short tactile fixation on the left hand and the red square represents a long tactile fixation on the right hand.	125
Figure 78. An example of tracking lost: red square represents the missed tracking (due to overlapping fingers).	126
Figure 79. Distribution of tactile fixations according to the fixation duration.	128
Figure 80. a. Average number of left and right tactile fixations, b. Average number of tactile fixations according to the type of graphic. (95% CI). 2DD: 2D Drawings; DwP: Drawings with Perspectives; GM: Geographic Maps; MG: Mathematical Graphs; NBM: Neighborhood-Building Maps.	129
Figure 81. Number of fixations according to the Task and Graphic Type (95% CI).	130
Figure 82. Fixation duration according to: a: the hand; b. the type of graphic; and c. the task. (95% CI). 2DD: 2D Drawings; DwP: Drawings with Perspectives; GM: Geographic Maps; MG: Mathematical Graphs; NBM: Neighborhood Building Maps.	131
Figure 83. Average duration according to the Task and Graphic Type. (95% CI).....	132
Figure 84. Conceptual illustration of the Anchor Point pattern. The right index is anchored to a point while the left index explores various other elements of the graphic.	133
Figure 85. Example of an Anchor Point pattern. Tactile fixations on left and right index fingers are represented by circles and squares respectively. Numbers correspond to the tactile fixation order. Blue color represents “short” fixations (0.5 to 1 s) and red color represents “long” fixations (> 5 s).	133
Figure 86. Conceptual illustration of Switching Fingers pattern. The right hand is at the center of the map while the left hand explores the left part of the map. After a while, the	

left hand replaces the right hand at its anchor point and the right hand begins to explore the right part of the map.....	134
Figure 87. Example of a Switching Fingers pattern. Tactile fixations on left and right index fingers are represented by circles and squares respectively. Numbers correspond to the tactile fixation order. Blue color represents “short” fixations (0.5 to 1 s) and orange color represents “middle” fixations (1 to 5 s).	134
Figure 88. Conceptual illustration of Chaining Hands pattern. The right hand is at the rabbit’s foot then it is joined by the left hand. Later, the right hand goes at the mouth of the rabbit and is followed by the left hand. The same movement occurs also at the ear of the rabbit.	135
Figure 89. Example of a Chaining Hands pattern. Tactile fixations on left and right index fingers are represented by circles and squares respectively. Numbers correspond to the tactile fixation order. Blue color represents “short” fixations (0.5 to 1 s).....	135
Figure 90. Heat map based on the distribution of tactile fixations.	141
Figure 91. A series of co-design workshops with pupils with VI and sighted pupils to refine the design of collaborative game [83].....	143
Figure 92. TIMMs remote learning application [80]......	144
Figure 93. An example of remote collaborative tool – Conceptboard.....	147
Figure 94. DERi device with an interactive raised-line drawing representing a bee.....	149
Figure 95. Different sizes of touchscreen devices that are compatible with DERi, from left to right: tabletop, touchscreen PC and tablet.	149
Figure 96. A simple example of a DERi drawing. The raised-line drawing is fixed over a touchscreen. When people with VI double tap interactive zones on the map, they get audio feedbacks.....	150
Figure 97. Design the digital graphics using Inkscape.	151
Figure 98. The main interface of the Editor. Users can import SVG digital graphics and then add interactions on points or areas of interests in the graphic.	151
Figure 99. The workspace created on Conceptboard.....	154
Figure 100. An example of remote tracking. From left to right: the teacher and pupil with VI screens.....	155

Figure 101. An example of remote content control. The North America is set to be invisible to pupils with VI.	156
Figure 102. An example of annotations. The pupils with VI added two annotations and the remote teacher can visualize and interact with these annotations at the same time.	156
Figure 103. An example of navigation. From left to right: two screens of pupils with VI showing the world map and European map respectively. When the pupils with VI performs a specific gesture, the navigation feature can be triggered and then the level of the map will also be changed.	157
Figure 104. Collecting and organizing comments of many participants using Padlet....	160
Figure 105. Designed tablet case for fixing raised-line graphics.....	165
Figure 106. Real-time finger tracking using Socket communication.	165
Figure 107. Two-handed exploration patterns based on tactile fixations	172
Figure 108. Multi-sensory interactive maps including objects providing touch sensation and sense of smell, etc.	173
Figure 109. Itsy-Bits recognizes 3D-printed tangible objects via the capacitive touchscreen.	173

Chapter 1 Introduction

This dissertation focuses on the non-visual tactile exploration of graphical information for people with visual impairments (VI). We use the term people with visual impairments (VI) to indicate the target users of our research, which covers both people with low-vision and blind people. Recent data from the World Health Organization (WHO) indicate that there are 285 million people with visual impairments in the world and among them, 39 million are blind ^[1]. In France, 1.7 million people have visual impairments including 932 000 of them with middle visual impairments (difficulties to read, write or draw) and 270 000 with severe visual impairments or who are totally blind [138].

As an important way to convey information, graphics are used widely in every domain. In terms of the graphical content, there exist many different types of graphics, such as maps, mathematical graphs, drawings, etc. At the same time, graphics can also be divided into many categories according to their form, such as digital graphics and tactile graphics.

The term digital graphics represent graphics presented on the display of digital devices. With the development of information technology, digital graphics become a major way for people to get graphical information. Compared with traditional visual graphics, digital graphics can take full advantage of digital information and are flexible regarding modification and interaction. However, accessibility issues with digital graphics has led to a digital gap between people with VI and sighted people (e.g. Figure 1). This gap is still expanding with the popularization of digital graphics and may finally cause inclusion issues of people with VI.

[1] <https://www.who.int/blindness/publications/globaldata/en/>

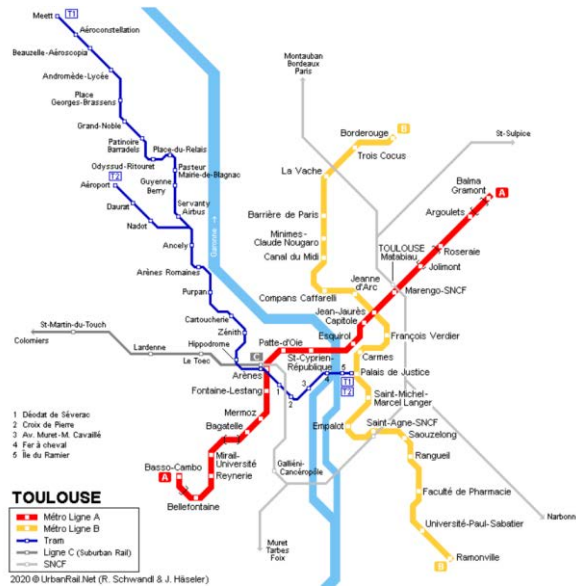

Figure 1. A visual metro map of Toulouse metropolis. Such a digital map is difficult to explore and understand for people with VI.

Tactile graphics (which include tactile pictures, tactile diagrams, tactile maps and tactile graphs) are graphics that rely on relief so that people with VI can feel them by touch (as shown in Figure 2). They are used as an accessible alternative to represent graphical information. Compared with digital graphics, tactile graphics are rare and often used to convey graphical information in Braille books. According to previous research [87], tactile graphics are not direct transcriptions of visual graphics and rely on adaptation processes that are mastered by professionals called tactile document makers.

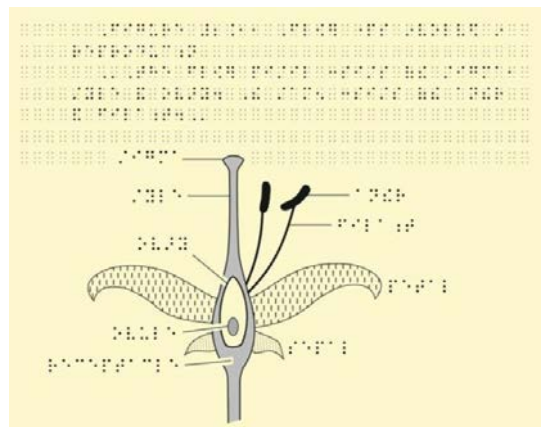

Figure 2. Tactile drawing of a flower from [87].

The difficulties in producing tactile graphics have led to a gap between the number of visual graphics and tactile graphics that are produced. In this context, assistive technology

research proposed to leverage graphic description [119] as a mean to access the content of the graphics. However, people with VI do not always only need to know the information about the content of the graphics. To have precise spatial knowledge of the graphics, it is necessary to conduct tactile exploration for people with VI. This cognitive behavior enables them to learn detailed graphical information actively according to their own needs and capacities.

In this dissertation, instead of improving the graphic descriptions, we focus on the issues raised during the tactile exploration of graphics (both digital and tactile) and the main objective is to improve the accessibility of tactile and digital graphics.

1.1 Context

1.1.1 Accessibility issues related to graphics

Graphical information becomes pervasive in current society, especially with the development of information technologies. However, access to this media for people with VI remains a challenging task. For both tactile graphics or digital graphics, their exploration and understanding cause different problems.

Tactile graphics provide tactile feedback to people with VI, which is important. But because of difficulties related to adaptation and production, they are relatively rare and expensive apart from special education institutions. Actual adaptation is experience-based, which means it is hard for novices to produce adapted tactile graphics. In addition, the lack of updatability (cannot be easily modified or updated) of tactile graphics also decreases its usability. For these two reasons, tactile graphics are not widely used by people with VI. In fact, the actual usage rate of tactile graphics is very low when compared with the needs for accessing to graphical information, which is a daily activity.

Digital graphics are spreading rapidly nowadays. From early images displayed on PCs to images presented on current daily used mobile devices (mobile phones, tablets, etc.), one of the most important advantages of these graphics is that they can be interactive and modified easily. But, because of the absence of tactile cues under the fingertips, the exploration of digital graphics remains an issue for people with VI [125] (see Figure 3).

When exploring tactile graphics, users with VI can instantly perceive the direction of the line under the fingertip. This tactile cue is important because it provides the user with knowledge on elements of the graphics (direction of the line) that can direct the next finger movement. This tactile cue facilitates the exploration process.

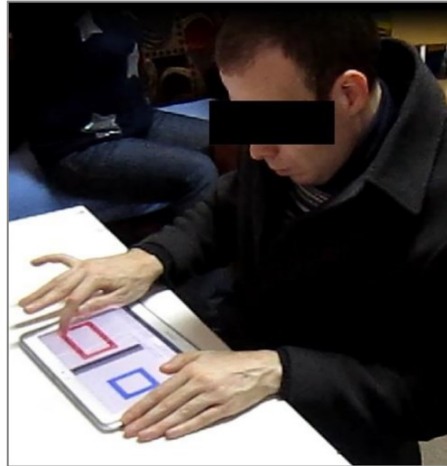

Figure 3. A blind user exploring digital graphics displayed on a tablet.

As a quick summary, there remain accessibility issues with both tactile and digital graphics. Hence, improving either the adaptation process of tactile graphics or the exploration of digital graphics can contribute to this societal need.

1.1.2 Tactile exploration of graphics

Tactile exploration of accessible graphics is performed by the hands (i.e. one-handed or two-handed). This hand behavior is sequential and imposes cognitive constraints. Nevertheless, the importance of tactile exploration is obvious. Different from common graphic description technologies, tactile exploration enables people with VI to precisely explore graphics by leveraging both tactile (for tactile graphics) and kinesthetic cues (for both tactile and digital graphics).

When the exploration focuses more on the content of the graphic rather than the contours, tactile exploration does not need to explore each points or segments of the graphic. Kinesthetic cues can indicate many information, such as the absolute or relative location of items (orientation and distance) and semantic information if included. A typical example, shown in Figure 4, illustrates a tactile exploration of a map based on kinesthetic cues only.

As indicated in [13], an user with VI can explore and compare the information contained in nine different cells relying only on kinesthetic cues. In contrary, when the focus of the exploration is on the contours, kinesthetic cues are not sufficient. In this case, tactile cues are needed.



Figure 4. A blind user exploring an invisible digital map based on movement tracking [13].

1.1.3 Need for remote collaborative graphics learning

Since the global pandemic of COVID-19, the demand for remote teaching and learning has grown exponentially. Remote learning systems such as MOOC [90] have played a crucial role for keeping education uninterrupted. For pupils with VI, the face-to-face teaching and learning have also been greatly affected due to confinements. Therefore, there is a real and urgent need to design and propose remote interactive tools for special education with pupils with VI.

Traditionally, pupils with VI leverage tactile graphics in special education schools. There are different types of tactile graphics for different subjects, such as STEM but also geography and history, Orientation & Mobility (O&M), etc. Hence, tactile graphics are important and useful during the curriculum. However, the pandemic showed the absence of tools for remote graphics learning of pupils with VI.

1.2 Research questions

In this dissertation, we focused on three general research questions related to “tactile exploration” and “accessibility of graphics without vision”, which we refined into more specific research questions:

Research question 1: Can we augment human’s tactile exploration ability so that people with VI can explore digital graphics more efficiently? (i.e. this research question leads to the work of VibHand)

- How to design a vibrotactile interface and tactile cues to improve non-visual tactile exploration of digital graphics?
- Can people with VI use such a vibrotactile interface to explore digital graphics without introducing additional cognitive load?

Research question 2: Can we understand the tactile exploration behavior at a more refined level (finger level) so that we can help producing accessible tactile graphics and designing interactive digital graphics? (i.e. this research question leads to the work of Tactile Fixation)

- How to better describe the manual exploration behavior (we proposed to rely on tactile fixations)?
- Do participants perform tactile fixations with both hands?
- Do tactile fixations vary according to the type of graphics?
- Do tactile fixations vary according to the instruction given in the task?
- Can we relate tactile fixations to more elaborated “exploration patterns”?

Research question 3: How to design a tool that allows remote collaborative learning based on graphics? (i.e. this research question leads to the work of TactileLink)

- Is there a need for remote graphics learning during the pandemic?
- What are the design and technological requirements of such an interactive tool supporting remote graphics learning with teachers?

1.3 Contributions

To answer the questions mentioned before, we did three studies including users with VI and/or professionals. We first investigated an on-hand vibrotactile interface called VibHand to enhance non-visual exploration of digital graphics. In the second study, we proposed the concept of “Tactile Fixations” by drawing a parallel with the well described “eye fixations” [110]. Finally, we co-designed a system called TactileLink to provide

pupils with VI and special education professionals with the ability to learn and explore graphics collaboratively and remotely.

In summary, our contributions can be divided into three parts:

- Design and implementation of VibHand by conducting a set of participatory studies and an experiment involving 12 participants with VI and 12 blindfolded participants showing that the cues generated by the proposed vibrotactile interface improved the non-visual exploration of digital graphics. The whole design process explored the potentials of the back-of-the-hand vibrotactile interface.
- The concept “Tactile Fixation”, which is a behavioral marker on how people with VI explore tactile graphics, as well as the method (with an algorithm) to identify tactile fixations and related analysis in terms of perception and comprehension using a set of hand movement data.
- Co-design of a remote collaborative graphics learning system called TactileLink by organizing two focus groups to refine progressively the interactive system.

1.4 Dissertation structure

In Chapter 2, we present related works about tactile and digital graphics and the main focus of this dissertation - tactile exploration. This chapter is organized according to our three main research questions and aims to provide the state of the art about manual exploration by people with VI.

In Chapter 3, we first present the design and implementation of VibHand, which is a vibrotactile system to enhance digital graphics exploration. Then we present the behavioral experiment involving both people with VI and sighted people showing that VibHand can improve the tactile exploration of digital graphics without introducing additional cognitive issues.

In Chapter 4, we introduce the concept of “Tactile Fixation”, a behavioral marker helping to explain how people with visual impairments explore tactile graphics. This concept was inspired by the research on “eye fixations”. Identifying tactile fixations can provide valuable information on the salient areas of the graphics as well as exploration patterns

used by people with VI. In this chapter, we not only present the general definition of a tactile fixation, but also the identification method that we created as well as some preliminary observations regarding fixations during tactile exploration. Finally, we discuss the interest of tactile fixations to further improve the adaptation process of tactile graphics as well as implications to many other domains.

In Chapter 5, we present the co-design process of a remote collaborative graphics learning system called TactileLink. We provide details about two focus groups with professionals for people with VI and many preliminary design consensuses based on discussions with them.

In Chapter 6 and 7, we provide the discussion, perspectives and general conclusion of this dissertation.

Chapter 2 Related work

As mentioned in the previous chapter, we focus on the non-visual tactile exploration of graphics by people with VI in this dissertation. Our main aim is to tackle exploration difficulties of both tactile and digital graphics. To better explain the different contributions of this dissertation, it is necessary to first conduct a review of recent research progresses on both tactile and digital graphics.

More precisely, in the first part of the chapter, we introduce the definition as well as the different types of tactile graphics. By providing different examples of tactile graphics, we would like to help readers to build a basic understanding of tactile graphics.

In the second part, based on the definition of tactile graphics, we present three different research focuses on tactile graphics exploration. They are: 1) Non-visual exploration of tactile graphics; 2) Recognition and identification of tactile graphics, and 3) Exploration strategies during tactile graphics exploration.

In the third part, we shift our focus to digital graphics and first review the interactive devices (e.g. smartphone, tablet, tabletop, etc.) and modalities (e.g. audio, vibratory, multimodal, etc.) for digital graphics exploration. We then review recent works on non-visual exploration of digital graphics which later inspired part of our research.

In the fourth part, we specifically review recent works on remote collaborative graphics learning. We present these works from three different aspects: collaborative learning of people with VI, remote collaborative activities of people with VI and collaborative graphics exploration of people with VI. We compare these research works and summarize their advantages and disadvantages in this part.

Finally, we conclude this chapter by summarizing the existing problems of current research and then introduce our research works.

2.1 Part I Tactile graphics

2.1.1 Tactile graphics for people with VI

Tactile graphics [32] (e.g. Figure 5) are special images that use raised surfaces enabling people with visual impairments to feel them with touch. As a special graphical information modality, they are used to convey non-textual information such as maps, paintings, graphs and diagrams. Tactile graphics can be seen as a subset of accessible images.

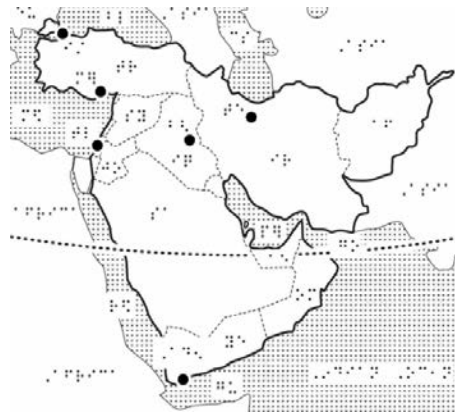

Figure 5. An example of tactile map.

Generally, there exist different types of tactile graphics leveraging various production technologies. Among them, one of the most commonly used method for producing a tactile graphic is **Thermoform** (also known as vacuum forming). To produce a thermoform graphic (see Figure 6), a sheet of plastic needs to be heated and vacuumed on top of a model. Compared with other techniques, the thermoform technique is generally time consuming due to the time needed to create the mold.

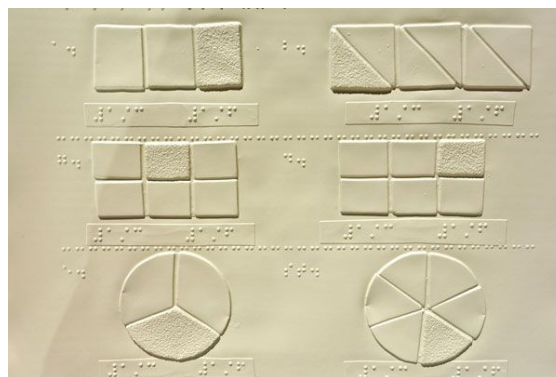

Figure 6. An example of tactile graphic generating by thermoforming.

Another common technique is to use **Swell paper** (see Figure 5), which has a special coating of heat-reactive chemicals. For this technique, microcapsules of alcohol implanted in the paper fracture when exposed to heat and make the surface of the paper inflate. Compared with Thermoform technique, this production technique is less robust but also takes less effort to produce. In addition, although both these two types of tactile graphics can be generated from digital images, using thermoform always needs additional molds which is less convenient. In fact, as indicated in [107], most of participants with VI had a preference of using swell paper.

In addition to the two abovementioned production techniques, some other methods, for example ink-jet printing [2] or modified Braille embossers [84], can also be used to produce tactile graphics. However, due to different limitations, they are still rare and thus less evaluated.

2.1.2 Design and adaptation of tactile graphics

As indicated in [87], tactile graphics need to be introduced early in the process of learning Braille. As we know, the ability to read tactile graphics can enable people with VI to understand the abstract concepts such as diagrams, graphs and maps. However, the design of tactile graphics needs to consider many elements such as legends, textures, symbols, dots, lines, etc. [32] and the complexity of the graphic usually depends on the number of these elements. In addition, the design process relies on the experience of the document maker and may depend on many factors such as the perceptual and cognitive capacities of the end-user, the type and the aim of the graphic, etc.

In this section, we focus on how to design and adapt visual graphics to tactile graphics for people with VI [95]. Firstly, according to [87], an important decision should be made at the beginning of the tactile graphics design: do we really need to produce the graphic (see Figure 7)? Actually, if the graphics do not add additional and necessary information than what is stated in the surrounding text, they can be omitted.

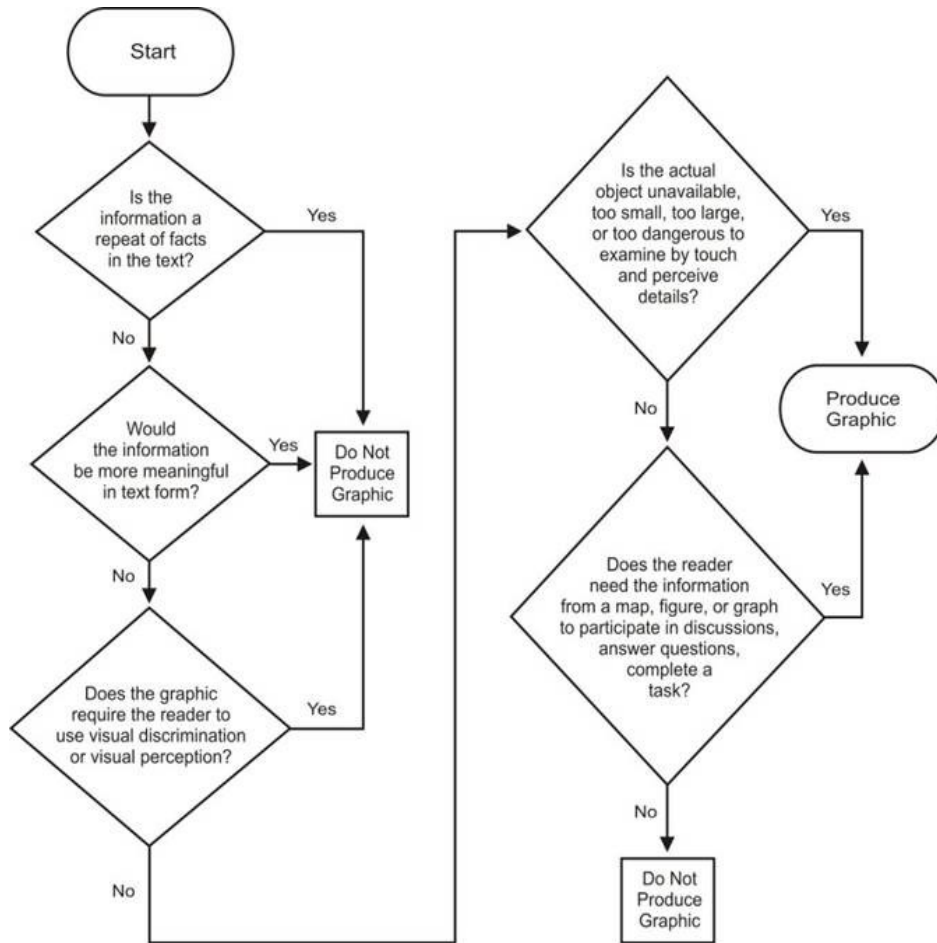

Adapted with permission of the American Foundation for the Blind from Ike Presley & Lucia Hasty. *Techniques for Creating and Instructing with Tactile Graphics*. Copyright © 2005. New York: American Foundation for the Blind. All rights reserved.

Figure 7. The decision tree from [87] to decide if we need to produce graphics.

When a tactile graphic is produced, several design principles should be respected (i.e. to avoid redundancy, only the most relevant principles are listed here):

- Tactile graphics are not an exact reproduction of print visual graphics. While adapting a visual graphic to tactile graphic, the original graphic needs to be simplified [32][34][35]. For example, as shown in Figure 8, many details of the border lines have been omitted in the adapted tactile European map.

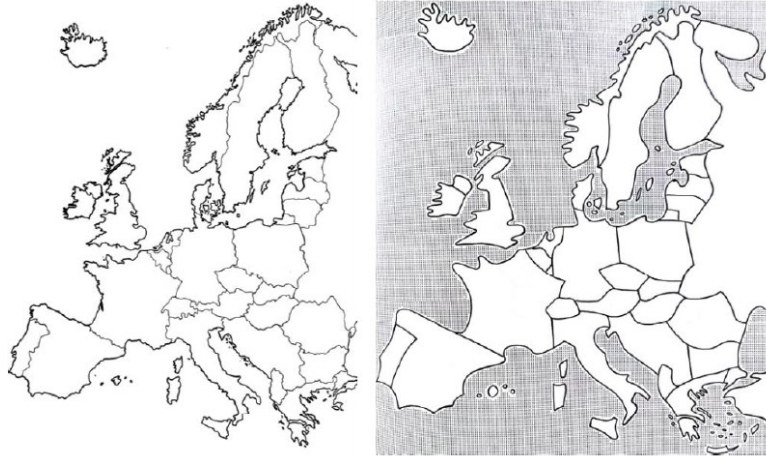

Figure 8. From left to right: the original European map and adapted tactile version [87].

- The most effective production medium for each graphic should be chosen. Although the production is always the final step while adapting a graphic, it is necessary to consider this point from the beginning. As we mentioned before, different production methods need different preparations. Therefore, the design and adaptation need to be flexible and adjusted according to the final production medium.
- The Braille code and format used in preparation of the tactile graphic must be consistent with the transcription of the main body of text. This is easy to understand because the objective of design and adaptation process is always to facilitate the use of the graphic by people with VI, rather than introducing additional difficulties because of consistency issues.
- Some eye-catching design techniques used in print, such as decorative borders should be omitted. For the visual graphics, their design usually follows the findings and principals of visual information. This means some graphical elements or design are not necessarily accessible for people with VI and we must omit them during the design and adaptation process.
- If the concept of depth is not required, a 3D view should be changed to a 2D view. This is because a 3D graphic usually includes perspectives. Although the perspectives can be used to give solid objects drawn on a flat surface the appearance of depth and distance, they usually do not correspond to any tactile experience and will introduce additional difficulties during the tactile exploration [32][35].

- Clutter occurs when components of the graphic are too close together or so similar that become hard to distinguish tactually. One of the most important principal of tactile graphics adaptation is to facilitate tactile exploration while ensuring the comprehension. Therefore, the design and adaptation should avoid clutter as much as possible.
- A combination of symbols, keys, and words may be used to convey information. Actually, keys and words could provide many additional information correspond to the explored symbols and may also improve the understanding of the graphics.
- The age and experience of the reader must be considered when designing a tactile graphic.

In addition to general principles, during the design and adaptation of tactile graphics, three most fundamental graphical elements (as shown in Figure 9) need to be considered particularly: lines, symbols and areas. For each type of element, there exist corresponding design principles:

- Lines in tactile graphics could have different width: from very thin to very thick and the lines can be continuous or discontinuous. One principal for using the different widths of lines is: the wider a line, the more important the graphic element. For about the length of the line, if the line is too short (less than 5cm), it can be regarded as a symbol.
- The symbols can also have many forms, either solid or hollow. But for tactile graphics, they always need to be relatively small to be recognized as symbols by tactile exploration with fingers.
- For the areas of tactile graphics, to ensure that they can be easily distinguished, the outline is generally represented by continuous lines. As for the inside of the area, different types of lines (i.e. texture) can be used according to the context and the types of the areas. For example, the sea can be represented by dotted lines.

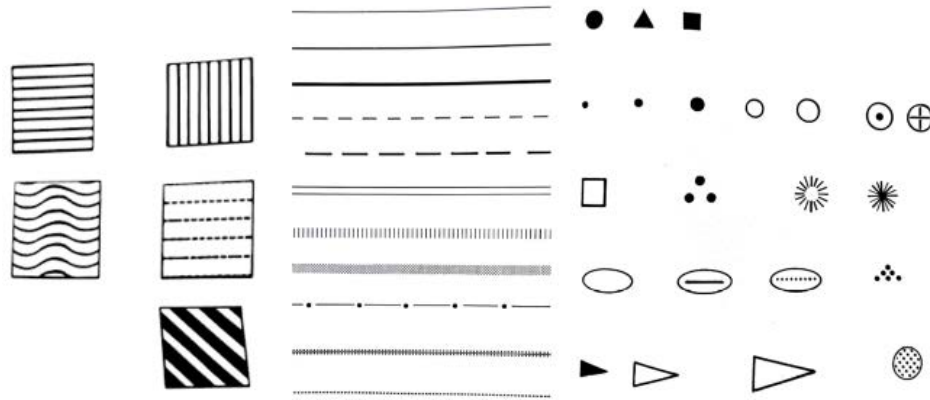

Figure 9. Examples of areas, lines and symbols in tactile graphics from [35].

Overall, by following these guidelines, the designed or adapted tactile graphics can be more accessible and easier to be perceived by tactile exploration. However, as indicated in [35], many pretests are necessary during the adaptation process to make sure different aspects of the tactile graphics can be correctly distinguished.

At the end of this part, we would like to give some examples of adapted tactile graphics coming from [87]. The right part of Figure 10 represents a tactile graphic of circulatory system, which is simplified from the original visual version by keeping only the most important information. In Figure 11, areas are represented by different textures and can be easily distinguished by people with VI.



Figure 10. From left to right: original and adapted graphic of circulatory system [87].

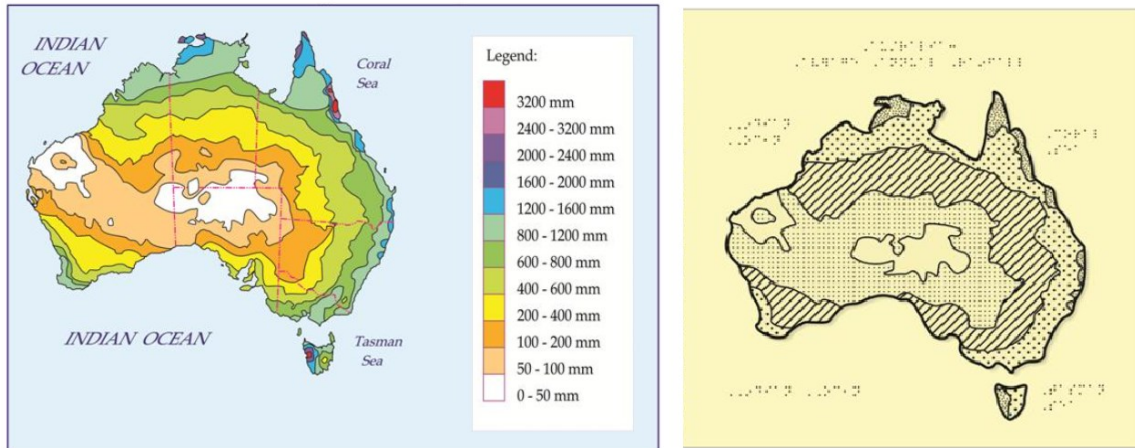

Figure 11. From left to right: original and adapted graphic of average annual rainfall of Australia [87].

2.2 Part II Exploration of tactile graphics

2.2.1 Non-visual exploration of tactile graphics

Tactile exploration is a common task for people with VI, especially while accessing graphical information. Such a hand(s) behavior is based on the touch sense (tactile perception) of exploring fingers and enables people with VI to understand the underlying elements. There are two types of manual tactile perception: cutaneous perception and haptic perception [120]. They can be distinguished as follows:

- The cutaneous perception (or passive perception) is generated by the stimulation on the skin, while the stimulated body part keeps still. A classic example is that a sharp object moves on the palm while the back of the hand is resting on a table. In this case, since only the superficial layer of the skin generates mechanical deformations, the perceptual processing only concerns the skin information related to the stimulus applied to the hand.
- The haptic perception, which is also known as active perception, is generated by the skin stimulation while performing active exploration movements. For example, when the hands and fingers follow the outline of an object, the skin mechanical deformation leads to the movements of muscles, joints and tendons at the same time. These joint movements together produce the haptic perception.

Based on the basic definitions of these two types of tactile perception, it is easy to know that the tactile exploration of graphics is generally a haptic perception task. However, for different types of graphics, their explorations still have differences. In this part, to better present the non-visual exploration of tactile graphics, we separate the existing works into two categories according to their graphics type.

Commonly used graphics (whether tactile or digital) can be divided into two categories [29]: 1) “Line-independent” graphics and 2) “Line-based” graphics. For a “line-independent” graphic, for example, a thematic map, the main focus is not the graphic itself but the related thematic information it contains. However, for a “line-based” graphic, we are more interested in the graphical elements, such as points, segments or the outline of the graphic.

Before presenting different types of research on non-visual exploration of graphics, we first give a clearer definition of them. Usually, a “line-independent” graphic refers to a thematic graphic and mostly, they are thematic maps. More precisely, a thematic map is a type of map specifically designed to show a particular theme connected with a specific geographic data, such as temperature variation, rainfall distribution or population density. There exist different types of thematic maps, we list them here:

- 1) Choropleth Map (Figure 12). The choropleth maps use color to represent statistics of an attribute feature which we are interested in proportionally to its location. Most of the commonly used unemployment rate maps of a country are choropleth maps. This type of thematic map is good at displaying densities using colors.

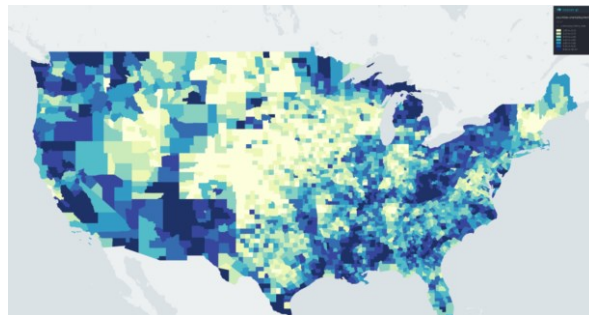

Figure 12. A choropleth map on unemployment of USA.

- 2) Dot Distribution Map (Figure 13). This type of thematic map uses dots to display the presence or absence of a feature.

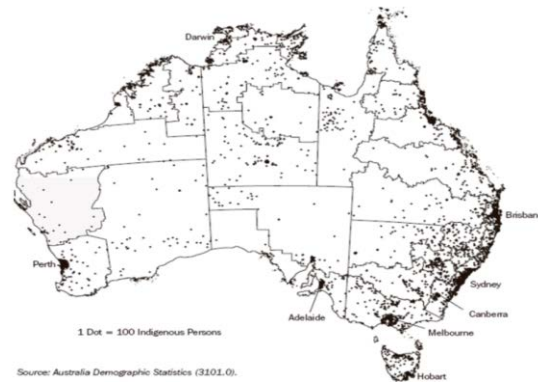

Figure 13. A dot distribution map on demographic statistics of Australia.

- 3) Graduated Symbol Map (Figure 14). Instead of using color to indicate feature statistics as the choropleth map, graduated symbol map leverages the points. With this type of thematic map, people can easily visualize the quantity distribution of the data.

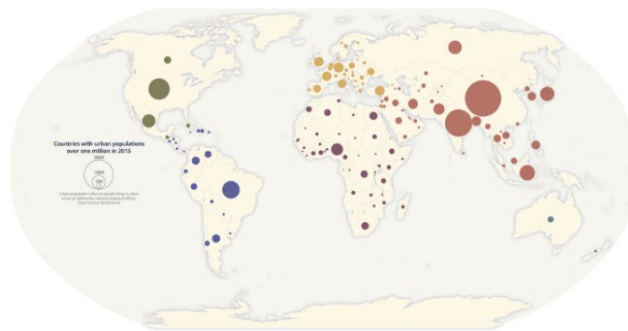

Figure 14. A graduated symbol map on urban population.

- 4) Heat Map (Figure 15). This type of thematic map can display the density of points on a geographic map and can visualize the intensity of the variable through a color scale. A heat map shows hot spots or concentrations of points. Heat maps are often used when geographic boundaries are not of key importance.

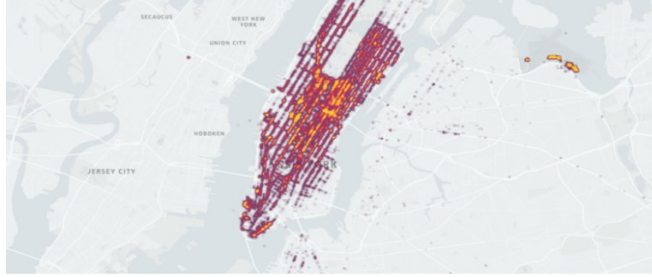

Figure 15. A heat map on New York city.

- 5) Cartogram (Figure 16). Compared with other types of thematic maps, a cartogram is special because its size of an area is rescaled to be proportional to the feature it represents. Thus, cartograms generally distort area sizes. The most commonly used cartogram is contagious cartogram, which the topology is maintained but the shape distorted dramatically.

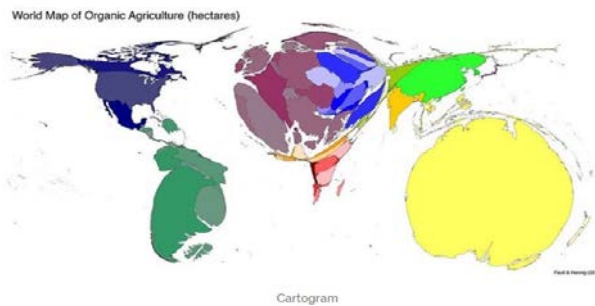
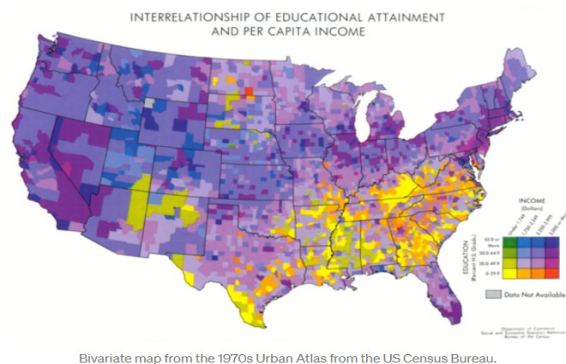

Figure 16. A cartogram on world's organic agriculture.

- 6) Bivariate Choropleth Map (Figure 17). Different from normal choropleth map, bivariate choropleth maps use two variables at once and can compare two dissimilar distributions on the same map.



Bivariate map from the 1970s Urban Atlas from the US Census Bureau.

Figure 17. A bivariate choropleth map on interrelationship of educational attainment and per capita income in USA.

- 7) Value by Alpha Map. The value-by-alpha is bivariate choropleth technique considering two variables that affect each other. The second variable acts as an equalizer for the other variable of interest. This type of thematic map modifies through the alpha variable (transparency), and lower values fade into the background while higher values pop up.

Despite various types of thematic maps, they all show that the most important information of the “line-independent” graphics is the thematic data, rather than the graphic itself. In this dissertation, since we focus on the accessibility issues of graphics for people with VI, the “line-independent” graphics should also be accessible and therefore are different from abovementioned visual thematic graphics in terms of forms. However, the main focus of this type of graphics stays the same, which is the thematic data behind the graphic. In fact, to access the thematic data of a “line-independent” tactile graphic, we often need additional text information or even assistance from other systems. For example, as shown in Figure 18, a user with VI is exploring the tactile map while he can get the corresponding thematic data from his smartwatch. Such a system contains both an audio/vibratory feedback system and a finger tracking system (e.g. the Kin’touch system in [9]).



Figure 18. Exploration of a tactile map with finger tracking [13].

Different from “line-independent” graphics, “line-based” graphics emphasize more the graphical elements. The commonly used tactile graphics (for example mathematical graphs, 2D or 3D drawings, geographic maps, etc.) are generally all “line-independent” graphics. By conducting tactile exploration on these “line-independent” graphics, people with VI can learn shapes, objects and many other graphical information.

With the basic understanding of “line-based” and “line-independent” graphics, it is interesting to investigate the non-visual exploration of these tactile graphics. When exploring “line-independent” tactile graphics, such as thematic maps showed in Figure 18, users generally do not need to carefully track the lines. Actually, they just need to perceive a border (even inaccurately) and they can focus on the data contained in different areas of the graphic. They can rely on the kinesthetic perception of hand and finger movements in order to perceive the general layout of the graphic.

Different from exploring the “line-independent” tactile graphics, the exploration of “line-based” tactile graphics relies not only kinesthetic cues (because they are not precise enough), but also the accurate tactile perception of lines of the graphics. A classic example in psychology is like [103], which requests people with VI to explore two-dimensional tactile patterns (as shown in Figure 19). As we know, such graphics do not contain any additional meaningful information and to fully understand them, an accurate line following exploration is essential. Another example comes from a commercial product called “READER” [105] (proposed by The Urban Development Association of Romania). As shown in Figure 20, to better understand the shape of the zone, the participant with VI needs to accurately follow the outline of the graphic.

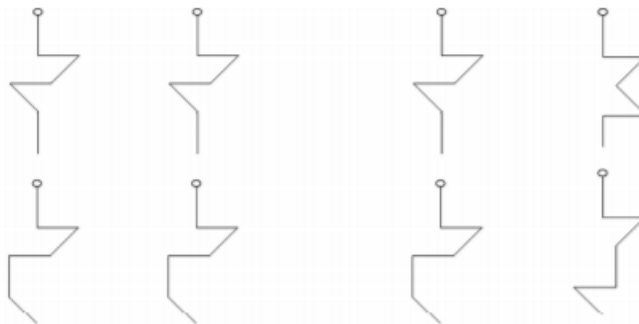

Figure 19. Two-dimensional tactile patterns from [103]. Left: identical pairs; Right: similar pairs.

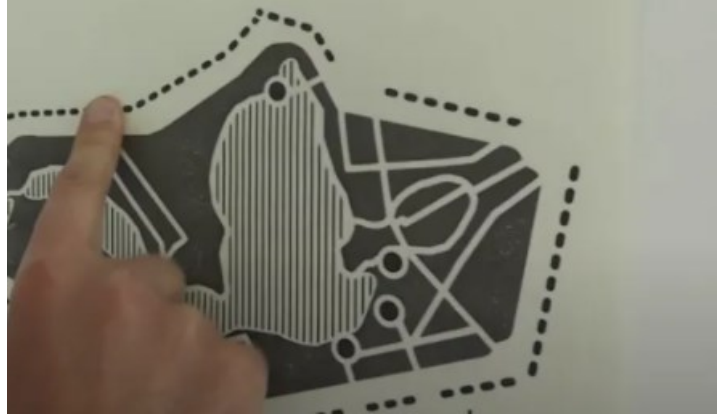

Figure 20. Accurate outline following by a people with VI [105].

In summary, the non-visual exploration of “line-independent” and “line-based” tactile graphics has their own features and should be evaluated respectively. As the most direct and basic way to understand tactile graphical information, non-visual exploration plays a very important role for people with VI and relates to many different non-visual tasks and cognitive strategies.

2.2.2 Differences on recognition and identification of tactile graphics

As we know, tactile graphics generally come from visual graphics, except that additional simplifications and adaptations are needed [123]. Previous sections presented the non-visual exploration of two different types of tactile graphics, but without discussing the objectives of these tactile explorations. To our knowledge, one main objective of tactile exploration is to conduct graphics recognition and identification task.

In the field of psychology, the impact of visual experience on tactile graphic recognition or identification has been widely evaluated [54][55][65][71][72][76][127]. These studies are generally conducted on two types of tactile graphics: a) common objects usually coming from the image set of Snodgrass et al. [117] (as shown in Figure 21). b) patterns which are specific graphic combinations [103] (as shown in Figure 19). In addition, these studies were usually based on comparative experiments involving people with different visual capacities, such as early blind, late blind and sighted.

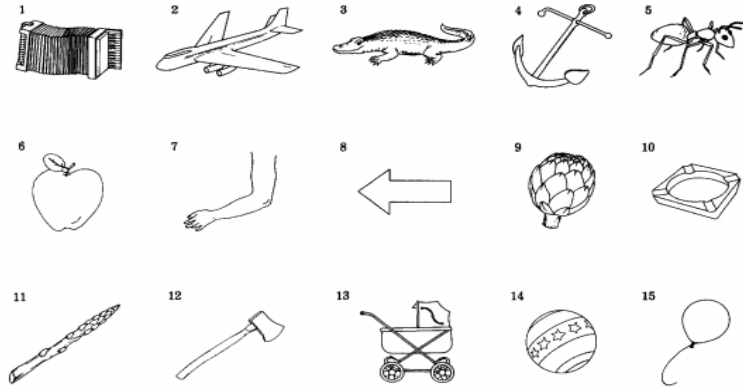

Figure 21. Visual graphics from the image set of Snodgrass et al. [117].

However, according to our analysis, the results of previous studies involving different types of participants were sometimes contradictory between people with different visual experiences and degrees of visual impairments. For example, [73][127] showed that sighted people had better recognition rates than people with visual impairments while [54] found opposite results. Among them, [71] conducted experiments on non-significant graphics instead of common objects and found that recognition depends on the participant's cognitive profile (i.e. spatial, visuospatial or kinesthetic memory).

More precisely, Thompson et al. [127] employed both sighted participants as well as early/late blind participants and asked them to identify tactile graphics constructed based on [117]. Final results revealed that the identification rates for early blind, late blind and sighted participants were 13%, 44% and 50% respectively. Although it seems that this research verified the advantage of visual experience on tactile graphic identification, the findings in [54] were not consistent. In fact, the study in [54] also conducted similar tasks with sighted participants and early/late blind participants. However, the first study consisting of 12 daily objects identification showed that late blind participants had a significantly better identification rate (36%) than sighted participants (13%) and early blind participants (9%). Further study in their research provided participants with a list of objects names and obtained similar results except the overall identification rates had been improved. The identification rates were 82% for late blind participants, 60% for sighted participants and 49% for early blind participants.

In general, although those abovementioned examples showed that there exist some disagreements in results, they actually still could verify the tactile graphics identification and recognition abilities of people with VI. However, the identification rates were still too low, especially when without previous knowledge of graphics. Therefore, one objective of this dissertation is to focus on the tactile exploration from a more precise aspect (i.e. differences on finger level). This knowledge may help to optimize the experience of tactile exploration and finally improve the recognition and identification rates. To do this, it is necessary for us to get a better understanding of how people with VI rely on tactile exploration to understand the graphics.

2.2.3 Cognitive exploration strategies without vision

As we mentioned in the last section, although many studies verified the ability of people with VI to conduct graphic recognition or identification with touch, the link between tactile exploration and inherent cognitive exploration strategies has never been deeply investigated. Thus, it is still not clear how people with VI are able to transform their tactile exploration to the understanding of the graphics. In this section, we reviewed previous research on cognitive exploration strategies used by people with VI while discovering and memorizing spatial graphics. Here, it should be noted that although it is still a challenging work to link exploration behaviors (i.e. what we observe) with the goals (i.e. what the user intends to do) [74], the observation of the exploratory movements on the spatial layout can provide information on the underlying user's cognitive strategy.

Non-visual tactile exploration relies on the hand's haptic movements. Previous research had revealed that the hands of people with VI may perform very differently during the tactile exploration of graphics. For example, Symmons et al. [124] conducted an experiment with blindfolded sighted participants to explore tactile graphics. The results showed that participants performed tactile exploration mostly with their index fingers or sometimes a combination of index fingers and other fingers. Moreover, their research found that participants preferred to separate the exploration area, which means using the left hand to explore the left part of the graphic and the right hand to explore the right part. Another research from Wijntjes et al. [133] compared the use of one hand and two hands while exploring the tactile graphics. In their study, participants were blindfolded and were

asked to recognize the explored tactile graphics. Results showed that two-handed exploration was performed in more than 83% of exploration time. Moreover, three different hand movements modes had been observed in their study: 1) one-handed; 2) two-handed alternately; 3) two-handed simultaneously.

In addition to differences between exploring hands, the exploration strategies of tactile graphics may also differ according to several factors. In this dissertation, we refer exploration strategy as a series of actions conducted to accomplish a specific task [56]. To our knowledge, studies about cognitive exploration strategies without vision converge towards the four following main strategies:

- 1) **Grid strategy** [56]. Users do systematic horizontal and vertical movements to locate all the elements depicted in the graphic. More precisely, a grid strategy can be detected while a participant performs a U-shaped pattern, which means a three-step exploration: a) explore from one side to the other side to form the first leg of a U; b) turn and explore the short leg of the U; c) turn again to explore the third leg of the U and return to the original side of the space.
- 2) **Perimeter strategy** [56]. In this case, users follow the outline(s) of the graphic and travel directly along at least three sides of the square space. With this strategy, the user aims to identify the main element(s) in the graphics based on their shapes.
- 3) **Cyclic strategy** [36]. The cyclic strategy consists in browsing a series of elements in the graphics and finally coming back to the first element (as shown in Figure 22). The aim of this strategy is to memorize the relative location of different elements in the graphics.
- 4) **Reference point strategy** [126]. It consists in touching different elements of the graphics located around one element called the reference point. This “star-like” strategy enables users to relate their exploration to salient landmarks and aims to understand the relationship between graphical elements located around this landmark. Relying on this strategy, users can encode a reference which is efficient in building a mental image of the graphic.

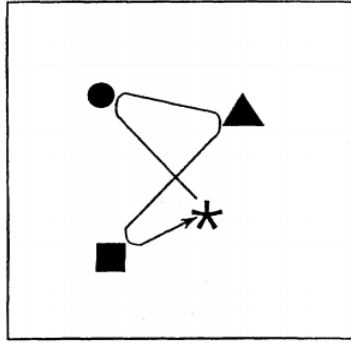

Figure 22. An example of Cyclic strategy from [36].

Overall, previous research showed that multiple strategies were involved during the exploration of tactile graphics. However, only a few of them have been fully investigated or defined, and their role during tactile exploration is still unclear. More investigations about these strategies may help to better design tactile graphics.

2.3 Part III Exploration of digital graphics

The two previous parts systematically reviewed the tactile graphics and their exploration. However, as an important alternative to tactile graphics, digital graphics are becoming more and more common. In this part, we focus on the digital graphics and present its features from three different aspects: interactive devices and modalities for presenting and exploring digital graphics as well as the exploration strategies used to conduct digital graphics exploration.

2.3.1 Interactive devices for digital graphics exploration

Different from traditional tactile graphics, digital graphics relying on computing devices could provide more interaction possibilities with the graphical information to users with VI [1][9]. To better compare these digital devices, Ducasse et al. [29] provided a classification method of interactive devices used for digital graphics presentation and exploration. According to their definition, the proposed interactive devices usually belong to two different categories: 1) **hybrid devices** and 2) **fully digital devices**. Hybrid devices always include both physical and digital components (like [30][38][99]) while fully digital

devices consist of only digital computing devices, such as commercial tablets or mobile phones.

For hybrid devices, one of the earliest work comes from McGookin et al. [85], who designed and implemented an interactive physical system to help people with VI to access mathematical graphs. In their system, the physical objects are called “phicons” (physical icons) and represent the points of the graph (as shown in Figure 23). People with VI, by touching different phicons placed in the grid, can gradually construct a correspondence between the physical objects and different points of a segment and then build a mental image of the segment. However, the proposed Tangible Graph Builder system can only represent simple mathematical graphs and caused several ergonomic problems due to the accessibility issues of phicons (for example, the phicons can be unintentionally moved by the hands during the non-visual exploration).

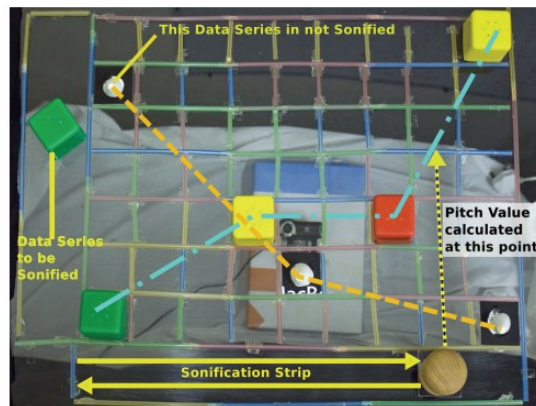

Figure 23. Construct a mathematical graph with proposed Tangible Graph Builder system [85].

More recently, Ducasse et al. [30] developed a tangible tabletop interface enabling people with VI to autonomously construct tangible maps. In their proposed system, called Tangible Reels (Figure 24), each tangible component includes a sucker pad to ensure the stability as well as a retractable reel to make the digital lines of the maps tangible. Such a design can avoid unexpected movement problem as in [85] and support more complex graphics. In addition, Tangible Reels could provide touch sensation, audio instructions (when the tangible reels are touched) and multi-touch interactions at the same time. Final results showed that by combining tangible objects and a large tabletop interface, Tangible Reels improved the exploration and understanding of complex maps by people with VI.

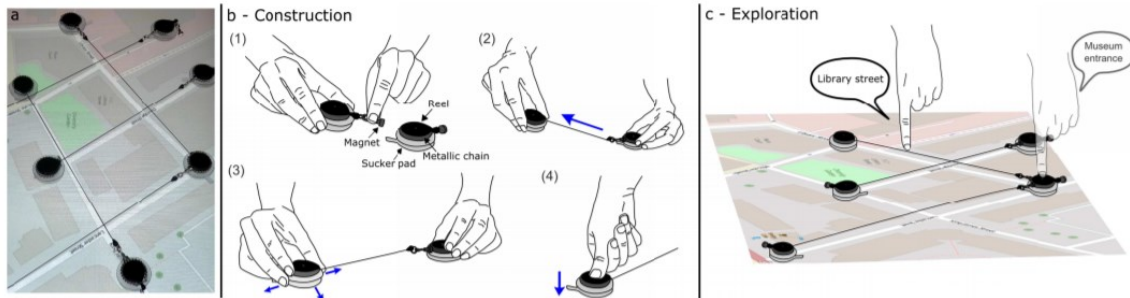

Figure 24. Tangible Reels: a tangible map for people with visual impairment [30].

In addition to static tangible objects, previous research also investigated the possibilities of using dynamic objects (for example the robots) to provide both touch sensation and “active” interaction to people with VI [39][83][93]. For example, Guinness et al. [49] proposed a haptic video player using mobile robots to create tangible video annotations (as shown in Figure 25). The use of this system consists of two steps: the first step is to add annotations by sighted people following by autonomous video exploration of people with VI. More precisely, during the first step, sighted people are able to annotate specific elements in the video (e.g. persons or objects) and add corresponding description. Besides, they can also define manually the moving paths of the robots (Figure 25 left), which are necessary for guiding the small robots during the second step (Figure 25 right).

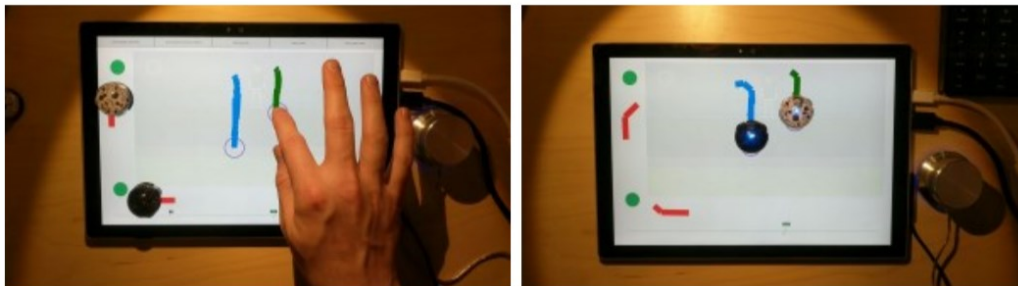

Figure 25. (left) Add annotations and paths to haptic video player by sighted people; (right) Robots are moving by following the pre-defined paths. Both from [49].

Ducasse et al. [31] proposed a tabletop tangible interface with small robots. In their system, the robots were used to represent cities and could move automatically after map zooming or panning. These dynamic tangible objects enable people with VI to easily reconstruct the mental map after changing the space structure by touch. Besides, Guinness et al. [50] proposed RoboGraphics, which was a new approach to create dynamic tactile graphics that combine a touch screen tablet, static tactile overlays and small mobile robots (see Figure

26). The proposed approach implemented a shape-changing display using low-cost and off-the-shelf technology and enabled people with VI to control the interactive content via touch and speech input.



Figure 26. From left to right: (1) Tactile Bar Chart; (2) Tortoise and the Hare; (3) Analog Clock; (4) Braille Assistant; (5) Digestive System. Both from [50].

Despite many advantages of hybrid devices (tactile, interactive, etc.), there are still some limitations. One of the biggest problems is that the number of usable tangible objects is very limited, especially when combining with commercial devices, such as tablets or mobile phones. Therefore, it is difficult to represent complex graphics with these hybrid devices.

As for fully digital devices, different from the abovementioned hybrid devices, graphical information is completely digital. For example, Bardot et al. [13] designed a mobile technique for map exploration. The proposed system enabled people with VI to explore digital maps using a smartwatch. In their system, the smartwatch was used to render localized audio and vibratory information during graphic exploration. They also explored information filtering based on hand gesture and spatial location. In addition, Albouys-Perrois et al. [1] iteratively designed and developed an augmented reality map for being used during Orientation & Mobility courses. The proposed system combined projection, audio output and allowed the construction and exploration of digital maps.



Figure 27. Digital maps exploration with smartwatch from [13].

In addition, systems based on touchscreen device have also been investigated. Tekli et al. [125] developed a single tablet based prototype, called EVIAC (as shown in Figure 28), to investigate how the vibration modality can be perceived by blind users when accessing simple contour-based images on a touch-screen. The idea of this system was relatively simple: once the finger touches any segment of the digital graphics, the tablet will give a vibratory feedback to indicate the finger position. [125] also tested the capacities in learning, distinguishing, identifying and recognizing basic shapes and geometrical objects of people with VI using EVIAC and proved that a single vibrating tablet was able to guide the exploration of simple graphics by people with VI.

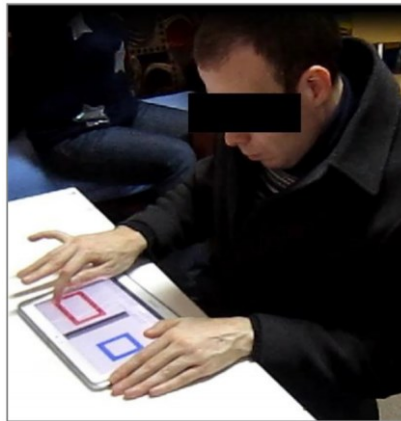

Figure 28. A blind user exploring geometrical graphics using EVIAC [125].

2.3.2 Interaction modalities for digital graphic exploration

In the context of human-computer interaction, a modality is the classification of a single independent channel of sensory information for the input/output between a computer and a human [64]. Computing systems leverage different technologies to communicate and send information to humans. For example, there are three common modalities: vision (computer graphics), audition (audio outputs) and tactition (vibration or tactile sensation) and five less common modalities: gustation (taste), olfaction (smell), thermoception (heat), nociception (pain) and equilibrioception (balance).

Research in HCI, including the Accessibility domain, have widely evaluated different modalities for interaction. Previously, Brewster et al. [8] proposed Tactons, which are tactile icons used for communicating non-visually structured and abstract messages.

Different parameters such as frequency, amplitude, duration, rhythm and location can be adjusted to provide interaction possibilities while the visual display is overloaded, limited in size or not available. In fact, such vibrotactile interface has become one of the most important alternatives to traditional visual interface recently and many similar research about vibrotactile interaction modality have showed promising results. For example, Vibrotactile display [115] has been used in many contexts and has proved to be an efficient non-visual interaction method. Chen et al. [26] systematically evaluated users' ability to recognize vibrotactile patterns generated by vibrotactile displays in a real-world environment. Elvitigala et al. [33] conducted similar study to investigate the perception of tactile cues applied on the wrist and fingers. Both studies revealed that a vibrotactile interface is an efficient way to transfer non-visual information, especially in a discrete and private way [25][79], which are important issues for people with VI.

Concerning the vibrotactile modality used for digital graphics exploration, there are also many applications. As we mentioned before, [125] leveraged a single tablet vibration to guide digital graphics exploration and showed that people with VI are able to explore simple graphics. Palani et al. [97] conducted six human behavioral studies with 64 blind and 105 blindfolded-sighted participants to explore the viability of new touchscreen-based haptic/vibrotactile interactions as a primary modality for perceiving visual graphical elements in eye-free situations.

In addition to vibrotactile modality, the audio feedbacks have also gained a lot of attention in Accessibility research for people with VI. For example, audio-based image descriptions are very common for helping people with VI to understand the content of graphics [119]. Such descriptions generally can provide people with VI an abstract introduction of the image content and have been proved useful for understanding [92]. At the same time, audio-based graphical information exploration has also been investigated. Yoshida et al. [135] proposed a framework for users with VI to recognize objects in an image by sonifying image edge features and distance-to-edge maps. They proposed two types of sonification: 1) local edge gradient sonification and 2) sonification of the distance to the closest image edge, which showed to be effective for understanding basic line drawings.

Since both vibrotactile and audio modalities have shown their usefulness for digital graphics exploration, research has begun to consider to introduce multimodal interactions by combining several interaction modalities. Goncu et al. [42] proposed a multimodal system called GraVVITAS to enable VI users to explore graphics based on audio and vibratory feedbacks (as shown in Figure 29). This system used a multi-touch display for tracking the position of the user's fingers and all two exploring fingers were augmented by small vibrating motors to provide haptic feedback. In addition, audio feedback was also provided for navigation as well as non-geometric information. Final results showed that participants with VI could understand different types of digital graphics, such as tables, line graphs and floorplans.

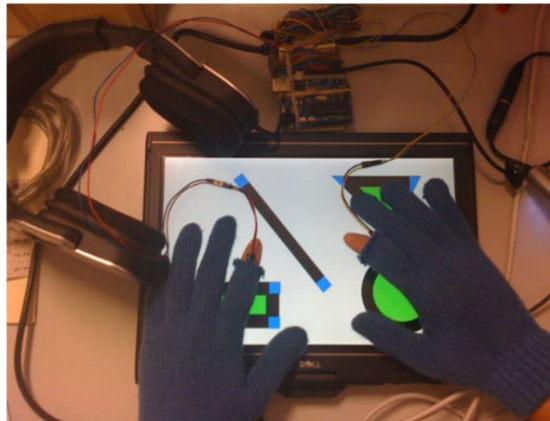

Figure 29. Exploring a digital graphic using GraVVITAS [42].

Similarly, Giudice et al. [37] proposed a vibro-audio interface (see Figure 30) which is an inexpensive and intuitive approach for providing non-visual access to graphic material. This system provided simultaneously both vibration patterns and auditory information when the user is exploring a graphic element. By conducting three different experiments (i.e. relative location, global structure and orientation discrimination), authors showed that the proposed vibro-audio system had similar performance as tactile graphics but providing more interactive information.



Figure 30. Exploring a T-like digital graphic with vibro-audio mode [37].

2.3.3 Exploration strategies of digital graphics

Previous sections reviewed the interactive devices and interaction modalities used for digital graphics exploration. Since there are many differences between tactile graphics systems and digital graphics systems, their explorations are also very different [53][125][75]. For example, people with VI like to use two hands with traditional embossed material while using more often one finger when exploring a vibrotactile touchscreen-based interface [43]. To better understand these differences, some recent studies on 3D printed maps [44][53] and digital interactive graphics [14][47][48][62] have respectively investigated non-visual exploration behaviors involving one or two hands. In this section, we focus on digital graphics exploration and in this domain, one of the most important works comes from Guerreiro et al. [48]. Authors in [48] observed various two-handed strategies including Path Scan, Focused, To-The-Point and Freeform while non-visually exploring digital graphics:

- **Path Scan** (see Figure 31). This strategy is similar to the structured scanning paths used by screen readers. Users usually perform the exploration from the faraway edge or corner of the surface and drag their finger horizontally until that row has been covered. They then adjust their fingers and perform similar explorations in the opposite direction. This finger action repeats several times until the user reaches their target or finishes exploring the whole surface. Users can perform such type of exploration using both one hand or two hands at the same time, but generally they prefer to separate the exploration space when they explore with two hands

simultaneously. One interesting point is that the users like to perform mirror exploration paths which result to a symmetrical trace.

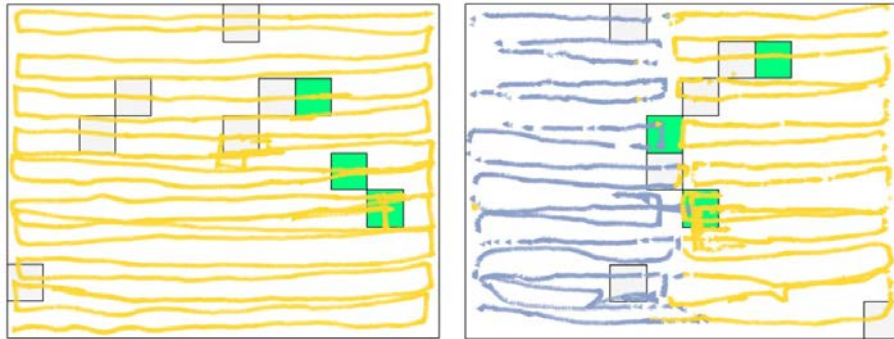

Figure 31. From left to right: one-handed and two-handed path scan exploration [48].

- **Focused** strategy (see Figure 32) occurs during the target locating tasks based on prior knowledge. It represents a series of one-hand unstructured hand search behaviors and does not specifically start from the edge of the surface. This knowledge-based exploration is often represented by overlapped finger paths. Here, it should be noted that the exploration areas could be gradually increased if the user is unable to locate the target in current zone.



Figure 32. Example of focused exploration [48].

- **To-the-Point** (see Figure 33). Similar to Focused strategy, this one-handed exploration strategy is also used in target locating tasks. However, different from the Focused strategy which needs many exploratory attempts to reach the target, users with this strategy go directly to the target location with previous knowledge. Therefore, this type of exploration strategy is more structured and usually takes less time.

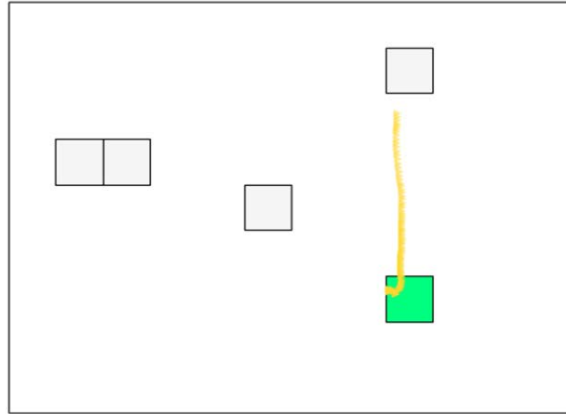

Figure 33. Example of to-the-point exploration [48].

- **Freeform** (see Figure 34 & Figure 35). This strategy represents unpredictable exploration without discernable pattern. Deeper analysis of this exploration strategy can result into two sub strategies: Freeform Symmetry and Trailing Finger. For the first one, it is a two-handed exploration strategy simultaneously exploring in an unstructured and symmetric way. As for the second one, users use the second finger to perform parallel exploration and both hands share similar movements but with a horizontal offset between them.



Figure 34. Example of freeform symmetry exploration [48].

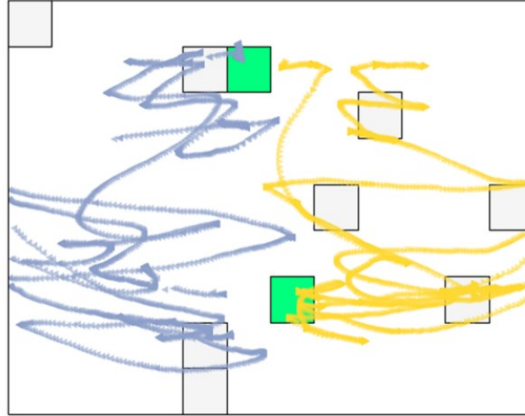

Figure 35. Example of trailing finger exploration [48].

In addition, Bardot et al. [14] also observed several exploration strategies while exploring digital maps. More precisely, they found that participants with VI explored the map with their two hands and each hand mainly explored one half of the map only. They also found that with bimanual strategies, users were more efficient when exploring a map and when comparing the location of different regions.

In summary, when exploring digital graphics, there exist also various exploration strategies. By analyzing these strategies, we can have a basic knowledge about how people with VI organize their one or two-handed explorations. However, there is always a lack of deeper analysis on how to relate exploration strategies to higher level cognitive process. It is also unclear about the similarities and differences between exploration strategies of digital and tactile graphics.

2.4 Part IV Remote collaborative graphic learning

Previous sections reviewed non-visual tactile exploration of graphical information. Generally, these studies do not involve collaborative activities between multiple people and the research results are often applied to face-to-face special education. However, due to the global pandemic caused by COVID-19, most of teaching and learning activities moved to online. This brought huge challenges to special education for pupils with VI, especially when there are no appropriate interactive tools supporting collaborative remote teaching and learning without accessibility issues. To better understand current research progress in this domain, in this part, we first conduct a review on non-visual collaborative

activities and then we focus on collaborative learning (i.e. including collaborative graphics learning) of pupils with VI.

2.4.1 Collaborative activities of people with VI

In human-computer interaction, the field computer-supported cooperative work (CSCW) [45] explores the technical, social, material, and theoretical challenges of designing technology to support collaborative work and life activities. Among the various types of collaborative activities, group/pair discussion [27], games [46][137] and collaborative learning [116] are three of the main research themes.

Previous research on Accessibility for people with VI has explored the topic of collaborations between people with VI or VI-sighted groups. For instance, Branham et al. [20] conducted semi-structured interviews in the homes of 10 pairs of close companions (one blind and one sighted) to understand the social collaborative needs in the domestic setting. Results found that partners engaged in collaborative accessibility by taking active roles in co-creating an accessible environment. Similar study from Yuan et al. [136] investigated the collaborative shopping practices between VI-sighted groups and concluded three factors influencing the co-shopping experience: 1) knowledge about how to assist people with VI; 2) interpersonal knowledge resulting from common experience and interpersonal relationship history; 3) knowledge of shopping as a practice.

In addition to these qualitative studies on collaborative activities, collaborative tools have also been proposed for supporting different tasks between people with VI or VI-sighted groups. For example, Kane et al. [63] proposed an application for tablets PC called OneView (see Figure 36) to enable blind and sighted students to work collaboratively by integrating visual sketching tools with an accessible talking touch screen surface. The OneView prototype enables users (sighted or visually impaired) to create, browse and edit diagrams collaboratively by respecting five design goals: 1) equal use; 2) group awareness; 3) flexible use; 4) easy configuration and 5) universal usability.

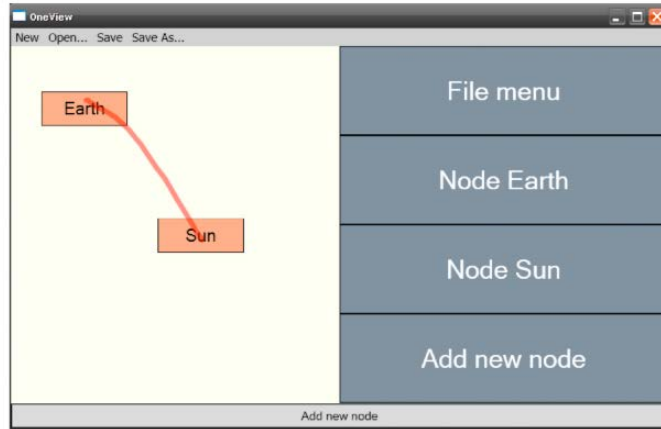

Figure 36. OneView interface [63]. Left: a visual, sketch-based interface; Right: a hierarchical talking menu.

Previous work has also investigated the use of different interaction modalities for collaboration. For instance, Huang et al. [59] investigated the effect of combining audio and haptic cues in visual interface (see Figure 37) for collaborations between a sighted and a blindfolded person (they recruited blindfolded people because similar behaviors with people with VI were performed with their configuration [109]). By conducting a collaboration-based experiment leveraging a Phantom Desktop force feedback system and a collaborative interface, they found that task performance was significantly faster in the audio, haptic and visual feedback condition compared with the haptic and visual feedback condition.

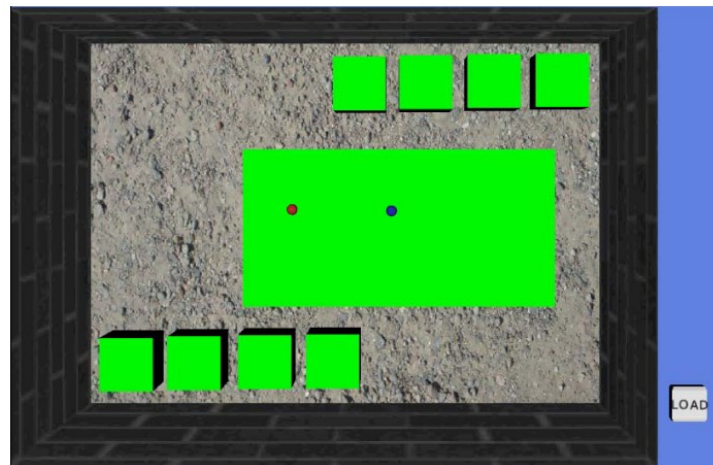

Figure 37. The collaborative interface used during the experiment [59]. The red and blue point indicate the sighted and blind participant.

Finally, a recent study from Waqar et al. [128] proposed an interactive and intelligent interface enabling people with VI to perform educational activities, such as editing, writing or reviewing documents, in collaboration with sighted people. The whole system consists of several different features: the high-quality awareness providing instant voice notifications about the actions and events occurred in the shared environment and the speech-recognition allowing users to interact with the application. To evaluate the proposed collaborative interface, [128] conducted an article writing experiment with participants with VI and sighted companions (as shown in Figure 38). During the experiment, the usability of UI components and the acceptance level of the application were selected as main evaluation parameters. Final results showed that the proposed interface was promising and could enhance group awareness among blind collaborators as well as interaction between users and systems.

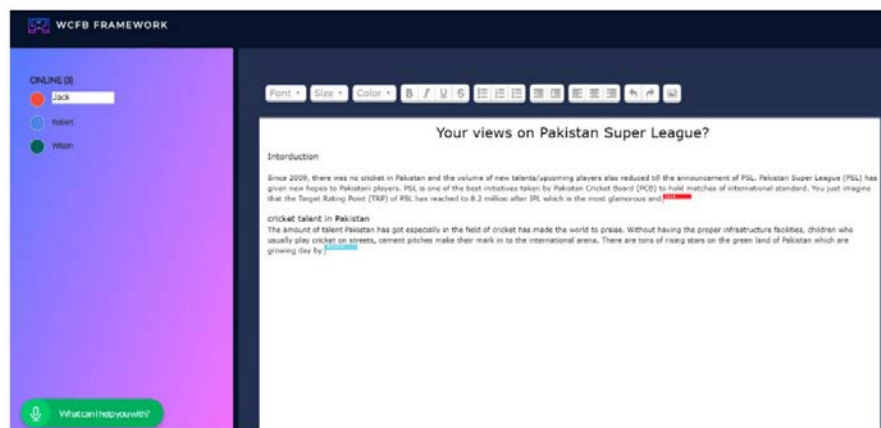

Figure 38. The collaborative article writing interface from [128]. Both visually impaired and sighted participants work in the same interface.

Besides, collaborations between people with VI during Orientation & Mobility (O&M) tasks are also very common. For example, Jan et al. [16] investigated collaborative navigation of people with VI by conducting a series of qualitative studies using proposed collaborative navigation system. They focused on a common problem in existing navigation solutions: lack of an environment description on special navigation points and orientation cues for people with VI, and proposed to leverage systems supporting direct simultaneous help between people with VI. Final results showed that people with VI were able to remember quite long route descriptions (in cognitive maps) and could describe all important navigation information to other people. In general, [16] verified the essential

conditions (communication needs and abilities) for setting up a navigation system based on collaboration among people with VI and opened new research directions.

2.4.2 Collaborative learning for people with VI

As indicated in [106], collaboration is a coordinated, synchronous activity that is the result of a continued attempt to construct and maintain a shared conception of a problem. There are many differences between collaboration and cooperation. One of the main points is that a cooperative work is accomplished by dividing the tasks among participants, while a collaborative work reflects the joint efforts of participants. In fact, collaboration is a specific form of cooperation: cooperation works on the level of tasks and actions, while collaboration works on the plane of ideas, understandings and representations [7].

Collaborative learning (CL), as one of the most important collaborative activities, refers to collaborative construction of knowledge [118]. During the collaborative learning, partners need to negotiate and share their understandings relevant to the task they seek to address. Finally, the consensus [69] or knowledge [118] are developed through the interactions between participants. Generally, there exist five main characteristics for CL [7], as follows:

- 1) **Equal.** During the CL process, participants (mostly pupils) are involved equally in terms of their *status* and *rights* to intervene in the interaction.
- 2) **Single shared production or solution.** The group work conducted during the CL requires an effective collaboration situation (although difficult to design) which means that to accomplish the task, it is necessary to work together. As indicated in [6], being motivated to share the experience with others is part of what it means to be human and could better engage the participations.
- 3) **Not all group work is either cooperative or collaborative.** The term collaboration is most likely only be applicable to certain specific phases of group work. Collaboration presupposes a high degree of joint attention and a mostly synchronous interaction.
- 4) **A known procedure exists for solving the problem.** Although many procedures to solve the problem are well known, the most collaborative situations occur during

the exploratory phases, where no clear plan or procedure exists for solving the problem.

- 5) **Different roles of teachers in CL.** In most CL situations in the classroom, or via Internet, the role of the teacher differs from one-to-one or whole class situation. However, teachers could at least create groups of students on the basis of different conditions (e.g. differences in individual participants' prior knowledge or competence, gender differences, group size, interpersonal relationships, etc.) for better collaboration.

In Accessibility for people with VI, prior research has investigated both collaboration between two people with VI or VI-sighted pairs. For example, Thieme et al. [122] proposed a tangible collaborative tool, Torinos, (see Figure 39) to enable children with VI to learn computer programming. More precisely, Torino is a physical programming language for teaching programming constructs and computational thinking to children aged 7-11. This research highlighted the definition of collaborative learning and evaluated how CL took place with Torino by conducting three consecutive sessions (i.e. two sessions attended by the pairs of children to learn the programming by collaborative use of Torino and an additional session with their parents to explain the program) over a two-month period. Final results have highlighted the opportunities and importance of the “social” (i.e. collaboration) in learning. [122] also contributed insights to the role of touch, audio feedback and visual representations in inclusive design of children with VI.

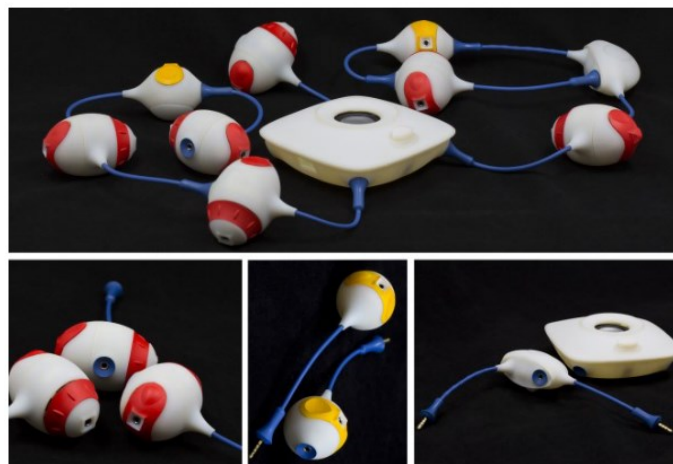

Figure 39. The configuration of Torino [122]. Top: Instruction beads connected to the main hub for the creation of an audio-based computer program. Bottom from left to right: play bead, pause bead, loop bead and hub.

CL has also been applied during traditional collaborative activities for people with VI. Plimmer et al. [104] proposed McSig, which is a multimodal teaching and learning environment enabling pupils with VI to learn character shapes, handwriting and signatures collaboratively with their teachers. As shown in Figure 40, during the training mode, the teacher works collaboratively with the student to draw the letter. During the CL process, both side maintains the same objective (which is to learn the shape) and the action awareness (visual feedback for the sighted teacher and haptic feedback for the pupil with VI).



Figure 40. The system McSig [104]. The teacher on the left draws on a Tablet PC to create a shape and the student on the right can feel, explore and be moved around the shape.

In terms of collaborative graphics learning, some studies have also proposed corresponding interactive tools [89]. For instance, Moll et al. [89] presented two haptic and visual applications for collaboratively learning geometrical concepts in primary school. The proposed applications support collaborations between sighted pupils and pupils with VI, and were systematically evaluated in four schools with sighted-VI pupil groups. More precisely, among the two proposed applications, the static application is a three-dimensional environment that supports learning to discriminate between different angles (as shown in Figure 41) and participants were able to follow the lines collaboratively (from both sides) without slipping over them.

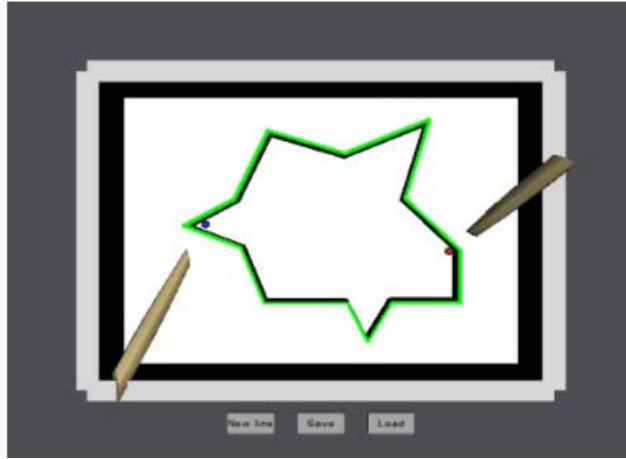

Figure 41. One sighted pupil and one pupil with VI are classifying angles using PHANTOM system [89].

As for the dynamic application (Figure 42), it is also a three-dimensional environment but supports collaborative learning of geometrical shapes such as cubes and concepts such as area and volume. During the experiment, the sighted-VI group was asked to first feel and recognize the different geometrical shapes and then pick up and move around collaboratively the objects using PHANTOM. Final results based on common ground, awareness, guiding, navigation and initiative showed that sighted pupil and pupil with VI were able to work together in a shared haptic virtual environment and maintain a common ground of the layout.

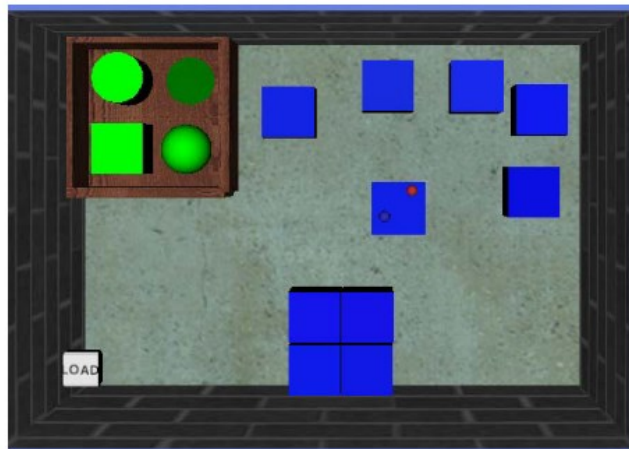

Figure 42. The dynamic application with two users represented by a blue and red sphere respectively [89].

2.4.3 Remote online learning

Online learning or e-learning is the delivery of learning and training through digital resources, such as computers, tablets and even cellular phones that are connected to the Internet [131]. There are several factors that can decide the quality of e-learning, for example the Internet, the development of multimedia, the affordable digital devices and the well-built Learning Management Systems (LMS). Recently, the use of e-learning system has become very common, especially during the pandemic of COVID-19.

As we know, online learning is essentially one type of remote learning which the latter one occurs when the learner and instructor, or source of information, are separated by time and distance. During the remote learning, information is generally transmitted via information technologies, such as email, discussion boards, video conference and audio bridge. As indicated in [86], remote learning can be classified into two categories: synchronous and asynchronous. Neither of them requires physical presence.

For asynchronous remote learning, one of the most famous platform is Massive Open Online Courses (MOOCs), which has attracted millions of learners every year [90]. Recently, many studies had been conducted to investigate the use of MOOCs (as well as its mobile version) and the engagement of participants, for example AttentiveLearner in [100], AttentiveLearner 2 in [101] and AttentiveReview (see Figure 43) in [102]. As for synchronous remote learning, with the development of Internet and cameras, more and more students participate in live online lectures around the world.

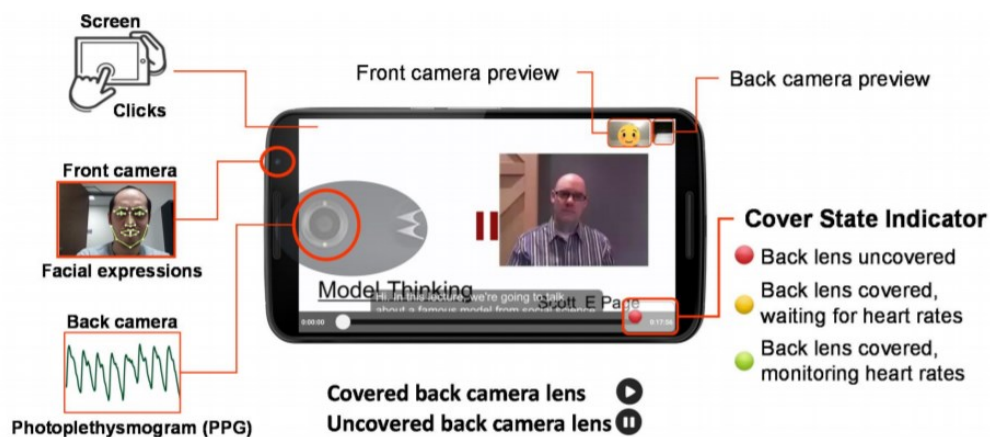

Figure 43. The primary interface of AttentiveReview [102].

Comparing with traditional teaching-learning mode, remote online learning systems cannot provide instructors with the important cues of audience feedback such as raised hands or facial expressions at the time of teaching. To tackle this problem, Sun et al. [121] presented an explorative study investigating how presenters perceive and react to audience feedback during live online lectures. The experimental system (see Figure 44) could predict audience’s psychological states (e.g. anxiety, flow, boredom) through real-time facial expression analysis. Final results based on eight online lectures verified that the real-time feedback of learner’s learning states was helpful for live online lectures and could support instructor’s decision-making on teaching adjustment.

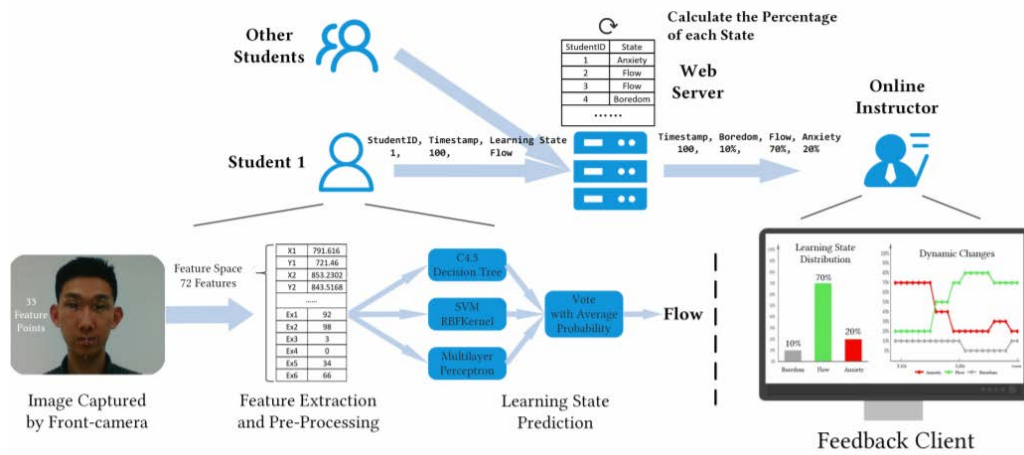

Figure 44. Workflow of the experimental system used for online live lectures [121].

In the domain of Accessibility for people with VI, remote and online learning has also been investigated. For example, Manshad et al. [80] presented a tangible collaborative distance learning environment called Trackable Interactive Multi-modal Manipulatives (TIMMs). The proposed TIMMs enable distance collaboration among students and with instructors. More precisely, it supports remote and active position, proximity, stacking and orientation tracking on table-top surfaces. As shown in Figure 45, each pupil with VI has their own set of TIMMs and can construct the graph (here an equation graph) individually. The instructor can remotely monitor the pupils’ action and help correct pupil’s work if necessary. The instructor can also send instructions to the pupils with VI which will be presented in the form of auditory or music feedback. In terms of collaboration, TIMMs provide instructors the function to participate the manipulation process of each student and collaboratively accomplish the learning task.

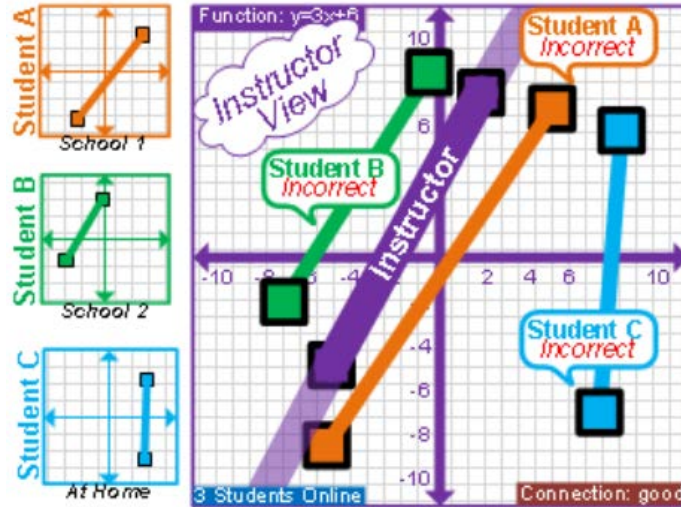

Figure 45. Left side: interfaces of three pupils with VI. Right side: interface of the remote instructor [80].

In summary, collaboration between people with VI or VI-sighted pairs are various and has become common in daily life or sometimes professional activities. But at the same time, the degree of collaboration is still very limited, especially during CL tasks. In addition, interactive tools supporting remote collaborative graphics learning are especially rare, which is impairing the special education.

2.5 Conclusion of Chapter 2

In this chapter, we have systematically reviewed previous research on tactile and digital graphics and presented the state-of-the-art about tactile explorations of these two types of graphics. As one of the major accessible issue for people with VI, the difficulties encountered during graphical information access greatly hinder the inclusion of people with VI into the current society.

As we presented before, tactile graphics are the most intuitive alternatives to visual graphics for people with VI. Although the use of tactile graphics is very common in special education, their mass use is still impossible. For now, the adaptation process is still experience-based and the existing guidelines cannot cover diverse scenarios. In addition, we found that although there exist many studies investigating cognitive abilities of people with VI for using tactile graphics, they focused generally on the identification and recognition aspects and only a small part of the research conducted simple studies to

investigate the cognitive exploration strategies. In fact, there exist possible relationships between tactile exploration and related cognitive strategies. Investigating these relationships could help to better understand how people with VI organize their two-handed tactile exploration and may reveal some efficient exploration strategies, which can further be used for improving the adaptation process of tactile graphics. In addition, such type of evaluations could also be used to address psychological questions related to the observed behaviors, the involved cognitive strategies and the participants' performance.

Our review of the state-of-the-art on digital graphics showed that previous interactive systems used for helping people with VI to explore digital graphics are still limited. This is especially obvious while exploring "line-based" digital graphics. Although digital graphics can provide more interaction and are much easier to update and modify, their explorations are very difficult due to the lack of tactile cues under the fingertip. Therefore, most of the previous research on digital graphics exploration focused on "line-independent" graphics and enabled people with VI to interact with semantic information contained in these graphics. Proposing more advanced vibrotactile interfaces to compensate the finger tactile cues could be a solution to improve the exploration of "line-based" digital graphics.

Our last part of the related work presented previous work on collaborative activities (especially collaborative learning) involving people with VI. Although there exist various types of collaborations between people with VI or sighted-VI groups, past studies focused generally on daily activities, for example shopping, writing, etc. According to our review, collaborative graphics learning is still rarely investigated. However, this is a real need for pupils with VI and there is a lack of interactive tools supporting this learning activity.

Chapter 3 VibHand: On-Hand Vibrotactile Interface Enhancing Non-Visual Exploration of Digital Graphics

Related publications

These two publications together make up the content of this chapter.

Kaixing Zhao, Frédéric Rayar, Marcos Serrano, Bernard Oriola, and Christophe Jouffrais. 2019. Vibrotactile cues for conveying directional information during blind exploration of digital graphics. In Proceedings of the 31st Conference on l’Interaction Homme-Machine (IHM 19). Association for Computing Machinery, New York, NY, USA, Article 9, 1-12. DOI: <https://doi.org/10.1145/3366550.3372255>

Kaixing Zhao, Marcos Serrano, Bernard Oriola, and Christophe Jouffrais. 2020. VibHand: On-Hand Vibrotactile Interface Enhancing Non-Visual Exploration of Digital Graphics. Proc. ACM Hum. – Comput. Interac. 4, ISS, Article 207 (November 2020), 19 pages. DOI: <https://doi.org/10.1145/3427335>

3.1 Introduction

3.1.1 Context

In recent years, many studies have focused on non-visual exploration of digital graphics, which allow for taking full advantage of the benefits of digital information (easily modifiable [29] and interactive [13]). Among these studies, various interaction modalities (for example haptic [125], audio [1] or multimodal [42]) were investigated to provide richer information. Recently, Tekli et al. [125] showed that it is possible for people with VI to use the vibration of a tablet to explore a simple digital graphic (as shown in Figure 46). In their work, the tablet vibration is triggered, and stays on, as long as the exploring finger touches a segment of the graphic. Their study revealed that people with VI can understand basic shapes and simple geometrical objects. However, the absence of tactile cues under the fingertip when exploring digital graphics remains an issue. In contrast, when touching raised-line graphics, users can instantly perceive the direction of the line under the fingertip. This cue is important because it provides users with the direction of the next finger movement, which greatly facilitates the exploration process, especially for complex graphics.

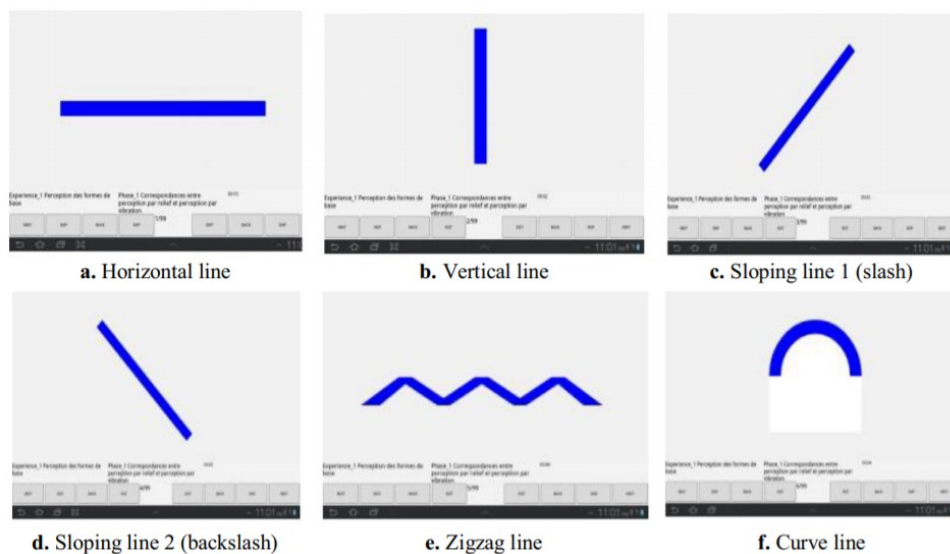

Figure 46. Simple digital graphics evaluated by Tekli et al [125].

In this chapter, we present our study which extended the idea of using the tablet vibration and explored if the use of guidance cues generated by on-hand vibrotactile interface can improve the exploration of complex digital graphics on touchscreens. Following an iterative and participatory design process, we investigated the use of a vibrotactile display on the back of the hand to convey two types of guidance cues: a pre-cue [28] for segment direction and a confirmation cue concerning exploration progression (i.e. how far the finger is from the end of the segment).

3.1.2 Research questions

Our research was based on the following research questions:

1) How to design a vibrotactile interface and corresponding tactile cues to improve non-visual tactile exploration of digital graphics?

The related work on “line-based” digital graphic exploration highlights the limitations of existing solutions based on ongoing vibrations, and the lack of studies on the use of more advanced vibrotactile interfaces for improving the non-visual exploration. Therefore, our goal was to propose a novel vibrotactile interface to improve the exploration of line-based digital graphics. Our idea was based on the combination of the tablet vibration and a vibrotactile display attached to the back of the hand.

2) Can people with VI use such a tactile interface to explore digital graphics without introducing additional cognitive load?

The combination of multiple vibrations could provide more information at the same time, but it could also impair the exploration process due to the complexity of the feedback and increase the cognitive load. To fully understand the usability of our technique and to compare possible differences between people with VI and sighted people on non-visual exploration, we aimed to conduct a series of behavioral experiments to evaluate user’s experience and performance from several aspects.

3.1.3 Motivations

Inspired by the research of Tekli et al. [125], we would like to implement a more ubiquitous vibrotactile solution for digital graphics exploration. Since the lack of finger tactile cues

impairs the exploration process, we proposed to add external vibrotactile cues to compensate the impaired tactile sensation. In our research, by conducting a set of exploratory tests, we systematically investigated several vibrotactile design factors on the back of the hand, which have never been studied before. These exploratory tests informed the final design of the technique, which was called VibHand. We compared our solution with the technique of Tekli et al. [125] and the results showed that the proposed vibrotactile interface enabled rapid and efficient exploration of complex digital graphics and improved the identification of the graphics.

3.1.4 Contributions

In summary, the research of this chapter presents two main contributions: 1) A set of participatory studies to explore the properties of the back-of-the-hand vibrotactile interface assisting tactile exploration of digital graphics; 2) A series of experiments involving participants with VI and blindfolded sighted participants showing that the cues generated by the proposed vibrotactile interface improve (quicker and more efficient) the non-visual exploration of digital graphics.

3.1.5 Chapter structure

In this chapter, we focus on the tactile exploration of digital graphics for people with VI. We present our contributions by gradually introducing the proposed vibrotactile interface on the back of the hand. More precisely, in section 2, we systematically present the definition of vibrotactile display as well as its two main different forms. In section 3, we present our participatory process to evaluate and determine several important vibrotactile factors. In the section 4, we present our principal behavioral experiment used to evaluate the proposed VibHand and we conclude our findings in section 5. Finally, in section 6, we give a conclusion of this chapter.

3.2 Vibrotactile display

As an effective information transmission method, vibrotactile display can provide non-visual information by activating a specific set of mechanoreceptors in the skin using low-cost, easily embedded but also easily misused factor technology [115]. Among different

types of vibrotactile display, Spatiotemporal Vibrotactile Pattern (SVP) [26] and Apparent Tactile Motion (ATM) [60] have been well studied in HCI.

3.2.1 Spatiotemporal Vibrotactile Pattern

A Spatiotemporal Vibrotactile Pattern (SVP) is generally based on several sequential or simultaneous vibrations applied to different vibrators and has often been used to give notifications [5]. Figure 47 shows two types of SVP: sequential and simultaneous. SVP can be controlled by several factors, such as duration of the stimulation, amplitude and vibration mode, etc.

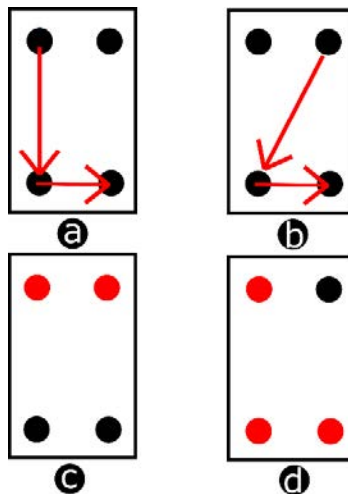

Figure 47. (a) and (b): Sequential SVP [26], the arrows represent the order of activated vibrators. This stimulation gives the sensation of a moving vibration. (c) and (d): simultaneous SVP, the red points represent the activated vibrators. This stimulation gives the sensation of an intermediate “phantom” vibration generated between the two or three real vibrations.

A recent study from Chen et al. [26] investigated the effect of temporality, physical activity and cognitive load on the perception of SVP. Their study confirmed the ability of users to recognize 4-tactor SVP in a real environment. In fact, the results showed a relatively high recognition rate (89.7% while sitting but 72.4% when including a parallel cognitive task). In addition, Eltitigala et al. [33] conducted a series of studies to evaluate the usability of the vibrotactile display. The results showed that SVP was more easily perceptible on the hand than on the forearm and suggested that the vibrotactile information channel should be limited to two simultaneous bits.

3.2.2 Apparent Tactile Motion

Apparent Tactile Motion (ATM) is a tactile illusion that occurs when two or more vibrators are activated with a pre-defined delay on the skin and can be controlled by two factors: duration of stimulation and SOA (Stimulus Onset Asynchrony, i.e. the time interval between two stimuli). Comparing to SVP, there are always intersections of vibration for ATM.

Although a large number of perceptual experiments have investigated the tactile illusion in psychology [41], research interests in HCI emerged with the work of Israr et al. [60]. In their study, they proposed an algorithm that could generate the illusion of continuous tactile movements on the skin based on two separated vibrators (a few centimeters of distance). Their method combined two types of known tactile illusions: Tactile Apparent Movement [66] and Phantom Sensation [4][77] and determined in particular the relationship between the value of SOA and the vibration duration of the two vibrators involved (see Figure 48).

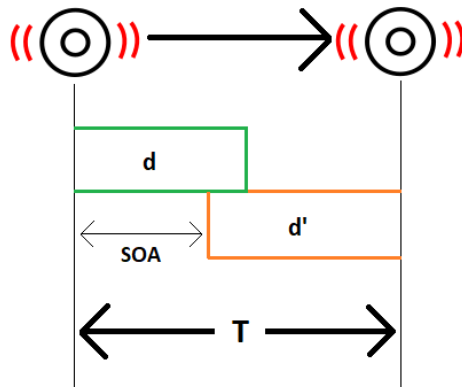

Figure 48. Chronogram of an ATM [60]. d and d' : the vibration duration of the departure and arrival vibrators. T : the total duration of the movement. SOA : the time interval between two stimuli. This stimulation gives the sensation of a vibration moving between two vibrators.

More precisely, to maintain the illusion, the following equations should always be followed:

$$SOA + d' = T \quad (1)$$

$$SOA = 0.32 d + 47.3 \quad (2)$$

$$d = d' \quad (3)$$

Here, d and d' are vibration durations of the departure and arrival vibrators. T is the total duration of the movement. The equation (3) can ensure the consistency of the movement speed.

Based on [60], various applications have been proposed for conveying different types of information. For example, FeelSleeve [134] created vibrotactile cues to improve the reading experience of children. Park et al. [98] extended the algorithm of [60] by creating a Phantom Sensation based on three vibrators placed on the palm of the hand, which further improved the perception of the trajectory and the stability of the movement. However, although there are many ATM-based applications, we did not find dedicated studies to represent directional information by ATM, especially in the domain of assistive technology for people with VI.

3.3 Participatory design

To tackle the two research questions, we collaborated with a special education center for people with VI and adopted a participatory design approach [112] in which several people with VI participated to the design process. The whole design process was divided into two phases: 1) understanding users' needs and 2) designing the vibrotactile interface.

3.3.1 Phase 1: Understanding users' needs

We had many preliminary discussions with people with VI and special education teachers to explore the ideas of augmenting tactile exploration on tablets. We also conducted a semi-structured interview with one special education teacher and three young adults with VI (trainees in the same institution, average age 29.1, $SD = 0.8$, two males and one female and all totally blind). During this interview, we addressed various topics such as tactile graphics, audio and vibratory feedbacks, etc. We summarize the main outcomes below:

- **Audio-based tools and systems.** Using audio-based tools or systems (as shown in Figure 49) is very common for people with VI (e.g. screen reader for reading texts), and they are also used to interact with them. The participants confirmed that audio description of graphics can improve comprehension [119], but also indicated some issues already observed in the literature [129]. For instance, they explained that

while using audio-based tools, they must pay attention to surrounding sounds and people simultaneously (even in closed areas such as a classroom). To avoid confusion, when they use the earphones, they usually wear only one earphone to make sure one ear focuses on the audio feedback while the other ear is available to monitor the environment. But even so, both sound sources can eventually be in conflict and it is difficult to continue paying attention to different sounds at the same time. In this case, they have to make the choice to focus on one of the two sound sources. Therefore, if possible, they would prefer not to use audio-based enhancement during some specific activities, such as the main focus of this dissertation (graphical information exploration), which requires more cognitive load.



Figure 49. People with VI interact with their smartphone using audio feedback [129].

- **Choice of device and exploration cues.** During the interview, all the participants agreed that using a vibrotactile interface (e.g. vibrators on hands or arms) coupled with a regular tablet for presenting the digital graphics could be a valuable solution. A tablet is portable and can easily display graphics (easier than using tactile graphics obviously). A tablet is also a good tradeoff between size and weight, especially for classroom or mobile situations. But the absence of tactile cues is an issue for tactile explorations. In this case, the vibratory feedback could fit the aim of guiding the hand towards a given direction.
- **Graphical information.** The participants confirmed that in special education lessons, graphics (including maps, mathematical graphs, schemas, etc.) are simplified into coarse lines to be printed on a raised-line paper (as shown in Figure 50). As a first step into making digital graphics more accessible, it is possible to

consider only linear segments (i.e. excluding curved lines) and eight segment directions (corresponding to the eight cardinal directions). Besides segment direction, providing progression (i.e. how much of a segment has been explored, as proposed in [23]) appeared as an interesting feature to facilitate the exploration of graphics with many segments.

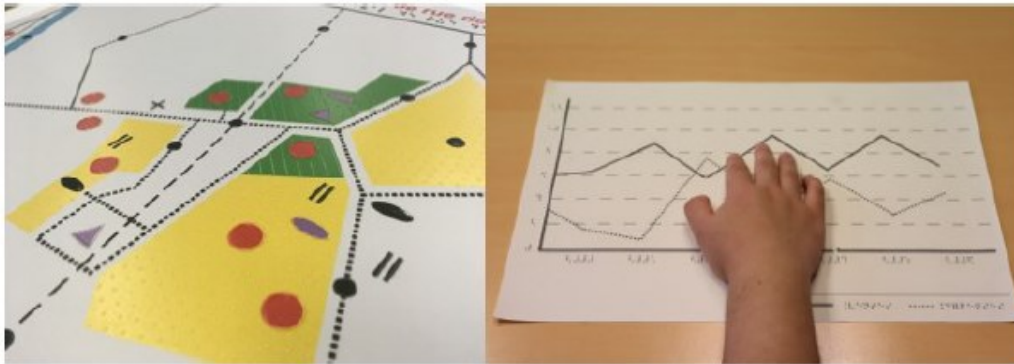

Figure 50. Examples of adapted tactile graphics. Left: geographic map; Right: mathematical graph.

3.3.2 Phase 2: Designing the vibrotactile interface

In this phase, we iteratively explored the different factors involved in the design of the vibrotactile interface. We conducted a series of formative tests with both blindfolded (BF) and visually impaired participants. Here, our rationale for including blindfolded people in the formative tests was based on [97], which suggests that the ability to learn and mentally represent graphical material via vibrotactile feedback is similar between blindfolded users and users with VI. Relying on blindfolded subjects helps to reduce the constraints associated to the participation in experiments of people with VI (especially mobility issues and small number of available subjects [11]).

3.3.2.1 Vibrotactile factors

To represent eight cardinal directions, several factors need to be considered. We present our design process as following:

- **Position of the vibrotactile interface on the body.** Vibratory feedback has been investigated on multiple body parts, including finger [33], waist [79], arm [26] and feet [81]. However, brainstorming sessions with the two subjects with VI confirmed that the back of the hand was more convenient for tactile exploration for several

reasons. The main one relies on the cognitive process involved in hand guidance: if the tactile cues are applied on any other body parts, the user must mentally switch from the sensory reference frame (location of the tactile display) to the motor reference frame used for executing hand movements [28]. With the tactile display being fixed on the hand, there is an overlap between the sensory and motor reference frames. In addition, the back of the hand is always available and easy to access during the tactile exploration of graphics. In contrast, the palm is often in contact with the underlying surface, which makes it less suitable to accommodate the vibrators.

- **Number of vibrators.** With the aim of representing eight cardinal directions, we could use eight vibrators [5]. But due to limited space on the back of the hand and restriction of minimum inter-vibrator distance (for generating identifiable vibrations), we had to reduce the number of vibrators to four and use more advanced and combined vibrotactile display to increase the number of directional cues to eight.
- **Stimulation method.** In our research, we focused on the two abovementioned vibrotactile displays (stimulation methods): Spatiotemporal Vibrotactile Patterns (SVP) [26] and Apparent Tactile Motion (ATM) [60]. SVP and ATM are all combined vibrotactile stimulations. As presented earlier, SVP is based on sets of sequential or simultaneous vibrations applied to different vibrators and ATM is a tactile illusion that occurs when two or more vibrators are activated with a pre-defined delay on the skin.
- **Vibration duration.** In our design, directional cues are based on vibrations generated by one or two vibrators. One important aspect when using vibratory cues to assist graphic exploration is that the vibration duration should be as short as possible – although being unambiguously perceivable – in order to avoid slowing down the exploration process.
- **Layout shape of the vibrators.** The layout shape of the vibrators was another factor that we examined. Following the brainstorming sessions and formative tests (with three blindfolded participants and two participants with VI), we designed two layout on the back of the hand based on Square and Cross shapes (e.g. A and B in

Figure 51). Finally, we obtained the following table showing how to represent each direction using different stimulation methods and with different layout shapes:

Table 1. Demonstration of vibrotactile directional cues using different stimulation methods and with different layout shapes.

	SVP Square	ATM Square	SVP Cross	ATM Cross
West (W)				
East (E)				
North (N)				
South (S)				
Northwest (NW)				
Northeast (NE)				

Southwest (SW)				
Southeast (SE)				

- Layout position of the vibrators.** In addition, another important question during the design was about using the back of the hand only or including the fingers in the layout. The rationale for including the index finger comes from [33], which suggests that recognition accuracy of vibrations applied to the index finger is much better. We then proposed four configurations (see Figure 51) combining two different layout shapes (Square & Cross) and two possible positions on the hand (Back-of-the-hand & Finger-Hand combination).

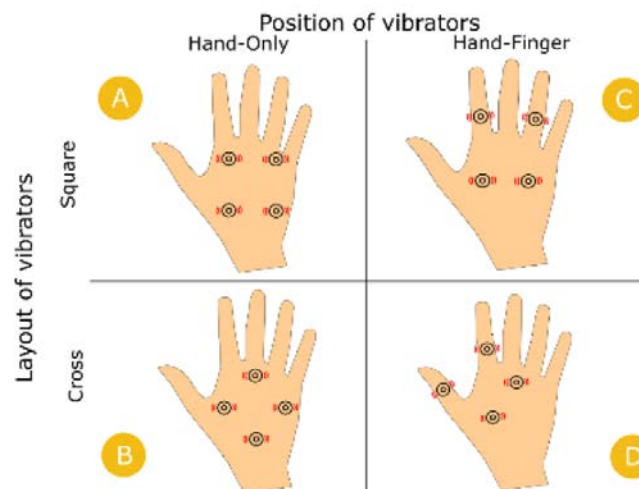

Figure 51. Four possible configurations according to the layout shapes and layout positions of vibrators on the back of the hand (A and B: square- and cross-shape on the back of the hand; C and D: square- and cross-shape on the back of the hand and fingers).

- Vibrotactile progression cues.** To represent the progression information (i.e. how far is the end of the segment), it was important to design a technique compatible with the directional cues to avoid any confusion. First of all, we defined the duration of the progression cues to 500 ms (i.e. more than twice longer than the directional

cues). This choice was inspired by [23] which applied vibrations of 600 ms on the wrist. Since the hand is more sensible than the wrist, we decided to reduce this value to 500 ms, as our goal was to have the shortest possible vibrations so as not to slow down the exploration task. Next, we identified two cases of progression cues according to the number of cues provided for a segment. In the first case, we proposed to use four successive vibrations located respectively at 20%, 40%, 60% and 80% of the segment and with increasing or decreasing intensity. In the second case, the progression cues were triggered only twice, at 40% and 80% of the segment with also increasing or decreasing intensity.

- **Cues triggering.** In our design, the directional cue is triggered as soon as the fingertip touches a line on the graphic. If the finger arrives at near the middle of a segment, the directional cue to the furthest end is chosen. As for the progression cues, as explained earlier, they appear at several fixed points of the segment.
- **Graphic line width.** We initially decided to use the same line width as previous work on digital graphics (8.9 mm in [125]). However, after preliminary tests, we found that such width: 1) is far too large to represent complex graphics on a tablet; 2) is larger than lines on tactile graphics (they are usually about 2 mm width) and thus does not correspond to the experience of exploring tactile graphics. Hence, we reduced the line width according to the results of [97]. With a 4 mm line width, participants can explore digital segments on touchscreens without perceptual issues. Obviously a 4 mm line width is more compatible with complex (meaningful) graphics displayed on 10 inches' commercial tablets.

The final design of VibHand is shown as Figure 52 C. Vibrotactile cues on the back of the hand and the vibration from the tablet work together to guide the finger movements.

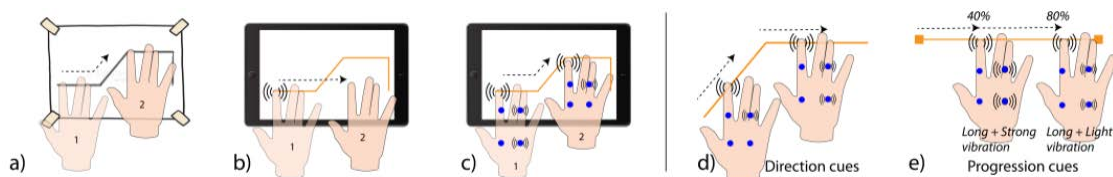

Figure 52. (a) Raised-line graphic exploration: tactile cues under the fingertip allow users to easily perceive line direction. (b) Digital graphic exploration: the tablet vibrates when the fingertip is over a digital line. Exploration is difficult because of the absence of fingertip tactile cues. (c) VibHand: a back-of-the-hand vibrotactile feedback that provides users with directional (d) and progression (e) cues to improve the exploration of digital graphics on tablets.

3.3.2.2 Optimal vibration duration

From this section, we present a series of formative tests conducted with both participants with VI and blindfolded sighted participants to determine the design of different vibrotactile factors.

To ensure that the vibrotactile cues were effective and brief, it was necessary to define the optimal duration of vibrations. We therefore conducted a pilot study to investigate the relationship between the duration of vibrations and the recognition rates of vibrotactile cues with the two stimulation methods. Our goal was to find the shortest time threshold to recognize a given vibration with minimal errors.

Experimental setup. The use of the gloves is the most common solution for attaching vibrators to the hand [51][68]. However, we wanted to evaluate the four different configurations, which requires changing the position of the vibrators several times during the experiment. Therefore, we decided not to use the gloves. Inspired by [91], we glued the four vibrators directly on the skin. The Figure 53 shows the device. The vibrators that we used were model RB-See-403, manufactured by SeedStudio. The amplitude of the vibration can be controlled with the Pulse Width Modulation (PWM) of the Arduino UNO. Since the relationship between voltage and amplitude is linear around the operating range (2.5V to 3.5V), it is possible to easily change the amplitude.

In terms of software, the device was controlled by a Python program which allowed us to easily change the vibrotactile display. The SVP stimulation was simple to generate since all vibrators can be controlled independently. The ATM stimulation followed the equation in [60]. The d , d' and SOA values were based on the total vibration time T .

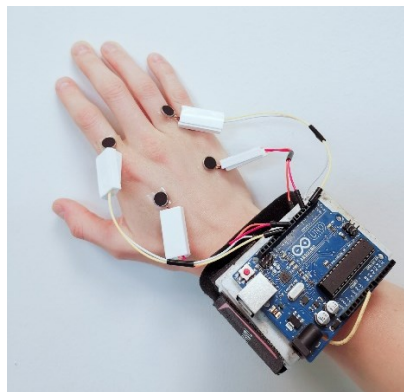

Figure 53. Vibrotactile prototype on the hand.

Participants and tasks. We recruited 12 blindfolded sighted participants from our university (5 females and 7 males) aged from 23 to 28 years old ($M = 25$; $SD = 1.9$). The task was to recognize eight different directions while blindfolded: north, south, west, east, northwest, northeast, southwest and southeast. The duration of the vibrotactile cues was variable (50 ms, 150 ms, 200 ms, 250 ms and 350 ms) and was chosen according to two criteria: 1) to be greater than or equal to the shortest perceptible durations [88]; 2) be as short as possible to make the stimulation compatible with the exploration movement of a digital graphics. In order to ensure that the experiment time is less than an hour and can be representative, we have only chosen two configurations: A and C (see Figure 51). The experiment was separated into two blocks corresponding to the two configurations. For each block, we randomly presented the 8 directions with the two stimulation methods and five different durations. For each trial, the stimulation was given only once and no feedback about the trial was given to participants. The order of the stimulation method and the duration were counterbalanced across users. The total duration of this experiment was approximately one hour.

Results. The Figure 54 shows that recognition rates of SVP and ATM vibrotactile directional cues (average values of two configurations) reach a plateau from the duration of 200 ms. In fact, the recognition rate reached 83.9% at 200 ms for SVP and 74.5% for ATM. We therefore took the value of 200 ms as the total duration of vibration for our following studies.

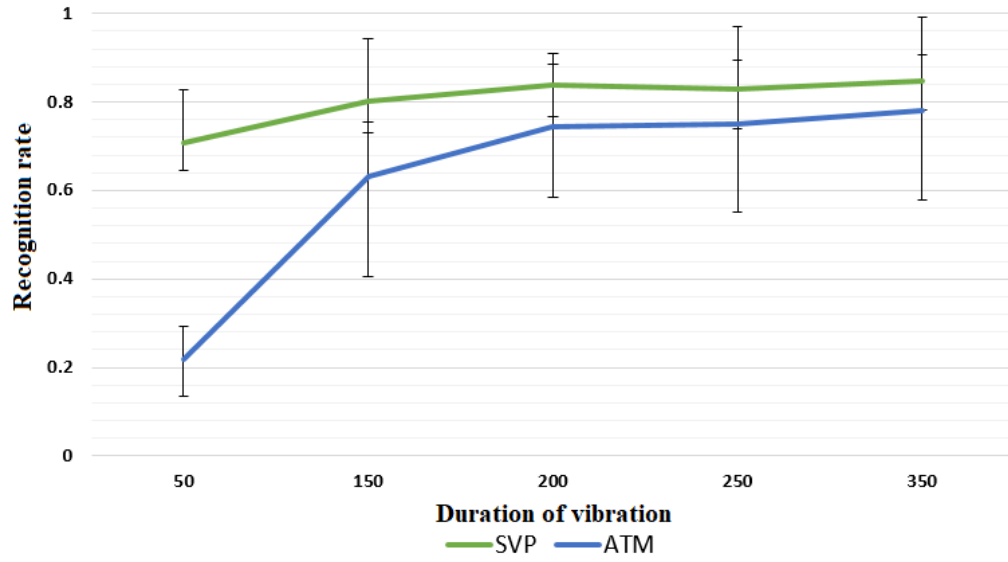

Figure 54. Recognition rates according to the vibration duration (ms). The error bars indicate 95% confidence intervals.

3.3.2.3 Optimal stimulation method and configuration

In this section, we present a formative study with the goal to determine the optimal stimulation method (SVP or ATM) and the best configuration of the vibrators (layout shape and position on the hand) to recognize the directional cues applied to the back of the hand.

Participants and tasks. We recruited 16 blindfolded sighted participants (6 females and 10 males) aged between 21 and 31 ($M = 25.1$, $SD = 2.7$) from our laboratory. Both of the participants have no sensory or motor impairment and none of them have participated in our previous experiments. The task was to recognize the direction of a vibrotactile stimulus applied to the hand among the eight possible cardinal directions.

Experimental plan and procedure. We followed a $2 * 4$ intra-subjects experimental design with Method (SVP and ATM, see Table 1) and Configuration (A: Square Back of the hand; B: Cross Back of the hand; C: Square Finger-Hand Combination; D: Cross Finger-Hand Combination, see Figure 51) as factors.

Following the results of the previous study, we used vibrations of 200 ms for both ATM and SVP. The study consisted of four blocks corresponding to the four vibrator configurations. The order of these blocks was counterbalanced between users using a Latin square. For each block, the order of the stimulation methods (SVP or ATM) was also

counterbalanced. Finally, the eight vibrotactile directions were provided following a random order generated before each block.

Before each test block, participants familiarized themselves with the different configurations of the vibrators and the two stimulation methods. During the familiarization phase, participants had to recognize the generated stimuli (eight vibrotactile directions). The experimenter gave verbal feedback (true or false, and the correct answer if false) on the direction of the stimulus, and the participants were able to practice several times until they were confident.

During the test phase, participants had to recognize the direction of the stimulus in each trial as quickly as possible. They were only allowed to give one response and would not receive any feedback from the experimenter. The eight directions were repeated three times randomly. The total number of trials was: 16 Participants * 2 Methods * 4 Configurations * 8 Directions * 3 Repetitions = 3072 trials.

In order to avoid the potential effect due to the acoustic or visual cues generated by the vibrators, all participants had to put their hand in a box and wear headphones which emit white noise.

Variables measured. We measured the recognition rate for each configuration. We also evaluated user preference by asking which stimulation method they preferred at the end of each block (subjective effectiveness and overall satisfaction) and also which configuration they preferred at the end of the experiment (subjective effectiveness and overall satisfaction).

Results. According to the Shapiro-Wilk test, the recognition rate did not follow normal distribution ($p < .05$). We therefore performed a Friedman test which showed a significant difference of recognition rates on the configurations ($\chi^2 = 59,7$; $p < .001$). We finally conducted a post-hoc test (Pairwise Wilcoxon test with Bonferroni adjustment) which showed that for each configuration, SVP was always statistically better than ATM.

The Figure 55 illustrates the average recognition rates according to the configurations. It shows that SVP always has superiority over ATM, especially with the configuration C which achieves an average accuracy of 92.7%. In detail, the recognition rates by

configuration are as follows (SVP vs. ATM): A (82.3% vs. 71.1%); B (76.0% vs. 66.4%); C (92.7% vs. 75.8%) and D (81.8% vs. 66.4%).

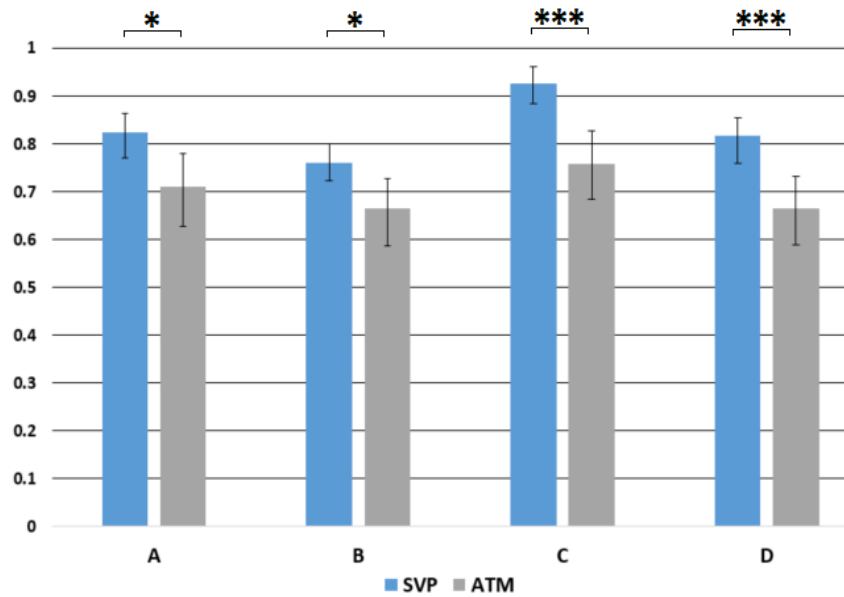

Figure 55. Average recognition rates according to the configurations. The error bars indicate 95% of confidence intervals. The upper bars indicate the statistical significance (* < .05, *** < .001)

To illustrate the errors made on different directions, we also calculated the confusion matrix for each configuration. Figure 56 and Figure 57 show the distribution of responses for the eight directions, with the SVP and ATM methods respectively.

The observation of Figure 56 with the SVP method shows that with the square layout (configuration A and C), the participants often confused the direction N (North) and E (East), with an average of 19.7% of confusion. With the cross layout (configuration B and D), we observe confusions between S (South) and either N (North) or E (East), with average confusions of 23.8% and 11.6% respectively.

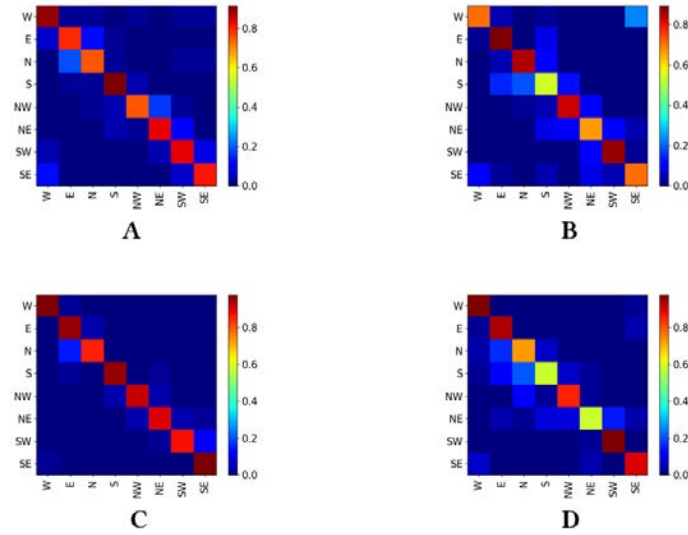

Figure 56. Confusion matrices with SVP for each configuration (The vertical axis represents the desired responses).

The confusion matrices in Figure 57 show that there were much more errors with ATM than with SVP (30.3% with ATM vs. 17% with SVP in terms of average confusion) and they were more distributed between the different directions. With ATM, participants were less confident in the direction they felt, seemed that they had given a more random answer than with SVP. We also observed that the confusions occurred during the cross layout (configuration B and D) were generally on the direction S (South), W (West) and NW (Northwest).

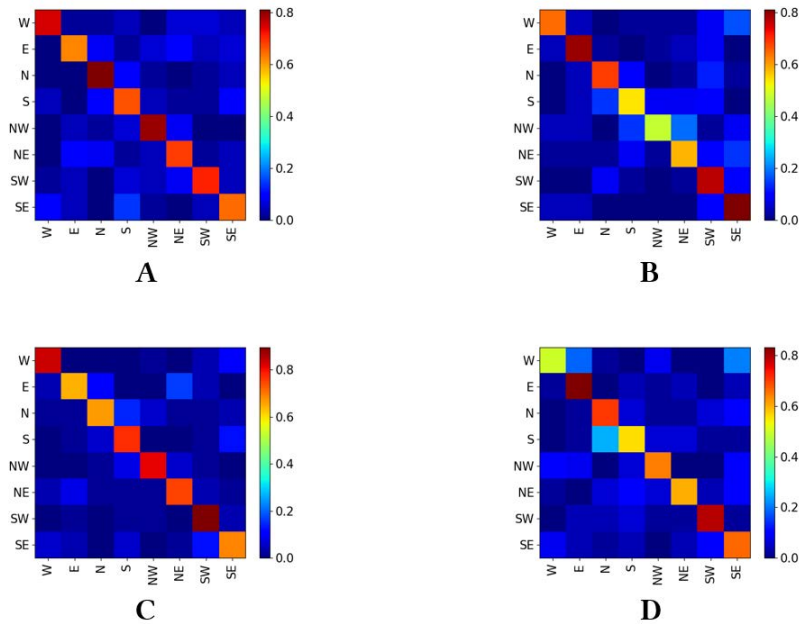

Figure 57. Confusion matrices with ATM for each configuration (The vertical axis represents the desired responses).

Consistent with recognition rates, subjective preferences showed that 8 out of 16 participants preferred configuration C, and 9 out of 16 participants thought it was more effective for representing vibrotactile directions (Figure 58). It is also interesting to note that there was also a consistency on preference between stimulation methods: 12 out of 16 participants thought SVP was more effective and 10 participants preferred SVP overall (Figure 59). Although two participants preferred ATM, they obtained better results with SVP.

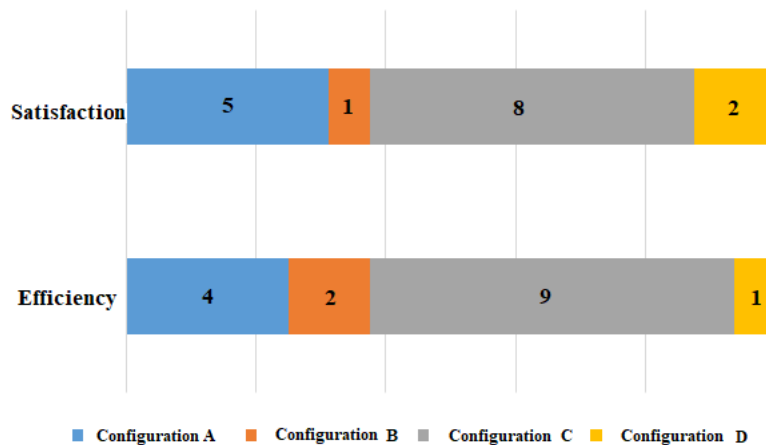

Figure 58. Subjective efficiency and satisfaction of the four configurations.

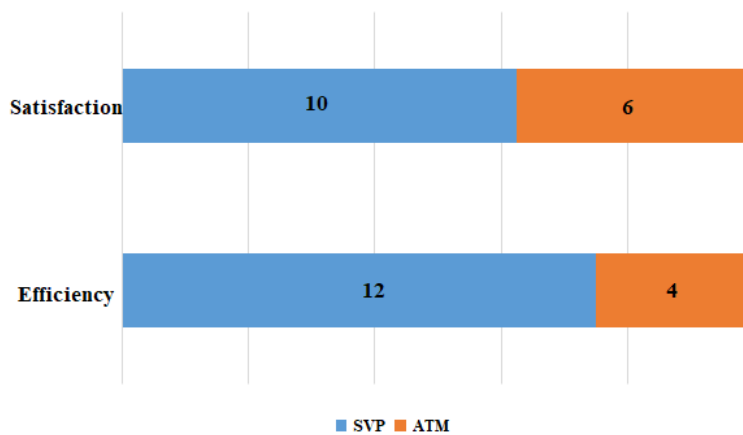

Figure 59. Subjective efficiency and satisfaction of the two stimulation methods.

In agreement with the work of [26][33], our results validated the effectiveness of vibrotactile cues to transmit directional information. In addition, we also observed that the most effective configuration for representing directions on the hand is a vibrotactile matrix

applied on the fingers and back of the hand in a square shape. Finally, the comparison between the two stimulation methods showed that SVP could offer a higher recognition rate than ATM. One possible explanation was that SVP is easier to understand and requires less cognitive effort than ATM.

3.3.2.4 Vibrotactile progression cues

As presented earlier, we identified two cases (two vibration patterns) of vibrotactile progression cues. To further determine the best one, we conducted a last formative test which consisted on exploring a single segment on different directions with progression cues. We recruited four blindfolded participants who had taken part in the study on vibration duration. Each participant completed 96 trials corresponding to 2 Vibration patterns (two vs. four stimuli) * 2 Vibration modes (increasing vs. decreasing) * 8 Directions * 3 Repetitions. The results based on a 5-level Likert scale showed that all four participants preferred using two progression cues (instead of four) and three out of four participants preferred progressions cues with decreasing intensity (instead of increasing). Here, it should be noted that since the progression cues were not the principal contribution of this study, we decided to simplify the evaluation procedure and therefore we conducted only qualitative analysis.

In summary, from a series of formative tests with blindfolded sighted participants, we quickly verified the different vibrotactile factors on the back of the hand. Based on these results, we could begin to formally investigate if the vibrotactile cues can be used to improve the non-visual tactile exploration of digital graphics.

3.4 Experiment: exploring and identifying geometrical and non-figurative graphics

Based on the participatory design process, we gradually confirmed the optimal design of the vibrotactile interface on the back of the hand (i.e. SVP for the directional cues and a two-stimulus pattern for the progression cues). To further verify the effectiveness and usability of the proposed VibHand, we conducted an experiment with both blindfolded sighted participants and participants with VI. The aim of this behavior experiment was to

verify the general hypothesis that the two cues rendered by the vibrotactile interface can enhance digital graphics exploration without introducing additional perceptual or cognitive issues.

3.4.1 Participants

In line with [37], we included blindfolded sighted participants in our experiment design to investigate if there are differences on the exploration performance between people with VI and blindfolded sighted people due to cognitive skills. Blindfolded sighted participants can be considered as novices in tactile exploration. We recruited 24 participants that were divided into two groups according to their visual status: BF group (12 blindfolded participants; 2 females, 10 males) aged between 21 and 28 ($M = 25.1$, $SD = 1.9$); and VI group (12 people with VI; 6 females, 6 males) aged between 25 and 60 ($M = 45.9$, $SD = 12.2$). None of the VI and BF participants (described in Table 2) present any additional sensory impairments nor took part in the previous studies.

Table 2. Description of the VI and BF participants.

ID	Gender	Age	Description	ID	Gender	Age	Description
VI 01	M	27	Engineer, Blind from age 12	BF 01	M	21	Undergradu ate student
VI 02	M	54	Special education teacher, blind form age 12	BF 02	M	28	Ph.D. student
VI 03	F	59	Special education teacher, blind from birth	BF 03	M	23	Undergradu ate student
VI 04	M	28	Unemployed, blind from birth	BF 04	M	26	Master student

VI 05	F	48	Special education teacher, low vision from age 11	BF 05	M	25	Master student
VI 06	F	60	Teacher, low vision from birth	BF 06	M	23	Master student
VI 07	F	50	Special education teacher, very low vision from birth	BF 07	M	26	Ph.D. student
VI 08	M	45	Unemployed, blind from birth	BF 08	F	25	Master student
VI 09	M	44	Unemployed, very low vision from birth	BF 09	M	26	Engineer
VI 10	M	59	Engineer, blind from age 6	BF 10	M	27	Master student
VI 11	F	52	Teacher, very low vision from birth	BF 11	F	26	Ph.D. student
VI 12	F	25	Student, very low vision from birth	BF 12	M	25	Engineer

3.4.2 Task and instructions

We used a Delayed-Matching-to-Sample (DMTS) task [103], which consists in comparing pairs of stimuli and is widely used in working memory studies. In our case we asked participants to explore and compare pairs of digital graphics. More precisely, for each trial, the participant was first presented with a sample stimulus (sample graphic) and then an alternative stimulus (alternative graphic) after a short delay. The exploration of each pair included three steps:

- 1) **Encoding phase:** participants were asked to completely explore the sample graphic as quickly and accurately as possible. After the exploration, and for the geometrical graphics only, they had to verbally identify the shape, e.g. “square” (identification task).
- 2) **Retention delay:** a short delay between the two stimuli. Here, we chose a 5 seconds retention delay to elicit the use of memory strategies [24].
- 3) **Test phase:** participants were asked to explore the alternative graphic as quickly and accurately as possible. They were free to stop the exploration as soon as they can decide that the pair is identical or different (comparison task).

3.4.3 Digital graphics

We selected two different types of digital graphics: Simple Geometrical Graphics (shown in Figure 60, sets A and B) and Non-Figurative Graphics (shown in Figure 60, sets C and D).

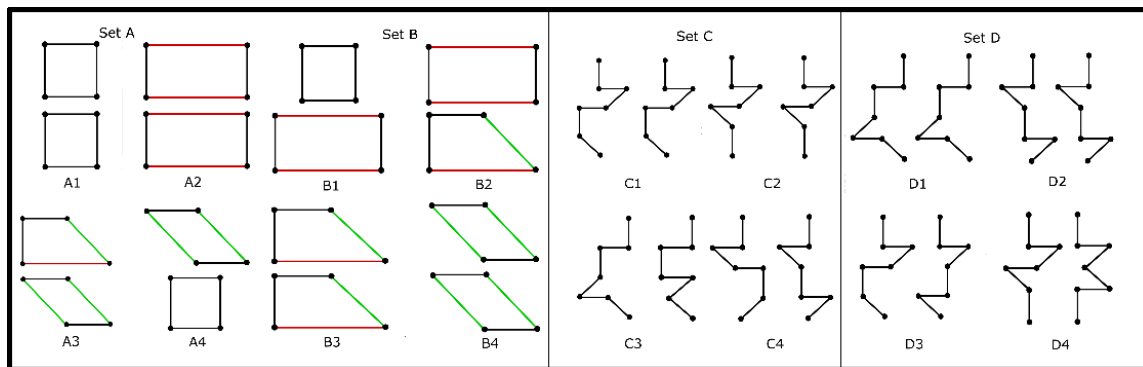

Figure 60. Sets A and B: Geometrical graphic pairs; Sets C and D: Non-Figurative graphic pairs.

Simple Geometrical Graphics (G-Graphics): these digital graphics are common geometrical shapes that were selected by meeting three criteria: 1) Same complexity: all the selected graphics have the same numbers of segments. 2) Similar shape: in order to design a DMTS task that was not too simple, the selected graphic pairs have at least two identical segments (but subjects were not aware of that). 3) Commonly used: all the graphics are known by users. Finally, the G-Graphics group included four common quadrilaterals: Square, Rectangle, Right Angle Trapezoid and Parallelogram.

Non-Figurative Graphics (NF-Graphics): these digital graphics were 2-D patterns made from a combination of 6 segments (2 horizontal, 2 vertical, 1 slash and 1 backslash). The use of such patterns was inspired by [54], which mentioned that, contrary to geometrical shapes, the tactile exploration of 2D non-figurative patterns is not dependent on existing mental representation of the shape. Like geometrical graphics, we designed “identical” and “similar” pairs. Here, similar pairs mean that the two graphics started with three same segments and always differed on the fourth or fifth segment (but subjects were not aware of that).

3.4.4 Interaction techniques

We compared the VibHand technique, described in the previous section, with a touchscreen vibration technique for tablets (i.e. control condition) which was proposed by Tekli et al. [125]. While our technique provides more cues than the control condition (which is based on touchscreen vibration only), we aimed to check whether introducing additional vibrations may increase cognitive load and then decrease the performance. Concerning the inclusion of other modalities, our initial analysis showed that the audio channel is overloaded in Assistive Technologies and that audio guidance can interfere with surrounding sounds and speech. Therefore, we discarded to include any audio-based solution in our study.

3.4.5 Experimental design

We used a within-subjects design with three factors: the interaction technique (VibHand vs. Control), the type of the graphic (G-Graphics vs. NF-Graphics) and participants’ visual status (BF vs. VI).

The study included two familiarization phases followed by two test phases. During the first familiarization phase, participants were presented with vibrotactile cues along eight directions: Top, Bottom, Left, Right, Top Left, Top Right, Bottom Left and Bottom Right. They were free to practice several times in each direction with both techniques. During the second familiarization phase, participants were asked to explore carefully four digital segments: Horizontal, Vertical, Slash and Backslash using both interaction techniques. They were free to practice several times until they felt confident with both interaction techniques.

Then the session was divided into two blocks corresponding to the two types of digital graphics (first block with the G-Graphics and second block with NF-Graphics), i.e. with increasing difficulty. In each block, the participants explored the graphics with the control technique first and then VibHand, or vice versa. We counterbalanced the order of interaction techniques across participants. It is important to note that although we included the type of graphics as a factor in our study, our analysis does not intend to look for differences across both types of graphics (because they have different complexity and length), but rather look for interactions with the other factors (interaction technique and participant's visual status).

3.4.6 Experimental setup

During the experiment, participants were asked to comfortably sit in front of a Samsung Galaxy Tab S4 (10.5 inch, 1600 x 2560 px, 287 ppi density). The vibrotactile cues (VibHand) were generated by four vibrators (model RB-See-403, SeeedStudio) attached on the back of the hand (see Figure 61). The vibration (intensity and duration) was controlled by the Pulse Width Modulation (PWM) of the Arduino UNO, which was wire connected to a nearby laptop (we ensured that the wires did not interfere with hand movements).

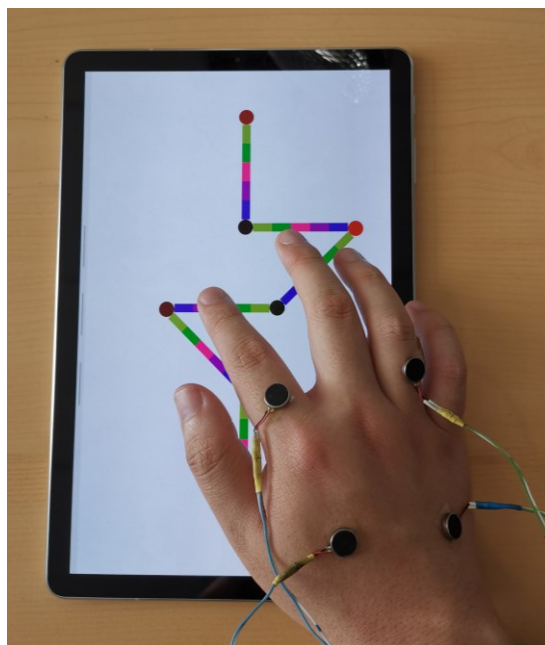

Figure 61. Experimental setup with a NF-Graphic displayed on the tablet and the four vibrators attached to the back of the hand.

3.4.7 Collected data and dependent variables

We recorded the finger path during the exploration of each graphic. We compared different dependent variables: the exploration speed in cm/s for each sample graphic; the unrelated finger path as the difference in cm between users' real finger path and the length of the graphic; the time needed to compare the pair (response time); the graphic identification rate (for the sample graphic on the geometrical set); and comparison rate (for each pair). We also collected the subjective rating (on a 5-point Likert scale) about the following questions: a) Are directional cues easy to use? b) Do directional cues make the exploration easier? c) Are progression cues useful? and d) Do you prefer VibHand or Control?

In total, we collected 24 (12 blindfolded participants + 12 participants with VI) * 4 (2 sets of geometrical graphics + 2 sets of non-figurative graphics) * 4 (4 pairs of graphics in each set) = 384 trials (1 trial = 1 pair). Since the alternative graphic was not systematically completely explored, these trials represent between 1536 segments (if only the sample graphics were explored) and 3072 segments (if all the alternative graphics were fully explored).

3.4.8 Results

In total, participants explored 2716 segments (i.e. 88.4% of the total set of segments).

3.4.8.1 Identification of G-Graphics

According to the Shapiro-Wilk test, the average identification rate did not follow a normal distribution ($p < .001$). Since the raw data of this measure was dichotomous, we adopted a Chi-Squared test. The results showed a significant effect of the interaction technique ($X^2 = 20.841, p < .001$) but no effect of the visual status ($X^2 = .2573, p = .612$). The identification accuracy was better with VibHand than with Control (90.6% vs. 61.4%, see Figure 62). Identification errors generally corresponded to participants mixing square with rectangle, and trapezoid with parallelogram.

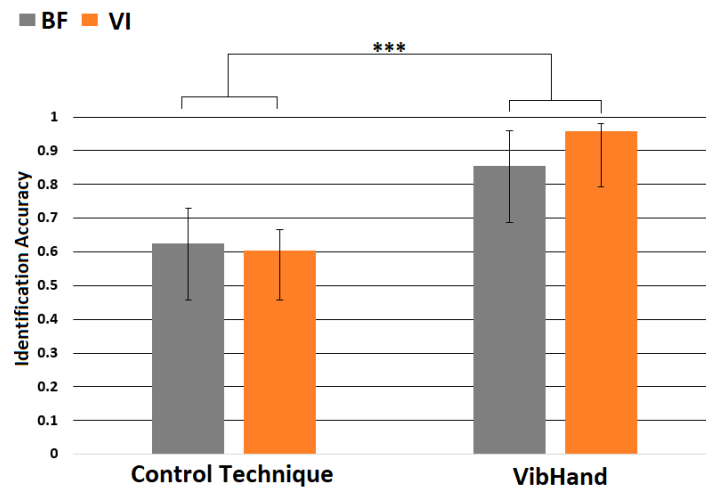

Figure 62. Average identification accuracy for G-Graphics (95% of CI).

3.4.8.2 Pair comparison

The pair comparison accuracy did not follow a normal distribution according to the Shapiro-Wilk test ($p < .001$). Similarly, since the raw data of this measure was dichotomous, we also adopted a Chi-Squared test. The results showed a significant effect of the interaction technique ($X^2 = 18.665, p < .001$) but no effect of the visual status ($X^2 = .921, p = .337$) nor the graphic type ($X^2 = 1.44, p = .23$). Overall, the comparison accuracy was better with VibHand than with Control (85.9% vs. 66.6%, Figure 63).

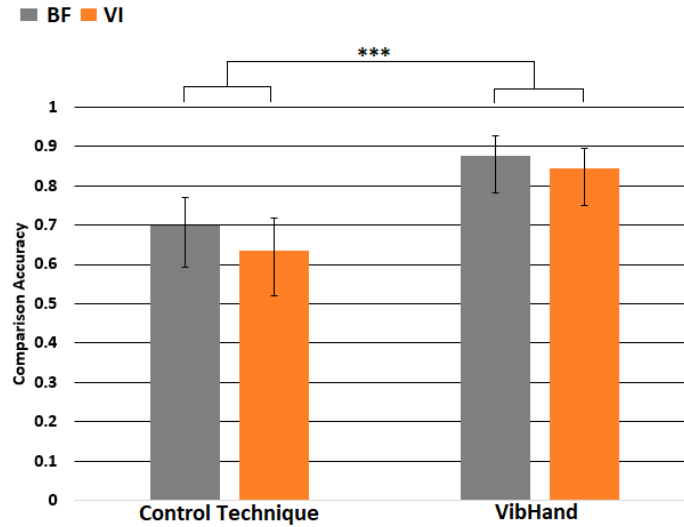

Figure 63. Average comparison accuracy (95% of CI).

3.4.8.3 Response Time (to judge same or different)

This measure is based on the exploration time of alternative graphics (i.e. the second graphic of each pair), which reflects on the time needed to explore the alternative graphic and judge if it is identical or different. The distribution was not normal according to the Shapiro-Wilk test ($p < .001$). However, after a Box-Cox transformation [108], the response times finally followed a normal distribution ($p = .84$). Then the results of the ANOVA showed that there was a main effect of the interaction technique ($F(1,11) = 16.6, p = 5e-5$) and of the graphic type ($F(1,11) = 6.9, p = .00883$), but no effect of the visual status ($F(1,11) = 1.49, p = .22$). There was also an interaction between the type of graphic and the visual status ($F(1, 11) = 4.05, p = .045$). The average response time was shorter with VibHand than with Control (42.0 s vs. 53.4 s, see Figure 64), which showed that it was easier to make the comparison with VibHand. It was also shorter for G-Graphics than for NF-Graphics (45.2 s vs. 50.2 s).

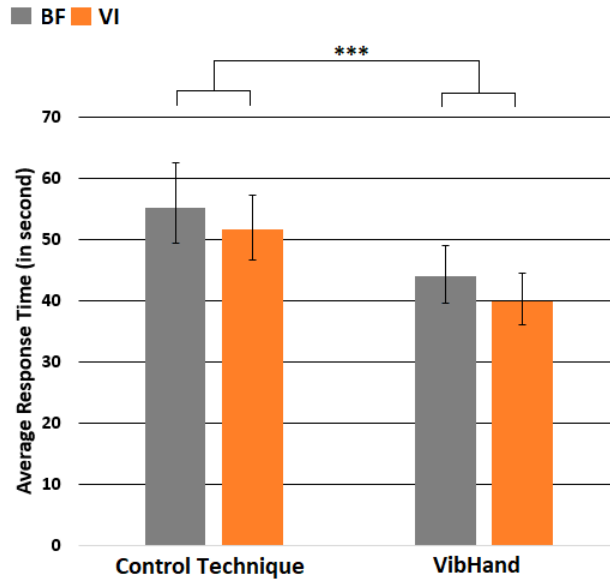

Figure 64. Average response time (95% of CI).

3.4.8.4 Unrelated finger path for the sample graphic

The Shapiro-Wilk test showed that the average unrelated finger path did not follow a normal distribution ($p < .001$). Hence, we transformed the data to normal using Box-Cox ($p = .096$). The ANOVA showed a significant effect of the interaction technique ($F(1, 11) = 248.94, p = 2e-16$) and visual status ($F(1, 11) = 19.56, p = 1e-7$) on the unrelated finger path, but no effect of the type of graphic ($F(1, 11) = 0.25, p = 0.62$). We also found an interaction effect between two pairs of factors: interaction technique * type of graphic ($F(2, 21) = 5.29, p = 0.022$) and visual status * type of graphic ($F(1, 11) = 3.93, p = 0.0483$). In fact, VibHand decreased the average unrelated paths (45.0 cm vs. 132.8 cm) as illustrated in Figure 65. The average unrelated finger path was smaller for VI participants than for BF participants (70.9 cm vs. 106.9 cm). The Tukey post-hoc test showed significant effects on both G-Graphics and NF-Graphics (for both BF and VI groups, the $p < .001$).

The interaction effects showed that the differences were always more pronounced on non-figurative graphics: VibHand performed better on NF-Graphics than on G-Graphics compared with Control. This effect showed that it was easier to explore NF-Graphics with VibHand. However, it could just be related to the fact that NF-Graphics were always explored in the second block (learning effect).

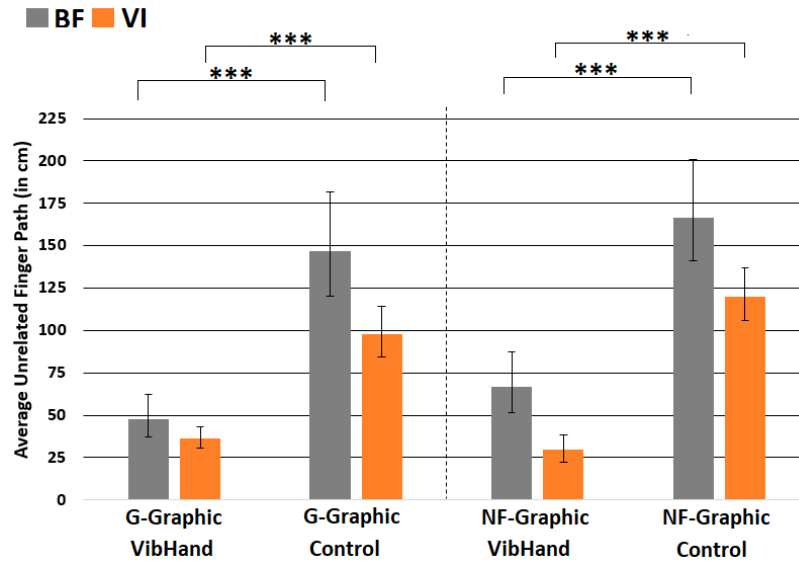

Figure 65. Average unrelated finger path (95% of CI).

3.4.8.5 Exploration speed

Since the two types of digital graphics do not have the same complexity (the number of segments for geometrical and non-figurative graphics are 4 vs. 6 respectively), we conducted the statistical analysis on exploration speed (and not exploration time).

The Shapiro-Wilk test showed that the exploration speed did not follow a normal distribution ($p < .001$). Hence we transformed the data using Box-Cox ($p = .086$). The ANOVA showed that there was a significant effect of visual status ($F(1, 11) = 6.34, p = 0.0122$), interaction technique ($F(1, 11) = 75.47, p = 2e-16$) and graphic type ($F(1, 11) = 4.8, p = 0.029$) on exploration speed, but no interactions between factors. For both BF and VI participants, the exploration speed was faster with VibHand than with the control technique (0.61 cm/s vs. 0.42 cm/s, see Figure 66-b) and participants with VI explored graphics on average faster than BF participants (0.54 cm/s vs. 0.48 cm/s, see Figure 66-a). In addition, the average exploration speed of G-Graphics and NF-Graphics were 0.50 cm/s and 0.53 cm/s respectively (see Figure 66-c).

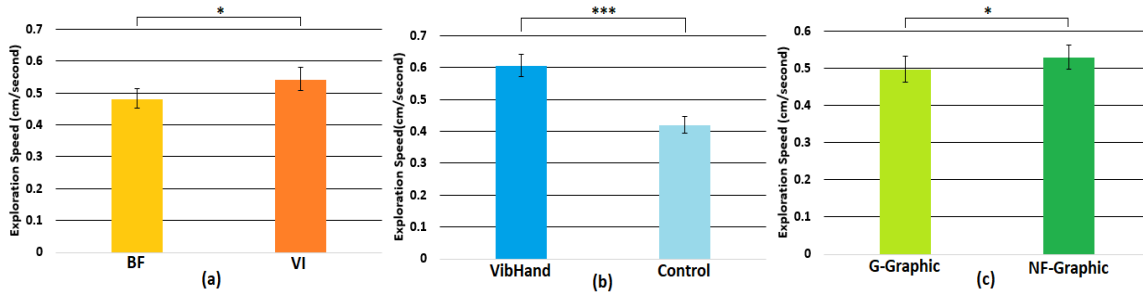

Figure 66. Average exploration speed (95% of CI) by a) visual status; b) interaction technique and c) graphic type.

3.4.8.6 Exploration movements

In addition to the previously described measures, we analyzed the overall finger path observed with the two techniques. We observed numerous inefficient exploration movements with the control technique. For example, when reaching the end of a segment with this technique, participants came up with two strategies to find the next path: doing a circular movement with the finger until finding the next segment (Figure 67A, participant VI 02); or initiating a finger movement in many different directions, drawing a “star like” path (Figure 67B, participant VI 06). Obviously, both “circles” and “stars” waste time and increase the unrelated finger paths. In addition, they are probably confusing too, which can also explain worse identification and comparison scores.

The comparison of the finger paths with VibHand clearly shows that the reduction in unrelated finger path comes from: a) more linear paths when exploring segments, and b) more efficient transitions at the end of segments.

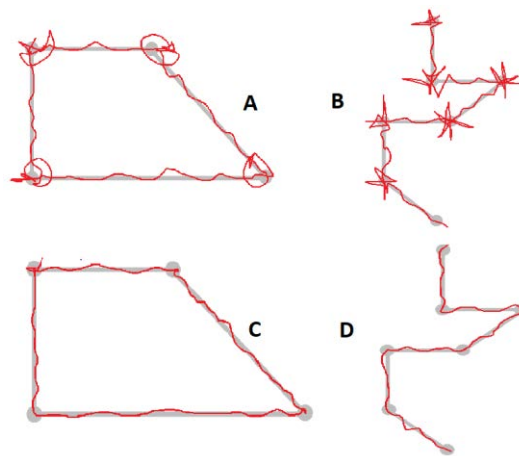

Figure 67. A and C: VI 02 finger paths when exploring a geometrical graphic with control technique and VibHand respectively; B and D: VI 06 finger paths when exploring a non-figurative graphic with control technique and VibHand respectively.

3.4.8.7 Qualitative feedback

Eleven out of 12 VI participants strongly agree or agree that the vibrotactile directional cues are easy to use and make the exploration easier. Nine strongly agree or agree that the progression cues are useful, and eleven prefer exploring with VibHand. Figure 68 shows the responses of participants with VI. The only participant with VI who disagreed (VI 04) explained that “Personally I don’t like the vibration. Even for my mobile phone, I don’t activate the vibration mode, I’m kind of special!”.

Verbatim recorded during the experiment were useful to understand the feelings of the participants. For example, while exploring with VibHand, VI 09 said “I understand! I know how to translate the vibration now and it’s really cool”! In contrast, exploring the same graphic with the control technique, he said “It’s really hard, how do you follow the lines? I can’t do this.” Similar reactions occurred also to many other participants (both blindfolded participants and participants with VI).

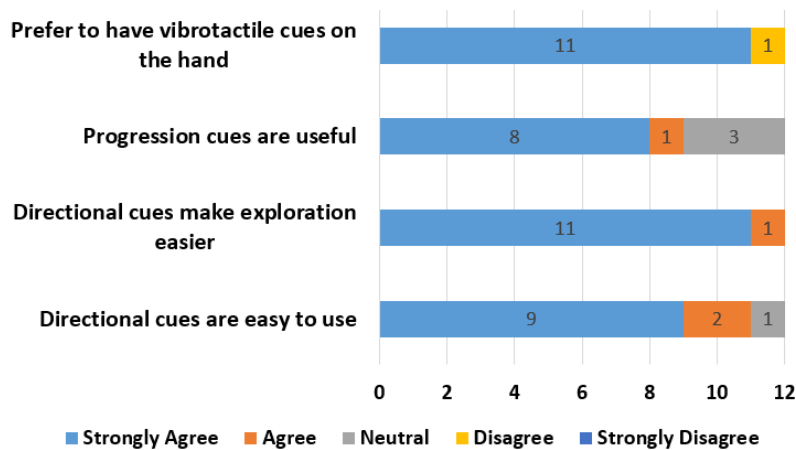

Figure 68. Qualitative feedback of VI participants for the VibHand technique.

3.5 General discussion and perspectives

3.5.1 Vibrotactile cues improve digital graphic exploration

The results confirm our hypothesis that VibHand improves non-visual digital graphic exploration (for both people with VI and blindfolded sighted people). It improves both the identification accuracy of known graphics and the comparison between two graphics. In addition, it reduces the unrelated finger path, increases the exploration speed and also decreases the time needed to compare two graphics. The comparison of the finger paths with VibHand shows that the reduction in unrelated finger path comes from: a) more linear paths when exploring segments, and b) more efficient transitions at the end of segments. Finally, although this result may still need to be confirmed with a standardized test of cognitive load (for example, NASA-TLX or SAGAT, etc.), the qualitative feedback and verbatim indicate that the technique does not introduce additional perceptual or cognitive load during exploration.

3.5.2 Impact of user's visual status

By comparing BF and VI participants, we did not observe any difference on the identification accuracy of known graphics, nor on the comparison accuracy. Both blindfolded sighted subjects and subjects with VI were able to do the task with good accuracy, which is in line with [97]. However, the results showed that VI participants took less time and had shorter unrelated finger paths than BF participants. The most probable explanation is that the difference is not perceptual but cognitive. The results also showed that both VI and BF participants were able to rely on the directional and progression cues to explore digital graphics but VI participants were more efficient. In fact, VI people are used to exploring raised-line graphics, as well as digital contents on smartphones or tablets, and can be considered as experts in tactile exploration. Our interpretation is that they rely on better cognitive skills than BF participants: they can better integrate perceptual cues in time and space in order to form a mental representation of the displayed graphics.

This result also means that there is no advantage for blindfolded sighted people, in these two specific tasks, although it has been shown that vision helps to get better mental

representation of shapes. In our idea, it could be that these two effects cancel each other. More research work should address this question.

Finally, we recruited participants with VI and blindfolded sighted participants having different educational background and age. It appears that the blindfolded sighted participants are, on average, younger and with a higher educational background. Although we believe that these differences in education and age should be in favor of the blindfolded sighted participants in the tasks that we proposed, the question should be addressed in a future work.

3.5.3 Application scenarios

In our work, we evaluated relatively simple graphics (but more complex than those in [125]). However, VibHand can easily be applied to different real scenarios. We acknowledge that all the scenarios including VibHand require a simplification of the graphics first (segments along the eight cardinal directions only). But it is important to note that this is already the case when creating raised-lines graphics for people with VI [130]. Here, we present and discuss two possible applications scenarios (among many others):

Digital map exploration for orientation and mobility lessons. During the collaboration with the special education center, we found that neighborhood maps are used almost daily in classes of Orientation & Mobility. A frequent request of students with VI is to have access to these maps in different situations (at home, in a public building, in an unknown place, etc.). Using a regular tablet with VibHand, users with VI could access to digital graphics everywhere. Figure 69 left illustrates a simplified digital neighborhood map, where each line represents a road. VibHand can be used to explore the map and provide users with better knowledge of the paths between two points of interest (e.g. between the subway exit and the school). As we know, although people with VI already use raised-line maps in such situations, during O&M classes for instance, they cannot bring as many raised-lined maps as they want because it takes time to prepare and they are also too cumbersome. However, they could bring as many as they want with a tablet combining VibHand.

Mathematical graphs. Mathematical graphs, and specifically line graphs, are very often used in classes. With VibHand, users with VI can easily explore a digital version of a line

graph and carry usual data analytics tasks (Figure 69 right), such as looking for max and min values, or compare two-line graphs (similar to the comparison task in our study).

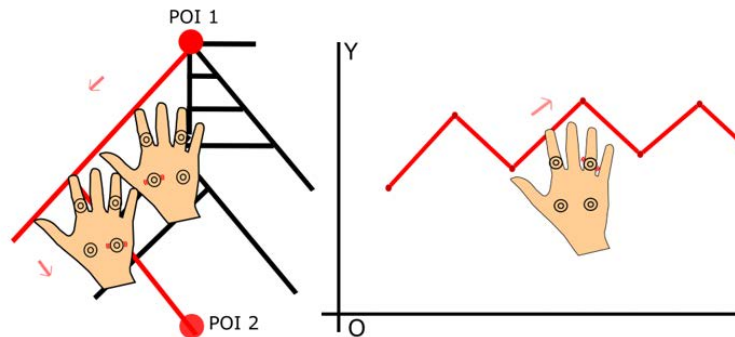

Figure 69. A user exploring a path between two POIs on a neighborhood map (left) and a line plot on a mathematical graph (right) with VibHand.

3.5.4 Limitations and Future work

Overall, these results show that VibHand improves the efficiency of tactile exploration as well as the mental representation of the explored graphics. An important question is to compare the exploration with VibHand to the exploration with regular raised-line graphics. This question should be addressed in future work. We do not believe that VibHand would outperform raised-line graphics, but we make the hypothesis that VibHand would provide VI users with ubiquitous useful and convenient access to digital graphics in many real-life contexts. Such a comparison should then not only address the compared usability of the two techniques but also the ubiquity of the techniques with different graphics (maps, mathematical graphs, etc.) and different tasks to be achieved (exploration, recognition, comparison, decision making, etc.).

Another important point to be addressed in a future work is the integration of VibHand in a more ergonomic device. The current VibHand prototype is made of four vibrators connected to an Arduino, which is connected to the tablet with network. The next prototype could be a mitt that contains the vibrators and microcontrollers.

In addition, the current design of VibHand includes eight cardinal directions only. Therefore, it can only work with simplified graphics (similar to the most common raised-line graphics used in special education center). However, providing more directions could give access to more complex graphics, but at the same time increase the cognitive load

associated to the exploration and the cognitive integration of the graphic. In the future, we plan to investigate the possibility of extending the number of vibrotactile cues to provide more directions. We plan to investigate the use of tactile illusions [58], such as the phantom sensation [4]. Previous work showed that it is possible to generate a virtual vibration between two real vibrations [98]. This could provide VibHand with more directions without adding vibrators, but further studies are needed to evaluate if these vibrotactile illusions can be used for exploration and do not raise any cognitive issues.

3.6 Conclusion of Chapter 3

In this chapter, we presented VibHand, a promising non-visual vibrotactile interface for providing a better access to digital graphics on tablets. VibHand extends regular tablet vibrations by providing both directional and progression cues using four vibrators on the back of the hand. Our design is based on a set of formative iterations leading to a summative study with 12 blindfolded participants and 12 participants with VI. The results confirm the advantages of VibHand on digital graphic exploration speed, recognition accuracy and user preference. Our comparison of BF and VI groups revealed no difference on the identification accuracy of known graphics, nor on the comparison accuracy. However, VI participants take less time and have shorter unrelated finger paths than BF participants.

Chapter 4 Tactile Fixations: a behavioral marker on how people with visual impairments explore raised-line graphics

Related publications

This publication summarizes the main content of this chapter.

Kaixing Zhao, Sandra Bardot, Marcos Serrano, Mathieu Simonnet, Bernard Oriola, and Christophe Jouffrais. 2021. Tactile Fixations: A Behavioral Marker on How People with Visual Impairments Explore Raised-line Graphics. In Proceedings of the 2021 CHI Conference on Human Factors in Computing Systems (CHI 21). Association for Computing Machinery, New York, NY, USA, Article 9, 1-12.

4.1 Introduction

4.1.1 Context

Tactile graphics, more precisely, the raised-line graphics that are commonly used in special education institutions for people with VI. As mentioned before, although this particular type of documents is not easy to produce, they are still the most direct alternative to common visual graphics and can provide people with VI the access to different types of graphical information, for instance mathematical graphs, maps and drawings, etc. Comparing with visual graphics, the raised-line graphics are often printed on Swell Touch Paper (as shown in Figure 70) and allow people with VI to explore the lines (raised by the printer) with their finger touch.

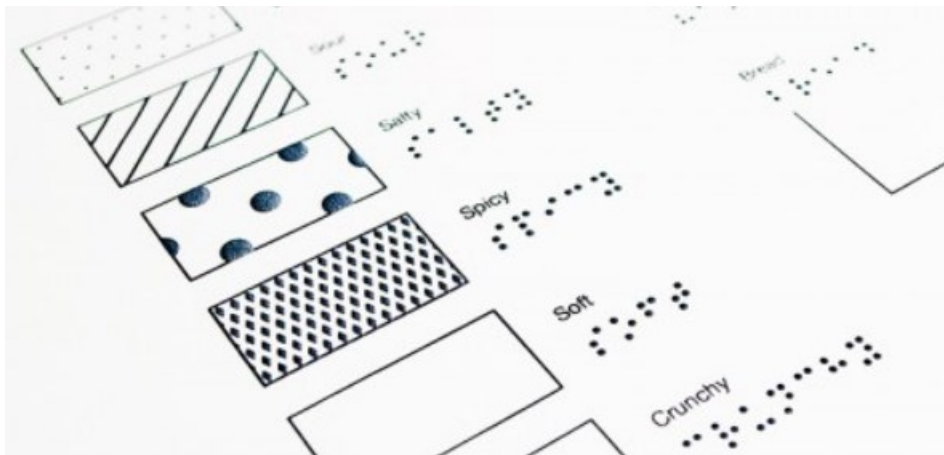

Figure 70. An example of Swell Touch Paper.

To better guide the design of the raised-line graphics, some research like [32] summarized the design process as well as the techniques and indicated that the design of raised-line graphics is a complicated task requiring consideration of various different graphical elements, such as legends, textures, symbols, dots, lines, etc. However, the design process (i.e. which graphical elements should be selected and how many of them should be included) highly relies on the experience of the tactile document maker and needs to consider many factors, for example the perceptual and cognitive capacities of the end-user,

the type and the aim of the graphic, etc. Therefore, to design more useful raised-line graphics, there is a need to better understand how people with VI explore these types of graphics (i.e. how they organize their one-handed or two-handed movements). This knowledge may inform a better design of raised-line graphics and may also have the potential to improve the design of interactive graphics (i.e. talking tactile graphics, see [10][70]).

To do this, we focused on the users' hand (finger) movements by introducing a behavioral marker called "Tactile Fixation" (as shown in Figure 71). A tactile fixation occurs when a finger is motionless within a spatial and temporal window. When people with VI explore a raised-line graphic, their fingers often stop over specific elements of the graphics. Identifying such stops (tactile fixations) may provide valuable information on the salient areas of the graphics and also on the exploration strategies of the users. Therefore, in this chapter, we address different research questions on how to identify tactile fixations and on the role of tactile fixations during the exploration of raised-line graphics.

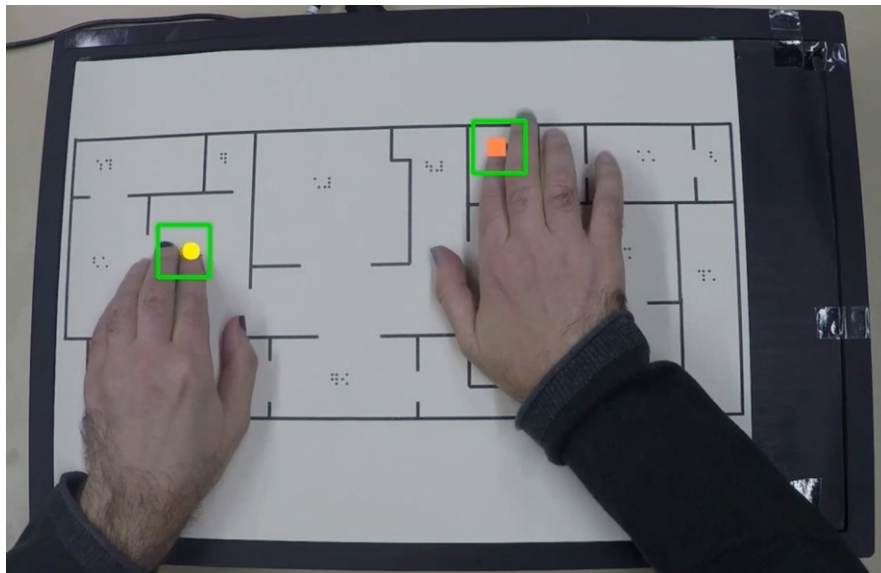

Figure 71. Left and right index fingers stop often to "read" underlying information. Each stop may become a tactile fixation if it meets the conditions of tactile fixations. In this figure, the yellow point on the left hand and the orange square on the right hand represent a short and middle tactile fixation respectively.

More precisely, we conducted a behavioral study with ten people with VI who performed tactile exploration tasks on different types of raised-line graphics and with different instructions. We logged the participants' finger movements and then we identified tactile

fixations from the recorded finger paths with a tactile fixation identification algorithm inspired by previous research on eye fixations. The statistical analysis show that there are tactile fixations of different durations, which are involved in different one-handed or two-handed behavioral patterns. By manually reviewing the exploration videos, we summarize and illustrate these different behavioral patterns and discuss the interest of the novel approach on the design of raised-line graphics as well as on the design of non-visual interfaces or/and interaction techniques.

4.1.2 Research questions

Tactile fixations have been observed in previous work on tactile exploration [124][133]. However, we know little about when and why they occur. To drive our deeper investigation, we identified a set of research questions related to tactile fixations:

- How to identify tactile fixations?
- Do participants perform tactile fixation with both hands?
- Do tactile fixations vary according to the type of graphic?
- Do tactile fixations vary according to the exploration task? The hand movement may not be the same if the participant is doing a non-guided vs. guided exploration (i.e. to find the response to a question about the graphic).
- Can we relate tactile fixation to exploration patterns?

4.1.3 Motivations

When exploring a raised-line graphic, cognitive exploration strategies may differ across users [15][54][61][133]. The basic purpose of the cognitive exploration strategy is to find out what information is encoded in the graphic and to elaborate a functional mental representation of the graphic [56]. In fact, hand movements can reveal underlying strategies [52][124]. For example, Wijnthes et al. [133] identified three categories of hand movements based on the use of one hand only, both hands alternately or simultaneously. All these studies revealed that the fingers are not always moving and may perform different actions (for instance, it has been observed that the exploring hands stops often) during the tactile exploration. But little is known about how people with VI organize their two hands

when exploring these raised-line graphics, and there are a lack of measures to evaluate this behavior.

4.1.4 Contributions

In summary, our contributions in this chapter are: 1) the definition of the concept of “tactile fixation” which is a behavioral marker on how people with VI explore raised-line graphics; 2) a method (with an algorithm) to identify “tactile fixations”; 3) the analysis of tactile fixations in terms of perception and comprehension of raised-line graphics using a set of hand movement data.

4.1.5 Chapter structure

In this chapter, we focus on the tactile fixations used for evaluating tactile exploration. We present our contributions by proposing the definition, the identification method and the evaluation of tactile fixations. More precisely, in section 2, we present the eye fixations as well as its identification methods to further introduce the concept of tactile fixations. In section 3, we officially give the definition and explication of the tactile fixation. In section 4, we present our principal behavioral experiment to systematically study how to identify a tactile fixation and what evaluations should be conducted to evaluate the identified tactile fixations. In section 5, we answer the research questions that we propose at the beginning of the chapter and discuss the potential implications of tactile fixations to HCI and other domains. Finally, in section 6, we give a conclusion of this chapter.

4.2 From eye fixations to tactile fixations

4.2.1 Eye fixations

Eye fixation is one of the most important types of eye movements and also the most common feature of looking that eye tracking researchers analyze to make inferences about cognitive processes or behavioral states that they are interested in probing [78]. Eye fixations occur when people’s eyes stop scanning about the scene and hold the central foveal vision in place so that the visual system can read detailed information. For example, as shown in Figure 72, two eye fixations (fixation No. 1 and 2) are performed to retrieve

more detailed local visual information. From these two eye fixations, we can easily understand the main focus of the observer, which also reflect their cognitive process to the image.



Figure 72. Two eye fixations correspond to two detailed visual information retrieval processes.

Generally, it is difficult to reveal deeper information from one single eye fixation. However, by studying a series of consecutive eye fixations, we can obtain more understandings about user's eye movements as well as their visual cognitive process. As shown in Figure 73, the eye fixations provide us each focus of the user and by linking all of the eye fixations, we can easily understand how the user read the current webpage. In UX research, the latter information is very important as a mean to evaluate user's experience about the content of the webpage.



Figure 73. A series of consecutive eye fixations reveal the user's eye movements.

To our knowledge, there exist several facts about the eye fixations, for example:

- An eye fixation is composed of slower and minute movements (microsaccades, tremor and drift) that helps the eye align with the target and avoid perceptual fading (fixational eye movements).
- The duration varies generally between 50 – 600 ms (although longer fixations exist).
- The minimum duration required for information intake depends on the task and stimulus.

4.2.2 I-DT for eye fixation identification

To analyze the eye fixations, it is essential to first identify them from the eye movements. As indicated in [110], there exist several different algorithms enabling us to separate and label the eye fixations, for example Velocity-Threshold Identification (I-VT) [114], Hidden Markov Model Fixation Identification (I-HMM) [111], Dispersion-Threshold Identification (I-DT) [132], Minimum Spanning Trees identification (I-MST) [40], etc.

Among these algorithms, the Dispersion-Threshold Identification (I-DT), which identifies fixations as groups of consecutive points within a particular dispersion, or maximum separation, is considered as one of the simplest methods. The I-DT algorithm leverages a moving window that spans consecutive data points checking for potential fixations. More precisely, with a given duration threshold and sampling frequency, we can determine a

moving window which covers each time a number of points. Then the algorithm checks the dispersion of selected points to decide if the window need to move forward (if the dispersion is above the dispersion threshold, the window does not represent a fixation and need to move a point forward. In contrast, the window represents a fixation and we need to expand the moving window until its dispersion is above the threshold). Finally, the eye fixation is defined as the centroid of the window points. The core idea of this algorithm is shown in Figure 74:

```
I-DT (protocol, dispersion threshold,
duration threshold)
While there are still points
  Initialize window over first points to
  cover the duration threshold
  If dispersion of window points <=
  threshold
    Add additional points to the window
    until dispersion > threshold
    Note a fixation at the centroid of the
    window points
    Remove window points from points
  Else
    Remove first point from points
Return fixations
```

Figure 74. Pseudocode for the I-DT algorithm [110].

4.2.3 Towards to tactile fixations

Since eye fixations can be used widely to evaluate people's visual attention, we started to consider the counterpart for people with VI. For people with VI, tactile exploration with hands is one of the most important way to get information, especially the graphical information. However, there is still no appropriate evaluation for tactile exploration. Therefore, inspiring by eye fixations, we proposed the definition of "Tactile Fixation" and as we mentioned before, by investigating these tactile fixations, we may better understand the exploration process of people with VI and then possibly improve the design of raised-line graphics.

Similar to the eye fixations, to conduct further analysis about the hand's tactile fixations, it is essential to first identify them from the hand tactile exploration movements. Since the

simplicity of the I-DT algorithm (requires only two parameters) makes it possible to be more easily extended to other domain, we decided to investigate the potential of this algorithm for tactile exploration. We will precise more details in next sections about how we define and identify tactile fixation inspired by eye fixation and then present a series of evaluation on identified tactile fixations.

4.3 Concept

In this section, we introduce the concept of tactile fixations by drawing a parallel with eye fixations. Comparing with eye fixations, tactile fixations are inherently different. When searching for a specific visual information, human eyes are either in movement (saccades) or still (fixations). The human eye can perceive information during the fixations, which are usually very short, between 200-300 ms [17][19][22][110]. Researchers often analyze eye movements to assess the user's attention and better understand how images, texts or web pages are perceived [22]. Thus, the study of eye fixations informs on the attention devoted to the different regions of the image and the saliency of the visual content [19].

Previous research on tactile exploration (see related work) has already identified behaviors where the exploring hand stays still for a certain time during the exploration. We made the hypothesis that the eye fixation paradigm can apply to the tactile exploration of raised-line graphics. More precisely, we suggest that tactile fixations are single behaviors that are associated and organized to set up different cognitive strategies. During fixations, fingers can detect salient elements of the graphic, but they can also be anchor points used to better understand the relationships between graphical elements, and hence the signification of the whole graphic. The main differences between eye and tactile fixations are related to the fact that: i) the hands can move along an outline and hence do not always jump from one element to the other; ii) the two hands are more independent than the two eyes, allowing complex two-handed strategies.

4.4 Behavioral study

4.4.1 Participants

We recruited 10 participants with VI (4 females, 6 males) with an average age of 52.3 (SD = 13) from a local special education institution. Among them, eight were legally blind and two had limited residual vision. Here, we define the definition – legally blind according to the U.S. Social Security Administration (SSA). Generally, people are considered as legally blind if their better eye – when using a corrective lens – has a central vision acuity of 20/200 or lower, or if the field of vision is smaller than 20 degrees. In addition, among the two participants with residual vision, one can only perceive light and shadows and the other can only perceive light and contrast. None of them can use their residual vision to understand drawings, and both were taught to explore tactile graphics. Although not mandatory, we blindfolded them to make sure they did not use any visual cues to identify the graphics without exploring it. On average, blind participants lost sight at 10 years old (SD = 17). All the participants are right-handed and all of them read Braille with their left hand. The details of the participants are presented in the Table 3.

We conducted an interview to assess their level of expertise on raised-line graphics before starting data collection. Five participants reported that they had never received any training on raised-line graphic exploration. Five of them received lessons on tactile exploration. Only one person reported using raised-line graphics daily. The other participants mentioned that they do not use them regularly: five participants do not have any raised-line graphics at home but can occasionally use them, and four participants do not have the need nor the opportunity to use raised-line graphics.

Table 3. Details of the participants.

ID	Gender	Age	Degree VI	Residual	Onset age of VI	Age learning Braille	Braille expertise (1-7)	Dominant hand
P1	M	45	Blind	No	0	5	4	Right
P2	F	61	VI	Light & Contrast	15	18	3	Right
P3	M	62	Blind	No	3	5	6	Right
P4	M	68	Blind	No	2	5	5	Right

P5	F	37	Blind	No	2	5	6	Right
P6	M	46	VI	Light & Shadow	18	18	1	Right
P7	M	45	Blind	No	0	6	7	Right
P8	F	63	Blind	No	57	61	1	Right
P9	F	48	Blind	No	5	9	6	Right
P10	M	48	Bind	No	5	12	4	Right

4.4.2 Raised-line graphics

In our study, we introduced five different types of raised-line graphics including 2D Drawings, Drawings with Perspective, Mathematical Graphs, Geographic Maps, and Neighborhood-Building Maps. All the graphics were made with the assistance of a tactile document maker (with 15 years of expertise and working in a special education center for people with VI) as well as a blind people frequently using tactile documents. The graphics were printed on A3 sheets of Swell Touch Paper. The detailed information of these graphics are as follows:

- **2D Drawings.** We selected 2D drawings from a set of 260 images designed in [117], which was created for being used in psychology experiments. We have selected graphics representing common animals only (Figure 75 A) in order to have graphics from a single family that users know.
- **Drawings with Perspective.** The drawings with perspectives were chosen from the same image set [117]. We separated 2D drawings from drawings that include perspectives because the perspective is a visual convention used to give solid objects drawn on a flat surface the appearance of depth and distance. Perspective does not correspond to any tactile experience but introduces additional difficulties during tactile exploration [32][35]. In this category, we have selected tools of transportation (Figure 75 B) in order to get graphics from a single family that users know (similar to 2D drawings). It must be noted that, according to the tactile document maker, the details represented in our 2D drawings and drawings with perspectives are not adapted for tactile exploration by people with VI due to the occlusions and perspectives represented in the graphics. However, we included them because similar ones have been used in different studies on tactile exploration

in psychology [67][76], especially in [71] which compared the accuracy and response time in identifying raised-line graphics.

- **Mathematical Graphs.** We have designed this set in accordance with [87]. Here, two types of mathematical graphs were included: line graphs that display information as a series of points linked by segments, and histograms with vertical or horizontal bars (Figure 75 C). For both types of graphs, the x- and y- axis were drawn with thick lines. We also added dashed lines to represent the main graduations on each axis. For line graphs, we used two different line styles (solid line and tight dotted line) to represent the series of data. For the histograms, we used different textures for different series of bars. The legend was added at the bottom right of the graphic.
- **Geographic Maps.** We have designed two types of geographic maps showing either the different regions of a country or the different cities of a country (Figure 75 D) [34]. The borders between neighboring countries were drawn with solid lines and the borders between regions were drawn with dotted lines. All the cities were represented by solid circles [32] and each city or region was associated with Braille number for simplicity. The sea was represented by a specific texture and the caption was added at the bottom right of the graphic which included two columns: the symbols on the left column and the Braille legend on the right column.
- **Neighborhood-Building Maps** (Figure 75 E). In the neighborhood maps, the streets were represented by solid lines (sidewalks and street width did not appear), as proposed in [18]. For additional elements on the map, we have used both solid dots or solid/empty triangles which are both symbols recommended in [94]. The caption was added at the bottom right of the graphic. In the building maps, the walls were represented by solid lines and the gaps corresponded to the doors. Each room was identified by a Braille number.

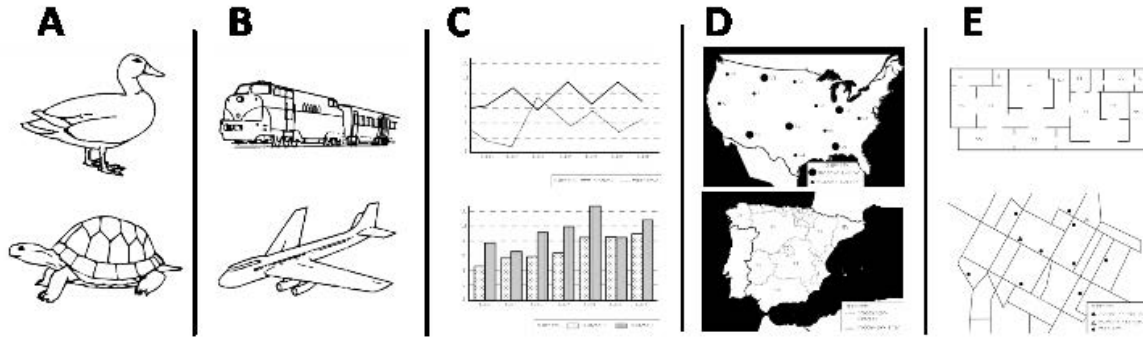

Figure 75. Example of raised-line graphics used for behavioral study. A: 2D Drawings; B: Drawings with Perspective; C: Mathematical Graphs; D: Geographic Maps; and E: Neighborhood-Building Maps.

4.4.3 Experimental setup

During the experiment, participants were comfortably sitting in front of the raised-line graphic placed on a table. A GoPro Hero4 camera (60 Hz) was attached above the graphics (as shown in Figure 76 left). We painted the left and right index fingernails of the participants with red and yellow nail varnish respectively (as shown in Figure 76 right) to track them using computer vision algorithms (see section 4.5). The explanations about the experiment and instructions were read verbally to get participants' consent.

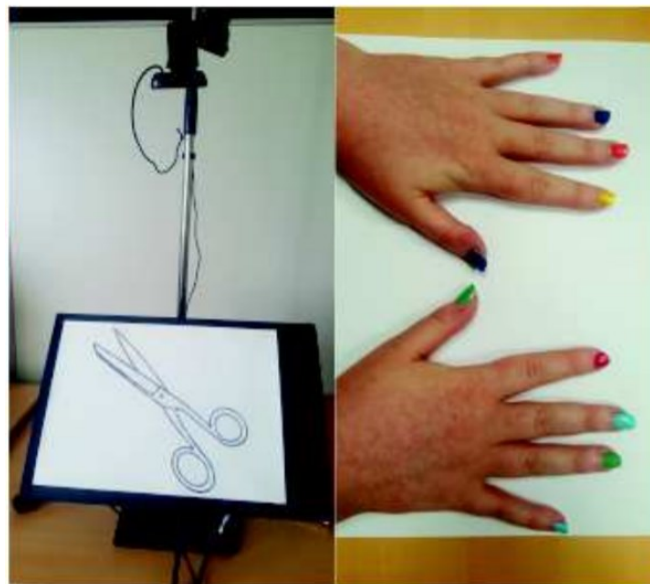

Figure 76. The experimental setup used in this study.

4.4.4 Task and Procedure

The instruction can strongly influence how people explore tactile graphics [15]. Hence, we designed three types of tasks based on different instructions. Among the three tasks, the first two tasks focus on image identification while the third one focuses on image comprehension.

- 1) **Free exploration (Free):** the participant freely explores the graphic for up to 60 seconds until eventual identification.
- 2) **Exploration with context (Context):** before the exploration, the experimenter mentions the graphic type. The participant then freely explores the graphic for up to 60 seconds until eventual identification.
- 3) **Purposeful exploration (Purpose):** before the exploration, the experimenter mentions the graphic type and provides an instruction related to the graphic elements. The participant then explores the graphic for up to 90 seconds to answer the question.

The questions differed according to the type of graphic. For 2D drawings or drawings with perspectives, they were forced choice questions with two levels (e.g. “is it a <animal 1> or a <animal 2>?”). We chose two similar animals not to make the task too easy. For the mathematical graphs, the questions were about comparing data (e.g. “Are purchases more important than sales in <year 1> or <year 2>?”). For geographic maps, questions were about distance or size (e.g. “Is <city 1> closer to <city 2> or <city 3>?” or “Is <region 1> larger than <region 2>?”). For neighborhood maps, the questions focused on path departure and arrival (“Between departure and arrival points on that path, which one is the closest to a grocery?”). Finally, for building maps, the questions were about comparing different rooms (e.g. “Is <room 1> closer to <room 2> or <room 3>?”).

The experiment followed a within-subject design with two factors: the type of graphics (2D Drawings, Drawings with Perspective, Mathematical Graphs, Geographic Maps and Neighborhood-Building Maps) and the task (Free, Context, and Purpose). The study was divided into three blocks corresponding to each of the three tasks. Each block was composed of 10 trials with two raised-line graphics of each type. Within each block, the order of the trials (graphics) was randomized. The order of the blocks was always the same

for all the participants: 1) Free, 2) Context, and 3) Purpose. The maximum duration for each trial was 60 seconds (Free and Context tasks) or 90 seconds (Purpose task). During the experiment, users were free to take a break between blocks.

4.4.5 Methods

In total, each participant explored 30 raised-line graphics. We collected data from: 3 (Tasks) * 5 (Types of graphics) * 2 (Repetitions) * 10 (Participants) = 300 trials.

4.4.5.1 Finger Tracking Algorithm

In order to identify tactile fixations, we tracked the participants' finger movements by leveraging color tracking algorithms. Our tracking algorithm is based on a series of image processing techniques that enable us to detect predefined color blocks (red and yellow color on nails) in each video frame. More precisely, the main steps of our method are as follows and an example of tactile fixation identification result (one image represents one frame) is shown in Figure 77:

- 1) Gaussian Blurring with the aim of reducing image noise and enhancing image structures;
- 2) HSV color space transformation. HSV (Hue, Saturation, Value) color space is an alternative representation of the RGB color model. It is often used for object detection and tracking in Computer Vision;
- 3) Color block tracking in each video frame;
- 4) Corrosion operation to decrease the size of the detected color blocks, which can be used to discard small and meaningless targets;
- 5) Region expansion aiming at increasing the size of meaningful color blocks. The operation leads to the merge of neighboring color points.

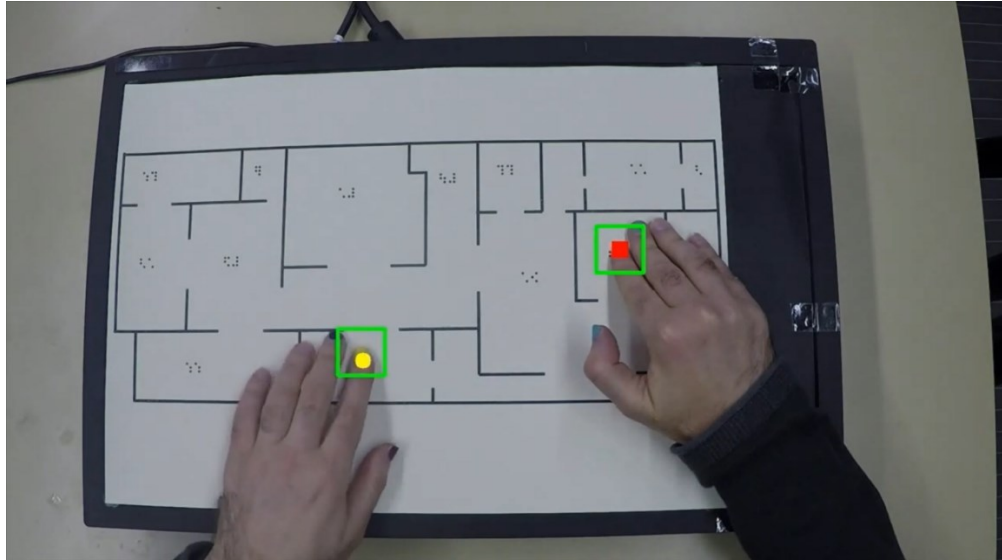

Figure 77. An example of real-time finger tracking and tactile fixations identification. Yellow point represents a short tactile fixation on the left hand and the red square represents a long tactile fixation on the right hand.

We applied our finger tracking algorithm on 296 videos (4 videos were discarded because the participants' head was accidentally recorded). Duration of the videos differs according to the participants and tasks. More precisely, the videos are between 12 and 90 seconds long, and the average duration is 54.8 seconds. We calculated the hit rate of our finger tracking algorithm which is the ratio between the number of frames with finger detection and the total number of frames in all the trials.

Here, it should be noted that to make sure we can obtain a high hit rate, we conducted a data cleaning process: we developed a Python program to automatically play each video frame by frame. For each frame without finger tracking, we manually verified the reason. If the missing tracking occurred when the finger was out of the image or when another finger was masking the color block of current finger (as shown in Figure 78), we moved to the next frame. If the absence of tracking was due to the performance of the finger tracking algorithm, we manually added a tag in the video. Finally, the hit rates for the left and right index fingers were 98.0% and 97.3% respectively. The missing detections were due to the reasons presented earlier.

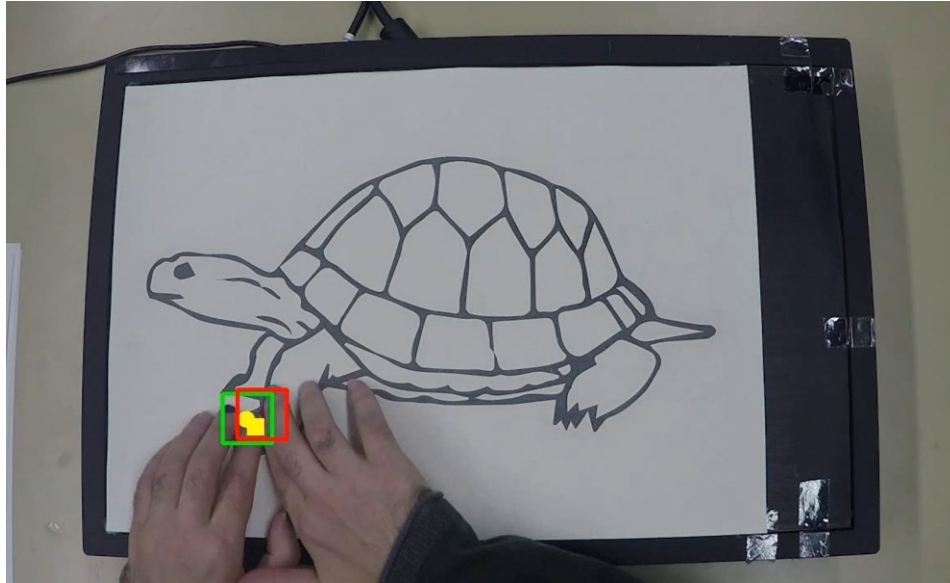

Figure 78. An example of tracking lost: red square represents the missed tracking (due to overlapping fingers).

4.4.5.2 Identification of tactile fixations

As said earlier, we define a tactile fixation as the exploring finger being stationary within a given spatial and temporal window. Due to the technical similarity between eye fixations and tactile fixations, we applied the Dispersion-Threshold Identification (I-DT) algorithm that was initially used for detecting ocular/eye fixations [110]. The I-DT algorithm is relatively simple to use compared to other algorithms that generally require specific data. For I-DT, only two parameters are needed: maximal spatial dispersion and minimal fixation duration. Both parameters are important since they define the tolerance of the detection algorithm. Increasing dispersion or decreasing duration leads to detecting more fixations. It is important to note two observations: i) hand movements are more continuous than eye movements and sometimes jump from one element to the other (saccade-like movements). Hence, it is possible to detect very short tactile fixations if the fixation duration threshold is too low; ii) a finger is not rigorously static during a tactile fixation. In fact, it is slightly moving to retrieve information about the underlying element. Hence, the spatial dispersion threshold must tolerate these small movements.

Therefore, an important question concerning the use of I-DT algorithm is the value of the two parameters. The threshold values of the eye fixations (usually between 20-50 pixels for the dispersion and 200-300 ms for the duration) are not applicable for tactile fixations

because the hand movements are less accurate and slower than eye movements. The minimum fixation duration and the maximum spatial dispersion should be greater than for eye fixations. Considering our setting, we used 50 pixels for dispersion, which corresponds to 14 mm (the correspondence between 50 pixels and 14 mm is specific to the conditions of our study. It depends on the distance between the camera and the surface and on the camera lens being used too). The value of 50 pixels (e.g. 14 mm) is large enough for identifying a tactile fixation since the average dimension of an index finger is 9 mm width and 16 mm length [76]. We used 500 ms as the minimum fixation duration because it discards very brief fixations during exploration. Using a shorter duration threshold would result in detecting a very large number of events that are not relevant.

4.4.5.3 Statistical tests

For all the measured variables, we first used a Shapiro-Wilk or Anderson-Darling (if the number of data is more than 5000) test to determine if their distribution was normal. If not, we tried to transform the data to get a normal distribution with a Box-Cox transformation [108] and then conducted an ANOVA test. For the data that could not be transformed, since our study followed a within-subject design, we conducted a Friedman test which is specifically intended for non-parametric data.

4.4.6 Results

In this section, we first report the identification rates (i.e. how well participants completed each task). Then we detail our findings on the temporal distribution of tactile fixation. We then present our systematic analysis of tactile fixations inspired by different methods indicated in [21] and describe three recurrent movement patterns involving one or two hands during the tactile exploration.

4.4.6.1 Identification rate and correct answer rate

We calculated the graphic identification rate for the Free and Context tasks, as well as the percentage of correct answers for the Purpose task. Participants had an identification rate of 32.9% (CI [22.1%, 43.7%]) in the Free task and 60% (CI [49.0%, 70.9%]) in the Context task. The percentage of correct answers in the Purpose task was 80% (CI [67.7%, 92.3%]).

4.4.6.2 Tactile fixations

To get comparable results for the two hands, we conducted a preprocessing step to discard fixations detected on legends of each raised-line graphic. The rationale for excluding these tactile fixations comes from [15], which indicated that people with VI more often use their left hand (rather than the right hand) to read Braille (especially legends). Therefore, we ignored these fixations to remove the effect of legends when comparing the two hands. In total, we detected 13209 tactile fixations for all users (instead of 14975 fixations before the preprocessing phase).

We generated a temporal distribution of the tactile fixations (see Figure 79). From this figure and the original data, we can make four observations: 1) The durations of tactile fixations vary from 500 ms to 48 s (very long fixations sometimes correspond to “forgotten hands”, see discussion); 2) The number of tactile fixations decreases when the fixation duration increases with a lognormal distribution; 3) 84.3% of the tactile fixations are less than 1-second-long; 4) There is a peak of the durations between 550 and 600 ms.

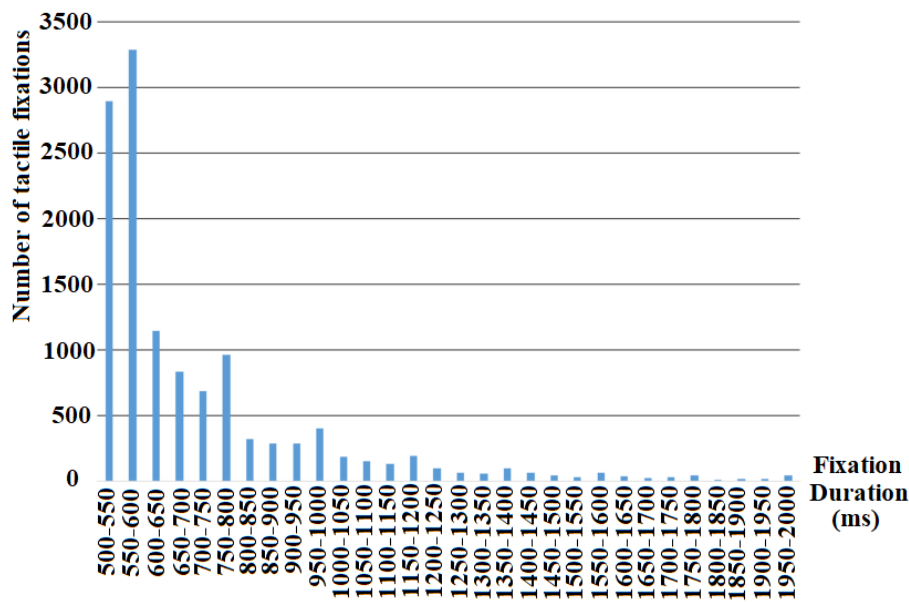

Figure 79. Distribution of tactile fixations according to the fixation duration.

4.4.6.3 Number of tactile fixations

We analyzed the number of fixations according to three variables: Hand, Graphic Type and Task. The Shapiro-Wilk test showed that the number of tactile fixations did not follow a normal distribution ($w = .98$, $p < .001$). We transformed the distribution to normal using

Box-Cox (after the transformation, the distribution was normal with $p = .189$). The ANOVA on the transformed data showed a significant difference between the numbers of tactile fixations according to both Hand ($F = 11.94, p < .001$) and Graphic Type ($F = 7.89, p < .001$), but not to the Task ($F = .13, p = .878$). There was also an interaction between Task and Graphic Type ($F = 3.33, p < .001$).

The average number of tactile fixations was 24.2 on the left finger and 20.4 on the right finger (see Figure 80-a). Although the tactile fixations on the legend areas have been discarded, we still observed more fixations with the left finger than the right finger.

The Tukey post-hoc test showed a significant difference between 2D Drawings and the four other types of graphic (Drawing with Perspective: $p < .01$, Geographic Map: $p < .05$, Mathematical Graph: $p < .001$, Neighborhood-Building Map: $p < .01$). The average number of fixations was smaller for 2D Drawings (17.8) than for Drawings with Perspective (22.9), Geographic Maps (22.4), Mathematical Graphs (25.2) and Neighborhood-Building Maps (23.3), as illustrated in Figure 80-b.

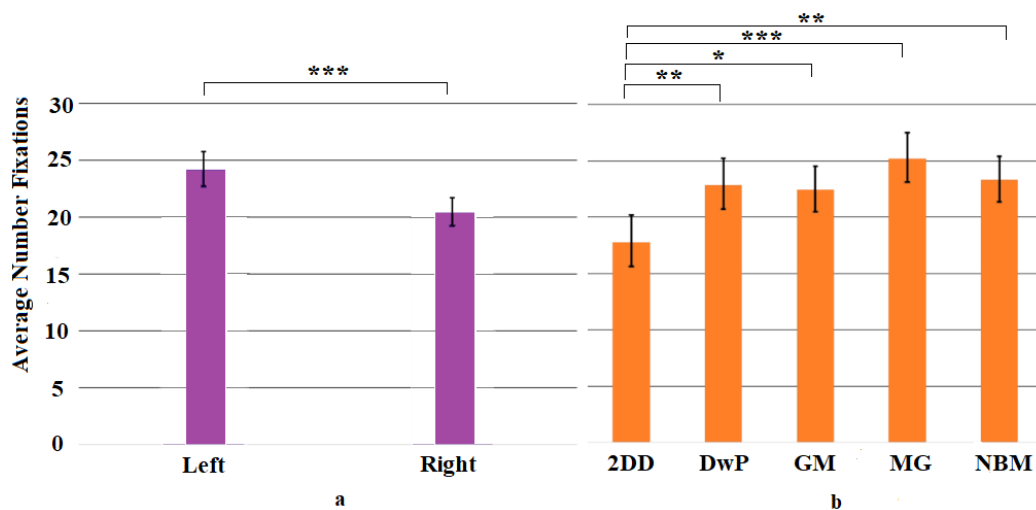

Figure 80. a. Average number of left and right tactile fixations, b. Average number of tactile fixations according to the type of graphic. (95% CI). 2DD: 2D Drawings; DwP: Drawings with Perspectives; GM: Geographic Maps; MG: Mathematical Graphs; NBM: Neighborhood-Building Maps.

Concerning the interaction between Task and Graphic Type ($p = 0.012$, see Figure 81), the Tukey post-hoc test showed that there was a significant difference between the number of fixations on 2D Drawings and the number of fixations on Drawings with Perspective ($p < .05$), Mathematical Graphs ($p < .001$) and Neighborhood-Building Maps ($p < .001$) for

the Purpose task. We did not find such difference between 2D Drawings and the other graphics for the Free and Context tasks (see Figure 81).

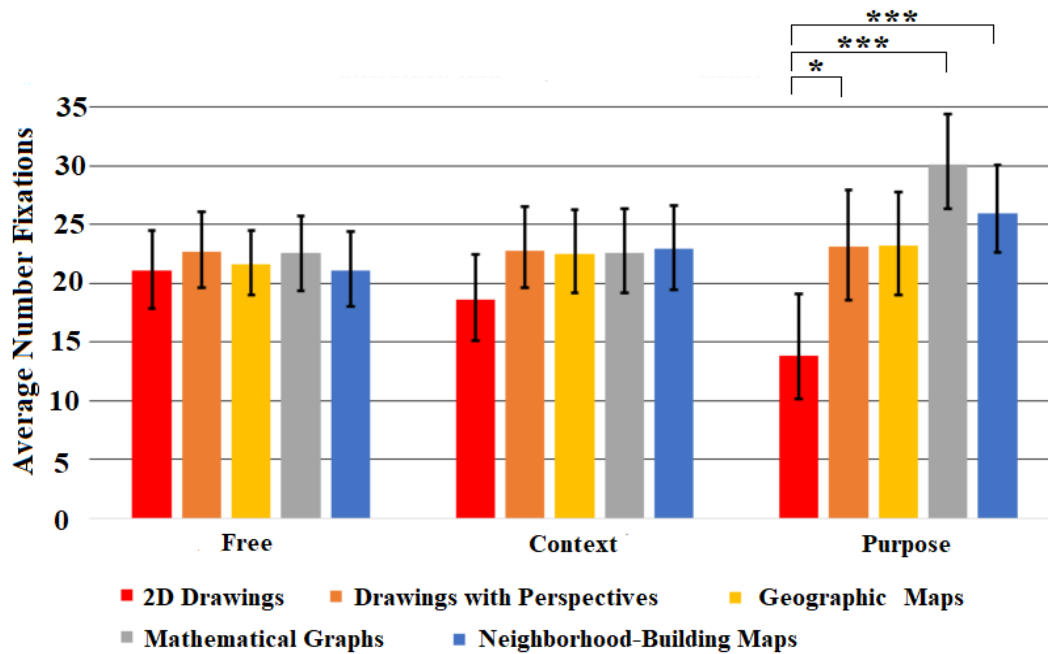

Figure 81. Number of fixations according to the Task and Graphic Type (95% CI).

4.4.6.4 Duration of tactile fixations

The Anderson-Darling test (instead of Shapiro Wilk test because we had more than 5000 samples) showed that the fixation durations did not follow a normal distribution ($A = 2890.2$, $p < .001$). Since the distribution cannot be transformed to normal, we used a Friedman test which showed that there was a significant difference of fixation durations according to Hand ($p < .01$), Graphic Type ($p < .001$) and Task ($p < .001$). There was also an interaction between Task and Graphic Type ($p < .001$).

The overall average fixation duration was 897 ms. As shown by the Friedman, it was significantly shorter with the left hand (835 ms) than with the right hand (970 ms; see Figure 82-a).

Regarding the Type of Graphic, a Pairwise Wilcoxon test with Bonferroni adjustment showed that there were significant differences between 2D Drawings and three other types of graphics (Geographic Maps: $p < .05$, Mathematical Graphs: $p < .001$ and Neighborhood-Building Maps: $p < .01$), as well as between Drawings with Perspective and three other

types of graphics (Geographic Maps: $p < .01$, Mathematical Graphs: $p < .001$ and Neighborhood-Building Maps: $p < .001$). Overall, fixations were shorter on 2D Drawings (813 ms) and Drawings with Perspective (810 ms) than on Geographic Maps (917 ms), Mathematical Graphs (973 ms), and Neighborhood-Building Maps (948 ms; see Figure 82-b).

Regarding the Task, a Pairwise Wilcoxon test with Bonferroni adjustment showed that there was a significant difference between the Free and Purpose task ($p < .001$) and the Context and Purpose task ($p < .001$). The average fixation duration was larger for Purpose (1019 ms) than Context (829 ms) and Free (834 ms), as illustrated in Figure 82-c.

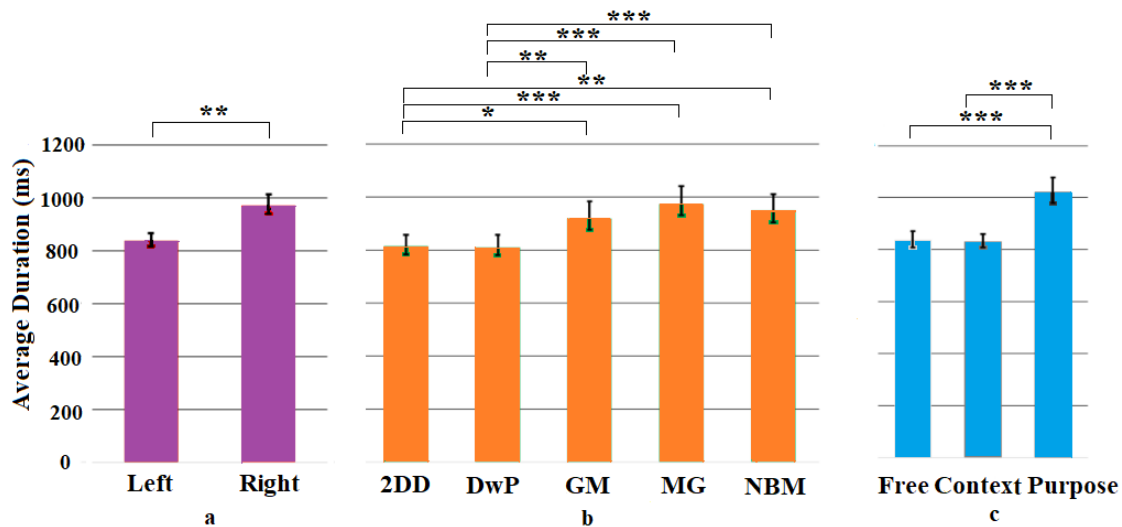

Figure 82. Fixation duration according to: a: the hand; b: the type of graphic; and c: the task. (95% CI). 2DD: 2D Drawings; DwP: Drawings with Perspectives; GM: Geographic Maps; MG: Mathematical Graphs; NBM: Neighborhood Building Maps.

Concerning the interaction between Task and Graphic Type ($p < .001$), we found that: 1) the aforementioned difference between 2D Drawings, Drawing with Perspective and the other types of graphic, was only true for the Purpose task (both $p < .001$). 2) The fixation durations for Geographic Maps, Mathematical Graphs and Neighborhood-Building Maps, were significantly longer in the Purpose task than in the two other tasks (both $p < .001$; see Figure 83).

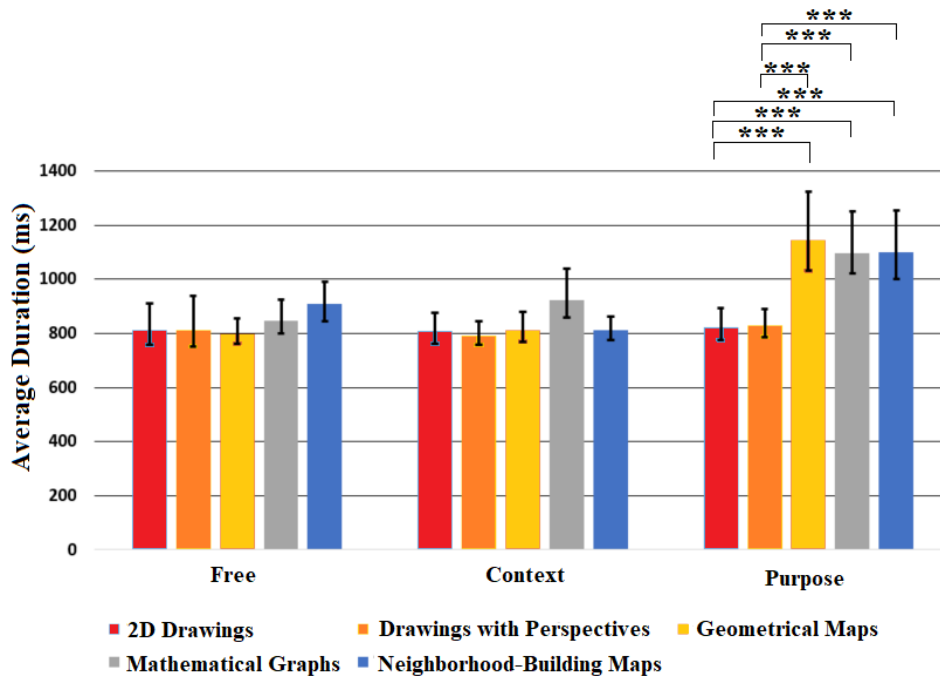

Figure 83. Average duration according to the Task and Graphic Type. (95% CI)

4.4.6.5 Exploration patterns

In our study, we started questioning the role of tactile fixations during the exploration of a whole graphic. More precisely, we looked for patterns that include successive tactile fixations. We first tagged the 296 videos with the occurrences of tactile fixations. Then we watched all the videos to tag exploration patterns relying on tactile fixations. Among the 296 videos, 98% of the videos showed two-handed exploration. This is in line with [133], which suggested that when the workspace is large enough (A3 format in our setting), there are more two-handed movements and the identification of the graphic is improved. We classified two-handed patterns including tactile fixations into the three following categories:

- 1) **Anchor Point.** In this pattern, one finger remains steady (long tactile fixation) on the anchor point while the other hand moves around the graphic (with eventual short tactile fixations) (see Figure 84). In general, the aim of this pattern is to do a comparison between graphical elements according to the anchor point, for example to create orientation and distance relations between graphical elements.

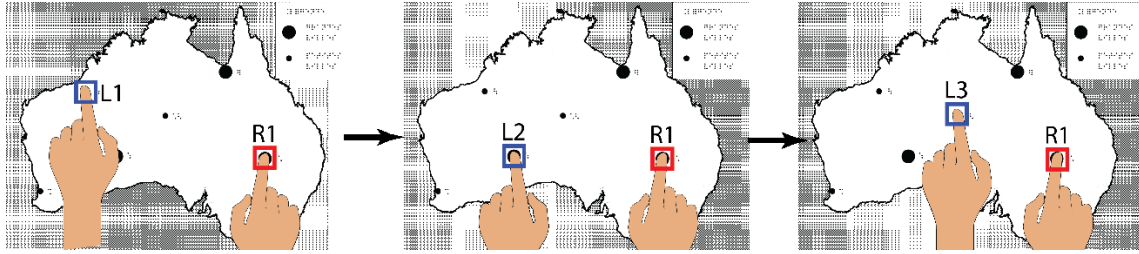

Figure 84. Conceptual illustration of the Anchor Point pattern. The right index is anchored to a point while the left index explores various other elements of the graphic.

In Figure 85 we can identify at least one Anchor Point pattern observed with subject No. 9 while exploring a geographic map in the Purpose task. It starts with a long anchor point of the right finger (red square No. 21), during which the left finger performs many short tactile fixations (blue circles No. 22 to 27) at the top of the graphic.

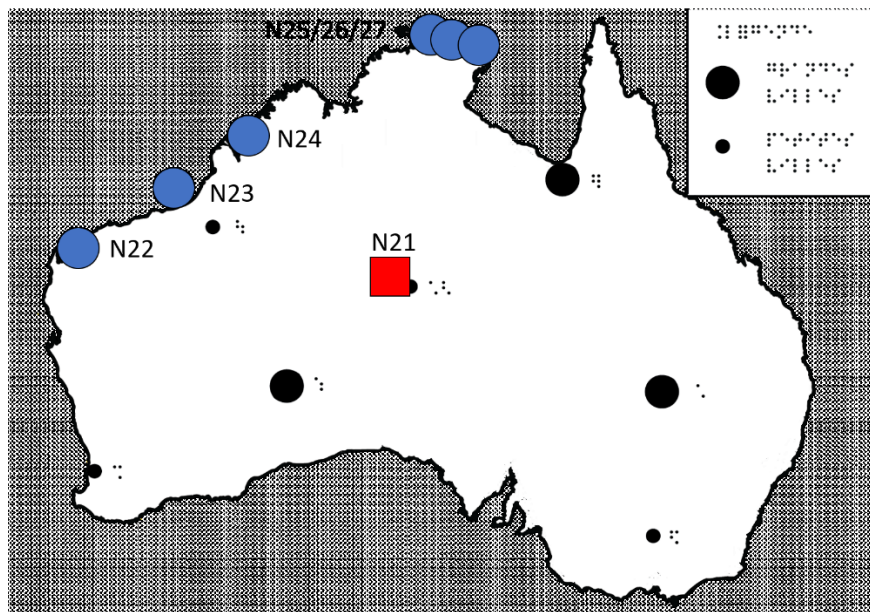

Figure 85. Example of an Anchor Point pattern. Tactile fixations on left and right index fingers are represented by circles and squares respectively. Numbers correspond to the tactile fixation order. Blue color represents "short" fixations (0.5 to 1 s) and red color represents "long" fixations (> 5 s).

- 2) **Switching Fingers.** In this case, the user first selects a specific point as the anchor point with one hand (tactile fixation). Then he changes the finger used for holding the anchor point (Figure 86). Most often the switch occurs between left and right index fingers (or vice versa).

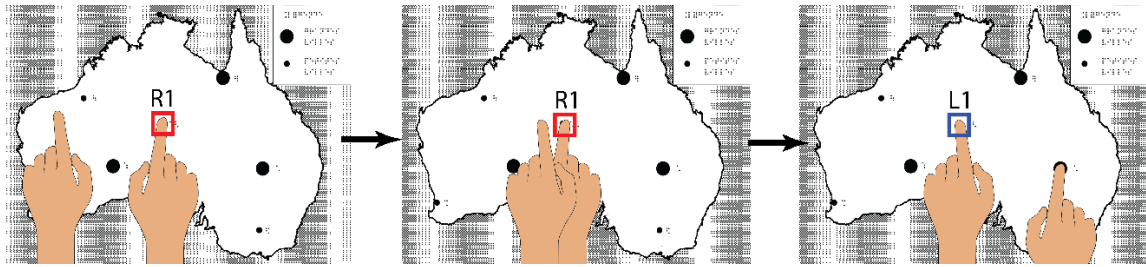

Figure 86. Conceptual illustration of Switching Fingers pattern. The right hand is at the center of the map while the left hand explores the left part of the map. After a while, the left hand replaces the right hand at its anchor point and the right hand begins to explore the right part of the map.

Figure 87 illustrates a Switching Fingers pattern between the right and left fingers with subject No. 8 while exploring a geometric map in the Free task. The right finger is holding an anchor point at the middle of the graphic (orange square No. 2) while the left finger is exploring the left part of the graphic (tactile fixations No. 1, 3 and 4). Then, the left finger replaces the right finger at the fixation No. 5 and the right index finger conducts the exploration of the right side of the graphic (tactile fixations No. 6 and 7).

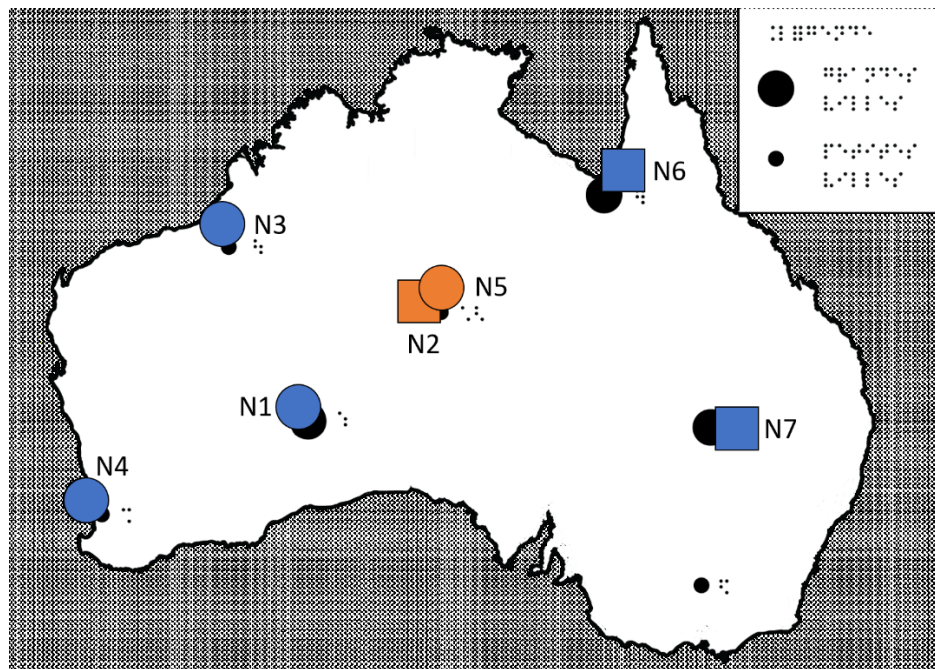

Figure 87. Example of a Switching Fingers pattern. Tactile fixations on left and right index fingers are represented by circles and squares respectively. Numbers correspond to the tactile fixation order. Blue color represents "short" fixations (0.5 to 1 s) and orange color represents "middle" fixations (1 to 5 s).

- 3) **Chaining Hands.** This pattern appears when the right hand follows the left hand (or vice versa) from one point to another one (see Figure 88). In addition, Figure

89 illustrates a Chaining Hands pattern observed with subject No. 3 during the exploration of a geometric map in Free task. In this example, the right hand (squares) follows the left hand (circles). The fixation No. 1 and 2 on the left part of the graphic are the first ones (left and then right hand at the anchor point). Then both fingers go to the middle of the graphic (tactile fixations No. 3 and 4). The same patterns (left and then right hand) appears again with tactile fixations No. 6 - 7, No. 8 - 9 and No. 10 - 11. This pattern was frequently observed at points of interests in the graphics but also during the Braille reading.

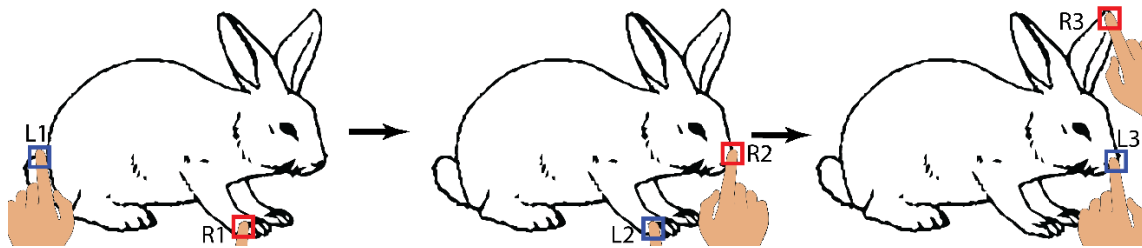

Figure 88. Conceptual illustration of Chaining Hands pattern. The right hand is at the rabbit's foot then it is joined by the left hand. Later, the right hand goes at the mouth of the rabbit and is followed by the left hand. The same movement occurs also at the ear of the rabbit.

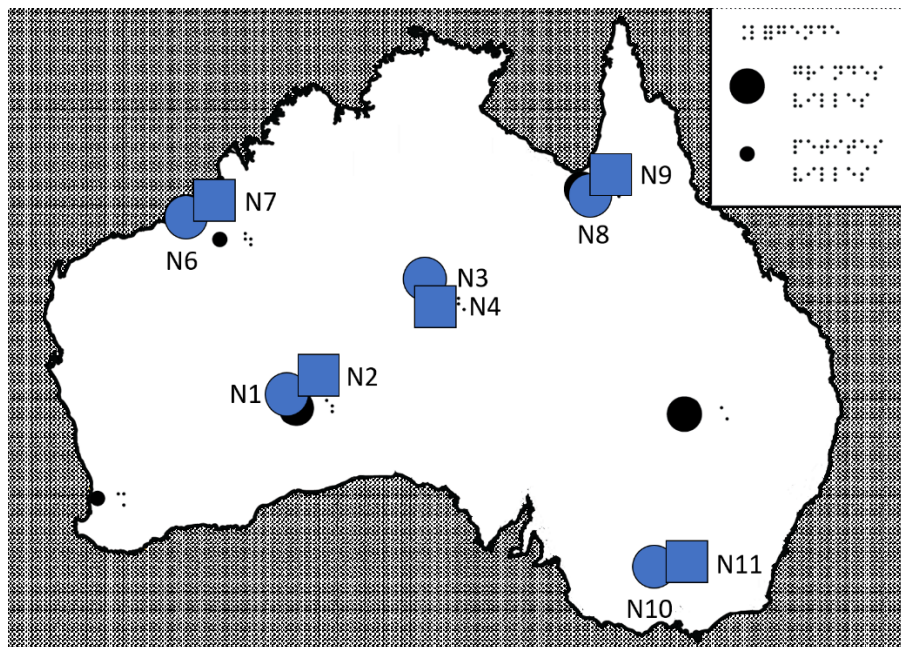

Figure 89. Example of a Chaining Hands pattern. Tactile fixations on left and right index fingers are represented by circles and squares respectively. Numbers correspond to the tactile fixation order. Blue color represents "short" fixations (0.5 to 1 s).

4.5 General discussion and perspectives

In the discussion, we first answer the research questions that were introduced at the beginning of this chapter and then we discuss the main limitations as well as recommendations for future work.

4.5.1 Can we detect tactile fixations?

The results show that it is possible to detect tactile fixations on two-handed movement data related to raised-line graphics exploration. The I-DT algorithm that we chose provides valuable results. They show that the number and duration of fixations vary according to the hand being used, the type of graphic and the task being performed. The values that are chosen for dispersion and duration in this algorithm will modify the number of “very short” fixations. Although we spent a lot of time trying to find a minimum duration threshold in the distribution of tactile fixations, we have not converged towards an indisputable value, and we finally chose a threshold (500 ms) that makes sense according to the tactile exploration behavior (hand movements are not as quick as eye movements). This was not prohibitive in our case because we have carried out a comparative behavioral experiment (number of fixations according to different variables). However, future work will have to ask the question about the separation between slow contour-following movements and tactile fixations on graphical elements. In short, further studies about the duration threshold should be conducted but it should be noted that this value may do not exist, or very difficult to identify.

Our results also show that the duration of tactile fixations varies from short fixations – starting at 500 ms in our case – to very long fixations. The longer one was 48 seconds long, but 80% of the fixations are less than one second long. Looking at the videos, we observed that some very long fixations correspond to a “forgotten hand”, which means that the subject is focusing on the other hand only. It is an open question to assess the role of what we call “forgotten hand”. In the videos, we observed that these tactile fixations are less than 2%. Other long fixations seem that were made on purpose and occurred when participants were required to answer specific questions (i.e. the Purpose task in our study, see section 5.3). This observation suggests that users rely on longer fixations to answer the

question: generally, while performing long fixations with one hand, the other hand is used to explore different graphical elements related to the question. Users rely on the different exploration patterns that we identified to conduct various types of tasks such as the data comparison tasks. Finally, we realized that answering specific questions requires more attention but the question is open to verify whether long fixations systematically correspond to higher cognitive loads.

4.5.2 Do users perform tactile fixations with both hands?

Both hands do tactile fixations during the exploration, but, in line with [15], our results show that there are significantly more fixations with the left hand than with the right hand, independently of the graphic type or ongoing task. On the contrary, the duration of tactile fixations is generally longer on the right hand than on the left hand. Among all the trials, we found 109 fixations longer than 5 seconds with the right hand, against only 46 with the left hand. This tradeoff between the number and the duration of tactile fixations is not easy to interpret but may reflect the fact that the left hand is more often used as a probe to find elements in the graphics whereas the right hand is more often used as an anchor to build topographic relationships between elements included in the graphic.

4.5.3 Do tactile fixations vary according to the type of graphics and the exploration task?

Our results show that there is a significant effect of the graphic type on the number and duration of tactile fixations. As mentioned by the tactile document maker that we consulted, 2D drawings with and without perspective in our study are not suitable for tactile exploration while the other three categories of graphics have been already designed to be interpretable for tactile exploration. One reason that we can imagine about the differences (in the number and duration of tactile fixations) occurred between different types of graphics is that there are more areas of interest in these adapted graphics and that it is easier for users to make sense of them.

Another interesting result concerns the observation of significantly longer fixation durations during the "Purpose" task. This is quite logical considering that in this task the users must relate different elements of the graphic to answer the question. For example, for

mathematical graphs - but this is also true for the other types of graphics - they must compare several points of interest in order to deduce the correct answer to the question. It is therefore not surprising that users make longer tactile fixations on one hand while the other hand explores the points to be compared.

4.5.4 Can we relate tactile fixations to exploration strategies?

Our results are in line with previous observations on exploration strategies showing that both hands are frequently doing stops as well as back and forth movements when exploring a tactile graphic [56][126]. They suggest that tactile fixations are gathered into patterns which themselves can be grouped in time and space to build more elaborate cognitive strategies aiming to interpret the graphic. For example, the “point of reference” strategy mentioned by [126] is an assembly of Anchor Point patterns that allows the user to understand the relationships between an important element of the graphic and several other elements around it. The Switching Fingers pattern seems to be an adaptation of the Anchor Point pattern, which avoids crossing hands when exploring both sides of the graphic. In other words, both patterns would give evidence of the use of the same cognitive strategy but considering the constraint of the spatial layout of the graphic. During the Chaining Hands pattern, participants browse a series of elements of the configuration. This pattern can give rise to the cyclic cognitive strategy observed by [36]. It would reveal the intention to memorize a “route” or a succession of meaningful elements in the graphic. In addition, although the Anchor Point pattern has already been observed by Wijntjes et al. [133], the Switching Fingers and Chaining Hands patterns have never been observed before. We suggest that these two-handed exploration patterns are at an intermediate level and can be put together to give rise to higher level successful strategies that have been previously described (e.g. the reference point and cyclic strategies observed respectively in [133] and [36]).

4.5.5 Lessons learned and implications for HCI and other fields

The main contribution of our study is a method to track fingers movements and then to identify tactile fixations, which can be further used to assess the non-visual graphics exploration strategies involved. This method can have many implications for specialized

teachers, document makers, designers and researchers. We detail different implications below:

- 1) To our knowledge, there are instruction techniques related to how to explore tactile graphics at a higher level in special education for people with VI (start with reading the title, finding and exploring the legend, etc.). However, there is no recognized instruction technique relying directly on tactile fixations or exploration patterns based on tactile fixations. With our method, special education teachers can identify tactile fixations and exploration patterns leading to a better understanding of tactile graphics. They can then propose recommendations on how to better perform two-handed exploration of tactile graphics.
- 2) Tactile document makers can easily observe that some important points of tactile graphics have not been touched or, on the contrary, that irrelevant points of the graphics are touched many times with long tactile fixations, which may reflect user's confusion. They can then propose guidelines to better design tactile graphics.
- 3) Interaction designers can design feedback for audio-tactile graphics (see [10]) that are coherent with the user's behavior. For instance, during the discovery phase of a tactile graphic, there is no need to design feedback for short tactile fixations because they are too frequent, but they can add feedback on long fixations to assist the user's exploration (e.g. naming the point). In addition, the system can inform users that some important points of the graphics have not been touched yet and indicate where they are. During the memorization phase (i.e. after the discovery phase), command menus can be added to relevant points of the graphic (points with long fixations) to better compare or memorize the relative location of points of interest, and hence improve the comprehension of the graphic. Interestingly, these contextual menus will not interrupt the exploration process.
- 4) Finally, researchers in psychology and HCI can use this method to better understand the exploration strategies of tactile graphic. Many questions related to the link between the observed behaviors, the involved cognitive strategies and the participants' performances can be addressed.

4.5.6 Limitations and future work

There are limitations and open questions arising from this initial study on tactile fixations. The first limitation we can mention concerns the technical implementation of the tactile fixation identification algorithm. We opted for a visual tracking based on colors. Although this is easy to implement, illumination conditions and occlusions induce tracking breakdowns that we corrected by visually checking the videos (with our finger tracking algorithm, the average tracking loss rate was less than 5%). This is time consuming and not optimal. It would be interesting to use a more reliable tracking system. An infra-red motion capture system could ease tracking in lab conditions, but only if the sensors placed on the fingers do not hinder exploration. In terms of interpretation, our results need to be complemented by further analysis of the occurrences of exploration patterns and their concatenation to build more elaborate cognitive strategies. Beyond the identification and interpretation of tactile fixations, it would be interesting to implement algorithms to identify exploration patterns in order to finally link them to cognitive strategies. Besides, we did not investigate the potential impact of tactile expertise on the fixations. Finally, thanks to our experimental design including three tasks (free, context, purpose), we have observed the differences in exploration behaviors according to the task being performed. This result confirms the hypothesis that we made by observing people with visual impairments exploring tactile graphics under different uncontrolled conditions. It opens up a set of research questions related to the impact of the task on exploration behaviors.

We also think about interesting future work based on tactile fixations. The concept of tactile fixations comes from research studies on eye fixations. In this domain, fixations can indicate the most salient elements in the visual scene, but they can also indicate the attention paid to certain elements in the scene [57]. Similarly, tactile fixations can be used to identify the salient elements of the tactile graphic, but also the elements - salient or not - on which the user is focusing his/her attention (as shown in Figure 90). As mentioned in the previous section, these analyses can lead to design better tactile graphics, inducing less difficulties during exploration, and they can also inform the design of more usable interaction techniques with hybrid or digital graphics [30]. For example, one can imagine that command menus appear as a function of the time spent exploring certain elements of

the graphic or when certain behavioral patterns - such as the Anchor Point - are detected. Such a system could help young users with visual impairments, who are learning to read tactile graphics, to interpret them more easily.

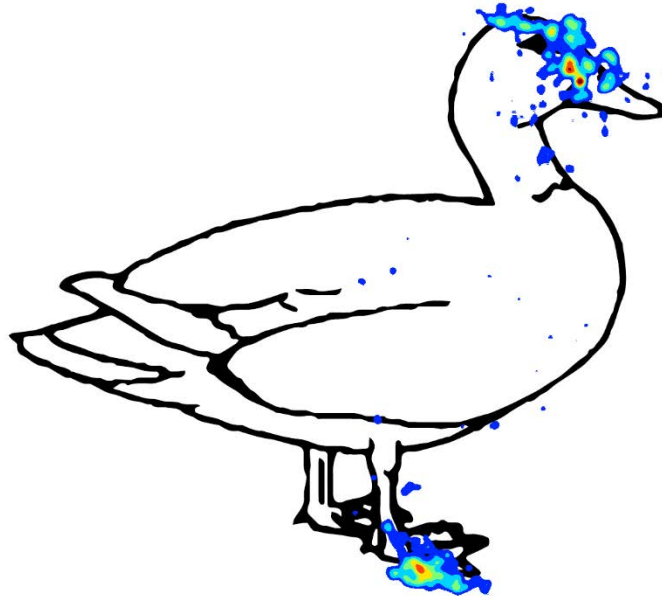

Figure 90. Heat map based on the distribution of tactile fixations.

4.6 Conclusion of Chapter 4

In this chapter, we proposed a behavioral marker that we called “tactile fixation”, which can help to understand how people with VI explore raised-line graphics. The results from analyzing a large data set of finger explorations, collected through a controlled study with participants with VI, demonstrate that such fixations not only exist, but also can help to explain the different behaviors observed during the exploration of tactile graphics. We are convinced that future research on tactile fixations can provide valuable insights on how to design better tactile graphics but also on the difficulties observed during the exploration of tactile documents by people with visual impairments. We also think that it can inform the design of more usable interaction techniques helping to explore and understand non-visual digital graphics. By introducing such a novel observation, we hope that our work will inform future research and open new research questions with the common goal of improving the accessibility of graphics to people with VI.

Chapter 5 TactileLink: a remote collaborative graphics learning tool for pupils with visual impairments

5.1 Introduction

5.1.1 Context and motivations

Collaborative Learning (CL) is an important concept in educational science and has been commonly applied during the teaching process [116]. In special education for pupils with VI, designing collaborative activities to improve the learning and inclusion of pupils with VI has also been investigated in recent years (see chapter Related Work). For example, the collaborative game (see Figure 91) co-designed by Metatla et al. in [83] aimed to tackle the barriers about the social engagement and participation faced by pupils with VI in mainstream schools. By conducting a series of focus group discussions and co-design workshops with both pupils with VI and sighted pupils, [83] proposed guidelines for designing inclusive collaborative games and found that such games could trigger dynamics in group learning and improve CL experiences.



Figure 91. A series of co-design workshops with pupils with VI and sighted pupils to refine the design of collaborative game [83].

However, although there exist various studies investigating CL of pupils with VI, most of them are still limited to face-to-face learning or teaching. This limitation is especially obvious in the field of learning based on graphics for pupils with VI. To our knowledge, in recent years, only [80] proposed a remote collaborative graphics learning system called TIMMs (see Figure 92). Although the design of TIMMs is still interesting and usable today, unfortunately, [80] was still a concept and has never been implemented or evaluated with stakeholders. Therefore, it is difficult to get valuable feedback concerning the difficulties faced by pupils with VI as well as their instructors during remote sessions.

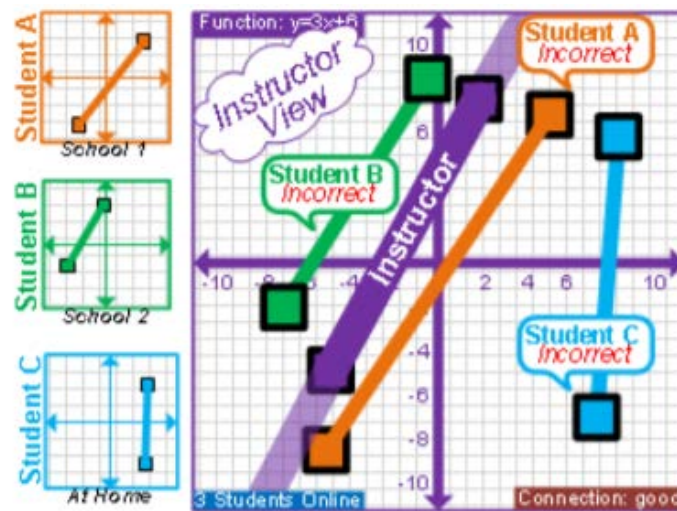

Figure 92. TIMMs remote learning application [80].

Since the end of year 2019, the COVID-19 pandemic greatly changed the way of learning. In France, online remote learning has been widely deployed since March 2020. In special education centers for pupils with VI, the way of learning has also been challenged. According to our discussions with special education teachers, they faced a lot of difficulties for preserving acceptable teaching, especially when the content relies on drawings (e.g. STEM, History, Geography, etc.). This situation has caught our attention and therefore, we started investigating the possibility of proposing a remote collaborative graphics learning tool.

5.1.2 Survey

Due to the COVID-19 pandemic, most of the learning moved online and there was an important need for remote collaborative tools for special education teachers. To better

understand the context and the needs, we launched an online survey during the national confinement in France. The objectives of this survey were to identify the online tools that special education teachers already used, the ones that they developed during the confinement, their unmet needs about remote learning and their teaching experience.

This survey was conducted in April 2020, with the participation of 59 professionals for people with VI. Twenty-five of them (16 special education teachers, 5 educators and 4 O&M instructors) conduct face-to-face teaching in normal situations, and had to adapt during the confinement. Other participants are psychologists, tactile document makers, etc. 51% of the participants have more than 10 years of working experience. Since the main focus of this chapter is about collaborative tools used during remote learning, we only describe findings related to our focus here:

- All professionals use computers daily during their work and this use is often in combination with smartphones. Tablets are also used in combination with smartphones but the use of tablets is less frequent. However, tablets are appropriate for some tasks, especially when a larger screen size is needed.
- During remote learning sessions, digital applications such as Zoom, Text-to-Speech, speech recognition, etc. were more used than specific assistive tools (e.g. Inside One). This is mainly because of two reasons: 1) they are easy to use and relatively accessible; 2) people with VI prefer to use common tools that are less stigmatizing.
- Computers are preferred for educational tasks. But, O&M instructors prefer using smartphones because the features of smartphones (mobile microphone and camera) can better answer their needs.
- Professionals are open to both group and individual remote learning. Although it is good for inclusion to work as groups, it is difficult to maintain teaching quality if there are no additional supports (i.e. teaching materials, tools, etc.).
- There were notable changes in terms of teaching mode during the confinement: teachers sent fewer documents (due to difficulties to maintain the learning quality) but contacted their pupils more often by email and phone.

In summary, the results of this survey show that some digital tools and applications have been used by professionals for people with VI. However, the types and functions of these

tools as well as applications are still limited: they can only provide common and simple functions and are not specifically designed for remote learning (including remote graphics learning) for pupils with VI. In addition, this survey confirms that professionals and pupils with VI have faced challenges and difficulties during the confinement and that there is an urgency to design digital tools supporting remote collaborative learning, especially when based on graphics.

5.1.3 Method and research questions

In this section, we present the research questions that we identified based on the results of the survey and discussions with professionals. As we mentioned before, we aim to tackle the challenges faced during remote collaborative graphics learning. Our aim is to design a tool that is accessible for both pupils with VI and professionals and that supports remote collaboration on graphics. We relied on a co-design method that involves stakeholders from the beginning in order to improve usability and accessibility. We identified the following main research questions to drive the design:

- Is there a need for designing a remote collaborative graphics leaning system?
- What are the main requirements for such a system?
- What are the envisioned difficulties?
- What are the envisioned application scenarios?
- How to implement the system?
- How to evaluate the usability of the system?

5.1.4 Motivations

Remote learning has become common for pupils during the confinement. However, compare with traditional education (with sighted pupils), the special education for pupils with VI obviously faces more difficulties. This is mainly due to the lack of appropriate digital tools supporting different educational tasks. As we know, during the traditional education with sighted pupils, it is easy to keep interactions between pupils and their teachers via video conference tools. Teachers can also follow pupils' learning process by

using either camera, screen sharing or many other online collaborative tools, for example Google Docs, Conceptboard (see Figure 93), etc.

However, with these tools, it is difficult for special education teachers to remotely control the learning content of pupils with VI and follow their learning process in real time. This is even more problematic for remote graphics learning since teachers need often check the finger explorations of pupils with VI to give corresponding advices. Therefore, there is a need to re-consider a remote collaborative graphics learning tool for both pupils with VI and special education teachers. Different from [80], to design a fully usable tool, we decided to leverage the co-design method (as indicated in [83]) and refine the system gradually with stakeholders.

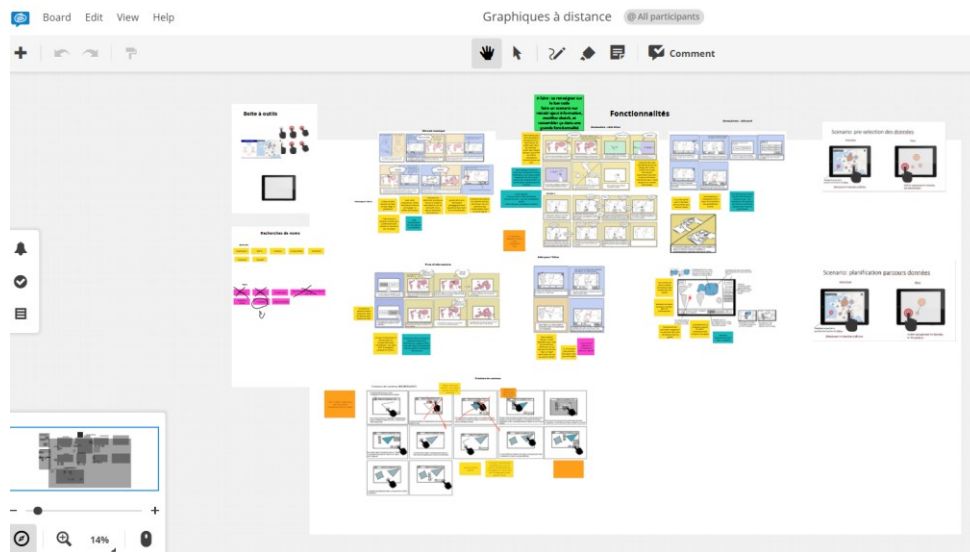

Figure 93. An example of remote collaborative tool – Conceptboard.

5.1.5 Contributions and structure of the chapter

Our main contribution in this study is the design of a remote collaborative graphics learning tool called TactileLink, based on a co-design method. At the time of the writing, we did not yet fully implement the system and conduct user evaluations about the utility and usability of the tool. Here, we report on our findings from a series of co-design focus groups.

In section 2, we present the project called DERi, which is an application developed in our lab for making interactive (audio) raised-line graphics. DERi is the basis of TactileLink. In section 3 and 4, we provide details about the design of TactileLink by presenting the two

focus groups that we organized with the professionals respectively. Then we summarize the results and give a general discussion in section 5. Section 6 is a conclusion of this chapter.

5.2 Project DERi

The « Cherchons pour Voir » lab aims at developing knowledge on visual impairments and assistive technologies to improve the autonomy and quality of life of blind and visually impaired people. The DERi is a CPV project for helping people with VI to explore and understand graphical information more independently.

Before presenting further the DERi, we give two reasons why we aim to merge TactileLink with the existing DERi:

- 1) As an accessible and interactive graphics learning tool, DERi is a relatively mature device. Designing a new tool based on this stable existing platform can greatly accelerate further implementation.
- 2) There are several common functions that are identical and can be reused between these two projects, such as the graphics interactions with audio feedbacks. Compared with DERi, the main new feature of TactileLink is the remote collaboration.

5.2.1 What is DERi?

The project DERi (in French “Dessin En Relief interactif”, which means interactive Raised-Line Drawings) is a device with tactile overlays (e.g. raised-line drawings) placed over a touchscreen (i.e. applicable for touchscreens of any size, see Figure 94). The overlay provides tactile cues for hand/finger exploration, which is very important for people with VI. The touchscreen provides interactivity by adding vocal and sound feedback to any points or areas of interests of the tactile overlay.



Figure 94. DERi device with an interactive raised-line drawing representing a bee.

There are two applications with DERi: The Editor and the Reader. The Editor is used to create the interactions on the raised-line graphics. The Reader is installed on Windows or Android touchscreens and enables users to explore the interactive raised-line graphics of different sizes (tabletop, Figure 95 left; touchscreen PC, Figure 95 middle; and tablet, Figure 95 right).

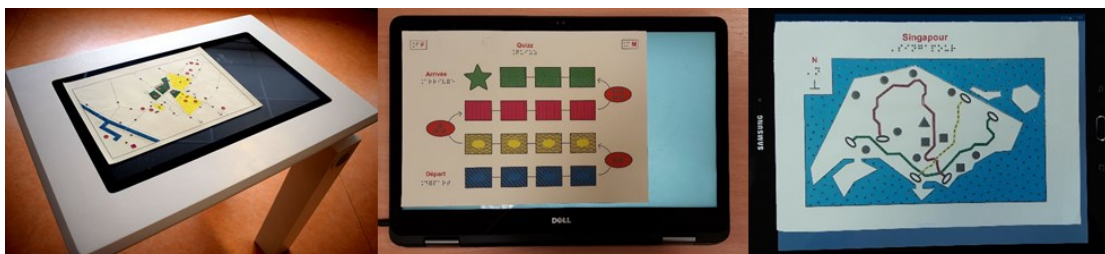

Figure 95. Different sizes of touchscreen devices that are compatible with DERi, from left to right: tabletop, touchscreen PC and tablet.

Finally, Figure 96 gives a simple demo about how DERi can be used. As we can see, the raised-line map represents France and has been added interactions. When people with VI double tap the interactive zones on the map, they receive audio feedbacks.

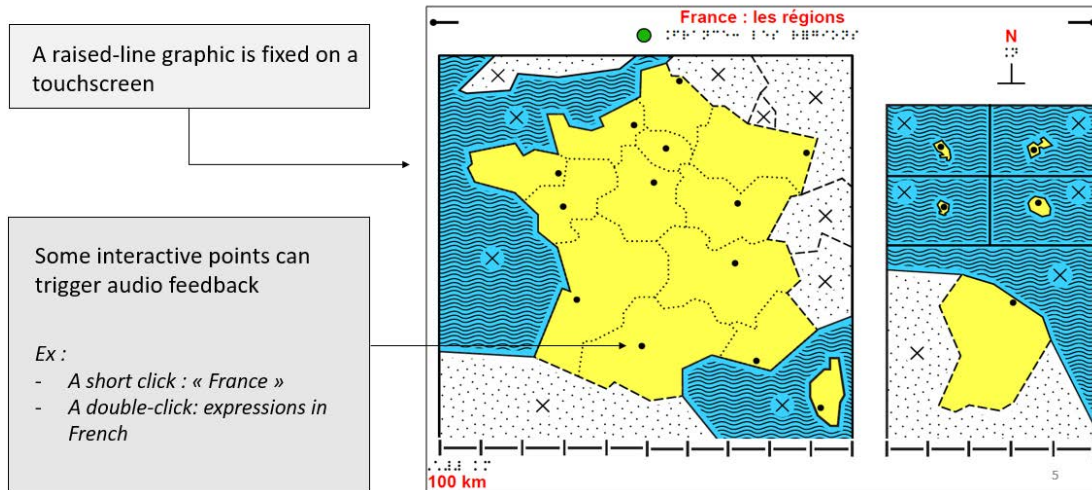

Figure 96. A simple example of a DERi drawing. The raised-line drawing is fixed over a touchscreen. When people with VI double tap interactive zones on the map, they get audio feedbacks.

5.2.2 DERi Editor and Reader

As mentioned in the previous section, the DERi device is usable when both the Editor and the Reader are available. In this section, we give more details about these two main components of DERi.

The Editor is an application that enables professionals of VI to add interactions on digital drawings (which are digital versions of raised-line drawings). There are three main steps when using the Editor:

- Draw the digital drawing. Before adding interactions, it is necessary to get the digital file of the drawing (i.e. SVG or PNG file). Professionals can choose to draw their own digital graphics on any existing software (e.g. Inkscape) or leverage existing graphics (i.e. the Editor can import existing SVG graphics). Figure 97 shows how to design corresponding digital graphics (in SVG format) using Inkscape.

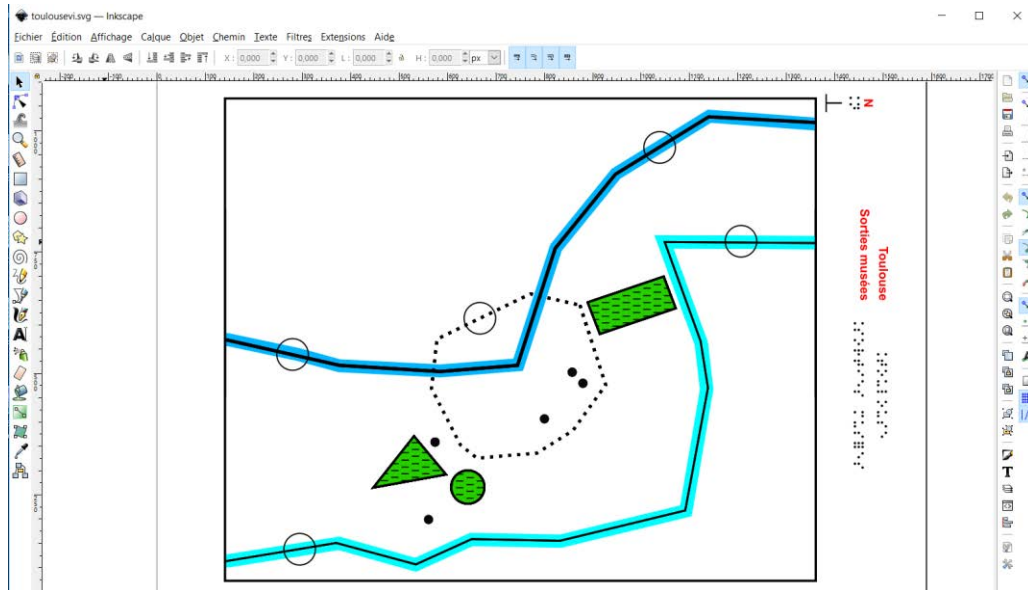

Figure 97. Design the digital graphics using Inkscape.

- Import the digital graphics into the Editor and add the interactions. The main interface of the Editor is shown in Figure 98. As we can see, there are tools for selecting the points of interests or the areas of interests. Once we have selected the points or areas of interests, we can add audio feedback on them. After the design process, all the interactions will be saved in a CSV file and can be read along with the raised-line graphics during the exploration.

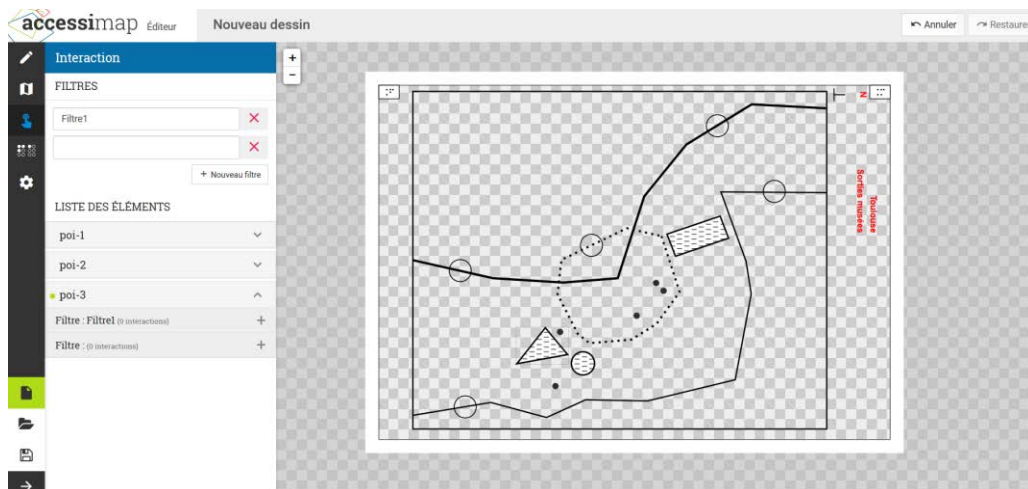

Figure 98. The main interface of the Editor. Users can import SVG digital graphics and then add interactions on points or areas of interests in the graphic.

- Print the raised-line drawing and export the DERi file to the Reader. This is the last step with the Editor. The drawing must be printed as a raised-line drawing and the DERi file including the interactions must be sent to the Reader.

During exploration, the touchscreen displays the same content as the raised-line drawing and tracks the fingers locations to trigger interactions. The designed interactions on points or areas of interests can be triggered by single or double tap or any other pre-defined actions (gesture). The Reader application is accessible and can be used by people with VI.

5.2.3 Challenges of using DERi for remote learning

The COVID-19 pandemic seriously affected the education, especially the special education for people with VI. Although there was a need of interactive tools for supporting remote graphics learning of pupils with VI, we did not find many studies tackling this problem. Therefore, we proposed the idea of TactileLink based on the existing platform DERi. However, the DERi application was designed for face-to-face learning and has never been implemented and evaluated in a remote mode.

According to our preliminary analysis, there are at least the following challenges or needed functions when using DERi for remote teaching:

- In a traditional face-to-face scenario, it is easy for teachers to control the materials (e.g. raised-line graphics to be used in current class) and the behavior of the pupils (what he is touching). In order to use DERi remotely, all the necessary raised-line graphics must be delivered to pupils before the class. In addition, the current DERi application does not allow the teachers to change the DERi files remotely. However, to conduct remote collaborative learning, this function becomes especially important because it ensures remote teacher and pupils with VI can work on the same content (i.e. common grounding in CSCW).
- Different from face-to-face scenario, using DERi remotely needs the DERi application to include many other extra features. For example, the feature ensuring remote tracking of the learning process is very important. Without this feature, the teachers are unable to follow the pupils learning and will greatly impair the teaching and learning quality.

- Although the main difference between TactileLink and DERi is the remote collaboration, to use TactileLink, pupils with VI need stronger personal ability: for example, pupils with VI should be able to change the raised-line graphics as independently as possible. In addition, remote learning may encounter many other problems, such as network problem. This also requires pupils to have the ability to solve problems or to seek help.

These main challenges are the most intuitive ones while considering to use the DERi application remotely. To better understand the needs of the stakeholders, we conducted a series of focus groups with professionals.

5.3 First focus group

In this section, we present a focus group that we conducted with professionals of VI. The main objective of this focus group was to verify the basic idea of the remote collaborative graphics learning tool by discussing directly with them. Due to the national confinement, the focus group discussion was held online. During the two-hour discussion, we first presented our research objectives and then asked several questions concerning the concept of TactileLink. We then let participants drive the discussions and invited them to describe their needs for remote teaching and learning activities. We recorded and transcribed the discussions and then used the thematic analysis [3] method to label the key segments. The data analysis was validated through peer validation (3 people individually checked the results).

5.3.1 Focus group preparation

Since we decided to conduct the focus group online, we made some changes according to the situation. First, we tried several video conference platforms before inviting participants. We finally decided to use Zoom because it's the most accessible one for people with VI. However, the screen sharing feature of Zoom does not allow to interactively co-work with participants. Therefore, we created a workspace on Conceptboard (see Figure 99), which allows all participants to leave notes at the same time. Conceptboard is a collaborative online whiteboard and enables to conduct a virtual brainstorming using sticky-notes,

sketches, shapes, arrows and many other components. In addition, to better present the concept of TactileLink, we made several mockups with Axure. Axure is a software for creating mockups for websites and applications. It offers drag and drop placement, resizing and formatting of widgets. The mockups generated by Axure are interactive and can simulate the real use.

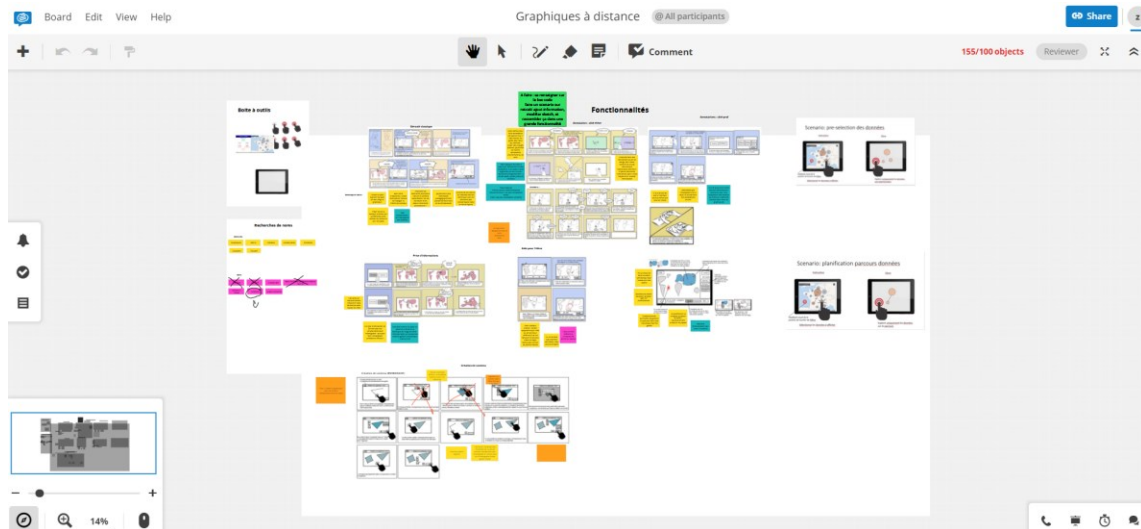

Figure 99. The workspace created on Conceptboard.

5.3.2 Participants

In total, six professionals participated to this focus group. Among the six professionals, five are special education teachers and one is a regular teacher that is involved in helping pupils with VI.

5.3.3 Scenario

We led the focus group by using a real case scenario: the propagation of the coronavirus all over the world (i.e. we collected the daily cases and deaths from the website of John Hopkins University). More precisely, while presenting each envisioned feature of TactileLink, we showed a mockup (e.g. explore the daily COVID-19 cases in a specific region) using Axure.

5.3.4 Mockups for the focus group

Based on preliminary discussions, we designed four different features, which were: 1) **remote tracking**; 2) **remote control**, 3) **annotation** and 4) **navigation**. It should be noted that they were only used to drive the focus group and to inspire more ideas for TactileLink. Participants were free to propose their own ideas during the focus group.

For the remote tracking feature, the left part of Figure 100 represents the screen of the teacher and the right side is the screen of the pupil. The two screens display the same content (i.e. the global coronavirus propagation map in our scenario). When the pupil with VI explores the map with their finger, there is a touch mark displaying on the teacher's screen at the same time. Therefore, the special education teacher can track the finger movements in real-time.

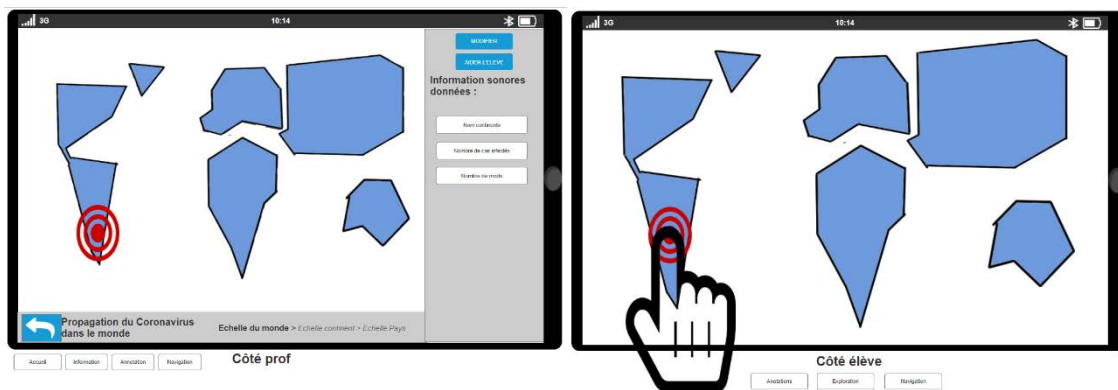

Figure 100. An example of remote tracking. From left to right: the teacher and pupil with VI screens.

Another important feature that we proposed is the remote control of the interactive content. As shown in Figure 101, the special education teacher can (in)activate the interactions and feedback on North America is muted in this example. In addition, the teacher can also conduct data filtering. For example, the teacher can select to provide only the daily COVID cases to pupils (rather than both cases and deaths). To do this, the teacher must (un)select the corresponding data in his/her interface.

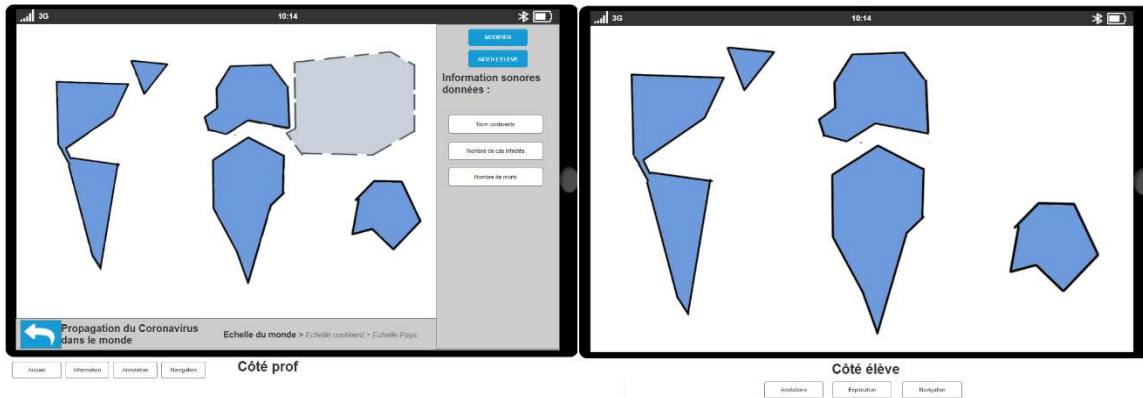

Figure 101. An example of remote content control. The North America is set to be invisible to pupils with VI.

In addition, annotation is also an important feature. Both pupils with VI and teachers can add annotations anywhere they want. There are two types of annotations: audio and vibratory. In the example of Figure 102, the pupil with VI (Figure 102 right) added two annotations (one audio and one vibratory) on the map and the teacher (Figure 102 left) can visualize and interact with these annotations at the same time. We did not limit the methods to add annotations, but we proposed to use some specific interaction actions (gestures), such as two-finger click, long touch, etc. to add and select different types of annotations.

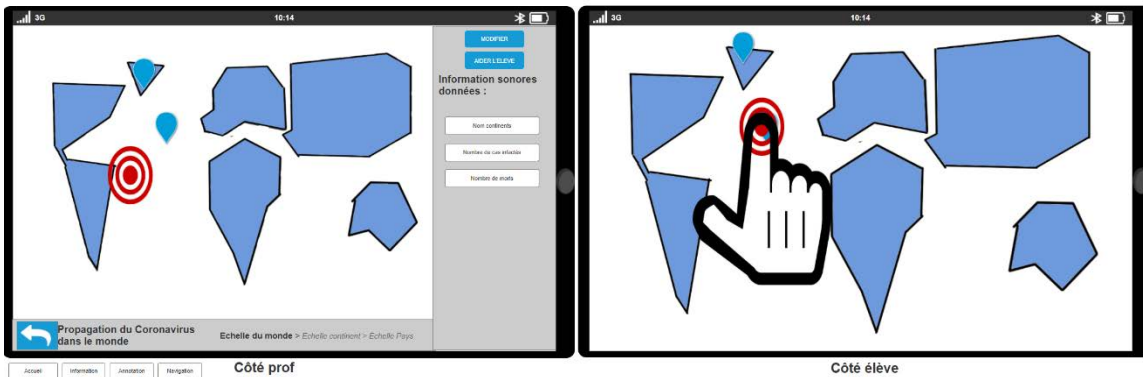

Figure 102. An example of annotations. The pupils with VI added two annotations and the remote teacher can visualize and interact with these annotations at the same time.

The last feature is called navigation. Here, the navigation means to change the graphics level, for example changing from the map of the world to the map of Europe and then to the map of France. This feature can be conducted by both the teacher and pupils with VI. Figure 103 shows an example of navigation conducted by the pupil with VI: when the pupil with VI performs a specific gesture, the level of the graphic is changed (from the world

map to the European map). This feature enables teachers and pupils with VI to navigate between different levels of graphical information.

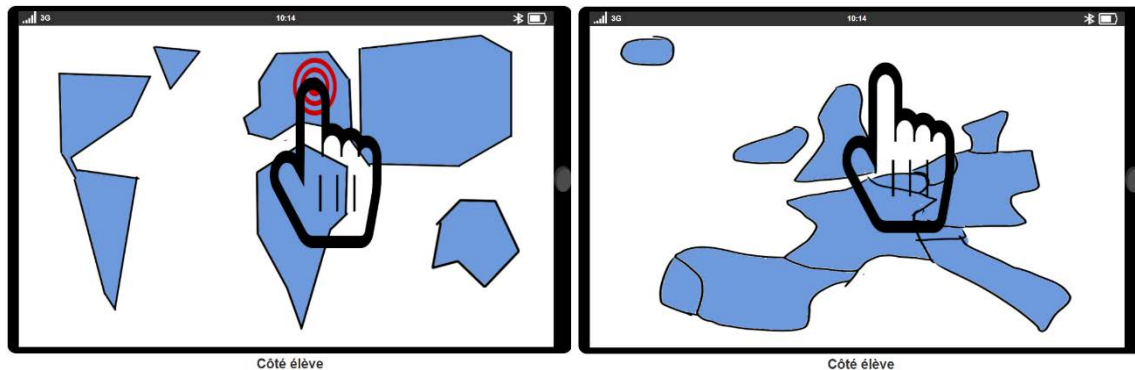

Figure 103. An example of navigation. From left to right: two screens of pupils with VI showing the world map and European map respectively. When the pupils with VI performs a specific gesture, the navigation feature can be triggered and then the level of the map will also be changed.

5.3.5 Procedure of the focus group

The focus group discussion was divided into several parts:

- **Introduction.** Before presenting TactileLink, we gave an introduction about the objectives of the focus group and rules to be followed. We highlighted that the TactileLink concept came from real needs observed during the confinement. We also explained that during the focus group, all points of view are welcome and participants are free to comment.
- **Presentation of TactileLink.** We presented the four different TactileLink features with mockup generated by Axure. Here, it should be noted that during this focus group discussion, we did not present the DERi application and participants were free to propose any types of ideas about remote graphics learning. This was because: 1) we did not want to limit the design of participants during the first co-design session; 2) the use of raised-line graphics is relatively inconvenient and if professionals could propose better solutions that do not need to include raised-line graphics, the remote deployment of TactileLink could be much easier.
- **Questions.** To drive the discussion, we proposed four questions related to the usability and accessibility of TactileLink. They were:

- What do you think about this remote collaborative tool (pros and cons of TactileLinks and its envisioned functions)?
- Do you have comments about the general use of this tool?
- Do you think the proposed tool is easy to use?
- Can you imagine scenarios of interest to you based on this tool?

5.3.6 Outcomes of the focus group

In total, this focus group lasted 1 hour and 50 minutes. After transcribing the discussion and labeling the key segments, we have summarized the following tables (left column: key segments, and right column: number of occurrences).

Table 4. General comments about TactileLink.

Comment	Occurrences
Compatibility with Inside One.	2
Mental representation of the map while exploring the digital map.	6
Get a larger amount of information.	5
Rely on or accompanied with raised-line drawings.	5
No tactile cues.	4
Useful for remote teaching.	5

Table 5. Comments about the annotations.

Comment	Occurrences
Teacher can make and share annotations.	3
Pupils can receive annotations from the teacher.	2
Add notes during the class.	2
Ability to explore annotations.	1
Combine different types of annotations.	2
Save the annotations for later use.	2
Implement on different platforms (Android, iOS, etc.).	2

Table 6. Comments about the navigation between different levels of the graphics.

Comment	Occurrences
For large map.	1
Use common Android or iOS gestures.	1
Audio feedback to indicate change of level.	1
Put several layers of information.	1
Ability to understand	4

From the abovementioned key transcription segments and our direct discussions with participants, we can conclude three important points:

- 1) For most of professionals, the proposed remote collaborative graphics learning tool is interesting. They also agreed that such tool would be especially useful for educational use.
- 2) For all the professionals, they proposed to include raised-line graphic while using TactileLink. They agreed that exploring digital graphics directly could simplify the preparation process. However, they thought for a collaborative activity, the difficulties of exploring digital graphics may cause too much cognitive load and thus impair the collaboration. This would be more obvious for pupils with VI since they do not have enough cognitive abilities and tactile exploration experiences.
- 3) The feature navigation should not be included in TactileLink. Although this feature can support more complex exploration tasks, the change of reference or level of graphical information would cause many problems for people with VI. It is always very difficult for people with VI to understand this change, especially for pupils without enough knowledge.

5.4 Second focus group

Following the results of the first focus group, we further organized the second co-design focus group specifically involving instructors and special education teachers. The principal aim of this focus group was to co-design with target users the potential application scenarios and also to refine the functions of TactileLink.

5.4.1 Focus group preparation

Compared with our first focus group, there were many differences in terms of preparation. For the second focus group, we kept using Zoom as the communication tool. However, we decided not to use Axure to present the different features of TactileLink. This was because we found that for most of the participants, they were not familiar with Axure and they rarely tried to interact with different components of the Axure mockup. In this case, it seemed that there was no difference between the use of Axure and simple PowerPoint slides. We also changed the tool used for remote participation. We used an interactive online brainstorming tool called Padlet (as shown in Figure 104) to collect the comments from participants. We decided to change to Padlet mainly because this tool supports online real-time voting, which means for each comment, we can know how many participants agree or disagree with it.

Par qui ?	Pour qui ?	Pour quoi ?	Avec quoi ?	Comment ?	Quand ?	Où ? (contexte d'utilisation)	Avantages / Plus-value attendue	Limites / difficultés envisagées
Les enseignants spécialisés,	enfants ayant des prérequis au niveau du module de spécialité, et sans besoin de guidage physique	familiarisation à une école avant d'y aller (sécurité, problème des vacances d'été, école fermée, table à la rentrée)	jeu grand format car on n'est pas en situation de déplacement. Pour être plus facile pour jouer à distance (V & A de l'époque)	Instructeurs de locomotion avec parent et son enfant DV	Locomotion	En classe et en cas de la découverte du parent	ça peut faire gagner du temps sur les périodes de rush (dép. rentrée scolaire)	attention à la hauteur du guidage verbal, risque d'abandon par l'instructeur de locomotion
Parents	Seul avec des enfants 7 ans, certains 7 ans (moins simples ?)	Applications ludiques	pourquoi pas tous les supports (ord. tablette téléphone) en fonction de l'équipement de cette découverte tactile	une ou plusieurs séances en face à distance (peut de travailler en réel distance)	Locomotion	Accompagnement lors du regard oral (discours / énoncé)	Non avec la famille sur les traces	Utilisation plutôt en présentiel, parent compliqué en distanciel
Instructeurs laïc	Les élèves	Les adultes en S2S	Les ordinateurs tablettes	en présence ou distanciel avec pap	Confinement		Depuis les locaux	autonomie de l'utilisateur
Enseignants	Il faudrait faire de l'accompagnement avec que S2S	Travail de l'exploration/découverte tactile plus l'usage de jouets	Tablettes	Ordinateur portable	Pédagogie		Autonomie	Nécessite un accompagnement de haut / pas mis en avant lors, notamment sur le tactile
Ergo	On trouve d'abord les parents en soutien	Pour de la locomotion	Tablets tactiles	Instructeur de base et duo enfant/éduc				transmission du plan qui doit être donné en avant
éducateurs	élèves déficients visuels	Exercices	Encre tactiles verticales ?	avec enfant DV et fratrie				Exploration des deux mains visible ?
avistes	Pour des personnes déficientes visuelles à faire avec l'utilisation de la mobilité tactile et l'informatique	Pour les parents						Est-ce que l'utilisation de lectures sur le DER permettrait de voir le trajet ?
Enseignant spécialisé itinérant		préparation triptés pour les élèves (avec le jeune et/ou son parent)						Modèle de fixation, notamment en déplacement
Enseignant avec un élève DV en inclusion	Pour des personnes DV à faire avec la mobilité tactile et l'informatique	Pour anticiper des repérages spatiaux, pour mieux les mémoriser						Ajouter des interactions : la DER rétrocar pas
Enseignant spécialisé dans une classe DV	Visiteurs/employés DV	élèves DV						Prendre en compte le temps de travail au niveau institutionnel
Chargé de pôle accessibilité (Marséennes)		Révisions scolaires à distance avec TACTEL						Exercices à rendre
De parents à enfant à distance								
Personnel culturel et sportif								
Entreprises du privé favorisant le recrutement de personnes en situation de handicap								

Figure 104. Collecting and organizing comments of many participants using Padlet.

5.4.2 Participants

The second focus group was conducted with 4 special education teachers and 2 instructors for pupils with VI (i.e. they have never participated in our previous discussions).

5.4.3 Procedure

Similar to the previous focus group, during the second co-design focus group, the first step was also to introduce the objectives and participants. Since all the participants of this focus group have never participated in a previous discussion, we first gave a brief introduction of the interactive tool DERi. We then gradually presented the three main features fixed by the first focus group: 1) Remote real-time visualization of tactile exploration of pupils with VI; 2) Activation / deactivation of interactions and 3) Real-time manipulation (add, delete and modify) of contents. We also emphasized that the use of our tool is based on DERi and should accompany with a raised-line graphic. Including raised-line graphics is also one of the most important consensus of the first focus group. During the discussion phase, we first separated the six participants into two groups. Each group had one host from our laboratory to manage the discussion and answer questions. After 40 minutes' discussion, we re-organized them to the same communication channel to present their opinions about different questions of this focus group. Finally, we organized a series of vote to select the best answers for each question and then made a conclusion.

5.4.4 Main questions of the focus group

During this focus group, to better drive the discussion, we prepared seven questions covering different aspects while using TactileLink. They were:

- 1) Who would use this tool? A teacher (you) with a single pupil with VI or with many pupils with VI? Pupils among themselves? How old are the pupils likely to use it?
- 2) Where would the pupils be? In the classroom? At their home? And you, where would you be (classroom, elsewhere)?
- 3) When would you use TactileLink?
- 4) Which device would you use (PC, tablet, smartphone, or anything else)? Which device would the pupils use?

- 5) Which scenarios would you use TactileLink for? With which students? For which classes? Would everything be prepared in advance or would you use the Editor during the teaching session?
- 6) In your opinion, what would be the main advantages of TactileLink? Why?
- 7) In your opinion, what would be the main difficulties in using TactileLink? Why?

5.4.5 Outcomes of the focus group

The focus group lasted two hours. We recorded the verbatims of the participants and the Padlet notes. We present a synthesis of the results here:

- **Who can be TactileLink useful for?** The participants have confirmed that this tool can be useful for pupils with VI. However, they also stressed the need for prerequisite skills or knowledge. They mentioned mandatory skills related to the use of digital tools as well as knowledge on raised-line graphic exploration, especially for younger learners. A locomotion instructor indicated that: *“this could be useful but only for children with prerequisites about spatial vocabulary and without the need for physical guidance”*. However, the professionals could develop solutions to compensate the possible lack of specific skills: one interesting solution was to commit parents in the activity. Another proposed solution was the dedicated design corresponding to the pedagogical level such as the adaptation of the teaching materials or the guidance.
- **What can be TactileLink useful for?** One common point of view was that this tool can be useful for multiple classes and all the professionals in the field of VI (e.g. special education teachers, O&M instructors, occupational therapists, etc.). The use in culture and leisure has also been mentioned. However, as mentioned by participants (mainly teachers), the most useful context would be education. Although many different tasks were proposed, most of the discussion focused on exercises conducted at home in order to strengthen knowledge learned during face-to-face lectures. In this scenario, the possibility of adding interactions for learners with VI would be particularly interesting. Another scenario that was considered as interesting concerns orientation and mobility. In that scenario, TactileLink can be used to get familiar with spatial landmarks or to be used during orientation and

mobility lessons (embedded smartphone or tablet). The participants agreed that the selection of the device being used should be made according to the target task and context.

- **Advantages of TactileLink.** All the participants agreed that TactileLink can improve the inclusion of pupils with VI. They also emphasized that TactileLink would be an interesting tool for committing parents of the students in the learning of pupils with VI.
- **Potential issues.** The participants raised several potential issues during the focus group. Among them, some were related to TactileLink itself and others focused on its use. For example, they wondered how to provide the pupils with VI with the raised-line graphics if they are not in a face-to-face lecture. The possibility of adding new interactions without modifying the original graphics might also raise questions. In addition, the efficiency of the collaboration between pupils with VI and the teachers was also questioned. Finally, the participants also discussed pedagogical considerations. While some of them pointed out that TactileLink could facilitate independence, others thought this could only be the case if the pupils had already prerequisite knowledge. According to them, initial use of this tool should be in the face-to-face lectures before leaving the pupils with VI autonomy. Moreover, although some participants thought this tool could save time in their teaching, others questioned the amount of preparation time required.

5.5 General discussion and perspectives

Due to limited time during the writing of this dissertation and the COVID-19 context, we did not finish the TactileLink project yet. In this chapter, we only present the results about the design and no details concerning implementation and evaluation.

During the two focus groups with professionals, three important points were determined: 1) the importance of raised-line graphics while using TactileLink; 2) three main features of TactileLink and 3) usage scenarios, target groups and usage suggestions of TactileLink. For the first point, at the beginning, we proposed to use our tool directly without adding additional supporting materials. However, all the participants of the first focus group

believed that it would be very difficult for pupils with VI to explore directly digital graphics. This is not only because the lack of tactile cues on the digital devices, but also the familiarization degree of pupils with VI on digital graphics exploration. Without including corresponding raised-line graphics, the proposed remote collaborative activity seems impossible. However, after several additional discussions with professionals, both of them agreed that it would be interesting to use directly the TactileLink (without additional supporting materials) in the future. They proposed to conduct such type of evaluations after pupils with VI are more familiar with TactileLink. Concerning the second point, by discussing with professionals, we adjusted and refined the three features of TactileLink. Finally, direct discussions with professionals of VI validated the possible usage scenarios (mainly for educational use), users (pupils with VI having prerequisite skills or knowledge) as well as usage suggestions (e.g. inclusion of parents).

Our next works will focus on: 1) co-design with special education teachers and instructors respectively. 2) implement and evaluate TactileLink in one or two dedicated scenarios. Actually, through discussions with many participants, we found that for different types of professionals, they sometimes have different expectations for TactileLink. To better understand their needs and then co-design corresponding features and interactions, we decided to conduct two additional workshops with special education teachers and instructors respectively in our next work. We selected these two types of professionals because tasks with them can represent most of the usage scenarios that TactileLink focuses on.

For about the implementation of TactileLink, for now, we already started working on two issues that were raised: 1) how to fix the raised-line graphics on the tablet, and 2) how to implement TactileLink from the technical level. For the first issue, we have designed a tablet case as shown in Figure 105. As we can see, this case has a small protrusion which enable pupils with VI to perceive the orientation of the tablet and fix the raised-line graphics on the screen. In addition, this case can also provide them with landmarks regarding the outline of the display.



Figure 105. Designed tablet case for fixing raised-line graphics.

To tackle the second issue, we developed a simple demo to evaluate if the commonly used Socket communication can support this real-time collaborative activity. As shown in Figure 106, when someone explores the graphic on the tablet (left), the corresponding finger location is displayed on the smartphone (right). During the preliminary tests, we did not find any transmission delay in a local network. It seemed that the Socket communication is usable for us.

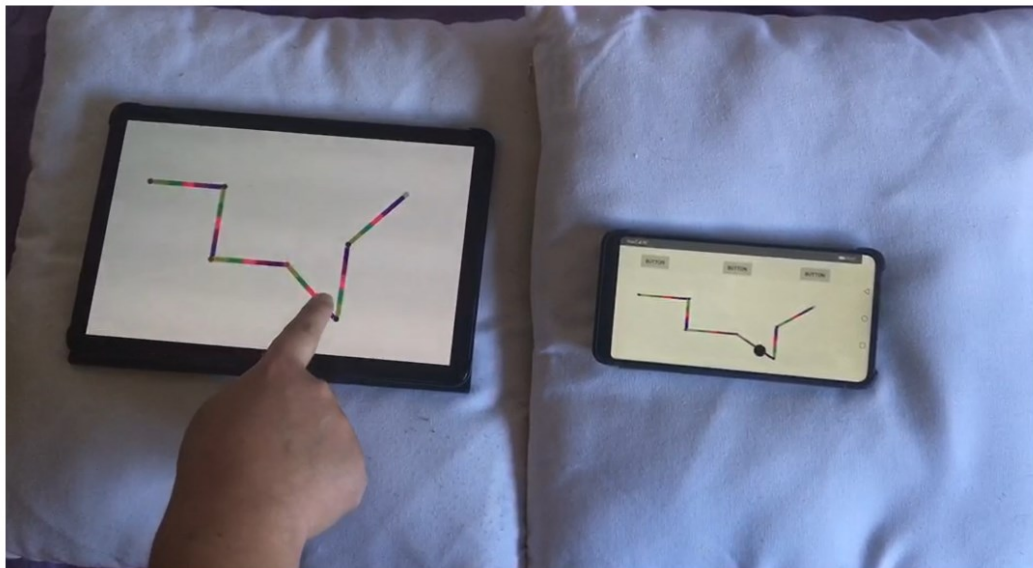

Figure 106. Real-time finger tracking using Socket communication.

5.6 Conclusion of Chapter 5

In this chapter, we presented the design of a remote collaborative graphics learning tool called TactileLink. Although TactileLink has not been fully implemented nor evaluated, the results of the focus groups informed us on important features regarding the tasks, the context of usage, and the functions to include. The ongoing step is the implementation and the evaluation of TactielLink.

Chapter 6 General discussion and perspectives

Throughout this dissertation, we aimed to improve the accessibility of graphical information for people with VI by exploring the tactile exploration of graphics (including both tactile and digital graphics). By proposing VibHand, Tactile Fixations and TactileLink, this dissertation covers different aspects of accessibility issues of graphical information. In this chapter, we first summarize the different contributions of this dissertation by relating them with corresponding research questions. Then, as we already discussed the limitations of the three projects in the corresponding chapters, we give more general discussion about our contributions from a higher level here and propose several perspectives for future research.

6.1 Dissertation summary and contributions

In Chapter 1, we proposed three main research questions of this dissertation, which were: 1) Can we augment human's tactile exploration ability so that people with VI can explore digital graphics more efficiently? 2) Can we understand the tactile exploration behavior at a more refined level (finger level) so that we can help with producing accessible tactile graphics and designing interactive digital graphics? 3) How to design a tool that allows remote collaborative learning based on graphics?

6.1.1 Augment human's tactile exploration ability of digital graphics

In Chapter 2 Part III, we discussed the digital graphics exploration and we especially emphasized the research of Tekli et al. [125], which validated the feasibility of exploring simple digital graphics directly on a touchscreen based tablet. Inspired by this research, we started to investigate the possibility of exploring complex digital graphics. However, the biggest challenge for efficient tactile exploration on tablets is the lack of tactile cues under the fingertip. Without these indicative cues, the exploring fingers of people with VI will be lost very often.

Although previous research has proposed audio based methods for helping exploring digital graphics (Chapter 2 Part III), designing vibrotactile interface on the hand to compensate the lack of tactile cues is still meaningful for some scenarios and has never been investigated before. Such a design involving various factors, for example the vibrotactile duration, layout and patterns, etc. has faced many challenges, but as we summarized in Chapter 3 Section 5, the final design of VibHand has met our expectations and improved both graphics recognition, comparison accuracies and the speed, unrelated finger path, etc.

Overall, comparing with previous research, the results of our evaluations with VibHand were in line with [97] and [125]. The use of VibHand does not impair the finger tactile exploration, instead, by providing directional and progression cues, the exploration process becomes more efficient. The results of VibHand validated the possibility of exploring complex digital graphics on tablets by leveraging only vibratory feedback. Although such exploration experience cannot compare to tactile graphics exploration, the advantage of VibHand is that digital graphics are always easy to produce or to update.

6.1.2 Understand tactile exploration behavior at finger level

In Chapter 2 Part II, we gave a detailed presentation about tactile graphics and we presented also the different exploration strategies leveraged by people with VI while exploring tactile graphics. However, the strategies that have been discovered are still staying at a high cognitive level and a more refined level of analysis at fingers may reveal more useful information about the exploration strategies. In Chapter 4, we proposed the new concept – “Tactile Fixation”, which was inspired by eye fixations, to help describe and understand the finger-level tactile explorations.

In Chapter 4 Section 5, we answered the different research questions about the proposed tactile fixations. Overall, by applying the paradigm of eye fixations as well as its identification algorithm to tactile explorations, we successfully identified tactile fixations. The results based on duration, number of tactile fixations met our hypothesis. In addition, as an unexpected discovery, the three identified tactile exploration patterns: Anchor Point,

Switching Fingers and Chaining Hands, are in line with previous discovered higher level cognitive strategies and helped us to establish a preliminary relationship with them.

Finally, the identified tactile fixations can enable professionals like tactile document maker, interaction designers to analyze the finger stops during the tactile exploration in both quantitative and qualitative ways. The tactile fixations during the exploration of tactile graphics provide valuable information on how people with VI organize their one-handed or two-handed behavior. The salient points or regions can also be revealed by analyzing the distributions of tactile fixations.

6.1.3 Design interactive tool for remote graphics learning

During the writing of this dissertation, the spread of COVID-19 is still very active all over the world. As a real need during this difficult time, the findings based on the co-design of TactileLink provide valuable information about how to design remote collaborative tools for people with VI.

By discussing with different professionals, we fixed the basic functions of TactileLink as well as the target users, scenarios, etc. Overall, such a design method was efficient and met our expectations. But more discussion about awareness of users, common knowledge grounding, graphical data access, roles and social practices during the collaboration should be conducted. The implementation and evaluation of the TactileLink should also be considered in the near future.

6.2 Perspectives

6.2.1 Perspectives of our contributions

VibHand was designed to improve the exploration of digital graphics. However, as presented before, since the current vibrotactile interface supports only eight basic directions, all the digital graphics used by VibHand should be simplified. This increases the workload of users and also greatly limits the flexibility of VibHand. In the chapter of VibHand, we proposed to investigate other vibrotactile methods such as the tactile illusion to increase the directions that can be represented. Theoretically, tactile illusions enable us

to generate any directions according to our need as long as their parameters are set correctly. We have found studies investigating tactile illusion, but they have never been applied to the back of the hand nor to the digital graphics exploration scenario. We think that such research would be valuable and may provide a general solution for digital graphics exploration if people with VI are able to understand different vibrations at the same time (i.e. tablet, direct vibrotactile feedback of vibrators and virtual vibrations generated by tactile illusions). In addition, for now, we did not include any audio feedback while using VibHand. However, it is possible to combine VibHand with audio information and then use it at home (in a quiet environment). At the same time, we are also considering two-handed exploration with VibHand. Investigating if the second hand have a different role while being instrumented would be interesting. Finally, future works on VibHand may also be combinations of our different contributions, one possible research question can be: could knowledge from tactile fixations be used to revisit the feedback given by VibHand according to user's tactile exploration context.

Another important contribution of this dissertation – tactile fixation, is a novel concept in HCI and was first systematically investigated from quantitative and qualitative aspects in our work. As a first dedicated work to tactile fixation, our research was unavoidably limited and left many open question. But at the same time, these open questions enable us to think about more perspectives on tactile fixations. For example, Figure 107 numbered all the two-handed tactile fixations. By following these tactile fixations according to their order, we can understand the cognitive process of the users with VI: the exploration begins with the tail of the horse and then followed by the head and the two hoofs of the horse. Such direct visualization of tactile fixations is useful for many different types of professionals, such as psychologists, special education teachers and designer, etc. Overall, tactile fixations can be analyzed from different aspects, whether single or combined, static or dynamic, they have potentials to reveal more information about the tactile exploration.

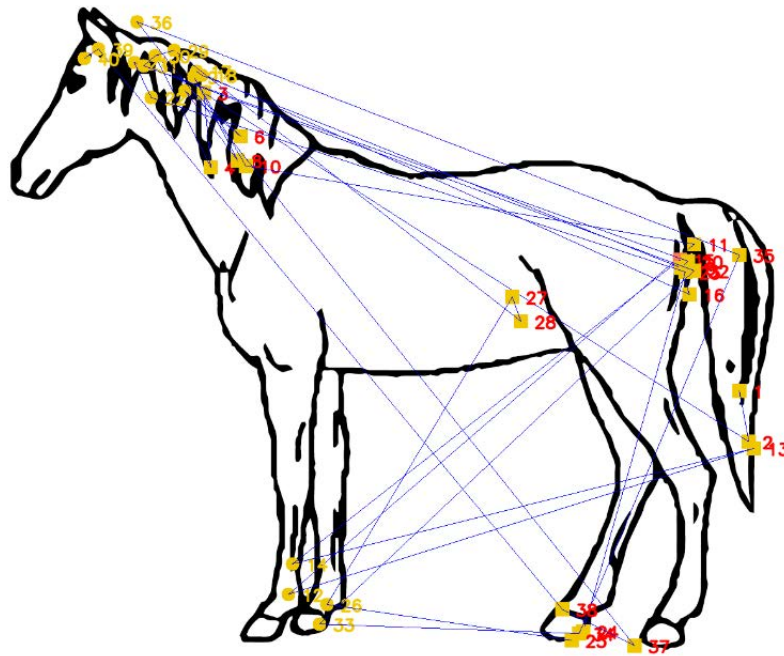

Figure 107. Two-handed exploration patterns based on tactile fixations

Concerning the TactileLink project, although we have not finished the co-design process as well as the implementation and evaluation, from the preliminary discussion with professionals, we already found that such a tool would be interesting for remote teaching and learning, especially when the face-to-face teaching has become impossible in this period. Despite that the TactileLink tool was designed for graphics learning, its versatile design makes it possible to be used as a general remote learning tool for pupils with VI. As proposed by special education teachers, it can be also used to conduct reading, drawing and many other educational activities. But more in-situ evaluations should be conducted later to ensure its usability and user experience.

6.2.2 Perspectives of non-visual tactile exploration of graphics

In terms of long-term perspectives, the research on non-visual tactile exploration of graphics still has a long way to go. But this field is worth studying. From our point of view, there are at least following research directions that have potentials:

- **Multimodal.** The term multimodal has been commonly used in HCI. However, one of the most promising and useful applications of multimodal feedback would be

assistive technologies for people with VI. This has been verified by a lot of studies, such as [42], which showed that the combination of audio and vibratory feedback could improve users' tactile exploration experience. Although we have designed multimodal feedback (i.e. audio and vibratory) in our proposed TactileLink, its use is still very basic in this dissertation. Actually, multimodal feedback could integrate many other output interaction channels. The research from [12] (see Figure 108), which designed multi-sensory interactions, can be a good example for inspiring more advanced multimodal interaction.

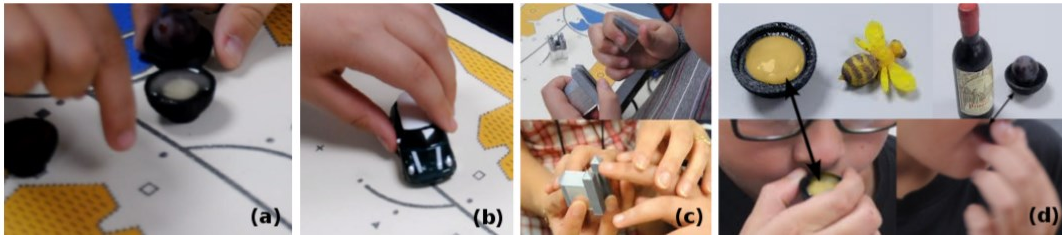

Figure 108. Multi-sensory interactive maps including objects providing touch sensation and sense of smell, etc.

- **Tangible.** Tangible interaction is also very interesting for people with VI because it can naturally provide haptic feedback. As proposed by [113], Itsy-Bits (shown in Figure 109) is a system that can recognize small 3D-printed tangible objects on capacitive touchscreens. This idea could inspire the design of next-generation TactileLink (i.e. without accompanying tactile graphics) and the tangible objects can be used to represent some important graphical elements of the digital graphics.



Figure 109. Itsy-Bits recognizes 3D-printed tangible objects via the capacitive touchscreen.

6.3 Towards a broader scope

6.3.1 Design with blindfolded sighted people

In this dissertation, especially during the design of VibHand, we recruited sighted participants (who were blindfolded during the experiments) to compensate the lack of participants with VI. We acknowledge this could be controversial in some situations, but our rationale to include them in our design comes from [97], which has verified that there are no differences observed between people with VI and sighted people in tactile exploration using vibrotactile access to graphical content rendered on tablets. The results on graphics recognition and comparison of VibHand confirmed this point again.

From our results and the results of [97], we would like to introduce the question which has been discussed for several years in HCI: can blindfolded sighted people replace people with VI for experiments? In fact, if we limit to the tactile exploration of digital graphics on tablet, it seems that it is feasible to recruit directly sighted participants and this will greatly reduce the difficulty of the research because sighted participants are easy to recruit. But at the same time, we also should know that in our experiment with VibHand, although the recognition and comparison accuracies have similar results between people with VI and sighted people, other variable such as the unrelated finger paths are very different. We assumed that this type of difference came from the difference on cognitive ability.

Therefore, in our opinion, it is possible that sighted people can replace people with VI in some very specific situations (for example tactile exploration on tablets with no differences on perceptual ability).

6.3.2 Expand to other domains

This dissertation focuses accessibility issues of graphical information for people with VI and our three contributions are all designed for people with VI. However, one possible question is that can we expand our contributions to other domains?

More precisely, for VibHand, the designed vibrotactile directional and progression cues on the back of the hand are still effective and usable without the context of digital graphics

exploration. Then, it seems that the prototype VibHand can be used also in other non-visual tasks. For example, during the rescue mission of fireman, when the hands are blocked by obstacles, VibHand can be used to indicate directions or distance in combination with other sensors.

The proposed tactile fixations can be also applied to other domains. For example, during the UX research based on touchscreen, people may leverage tactile fixations to evaluate user's finger touch interactions, especially when there are long and continuous finger movements.

Chapter 7 Conclusion

In this dissertation, we focused on the accessibility issues faced by people with visual impairments during the exploration of graphical information. We presented our contributions, their limitations as well as applications in the previous chapters. We also gave several perspectives based on different contributions. Although this research is still not complete and left open questions need to be investigated, this dissertation can still inspire future studies. In this final chapter, we analyze the pros and cons of this dissertation and discuss the potential societal impact of our contributions. We conclude the dissertation by discussing the main challenges in the coming years.

7.1 Pros and cons of this dissertation

In this dissertation, we investigated the non-visual tactile exploration on both digital and tactile graphics by people with VI. Our final objective was to help people with VI to better understand the world of graphics and to bridge the inclusive gap between people with VI and sighted people on graphical information. In this section, to better discuss the pros and cons of the different contributions of this dissertation, we first separate this section according to the type of graphics. Then we give a more general conclusion.

In terms of tactile graphics, as a traditional and efficient alternative to visual graphics, its use is very common in special education for people with VI. The existing studies on tactile graphics have shown its usability but also the difficulties during the adaptation and production. In this dissertation, the Chapter “Tactile Fixations” specifically focused on the exploration of tactile graphics. By conducting a behavioral experiment, the proposed tactile fixations have been proven to be useful for describing the finger-level tactile exploration stops. As a novel concept in HCI, the contribution on tactile fixations is valuable for being used to evaluate tactile exploration and can be easily used as evaluation method in future studies. The finger-level analysis on tactile exploration can also provide more refined analysis and help to relate to higher level cognitive behaviors. However, the limitations of this contribution is also obvious, which are many open questions to be investigated in future.

We acknowledge that more systematic studies are needed to make the concept of tactile fixation being solid and we will continue completing this domain.

For about contributions on digital graphics, based on the previous research of Tekli et al. [125] as well as the real need during the global pandemic, we proposed VibHand and TactileLink respectively. The design and evaluation of VibHand were very detailed in this dissertation and the use of VibHand has also shown its superiority over the research of [125]. However, the design process of VibHand can be further improved and evaluation on vibrotactile progression cues need more rigorous experiment. Finally, we leave the question to what extent the proposed VibHand can be used in real scenarios. Although commonly used tactile graphics are also simplified, we did not conduct further investigation on how many usage scenarios can be covered by VibHand.

As for the proposed TactileLink, the idea of doing research based on real needs was exciting. The co-design of TactileLink responded to the needs of professionals for pupils with VI and the results of co-design process could also inspire other similar studies. But in this dissertation, the lack of implementation and evaluation of TactileLink was a bit regrettable.

Overall, the contributions of this dissertation improved the accessibility of graphical information for people with VI. For both tactile graphics and digital graphics, their non-visual tactile exploration was investigated in this dissertation. Whether from technical or theoretical aspect, the proposed solutions or concepts are valuable. But we acknowledge that further and deeper studies are very needed to compensate the limitations of our contributions.

7.2 Societal impact

As a research institution focusing on Accessibility of people with VI, the laboratory “Cherchons pour voir” already has certain influence in France. Professionals for people with VI that we collaborate in France have relied on the technical progress of our laboratory for advancing their special education with people with VI. The contributions of this dissertation, which could be used for improving the graphical information access, will

bring benefits to society, especially to the French community. The proposed VibHand has attracted attentions of professionals and they were interested in co-designing a more ergonomic prototype with us. The use of VibHand in museum as an assistive device for letting people with VI get familiar with special visiting routes was already in discussion. In addition, the concept of tactile fixation was also interesting to some psychologists. They proposed to co-develop a general library implementing different algorithms for tactile fixations identification with us and then publish this library as a public tool for being used by researchers. Finally, during the writing of this dissertation, the implementation and evaluation of TactileLink is in progress. Professionals, especially special education teachers, are looking forward to have a stable tool to maintain their remote teaching for pupils with VI.

7.3 Decreasing the gap of graphical information access

Throughout this dissertation, we propose three different contributions focusing on digital or tactile graphics and also face-to-face or remote graphics exploration activities. By proposing VibHand, we demonstrated the potential of a vibrotactile interface for helping people with VI to explore digital graphics. By applying the paradigm of eye fixations to tactile exploration, we proposed the concept “Tactile Fixation” to better reveal the tactile exploration from a refined level. Finally, by co-designing the TactileLink with professionals, the challenges of remote learning of pupils with VI could be solved soon. Although the perspectives of these projects described in the previous chapters were very different, the general aim of this dissertation remains the same, which is to decrease the gap of graphical information access between people with VI and sighted people.

Altogether, we hope that we can improve the non-visual tactile exploration of graphics by people with VI. Although our contributions are insignificant compare with the difficulties faced by people with VI while exploring and understanding graphical information, we believe that the designs, implementations, evaluations as well as perspectives included in this dissertation will encourage further studies and give more hope to people with VI. In addition, we think that with the development of information technology, there will have more advanced and more efficient interactive devices or techniques for helping people with

VI interact with digital information, especially with more and more digital graphics. Although there is still a long way for implementing equal access to graphical information for people with VI, we believe more studies like this dissertation will facilitate the inclusion of people with VI. Finally, we hope this dissertation can really contribute to the HCI domain, especially Accessibility research for people with visual impairments.

References

- [1] Jérémy Albouys-Perrois, Jérémy Laviolle, Carine Briant and Anke M. Brock. 2018. Towards a Multisensory Augmented Reality Map for Blind and Low Vision People: a Participatory Design Approach. In Proceedings of the 2018 CHI Conference on Human Factors in Computing Systems (CHI 18). ACM, New York, NY, USA, Paper 629, 14 pages. DOI: <https://doi.org/10.1145/3173574.3174203>
- [2] Kaffel Ahmed, Don McCallum and Derek F. Sheldon. 2005. Multiphase Mico-Drop Interaction In Ink-jet Printing of 3D Structures for Tactile Maps. Modern Physics Letters B. Nos. 28&29, pp 1699-1702.
- [3] Mohammed Ibrahim Alhojailan. 2012. Thematic analysis: A critical review of its process and evaluation. West East Journal of Social Sciences 1, 1 (2012), 39-47.
- [4] David S. Alles. 1970. Information Transmission by Phantom Sensations. 1970. IEEE Transa. Man-Machine Syst. 11, 1 (1970), 85-91. DOI: <https://doi.org/10.1109/TMMS.1970.299967>
- [5] Jessalyn Alvina, Shengdong Zhao, Simon T. Perrault, Maryam Azh, Thijs Roumen, and Morten Fjeld. 2015. OmniVib: Towards Cross-Body Spatiotemporal Vibrotactile Notification for Mobile Phones. In Proceedings of the 33rd Annual ACM Conference on Human Factors in Computing Systems (CHI '15). ACM, New York, NY, USA, 2487-2496. DOI: <https://doi.org/10.1145/2702123.2702341>
- [6] Michael J. Baker, Jerry Andriessen and Sanna Jarvela. 2013. Affective learning together: Social and emotional dimensions of collaborative learning. Routledge.
- [7] Michael J. Baker. 2015. Collaboration in Collaborative Learning. Interaction Studies: Social Behavior and Communication in Biological and Artificial Systems, 16 (3), 451-473. November 2015. Special issue on “Coordination, Collaboration and Cooperation: Interdisciplinary Perspectives”.
- [8] Stephen Brewster and Lorna M. Brown. 2004. Tactons: structured tactile messages for non-visual information display. In Australasian User Interface Conference, 18-22. ACS Conferences in Research and Practice in Information Technology.
- [9] Anke M. Brock, Samuel Lebaz, Bernard Oriola, Delphine Picard, Christophe

- Jouffrais and Philippe Truillet. 2012. Kin'Touch: understanding how visually impaired people explore tactile maps. In CHI 12 Extended Abstracts on Human Factors in Computing Systems (CHI EA 12). ACM, New York, NY, USA, 2471-2476. DOI: <https://doi.org/10.1145/2212776.2223821>
- [10] Anke Brock, Philippe Truillet, Bernard Oriola, Delphine Picard, and Christophe Jouffrais. 2015. Interactivity improves usability of geographic maps for visually impaired people. *Human-Computer Interaction* 30, 2 (2015), 156-194.
- [11] Emeline Brulé, Brianna J. Tomlinson, Oussama Metatla, Christophe Jouffrais, and Marcos Serrano. 2020. Review of Quantitative Empirical Evaluations of Technology for People with Visual Impairments. In *Proceedings of the 2020 CHI Conference on Human Factors in Computing Systems (CHI '20)*. Association for Computing Machinery, New York, NY, USA, 1-14. DOI: <https://doi.org/10.1145/3313831.3376749>
- [12] Emeline Brule, Gilles Bailly, Anke Brock, Frederic Valentin, Grégoire Denis, and Christophe Jouffrais. 2016. MapSense: Multi-Sensory Interactive Maps for Children Living with Visual Impairments. In *Proceedings of the 2016 CHI Conference on Human Factors in Computing Systems (CHI '16)*. Association for Computing Machinery, New York, NY, USA, 445–457. DOI:<https://doi.org/10.1145/2858036.2858375>
- [13] Sandra Bardot, Marcos Serrano, and Christophe Jouffrais. 2016. From tactile to virtual: using a smartwatch to improve spatial map exploration for visually impaired users. In *Proceedings of the 18th International Conference on Human Computer Interaction with Mobile Devices and Services (MobileHCI '16)*. ACM, New York, NY, USA, 100–111. DOI: <https://doi.org/10.1145/2935334.2935342>
- [14] Sandra Bardot, Marcos Serrano, Simon Perrault, Shengdong Zhao and Christophe Jouffrais. 2019. Investigating Feedback for Two-Handed Exploration of Digital Maps Without Vision. In *IFIP Conference on Human-Computer Interaction (INTERACT 2019)*. Springer, Cham, 305-324. http://doi.org/10.1007/978-3-030-29381-9_19
- [15] Sandra Bardot, Marcos Serrano, Bernard Oriola, and Christophe Jouffrais. 2017. Identifying how Visually Impaired People Explore Raised-line Diagrams to Improve

- the Design of Touch Interfaces. In Proceedings of the 2017 CHI Conference on Human Factors in Computing Systems (CHI 17). Association for Computing Machinery, New York, NY, 550-555. DOI: <https://doi.org/10.1145/3025453.3025582>
- [16] Jan Balata, Jakub Franc, Zdenek Mikovec and Pavel Slavik. 2014 Collaborative navigation of visually impaired. *Journal on Multimodal User Interface* 8, no. 2: 175-185.
- [17] David Beymer, Peter Z. Orton, and Daniel M. Russell. 2007. An eye tracking study of how pictures influence online reading. In *IFIP Conference on Human-Computer Interaction (INTERACT 2007)*. Springer-Verlag, Berlin, Heidelberg, 456-460. https://doi.org/10.1007/978-3-540-74800-7_41
- [18] B. L. Bentzen. 1983. Tactile specifications of route configurations. In *Proceedings of the First International Symposium on Maps and Graphics for the Visually Handicapped*. Association of American Geographers, Washington, DC, 125-136.
- [19] Tanja Blascheck, Lonni Besançon, Anastasia Bezerianos, Bongshin Lee, and Petra Isenberger. 2019. Glanceable Visualization: Studies of Data Comparison Performance on Smartwatches. *IEEE Transaction on Visualization and Computer Graphics* 25, 1 (2019), 616-629.
- [20] Stacy M. Branham and Shaun K. Kane. 2015. Collaborative Accessibility: How Blind and Sighted Companions Co-Create Accessible Home Spaces. *Proceedings of the 33rd Annual ACM Conference on Human Factors in Computing Systems*. Association for Computing Machinery, New York, NY, USA, 2373–2382. DOI:<https://doi.org/10.1145/2702123.2702511>
- [21] Emeline Brulé, Brianna J. Tomlinson, Oussama Metatla, Christophe Jouffrais, and Marcos Serrano. 2020. Review of Quantitative Empirical Evaluations of Technology for People with Visual Impairments. In *Proceedings of the 2020 CHI Conference on Human Factors in Computing Systems (CHI 20)*. Association for Computing Machinery, New York, NY, 1-14. <https://doi.org/10.1145/3313831.3376749>
- [22] Georg Buscher, Edward Cutrell, and Meredith Ringel Morris. 2009. What do you see when you're surfing? Using eye tracking to predict salient regions of web pages. In *Proceedings of the SIGCHI Conference on Human Factors in Computing Systems (CHI 09)*. Association for Computing Machinery, New York, NY, 21-30.

<https://doi.org/10.1145/1518701.1518705>

- [23] Jessica R. Cauchard, Janette L. Cheng, Thomas Pietrzak, and James A. Landay. 2016. ActiVibe: Design and Evaluation of Vibrations for Progress Monitoring. In Proceedings of the 2016 CHI Conference on Human Factors in Computing Systems (CHI '16). Association for Computing Machinery, New York, NY, USA, 3261-3271. DOI: <https://doi.org/10.1145/2858036.2858046>
- [24] Cornoldi Cesare, Carla Tinti, Irene C. Mammarella, Anna Maria Re, and Diego Varotto. 2009. Memory for an imagined pathway and strategy effects in sighted and in totally congenitally blind individuals. *Acta Psychologica* 130, no. 1: 11-16.
- [25] Angela Chang, Sile O'Modhrain, Rob Jacob, Eric Gunther and Hiroshi Ishii. 2002. ComTouch: design of a vibrotactile communication device. In Proceedings of the 4th Conference on Designing Interactive System (DIS 02). ACM, New York, NY, USA, 312-320.
- [26] Qin Chen, Simon T. Perrault, Quentin Roy and Lonce Wyse. 2018. Effect of temporality, physical activity and cognitive load on spatiotemporal vibrotactile pattern recognition. In Proceedings of the 2018 International Conference on Advanced Visual Interfaces (AVI 18). ACM, New York, NY, USA, Article 25, 9 pages. DOI: <https://doi.org/10.1145/3206505.3206511>
- [27] Roy Corden. 2001. Group discussion and the importance of a shared perspective: Learning from collaborative research. *Qualitative Research* 1, no. 3, 347-367.
- [28] Camors Damien, Damien Appert, Jean-Baptiste Durand, and Christophe Jouffrais. Tactile Cues for Improving Target Localization in Subjects with Tunnel Vision. 2019. *Multimodal Technologies and Interaction* 3, no. 2 (2019): 26.
- [29] Julie Ducasse, Anke M. Brock, and Christophe Jouffrais. 2018. Accessible interactive maps for visually impaired users. *Mobility of visually impaired people* (2018), 537-584.
- [30] Julie Ducasse, Marc J-M Macé, Marcos Serrano, and Christophe Jouffrais. 2016. Tangible Reels: Construction and Exploration of Tangible Maps by Visually Impaired Users. In Proceedings of the 2016 CHI Conference on Human Factors in Computing Systems (CHI 16). ACM, New York, NY, USA, 2186-2197. DOI:

<https://doi.org/10.1145/2858036.2858058>

- [31] Julie Ducasse, Marc Macé, Bernard Oriola, and Christophe Jouffrais. 2018. BotMap: Non-Visual Panning and Zooming with an Actuated Tabletop Tangible Interface. *ACM Trans. Comput.-Hum. Interact.* 25, 4, Article 24 (September 2018), 42 pages. DOI:<https://doi.org/10.1145/3204460>
- [32] Polly Edman. Tactile graphics. American Foundation for the Blind, 1992.
- [33] Don Samitha Elvitigala, Denys J. Matthies, Vipula Dissanayaka, Chamod Weerasinghe and Suranga Nanayakkara. 2019. 2bit-TactileHand: Evaluating Tactons for On-Body Vibrotactile Displays on the Hand and Wrist. In *Proceedings of the 10th Augmented Human International Conference (AH2019)*. ACM, New York, NY, USA, Article 3, 8 pages.
- [34] Y. Eriksson, G. Jansson and M. Strucel. 2003. Tactile maps: guidelines for the production of maps for the visually impaired.
- [35] Y. Eriksson and M. Strucel. 1995. Production of tactile graphics on swellpaper. Swedish Library of Talking Books and Braille, Sweden.
- [36] Florence Gaunet and Catherine Thinus-Blanc. 1996. Early-blind subjects' spatial abilities in the locomotor space: Exploratory strategies and reaction-to-change performance. *Perception* 25, 8 (1996), 967-981.
- [37] Nicholas A. Giudice, Hari Prasath Palani, Eric Brenner and Kevin M. Kramer. 2012. Learning non-visual graphical information using a touch-based vibro-audio interface. In *Proceedings of the 14th International ACM SIGACCESS Conference on Computers and Accessibility (ASSETS 14)*, ACM, New York, NY, USA, 103-110. DOI: <https://doi.org/10.1145/2384916.2384935>
- [38] Nicholas A. Giudice, Benjamin A. Guenther, Nicholas A. Jensen and Kaitlyn N. Haase. 2020. Cognitive mapping without vision: Comparing wayfinding performance after learning from digital touchscreen-based multimodal maps vs. embossed tactile overlays. *Frontiers in Human Neuroscience*. 14:87.
- [39] Mathieu Le Goc, Lawrence H. Kim, Ali Parsaei, Jean-Daniel Fekete, Pierre Dragicevic and Sean Follmer. 2016. Zooids: Building Blocks for Swarm User Interfaces. In *Proceedings of the 29th Annual Symposium on User Interface Software*

and Technology (UIST 16), 97-109. <https://doi.org/10.1145/2984511.2984547>

- [40] Joseph H. Goldberg, and Jack C. Schryver. 1995. Eye-gaze-contingent control of the computer interface: Methodology and example for zoom detection. *Behavior Research Methods, Instruments & Computers*, vol. 27, pp. 338-350.
- [41] Daniel Goldreich, and Jonathan Tong. 2013. Prediction, postdiction, and perceptual length contraction: a Bayesian low-speed prior captures the cutaneous rabbit and related illusions. *Frontiers in psychology* 4 (2013): 221.
- [42] Cagatay Goncu and Kim Marriott. 2011. GraVVITAS: Generic Multi-touch Presentation of Accessible Graphics. In *Proceedings of the 13th IFIP TC 13 Conference on Human-Computer Interaction (INTERACT 11)*, 30-48. DOI: <https://doi.org/10.1007/978-3-642-23774-4>
- [43] Jenna L. Gorlewicz, Jennifer L. Tennison, P. Merlin Uesbeck, Margaret E. Richard, Hari P. Palani, Andreas Stefik, Derrick W. Smith and Nicholas A. Giudice. 2020. Design Guidelines and Recommendations for Multimodal, Touchscreen-Based Graphics. *ACM Transactions on Accessible Computing (TACCESS)*, 13(3), Article 10, 1-10.
- [44] Timo Gotzelmann and Aleksander Pavkovic. 2014. Towards automatically generated tactile detail maps by 3D printers for blind persons. In *Proceedings of International Conference on Computers for Handicapped Persons (ICCHP 2014)*. Springer, Cham, 1-7.
- [45] Jonathan Grudin. 1994. Computer-supported cooperative work: History and focus. *Computer* 27, no. 5: 19-26.
- [46] Kaj Grønbaek, Ole S. Iversen, Karen Johanne Kortbek, Kaspar Rosengreen Nielsen, and Louise Aagaard. 2007. IGameFloor: a platform for co-located collaborative games. In *Proceedings of the international conference on Advances in computer entertainment technology (ACE '07)*. Association for Computing Machinery, New York, NY, USA, 64–71. DOI:<https://doi.org/10.1145/1255047.1255061>
- [47] William Grussenmeyer, Jesel Garcia and Fang Jiang. 2016. Feasibility of using haptic directions through maps with a tablet and smart watch for people who are blind and visually impaired. In *Proceedings of the 18th International Conference on Human-*

Computer Interaction with Mobile Devices and Services (MobileHCI 16). Association for Computing Machinery, New York, NY, 83-89.
<https://doi.org/10.1145/2935334.2935367>

- [48] Tiago Guerreiro, Kyle Montague, Joao Guerreiro, Rafael Nunes, Hugo Nicolau and Daniel J.V. Goncalves. 2015. Blind People Interacting with Large Touch Surfaces: Strategies for One-handed and Two-handed Exploration. In Proceedings of the 2015 International Conference on Interactive Tabletops & Surfaces (ITS 15). Association for Computing Machinery, New York, NY, 25-34.
<https://doi.org/10.1145/2817721.2817743>
- [49] Darren Guinness, Annika Muehlbradt, Daniel Szafir, and Shaun K. Kane. 2018. The Haptic Video Player: Using Mobile Robots to Create Tangible Video Annotations. In Proceedings of the 2018 ACM International Conference on Interactive Surfaces and Spaces (ISS '18). Association for Computing Machinery, New York, NY, USA, 203–211. DOI:<https://doi.org/10.1145/3279778.3279805>
- [50] Darren Guinness, Annika Muehlbradt, Daniel Szafir, and Shaun K. Kane. 2019. RoboGraphics: Dynamic Tactile Graphics Powered by Mobile Robots. In The 21st International ACM SIGACCESS Conference on Computers and Accessibility (ASSETS '19). Association for Computing Machinery, New York, NY, USA, 318–328. DOI:<https://doi.org/10.1145/3308561.3353804>
- [51] Sebastian Gunther, Florian Muller, Markus Funk, Jan Kirchner, Niloofar Dezfuli, and Max Muhlhauser. 2018. TactileGlove: Assistive Spatial Guidance in 3D Space though Vibrotactile Navigation. In Proceedings of the 11th Pervasive Technologies Related to Assistive Enviroments Conference (PETRA '18). ACM, New York, NY, USA, 273-280. DOI: <https://doi.org/10.1145/3197768.3197785>
- [52] Yvette Hatwell, Arlette Streri, and Edouard Gentaz. 2003. Touching for knowing: cognitive psychology of haptic manual perception. AJohn Benjamins Publishing, Amsterdam, The Netherlands.
- [53] Leona Holloway, Kim Marriott, and Matthew Butler. 2018. Accessible Maps for the Blind: Comparing 3D Printed Models with Tactile Graphics. Proceedings of the 2018 CHI Conference on Human Factors in Computing Systems. Association for

Computing Machinery, New York, NY, USA, Paper 198, 1–13.
DOI:<https://doi.org/10.1145/3173574.3173772>

- [54] Morton A Heller. 1989. Picture and Pattern Perception in the Sighted and the Blind: The Advantage of the Late Blind. *Perception* 18, 3: 379-389.
<https://doi.org/10.1068/p180379>
- [55] Morton A Heller, Melissa McCarthyn and Ashley Clark. 2005. Pattern perception and pictures for the blind. *Psicologica* 26, 1 (2005), 161-171.
- [56] Everett W. Hill, John J. Rieser, M-M Hill, Marc Hill, J. Halpin and R. Halpin. 1993. How persons with visual impairments explore novel spaces: Strategies of good and poor performers. *Journal of visual impairment & Blindness* 87, 8 (1993), 295-301.
<https://psycnet.apa.org/record/1994-18302-001>
- [57] James E. Hoffman. 1998. Visual attention and eye movements. *Attention* 31 (1998), 119-153.
- [58] Jonggi Hong, Alisha Pradhan, Jon E. Froehlich, and Leah Findlater. 2017. Evaluating Wrist-Based Haptic Feedback for Non-Visual Target Finding and Path Tracing on a 2D Surface. In *Proceedings of the 19th International ACM SIGACCESS Conference on Computers and Accessibility (ASSETS 17)*. Association for Computing Machinery, New York, NY, USA, 210-219. DOI:
<https://doi.org/10.1145/3132525.3132538>
- [59] Ying Ying Huang, Jonas Moll, Eva-Lotta Sallnas and Yngve Sundblad. 2012. Auditory feedback in haptic collaborative interfaces. *International Journal of Human-Computer Studies* 70, no. 4: 257-270.
- [60] Ali Israr and Ivan Poupyrev. 2011. Tactile brush: drawing on skin with a tactile grid display. In *Proceedings of the SIGCHI Conference on Human Factors in Computing Systems (CHI '11)*. ACM, New York, NY, USA, 2019-2028. DOI:
<https://doi.org/10.1145/1978942.1979235>
- [61] R. Dan Jacobson. 1998. Cognitive mapping without sight: Four preliminary studies of spatial learning. *Journal of Environmental Psychology* 18, 3 (1998), 289-305.
- [62] Shaun K. Kane, Meredith Ringel Morris, Annuska Z. Perkins, Daniel Wigdor, Richard E. Ladner and Jacob O. Wobbrock. 2011. Access Overlays: Improving Non-

Visual Access to Large Touch Screens for Blind Users. In Proceedings of the 24th Annual ACM Symposium on User Interface Software and Technology (UIST 11). Association for Computing Machinery, New York, NY, 273-282. <https://doi.org/10.1145/2047196.2047232>

- [63] Shaun K. Kane, Kristen Shinohara and Jacob O. Wobbrock. 2015. OneView: Enabling Collaboration Between Blind and Sighted Students.
- [64] Fakhreddine Karray, Milad Alemzadeh, Jamil Abou Saleh and Mo Nours Arab. 2008. Human-computer interaction: Overview on state of the art.
- [65] John M. Kennedy and Juan Bai. 2002. Haptic Pictures: Fit Judgments Predict Identification, Recognition Memory, and Confidence. *Perception* 31, 8 (2002), 1013-1026.
- [66] Jacob H. Kirman. 1983. Tactile apparent movement: The effect of shape and type of motion. *Perception & Psychophysics*. 34, 1 (1983), 96-102. DOI: <https://doi.org/10.3758/BF03205902>
- [67] Roberta L. Klatzky, Jack M. Loomis, Susan J. Lederman, Hiromi Wake, and Naofumi Fujita. 1993. Haptic identification of objects and their depictions. *Perception & Psychophysics* 54, 2 (1993), 170-178. <https://doi.org/10.3758/BF03211752>
- [68] Sreekar Krishna, Shantanu Bala, Troy McDaniel, Stephen McGuire, and Sethuraman Panchanathan. 2010. VibroGlove: an assistive technology aid for conveying facial expressions. In CHI '10 Extended Abstracts on Human Factors in Computing Systems (CHI EA '10). ACM, New York, NY, USA, 3637-3642. DOI: <https://doi.org/10.1145/1753846.1754031>
- [69] Marjan Laal, and Seyed Mohammad Ghodsi. 2012. Benefits of collaborative learning. *Procedia-Social and Behavioral Sciences* 31, 486-490.
- [70] Steven Landau, Michael Russel, Karen Gourgey, Jane N. Erin, and Jennifer Cowan. 2003. Use of the talking tablet in mathematics testing. *Journal of Visual Impairments & Blindness* 97, 2 (2003), 85-96.
- [71] Samuel Lebaz, Christophe Jouffrais and Delphine Picard. 2012. Haptic identification of raised-line drawings: high visuospatial imagers outperform low visuospatial images. *Psychological research* 7, 5 (2012), 667-675.

- [72] Susan J. Lederman and Roberta L. Klatzky. 2009. Haptic perception: A tutorial. *Attention, Perception & Psychophysics* 71, 7 (2009), 1439-1459.
- [73] Susan J. Lederman, Roberta L. Klatzky, Cynthia Chataway and Craig D. Summers. 1990. Visual mediation and the haptic recognition of two-dimensional pictures of common objects. *Perception & Psychophysics* 47, 1 (1990), 54-64.
- [74] Susan J. Lederman, Roberta L. Klatzky, April Collions and Jackie Wardell. 1987. Exploring Environments by Hand or Foot: Time-Based Heuristics for Encoding Distance in Movement Space. *Journal of Experimental Psychology: Learning, Memory, and Cognition* 13, 4 (1987), 606. <https://doi.org/10.1037/0278-7393.13.4.606>
- [75] Susan J. Lederman and Roberta L. Klatzky. 1987. Hand movements: A window into haptic object recognition. *Cog. Psychol.* 19 (1987), 342-368.
- [76] Jack M. Loomis, Roberta L. Klazky and Susan J. Lederman. 1991. Similarity of tactual and visual picture recognition with limited field of view. *Perception* 20, 2 (1991), 167-177.
- [77] Jose V. Salazar Luces, Keisuke Okabe, Yoshiki Murao, and Yasuhisa Hirata. 2018. A Phantom-Sensation Based Paradigm for Continuous Vibrotactile Wrist Guidance in Two-Dimensional Space. *IEEE Robotics and Automation Letters.* 3, 1 (2018), 163-170. DOI: <https://doi.org/10.1109/LRA.2017.2737480>
- [78] Land M., Tatler B. 2009. *Looking and Acting: Vision and eye movements in natural behavior.* Oxford University Press.
- [79] Zhuoluo Ma, Yue Liu, Dejiang Ye and Lu Zhao. 2019. Vibrotactile Wristband for Warning and Guiding in Automated Vehicles. In *Extended Abstracts of the 2019 CHI Conference on Human Factors in Computing Systems (CHI EA 19)*. ACM, New York, NY, USA, Paper LBW2220, 6 pages.
- [80] Muhanad S. Manshad, Enrico Pontelli, and Shakir J. Manshad. 2013. Exploring tangible collaborative distance learning environments for the blind and visually impaired. In *CHI '13 Extended Abstracts on Human Factors in Computing Systems (CHI EA '13)*. Association for Computing Machinery, New York, NY, USA, 55–60. DOI:<https://doi.org/10.1145/2468356.2468367>
- [81] Anita Meier, Denys J. C. Matthies, Bodo Urban, and Reto Wettach. 2015.

Exploring vibrotactile feedback on the body and foot for the purpose of pedestrian navigation. In Proceedings of the 2nd International Workshop on Sensor-based Activity Recognition and Interaction, ACM, 1-11. DOI: <https://doi.org/10.1145/2790044.2790051>

- [82] Giuseppe Melfi, Karin Müller, Thorsten Schwarz, Gerhard Jaworek, and Rainer Stiefelhagen. 2020. Understanding what you feel: A Mobile Audio-Tactile System for Graphics Used at Schools with Students with Visual Impairment. In Proceedings of the 2020 CHI Conference on Human Factors in Computing Systems (CHI '20). Association for Computing Machinery, New York, NY, USA, 1–12. DOI:<https://doi.org/10.1145/3313831.3376508>
- [83] Oussama Metatla, Sandra Bardot, Clare Cullen, Marcos Serrano, and Christophe Jouffrais. 2020. Robots for Inclusive Play: Co-designing an Educational Game With Visually Impaired and sighted Children. In Proceedings of the 2020 CHI Conference on Human Factors in Computing Systems (CHI '20). Association for Computing Machinery, New York, NY, USA, 1–13. DOI:<https://doi.org/10.1145/3313831.3376270>
- [84] Don McCallum, Kafeel Ahmed, Sandra Jehoel, Snir Dinar and Derek Sheldon. 2005. The design and manufacture of tactile maps using an ink-jet process. *Journal of Engineering Design*. Vol. 16, no. 6, pp. 525-544.
- [85] David McGookin, Euan Robertson, and Stephen Brewster. 2010. Clutching at Straws: Using Tangible Interaction to Provide Non-Visual Access to Graphs. In Proceedings of the 28th International Conference on Human Factors in Computing System (CHI 10), 1715-1724. <https://doi.org/10.1145/1753326.1753583>
- [86] Scott F. Midkiff and Luiz A. DaSilva. 2000. Leveraging the web for synchronous versus asynchronous distance learning. In *International Conference on Engineering Education*, vol. 2000, pp. 14-18.
- [87] Irene Miller, Aquinas Pather, Janet Milbury, Lucia Hasty, Allison O’Day, Diane Spence, and S. Osterhaus. 2010. Guidelines and Standards for Tactile Graphics. The Braille Authority of North America.
- [88] Hoshiyama Minoru, Ryusuke Kakigi and Yohei Tamura. 2004 Temporal

discrimination threshold on various parts of the body. *Muscle & Nerve: Official Journal of the American Association of Electrodiagnostic Medicine* 29, no. 2: 243-247.

- [89] Jonas Moll and Eva-Lotta Sallnäs Pysander. 2013. A Haptic Tool for Group Work on Geometrical Concepts Engaging Blind and Sighted Pupils. *ACM Trans. Access. Comput.* 4, 4, Article 14 (July 2013), 37 pages. DOI:<https://doi.org/10.1145/2493171.2493172>
- [90] MOOCs. https://en.wikipedia.org/wiki/Massive_open_online_course
- [91] Giulio Mori, Fabio Paterno, and Carmen Santoro. 2018. Towards understanding the usability of vibrotactile support for indoor orientation. In *Proceedings of the 2018 International Conference on Advanced Visual Interfaces (AVI '18)*. ACM, New York, NY, USA, Article 76, 3 pages. DOI: <https://doi.org/10.1145/3206505.3206584>
- [92] Meredith Ringel Morris, Jazette Johnson, Cynthia L. Bennett, and Edward Cutrell. 2018. Rich Representations of Visual Content for Screen Reader Users. *Proceedings of the 2018 CHI Conference on Human Factors in Computing Systems*. Association for Computing Machinery, New York, NY, USA, Paper 59, 1–11. DOI:<https://doi.org/10.1145/3173574.3173633>
- [93] Isabel Neto, Wafa Johal, Marta Couto, Hugo Nicolau, Ana Paiva, and Arzu Guneyusu. 2020. Using tabletop robots to promote inclusive classroom experiences. In *Proceedings of the Interaction Design and Children Conference (IDC '20)*. Association for Computing Machinery, New York, NY, USA, 281–292. DOI:<https://doi.org/10.1145/3392063.3394439>
- [94] Carson Y. Nolan and June E. Morris. 1971. *Improvement of Tactual Symbols for Blind Children*. American Printing House for the Blind, Louisville, US.
- [95] Sile O'Modhrain, Nicholas A. Giudice, John A. Gardner and Gordon E. Legge. 2015. Designing media for visually-impaired users of refreshable touch displays: Possibilities and pitfalls. *Transactions on Haptics*, 8(3), 248-257.
- [96] Ayberk Ozgur, Severin Lemaignan, Wafa Johal, Maria Beltran, Manon Briod, Lea Pereyre, Francesco Mondada and Pierre Dillenbourg. 2017. Cellulo: Versatile Handheld Robots for Education. In *Proceedings of the 2017 ACM/IEEE International Conference on Human-Robot Interaction (HRI 17)*, 119-127.

<https://doi.org/10.1145/2909824.3020247>

- [97] Hari P. Palani, Paul D. S. Fink and Nicholas A. Giudice. 2020. Design Guidelines for Schematizing and Rendering Haptically Perceivable Graphical Elements on Touchscreen Devices. *International Journal of Human-Computer Interaction*, 1-22.
- [98] Jaeyoung Park, Jaeha Kim, Yonghwan Oh, and Hong Z. Tan. 2016. Rendering moving tactile stroke on the palm using a sparse 2d array. In *International Conference on Human Haptic Sensing and Touch Enabled Computer Applications*. Springer, Cham, 47-56. DOI: <https://doi.org/10.1007/978-3-319-42324-1>
- [99] Don Parks. 1988. NOMAD: An audio-tactile tool for the acquisition, use and management of spatially distributed information by partially sighted and blind persons. In A.F. Tatham & A.G. Dodd's (Eds.), *Proceedings of the Second International Symposium on Maps and Graphics for Visually Handicapped People*. King's College, London, April 20-22 (pp. 54-64).
- [100] Phuong Pham and Jingtao Wang. 2015. AttentiveLearner: improving mobile MOOC learning via implicit heart rate tracking. In *International Conference on Artificial Intelligence in Education*. Springer, 367-376.
- [101] Phuong Pham and Jingtao Wang. 2017. AttentiveLearner 2: a multimodal approach for improving MOOC learning on mobile devices. In *International Conference on Artificial Intelligence in Education*. Springer, 561-564.
- [102] Phuong Pham and Jingtao Wang. 2018. Adaptive Review for Mobile MOOC Learning via Multimodal Physiological Signal Sensing-A Longitudinal Study. In *Proceedings of the 2018 on International Conference on Multimodal Interaction*, ACM, 63-72.
- [103] Delphine Picard, Samuel Lebaz, Christophe Jouffrais, and Catherine Monnier. "Haptic recognition of two dimensional raised line patterns by early blind, late blind, and blindfolded sighted adults." *Perception* 39, no. 2 (2010): 224-235.
- [104] Beryl Plimmer, Andrew Crossan, Stephen A. Brewster, and Rachel Blagojevic. 2008. Multimodal collaborative handwriting training for visually-impaired people. In *Proceedings of the SIGCHI Conference on Human Factors in Computing Systems (CHI '08)*. Association for Computing Machinery, New York, NY, USA, 393-402.

DOI:<https://doi.org/10.1145/1357054.1357119>

- [105] Product READER. <https://tactileimages.org/en/blog-en/the-free-mobile-solution-that-empowers-the-blind-to-explore-tactile-graphics-independently>
- [106] Jeremy Roschelle and Stephanie D. Teasley. 1995. The construction of shared knowledge in collaborative problem solving. In *Computer Supported Collaborative Learning*, pp. 69-97. Springer, Berlin, Heidelberg.
- [107] Jonathan Rowell and Simon Ungar. 2005. Feeling our way: Tactile map user requirements—a survey. In *International Cartographic Conference*, La Coruna.
- [108] R. M. Sakia. The Box-Cox transformation technique: a review. *Journal of the Royal Statistical Society: Series D (The Statistician)*, 41(2), 169-178.
- [109] Eva-Lotta Sallnas, Jonas Moll and Kerstin Severinson-Eklundh. 2007. Group work about geometrical concepts among blind and sighted pupils using haptic interfaces. In *Second Joint EuroHaptics Conference and Symposium on Haptic Interfaces for Virtual Environment and Teleoperator Systems (WHC 07)*, pp. 330-335. IEEE
- [110] Dario D. Salvucci and Joseph H. Goldberg. 2000. Identifying fixations and saccades in eye-tracking protocols. In *Proceedings of the symposium on eye tracking research & applications (ETRA '00)*. Association for Computing Machinery, New York, NY, 71–78. <https://doi.org/10.1145/355017.355028>
- [111] Dario D. Salvucci, and John R. Anderson. 1998. Tracing eye movement protocols with cognitive process models. In *Proceedings of the Twentieth Annual Conference of the Cognitive Science Society*, pp. 923-928.
- [112] Elizabeth B-N Sanders. 2002. From user-centered to participatory design approaches. *Design and the social sciences: Making connections* 1, 8 (2002).
- [113] Martin Schmitz, Florian Muller, Max Muhhauser, Jan Riemann, Huy Viet Le. 2021. Itsy-Bits: Fabrication and Recognition of 3D-Printed Tangibles with Small Footprints on Capacitive Touchscreens. In *Proceedings of the 2021 CHI Conference on Human Factors in Computing Systems (CHI '21)*.
- [114] Tayyar Sen, Ted Megaw. 1984. The effects of task variables and prolonged performance on saccadic eye movement parameters. *Advances in Psychology*, vol. 22, pp. 103-111.

- [115] Choi Seungmoon and Katherine J. Kuchenbecker. 2012. Vibrotactile Display: Perception, Technology and Applications. In Proceedings of the IEEE, vol. 101, no. 9, pp. 2093-2104.
- [116] Barbara Leigh Smith and Jean T. MacGregor. 1992. What is collaborative learning. Towards the Virtual University: International Online Learning Perspectives: 217-232.
- [117] Joan G. Snodgrass and Mary Vanderwart. 1980. A standardized set of 260 pictures: norms for name agreement, image agreement, familiarity, and visual complexity. *Journal of experimental psychology: Human learning and memory* 6, 2 (1980), 174–215.
- [118] Gerry Stahl, Timothy Koschmann and Dan Suthers. 2006. Computer-supported collaborative learning: An historical perspective. *Cambridge handbook of the learning science*, 409-426.
- [119] Abigale Stangl, Meredith Ringel Morris, and Danna Gurari. 2020. "Person, Shoes, Tree. Is the Person Naked?" What People with Vision Impairments Want in Image Descriptions. Proceedings of the 2020 CHI Conference on Human Factors in Computing Systems. Association for Computing Machinery, New York, NY, USA, 1–13. DOI:<https://doi.org/10.1145/3313831.3376404>
- [120] Arlette Streri. *Toucher pour connaître: psychologie cognitive de la perception tactile manuelle*. Presses Universitaires de France, 2018.
- [121] Wei Sun, Yunzhi Li, Feng Tian, Xiangmin Fan, and Hongan Wang. 2019. How Presenters Perceive and React to Audience Flow Prediction In-situ: An Explorative Study of Live Online Lectures. *Proc. ACM Hum.-Comput. Interact.* 3, CSCW, Article 162 (November 2019), 19 pages. DOI:<https://doi.org/10.1145/3359264>
- [122] Anja Thieme, Cecily Morrison, Nicolas Villar, Martin Grayson, and Siân Lindley. 2017. Enabling Collaboration in Learning Computer Programming Inclusive of Children with Vision Impairments. In Proceedings of the 2017 Conference on Designing Interactive Systems (DIS '17). Association for Computing Machinery, New York, NY, USA, 739–752. DOI:<https://doi.org/10.1145/3064663.3064689>
- [123] Leanne Thompson and Edward Chronicle. 2006. Beyond visual conventions: Rethinking the design of tactile diagrams. *British Journal of Visual Impairment* 24, 2:

76-82. <https://doi.org/10.1177/0264619606063400>

- [124] M Symmons and B Richardson. 2000. Raised line drawings are spontaneously explored with single finger. *Perception*, 29, 5: 621-626.
- [125] Joe Tekli, Youssef Bou Issa, and Richard Chbeir. 2018. Evaluating touch-screen vibration modality for blind users to access simple shapes and graphics. *International Journal of Human-Computer Studies* 110, August 2017 (2018), 115–133. DOI:<https://doi.org/10.1016/j.ijhcs.2017.10.009>
- [126] Jon M. Tellevik. 1992. Influence of spatial exploration patterns on cognitive mapping by blindfolded sighted persons. *Journal of Visual Impairment & Blindness* 86, 5 (1992), 221-224.
- [127] Leanne J. Thompson, Edward P. Chronicle and Alan F. Collins. 2006. Enhancing 2-D Tactile Picture Design from Knowledge of 3-D Haptic Object Recognition. *European Psychologist* 11, 2 (2006), 110-118. <https://doi.org/10.1027/1016-9040.11.2.110>
- [128] Mirza Muhammad Waqar, Muhammad Aslam and Muhammad Farhan. 2019. An Intelligent and Interactive Interface to Support Symmetrical Collaborative Educational Writing Among Visually Impaired and Sighted Users. *Symmetry* 11, no. 2: 238.
- [129] Ruolin Wang, Chun Yu, Xing-Dong Yang, Weijie He, and Yuanchun Shi. 2019. EarTouch: Facilitating Smartphone Use for Visually Impaired People in Mobile and Public Scenarios. In *Proceedings of the 2019 CHI Conference on Human Factors in Computing Systems (CHI '19)*. ACM, New York, NY, USA, Paper 24, 13 pages. DOI: <https://doi.org/10.1145/3290605.3300254>
- [130] Zheshen Wang, Baoxin Li, Terri Hedgpeth, and Teresa Haven. 2009. Instant tactile-audio map: enabling access to digital maps for people with visual impairment. In *Proceedings of the 11th international ACM SIGACCESS conference on computers and accessibility (Assets 09)*. ACM, New York, NY, USA, 43-50. DOI: <https://doi.org/10.1145/1639642.1639652>
- [131] What is e-learning. <https://www.learnupon.com/blog/what-is-elearning/>
- [132] Heino Widdel. 1984. Operational problems in analyzing eye movements. *Advances in Psychology*, vol. 22, pp. 21-29.

- [133] Maarten W.A. Wijntjes, Lienne T Van, Ilse M Verstijnen, Astrid M L Kappers and Thijs van Lienne. 2008. The influence of picture size on recognition and exploratory behavior in raised-line drawings. *Perception* 37, 4: 602-614. <https://doi.org/10.1068/p5714>.
- [134] Nesra Yannier, Ali Israr, Jill Fain Lehman, and Roberta L. Klatzky. 2015. FeelSleeve: Haptic Feedback to Enhance Early Reading. In Proceedings of the 33rd Annual ACM Conference on Human Factors in Computing Systems (CHI 15). ACM, New York, NY, USA, 1015-1021. DOI: <https://doi.org/10.1145/2702123.2702396>
- [135] Tsubasa Yoshida, Kris M. Kitani, Hideki Koike, Serge Belongie, and Kevin Schlei. 2011. EdgeSonic: image feature sonification for the visually impaired. In Proceedings of the 2nd Augmented Human International Conference (AH '11). Association for Computing Machinery, New York, NY, USA, Article 11, 1–4. DOI:<https://doi.org/10.1145/1959826.1959837>
- [136] Chien Wen Yuan, Benjamin V. Hanrahan, Sooyeon Lee, Mary Beth Rosson, and John M. Carroll. 2017. I Didn't Know that You Knew I Knew: Collaborative Shopping Practices between People with Visual Impairment and People with Vision. *Proc. ACM Hum.-Comput. Interact.* 1, CSCW, Article 118 (November 2017), 18 pages. DOI:<https://doi.org/10.1145/3134753>
- [137] José P. Zagal, Jochen Rick and Idris His. 2006. Collaborative games: Lessons learned from board games. *Simulation & Gaming* 37, no. 1: 24-40.
- [138] Kaixing Zhao, Frédéric Rayar, Marcos Serrano, Bernard Oriola, and Christophe Jouffrais. 2019. Vibrotactile cues for conveying directional information during blind exploration of digital graphics. In Proceedings of the 31st Conference on l'Interaction Homme-Machine (IHM '19). Association for Computing Machinery, New York, NY, USA, Article 9, 1–12. DOI:<https://doi.org/10.1145/3366550.3372255>