



HAL
open science

Development of an intelligent garment integrating physiological sensors and a decision making system : applied to the online human well-being monitoring

Xin Zhao

► **To cite this version:**

Xin Zhao. Development of an intelligent garment integrating physiological sensors and a decision making system : applied to the online human well-being monitoring. Computer Aided Engineering. Université de Lille, 2020. English. NNT : 2020LILUI076 . tel-03342377

HAL Id: tel-03342377

<https://theses.hal.science/tel-03342377v1>

Submitted on 13 Sep 2021

HAL is a multi-disciplinary open access archive for the deposit and dissemination of scientific research documents, whether they are published or not. The documents may come from teaching and research institutions in France or abroad, or from public or private research centers.

L'archive ouverte pluridisciplinaire **HAL**, est destinée au dépôt et à la diffusion de documents scientifiques de niveau recherche, publiés ou non, émanant des établissements d'enseignement et de recherche français ou étrangers, des laboratoires publics ou privés.

Order Number:



DOCTORAL THESIS

submitted in fulfillment of the requirements of the degree of

DOCTOR OF PHILOSOPHY

in the

“AUTOMATION, COMPUTER ENGINEERING, IMAGE AND SIGNAL PROCESSING”

by

Xin ZHAO

Development of an Intelligent Garment Integrating Physiological Sensors and a Decision Making System - Applied to the Online Human Well-being Monitoring

Presented on November 16, 2020

Jury composed of

<i>Ms.</i>	SYLVIE DESPRES	Professor, Paris-XIII University	(Reviewer)
<i>Mr.</i>	GÉRARD DRAY	Professor, IMT Mines Alès	(Reviewer)
<i>Ms.</i>	FLORENCE RAZAN	Professor, ENS Rennes	(Examiner)
<i>Mr.</i>	YE-QIONG SONG	Professor, University of Lorraine	(Examiner)
<i>Mr.</i>	JULIEN DE JONCKHEERE	Professor, INSERM CIC-IT 1403	(Examiner)
<i>Mr.</i>	XIANYI ZENG	Professor, ENSAIT	(Director of Thesis)
<i>Mr.</i>	LUDOVIC KOEHL	Professor, ENSAIT	(Co-Director of Thesis)
<i>Mr.</i>	GUILLAUME TARTARE	Assistant Professor, ENSAIT	(Co-Advisor of Thesis)

GEMTEX (Textile Engineering and Materials) laboratory
ENSAIT (ECOLE NATIONALE SUPÉRIEURE DES ARTS ET INDUSTRIES TEXTILES)
59056 ROUBAIX FRANCE

Numéro d'ordre :



THÈSE DE DOCTORAT

pour obtenir le grade de :

DOCTEUR DE L'UNIVERSITÉ DE LILLE

dans la spécialité

“AUTOMATIQUE, GÉNIE INFORMATIQUE, TRAITEMENT DES IMAGES ET DU SIGNAL”

par

Xin ZHAO

Développement d'un vêtement connecté et intelligent
par l'intégration des capteurs physiologiques et muni
d'un système d'aide à la décision - application à la
surveillance en ligne de la santé humaine

Thèse soutenue le 16 novembre 2020

devant le jury composé de :

Mme.	SYLVIE DESPRES	Professeur, Université Paris-XIII	(Rapporteuse)
M.	GÉRARD DRAY	Professeur, IMT Mines Alès	(Rapporteur)
Mme.	FLORENCE RAZAN	Professeur, ENS Rennes	(Examinatrice)
M.	YE-QIONG SONG	Professeur, Université de Lorraine	(Examineur)
M.	JULIEN DE JONCKHEERE	Professeur, INSERM CIC-IT 1403	(Examineur)
M.	XIANYI ZENG	Professeur, ENSAIT	(Directeur de Thèse)
M.	LUDOVIC KOEHL	Professeur, ENSAIT	(Co-Directeur de Thèse)
M.	GUILLAUME TARTARE	Maître de conférences, ENSAIT	(Co-Encadrant de Thèse)

Laboratoire GEMTEX (Génie des Matériaux Textiles)

ENSAIT (ECOLE NATIONALE SUPÉRIEURE DES ARTS ET INDUSTRIES TEXTILES)

59056 ROUBAIX FRANCE

Copyright © Xin ZHAO
Gemtex, ENSAIT
2 Allée Louise et Victor Champier
59056 Roubaix, France

CONTENTS

GENERAL INTRODUCTION	5
1 RESEARCH CONTEXT	9
1.1 INTRODUCTION	9
1.2 FETAL WELL-BEING ASSESSMENT: STATE-OF-THE-ART TECHNIQUES AND CHALLENGES	10
1.2.1 Doppler ultrasound and ultrasound imaging	10
1.2.2 Fetal heart-rate monitoring	10
1.2.3 Fetal Movement Monitoring: An Easily-Accessible Way to Assess Fetal Well-being	11
1.3 WEARABLE SENSORS AND SYSTEMS: A BRIEF REVIEW	16
1.3.1 Wearable Technology: Next Generation of Human-Machine Interaction Medium	16
1.3.2 Intelligent Garments	18
1.3.3 Sensors Used in Wearable Systems	20
1.3.4 Processing Units of Wearable Systems	22
1.3.5 Embedded Intelligence - Improving the Intelligence Level of Wearable Systems	24
1.3.6 Wireless Communication Solutions Used in Wearable Systems	24
1.3.7 Applications of Wearable Systems	25
1.3.8 Current Challenges of Wearable Technology	28
1.4 ARTIFICIAL INTELLIGENCE TECHNIQUES APPLIED TO MEDICAL DIAGNOSIS AND MONITORING	30
1.5 OBJECTIVE OF THE THESIS	32
1.6 CONCLUSION	32
2 OVERALL DESCRIPTION OF THE MATERIALS AND METHODS	35
2.1 INTRODUCTION	35
2.2 TOWARDS AN IoT-BASED INTELLIGENT GARMENT - AN OVERVIEW OF THE SYSTEM ARCHITECTURE	35
2.2.1 The Wearable Device	37
2.2.2 Local Monitoring Platform	40
2.3 AN OVERVIEW OF THE APPLIED METHODOLOGIES	42

2.3.1	Architecture of the Proposed Fetal Health Evaluation Algorithm	43
2.3.2	Signal Pre-Processing	43
2.3.3	Peak and Threshold Detection	45
2.3.4	Cross-Correlation for Artifact Elimination	46
2.3.5	Training of Machine Learning Algorithms for Signal Classification	47
2.3.6	Automated Counting of Fetal Movements	47
2.4	DATA ACQUISITION AND LABELING	49
2.4.1	Data Acquisition Criteria and Strategies	49
2.4.2	Labeling of Fetal Movement Signals	50
2.5	SOME THOUGHTS ABOUT SYSTEM EFFICIENCY	51
2.5.1	Reducing the Computational Burden	51
2.5.2	Distribution of Computational Tasks Between the Garment and the Local Monitoring Platform	52
2.6	CONCLUSION	53
3	GARMENT DESIGN: THE CHOICE OF THE MOST APPROPRIATE FABRIC AND GARMENT STYLE	55
3.1	INTRODUCTION	55
3.2	CHOICE OF THE MOST RELEVANT FABRIC PARAMETERS	56
3.3	TOWARDS AN ERGONOMIC GARMENT DESIGN - DESIGN OF THE MOST ADAPT- ABLE GARMENT STYLE	59
3.3.1	Acquisition of Pregnant Women Body Measurement Using Human 3D scanning Technology	59
3.3.2	Design of the Most Appropriate Garment Style for Long-term Use	60
3.3.3	Validation of the Proposed Garment in Terms of Tightness with Virtual Fitting	62
3.3.4	Validation of the Proposed Garment by the Wearers Based on Sensory Eval- uation	62
3.4	CONCLUSION	63
4	FETAL MOVEMENT SIGNAL CLASSIFICATION USING ANFIS	65
4.1	INTRODUCTION	65
4.2	PRELIMINARY KNOWLEDGE	66
4.2.1	Basic Principles of Fuzzy Logic and Fuzzy Systems	66
4.2.2	Applications of Fuzzy Logic in Medicine Fields	66
4.2.3	Artificial Neural Network	67
4.2.4	Adaptive Neuro Fuzzy Inference System (ANFIS)	69
4.3	FEATURE EXACTION BASED ON STATISTICAL FEATURES IN TIME AND FRE- QUENCY DOMAIN	71
4.4	ANFIS-BASED CLASSIFICATION APPROACH	72
4.4.1	Data acquisition	73
4.5	EXPERIMENT AND RESULTS	74

4.5.1	Training of the ANFIS Classifier	74
4.5.2	Evaluation of the Trained ANFIS Model	75
4.6	CONCLUSION	76
5	MANUAL FEATURE EXTRACTION OF FETAL MOVEMENT SIGNALS WITH SIGNAL CLASSIFICATION USING FUZZY ARTMAP	77
5.1	INTRODUCTION	77
5.2	PRELIMINARY KNOWLEDGE	78
5.2.1	Feature Dimensionality Reduction with Sequential Feature Selection Algorithm	78
5.2.2	Principle Component Analysis	78
5.2.3	Fuzzy ARTMAP	79
5.3	DATA ACQUISITION	80
5.4	COMBINATION OF TIME-DOMAIN AND DISCRETE WAVELET-DOMAIN FEATURES FOR AN EFFECTIVE ELIMINATION OF MATERNAL BODY MOTION ARTIFACTS	81
5.4.1	Description of the Extracted Features	81
5.4.2	Principal Component Analysis for Feature Visualization	82
5.4.3	Training of Fuzzy ARTMAP Classifier Using the Extracted Features	83
5.4.4	Validation of the Trained Model on New Data	83
5.5	SELECTING THE MOST RELEVANT FEATURES	84
5.5.1	Finding out the Most Representative Features	85
5.5.2	Evaluation of the Classification with the Fuzzy ARTMAP Classifier	86
5.6	CONCLUSION	87
6	TOWARDS AUTOMATED FEATURE EXTRACTION OF FETAL MOVEMENT SIGNALS	89
6.1	INTRODUCTION	89
6.2	PRELIMINARY KNOWLEDGE	91
6.2.1	1-Dimensional Convolutional Neural Networks	91
6.2.2	Generative Adversarial Networks	93
6.3	METHODOLOGY	94
6.3.1	General Overview of the Proposed Approach	94
6.3.2	Pre-processing of Raw Acceleration Signals	94
6.3.3	1-Dimensional Deep Convolutional Generative Adversarial Network for Data Augmentation	95
6.3.4	1D CNN for Fetal Movement Signal Classification	97
6.3.5	Implementation of the Pre-trained 1D CNN Model into a Microcontroller	98
6.4	EXPERIMENTAL RESULTS	98
6.4.1	Data Clustering of Fetal Movement Signals	98
6.4.2	Training of 1D GAN for data augmentation	100
6.4.3	Training of 1D CNN	101
6.4.4	Horizontal Comparison of the Performance of the Three AI Algorithms Used in This Thesis under the Same Condition	103

6.4.5	Implementation of Pre-Trained CNN into a Microcontroller	104
6.5	CONCLUSION	105
7	QUALITATIVE EVALUATION OF FETAL HEALTH CONDITION	107
7.1	INTRODUCTION	107
7.2	METHODOLOGY	108
7.2.1	Fetal Movement Counting Algorithm	108
7.2.2	Towards Long-Term Evaluation of Fetal Health	110
7.3	EXPERIMENTAL RESULTS	111
7.4	CONCLUSION	112
	GENERAL CONCLUSION	115

LIST OF FIGURES

1.1	A fetal leg movement ("fetal kick") of 20 weeks shown in MRI (Magnetic Resonance Imaging) Scan (adapted from [Verbruggen et al. (2018)]).	11
1.2	Fetal movement counting chart (reprinted from [Saastad et al. (2011)]). . . .	13
1.3	(a) Tri-axial accelerometers are placed on the maternal abdomen for the recording of fetal movements, and (b) the acquired fetal movement signals (adapted from [Boashash et al. (2014)]).	14
1.4	(a) An accelerometer-based fetal movement recorder together with (b) an example of acquired signals using the recorder (only acceleration signals on z-axis were studied and illustrated) with other physiological signals e.g. maternal ECG and respiration (adapted from [Ryo et al. (2012)]).	15
1.5	General representation of a remote health monitoring system based on wearable sensors (reprinted from [Patel et al. (2012)]).	18
1.6	Physiological signals that are monitored from human body (reprinted from [Cho (2009)]).	21
1.7	Illustration of the Apple Watch with sensors perfectly integrated inside the back of the watch structure [iFixit].	22
1.8	A smart wristband integrating flexible sensors presented in [Gao et al. (2016)].	23
1.9	Some examples of commercialized smart wearables, (a) A smartwatch for monitoring heart rate, blood oxygen saturation levels and GPS tracking, (b) a comfortable chest strap for monitoring heart rate, (c) a smart shirt for ECG (electrocardiogram), heartbeat, heart rate variability, breathing rate, etc. and (d) Google Glass, a smart glasses integrated a touchpad, a camera as well as a display.	26
1.10	The convergence of these two multidisciplinary research topics results in a new era.	33
2.1	General architecture of the proposed wearable system for fetal well-being monitoring.	36
2.2	Figure illustrating contents of different chapters.	37
2.3	Intelligent garment hardware.	39
2.4	Embedding the hardware in the garment.	40
2.5	An overall picture of the final intelligent garment prototype integrating the sensors and the main circuit (invisible, inside that small size box).	41
2.6	GUI of the local monitoring platform.	42

2.7	General workflow of the proposed fetal well-being monitoring system. . . .	44
2.8	The magnitude and phase response of the designed IIR filter (type band-pass, band width = [0.5Hz - 20Hz]).	45
2.9	Signals showing artifacts caused by maternal body motions (red rectangle) featuring high cross-correlation values among each channel and an isolated fetal movement (green circle).	46
2.10	Experimental setup for fetal movement data acquisition.	50
2.11	Data Stream demonstrating how to reduce the computational burden by using threshold detection and cross correlation.	51
3.1	(a) Image of experimental setup showing Instron machine, probe and silicone rubber sheet, and (b) a graph comparing average of experimental forces with forces predicted computationally (reprinted from [Verbruggen et al. (2018)]).	56
3.2	Testing of signal attenuation of different fabrics using a solenoid.	57
3.3	Acceleration g values of different knitting constructions in terms of signal attenuation.	57
3.4	Figure illustrating acceleration signal magnitude attenuation property of Jersey fabric after receiving one hit.	58
3.5	Figure indicating how to evaluate the signal attenuation given a acceleration signal in response to one hit.	58
3.6	Figure demonstrating size measurement of a pregnant woman's body shape based on 3D scan.	60
3.7	Size measurement of pregnant women using 3D body scan.	60
3.8	Two garment styles have been initially designed.	61
3.9	Tightness simulation results.	62
3.10	Sensory evaluation results of the two commercialized maternity belts (G1, G2) along with our proposed garment (G3). the 4 subplots are illustrated based on feedbacks from 4 subjects S1-S4 (pregnant women), in terms of 4 criteria C1-C4.	63
4.1	An example of exam marks represented in a fuzzified way.	66
4.2	An typical architecture of two successive layers in an ANN.	68
4.3	ANFIS architecture. Circles indicate fixed nodes, whereas squares indicate adjustable ones.	69
4.4	(a) A fetal movement signal with its time-frequency representation and (b) a non-fetal movement signal with its time-frequency representation. (adapted from [Boashash et al. (2014)])	71
4.5	A comparison of the feature distribution of a fetal movement signal with that of a noise signal.	73
4.6	Flowchart of the proposed ANFIS-based system.	74
4.7	The RMSE training curve of the ANFIS model.	75

4.8	Offline evaluation results of the proposed algorithm on the second signal. .	76
5.1	Architecture of the fuzzy ARTMAP algorithm.	79
5.2	PCA results providing a visualization of the selected feature set. It is observed from the figure that the two categories are clearly separable in a 3-dimensional space, as indicated with a red dotted line.	82
5.3	Classification results.	84
5.4	Average classification performance on the training samples, with forward feature construction on time domain (a) and db2 wavelet (b).	86
6.1	Overview of GAN structure.	93
6.2	General workflow of the proposed approach.	95
6.3	The proposed 1-dimensional deep convolutional GAN architecture.	96
6.4	Minibatch discrimination.	97
6.5	The proposed 1DCNN used for fetal movement signals classification.	98
6.6	An example of pre-processing data before feeding to SOM.	99
6.7	Fetal movement signal clustering results using SOM.	100
6.8	Training process of the GAN model.	100
6.9	Training loss curves for the generator and discriminator.	101
6.10	Some generated signals.	102
7.1	Multiplexing of data: from quantitative signal classification results to qualitative fetal health evaluation.	107
7.2	Merging MPIs to one MCI.	110
7.3	Illustration explaining how the fetal movement counting algorithm works: classification results on a 4-second window of 4 sensors are merged into one single output, then 15 consecutive epochs of 4-second are merged in to a new window of 1 minute in length which is used for fetal movement counting.	111
7.4	The estimated counting of fetal movements on new data over 15 minutes. The experimental results show high compliance with the maternal perception.112	

List of Tables

1.1	List of vital parameters assessed using different types of sensors.	20
1.2	Commonly used microcontrollers for wearable systems.	22
1.3	Technical comparison of key characteristics of the wireless technologies that are commonly used in wearable systems.	25
1.4	List of wearable systems	26
3.1	Sensory evaluation of the two candidate garment models	61
4.1	Extracted features of one fetal movement signal segment and one noise signal segment.	72
4.2	Description of the two datasets used for ANFIS training and testing.	73
4.3	Description of the two signals used in ANFIS training and testing.	74
5.1	Description of the training dataset.	80
5.2	Frequencies corresponding to different levels of wavelet decomposition (4-level), with a sampling frequency of 60Hz.	81
5.3	Initial parameter settings of the fuzzy ARTMAP model.	83
5.4	List containing candidate features utilized for feature selection.	85
5.5	Performance comparison of different wavelets on acceleration signal classification.	86
5.6	Final feature set comprising both time and wavelet features.	87
5.7	The confusion matrix of the classification results on test set (with fuzzy ARTMAP classifier).	87
6.1	Sample Distribution of the Extended Training Dataset	101
6.2	Confusion matrix	102
6.3	Performance comparison	103
6.4	Confusion matrix of the classification results on test set (with ANFIS classifier).	103
6.5	Confusion matrix of the classification results on test set (with 1D CNN classifier).	104
6.6	An Horizontal Comparison of the Three Algorithms	104
6.7	Memory analysis of the embedded CNN model	105
7.1	Statistical Report of the System's Counting Results	112

ACRONYMS

AI Artificial Intelligence.

ANFIS Adaptive-Network-Based Fuzzy Inference System.

ANN Artificial Neural Network.

AP Access Point.

ATT Attribute Protocol.

BSS Backward Sequential Selection.

CNN Convolutional Neural Network.

CPU Central Processing Unit.

CT Computed Tomography.

CTG Cardiotocography.

DCGAN Deep Convolutional Generative Adversarial Network.

DFM Decreased Fetal Movement.

DIY Do It Yourself.

DL Deep Learning.

DWT Discrete Wavelet Transform.

ECG Electrocardiogram.

EEG Electroencephalography.

EHRs Electronic Health Records.

EMG Electromyography.

fECG fetal Electrocardiography.

FPGA Field Programmable Gate Arrays.

FSS Forward Sequential Selection.

GAN Generative Adversarial Network.

GDP Gross Domestic Product.

GPS Global Positioning System.

GUI Graphical User Interface.

I²C Inter Integrated Circuit.

ICT Information and Communication Technology.

IIR Infinite Impulse Response.

IoT Internet of Things.

IT Information Technology.

LED Light-Emitting Diode.

MCI Minimum Counting Interval.

MEMS Microelectromechanical Systems.

ML Machine Learning.

MPI Minimum Processing Interval.

MRI Magnetic Resonance Imaging.

NLP Natural Language Processing.

NN Neural Network.

OS Operating System.

PC Principal Component.

PCA Principal Component Analysis.

PCB Printed Circuit Board.

PCG Phonocardiography.

PCs Personal Computers.

PDA Personal Digital Assistant.

PPG Photoplethysmogram.

ReLU Rectified Linear Unit.

RF Random Forest.

RMS Root Mean Square.

RMSE Root Mean Square Error.

SCG Scaled Conjugate Gradient.

SDK Software Development Kit.

SFS Sequential Feature Selection.

SNR Signal-to-noise ratio.

SOM Self-Organizing Map.

SPI Serial Peripheral Interface.

SVM Support Vector Machine.

TF Time-Frequency.

UART Universal Asynchronous Receiver Transmitter.

WBAN Wireless Body Area Networks.

GENERAL INTRODUCTION

The world's population will increase to 8.1 billion around year 2025 [Norman and Skinner (2006)]. Continuous growing of world population as well as an increasing percentage of aging population has placed a heavy burden to our public health care systems, whose resources are always limited. It is nowadays challenging to provide in-hospital health care and monitoring to every person in the target population. In Europe, with the falling GDP (Gross Domestic Product) and rising unemployment, this burden could be further increased [Thomson (2013)]. This could bring about serious social problems from a worldwide perspective as public health services and investments in those less-developed countries are significantly below the average of that in developed countries, threatening people's life.

To solve the above-mentioned issue, *e-health* has gained considerable attention in the literature and practice. Here, we quote the definition of this emerging technology as "*e-health is an emerging field in the intersection of medical informatics, public health and business, referring to health services and information delivered or enhanced through the Internet and related technologies. In a broader sense, the term characterizes not only a technical development, but also a state-of-mind, a way of thinking, an attitude, and a commitment for networked, global thinking, to improve health care locally, regionally, and worldwide by using information and communication technology*" [Eysenbach (2001)]. As the quotation indicates, e-health is a broad concept, which covers aspects such as remote health care and health surveillance, health literature, health information system, medical expert system, etc. Recently, e-health has advanced significantly with the broad use of Personal Computers (PCs), portable smartphones, Personal Digital Assistant (PDA) or hand-held tablet computers. High agree acceptance of e-health by patients as well as improved skill set of medical professionals further contributes to this trend [Norman and Skinner (2006)]. E-health also has the potential to largely improve the efficiency of the current public health care system, reallocate scarce medical resources as well as reduce medical costs.

In modern society, as a result of fast developing technologies in microelectronics, sensors and actuators, telecommunications, computer-aided decision-making and artificial intelligence, human disease assessment and online and remote health monitoring using *wearable systems* have been brought to our attention. As a powerful online and remote monitoring and illness prevention approach in the context of e-health, wearable systems have their unique and precious advantages compared to hospital-based health care such as 1) a remote and in-home setting enables the target patients to be monitored anywhere at anytime, 2) being wearable, they can integrate into our daily life without interfering

with our routine activities, 3) wearable devices are small and less-expensive, thus more consumer-accessible, and 4) they help to reduce the burden of current public health care system and reallocate public health resources more reasonably (patients go to hospital only when necessary or emergency) [Baig et al. (2017)] [Fernández-Caramés et al. (2018)]. As a result, this technology has broadened the concept of health care from clinical medicine with in-hospital settings to a much larger scope. Today, wearable systems can be seen almost everywhere in our daily life: Smart bracelets/smart watches for sport and fitness tracking [Samsung Galaxy Fit], chest straps for Electrocardiogram (ECG) monitoring [Polar H10], smart shirts for respiratory diseases diagnosis [Hexoskin Smart Shirt], smart garments that offer protection and are used by people involved in special type of work (e.g. firefighters [TextileToday], soldiers, etc), the list goes on. Wearable technology is of great potential for providing ubiquitous health monitoring and remote health care to everyone of us.

In this context, our research team has engaged in a research project which applies e-health in antenatal care - more precisely, we aim at developing a wearable system for the online monitoring of fetal movements. Fetal movements are a crucial indicator of fetal health condition, and regular fetal movement monitoring during pregnancy plays an important role in ensuring normal fetal development, improving maternal and fetal outcomes. The motivation and initiative of our project lies in addressing the drawbacks and inconvenience of the current clinically-available fetal health monitoring technologies: 1) maternal perception of fetal movements suffers from subjectivity and being imprecise, which in turn causes anxiety to the mother, whereas 2) in most cases, an advanced and accurate fetal health evaluation could only be done in hospital with expensive instruments/devices and experienced professionals. As a result, there is a strong need to develop an reliable, automated, less-expensive and easily-accessible method for the evaluation of fetal health during pregnancy.

The wearable system proposed in this work fully addresses the above issues. It features a garment integrating several accelerometer sensors for data acquisition of fetal movement signals, a local decision support unit and a cloud-computing platform together with a remote expert system. This system is able to automatically and continuously monitor fetal movements while the mother does not need to go to the hospital - she can stay at home while the health condition of her fetus is reliably monitored on an online and real-time basis. Moreover, key information about her baby is uploaded to the cloud-computing platform while advanced diagnosis and consultations from the assigned expert are sent remotely back to the mother. Compared to existing works in the literature which are mostly focused on only the data acquisition and processing of fetal movement signals using accelerometers [Boashash et al. (2014)] [Altini et al. (2017)] [Minjie et al. (2012)], this work features the following remarkable original contributions: 1) an all-round design of the garment/textile as well as a reasonable integration of garment/electronic devices thereby significantly improving the comfort and usability of the proposed wearable sys-

tem, 2) the intelligence of the wearable system as a whole has been further improved with a distributed deployment of AI (Artificial Intelligence)-based signal processing and decision-making algorithms, as well as the communication and interaction with a cloud expert system, and 3) an effective fetal movement counting algorithm based on the analysis of the acquired fetal movement acceleration signals (*quantitative evaluation*), as well as a decision making system for the *qualitative evaluation* of fetal health condition on a long-term basis.

This work is of a multidisciplinary nature, which makes full use of the cutting-edge techniques in the field of textile, sensor technology, IoT (Internet of Things), edge computing and embedded AI. As a result, the development of this wearable garment for fetal health monitoring comprises multiple aspects: from fabric selection and garment style design to hardware circuit design; from manual extraction of features from sensor-recorded fetal movement signals to employing Machine Learning (ML) algorithms for automated signal classification and analysis; from the accurate detection of every single fetal movement signals to the overall evaluation of fetal well-being by statistical counting and analyzing fetal movements during a long period.

This research work is financially supported by the French national research agency (Agence Nationale de la Recherche, ANR) from the year 2015 to 2019 in the frame of French national research project IOTFetMov (project number: ANR-14-CE24-0035-01). It is in collaboration with CIC-IT of Lille, the French clinical investigation center for innovative technology.

In the following chapters of this thesis the reader will find all the information needed for having a better understanding of the project. The rest of this thesis is organized as follows: Chapter 1 gives a brief presentation of the research context with regard to two different parts: the promise of wearable technologies and the challenges in the current techniques for fetal movement monitoring, respectively, and further discusses our objective of developing a wearable system to solve the existing issues. Chapter 2 describes an overview of the algorithms and methodologies applied in our work in order to develop this system. The other chapters further discuss the key parts and original contributions of the proposed system: Chapter 3 presents the work concerning the garment and fabric design, Chapter 4, 5 and 6 have attempted to solve one of the toughest issues in existing sensor-based fetal movement monitoring approaches which hinder their successful application in clinical practice - how to effectively capture fetal behaviors with accelerometers while successfully distinguishing real fetal movements from other artifacts. Take one step further, Chapter 7 introduces our work on how to accurately, reliably and continuously evaluate fetal health condition based on the fetal movement signals, not just focused on the manual acquisition of these signals - as most other studies still struggle at their current research stages.

Acknowledgments

I would like to express my special thanks and appreciation to my thesis supervisor, Professor Xianyi ZENG, for his continuous encouragement, guidance and support during this project. In every phase of my PhD study he shared his experience and expertise. Without his supervision the completion of this thesis would not be possible. I would also thank him for helping me keeping things in perspective, both in work and private life.

I am very grateful to my co-supervisor, Professor Ludovic KOEHL, for giving me professional suggestions and guidance.

I convey my sincere gratitude to my co-advisor, Mr. Guillaume TARTARE, PhD, for his insightful comments.

My sincere thanks also goes to Professor Julien DE JONCKHEERE, for his patience, motivation, enthusiasm and immense knowledge in the medical field.

I greatly appreciate the support received through the collaborative work undertaken with Hangzhou Dianzi University, China and Cynoware Electronics, Inc. China. I am grateful to maternity hospital Jeanne de Flandre, Lille, France.

My deep respect and admiration goes to all of my colleagues and friends at ENSAIT engineering school who have encouraged, supported and helped me during my PhD study.

RESEARCH CONTEXT



1.1 INTRODUCTION

Wearable technology has a promising future in online, remote and ubiquitous monitoring of human health condition, activity & fitness tracking and environment monitoring. There has already been a noticeable successful wearable products and solutions - that the reader will discover later in this chapter, both in the literature and industry. Being a member of garment-based wearable system, the system proposed in our work aims to apply the latest advances in wearable technology to solve an important issue in antenatal care - how to reliably, easily accessibly and continuously monitor fetal movements.

Divided into three parts, this chapter will give the reader a global and comprehensive context related to our research work. First, we will give a brief overview of current clinically-available technologies for fetal movement monitoring during pregnancy. Their existing issues and challenges are pointed out, followed by an review of up-to-date, sensor technology-based solutions (most of them are accelerometer-based) proposed by related research works/publications in the literature. However, as the reader will discover later in this chapter, these solutions collectively suffer from disadvantages such as impractical to use, low comfort level, low reliability and low robustness, not suitable for long-term use, etc. This context inspires us to make full use of advanced wearable technology with integrated sensors and embedded AI to overcome the just-mentioned issues. In order to give the reader a general idea about how wearable technology works in providing handful, flexible, comfortable and continuous monitoring of human health and activity, we introduce in the second part of this chapter a concise review of the state-of-the-art wearable systems dedicated to a variety of health monitoring-related, disease prevention-related and fitness/activity tracking-related applications. In the third part of this chapter, we introduce AI algorithms that have been studied or applied in medicine. Finally, this chapter ends with a clear statement of our research mission and objective: design and development of a garment-based wearable system which is exclusively used for online monitoring of fetal movements. Our research work aims to address the existing issues that current fetal monitoring techniques are facing by inheriting the inherent advantages of sensor technology and wearable systems such as low-cost, out-of-hospital settings, remote and ubiquitous monitoring as well as the ability of long-term and continuous

monitoring without causing discomfort to the user. A more detailed presentation is given in the rest of this chapter.

1.2 FETAL WELL-BEING ASSESSMENT: STATE-OF-THE-ART TECHNIQUES AND CHALLENGES

Despite advances in diagnosis and prenatal management, stillbirths are still a major problem around the world today [J.E. et al. (2016)]. It is reported that nearly 3 million fetuses are died during third trimester of pregnancy each year around the world, most of which occur in low-income and middle-income countries [Goldenberg et al. (2011)]. Evidence shows that some high-income countries have already lowered their stillbirth rate to fewer than 5 per 1000 births by improving the quality of antenatal care. However, countries with poor health care infrastructures still suffer significantly problems related to high stillbirth rate.

Researchers continue to develop and test new techniques to reduce fetal deaths. Following advances in medical instruments and equipments, modern clinical medicine has made it possible to perform technology-assisted monitoring of fetal well-being throughout the pregnancy. For example, today we can perform prenatal screening tests using ultrasound scan technique to evaluate if any structural abnormalities exist, or conduct maternal blood test to measure the level of key physiological indicators [Larsson et al. (2008)], thus making early and timely treatment to save the fetus' life.

Clinically-available technologies for performing fetal well-being assessment during pregnancy are presented below [Johns Hopkins Medicine].

1.2.1 Doppler ultrasound and ultrasound imaging

Ultrasound-based technology can be used during early, middle and late pregnancy for different purposes. Conventional ultrasound techniques such as 2D and 3D ultrasound provide static images of the fetus' body parts, whereas Doppler ultrasound, based on the Doppler effect, can be used to visualize internal moving objects such as fetal blood flow. Being largely utilized in clinical practice for decades, though, concerns have been expressed about the exceeded exposure of ultrasound, which could have a negative effect on maternal and fetal outcome [Houston et al. (2009)]. For more detailed information about ultrasound technology for fetal assessment, the reader is referred to [Stampalija et al. (2010)].

1.2.2 Fetal heart-rate monitoring

Usually performed during late pregnancy and labor, fetal heart-rate monitoring assesses the rate and rhythm of the fetal heartbeat. Abnormalities on the fetal heartbeat

could be a sign of compression of umbilical cord or fetal hypoxia [Struzik et al. (2001)]. Fetal heart-rate monitoring can be done by using Cardiotocography (CTG) or fetal Electrocardiography (fECG) [Alfirevic et al. (2017)][Peters et al. (2004)].

The two above-mentioned technologies are commonly used in clinical practice with high reliability and accuracy. However, they usually require an in-hospital settings and trained personnel to manipulate the device, considerably limiting their availability.

1.2.3 Fetal Movement Monitoring: An Easily-Accessible Way to Assess Fetal Well-being

Fetal movements, the spontaneous motions of a fetus in utero that generated by his/her own muscles, are early expressions of fetal neural activities [Lai et al. (2016)] [Nowlan, N. C. (2015)]. Fetal movements can be felt by the mother from as early as 16 gestational weeks until late pregnancy. It is also reported that fetal movements perceived by the mother can be of different types and patterns as pregnancy progresses, such as fetal limb movements (kick, punch), body movements (twitch, twist, wriggle, roll), head movements, respiratory or a combination of the just-mentioned movements [Birnholtz et al. (1978)]. However, most fetal movements perceived by the mother are fetal kicks because they are stronger and more powerful, thus easy to be felt. In fact, in clinical practice, doctors and pregnant women often use the term "fetal kicks" to refer to fetal movements (see Fig 1.1).

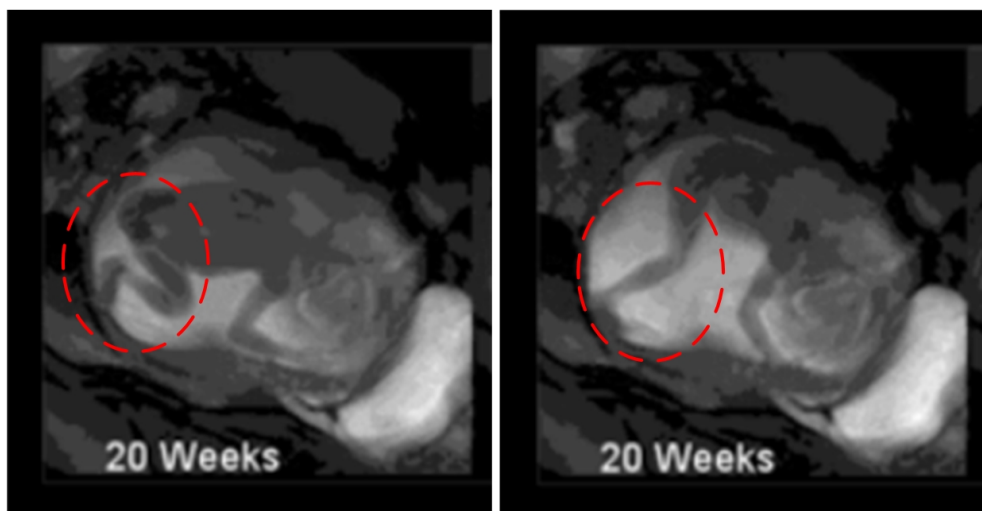

Figure 1.1 – A fetal leg movement ("fetal kick") of 20 weeks shown in MRI (Magnetic Resonance Imaging) Scan (adapted from [Verbruggen et al. (2018)]).

Regular fetal movements are a positive indicator of fetal well-being, whereas both changes and disappearance of fetal movements could be a sign to fetal hypoxia [Heazell et al. (2008)], fetal growth restriction [Jakes et al. (2018)] and neurological dysfunction [Prechtl (1990)]. It is also observed that fetal breathing movements could be reduced in cases of placental insufficiency [Neerhof et al. (2008)]. To save life of a fetus in case of

high risk pregnancy especially when placental insufficiency is long-standing, monitoring of fetal movements and early detection of fetal compromise during pregnancy has its greatest value [Lai et al. (2016)].

In clinical practice as well as in academia, there exist several major methods for the monitoring of fetal movements as listed below:

1.2.3.1 Ultrasound Imaging for Fetal Movement Monitoring

Ultrasound-based technology utilizes high frequency pulses to provide images of internal fetal anatomy, enabling the visualization of fetal movements inside the womb [Whitworth et al. (2015)]. Trained expertise may select the most relevant ultrasound mode based on specific requirements and needs. Recent research on 4-dimensional (4-D) Ultrasound technology further allows us to observe fetal movements on a real-time basis [Hata et al. (2010)]. In the literature, real-time ultrasound imaging is often taken as the gold standard for qualifying fetal movements. However, this technique usually requires an in-hospital setting. Besides, overuse and non-medical use of ultrasound devices could bring negative effects such as exposure of the fetus to ultrasound waves and potential danger caused by uncertified or untrained operators.

1.2.3.2 Maternal Perception of Fetal Movements

In clinical practice, doctors ask pregnant women to qualitatively and routinely record fetal movements by themselves. This technique is widely known as *fetal movement counting* or *kick counting* [Preston et al. (2013)]. Maternal perceptions of reduced fetal movements and early alerting caregivers in case of abnormalities help to determine the optimal time for delivery especially for high-risk fetus, saving their lives [Neldam (1986)]. In clinical practice, there exist different guidelines for how many kicks are normal in a certain time based on each country/region's situation and recommendations. Among them, the famous "count-to-ten" approach is generally acknowledged within the medical community. This approach helps effectively pregnant women to count fetal movements as well as to identify decreased fetal movement (DFM). The "count-to-ten" approach follows the 2-hours alarm" criteria, which means that DFM is identified if less than ten fetal movements are perceived within 2 hours [Winje et al. (2011)]. One example of "kick chart" used by the mother to record fetal movement counting is shown in Fig. 1.2.

Being widely used worldwide, however, the drawbacks of this approach are obvious. First, this approach suffers from imprecision and subjectivity, therefore leading to wrong diagnosis results. In practice, a pregnant woman usually has no time to perform long-term counting or she cannot fully focus on feeling fetal movements when she is busy working or caring for other babies. It is also reported that maternal counting of fetal movements sometimes leads to unnecessary concern and anxiety to the mother, placing an additional

Note: Tick the box with a pen

I start counting today (date, dd.mm.yy) ..

My due date is (dd.mm.yy) ..

I normally count between (time): and

WEEKDAYS	START COUNTING	MINUTES										WEEK											
		0-5	6-10	11-15	16-20	21-25	26-30	31-35	36-40	41-45	46-50		51-55	56-60	61-65	66-70	71-75	76-80	81-85	86-90	91-95	96-100	101-105
		5 minutes per box																					
		5 minutes per box																					
		Over 2 hours																					

Day 7
Day 6
Day 5
Day 4
Day 3
Day 2
Day 1

Day 7
Day 6
Day 5
Day 4
Day 3
Day 2
Day 1

Day 7
Day 6
Day 5
Day 4
Day 3
Day 2
Day 1

Day 7
Day 6
Day 5
Day 4
Day 3
Day 2
Day 1

Day 7
Day 6
Day 5
Day 4
Day 3
Day 2
Day 1

Day 7
Day 6
Day 5
Day 4
Day 3
Day 2
Day 1

Day 7
Day 6
Day 5
Day 4
Day 3
Day 2
Day 1

WEEK 28

WEEK 29

WEEK 30

WEEK 31

WEEK 32

WEEK 33

WEEK 34

Figure 1.2 – Fetal movement counting chart (reprinted from [Saastad et al. (2011)]).

burden on hospitals and maternity healthcare providers whose resources are generally limited [Mangesi et al. (2015)].

1.2.3.3 Accelerometer-Based Recording of Fetal Movements

As a result of fast developing technologies in microelectronics, sensors/actuators and telecommunications, monitoring of fetal movements using accelerometer sensors connected with embedded systems, portable devices or a personal computer has gained increasing attention. This technique is based on the fact that the maternal abdominal wall is thin, resulting in deflections on the abdominal wall when the fetus inside the uterus moves his body or limbs [Stanger et al. (2017a)]. This inspires researchers to place accelerometers on the maternal abdomen to record these deflections, and therefore to monitor fetal movements in a non-invasive way. Fig. 1.3 recaps the research work presented in [Boashash et al. (2014)], within which they utilized three tri-axial accelerometers placed on the maternal abdomen for the recording of fetal movements (one additional accelerometer was placed on the maternal chest in order to record maternal body motions - which are used as reference signals for artifact elimination). Similarly, a fetal movement monitoring device based on two accelerometers proposed by [Ryo et al. (2012)] together with the fetal movement signals acquired using their monitoring device is illustrated in Fig. 1.4.

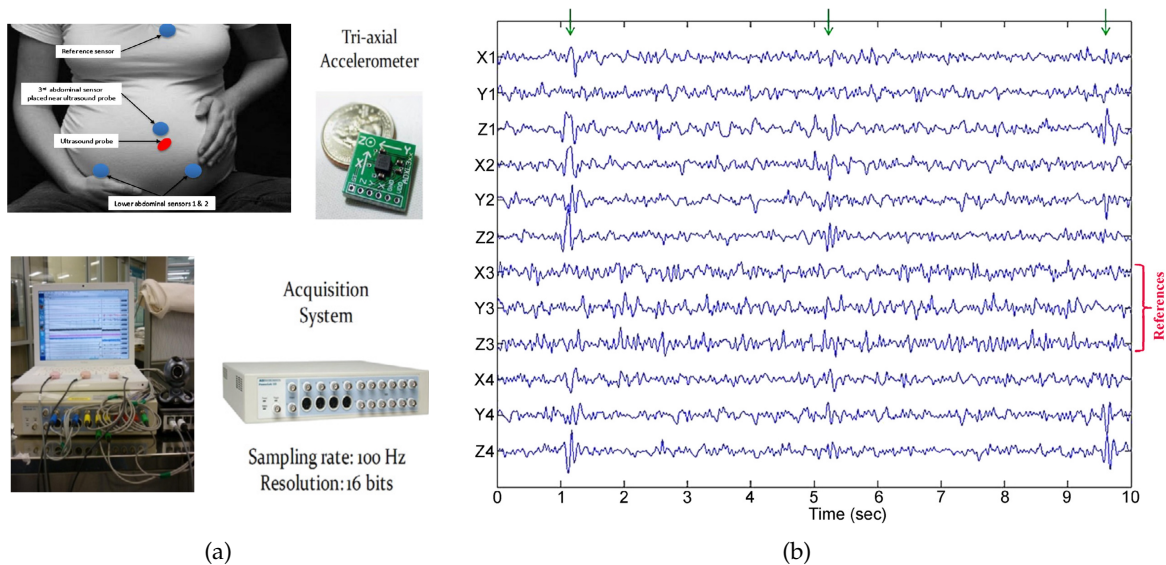

Figure 1.3 – (a) Tri-axial accelerometers are placed on the maternal abdomen for the recording of fetal movements, and (b) the acquired fetal movement signals (adapted from [Boashash et al. (2014)]).

Several works have been published on the processing and analysis of accelerometer-recorded fetal movement signals. Probably the first research work involved in this topic, [Girier et al. (2010a)] utilized a simple threshold to group the sensor signals into *fetal movement* or *non-fetal movement* based on the signal's amplitude. [Minjie et al. (2012)] applied wavelet transform technique to decompose the signal frequency representation into components of different levels. [Khlif et al. (2011)] [Boashash et al. (2014)] introduced TF

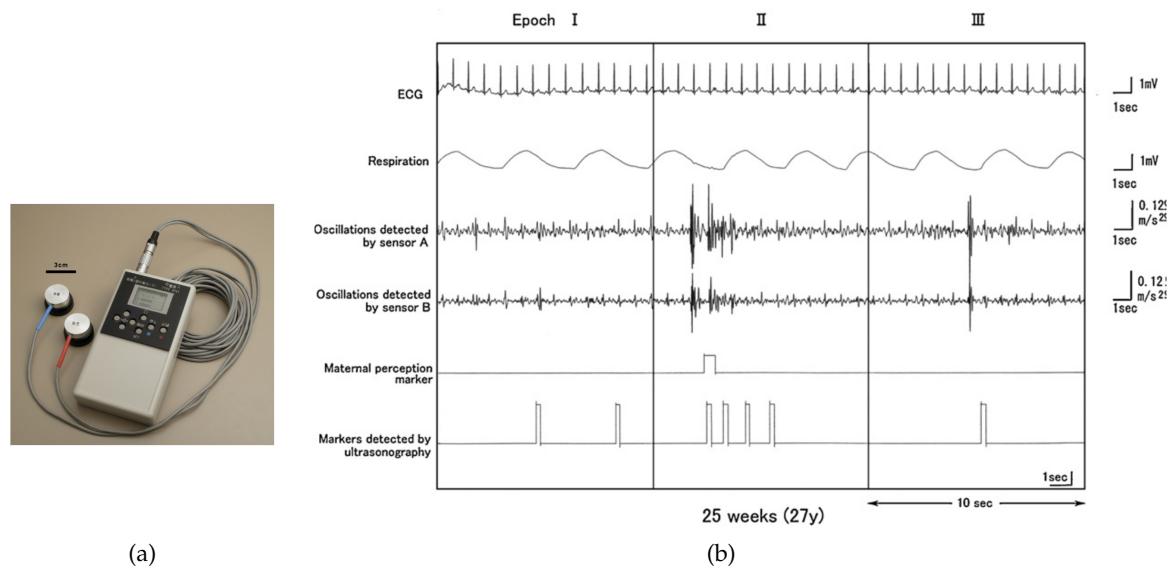

Figure 1.4 – (a) An accelerometer-based fetal movement recorder together with (b) an example of acquired signals using the recorder (only acceleration signals on z-axis were studied and illustrated) with other physiological signals e.g. maternal ECG and respiration (adapted from [Ryo et al. (2012)]).

(Time-Frequency) analysis in order to achieve a better frequency resolution of recorded fetal movement signals. However, the drawback of their work lies in the high computational complexity which hinders it from being applied in wearable embedded systems. [Layeghy et al. (2014)] [Altini et al. (2016)] employed machine learning technique to classify the sensor signals into fetal movement or not based on the features extracted from these signals. [Nishihara et al. (2015)] developed a software for automated detection of fetal movements based on analyzing the amplitude of the acquired sensor data.

The above-cited researches systematically utilized ultrasound records, which is widely regarded as the gold standard for fetal movement monitoring, as a reference to evaluate their proposed methods. However, using ultrasound simultaneously when recording fetal movement signals with accelerometers raises a problem: moving the probe back and forth could introduce additional noise which significantly interferes with the accelerometers. To overcome this problem, [Altini et al. (2016)] [Altini et al. (2017)] utilized maternal perceptions as a reference for fetal movement recording. Despite that the sensitivity of maternal perceptions on the ultrasound-observed fetal movements is relatively low, using maternal perceptions as reference rather than ultrasound is still reasonable [Hijazi et al. (2010a)]. Finally, differing from the research works that only applied accelerometers, [Lai et al. (2018)] presented a fetal movement monitoring system based on a combination of accelerometers and acoustic sensors in order to deal with the problem of maternal body motion artifacts.

Despite encouraging achievements, the above-mentioned accelerometer-based and technique-assisted studies still face challenges before they can be widely used in clinical practice. At the hardware level, they collectively lack a systematic consideration of im-

plementing their proposed approaches into a portable and embedded system and further embedding the electronic components into a garment or a wearable accessory in order to offer a good usability and comfort to the user, limiting their potentials. At the software level, most of the published studies only focus on the signal processing of sensor-recorded signals and the related algorithms for the automated detection of these signals. However, there is no study on how to relate these signals to the real health status of the fetus being monitored.

The reader may have already noticed the numerous disadvantages of the above-mentioned fetal monitoring techniques currently used in clinical practice or studied in the literature, whether for those professional instruments which are expensive, low accessibility, lack of continuous monitoring ability, need of an in-hospital setting, etc., or for the newly-developed and accelerometer-based techniques but suffering from limited comfort level, low portability, low reliability and low robustness, significantly limiting their effectiveness and performance.

A combination of sensor-based approach for fetal movement monitoring with the promise of wearable technology while enhancing the intelligence level by employing embedded AI could be a good alternative to solve these issues. The following section presents the promise of wearable technology, its successful applications as well as its potential of solving the above-mentioned issues.

1.3 WEARABLE SENSORS AND SYSTEMS: A BRIEF REVIEW

1.3.1 Wearable Technology: Next Generation of Human-Machine Interaction Medium

Wearable systems based on wearable sensors are a broad concept, it can refer to any electronic devices integrating small size sensors that can be worn on the human body in order to 1) offer auxiliary functions to facilitate the everyday life of the wearer (e.g., providing information such as time, environmental temperature, humidity, etc.), 2) monitor the health condition of the patients who are under specific situations (e.g., chronic diseases, intensive care, rehabilitation, etc.), 3) giving guidance to the targeted population (e.g., the elderly, the disabled, soldiers, athletes, etc.) as well as providing feedback to their supervisors (e.g. a clinician in the hospital, an officer or a sport coach). Being the next generation of human-machine interaction medium, wearable systems have great potential in the future.

A typical wearable system should at least comprise three basic elements, namely 1) one or a series of sensors and/or actuators, 2) an embedded system comprising a microcontroller for on-board signal processing and storage, and 3) a physical support (e.g., a garment, a wristband, a chest strap, etc.) that integrates sensors and other electronic components in order to fix them to the human body.

At first consideration, a wearable system, as its name indicates, should be *wearable* and *portable*. The entire device should be ergonomically and carefully designed with all the necessary electronic components (e.g. sensors, data processing devices, battery, etc.) embedded into that physical support which perfectly fits the human body shape. It should provide services to the user in a comfortable, convenient and intelligible way while minimizing disturbance to the user. It should be light in weight, no or little invasive. Besides, the design of a wearable device should fully consider minimizing the restriction of the wearer's movements, especially if the target users are engaged with intensive physical movements when wearing these wearable devices (e.g., a wearable system for monitoring an athlete's training effectiveness, or a wearable system, used for firefighters in action, that monitors extreme environmental conditions). Obviously, a system with sensors exposed and connected by bulky electrical wires and cables to other cumbersome devices and instruments, with which the wearer's daily activities and body motions are significantly restricted or limited, is outside the scope of the notion of "wearables".

Most recent wearable systems are equipped with a wireless communication unit for data transmission, such as transmitting raw signals acquired with the sensors or data from the embedded processing unit, to the nearby access point or personal computer via short-range communication protocols (e.g., Bluetooth, Zigbee) for offline data storage and analysis. It is worth noting that most modern wearable devices are connected to the user's smartphones or tablets. Connecting the wearable systems to the users' smart mobile devices brings benefits, as with the rapid development of Information Technology (IT) and microelectronics technology, these high-end portable communication devices feature large storage capacity for the local storage of data as well as increased computing power which can be used for the online processing of the data from wearable sensors and systems. Besides, they are also served as a GUI (Graphical User Interface) which provides the user with key information related to the wearable systems in a visual and intelligible way. Moreover, using these mobile devices as a network gateway or an Access Point (AP), wearable devices can be easily connected to a remote cloud computing platform or a remote control center via the Internet. This builds direct interactions between the wearers and their supervisors which, in turn, provide remote services and consultations to each end-user. Connecting wearable devices to a remote cloud computing platform also helps to perform new knowledge exploitation from measured physiological data using advanced data-mining techniques [Park et al. (2014)].

In clinical medicine, remote health monitoring using wearable systems could benefit the public health care system as it helps to significantly reduce the use of medical resources. This is because that with wearable systems, the information related to the target patient's health condition and other physiological parameters can be remotely and continuously monitored by the caregivers while the patient himself doesn't have to stay in hospital during rehabilitation.

A comprehensive architecture of a typical wearable system in the example of health monitoring for elderly population is illustrated in Fig. 1.5. In this example, heart rate

sensors and respiratory sensors are fixed on the patient's body by using a body strap while motion sensors (e.g., accelerometers) are fixed using a wristband on the wearer's wrist and ankle in order to maximize the acquired motion signals' amplitude when the wearer moves his limbs.

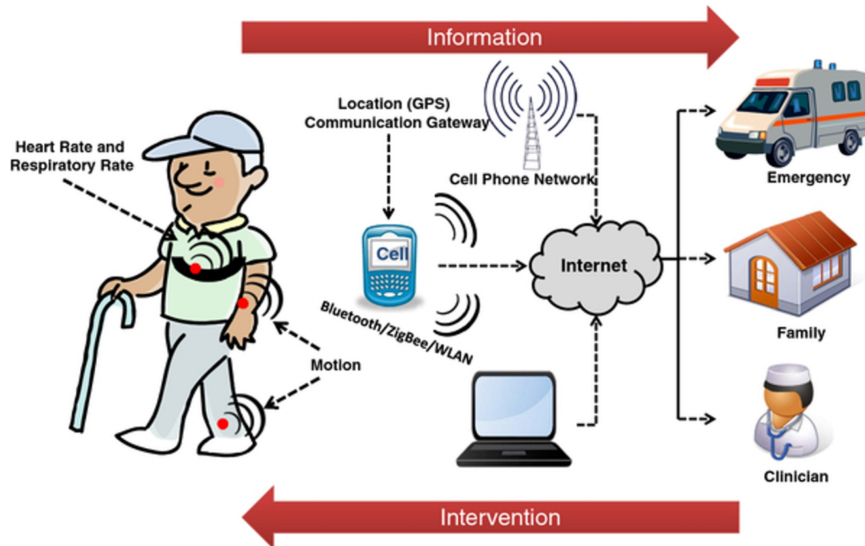

Figure 1.5 – General representation of a remote health monitoring system based on wearable sensors (reprinted from [Patel et al. (2012)]).

1.3.2 Intelligent Garments

Garments or clothing are indispensable in our daily life. Our ancient ancestors learned to cover their bodies with animal skins, leaves, stems or other natural fibers especially if they lived in a cold climate and needed something other than their skin and hair to keep warm. With thousands of years in the development of textile industry, people have learned to make clothes and fabrics with yarns and fibers by using various advanced techniques such as weaving, knitting and spinning. In modern society, we human beings need garments not only for covering our torso and limbs to protect ourselves from harsh weather, but also for many other reasons. For example, we need special clothes to protect our skin from harm or injury when performing dangerous labor in certain situations (e.g., high-visibility clothing, usually called "Hi-Vis", features highly luminescent property which protects the wearer from potential accidents by making the wearer more visible to other people around). Besides, garments also bring us specific cultural and social meanings.

The fact that a garment is worn during most of the time in a day with close contact to the wearer's body motivates researchers to integrate wearable devices into the garment fabric. This brings significant advantages, since garments provide a suitable support to those embedded wearable sensors, allowing them to be perfectly located next to the wearer's skin when acquiring his or her physiological and motion signals. Besides, compared to wearable accessories such as wristbands or smartwatches, a garment is capable of integrating more wearable sensors and covering larger area of human body, therefore

collecting more physiological signals. Moreover, a garment enables to optimally design the textile structure in order to perfectly integrate miniature electronic components connected with a flexible wireless network into the garment while maintaining the comfort and accessibility to the wearer even for a long-term use.

The above mentioned garments integrating sensors and other electronic components into its fabric structure are commonly referred to as *intelligent garments*, *smart clothes* or *e-textiles* in the literature. Considered as one category of wearable systems, an intelligent garment is playing an essential role for human activity monitoring and physiological health monitoring in modern society [Suh et al. (2010)]. Currently, a large number of intelligent garment prototypes have been developed for monitoring of chronic diseases, aged people, disabled people, etc. [Chan et al. (2012)]. Several examples are given below.

The cardiovascular illnesses can be detected from online analysis of signals of ECG measured from the instrumented garment [Maric et al. (2009)]. For patients with diabetes, glucose level and insulin infusion can be continuously controlled by an artificial pancreas [Gómez et al. (2008)]. Monitoring of wearer's posture and movements can be realized by accelerometers mounted on a belt attached to the lumbosacral region. This allows the evaluation of motor recovery and physical efficacy for hemiplegic stroke patients [Akay et al. (2003)]. Human postures and gestures can be monitored by a number of accelerometers and magnetometers mounted on the garment. These sensors can be electronic devices or textile materials [Lorussi et al. (2009)]. Moreover, complex movements can be detected by combining several mobile sensors attached to the garment: a gyroscope, a compass, an accelerometer, a magnetometer, a piezoelectric sensor, and a GPS (Global Positioning System) [Gabaglio et al. (2000)].

Many intelligent garment prototypes have been developed for helping aged people, particularly for detecting wearer's fall and geolocation. Regarding fall detection, the embedded system integrated into the garment can collect signals of acceleration, vibration and inclination in order to determine if the predefined thresholds are exceeded or not. This system enables to take a decision from a single signal or a combination of several different signals [Zhang et al. (2006)]. A tri-axial accelerometer mounted on the wearer's belt, combined with a wireless communication network of Zigbee type to a remote center, is a method frequently used in these prototypes. The wearer's position can also be identified from measures of several accelerometers, mounted on five positions of the human body respectively: ankles, thighs, hip, arms and wrists, and a detection algorithm of the microcontroller, merging all measured data on the walk of the wearer [Mannini et al. (2015)].

Despite numerous publications in the literature, many researches suffer disadvantages which hinder the effective implementation of their proposed solutions and systems:

1. The current systems have been developed by the approaches of material, design and ICT (Information and Communication Technology) separately and they lack a systematic integration of various technologies to meet specific functional requirements while maintaining human comfort, aesthetics and easy to care. For example, most

of the wearable systems presented in the literature suffer from a bulky structure with wires and other electronic components exposed outside to the user, causing an unpractical and even dangerous measurement environment.

2. The existing systems mainly focus on hardware (sensors, actuators) and related software development is relatively weak, which restricts exploitation of measured human data. In practice, an effective and sustainable business model of wearable systems can be obtained by deeply exploiting measured physiological data [Park et al. (2014)].

1.3.3 Sensors Used in Wearable Systems

As an essential component of wearable systems, wearable sensors are designed to acquire *physiological signals* such as respiratory rate, heart rate, ECG, EEG (Electroencephalography), EMG (Electromyography), blood pressure and blood oxygen saturation, *motion signals* such as gestures or body motions, and *location signals* of the wearer on a regular basis based on required specifications, etc. Generally speaking, these wearable sensors require close contact with the wearer's body or skin when being worn in order to ensure good quality of the acquired data. By analyzing and processing the acquired sensor data, a wearable system is able to perceive the environment around it and therefore take corresponding actions or provide suggestions to its wearer. Physiological signals that can be measured from human body using wearable sensors are shown in Fig. 1.6.

Correspondingly, different types of wearable sensors have been invented and commercialized in accordance with the requirement of acquiring different types of signals as mentioned above. A list of different types of wearable sensors in corresponding to the vital signals that each sensor is able to acquire is shown in Table 1.1.

Table 1.1 – List of vital parameters assessed using different types of sensors.

Type of vital signals	Type of sensor	Signal source
Electromyogram (EMG)	Skin electrodes	Electrical activity of a muscle
Electroencephalogram (EEG)	Scalp-placed electrodes	Electrical activity of brain, Brain potentials
Activity, mobility, fall	Accelerometer	Gesture posture/limb movements
Respiration rate	Piezoelectric/piezoresistive sensor	Inspiration and expiration per unit time
Heart sounds	Phonograph	Record of heart sounds, with a microphone
Blood glucose	Glucose meter	Assessment of the amount of glucose in blood
Oxygen saturation	Pulse oximeter	Oxy-hemoglobin in blood
Body or skin temperature	Temperature probe or skin patch	Body or skin
Galvanic skin response	Woven metal electrodes	Skin electrical conductivity

Note. Reprinted from [Chan et al. (2012)].

Thanks to the fast developing technologies in microelectronics, sensor technology and MEMS (Microelectromechanical Systems), it is nowadays possible to manufacture small size and lightweight sensors with high sensitivity, low price, high performance and energy consumption efficiency, promoting the vigorous development of wearable technologies. Today's sensors can be easily embedded in a garment or an accessory for long-term use

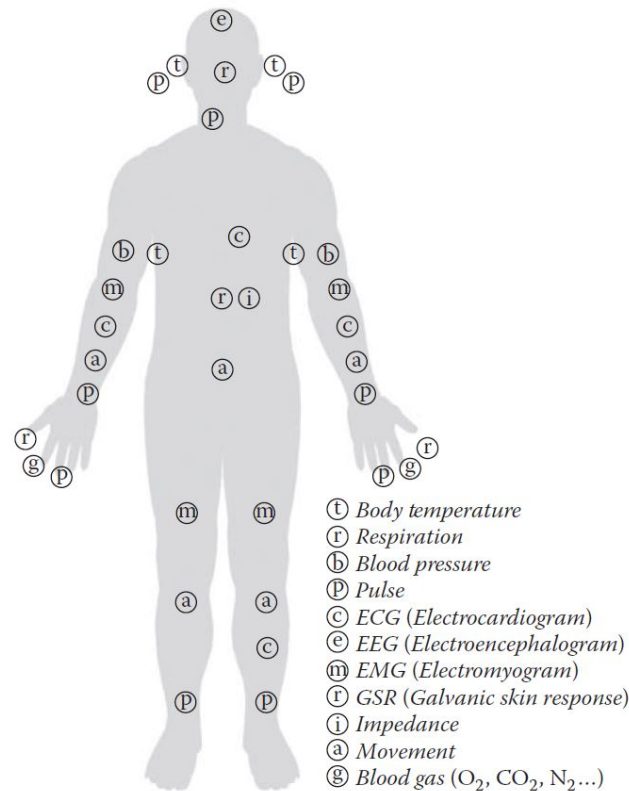

Figure 1.6 – Physiological signals that are monitored from human body (reprinted from [Cho (2009)]).

without interfering with the wearer's daily life, which could scarcely be imagined several decades ago. With careful and ergonomics design, some of wearable sensors can be perfectly hidden inside a wearable structure without even being noticed by the user when being worn. For the sake of clarity, Fig. 1.7 illustrates the Apple Watch, a smartwatch from Apple Inc, where we can see those tiny size sensors are perfectly integrated into the watch structure.

Moreover, recent breakthroughs in electrochemical techniques enable sensors to be flexible [Nag et al. (2017)] and textile-based [Cherenack et al. (2010)], further enhancing the comfort and flexibility of the wearable systems. Flexible and textile-based sensors are fabricated with non-rigid materials so that they can be bended at a certain angle or even folded without interfering with their mechanical and electrical properties. An example with flexible sensor array is illustrated in Fig. 1.8.

Besides the above-mentioned wearable sensors which are worn on the human body, there also exist patchable and implantable wearable sensors which are, more exclusively, used for acquisition of human biochemical signals. This thesis is not aimed at providing detailed presentation and application of these types of sensors because they are beyond the scope of our research work, but the interested readers are referred to [Ashbrook et al. (2018)] for a more detailed introduction.



Figure 1.7 – Illustration of the Apple Watch with sensors perfectly integrated inside the back of the watch structure [iFixit].

1.3.4 Processing Units of Wearable Systems

As a result of the advanced technologies in edge computing and IoT, it is now possible for wearable systems to locally process and store sensor data with high integration level and high performance microcontrollers. This brings significant benefits to the development and evolution of wearable systems, of which the arguments are stated as follows: 1) Rather than sending raw sensor data directly to the nearby access point, wearable systems can now locally perform preliminary processing and treatment of sensor data, and only send data processing results to the nearby access point. This could significantly save the battery life and improve the power efficiency. 2) By running embedded rule-based decision making algorithms, wearable systems become more intelligent. They can now provide first-level suggestions to the user and send alarm messages automatically to caregivers at first time in case of urgency. This also avoids the delay caused by the transmission of local data to the remote center. 3) Local processing of sensor data also contributes to a better security level in terms of user data and privacy protection. 4) Most modern microcontrollers feature popular serial communication protocols such as I^2C (Inter-Integrated Circuit) and SPI (Serial Peripheral Interface), which ensures easy communication with the nearby sensors via flexible and light-weighted wires. Commonly used microcontrollers applied in wearable systems are listed in the Table 1.2:

Table 1.2 – Commonly used microcontrollers for wearable systems.

Microcontroller Family	Manufacturer	Examples
STM32 family	STMicroelectronics	[Fu et al. (2015)]
AVR family	Microchip (Atmel)	[Buechley et al. (2008)]
MSP430 family	Texas Instruments	[Wu et al. (2016)]
Field Programmable Gate Array (FPGA)	Xilinx	[Ahola et al. (2007)]

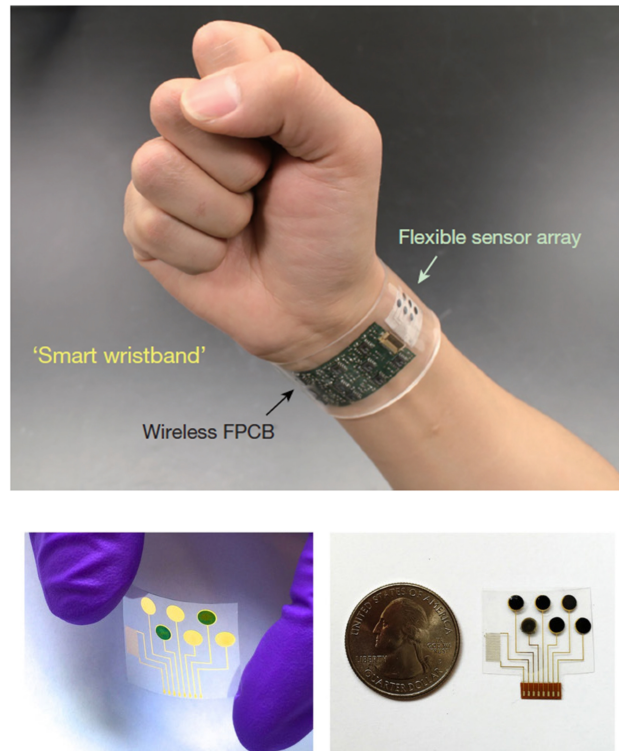

Figure 1.8 – A smart wristband integrating flexible sensors presented in [Gao et al. (2016)].

The STM32 family from STMicroelectronics, based on ARM cortex platform, provides high performance microcontrollers. For example, the STM32F7 series with Arm Cortex-M7 core provides up to 216MHz CPU (Central Processing Unit) frequency. The AVR family from Microchip often features a 8-bit CPU architecture. It is quite well known in the DIY (Do It Yourself) community due to the fact that it supports the famous Arduino library and its ecosystem which is great for prototyping and pilot production of customized embedded devices and systems (note that some recent STM32 microcontrollers also support Arduino). The MSP430 features advantages such as low cost, low power consumption and stand alone applications which do not require much processing. The FPGA, on the other hand, can be configured "in the field" by the designers to perform specific operations. It is fully re-programmable and executes all the operations in a parallel way.

Nowadays, high-end microcontrollers support the on-board implementation of several Operating Systems (OS) that are specifically designed for running in an embedded environment with relatively low hardware resource and memory requirements. The use of embedded OS on a wearable system brings benefits such as the support of real-time functionalities for time critical applications, multithreading and optimal management of hardware resources [Ojo et al. (2018)].

1.3.5 Embedded Intelligence - Improving the Intelligence Level of Wearable Systems

Cutting-edge technologies in AI and ML specially targeted to embedded systems make it possible to run pre-trained machine learning models on a microcontroller on a online and real-time basis, enhancing the wearable system's performance in terms of sensor signal classification accuracy [Luna-Perejón et al. (2020)]. Being a member of "*Intelligence on the edge*", "*Edge Machine Learning*" or "*Edge AI*" family, today's wearable systems are able to locally process the wearer's physiological data using the AI algorithms stored on a hardware device instead of getting them remotely processed in the cloud computing platform. Successful business applications of embedded AI comprise STM32Cube.AI ecosystem [STMicroelectronics] and Tensorflow Lite [Google Inc.].

Applying AI and ML to wearable and embedded devices has great potential, since this not only enables onboard and local data processing, decision making and inference, but also helps to significantly reduce the power consumption due to wireless transmission and security vulnerability associated with cloud-based data processing. However, edge machine learning is still a new field where relative tools, SDKs (Software Development Kit) and developing environments are relatively immature.

1.3.6 Wireless Communication Solutions Used in Wearable Systems

Faster, farther, the recent advances in various wireless communication protocols in technologies have significantly boosted the potential capabilities of wearable sensors/wearable systems and have made them become more prevalent than ever. Applications and contributions of wireless technology to the field of wearable systems can be found in four aspects:

1. It enables a stable and wire-free data exchange between the embedded processing unit of a wearable system and the nearby router or access point (e.g., a personal computer, smartphone or tablet). This contribution is crucial, as it largely enhances the freedom of movement of the user by eliminating those cumbersome wires connecting those body-worn sensors to the nearby devices for offline data storage.
2. It allows the development of a wireless sensor network that wirelessly interconnects each sensor. Such network configuration is commonly called Wireless Body Area Networks (WBAN) in the literature [Movassaghi et al. (2014)]. This largely benefits the comfort and usability of a wearable system as it further helps to remove physical wires that were once used to connect each sensor to the embedded processing unit.
3. It makes wearable systems more solid and durable by eliminating the physical connections between sensor-sensor and sensor-microcontroller, thereby prolonging service life.
4. When it comes to an intelligent garment, wireless technology further improves the system's comfort and user experience by eliminating those physical wires and connectors inside the garment fabric.

A technical comparison of the wireless communication technologies that are commonly used in wearable systems can be found in Table 1.3.

Table 1.3 – *Technical comparison of key characteristics of the wireless technologies that are commonly used in wearable systems.*

Features	IEEE 802.11 (Wi-Fi TM)	WiMedia (UWB [®])	IEEE 802.15.1 (Bluetooth [®])	IEEE 802.15.4 (ZigBee TM)
Battery life	Hours	Days	Days	Years
Cost per module	\$9	\$6	\$6	\$3
Complexity of MAC and physical layers	Very complex	Simple	Complex	Simple
Radio spectrum	2.4 GHz	3.1-10.6 GHz	2.4 GHz	868 MHz, 915 MHz, 2.4 GHz
PHY coding	OFDM	OFDM	FHSS	DSSS
Max. data rate	54 Mbps	480 Mbps	700 kbps	250 kbps
Network size	32 nodes	Unknown	7 nodes	64 000 nodes
Security	WEP keys	128 bits AES	64, 128 bits	128 bits AES
Range	100 m	10 m	10 m	30 m
Applications	High-bandwidth applications	High-bandwidth cable replacement	Low-bandwidth cable replacement	Low-bandwidth sensors and automation

Note. Reprinted from [Hao et al. (2008)].

1.3.7 Applications of Wearable Systems

In the smart wearable market, there exist already many mature commercial products available especially in sports and fitness tracking. Most of these wearable products feature different types of sensors integrated inside one single device that is able to monitor motion sensing, heart rate, breathing rate, blood oxygen saturation levels, etc. simultaneously. Fig .1.9 illustrates several successful commercial products available in the market. Specifically, Google Inc. has introduced and industrialized a *smartglasses* that integrates some exciting innovative ideas such as an embedded camera for taking photos and recording videos, a build-in screen and a touchpad for facilitating the manipulation of the glasses. However, reports from consumer markets have shown that the consumer adoption of such intelligent glasses is quite low due to their impractical functions and high price [Nunes et al. (2018)].

From a more general point of view, however, the scope of potential applications of wearable systems could be much larger. It may includes, but not limited to, vital sign monitoring for patients, well-being monitoring for dependent population (the population aged 0-19 and 65 and over), people suffering from chronic diseases, GPS tracking for soldiers, firefighters, etc., posture and motion monitoring for training athletes, motor recovery, fall detection, rehabilitation, movement and muscle activity recovery, the list goes on. After a critical survey of the published papers, projects as well as commercialized products within the area of wearable technology between 1993 and 2012, [Chan et al. (2012)] published a comprehensive review of the state-of-the-art wearable system prototypes/commercialized

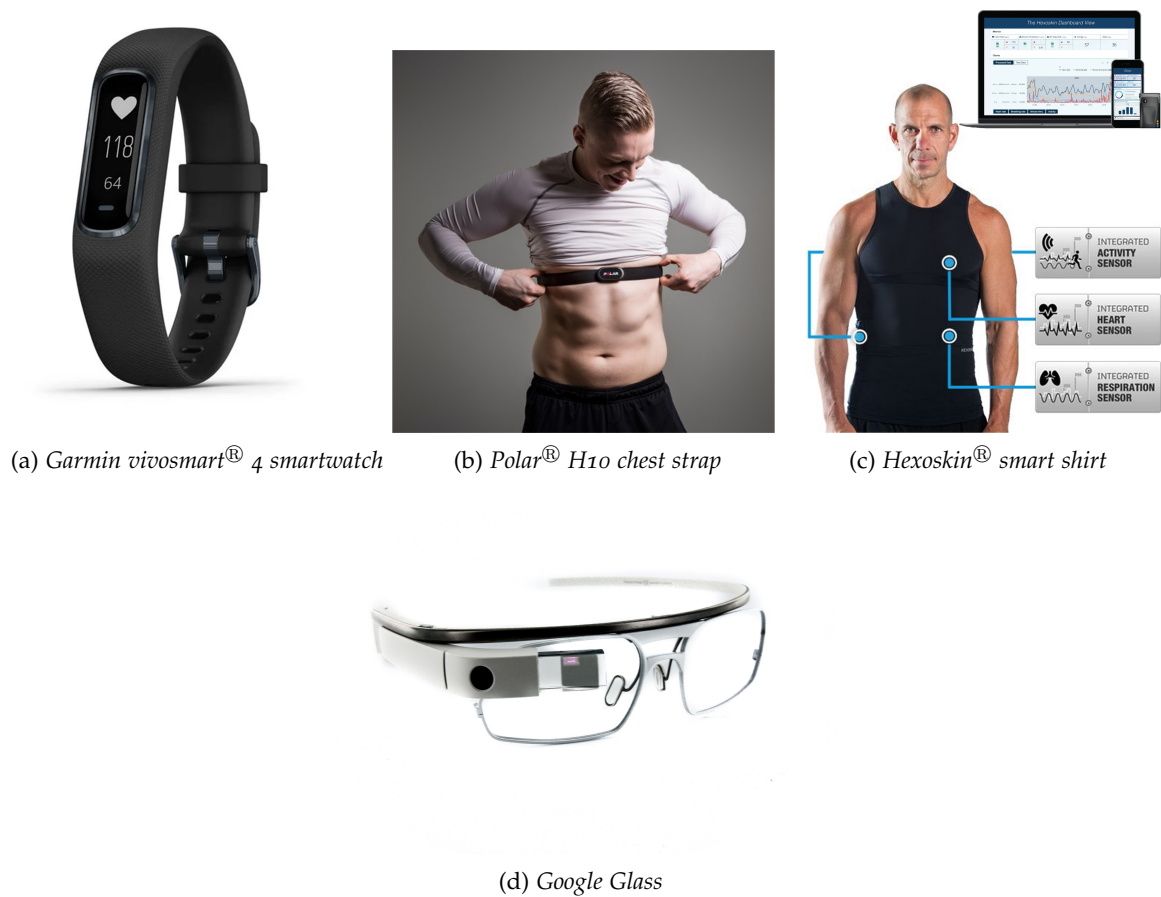

Figure 1.9 – Some examples of commercialized smart wearables, (a) A smartwatch for monitoring heart rate, blood oxygen saturation levels and GPS tracking, (b) a comfortable chest strap for monitoring heart rate, (c) a smart shirt for ECG (electrocardiogram), heartbeat, heart rate variability, breathing rate, etc. and (d) Google Glass, a smart glasses integrated a touchpad, a camera as well as a display.

products dedicated to a variety of applications with most representative and illustrative examples as listed in Table 1.4. Note that by the time this thesis is being written, some among them are no longer available (their website links mentioned in the article are no longer accessible) and have been excluded from the original table.

Table 1.4 – List of wearable systems

Author	System description	Applications
Santini et al. (1999)	Microchip	Autonomous controlled release implant ('Pharmacy-on-a-chip') or controllable tablet ('smart tablet') for oral drug delivery
Curone et al. (2007)	'ProeTEX' smart garment	Health-state parameters, environmental variables
Curone et al. (2010)		
Kario et al. (2003)	Multifunctional device	Heart rate, physical activity
Gómez et al. (2008)	Pumping, controller and power system	Insulin controller to achieve regulation of blood glucose
Fissell et al. (2007)	Unique technology toolkit, MEMS system	Membrane prototyped for renal replacement
Okubo et al. (2008)	Home care sensor system	Respiratory diseases
Islam et al. (2007)	Wellness monitor	Wellness for patients suffering cancer

Akay et al. (2003)	Accelerometer unit	Body motion in healthy subjects, patients with Parkinson's disease and post stroke hemiplegic patients
Prochazka et al. (1997)	Electrical stimulator garment (glove)	Controlled grasp and hand opening in quadriplegia
Lorussi et al. (2005)	Strain sensors integrated in garments (gloves, leotards etc.)	Hand posture and gesture monitoring
Niazmand et al. (2011)	Sensor based smart glove	Parkinson's disease evaluation
Coyle et al. (2009)	Textile-based sensor ('Biotex')	Measuring sweat
Katsis et al. (2011)	'Aubade' sensor system	EMG, ECG, respiration, skin conductivity (EDR)
Jovanov et al. (2003)	Wireless intelligent sensor system	Heart rate variability for stress measuring
Jourand et al. (2010)	Wearable textile garment	Sudden infant death syndrome
Rimand et al. (2007)	Bootee	Wearable multiparameter monitor
Anliker et al. (2004)	'Amon' portable telemedical monitor	High-risk cardiac/respiratory patients
Wu et al. (2009)	RFID ring-type pulse sensor, optical sensor	Pulse and temperature signals, heart rate measures
Haahr et al. (2008)	Electronic patch	EMG, arterial oxygen saturation
Ma (2011)	Electronic second skin	Antenna, LED (Light-Emitting Diode), strain gauge, temperature sensor, ECG, EMG, Wireless power coil, RF coil, RF diode
Miwa et al. (2007)	Wearable sensor	Roll-over detection, sleep quality
Lanata et al. (2010)	Wearable system	Several vital signs and physiological variables to determine the cardiopulmonary activity during emergencies
Bamberg et al. (2008)	Shoe	Gait analysis
Simone et al. (2007)	Glove	Monitoring and functional hand assessment
Beach et al. (2001)	In vivo telemetry system	Improvement of the function of an implant evaluated in situ, in blood vessel growth (angiogenesis), reduced inflammation, reduction of foreign body encapsulation
Maqbool et al. (2009)	Smart pill	Monitoring system with scintigraphy for measuring whole gut transit
Chaudhary et al. (2010)	Biosensor	Glucose measures
Giorgino et al. (2009)	Sensorized cloth	Remote monitoring and control of motor rehabilitation
Vivago	'Vivago' (Wellness monitoring)	Vital signs
Lee et al. (2005)	'Lifeguard' cigarette pack size box	Physiological signs
Sung et al. (2005)	'LiveNet' mobile platform	Accelerometer, ECG, EMG, galvanic skin conductance
Chien et al. (2005)	Portable system	PCG (Phonocardiography), electrocardiography, body temperature, Bluetooth
Jagos et al. (2008)	Shoe	Human gait
Riva et al. (2009)	'Intrepid' multi-sensor context-aware wearable	Anxiety
Vuorela et al. (2010)	Portable signal recorder	Electrocardiography, bioimpedance and user's activity
Di Rienzo et al. (2007)	'MagIC' vest	Atrial fibrillation, atrial and ventricular ectopic beat, ECG, respiration rate, skin temperature
Luprano (2006)	'Meremoth' clothes	ECG, respiratory inductance plethysmography, skin, temperature, activity
Weber et al. (2005)	VTAM clothing	ECG, GPS, biosensors and bioactuators
Knight et al. (2005)	'SensVest'	Vital signs: movement, energy expenditure, heart rate, body temperature
Borges et al. (2008)	'Smart-Clothing'	Fetal movement in the last 4 weeks of the pregnancy

Mithril	'Mithril'	Supporting daily use functions: grocery list, messaging, e-mail, conversational note taking, and movie recommendations
Pandian et al.	'Smart Vest'	ECG, PPG (Photoplethysmogram), heart rate, systolic and diastolic blood pressure
Shnayder et al. (2005) Chung et al.	'CodeBlue' mote based system A u-healthcare system	Pulse oximetry, ECG, EMG, mobility activity ECG, blood pressure patterns transmitted to the hospital
Loew et al. (2007) Xiao et al. (2009)	'BASUMA' 'MicaZ' mote based system	Chronically ill patients Heartbeat, ECG, blood pH, glucose, mobility, walking
Guo et al. Oliver et al. (2006)	BSN based system Wireless medical monitoring system	Vital signs Surgery recovering patients
Sullivan et al. (2005) Schneider et al.	'Verichip' Implantable sensor	Patient identity Nerve stimulation capable of alleviating acute pain in patients suffering cancer or Parkinson's disease
Valdastri et al. (2004)	Implantable telemetry platform system	Gastro oesophagus pressure, pH, glucose monitoring
Igor et al. (2012)	Wireless capsule	Endoscopy
Sieg et al. (2004)	'GlucoWatch Biographer'	Blood glucose measure
Buford et al.	Microwave sensor	Blood glucose measure
Jiang et al. (2010)	Carbon nanotube electrode	Glucose concentration in human serum
Bhattacharya et al.	Carbon nanotube based sensor	Detection of viruses
Kawano et al.	Si microprobe electrode	Neural recording, stimulation of neurons
Cherevko et al.	Gold nanowire array electrode	Glucose detection
Lu et al.	Doppler radar system	Heartbeat measures
Morgan et al.	Doppler radar system	Cardiopulmonary sensing
Yazicioglu et al.	Ultra-low-power biopotential interfaces	EEG measure
Hayes et al. (2001)	Probe	Pulse oximetry, Photoplethysmographic signal or blood volume pulse
Lee et al.	Wearable or automatic defibrillator	Sudden cardiac death
Bourennane et al. BodyMedia	Identification, location 'Bodymedia' health wear armband	Dangerous events detection Vital signs
WelchAllyn	'Micropaq' wearable device worn in a carrying pouch	Pulse oximetry, ECG
Cardionet Medtronic	'Cardionet' 'CGMS' 'Guardian'	Cardiac patient telemetry system Glucose concentration variation Hypo and hyper glucose concentration measurement
Poscia et al. (2003) Varalli et al. (2003)	'Glucoday'	Subcutaneous glucose level measurements
Bleakly (2011)	'FreeStyle Navigator'	Interstitial glucose measurements

Note: Adapted from [Chan et al. (2012)].

1.3.8 Current Challenges of Wearable Technology

Despite the promising achievement of smart wearable systems in the field of health monitoring and disease prevention, rehabilitation and fitness tracking, there still exist significant challenges before they are clinically accepted and used on a large scale. Barriers that need to be addressed in the future are listed as follows.

1. The consumer market for wearable systems in the field of health and fitness track-

ing is relatively mature with a large diversity of commercial products can be found nowadays (e.g., fitness tracking wristbands or smartwatches). This is due to the fact that they are technically simple and do not require rigorous and accurate feedback to the wearer. However, when it comes to health monitoring of dependent people especially for those who are under emergency conditions (e.g., patients suffering heart diseases, stroke survivors, or aged population with chronic health problems, etc.), the technical and clinical validation on the wearable systems designed for these target population could be extremely strict before they can be largely applied on a large scale. Concerns involve low accuracy in disease detection, false alarms and considerable delay in data processing due to limited on-board computation resources, which could be fatal when it comes to intensive care of patients under special conditions, as well as computer-supervised rehabilitation for various conditions in both in-hospital and home-based settings.

2. Wearable systems used for the monitoring of physiological signals such as ECG or EEG signals suffer body motion artifacts from the wearer which are hard to be filtered with conventional signal processing approaches [Baig et al. (2017)]. Therefore, future wearable system design should take advanced signal processing techniques as well as motion artifact elimination techniques into consideration.
3. The level of intelligence of the wearable system as a whole need to be further enhanced. This can be done by investigating embedded AI and machine learning algorithms that can be integrated into the wearable system and run online. Besides, further studies are needed to connect wearable systems to a cloud or remote server with which data are exchanged over the air and advanced services powered by cloud-computing and data mining technique are provided remotely to each user.
4. Since it is nowadays possible to transfer, store and process data of each wearable system (user) remotely with a cloud server, as well as sharing and communicating each individual's information with other users, profound research into data security, privacy and confidentiality of individuals need to be conducted [Fernández-Caramés et al. (2018)].
5. Some technique-related issues such as limited battery capacity which hinders long-term monitoring, lack of waterproofness, etc.

As the reader will discover in the following section as well as in the rest parts of this thesis, the design of the wearable system proposed in our work fully considers the first three of the above-mentioned challenges. However, for other aspects such as data confidentiality, absolutely essential though, is outside the scope of this thesis.

1.4 ARTIFICIAL INTELLIGENCE TECHNIQUES APPLIED TO MEDICAL DIAGNOSIS AND MONITORING

The origin of the term *modern artificial intelligence* comes from the field of computer science and robotics, where researchers attempted to model the process of human thinking with mathematical symbols, therefore implementing this biochemical process with a computer [Nilsson, Nils J. (1980)]. Perhaps the most famous example of AI application that brings this revolutionary technique into the public eye is IBM's chess computer Deep Blue [IBM Deep Blue]. Equipped with a piece of specific AI algorithm which enables it to learn to play chess games, and finally against a real person, Deep Blue beat the world chess champion on May 11, 1997.

Applying AI-based techniques in the field of medical diagnosis and monitoring has gained great attention in recent years. Based on [Hamet et al. (2017)], AI applications in medicine can be grouped into two branches, namely virtual and physical branch, respectively. The virtual branch represents the applications of AI in the processing of complex medical data (e.g., electronic medical records, patient health records, biophysical and biochemical data, etc.), whereas the physical branch represents using AI-based techniques to intelligently control medical devices and instruments such as using AI to control operating robots in robotic surgery [Panesar et al. (2019)]. The following text presents some representative AI algorithms that have been widely discussed in medicine.

Being a member of Neural Network (NN) family, Artificial Neural Network (ANN) is perhaps the most powerful tool for implementing machine learning and Deep Learning (DL) in real world applications. NN-based algorithms are capable of learning the underlying non-linear relationships between data, which are difficult to observe through normal statistics. In medicine, ANN can be applied in disease diagnosis [Er, Orhan (2010)] [Zhou et al. (2003)], decision support and decision making [Lisboa et al. (2006)], radiology and image processing and cardiovascular medicine [Itchhaporia et al. (1996)].

Convolutional Neural Network (CNN) is a specific type of ANN with one or a series of convolutional layers and is a powerful tool for image processing and image classification. In medicine, CNN helps physicians and radiologists to make predictions of potential diseases based on MRI (Magnetic Resonance Imaging) or CT (Computed Tomography) inspections. The advantage of using AI for MRI/CT scan analysis lies on the fact that AI is able to find tiny abnormalities from high-resolution images which are less visible to the naked eye. Successful applications of CNN in medicine include medical image analysis [Jiang et al. (2010)] and MIR image segmentation [Tran, Phi Vu. (2016)].

Fuzzy logic is another powerful tool in dealing with medical data. A medical decision making often involves uncertainty, and doctors often make diagnosis based on a probabilistic reasoning and incomplete data [Holzinger et al. (2019)]. Fuzzy logic has its inherent ability to treat these types of data, due to the fact that fuzzy logic uses linguistic representations and probabilistic reasoning rather than dealing with exact and absolute truth &

false values. In real world applications, fuzzy IF-THEN rules and membership functions can be established either by incorporating prior expert knowledge or in a data-driven way by combining fuzzy logic with other NN-based learning algorithms. A famous example is ANFIS (Adaptive-Network-based Fuzzy Inference System) algorithm. Compared to other AI algorithms, the most promising feature of fuzzy logic and fuzzy inference system lies in its high causability and explainability. Applications include fuzzy logic-based clinical decision support [Warren et al. (2000)], fuzzy control used in automated control of drug delivery [Mason, D. G., et al. (1997)] and position and action control in robotic surgery [Song et al. (2015)].

Cloud-based AI provides superior centralized hardware with high performance AI algorithms for each connected patient to upload and process their medical data remotely. Differ from a standalone system which is used only by one individual, cloud-based AI is able to converge data from a large number of patients, therefore building a complete medical database for future research and studies [Mintz et al. (2019)]. With remotely deployed expert system, remote health monitoring, online consultation and online diagnosis become possible. A successful application of cloud-based AI in medicine is centralized management and maintenance of Electronic Health Records (EHRs) [Bahga et al. (2013)]. Moreover, the system can continuously improve its performance by updating algorithm architecture & parameters using incremental learning (e.g., Fuzzy ARTMAP), continual learning and reinforcement learning-based algorithms.

Besides, Natural Language Processing (NLP) -based techniques can be used in medical applications to extract information from electronic medical records or to interact with patients (e.g., AI-chat-bot).

Compared to conventional medicine, AI-based approaches feature several significant advantages. A computer is able to perform fast, paralleled and complex computation tasks within a short time. For example, AI algorithms is able to analyze millions of MRI/CT scans within hours, which would take years of work if performed by a human being. AI helps prevent medical errors during diagnosis. AI is able to treat medical data with low error rate, no fatigue and no emotional bias [Mason et al. (2018)]. Besides, AI helps to decrease health costs [Hamet et al. (2017)].

As the reader may discover later in the following chapters of this thesis, the design and development of our proposed fetal movement monitoring system takes fully advantage of cutting-edge AI techniques when it comes to the processing of data as well as decision making. The reader can refer to Chapter 4 and 5 where we applied NN-based fuzzy logic (ANFIS and Fuzzy ARTMAP) for fetal movement acceleration signal classification, Chapter 6 for a deep discussion of using CNN and DL for automated feature extraction and signal classification, as well as Chapter 7 for a classical rule-based decision-making algorithm for long-term evaluation of fetal health.

1.5 OBJECTIVE OF THE THESIS

Fully taking into account of the existing issues raised in current techniques of fetal movement monitoring for the assessment of fetal well-being during pregnancy, this work has aimed to pave the way towards a garment-based intelligent wearable system applied to the online, remote, continuous and reliable monitoring of fetal movements. Following the general architecture of typical remote health monitoring systems as illustrated in Fig. 1.5, the design of this system aims to offer a complete and end-to-end solution for fetal movement monitoring - from each end user (pregnant woman), through the local monitoring unit (intelligent garment), up to the cloud computing platform & remote expert system with remote interactions and exchanges with doctors and medical experts. This thesis is based on the current research achievements and findings which utilized accelerometers placed on the maternal abdomen to acquire fetal movement data. However, in contrast to the current research works on this topic, our proposed system has been dedicated to improving the monitoring system's intelligence and autonomy by integrating embedded AI and ML while maintaining maximum accessibility, usability and comfort to the user (pregnant woman) with minimum negative impacts to her daily life.

The original contributions of this thesis is summarized as follows:

1. An all-round design process of the proposed intelligent garment has been proposed by combining textile/garment design, sensor integration and ICT approaches (data analysis, decision support, and communication with the cloud platform), permitting to optimize the criteria of signal quality, wearer's comfort and easy-to-care together.
2. The computing capacity of the software has been enhanced by developing a data-based decision support system with learning mechanisms, whose operations have been optimally distributed between the microcontroller of the garment and the wearer's smartphone. This treatment can effectively improve the autonomy of the garment, reduce consumed energy and increase data processing efficiency.
3. The capacity of the whole wearable system can be improved by communications and interactions between the intelligent garment and cloud expert system for further medical knowledge exploitation and advanced diagnosis of pregnant women (the details of the cloud expert system has been presented in [Song et al. (2019)]). A new business model for transactions of the intelligent garment and wearable system can be further developed by exploiting human body data collected from various wearers.

1.6 CONCLUSION

Continuous and reliable monitoring of fetal health condition during pregnancy is essential for ensuring normal fetal development. Current techniques for the monitoring of fetal movements, which are an important measure of fetal health, suffer from several important issues. Research works that have been published in the literature discussed the

promising potential of using sensor technology (accelerometers) for in-home and automated monitoring of fetal movements. However, still at their early stage, these works collectively suffer from drawbacks such as impractical to use, low portability, low intelligence level as well as poor reliability and robustness.

The promising advances of wearable technology as well as its successful applications in health monitoring, rehabilitation and sport/fitness tracking have motivated us to apply this technology into this research topic for solving the existing issues. Within the scope of IOTFetMov research project, our work aims to design and develop a garment-based wearable system integrating accelerometers, advanced signal processing techniques and embedded AI for online, reliable and continuous monitoring of fetal movements. This system is capable of qualitatively evaluating fetal health based on the continuous and quantitative counting of fetal movements. Taking one step further, the intelligent garment is connected to a cloud computing platform with a remote expert system in order that remote health monitoring and consultations becomes available. It ensures remote and effective interactions and exchanges between the patients and doctors. This work is of great importance as it introduces, for the first time, the advantages of wearable technology such as low-cost, high comfort level, out-of-hospital setting as well as remote and ubiquitous health assessment to the field of fetal movement monitoring.

This chapter gives the reader a brief and comprehensive overview of the research context. It also emphasizes the multidisciplinary nature of this research work (see Fig. 1.10). In the following chapters of this thesis the reader will discover detailed information of different aspects throughout the entire design and development process of the proposed system, as well as the solutions and discussions to the problems encountered.

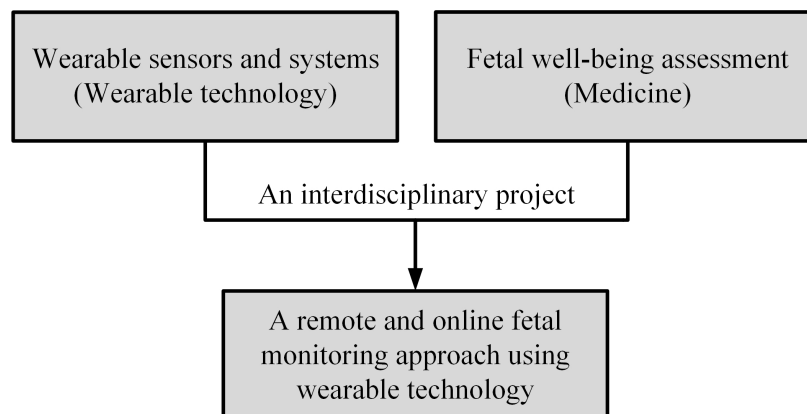

Figure 1.10 – *The convergence of these two multidisciplinary research topics results in a new era.*

OVERALL DESCRIPTION OF THE MATERIALS AND METHODS

2

2.1 INTRODUCTION

In this chapter, we provide a summary that is intended to give the reader an overview of the key information contained in the following chapters of this thesis. This chapter briefly presents the key theoretical ideas and techniques applied behind the design and development of the proposed wearable system for automated monitoring of fetal movements, as well as our reflections and discussions on some crucial issues. For the sake of brevity, this chapter does not dig too much into technical details. However, topics and issues that are further discussed and studied in the subsequent chapters are labeled with hyperlinks which redirect the reader to the corresponding places.

2.2 TOWARDS AN IoT-BASED INTELLIGENT GARMENT - AN OVERVIEW OF THE SYSTEM ARCHITECTURE

Before going more into technical details of the proposed wearable system, we would like to give the reader a comprehensive overview of its general architecture. As illustrated in Fig. 2.1, the general architecture of the system mainly consists of two subsystems, namely *local monitoring unit* and *centralized cloud monitoring unit*, respectively. Detailed descriptions of each part are given below:

1) The local monitoring unit comprises an intelligent garment (wearable device) worn by the mother and a local monitoring platform e.g. a piece of application software with GUI running on an Android smartphone.

When being worn, the four accelerometers embedded in the intelligent garment can be correctly placed on the maternal abdomen for data acquisition of fetal vital signs. Two microcontrollers connecting the accelerometers process the acquired signals, make decisions based on the embedded algorithms and transmit data related to the fetus' well-being to the upper level of the monitoring system (the monitoring platform located in the local monitoring unit).

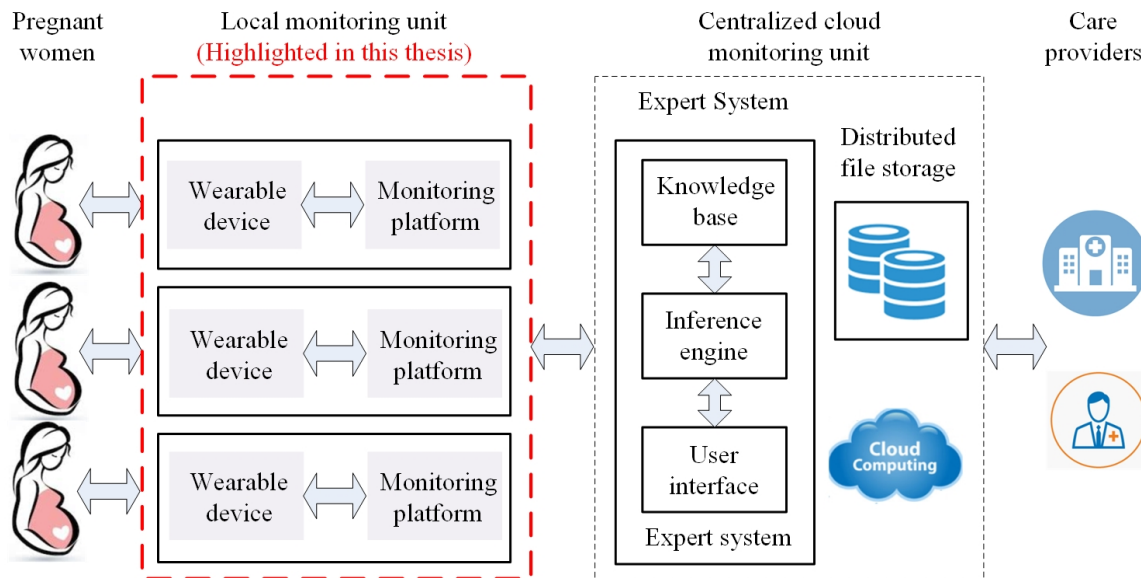

Figure 2.1 – General architecture of the proposed wearable system for fetal well-being monitoring.

On the other hand, the local monitoring platform can be implemented into any mobile device commonly used nowadays (e.g., a smartphone, a tablet computer or other customized devices). The monitoring platform communicates with the intelligent garment via Bluetooth protocol. The main role of this monitoring platform is to provide the user with her baby's health status on a real time and online basis via a user-friendly interface. Besides, as we will describe later in Section 2.5, the monitoring platform is not just a tool for information visualization, we can be quite sure to transfer and implement algorithms that are too computationally heavy for the embedded microcontrollers into here, since nowadays most consumer-grade smartphones and tablets offer a decent performance in terms of both data processing ability and data storage. Furthermore, working as an access point or a gateway, the local monitoring platform connects the wearable system to the outer world via the Internet, transmits the information related to fetal vital signs to the centralized cloud monitoring unit, which itself is connected to hospitals and caregivers, for providing the users (pregnant women) with advanced diagnosis and treatment.

2) The centralized cloud monitoring unit dedicated to clinical professionals mainly comprises a distributed data storage module for collecting fetal well-being features and other key data transmitted from the local monitoring platform, a user interface for interactions between the clinician and patient, a medical knowledge base with self-updating (self-learning) mechanism and a parallel cloud computing module for evaluating medical solutions. The role of this unit is to provide each user connected to it via the wearable system with advanced diagnosis and treatment based on the processing of their uploaded data. As the reader may have already noticed, detailed discussions of this part, which has been developed by another colleague in our research group, is beyond the scope of this thesis. For more detailed information concerning this part, the reader is referred to the

original publication [Song et al. (2019)].

For the sake of clarity, the organization of the following contents of this thesis is illustrated in Fig. 2.2.

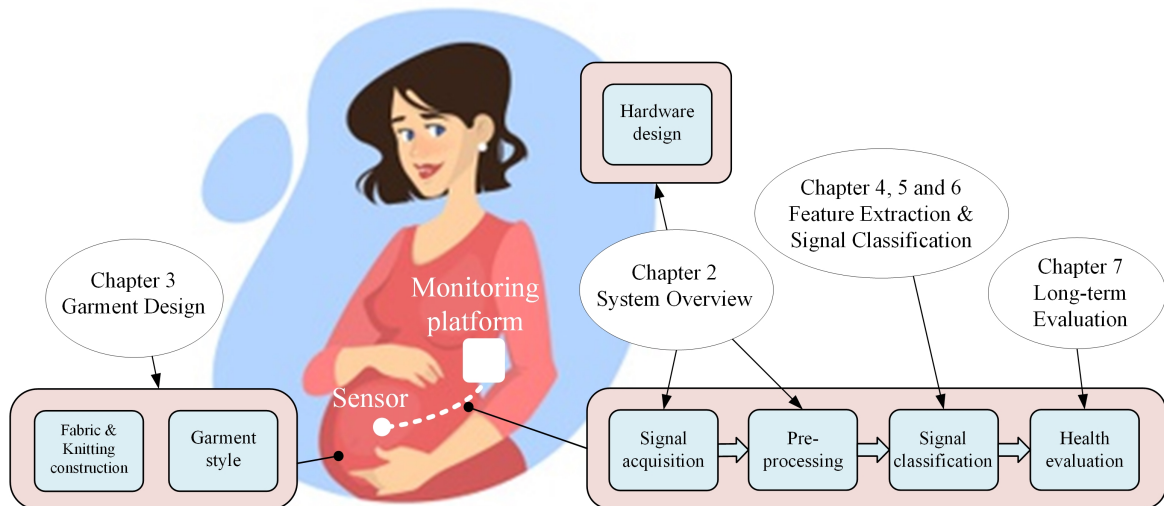

Figure 2.2 – Figure illustrating contents of different chapters.

2.2.1 The Wearable Device

2.2.1.1 Garment Design

When it comes to an intelligent garment, the main function of the garment is to embed and fix wearable electronic components into the garment's fabric structure while ensuring good comfort and convenience to the wearer - as are its most basic requirements. When being worn, a well designed intelligent garment should accurately locate the embedded measuring sensors to their required location on the wearer's body with a desired pressure - not too tight, not too loose. Fixing measuring sensors in their specific location with a close contact with the wearer's body structure is necessary to avoid any displacement that could generate additional noise due to the frictions between the sensor and fabric.

In our study, the design of the intelligent garment concerns the following aspects:

- **The choice of the most appropriate garment fabric**

We conducted a series of tests among different fabrics in order to compare their properties in terms of signal attenuation and comfort. A knit made from a mixture of polyamide (90%, abrasion resistant to long-time wear without deformation) and elastane (10%, elastic and cling to the skin) fibers with a Jersey pattern has been proved to be the most relevant fabric at the Point of Maximum Impulse (PMI).

- **Design of the most relevant garment style dedicated to long-term use**

We have initially considered and designed several garment models to meet the re-

quirement in terms of both comfort and functionality: the first model features two belts connected with a dorsal part. The placement of these belts on the maternal abdomen can be adjusted with regard to different scenarios. An extra dorsal part is equally considered, providing additional length when it comes to pregnant women with big waistlines. Another garment model comprising a whole piece of fabric covering a large area of the maternal abdomen has also been considered at the early stage of the research, however, a sensory evaluation conducted among several pregnant women on this garment design has shown that this model is too tight and less comfortable for a long-term wearing.

An ergonomic design of the garment style/shape as well as a reasonable integration of the wearable electronic devices into the garment structure contribute significantly to the originality and innovation of the IOTFetMov project. For a detailed discussion and analysis on this topic, the reader is referred to Chapter 3.

2.2.1.2 Hardware Design

The design of the intelligent garment hardware mainly incorporates four accelerometer sensors (NXP Semiconductors N.V., MMA8451Q [NXP Semiconductors]) for data acquisition and a high-performance 32-bit microcontroller (NXP Kinetis KL16 Sub-Family [NXP Semiconductors (2012)]) for the implementation of signal processing-related algorithms. The accelerometers are set to a measuring range of $\pm 2g$ ($1g = 9.81m/s^2$) and digital sensitivity of 4096 counts/g. We choose a sampling frequency of 60Hz by following the Nyquist-Shannon sampling theorem which restricts the sampling frequency to be at least two times higher than the maximum frequency of the signal to be sampled - as the spectrum of most accelerometer-recorded fetal movement signals does not exceed 20Hz [Boashash et al. (2014)]. Experimental results has shown that this setting is appropriate for fetal movement signal acquisition with most maternal-perceived fetal movements being successfully captured (see Fig. 2.9 and Fig. 2.10a for a better understanding of what accelerometer-recorded fetal movement signals look like). Data communication between the four accelerometers and this microcontroller is implemented via the I²C protocol. Besides, the microcontroller interconnects with an external SPI flash memory chip of 256Mb (Winbond, W25Q256FV [Winbond (2014)]) for local storage of data. A second microcontroller chip (Texas Instruments, CC2541 [Texas Instruments (2012)]) is considered, which allows the garment to communicate with the monitoring platform via the Bluetooth 4.0 specification (known as Bluetooth Low Energy, "BLE"). The wireless throughput of the system is merely 5 bytes/second when working¹, due to the optimal distribution of the workload between the intelligent garment and the local monitoring platform. The con-

1. Based on Bluetooth 4.0 specification, the default values for the maximum ATT payload (the maximum packet length) is 20 bytes, as the reader will read in the subsequent chapters, the embedded system processes signals and sends processing results (one packet) once every 4 seconds, that is to say, a throughput of 5 bytes per second.

nection between the two microcontrollers is implemented with UART (Universal Asynchronous Receiver-Transmitter) interface. Besides, a Li-ion battery of 1100mAh provides power to the intelligent garment. It is able to work about 53 hours under continuous operation after fully charged. The block circuit diagram of the above-mentioned hardware design for the intelligent garment is illustrated in Fig. 2.3a.

Furthermore, a carefully and thoughtfully design of the hardware's PCB (Printed Circuit Board) layout minimizes the size of the circuit boards, ensuring that the wearer is not too much aware of their presence when wearing the garment on a long-term basis. Finally, the main circuit board containing all the electronic components (e.g. microcontrollers, antenna, battery, etc.) are put together into a small size portable box which can be easily fixed to the garment. Detailed illustrations of the hardware prototype can be found in Fig. 2.3b.

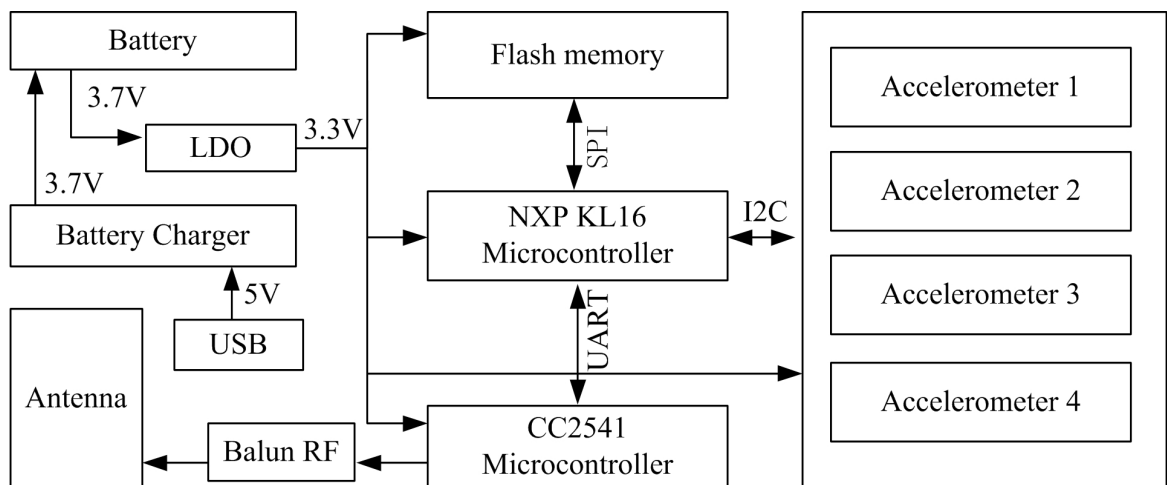

(a) Block circuit diagram of the intelligent garment hardware.

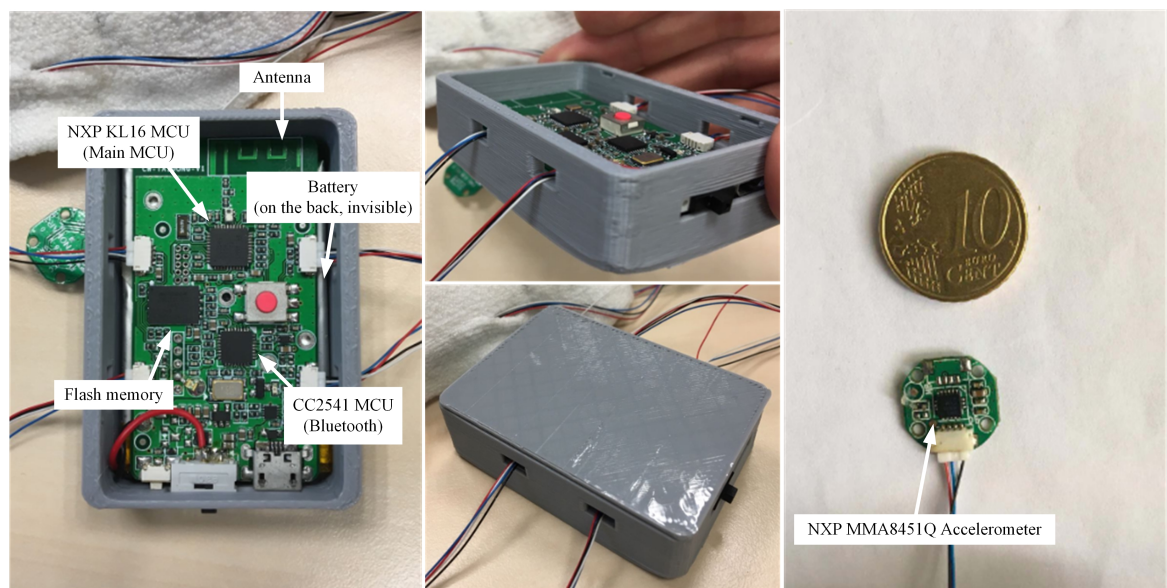

(b) Actual pictures of the main circuit (in a small size box) and the sensor circuit.

Figure 2.3 – Intelligent garment hardware.

Since we do not utilize other types of sensors when designing this system, for the rest of this thesis no differentiation between accelerometers and sensors is made when mentioning our monitoring system.

2.2.1.3 Embedding the Hardware into the Garment

Integration of the electronic devices into the garment while maintaining the latter's comfort and high convenience level is another key element to be considered during the design of an intelligent garment. Specifically, in the late pregnancy, the pregnant woman's waist and abdomen bear a significant weight coming from the fetus, and therefore any extra equipment added to the maternal body would increase this burden.

Our proposed method of integrating the electronic components into the garment fabric is shown in Fig. 2.4, where two of the sensors are mounted into one belt and two others into another one. This configuration allows to cover a large area on the maternal abdomen and collect as much information as possible. The box containing the main circuit can be attached on the upper belt in front of the body, which does not bother the pregnant woman when she is lying down on her side (which is always the case during late pregnancy). The box can be taken off when washing the garment, protecting the hardware. The sensors are to some degree waterproof, and can be washed together with the garment. Wires for sensor network interconnections are soft and flexible, crossing and hiding inside a two-layer-structure fabric with extra length so that they won't get broken when the fabric is stretched. A pregnant woman wearing the final intelligent garment prototype that integrates all the electronic components is illustrated in Fig. 2.5.

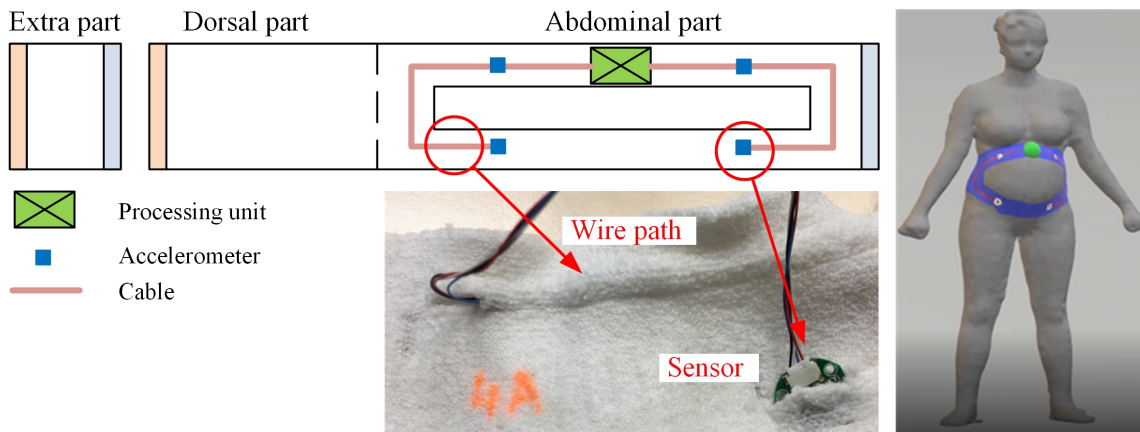

Figure 2.4 – Embedding the hardware in the garment.

2.2.2 Local Monitoring Platform

As its name implies, the local monitoring platform acts as an interface between the user and the intelligent garment, Here I carefully choose the term *local* to describe this monitoring platform in order to differentiate it from the *remote monitoring platform* located in the centralized cloud monitoring unit for clinical professionals. The local monitoring



Figure 2.5 – An overall picture of the final intelligent garment prototype integrating the sensors and the main circuit (invisible, inside that small size box).

platform can be implemented in the form of an application into any user-side smart devices e.g. a smartphone or a tablet computer. In our research, we have utilized an Android smartphone as the target smart portable device due to the development simplicity and fast prototyping with Android ecosystem.

The monitoring platform communicates with the garment in an autonomous way. We have developed a decision making framework which, based on several pre-defined rules, is able to automatically monitoring the fetus' health condition by analyzing fetal movement counting in a long-term way. It alerts the user when something abnormal is detected e.g. reduced fetal movement, and informs the user to visit the doctor in case of necessary. For more detailed description about this topic, the reader is referred to Chapter 7 of this thesis.

By interacting with this monitoring platform via its user-friendly GUI, the pregnant woman is able to access key information coming from the garment she is wearing. This feature could significantly enhance the usability and user experience on the proposed intelligent garment. More importantly, the mother is able to visualize key information related to her baby's health status on a long-term basis in the form of statistical tables and graphic charts, which helps to detect potential symptoms of fetal compromise at early stage. The GUI of the local monitoring platform is illustrated in Fig. 2.6.

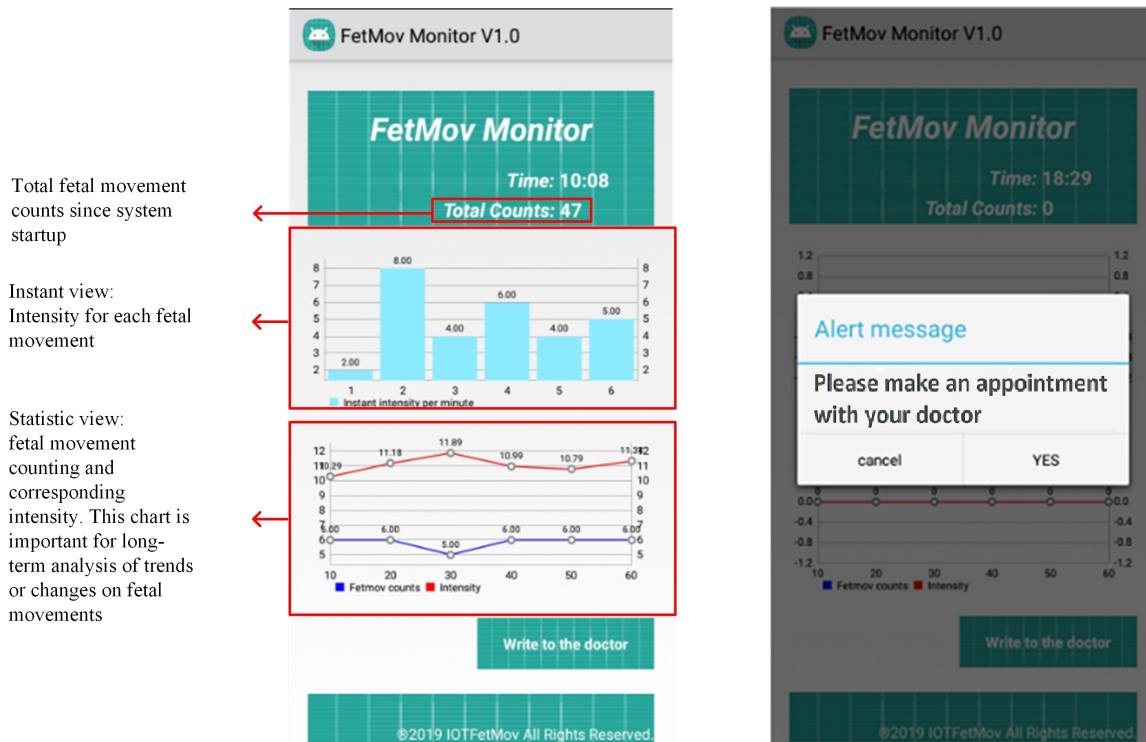

Figure 2.6 – GUI of the local monitoring platform.

Another important role of the local monitoring platform is to communicate with upper levels of the proposed IoT wearable system e.g. the cloud computing platform or the remote expert system. Deployed in the user's smartphone or tablet, the monitoring platform can easily access the internet via Wi-Fi or cellular network, therefore remotely visit the database of the centralized cloud monitoring unit and get advanced consultations and suggestions from the remote expert system. It also builds a communication bridge between the patient (pregnant woman) and doctors: doctors can access the information of all the users (garments) at distance. whereas each end user, in return, can interact with her assigned specialist remotely while staying at home.

2.3 AN OVERVIEW OF THE APPLIED METHODOLOGIES

This section presents a variety of the methodologies and algorithms applied during the design and development of the proposed wearable system for fetal health monitoring. It gives the reader a sketchy description of how the system utilizes accelerometers to capture fetal movements and how to monitor and assess fetal well-being in an automated way by using these acquired signals. It also guides the reader to the other corresponding chapters and sections of this thesis when more detailed descriptions and discussions are presented elsewhere. The content of this section covers aspects including signal pre-processing of the fetal movement signals acquired using accelerometers, classification of the pre-processed signals into different categories using machine learning techniques, automated fetal move-

ment counting, and a novel rule-based decision making algorithm which qualitatively evaluates the fetus' health status on a continuous and long-term basis.

2.3.1 Architecture of the Proposed Fetal Health Evaluation Algorithm

As shown in Fig. 2.7, the acquired acceleration signals are first pre-processed before entering the next levels of the system. *Signal pre-processing* procedure includes signal magnitude calculation, filtering and segmentation. *Peak and threshold detection* further excludes abnormal signals (e.g., signals with extremely large amplitude) and labels them as artifacts. *Cross-correlation* compares signals having the same timestamp but from different sensors. It calculates the cross-correlation values between each two channels and eliminates signals that have a high degree of similarity based on the cross-correlation results. This is based on the observation that fetal movements are always captured by one or two sensors only, whereas when it comes to a maternal body motion, all the four sensors displace simultaneously in the same direction (high cross-correlation value). This mechanism further enhances the system's robustness with strong anti-interference ability. As a result, only signals that have not been excluded by both threshold detection module and cross-correlation module are entered to the next levels of the system. *Feature extraction* module extracts representative features from raw acceleration signals, thus reducing the computational burden of the system. *Classification* module classifies signal segments into different groups based on the extracted features, therefore identifying fetal movements signals from other noise signals and artifacts. *Fetal movement counting* module counts fetal movements based on the classification results (labels). Finally, *decision making* evaluates qualitatively the fetus' health status and sends alert messages in case of necessary.

The whole process of the above mentioned fetal movement monitoring algorithm repeats as signals are acquired by the sensors in a continuous way. The reader may have noticed from Fig. 2.7 that some modules are compulsory (solid box) for the normal functioning of the system while others are optional (dotted box). This flexible configuration helps to reduce the computational burden as a whole when running on a low-performance embedded hardware (disable some optional modules accelerates calculation but at the expense of the system's robustness and signal classification accuracy). Whether or not an optional module is activated also depends on its subsequent modules: e.g., when using raw acceleration signals as input to the classification module, feature extraction is not necessary. Detailed explanations and discussions of each module inside the system can be found in the following parts of this section.

2.3.2 Signal Pre-Processing

The raw fetal movement signals acquired using accelerometers undergo a series of pre-processing operations in order to improve data quality, find and remove outliers. Signal

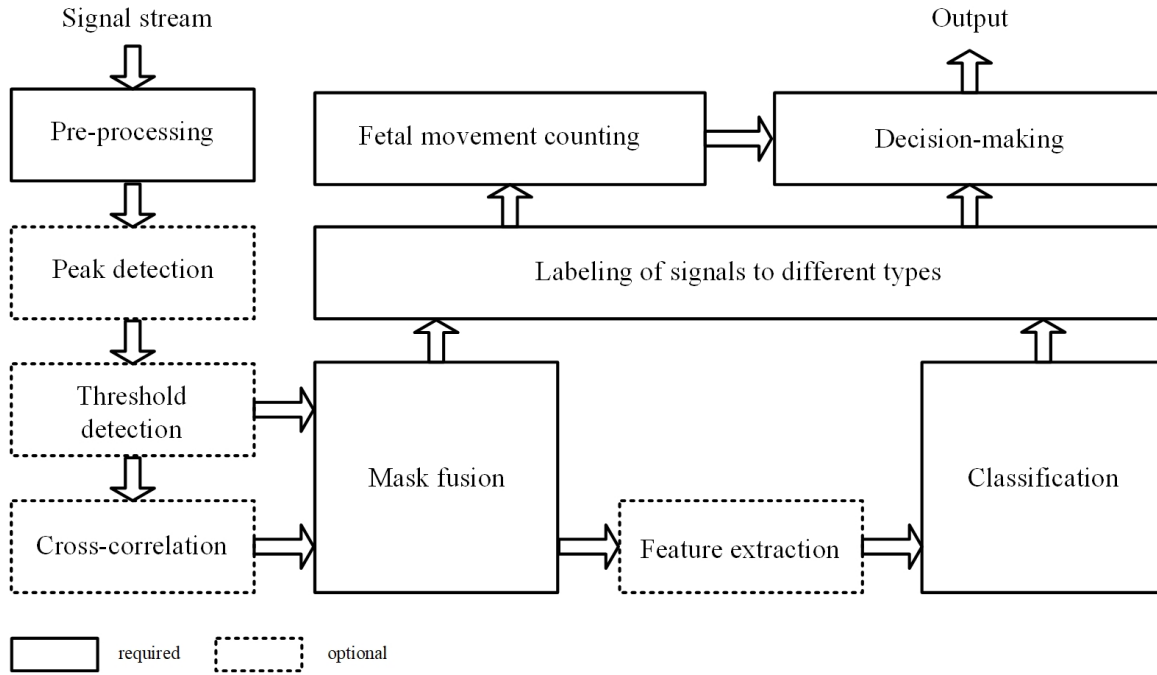

Figure 2.7 – General workflow of the proposed fetal well-being monitoring system.

pre-processing includes signal magnitude calculation, filtering and signal segmentation, respectively. A detailed description can be found below.

2.3.2.1 Calculation of Signal Magnitude

The accelerometer used in our research work features three axes (refer to Subsection 2.2.1 of this chapter, part Hardware Design), meaning that the acquired signals contain x , y and z channel. However, it is accepted that signal amplitudes contain more important and informative information than the direction when it comes to detecting fetal movements [Khelif et al. (2011)]. Besides, using magnitude can also eliminate the disturbances caused by sensor rotation. Given the three-channel data, the amplitude of acceleration signals is calculated as follows (note that the gravitational acceleration has been extracted so that a stationary sensor measures $0g$ for all the three axis):

$$g_a = \sqrt{g_x^2 + g_y^2 + g_z^2} \quad (2.1)$$

For the rest of this thesis only the signal magnitude is studied and analyzed.

2.3.2.2 Filtering

Filters play an important role in signal processing. A well-designed filter helps to effectively and efficiently eliminate noise signals within a specific frequency range. In our study, we mainly focus on the elimination of low-frequency noise signals (e.g. maternal respiration, maternal slow body motion) and high-frequency noise signals (e.g. mechanical noise caused by the sensor itself or by the friction from contacts between the wearer's skin and the sensors).

It is widely known that the respiration frequency of a healthy adult is between 15-20 times per minute (0.2Hz - 0.33Hz). Also, some publications reported that fetal movement signals are mostly inferior to 20Hz [Boashash et al. (2014)]. Based on the given information, we designed an 8th order bandpass IIR (Infinite Impulse Response) filter with lower 3dB frequency of 0.5Hz and higher 3dB frequency of 20Hz. Fig. 2.8 visualizes the magnitude response (blue line) as well as the corresponding phase response (red line) of the designed filter.

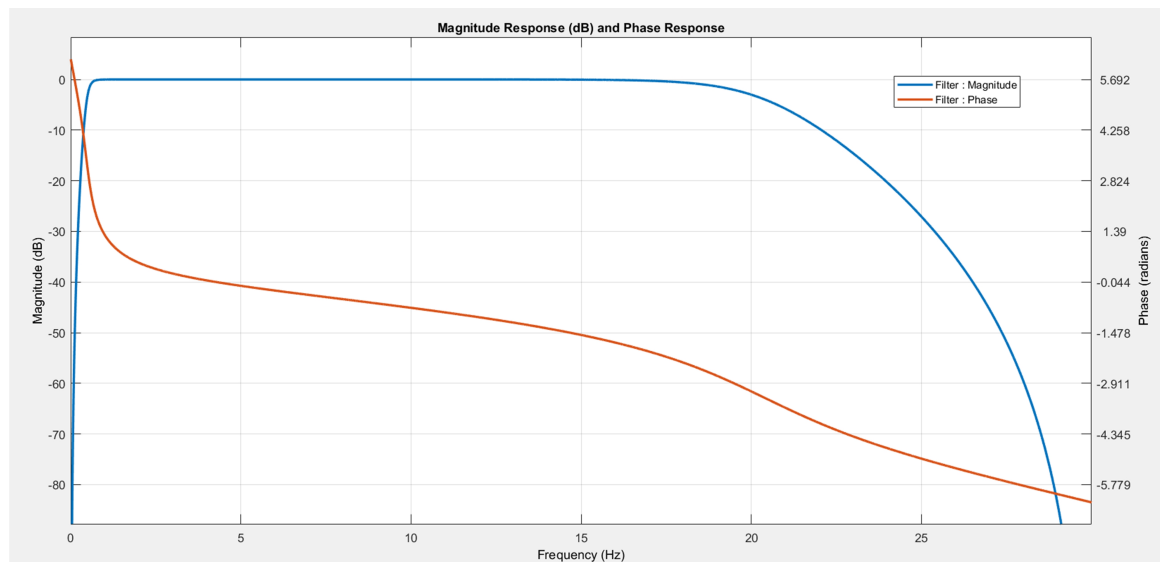

Figure 2.8 – The magnitude and phase response of the designed IIR filter (type band-pass, band width = [0.5Hz - 20Hz]).

2.3.2.3 Signal Segmentation

A single data point on an acceleration signal does not offer significant information. When it comes to online and real-time processing of acceleration signals, a widely accepted solution is to utilize windowing techniques to split time-based signals into segments [Preece et al. (2009)]. In our research, we utilize a moving window with a length of 4 seconds for signal splitting and therefore extracting representative information from each signal segment. The choice of 4 seconds as the window size is based on an intuitive and visual inspection of all the acquired fetal movement signals, most of whom are found to be able to get covered by this window size. Signal segments are also called *epochs*.

2.3.3 Peak and Threshold Detection

Peak and threshold detection helps to roughly eliminate abnormal signals that feature amplitudes too large or too small. It comprises a *minimum threshold* and a *maximum threshold*, respectively. Signals to be filtered out include background noise with amplitude lower than the minimum threshold, as well as large signals caused by the intensive body motions of the wearer, which are detected and eliminated by the maximum threshold.

2.3.4 Cross-Correlation for Artifact Elimination

An underlying connection between the similarity among the signals from different sensors acquired at the same time and whether or not these signals are generated by the wearer's body motions is another interesting finding after undergoing an intuitive and visual inspection of all the acquired acceleration signals. As an example illustrating this finding as shown in Fig. 2.9, some artifact signals caused by a series of maternal body motions (located inside the red rectangle) often feature high similarity, whereas an observed isolated fetal movement signal (in the green circle) marked by the mother (thin red lines) only appears on the first channel.

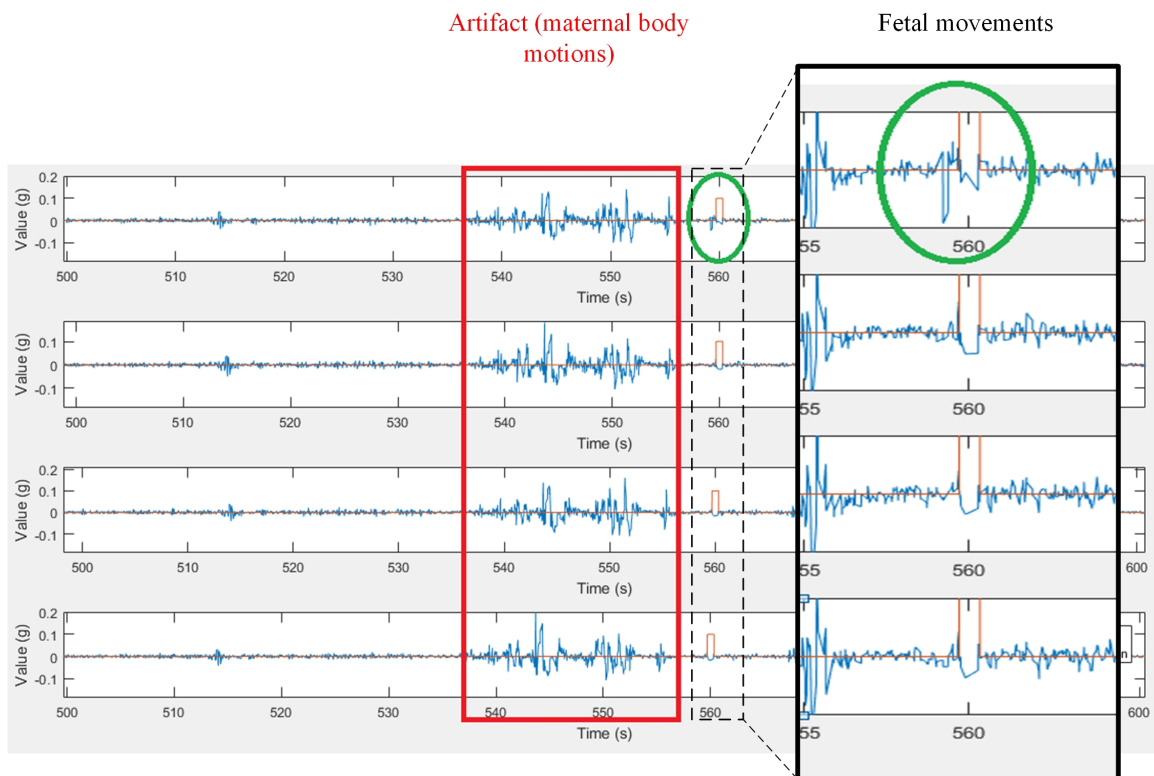

Figure 2.9 – Signals showing artifacts caused by maternal body motions (red rectangle) featuring high cross-correlation values among each channel and an isolated fetal movement (green circle).

The reason behind this observation is explained as follows: artifact signals caused by maternal motions often feature a high similarity degree (high cross-correlation value) among each other, meaning that the whole garment might have had an overall movement at a certain time caused by the wearer's body motions, causing a displacement of all the four sensors. On the other hand however, fetal movements often occur over small areas inside the mother's abdomen, therefore those deflections on the mother's abdominal wall caused by the fetus are often captured, though this is not always the case, by only one or two sensors.

It is worth mentioning that the position of the four sensors on the maternal abdomen as well as the distance between each other could significantly influence the effectiveness

of this approach (if the sensors are too close to each other, the cross-correlation value for fetal movement signals from the four channels would be high enough that the system is no longer able to distinguish maternal artifacts). In practice, we put two sensors on the lower abdomen close to the fetus in order to ensure good quality of fetal movement signals with sufficient amplitude, and two others located on the upper body (close to the breast) for acquiring maternal body motions. For more information about how to detect fetal movements based on the information fusion of the signals from the four channels (sensors), the reader is referred to Subsection 7.2.1 of Chapter 7.

The cross-correlation values among epochs from the different channels evaluates the degree of signal similarity, thus helps to distinguish and eliminate maternal artifacts. Being computationally simple, the cross-correlation module together with the peak and threshold detection module could significantly reduce the system's computational burden as a whole. More detailed discussion about this topic can be found in Subsection 2.5.1 of this chapter.

2.3.5 Training of Machine Learning Algorithms for Signal Classification

Classification of signal segments into different categories based on either extracted informative features or raw signal data points is another important step towards a fully automated system for online fetal well-being monitoring. By training a machine learning model with labeled signal samples e.g., signals containing fetal movement, maternal artifacts or only background noise, the trained model can classify new data over a fixed window. That way, we can develop a monitoring system which is able to distinguish fetal movement signals from acquired acceleration data in a real-time and autonomous way without any human interference. Compared to simple threshold-based fetal movement detection approaches, integration of machine learning algorithms into the monitoring system for signal classification could significantly boost the system's performance and robustness in terms of classification accuracy.

An effective, accurate and robust classification of acceleration signals is an important part which plays a key role in building a reliable fetal movement monitoring system. This topic will be discussed extensively in the rest parts of this thesis. For more detailed information the reader is referred to Chapter 4, 5 and 6.

2.3.6 Automated Counting of Fetal Movements

Now that the reader has a fundamental understanding of how the proposed monitoring system acquires, pre-processes and classifies acceleration data, thus detects and distinguishes fetal movement signals from the ongoing acceleration data stream. Next question is: how to relate these classification results to the fetus' health condition? Or how to qualitatively evaluate the fetus' health condition based on these quantitative information?

In order to answer this question, we would like to break it down into two smaller parts that will be addressed separately:

1. **How to count fetal movements based on these labeled signals over the time window of 4 seconds?**

As mentioned earlier in this thesis, fetal well-being can be assessed by regular counting of fetal movements. Currently available recommendations on daily fetal movement counting can be found in [World Health Organisation (WHO) (2018)]. In clinical practice, various methods have been described, with two widely acceptable methods listed as follows:

- if fewer than 6 distinct movements are felt with 2 hours, and
- if fewer than 10 distinct movements are felt within 12 hours (the "count-to-ten" method).

Therefore, our next target is to build a liaison or find the causality between the signal classification results over the 4 seconds window and the corresponding number of fetal movements. Taking it one step further, we need to develop a decision making framework which integrates the above-mentioned rules and qualitatively evaluates the fetus' health condition based on the number of fetal movements.

We propose an novel algorithm to address this issue. For detailed information and rigorous discussions the reader is referred to Chapter 7.

2. **How to accurately distinguish real fetal movements from other artifacts e.g., maternal body motions?**

This problem is in essence related to the robustness, reliability and anti-interference capability of the monitoring system as a whole. Accelerometers are attached on the maternal abdomen, which means any maternal movement involving this part of the body can result in a displacement of those embedded accelerometers, introducing artifacts. If poorly addressed, this problem could lead to catastrophic consequences which no one wishes to see: the system incorrectly regards artifacts as real fetal movement and keeps claiming that the fetus is under normal conditions whereas the baby's real health status remains unknown, leading potential fetal death. This issue is related to the system's *specificity* in terms of classifying different types of signals acquired by the accelerometers. The reader is referred to Chapter 5 and 6 for a detailed discussion about this topic with our consistent pursuit of improving the system's specificity.

These two issues are actually so crucial and challenging that the research work on how to address them constitutes the main tasks during my PhD study. It is worth noting that, according to the clinical practice of medical experts, it is advisable to monitor fetal movements from about 20 weeks to late pregnancy. Therefore, the intelligent garment has

been designed for this period. We do not consider fetal movements in early pregnancy (before 20 weeks) since they are too weak to be detected either by any sensor or perceived by the mother (they cannot generate deflections with a considerable force on the maternal abdominal wall).

2.4 DATA ACQUISITION AND LABELING

Considering the unclear nature of accelerometer-recorded fetal movement signals as well as the need of building an initial acceleration signal dataset with reliable labels for training machine learning algorithms, raw data acquisition with the proposed intelligent garment hardware was conducted. With these offline acquired data, we are able to conduct a deep and rigorous study of the nature of accelerometer-recorded fetal movement signals.

2.4.1 Data Acquisition Criteria and Strategies

Throughout my research as a PhD student, we have successfully conducted several signal acquisitions in the hospital Jeanne de Flandre, Lille, France, under the guidance and supervision of Professor Julien De Jonckheere, researcher in the research institute INSERM, CIC-IT 1403, Lille, France. During data acquisition, our intelligent garment sent raw acceleration data directly to the Android monitoring platform without any pre-processing. The Android smartphone, on the other hand, saved these acquired data locally into a text file. The average recording duration was about 15 minutes, which varies depending on the pregnant woman's comfort and willingness.

Before starting a measurement, the pregnant woman was asked to locate the area on the abdomen where she felt the strongest fetal movements, and one belt was placed just above this area so that the most intensive fetal movement signals could be collected by the two sensors in this belt. However, the placement of the second belt varied according to the specific experimental requirements. For some measurements the two belts were placed next to each other to focus on the area where the most intensive movements were perceived by the mother. In other cases however, it was placed on the pregnant woman's upper body (close to the breast) to record maternal heartbeat signals for future analysis of this artifact. A comparison of the system performance between these two experimental settings may also help to find out the most efficient way for multisensory fetal movement monitoring.

During data acquisition, the subject (pregnant woman) was instructed to hold a push button in the hand so that each time she felt a fetal movement by herself she pressed the button to record it. The push button recordings can be used as reference to label fetal movement signals from the recorded data. Fig. 2.10a illustrates the experimental setup for fetal movement data acquisition. Note that there may be a delay between the actual occurrence of each fetal movement and the corresponding push-button action, which depends on each pregnant woman's habit, concentration level and response time. Note that

in the later research stages, we added three additional buttons namely *talking*, *walking* and *body motions* located on the touch screen of the Android monitoring platform, which were used by the observer (usually myself) to label artifact signals simultaneously in case of any above-mentioned artifact was visually observed (see Fig. 2.10b).



(a) Maternal labelings of fetal movements with a push button.

(b) GUI with 3 buttons for the observer to label artifacts.

Figure 2.10 – Experimental setup for fetal movement data acquisition.

For some measurements, the pregnant woman was required to stay still in order to collect clean and undistorted signals without any interference caused by maternal body motions, while for other measurements the subject was allowed to move her body, talk or even walk. These activities were noted synchronously by the observer and were stored for future analysis.

2.4.2 Labeling of Fetal Movement Signals

After recording, one clinical expert was demanded to further inspect the offline recorded data and label any outliers. He then labeled fetal movements signals from the data with respect to the maternal perception markers. More precisely, areas that are 5 seconds in advance of each maternal perception marker were regarded as *potential areas*, bursts or spikes located in these areas were labeled as potential fetal movements. Visual inspections were performed to exclude abnormal signals such as maternal body motions (usually with much larger signal amplitude or a different wave morphology with regard to a typical fetal movement signal).

Fetal movement signals is labeled by human beings, which cannot guarantee absolute correctness. In fact, although we require the subject to keep quiet during the test, it is unrealistic to force them to remain absolutely still and not to introduce any maternal movements. On the other side however, machine learning models depend on data. Without a foundation of high-quality training data, even the most effective algorithms can be

rendered useless. In the principle of utilizing fewer but high quality training patterns for machine learning, hoping not to include any pseudo patterns into training dataset, any signal with an uncertain behavior was regarded as non-fetal movement.

2.5 SOME THOUGHTS ABOUT SYSTEM EFFICIENCY

2.5.1 Reducing the Computational Burden

Fetal movements happen infrequently: studies show that it varies from 25 per hour to 4 in 24 hours in the third trimester [Rådestad (2010)]. It is also reported that the fetus stays inactive during sleep cycles which could last up to 1 hour, resulting no or only a few movements [Suwanrath et al. (2010)]. Running on a real-time basis however, our monitoring system keeps analyzing irrelevant signals e.g. mechanical noise from the sensor itself, leading unnecessary calculations and wireless data transmission.

As mentioned earlier in this chapter, by involving threshold-detection and cross-correlation modules prior to deep analysis of the acquired signals, the calculation burden of the monitoring system as a whole can be significantly reduced. This is because the epochs that are labeled as artifacts by either of these two modules are abandoned without further processing or analysis. That way, the computational resources can be reserved for analyzing important and useful signals, which could make the system act faster and more efficient. This idea of multistage signal processing is illustrated in Fig. 2.11, where the width of arrows qualitatively represents the volume of data flow. For more details about the threshold-detection and cross-correlation-based approach the reader is referred to Subsection 2.3.3 and 2.3.4.

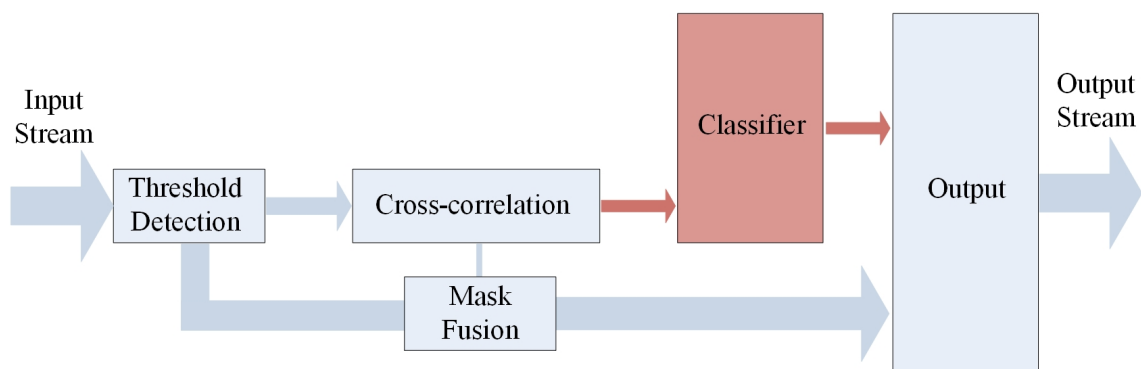

Figure 2.11 – Data Stream demonstrating how to reduce the computational burden by using threshold detection and cross correlation.

We admit that applying manually fixed threshold may, to some extent, negatively affect the system's performance in terms of both sensitivity and specificity. Solutions to this issue may lie in a statistical analysis of fetal movement signal magnitudes based on a large dataset, which allows us to choose a more reasonable value for the minimum and maximum thresholds.

2.5.2 Distribution of Computational Tasks Between the Garment and the Local Monitoring Platform

As the reader may have already noticed, the proposed intelligent garment comprises two parts that can be used for edge-computing: the microcontroller embedded in the garment and the local monitoring platform, respectively. Now that we need to implement the entire proposed fetal health evaluation algorithm (see Subsection 2.3.1 of this chapter) into the intelligent garment, we have to think about how to optimally distribute the workload between these two computing devices.

Now let's take a look at two extremes: implementing the whole algorithm only into the garment and implementing it only into the local monitoring platform, respectively.

1. Implementation of the proposed algorithm only in the garment (microcontroller)

This option provides the garment with high degree of intelligence and autonomy in terms of monitoring and assessment of fetal well-being. In this case, the local monitoring platform merely serves as an GUI for information visualization and a *data pass-through* device, which sends garment data directly to the upper level without any further processing. One significant advantage of this configuration lies on the reduction of volume of the data being wirelessly transmitted, since the garment processes the data locally and only transmits the processing results to the upper level. However, considering the limited computational power and storage capability of common microcontrollers, implementation of the whole monitoring system raises challenges especially when it comes to implementing machine learning-based algorithms. Our research work of implementing a pre-trained neural network classifier into a high-performance microcontroller can be find in Chapter 7.

2. Implementation of the proposed algorithm only in the local monitoring platform (smartphone)

This option is relatively easy to implement since modern smartphones often have more powerful processing ability and extended memory space than an embedded system using traditional microcontrollers. In this case, the garment transmits raw data directly to the higher level without any processing. However, this configuration may lead to mass volume of data being transmitted wirelessly, resulting in extensively consumption of the battery of the intelligent garment.

Based on the above analysis, we need to find an optimal balance between these two extremes in order to effectively improve the autonomy of the garment, reduce consumed energy and increase data processing efficiency. In our research, the general guideline is to empower as much autonomy as possible to the garment (microcontroller), minimizing the data transmission between the garment and the local monitoring platform.

2.6 CONCLUSION

The design of the proposed system for continuous and reliable fetal movement monitoring fully reflects its key features such as low cost, high portability, high accessibility as well as ubiquitous monitoring at anytime and anywhere. Compared to most existing clinically-available fetal health monitoring techniques which often involve expensive and cumbersome instruments and devices, trained personnel for the manipulation, as well as limited accessibility (they are usually located in hospital), the proposed system has competitive superiority in terms of portability and ease of use. Besides, the fact that each intelligent garment is connected to the centralized cloud monitoring unit (see Fig. 2.1), though not technically and detailed explained in this thesis, further equipped the system with remote and online health monitoring ability, demonstrating a good example of e-textile and e-health in the field of antenatal care.

In this chapter we have presented the general architecture of the intelligent garment used for fetal well-being monitoring, as well as the methodologies and algorithms applied in order to implement each part of the system framework. Topics and issues to be further discussed in subsequent chapters of this thesis have been marked with hyperlinks that redirect the reader to the corresponding places. The rest of this thesis is organized as follows: Chapter 3 discusses the design and development of the garment fabric and style, Chapter 4, 5, 6 and 7 present detailed solutions and discussions focusing on the key parts of the data-based decision support system with learning mechanisms.

Note that although the general concept and architectural blueprint of the wearable system has already been set at the beginning of the project, the methodologies and algorithms, however, evolve and update continuously as my understanding grows concerning the research context and the targeted problems to be solved.

GARMENT DESIGN: THE CHOICE OF THE MOST APPROPRIATE FABRIC AND GARMENT STYLE

3

3.1 INTRODUCTION

As a key component of intelligent garments and the actual physical support for their embedded electronic components, the garment itself plays a crucial role in comfort and usability. The design of a garment which is specifically dedicated to wearable systems involves several aspects: First, as regards comfort and flexibility, the garment fabric should be soft, elastic and resistant, offering the wearer support from the abdomen as well as from the back. This requires the choice of the most relevant textile parameters namely: 1) the best fabric texture (binding/yarn intertwining within the fabric and 2) the use of comfortable fibers and threads for the wearer. Secondly, garment design should fully consider the morphology of the target users (in our case they refer to pregnant women who feature a changing morphology at different pregnant stages) without causing any discomfort to them even for long term use. In our study, we have utilized advanced 3D human body scan technology for data acquisition of accurate body measurement information of pregnant women of different gestational weeks before the actual design and making of our intelligent garment prototypes. The fact that the design of garment style fully takes these morphology data in to consideration helps the final garment to be perfectly fits the pregnant women's body shape. Thirdly, the design of the garment should ensure those in-textile sensors to have a decent working environment for data collection with the optimal SNR (Signal-to-Noise Ratio). In the context of our research, a tight contact between the accelerometers and the abdominal skin need to be guaranteed, minimizing the noise generated by frictions between sensor-fabric and fabric-skin. However, the level of this tightness should be deliberately selected and controlled. More importantly, the garment after integrating electronic components should not bring any discomfort and inconvenience to the wearer's daily life.

This chapter presents the work that has been done in the frame of garment design when developing our intelligent garment. Corresponding to the above-mentioned argu-

ments, the contents of this chapter is divided mainly into two parts: the choice of the most appropriate textile and towards an ergonomic garment design - the design of the most comfortable garment style, respectively.

3.2 CHOICE OF THE MOST RELEVANT FABRIC PARAMETERS

In the context of signal acquisition, the most optimal fabric for our intelligent garment should be the one with minimum signal attenuation. This is because that with a known hit (e.g., a fetal kick on the mother's abdomen) that acts on the fabric of the intelligent garment (with at least one accelerometer nearby that can capture this hit), the less signal attenuation that the fabric features, the higher signal amplitude we can get from sensor output, thus the better signal SNR we can achieve.

In order to test the signal attenuation ability of different knitting structures in terms of fetal movements, therefore selecting the most relevant knitting construction with minimum signal attenuation, we have to first find out a suitable method to simulate/model a fetal movement, as well as to get to know what type of force with which strength level a typical fetal movement features. For the sake of simplicity, we consider in this thesis that most maternal-perceived fetal movements are fetal kicks (see Subsection 1.2.3 of Chapter 1). Several works have been published in the literature presenting their research works of modeling and simulating fetal kicks [Verbruggen et al. (2016)] [Sazali et al. (2019)] (see Fig. 3.1). Referring to the results from both of the just-mentioned works, we choose a force of $200cN$ (centinewton, $1cN = 0.01N$) as the minimum force generated by a fetal kick that can be captured by our monitoring system.

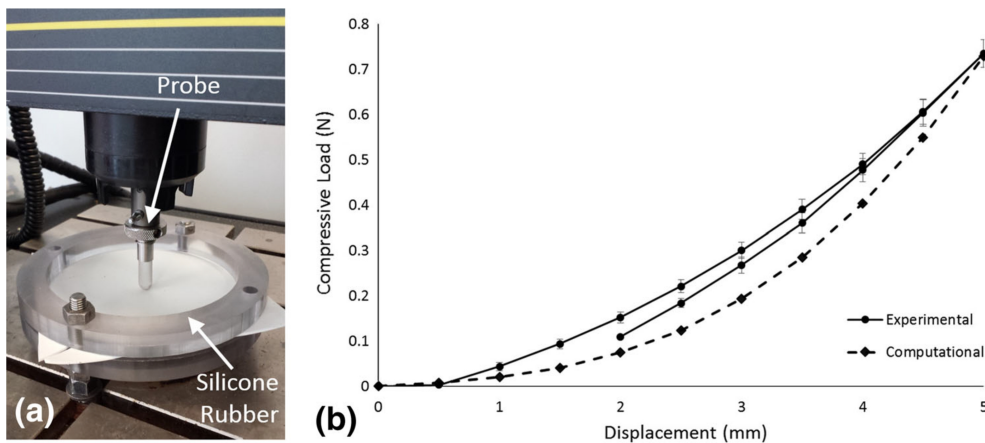

Figure 3.1 – (a) Image of experimental setup showing Instron machine, probe and silicone rubber sheet, and (b) a graph comparing average of experimental forces with forces predicted computationally (reprinted from [Verbruggen et al. (2018)]).

Based on the above information, we have conducted a series of tests to compare different knitting constructions while fixing all the other features (e.g., yarn characteristics). As shown in Fig. 3.2, we utilized a solenoid to generate a specific force of $200cN$ on the surface of a knitting fabric where an accelerometer was integrated. The use of the solenoid

is to imitate fetal kicks. Acceleration signals in response to the solenoid hits were acquired for 6 types of knitting samples: Jersey, Locknit, 1x1 rib, Roman Stitch, 2x1 rib and English Rib, respectively. Fig. 3.3 illustrates the acceleration response signals of these fabrics after receiving one hit from the solenoid.

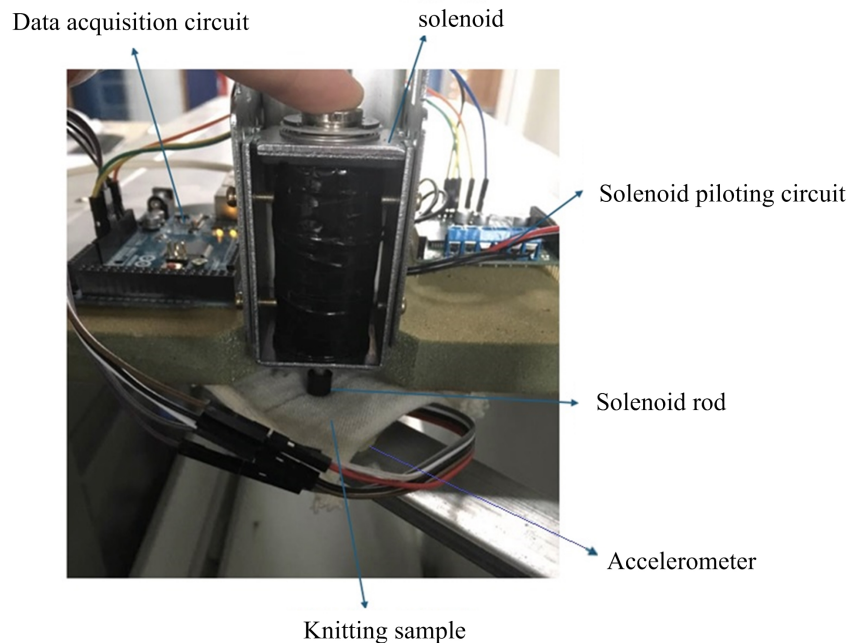

Figure 3.2 – Testing of signal attenuation of different fabrics using a solenoid.

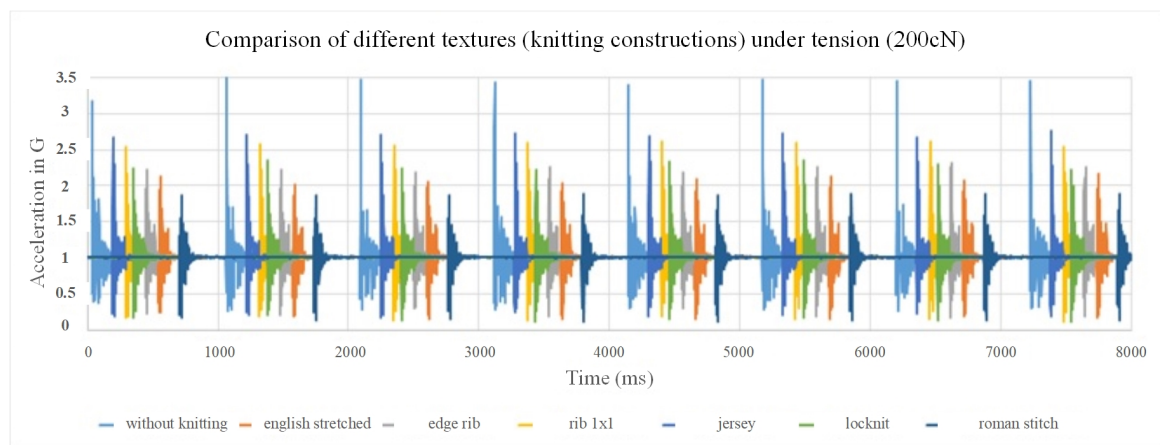

Figure 3.3 – Acceleration g values of different knitting constructions in terms of signal attenuation.

The calculation and evaluation of signal attenuation concerning different knitting patterns in response to one hit generated by the solenoid is described as follows. Here we take Jersey pattern as an example, Fig. 3.4 illustrates its acceleration response after receiving one hit. The data is sampled with a sampling frequency of 1000Hz, that is to say 1 millisecond interval between each two adjacent sampling points. After several oscillations in response to the hit, the acceleration value returns to 1g, which represents the gravitational acceleration (oscillation stopped).

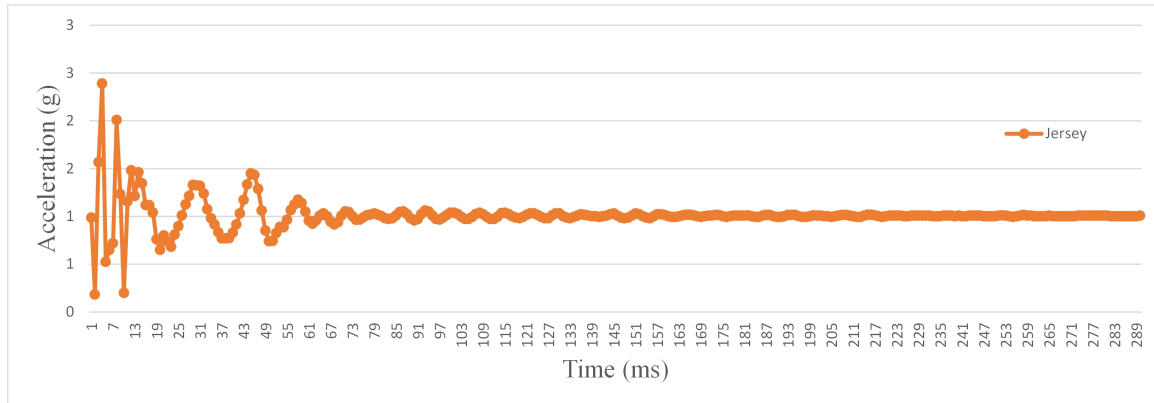

Figure 3.4 – Figure illustrating acceleration signal magnitude attenuation property of Jersey fabric after receiving one hit.

Now let us focus on the signal between two adjacent sampling points. As shown in Fig. 3.5, we approximately consider that the area under the curve (indicated with red color in the figure) between point n and $n + 1$ equals to the surface of the trapezoid (the green area together with the gray area) that is defined by the four points $(n, y(n)), (n, 0), (n + 1, y(n + 1))$ and $(n + 1, 0)$.

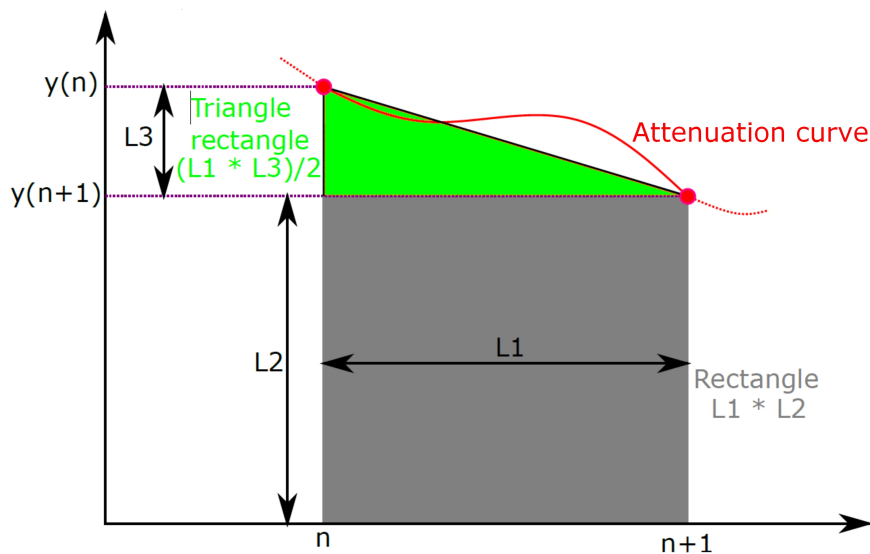

Figure 3.5 – Figure indicating how to evaluate the signal attenuation given a acceleration signal in response to one hit.

Based on the above assumption, we can therefore calculate the area under the curve by calculating the area of the trapezoid using the following equation below:

$$\begin{aligned}
 Surface_{Trapezoid} &= Surface_{Triangle} + Surface_{Rectangle} \\
 &= \frac{1}{2} \times L1 \times L3 + L1 \times L2
 \end{aligned}
 \tag{3.1}$$

where $L1 = 1$ (millisecond), $L2 = y(n + 1)$ and $L3 = y(n) - y(n + 1)$. The $y(n)$ and $y(n + 1)$ are actually acceleration g values.

Take one step further, the entire signal oscillation intensity in response to the hit on the fabric can therefore be evaluated by summing up all the trapezoid surfaces as shown below:

$$Surface_{Total} = \sum Surface_{Trapezoid}$$

Signal attenuation of the other above-mentioned knitting patterns has been evaluated using the same method. Then, the pattern with minimum signal attenuation property has been identified after a horizontal comparison of the experimental results of all the seven candidate patterns. We identified that the most relevant fabric is a knit with a Jersey pattern, which is capable of transmitting at least 80% of original human movement data. Besides, the final fabric material is made from a mixture of polyamide (90%, resistant to long-time wear without deformation) and elastane (10%, elastic and cling to the skin) fibers, which has been justified by the textile engineer's experience and many commercialized maternity support belts [Bérangère (2016)]. This fiber proportion can effectively guarantee the fabric properties of softness, resistance to friction and elasticity.

3.3 TOWARDS AN ERGONOMIC GARMENT DESIGN - DESIGN OF THE MOST ADAPTABLE GARMENT STYLE

3.3.1 Acquisition of Pregnant Women Body Measurement Using Human 3D scanning Technology

In order to design a garment with the optimal size and shape that is fully adapted to pregnant women's body morphology, we utilized 3D body scanning technology with Size Stream[®] [Size Stream] to obtain body measurement data of pregnant women with different gestational ages. This technology is capable of obtaining full body measurements by using infrared sensors installed on the aluminum frame of a 3D scanner, providing a non-invasive human body scanning solution (see Fig. 3.6). The scanner is capable to detect more than 100 data points and provides more than 400 types of measurements including circumferences, lengths, surface areas and body volume. An example of measurement data acquisition using the software coming with the Size Stream 3D scanner is illustrated in Fig. 3.7.

In order to collect data while the subject's body shape changes as pregnancy develops, two pregnant women came to our laboratory once per week for an entire body scanning. These two subjects have different body morphologies, ensuring rich and differentiated body measurement data. The measurement data obtained from the 3D scanner enable us to choose the most appropriate garment size and shape. That way, the garment can fit the wearer's morphology with a minimum gap. We also designed a desirable pressure between the textile surface and skin (small negative ease allowance values) in order to ensure close contact of the embedded sensors with the user's skin.

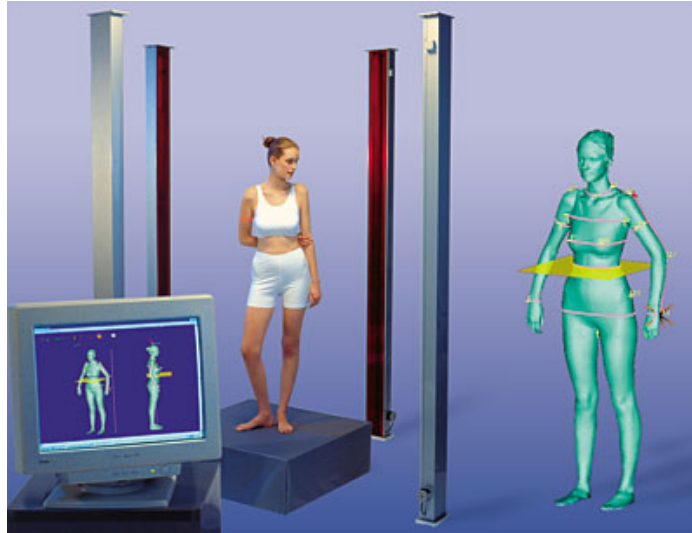

Figure 3.6 – Figure demonstrating size measurement of a pregnant woman's body shape based on 3D scan.

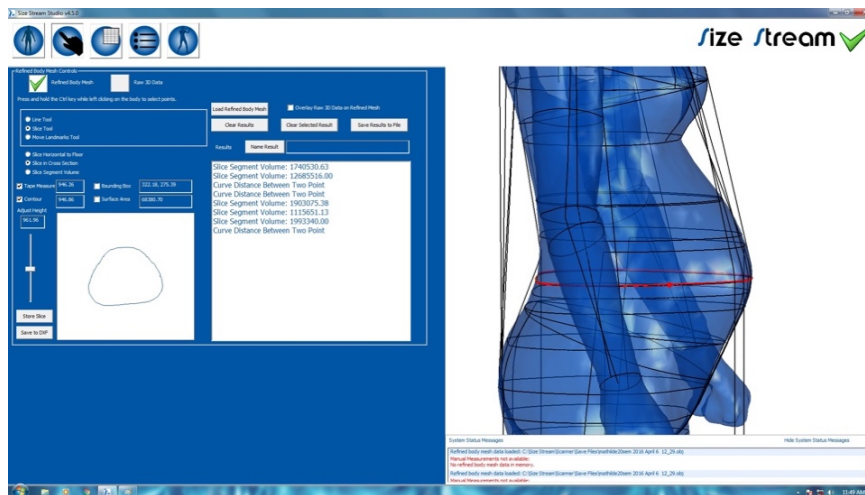

Figure 3.7 – Size measurement of pregnant women using 3D body scan.

3.3.2 Design of the Most Appropriate Garment Style for Long-term Use

Now we have body measurements of several pregnant women with different morphologies at different pregnancy stages. The next step is to consider garment styles and patterns. In our study we initially designed two garment models M1 and M2, with the first model (M1) utilizes two separate belts connected with a dorsal support part and the second model (M2) consists of a whole piece of fabric covering a large area of the wearer's abdomen (see Fig. 3.8).

We further conducted a sensory evaluation in order to find out the most relevant model based on user experience [Bérangère (2016)]. Five pregnant women of different gestational ages were involved and each of them was instructed to wear the two models sequentially for several minutes and give their feedback concerning the comfort and usability of each model. The sensory evaluation results have shown that M2 is too tight and not comfortable for a long-term wearing, and could make the user feel stuffy especially when the weather



Figure 3.8 – Two garment styles have been initially designed.

Table 3.1 – Sensory evaluation of the two candidate garment models

Criteria	18 weeks		28 weeks		29 weeks		30 weeks		33 weeks	
	M1	M2	M1	M2	M1	M2	M1	M2	M1	M2
Comfort	0	+2	0	+2	N/A	+2	0	+2	+2	+2
Abdominal support	0	+2	+2	+2	N/A	+2	0	+2	+1	+2
Dorsal support	0	+2	0	+2	N/A	+2	0	+2	+2	+2
Relief from back pain	N/A	+2	N/A	N/A	N/A	+2	0	+2	+2	+2
Freedom of movement	+1	+2	+1	+2	N/A	+2	0	+2	+1	+2
Model chosen		✓		✓		✓		✓		✓

N/A: not fitted, 0: not appreciated, +1: appreciated at first but feeling uncomfortable after a few minutes, and +2: appreciated.

Note. Reprinted from [Bérangère (2016)].

is hot. As a result, the M1 model has been chosen, based on which the final garment prototype are made. The sensory evaluation results are shown in Table 3.1.

3.3.3 Validation of the Proposed Garment in Terms of Tightness with Virtual Fitting

For validating the size and shape of the final garment prototype, we evaluated its virtual fitting on a typical pregnant 3D human model using the Modaris 3D Fit CAD software. From Fig. 3.9, a fabric pressure coloration map that is usually used for expressing garment comfort, we can find that the surface of the prototype is in very light blue (very small gap with skin), ensuring tight contact between the sensors and the body surface. The proposed prototype is neither loose (without dark blue color) nor too tight (without red color), showing that a good compromise can be established between comfort and tightness.

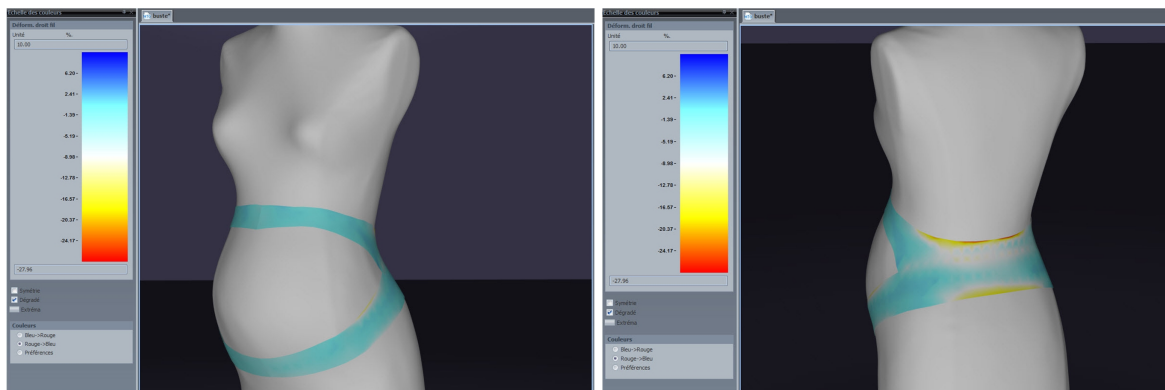

(a) Tightness simulation for the abdominal side

(b) Tightness simulation for the dorsal side

Figure 3.9 – Tightness simulation results.

3.3.4 Validation of the Proposed Garment by the Wearers Based on Sensory Evaluation

One advantage of the intelligent garment proposed in our study lies on its ergonomic design based on advanced 3D body scan technology applied to pregnant women of different gestational ages. In order to evaluate the appreciation of the real intelligent garment in terms of wearer's comfort and tightness, we further carried out a quantitative descriptive sensory evaluation. In this test, 4 pregnant women covering different gestational ages (week 27, 28, 33 and 34, respectively) have been involved. Each subject was invited to wear, for 10 minutes, the proposed prototype (G3) and two commercialized maternity support belts frequently used by pregnant women (G1 and G2), and then give a score from the set fo (not fitted), 1 (not appreciated), 2 (appreciated at first but feeling uncomfortable after a few minutes), 3 (appreciated)g to each criterion of garment comfort, determined by designers. These criteria include: C1: overall garment comfort, C2: feeling dorsal support, C3: feeling relief from back pain, C4: easy to put on.

The evaluation results given by all the four subjects on these criteria are shown in Fig. 3.10. 3 subjects complained about the unfitful size of the first belt (G1) thereby failed to put it on, resulting in missing blue curves in Fig. 3.10a, Fig. 3.10b and Fig. 3.10d. The

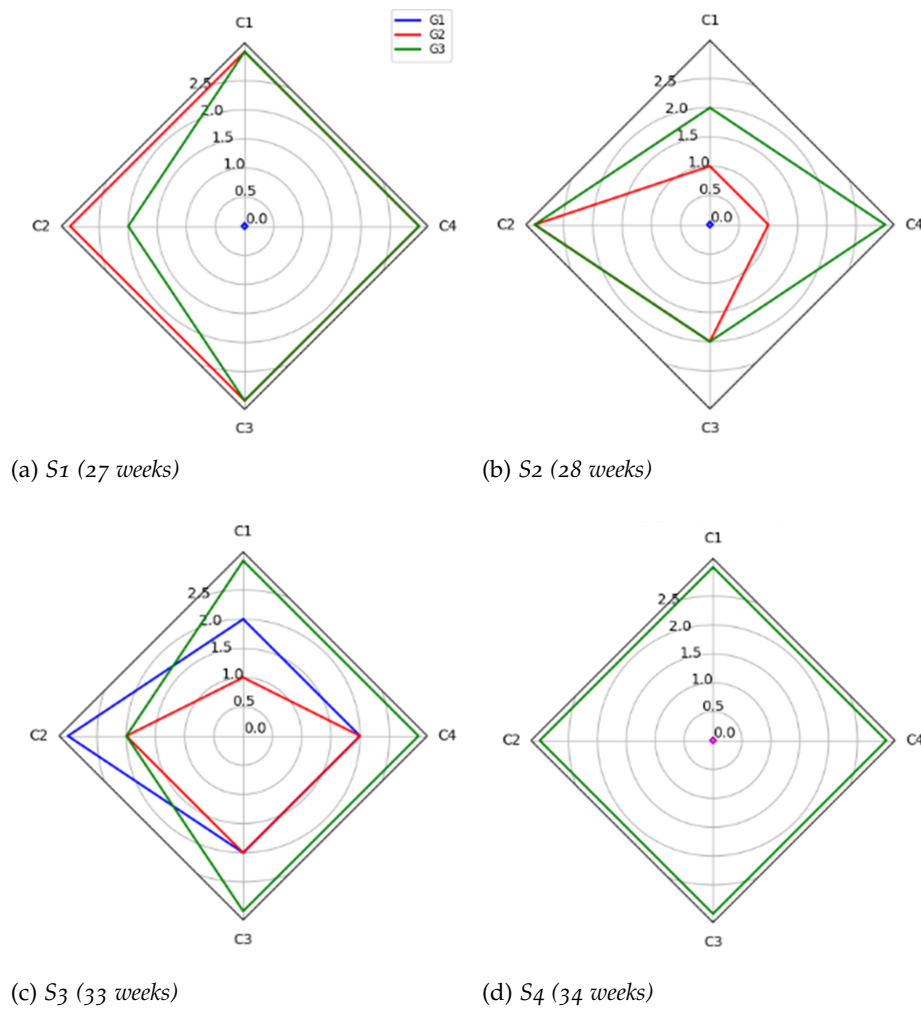

Figure 3.10 – Sensory evaluation results of the two commercialized maternity belts (G_1 , G_2) along with our proposed garment (G_3). the 4 subplots are illustrated based on feedbacks from 4 subjects S_1 - S_4 (pregnant women), in terms of 4 criteria C_1 - C_4 .

same scenario occurred for the second belt (G_2). The evaluation results show that the proposed intelligent garment prototype is mostly appreciated (≥ 2) by the pregnant women at different gestational ages due to its capacity of adaptation to various morphologies.

3.4 CONCLUSION

This chapter has discussed the choice of optimal fabric material and knitting pattern used for the intelligent garment while maintaining a good SNR and comfort to the user, as well as the ergonomic design of the garment style and shape. Original contributions are concluded as follows:

- 1) We have conducted rigorous tests to evaluate the influence of different types of knitting patterns on the attenuation of signals acquired by the embedded sensors, with which we are able to choose the most relevant material for fabricating the garment.

2) We have obtained the most appropriate garment size/shape based on the 3D body scans on several pregnant women of different gestational weeks and different morphologies. The ergonomic design of the garment ensures the embedded sensors have a tight contact with the wearer's abdomen when being worn without causing much pressure and discomfort to the wearer. This offers good user experience and satisfaction to the wearer even for a long-term use.

Most of the garment design and developing phase discussed in this chapter had been carried out before I started my PhD thesis, except the sensory evaluation of the final prototype as presented in Subsection 3.3.4, which was conducted during the third year of my research work. For other aspects of information related to the garment design, the reader is referred to the original publication [Bérangère (2016)].

FETAL MOVEMENT SIGNAL CLASSIFICATION USING ANFIS

4.1 INTRODUCTION

This chapter presents the research work done during my first year's PhD study, which was a preliminary study trying to understand the nature of accelerometer-recorded fetal movement signals. The objective of this study has been to attempt find out distinguishable and unique features of fetal movement acceleration signals, which would be essential to efficiently and accurately separate them from the ongoing sensor data stream.

Attempts to extract the most representative information, in terms of both time and frequency domains, from the raw acceleration signals were made. These representative information, or *features* in the field of machine learning, are then used to train a machine learning classifier, which then will be able to classify new signals into several distinguishable categories (or *classes*) after being trained. We evaluate the effectiveness of our feature extraction approach by evaluating the classification performance of the machine learning classifier trained with these features.

When it comes to the choice of a suitable machine learning model, we employed ANFIS (Adaptive-Network-based Fuzzy Inference System) in that early research stage. The ANFIS model architecture is actually an integration of neural networks and a fuzzy logic system, so that it has potential to capture the benefits of both in a single framework. For more information about the ANFIS algorithm the reader is referred to Subsection 4.2.4 of this chapter.

Due to the continuous evolution and improvement of the fetal movement monitoring system as the research progresses, some premise parameters used in this chapter e.g., the cutoff frequency for the filter and whether or not overlapping the window for signal segmentation, may slightly differ from the general architecture of the system presented in Section 2.3.1 as well as from other subsequent chapters. Nevertheless, the basic principles remain consistent.

4.2 PRELIMINARY KNOWLEDGE

4.2.1 Basic Principles of Fuzzy Logic and Fuzzy Systems

The idea of fuzzy theory was first introduced in [Zadeh (1965)]. Fuzzy logic is a generalization of standard logic. Unlike the typical way of thinking and analyzing things in the field of computer science, where a binary value equals either 0 or 1 - True or False, fuzzy logic, however, deals with uncertainty. Similar to possibility theory, fuzzy logic represents uncertain information, meaning that output of a fuzzy logic system can be any values between 0 and 1, indicating the possibility that an object might be categorized to a specified class or an specific action might be taken.

Fuzzy logic divides input data entity that is being analyzed into several regions, namely *fuzzy sets* [Zimmermann (1993)]. E.g., the exam marks of a student can therefore be grouped into *linguistic representations* such as "bad", "average" or "good", based on *membership functions* associated to each group (see Fig. 4.1). Note that different types of membership functions can be chosen based on specific requirements. Commonly used membership functions are *Triangular*, *Trapezoidal*, *Singleton* and *Gaussian*. The concept *fuzzification* refers to the process of assigning a numerical input value to a fuzzy set with respect to the corresponding *degree of membership*. In our example, the output of this student's exam marks after fuzzification is "80% average and 20% good" which means that this student is rather an average one. By this way, his mark is *fuzzified*.

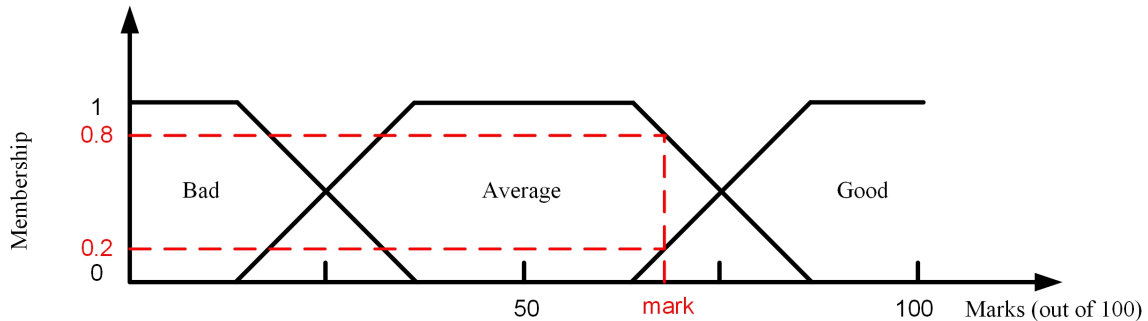

Figure 4.1 – An example of exam marks represented in a fuzzified way.

Fuzzy logic measures the degree to which the proposition is correct, based on *IF-THEN* rules. Let's say this student took two examinations *A* and *B*, examples of the mathematical expression of fuzzy logic to qualify his level is shown below.

IF mark A is good AND mark B is good THEN this student is qualified
IF mark A is bad AND mark B is bad THEN this student is not qualified

4.2.2 Applications of Fuzzy Logic in Medicine Fields

Fuzzy theory and fuzzy logic-based systems have largely been applied in the world of medicine [Mardani et al. (2019)]. It is well known that there are many complex illnesses

with diverse possible symptoms with uncertainty in medical issues, and a medical expert often make his decision based on the reasonable consideration of the uncertainty of evidence which exists in the medical data as well as in observations. In other words, most medical diagnosis are made on the basis of possibility of the identified symptoms.

Fuzzy logic has advantages of simulating human behaviors and dealing with uncertain situations in the real world. It has become an effective and efficient tool for describing vagueness and imprecision using precise mathematical expressions (membership functions). It is easier to map quantitative values obtained with medical measuring devices or from historical patient data to a qualitative linguistic expression, which significantly improves the user's ability to comprehend. For example, in intensive care, fuzzy logic and fuzzy systems help to group a patient's current situation into several categories or *medical states* (e.g., extremely critical, critical, serious but stable, guarded, etc.) based on a short-term but comprehensive analysis of the vital signs and physiological signals of the patient under intensive care [Bates et al. (2003)]. Another interest of using fuzzy-based approaches lies on its ability of combined analysis on different sets of symptoms, which may be associated with different problems or causes. Compared to other conventional data-driven AI approaches, a fuzzy system is more like a rule-based inference system with its *IF AND/OR IF THEN* rules, connecting different sets of symptoms, either representing human expert knowledge or being extracted from a deep mining of medical data [Medina et al. (2018)] [Nauck et al. (1999)].

In our case, a fuzzy-based inference system might be a good alternative for fetal movement signal pattern recognition and classification due to the blur boundary between fetal movement signals and some artifacts e.g. maternal body motion signals. In clinical practice, the clinician asks the mother to note down, on a *fetal movement counting chart*, whether or not fetal movements occur during successive pre-defined and short-term periods (e.g., record every 5 minutes with total record time: 2 hours. Please refer to Fig. 1.2 in Chapter 1 for more information). This is rather a possibility-oriented question (0 or 1, impossible or possible), whereas monitoring and evaluation of fetal movement would not make much sense if the clinician accurately quantify these fetal movement counts. Besides, with simple fuzzy IF-THEN rules and computationally inexpensive inference procedure, the computational burden of the system as a whole can be significantly reduced, improving the power efficiency.

4.2.3 Artificial Neural Network

Inspired by the architecture of human-being's nervous system, an ANN mainly comprises *neurons* and *connections* that links these neurons. An ANN may comprise a series of *layers* with each layer receives the output from its precursor layer as its own input, and feeds its successors with its output. A typical architecture of two successive layers in an ANN is shown in Fig. 4.2.

The $f()$ denoting *activation functions*. As its name implies, an activation function is

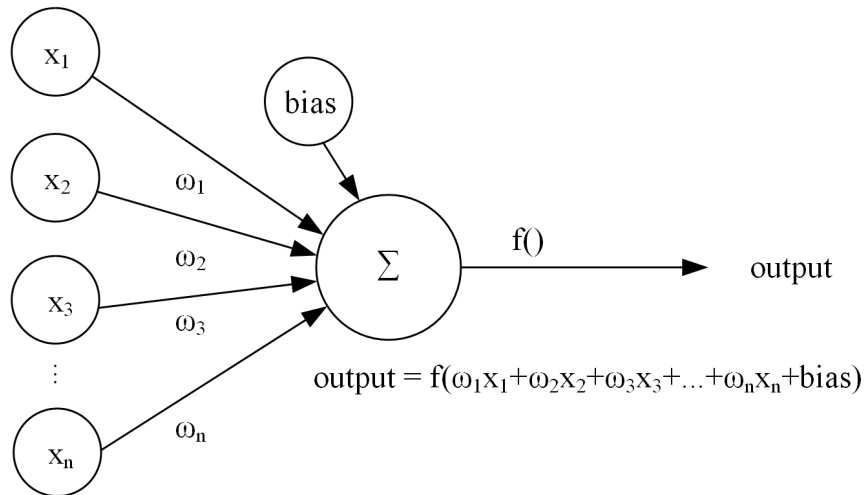

Figure 4.2 – An typical architecture of two successive layers in an ANN.

used to activate a specific neuron (or mute it) by calculating the weighted sum of its inputs. The use of activation functions helps an ANN to learn and approximate complex and non-linear behaviors between a system's input and its output. Some typical activation functions are listed below:

Rectified Linear Unit (ReLU):

$$f(x) = \max(0, x)$$

Sigmoid:

$$f(x) = \frac{1}{1 + e^{-x}}$$

Tanh:

$$f(x) = \frac{2}{1 + e^{-2x}} - 1$$

Forward passing of a system's input through all of its layers until obtaining the final output is called *inference*. By running inference, an ANN is capable to classify and recognize new inputs.

An ANN learns from labeled dataset, called *training*. It runs inference procedure with all the samples from the training dataset and compares its outputs with the samples' labels. The difference between the actual values (labels) and the predicted values (ANN's output) is formulated in the form of *cost function*. The more accurate the system predicts, the smaller value the result of the cost function will be. The goal of training process is to find a set of weights and biases that minimizes the cost function.

Updating the system's weights based on the cost function is realized by calculating the latter's *partial derivative* with respect to the weights and biases. This process is known as *backpropagation*, as it propagates errors back to the whole network and adjusts the system's parameters in a way that a better prediction can be made next time.

The original intention of employing ANN in our study lies in its ability to learn and model non-linear and complex relationships, which is the case in fetal movement signal processing and classification. Besides, ANN does not impose much restrictions on the structure of input data.

In our study, we have attempted to make full use of the advantages of fuzzy logic in dealing with uncertainties (in our case, the uncertainties come up with processing of medical data) while trying to combine it with the automatic training and learning capabilities of ANN. In this way, the fuzzy inference system can be trained automatically and learn information in a data-driven way. Fortunately, there exist already several types of mature algorithms being able to meet this need, and the algorithm to be presented in the following subsection is the most famous one.

4.2.4 Adaptive Neuro Fuzzy Inference System (ANFIS)

The ANFIS was first advanced by Dr. Jyh-Shing Roger Jang [Jang (1993)]. This algorithm is in nature an ANN with some of its neurons implemented using fuzzy set theory (e.g., a membership function). Unlike other conventional fuzzy inference systems, ANFIS is able to learn automatically from training data due to its inherent ability of machine learning. The original version of ANFIS presented in [Jang (1993)] uses gradient descent and backpropagation, as well as least squares estimate to adjust the network's membership functions and other parameters.

We take two fuzzy IF-THEN rules in order to describe how an ANFIS works as follows.

Rule 1: IF x is A_1 AND y is B_1 THEN $f_1 = p_1x + q_1y + r_1$

Rule 2: IF x is A_2 AND y is B_2 THEN $f_2 = p_2x + q_2y + r_2$

where x and y are the two inputs to the ANFIS, A_i and $B_i, i = 1, 2$ are two fuzzy sets corresponding to x and y , respectively, and p_i, q_i and $r_i, i = 1, 2$ are adjustable system parameters. The network architecture of the ANFIS in accordance with the above setting is shown in Fig. 4.3.

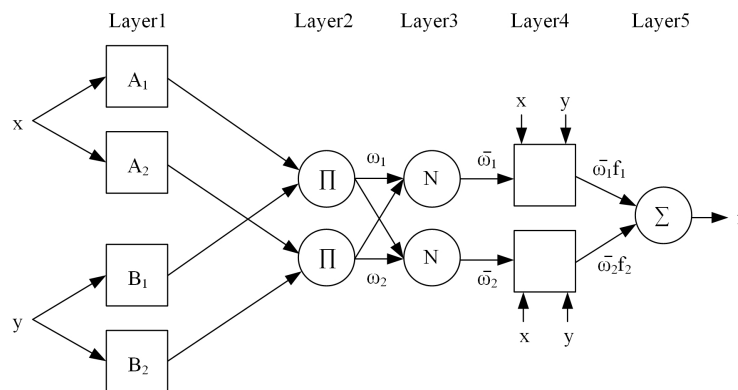

Figure 4.3 – ANFIS architecture. Circles indicate fixed nodes, whereas squares indicate adjustable ones.

As shown in Fig. 4.3, a typical ANFIS features five layers¹. The outputs of layer 1 are the results from the membership functions $\mu()$ applied to the inputs. As mentioned earlier, there exist different types of membership functions. For example, Gaussian membership function can be expressed as:

$$\mu(x) = \exp \left[-\left(\frac{x-c}{a} \right)^2 \right] \quad (4.1)$$

where a and c are adjustable parameters that can be modified during the training process.

The mathematical expressions of each layer are as follows.

Layer 1 :

$$O_i^1 = \mu_{A_i}(x), i = 1, 2, \text{ and} \quad (4.2)$$

$$O_i^1 = \mu_{B_{i-2}}(y), i = 3, 4 \quad (4.3)$$

where O denoting output with the superscript 1 indicating the first layer.

Layer 2 :

$$O_i^2 = \omega_i = \mu_{A_i}(x) \times \mu_{B_i}(y), i = 1, 2 \quad (4.4)$$

Layer 3 (the normalization layer):

$$O_i^3 = \bar{\omega}_i = \frac{\omega_i}{\sum \omega_i}, i = 1, 2 \quad (4.5)$$

Layer 4 :

$$O_i^4 = \bar{\omega}_i f_i = \bar{\omega}_i (p_i x + q_i y + r_i), i = 1, 2 \quad (4.6)$$

Layer 5 :

$$O^5 = \sum (\bar{\omega}_i f_i) = \frac{\sum \omega_i f_i}{\omega_1 + \omega_2}, i = 1, 2 \quad (4.7)$$

As shown in the above mathematical expressions, there are several adjustable parameters i.e. membership function coefficients a and c in Layer 1 (note that this may change based upon the type of the applied membership function), as well as p_i , q_i and r_i in Layer 4. These parameters are updated during the training process.

1. In fact, there are three types of fuzzy inference system. Fig. 4.3 illustrates the famous type-3, namely Takagi and Sugeno's type. For more information about ANFIS the reader is referred to [Jang (1993)].

4.3 FEATURE EXACTION BASED ON STATISTICAL FEATURES IN TIME AND FREQUENCY DOMAIN

In this section I will present to the reader my first attempt to extract features from accelerometer recorded signals. The goal is to accurately distinguish fetal movement signals from ongoing background noise by using the extracted features.

If we analyze maternal motion-free acceleration signals, we can intuitively find that fetal movement signals feature relatively large amplitude (compared to that of background noises) with short occurrence time (refer to Fig. 2.10 of Chapter 2). Therefore, statistical features calculated from signal amplitude could be representative. Besides, based on a visual inspection of the acquired signals, we also find that most fetal movement signals feature peaks and spikes, meaning that they could contain high-frequency components which are concentrated in a very narrow band. [Boashash et al. (2014)] reported a similar observation (see Fig. 4.4). This finding inspires us to further analyze the signals' frequency representations in the hope that the machine learning classifier, trained with a combination of both time and frequency domain features, is able to distinguish fetal movement signals from other fetal movement-like artifacts even if in the case that both of them feature the same signal amplitude.

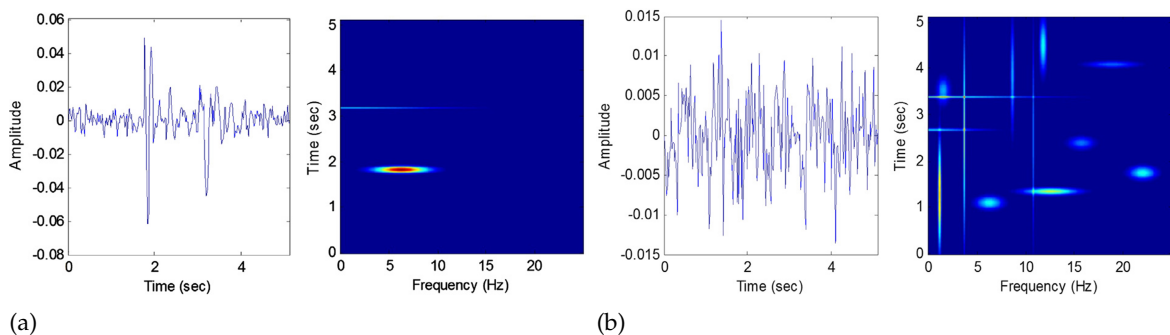

Figure 4.4 – (a) A fetal movement signal with its time-frequency representation and (b) a non-fetal movement signal with its time-frequency representation. (adapted from [Boashash et al. (2014)])

For statistical measures on time domain features, at the early stage of the research work we employed mean and standard deviation due to its simplicity of calculation but also the ability of identifying, roughly though, the peaks and spikes in the signal. The mean of the absolute value of the signal amplitude (acceleration g value) presents the overall signal intensity whereas the standard deviation measures the degree of dispersion.

Discrete Wavelet Transform (DWT) is a powerful tool for time-frequency analysis of non-stationary signals. It provides a multi-resolution way to extract information from time series signals by decomposing them into a collection of frequency sub-bands [Heil et al. (1989)]. In the literature, DWT is widely used in medical data-related signal processing and feature extraction tasks [Subasi et al. (2010)] [Jahankhani et al. (2006)]. In our study, the choice of DWT for the estimation of signal frequency domain features is based on the observation that fetal movement signals feature different energy distribution character-

istics and different frequency components when compared to other fetal movement-like artifacts. We utilize 3-level DWT to extract time-frequency information from segmented fetal movement signals. Furthermore, in order to reduce the volume of the extracted feature data, mean and standard deviation of DWT coefficients of each level are calculated [Jahankhani et al. (2006)].

Finally, together with the mean and standard deviation calculated from signal amplitudes, an eight-dimensional feature vector is extracted from each signal epoch. Detailed description of the eight extracted features are listed below:

1. Mean of the absolute value of the amplitude
2. Standard deviation of amplitude values
3. Mean of the absolute values of the coefficients in each sub-band of the wavelet coefficients
4. Standard deviation of the coefficients in each sub-band of the wavelet coefficients

Table 4.1 shows the feature vector extracted from one fetal movement signal sample and that from one noise signal. From the table we can clearly observe the difference between these two feature sets. A more intuitive visualization of the difference between the two extracted feature vectors can be found in Fig. 4.5.

Table 4.1 – *Extracted features of one fetal movement signal segment and one noise signal segment.*

		Amplitude	D ₁	D ₂	D ₃	A ₃
Fetal movement	Abs Mean	0.0130	0.0157	0.0123	0.0126	0.0180
	Std	0.0228	0.0225	0.0213	0.0213	0.0269
Noise	Abs Mean	0.0024	0.0027	0.0022	0.0027	0.0028
	Std	0.0032	0.0034	0.0027	0.0036	0.0035

Note. Abs Mean: mean of the absolute value, Std: standard deviation.

4.4 ANFIS-BASED CLASSIFICATION APPROACH

The general architecture of the proposed ANFIS-based fetal health evaluation system is shown in Fig. 4.6. The filter that we utilized in this study is an IIR bandpass filter with a range of [0.2Hz, 20Hz], and we set the threshold detection module with parameters [0.05g, 0.8g]. The cross-correlation module is not involved (refer to Subsection 2.3.1), instead, the system simply excludes all the signals from the four sensors within a specific time interval in case if the any sensor's signal amplitude exceeds the upper threshold.

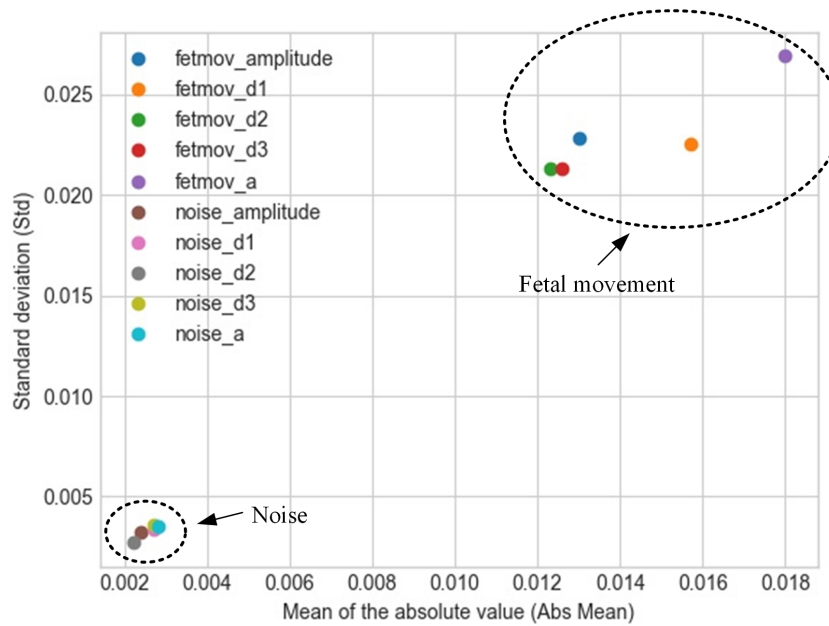

Figure 4.5 – A comparison of the feature distribution of a fetal movement signal with that of a noise signal.

4.4.1 Data acquisition

Just like other data-driven machine learning approaches, the development of the proposed ANFIS-based approach mainly comprises two steps: *training* and *testing*, respectively, which relies on a large volume dataset to achieve a good classification performance. However, by the time this approach was developed, we had acquired only two fetal movement signals, each with an acquisition time of about 20 minutes. It is therefore straightforward to utilize one signal for training the ANFIS model and the other one for testing the trained model's performance. Detailed description of data acquisition can be found in Section 2.4 of Chapter 2.

After filtered, these two signals were split into segments using a time window of 4 seconds in length with 50% overlapping. These split signal segments (also called samples) were then labeled by an expert clinician based on the maternal perception markers (fetal movements or not) documented during data acquisition. A brief recapitulation of these two datasets after signal processing and labeling is shown in Table 4.2.

Table 4.2 – Description of the two datasets used for ANFIS training and testing.

Number	Length (min)	Number of channels (sensors)	Samples per channel	Usage
1	15.2	4	456	Training
2	23.5	4	705	Testing

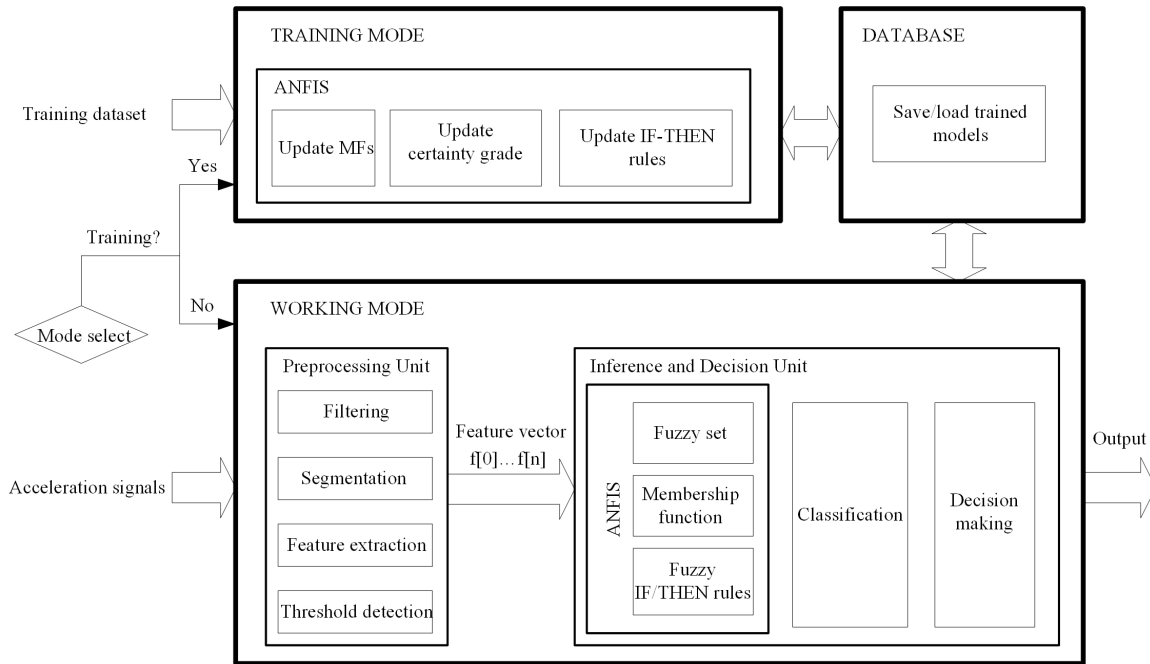

Figure 4.6 – Flowchart of the proposed ANFIS-based system.

4.5 EXPERIMENT AND RESULTS

4.5.1 Training of the ANFIS Classifier

We tested the performance of the proposed ANFIS-based approach using Matlab R2017a (The Mathworks, Natick, MA) running on a personal computer. The initial settings of the ANFIS model are described in Table 4.3:

Table 4.3 – Description of the two signals used in ANFIS training and testing.

Item name	Value	Remark
Fuzzy inference type	Sugeno	
Number of inputs	10	
Number of input membership functions	20	
Number of outputs	1	
Number of output membership functions	2	
Range of outputs	[1, 2]	1: Fetal movement, 2: Noise

The training of the ANFIS model mainly comprises two steps:

1. Initialize each input membership function of the ANFIS model by using the statistical distribution of the training dataset. Take the membership function for signal amplitude for example, the mean and standard deviation values of the signals' amplitudes over the entire training dataset were calculated, then the parameters c and a in Equation 4.1 were set accordingly.
2. Train the ANFIS model in an iterative way using the entire training dataset (we

did not divide the training dataset into batches). Note that compared to the initial version presented in [Jang (1993)], our ANFIS model was trained with the SCG (Scaled Conjugate Gradient) algorithm [Møller (1993)] for determining the optimum values of the nonlinear parameters, due to its faster execution time. We utilize root mean square error (RMSE) for evaluating the training and test performance. The RMSE is formulated as follows:

$$RMSE = \sqrt{\frac{\sum_{i=1}^N (d_i - o_i)^2}{N}} \quad (4.8)$$

where N denotes the total number of training samples in the training dataset ($N = 456 \times 4$ channels = 1824 in our case), o_i and d_i are the ANFIS model's outputs and the samples' corresponding real classes (labels), respectively.

The number of iterations was set to 100 in order that the training RMSE value fully converges to its minimum. The RMSE training curve is illustrated in Fig. 4.7.

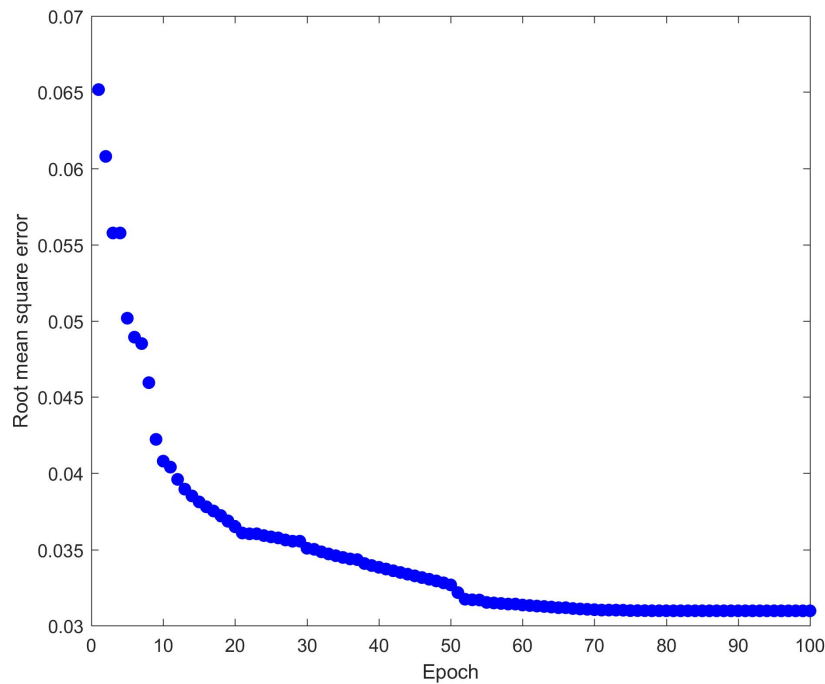

Figure 4.7 – The RMSE training curve of the ANFIS model.

4.5.2 Evaluation of the Trained ANFIS Model

The performance of the trained ANFIS model was evaluated using the second dataset. The classification accuracy on the testing dataset is 88.51% (624 out of 705 epochs have been correctly classified). The classification results of the signal corresponding to the third sensor is illustrated in Fig. 4.8.

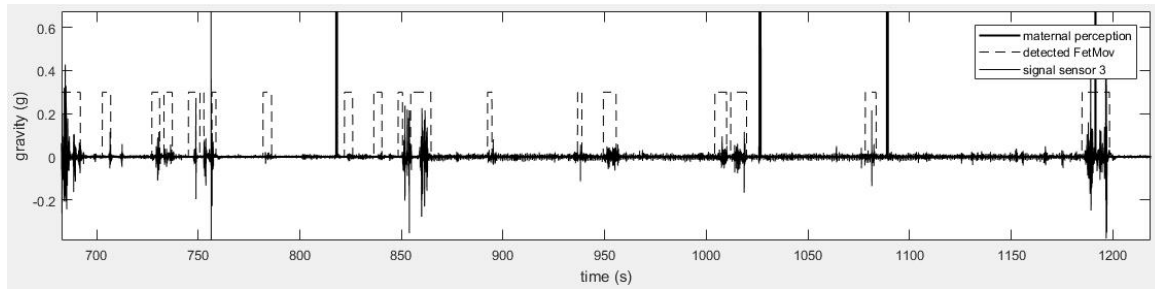

Figure 4.8 – Offline evaluation results of the proposed algorithm on the second signal.

4.6 CONCLUSION

The experimental results presented in Section 4.5 have shown a decent classification accuracy using an ANFIS-based classifier. As a member of fuzzy inference systems, one of the most significant advantages of ANFIS algorithm lies in its ability of linguistic modeling and approximate reasoning. However, only two types of signals had been considered by the time this work was conducted (fetal movement signals and background noise signals when the user stays still, respectively). The system was therefore not capable of monitoring fetal movements when there exist other artifact signals (e.g, if the mother is in activity during the measurement). Another limitations about this research lies on its incompleteness in terms of qualitative monitoring of fetal movements. In fact, merely being able to provide the number of signals labeled as FetMov (fetal movement) or NonFetMov (not a fetal movement) based on a 4-time interval, the monitoring system proposed in this chapter failed to propose a solid solution on how to relate these acquired fetal movement signals to the baby's real health condition. It was not until in the second year that I started to consider how to count fetal movements in a more rational and reasonable way rather than only focusing on the signal classification. For a detailed discussion about how to relate quantitative signal classification results to a qualitative evaluation of fetal health, the reader is referred to Chapter 7.

MANUAL FEATURE EXTRACTION OF FETAL MOVEMENT SIGNALS WITH SIGNAL CLASSIFICATION USING FUZZY ARTMAP

5.1 INTRODUCTION

As my understanding of the research project grows, my interests have been implicated in more specific issues concerning the accurate identification of fetal movement signals as well as the effective elimination of artifacts. It was at that stage of the research work that I started to think seriously about the following issues:

1. I started to notice the importance of analyzing not only fetal movement signals but also artifacts caused by the wearer (the pregnant woman) e.g., artifacts from maternal body motions or even from her walking activities. Indeed, it is not usual that a pregnant woman monitors her baby's movements while walking, because in this case it is hard for her to perceive fetal movements by herself. However, we have still attempted to detect fetal movement signals from mixed walking signals, which could be of benefit to improve the system's robustness dealing with different usage scenarios. If not handled properly, these artifacts could result in serious problems in terms of timely and accurately monitoring the fetus' health especially if the system has a poor specificity in distinguishing fake fetal movements from real ones.
2. I started to think about which features are most representative among others when dealing with signal classification-related problems, and how to find them. Classifying signals using the most relevant features has advantages: it can boost the classification accuracy and reduce the computational burden as redundant features are eliminated.
3. I considered the problem about how to make full use of all the four sensors when detecting fetal movements. Are there any relationship/correlations between signals coming from different sensors? It is at that time that I utilized cross-correlation

values between the two adjacent channels as a auxiliary tool to process signals (see Subsection 2.3.4 of Chapter 2).

4. I also realized the underlying difficulties in the acquisition of large volume of valuable fetal movement acceleration signals, which has been an obstacle to the use of data driven-based machine learning algorithms for signal classification. This is the reason why I started to put my focus on some machine learning algorithms who have incremental learning ability - Fuzzy ARTMAP used in this chapter is an example. Incremental learning allows an algorithm to continuously update its parameters (e.g. weight vectors or topology) once new training samples are available without catastrophic forgetting of what it has learned before.

Following the above-mentioned issues, this chapter mainly discusses two topics 1) a more rigorous and serious approach to extract features from fetal movement acceleration signals, and 2) signal classification using Fuzzy ARTMAP algorithm. Contents presented in this chapter are a combination of two published papers during my second year of PhD study both of which utilized Fuzzy ARTMAP classifier for the classification of acceleration signals. The experimental results concerning the first publication is stated in Section 5.4, and those for the second publication can be found in Section 5.5.

5.2 PRELIMINARY KNOWLEDGE

5.2.1 Feature Dimensionality Reduction with Sequential Feature Selection Algorithm

There has been attention to feature selection technique for decades [Fu (1970)]. In a classification task, feature dimensionality reduction by using feature selection helps to find the optimal feature subset from the original set and eliminate feature space redundancy and find the optimal feature subset. This brings benefits such as dealing with *overfitting* problem as well as reducing computational complexity [Motoda et al. (2002)].

Sequential Feature Selection (SFS) algorithm is one popular method to employ feature selection. Being a family of greedy search algorithm, this algorithm can be implemented in two ways: 1) Forward Sequential Selection (FSS), which starts with one feature only and progressively adds one feature at a time until the classifier reaches the highest classification, and 2) Backward Feature Selection (BSS), which start with the original feature set and remove one feature at a time [Aha et al. (1996)].

5.2.2 Principle Component Analysis

The very first discussion about the Principal Component Analysis (PCA) can be traced back to early 20th century [Hotelling (1933)]. This approach has widely been used in statistical analysis during the decades. PCA maps data from a high dimensional space into new orthogonal axes, which are called Principal Components (PCs), in order to reduce the dimension of the original feature space. Besides, PCA allows to visualize a high-dimension

feature set by transforming the original feature set into a 3-dimensional or 2-dimensional space.

5.2.3 Fuzzy ARTMAP

Based on adaptive resonance and fuzzy set theory, fuzzy ARTMAP is a lightweight machine learning algorithm different from other neural network-based algorithms. The most important advantage of using fuzzy ARTMAP lies in its easy implementation in an embedded microcontroller due to its low computational complexity. Another advantage lies on its property of incremental learning, with which it can continuously update its parameters (e.g. weight vectors or topology) once new training samples are available without catastrophic forgetting of what it has learned before. More detailed description on the fuzzy ARTMAP algorithm can be found in [Carpenter et al. (1992)].

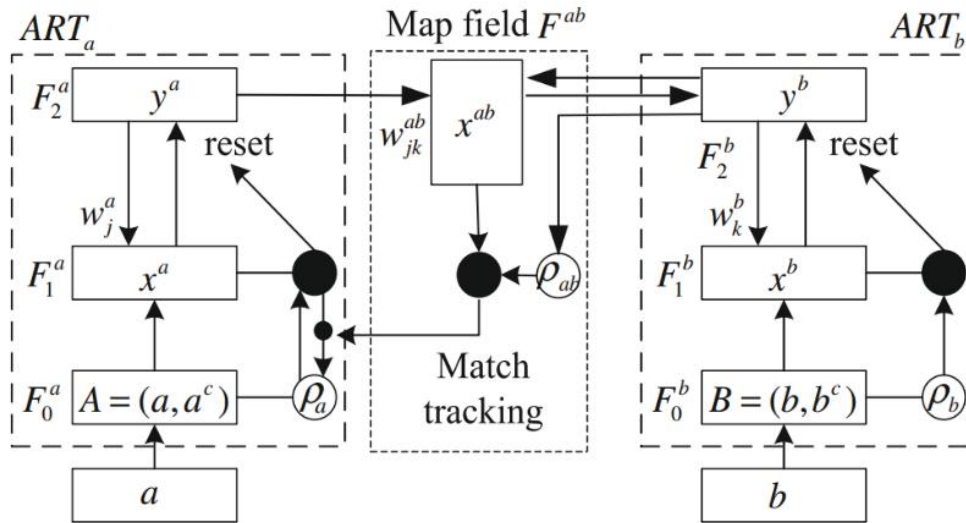

Figure 5.1 – Architecture of the fuzzy ARTMAP algorithm.

The architecture of the fuzzy ARTMAP is shown in Figure 5.1. It mainly consists of two fuzzy ART modules interconnected through the map field module F^{ab} . During the supervised training, the F_0^a layer in the ART_a module is fed with complement coded input vectors, and the ART_b module deals with the relevant correct prediction labels. If the prediction result given by ART_a based on input vector does not match the correct label given by ART_b , match tracking will take place. Match tracking triggers ART_a to search for another category that correctly predicts the label given by ART_b or adds a new category in case if no existing categories matches. Selection of one category from F_2^a is done based on the category choice function 5.1.

$$T^j = \frac{|I \wedge \omega^j|}{\alpha + |\omega^j|} \quad (5.1)$$

where I is the complement code of input vector, α is the choice parameter, ω_j is the weight of node j , and the fuzzy AND operator \wedge is defined by equation 5.2.

$$(p \wedge q)_i = \lim (p_i, q_i) \quad (5.2)$$

The node that with the highest category choice value in F_2^a is then tested with the vigilance value ρ according to the match criterion equation 5.3, if this condition is met, the parameter update is executed by equation 5.4.

$$\frac{|I \wedge \omega|}{|I|} \geq \rho \tag{5.3}$$

$$\omega_j^{new} = \beta(I \wedge \omega_j^{old}) + (1 - \beta)\omega_j^{old} \tag{5.4}$$

where β is the learning rate with the range of $[0, 1]$.

5.3 DATA ACQUISITION

By the time these two papers were published, I had already successfully collected 15 signals from 14 subjects (pregnant women) between the 25th - 39th week of gestation. A wide range of gestation weeks was covered in order to collect different types of fetal movement signals. Only subjects with singleton pregnancy were considered. The average recording duration was about 15 minutes. During the measurement, the subject was asked to hold the push-button in the hand to record maternal perceptions. After each data acquisition, a clinical expert labeled the acceleration signals with respect to the maternal perception markers.

Fetal movement patterns were labeled by human beings, which cannot guarantee absolute correctness. In fact, we do require the subject to keep quiet during the test, but it is unrealistic to force them to remain absolutely still and not to introduce any maternal movements. In the principle of utilizing fewer but better training patterns for machine learning, hoping not to include any pseudo patterns into training dataset, only 382 epochs were finally labeled as fetal movements among all the recorded data. At the same time, some artifact signal samples (e.g., the wearer’s body motion signals, walking, etc.) have also been acquired. These artifact signal samples are used for the training of the classifier model together with the fetal movement signals.

The acquired signals were pre-processed identically as presented in Subsection 2.3.2 of Chapter 2. A detailed description of the dataset after pre-processed can be found in Table 5.1.

Table 5.1 – Description of the training dataset.

Type	Number of samples (length: 4 seconds)
Fetal movement	382
Fetal heartbeat	655
Wearer’s body motion	368
Walking	552
Background noise	598

5.4 COMBINATION OF TIME-DOMAIN AND DISCRETE WAVELET-DOMAIN FEATURES FOR AN EFFECTIVE ELIMINATION OF MATERNAL BODY MOTION ARTIFACTS

This section presents a pilot experiment focusing on distinguishing between real fetal movement signals and maternal body motion signals. Similar to the feature extraction approach presented in Section 4.3, we have utilized a series of informative features extracted from both time and wavelet domain in order to maintain the computational simplicity of time features as well as the multi-resolution analysis ability of different frequency sub-bands when it comes to DWT.

5.4.1 Description of the Extracted Features

1) Time-domain features

The time-domain features extracted from the original signals comprise the following:

- Maximum absolute value of signal magnitudes
- Mean absolute value of signal magnitudes

2) Wavelet-domain features

Daubechies 2 (db2) wavelets with 4-level have also been utilized with the frequency range of each level shown in Table 5.2.

Table 5.2 – Frequencies corresponding to different levels of wavelet decomposition (4-level), with a sampling frequency of 60Hz.

Decomposed signal	Frequency range (Hz)
CD1	15 - 30
CD2	7.5 - 15
CD3	3.75 - 7.5
CD4	1.875 - 3.75
CA	0 - 1.875

In order to further decrease the dimensionality of the extracted DWT features, the following statistical information over the wavelet coefficients from each sub-band were calculated and used as the candidate features for the signal classification task [Subasi (2007)]:

- Mean value of the absolute values of the coefficients.
- Average power of the coefficients.
- Standard deviation of the coefficients.

- Ratio of the mean absolute values among all the sub-bands.

From the above four statistical features, the first and second represent the frequency distribution of a signal, and the other two represent the amount of changes in frequency distribution.

Finally, the combination of both the time-domain features and the statistical values calculated from the DWT coefficients results in a 22-dimensional feature vector. That is to say, after feature extraction, each time-based signal sample from the dataset (containing 240 data points) is now transferred to a vector of 22 data points.

5.4.2 Principal Component Analysis for Feature Visualization

We utilize PCA to map each 22-dimensional feature vector calculated using the above-mentioned feature extraction approach in 3-dimension space. Fig. 5.2 visualizes PCA results calculated based on the feature vectors from two categories: fetal movement and maternal body motion, respectively. From the figure it is observed that the samples from these two categories are clearly separable by a red dotted line, proving that the above-mentioned feature extraction approach is able to generate representative features that can effectively separate these two types of signals from each other.

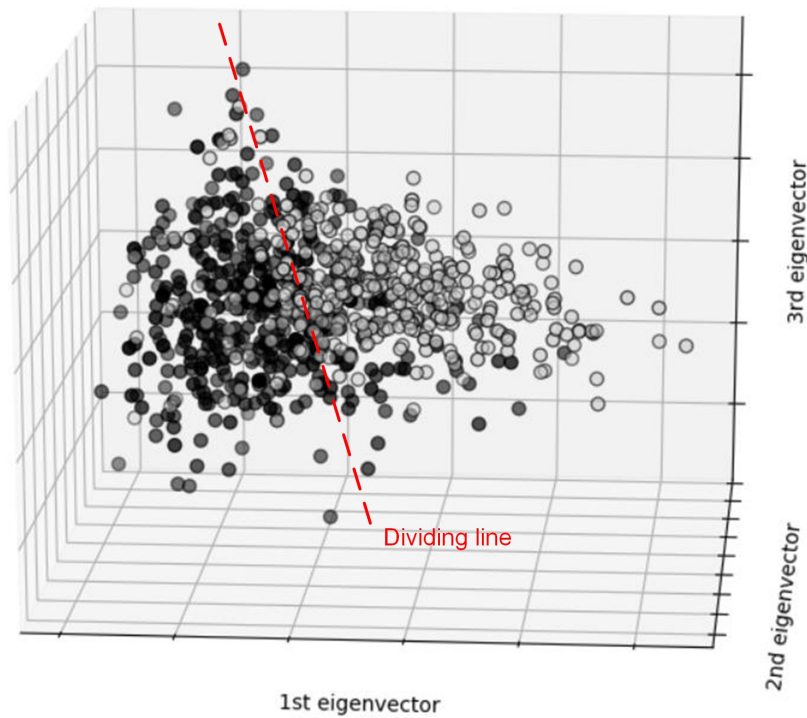

Figure 5.2 – PCA results providing a visualization of the selected feature set. It is observed from the figure that the two categories are clearly separable in a 3-dimensional space, as indicated with a red dotted line.

5.4.3 Training of Fuzzy ARTMAP Classifier Using the Extracted Features

In this pilot study, 147 fetal movement samples from two categories, namely fetal movement and maternal body motion, respectively, are carefully selected from the original dataset, and the features calculated from these samples by using the above-mentioned approach were used to train a fuzzy ARTMAP model. The initial parameter settings of the model is listed in the Table 5.3.

Table 5.3 – Initial parameter settings of the fuzzy ARTMAP model.

ART^α vigilance ρ_α	Bias	No. of epochs	No. of classes	Learning rate
0.75	0.000001	100	2	1

5.4.4 Validation of the Trained Model on New Data

We prepared a new signal (not part of the original dataset) to validate the trained fuzzy ARTMAP classifier. This new signal with a length of 10 minutes was recorded with a pregnant woman of 29 weeks gestation by using our intelligent garment working on raw data recording mode (sending raw sensor signals directly to the Smartphone without any pre-processing). Although the mother was recommended to avoid intensive body motions during the measurement, totally 4 maternal movements were recorded by the observer. During the measurement, the mother totally pressed the push button 15 times (each representing one maternal perception of fetal movement). The recorded signal from the third sensor together with the corresponding maternal markers is illustrated in Fig. 5.3a).

Correspondingly, the classification results of the trained fuzzy ARTMAP classifier on this offline data is shown in Fig. 5.3b. It is observed that the system accurately identified the fetal movements from around 150 seconds to 600 seconds. However, the classifier delivered some false positive outputs at the beginning of the signal where no maternal annotations are recorded. This is because that the subject was not yet ready for data acquisition when just settled down, which involves artifact signals that the system wrongly considered as fetal movements.

The experimental results have proven that the proposed monitoring system feature good sensitivity. However, since there is no absolutely trustworthy reference for fetal movement, and the mother may not be able to feel some fetal movements which are actually detectable by the monitoring system, it is difficult to evaluate the system's specificity. This experiment further confirmed that the moving window with a length of 4 seconds is suitable for fetal movement signal detection. It is worth noting that, this experiment introduced, for the first time, another time window with a length of 10 seconds. This second window working synchronously with the first one were used for artifact elimination based on a large time granularity [Altini et al. (2017)]. Using this "multiple-length window" configuration, the monitoring system successfully excluded the two maternal body

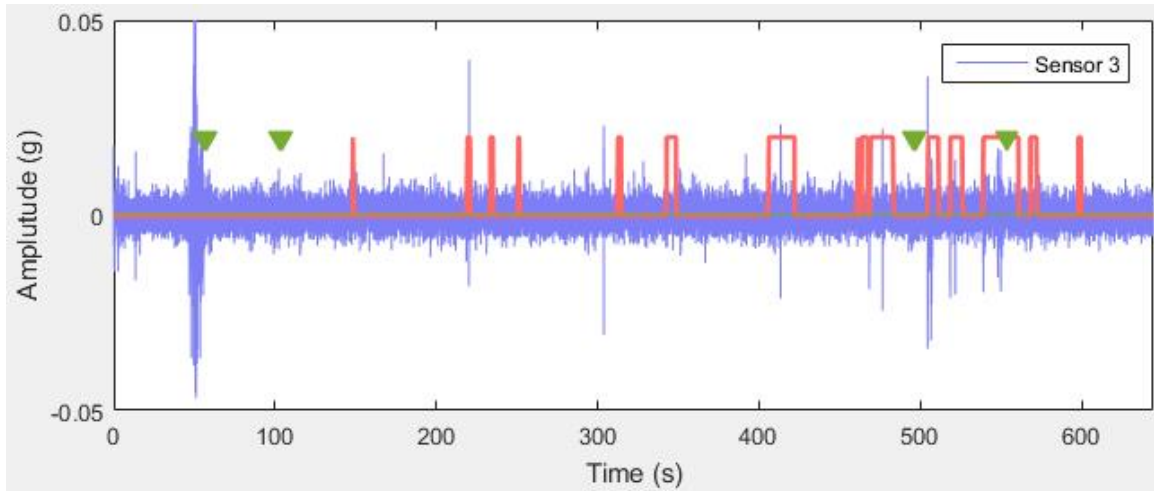

(a) Acceleration data from sensor 3 (purple) together with maternal perception (red) and the observer's markers for labeling the artifacts (green).

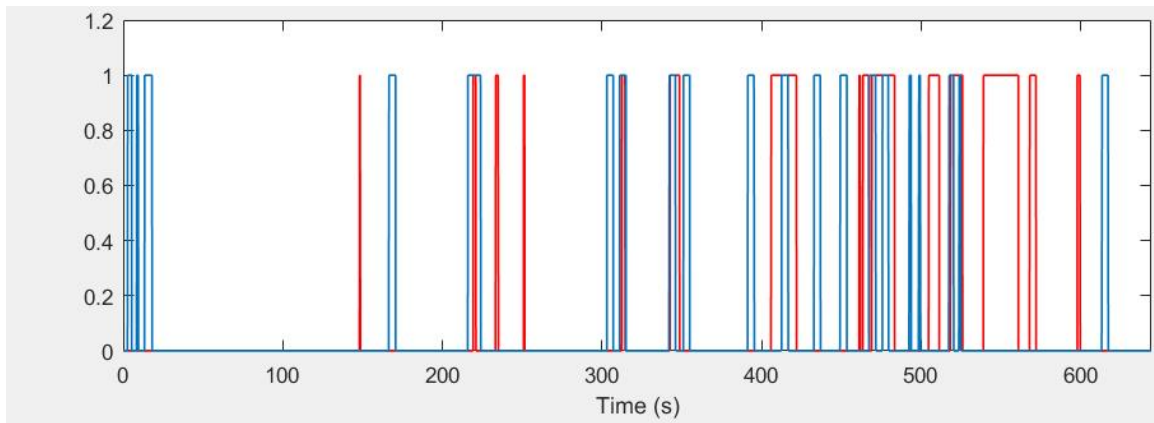

(b) Output of the proposed monitoring system (blue) together with maternal perception (red).

Figure 5.3 – Classification results.

motion artifacts at around 50 seconds and 550 seconds, further reducing false positive rate.

5.5 SELECTING THE MOST RELEVANT FEATURES

For effective classification of time series signals, it is important to identify a set of features with high discriminative ability. However, finding a good data representation is very domain specific and is related to available measurements. On the one side, it is always better to be too inclusive rather than discarding any potential vital information [Guyon et al. (2008)], on the other side however, extracting high-dimensional features from raw data makes it challenging to implement the related algorithm into wearable embedded systems due to the latter's limited memory and restricted computational capability.

This section presents our research work (the second publication mentioned in the current chapter) concerning identifying the most representative features from a set of data

and removing the irrelevant or less important features which do not contribute much to the classification accuracy.

5.5.1 Finding out the Most Representative Features

We first listed all the potential informative features in both time domain and DWT domain [Subasi (2007)] [Phinyomark et al. (2012)] (see Table 5.4). We then utilized SFS algorithm to find out the most representative features from the candidate features. Forward sequential selection algorithm was used. Besides, we assigned a Random Forest (RF) classifier for directing the search of the sequential algorithm for the most relevant features.

Table 5.4 – List containing candidate features utilized for feature selection.

Domain type	Number	Feature name	
Time domain	1	Maximum of absolute value	
	2	Minimum of absolute value	
	3	Mean	
	4	Standard deviation	
	5	Max.Abs - Min.Abs	
	6	Integrated value	
	7	Simple square integral	
	8, 9, 10	Absolute value of the 3 rd , 4 th and 5 th temporal moment	
	11	RMS	
	12	Log detector	
	13	Waveform length	
	14	Difference absolute standard deviation value	
	15	Skewness	
	16	Kurtosis	
	DWT	1	Mean absolute values of the coefficients
		2	Average power of the wavelet coefficients
3		Standard deviation of the coefficients	
4		Ratio of the absolute mean values in all the sub-bands	

In our previously researches, we systematically utilized Wavelet Daubechies 2 (db2) wavelet because it is widely used in the literature to solve similar classification problems [Tautges et al. (2011)]. However, no detailed and rigorous examination on other types of wavelet has been conducted. This section investigates the performance of different wavelets based on the classification accuracy of accelerometer signals. More exactly, Daubechies wavelet db1, db2, db6, Symmlet wavelet sym6, sym10 and Coiet wavelet coif2, coif4 were tested respectively. The result shows that the db2 wavelet outstands among others, validating our prior assumption (see Table 5.5).

Table 5.5 – Performance comparison of different wavelets on acceleration signal classification.

Feature space	Wavelet type	Accuracy
DWT	db1	0.966
	db2	0.967
	db6	0.962
	sym6	0.964
	sym10	0.954
	coif2	0.963
	coif4	0.959

Feature dimensionality reduction was applied separately to the candidate features of time-domain and those of DWT-domain (see Fig 5.4), and the final feature set was obtained by combining the optimal subsets in both time domain and DWT domain (see Table. 5.6). Combining the subsets from these two domains helps to improve the robustness and generalization ability of the monitoring system, as time-domain features are computationally simple whereas those of DWT-domain represent signals energy distribution in frequency sub bands.

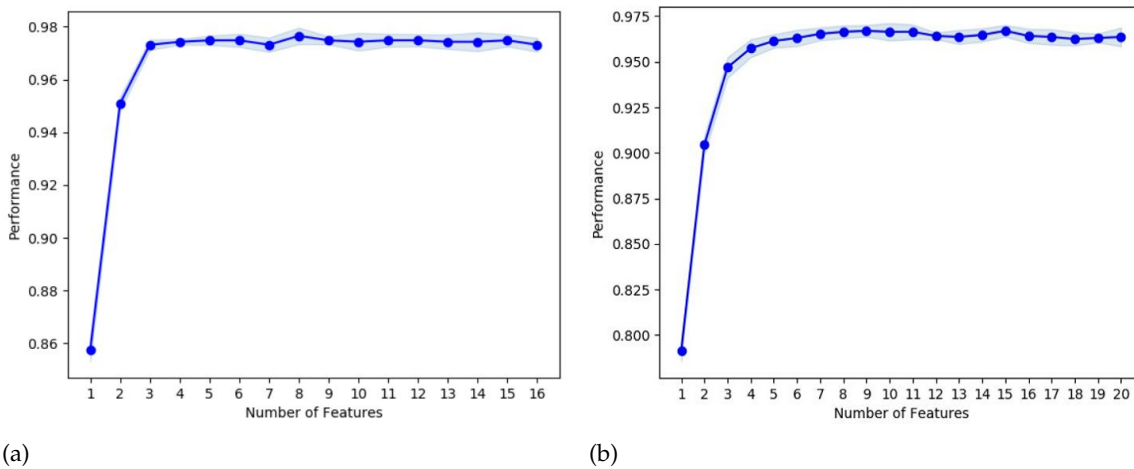

Figure 5.4 – Average classification performance on the training samples, with forward feature construction on time domain (a) and db2 wavelet (b).

5.5.2 Evaluation of the Classification with the Fuzzy ARTMAP Classifier

We utilized the famous 7 : 3 (training : testing) configuration to train and evaluate the performance of the fuzzy ARTMAP model, meaning that 70% of the entire training samples (feature vectors extracted from the entire collected acceleration data presented in Section 5.3) were used for training the model and the others used for testing. The confusing matrix of the classification results on testing data is shown in Table 5.7.

Table 5.6 – Final feature set comprising both time and wavelet features.

Domain	Feature number
Time	1, 5, 6, 7, 12, 13, 14, 15
DWT (db2 wavelet)	1, 2, 3, 4 for D1; 2, 4 for D2; 2, 4 for D3 and 4 for D4

From the confusing matrix it is observed that compared with the other artifacts, those caused by maternal body movements are relatively difficult to be distinguished from real fetal movement signals (with about 10% of the fetal movement signals misclassified as maternal body motion). The reason behind this is that some maternal body movements may cause abdominal deflections similar to those caused by a real fetal movement.

Table 5.7 – The confusion matrix of the classification results on test set (with fuzzy ARTMAP classifier).

		CLASSIFIED					
		Unknown	FetMov	Body motion	Walking	Heartbeat	BG
TRUTH	Unknown	0	0	0	0	0	0
	FetMov	0	92	12	4	3	3
	Body motion	0	5	103	0	0	0
	Walking	2	0	3	159	0	0
	Heartbeat	0	2	0	0	193	0
	BG noise	0	0	0	0	0	185

FetMov: fetal movement and BG: background noise.

5.6 CONCLUSION

The contents in this chapter mainly come from the two publications during the second year of my PhD study. At that stage of the research I have already acquired a decent amount of acceleration data containing not only fetal movement signals but also other types of artifacts e.g. body motion signals collected from the wearer. It is with these collected data that I was capable of conducting a more serious and rigorous feature extraction and analysis than the research work presented in the previous chapter. Finally, a feature set that comprises 17 informative and representative features has been decided after a greedy best-first search from all the candidate features using the SFS/FSS algorithm.

In this chapter we utilized a fuzzy ARTMAP model for signal classification-related tasks. As a member from the family of incremental learning algorithms, this algorithm features the ability of continuous learning from new incoming data without catastrophic forgetting of what it has been learned before. This brings significant benefits especially when dealing with the lack of training data.

As the reader can see from the experimental results presented in this chapter, the fuzzy

ARTMAP model trained with the final feature set has achieved almost perfect classification performance in terms of both sensitivity and specificity, which validated the efficiency and efficacy of the proposed feature extraction approach.

Promising though, this chapter still failed to answer "how these classification results relate to the fetus' well-being", which will be presented in Chapter 7.

TOWARDS AUTOMATED FEATURE EXTRACTION OF FETAL MOVEMENT SIGNALS

6.1 INTRODUCTION

As the reader can discover from the previous chapters, the processing of accelerometer-recorded fetal movement signals suffers from noises and artifacts mainly caused by maternal body motions and complex interactions between the sensors integrated in a wearable system and wearer's skin. An effective fetal movement monitoring system should be capable of accurately distinguishing real fetal movements from other artifacts as poor specificity could lead to severe consequence: the system regards noise signals as true fetal movements whereas the actual health condition of the fetus remains uncertain, resulting in potential fetal death. Therefore, there is a strong need to develop a robust and accurate system to overcome this problem.

In the literature, most proposed solutions to this issue involve hard-coded thresholds with features that are manually extracted from raw acceleration signals. [Girier et al. (2010b)] proposed simple statistical features, however, their system performed poorly in terms of both sensitivity and specificity, [Boashash et al. (2014)] developed a time-frequency approach based on the finding that fetal movement signals feature different frequency distribution compared to artifacts, [Nishihara et al. (2015)] and [Ryo et al. (2012)] presented their studies of analyzing accelerometer recorded signals both manually and with an automated software platform.

Despite great achievements, however, most of these studies based on the manual feature extraction of acceleration signals are still in their early stage. It is well known that feature extraction requires deep expertise in the field, badly selected features cannot accurately represent the underlying structure of the data, significantly degrading the performance of the model. This is the reason why a fetal movement monitoring system based on simple and manually extracted features with fixed thresholds often performs poorly in terms of accuracy and specificity especially when operating in a noisy environment (e.g., maternal body motions which are recorded by the accelerometers attached to the

mother's body). Based on a visual inspection of the acquired samples, [Boashash et al. (2014)] described that fetal movement acceleration signals can be grouped into two types based on signal morphology. However, our pilot experiment using a Self-organizing Map (SOM) for data clustering shows poor relevancy between signal morphological features and their corresponding categories (clusters) (see Subsection 6.4.1 of this chapter for more detailed information), revealing the difficulty of manual and intuitive feature extraction by human observers.

In recent years, some studies applied machine learning techniques to avoid the use of manually fixed thresholds, [Altini et al. (2016)] and [Altini et al. (2017)] trained a RF (Random Forest) model using time-domain features computed from raw signals over a time window, and [Layeghy et al. (2014)] employed SVM (Support Vector Machine) trained with time-frequency features of raw acceleration data. However, this raises two main concerns:

1. These studies systematically suffer from a lack of a large training dataset. It is well known that the acquisition of valuable medical signals could be quite time-consuming and inefficient. Taking fetal movement acceleration signal acquisition as an example, studies show that the number of fetal movements varies from 25 per hour to 3 in 24 hours in the third trimester [Rådestad (2010)]. It is also observed that the fetus stays inactive during a sleep cycle which could last up to 1 hour, resulting in no or only a few movement signals acquired for hours. Besides, the mother has to keep quiet and stay still during data acquisition in order not to involve any maternal body motions, largely interfering with her normal daily life.
2. Manually labeling of acquired raw data is another heavy task, and mistakes and inaccuracy in data labeling negatively affect a dataset's quality and the overall performance of the system. Labeling of fetal movement signals can be done with maternal annotation of fetal movements: before data are acquired, the mother is asked to hold a push button in the hand and push it each time she feels a fetal movement. However, studies show that only about 30% of fetal movements are perceived by the mother [Hijazi et al. (2010b)]. Miscellaneous though, this manipulation is inevitable for data labeling. Some studies proposed ultrasound imaging which works simultaneously with data acquisition by accelerometers to record and label fetal movements. However, moving the probe back and forth, which is necessary for an ultrasound scan, could introduce additional noises, interfere with the nearby sensors, and distort useful signals.

To the best of our knowledge, there is no study in the literature that employs deep learning techniques to learn to automatically extract features from raw fetal movement acceleration signals, neither does a deep and rigorous feature engineering based on a large dataset.

This chapter describes a novel approach based on deep learning with data augmentation technique to address the above mentioned issues. The promise of deep learning

lies on its ability of automatically learning and extracting internal representations directly from a large dataset without human intervention [Schmidhuber (2015)]. In this way, we neither need to manually extract and analyze features from signals, nor involve any hard-coded thresholds. Working as a classifier, the trained deep learning model can be used as an effective tool to classify fetal movement signals and detect other artifacts, improving the monitoring system's performance and robustness. Secondly, in order to address the problem of training data missing, we employ a 1-dimensional deep convolutional Generative Adversarial Network (GAN) which is trained with a small dataset of fetal movement acceleration signals and learns to generate new plausible signal samples from random noise, leading to expansion of the original dataset. The successful generation of plausible fetal movement signals is crucial, as it makes it possible to train a deep learning model for reliable classification of fetal movement signals without the actual demand for acquiring and labeling a large amount of real data. The experimental results show that an 1-Dimensional Convolutional Neural Network (1D CNN) deep learning model trained with the extended training dataset (real signal samples together with synthesized ones) achieved better classification performance in terms of both sensitivity and specificity compared to previous publications, leading to the validation of the proposed approach. As the continuation and extension of our previous research work as presented in the earlier chapters of this thesis, this chapter further demonstrates the feasibility of implementing the pre-trained 1D CNN into a common microcontroller with limited computational and storage capacities, paving the way towards the application of the proposed approach to wearable systems for online and real-time pregnancy health monitoring.

The work presented in this chapter provides guidance on applying deep learning to human physiological signal classification especially when the size of the available dataset for training the deep learning model is limited.

6.2 PRELIMINARY KNOWLEDGE

6.2.1 1-Dimensional Convolutional Neural Networks

Featuring one or a series of convolutional layers, a CNN is a member in NN family in deep learning. It is widely used for image recognition and processing tasks. A typical CNN model comprises one or a series of convolutional layers, pooling layers and fully-connected layers. The advantage of CNNs lies on its convolutional kernels (filters) which automatically extract key information from the original images without human intervention [Rawat et al. (2017)].

1D CNNs are similar to traditional CNNs except that they feature 1-dimensional convolution kernels in order to process time series data. Suppose the input vector to a convolutional layer is $\mathbf{x} = [x_1, \dots, x_n]$, its output can be formulated as:

$$o_i^{l,j} = \sigma \left(b_j^l + \sum_{m=1}^M w_m^{l,j} x_{i-m}^{l-1,j} \right),$$

where $i \in [0, k]$ with k the dimension of the output vector, l is the layer index, j is the feature map index, b is the bias value, w denotes the weight, m represents the kernel size and σ represents the activation function.

Activation functions play an key role in the accuracy and the computational efficiency of a CNN model. There exist several types of activation functions, the most commonly used are given below:

Rectified Linear Unit (ReLU):

$$\sigma_{relu}(x) = \max(0, x)$$

Sigmoid:

$$\sigma_{sigmoid}(x) = \frac{1}{1 + e^{-x}}$$

and Tanh:

$$\sigma_{tanh}(x) = \frac{2}{1 + e^{-2x}} - 1$$

A fully-connected layer takes the inputs from its precedent layer and applies weights on them. The mathematical expression of a fully-connected layer can be formulated as below:

$$f_i^l = \sum_j w_{ij}^{l-1} (\sigma(o_j^{l-1}) + b_j^{l-1}),$$

where l is the index of the current layer, o_j^{l-1} denotes j^{th} output from the previous layer, w_{ij}^{l-1} is weight of the previous layer associated with j^{th} nodes connected to the i^{th} node of current layer, σ is the above-mentioned activation function and b denotes the bias value.

Training of a CNN model involves an important notion: *backpropagation*, which is the abbreviation of "backward propagation of errors". Backpropagation updates the model's weights based on the errors between the model's outputs and actual labels of the training dataset. Backpropagation through the fully-connected layer (which is often the case for the layer before the output layer) can be formulated as below:

$$\frac{\partial E}{\partial w_{ij}^l} = a_i^l \frac{\partial E}{\partial x_j^{l+1}},$$

where a denotes $\sigma x + b$ and E is the cost function, which typically represents the difference between the predicted value and the actual dataset labels.

Similarly, the weights w of previous layers of the model are updated in a propagative way using the chain rule formulated as follows:

$$\frac{\partial z}{\partial x} = \frac{\partial z}{\partial y} \cdot \frac{\partial y}{\partial x}.$$

6.2.2 Generative Adversarial Networks

First proposed by [Goodfellow et al. (2014)], Generative Adversarial Networks (GANs) have been widely studied in the literature. As illustrated in Fig. 6.1, a typical GAN model comprises two sub-models: a *generator* and a *discriminator*, respectively. Fed with random input \mathbf{z} from a prior noise distribution $p_z(\mathbf{z})$, the generator attempts to generate plausible-looking samples \mathbf{x} with $\mathbf{x} = G(\mathbf{z})$ by learning the distribution of data, whereas the discriminator takes a sample as input and estimates whether it is real or fake based on the model's output $D(\mathbf{x})$. It is in essence a binary classification problem from the point of view of the discriminator: a sample \mathbf{x} is considered to be real if $D(\mathbf{x}) \in [0.5, 1]$, and fake if $D(\mathbf{x}) \in [0, 0.5]$.

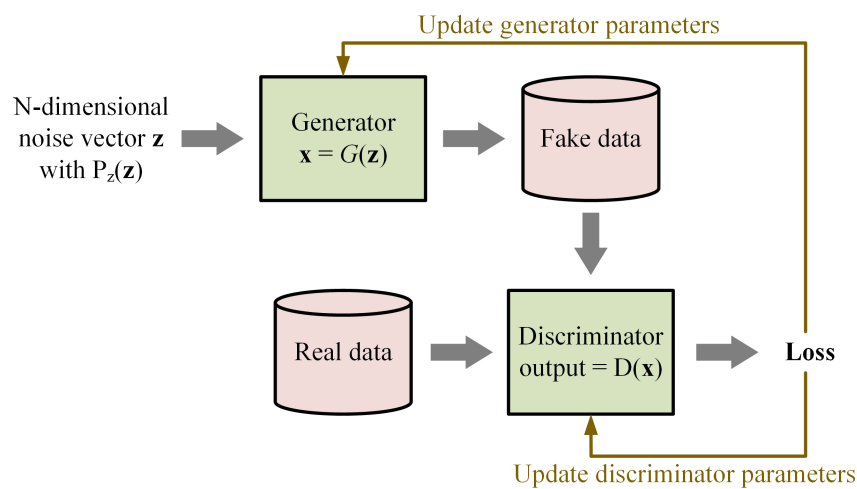

Figure 6.1 – Overview of GAN structure.

Training of GAN is described as follows: within each iteration, the discriminator first estimates given inputs (a mix of real and fake instances) and, based on the corresponding data labels of these inputs, calculates loss using the following loss function:

$$\mathbb{E}_{\mathbf{x} \sim P_x}[\log D(\mathbf{x})] + \mathbb{E}_{\mathbf{z} \sim P_z}[\log(1 - D(G(\mathbf{z})))]$$

where \mathbb{E} denotes the expected error over the input dataset, $D(G(\mathbf{z}))$ denotes the discriminator's estimate on a fake instance. We then train the two sub-models based on the loss value. The generator's parameters and weights are updated to the target that $D(G(\mathbf{z})) = 1$, which means that the discriminator estimates fake instances as real. Conversely, the discriminator learns to achieve $D(\mathbf{x}) = 1$ with $D(G(\mathbf{z})) = 0$ in order to perfectly distinguish real from fake. In other words, the discriminator always tries to maximize its probability of success in prediction while the generator minimizes it. This min-max objective of the GAN training process (also named *the zero-sum game*) can be formulated by the equations below:

$$\max_D V(D) = \mathbb{E}_{\mathbf{x} \sim P_x}[\log D(\mathbf{x})] + \mathbb{E}_{\mathbf{z} \sim P_z}[\log(1 - D(G(\mathbf{z})))]$$

$$\min_G V(G) = \mathbb{E}_{z \sim P_z} [\log(1 - D(G(z)))]$$

The discriminator's prediction accuracy degrades as the generator continuously improves with training. It will drop to 50% after enough iterations, meaning that the discriminator estimates its inputs by "guessing" because it cannot tell the difference between fake and real. A properly trained GAN can be used for data augmentation, as it is capable of generating plausible data to increase both the size and diversity of the original training dataset without actually collecting huge volumes of real data.

Despite the promising potential, however, there exists a well-known challenging problem when training a GAN model, commonly referred to as "*mode collapse*". When mode collapse occurs, the trained generator is able to create only one single or a small number of modes despite the multimodal nature of the given training dataset instead of producing a wide variety of outputs. The mode collapse problem lies on the fact that during the training, the generator is always trying to find the only output that seems most plausible to the discriminator [Salimans et al. (2016)].

There exist several GAN variations published in the literature due to different architectures and implementation strategies concerning the discriminator and the generator. Our study focuses on 1-dimensional GANs in order to deal with fetal movement time series signals. More specifically, we choose 1D CNN architecture to implement our GAN models. For more related detailed description, the reader is referred to Subsection 6.3.3 of this chapter.

6.3 METHODOLOGY

6.3.1 General Overview of the Proposed Approach

We present a multistage approach in order to develop a robust and reliable deep learning model for real-time fetal movement acceleration signal classification. Previously acquired raw data are first pre-processed prior to training, followed by training a 1-dimensional deep convolutional GAN model to generate new plausible samples and expand the original dataset (stage 1). A 1D CNN model is then trained with the expanded dataset (the original dataset together with the synthesized instances generated by the trained GAN model) which can be used for fetal movement signal classification. We further implement the pre-trained 1D CNN model into a common microcontroller, demonstrating the application of the proposed approach into an embedded wearable system for online pregnancy health monitoring (stage 2). The general workflow of the proposed approach is shown in Fig.6.2.

6.3.2 Pre-processing of Raw Acceleration Signals

We re-utilized the data that have been collected as described in Subsection 5.3 of Chapter 5. For the pre-processing approach of the raw data, the reader is referred to Subsection

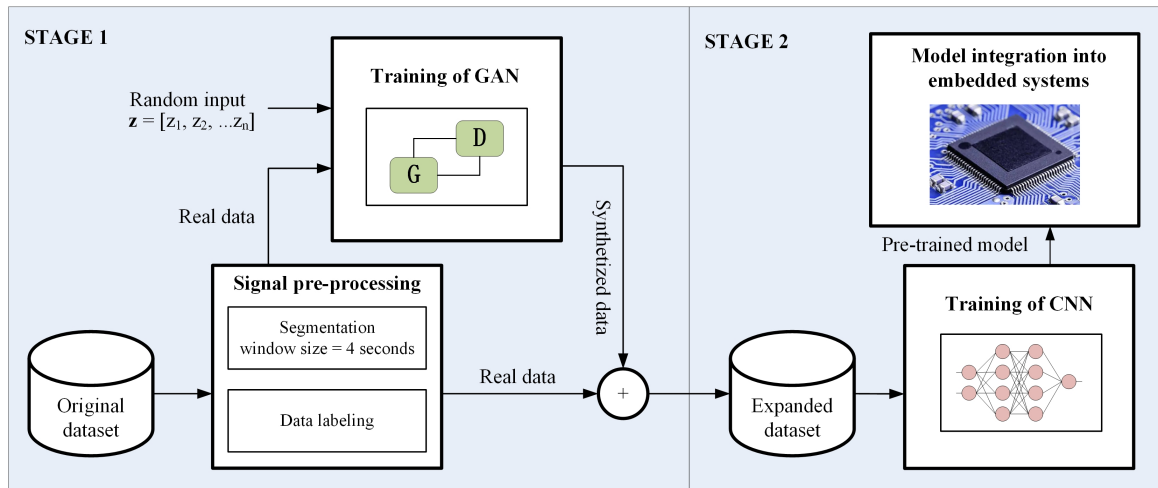

Figure 6.2 – General workflow of the proposed approach.

2.3.2 of Chapter 2. Please note that in order to employ deep neural network-based algorithms, we further performed data normalization which re-scales signal amplitudes (acceleration g values) to $[0 - 1]$ interval.

6.3.3 1-Dimensional Deep Convolutional Generative Adversarial Network for Data Augmentation

The proposed 1D GAN architecture in this chapter is mostly inspired by the well-known Deep Convolutional Generative Adversarial Network (DCGAN) [Radford et al. (2016)], which performs promisingly in image generation tasks and provides a robust starting point for most GAN applications. Dealing with time series accelerometer signals (1D data arrays) rather than images, we modify the original network architecture by employing 1D convolutional layers. Convolutional layers are utilized in both discriminator and generator sub-models, meaning that both of them are in essence 1D CNNs in terms of model architecture. Other layer-level modifications have also been considered compared to the original DCGAN architecture in order to achieve a promising performance in our study. The architecture of the proposed 1D GAN model is shown in Fig. 6.3. Detailed description is shown below:

6.3.3.1 Generator

Input to the generator is random noise with uniform distribution:

$$\mathbf{z} \sim \mathcal{U}(-1, 1)$$

The generator is comprised of an fully-connected layer, two 1D convolutional layers next to each other followed by a dropout layer to prevent *overfitting*, a pooling layer, then a flatten layer and another fully-connected layer. Outputs of the generator are 1D vectors of 240 data points identical to the size of a real fetal movement single sample in the dataset.

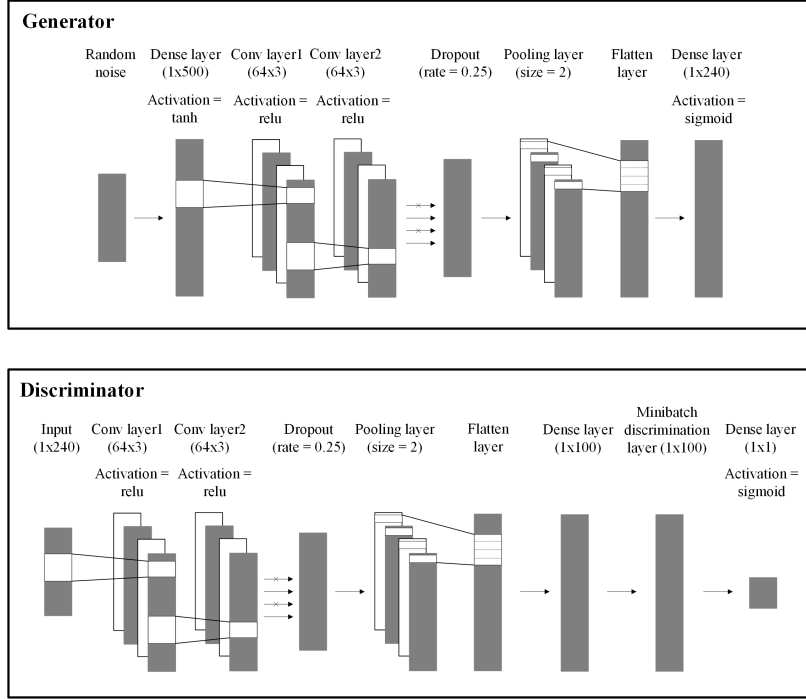

Figure 6.3 – The proposed 1-dimensional deep convolutional GAN architecture.

6.3.3.2 Discriminator

Inputs to the discriminator are time series signals with a fixed length (in our case 240 data points):

$$\mathbf{x} = [x_1 \dots x_n], n = 240$$

The discriminator has a similar architecture and configuration to the generator, it also features two adjacent 1D convolutional layers, followed by a dropout layer, a pooling layer, a flatten layer and two fully-connected (dense) layers. Outputs of the discriminator are binary values indicating whether an input sample is real or fake (generated).

One point worth mentioning is that between the two fully-connected layers, a *mini-batch discrimination* layer is employed to prevent mode collapse [Salimans et al. (2016)]. The minibatch discrimination allows the discriminator to compare the similarity of the generated samples within a batch, and thus penalize the generator if this similarity value is high. As illustrated in Fig. 6.4, we denote an output from a discriminator's intermediate layer as $f(\mathbf{x}_i) \in \mathbb{R}^A$ with x_i representing a given input instance, $M_i \in \mathbb{R}^{B \times C}$ is a matrix resulted from multiplying $f(\mathbf{x}_i)$ with a transformation matrix $T \in \mathbb{R}^{A \times B \times C}$, $c_b(\mathbf{x}_i, \mathbf{x}_j) = \exp(-\|M_{i,b} - M_{j,b}\|_{L1}) \in \mathbb{R}$ which is the L_1 -distance between the rows of two matrices to compute the similarity between x_i and other samples in the same batch. The similarity $o(\mathbf{x}_i) = [o(\mathbf{x}_i)_1, o(\mathbf{x}_i)_2, \dots, o(\mathbf{x}_i)_B] \in \mathbb{R}^B$ is fed into the next layer of the discriminator together with $f(\mathbf{x}_i)$.

When training the GAN model, we utilize binary cross-entropy loss function for both the generator and the discriminator as formulated below:

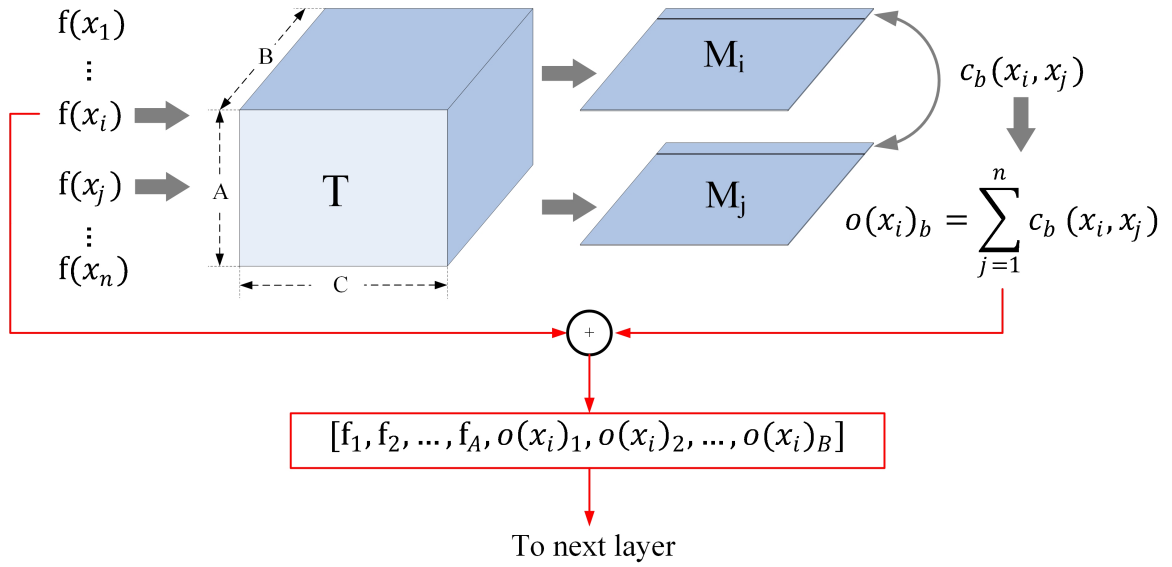

Figure 6.4 – Minibatch discrimination.

$$L = -\frac{1}{N} \sum_{c=1}^N [y_n \log y_n + (1 - y_n) \log(1 - y_n)]$$

where N denotes the number of samples.

6.3.4 1D CNN for Fetal Movement Signal Classification

We utilize a 1D CNN deep learning model for the classification of fetal movement signals. Our initial attempt was to reuse the discriminator of the trained GAN previously presented in this chapter as an auxiliary classifier. However, in real applications, a practical and robust pregnancy health monitoring system should be able to distinguish not only real fetal movement signals from fake ones (*binary classification*), but also to distinguish fetal movements from other human activities e.g. maternal body motions and background noise (*multiclass classification*). As the readers will discover in Section 6.4 of this chapter, the 1D CNN model is trained with a multi-label dataset comprising fetal movement signals as well as the above mentioned artifacts. In this case, the model is no longer trained with binary cross-entropy loss function as mentioned in Subsection 6.3.3 of this chapter, but has to be with categorical cross-entropy loss function since the model is considered to generate multiclass outputs. It therefore seems desirable to train a new 1D CNN model with the appropriate architecture. This new model with a similar architecture to the proposed GAN discriminator is shown in Fig. 6.5. After trained with the extended dataset, the 1D CNN model is capable of accurately classifying time series signals with fixed length (240 points) into multiple classes with better performance compared to the results presented in previous publications (see Subsection 6.4.3 for details).

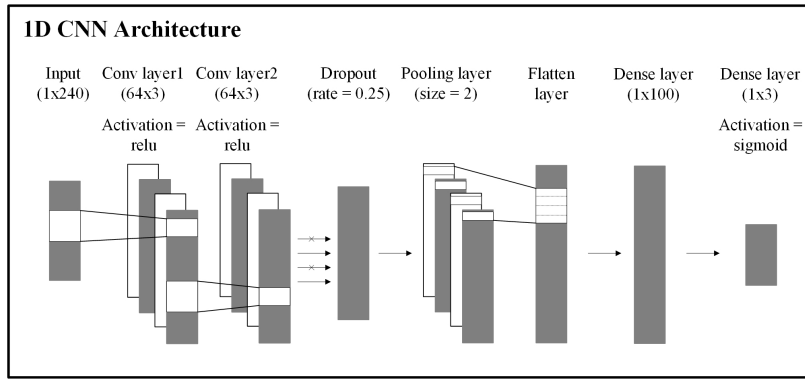

Figure 6.5 – The proposed 1DCNN used for fetal movement signals classification.

6.3.5 Implementation of the Pre-trained 1D CNN Model into a Microcontroller

As a subsequent work of our previous research work, one task of this study is to analyze the feasibility of embedding the pre-trained 1D CNN model into a microcontroller (STM32F7 series, STMicroelectronics Int. N.V. [STMicroelectronics]) of which the processing and memory resources are limited compared to an ordinary personal computer. That way, our proposed approach can be applied to microcontroller-based wearable systems with embedded accelerometers to perform online fetal movement signal classification of acceleration data, providing online and real-time pregnancy health monitoring. More detailed information and discussion about this topic can be found in Subsection 6.4.5.

6.4 EXPERIMENTAL RESULTS

6.4.1 Data Clustering of Fetal Movement Signals

It is reported in the literature that there are mainly two types of accelerometer-recorded fetal movement signals in terms of signal morphology (shape): one type of signals featuring one or two high frequency spikes or bursts and the other one with linear behaviors [Boashash et al. (2014)]. However, their finding is only based on an intuitive visual observation.

We suggest that different signal morphologies represent different fetal movement patterns (e.g., independent limb motions, head motions, fetal body motions, etc. [Birnholz et al. (1978)]), as different patterns feature different posture and intensity. For example, fetal limb motions could lead to the collected acceleration signals containing higher frequency compared to those corresponding to slow body movements. Different fetal movement patterns could also affect the amplitude (acceleration g value) of the acquired signals. We admit that there are also signals combining both behaviors, which probably indicates a combination of fetal body and limb movements occurred simultaneously. The causality between signal morphologies and the corresponding fetal movement patterns is not in the scope of this study.

In order to investigate whether our fetal movement dataset can be grouped based on

different morphologies, we employed a self-organizing map (SOM) for data clustering. One advantage of utilizing SOM for data analysis lies on its ability of visualizing the underlying group information of a given dataset by reducing input dimensions (feature vector size) into a two-dimensional space, which is called a map. Unlike other feature analysis tools such as PCA (Principle Component Analysis), SOM is an unsupervised algorithm, it features competitive learning and uses a neighborhood function to preserve the topological properties of the input space. The SOM was implemented with a PC running Matlab R2017a with Deep Learning Toolbox. The model was parameterized to 2-dimensional layer of 64 neurons (8×8 matrix).

The original dataset were pre-processed to offer better signal representation before being fed into the SOM model: mean values were subtracted, followed by squaring their absolute values, signals were then smoothed with a moving time window of 10 data points (meaning that average value was calculated inside each window), resulting in 24×1 dimension feature vectors. This manipulation highlights spikes in a signal while eliminated other redundant and irrelevant features (see Fig. 6.6).

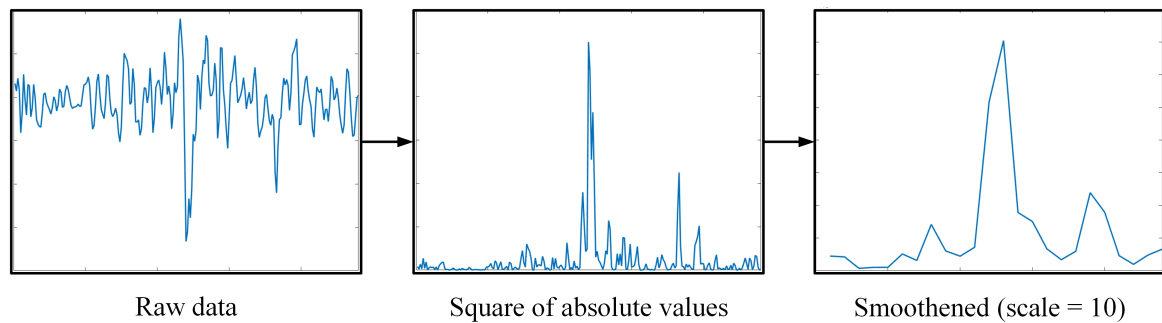

Figure 6.6 – An example of pre-processing data before feeding to SOM.

The clustering result shown in Fig. 6.7 clearly indicates the dataset are mainly grouped into three areas (containing 134, 70 and 41 samples, respectively). However, after a visual inspection to the samples located in each of these three top hit areas, we still found that different signals in terms of morphology are all mixed together, which violated our initial assumption of only one homogeneous signal morphology should be found inside one given cluster. Without showing any statistical associations, the experimental result presented in this subsection indicates that the signal morphology is not a key-feature (at least not the only one) that could exclusively represent the essential nature of a fetal movement signal. A Deep analysis and feature extraction need to be done in order to find out real key-features. This experimental result further underlines the tricky nature and potential unreliability of intuitive and manual feature extraction by human observers, and therefore encourages the use of deep learning algorithms to automatically learn and extract features from raw fetal movement acceleration data.

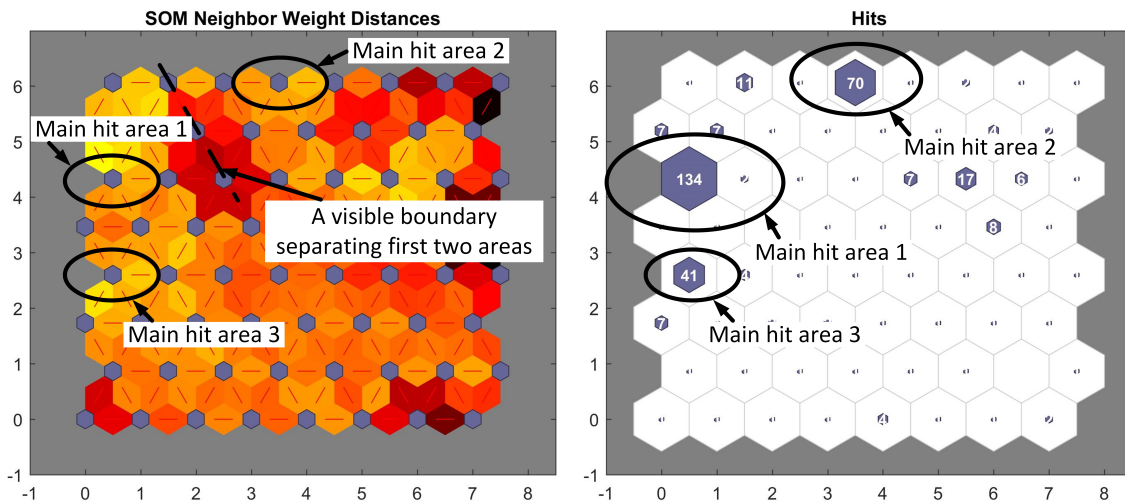

Figure 6.7 – Fetal movement signal clustering results using SOM.

6.4.2 Training of 1D GAN for data augmentation

The 1D GAN model presented in the previous part of this paper was trained with the dataset containing real fetal movement signal samples. The convolutional layers in both the generator and discriminator utilized *ReLU* as activation function, while the output layers employed *Sigmoid*. The model was implemented with TensorFlow’s high-level API Keras (TensorFlow version v2.1.0). During the experiment, we found that the generator suffers from high loss values if the batch size is too large, we therefore set batch size to 20, meaning that it takes 19 iterations to complete 1 epoch which passes through all the 382 samples). The training process repeated 800 times (epochs) in order that the generator produced plausible fetal movement signals. The general training process is illustrated in Fig.6.8.

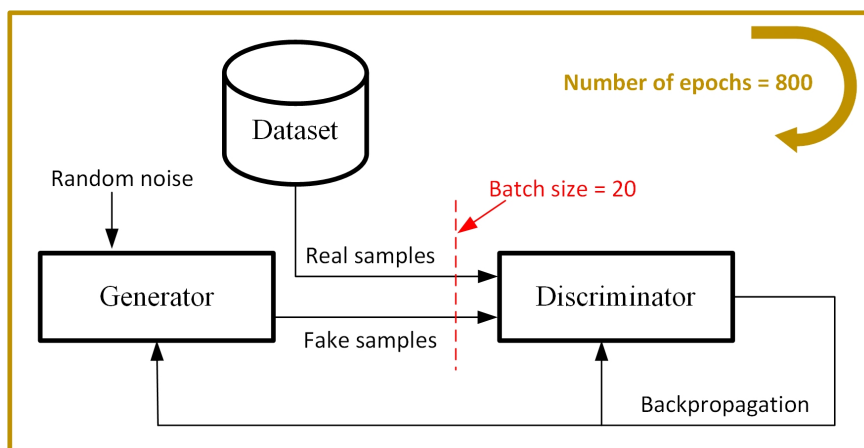

Figure 6.8 – Training process of the GAN model.

The training loss curves for both generator and discriminator are shown in Fig. 6.9. The convergence being noisy, though, it is observed that all curves successfully reached to a balance at about 1500 iterations. The generator’s curve remains relatively stable and holds

the value to about 4×10^0 , whereas the two discriminator curves (both for real samples and fake ones) feature large volatility especially at about 1000^{th} iteration. Plausible signals could be generated after training, with some examples illustrated in Fig. 6.10).

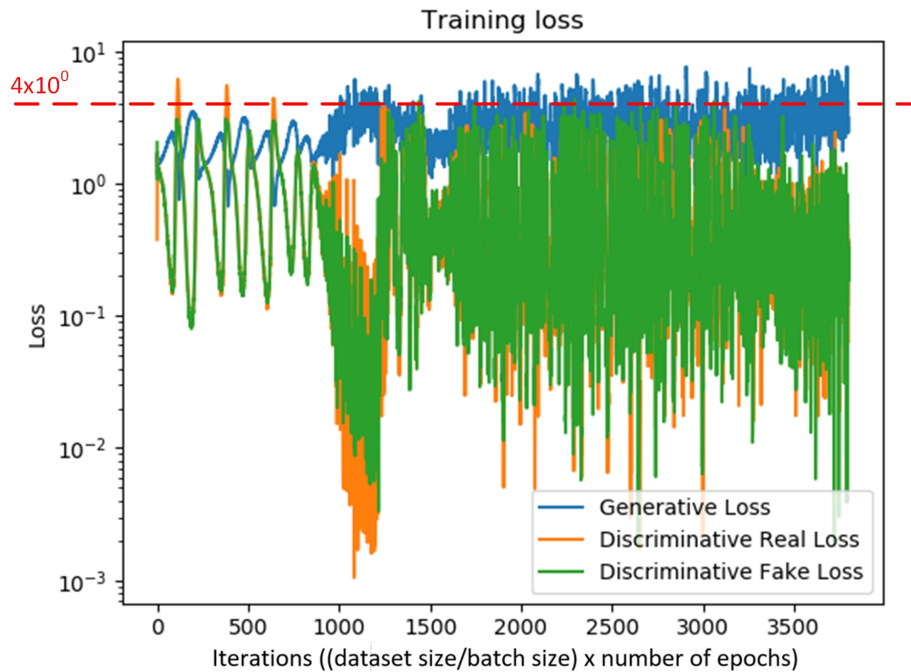

Figure 6.9 – Training loss curves for the generator and discriminator.

Being able to generate high quality synthesized fetal movement signals, the trained 1D GAN model was then used for data augmentation. Totally 3000 fetal movement samples have been generated using the trained GAN model. In order to avoid class imbalance of the extended dataset which could negatively affect the trained model's performance, we further generated 3000 maternal body motion signals using the same 1D GAN model as it is proved to be equally competent. A detailed description of the extended dataset distribution is shown in Table 6.1.

Table 6.1 – Sample Distribution of the Extended Training Dataset

Category	Number	Generated number	Total number
FetMov	382	3000	3382
BM	368	3000	3368
BG noise	3584	0	3584

FetMov: fetal movement, BM: maternal body motions, BG noise: background noise.

6.4.3 Training of 1D CNN

We used the extended dataset obtained in last subsection to train the 1D CNN model previously presented in this paper. We used adam (adaptive moment estimation) with

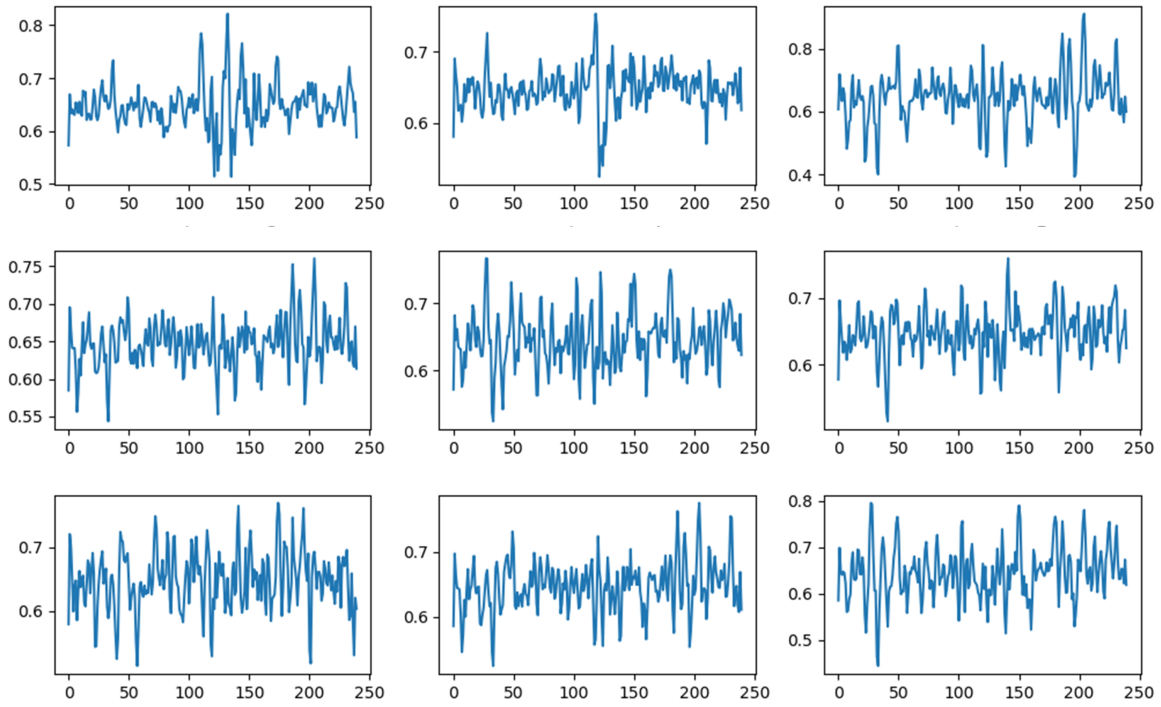

Figure 6.10 – Some generated signals.

learning rate set to 0.001 as the optimization algorithm. Same as the 1D GNN configuration, the convolutional layers employed *ReLU* as activation functions with the output layer utilizing *Sigmoid*. The entire dataset was split into training and testing set with the ratio of 70% : 30%, respectively. The evaluation of the model was repeated 10 times and the confusion matrix of the best performance is shown in Table 6.2. Calculations of these performance criteria are expressed as follows.

$$Sensitivity = \frac{TP}{TP + FN} \times 100\%$$

$$Specificity = \frac{TN}{TN + FP} \times 100\%$$

Table 6.2 – Confusion matrix

		Predicted		
		FetMov	BM	BG noise
Actual	FetMov	975	7	8
	BM	2	984	0
	BG noise	0	0	1125

FetMov: fetal movement, BM: maternal body motions, BG noise: background noise.

To validate the effectiveness of the proposed approach, we further conducted a performance comparison in terms of classification sensitivity and specificity between the 1D

CNN network trained with the extended dataset and other published studies in the literature. Only the studies that used maternal perceptions as reference to label data were involved. The comparison results (see Table 6.3) show that the our 1D CNN model achieved better classification performance with a sensitivity of 98.5% and specificity of 99.9%.

Table 6.3 – *Performance comparison*

Method	Sensitivity	Specificity
Time features + variable-length window [Altini et al. (2017)]	0.74	N/A
Time domain features [Altini et al. (2016)]	0.75	N/A
Time/frequency features [Subsection 5.5.2 of Chapter 5]	0.807	0.989
Proposed algorithm (calculated based on Table 6.2)	0.985	0.999

6.4.4 Horizontal Comparison of the Performance of the Three AI Algorithms Used in This Thesis under the Same Condition

This subsection further trains the three above-mentioned AI classifiers, namely ANFIS in Chapter 4, fuzzy ARTMAP in Chapter 5 and 1D CNN used in this chapter, by using the same dataset as presented in Subsection 5.3 and same training strategy i.e. splitting the dataset into training : testing of 70% : 30%. This allows a horizontal performance comparison of these three AI algorithms. In terms of classifier input, ANFIS and fuzzy ARTMAP utilize the extracted features as presented in Section 5.5, whereas the 1D CNN is fed with acceleration signal amplitudes. Advantages and drawbacks of each algorithm are discussed as well.

The two confusion matrices corresponding to ANFIS and 1D CNN are shown in Table 6.4 and Table 6.5, respectively. Together with that of fuzzy ARTMAP (already presented in Table 5.7), we can therefore evaluate the performance of each algorithm as shown in Table 6.6.

Table 6.4 – *Confusion matrix of the classification results on test set (with ANFIS classifier).*

		CLASSIFIED				
		FetMov	Body motion	Walking	Heartbeat	BG
TRUTH	FetMov	93	21	2	0	0
	Body motion	6	104	0	0	0
	Walking	3	0	158	0	0
	Heartbeat	21	7	0	180	0
	BG noise	3	0	0	0	168

FetMov: fetal movement and BG: background noise.

From Table 6.6 we conclude that the three algorithms feature approximately the same performance in terms of classification sensitivity and specificity with 1D CNN outstands

Table 6.5 – Confusion matrix of the classification results on test set (with 1D CNN classifier).

		CLASSIFIED				
		FetMov	Body motion	Walking	Heartbeat	BG
TRUTH	FetMov	94	8	0	7	3
	Body motion	6	94	2	4	0
	Walking	0	0	179	0	0
	Heartbeat	3	0	0	190	0
	BG noise	0	0	0	0	177

FetMov: fetal movement and BG: background noise.

Table 6.6 – An Horizontal Comparison of the Three Algorithms

Category	Sensitivity	Specificity	Pros	Cons
ANFIS	0.802	0.949	computationally simple;	N/A
fuzzy	0.807	0.989	highly interpretable	N/A
ARTMAP			support incremental learning	
1D CNN	0.839	0.986	better performance	need large training data; low interpretability

Note: We consider fetal movement signals as *positive* when calculating TP, TN, FP and FN.

slightly among others regarding sensitivity. Having performed this comparison using a relatively small dataset, we claim that the 1D CNN model could perform much better if it is fed with a larger training dataset, as has already been proved by using an extended training dataset containing plausible generated data earlier in this Chapter.

6.4.5 Implementation of Pre-Trained CNN into a Microcontroller

The implementation of the pre-trained 1D CNN into a embedded platform was realized using ST's Discovery kit with STM32F746NG microcontroller, STM32CubeMX framework, Keil μ Vision 5 IDE (Integrated Development Environment) and ST-Link. As one member of the ST's high performance STM32F7 family, The STM32F746NG microcontroller features 1MB of Flash memory and 320KB RAM (Random-access Memory) with up to 216MHz system frequency. After converted into c-code that could further compile and run on the microcontroller, the pre-trained 1D CNN Keras model occupied 808.27KBytes Flash memory and 61.95 KBytes of RAM, which is within the microcontroller's capacities. Detailed information concerning the storage and memory usage can be found in Table 6.7. The on-board experiments which run the embedded 1D CNN model on the microcontroller showed that it takes an average duration of 121.62 ms for one inference with 200MHz system frequency. Considering the wearable system proposed by our previous work which embeds 4 accelerometers, this inference time needs to be multiplied by 4, resulting in less than 500ms. Given the previous setting that signals are split based on

a 4 seconds window (meaning that the inference system should be able to complete the processing of the current signal within 4 seconds before the next window arrives), this inference duration is fully acceptable for online and real-time processing of acceleration signals.

Table 6.7 – *Memory analysis of the embedded CNN model*

Layers	ROM used (Bytes)
Conv layer 1 (input side)	1024
Conv layer 2 (network side)	49408
FC layer 1 (network side)	756624
FC layer 2 (output side)	1212
Total	808268 (789.32 KBytes)

Conv: convolutional, FC: fully-connected.

6.5 CONCLUSION

This chapter presents a novel approach using deep learning techniques for the automatic and accurate classification of fetal movement acceleration signals. The promise of employing deep learning lies on its ability of automatically extracting underlying representations of signals without human intervention, thus avoiding the unreliability and difficulty of manual feature extraction. In order to deal with the lack of large dataset for training the deep learning model, we employed data augmentation using a 1D deep convolutional GAN model to generate plausible fetal movement signals, extending the original dataset. Experimental results shows that a 1D CNN deep learning model trained with the extended dataset can achieve better classification performance compared to previous work, validating the proposed approach. Besides, the successful implementation of the pre-trained 1D CNN model into a microcontroller makes it possible to apply the proposed approach to wearable systems for real-time pregnancy health monitoring.

Further work involves developing a novel customized hardware platform integrating the microcontroller validated in this study and building a robust and accurate wearable system for online fetal movement monitoring combining our previous research results. We will also conduct a deep analysis of the proposed machine learning models by fine-tuning the relevant parameters for further boosting the system's performance in terms of signal classification accuracy.

QUALITATIVE EVALUATION OF FETAL HEALTH CONDITION

7

7.1 INTRODUCTION

Previous chapters have aimed to accurately classify 4-second time series signals into different categories, and therefore identify fetal movement signals while effectively eliminating artifacts from the ongoing acceleration signals. However, only based on this short time interval one cannot reasonably evaluate the fetus's health condition. This chapter presents a specifically designed algorithm for counting of fetal movements over a larger time intervals, which is based on analyzing a series of consecutive short-length time epochs. Take one step further, this chapter presents a role-based decision making process for long-term autonomous fetal health monitoring by analyzing fetal movement counting.

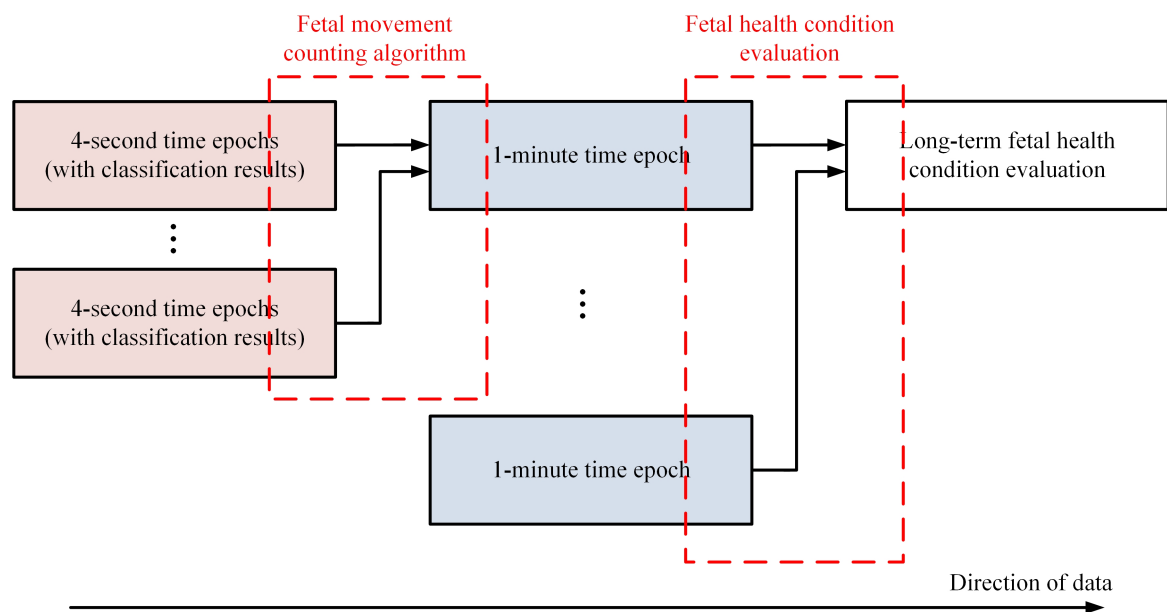

Figure 7.1 – Multiplexing of data: from quantitative signal classification results to qualitative fetal health evaluation.

As shown in Fig. 7.1, from a macroscopic point of view, if we consider this fetal movement counting algorithm as a black box (in the sense that we do not pay much attention to

the internal structures of the algorithm), then the input to this black box is a sequence of the signal classification outputs of any given machine learning classifier presented in the previous Chapter 4, 5 and 6, and its own output would be the number of fetal movements during the period corresponding to the total length of its input time series. The main objective of this algorithm is to build a bridge or to find a mapping relationship between the signal classification outputs (based on short time intervals) and the clinically accepted fetal movement counting criteria.

The reader may ask: why don't we count fetal movements directly based on the 4-second intervals? The reason is stated as follows: splitting signals over a 4-second window is suitable for identifying most of fetal movement acceleration signals since this window length is large enough to cover them (see 2.3.2.3), however, it is too short for counting fetal movements compared to the conventional clinical fetal movement counting approaches. Let's consider a situation where the fetus is quite active and moves much, then the monitoring system would count up to 25 fetal movements within one minute (4×25 seconds = 60 seconds) if based on the classification interval, which obviously makes no sense. In fact, as suggested by clinical professionals, a successive series of short fetal movements could be regarded as, more reasonably, as *one fetal movement phase*.

In this context, we set the basic time interval for fetal movement counting to 1 minute in accordance with the way a clinician or a mother counts fetal movements in clinical practice. For the sake of simplicity, This new interval is denoted as *Minimum Counting Interval (MCI)*. Correspondingly, the short window length used for signal segmentation and classification is denoted as *Minimum Processing Interval (MPI)*. Based on the above setting, one MCI consists of 15 consecutive MPIs.

7.2 METHODOLOGY

7.2.1 Fetal Movement Counting Algorithm

This subsection will present a novel algorithm for counting fetal movements (based on 1-minute interval) based on signal classification results (based on 4-second interval). The proposed algorithm comprises two steps: information fusion of the classification results from the four sensors (*spatial information fusion*) and information fusion from a successive MPIs to one MCI (*temporal information fusion*), respectively. Detailed descriptions of these two steps can be found below.

7.2.1.1 Step 1: Spatial Information Fusion - Information Fusion of Data from the Four Sensors

The reader has already noticed that our proposed wearable system features four accelerometers for physiological signal acquisition, which means that after running the inference procedure one time on the trained machine learning model, we get 4 signal classification results (each sensor corresponds to one result). We therefore need to define

some rules which merge these results into one single label in order to quantitatively analyze whether or not the system has detected fetal movements. According to the clinical experiments, we define the basic principles and rules as shown in Algorithm 1.

Algorithm 1: The spatial information fusion algorithm.

```

for the 4 classification results generated from the different sensors within the same
basic time interval do
  if at least two results are labeled by the class of "fetal movement" then
    label the merged result by the class of "fetal movements"
  else if at least two classification results are labeled by the class of "maternal body
movements" or "walking" then
    label the merged result by the same class
  else
    label the merged result by the class of "no action"
  end if
end for

```

7.2.1.2 Step 2: Temporal Information Fusion - Information Fusion from Consecutive MPIs to an MCI

Next, based on the spatial information fusion results, we perform the temporal information fusion in order to finally determine whether or not to *count* one fetal movement based on its MCI label. We determine the following principles:

1. If the number of basic time intervals labeled by the class of "maternal body movements" or "walking" exceeds 80% of the total number of basic time intervals, we consider that fetal movement cannot be identified in this decision time interval (uncertain status) because it is masked by strong signals of the wearer's activities.
2. If the condition in 1) is false and the number of basic time interval labeled by the class of fetal movements is more than a predefined threshold T_h (we have $T_h=2$ in our experiments), we consider that a fetal movement exists in this decision time interval.
3. If the conditions in 1) and 2) are both false, we consider that there is no fetal movement in this decision time interval.

Each MCI has three possible outputs, which are "FETAL MOVEMENT DETECTED", "NO FETAL MOVEMENT" and "UNKNOWN", respectively. Particularly, a MCI output could be "UNKNOWN", since when excessive artifacts are present, fetal movement signals could probably get distorted and overlaid, thus remains undetected, in which case the system is unable to clarify whether a fetal movement really occurs or not. An pseudo code explaining this procedure is shown in Algorithm 2. Figure 7.2 further illustrates this idea.

Specially, the intensity (represented by I) of a counted fetal movement can be calculated using Equation 7.1, in which N denotes the number of the MPIs that are labeled by the

Algorithm 2: The temporal information fusion algorithm.

for all the basic time intervals within a specific decision time interval **do**
 count the number of the merged results that are labeled by the class of “fetal movements”, “maternal body movements”, “walking” and “no action”, generated by the spatial information fusion algorithm
end for
if the number of the basic time intervals labeled by the class of “maternal body movements” or “walking” exceeds 80% of the total number of the basic time intervals included in this specific decision time interval **then**
 label this decision time interval as “unknown”
else if the number of the basic time intervals labeled by the class of “fetal movements” exceeds a predefined threshold T_h **then**
 label this decision time interval as “a fetal movement event was detected?”
else
 label this decision time interval as “no fetal movements”
end if{The threshold T_h is currently set to 2}

class of fetal movement inside this MCI, and i_k is the maximum of the signal magnitude values in the k^{th} labeled MPI.

$$I = \sum_{T_h \text{ in Algorithm 2} \leq k \leq N, N \leq 15} i_k \quad (7.1)$$

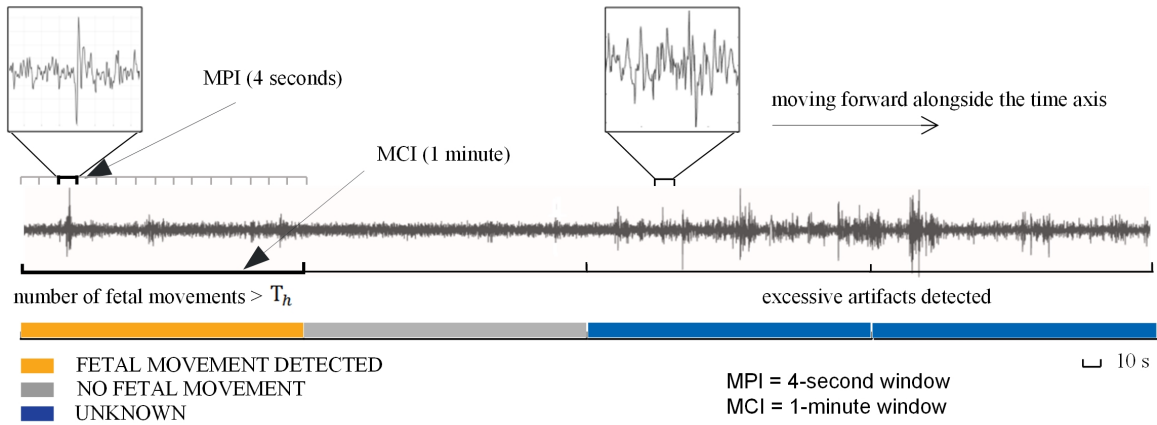

Figure 7.2 – Merging MPIs to one MCI.

In general, fetal movement counting estimation is efficient when the wearer’s activities are less intensive or intermittent.

7.2.2 Towards Long-Term Evaluation of Fetal Health

Taking one step further, this subsection presents a rule-based decision making process which analyzes fetal movement counting on a long-term and continuous basis, and

qualitatively evaluates fetal health conditions. Based on the relevant publications in the literature ([Graven et al. (2008)] [Jakes et al. (2018)] [Frøen et al. (2008)]) as well as clinical professionals' experiences, the decision making process mainly follows three principles as listed below:

1. The fetus should be active when awake.
2. The fetus should be quiet when sleeping.
3. Either change in intensity or in interval should cause concern.

The working process of the decision making algorithm is briefly described as follows: the algorithm will first learn and establish the sleep-wake cycle of the fetus by continuously monitoring fetal movements during several days. It will divide one day into intervals of 2 hours and label each interval as "wake" or "sleep" based on a statistical analysis of the recorded fetal movements. It then stores the sleep-wake cycle information locally for future use. Once this information is documented, it starts monitoring the fetal health conditions based on both recorded sleep-week cycle and the real-time fetal movement counting information. Once it detects abnormalities, it sends an alert message to the mother as well as the caregiver. It is also possible that the stored sleep-wake cycle information updates regularly as the fetus evolves. A detailed flowchart illustrating this process is shown in Fig. 7.3

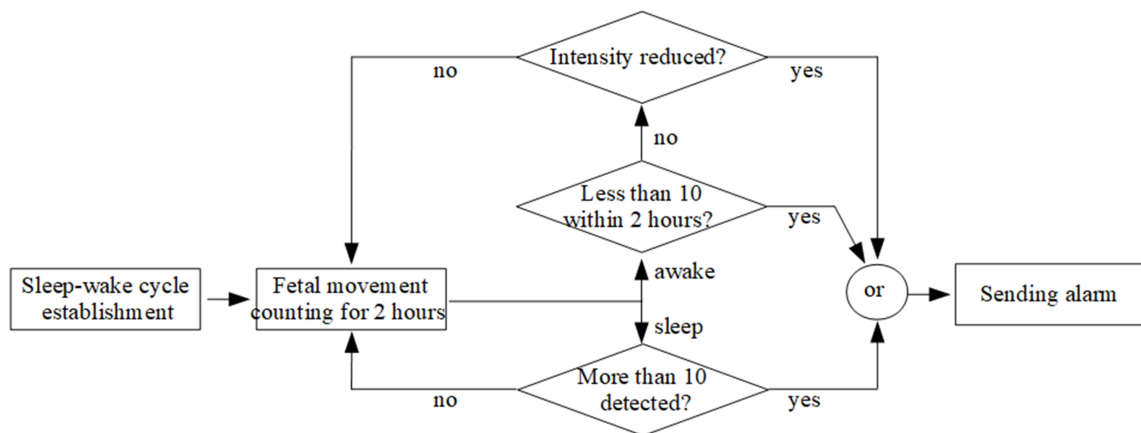

Figure 7.3 – Illustration explaining how the fetal movement counting algorithm works: classification results on a 4-second window of 4 sensors are merged into one single output, then 15 consecutive epochs of 4-second are merged in to a new window of 1 minute in length which is used for fetal movement counting.

This algorithm is implemented into the wearer's smartphone with a user-friendly graphical interface (see Fig. 2.6 in Chapter 2). Please note that this part is still in process and actually we are trying to find a way for clinical validation.

7.3 EXPERIMENTAL RESULTS

In order to evaluate the overall performance of the proposed local decision support system on estimation of fetal movements, we test it with a new pregnant woman wearing

the proposed intelligent garment and compare the final results given by the system with the maternal perception counting. We propose the following validation criteria: for each decision time interval (MCI, 1 minute) labeled as one fetal movement, when it overlaps a maternal perception counting by at least 50%, we consider that this decision time interval is regarded as a validated counting, otherwise it is characterized as a false positive and vice versa. The experimental results have proved that the proposed algorithm has a high agreement with the maternal perceptions (see Fig. 7.4), and has potential applications in assisting the pregnant woman with counting of fetal movements. A statistical summary of the algorithm’s counting results with regard to the maternal perceptions is shown in Table 7.1. We can find that a high estimation of fetal movements can be obtained with a true detection rate of 84%.

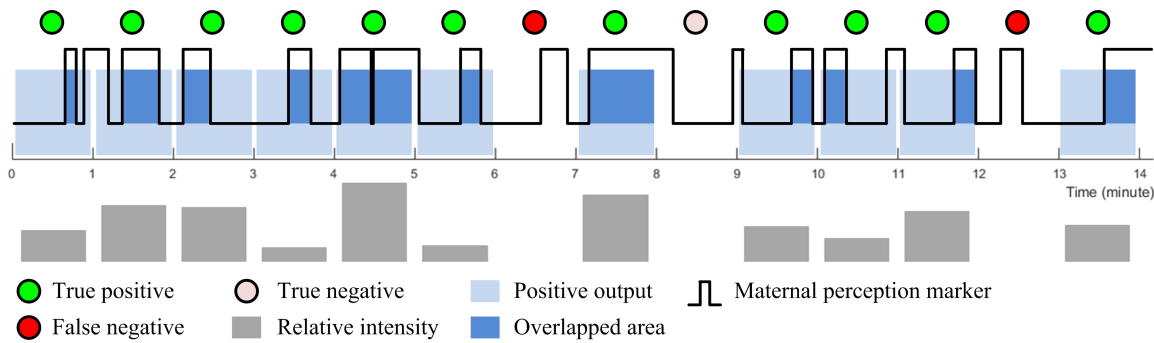

Figure 7.4 – The estimated counting of fetal movements on new data over 15 minutes. The experimental results show high compliance with the maternal perception.

Table 7.1 – Statistical Report of the System’s Counting Results

TFM	DF	FD	MD	TDR
13	11	0	2	0.84

TFM: total fetal movements perceived by the mother, DF: Detected fetal movements, FD: false detections, MD: missed detections and TDR: true detection rate.

7.4 CONCLUSION

This chapter presents a novel algorithm for fetal movement counting based on short time series acceleration signal classification results. The proposed algorithm helps to build a connection between the short time interval used for acceleration signal classification and the time interval used for counting fetal movements in clinical practice, which is much longer than the former. Therefore, the health condition of the fetus can be continuously evaluated by using the current clinically available criteria (e.g., the "count to ten" method: at least 10 distinct movements should be felt by the mother within 12 hours) on the number of fetal movements counted by the proposed algorithm. By this way, we can establish an early warning mechanism which is able to automatically detect reduced fetal movements

and send alerting messages to the mother and the caregivers to save the fetus' life. Besides, long-term analysis of the trends and changes of fetal movements in terms of both number and strength helps to achieve a long-term assessment of fetal well-being and detect early symptoms of fetal compromise.

GENERAL CONCLUSION

This doctoral thesis presents the research work during my three years' PhD study in Gemtex (Génie des Matériaux Textiles) Laboratory, ENSAIT, France. The main objective of this thesis is to design and develop a garment-based wearable system for reliable evaluation of fetal well-being by continuous monitoring of fetal movements. This work fully addresses the existing issues of current clinically-available fetal movement approaches and proposes an easily-accessible and reliable way for online, remote and ubiquitous monitoring of fetal movements. The design and develop of the proposed system mainly follows the following roadmap:

stage 1: analyze of the current clinically-available fetal movement monitoring approaches as well as the up-to-date publications and research works on this topic in the literature; troubleshoot existing problems and challenges; study the advances and features of wearable technology that could be solutions to these issues.

stage 2: design the overall architecture of the wearable system while fully considering the solutions to the issues identified in stage 1; define every functional blocks inside the system.

stage 3: wearable system hardware design, including sensors and embedded control and signal processing system; wearable system garment design; integration of the hardware into the garment structure.

stage 4: once the wearable system realized in stage 3 is able to be worn comfortably while being capable of acquiring data using the embedded sensors, we can use it to collect fetal movement data and build an initial database for future studies and analysis.

stage 5: data analysis of the acquired fetal movement signals, including data pre-processing, data segmentation, labeling, etc.

stage 6: train the selected machine learning algorithms for data classification, and establish a decision-making framework based on the signal classification results - integrating intelligence into the system.

stage 7: verification and evaluation of the wearable system's performance on continuous and quantitatively monitoring of fetal movements and qualitatively assessing of fetal well-being.

This thesis covers multidisciplinary topics and is of great significance by means of the introducing e-health and remote health care using wearable technology to the traditional field of fetal health monitoring. Original contributions of this work are profound:

1. Unlike other researches on this topic, this work for the first time proposed a complete and comprehensive wearable system for fetal movement monitoring while systematically considering every aspects during the system design - textile/garment design, sensor integration and ICT approaches.
2. It for the first time proposed a robust and solid solution for the automated, online and long-term evaluation of fetal health condition based on the accurate classification of accelerometer-recorded fetal movement signals.
3. It to the greatest extent integrates intelligence into the system, boosting its robustness and autonomy.
4. It further establish a valuable initial fetal movement signal database with maternal labels for other researchers to continue on this topic.

We believe that the work and contributions conducted in this thesis provides an innovative insight and guidance to future research and initiatives on maternal and fetal medicine.

Further improvements need to be considered before the proposed system can be commercialized and ready to be used in clinical practice:

1. Some technical improvements need to be considered such as total waterproofness, easy maintenance and repair of damaged components, etc.
2. The influence of sweat, moisture and washing processes especially after long-term use need to be studied.
3. Advanced noise elimination techniques enabling the system to detect and identify fetal movements even when the mother engages in intensive physical activities could be an option for further improving the system's robustness and reliability.

POSTSCRIPT

Over the three years, my experience as a PhD student has taught me a lot. My understanding of the mission and the context of the IOTFetMov research project improves as the research work evolves, so do my professional competences in signal processing, embedded systems & embedded machine learning and wearable technology. This valuable experience with rigorous thought and creativity has also taught me how to organize my own thoughts when dealing with an unknown issue and how to systematically dig in my own brain for novel ideas and possible solutions. It has taught me to keep going and try all the possible ways till success. It has improved my ability to work on some issues individually as well as in a team. This valuable PhD experience has definitely made me a better person when it comes to improving myself by continuing to learn and expanding my horizons, and is of great importance for my future professional careers.

BIBLIOGRAPHY

- Aha, David W. and Bankert, Richard L. A Comparative Evaluation of Sequential Feature Selection Algorithms. pages 199–206, 1996.
- Ahola, Tom, Korpinen, Pekka, Rakkola, Juha, Rämö, Teemu, Salminen, Jukka, and Savolainen, Jari. Wearable FPGA based wireless sensor platform. In *Annual International Conference of the IEEE Engineering in Medicine and Biology - Proceedings*, pages 2288–2291. IEEE, 2007. ISBN 1424407885.
- Akay, Metin, Sekine, M., Tamura, T., Higashi, Y., and Fujimoto, T. Unconstrained Monitoring of Body Motion During Walking. *IEEE Engineering in Medicine and Biology Magazine*, 22(3), p. 104–109, 2003. ISSN 07395175.
- Alfirevic, Zarko, Devane, Declan, Gyte, Gillian M.L., and Cuthbert, Anna. Continuous cardiotocography (CTG) as a form of electronic fetal monitoring (EFM) for fetal assessment during labour. *Cochrane Database of Systematic Reviews*, 2017(2), 2017. ISSN 1469493X.
- Altini, Marco, Mullan, Patrick, Rooijackers, Michiel, Gradl, Stefan, Penders, Julien, Geusens, Nele, Grieten, Lars, and Eskofier, Bjoern. Detection of fetal kicks using body-worn accelerometers during pregnancy: Trade-offs between sensors number and positioning. *Proceedings of the Annual International Conference of the IEEE Engineering in Medicine and Biology Society, EMBS*, 2016-October, p. 5319–5322, 2016. ISSN 1557170X.
- Altini, Marco, Rossetti, Elisa, Rooijackers, Michiel, Penders, Julien, Lanssens, Dorien, Grieten, Lars, and Gyselaers, Wilfried. Variable-length accelerometer features and electromyography to improve accuracy of fetal kicks detection during pregnancy using a single wearable device. In *2017 IEEE EMBS International Conference on Biomedical and Health Informatics, BHI 2017*, pages 221–224. IEEE, 2017. ISBN 9781509041794.
- Anliker, Urs, Ward, Jamie A., Lukowicz, Paul, Tröster, Gerhard, Dolveck, François, Baer, Michel, Keita, Fatou, Schenker, Eran B., Catarsi, Fabrizio, Coluccini, Luca, Belardinelli, Andrea, Shklarski, Dror, Alon, Menachem, Hirt, Etienne, Schmid, Rolf, and Vuskovic, Milica. AMON: A wearable multiparameter medical monitoring and alert system. *IEEE Transactions on Information Technology in Biomedicine*, 8(4), p. 415–427, dec 2004. ISSN 10897771.
- Apple Watch Teardown - iFixit. URL <https://www.ifixit.com/Teardown/Apple+Watch+Teardown/40655>. Accessed on 2020-08-16.

- Ashbrook, Sharon E., Griffin, John M., and Johnston, Karen E. Annual Review of Analytical Chemistry Recent Advances in Solid-State Nuclear Magnetic Resonance Spectroscopy. *Annu. Rev. Anal. Chem.*, 11(1), p. 485–508, 2018. ISSN 1936-1327.
- Bahga, Arshdeep, and Vijay K. Madiseti. A cloud-based approach for interoperable electronic health records (EHRs). *IEEE Journal of Biomedical and Health Informatics*, 17(5), p. 894–906, 2013. ISSN 21682194.
- Baig, Mirza Mansoor, GholamHosseini, Hamid, Moqem, Aasia A., Mirza, Farhaan, and Lindén, Maria. A Systematic Review of Wearable Patient Monitoring Systems – Current Challenges and Opportunities for Clinical Adoption. *Journal of Medical Systems*, 41(7), p. 1–9, jul 2017. ISSN 1573689X.
- Bamberg, Stacy J. Morris, Benbasat, Ari Y., Scarborough, Donna Moxley, Krebs, David E., and Paradiso, Joseph A. Gait analysis using a shoe-integrated wireless sensor system. *IEEE Transactions on Information Technology in Biomedicine*, 12(4), p. 413–423, jul 2008. ISSN 10897771.
- Bates, J.H. and Young, M.P. Applying fuzzy logic to medical decision making in the intensive care unit. *American journal of respiratory and critical care medicine*, 167(7), p. 948–952, apr 2003. ISSN 1073449X.
- Beach, Richard D. and Moussy, Francis. Totally implantable real-time in vivo video telemetry monitoring system for implant biocompatibility studies. *IEEE Transactions on Instrumentation and Measurement*, 50(3), p. 716–723, jun 2001. ISSN 00189456.
- Bérangère, Delaby. Vêtement intelligent pour la surveillance des mouvements foetaux, élaboration and caractérisation de structures tricotées, 2016.
- Bhattacharya, M, Hong, S, Lee, D, . . . , T Cui Sensors, B, Actuators, et undefined 2011. Carbon nanotube based sensors for the detection of viruses. *Elsevier*.
- Birnholtz, J. C., Stephens, J. C., and Faria, M. Fetal movement patterns: A possible means of defining neurologic developmental milestones in utero. *American Journal of Roentgenology*, 130(3), p. 537–540, 1978. ISSN 0361803X.
- Bleakly, Rhonda. Continuous glucose monitoring in children with type 1 diabetes. *Journal of Diabetes Nursing*, 15(6), p. 211–219, 2011. ISSN 13681109.
- Boashash, B., Khlif, M. S., Ben-Jabeur, T., East, C. E., and Colditz, P. B. Passive detection of accelerometer-recorded fetal movements using a time-frequency signal processing approach. *Digital Signal Processing: A Review Journal*, 25(1), p. 134–155, 2014. ISSN 10512004.
- BodyMedia. URL <https://bodymedia.com/>. Accessed on 2020-08-03.

- Borges, L. M., Rente, A., Velez, F. J., Salvado, L. R., Lebres, A. S., Oliveira, J. M., ... and Ferro, J. Overview of progress in Smart-Clothing project for health monitoring and sport applications. 2008 First International Symposium on Applied Sciences on Biomedical and Communication Technologies, pp. 1–6.
- Bourennane, W, Charlon, Y, Chan, M, international . . . , D Estève Proc 8th, and undefined 2011. Integration of wearable device with actimetry system for monitoring Alzheimer's patients.
- Buechley, Leah and Eisenberg, Michael. The LilyPad Arduino: Toward wearable engineering for everyone. *IEEE Pervasive Computing*, 7(2), p. 12–15, 2008. ISSN 15361268.
- Buford, RJ, . . . , EC Green 2008 IEEE Sensors, and undefined 2008. A microwave frequency sensor for non-invasive blood-glucose measurement. *ieeexplore.ieee.org*.
- Carpenter, Gail A., Grossberg, Stephen, Markuzon, Natalya, Reynolds, John H., and Rosen, David B. Fuzzy ARTMAP: A Neural Network Architecture for Incremental Supervised Learning of Analog Multidimensional Maps. *IEEE Transactions on Neural Networks*, 3(5), p. 698–713, 1992. ISSN 19410093.
- Chan, Marie, Estève, Daniel, Fourniols, Jean Yves, Escriba, Christophe, and Campo, Eric. Smart wearable systems: Current status and future challenges. *Artificial Intelligence in Medicine*, 56(3), p. 137–156, nov 2012. ISSN 09333657.
- Chaudhary, Ayesha, McShane, Michael J., and Srivastava, Rohit. Glucose response of dissolved-core alginate microspheres: Towards a continuous glucose biosensor. *Analyst*, 135(10), p. 2620–2628, sep 2010. ISSN 13645528.
- Cherenack, Kunigunde, Zysset, Christoph, Kinkeldei, Thomas, Münzenrieder, Niko, and Tröster, Gerhard. Woven electronic fibers with sensing and display functions for smart textiles. *Advanced Materials*, 22(45), p. 5178–5182, 2010. ISSN 09359648.
- Cherevko, S, Chemical, CH Chung Sensors, B:, Actuators, and undefined 2009. Gold nanowire array electrode for non-enzymatic voltammetric and amperometric glucose detection. *Elsevier*.
- Chien, Jia Ren Chang and Tai, Cheng Chi. A new wireless-type physiological signal measuring system using a PDA and the bluetooth technology. *Biomedical Engineering - Applications, Basis and Communications*, 17(5), p. 229–235, oct 2005. ISSN 10162372.
- Cho, Gilsoo. *Smart clothing: technology and applications*. CRC press, 2009. ISBN 142008853X.
- Chung, WY, Lee, SC, International, SH Toh 2008 30th Annual, and undefined 2008. WSN based mobile u-healthcare system with ECG, blood pressure measurement function. *ieeexplore.ieee.org*.

- Coyle, Shirley, Morris, Deirdre, Lau, King-Tong, Diamond, Dermot, and Moyna, Niall. Textile-Based Wearable Sensors for Assisting Sports Performance. pages 307–311. Institute of Electrical and Electronics Engineers (IEEE), sep 2009.
- Curone, Davide, Dudnik, Gabriela, Loriga, Giannicola, Luprano, Jean, Magenes, Giovanni, Paradiso, Rita, Tognetti, Alessandro, and Bonfiglio, Annalisa. Smart garments for safety improvement of emergency/disaster operators. In *Annual International Conference of the IEEE Engineering in Medicine and Biology - Proceedings*, pages 3962–3965, 2007. ISBN 1424407885.
- Curone, Davide, Secco, Emanuele Lindo, Tognetti, Alessandro, Loriga, Giannicola, Dudnik, Gabriela, Risatti, Michele, Whyte, Rhys, Bonfiglio, Annalisa, and Magenes, Giovanni. Smart garments for emergency operators: The ProeTEX project. *IEEE Transactions on Information Technology in Biomedicine*, 14(3), p. 694–701, may 2010. ISSN 10897771.
- Di Rienzo, Marco, Rizzo, Francesco, Meriggi, Paolo, Castiglioni, Paolo, Mazzoleni, Paolo, Ferrarin, Maurizio, and Ferratini, Maurizio. MagIC: A textile system for vital signs monitoring. Advancement in design and embedded intelligence for daily life applications. In *Annual International Conference of the IEEE Engineering in Medicine and Biology - Proceedings*, pages 3958–3961, 2007. ISBN 1424407885.
- Er, Orhan, Feyzullah Temurtas, and A. ĀĀetin TanrĀĀskulu. Tuberculosis disease diagnosis using artificial neural networks. *Journal of medical systems*, 34(3), p. 299–302, 2010. ISSN 0148-5598.
- Eysenbach, Gunther. What is e-health? *Journal of Medical Internand Research*, 3(2), p. 1–5, jun 2001. ISSN 14388871.
- Fernández-Caramés, Tiago M. and Fraga-Lamas, Paula. Towards the internet-of-smart-clothing: A review on IoT wearables and garments for creating intelligent connected E-textiles. *Electronics (Switzerland)*, 7(12), p. 405, 2018. ISSN 20799292.
- Fissell, William H., Fleischman, Aaron J., Humes, H. David, and Roy, Shuvo. Development of continuous implantable renal replacement: past and future, dec 2007. ISSN 19315244.
- Frøen, J. Frederik, Heazell, Alexander E.P., Tveit, Julie Victoria Holm, Saastad, Eli, Fretts, Ruth C., and Flenady, Vicki. Fetal Movement Assessment. In *Seminars in Perinatology*, volume 32, pages 243–246. Elsevier, 2008. ISBN 0146-0005.
- Fu, King S. *Sequential methode in pattern recognition and machine learning*. Academic press, 1970. ISBN 0080955592.
- Fu, Yu and Liu, Jian. System Design for Wearable Blood Oxygen Saturation and Pulse Measurement Device. *Procedia Manufacturing*, 3, p. 1187–1194, 2015. ISSN 23519789.
- Gabaglio, Vincent and Merminod, Bertrand. Using Satellite Positioning System and Inertial Sensors for Human Navigation. *Strategy*, 2000.

- Gao, Wei, Emaminejad, Sam, Nyein, Hnin Yin Yin, Challa, Samyuktha, Chen, Kevin, Peck, Austin, Fahad, Hossain M., Ota, Hiroki, Shiraki, Hiroshi, Kiriya, Daisuke, Lien, Der Hsien, Brooks, George A., Davis, Ronald W., and Javey, Ali. Fully integrated wearable sensor arrays for multiplexed in situ perspiration analysis. *Nature*, 529(7587), p. 509–514, jan 2016. ISSN 14764687.
- Giorgino, Toni, Tormene, Paolo, Lorussi, Federico, De Rossi, Danilo, et Quaglini, Silvana. Sensor evaluation for wearable strain gauges in neurological rehabilitation. *IEEE Transactions on Neural Systems and Rehabilitation Engineering*, 17(4), p. 409–415, aug 2009. ISSN 15344320.
- Girier, Thomas, O’Toole, John, Mesbah, Mostefa, Boashash, Boualem, Clough, Ian, Wilson, Stephen, Fuentes, Miguel, Callan, Susan, East, Christine, and Colditz, Paul. Detecting fetal movements using non-invasive accelerometers: A preliminary analysis. *10th International Conference on Information Sciences, Signal Processing and their Applications, ISSPA 2010*, (Isspa), p. 508–511, 2010a.
- Girier, Thomas, O’Toole, John, Mesbah, Mostefa, Boashash, Boualem, Clough, Ian, Wilson, Stephen, Fuentes, Miguel, Callan, Susan, East, Christine, and Colditz, Paul. Detecting fetal movements using non-invasive accelerometers: A preliminary analysis. In *10th International Conference on Information Sciences, Signal Processing and their Applications, ISSPA 2010*, pages 508–511, 2010b. ISBN 9781424471676.
- GoBio. URL <https://www.gobio.com/>. Accessed on 2020-08-03.
- Goldenberg, Robert L., McClure, Elizabeth M., Bhutta, Zulfiqar A., Belizán, José M., Reddy, Uma M., Rubens, Craig E., Mabeya, Hillary, Flenady, Vicki, and Darmstadt, Gary L. Stillbirths: The vision for 2020. *The Lancet*, 377(9779), p. 1798–1805, 2011. ISSN 1474547X.
- Gómez, Enrique J., Hernando Pérez, M. Elena, Vering, Thomas, Cros, Mercedes Rigla, Bott, Oliver, García-Sáez, Gema, Pretschner, Peter, Bruguéz, Eulalia, Schnell, Oliver, Patte, Caroline, Bergmann, Joachim, Dudde, Ralf, and de Leiva, Alberto. The INCA system: A further step towards a telemedical artificial pancreas. *IEEE Transactions on Information Technology in Biomedicine*, 12(4), p. 470–479, 2008. ISSN 10897771.
- Goodfellow, Ian J., Pouget-Abadie, Jean, Mirza, Mehdi, Xu, Bing, Warde-Farley, David, Ozair, Sherjil, Courville, Aaron, and Bengio, Yoshua. Generative adversarial nets. In *Advances in Neural Information Processing Systems*, volume 3, pages 2672–2680, 2014.
- Google Inc. TensorFlow Lite | ML for Mobile and Edge Devices. URL <https://www.tensorflow.org/lite>. Accessed on 2020-06-05.
- Graven, Stanley N. and Browne, Joy V. Sleep and Brain Development. The Critical Role of Sleep in Fetal and Early Neonatal Brain Development. *Newborn and Infant Nursing Reviews*, 8(4), p. 173–179, 2008. ISSN 15273369.

- Guo, DG, Tay, FEH, Xu, L, , . . . , LM Yu . . . on Wearable, and undefined 2009. Characterization and fabrication of novel micromachined electrode for BSN-based vital signs monitoring system. *ieeexplore.ieee.org*.
- Guyon, Isabelle, Gunn, Steve, Nikraves, Masoud, and Zadeh, Lofti A. *Feature extraction: foundations and applications*, volume 207. Springer, 2008. ISBN 3540354883.
- Haahr, Rasmus G., Duun, Sune, Thomsen, Erik V., Hoppe, Karsten, and Branebjerg, Jens. A wearable "electronic patch" for wireless continuous monitoring of chronically diseased patients. In *Proc. 5th Int. Workshop on Wearable and Implantable Body Sensor Networks, BSN2008, in conjunction with the 5th Int. Summer School and Symp. on Medical Devices and Biosensors, ISSS-MDBS 2008*, pages 66–70, 2008. ISBN 9781424422531.
- Hamet, Pavel, and Johanne Tremblay. Artificial intelligence in medicine. *Metabolism*, 69 , p. S36 - S40, 2017. ISSN 15328600.
- Hao, Yang and Foster, Robert. Wireless body sensor networks for health-monitoring applications. *Physiological Measurement*, 29(11), p. R27–R56, 2008. ISSN 09673334.
- Hata, Toshiyuki, Dai, Shu Yan, and Marumo, Genzo. Ultrasound for evaluation of fetal neurobehavioural development: From 2-D to 4-D ultrasound. *Infant and Child Development*, 19(1), p. 99–118, 2010. ISSN 15227227.
- Hayes, Matthew James and Smith, Peter R. A new method for pulse oximetry possessing inherent insensitivity to artifact. *IEEE Transactions on Biomedical Engineering*, 48(4), p. 452–461, 2001. ISSN 00189294.
- Heazell, A. E.P. and Frøen, J. F. Methods of fetal movement counting and the detection of fetal compromise. *Journal of Obstetrics and Gynaecology*, 28(2), p. 147–154, 2008. ISSN 01443615.
- Heil, Christopher E. and Walnut, David F. Continuous and discrete waveland transforms. *SIAM Review*, 31(4), p. 628–666, 1989. ISSN 00361445.
- Hexoskin. Hexoskin Smart Shirt. URL <https://www.hexoskin.com/> Accessed on 2020-09-20.
- Hijazi, Zina R., Callan, Susan E., and East, Christine E. Maternal perception of foetal movement compared with movement detected by real-time ultrasound: An exploratory study. *Australian and New Zealand Journal of Obstetrics and Gynaecology*, 50(2), p. 144–147, 2010a. ISSN 00048666.
- Hijazi, Zina R., Callan, Susan E., and East, Christine E. Maternal perception of foetal movement compared with movement detected by real-time ultrasound: An exploratory study. *Obstetrical and Gynecological Survey*, 65(9), p. 556–557, 2010b. ISSN 00297828.

- Holzinger, Andreas, Georg Langs, Helmut Denk, Kurt Zatloukal, and Heimo MÄijller. Causability and explainability of artificial intelligence in medicine. *Wiley Interdisciplinary Reviews: Data Mining and Knowledge Discovery*, 9(4), p. e1312. ISSN 1942-4787.
- Hotelling, H. Analysis of a complex of statistical variables into principal components. *Journal of Educational Psychology*, 24(6), p. 417–441, 1933. ISSN 00220663.
- Houston, Laura E., Odibo, Anthony O., and Macones, George A. The safety of obstetrical ultrasound: A review. *Prenatal Diagnosis*, 29(13), p. 1204–1212, dec 2009. ISSN 01973851.
- IBM100 - Deep Blue. URL <https://www.ibm.com/ibm/history/ibm100/us/en/icons/deepblue/>. Accessed on 2020-09-28.
- Igor, Zhukov, Evgeny, Fedorov, Dmitry, Mikhaylov, Ekaterina, Ivanova, Alexander, Kukushkin, Andrey, Starikovski, and Anastasia, Tolstaya. General Research on Automatic Image Shrinking in the Wireless Capsule Endoscopy. *International Journal of Image, Graphics and Signal Processing*, 4(3), p. 22–27, 2012. ISSN 20749074.
- Islam, Rezwan, Ahamed, Sheikh I., Talukder, Nilothpal, and Obermiller, Ian. Usability of mobile computing technologies to assist cancer patients. In *Lecture Notes in Computer Science (including subseries Lecture Notes in Artificial Intelligence and Lecture Notes in Bioinformatics)*, volume 4799 LNCS, pages 227–240. Springer Verlag, nov 2007. ISBN 9783540768043.
- Itchhaporia, Dipti, Peter B. Snow, Robert J. Almassy, and William J. Oetgen. Artificial neural networks: current status in cardiovascular medicine. In *Journal of the American College of Cardiology*, 28, no 2, pages 515–521. 1996. ISBN 9783540768043.
- Jagos, Harald and Oberzaucher, Johannes. Development of a wearable measurement system to identify characteristics in human gait - ESHOE -. In *Lecture Notes in Computer Science (including subseries Lecture Notes in Artificial Intelligence and Lecture Notes in Bioinformatics)*, volume 5105 LNCS, pages 1301–1304. Springer, Berlin, Heidelberg, 2008. ISBN 3540705392.
- Jahankhani, Pari, Kodogiannis, Vassilis, and Revett, Kenneth. EEG signal classification using waveland feature extraction and neural networks. *Proceedings - IEEE John Vincent Atanasoff 2006 International Symposium on Modern Computing, JVA 2006*, pages 120–124, 2006.
- Jakes, Adam D., Whybrow, Rebecca, Spencer, Clare, and Chappell, Lucy C. Reduced fetal movements. *BMJ (Online)*, 360, p. 16, 2018. ISSN 17561833.
- Jang, Jyh Shing Roger. ANFIS: Adaptive-Network-Based Fuzzy Inference System. *IEEE Transactions on Systems, Man and Cybernetics*, 23(3), p. 665–685, 1993. ISSN 21682909.

- J.E., Lawn, H., Blencowe, P., Waiswa, A., Amouzou, C., Mathers, D., Hogan, V., Flenady, J.F., Froen, Z.U., Qureshi, C., Calderwood, S., Shiekh, F.B., Jassir, D., You, E.M., McClure, and M., Mathai. Stillbirths: Rates, risk factors, and acceleration towards 2030. *The Lancet*, 387(10018), p. 587–603, 2016. ISSN 0140-6736.
- Jiang, Liao Chuan and Zhang, Wei De. A highly sensitive nonenzymatic glucose sensor based on CuO nanoparticles-modified carbon nanotube electrode. *Biosensors and Bioelectronics*, 25(6), p. 1402–1407, feb 2010. ISSN 09565663.
- Jiang, Jianmin, P. Trundle, and Jinchang Ren. Medical image analysis with artificial neural networks. *Computerized Medical Imaging and Graphics*, 34(8), p. 617–631, feb 2010. ISSN 08956111.
- Common Tests During Pregnancy. Johns Hopkins Medicine. URL <https://www.hopkinsmedicine.org/health/wellness-and-prevention/common-tests-during-pregnancy>. Accessed on 2020-08-10.
- Jourand, Philippe, De Clercq, Hans, and Puers, Robert. Robust monitoring of vital signs integrated in textile. *Sensors and Actuators, A: Physical*, 161(1-2), p. 288–296, jun 2010. ISSN 09244247.
- Jovanov, Emil, O'Donnell Lords, Amanda, Raskovic, Dejan, Cox, Paul G., Adhami, Reza, and Andrasik, Frank. Stress Monitoring Using a Distributed Wireless Intelligent Sensor System. *IEEE Engineering in Medicine and Biology Magazine*, 22(3), p. 49–55, may 2003. ISSN 07395175.
- Kario, Kazuomi, Yasui, Nobuhiko, and Yokoi, Hiroyuki. Ambulatory Blood Pressure Monitoring for Cardiovascular Medicine. *IEEE Engineering in Medicine and Biology Magazine*, 22(3), p. 81–88, may 2003. ISSN 07395175.
- Katsis, C. D., Goletsis, Y., Rigas, G., and Fotiadis, D. I. A wearable system for the affective monitoring of car racing drivers during simulated conditions. *Transportation Research Part C: Emerging Technologies*, 19(3), p. 541–551, jun 2011. ISSN 0968090X.
- Kawano, T, Takao, H, . . . , K Sawada The 26th Annual, and undefined 2004. Neural recording chip with penetrating Si microprobe electrode array by selective vapor-liquid-solid growth method. *ieeexplore.ieee.org*.
- Khlif, M. S., Boashash, B., Layeghy, S., Ben-Jabeur, T., Mesbah, M., East, C., and Colditz, P. Time-frequency characterization of tri-axial accelerometer data for fetal movement detection. In *IEEE International Symposium on Signal Processing and Information Technology, ISSPIT 2011*, pages 466–471, 2011. ISBN 9781467307529.
- Knight, James F., Schwartz, Anthony, Psomadellis, Fotis, Baber, Chris, Bristow, Huw H., and Arvanitis, Theodoros N. The design of the SensVest. *Personal and Ubiquitous Computing*, 9(1), p. 6–19, jan 2005. ISSN 16174909.

- Lai, Jonathan, Nowlan, Niamh C., Vaidyanathan, Ravi, Shaw, Caroline J., et Lees, Christoph C. Fetal movements as a predictor of health. *Acta Obstetrica and Gynecologica Scandinavica*, 95(9), p. 968–975, 2016. ISSN 16000412.
- Lai, Jonathan, Woodward, Richard, Alexandrov, Yuriy, ain Munnee, Qurratul, Lees, Christoph C., Vaidyanathan, Ravi, and Nowlan, Niamh C. Performance of a wearable acoustic system for fetal movement discrimination. *PLoS ONE*, 13(5), p. e0195728, 2018. ISSN 19326203.
- Lanata, Antonio, Pasquale Scilingo, Enzo, and De Rossi, Danilo. A multimodal transducer for cardiopulmonary activity monitoring in emergency. *IEEE Transactions on Information Technology in Biomedicine*, 14(3), p. 817–825, may 2010. ISSN 10897771.
- Larsson, A., Palm, M., Hansson, L. O., and Axelsson, O. Reference values for clinical chemistry tests during normal pregnancy. *BJOG: An International Journal of Obstetrics and Gynaecology*, 115(7), p. 874–881, jun 2008. ISSN 14700328.
- Layeghy, Siamak, Azemi, Ghasem, Colditz, Paul, and Boashash, Boualem. Classification of fetal movement accelerometry through time-frequency features. *2014, 8th International Conference on Signal Processing and Communication Systems, ICSPCS 2014 - Proceedings*, (January), 2014.
- Lee, BK, treatment options in cardiovascular Medicine, JE Olgin Current, et undefined 2009. Role of wearable and automatic external defibrillators in improving survival in patients at risk for sudden cardiac death. *Springer*.
- Lee, Jeffrey, and Sanjeev Oghra. *Biomedical Telemedicine.CSSI E-170*, January 11, 2005.
- Lisboa, Paulo J., and Azzam FG Taktak. The use of artificial neural networks in decision support in cancer: A systematic review. *Neural networks*, 19.4, p. 408–415, 2006. ISSN 14700328.
- Loew, N., Winzer, K. J., Becher, G., Schönfuß, D., Falck, Th, Uhrich, G., Katterle, M., and Scheller, F. W. Medical sensors of the BASUMA body sensor network. In *IFMBE Proceedings*, volume 13, pages 171–176. Springer Verlag, 2007. ISBN 9783540709930.
- Lorussi, Federico, Galatolo, Stefano, and De Rossi, Danilo E. Textile-based electrogoniometers for wearable posture and gesture capture systems. *IEEE Sensors Journal*, 9(9), p. 1014–1024, 2009. ISSN 1530437X.
- Lorussi, Federico, Scilingo, Enzo Pasquale, Tesconi, Mario, Tognetti, Alessandro, and De Rossi, Danilo. Strain sensing fabric for hand posture and gesture monitoring. *IEEE Transactions on Information Technology in Biomedicine*, 9(3), p. 372–381, sep 2005. ISSN 10897771.

- Lu, G, Yang, F, Jing, X, Conference, J Wang 2010 International, and undefined 2010. Contact-free measurement of heartbeat signal via a doppler radar using adaptive filtering. *ieeexplore.ieee.org*.
- Luna-Perejón, Francisco, Domínguez-Morales, Manuel, Gutiérrez-Galán, Daniel, and Civit-Balcells, Antón. Low-Power Embedded System for Gait Classification Using Neural Networks. *Journal of Low Power Electronics and Applications*, 10(2), p. 14, 2020.
- Luprano, Jean. European projects on smart fabrics, interactive textiles: Sharing opportunities and challenges. *Workshop Wearable Technol. Intel. Textiles, Helsinki, . . .*, 2006.
- Ma, Zhenqiang. An electronic second skin, aug 2011. ISSN 00368075.
- Mangesi, L, Gj, Hofmeyr, Smith, V, and Rmd, Smyth. Fetal movement counting for assessment of fetal wellbeing (Review) SUMMARY OF FINDINGS FOR THE MAIN COMPARISON. *JohnWiley & Sons, Ltd*, (10), p. 4–5, 2015.
- Mannini, Andrea, Sabatini, Angelo M., and Intille, Stephen S. Accelerometry-based recognition of the placement sites of a wearable sensor. *Pervasive and Mobile Computing*, 21, p. 62–74, 2015. ISSN 15741192.
- Maqbool, Sabba, Parkman, Henry P, and Friedenber, Frank K. Wireless capsule motility: comparison of the SmartPill GI monitoring system with scintigraphy for measuring whole gut transit. *Digestive diseases and sciences*, 54(10), p. 2167–74, oct 2009. ISSN 1573-2568.
- Mardani, A., Hooker, R.E., Ozkul, S., Yifan, S., Nilashi, M., Sabzi, H.Z. and Fei, G.C. Application of decision making and fuzzy sets theory to evaluate the healthcare and medical problems: a review of three decades of research with recent developments.. *Expert Systems with Applications*, 137, p. 202–231, 2019. ISSN 09574174.
- Maric, Biljana, Kaan, Annemarie, Ignaszewski, Andrew, and Lear, Scott A. A systematic review of telemonitoring technologies in heart failure. *European Journal of Heart Failure*, 11(5), p. 506–517, 2009. ISSN 13889842.
- Mason, D. G., J. J. Ross, N. D. Edwards, D. A. Linkens, and C. S. Reilly. Self-learning fuzzy control of atracurium-induced neuromuscular block during surgery. *Medical and Biological Engineering and Computing*, 35(5), p. 498–503, 1997. ISSN 01400118.
- Mason, A. J., A. Morrison, and S. Visintini. An Overview of Clinical Applications of Artificial Intelligence. *Ottawa: CADTH*, 2018.
- Medina, J., Espinilla, M. and Nugent, C. Real-time fuzzy linguistic analysis of anomalies from medical monitoring devices on data streams. *Proceedings of the 10th EAI international conference on pervasive computing technologies for healthcare*, p. 300–303, 2016.

- Medtronic. URL <https://www.medtronic.com/us-en/index.html>. Accessed on 2020-08-03.
- Minjie, Liu, Yongkang, Tao, Yunfeng, Liu, Song, Yu, Jingxin, Dong, Obstetrics, Beijing, and Hospital, Gynecology. Fetal Movement Detection Based on MEMS Accelerometer Department of Precision Instruments and Mechanology Beijing Obstetrics and Gynecology Hospital LabVIEW software program. 2, p. 203–206, 2012.
- Mintz, Yoav, and Ronit Brodie. Introduction to artificial intelligence in medicine. In *Minimally Invasive Therapy & Allied Technologies*, 28(2), p. 73-81, 2019. ISSN 1364-5706.
- MiThril. URL <https://www.media.mit.edu/wearables/mithril/>. Accessed on 2020-08-03.
- Miwa, Hiroyasu, Sasahara, Shin Ichiro, and Matsui, Toshihiro. Roll-over detection and sleep quality measurement using a wearable sensor. In *Annual International Conference of the IEEE Engineering in Medicine and Biology - Proceedings*, pages 1507–1510, 2007. ISBN 1424407885.
- Møller, Martin Fodslette. A scaled conjugate gradient algorithm for fast supervised learning. *Neural Networks*, 6(4), p. 525–533, 1993. ISSN 08936080.
- Morgan, DR, Processing, MG Zierdt Signal, and undefined 2009. Novel signal processing techniques for Doppler radar cardiopulmonary sensing. *Elsevier*.
- Motoda, Hiroshi and Liu, Huan. Feature selection, extraction and construction. *Communication of IICM*, 5, p. 67–72, 2002.
- Movassaghi, Samaneh, Abolhasan, Mehran, Lipman, Justin, Smith, David, et Jamalipour, Abbas. Wireless body area networks: A survey. *IEEE Communications Surveys and Tutorials*, 16(3), p. 1658–1686, 2014. ISSN 1553877X.
- Nag, Anindya, Mukhopadhyay, Subhas Chandra, and Kosel, Jurgen. Wearable Flexible Sensors: A Review, jul 2017. ISSN 1530437X.
- Nauck, D. and Kruse, R. Obtaining interpretable fuzzy classification rules from medical data. In *Artificial intelligence in medicine*, 16(2), p. 149–169, 1999. ISSN 09333657.
- Neerhof, Mark G. and Thaete, Larry G. The Fetal Response to Chronic Placental Insufficiency. In *Seminars in Perinatology*, volume 32, pages 201–205. Elsevier, 2008. ISBN 0146-0005.
- Neldam, S. Fetal movements as an indicator of fetal well-being. *Danish medical bulletin*, 33 (5), p. 213–221, 1986. ISSN 09078916.
- Niazmand, K., Tonn, K., Kalaras, A., Fietzek, U. M., Mehrkens, J. H., and Lueth, T. C. Quantitative evaluation of Parkinson's disease using sensor based smart glove.

- In *Proceedings - IEEE Symposium on Computer-Based Medical Systems*, 2011. ISBN 9781457711909.
- Nishihara, Kyoko, Ohki, Noboru, Kamata, Hideo, Ryo, Eiji, and Horiuchi, Shigeko. Automated software analysis of fetal movement recorded during a pregnant woman's sleep at home. *PLoS ONE*, 10(6), p. 1–15, 2015. ISSN 19326203.
- Nilsson, Nils J. Principles of artificial intelligence. Morgan Kaufmann Publishers, Inc. ISBN 0-934613-10-9.
- Norman, Cameron D. and Skinner, Harvey A. eHealth literacy: Essential skills for consumer health in a networked world. *Journal of Medical Internand Research*, 8(2), p. e9, jun 2006. ISSN 14388871.
- Nowlan, N. C. Biomechanics of foetal movement. *Eur Cell Mater*, 29, p. 1-21, jan 2015. ISSN 1473-2262.
- Nunes, Gibran Sales and Arruda Filho, Emílio José Montero. Consumer behavior regarding wearable technologies: Google Glass. *Innovation & Management Review*, 15(3), p. 230–246, jul 2018. ISSN 2515-8961.
- NXP Semiconductors. MMA8451Q 3-Axis, 14-bit/8-bit Digital Accelerometer, Data sheet. URL <http://www.nxp.com/products/:MMA8451Q>.
- NXP Semiconductors. Kinetis KL16: 48MHz Cortex-M0+ 256KB Flash (64 pin). URL <https://www.nxp.com/docs/en/data-sheet/KL16P64M48SF4.pdf>
- Ojo, Mike O., Giordano, Stefano, Procissi, Gregorio, and Seitanidis, Ilias N. A Review of Low-End, Middle-End, and High-End Iot Devices, 2018. ISSN 21693536.
- Okubo, Masahiko, Imai, Y., Ishikawa, T., Hayasaka, T., Ueno, S., and Yamaguchi, T. Development of automatic respiration monitoring for home-care patients of respiratory diseases with therapeutic aids. In *IFMBE Proceedings*, volume 22, pages 1117–1120. Springer, Berlin, Heidelberg, 2008. ISBN 9783540892076.
- Oliver, Nuria and Flores-Mangas, Fernando. HealthGear: A real-time wearable system for monitoring and analyzing physiological signals. *Proceedings - BSN 2006: International Workshop on Wearable and Implantable Body Sensor Networks*, 2006, p. 61–64, 2006.
- Pandian, PS, Mohanavelu, K, . . . , KP Safeer Medical engineering &, et undefined 2008. Smart Vest: Wearable multi-parameter remote physiological monitoring system. *Elsevier*.
- Panesar, Sandip and Cagle, Yvonne and Chander, Divya and Morey, Jose and Fernandez-Miranda, Juan and Kliot, Michel. Artificial intelligence and the future of surgical robotics. In *Annals of surgery*, 270(2), pages 223–226. LWW, 2019. ISSN 0003-4932.

- Park, Sungmee, Chung, Kyunghee, and Jayaraman, Sundaresan. Wearables: Fundamentals, Advancements, and a Roadmap for the Future. In *Wearable Sensors: Fundamentals, Implementation and Applications*, pages 1–23. Elsevier, 2014. ISBN 9780124186668.
- Patel, Shyamal, Park, Hyung, Bonato, Paolo, Chan, Leighton, and Rodgers, Mary. A review of wearable sensors and systems with application in rehabilitation, apr 2012. ISSN 17430003.
- Peters, Chris H.L., Ten Broeke, Edith D.M., Andriessen, Peter, Vermeulen, Barbara, Berendsen, Ralph C.M., Wijn, Pieter F.F., and Oei, S. Guid. Beat-to-beat detection of fetal heart rate: Doppler ultrasound cardiocography compared to direct ECG cardiocography in time and frequency domain. *Physiological Measurement*, 25(2), p. 585–593, apr 2004. ISSN 09673334.
- Phinyomark, Angkoon, Phukpattaranont, Pornchai, and Limsakul, Chusak. Feature reduction and selection for EMG signal classification. *Expert Systems with Applications*, 39 (8), p. 7420–7431, 2012. ISSN 09574174.
- Polar Inc. Polar H10 heart rate sensor URL https://www.polar.com/us-en/products/accessories/h10_heart_rate_sensor. Accessed on 2020-09-20.
- Poscia, A., Mascini, M., Moscone, D., Luzzana, M., Caramenti, G., Cremonesi, P., Valgimigli, F., Bongiovanni, C., and Varalli, M. A microdialysis technique for continuous subcutaneous glucose monitoring in diabetic patients (part 1). *Biosensors and Bioelectronics*, 18(7), p. 891–898, 2003. ISSN 09565663.
- Prechtl, H. F.R. Qualitative changes of spontaneous movements in fetus and preterm infant are a marker of neurological dysfunction. *Early Human Development*, 23(3), p. 151–158, 1990. ISSN 03783782.
- Preece, Stephen J., Goulermas, John Y., Kenney, Laurence P.J., Howard, Dave, Meijer, Kenneth, and Crompton, Robin. Activity identification using body-mounted sensors - A review of classification techniques. *Physiological Measurement*, 30(4), p. R1, 2009. ISSN 09673334.
- Preston, S., Mahomed, K., Chadha, Y., Flenady, V., Gardener, G., MacPhail, J., Conway, L., Koopmans, L., Stacey, T., Heazell, A. and Fretts, R.. Clinical Practice Guideline for the Management of Women who report Decreased Fetal Movements. *Brisbane: Australia and New Zealand Stillbirth Alliance*, 2010.
- Prochazka, Arthur, Gauthier, Michel, Wieler, Marguerite, and Kenwell, Zoltan. The bionic glove: An electrical stimulator garment that provides controlled grasp and hand opening in quadriplegia. *Archives of Physical Medicine and Rehabilitation*, 78(6), p. 608–614, jun 1997. ISSN 00039993.

- Rådestad, Ingela. Fetal movements in the third trimester - Important information about wellbeing of the fetus. *Sexual and Reproductive Healthcare*, 1(4), p. 119–121, 2010. ISSN 18775756.
- Radford, Alec, Metz, Luke, and Chintala, Soumith. Unsupervised representation learning with deep convolutional generative adversarial networks. *4th International Conference on Learning Representations, ICLR 2016 - Conference Track Proceedings*, 2016.
- Rawat, Waseem and Wang, Zenghui. Deep convolutional neural networks for image classification: A comprehensive review. *Neural Computation*, 29(9), p. 2352–2449, 2017. ISSN 1530888X.
- Rimet, Yves, Brusquet, Yves, Ronayette, Dominique, Dageville, Christian, Lubrano, Marc, Mallet, Eric, Rambaud, Caroline, Terlaud, Christian, Silve, Jérôme, Lerda, Olivier, Netchiporouk, Larissa I., and Weber, Jean Luc. Surveillance of infants at risk of ap-parent life threatening events (ALTE) with the BBA bootee: A wearable multiparameter monitor. In *Annual International Conference of the IEEE Engineering in Medicine and Biology - Proceedings*, pages 4997–5000, 2007. ISBN 1424407885.
- Riva, Giuseppe, Gorini, Alessandra, and Gaggiolia, Andrea. The intrepid project - Biosensor-enhanced virtual therapy for the treatment of generalized anxiety disorders. In *Studies in Health Technology and Informatics*, volume 142, pages 271–276, 2009. ISBN 9781586039646.
- Ryo, Eiji and Kamata, Hideo. Fetal movement counting at home with a fetal movement acceleration measurement recorder: A preliminary report. *Journal of Maternal-Fetal and Neonatal Medicine*, 25(12), p. 2629–2632, 2012. ISSN 14767058.
- Ryo, Eiji, Nishihara, Kyoko, Matsumoto, Sachiyo, and Kamata, Hideo. A new method for long-term home monitoring of fetal movement by pregnant women themselves. *Medical Engineering and Physics*, 34(5), p. 566–572, 2012. ISSN 13504533.
- Saastad, Eli, Winje, Brita A., Pedersen, Babill Stray, and Frøen, J. Frederik. Fetal movement counting improved identification of fetal growth restriction and perinatal outcomes - a multi-centre, randomized, controlled trial. *PLoS ONE*, 6(12), dec 2011. ISSN 19326203.
- Salimans, Tim, Goodfellow, Ian, Zaremba, Wojciech, Cheung, Vicki, Radford, Alec, and Chen, Xi. Improved techniques for training GANs. In *Advances in Neural Information Processing Systems*, pages 2234–2242, 2016.
- Samsung Electronics. Samsung Galaxy Fit Smart Fitness Band. URL <https://www.samsung.com/us/mobile/wearables/smart-fitness-bands/samsung-galaxy-fit-sm-r370nzkaxar/> Accessed on 2020-09-20.
- Santini, John T., Cima, Michael J., and Langer, Robert. A controlled-release microchip. *Nature*, 397(6717), p. 335–338, jan 1999. ISSN 00280836.

- Sazali, Amirul Ridhwan and Al-Ashwal, Rania. Fetal movement simulator for fetal monitoring system testing. In *2018 IEEE EMBS Conference on Biomedical Engineering and Sciences, IECBES 2018 - Proceedings*, pages 544–547. IEEE, 2019. ISBN 9781538624715.
- Schmidhuber, Jürgen. Deep Learning in neural networks: An overview. *Neural Networks*, 61, p. 85–117, 2015. ISSN 18792782.
- Schneider, Andreas and Stieglitz, Thomas. Implantable flexible electrodes for functional electrical stimulation. *Medical device technology*, 15(1), p. 16–8. ISSN 1048-6690.
- Shnayder, Victor, Chen, Bor-rong, Lorincz, Konrad, Jones, Thaddeus R. F. Fulford, and Welsh, Matt. Sensor networks for medical care. page 314, 2005.
- Sieg, Anke, Guy, Richard H., and Delgado-Charro, M. Begoña. Simultaneous extraction of urea and glucose by reverse iontophoresis in vivo. *Pharmaceutical Research*, 21(10), p. 1805–1810, oct 2004. ISSN 07248741.
- Simone, Lisa K., Sundarajan, Nappinnai, Luo, Xun, Jia, Yicheng, and Kamper, Derek G. A low cost instrumented glove for extended monitoring and functional hand assessment. *Journal of Neuroscience Methods*, 160(2), p. 335–348, mar 2007. ISSN 01650270.
- Size Stream. Size Stream. URL <http://sizestream.com/>. Accessed on 2020-06-07.
- Song, Kehui, Jonckheere, Julien De, Zeng, Xianyi, Koehl, Ludovic, Yuan, Xiaojie, and Zhao, Xin. Development of a data-based interactive medical expert system for supporting pregnancy consultations: General architecture and methodology. In *IFAC-PapersOnLine*, volume 52, pages 67–72, 2019.
- Song, Seung Joon, Youngjin Moon, Duck Hee Lee, Chi Bum Ahn, Youngho Jo, and Jaesoon Choi. Comparative study of fuzzy PID control algorithms for enhanced position control in laparoscopic surgery robot. In *Journal of Medical and Biological Engineering*, volume 35, (1) pages 34–44, 2015.
- Stampalija, Tamara, Gyte, Gillian ML, and Alfirevic, Zarko. Utero-placental Doppler ultrasound for improving pregnancy outcome. *Cochrane Database of Systematic Reviews*, (9), 2010. ISSN 1469-493X.
- Stanger, Jonathan J., Horey, Dell, Hooker, Leesa, Jenkins, Michael J., et Custovic, Edhem. Fetal movement measurement and technology: A narrative review. *IEEE Access*, 5, p. 16747–16756, 2017a. ISSN 21693536.
- Stanger, Jonathan J., Horey, Dell, Hooker, Leesa, Jenkins, Michael J., et Custovic, Edhem. Fetal movement measurement and technology: A narrative review. *IEEE Access*, 5, p. 16747–16756, 2017b. ISSN 21693536.

- STMicroelectronics. STM32F7 series of very high-performance MCUs - STMicroelectronics.. URL <https://www.st.com/en/microcontrollers-microprocessors/stm32f7-series.html> Accessed on 2020-08-25.
- STMicroelectronics. X-CUBE-AI - AI expansion pack for STM32CubeMX - STMicroelectronics. URL <https://www.st.com/en/embedded-software/x-cube-ai.html>. Accessed on 2020-06-05.
- Struzik, Zbigniew R., and Willem J. van Wijngaarden. Cumulative Effective Hölder Exponent Based Indicator for Real-Time Fetal Heartbeat Analysis During Labour. *Emergent Nature: Patterns, Growth and Scaling in the Sciences*, pp. 45–54, 2001. ISSN 1386-3681.
- Subasi, Abdulhamit. EEG signal classification using waveland feature extraction and a mixture of expert model. *Expert Systems with Applications*, 32(4), p. 1084–1093, 2007. ISSN 09574174.
- Subasi, Abdulhamit and Gursoy, M. Ismail. EEG signal classification using PCA, ICA, LDA and support vector machines. *Expert Systems with Applications*, 37(12), p. 8659–8666, 2010. ISSN 09574174.
- Suh, Minyoung, Carroll, Kate, and Cassill, Nancy. Critical review on smart clothing product development. *Journal of Textile and Apparel, Technology and Management*, 6(4), 2010. ISSN 15330915.
- Sullivan, Frank and Wyatt, JC. ABC of health informatics: Why Is This Patient Here Today ? *BMJ: British Medical Journal*, 331(7518), p. 678–680, 2005.
- Sung, Michael, Marci, Carl, and Pentland, Alex. Wearable feedback systems for rehabilitation. *Journal of NeuroEngineering and Rehabilitation*, 2(1), p. 1–12, jun 2005. ISSN 17430003.
- Suwanrath, Chitkasaem and Suntharasaj, Thitima. Sleep-wake cycles in normal fetuses. *Archives of Gynecology and Obstetrics*, 281(3), p. 449–454, mar 2010. ISSN 09320067.
- Tautges, Jochen, Zinke, Arno, Krüger, Björn, Baumann, Jan, Weber, Andreas, Helten, Thomas, Müller, Meinard, Seidel, Hans Peter, et Eberhardt, Bernd. Motion reconstruction using sparse accelerometer data. *ACM Transactions on Graphics*, 30(3), p. 1–12, 2011. ISSN 07300301.
- Texas Instruments. CC2541 - Bluetooth Low Energy. URL <https://www.ti.com/product/CC2541>
- TextileToday. Smart clothing with improved comfort and safety for future firefighters. URL <https://www.textiletoday.com.bd/smart-clothing-improved-comfort-safety-future-firefighters/> Accessed on 2020-09-21.

- Thomson, Sarah. Health, health systems and economic crisis in Europe Impact and policy implications. *European Observatory on Health Systems and Policies Series*, 12, p. IV– 16, 2013.
- Tran, Phi Vu. A fully convolutional neural network for cardiac segmentation in short-axis MRI. *arXiv preprint arXiv:1604.00494*, jan 2016.
- Valdastri, Pietro, Menciacchi, Arianna, Arena, Alberto, Caccamo, Chiara, et Dario, Paolo. An Implantable Telemetry Platform System for In Vivo Monitoring of Physiological Parameters. *IEEE TRANSACTIONS ON INFORMATION TECHNOLOGY IN BIOMEDICINE*, 8(3), 2004.
- Varalli, M, Marelli, G, Maran, A, , . . . , S Bistoni Biosensors, and 2003, Undefined. A microdialysis technique for continuous subcutaneous glucose monitoring in diabetic patients (part 2). *Biosensors and Bioelectronics*, 18(7), p. 899–905, 2003.
- Verbruggen, Stefaan W., Kainz, Bernhard, Shelmerdine, Susan C., Hajnal, Joseph V., Rutherford, Mary A., Arthurs, Owen J., Phillips, Andrew T.M., et Nowlan, Niamh C. Stresses and strains on the human fetal skeleton during development. *Journal of the Royal Society Interface*, 15(138), p. 20170593, jan 2018. ISSN 17425662.
- Verbruggen, Stefaan W., Loo, Jessica H.W., Hayat, Tayyib T.A., Hajnal, Joseph V., Rutherford, Mary A., Phillips, Andrew T.M., and Nowlan, Niamh C. Modeling the biomechanics of fetal movements. *Biomechanics and Modeling in Mechanobiology*, 15(4), p. 995–1004, 2016. ISSN 16177940.
- VIVAGO. URL <https://www.vivago.fr/>. Accessed on 2020-08-03.
- Vuorela, Timo, Seppä, Ville Pekka, Vanhala, Jukka, and Hyttinen, Jari. Design and implementation of a portable long-term physiological signal recorder. *IEEE Transactions on Information Technology in Biomedicine*, 14(3), p. 718–725, may 2010. ISSN 10897771.
- Warren, James, Gleb Beliakov, and Berend Van Der Zwaag. Fuzzy logic in clinical practice decision support systems. *Proceedings of the 33rd Annual Hawaii International Conference on System Sciences*, pp. 10-pp, IEEE 2000. ISSN 10603425.
- Weber, J. L., Blanc, D., Dittmar, A., Comet, B., Corroy, C., Noury, N., Baghai, R., Vaysse, S., and Blinowska, A. Telemonitoring of vital parameters with newly designed biomedical clothing. *Studies in Health Technology and Informatics*, 108, p. 260–265, 2005. ISSN 18798365.
- Welch Allyn. URL <https://www.welchallyn.com/en.html>. Accessed on 2020-08-03.
- Whitworth, Melissa, Bricker, Leanne, and Mullan, Clare. Ultrasound for fetal assessment in early pregnancy. *Cochrane Database of Systematic Reviews*, 2015(7), 2015. ISSN 1469493X.

- Winbond. 3V 256M-BIT SERIAL FLASH MEMORY WITH DUAL/QUAD SPI & QPI. URL https://www.winbond.com/hq/product/code-storage-flash-memory/serial-nor-flash/?__locale=en&partNo=W25Q256FV
- Winje, B. A., Saastad, E., Gunnes, N., Tveit, J. V.H., Stray-Pedersen, B., Flenady, V., and Frøen, J. F. Analysis of 'count-to-ten' fetal movement charts: A prospective cohort study. *BJOG: An International Journal of Obstetrics and Gynaecology*, 118(10), p. 1229–1238, sep 2011. ISSN 14700328.
- World Health Organisation (WHO). WHO recommendation on daily fetal movement counting. *The WHO Reproductive Health Library*, (March), p. 1–6, 2018.
- Wu, Jian, Sun, Lu, and Jafari, Roozbeh. A Wearable System for Recognizing American Sign Language in Real-Time Using IMU and Surface EMG Sensors. *IEEE Journal of Biomedical and Health Informatics*, 20(5), p. 1281–1290, 2016. ISSN 21682194.
- Wu, Yu Chi, Chen, Pei Fan, Hu, Zhi Ang, Chang, Chao Hsu, Lee, Gwo Chuan, and Yu, Wen Ching. A mobile health monitoring system using RFID ring-type pulse sensor. In *8th IEEE International Symposium on Dependable, Autonomic and Secure Computing, DASC 2009*, pages 317–322, 2009. ISBN 9780769539294.
- Xiao, Shuo, Dhamdhere, Ashay, Sivaraman, Vijay, and Burdett, Alison. Transmission power control in body area sensor networks for healthcare monitoring. *IEEE Journal on Selected Areas in Communications*, 27(1), p. 37–48, 2009. ISSN 07338716.
- Yazicioglu, RF, Torfs, T, Merken, P, . . . , J Penders Microelectronics, et undefined 2009. Ultra-low-power biopotential interfaces and their applications in wearable and implantable systems. *Elsevier*.
- Zadeh, Lotfi A. Fuzzy sets. *Information and control*, 8(3), p. 338–353, 1965. ISSN 0019-9958.
- Zhang, Tong, Wang, Jue, Xu, Liang, and Liu, Ping. Fall detection by wearable sensor and one-class SVM algorithm. In *Lecture Notes in Control and Information Sciences*, volume 345, pages 858–863. Springer, 2006. ISBN 3540372571.
- Zhao, X., Zeng, X., Koehl, L., Tartare, G., and De Jonckheere, J. A Wearable System for In-Home and Long-Term Assessment of Fetal Movement. *Irbm*, 2019a. ISSN 18760988.
- Zhao, Xin, Zeng, Xianyi, Koehl, Ludovic, Tartare, Guillaume, Jonckheere, Julien De, and Song, Kehui. An IoT-based wearable system using accelerometers and machine learning for fetal movement monitoring. In *Proceedings - 2019 IEEE International Conference on Industrial Cyber Physical Systems, ICPS 2019*, pages 299–304. IEEE, 2019b. ISBN 9781538685006.
- Zhou, Zhi-Hua, and Yuan Jiang. Medical diagnosis with C4. 5 rule preceded by artificial neural network ensemble. In *IEEE Transactions on information Technology in Biomedicine*, 7.1, pages 37–42. 2003. ISBN 10897771.

Zimmermann, Hans-Jürgen. *Fuzzy sand theory and its applications*. Springer Science & Business Media, 1993.

Titre Développement d'un vêtement connecté et intelligent par l'intégration des capteurs physiologiques et muni d'un système d'aide à la décision - application à la surveillance en ligne de la santé humaine

Résumé Les mouvements fœtaux sont un indicateur significatif de l'état de santé du fœtus. La diminution ou l'arrêt des mouvements du fœtus perçus par la mère peuvent être des signes précurseurs que le développement fœtal nécessite une surveillance accrue. En pratique, la perception maternelle de la diminution des mouvements fœtaux aide à déterminer le moment optimal pour l'accouchement, surtout dans les cas de grossesses à risque. Cependant, le dénombrement des mouvements fœtaux par la mère souffre d'imprécision et de subjectivité en raison des habitudes, des activités et des périodes de veille et de repos de chaque mère. Cela conduit généralement à une inquiétude et une anxiété inutiles pour la mère. A contrario, la technologie basée sur l'échographie peut être utilisée pour une surveillance précise et fiable des mouvements du fœtus. Cependant, des inquiétudes ont été exprimées dans la littérature concernant l'exposition prolongée et intense aux ultrasons, ce qui pourrait avoir des effets négatifs. En outre, leur usage nécessite un environnement en milieu hospitalier, parfois éloigné du cadre de vie, une immobilisation de la mère et des personnels formés pour la manipulation.

Dans cette étude, nous présentons un nouveau vêtement intelligent pour la surveillance en ligne des mouvements du fœtus. Le système proposé est principalement composé de : 1) un vêtement soigneusement conçu pour améliorer le confort de la femme enceinte et garantir la qualité des signaux acquis, 2) un réseau de capteurs avec un système embarqué et communicant intégrés à des emplacements judicieux sur le vêtement et 3) une application mobile connecté au vêtement et faisant le lien avec le cloud auprès de professionnels de santé permettant à la mère de transmettre et visualiser en retour les informations importantes liées à la santé du fœtus. Ces travaux mettent en avant le développement d'outils algorithmiques d'aide à la décision locale pour un comptage en ligne et fiable des mouvements du fœtus basé sur les données des capteurs. Le système conçu et embarqué est connecté à distance à un système expert sur une plateforme de cloud computing avec lequel les cliniciens sont en mesure de poser un diagnostic avancé. Distincts des solutions portables existantes, le vêtement intelligent proposé dans cette étude prend pleinement en compte les problèmes liés à l'électronique / les signaux et à la conception du textile / vêtement. L'équilibre entre l'intelligence embarquée et celle du cloud a été pensé pour garantir une nette amélioration. Les résultats expérimentaux ont montré que le système proposé peut effectuer efficacement et automatiquement le comptage des mouvements du fœtus et a des applications potentielles pour offrir une solution innovante dans le domaine de la santé humaine, libérer les femmes enceintes et soulager les systèmes de santé pour une application au suivi du développement du fœtus. Cette recherche fournit des conseils pour l'application de la surveillance à distance de la santé en utilisant des wearables dans le domaine des soins prénatals.

Mots-clés mouvements fœtaux, wearable systems, vêtement intelligent, surveillance à distance de la santé, intelligence artificielle, systèmes d'aide à la décision.

Title Development of an Intelligent Garment Integrating Physiological Sensors and a Decision Making System - Applied to the Online Human Well-being Monitoring

Abstract Fetal movements are one significant indicator of fetal health status. Reduction or discontinuation in fetal movements perceived by the mother could be a sign that fetal development requires enhanced monitoring. In practice, maternal perception of reduced fetal movements helps to determine the optimal time for delivery especially for high-risk pregnancy. However, fetal movement counting by the mother suffers from imprecision and subjectivity due to each mother's personal habits, customs and activity-rest periods, which usually leads to unnecessary concern and anxiety to the mother. Ultrasound-based technology, on the other hand, can be used for accurate and reliable monitoring of fetal movements. However, concerns have been expressed in the literature about the exceeded exposure of ultrasound, which could have a negative effect. Besides, it requires an in-hospital setting which can sometimes be far from the living environment, immobilization of the mother, and trained personnel to manipulate the device.

In this study, we present a new garment-based wearable system for online monitoring of fetal movements. The proposed system is mainly composed of: 1) a garment carefully designed for enhancing pregnant women's comfort and guaranteeing the quality of measured signals, 2) a network of sensors/a communicating embedded system integrated into the right positions of the garment and 3) a mobile application connected to the garment and linking to the cloud with healthcare professionals allowing the mother to transmit and visualize in return the key information related to her baby's health. This work highlights the development of an embedded decision-making algorithm for online and reliable counting of fetal movement based on the sensor data. The proposed system is connected to a remote medical expert system on the cloud computing platform with which clinicians can make advanced medical diagnosis. Different from the existing wearable systems, both the electronic/signal issues and textile/garment design have been fully taken into account in the proposed intelligent garment, and a balance between the embedded intelligence and that of the cloud has been considered to guarantee an overall improvement. The experimental results has proved that the proposed system can effectively and automatically perform fetal movement counting, and has potential applications in offering an innovative solution in the field of human health, benefiting pregnant women, alleviating the burden on health systems for applications to the monitoring of fetal development.. This research provides guidance for the application of remote health monitoring by using wearable systems in antenatal care.

Keywords fetal movement, wearable system, intelligent garment, remote health monitoring; artificial intelligence, decision support system.