



HAL
open science

Caractérisation des dyslexies visuo-attentionnelles : vers un dépistage précoce et une remédiation spécifique

Audrey Vialatte

► To cite this version:

Audrey Vialatte. Caractérisation des dyslexies visuo-attentionnelles : vers un dépistage précoce et une remédiation spécifique. Sciences agricoles. Université de Lyon, 2020. Français. NNT : 2020LYSE1294 . tel-03346010

HAL Id: tel-03346010

<https://theses.hal.science/tel-03346010>

Submitted on 16 Sep 2021

HAL is a multi-disciplinary open access archive for the deposit and dissemination of scientific research documents, whether they are published or not. The documents may come from teaching and research institutions in France or abroad, or from public or private research centers.

L'archive ouverte pluridisciplinaire **HAL**, est destinée au dépôt et à la diffusion de documents scientifiques de niveau recherche, publiés ou non, émanant des établissements d'enseignement et de recherche français ou étrangers, des laboratoires publics ou privés.



N°d'ordre NNT : 2020LYSE1294

THESE de DOCTORAT DE L'UNIVERSITE DE LYON

opérée au sein de
l'Université Claude Bernard Lyon 1

Ecole Doctorale ED 476
Neurosciences et Cognition

Spécialité de doctorat : Neurosciences

Soutenue publiquement le 16/12/2020, par :
Audrey VIALATTE

Caractérisation des dyslexies visuo-attentionnelles, vers un dépistage précoce et une prise en charge spécifique.

Devant le jury composé de :

ROSSETTI Yves, PU-PH, Université Lyon 1

Président

COLLINS Thérèse, Professeure des Universités, Université Paris Descartes

Rapporteuse

HABIB, Michel, PH, CHU Timone Marseille

Rapporteur

BOSSE Marie-Line, Professeure des Universités, Université Grenoble Alpes

Examinatrice

DEVINCK Frédéric, Maître de conférences, Université de Rennes 2

Examineur

PISELLA Laure, DR, CNRS Lyon

Directrice de thèse

« La peur n'évite pas le danger »

Résumé

La dyslexie (trouble développemental d'apprentissage de la lecture) est majoritairement considérée comme ayant pour origine un trouble phonologique. Or la lecture est également une activité visuelle car elle repose sur du support écrit. Pour lire correctement il faut être capable de bien reconnaître les unités fonctionnelles composées de lettres (graphèmes) en codant précisément l'ordre et l'identité des lettres. L'objectif principal de cette thèse est de caractériser les déficits visuo-attentionnels qui peuvent être à l'origine de certaines dyslexies, en étudiant des enfants dyslexiques mais aussi chez une patiente cérébrolésée le rôle du lobe pariétal supérieur (LPS) dans la perception visuelle car cette structure cérébrale a été montrée sous-activée dans la dyslexie développementale.

Pour cela nous nous sommes éloignés du contexte de la lecture en utilisant des tâches de perception visuelle. Nous savons que les enfants dyslexiques sont plus lents en recherche visuelle lorsqu'il faut trouver un symbole (item fait de combinaisons de lignes à l'instar des lettres) que pour trouver une ligne simple. En utilisant une fenêtre mobile de visibilité bougeant avec les yeux (Étude 2), nous avons montré que le traitement visuel des symboles est similaire lorsqu'ils réalisent la tâche avec une fenêtre réduite, alors que chez les enfants normo lecteurs et dyslexiques qui ne sont pas ralentis dans la recherche de symboles la réduction de la visibilité augmentait leurs temps de réponses. Cette lenteur de traitement correspond donc à l'utilisation d'un champ visuo-attentionnel réduit face aux symboles. Dans le contexte de la lecture, ceci empêcherait de traiter les mots dans leur ensemble et entraînerait une lenteur et des erreurs pour les longs graphèmes. Nous avons également regardé si ces enfants dyslexiques ont des difficultés dans d'autres tâches visuo-attentionnelles ou visuo-spatiales relevant de la voie dorsale de traitement cortical de l'information visuelle. Les enfants dyslexiques lents au repérage de symboles ne présentent pas systématiquement les autres déficits. Ils présentent au niveau du groupe une réduction de leur empan visuo-attentionnel de lettres mais les enfants rapides aussi. Également notre (petit) groupe présente une prévalence plus importante de présentation d'un score inférieur à l'interquartile de la population normale du même âge au test de dépistage de déficit de perception visuo-spatiale élémentaire (test PVSE) (40%). Bien que ce pourcentage soit plus faible que ce

qui a été retrouvé dans une autre étude (Étude 1) avec un échantillon plus large d'enfants avec trouble spécifique des apprentissages (59%), il reste plus élevé que dans le groupe de dyslexiques qui ne présente pas de difficulté de traitement visuel des symboles (24%). Par contre le biais d'attention locale souvent décrit dans la dyslexie n'a pas été retrouvé à l'échelle du groupe. Différents profils semblent donc être observés même au sein des dyslexies neuro-visuelles et il semble important de les prendre en considération pour une remédiation plus spécifique.

Une patiente présentant une lésion bilatérale du LPS s'étant traduite en phase aigüe par une totale simultanagnosie présente quant à elle l'ensemble de ces déficits. Le LPS a été impliqué dans la dyslexie de par son rôle dans le traitement simultané de multiples éléments (empan visuo-attentionnel). Nous avons donc étudié le traitement visuel simultané des symboles chez cette patiente lors de tâches de recherche visuelle (Étude 3) et d'identification d'un élément au sein d'un triplet dans différentes conditions d'interférence et d'encombrement spatial (Étude 4). Les résultats ont montré un déficit de localisation des objets. Les symboles résultant de la combinaison de plusieurs lignes introduisent un déficit supplémentaire de localisation intra-objet qui ralentit voire empêche leur identification. De plus si les symboles sont tous différents (comme dans la lecture), l'incertitude visuo-spatiale est telle que seul un traitement symbole par symbole est possible.

La caractérisation des déficits visuo-attentionnels chez l'enfant dyslexique permet d'envisager un dépistage et une remédiation précoce car ce sont des processus qui peuvent être testés avant l'apprentissage de la lecture.

Abstract

Developmental dyslexia (impairment to learn to read)(DD) is mainly considered with a phonological origin. But reading is a process which also involve visual processing. Indeed, to have an expert reading we need to recognize grapheme (small unity of letters) by coding the correct letters and their localization. The main purpose of this thesis is to characterize the visuo attentional deficits that can lead to dyslexia, by studying both children with DD and a patient with a bilateral lesion of the superior parietal lobule (SPL) because this cerebral structure is under-activated in some dyslexic children.

We moved away from the reading context using visual perception tasks. It has been shown that dyslexic children are slower than normo readers for visual searches involving symbols (stimuli made by separable features) while they perform as fast as normo readers for visual searches involving full objects or objects made by a single line. Here (Étude 2), we showed in those dyslexics exhibiting this specific slowness, using the moving window paradigm, that a gaze-contingent visibility reduction did not increase response time in visual search involving symbols whereas this reduction increased response time in normoreaders and in dyslexic children who were not slow in visual search involving symbols. Therefore, we demonstrated that this slowness corresponds to a shrinkage of the visuo attentional field when they had to process symbol. Letters being symbols, this shrinkage can prevent them to process whole words, and can lead to slow reading and errors especially for long grapheme. This impairment is specific to symbols since during visual search involving full object the visibility reduction significantly increased response time in all children's groups. We also studied the correlation between this visuo attentional field reduction and the other visuo-attentional or visuo-spatial deficits reported in DD. Dyslexic children slow to process symbols did not systematically present the other deficits. At the group level, they had a smaller visuo-attentional span than normo readers but this was also the case for the group of dyslexic children not impaired to process symbols. Our (small) group of dyslexics slow with symbols also had a great prevalence of scoring below the interquartile range of their age category at the elementary visuo spatial perception screening test (40%). While this percentage is less important than the prevalence

observed in another study (Étude 1) with a larger population of children with neurodevelopmental disorders (59%), it was higher than the prevalence observed in the group of dyslexics without impairment in symbols processing (24%). The local attentional bias also reported in DD was not found in our groups of dyslexics due to high variability. Different cognitive profiles seem therefore to be observed in DD, it is important to take account of this heterogeneity to propose a remediation adapted to each child specific to the deficits observed.

A patient with bilateral SPL lesion presents with all these deficits. SPL has been related to DD because this cortical region of the dorsal visual stream is crucially involved in simultaneous processing of multiple elements. By studying the performance of this brain-damaged patient in visual search tasks involving symbols versus full objects (Étude 3), and in an identification task where the patient had to recognize a target when surrounded by other elements in varying interference and crowding conditions (Étude 4), we therefore indirectly studied the role of the SPL in simultaneous visual perception. Results showed a localization deficit consecutive to the bilateral SPL lesion. Symbols resulting from the combination of separable features introduce an additional intra-object spatial uncertainty which slows down or even prevent objects' identification. Moreover, when several dissimilar symbols are presented simultaneously (like in reading), the visuospatial uncertainty is such that only symbol-by-symbol processing is possible.

The characterization of visuo-attentional deficits in children with DD can lead to an early detection of children at risk because these basic processes are acquired and testable before reading acquisition. Early detection would open perspectives of early and more specific remediation.

Remerciements

Je tiens d'abord à remercier les membres de mon jury, Thérèse COLLINS, Michel HABIB, Marie-Line BOSSE, Frédéric DEVINCK et Yves ROSSETTI qui ont accepté de lire ce manuscrit et d'évaluer mon travail de thèse en apportant leur expertise.

Je remercie également la Fondation de France et plus particulièrement la Fondation Berthe Fouassier qui a permis de financer cette thèse.

Ensuite, un grand merci à Laure pour toutes ces années depuis le master où tu m'as accompagnée et épaulée. Merci de m'avoir fait confiance et de m'avoir guidée jusqu'à l'écriture de ce manuscrit avec des échanges toujours intéressants qui m'ont permis de me forger un solide esprit critique qui j'en suis sûre fera de moi une meilleure orthoptiste.

Je remercie aussi la team du pays de Gex avec Eric, Agnès et les AurélieS (Patrice et Alexandre des intérimaires de luxe) pour les super moments passés et à venir ainsi que l'enrichissement que m'apporte tous ces échanges entre nos différentes professions. To be continued.... J'ai aussi une pensée pour Nathalie avec qui j'ai partagé le bureau ces derniers mois de rédaction et qui est toujours bienveillante et réconfortante tant par ses paroles que par ses cookies. Elle a su aussi me guider lors de mes comités de suivi de thèse avec Sylviane Valdois que je remercie également ici.

Je remercie également les ingénieurs du labo, Eric K, Roméo et Pierre Emmanuel qui m'ont apportés leur aide pour que les expériences se passent sans encombre, ainsi que Sonia, la super gestionnaire qui est toujours là pour les missions de dernière minute. Et plus généralement je remercie toutes les personnes de l'équipe ImpAct et de la future équipe Trajectoires avec qui j'ai pu échanger : Bertrand, Clément, Grégoire, Laura, Alessandro, Salam, Cécile T, Samy, Amélie, Lisa, Marion, Clara, Silvia, Simon, Cécile F.

J'ai bien sûr une pensée particulière pour ces collègues devenus de véritables Amis, vous savez que je ne suis pas la meilleure niveau empathie (0/20) et perspective taking (2/20) mais il est sûr que sans vous ces (presque) 4 années de thèse n'auraient

pas eu la même saveur : Alexis, Leslie, Audrey, Camille, François et Nico (même si t'es pas du labo tu fais partie de la team). J'espère que nos folles aventures vont continuer.

Une grosse pensée pour mes orthoffus, mes camarades orthoptistes (la plus belle profession du monde sans chauvinisme) toujours là malgré les années qui passent et la distance.

Enfin niveau plus personnel je remercie ma famille, Maman, Jennifer, Matthieu, Mémère, Florence et Yves même si on se voit peu et que je ne suis pas très loquace votre soutien est important et nécessaire pour moi. Merci de me supporter et de croire en moi quoi que j'entreprenne. Après il y a les amis qui sont par la force des choses devenus la famille, Maïté, Manon, Élodie, Caro (ma meuf ;)), Laurence et tous ceux du HBC Chambly. Je vous vois peu mais je sais que si jamais j'ai un souci je pourrai toujours compter sur vous et vice versa. Le HBC Chambly aura toujours une place spéciale dans ma vie.

Enfin comment ne pas avoir une pensée pour toi Papa qui n'a pas pu connaître mes velléités de recherche. J'ai toujours senti ton soutien m'accompagner toi qui étais si fier que tes enfants fassent des études. J'espère continuer à te rendre fier.

J'espère n'avoir oublié personne (ne me jetez pas de pierre) mais au cas où je remercie toutes les personnes qui ont jalonné ma vie et surtout tous les participants ainsi que leur famille qui ont gentiment acceptés de participer à mes expériences (parfois longues....).

Liste des abréviations

EVA	Empan Visuo-Attentionnel
VA	Visuo-Attentionnel
LPS	Lobule Pariétal Supérieur
CPP	Cortex Pariétal Postérieur
VWFA	Visual Word Form Area – Aire de la forme visuelle des mots
TDAH	Trouble du déficit de l'attention avec ou sans hyperactivité

Liste des figures

I introduction

Figure 1 – Paradigme de la fenêtre mobile	9
Figure 2 – Images de la tâche de Navon (1977)	10
Figure 3 : Stimuli de l'étude de Casco & Prunetti	12
Figure 4 – Les voies visuelles dorsale et ventrale	31
Figure 5 – Structures visuelles liées à la lecture et à son apprentissage	35
Figure 6 – Magnification corticale	37
Figure 7 – Tâche mettant en évidence le phénomène de crowding	38

II Contributions expérimentales

Étude 1

Figure 1	43
Figure 2	44
Figure 3A	46
Figure 3B	46
Figure 3C	46
Table 1	45
Table 2	45

Étude 2

Figure 1	58
Figure 2	60
Figure 3	63
Table 1	64

Étude 3

Figure 1	77
Figure 2	79
Figure 3	83

Figure 4	85
Figure 5	86
Figure 6	87
Figure 7	88
Figure 8	89
Figure 9	90

Étude 4

Figure 1	103
Figure 2	103
Figure 3	104
Figure 4	105
Figure 5	106
Figure 6	107
Figure 7	107
Figure 8	108
Figure 9	108
Figure 10	109
Figure 11	109

III Discussion

Figure 8 – Images du dépistage sur tablette tactile	123
Figure 9 – Score brut de la distance en fonction de l'âge	125
Figure 10 – Score corrigé de la distance en fonction de l'âge	126
Figure 11- Corrélation des scores au test visuel et à la lecture chez les CM1et CM2	128
Figure 12 – Images de la remédiation sur tablette tactile	133
Figure 13 - Performance en recherche visuelle avant et après remédiation	134
Figure 14 - Performance en lecture avant et après remédiation	135

Table des matières

Résumé	i
Abstract	iii
Remerciements	v
Liste des abréviations	vii
Liste des figures	ix
Table des matières	xi
I Introduction	1
<u>Partie 1 : La dyslexie</u>	
1.1 Historique et présentation	1
1.2 Différentes théorie de la dyslexie	4
1.2.1 Théorie visuelle	4
1.2.1.1 Théorie magnocellulaire	5
1.2.1.2 Théories visuo attentionnelles	8
1.2.2 Théorie phonologique	16
1.2.3 Autres théories	20
1.2.3.1 Théorie cérébelleuse	20
1.2.3.2 Théorie de la dysproprioception	21
<u>Partie 2 : L'apprentissage de la lecture, une activité visuelle ?</u>	
1.1 Théorie de l'apprentissage de la lecture d'Uta Frith (1985)	23
1.2 Modèle de Linnea C.Ehri (1995)	24
1.3 Théorie à double fondation de Seymour (1997)	25
1.4 Le modèle multitraces d'Ans, Carbonnel et Valdois (1998)	26
<u>Partie 3 : De la perception à l'analyse visuelle</u>	
3.1 De l'environnement au cortex visuel primaire : réception de l'information	29

3.2 Du cortex visuel primaire aux structures secondaires : traitement de l'information visuelle	30
3.2.1 Les voies visuelles	30
3.2.1.1 La voie ventrale	30
3.2.1.2 La voie dorsale	30
3.2.1.3 Interactions entre ces deux voies	31
3.2.2 Structures cérébrales liées à la lecture ou son apprentissage	32
3.2.2.1 La visual word form area (VWFA)	33
3.2.2.2 Le cortex pariétal postérieur (CPP)	33
3.2.2.3 Le lobule pariétal supérieur (LPS)	35
3.2.2 Le phénomène de crowding	38
II Contributions Expérimentales	41
Étude 1	41
Étude 2	51
Étude 3	71
Étude 4	99
III Discussion	115
1. Récapitulatifs des résultats	115
1.1 Etude 1 : prévalence de troubles visuo spatiaux dans la dyslexie	115
1.2 Etude 2 : fenêtre visuo attentionnelle de recherche visuelle chez les enfants dyslexiques	117
1.3 Etude 3 : traitement visuo attentionnel dans différentes conditions de recherche visuelle, rôle du LPS	119
1.4 Etude 4 : rôle du LPS dans la perception et la localisation de multiples Éléments	121
2. Perspectives	123
2.1 Dépistage précoce	123
2.2 Remédiation visuo-attentionnelle	132
3. Conclusion générale	136
IV Bibliographie	139
V Annexes	151
Annexe 1 : Handbook, Syndrôme de Bâlint	151

I Introduction

Partie 1 : La dyslexie

1.1 Historique et présentation

Le terme dyslexie a été introduit pour la première fois par [Rudolph Berlin](#) en 1887 pour décrire des cas de patients adultes qui n'arrivaient pas à lire plus de 5 mots de suite bien que leurs examens ophtalmologiques soient normaux. Il émet l'hypothèse que la dyslexie est due à une « maladie du cerveau » mais n'en connaît pas l'origine exacte. Comme ses patients avaient également des symptômes situés sur le côté droit du corps, il a suggéré que les lésions étaient situées dans l'hémisphère gauche. Il considérait que la dyslexie était le premier symptôme d'une lésion cérébrale acquise, ce qui signifie que ces patients lisaient correctement avant la survenue de la lésion.

Cette dyslexie acquise est donc à bien distinguer de la dyslexie développementale (présente dès la naissance) dont il est sujet dans ce manuscrit.

Le premier cas rapporté de dyslexie congénitale ou développementale l'a été en 1896 par [Pringle Morgan](#). Mais le terme dyslexie n'est pas employé, il le remplace par « congenital word blindness » que l'on peut traduire par cécité congénitale des mots. Dans cet article, l'auteur rapporte le cas de Percy, adolescent de 14 ans décrit comme intelligent et brillant. Cependant il a été incapable d'apprendre à lire bien qu'il fut scolarisé normalement depuis ses 7 ans. Il y a eu beaucoup d'efforts de fournis pour lui apprendre à lire mais sans succès car il arrive seulement à épeler des mots de 1 syllabe. [Pringle Morgan](#) fait donc passer à Percy plusieurs tests, il est capable de lire et d'écrire toutes les lettres individuellement mais lors d'une dictée il n'est capable d'écrire que les mots les plus simples. Il échange même 2 lettres lors de l'écriture de son propre prénom. Lors de la lecture, seuls les mots simples et courts sont lus correctement (ex : « and », « the », « of »), les autres mots semblent inconnus pour lui. Il ne semble pas pouvoir mémoriser les mots même si ils sont fréquents dans la langue mis à part les mots courts

et simples (ex : « and », « the », « of »). Ses difficultés sont vraiment spécifiques à la lecture de mots car lors de lecture de chiffres ou de calcul il est aussi performant que les enfants de son âge. L'auteur précise qu'il n'y a aucun antécédent de maladie ou de blessure et que sa vision est bonne. Son incapacité à apprendre à lire est donc congénitale et sûrement due à un développement atypique de certaines régions cérébrales.

Depuis la description de ce cas, qui expose les déficits que l'on peut observer encore aujourd'hui chez les dyslexiques, plusieurs définitions de la dyslexie ont été publiées.

Les dernières définitions qui font référence sont celles parues dans le DSM V (2013) et la CIM-10.

Le DSM V, manuel de diagnostic des troubles mentaux publié par l'association américaine de psychiatrie, définit la dyslexie comme un ensemble de problèmes d'apprentissage caractérisé par des difficultés dans la reconnaissance exacte et fluide des mots, un mauvais décodage et des difficultés en orthographe. Elle est classée dans la sous-entité trouble spécifique des apprentissages des troubles neuro-développementaux.

Un trouble spécifique des apprentissages est défini comme :

- une difficulté à apprendre et à utiliser les compétences scolaires ou universitaires, comme en témoigne la présence d'au moins un des symptômes suivants ayant persisté pendant au moins 6 mois, malgré la mise en place de mesures ciblant ces difficultés :
 - lecture des mots inexacte ou lente et réalisée péniblement
 - difficulté à comprendre le sens de ce qui est lu (même si lu correctement)
 - difficultés à épeler
 - difficultés d'expression écrite (par exemple erreurs de ponctuation ou grammaticales, manque de clarté de l'expression des idées)
 - difficulté à maîtriser le sens des nombres, les données chiffrées ou le calcul
 - difficulté avec le raisonnement mathématique
- Les compétences scolaires ou universitaires perturbées sont nettement au-dessous du niveau escompté pour l'âge chronologique du sujet et ce de manière

quantifiable. Cela interfère significativement sur les performances scolaires, universitaires ou professionnelles ou avec les activités de la vie courante.

- Les difficultés d'apprentissage débutent au cours de la scolarité mais peuvent ne pas se manifester entièrement tant que les demandes concernant ces compétences scolaires ou universitaires altérées ne dépassent pas les capacités limitées du sujet.
- Les difficultés d'apprentissage ne sont pas mieux expliquées par un handicap intellectuel, des troubles non corrigés de l'acuité visuelle ou auditive, d'autres troubles neurologiques ou mentaux, une adversité psychosociale, un manque de maîtrise de la langue de l'enseignement scolaire ou universitaire ou un enseignement pédagogique inadéquat.

La CIM-10, classification internationale des maladies publiée par l'Organisation Mondiale de la Santé quant à elle répertorie la dyslexie comme un trouble spécifique de la lecture qui est défini par : « une altération spécifique et significative de l'acquisition de la lecture, non imputable exclusivement à un âge mental bas, à des troubles de l'acuité visuelle ou à une scolarisation inadéquate. Les capacités de compréhension de la lecture, la reconnaissance des mots, la lecture orale et les performances dans les tâches nécessitant la lecture, peuvent toutes être atteintes. Le trouble spécifique de la lecture s'accompagne fréquemment de difficultés en orthographe, persistant souvent à l'adolescence, même quand l'enfant a pu faire quelques progrès en lecture. Les enfants présentant un trouble spécifique de la lecture ont souvent des antécédents de troubles de la parole ou du langage. Le trouble s'accompagne souvent de troubles émotionnels et de perturbations du comportement pendant l'âge scolaire.

Le diagnostic de dyslexie est donc fait après exclusion d'autres facteurs qui pourraient expliquer les difficultés en lecture comme un déficit intellectuel ou sensoriel, ou bien une carence socio-éducative.

Ces définitions se basent essentiellement sur les capacités générales de lecture et n'abordent pas le ou les déficits cognitifs et / ou cérébraux sous-jacents qui pourraient conduire à une dyslexie. Dans la communauté scientifique ces questions sur l'origine de

la dyslexie sont donc encore très débattues. C'est ainsi que l'on peut distinguer plusieurs théories qui tentent d'expliquer l'origine de la dyslexie (Rapport INSERM, 2007).

Historiquement la première origine qui a été rapportée est un mauvais traitement visuel des lettres ou du mot, des inversions de lettres dans le mot, des lettres en miroirs. Mais depuis les années 70 cette origine « visuelle » est débattue et l'hypothèse phonologique fait son apparition dans les laboratoires de recherche. Ces deux théories restent encore très débattues et sont souvent en opposition. D'autres théories plus marginales sont également avancées, comme un déficit de la fonction cérébelleuse ou même un trouble général de la posture et de la proprioception (syndrome de dysproprioception). Dans ce premier chapitre nous allons faire le point sur ces différentes théories.

1.2 Différentes théories sur la dyslexie

1.2.1 Théorie visuelle

Comme dit plus haut, le premier cas de dyslexie rapporté en 1896 l'était sous le nom de « cécité congénitale des mots », comme si cet enfant n'arrivait pas à voir spécifiquement les mots alors que les lettres isolées étaient bien reconnues. Les années qui suivirent, plusieurs cas ont été rapportés dont 2 cas dans une même fratrie, ils étaient incapables de reconnaître des mots écrits sauf ceux d'une syllabe et très courants, par contre lorsque l'on prononçait oralement les mots ils n'avaient aucun mal à les répéter. De plus lorsqu'on leur épelle le mot ils sont également capables de le prononcer (Hinshelwood, 1911). L'auteur décrit que ces deux enfants ont des difficultés pour mémoriser la forme des mots. Ces études décrivent donc un problème de traitement visuel comme origine de la dyslexie.

On peut donc voir que dès la publication des premières études sur la dyslexie l'origine d'un déficit du traitement visuel avec un dysfonctionnement d'une région cérébrale spécifique est abordée.

A l'heure actuelle il existe plusieurs hypothèses sur le déficit en traitement visuel dans la dyslexie.

1.2.1.1 Théorie magnocellulaire

Une des plus anciennes hypothèses, elle émerge dans les années 70/80 grâce aux travaux de plusieurs chercheurs qui étudient le système visuel chez des dyslexiques. Plusieurs paramètres du système visuel sont ainsi étudiés :

- La persistance visuelle : rémanence d'un stimulus visuel, testée en examinant le temps nécessaire entre 2 présentations de stimuli pour que le sujet ait conscience qu'il y a un blanc entre les 2. Il existe une corrélation entre le temps de persistance et les performances en lecture, il faut un temps suffisamment long pour analyser le mot mais pas trop pour ne pas interférer avec le suivant. Les enfants avec un temps trop long ou trop court ont des compétences de lecture plus faibles que ceux avec un temps intermédiaire (Riding & Pugh, 1977). Chez les dyslexiques, il y a une augmentation de cette persistance chez les enfants (Lovegrove et al., 1978) ainsi que chez les adultes (Winters et al., 1989) à condition que les stimuli soient présentés à la même place sur la rétine ou dans des champs très proches (Di Lollo et al., 1983; Winters et al., 1989). Cette persistance est également plus grande que pour les normo lecteurs dans les basses fréquences spatiales (Slaghuis & Lovegrove, 1984).
- La sensibilité au contraste : les enfants dyslexiques ont une sensibilité au contraste diminuée pour les faibles fréquences spatiales comparée aux enfants normo lecteurs (Lovegrove et al., 1980).

Le traitement des hautes fréquences temporelles comme testé par la persistance visuelle et des basses fréquences spatiales est assuré par une voie spécifique du système visuel qui est la voie magnocellulaire. L'observation de déficit lors de ces traitements spécifiques laisse donc supposer que les dyslexiques ont une voie magnocellulaire déficitaire (Lovegrove et al., 1986). Ce déficit spécifique explique donc aussi la bonne acuité visuelle des dyslexiques, car celle-ci dépend d'une autre voie du système visuel qui traite les hautes fréquences spatiales et les basses fréquences temporelles : la voie parvocellulaire.

Le déficit de la voie magnocellulaire a également été mis en avant par des études comprenant des potentiels évoqués visuels, les électrodes étaient placées au niveau du cortex occipital et au sommet du crâne. Les enregistrements montraient une différence entre les normo lecteurs et les dyslexiques uniquement lors de la présentation de faibles

contrastes (qui théoriquement active la voie magnocellulaire). De plus dans cette étude une analyse histologique a été réalisée et chez les dyslexiques, la voie magnocellulaire est plus désorganisée avec des cellules plus petites que chez les normo lecteurs alors que la voie parvocellulaire est quant à elle intacte (Livingstone et al., 1991).

Un des arguments contre cette théorie est que l'impact de la voie magnocellulaire sur la lecture serait minime. En effet, la lecture nécessite une vision précise ce qui est du ressort de la voie parvocellulaire. Des chercheurs ont alors suggéré que la voie magnocellulaire avait un rôle d'inhibition sur la voie parvocellulaire lors d'une saccade (suppression saccadique, Breitmeyer, 1993). S'il y a un défaut d'inhibition de la voie magnocellulaire sur la voie parvocellulaire pendant la lecture, il pourrait donc avoir une persistance visuelle et le sujet pourrait voir 2 mots se superposer. Mais cette théorie a été remise en cause par d'autres études qui montrent que ce serait l'inverse, la suppression saccadique inhiberait la voie magnocellulaire uniquement et qu'il n'y a pas d'interaction entre la voie magnocellulaire et parvocellulaire lors d'une saccade (Burr et al., 1994; Skottun & Parke, 1999).

Un déficit de la voie magnocellulaire est donc souvent retrouvé chez les dyslexiques mais sans que ce cela puisse être relié de façon irréfutable comme une cause de celle-ci.

Avec l'émergence de la théorie phonologique sur l'origine de la dyslexie, la théorie magnocellulaire a pris un tournant également auditif, il y aurait un déficit général de la voie magnocellulaire qui toucherait donc les versants visuel et auditif. Une étude a montré que seuls les dyslexiques dits phonologiques présentaient une réduction de sensibilité visuelle dans les basses fréquences spatiales alors que ce n'est pas le cas chez les dyslexiques dits visuels (Borsting et al., 1996). Ces résultats suggèrent donc pour l'auteur que certaines dyslexies ont bien pour origine une dysfonction de la voie magnocellulaire de manière générale que ce soit pour la partie auditive ou visuelle de celle-ci. Par exemple, lorsqu'il était demandé à des sujets de distinguer des changements de fréquences auditives (pour des fréquences autour de 1000Hz), ce changement devait être plus important pour être perçu chez les dyslexiques par rapport aux normo lecteurs (McAnally & Stein, 1996). A l'instar de la modalité visuelle, un déficit de traitement de bas niveau de l'information auditive semble être présent chez les dyslexiques. Une étude a montré que contrairement aux normo lecteurs les dyslexiques présentaient une

asymétrie au niveau de leur corps genouillé médian (structure du thalamus qui reçoit les informations auditives pour les intégrer et ensuite projette vers les aires auditives). En effet les neurones du corps genouillé médian gauche sont plus petits que ceux présents dans le corps genouillé médian droit et comparativement aux normo lecteurs ils avaient plus de petits neurones et moins de gros (Galaburda et al., 1994). Les neurones de grande taille étant dévolus à la voie magnocellulaire, on peut donc penser que chez ces dyslexiques il pouvait avoir un déficit de cette voie vu qu'il y avait une sous-représentation des neurones impartis à la voie magnocellulaire auditive.

Cependant, la théorie magnocellulaire est controversée car les études ont des résultats contradictoires. Mais cela ne permet pas d'exclure un trouble visuel dans certaines dyslexies car ces études portent sur le traitement visuel de bas niveau or au niveau cortical le traitement visuel se divise en 2 voies distinctes après le cortex V1. La voie visuelle ventrale (occipito-temporale) qui est alimentée par les deux voies magno et parvocellulaire (Ferrera et al., 1994) et la voie visuelle dorsale (occipito-pariétale) qui est, quant à elle, alimentée presque exclusivement par la voie magnocellulaire (Maunsell et al., 1990). Un dysfonctionnement de la voie magnocellulaire peut donc conduire à un dysfonctionnement des deux voies visuelles ventrale et dorsale, avec un impact plus important sur cette dernière comme elle l'alimente presque exclusivement. La voie dorsale du cortex est impliquée dans le traitement des informations spatiales (localisation, taille, longueur, orientation...).

Étude 1

Dans une première étude nous avons donc testé la prévalence de troubles de la perception visuo-spatiale élémentaire dans la dyslexie, par comparaison aux autres troubles des apprentissages (Article DMCN, sous presse).

La voie dorsale est aussi le siège de l'attention visuelle. Par conséquent l'attention visuelle a fait l'objet de nouvelles recherches sur l'origine possible de certaines dyslexies.

1.2.1.2 Théories visuo-attentionnelles

La lecture nécessite un traitement visuo attentionnel de l'information et pas seulement un traitement visuel élémentaire. McConkie en 1975 a mis en évidence ce traitement visuo attentionnel en cherchant quel type d'information prenait le lecteur (longueur des mots, forme globale du mot ...). Pour cela, il a utilisé une fenêtre mobile de visibilité qui lui permettait de contrôler la quantité de lettres que pouvait correctement exploiter le sujet en une fixation (figure - 1). Cette fenêtre se déplaçait en fonction du regard, et ce qui était à l'extérieur de la fenêtre était modifié (soit par des X (figure - 1 conditions 1), des lettres proches visuellement (figure - 1 conditions 2) ou des lettres non visuellement proches (figure - 1 conditions 3)). D'autre part, les espaces entre les mots étaient respectés dans une condition (figure 1 - conditions A) et supprimés dans l'autre (figure - 1 conditions B). Il était demandé au sujet de lire un texte dans les différentes conditions et ses mouvements oculaires (saccades et fixations) étaient enregistrés avec un oculomètre. Cette étude a pu montrer que les sujets pouvaient traiter jusqu'à 15 caractères à droite du point de fixation. Cette fenêtre communément appelée « perceptual span » n'est pas symétrique, elle est plus réduite à gauche (jusqu'à 4 caractères) qu'à droite (jusqu'à 15 caractères) de la fixation (Rayner et al., 1980). Cette asymétrie est également retrouvée lors de l'étude du point de fixation optimal lors de la lecture de mot isolé. Ce point correspond à l'endroit où la fixation est la plus efficace pour lire le mot, et il a été montré qu'il était légèrement décalé à gauche du centre du mot (Montant et al., 1998; Nazir et al., 1991). Plus on s'éloigne de ce point, plus les performances diminuent mais pas de manière symétrique, les performances sont plus basses lorsque la fixation se déplace vers la fin du mot (pour les cultures dont la lecture se fait de gauche à droite). Cet effet d'asymétrie ne peut pas être résolu par une augmentation croissante de la taille des lettres autour du point de fixation pour compenser une éventuelle perte de résolution due à la topographie de la rétine (Nazir et al., 1998) ce qui est un argument de plus pour montrer que le traitement visuo attentionnel est important dans la lecture. Cette analyse visuo attentionnelle est déjà présente chez les apprentis lecteurs. Par contre, bien qu'ils aient la même zone de fixation optimale, les enfants dyslexiques n'ont pas d'asymétrie droite gauche, leurs performances décroissent de la même manière à droite ou à gauche (Ducrot et al., 2003). Cela peut suggérer qu'ils n'ont pas adapté leurs capacités visuo-attentionnelles à la lecture. En effet, lors de la lecture, on ne déploie pas son attention de manière

symétrique autour du point de fixation. Le déploiement de l'attention est plus important dans le sens de la lecture (à droite pour l'anglais et à gauche pour l'hébreu) (Pollatsek et al., 1981) ce qui permettrait d'anticiper les mouvements oculaires. Dans l'étude de McConkie (1975) décrite plus haut, les conditions qui respectaient la longueur des mots et leur espacement (figure - 1 conditions A) ont permis de montrer que la longueur des mots avait une influence sur l'amplitude des saccades lors de la lecture. Cela suggère que l'analyse de la longueur des mots permet de préparer l'amplitude des saccades afin d'optimiser la prochaine fixation pour qu'elle se situe le plus proche possible de la zone de fixation optimale. L'analyse de la durée des fixations en comparant les conditions lettres visuellement proches (figure - 1 condition 2A) ou non (figure - 1 condition 3A) a permis de mettre en évidence que l'information extraite de la forme des mots ne pouvait se faire que jusqu'à 10 caractères à droite de la fixation. Le déploiement efficace de l'attention visuelle semble donc jouer un rôle important dans la lecture.

```

          Graphology means personality diagnosis from hand writing. This is a
1A  XXXXXXXXXXXX XXXXX XXXXonality diagnosis XXXX XXXX XXXXXXXX. XXXX XX X
1B  XXXXXXXXXXXXXXXXXXXXXXXXXXXXonality diagnosisXXXXXXXXXXXXXXXXXXXXXXXXXXXX
2A  Cnojkaiazp wsorc jsnconality diagnosis tnaw kori mnlfirz. Ykle le o
2B  Crojkaiaqpewsourcejsnconality diagnosisetnawekoriemnlflrqeeYkliceleco
3A  Hbfxwysyvo tdfd! xiblontology diagnosis abyf wfdn hbemedv. Awcl el f
3B  Hbfxwysyvoetifdlexiblontology diagnosiscabyfwdnehbemedveeeAwelccclcf

```

Figure 1 – Paradigme de la fenêtre mobile. Autour du point de fixation les lettres sont remplacées par des X (conditions 1), par des lettres visuellement proche (conditions 2) ou non (conditions 3). La longueur des mots était respectée (conditions A) ou non (conditions B). McConkie (1975)

D'après des études neuropsychologiques, on sait qu'il y a une asymétrie hémisphérique pour le traitement visuo-attentionnel, l'hémisphère gauche traitant plutôt les détails et l'hémisphère droit la forme globale (Delis et al., 1986). Ces difficultés visuo attentionnelles peuvent également être mises en évidence avec une tâche dite de local/global. Par exemple, le test de Navon (1977) consiste à présenter une grande lettre constituée de multiples petites lettres, congruentes (figure 2 images 1) ou incongruentes (figure 2 images 2) avec la grande lettre. On peut demander aux patients quelle lettre ils

perçoivent spontanément. On peut également demander à identifier la lettre globale (le H pour les images 1A et 2B ou le S pour les images 1B et 2A de la figure 2), ou la lettre locale (le H pour les images 1A et 2A ou le S pour les images 1B et 2B de la figure 2). Le temps de réponse est enregistré et les conditions congruentes (figure 2 images 1) et incongruente (figure 2 images 2) sont comparées.

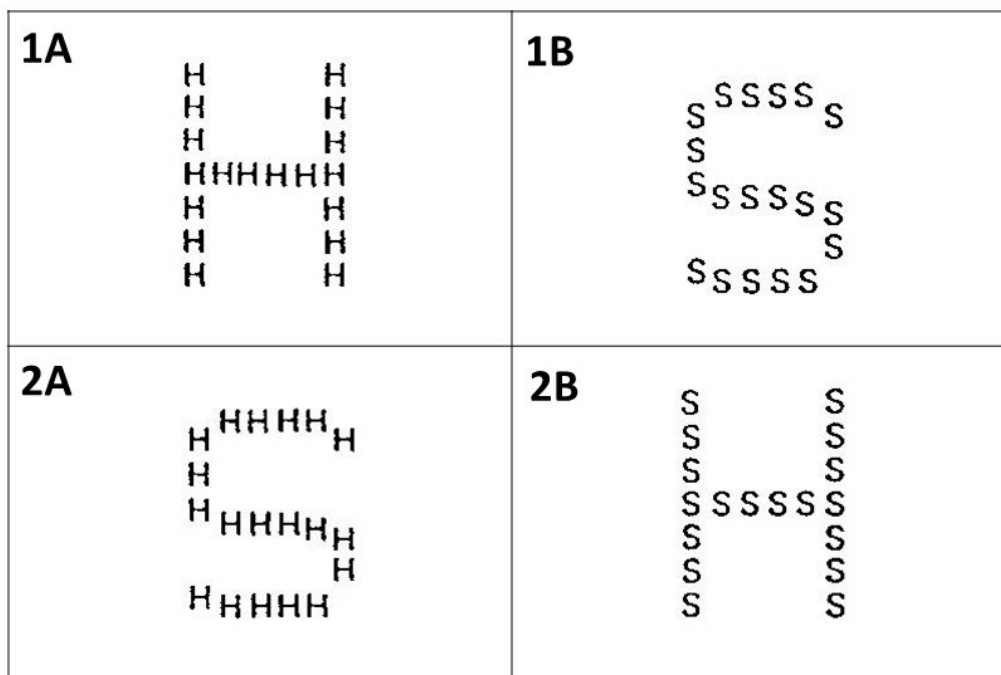

Figure 2 – Exemple de stimuli de la tâche de Navon (1977). Les stimuli 1 sont considérés comme congruents car la forme globale et la forme locale sont identiques. A l'inverse les stimuli 2 sont incongruents car la forme locale et la forme globale diffèrent.

Selon la théorie de la « gestalt » (forme) née en Allemagne à la fin du 19^e siècle, le processus de perception (au sens large, visuelle, auditive mais aussi représentation mentale) se fait de manière globale et non par addition d'éléments. En s'inspirant de cette théorie, Navon (1977) a montré que l'analyse visuelle d'une scène se fait dans un premier temps de façon globale (la scène dans son ensemble) avant de se focaliser sur les éléments qui la composent. Il y a donc une prédominance du global sur le local, l'analyse du global se ferait en premier puis le local pour voir les détails de la scène. Lorsqu'on demande d'identifier la forme locale, la forme globale incongruente traitée avant vient donc interférer avec le traitement local et ralentit la réponse du sujet. C'est moins le cas lorsqu'on demande d'identifier la forme globale. Dans les premières années de la vie, ce n'est pas le global qui prédomine dans l'analyse visuelle. Il y a une évolution de la prédominance locale (à 4 ans)

vers la prédominance globale (à 9 ans) avec un âge charnière à 6 ans (Poirel et al., 2008). Cette évolution s'accompagne également par des changements au niveau de la substance grise, diminuant au niveau des aires occipitales mais également pariétales (Poirel et al., 2011). Il semble donc y avoir une réorganisation de ces aires dans l'enfance. Cette évolution ne semble pas se faire chez certains enfants dyslexiques, en effet, certains gardent une prédominance du local même après 9 ans (Franceschini et al., 2017). Ces enfants ont donc une difficulté pour inhiber les détails (Bedoin et al., 2010) et traiter une scène (ou un mot) dans son ensemble. Un entraînement visuo attentionnel réalisé par le biais d' « action video games » qui ne mettent aucunement en jeu des compétences de lecture a permis à des enfants dyslexiques de normaliser leurs performances et d'avoir comme les normo lecteurs une prédominance du traitement global (Franceschini et al., 2017). Ces dernières études n'utilisent pas de lettres mais des symboles ce qui permet de s'éloigner du contexte de la lecture et ainsi ne pas être dépendant du manque d'expérience en lecture de certains dyslexiques ce qui est souvent décrit comme une limite des tâches visuo attentionnelles par les détracteurs de cette théorie.

Egalement, pour montrer que le déficit visuo attentionnel est présent même en dehors de tâches impliquant la lecture ou la reconnaissance de lettre, plusieurs chercheurs ont utilisé des tâches de recherche visuelle n'impliquant ni lettre ni support organisé en ligne. En 1996 Marrendaz et ses collaborateurs ont montré que les enfants dyslexiques étaient plus lents lors d'une tâche de recherche visuelle spécifique. Les auteurs ont utilisé 2 conditions de recherche différentes qui demandent un niveau d'attention différent. Lorsque la cible recherchée diffère des distracteurs par une caractéristique en plus (trouver un Q parmi des O) le temps de recherche n'est pas dépendant du nombre de distracteurs, la cible saute aux yeux (pop out) grâce à sa caractéristique en plus (ici la barre du Q). L'image est traitée globalement pour extraire la caractéristique en plus. Au contraire lorsque la cible ne diffère pas des distracteurs par une caractéristique en plus (ici chercher un O parmi des Q) le temps de recherche augmente avec le nombre de distracteurs. La recherche est dite sérielle, le sujet ne peut pas déployer son attention sur toute l'image et doit se focaliser sur quelques éléments à la fois. Dans cette étude il a donc été montré que les dyslexiques ne différaient pas des contrôles dans la recherche parallèle par contre dès que le niveau d'attention visuelle augmente avec la recherche sérielle, ils sont beaucoup plus lents. Ce qui laisse supposer un déficit dans le traitement visuo-attentionnel.

Au-delà de la nature de la recherche (pop-out versus sérielle), c'est surtout le type de stimuli utilisé qui semble avoir un impact. En effet, Casco & Prunetti (1996) ont montré que les dyslexiques et les normo lecteurs avaient des performances similaires dans des tâches de recherche visuelle lorsque celles-ci impliquaient des formes simples de type « objets pleins » même en variant le niveau d'attention visuelle. Lors d'une tâche de conjonction (couleur-orientation ou taille-orientation), qui fait pourtant appel à un traitement attentionnel sériel, dont le temps de recherche augmente significativement avec le nombre d'items, et nécessite une exploration oculaire (Treisman & Gelade, 1980), les dyslexiques n'étaient pas plus lents que les normo lecteurs. A contrario, les dyslexiques étaient plus lents pour des recherches dites parallèles impliquant des symboles (combinaison de traits). Lorsqu'il fallait trouver une barre inclinée parmi des barres verticales ils n'avaient aucune difficulté (figure 3 image 1). Par contre dès que cette unique barre inclinée était enchâssée avec d'autres traits ils devenaient plus lents que les normo lecteurs (Casco & Prunetti, 1996), que ce soit pour des lettres ou des formes non verbales (figure 3 images 2 et 3).

	Shape		Letter	
	Nontarget	Target	Nontarget	Target
1		/		—
2	F	∩	F	K
3	V	^	b	p

Figure 3 – Stimuli utilisés dans l'étude de Casco et Prunetti (1996). Ceux de la ligne 1 sont des traits simples et ceux des lignes 2 et 3 sont constitués de combinaisons de traits.

La lenteur en recherche visuelle des dyslexiques n'est donc pas due à un problème de traitement sériel. Elle ne peut non plus être imputée à un comportement oculomoteur différent (plus de saccades, fixations plus longues...) car les dyslexiques ont un pattern oculomoteur identique aux normo lecteurs lors de tâches proches de la

lecture, comme lorsqu'on leur demande de trouver une lettre dans un support qui ressemble à un texte (des chaînes de caractères séparées par des espaces mais impossibles à lire) (Hutzler et al., 2006; Prado et al., 2007). Cette lenteur peut donc être interprétée comme une difficulté à traiter autant d'éléments simultanément que le sujet normo-lecteur. Les dyslexiques ne pourraient traiter qu'un nombre restreint d'éléments en une fixation.

Cette réduction de traitement simultané a été mise en évidence grâce à la mesure de l'empan visuo attentionnel, EVA (Bosse et al., 2007). Cet empan permet de mesurer la quantité d'éléments visuels qui peut être traités simultanément. Pour cela il est présenté une ligne de 5 lettres pendant 200ms et on demande à l'enfant de rapporter autant de lettres qu'il a pu voir peu importe l'ordre. Il a été montré que certains enfants dyslexiques avaient une réduction de cet empan, ils ne pouvaient rapporter qu'un nombre réduit de lettres par rapport aux normo lecteurs. A l'instar de l'étude de Casco et Prunetti ce déficit est spécifique aux items constitués de combinaison de lignes (lettre ou symbole) car le traitement simultané de 5 disques de couleur ne pose aucun souci aux enfants dyslexiques (Valdois et al., 2012a). De plus, il a été montré que certains enfants dyslexiques avaient une diminution de l'EVA mais que leurs capacités phonologiques étaient préservées. A l'inverse certains avaient un EVA totalement dans la norme mais une atteinte de leurs capacités phonologiques. Certains enfants dyslexiques semblent donc traiter moins d'éléments simultanément que la moyenne des enfants de leur âge ce qui peut entraver la fluidité de la lecture car les mots ne peuvent être traités dans leur globalité.

L'aire cérébrale qui semble impliquée dans le traitement simultané de plusieurs éléments est le lobule pariétal supérieur (LPS). Des études d'imagerie ont montré que le LPS s'active spécifiquement lorsqu'il faut traiter plusieurs éléments en même temps. En effet, il s'active lors d'une tâche de traitement simultané (Lobier, Peyrin, et al., 2012) alors que lors de la présentation d'un élément isolé il ne s'active pas et ceci que ce soient des caractères alphanumériques (lettres ou chiffres) ou non (symboles). Chez les dyslexiques ayant une réduction de l'EVA le LPS ne s'active pas plus lors du traitement simultané que lors du traitement d'un élément isolé (Peyrin et al., 2011) contrairement aux enfants contrôles avec un EVA dans la norme qui voient une activation plus importante du LPS dans la condition traitement simultané. Un dysfonctionnement du

LPS chez certains dyslexiques pourrait donc être à l'origine du déficit en lecture observé car une lecture efficace nécessite de traiter le mot dans sa globalité et donc d'analyser plusieurs lettres en même temps.

De plus, on sait qu'une lésion acquise bilatérale du LPS entraîne une simultagnosie, syndrome clinique décrit comme une incapacité à traiter plusieurs éléments simultanément. L'étude d'une patiente ayant une lésion focale bilatérale de cette région cérébrale a montré que lors d'une tâche de recherche visuelle lorsque les stimuli étaient constitués de combinaison de traits elle avait une réduction de son champ visuo attentionnel. Par contre quand les stimuli étaient des formes simples de type « objets pleins » sa performance était comme celle des contrôles (Khan et al., 2016) à l'instar des dyslexiques de l'étude de Casco & Prunetti (1996) qui étaient plus lents que les normo-lecteurs uniquement lorsque les stimuli étaient constitués de combinaisons de traits. Cette réduction du champ visuo attentionnel, démontrée grâce au paradigme de la fenêtre mobile asservie à la position des yeux appliquée à la recherche visuelle (McConkie & Rayner, 1975), ne doit pas être confondue avec une réduction du champ visuel.

Une distinction entre champ visuel et champ visuo attentionnel a été décrite par Intriligator & Cavanagh (2001). Pour tester le champ visuel classique, on flashe un point de différentes tailles à différentes excentricités en vision périphérique et on demande au sujet s'il le perçoit. La taille des champs d'acuité visuelle à chaque excentricité correspondait à la taille des points nécessaire pour que le point soit perçu. Elle augmente avec l'excentricité pour compenser la magnification de la vision centrale au niveau de l'aire visuelle primaire. Pour mesurer le champ visuo-attentionnel, ces auteurs ont présenté un ou deux points très proches les uns des autres (distance variable paramétrée) à différentes excentricités en vision périphérique et demandé au sujet combien il y avait de points. La taille des champs attentionnels à chaque excentricité correspondait à la distance minimale entre les deux points pour qu'ils soient distingués en vision périphérique. Elle augmente davantage avec l'excentricité que celle des champs d'acuité visuelle, et surtout chez les patients avec lésion du cortex pariétal.

On pourrait dire que le champ visuel « classique » correspond à une détection d'un objet simple et unique alors qu'on parle de champ visuo attentionnel pour des tâches d'identification ou de discrimination entre plusieurs objets. Une notion similaire

est celle du « crowding » ou encombrement qui est un phénomène perceptif correspondant à une incapacité à reconnaître un élément entouré de 2 autres éléments distracteurs similaires (flankers) en vision périphérique alors qu'il est parfaitement reconnu lorsqu'il est présenté seul (Bouma, 1970). Le crowding peut être important dans un contexte de lecture, car il peut y avoir encombrement à l'échelle du mot (les lettres proches les unes des autres), de la phrase (mots proches les uns des autres), ou du texte (lignes proches les unes des autres). Un crowding excessif (c'est-à-dire une augmentation de la distance nécessaire entre les flankers et la cible pour pouvoir reconnaître celle-ci) a été mis en évidence chez les dyslexiques (Bouma & Legein, 1977), l'espacement critique nécessaire (entre la cible et les flankers) pour reconnaître une lettre centrale est plus grand chez les dyslexiques que chez les normo lecteurs (Martelli et al., 2009). Ce crowding excessif peut jouer un rôle important sur les capacités de lecture, comme le montre une étude qui décrit une augmentation de la vitesse de lecture de mot isolé chez les dyslexiques lorsque les lettres étaient plus espacées que la normale, mais cet espacement à une limite car s'il est trop grand l'effet inverse avec un ralentissement de la lecture est observé (Spinelli et al., 2002). Egalement lors de la lecture d'un texte, l'espacement conjointement des lettres (de 2.5 points), des mots (3 caractères entre chaque mot) et des lignes (double interligne) permet aux enfants dyslexiques de faire moins d'erreurs. Cette étude va plus loin en comparant la lecture du texte espacé à celui où juste les lignes sont espacées et ils ont montré que c'est l'espacement des lettres qui a un meilleur impact sur la lecture (Zorzi et al., 2012). Le crowding a souvent été décrit comme un phénomène de bas niveau mais de plus en plus de recherches tendent à montrer que l'attention visuelle peut le moduler (Albonico et al., 2018; Felisbert et al., 2005; Yeshurun & Rashal, 2010), ce crowding excessif chez certains dyslexiques peut donc être le signe également d'un déficit de l'attention visuo attentionnelle. Ce phénomène visuel sera l'objet d'un paragraphe plus bas dans l'introduction

Les difficultés visuo attentionnelles sont donc bien présentes chez certains dyslexiques et ceci même en dehors de tâche de lecture, certaines tâches comme la recherche visuelle ont même été décrites comme prédicteurs des futures capacités de lecture (Carroll et al., 2016). Ces difficultés ne peuvent donc pas être imputables à un manque d'expérience en lecture contrairement à ce qui est clamé par les tenants de la théorie phonologique (Goswami, 2015b).

Étude 2

Dans cette deuxième étude nous avons essayé de caractériser le déficit visuo attentionnel présent dans certaines dyslexies en s'éloignant du contexte de la lecture pour montrer qu'il peut en être à l'origine. Il s'agit de tester chez les enfants dyslexiques si le déficit de traitement simultané peut être présent même dans une tâche de recherche visuelle. On sait qu'une lésion bilatérale du LPS provoque une simultagnosie et que même après régression de celle-ci il persiste une réduction de la fenêtre visuo-attentionnelle dans une tâche de recherche mais uniquement pour des stimuli constitués de combinaison de traits (Khan et al, 2016). La deuxième étude a donc pour objectif d'utiliser la même méthodologie pour évaluer s'il y a une réduction du champ visuo-attentionnel de recherche chez les enfants dyslexiques. Pour cela nous avons mesuré le temps de recherche visuelle d'enfants dyslexiques avec des stimuli faits de combinaisons de traits ou pleins. Nous avons déterminé si la réalisation de ces deux tâches avec une fenêtre mobile réduite avait un coût seulement pour les objets pleins, ce qui démontrerait une réduction spécifique de leur fenêtre visuo attentionnelle pour les objets complexes. Nous avons aussi étudié si cette réduction s'accompagne d'autres déficits (visuo spatiaux, trouble du local global, trouble de l'EVA) ?

1.2.2 Théorie phonologique

La phonologie est la science qui étudie les sons du langage du point de vue de leur fonction dans le système de communication linguistique (Lang, 1973).

C'est la théorie de la dyslexie qui est actuellement la plus répandue et un trouble de la phonologie est l'origine la plus communément admise par la communauté scientifique.

Cette théorie se base essentiellement sur le fait que la lecture est une compétence acquise par l'homme après le langage. Il faut mettre en correspondance de l'écrit (les graphèmes qui sont nouveaux lors de l'apprentissage de la lecture) avec leur homologue oral (les phonèmes qui eux sont déjà connus grâce au développement du langage oral). Une mauvaise connaissance des phonèmes peut donc entraver la lecture car la correspondance ne se fera pas ou elle se fera mal.

Elle émerge dans les années 70 suite aux travaux de Liberman et ses collaborateurs qui en 1971 ont montré que les erreurs d'inversion décrites par Orton (1937) ne sont pas systématiquement présentes chez tous les mauvais lecteurs. En outre, ils font plus d'erreurs d'addition ou d'omission de consonnes que d'inversion de lettres dans un mot ou d'orientation au sein de la lettre (b/d, lettres miroirs). Ils montrent aussi que le contexte linguistique est plus déterminant que les confusions visuelles dans les erreurs de type lettre en miroir car ils font plus d'inversion d'orientation dans la condition lecture de mot que dans celle de lecture de lettre isolée. Les auteurs suggèrent donc que les mauvais lecteurs ont plus de difficulté dans le décodage du mot que dans l'analyse visuelle de celui-ci. Les auteurs vont ensuite plus loin en 1979 en comparant ces premiers résultats des mauvais lecteurs avec ceux de dyslexiques et leur profil d'erreur sont similaires, peu d'erreurs d'inversion ou d'orientation dans un mot mais beaucoup d'erreurs d'addition d'omission de consonnes. Ils émettent donc l'hypothèse que les dyslexiques ont plus de difficultés dans la segmentation et le codage phonémique que dans l'analyse visuelle du mot (Fischer et al., 1978).

Suite à ces travaux, le rôle de la phonologie dans la lecture et son apprentissage est de plus en plus étudié.

D'après Wagner et al. (1987), le traitement phonologique peut être dissocié en 3 aspects :

- *la conscience phonologique* est définie comme la connaissance que les mots de la langue sont formés de différents phonèmes, c'est un aspect très important de la phonologie. Une bonne conscience phonologique permet de manipuler les différents phonèmes et de les identifier. Elle est présente avant l'apprentissage de la lecture, et est importante dans cet apprentissage (Gillon, 2005). C'est également un prédicteur des futures capacités de lecture (Mann, 1984), les futurs bons apprenants lecteurs avaient un score d'erreur dans une tâche de comptage de syllabes significativement inférieur à celui des enfants qui allaient avoir des difficultés lors de l'apprentissage de la lecture. Elle se développe et s'enrichit aussi grâce à l'apprentissage de la lecture, en effet des adultes illettrés faisaient beaucoup plus d'erreurs dans une tâche de délétion et d'addition de phonème que des adultes qui savaient lire même s'ils avaient appris tard (Morais et al.,

1979). D'autres études ont montré que des enfants dyslexiques ont une conscience phonologique altérée par exemple lors de tâche de rime (Bradley & Bryant, 1978). Par la suite plusieurs recherches ont donc été effectuées pour montrer que la dyslexie pouvait avoir pour origine un trouble de la conscience phonologique.

Une étude d'imagerie a ainsi cherché à étudier les bases neurales de la conscience phonologique en faisant des tâches qui ne nécessitaient pas de lecture. Il a été montré qu'il y a une hyperactivation de la région du cortex préfrontal dorsolatéral gauche lors d'une tâche impliquant la conscience phonologique par rapport à une tâche qui n'y faisait pas appel. De plus dans cette étude, les auteurs ont montré que les enfants dyslexiques qui ont des performances plus faibles dans des tâches de conscience phonologique n'activent pas ou peu cette zone lors de la tâche. De plus des enfants de maternelle qui ont les mêmes performances en conscience phonologique que les dyslexiques activent les mêmes régions que les normo lecteurs. Ceci montre d'après les auteurs que cette région joue un rôle crucial dans la conscience phonologique chez les enfants typiques et que les enfants dyslexiques n'activent pas cette région pour le traitement phonologique ce qui explique leurs faibles performances (Kovelman et al., 2012).

- *l'accès au lexique* (ensemble des mots d'une langue) à partir d'un mot écrit. Il a été décrit deux principales méthodes pour accéder au lexique, une phonologique, le sujet transcrit le mot écrit dans sa forme phonologique puis a accès au lexique, une plus visuelle dans laquelle l'accès au lexique se fait par visualisation de la forme globale du mot. Est-il nécessaire de savoir prononcer un mot pour le reconnaître et le comprendre ? Dans une étude de Doctor et Coltheart en 1980, il est montré que c'est la première stratégie qui est privilégiée dans les premières années d'apprentissage de la lecture, les enfants utilisent plus le décodage phonologique pour l'accès au lexique. Ensuite, après 9 ans, c'est plus la stratégie visuelle qui est utilisée mais la transcription phonologique semble toujours jouer un rôle (Sauval et al., 2017). Cela a été mis en évidence grâce une tâche de décision lexicale (le sujet doit dire si le mot présenté existe), cette tâche était précédée d'un « primeur » (présentation rapide d'un autre mot avant le mot cible). L'effet du priming phonologique (lorsque l'on présente un

pseudohomophone avant le mot cible) restait stable tout au long du développement du jeune lecteur. Ce qui suggère que l'aspect phonologique continue de jouer un rôle même après l'apprentissage de la lecture (Ziegler et al., 2014). L'accès au lexique peut également être testé grâce à une tâche de dénomination rapide (le sujet doit nommer rapidement des éléments (images, couleurs, lettres...) qui lui sont présentés. Ces deux tâches ont été montrées comme déficitaires chez les dyslexiques (Norton & Wolf, 2012) et sont aussi un prédicteur de la dyslexie (McBride-Chang & Manis, 1996).

- *la mémoire de travail phonologique* est essentielle pour la lecture de mot nouveau ou de pseudo mot. On doit maintenir en mémoire les différents phonèmes afin de les combiner pour produire le mot correct. Elle est étudiée grâce à une tâche de répétition de pseudo mot.

Il a été montré que la mémoire de travail verbale (rapporter une liste de mots prononcée oralement) est spécifiquement atteinte chez les dyslexiques et pas la mémoire de travail de manière générale (Liberman et al., 1982). Une étude chez l'adulte normo lecteur a montré que le réseau impliqué dans cette mémoire de travail verbale était le gyrus temporal supérieur, le gyrus frontal inférieur et l'aire prémotrice supplémentaire de l'hémisphère gauche (Perrachione et al., 2017)

Un dysfonctionnement dans au moins un de ces trois aspects pourrait donc entraver l'apprentissage de la lecture et conduire à une dyslexie.

Cependant beaucoup de tâches de diagnostic font appel à des supports visuels (lectures de mots, pseudomots, non mots), il semble donc parfois difficile de faire la distinction entre un problème phonologique pur et/ou un problème de traitement visuel. Un enfant peut ne pas avoir de trouble phonologique mais comme son analyse visuelle est faussée il peut produire le mauvais mot et donc on peut conclure parfois à tort à un déficit phonologique.

En France on classe le plus souvent les dyslexiques en 3 catégories suivant leur déficit lors de la lecture de mots (profil visuel ou « de surface ») ou de pseudo mots (profil phonologique) et si les deux modalités sont atteintes on parle d'un profil mixte. Cependant, une étude de 2014 menée par Zoubrinetzky et ses collaborateurs a montré

qu'un même profil de lecture pouvait être dû à 2 déficits cognitifs sous-jacents distincts et qu'une origine visuo-attentionnelle n'atteint pas forcément que les mots connus. En effet un enfant peut échouer à la lecture de pseudomots car il a un déficit de conscience phonologique (testé oralement sans support visuel) mais également s'il a un déficit de l'EVA, car s'il ne peut traiter simultanément plusieurs lettres, les graphèmes longs (ex : eau) peuvent être mal lus. Grâce à cette étude on comprend bien l'importance de tester l'aspect phonologique en passant par l'oral et que l'on peut passer à côté d'un déficit de traitement visuel si on n'utilise que des supports visuels.

1.2.3 Autres théories

D'autres théories sur l'origine de la dyslexie plus récentes, moins répandues et plus controversées existent dont la théorie cérébelleuse et la théorie de la dysproprioception.

1.2.3.1 Théorie cérébelleuse

Elle est née fin des années 1990 sous l'impulsion d'Angela Fawcett et Rod Nicolson qui ont remarqué que les enfants dyslexiques avaient des troubles de l'équilibre et du tonus musculaire. Ces deux déficits seraient présents chez les dyslexiques avec la même proportion que les déficits de lecture et d'orthographe, mais ils seraient plus présents que les troubles de la segmentation phonémique ou de la répétition de non mot (Fawcett & Nicolson, 1999). L'imagerie a également mis en évidence une différence anatomique du cervelet entre les dyslexiques et les normolecteurs. Le volume de la substance grise du cervelet était moins important chez les dyslexiques (Brown et al., 2001; Eckert et al., 2005) et ils ne présentent pas d'asymétrie entre le lobe gauche et droit contrairement aux contrôles (droit < gauche) (Rae et al., 2002).

Ce dysfonctionnement du cervelet est encore débattu tant au niveau comportemental, des études ne retrouvent pas de déficits dans des tâches impliquant le cervelet (Ramus et al., 2003) alors que d'autres décrivent un trouble de l'équilibre plus fréquemment présent chez les dyslexiques que chez les normo lecteurs (Moe-Nilssen et al., 2003; Stoodley et al., 2005) qu'au niveau anatomique des études trouvent une différence (Fernandez et al., 2013) alors que d'autres non (Ashburn et al., 2019), que ce soit au niveau structurel ou fonctionnel. Récemment, une étude a décrit un déficit dans des tâches de coordination motrice fine impliquant le cervelet (enfilage de perle) chez

des dyslexiques adultes mais sans que celui-ci ne soit corrélé avec les aptitudes de lecture ou avec le volume de la substance grise du cervelet (Van Oers et al., 2018). La tâche n'impliquant pas uniquement le cervelet les auteurs ont donc suggéré que le déficit observé serait plus dû à un dysfonctionnement de circuits neuronaux plus large qu'à un dysfonctionnement spécifique du cervelet.

1.2.3.2 Théorie de la dysproprioception

Cette théorie s'inscrit également dans le cadre de l'observation d'un trouble de l'équilibre chez les dyslexiques mais la cause en serait différente. Dans cette théorie la dyslexie serait un symptôme d'un trouble plus général de la proprioception. La proprioception nous sert à savoir où sont positionnées nos différentes parties du corps entre elles et dans l'espace grâce aux informations venant de récepteurs situés dans les muscles, tendons et articulations. Cette théorie naît en 1979 sous le terme de syndrome de déficience posturale et postule une altération du contrôle postural et oculaire et un défaut d'information proprioceptive et visuelle (Martins Da Cunha, 1979). Elle évolue par l'impulsion du Dr Quercia sous le terme de Dysperception proprioceptive. Dans cette théorie la dyslexie ne serait donc pas d'origine cérébrale mais causée par une mauvaise perception de messages sensoriels périphériques (Quercia, 2008), il y aurait un dérèglement entre la perception visuelle et le codage de la position des yeux dans l'orbite et en découlerait donc une mauvaise localisation spatiale des objets et donc un déficit en lecture qui nécessite une bonne localisation des lettres et des mots.

Le dérèglement général proprioceptif se traduirait par des signes cliniques très variés classés en trois catégories : troubles musculaires (douleur dans le dos, cou, maux de tête, difficulté à fixer...), troubles spatiaux (chute, impression de marcher sans stabilité, sensation de vertige, difficultés pour marcher sur un support étroit) et troubles perceptifs (impression de voir les objets déformés, difficulté de concentration, sensation d'avoir froid aux pieds, sensation de fourmillement...). Ils existent un total de 33 signes et les enfants dyslexiques en rapportent 11 en moyenne. Un examen spécifique est également réalisé pour évaluer la dysproprioception (Quercia et al., 2005). Un traitement a été également développé et permettrait un rééquilibrage de la proprioception, il est basé sur 3 axes, le port de prismes pour modifier la perception de l'espace visuel, des semelles de posture et des exercices de reprogrammation posturale à faire quotidiennement. En complément s'ajoute parfois un traitement orthodontique.

Cette théorie qui a pour ambition de proposer une origine commune aux troubles de l'apprentissage est encore controversée car il n'y a pas d'étude objective qui montre une amélioration de la lecture après le traitement. De plus l'examen pour définir la dysproprioception qui a été mis au point n'a pas été évalué et les tests utilisés ne sont pas normés.

On ne peut que constater que les origines de la dyslexie sont pour le moment encore débattues malgré la prédominance de la théorie phonologique, ce qui peut parfois retarder le diagnostic ou proposer une remédiation mal adaptée au profil cognitif de l'enfant.

La phonologie joue un rôle important dans l'apprentissage de la lecture, mais la vision ou plus précisément le traitement visuel est également très important, il faut voir le mot correctement pour bien le lire.

Partie 2 : l'apprentissage de la lecture, une activité visuelle ?

L'apprentissage de la lecture fait l'objet de plusieurs théories qui vont être exposées dans ce paragraphe.

2.1 Théorie de l'apprentissage de la lecture d'Uta Frith (1985)

En 1985 Uta Frith, psychologue allemande, a écrit sa théorie sur l'apprentissage de la lecture. Elle propose 3 différentes étapes nécessaires à l'acquisition de la lecture, le stade logographique, le stade alphabétique et le stade orthographique. Ces 3 stades se succèdent au cours du développement et ils ne peuvent pas être « sautés ».

Le stade logographique correspond à la reconnaissance de mots familiers. Lors de cette étape les composantes graphiques du mot (couleurs, logo) sont très importantes, l'ordre des lettres et l'aspect phonologique passent totalement au second plan. Par exemple c'est lors de ce stade que l'enfant peut reconnaître des mots qu'il rencontre fréquemment comme des marques bien identifiables. Mais si ce mot est écrit d'une autre manière en changeant la police d'écriture la couleur ou le logo qui lui est associé l'enfant n'est plus capable de le reconnaître. Ce stade se construit grâce aux capacités de mémoire de l'enfant et permet le développement du vocabulaire

Survient ensuite le stade alphabétique, l'enfant apprend la correspondance graphème/phonème. Dans cette phase considérée comme primordiale et obligatoire des instructions explicites sont nécessaires. L'enfant doit apprendre les règles de conversion graphème phonème, il commence par apprendre les règles basiques puis celle plus complexes avec les irrégularités. L'enfant décode les mots, la place des lettres dans le mot et la connaissance de leur son jouent donc un rôle primordial. Cette lecture par décodage permet de lire les nouveaux mots (pas forcément correctement car les mots irréguliers seront « régularisés ») ainsi que les pseudo-mots

Une fois ce stade passé l'enfant passe dans le dernier stade qui est le stade orthographique. On entre dans la lecture globale, les mots sont traités comme des unités orthographiques. Ce stade se différencie du premier par son caractère analytique et

sémantique, les mots sont lus dans un contexte particulier et ils peuvent être reconnus même en étant écrits avec une autre police ou sans indice (couleur logo) associés. Et il se distingue du précédent car les unités traitées sont plus grandes et non phonologiques. L'enfant reconnaît le mot dans sa globalité et va chercher sa prononciation et son sens dans sa mémoire sémantique. Il n'a plus besoin de passer par une conversion graphème phonème. L'acquisition de ce stade permet une lecture experte et rapide.

Dans ce modèle il est nécessaire de passer par les différents stades pour acquérir la lecture, on ne peut passer au stade suivant si le précédent n'est pas acquis mais ces différents stades restent acquis et on peut y revenir dans certains cas. Lorsque le stade orthographique est atteint les autres stades sont toujours accessibles mais dans une moindre mesure.

2.2 Modèle de Linnea C.Ehri (1995)

Psychologue américaine, elle se démarque de la théorie d'Uta Frith en ajoutant une phase dans l'apprentissage de la lecture, la phase alphabétique est divisée en 2 parties. Il y a donc dans ce modèle 4 phases :

- Phase pré-alphabétique : c'est la phase logographique d'Uta Frith., elle en a changé le nom car le terme logographie pouvait être mal interprété et confondu avec les caractères non alphabétiques de certaines langues comme le chinois qui ne sont bien sûr pas reconnus par les pré-lecteurs. On retrouve donc dans cette phase les caractéristiques de la phase logographique, la connaissance de la correspondance lettre-son n'est pas impliquée, l'enfant prend un ou des indices visuels saillants dans le mot, même parfois à côté du mot pour se souvenir de sa prononciation.
- Phase alphabétique partielle : les apprentis lecteurs commencent à étudier la correspondance entre les lettres et leur son, durant cette phase ils arrivent à prononcer le mot en faisant des connexions alphabétiques partielles, ils utilisent souvent la première et la dernière lettre pour se souvenir du mot à prononcer. Elle appelle cela les indices phonologiques, étant dans le début de l'apprentissage de la correspondance graphème/phonème, les apprentis lecteurs privilégient les lettres dont le nom contient le son. Les indices phonologiques sont préférés aux

visuels car ils peuvent être transposés à différents mots et dans différentes polices.

- Phase alphabétique complète : dans cette phase, les apprentis lecteurs qui ont compris la conversion graphème/phonème font la transcription complète du mot. Cela permet d'être plus précis, car au stade précédent des erreurs pouvaient encore être commises, les règles de conversion n'étant pas toutes connues. A ce stade, ils peuvent également lire des mots qu'ils n'ont jamais vus auparavant.
- Phase de consolidation alphabétique : c'est la phase orthographique de la théorie d'Uta Frith. Le nom a été modifié car jugé trop général et ambigu. Les mots ne sont plus traités lettre par lettre mais dans des unités beaucoup plus larges. Les mots sont analysés dans leur ensemble.

Ces 2 modèles divisés sont organisés de manière séquentielle, l'enfant passe par les différents stades les uns après les autres. D'autres modèles plus interactifs ont émergé par la suite.

2.3 Seymour théorie à double fondations (1997)

Dans ce modèle on ne parle pas de stade mais de modules au nombre de 5 : les processeurs logographique et alphabétique, la conscience linguistique et les processeurs orthographique et morphographique.

- Dans le processeur logographique « les représentations des mots sont encodées, à partir d'informations partielles ou complètes sur l'identité de certaines lettres » (Word representations are encoded, normally consisting of partial or complete letter identity information). Contrairement au stade logographique du modèle de Firth ce processeur ne prend pas en compte uniquement les indices visuels mais aussi les indices phonologiques.
- Le processeur alphabétique « est fondé sur une connaissance des lettres et de leurs sons équivalents » (The alphabetic process is founded on a knowledge of the letters and their equivalent sounds). Ce processeur peut s'apparenter au stade alphabétique, l'apprenti lecteur encode la correspondance entre les lettres et leurs sons.

Ces 2 processeurs sont considérés par Seymour comme les fondements nécessaires pour l'apprentissage de la lecture, mais ils peuvent intervenir également plus tard.

- La conscience linguistique se développe avec l'apprentissage de la lecture et permet de mettre en relation des unités phonologiques avec des unités orthographiques. Elle est en interaction avec le processeur alphabétique et permet aux apprentis lecteurs d'acquérir une connaissance plus approfondie de la correspondance graphème/phonème.
- Le développement de la conscience linguistique permet le déploiement et l'enrichissement du processeur orthographique qui « est vu comme une structure qui encode une connaissance généralisée du système de correspondance avec les caractéristiques spécifiques des mots » (This is viewed as a structure that encodes a generalized knowledge of the correspondence knowledge together with word specific features). Ce processeur en interaction avec le processeur logographique et alphabétique permet d'encoder des unités plus larges que la lettre que sont les syllabes et ainsi amener l'apprenti lecteur à une lecture experte sans passer par la conversion fastidieuse graphème/phonème.
- Enfin, il y a le processeur morphographique qui peut être vu comme une structure qui recense les différentes syllabes et leurs combinaisons (i.e mots) ("This might be thought of as (...) a structure that references syllabic entities and their combinations"). Il permet d'encoder la structure morphologique de mots entiers ce que ne peut faire le processeur orthographique qui ne peut encoder que des syllabes voir des bi-syllabes. Ce processeur est dépendant du processeur orthographique et en interaction avec le processeur logographique. Il peut s'apparenter au stade orthographique du modèle d'Uta Frith.

2.4 Le modèle multitraces (Ans et al., 1998)

Ce modèle général de la lecture (pas spécifique à son apprentissage) est établi sur la langue française. Ce modèle postule qu'il y a 2 méthodes de lecture dans un même réseau, une globale et une analytique. Il est décrit comme un réseau de 4 couches interconnectées :

- O1 : couche orthographique d'entrée
- O2 : couche orthographique de sortie
- P : couche phonologique
- ME : couche de mémoire épisodique

Il distingue aussi 2 phases :

- Une d'apprentissage dans laquelle les mots sont encodés, les nouveaux mots rencontrés sont encodé dans la couche O1 et P et leur association est quant à elle encodé sur une unité de la couche ME. Cette couche est contexte dépendant donc si le même mot est rencontré dans un autre contexte il sera de nouveau encodé.
- Une de rappel, la couche O1 active plusieurs unité de ME en comparant leur similarité, l'activation des unités de ME va permettre de générer une réponse phonologique dans la couche P et orthographique dans la couche O2.

Ce modèle intègre une composante visuo-attentionnelle : la fenêtre visuo attentionnelle (FVA). Elle joue un rôle au niveau de O1 et permet de contrôler la quantité d'information qui sera traité par le modèle. Lors de la lecture la fenêtre cadrera sur le mot en entier, s'il y a génération d'un pattern orthographique de sortie identique à celui d'entrée le mot sera correctement lu et le pattern phonologique associé sera accepté. C'est une lecture globale dans laquelle le mot est traité en une fois dans son ensemble. Par contre s'il n'y a pas de correspondance entre O1 et O2 pour le mot en entier, la lecture va passer en mode analytique, la FVA va se réduire pour se focaliser que sur quelques lettres à la fois. Elle va ainsi scanner le mot unité sous lexicale par unité sous lexicale en générant à chaque fois une réponse phonologique qui devra être maintenue dans la mémoire de travail phonologique afin de pouvoir prononcer le mot final.

Dans ce modèle on peut donc voir que la phase d'apprentissage est importante pour qu'une lecture efficace puisse se mettre en place par la suite. La composante visuo attentionnelle joue un rôle important. Si un enfant à des difficultés pour traiter simultanément un grand nombre de lettres il va être très difficile pour lui d'encoder les mots entiers et il sera obligé de les segmenter ce qui à terme en phase de rappel ne lui permettra pas d'utiliser la procédure globale comme uniquement des petites unités de lettres ont pu être encodées. Ce modèle permet de comprendre comment un EVA faible (où peu de lettres peuvent être traitées simultanément, cf partie 1) peut mener à une dyslexie. Mais aussi les déficits phonologiques car si les correspondances entre les patterns ne sont pas correctement encodées dès l'apprentissage à cause du déficit phonologique la phase de rappel se fera sur de mauvais patterns qui induiront des erreurs.

Ces théories se différencient sur plusieurs aspects, plus d'étapes, des interactions différentes entre les différents processus. Cependant on peut remarquer qu'il y a une constante c'est le traitement visuel qui se fait en premier accompagné d'un traitement phonologique (processeurs logographiques et alphabétiques du modèle de Seymour ainsi que la phase d'apprentissage du modèle multi trace) ou non (stade logographique de Frith ou pré-alphabétique d'Erhi).

On peut donc considérer que pour bien lire et acquérir les correspondances graphème/phonème il est indispensable de traiter correctement les lettres, leur caractéristiques, leurs positions relatives dans le mot.

Le chapitre suivant va donc aborder le traitement visuel dans son ensemble et par la suite plus spécifiquement le traitement des lettres, des mots et des textes écrits.

Partie 3 : De la perception à l'analyse visuelle

3.1 De l'environnement au cortex visuel primaire : réception de l'information

L'œil est l'organe de la vision, la lumière de notre environnement traverse ses différents milieux, la cornée (rôle de réfracteur), l'humeur aqueuse, le cristallin (2^{ème} réfracteur qui peut modifier sa courbure afin que les rayons converge correctement et de former une image nette sur la rétine), l'humeur vitrée, et enfin arriver à la rétine.

La rétine est la membrane nerveuse qui tapisse le fond de l'œil, la lumière est captée par 2 types de photorécepteur :

- *les cônes* sont principalement présents au centre de la rétine (appelée fovéa). Leur nombre décroît ensuite en périphérie, ils interviennent dans la vision des couleurs et la vision fine

- *les bâtonnets* sont absents de la fovéa mais présents en périphérie. Ils sont activés lorsque la luminosité est faible et ne permettent pas la vision des couleurs.

Ensuite les photorécepteurs transforment l'influx lumineux en influx nerveux qui se propage dans les différentes couches de la rétine par le biais des cellules bipolaires qui projettent ensuite sur les cellules ganglionnaires (le message peut être modulé par les cellules amacrines et horizontales). Il existe plusieurs types de cellules ganglionnaires, les cellules ganglionnaires naines qui reçoivent l'information de cônes exclusivement, et les cellules ganglionnaires en parasol qui reçoivent l'information de cônes et de bâtonnets. Les axones des cellules ganglionnaires se rejoignent et forment le nerf optique qui va poursuivre sa route via le chiasma optique (structure situé sous l'encéphale), c'est le lieu où se fait la décussation (les axones qui ont captés les informations de l'hémichamp droit vont aller à gauche et ceux qui ont capté les informations de l'hémichamp gauche vont aller à droite). Les axones du nerf optique une fois dépassés le chiasma optique vont se projeter sur les neurones des corps genouillés latéraux des thalamus (un dans chaque hémisphère cérébral). C'est à ce moment qu'il y a une différenciation des voies magnocellulaire et parvocellulaire. Les cellules

ganglionnaires naines vont former la voie parvocellulaire et les cellules ganglionnaires en parasol vont former la voie magnocellulaire. Les neurones vont ensuite via les radiations optiques se projeter dans le cortex visuel primaire situé dans le lobe occipital à l'arrière du cortex. L'hémisphère droit reçoit les informations du champ visuel gauche et l'hémisphère gauche reçoit les informations du champ visuel droit.

L'information « brute » reçue par le cortex visuel primaire va ensuite être traitée par différentes structures.

3.2 Du cortex visuel primaire aux structures secondaires : traitement de l'information

Grâce à l'étude de patients ayant des lésions focalisées de certaines zones du cortex il a pu être mis en évidence qu'il y avait plusieurs voies visuelles qui se chargeaient du traitement de l'information.

3.2.1 Les voies visuelles

3.2.1.1 La voie ventrale

Voie occipito-temporale, comme son nom l'indique elle part de V1 et se termine dans le cortex temporal inférieur (figure 4). Elle reçoit des informations de la voie parvocellulaire ainsi que de la magnocellulaire (Ferrera et al., 1994). Grâce à l'étude de patients présentant des agnosies visuelles suite à des lésions focales de cette voie on a pu mettre en évidence que des zones cérébrales spécifiques sont attribuées à différents niveaux de traitement comme la reconnaissance de la couleur (Meadows, 1974), celle des visages (Barton, 2003). On la nomme donc également la voie du « Quoi ? » (Ungerleider & Mishkin, 1982) car elle est dédiée à la reconnaissance visuelle (identification de l'objet ou du stimulus et de son rôle ou de son utilisation).

3.2.1.2 La voie dorsale

Voie occipito-pariétale, qui part également de V1 et se termine au niveau du lobe pariétal postérieur (figure 4). Des lésions de cette région chez le macaque entraînent des difficultés visuo spatiales, incapacités à traiter le positionnement d'un objet dans l'espace ou par rapport à un autre objet (Pohl, 1973), Ungerleider et Mishkin en 1982 l'ont donc nommée la voie du « Où ? » par opposition à la voie ventrale du « Quoi ? ».

En 1992 une autre théorie émerge qui se base sur l'objectif du sujet lors du traitement, la voie dorsale aurait pour but une action (pointer, attraper...), ce serait la perception pour l'action au contraire de la voie ventrale qui serait la perception pour la vision. La voie dorsale est donc également nommée la voie du « Comment ? » (Goodale & Milner, 1992). Les 2 voies auraient des échelles temporelles différentes, la voie ventrale permettrait la reconnaissance de l'objet en tout temps en mémorisant les caractéristiques ce qui permet de le reconnaître même avec un point de vue différent, alors que la voie dorsale agirait en temps réel pour permettre à l'action de bien se dérouler et de s'adapter si il y a un changement.

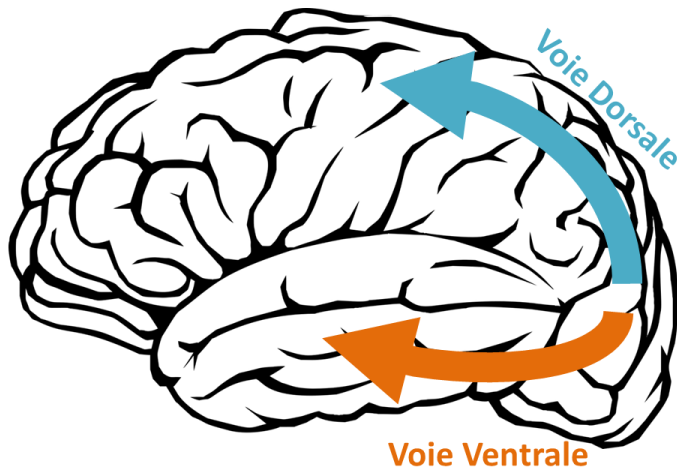

Figure 4 - Les voies visuelles corticales. La voie ventrale (orange) et la voie dorsale (bleu).

3.2.1.3 Interactions entre ces deux voies

Au départ, ces 2 voies sont décrites comme étant indépendantes et agissant en parallèle dans le traitement de l'information visuelle. Cependant, des études d'une patiente DF avec des lésions spécifiques de la voie ventrale et souffrant d'agnosie visuelle des formes (incapacité de reconnaître visuellement des formes simples) ont montré qu'il pouvait y avoir une interaction entre ces deux voies visuelles. En effet, lorsqu'on lui demandait d'attraper un objet elle était tout à fait capable d'orienter correctement sa main en fonction des caractéristiques de l'objet (taille, forme, orientation). Si un délai variable entre la présentation de l'objet et le début du mouvement était introduit (on montrait l'objet, on le retirait puis on lui demandait de l'attraper comme s'il était encore présent) elle n'était plus capable de faire le bon geste lorsque ce délai dépassait 2 secondes alors que les sujets contrôles en étaient capable et ceci même après un délai de 30 secondes. Ce résultat suggère qu'il existe une interaction

entre la voie dorsale qui a encodé les caractéristiques métriques de l'objet suffisantes au guidage du geste immédiat et la voie ventrale qui va coder les caractéristiques de l'objet de façon plus durable et permettre l'exécution d'un mouvement alors que l'objet n'est plus visible (Goodale et al., 1994). De plus, lors d'une autre tâche dans laquelle cette patiente DF devait attraper un objet avec des inclinaisons différentes, sa performance était comparable à celle des contrôles en vision binoculaire, par contre en vision monoculaire qui nécessite l'accès à des indices perceptifs assurés par la voie ventrale elle n'était pas capable d'orienter correctement sa main au contraire des contrôles. Ce résultat est donc également une preuve de l'existence d'un lien ventro-dorsal (Dijkerman et al., 1996).

L'interaction entre ces deux voies a également été montrée lorsqu'on lui demandait d'attraper un objet de la vie courante avec pour but de s'en servir, la patiente DF l'attrapait correctement d'un point de vue strictement physique (ouverture et orientation de la main correctes) mais ce n'était pas forcément fonctionnel (Carey et al., 1996). On sait que la voie ventrale traite le caractère sémantique de l'objet qui dépend de sa reconnaissance visuelle, or à cause de sa lésion elle est dans l'incapacité de le faire et commets donc des erreurs de préhension « fonctionnelle ». A l'inverse, la préhension d'une patiente avec lésion de la voie dorsale (patiente AT) était améliorée quand il s'agissait de saisir des objets de la vie quotidienne (Jeannerod et al., 1994).

L'interaction entre ces 2 voies semble donc bien exister surtout lors de tâches complexes. Dans le cadre de cette thèse nous nous sommes penchés sur le traitement spécifique de ces deux voies et leur interaction lors de la lecture, et surtout au moment de son apprentissage.

3.2.2 Structures cérébrales visuelles liées à la lecture ou à son apprentissage

La lecture n'est pas innée et nécessite un apprentissage, il n'y a pas à la naissance une structure cérébrale dédiée à la lecture. Dehaene et Cohen ont émis l'hypothèse en 2007 qu'il y avait, sous l'influence de l'apprentissage, un recyclage de certaines zones cérébrales qui vont devenir spécifiques à certains domaines comme la lecture ou l'arithmétique.

3.2.2.1 La visual word form area (VWFA)

Cette aire dédiée à la reconnaissance visuelle de la forme des mots écrits a été identifiée dans la voie ventrale. Elle est située dans l'aire occipito-temporale ventrale de l'hémisphère gauche (Cohen et al., 2000) (figure 4). Cette région serait au départ dévolue à la reconnaissance d'objet ou de visage et se spécialise lors de l'apprentissage de la lecture à la reconnaissance spécifique de la forme visuelle des mots (Cohen & Dehaene, 2004; Saygin et al., 2016). Ceci chez les enfants scolarisés mais également chez les adultes qui apprennent à lire tard (Dehaene et al., 2010). Cette région est à l'interface de la vision et du langage, en effet, ses connexions avec le réseau fronto-pariétal gauche (qui inclus les aires de Broca et Wernicke) augmentent avec l'apprentissage de la lecture pendant que ses connexions avec le réseau visuel latéral (réseau occipito-parieto-temporal qui regroupe les aires visuelles associatives) diminuent (López-Barroso et al., 2020). Les auteurs suggèrent donc que le VWFA est une structure qui fait le lien entre la vision et le langage, processus essentiel de la lecture, et que c'est l'interaction avec le réseau visuel latéral et en particulier le cortex pariétal postérieur (CPP) qui permet la spécialisation de la VWFA au début de l'apprentissage de la lecture. En effet, la connectivité entre ces 2 structures corrèle avec l'amélioration de la lecture pendant la première année d'apprentissage (Moulton et al., 2019). On peut suggérer que le traitement de l'information visuelle opéré par la voie dorsale et plus particulièrement le CPP permet à la VWFA de se spécialiser pour le langage écrit au sein de la voie ventrale.

Mais quel est le rôle du CPP ?

3.2.2.2 Le cortex pariétal postérieur (CPP)

Le CPP est situé dans la voie dorsale (figure 4 et 5), c'est un cortex associatif, qui permet une intégration sensori-motrice afin d'assurer le contrôle des mouvements volontaires (pointer, attraper...). Mais il est également impliqué dans l'attention. Son rôle a pu être mis en évidence grâce à l'étude de patients ayant une lésion bilatérale de cette région. Le premier cas a été décrit au début du XXe siècle par Balint (1909), il souffrait de 3 symptômes :

- Ataxie optique : incapacité de réaliser des mouvements visuo guidés surtout en vision périphérique.

- Réduction très importante de champ visuo attentionnel faisant qu'il n'était capable de traiter visuellement qu'un élément à la fois (simultagnosie)
- troubles de l'attention visuelle, latéralisés ou non, qui affectent le repérage (et la localisation) de cibles visuelles en périphérie, qui est maintenant considéré comme un trouble oculomoteur spécifique des saccades visuellement-guidées (apraxie oculomotrice).

Cette triade nous décrit bien le caractère intégratif sensori-moteur du CPP, car après une lésion les mouvements visuo guidés sont imprécis, mais également son rôle dans l'attention visuelle.

Une lésion unilatérale du CPP dans l'hémisphère droit produit une hémiparésie gauche (le patient ne prend pas en compte son champ visuel gauche mais aussi la partie gauche de son corps). Une lésion unilatérale du CPP dans l'hémisphère gauche produit le syndrome de Gerstmann qui comprend une désorientation droite gauche, une agnosie digitale et une apraxie d'utilisation d'objets. La désorientation droite gauche (trouble visuo-spatial) me semble importante à mentionner dans le cadre de la dyslexie (et en particulier des lettres miroir).

Dans cette thèse, nous allons nous attarder sur le rôle du CPP dans l'attention visuelle et le traitement visuo spatial car ce sont des éléments important lors de l'apprentissage de la lecture. En effet pour bien traiter les lettres il faut pouvoir combiner spatialement leurs différents traits et traiter correctement leur orientation spatiale. Pour les mots il faut être capable de déployer correctement son attention pour pouvoir ordonner les lettres et en avoir une vision globale simultanée. Enfin il faut être capable de déplacer cette attention de mots en mots pour obtenir une lecture fluide (Vidyasagar, 1999). On peut penser que lors de l'apprentissage de la lecture, les mots que l'on rencontre sont pour la plus part nouveau, la voie dorsale doit donc traiter correctement les lettres et leur ordre dans le mot qui pourra ensuite être encodé dans la VWFA.

Ce traitement nécessite l'analyse simultanée de plusieurs caractères qui est assurée, comme vu dans le chapitre de la dyslexie, par le lobule pariétal supérieur.

3.2.2.3 Lobule pariétal supérieur (LPS)

On a vu précédemment qu'une lésion bilatérale du CPP provoquait, parmi d'autres symptômes, une simultanagnosie (Wolpert, 1924). Des études plus récentes ont permis de spécifier la région du CPP impliqué dans le traitement simultané de plusieurs éléments grâce à l'étude de patient ayant une lésion plus focale : c'est le lobule pariétal supérieur (LPS) (figure 5). En effet, une patiente avec une lésion bilatérale du LPS présentait initialement une simultanagnosie qui a régressé avec le temps. Cependant elle présente encore des difficultés dans certaines tâches, par exemple lors d'une tâche de recherche visuelle lorsque les stimuli étaient constitués de combinaisons de traits elle avait une réduction de son champ visuo attentionnel par rapport à des sujets contrôles et ceci peu importe le nombre d'élément qui tombaient dans cette fenêtre. Par contre lorsque les stimuli étaient des formes pleines elle avait un temps de réponse comparable aux sujets sains. Le LPS semble donc être impliqué dans l'intégration spatiale intra objet (Khan et al., 2016). Cette intégration demande de grandes ressources attentionnelles et donc diminue la fenêtre visuo attentionnelle. Dans le cadre de la dyslexie il a été montré (cf partie1) que certains enfants avaient un dysfonctionnement de cette zone cérébrale ce qui a pour conséquence qu'ils n'arrivent pas à traiter plusieurs lettres simultanément, les mots ne peuvent donc pas être traités de manière globale ce qui pourrait empêcher de les encoder dans la VWFA.

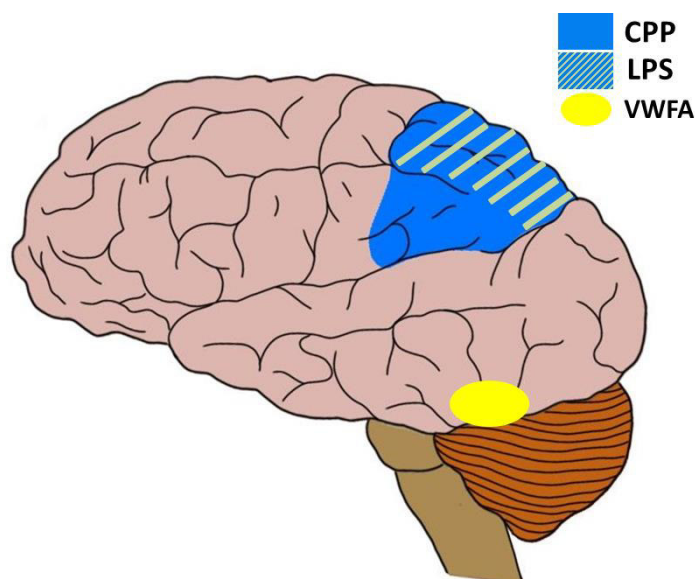

Figure 5 - Structures visuelles liées à la lecture et son apprentissage. Le cortex pariétal postérieur (bleu), le lobule pariétal supérieur (hachuré jaune) et la visual word form area (jaune)

Dans l'étude de Khan et al (2016), ce n'est pas une réduction du nombre d'élément qu'elle peut traiter en une fixation qui est retrouvé mais une réduction de la surface qu'elle peut traiter, car peu importe le nombre de distracteurs le rétrécissement du champ visuo attentionnel est le même. Or lorsque l'on parle de dysfonctionnement du LPS chez les enfants dyslexiques les chercheurs penchent plus pour un problème de traitement simultané de plusieurs éléments (lorsque ceux-ci sont constitués de plusieurs traits à l'instar des lettres) (Bosse et al., 2007; Peyrin et al., 2011; Valdois et al., 2012a). La différence entre ces études est que lors des tâches de recherche chez la patiente avec lésion les distracteurs étaient tous identiques alors que lors des tâches chez les dyslexiques les éléments étaient différents comme lors de la lecture. Il semblerait que les distracteurs identiques peuvent être visuellement groupés par cette patiente mais dans un espace plus restreint que pour les contrôles. Ce « groupement visuel » se retrouve dans une étude de 1959 dans laquelle l'auteur a observé qu'un patient avec lésion du LPS plus de facilité à rapporter les 2 formes présentées simultanément lorsqu'elles étaient identiques alors qu'il n'en rapportait qu'une quand elles étaient différentes (Luria, 1959). Malgré les lésions du LPS il semble donc possible de regrouper les mêmes éléments afin de faciliter l'analyse mais avec quand même une limite spatiale observée avec le rétrécissement de la fenêtre visuo attentionnelle et ce d'autant plus lorsque les stimuli sont complexes (avec plus de combinaisons de traits) (Khan et al., 2016).

Étude 3

L'objectif de la troisième étude est d'étudier le traitement visuo attentionnel lors de différentes tâches de recherche visuelle (distracteurs identiques ou non, composés de combinaisons de traits ou non) chez des sujets sains et chez une patiente avec lésion bilatérale du LPS et ainsi étudier plus précisément le rôle du LPS dans le traitement simultané. Dans quelles conditions traite-t-on une surface (une fenêtre spatiale limitée), et dans quelles conditions traite-t-on un nombre d'élément (un empan limité)? Une lésion du LPS a-t-elle des répercussions sur ce traitement ?

Cette réduction de la fenêtre attentionnelle dans certaines conditions après lésion du LPS nous interroge sur le traitement visuel de la vision périphérique chez ces patients. Une étude a montré que lors d'une tâche de pointage des patients avec une lésion du CPP faisaient des erreurs en vision périphérique dans le champ opposé à leur lésion et dirigées vers le point de fixation. Les erreurs de pointage étaient de plus en plus importantes en fonction de l'excentricité et il a été modélisé que le pattern d'erreur correspondait à la magnification corticale au niveau du cortex visuel primaire (Vindras et al., 2016). La magnification corticale du système visuel (figure 6) est due au fait qu'il y a plus de neurones qui traitent 1° en vision centrale qu'1° en vision périphérique. Donc en observant que la modélisation des erreurs de pointage reproduisent la magnification corticale les auteurs proposent que le CPP permet de compenser la sous-représentation de la vision périphérique dans le cortex visuel. Les patients avec lésions ne peuvent donc pas compenser la magnification et auraient donc une compression de leur champ visuel due à la sous-représentation corticale de la vision périphérique.

Retinotopic Organization

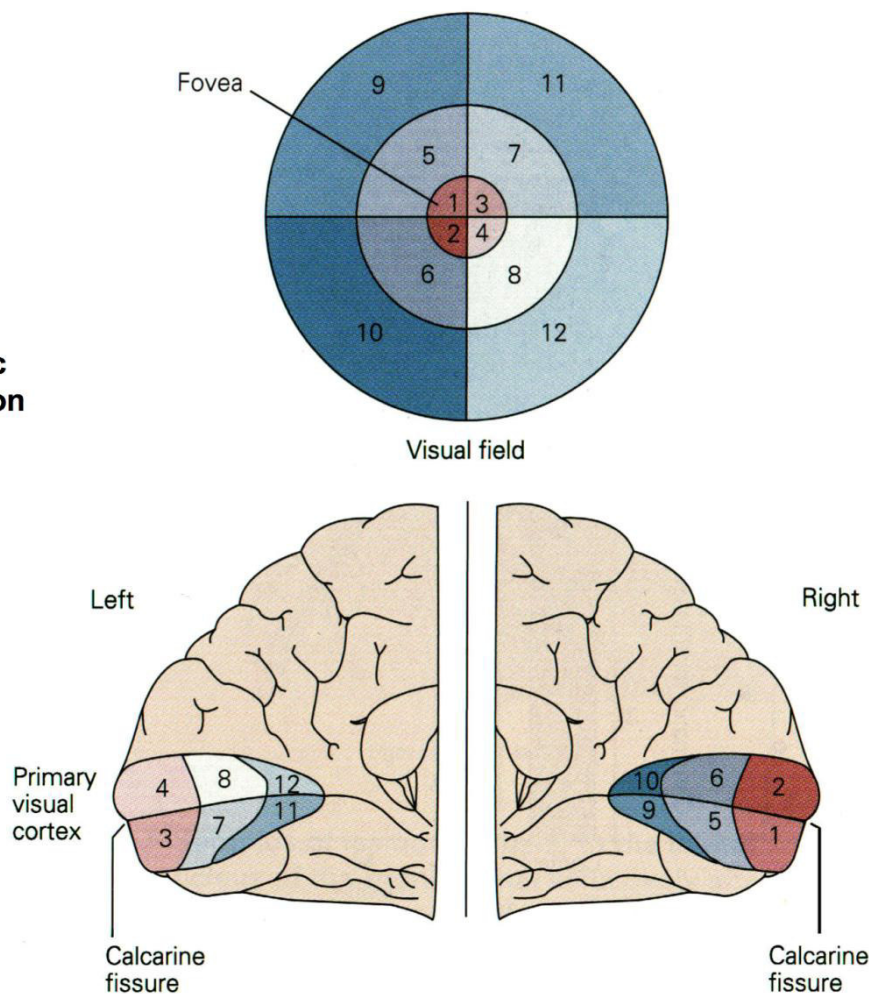

Figure 6 – Magnification corticale. Organisation de la rétine en haut et projection dans le cortex visuel primaire (V1) en bas. Il y a une surreprésentation de la vision centrale aux dépens de la vision périphérique dans V1

Source : Jaygandhi786 (2015). Visual Cortex. Available online at: https://commons.wikimedia.org/wiki/User:OgreBot/Uploads_by_new_users/2015_May_02_15:00 (Accessed Aug 29, 2017).

Mais les tâches utilisées sont visuo motrices or la lecture est une activité qui ne demande pas d'action visuo motrice. On s'est donc intéressé à une tâche perceptive pour étudier le rôle du LPS dans le traitement de la vision périphérique en utilisant une tâche bien connue dans laquelle le sujet doit reconnaître un élément entouré de 2 autres (l'excentricité de l'élément central et l'espacement entre les éléments peut être contrôlé).

3.2.3 Le phénomène de crowding

Lors de la tâche décrite précédemment (identification d'un élément entouré de 2 autres en vision périphérique) on observe un phénomène particulier, le crowding. Nous avons déjà succinctement abordé le sujet dans la partie sur la dyslexie mais il sera plus développé dans ce paragraphe.

Ce phénomène est décrit à partir des années 70, on peut le traduire par encombrement. C'est le fait qu'en vision périphérique on est dans l'incapacité d'identifier un élément entouré de 2 autres (appelés flankers) si ils ne sont pas à une certaine distance (distance critique) alors que la reconnaissance de cet élément présenté isolément reste correcte (Bouma, 1970) (figure 7).

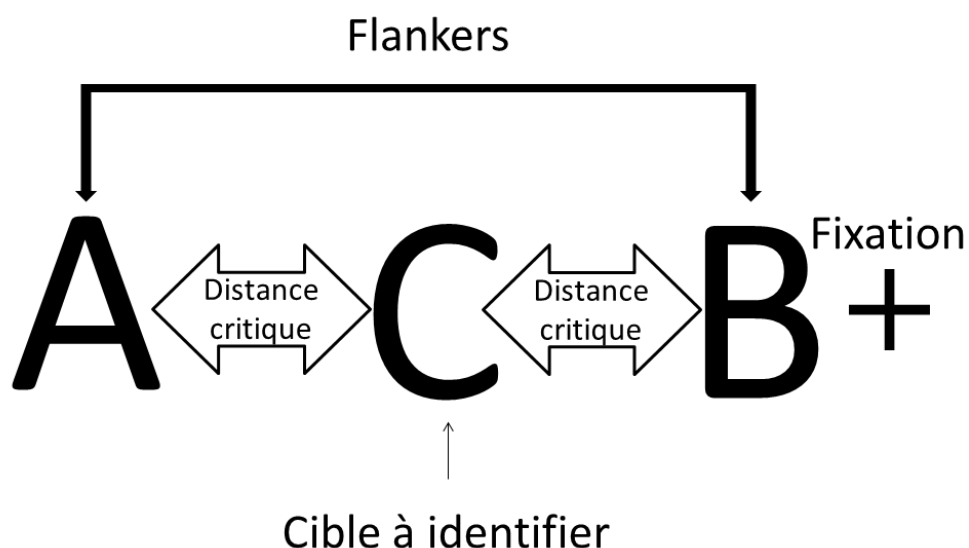

Figure 7 - Schéma représentant une tâche classique permettant de mettre en évidence le phénomène de crowding. Le sujet fixe la croix à droite et il doit reconnaître le C qui est entouré de A et B qui sont les flankers. La distance entre le C et les flankers est appelée la distance critique.

Ce n'est donc pas un problème de résolution de la vision périphérique. La distance critique est donc la distance minimale qu'il doit y avoir entre l'élément central et les flankers pour permettre la reconnaissance de celui-ci. Le crowding ne doit pas être confondu avec d'autre phénomène comme l'inhibition latérale (qui intervient au niveau de la rétine (Wilson, 2009) , le masquage (présentation d'un masque avant ou après le stimulus), ou la « surround suppression ». Whitney & Levi (2011) ont dans leur revue décrit 6 critères pour pouvoir parler de crowding :

- déficit d'identification et pas de détection (le sujet voit le stimulus mais ne peut pas l'identifier).
- les éléments sont perçus mais indistinctement ou mélangés entre eux.
- l'espacement critique augmente de façon linéaire avec l'excentricité (Bouma, 1970).
- Il y a une anisotropie, les flankers alignés entre le stimulus et le point de fixation ont plus d'effet que s'ils sont disposés tangentiellement (Toet & Levi, 1992).
- Asymétrie des flankers, lorsqu'il y a un seul flanker celui-ci n'a pas le même poids s'il est placé entre le stimulus et le point de fixation ou après le stimulus. La distance critique sera plus importante dans le premier cas (Bouma, 1970).
- Accord temporel : le crowding est plus important quand les flankers et le stimulus sont présentés en même temps et diminue drastiquement lorsqu'il y a un délai de présentation (Huckauf & Heller, 2004).

Le crowding n'est donc pas seulement dépendant de la résolution rétinienne, une autre structure semble être impliquée dans ce phénomène, le cortex pariétal. Une récente étude a montré une modification de l'effet de crowding lors d'une stimulation du cortex pariétal. Une stimulation électrique de 18Hz du cortex pariétal permet la diminution de la distance critique dans le champ visuel opposé à la stimulation alors qu'une stimulation « sham » (placebo) n'a aucun effet (Battaglini et al., 2020). Cette étude ainsi que l'augmentation linéaire de la distance critique peuvent apporter une preuve supplémentaire du rôle que joue le cortex pariétal sur la « remagnification » du cortex visuel et ceci même lors d'une tâche perceptive sans aspect moteur.

Comme vu dans la partie dyslexie, le crowding ne doit pas être confondu avec le champ visuel et le champ visuo attentionnel. Dans cette première partie, on a également vu que certains dyslexiques présentaient un dysfonctionnement du LPS dans une tâche

de traitement simultané et qu'un crowding excessif pouvait être décrit chez des dyslexiques. Nous avons aussi vu qu'il pouvait avoir un effet de crowding dans la lecture et que l'espacement des lettres améliorerait la vitesse de lecture des dyslexiques.

Étude 4

Une tâche évaluant le phénomène crowding semble être un bon moyen pour comprendre comment sont traités plusieurs éléments simultanément en vision périphérique. Avec le paradigme de la fenêtre mobile on a pu voir que le traitement d'une information pertinente en vision périphérique influe sur la vitesse de lecture (McConkie & Rayner, 1975). Le sujet doit pouvoir analyser correctement et simultanément plusieurs caractères au-delà de son point de fixation pour avoir une lecture efficiente. Ci-dessus on a vu que le cortex pariétal semblait jouer un rôle dans la modulation de ce phénomène de crowding. L'objectif de cette 4^e étude est donc de mieux comprendre le rôle du LPS dans la perception visuelle simultanée grâce à des tâches qui expérimentent ce phénomène chez une patiente avec lésion du LPS.

II

Contributions Expérimentales

Étude 1



Prévalence de déficit de la perception visuo spatiale
élémentaire dans les troubles neurodéveloppementaux

Prevalence of elementary visuo-spatial perception deficit
in children with neurodevelopmental disorders

Pisella L, **Vialatte A**, Martel M, Prost-Lefebvre M, Chatelus D, Caton C,
Stalder M, Yssad R, Roy A.C., Vuillerot C, Gonzalez-Monge S.

DMCN In press

Elementary visuospatial perception deficit in children with neurodevelopmental disorders

LAURE PISELLA¹  | AUDREY VIALATTE¹ | MARIE MARTEL² | MYRIAM PROST-LEFEBVRE³ | MARIE-CLÉMENCE CATON¹ | MÉLANIE STALDER¹ | ROSA YSSAD¹ | ALICE C ROY² | CAROLE VUILLEROT⁴  | SIBYLLE GONZALEZ-MONGE⁴

1 Centre de Recherche en Neurosciences de Lyon (CRNL), University de Lyon, Bron; **2** Laboratoire Dynamique du Langage, Université de Lyon, Lyon; **3** Hospices Civils de Lyon, Service de NeuroOphtalmologie, Bron; **4** Hospices Civils de Lyon, Hôpital Femme-Mère-Enfant, Service de Rééducation Pédiatrique, Bron, France.

Correspondence to Laure Pisella, Centre de Recherche en Neurosciences de Lyon (CRNL), Inserm U1028, CNRS UMR 5292, Université de Lyon, Bron, France. E-mail: laure.pisella@inserm.fr

PUBLICATION DATA

Accepted for publication 22nd October 2020.

Published online

ABBREVIATIONS

DCD	Developmental coordination disorder
EVSP	Elementary visuospatial perception
SLD	Specific learning disorder

AIM To assess the prevalence of elementary visuospatial perception (EVSP) deficit in children with neurodevelopmental disorders.

METHOD Using a screening test designed and validated to measure dorsal EVSP ability, 168 children (122 males, 46 females; mean age 10y [SD 1y 10mo], range 4y 8mo–16y 4mo) diagnosed with developmental coordination disorder (DCD), specific learning disorder (SLD), attention-deficit/hyperactivity disorder (ADHD), and/or oral language disorder were compared with a group of 184 typically developing children. We also tested 14 children with binocular vision dysfunction and no neurodevelopmental disorder.

RESULTS Children with SLD scored below the interquartile range of typically developing children as frequently (59%) as children with DCD, but only 5% were severely impaired (i.e. scored as outliers). Children with DCD were the most severely impaired (22% of outliers), even more so when they exhibited a co-occurring disorder. Children with language disorder and those with binocular vision dysfunction scored similarly to the group of typically developing children.

INTERPRETATION These results confirm the importance of assessing EVSP in the clinical evaluation of children with neurodevelopmental disorders, in particular those presenting with DCD or SLD.

Elementary visuospatial perception (EVSP) involves distinguishing, through vision, the relative position of objects in the environment, as well as their spatial metrics (size, length, and angle). It consists of collecting, overtly or covertly, different ‘snapshots’ in multiple reference frames and integrating them as an accurate conscious representation of surrounding space. Therefore, it implies spatial working memory processes.¹ EVSP is usually evaluated in clinical paediatric routine using a combination of multiple and sometimes non-specific tests. Therefore, we designed and validated a screening test lasting only 15 minutes and involving no motor manual response, visual gnosis, or language.^{2,3}

EVSP is ‘elementary’ in the sense that it contributes to the development of other cognitive and visuomotor functions; however, it overpasses the primary visual areas and relies on the middle occipital gyri (occipital score) and the posterior parietal cortex (parietal score) pertaining to the dorsal visual stream (see, in Pisella et al.,² the impaired performance of two patients with occipito-parietal damage as well as the full literature subserving this claim; see also reviews^{1,4,5} challenging the dual stream theory that

postulates that the dorsal visual stream is not involved in conscious visual perception). Atkinson and Braddick⁶ have proposed a ‘dorsal-stream vulnerability’ in many conditions of abnormal human development in relation to spatial cognition, attention, and planning of actions.

Meta-analyses have identified visuospatial processing as a major deficit in the population with developmental coordination disorder (DCD),^{7,8} whether visuospatial processing is assessed with or without temporal constraint, by motor or perceptual tasks (e.g. graphic copying skills, visuomotor constructional skills such as Block design, or tests of visual discrimination with responses selected among multiple choice, sometimes with superimposed shapes). In particular, children with DCD have been shown to be less proficient than typically developing children in discriminating shape, area, slope, pattern, line length, and size constancy.^{9,10} They performed poorly even when the motor component of the visual task was removed.^{11–19} The literature has also reported deficits of EVSP in specific learning disorder (SLD), especially in dyslexia^{20–22} and dyscalculia.^{22–25}

In this prospective study, we used our validated screening test³ to evaluate the prevalence of EVSP deficits in 168

children presenting with four categories of neurodevelopmental disorders defined by the the Diagnostic and Statistical Manual of Mental Disorders, Fifth Edition (DSM-5): DCD, SLD, oral language disorder, and/or attention-deficit/hyperactivity disorder (ADHD). Their performance at the EVSP screening test was compared with a population of 184 typically developing children. On the basis of the literature, we expected to find EVSP deficits in children with DCD or SLD but not in children with language disorder. We also tested a comparison group of 14 children with binocular vision dysfunction and no neurodevelopmental disorder to confirm that our screening test targets impairments of cortical visual processing and not of stereopsis, eye alignment, or oculomotor function.

METHOD

Participants

As illustrated in the flowchart (Fig. S1, online supporting information), 497 individuals in total were enrolled in this prospective study of the EVSP screening test. In the present analysis, we excluded a total of 131 individuals who were adult, were born preterm, or presented with cerebral palsy, epilepsy, autism spectrum disorders, or intellectual disability. We ended up with a final database of 366 children whose carers gave their informed written consent for the EVSP screening test. Clinical recruitment was done with approval of the Research Ethic Boards of the University Hospital of Lyon (CPP Sud-Est II, number 2015-54-2) among children coming for out-patient consultation (at the rehabilitation unit Delta01 of the OVE Foundation, at the orthoptist, or at the paediatric rehabilitation unit of the Hospices Civils de Lyon for a potential diagnosis of neurodevelopmental disorder). Typically developing children and several children with neurodevelopmental disorders also came from research recruitment (CPP Sud-Est II, n° 2009-036-AM3-2). The final database included 184 typically developing children; 14 children with no developmental disorder but presenting impaired binocular vision due to oculomotor, stereopsis, and/or eye alignment dysfunction; and 168 children (122 males, 46 females; mean age 10y [SD 1y 10mo], range 4y 8mo–16y 4mo) diagnosed with DCD, SLD, language disorder, and/or ADHD. The diagnoses were established by an interdisciplinary clinical team as defined by DSM-5.²⁶

The EVSP screening test

The EVSP screening test² aims to test EVSP in isolation, namely without involving any complex language, motor, and gnostic function. It comprises six subtests (T1, T2, T3, T4, T5, T6; see Fig. 1), each composed of 12 trials of increasing difficulty. A score of maximum 12 correct answers was computed for each subtest as well as a total score of maximum 72 correct answers. On the basis of the neural substrates found in the literature^{27–30} (see Pisella et al.² for a full account) and on the performance of two patients with slightly different occipito-parietal damage, Pisella et al.² also proposed computing two composite

What this paper adds

- More than half of children with developmental coordination disorder (DCD) scored below the normal interquartile range on the elementary visuospatial perception (EVSP) test.
- More than half of children with specific learning disorder (SLD) scored below the normal interquartile range on the EVSP test.
- Twenty-two percent of children with DCD performed as outliers on the EVSP test.
- Children with language disorder and those with binocular vision dysfunction scored similarly to typically developing children.

scores. The ‘occipital’ score was the sum of the scores at T1 and T2, the two subtests requiring magnitude comparison (with a maximum of 24 correct answers), while the ‘parietal’ score was the sum of the scores at T3, T4, T5, and T6, the four tests requiring spatial integration between an object and a landmark (with a maximum of 48 correct answers).

Testing conditions

The children were comfortably seated in front of a table on which the visual stimuli were presented in turn on cardboard sheets without any time constraints. Each subtest began with two easy training trials for which the experimenter gave the correct responses. The entire test was expected to last no more than 15 minutes, even for young children and those with neurodevelopmental disorder.

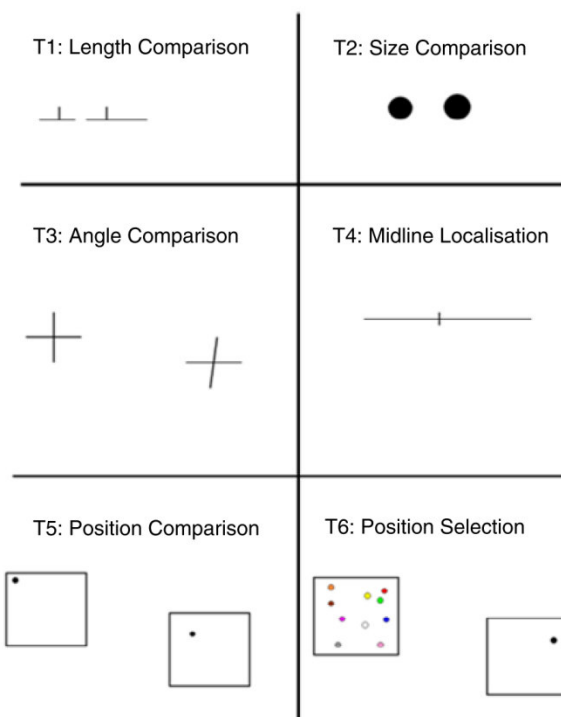

Figure 1: Examples of perceptual comparisons required in each of the six subtests of the elementary visuospatial perception (EVSP) screening test.

Scoring

For each participant, using the 12 binary responses for each trial ('correct' vs 'incorrect'), we first computed the score for each subtest (range 0–12) as well as the total score (best performance: $12 \times 6 = 72$) and the 'occipital' and 'parietal' composite scores (best performance: $2 \times 12 = 24$ and $4 \times 12 = 48$ respectively).²

The scores of individuals from the typically developing group were used to compute the mean and the median (M), the lower and higher limits of the interquartile range (IQR; named Q1 and Q3 respectively) and the lower and higher outlier limits ($OL_sup = Q3 + [1.5 \times IQR]$; $OL_inf = Q1 - [1.5 \times IQR]$) of the normative distributions for each age category.³

Statistical analysis

Statistics were analysed using Statistica software (StatSoft, Inc., Tulsa, OK, USA) in 2019 on a database collected over 9 years. To do statistical analyses with all data independently of age category, the raw scores of individuals were compared with the normative limits of their age category and converted into six scoring classes along the schematic representing the box-and-whiskers as presented in Figure 2.

Prevalence

To evaluate the prevalence of EVSP deficit in each clinical group, we computed the number of individuals in this

group who performed with a score inferior to the lower outlier limit of the scoring distribution of typically developing children of their age category (class 1) and transformed the number into an observed percentage of severely impaired children among a given clinical population. We then performed a statistical comparison of this observed percentage with the percentage of 5% (corresponding to the theoretical percentage of scoring in class 1 in the group of typically developing children on the basis of the definition of the lower outlier limit limit) using an alternative to the χ^2 test for low samples: Fisher's exact test. To specifically test whether the distribution of individuals scoring below the outlier limit was significantly higher than normal in a given group, we used a one-sided statistical comparison.

To test statistically whether the occurrence of low EVSP scores was important in a given clinical group, we also computed the number of individuals in this group who performed with a score inferior to the IQR (Q1) of the scoring distribution of typically developing children of their age category. This number included children scoring in classes 1 or 2 and was also transformed into a percentage that was statistically compared with the percentage of 25% (corresponding to the theoretical percentage of scoring below Q1 in the group of typically developing children on the basis of the definition of the lower IQR limit Q1 using Fisher's exact test). To test whether the distribution of individuals scoring below Q1 was significantly higher

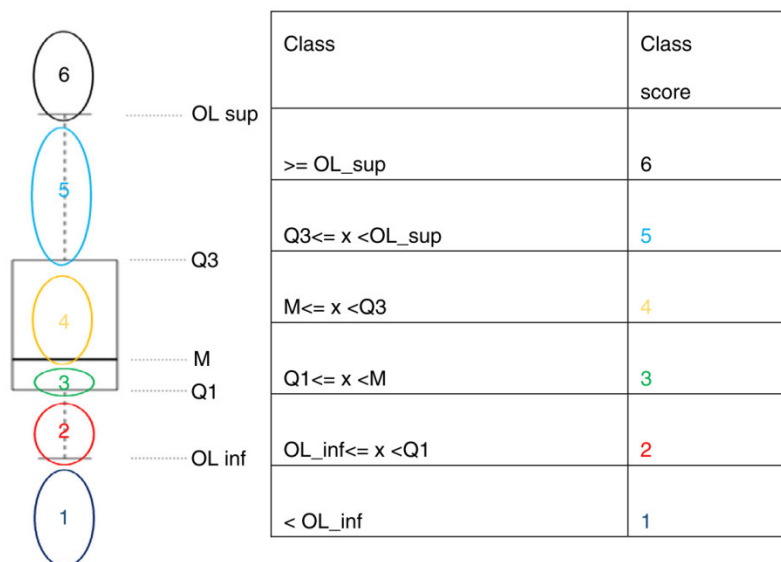

Figure 2: Method of scoring independent of age. The table on the right shows that the raw scores obtained by an individual at the elementary visuospatial perception (EVSP) screening test (x) were compared with the distribution of the typically developing population of the same age category and converted into six class scores. The distribution of typically developing children is schematized as a box-and-whisker plot in the left panel: the 25% of typically developing children scoring the highest are above the higher quartile limit (Q3), the 25% of typically developing children scoring the lowest are below the lower quartile limit (Q1), the 50% of the typically developing population lies in-between, i.e. in the interquartile range represented by the box. The median (M) is included within this box, and the outlier limits are represented by the whiskers (inferior and superior outlier limits: OL_inf and OL_sup respectively).

than normal in a given group, we used a one-sided statistical comparison. The significance threshold was fixed at 5%.

Statistical comparison of EVSP between groups

Given that the EVSP scores increase significantly with age^{2,3} and that our database included children with a large and various age distribution (Fig. S1), we could not perform analysis of variance (ANOVA) and post hoc tests between groups directly comparing the raw total scores. Instead, we were able to undertake Kruskal–Wallis one-way ANOVA and multiple bilateral Mann–Whitney *U* tests corrected for false detection rate to compare the mean class of total scoring between clinical groups, and separately for the occipital and parietal scores.

RESULTS

Description of the non-typically developing children population

The age distribution, sex ratio, and percentage of children needing assistance or specialized schooling observed for each category of clinical diagnosis are presented in Table 1.

The sex ratio of our sample is representative of a population of non-typically developing children with a larger percentage of males for all clinical categories of the DSM-5 (about two males for one female on average, which corresponds to 66% being males).

Prevalence of EVSP deficit in clinical groups

Table 2 presents the number of individuals assessed in each clinical group, and the number of individuals scoring below the lower limit of the IQR of their age category

(<Q1, classes 1 and 2; see Fig. 3), and the number of those among them scoring below the outlier limit (class 1).

A total of 97 children with DCD were enrolled in this prospective study. Among them, 36 presented DCD without comorbidity. Among these children with DCD only, 58% presented a score below the lower quartile (Q1) of their age category (this percentage is significantly different to 25%, $p<0.01$) and 22% presented a clear pathological performance, scoring below the outlier limit of their age category ($p<0.01$). In individuals with DCD and at least one other co-occurring neurodevelopmental disorder, over 57% presented scores below Q1 and over 26% presented scores below the outlier limit, except when DCD was only associated with SLD. In the ‘multidys’ group (defined as presenting with DCD and two or three additional neurodevelopmental disorders), 77% had scores below Q1 ($p<0.01$) and 43% had scores below the outlier limit ($p<0.01$). The presence of DCD is thus specifically associated with a high percentage of pathological performance at the EVSP screening test (below the outlier limit of the same age category).

In the group with SLD only, 59% had scores below Q1 ($p<0.01$). Nevertheless, in contrast to DCD, the scores of SLD children remained above the outlier limit of the typically developing children of the same age category (only 5% of scores below the outlier limit, $p=0.25$).

In our small group of children with ADHD only, 57% scored below Q1 and only two (14%) scored as outliers, both percentages did not reach significance ($p=0.11$ and $p=0.23$ respectively).

Table 1: Demographic information per clinical group

Clinical groups	<i>n</i>	Mean age (range), y:mo	Males (%)	Schooling (% of children needing assistance or specialized schooling)
DCD	36	10:8 (7:5–16:4)	77	65
SLD	37	10:1 (7:6–15:8)	65	13
Oral language disorder	20	8:5 (4:8–11:10)	65	56
ADHD	14	10:10 (7:6–16:2)	64	25
DCD+ADHD	11	9:8 (6:5–15:0)	73	33
DCD+SLD	13	10:2 (7:4–15:11)	61	23
DCD+language disorder	23	9:10 (5:11–15:6)	87	78
Multidys (DCD+more than one comorbidity)	14	9:10 (6:1–12:4)	85	77
Children with binocular vision dysfunction but no developmental disorder	14	9:0 (6:1–16:5)	57	0

DCD, developmental coordination disorder; SLD, specific learning disorder; ADHD, attention-deficit/hyperactivity disorder.

Table 2: Prevalence of elementary visuospatial perception deficit in clinical groups

Groups	<i>n</i> (%) of individuals with a total score below Q1 of the same age category	<i>n</i> (%) of individuals with a total score below the outlier limit of the same age category
DCD	21 (58) ^a	8 (22) ^a
SLD	22 (59) ^a	2 (5)
Language disorder	4 (20)	0
ADHD	8 (57)	2 (14)
DCD+ADHD	8 (73) ^b	4 (36) ^b
DCD+SLD	7 (54)	1 (8)
DCD+language disorder	13 (57) ^a	6 (26) ^b
Multidys (DCD+more than one comorbidity)	10 (77) ^a	6 (43) ^a
Total neurodevelopmental disorders	93 (55) ^a	29 (17) ^a
Children with binocular vision dysfunction but no developmental disorder	5 (36)	2 (14)

The groups comprised 36 individuals with developmental coordination disorder (DCD), 37 with specific learning disorder (SLD), 20 with oral language disorder, 14 with attention-deficit/hyperactivity disorder (ADHD), 11 combining DCD and ADHD, 13 combining DCD and SLD, 23 combining DCD and language disorder, and 14 combining DCD and more than one comorbidity. The prevalence is also displayed for the total group of 168 children presenting with neurodevelopmental disorders and for the group of 14 children with binocular vision dysfunction but no developmental disorder.

^a $p<0.01$, ^b $p<0.05$.

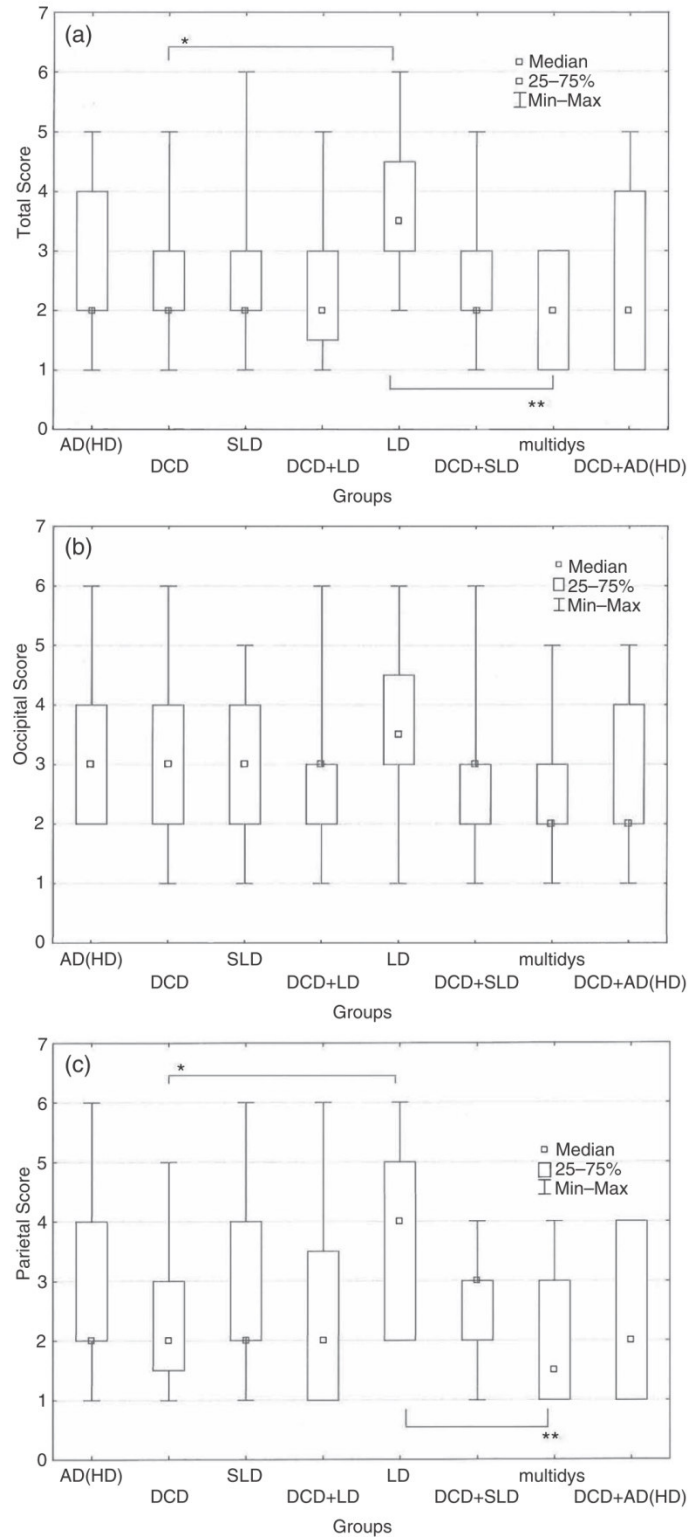

Figure 3: (a) Elementary visuospatial perception (EVSP) minimal and maximal class score (whiskers), median (horizontal line), and interquartile range (box) in the different clinical categories of developmental disorder: developmental coordination disorder (DCD); specific learning disorder (SLD); attention-deficit/hyperactivity disorder (ADHD); oral language disorder (LD). Significant Mann–Whitney *U* test comparisons between groups are mentioned (* $p < 0.05$, ** $p < 0.01$). (b) Same box-whisker graph and statistics for the ‘occipital’ sub_score (sum of T1 and T2). (c) Same box-and-whisker graph and statistics for the ‘parietal’ sub_score (sum of T3, T4, T5, and T6).

In the group of 20 children presenting with isolated oral language disorder, only four (20%) scored below Q1 of their age category, which did not differ from the distribution of the population of typically developing children ($p=0.48$). The group of 14 children with no neurodevelopmental disorder but impaired binocular vision constituted another 'control' group, with two children (14%) scoring as outliers and only five (36%) scoring below Q1 of their age category. These scores did not differ from the distribution of the population of typically developing children ($p=0.54$ and $p=0.23$ respectively).

Statistical comparison of EVSP total and subscores between clinical groups

As illustrated in Figure 3a, the Kruskal–Wallis one-way ANOVA performed on the median class score showed a significant effect of the clinical group ($H_{7,167}=20.2$; $p<0.01$). Multiple bilateral Mann–Whitney U tests showed that both DCD and multidys groups were statistically different to the group with language disorder (language disorder vs DCD: $z=3.22$; $p<0.05$; language disorder vs multidys: $z=3.86$; $p<0.01$) and there was no difference between SLD and other groups (all $z<2.78$; $p>0.05$).

As illustrated in Figure 3b,c, this significantly lower performance of the groups of children with DCD and multidys at the EVSP test was mainly driven by the lower 'parietal score'. Indeed, the Kruskal–Wallis one-way ANOVAs showed a highly significant effect of the group on the parietal score ($H_{7,167}=19.6$; $p<0.01$) but no significant effect of the group on the occipital score ($H_{7,167}=9.8$; $p=0.20$). Multiple bilateral Mann–Whitney U tests showed that both DCD and multidys groups were statistically different from the group with language disorder for the parietal score (language disorder vs DCD: $z=3.34$; $p<0.05$; language disorder vs multidys: $z=3.81$; $p<0.01$), but not for the occipital score (language disorder vs DCD: $z=1.36$; $p>0.05$; language disorder vs multidys: $z=2.49$; $p>0.05$). The comparison between language disorder and SLD groups did not reach significance (parietal score: $z=2.80$; $p>0.05$; occipital score: $z=1.43$; $p>0.05$).

DISCUSSION

The EVSP screening test is an easy and fast, but nevertheless specific, way to evaluate conscious visuospatial processing ability in children.^{2,3} This test has been designed to measure the two-dimensional visuospatial perceptual abilities of the dorsal stream of cortical visual processing, which have to be distinguished from 'peripheral' visual function. Indeed, the two patients with occipito-parietal damage showing a clear impairment on the EVSP screening test² had neither visual acuity and binocular vision nor eye alignment and oculomotor dysfunction after the damage to their central nervous system. Also, our group of children with binocular vision dysfunction and no neurodevelopmental disorder did not score significantly differently than the typically developing population at the EVSP screening test.

In this study, we used the EVSP screening test to evaluate the prevalence of dorsal-stream visuospatial processing deficits in non-typically developing children. Our sample of non-typically developing children comprised 22% with SLD, 21% with DCD, 12% with language disorder, 8% with ADHD, and 36% with at least two comorbidities. Our sample thus reflected the French population of children with neurodevelopmental disorders since about 40% of them present comorbidities (<https://www.inserm.fr/information-en-sante/dossiers-information/troubles-specifique-s-apprentissages>), with the most frequent comorbidities being DCD with language disorder, DCD with ADHD, and DCD with SLD. The mean age and sex ratio of each clinical category in our sample (Table 1) was also representative of what is reported for their mean age of diagnosis in the French population (http://www.ffdys.com/wp-content/uploads/2016/11/FFDYS_SYNTHESE_Enquete_2015-parcours_de_sante.pdf), since oral language develops earlier, language disorder is diagnosed the earliest, followed by DCD and SLD, and then ADHD which is often diagnosed later than 10 years of age in France. Our sample also reflected the French population for the frequency of each clinical category: the French 'Fédération des Dys' reports that in the total population of schoolchildren, SLD is the most frequent (about 4% for developmental dyscalculia and/or dyslexia), followed by DCD (3%), and then language disorder (2%). The reported prevalence of ADHD is between 3% and 5% (https://www.has-sante.fr/jcms/c_2025618/fr/trouble-deficit-de-l-attention-avec-ou-sans-hyperactivite-tdah-reperer-la-souffrance-accompagner-lenfant-et-la-famille-questions--reponses), which fits our sample if we consider our population with ADHD only combined with our population presenting with ADHD as a comorbidity (98% of children with ADHD have reported a comorbidity in the 2015 survey of the French 'Fédération des Dys': http://www.ffdys.com/wp-content/uploads/2016/11/FFDYS_SYNTHESE_Enquete_2015-parcours_de_sante.pdf).

In the present study, we excluded potential causes of brain injury that might lead to cerebral visual impairment (see our exclusion criteria in Fig. S1). Nevertheless, the prevalence of low scoring at the EVSP screening test was high in our population of 168 non-typically developing children, with more than half scoring below the lower quartile limit (Q1) and 17% scoring as outliers. If we consider children in this population who exhibited more than two comorbidities (multidys group), an even larger percentage (77%) scored below Q1 and 43% scored below the outlier limit. Many of these children with neurodevelopmental disorders thus displayed a developmental dysfunction of the dorsal visual stream of unknown origin.

Importantly, the prevalence of dorsal-stream visuospatial processing deficits was different between the clinical categories as defined by the DSM-5. On the one hand, the low prevalence of EVSP deficit in children with oral language disorder supports divergent construct validity for our screening test. On the other hand, the significantly high

prevalence of EVSP deficit in children with SLD only (59%) and DCD only (58%) was also expected from the literature, as further developed below.

In the group of children with SLD, 54% scored like the worst 25% of typically developing children (between Q1 and the lower outlier limit) and only 5% scored as outliers of their age category. This high prevalence of low scoring in children with SLD is in accordance with the correlation of the EVSP screening test with the arithmetic subtest and the Working Memory Index of the Wechsler Intelligence Scale for Children, Fourth Edition.³ It suggests an important contribution of EVSP deficit to developmental dyscalculia, probably through inability to use visuospatial imagery as a support for logico-mathematical reasoning.³¹ The EVSP screening test score has been found not to correlate with reading age,³ probably because of the large heterogeneity of profiles between the children with dyslexia. Future investigations should evaluate whether low EVSP scores are observed more specifically in children with dyslexia exhibiting visual confusions of letters, and whether it correlates with the visuoattentional letter span.³²

The severity of the deficit was higher in the group of children with DCD, with more than 20% exhibiting scores below the lower outlier limit of their age category. This severity explains why, when comparing the performance between clinical groups (Fig. 3), only the mean score of the DCD group (not of the SLD group) was significantly lower than the group with language disorder. The high prevalence of EVSP deficit in children with DCD, with or without comorbidities, is consistent with the correlation of the EVSP screening test,³ with tests of visuoconstructive abilities (Block test³³) and tests evaluating manual dexterity under visual control such as the Purdue pegboard³⁴ and the manual dexterity tasks of the Movement Assessment Battery for Children.³⁵ However, the EVSP score correlated neither with the other subscores of the Movement Assessment Battery nor with its total score used to diagnose DCD, suggesting that different aspects of DCD are being assessed by these different subscores. Children with DCD can have a pathological total score on the Movement Assessment Battery with heterogenous profiles.

In the EVSP screening test, children with DCD exhibiting outlier scores were more precisely impaired on the 'parietal' subscore (Fig. 3). The sum of the subtests T3, T4, T5, and T6 constituting the 'parietal' score provides an accumulation of evidence of a deficit in 'landmark relative positioning ability' ('where' function²⁷). The usefulness of the two other subtests (T1 and T2) is not clear from the present study since no group of neurodevelopmental

disorders statistically differed from the group with language disorder on this 'occipital' subscore evaluating 'magnitude processing' (length and size). Further investigations in clinical categories not included in the present study might show impaired performance at this 'occipital' subscore, for example in children born preterm and/or with cerebral palsy at risk of cerebral visual impairment.

The EVSP screening test could thus be used to refine the diagnosis within the traditional categories of neurodevelopmental disorders and to provide more specific indications for rehabilitation. If the EVSP test is being used as a screening test that will be completed by further assessments, then it should have a minimum of false negatives, hence scoring below Q1 would seem to be a suitable detection threshold for children who could benefit from a specific EVSP rehabilitation.

Reflecting the age at which neurodevelopmental disorders are clinically diagnosed, the distribution of our non-typically developing group across age categories was uneven and particularly poor between 4 and 6 years old. This constitutes one limitation of our study because we would advise using our screening test as soon as possible to detect children at risk of developmental disorder and start them on early specific EVSP rehabilitation. Another limitation could be that children recruited at hospitals tend to have more severe and complex deficits. However, our additional research recruitment allowed us to test children more representative of the population with SLD and DCD and ensured the generability of the present results.

In conclusion, the EVSP screening test seems to be a useful tool to pinpoint those children who exhibit a visuospatial perceptual deficit among the heterogenous groups with DCD or SLD. In these numerous children, the hypothesis that the EVSP deficit may contribute in varying degrees to their dexterity, reading, or logico-mathematical performance should be considered for their rehabilitation.

ACKNOWLEDGEMENTS

The authors wish to thank David Chatelus for his participation in data collection. The authors have stated they had no interests that might be perceived as posing a conflict or bias.

DATA AVAILABILITY STATEMENT

Data are available on request to the corresponding author.

SUPPORTING INFORMATION

The following additional material may be found online:

Figure S1: Flowchart of the present study involving the assessment of children using the EVSP screening test.

REFERENCES

1. Pisella L. Visual perception is dependent on visuospatial working memory and thus on the posterior parietal cortex. *Ann Phys Rehabil Med* 2017; **60**: 141–7.
2. Pisella L, André V, Gavault E, et al. A test revealing the slow acquisition and the dorsal stream substrate of visuo-spatial perception. *Neuropsychologia* 2013; **51**: 106–13.
3. Pisella L, Martel M, Roy AC, Vuillerot C, Gonzalez-Monge S. Validation of a simple screening test for elementary visuo-spatial perception deficit. *Ann Phys Rehabil Med* 2020; **63**: 302–8.

4. Pisella L, Sergio L, Blangero A, Torchin H, Vighetto A, Rossetti Y. Optic ataxia and the function of the dorsal stream: contributions to perception and action. *Neuropsychologia* 2009; **47**: 3033–44.
5. Rossetti Y, Pisella L, McIntosh RD. Rise and fall of the two visual systems theory. *Ann Phys Rehabil Med*. 2017; **60**: 130–40.
6. Atkinson J, Braddick O. From genes to brain development to phenotypic behavior: “dorsal-stream vulnerability” in relation to spatial cognition, attention, and planning of actions in Williams syndrome (WS) and other developmental disorders. *Prog Brain Res* 2011; **189**: 261–83.
7. Wilson PH, McKenzie BE. Information processing deficits associated with developmental coordination disorder: a meta-analysis of research findings. *J Child Psychol Psychiatry* 1998; **39**: 829–40.
8. Wilson PH, Ruddock S, Smits-Engelsman B, Polatajko H, Blank R. Understanding performance deficits in developmental coordination disorder: a meta-analysis of recent research. *Dev Med Child Neurol* 2013; **55**: 217–28.
9. Henderson SE, Barnett A, Henderson L. Visuospatial difficulties and clumsiness: on the interpretation of conjoined deficits. *J Child Psychol Psychiatry* 1994; **35**: 961–9.
10. Hulme C, Lord R. Clumsy children – a review of recent research. *Child Care Health Dev* 1986; **12**: 257–69.
11. Jarus T, Lourie-Gelberg Y, Engel-Yeger B, Bart O. Participation patterns of school-aged children with and without DCD. *Res Dev Disabil* 2011; **32**: 1323–31.
12. Loh PR, Piek JP, Barrett NC. Comorbid ADHD and DCD: examining cognitive functions using the WISC-IV. *Res Dev Disabil* 2011; **32**: 1260–9.
13. Crawford SG, Dewey D. Co-occurring disorders: a possible key to visual perceptual deficits in children with developmental coordination disorder? *Hum Mov Sci* 2008; **27**: 154–69.
14. Tsai CL, Wu SK. Relationship of visual perceptual deficit and motor impairment in children with developmental coordination disorder. *Percept Mot Skills* 2008; **107**: 457–72.
15. Tsai CL, Wilson PH, Wu SK. Role of visual-perceptual skills (non-motor) in children with developmental coordination disorder. *Hum Mov Sci* 2008; **27**: 649–64.
16. Van Waelvelde H, De Weerd W, De Cock P, Smits-Engelsman BC. Association between visual perceptual deficits and motor deficits in children with developmental coordination disorder. *Dev Med Child Neurol* 2004; **46**: 661–6.
17. Schoemaker MM, van der Wees M, Flapper B, Verheij-Jansen N, Scholten-Jaegers S, Geuze RH. Perceptual skills of children with developmental coordination disorder. *Hum Mov Sci* 2001; **20**: 111–33.
18. Parush S, Yochman A, Cohen D, Gershon E. Relation of visual perception and visual-motor integration for clumsy children. *Percept Mot Skills* 1998; **86**: 291–5.
19. Fletcher-Flinn C, Elmes H, Strugnell D. Visual-perceptual and phonological factors in the acquisition of literacy among children with congenital developmental coordination disorder. *Dev Med Child Neurol* 1997; **39**: 158–66.
20. Winner E, von Karolyi C, Malinsky D, et al. Dyslexia and visual-spatial talents: Compensation vs deficit model. *Brain Lang* 2001; **76**: 81–110.
21. Von Karolyi C, Winner E, Gray W, Sherman GF. Dyslexia linked to talent: global visual-spatial ability. *Brain Lang* 2003; **85**: 427–31.
22. Oszwa U. Mathematical, linguistic and visuospatial skills in Polish children with specific learning disabilities in reading and arithmetic. *Acta Neuropsychologica* 2006; **4**: 286–95.
23. Szucs D, Devine A, Soltesz F, Nobes A, Gabriel F. Developmental dyscalculia is related to visuo-spatial memory and inhibition impairment. *Cortex* 2013; **49**: 2674–88.
24. Bugden S, Ansari D. Probing the nature of deficits in the ‘Approximate Number System’ in children with persistent developmental dyscalculia. *Dev Sci* 2016; **19**: 817–33.
25. McCaskey U, von Aster M, O’Gorman Tuura R, Kucian K. Adolescents with developmental dyscalculia do not have a generalized magnitude deficit - processing of discrete and continuous magnitudes. *Front Hum Neurosci* 2017; **20**: 102.
26. American Psychiatric Association. Diagnostic and Statistical Manual of Mental Disorders (5th edition). Arlington, VA: American Psychiatric Association, 2013.
27. Ungerleider LG, Mishkin M. Two cortical visual systems. In: Ingle DJ, Goodale MA, Mansfield RJW, editors. Analysis of visual behavior. Cambridge, MA: MIT Press, 1982: 549–86.
28. Faillenot I, Decety J, Jeannerod M. Human brain activity related to the perception of spatial features of objects. *Neuroimage* 1999; **10**: 114–24.
29. McIntosh RD, Pritchard CL, Dijkerman HC, Milner AD, Roberts RC. Prehension and perception of size in left visual neglect. *Behav Neurol* 2001; **13**: 3–15.
30. Fink GR, Marshall JC, Shah NJ, et al. Line bisection judgments implicate right parietal cortex and cerebellum as assessed by fMRI. *Neurology* 2000; **54**: 1324–31.
31. Mathieu R, Epinat-Duclos J, Sigovan M, et al. What’s behind a “+” sign? Perceiving an arithmetic operator recruits brain circuits for spatial orienting. *Cereb Cortex* 2017; **14**: 1–12.
32. Bosse M-L, Tainturier MJ, Valdois S. Developmental dyslexia: The visual attention span deficit hypothesis. *Cognition* 2007; **104**: 198–230.
33. Wechsler D. Echelle d’Intelligence de Wechsler pour enfants et adolescents quatrième édition (WISC IV). Paris: Les Editions du Centre de Psychologie Appliquée, 2005.
34. Tiffin J, Asher EI. The Purdue Pegboard: norms and studies of reliability and validity. *J Appl Psychol* 1948; **32**: 234–47.
35. Soppelsa R, Albaret JM. Manuel de la Batterie d’Évaluation du Mouvement chez l’Enfant. Paris: Les Éditions du Centre de Psychologie Appliquée, 2004.

Étude 2

Vers la caractérisation d'une forme visuelle de dyslexie :
réduction du champ visuo attentionnel lors de la recherche
de symboles

Toward the characterization of a visual form of dyslexia:
reduced visuo attentional field for symbols visual search

Vialatte A, Chabanat E, Pisella L

Integrative, Multisensory Perception Action & Cognition Team (IMPACT), Lyon
neuroscience Research Center (CRNL), France

Abstract

Several studies have shown that some dyslexics cannot process multiple letters simultaneously. Tenants of the phonological theory of developmental dyslexia argued that this reduced visuo-attentional (V-A) span measured with letters can be a consequence of a poor reading experience in dyslexics. Here, we moved away from the reading context and used visual search tasks. [Casco & Prunetti \(1996\)](#) have shown that poor readers are slow in visual searches involving multifeatured shapes, i.e. when target and distracters are made of a combination of multiples lines (symbols) and not when they are made of a unique line or of full objects. We showed that dyslexics who are slower in visual search involving symbols than full objects exhibit a reduced V-A field when facing those stimuli made by separable lines (like letters). They also present with a reduced V-A span and 40% scored below the interquartile range of their age category. These findings are interesting because a reduced VA capacity was found outside the context of letters processing. Such a basic VA deficit can be revealed in pre-reading phase which opens up to prospects of early detection and remediation of VA dyslexia.

INTRODUCTION

Reading is an important competence in life (studies, work, daily life...) so when someone has difficulties to read he is very handicapped. The most common reading trouble is called developmental dyslexia (DD), a failure to acquire efficient reading despite normal intelligence and adequate education (Rutter & Yule, 1975).

The most common and sometime the only causal deficit admitted in DD is the phonological deficit (Hulme, 1987). However, researches exploring visuo-attentional (V-A) aspect of reading (Castles & Coltheart, 1993; Marendaz et al., 1996) shown that a V-A deficit is present in DD, characterized by a slow visual search ability or an inability to process multiple items in parallel, and sometimes in absence of a phonological impairment (Valdois et al., 2003). During these researches a concept emerged, the V-A span defined as the number of elements that can be processed simultaneously in a multiple-elements configuration. It has been shown that some dyslexics can have a reduced V-A span without phonological deficit, whereas some dyslexics have a phonological deficit with preserved V-A span (Bosse et al., 2007). A single V-A span deficit or a single phonological deficit can cause DD, some dyslexics display both (Bosse et al., 2007; Zoubrinetzky et al., 2016).

The brain regions involved in these 2 deficits (phonological and V-A) have been identified. The phonological one is the most described, it involves the superior temporal area, the supramarginal gyrus and the frontal inferior gyrus of the left hemisphere (Jobard et al., 2003). For the simultaneous processing of multiple elements, the superior parietal lobule (SPL) appears to be the key region: the SPL is activated when several elements have to be processed at the same time but is not activated during the processing of a single element (Lobier, Peyrin, et al., 2012). Another neuroimaging study showed that LPS was not activated bilaterally in dyslexics when they had to process several elements simultaneously (Lobier et al., 2014). Finally a neuroimaging study compared 2 dyslexics, one with phonological deficit but a preserved V-A span and one with reduced V-A span but good phonological skills. The one with the phonological deficit presented a normal activation of SPL in the multiple elements task but a decreased activation of the left hemisphere language areas in a phonological task. On the contrary, the dyslexic with reduced V-A span presented a normal left hemispheric

inferior fronto-temporo-parietal activation during the phonological task but abnormal SPL activation during the multiple elements task (Peyrin et al., 2012). This set of neuroimaging studies converged toward a SPL dysfunction in children with a reduced V-A span that can be at the origin of their DD. Not being able to process many characters simultaneously prevents from the ability to perceive the whole word and forces to use the analytic phoneme to grapheme conversion. As a consequence, reading remains slow, jerky and the irregular words cannot be well read.

In current clinical evaluations, a classification of two types of DD exists based on the ability to read regular, irregular and pseudo words. If the subject has a difficulty to read regular or pseudo-words, the hypothesis is that he has a phonological DD. If the subject has a difficulty to read irregular-words, he is rather classified as having surface (or visual) DD. With this classification, there is a lot of mixed DD (subjects presenting difficulties with both regular and irregular words). A study (Zoubrinetzky et al., 2014) tried to better classify the subjects with mixed DD using more specific tests, i.e. phonological awareness tasks and a measure of the V-A span. They found that more than 60 % of the population of mixed DD actually presented with a single deficit (phonological or V-A). This study therefore suggested that a better classification can be achieved by searching for underlying cognitive deficits, and that in many cases DD comes from a single, either phonological or V-A, deficit.

However, the V-A span theory is still very controversial, some authors think that V-A deficit is a consequence instead of a cause of DD (Goswami, 2015b) and others minimize the role of the V-A span in DD (Saksida et al., 2016). Goswami (2015a) consider that many impaired mechanisms claimed to underlie dyslexia may rather be a consequence of a specific linguistic deficit and poor reading experience. In particular, incomplete report of briefly presented letter strings considered to reflect a reduced visuo-attentional (VA) span, could rather be a consequence of dyslexia (Goswami, 2015b). In response, Lobier & Valdois (2015) argued that reduced VA span dyslexics also have incomplete report for non-verbal symbols (Lobier, Zoubrinetzky, et al., 2012). Goswami (2015b) in turn argued that, even with unfamiliar visual stimuli, recognition and retention may be mediated by verbal labelling (Vellutino, 1979). Moreover, the scanning of horizontal strings of symbols resembles the procedures used when reading a line of

text, which dyslexics have not developed as efficiently as good readers. Consequently, it is recommended to study non-linguistic deficits clearly outside the reading context in order to successfully demonstrate their causality for dyslexia. Visual search appears as a good paradigm since it uses non-verbal stimuli that are randomly organized in space, it does not involve visual-to-phonological mapping but rather visual feature integration and discrimination (Treisman & Gelade, 1980).

Moreover, non-linguistic theories should explain how a non-linguistic deficit, e.g. a visual deficit, will significantly impair only the reading ability and not lead to a more general impairment of visually-based functional abilities (Goswami 2015b). Accordingly, Casco & Prunetti (1996) have shown that poor readers were slow only in specific visual search conditions involving multi-featured shapes (i.e. symbols) made of the spatial integration of multiple lines (separable features): a single tilted line was found as quickly as controls among single vertical lines but search time was lengthened in poor readers when this tilted line was combined with others to form a single complex target stimulus (K or non-alphabetic symbol) among a set of identical distractors (F or non-alphabetic symbols). More recently, Khan et al. (2016) made a similar observation in a patient with bilateral SPL lesion recovering from clinical simultanagnosia, a deficit of simultaneous visual processing (Wolpert, 1924). The patient was significantly slower than controls in visual searches involving symbols made by a combination of lines (e.g. in the feature-absent task consisting to find a circle among lollipops) but not in visual searches involving full objects (e.g. to find a red disk among red squares, or a red disk among red squares and green disks). A moving window paradigm (McConkie & Rayner, 1975) demonstrated that this slowness observed when the search task involved separable features stimuli was associated with a reduced V-A field that can be mimicked in control subjects by applying artificially a reduced gaze-contingent search window. Moreover, when the patient performed the visual search with an artificially reduced gaze-contingent search window, this did not impair her performance, confirming that it was fitting her “natural” V-A deployment (Khan et al., 2016).

In the present study, we therefore used the same moving window paradigm and contrasted two conditions of visual search consisting to find the circle (versus disk) among identical distractors (empty versus full lollipops, respectively, see figure 1). We

aimed at testing the hypothesis that dyslexics who are specifically slow in the visual discrimination of symbols (and not of full objects) have a reduced V-A visual search field in this condition. If such a specific V-A shrinkage is observed when faced to the spatial integration of separable features (e.g. symbols) and not when stimuli are full objects, then this would cause a specific V-A deficit for letters and texts and be a possible causal origin of DD.

We also assessed whether such V-A shrinkage characteristic of SPL dysfunction (Michel & Henaff, 2004) was accompanied with other V-A deficits described in the literature in both DD and simultanagnosia like global shape perception (Bedoin et al., 2010; Clavagnier et al., 2006; Franceschini et al., 2017), V-A span of letters strings (Bosse et al., 2007, Valdois et al. 2016) and visuo-spatial perception (Pisella et al., 2013, 2020).

METHODS

1. Subjects

Children aged between 8 and 12 with or without DD were recruited. They had to display normal or corrected-to-normal vision and no neurological history.

Dyslexics were diagnosed by speech therapists in accordance to the current standard clinical testing and along the Diagnostic and Statistical Manual of Mental Disorders (Crocq et al., 2016) criteria. They all displayed a delay of at least 18 months at the reading test “L'alouette” (Lefavrais, 1967). They did not have any diagnosed comorbidities like developmental coordination disorder, oral language disorder or attentional disorder/hyperactivity.

Controls displayed typical development and schooling achievement with no history of learning deficit. They all displayed less than 18 months delay at the reading test “L'alouette” (Lefavrais, 1967) and thus constituted in the present study the “GoodReader” group.

All children and their careers gave written informed consent to this research. All experimental procedures were approved by the French health research ethics committee (CPP Ile de France VI, 2017-A02525-48).

2. Tasks

2.1 Visual search tasks

Children sit in a semi dark room with their eyes at a distance of 57 cm from a computer screen (40 × 30 cm, refresh rate: 60 Hz, resolution: 1280*1024), and their forehead and chin stabilized. Their eye positions were monitored by an eye tracker (EyeLink portable duo) at 1000 Hz and the trials are developed presented and recorded with experiment builder (SR research).

Each trial began with a central fixation cross. They had to fixate it for 1s to bring up the visual search display on the screen which remains until button press. Subject had to find the target among distractors. There were 2 kinds of visual displays in blocked conditions: those made with full objects and those with symbols composed of separable features. In the first condition they had to find the black disk among black filled lollipops (black disks with vertical bar, figure 1). In the second condition they had to find the empty lollipops (circles with vertical bar, figure 1). The target measured 1.3° of visual angle and could appear in one of the four quadrants of the visual search display (upper-left, upper-right, lower-left, lower-right), at a random location on a virtual perimeter of 7.5° or 12.5° around the initial fixation position, and among of 24 or 48 distractors (the items were distributed homogeneously across space pseudo-randomly, with a minimum spacing between them of 1.3°). Each task consisted of 32 target-present displays (2 repetitions of each target eccentricity, quadrant and set-size) and 4 target-absent displays (2 for each set-size) resulting in a total of 36 trials (randomly presented) for each condition of visual display.

Additionally, they performed the visual searches in two blocked experimental conditions: full view and reduced visibility window (gaze-contingent moving window paradigm). This circular window of 20° diameter masked the peripheral vision and moved along with the gaze thanks to the high-frequency eye tracker. The diameter of the visibility window was chosen from preliminary testing which allowed us to establish that it was increasing the time of research in control participants and not in our first recruited VA dyslexics.

At the end all participants performed the full view condition again to compensate any order effect between full objects and separable features conditions.

Altogether, each child performed 6 blocks of 36 visual searches (216 trials) in the following order:

- Full objects / full view
- Full objects / reduced view
- Separable features / full view
- Separable features / reduced view
- Full objects / full view
- Separable features / full view

The instruction was to provide a response as quick as possible by pressing the right arrow key of the keyboard when the target was present in the visual display and the space bar if they were sure that the target was absent.

We recorded the reaction time to press the button after visual display presentation (RT) and we analyzed only the correct target-present trials.

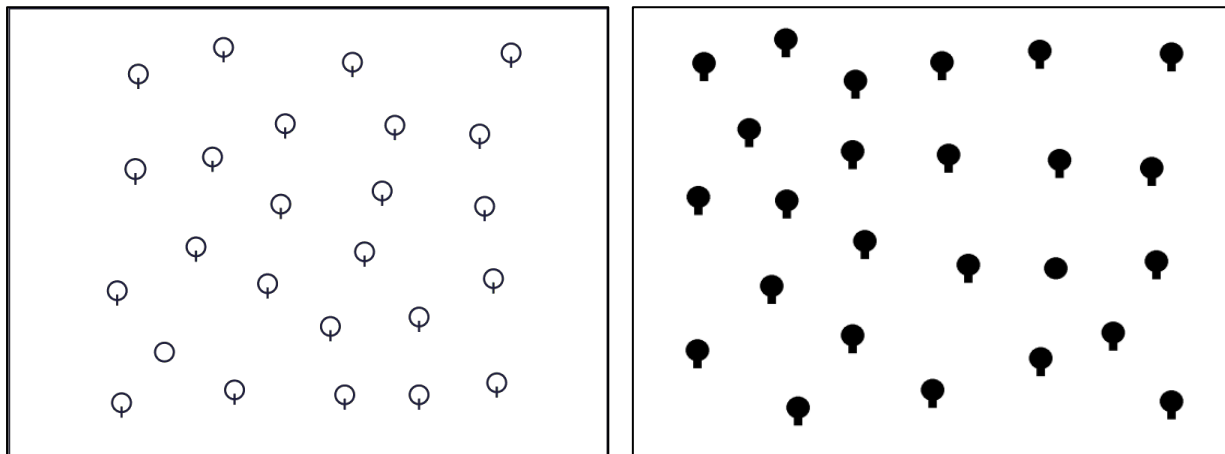

Figure 1 – Visual search display. On the left separable features (symbol) condition where subject had to find the circle among lollipops, on the right the full objects condition where subject had to find the black disk among full lollipops.

2.2 V-A span task

We used the global report test to measure the V-A letter span (Bosse et al., 2007). The subject sat in front of a screen at 50cm, he fixated a central cross during 1s, then a blank screen was presented for 500ms, followed by a centered string of 5 consonants

displayed for 200ms to prevent for any saccadic exploration. Children had to tell all the letters that they could see in any order. There was a familiarization task of 10 trials followed by the presentation of 20 strings of 5 consonants. We recorded the accuracy, each correct letter report gave 1 point, at the end we ended with a score out of 100 for each subject.

2.3 local/global test

Subject sat in a semi-dark room with their eyes at a distance of 50 cm from a screen (40 × 30 cm, refresh rate: 60 Hz, resolution: 1280*1024). The stimuli were adapted from Franceschini et al (2017). Different geometric shapes were displayed on the screen: a square (11.5*11.5° of visual angle) made by little squares (figure 2 – 1A) or by little triangles (figure 2 – 2A) (1.4*1.4° of visual angle), or a triangle (11.5*11.5° of visual angle) made by little squares (figure 2 – 2b) or little triangles (figure 2 – 2a) (1.4*1.4° of visual angle). Two tasks were run, the global identification task where the child had to report the global geometric shape (triangle or square), followed by the local identification task where the child had to report the little shapes (triangles or squares) that made the global shape. In the 2 two tasks, there were thus 2 congruent (where the global and the local shapes were the same) and 2 incongruent (where the global and local shapes were different) stimuli. There were 56 trials per task (global and local), composed of 28 congruent and 28 incongruent trials. Each trial began with a central fixation cross of 1s duration followed by the stimulus displayed on the center of the screen. The child had to respond the most quickly and accurately as possible by pressing the right arrow key (with the right index) for the square and the left arrow key (with the left index) for the triangle. The stimuli remained on the screen until the response was given. Response time and accuracy were recorded in the four different conditions of task (local/global) and congruency. We calculated a corrected RT score for each condition and each subject: $\text{meanRT} + (\text{meanRT}(1 - \text{efficiency}))$ where efficiency was the percentage of right answer. Then we subtracted the corrected RT score of incongruent condition by the corrected RT score of congruent condition to have an interference score for the local and global tasks. Finally we calculated the interference asymmetry by subtracting interference score of the local task by the local one.

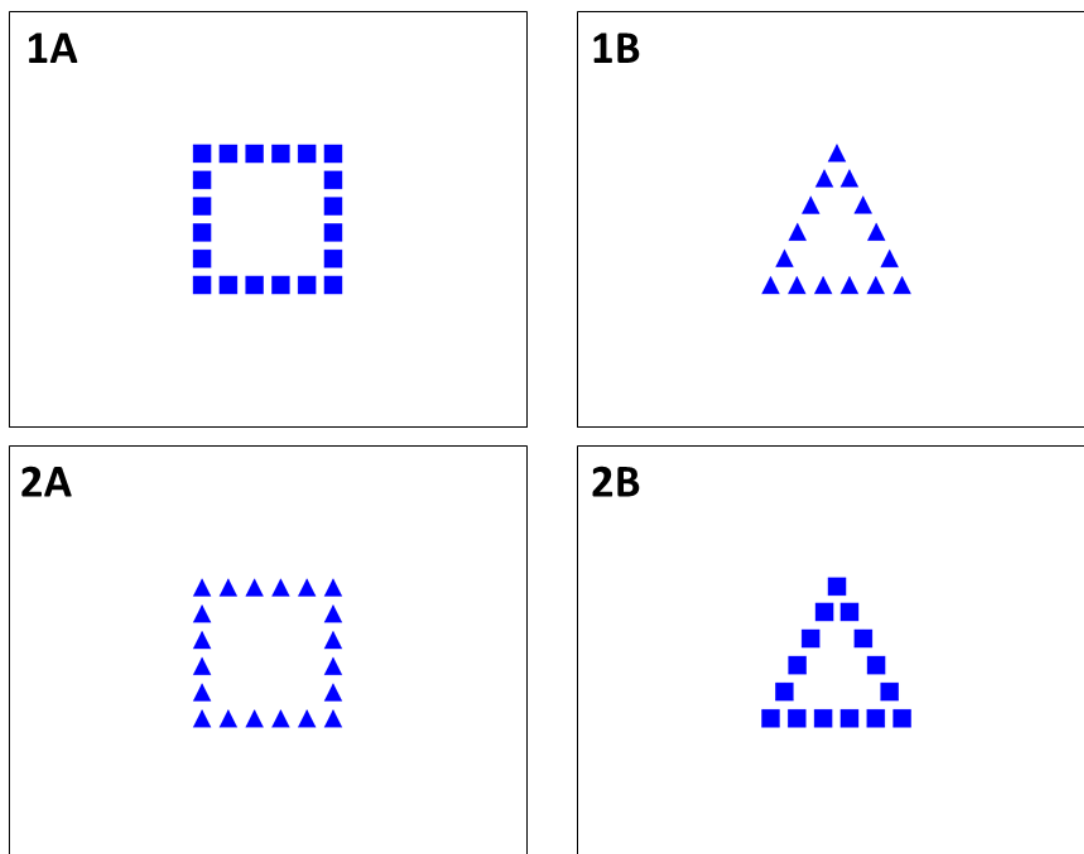

Figure 2 – visual display for the local-global task. Pictures 1 display congruent conditions and pictures 2 display the incongruent conditions

2.4 “Alouette” reading test

“L’alouette” is a french reading test without meaning (Lefavrais, 1967). The subject has to read the text for 3 minutes. We noted the number of errors and the time to complete the text when inferior to 3 minutes. A table provides a reading (or lexical) age which can be compared with the chronological age of the subject to establish whether the child has more than the pathological threshold fixed at 18 months of delay. Children with a lexical and a chronological age differing by less than 18 months were included to the GoodReader Group.

2.5 Elementary visuo-spatial perception (EVSP) test (Pisella et al., 2013, 2020)

Subject sit in front of a table and the visual stimuli are presented in turn on A4 white sheets of paper. The stimuli are composed of two items that the child is requested to compare. The child has to respond if they are identical or not. There are 6 subtests

testing respectively length, size, orientation, midline, dot-square position discrimination and localization. In each subtest there are 12 trials with 1 point by correct answer, therefore there are a maximum of 72 points.

3. Statistical analysis

The RT recorded for correct target-present displays will be analyzed first to constitute the two groups of dyslexics and second to assess the effect of the reduced visibility window in the two types of visual displays (symbols versus full objects).

First, the dyslexic children were divided in two groups according to their visual search performance in full view. We computed the individual difference between the means RT observed in full view- symbol condition and in full view- full object condition. We compared each dyslexic child with the mean and standard error of the GoodReader group using a one-tailed Crawford modified t-test (Crawford & Howell, 1998).

Each dyslexic child whose RT difference was significantly different from the GoodReader group was placed in the DysSlow group. The others formed the DysFast group. At the end we had 3 groups the GoodReader group, the DysFast group and the DysSlow group.

We made repeated measures ANOVA with condition (full object or symbol) and visibility (full view of reduced visibility window) as within-subject factors and group as between-subject factor.

Then we performed intra group paired t test Bonferroni corrected as post-hoc comparisons to precise the results.

After, we compared the different scores of the other visuo-attentional and visuo-spatial tests between the 3 groups using t tests.

RESULTS

1- Groups formation

At the beginning we had 35 dyslexic children (mean chronological age = 126.42 +/- 11.5 months, mean lexical age = 91.25 +/- 8.2 months) and 17 good readers (mean chronological age = 123.88 +/- 16.3 months, mean lexical age = 117.8 +/- 20.1 months).

As described above, dyslexic children were then separated in two groups: those individuals presenting with a difference of their mean RT in symbol and full object condition significantly larger than the difference of the GoodReader Group, and the

others. 10 children composed the former DysSlow group (mean chronological age = 120.1 +/- 11.5 months, mean lexical age = 90.2 +/- 7.9 month). 25 children composed the latter DysFast group (mean chronological age = 128.7 +/- 10.9 months, mean lexical age = 90.92 +/- 7.7 months). The 3 groups had the same chronological age (all student t tests $t_s < 1.9$, $p_s > 0.05$), and the GoodReader group had a greater lexical age than both the DysFast group ($t = 5.26$, $p < 0.05$) and the DysSlow group ($t = 5.04$, $p < 0.05$). The two dyslexic groups had similar lexical age ($t = 0.25$, $p = 0.81$).

The mean difference (symbol-full object) of the DysSlow was significantly different from the GoodReader group ($t = 8.16$, $p < 0.5$) and the DysFast group ($t = 8.46$, $p < 0.05$). These two last groups were not significantly different between each other ($t = 0.31$, $p = 0.76$).

2- Visual search performance (figure 3)

The percentage of false alarm (when they did not find the target when it was present) did not exceed 6% (GoodReader: 3.2%, DysFast: 2.1% and DysSlow: 5.5%) and of false positive errors (when they said there was the target while not) did not exceed 2.5% (GoodReader: 1.5%, DysFast: 1% and DysSlow: 2.5%). These erroneous trials were removed from the analysis.

The ANOVA performed on the median RTs showed a significant main effect of group ($F(2,49) = 4.44$, $p < 0.05$) and visibility ($F(1,49) = 86.16$, $p < 0.05$), no main effect of stimulus type ($F(1,49) = 2.72$, $p > 0.05$) and a significant interaction group*stimulus*visibility ($F(2,49) = 3.31$, $p < 0.05$). We performed paired t tests Bonferroni corrected for intergroup comparisons between the 2 visibility conditions for each stimulus type. In the full objects condition, all three groups showed a significant increase of their median RT in the reduced visibility condition compared to the full view condition (GoodReader $t = -5.6$, $p < 0.05$, DysFast $t = -6.4$, $p < 0.05$, DysSlow $t = -3.7$, $p < 0.05$). In the symbols condition only two groups increased significantly their median RT with reduced visibility, the GoodReader ($t = -4.5$, $p < 0.05$) and the DysFast ($t = -4.1$, $p < 0.05$). The DysSlow group did not show any difference between the two visibility conditions for symbols ($t = -1.8$, $p = 0.6360$), i.e. their search performance was not affected by the reduced visibility window, demonstrating that they already used a reduced visuo-attentional field of search in full view.

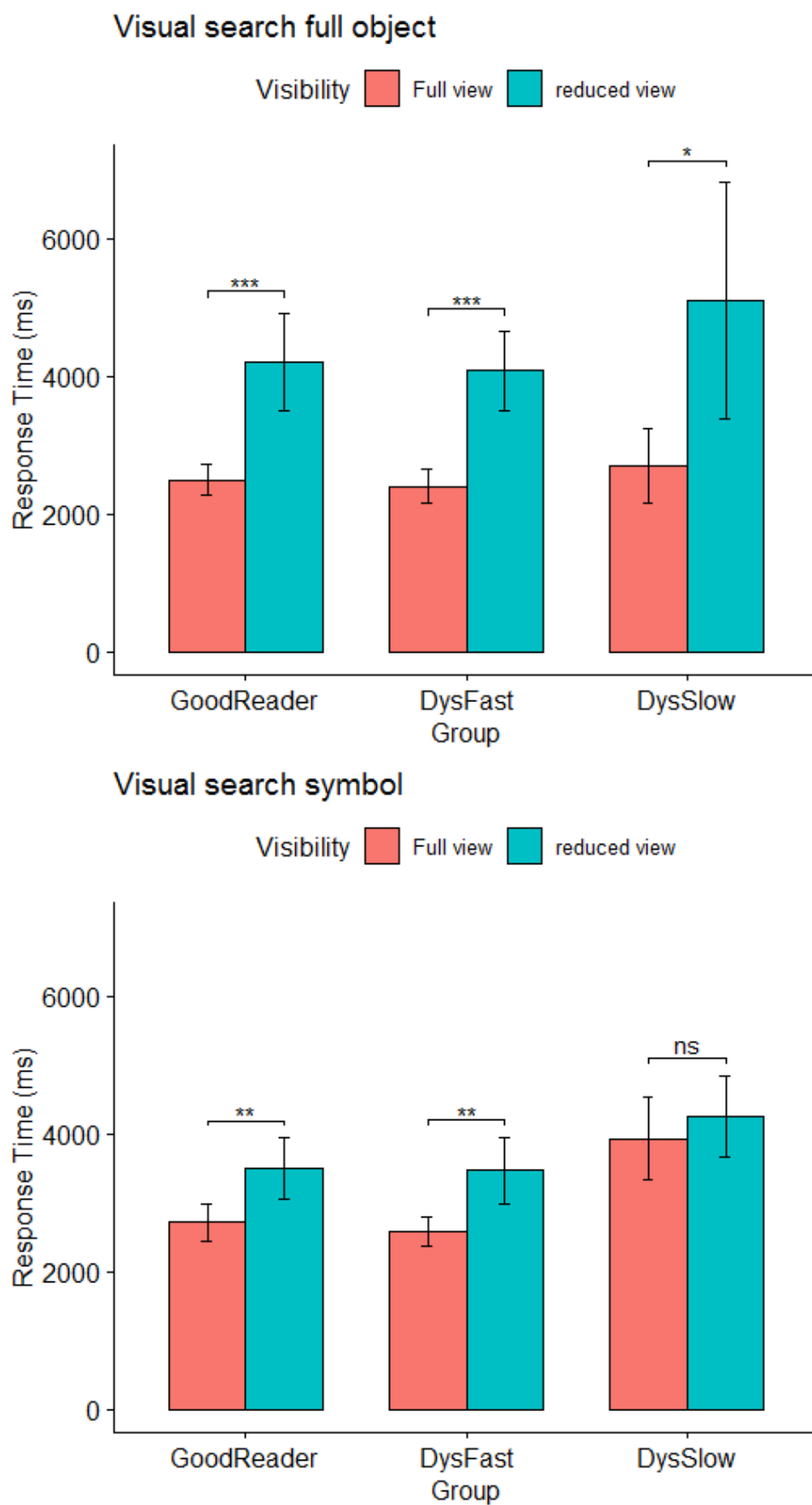

Figure 3 – Median RTs for the full objects (upper panel) and for the symbols (lower panel). In red the performance in full view and in blue with a reduced visibility window of 20°. Error bars represent the confidence interval of the groups. * $p < 0.05$; ** $p < 0.01$; *** $p < 0.001$ ns: not significant

3- Performance of the different groups at the other visual tasks (EVSP, V-A Span, local/global)

For the V-A span (VAS), Good Readers scored above both the DysFast ($t=4.16$, $p<0.05$) and the DysSlow ($t=3.67$, $p<0.05$) groups. The two dyslexic groups did not differ significantly ($t=-0.86$, $p=0.40$).

For the two other tests there was no significant difference between groups (EVSP: all $t_s<1.2$, $p_s>0.05$, local/global: all $t_s<1$, $p_s>0.05$). This was mainly due to the large variability observed in the two dyslexic groups, especially for the local/global interference asymmetry. For the EVSP screening test, normative interquartile and outlier values being available for children aged between 8 and 10 and for children aged between 10 and 12 years old, we further classified each individual global score based on the chronological age of each subject, as detailed in [Pisella et al. \(2020\)](#). About 40 % of dyslexics from for the DysSlow group scored below the interquartile range of their age category while 25% did so for the DysFast group and only 5.8% for the GoodReader group. This was nevertheless not sufficient to provide a statistically lower mean at the level of the DysSlow Group (global score: 59.9 not significantly different to the GoodReaders global score of 61.6).

Table 1 two provides the mean and standard error for each group and each test

Task Groups	VAS	EVSP	Local/global	Visual search
GoodReader	85.82 (8.1)	61.6 (2.8)	59.9 (4,3)	220 (360)
DysFast	74.6 (10.5)*	61.7 (3.3)	-3.5 (134.5)	182 (437)
DysSlow	70.4 (11.7)*	59.9 (4.3)	39.1 (106.8)	1235 (280)*

Table 1 – Mean scores (standard error) at the different visual tasks for each group. The VA span score (/100), the global score at the Elementary visuo-spatial perception screening test (/72), the local / global interference asymmetry (index described in the methods) and the visual search difference between mean RTs in symbol and Full Object conditions in full view. * different to the GoodReader group performance.

DISCUSSION

Poor readers have been shown to be impaired specifically in visual searches involving symbols (Casco & Prunetti, 1996). Here we aimed at investigating whether this was due to a reduced visuo-attentional capacity to process multiple separable elements, as suggested by Marrendaz & Valdois (1996) and Bosse et al. (2007). We also wanted to explore whether other visual deficits that have been observed in children with developmental dyslexia in the literature are systematically associated when visual search for symbols is slow. We measured the possible bias toward local processing (Bedoin et al., 2010; Franceschini et al., 2017), the possible poor performance in elementary visuo-spatial perception (Pisella et al. 2020) and the possible reduced visuo-attentional span of consonants (Bosse et al., 2007; Peyrin et al., 2012).

We first observed that not all dyslexic children were actually slow for symbols. This was expected since most DD are considered to emerge from phonological rather than visual deficit. We therefore divided the dyslexic children in two groups according to their visual search performance. Some performed like good readers with a small RT difference between symbol and full objects (not different to the good readers's mean RT of 220 ms, SD= 360), but more than a third of the dyslexics displayed actually a RT difference significantly larger than the GoodReader group.

These children (the DysSlow group) were affected for the full object visual search when we imposed a reduced gaze-contingent visibility window of 20° diameter, as well as the GoodReader and the DysFast group. In other words, all groups increased their RTs between the full view condition and the reduced view condition for the visual search involving full objects. However, this was not observed for visual searches involving symbols: only the GoodReader and the DysFast groups increased their RTs in the reduced visibility condition. The DysSlow group who was slower for the symbol condition in full view was not affected by a gaze-contingent visibility window of 20° diameter. This demonstrated that their search field displayed in full view was equal or smaller than 20° diameter, a small visuo-attentional field for symbols explaining their specific slowness. Processing at each fixation a smaller surface than the good reader children, they take more time to explore the whole display and find the symbol target. This cannot be due to oculomotor impairment since their visual search involving full objects was similarly efficient as good readers.

Such reduced visuo attentional field for symbols made of separable features (separable lines) had already been shown in a patient with bilateral SPL lesion (Khan et al., 2016). Using a task measuring the visuo-attentional span (VAS) in which subject had to report as much symbols as possible in one fixation (global report task), neuroimaging studies have established that this cortical region is involved in simultaneous multiple element process and underactivated in some dyslexic children (Lobier et al., 2014; Lobier, Peyrin, et al., 2012; Peyrin et al., 2011).

The second aim of the present study was to test in our groups the VAS and other visual tasks which have been reported in the literature to be impaired in DD. One critic by the tenants of the phonological theory concerning the observation of visual deficits in DD is that they are probably a consequence of the poor reading experience or that they are still connected to phonological processes (Goswami, 2015b). We rather found that not all dyslexic children displayed visual deficits even if there is no reason to consider that they would have different reading experience. Only our VAS measure could be connected to phonological deficit since we used consonants, but a reduced VAS has been shown in the literature with non-verbal symbols and categorization responses instead of verbal report (Lobier, Zoubrinetzky, et al., 2012). The VAS has been reported not reduced only for the report of color disks (Valdois et al., 2012b), which is consistent with the observation that the visual deficit in DD concerns specifically the symbols made of separable lines and not the full objects of everyday life. The high frequency of poor performance in an elementary visuo-spatial perception screening test involving black geometrical shapes is also along this line. We chose to use full objects in our local-global shape identification test in order to isolate this aspect from the processing of symbols. This might be the reason why we did not find a consistent local bias in our DysSlow group. We found that this reduced VA field in our DysSlow group of children could not be explained by elementary visuo-spatial perception or global attention deployment deficit because their performance in these two latter tasks were not impaired compared to the good reader group. Only the VAS was impaired, in this group as well as in the DysFast group, suggesting that a reduced visual capacity to access multiple consonants in one fixation might be impaired due to a reduced VA field in the DysSlow group and due a reduced phonological capacity to access consonants names in high temporal constraint in the DysFast group.

In conclusion, we found a reduced VA field in a visual condition which involves no letter or reading knowledge, and no verbal response. We thus argue that this reduced VA field cannot be connected to any phonological deficit or any lack of reading experience (Goswami, 2015b). This reduced VA field can nevertheless explain that dyslexics are specifically impaired with letter material since it is observed for a specific stimulus type made of combined separable lines (symbols) like letters. This reduced VA field for symbols would force the child to process only few letters simultaneously at each fixation, leading to slow reading or errors. This impaired VA field would prevent the child to process a whole word, and thus to encode long words and store them into his lexic. It would prevent the child to acquire an expert reading by developing the specialization of the visual word form area (Cohen & Dehaene, 2004; Moulton et al., 2019).

Acknowledgments

Thanks to all the families who gave their time to participate in this study. This work was conducted in accordance to ethical comity **CPP Ile de France VI le : 22/11/2017 69HCL17_0333**, with financial contributions from INSERM, CNRS, and Fondation de France .

References

- Bedoin, N., Kéïta, Leculier, Roussel, Herbillon, & Launay. (2010). *Diagnostic et remédiation d'un déficit d'inhibition des détails dans la dyslexie de surface*.
- Bosse, M.-L., Tainturier, M. J., & Valdois, S. (2007). Developmental dyslexia : The visual attention span deficit hypothesis. *Cognition*, 104(2), 198-230. <https://doi.org/10.1016/j.cognition.2006.05.009>
- Casco, C., & Prunetti, E. (1996). Visual search of good and poor readers : Effects with targets having single and combined features. *Perceptual and Motor Skills*, 82(3 Pt 2), 1155-1167. <https://doi.org/10.2466/pms.1996.82.3c.1155>
- Castles, A., & Coltheart, M. (1993). Varieties of developmental dyslexia. *Cognition*, 47(2), 149-180. [https://doi.org/10.1016/0010-0277\(93\)90003-e](https://doi.org/10.1016/0010-0277(93)90003-e)
- Clavagnier, S., Fruhmann Berger, M., Klockgether, T., Moskau, S., & Karnath, H.-O. (2006). Restricted ocular exploration does not seem to explain simultanagnosia. *Neuropsychologia*, 44(12), 2330-2336. <https://doi.org/10.1016/j.neuropsychologia.2006.05.012>
- Cohen, L., & Dehaene, S. (2004). Specialization within the ventral stream : The case for the visual word form area. *NeuroImage*, 22(1), 466-476. <https://doi.org/10.1016/j.neuroimage.2003.12.049>
- Crawford, J. R., & Howell, D. C. (1998). Comparing an Individual's Test Score Against Norms Derived from Small Samples. *The Clinical Neuropsychologist*, 12(4), 482-486. <https://doi.org/10.1076/clin.12.4.482.7241>
- Crocq, M.-A., Guelfi, J. D., & American Psychiatric Association. (2016). *DSM-5 ® : Manuel diagnostique et statistique des troubles mentaux*.
- Franceschini, S., Bertoni, S., Giancesini, T., Gori, S., & Facoetti, A. (2017). A different vision of dyslexia : Local precedence on global perception. *Scientific Reports*, 7(1), 17462. <https://doi.org/10.1038/s41598-017-17626-1>
- Goswami, U. (2015). Visual attention span deficits and assessing causality in developmental dyslexia. *Nature Reviews Neuroscience*, 16(4), 225-226. <https://doi.org/10.1038/nrn3836-c2>
- Hulme, C. (1987). Reading retardation. In *Cognitive approaches to reading* (In J. R. Beech & A. M. Colley, p. 94-128).
- Jobard, G., Crivello, F., & Tzourio-Mazoyer, N. (2003). Evaluation of the dual route theory of reading : A metanalysis of 35 neuroimaging studies. *NeuroImage*, 20(2), 693-712. [https://doi.org/10.1016/S1053-8119\(03\)00343-4](https://doi.org/10.1016/S1053-8119(03)00343-4)

- Khan, A. Z., Prost-Lefebvre, M., Salemme, R., Blohm, G., Rossetti, Y., Tilikete, C., & Pisella, L. (2016). The Attentional Fields of Visual Search in Simultanagnosia and Healthy Individuals : How Object and Space Attention Interact. *Cerebral Cortex (New York, N.Y.: 1991)*, 26(3), 1242-1254. <https://doi.org/10.1093/cercor/bhv059>
- Lefavrais, P. (1967). *Manuel du test de l'alouette : [Test psychologique] : test d'analyse de la lecture et de la dyslexie*. Centre de psychologie appliquée.
- Lobier, M., Peyrin, C., Le Bas, J.-F., & Valdois, S. (2012). Pre-orthographic character string processing and parietal cortex : A role for visual attention in reading? *Neuropsychologia*, 50(9), 2195-2204. <https://doi.org/10.1016/j.neuropsychologia.2012.05.023>
- Lobier, M., Peyrin, C., Pichat, C., Le Bas, J.-F., & Valdois, S. (2014). Visual processing of multiple elements in the dyslexic brain : Evidence for a superior parietal dysfunction. *Frontiers in Human Neuroscience*, 8, 479. <https://doi.org/10.3389/fnhum.2014.00479>
- Lobier, M., Zoubrinetzky, R., & Valdois, S. (2012). The visual attention span deficit in dyslexia is visual and not verbal. *Cortex*, 48(6), 768-773. <https://doi.org/10.1016/j.cortex.2011.09.003>
- Marendaz, C., Valdois, S., & Walch, J.-P. (1996). Dyslexie développementale et attention visuo-spatiale. *L'année psychologique*, 96(2), 193-224. <https://doi.org/10.3406/psy.1996.28893>
- McConkie, G. W., & Rayner, K. (1975). The span of the effective stimulus during a fixation in reading. *Perception & Psychophysics*, 17(6), 578-586. <https://doi.org/10.3758/BF03203972>
- Michel, F., & Henaff, M.-A. (2004). Seeing without the occipito-parietal cortex : Simultanagnosia as a shrinkage of the attentional visual field. *Behavioural Neurology*, 15(1-2), 3-13. <https://doi.org/10.1155/2004/836830>
- Moulton, E., Bouhali, F., Monzalvo, K., Poupon, C., Zhang, H., Dehaene, S., Dehaene-Lambertz, G., & Dubois, J. (2019). Connectivity between the visual word form area and the parietal lobe improves after the first year of reading instruction : A longitudinal MRI study in children. *Brain Structure and Function*. <https://doi.org/10.1007/s00429-019-01855-3>
- Peyrin, C., Démonet, J. F., N'Guyen-Morel, M. A., Le Bas, J. F., & Valdois, S. (2011). Superior parietal lobule dysfunction in a homogeneous group of dyslexic children with a visual attention span disorder. *Brain and Language*, 118(3), 128-138. <https://doi.org/10.1016/j.bandl.2010.06.005>
- Peyrin, C., Lallier, M., Démonet, J. F., Pernet, C., Baciú, M., Le Bas, J. F., & Valdois, S. (2012). Neural dissociation of phonological and visual attention span disorders in developmental dyslexia : fMRI evidence from two case reports. *Brain and Language*, 120(3), 381-394. <https://doi.org/10.1016/j.bandl.2011.12.015>

- Pisella, L., André, V., Gavault, E., Le Flem, A., Luc-Pupat, E., Glissoux, C., Barrière, A., Vindras, P., Rossetti, Y., & Gonzalez-Monge, S. (2013). A test revealing the slow acquisition and the dorsal stream substrate of visuo-spatial perception. *Neuropsychologia*, *51*(1), 106-113. <https://doi.org/10.1016/j.neuropsychologia.2012.11.015>
- Pisella, L., Martel, M., Roy, A. C., Vuillerot, C., & Gonzalez-Monge, S. (2020). Validation of a simple screening test for elementary visuo-spatial perception deficit. *Annals of Physical and Rehabilitation Medicine*, *63*(4), 302-308. <https://doi.org/10.1016/j.rehab.2019.03.006>
- Rutter, M., & Yule, W. (1975). The concept of specific reading retardation. *Journal of Child Psychology and Psychiatry, and Allied Disciplines*, *16*(3), 181-197. <https://doi.org/10.1111/j.1469-7610.1975.tb01269.x>
- Saksida, A., Iannuzzi, S., Bogliotti, C., Chaix, Y., Démonet, J.-F., Bricout, L., Billard, C., Nguyen-Morel, M.-A., Le Heuzey, M.-F., Soares-Boucaud, I., George, F., Ziegler, J. C., & Ramus, F. (2016). Phonological skills, visual attention span, and visual stress in developmental dyslexia. *Developmental Psychology*, *52*(10), 1503-1516. <https://doi.org/10.1037/dev0000184>
- Treisman, A. M., & Gelade, G. (1980). A feature-integration theory of attention. *Cognitive Psychology*, *12*(1), 97-136. [https://doi.org/10.1016/0010-0285\(80\)90005-5](https://doi.org/10.1016/0010-0285(80)90005-5)
- Valdois, S., Bosse, M.-L., Ans, B., Carbonnel, S., Zorman, M., David, D., & Pellat, J. (2003). Phonological and visual processing deficits can dissociate in developmental dyslexia: Evidence from two case studies. *Reading and Writing*, *16*(6), 541-572. <https://doi.org/10.1023/A:1025501406971>
- Valdois, S., Lassus-Sangosse, D., & Lobier, M. (2012). Impaired letter-string processing in developmental dyslexia: What visual-to-phonology code mapping disorder? *Dyslexia (Chichester, England)*, *18*(2), 77-93. <https://doi.org/10.1002/dys.1437>
- Vellutino, F. R. (1979). The Validity of Perceptual Deficit Explanations of Reading Disability: A Reply to Fletcher and Satz. *Journal of Learning Disabilities*, *12*(3), 160-167. <https://doi.org/10.1177/002221947901200307>
- Wolpert, I. (1924). Die simultanagnosie—Störung der gesamtauffassung. *Zeitschrift für die gesamte Neurologie und Psychiatrie*, *93*(1), 397-415. <https://doi.org/10.1007/BF02900065>
- Zoubrinetzky, R., Bielle, F., & Valdois, S. (2014). New insights on developmental dyslexia subtypes: Heterogeneity of mixed reading profiles. *PloS One*, *9*(6), e99337. <https://doi.org/10.1371/journal.pone.0099337>
- Zoubrinetzky, R., Collet, G., Serniclaes, W., Nguyen-Morel, M.-A., & Valdois, S. (2016). Relationships between Categorical Perception of Phonemes, Phoneme Awareness, and Visual Attention Span in Developmental Dyslexia. *PloS One*, *11*(3), e0151015. <https://doi.org/10.1371/journal.pone.0151015>

Étude 3

Limitation attentionnelle en recherche visuelle : surface ou
empan ?

Attentional limitation in visual search: space or span?

Vialatte A¹, Salemme R¹, Khan AZ², Pisella L¹

1 Integrative, Multisensory Perception Action & Cognition Team (IMPACT), Lyon
neuroscience Research Center (CRNL), France

2 School of Optometry, University of Montreal, Montreal, Canada, 2

Abstract

In a similar manner to patients with simultanagnosia, it has been thought that healthy individuals performing a serial search task explore objects one by one. The cost per item in reaction times suggests instead that a given group of stimuli is processed together for each task depending on visual complexity. Here we used the moving window paradigm in several serial visual search tasks to determine whether this group corresponds to a span (limited number of elements processed at each fixation) or to a working space (limited visual eccentricity at which the target can be identified) that can be mimicked by a circular gaze-contingent visibility window. Healthy individuals and a patient with simultanagnosia performed serial search tasks involving either symbols (made of separable lines) or full objects, and with distracters that were either all identical or all different. Search performance in a color task involving full objects and distracters all different was not affected by a given gaze-contingent visibility window of 30° diameter which corresponded to the task-specific « attentional field » used by the subjects in full view; this « working space », as well as the mean saccade amplitude used to displace it over the visual display, were independent of set-size. In the symbol task, a feature-absent search in which all feature-present distracters were dissimilar symbols, we observed that the mean saccade amplitude decreased with set size and that search performance could not be mimicked by a gaze-contingent visibility window of a single diameter; instead subjects seemed to process a fixed number of items (visual span). After bilateral lesion of the superior parietal lobule, the patient was not impaired in the color task. In contrast, her cost per item in the symbol task increased such as indicating that she has a clear deficit of simultaneous perception, i.e. a span of one item. These results confirmed that SPL damage affects only searches involving objects made of separable lines. When control participants use a fixed working space (balloon task), patient IG displays a similar search processing but with a smaller attentional field. When control participants turn to a different search process with a span limitation (symbol task) probably due to crowding, patient IG displays a reduced visual span.

INTRODUCTION

[Bálint](#) (1909) described a reduced functional “field of view” in a patient who manifested no attention for visual events appearing outside central vision, having neither a visual field deficit nor oculomotor paralysis. This component of the Balint’s triad consecutive to bilateral damage to the superior parietal lobule (SPL) is now often considered a deficit of objects’ simultaneous perception called simultanagnosia (a term coined by [Wolpert, 1924](#)). The original report of [Balint](#) (1909) already reflected the remaining ambiguity between a reduced “working space” or a reduced “working span” as perceptual consequence of bilateral posterior parietal damage: it described “an extreme restriction of visual attention, such that only one object is seen at a time” ([Bálint, 1909; Husain & Stein, 1988](#)).

With a similar ambiguity, it has been thought that healthy individuals performing a serial search task explore objects one by one. The effect of set-size (i.e. number of distracters) not corresponding to a fixed cost in reaction times per item instead suggests that a given group of stimuli is processed together for each task depending on visual complexity. A recent study ([Khan et al., 2016](#)) demonstrated that 1) visual search in healthy individuals was performed with a limited working space specific to a given task difficulty, as already stated by [Young & Hulleman](#) (2013), all objects falling within this working space being processed in one fixation, and that 2) simultanagnosia corresponded to a shrinking of this working space consecutive to bilateral SPL lesion, as already suggested by [Michel & Henaff](#) (2004), but only for stimuli made of separable lines. Indeed, healthy subjects performing the visual search tasks of [Khan et al](#) (2016) with gaze-contingent visible window of a given size exhibited a search time cost corresponding to a fixed off-set, irrespective of the number of distracters falling within this window (i.e. independent of set-size). Patient IG was significantly slow in feature-present and feature-absent visual searches and not in single feature or conjunction searches involving full objects ([Khan et al., 2016](#)). Furthermore, the gaze-contingent moving window paradigm demonstrated that this slowness was due to a reduced “working space”, i.e. a smaller visual eccentricity at which she could detect the target symbol in these conditions, irrespective of the number of objects falling in this working space. Indeed, patient IG’s mean search time in full view was comparable to the controls’ mean search time when they performed the pop-out balloon task with a gaze-contingent

moving visibility window of 15°, independent of the number of distracters present in the visual display (i.e; the set-size). Moreover, performing this pop-out balloon task with a gaze-contingent visibility window of 20° did not produce any cost in search time to find the target among 12, 24 or 48 distracters for this patient IG (Khan et al., 2016).

Interestingly, similar specific visual search deficit has been reported in developmental dyslexia. Casco & Prunetti (1996) tested several visual search displays of various difficulties in poor and good readers. They found that poor readers were not slower to detect targets when they were distinguished by a single feature of color or orientation, or by a conjunction of non-separable features (combination of orientation and color, or of orientation and shape). In contrast, they were slower when the target or the distractors involved complex geometrical shapes involving groups of separable features, regardless of whether the stimuli were non-verbal symbols or letters. They thus concluded that the visual search impairment in poor readers is observed only with shapes comprising a combination of lines. It has also been demonstrated that several dyslexics show a visuo-attentional (VA) span deficit (Bosse et al., 2007; Germano et al., 2014; Zoubrinetzky et al., 2014, 2016): they can only process a reduced number of distinct visual elements simultaneously (in one ocular fixation) due to limited visual attention capacity (Bogon et al., 2014; Lobier et al., 2013). Behaviorally, this visuo-attentional (VA) span deficit has been highlighted using the Global Report task in which a multi-consonant string is briefly and centrally presented on a computer screen and participants are required to orally report all the consonants. The string is presented for 200 ms to avoid its processing longer than one ocular fixation. The reduced span of report in dyslexics is not specific to letter strings since similar it is also observed for digits and other non-verbal symbols (Valdois et al., 2012a). However, the VA span deficit disappears when dyslexics are required to report the colour of five dots in a row (Valdois et al., 2012a) according to the specificity of VA impairment for stimuli made of separable lines reported in visual search in the Casco & Prunetti (1996) study. Neuroimaging studies have identified the superior parietal lobule (SPL) bilaterally as the neural substrate of reduced VA span in developmental dyslexia and the SPL as the key region for simultaneous process of multiple elements (Lobier et al., 2012a, 2012b, 2014; Peyrin et al., 2011, 2012; Reilhac et al., 2013). Recently patient IG was administered the Global Report task (Valdois et al., 2019). She was able to process fewer than 3 consonants simultaneously, both in conditions of large or normal spacing. This

pathologically reduced VA span in the Global Report task stands in contrast with the results of the visual search (Khan et al., 2016) in which patient IG exhibited a decrease of her “working space” irrespective of the number of elements to process within this working space at each fixation.

Here we aimed at determining in healthy individuals and in patient IG what are the factors determining whether visual search performance is based on a spatially limited working space versus a fixed number of objects, i.e. a span limitation. In the Khan et al (2016) study, visual searches involved distracters that were all identical, reducing the visual uncertainty, whereas in the Global Report task measuring the VA span, letters were all different (Bosse et al., 2007; Valdois et al., 2019). We argue that the fact that identical items can be grouped even in case of simultanagnosia (Luria, 1959) can explain why patient IG and healthy individuals displayed a spatially limited « working space » in visual search. Accordingly, in a recent study, patient IG was unable to identify a target in peripheral vision as soon as she was flanked by different distractors, but when the flankers were identical she could identify the central target (Vialatte et al., 2020). In the present study, we therefore varied not only the stimulus type (symbols versus full objects) but also the distractors (all the same versus all different). As in Khan et al. (2016), we used the gaze contingent moving window paradigm to measure how many elements can be processed simultaneously in healthy participants and in patient IG for each set-size.

If the group of stimuli processed simultaneously correspond to a variable number of objects falling in a limited « working space », it makes sense that this search window will have to be displaced to cover the entire visual display size in which the distractors are homogeneously distributed. This should be reflected by a mean number and mean amplitude of saccades performed to find the target independent of the set size. Because the size of the “working space” depends on the difficulty of the task (Young & Hulleman, 2013), it should be smaller when the task is more difficult. Consequently the number and amplitude of saccades will change depending on task difficulty but importantly not depending on set size. In contrast, if the group of stimuli processed simultaneously corresponds to a fixed number of objects (i.e. a limited span), then the mean number of saccades performed to find the target should instead increase and conversely saccade amplitude should decrease with set size.

METHODS

Case report

Patient IG was 49 year-old at the time of this experiment. She is a right-handed woman who suffered from an ischemic stroke when she was 29. The lesion involved all of area 7 and the intraparietal sulcus in both hemispheres, as well as the upper part of Brodmann's areas 19, 18 and 39 (corresponding to area PEG as defined by [Eidelberg & Galaburda, 1984](#)) but spared area 40 and the tempo-parietal junction (see Fig. 1a). Visual fields showed a partial right inferior homonymous quadrantanopia with temporal crescent sparing (Fig. 1b), due to the subcortical damage of the optical radiations below the parietal cortex in the left hemisphere. Her binocular vision and her visual acuity were normal (7/10 and 8/10 for the right and left eye respectively). She initially demonstrated a Balint syndrome (bilateral optic ataxia and simultanagnosia) without hemineglect. Her eye movements were completely normal during clinical assessment, with latencies and amplitudes similar to controls within the functional saccadic range: [Gaveau et al. \(2008\)](#) found deficits only for very far eccentricities, for example, 20° or greater, saccade amplitudes which are almost never used in everyday life as they would normally be implemented with a head contribution. Simultanagnosia was so severe initially that it prevented her from perceiving two dots presented simultaneously, but this recovered quickly ([Pisella et al., 2000](#)). During the acute phase, she reported that she could not clearly see more than one finger of her hand at once; she is now able to see "almost" all fingers simultaneously. 10 years after her ischemic stroke ([Khan et al., 2016](#)), she could correctly distinguish all the objects in overlapping figures, but the largest figure was reported late and last. She also struggled more than control participants (she was successful but took more time) to determine the exit of simple visual maze. For the Navon test ([Navon, 1977](#)), she did not show the classical global precedence effect of healthy controls: she was not slower in identifying the local letter when it was incongruent with the global letter (sH, hS) compared with when it was congruent (sS, hH). 15 years after her ischemic stroke, IG was administered a general neuropsychological screening battery to explore the cognitive long-term effects of her brain damage. She showed preserved executive functions, good verbal working memory and oral language abilities, good auditory attention and temporal attention shifting abilities, normal visual processing speed with single letters ([Valdois et al., 2019](#)). Only on-line visuo-motor guidance and visual attention were impaired.

A

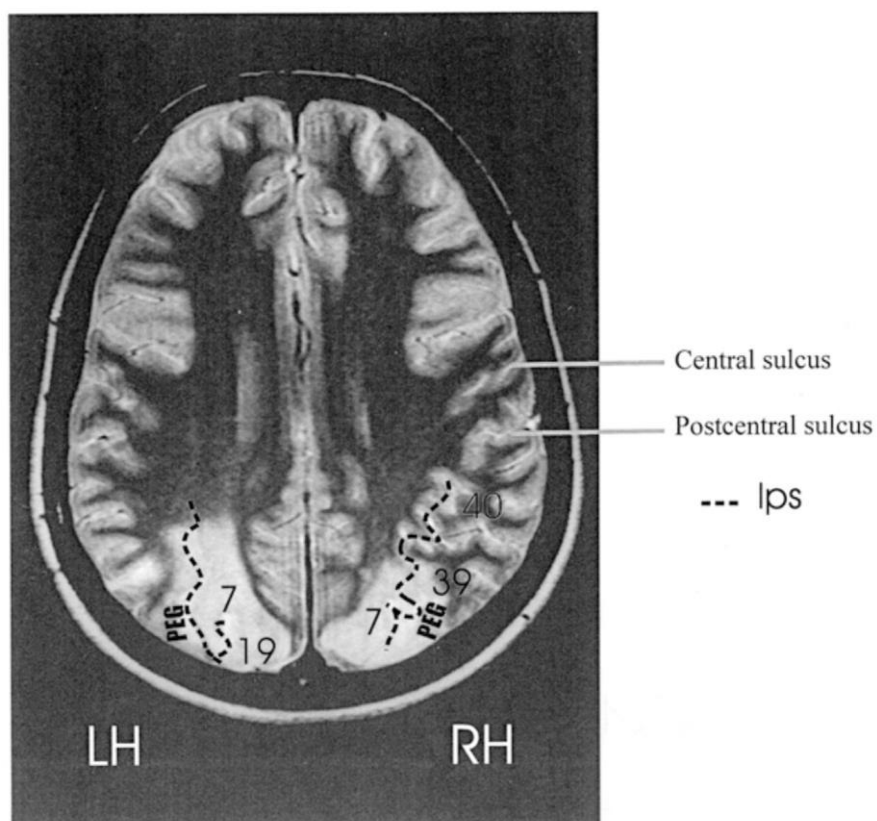

B

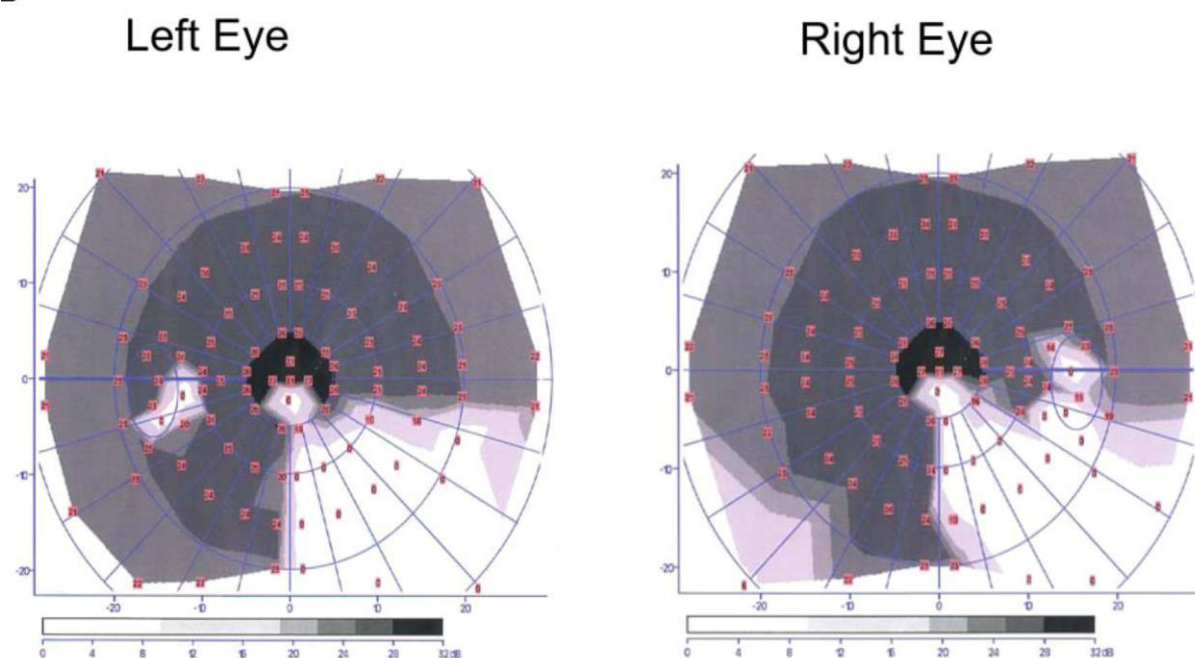

Figure 1 - A-Horizontal section through IG's brain, visualised with structural MRI. B- Visual field perimetry for patient IG showing quadrantanopia in the right lower quadrant of the visual field of both eyes.

Control participants

In addition, different groups of neurologically intact controls participated in the different tasks. 6 control participants (M= 38 years, age range = 24-55 years, 5 females) performed the 4 visual search tasks in full view and with a gaze-contingent quadrantanopic mask, 5 control participants (M= 30.4 years, age range = 24-43 years, 2 females) performed the color visual search tasks involving dissimilar distracters with several gaze-contingent visible windows of variable size and 6 control participants (M= 35.5 years, age range = 27-60 years, 3 females) performed the color visual search tasks involving dissimilar distracters with several gaze-contingent visible windows of variable size

Apparatus

Participants sat in a semi-dark room with their eyes at a distance of 57 cm from a high-speed CRT monitor (dimensions: 40 × 30 cm, refresh rate: 160 Hz), with their forehead and chin stabilized. Stimuli were presented on the screen using a real-time stimuli presentation (Visual Stimulus Generator ViSaGe, Cambridge Research System, Rochester, UK) along with custom-written code developed in the laboratory. Eye movements were recorded using a high-speed video Eyetracker (Cambridge Research System) at 1000 Hz. Participants responded using a ViSaGe response box.

Stimuli and tasks

The shape-color conjunction task (Fig 2A) consisted of finding a red disk among distracters that were red squares and green disks. The balloon feature-absent task (Fig 2B) consisted of finding a black circle (○) lacking a line among “balloons”. These two tasks were the same as in Khan et al. (2016).

Two new tasks were designed to be similar but to prevent perceptual grouping of the distracters (distracters all different). The color task (Fig 2C) consisted of finding the same red disk as the shape-color conjunction task but among disks of various colors. The symbol task (Fig 2D) consisted of finding the same black circle (○) as the balloon feature-absent task but among other black circles of variable sizes that were all combined with a line of different orientation and location.

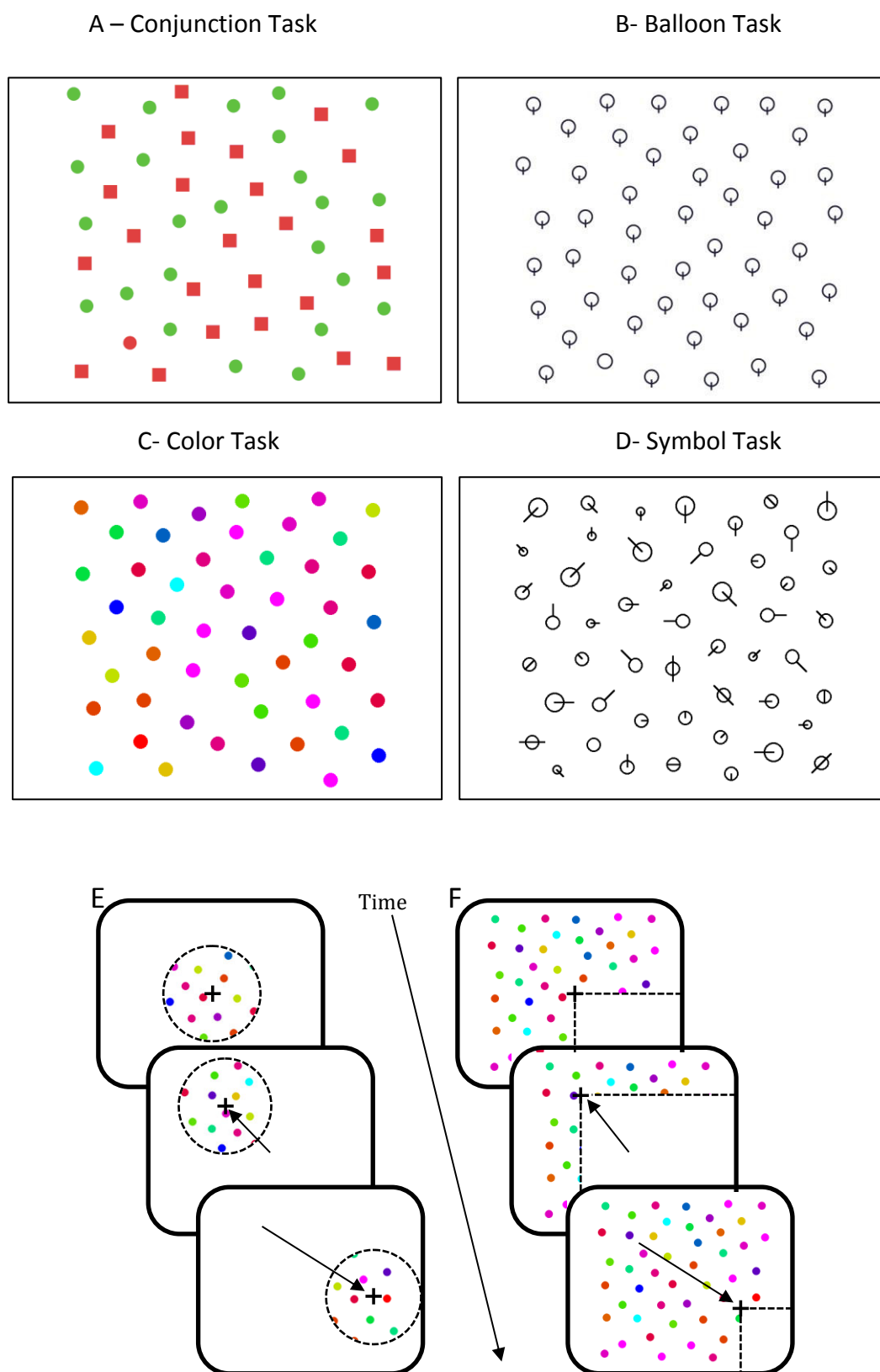

Figure 2 - The four visual search tasks (A: shape-color conjunction task, B: Balloon feature-absent task, C: Color task, D: Symbol task) illustrated for a set-size 49 and target in the lower left quadrant. Schematization over time of what participants actually see when performing the color task with the two different gaze contingent displays (E: reduced visibility window, F: quadrantanopic mask). Successive participant's gaze positions are indicated by a cross, saccades by an arrow.

For each task, a trial began with a fixation dot at the center of the screen. Once fixation on the dot was detected, the dot was replaced by the stimulus array. Participants were asked to press the right button on a response box as fast as possible with their right hand if they detected a target among distracters (target-present trials) and press the left button with their left hand if there was no target in the stimulus array (target-absent trials).

Each task consisted of 1 block of trials. Each block of trials consisted of 48 target-present trials (3 repeats of 16 trials for each group of 12, 24, or 48 distracters, corresponding to set-sizes of 13, 25 and 49 objects) and 6 target-absent trials (1 repeat of 2 trials of each set size) resulting in a total of 54 trials. Within each random sequence of 48 target-present trials, the target (1.3° diameter) appeared at an eccentricity of either 7.5° or 12.5° twice per quadrant. The distracters, depending on their number, were then distributed pseudo-randomly across the rest of the space with a minimum spacing of 1.3° between objects. The visual displays of different set-sizes were randomly intermingled within each block of trials.

Procedures

Six control participants and patient IG performed the 4 visual search tasks in the full view condition. For each task, each control participant ran 1 block of trials that represented 216 trials in total (54 per visual search task) and patient IG ran 3 blocks for each task.

The control participants also performed one block of each 4 tasks with a gaze-contingent quadrantanopic mask (Figure 2E right panel) to simulate the right lower quadrantanopia of the patient.

Five and six control participants (2 also performed the first part and the others are new control participants) additionally performed the color and the symbol tasks, respectively, with gaze-contingent visible windows (Figure 2E left panel) of 6, 10, 12.5, 15, 20, 25 and 30° diameters (one block each) for symbol task and 12.5, 15, 20, 25 and 30° diameters (one block each) for color task in order to investigate the attentional field used in these new tasks. The participants who did not participate at the first part also performed in full view and in quadrantanopia condition.

Data analysis

The total number of trials across the experiments for control participant was 6966 trials. Of those, 774 were target-absent trials (which were not analyzed) and 6192 were target-present trials. Patient IG performed 648 total trials, of which 576 were target-present trials. Target-absent trials represented 11% of total trials and were randomly presented among the target-present trials to avoid and check that the participants do not automatically press the target-present button. False-alarm errors (where the target was absent but was reported as present) represented 4% of the total target-absent trials for IG and 2.3% (SD= 2.3) for control participants. Incorrect trials (omissions, where the target was present but was reported as absent) comprised 0.5% of all trials for IG and 1% (SD= 0.9?) for control participant.

Only the correct target-present trials were analyzed. Search reaction times (RTs) were calculated for the trials with correct button presses as the difference between the time of the stimulus array onset and of the button press. Mean RT were computed for each set-size, subject and search condition.

The gaze-contingent conditions (Figures 2E and 2F) required on-line eye position analysis allowing the software to provide a gaze-contingent feedback.

For the off-line ocular behavior analysis, the scanning saccade detection threshold was set at $500^{\circ}/s$ and eye fixation was considered to have occurred if the gaze remained within a spatial dispersion threshold of 1.5° on both vertical and horizontal coordinates for at least 50 ms. Saccades that began between 0 and 100ms after the appearance of the stimulus array were considered anticipatory and were removed from the analysis. To take account of the decision time we also suppressed all saccades that took place within 70 ms of the button press time. Mean number of saccades, mean saccade amplitude and mean fixation durations (time >50 ms spent between consecutive saccade detections) were computed.

Statistics

Control participants' behavior analysis:

For each visual search task performed in the full view condition, we evaluated the set-size effect (13, 25 or 49 objects) using one way repeated-measures ANOVAs on the individual means of RTs, number of saccades, fixation durations and saccade amplitude.

The cost-per-item (CPI) was calculated for each task using linear fits across the 3 set sizes.

We also assessed the effect of gaze-contingent visibility windows of increasing diameters in the two new visual search tasks. The visible window diameters were 12.5°, 15°, 20°, 25 and 30° for the color task. For the symbol task, window diameters of 6 and 10° were also used. Two ways repeated-measures ANOVAs were performed on the mean individual RTs in order to evaluate the effect of the different window sizes and the 3 set-size (13, 25 or 49 objects). T tests *fdr* corrected were performed for each set size between performance in full view and with each window diameter to determine the larger window significantly affecting the RT (i.e. the larger window smaller than the attentional field of the controls).

Comparison between patient IG and controls performance:

To evaluate whether the parietal lesion of the patient (supposed to shrink the attentional field in specific conditions) affected her visual search in addition to her primary visual field deficit, we first compared patient IG's performance and control performance with gaze-contingent quadrantanopic mask. The mean RTs, mean number of saccades and mean fixation durations of patient IG were compared using modified Crawford t-tests (Crawford & Howell, 1998) to the mean and standard deviation of the same parameters computed for the control group performing the visual search tasks with a gaze-contingent mask simulating the right lower quadrantanopia of the patient.

If Patient IG's performance in a given visual search task was matched by Controls' performance with gaze-contingent quadrantanopic mask, then the patient was considered not having a high-level (visuo-attentional) deficit for this visual task. If not, we then compared IG's full view performance with controls' performance with gaze-contingent visibility windows of increasing diameters in order to determine whether the attentional deficit matched a fixed search field reduction. IG's performance was compared for each set size to the control performance with each window diameter using a Crawford test *fdr* corrected to determine the larger one which was not significantly different of her mean RT, i.e. the one that was the closest to her attention field.

RESULTS

Full view condition for control participants per set-size:

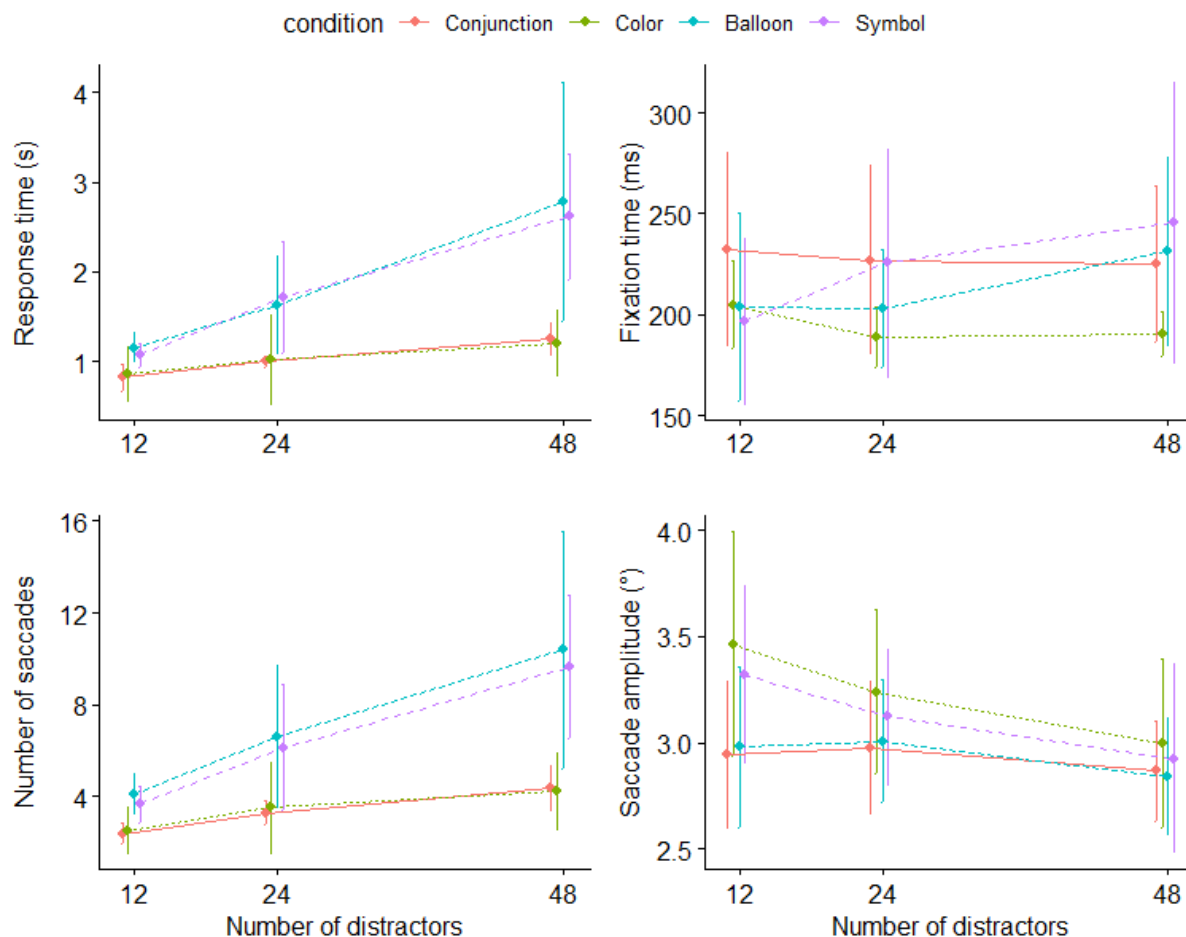

Figure 3 - controls' mean performance (RT, fixation time, number and amplitude of saccade) in the different visual search tasks

RT

One way ANOVAs performed separately for each task showed a significant effect of set size in all these serial tasks (all $F_s > 16$, $p < 0.05$). As can be seen in Figure 3A costs per item were 9.5 ms on average ($SD=2.9$) for the conjunction task, 9.2 ms ($SD=4.2$) for the color task, 30.3 ms ($SD=18.5$) for the balloon task and 41 ms ($SD=14.8$) for the symbol task. For the control participants, the conjunction task and the color task seem to involve a similar search processing, and the tasks involving stimuli made by separable features appear more “serial” (higher CPI), especially when distractors were all different.

Fixation time

One way ANOVAs revealed a non-significant set size effect for all tasks (all $F_s < 1.229$, $p > 0.333$, Fig. 3B).

Number of saccades

One way ANOVAs showed a significant set size effect for all tasks (all $F_s > 13.334$, $p < 0.05$). As can be seen in Figure 3C, the pattern was very similar to that of RT.

Saccade amplitude

One way ANOVAs showed a significant set-size effect only for the symbol task ($F(2,10) = 5.863$, $p < 0.05$): exploratory saccades were smaller for increasing set-sizes (Fig 3D, purple line). For the other tasks, the set size had no significant effect on saccade amplitude ($F_s < 1.936$, $p > 0.195$).

To sum up, mean RTs and saccade numbers increased with set-size for all visual search tasks, as a signature of a serial process of search. According to their CPI and previous results (Khan et al., 2016), the color and conjunction task seemed to be performed with a similar and fixed attentional field across set-sizes, and the balloon and symbol tasks seemed to be performed with a smaller group of stimuli at each fixation, that can explain the higher increase of RT across set-sizes. Fixation time could have been longer for these latter more difficult tasks and also longer for increasing set-sizes (especially when the search field used is fixed and more distracters are present within the fixed search window at each fixation) but this was not observed, suggesting that the target pops up in this attentional field. Only saccade amplitude seemed to distinguish between visual search tasks and predict the space versus span process. Indeed, it varied significantly across number of distractors only for the symbol condition (involving separable feature stimuli with dissimilar distractors).

Effect of gaze-contingent visibility windows of increasing diameters in controls:

Color task (figure 4)

A two-way repeated measures ANOVA revealed in control group a main effect of visibility window diameter ($F(6,24) = 44.3$, $p < 0.05$) and of set size ($F(2,8) = 40.8$, $p < 0.05$)

but no significant visibility*set size interaction effect($F(12,48)=1.25$, $p=0.28$), so this task was performed with a fixed attentional field of search across set-sizes, as it is the case for the conjunction and the balloon tasks (Khan et al. 2016).

Paired t - tests between RT in full view and the different visibility conditions showed that the window of 25°($p>0.05$, FDR corrected) was not different from the full view condition. In contrast, the 20° visibility condition had significantly higher RTs ($p<0.001$), such that the control group's attentional window (window where the subject is able to detect the target) could be estimated as larger than 20° diameter in this condition.

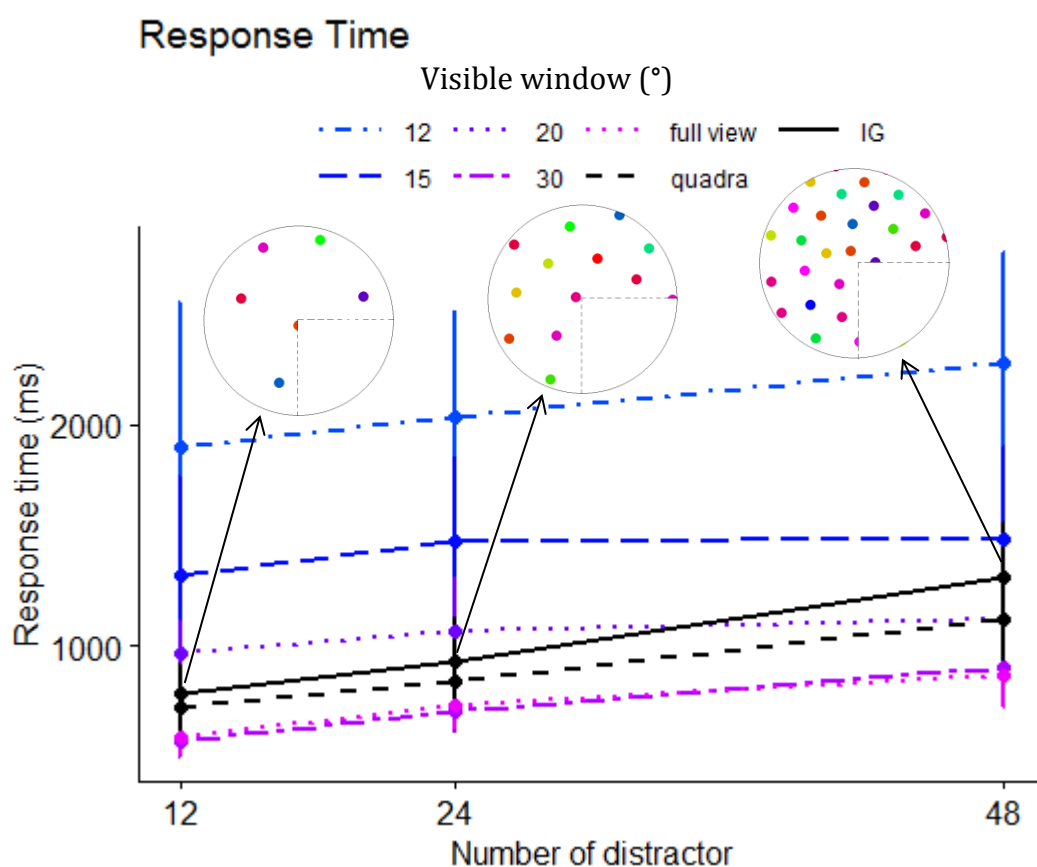

Figure 4: Effect of visible windows of increasing diameter on RT by set-size in controls, compared with IG RTs in full view condition in the Color task. Response time observed in control participants with a quadrantanopic mask simulating the patient's quadrantanopia is also illustrated because it matched the patient's performance, which was also not significantly different to the controls' performance with a circular gaze-contingent visibility window of 30°. The number of items probably processed at each fixation for each set-size by the patient is therefore illustrated by schematic disks of 30° diameter with a quadrantanopia. The results of the 25° visible window are not illustrated for sake of clarity.

Symbol task (figure 5)

For the symbol task in controls group, the two-way repeated-measured ANOVA revealed a main effect of visible window diameters ($F(7,35)=96.0$ $p<0.05$), a main effect of set-size ($F(2,10)=14.2$, $p<0.05$) and also a significant interaction between these two factors ($F(70,14)=2.2$, $p<0.05$). This significant interaction means that the RT of controls could not be fitted by a single reduced window that would correspond to a fixed limitation of the attentional field specific to the task irrespective of set-size. Instead, the visible window matching the RT in full view for controls was 25° for set-size 12, 15° for set-size 24 and 15° for set-size 48. This corresponded to 6-7 items at set-size 12, 5-6 items at set-size 24 and 8-10 items at set-size 48. This similar number of objects processed across set-sizes suggests that the symbol task was the only one performed with a visual span limitation rather than with an attentional “working space”/field limitation.

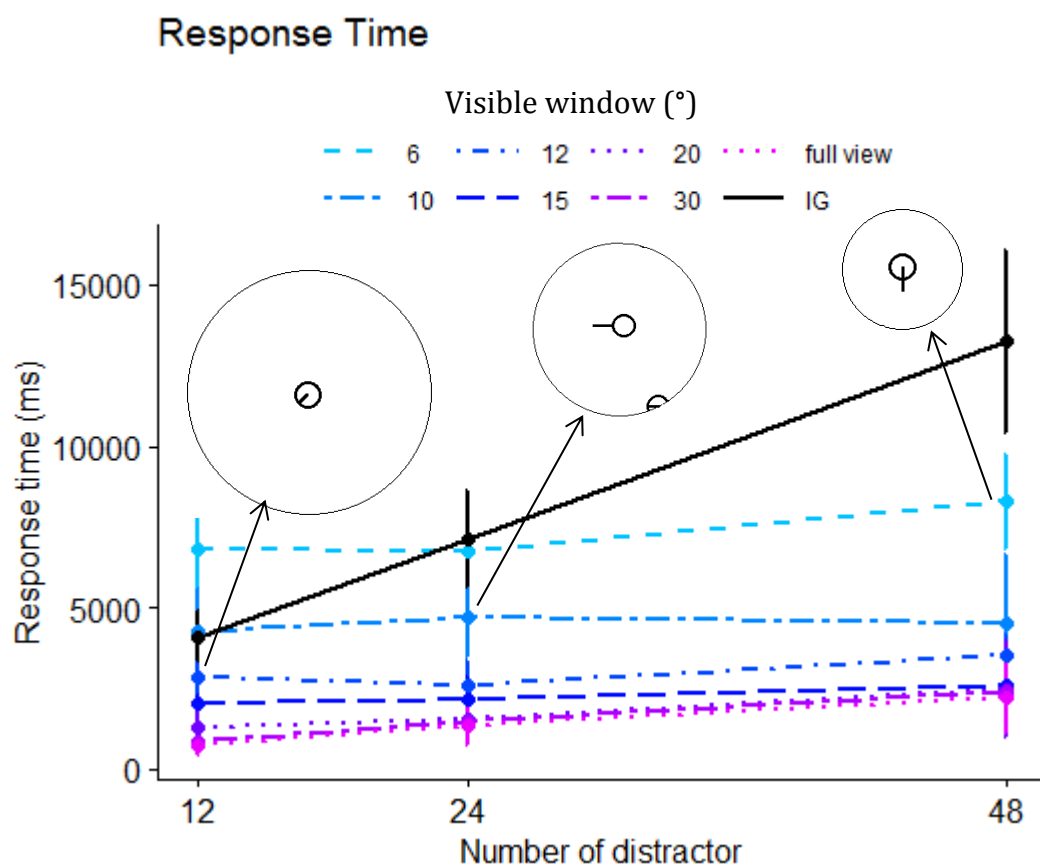

Figure 5 - Effect of visible windows of increasing diameter on RT by set-size in controls, compared with IG RTs in full view condition in the Symbol task. The visible window matching patient IG's RT in full view was 12° for set-size 12, 10° for set-size 24 and under 6° for set-size 48. The number of items probably processed at each fixation for each set-size by the patient is illustrated by schematic disks of corresponding decreasing diameter.

Comparison between patient IG's performance and control performance with gaze-contingent quadrantanopic mask:

RT

The cost per item of patient IG was on average 31.8 ms for the shape-color conjunction task, 14.8 ms for the color task, 125.4 ms for the balloon task and 253.8 ms for the symbol task. Thus, for IG, the color task was the easiest even though it involved stimuli that were all different, followed by the conjunction task, and the CPI massively increased for the tasks involving separable features, and even more when distractors were all different.

Patient IG was significantly slower than controls for all tasks (all $t > 3.6$, $p < 0.05$, FDR-corrected) except for the color condition (all $t_s < 0.31$, $p_s > 0.05$) and for the smaller set size of conjunction task ($t = 2.1$, $p > 0.05$) (Figure 6).

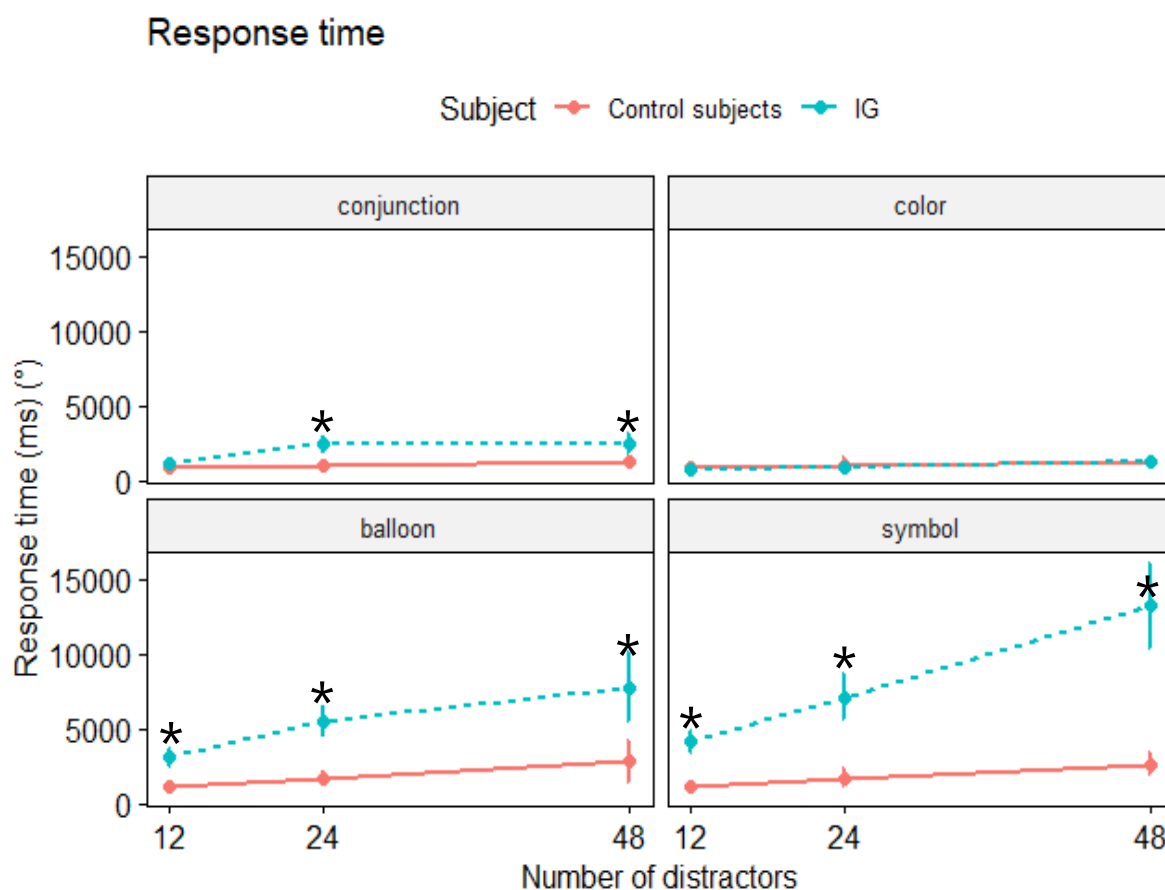

Figure 6: Response time (ms) for the 4 conditions, IG mean and inter-trials confidence interval in blue and control subjects with the quadrantanopic mask mean and inter-individual confidence interval in red. * = $p < 0.05$.

Fixation time

Patient IG's fixation times were not different from controls except for the two biggest set sizes in the color condition ($t > 5.5$, $p < 0.05$) (Figure 7).

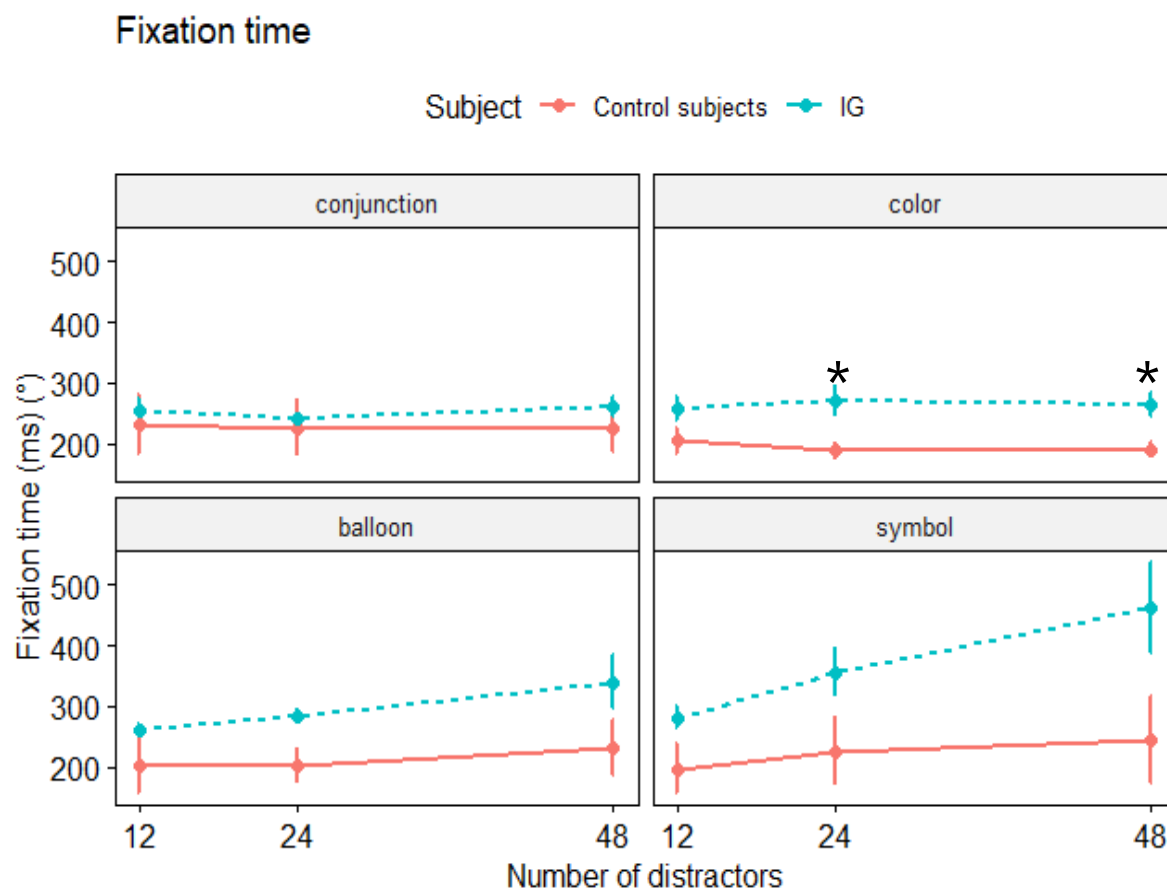

Figure 7 - Fixation time (ms) for the 4 conditions, IG mean and inter-trials confidence interval in blue and control subjects with the quadrantanopic mask mean and inter-individual confidence interval in red. * = $p < 0.05$.

Number of saccades

IG made no more saccades than controls for the color condition (all $t_s < 2.7$, $p_s > 0.05$). In the balloon condition, she made more saccades only for the smallest set size, while in the conjunction task she made more saccades for the two bigger set sizes. In the symbol task, she made more saccades for all three set sizes (all $t_s > 3.78$, $p_s < 0.05$) (Figure 8).

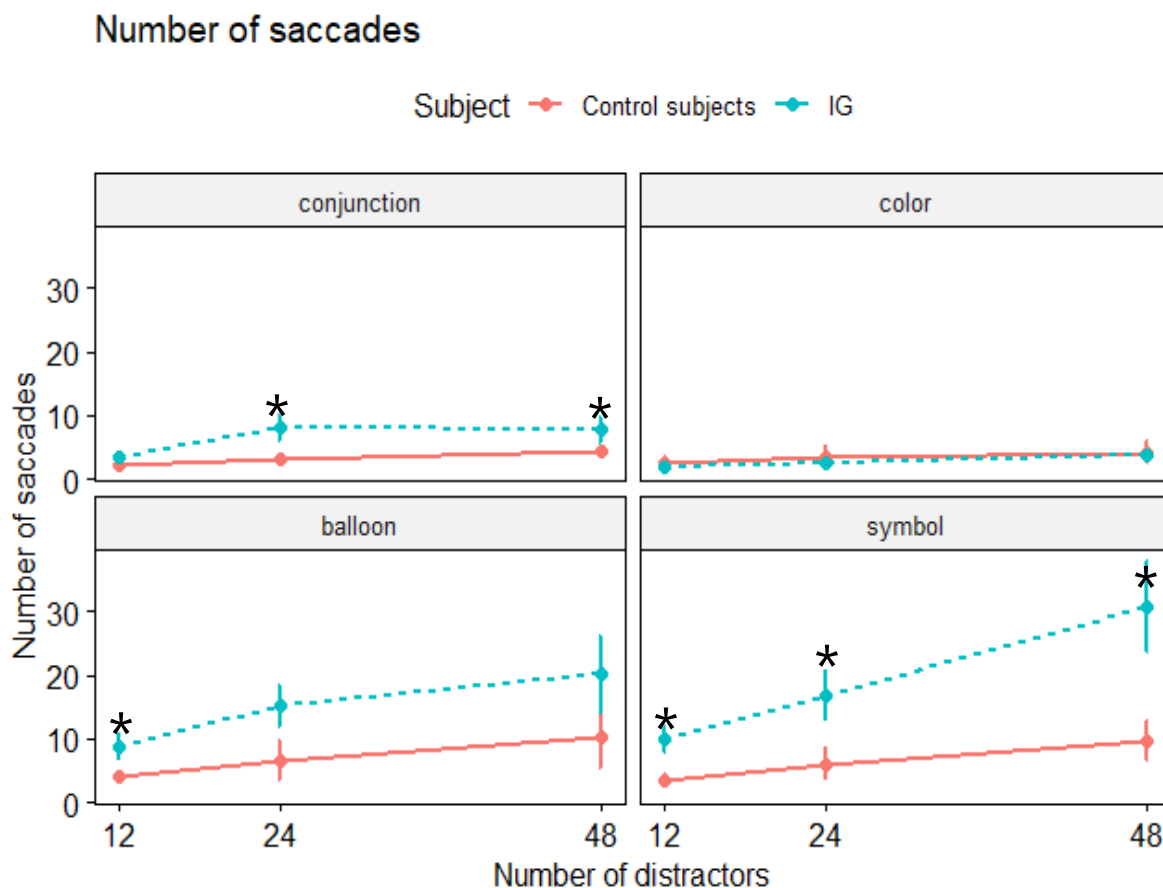

Figure 8 - Number of saccades for the 4 conditions, IG mean and inter-trials confidence interval in blue and control subjects with the quadrantanopic mask mean and inter-individual confidence interval in red. * = $p < 0.05$.

Saccade amplitude

IG saccade amplitudes were not significantly different from controls with quadrantanopia for all tasks (all $t < -2.3$, $p > 0.05$) except for the symbol task where p values equal to 0.05 were found at each set-size and for the balloon task at set-sizes 24 and 48 (Figure 9).

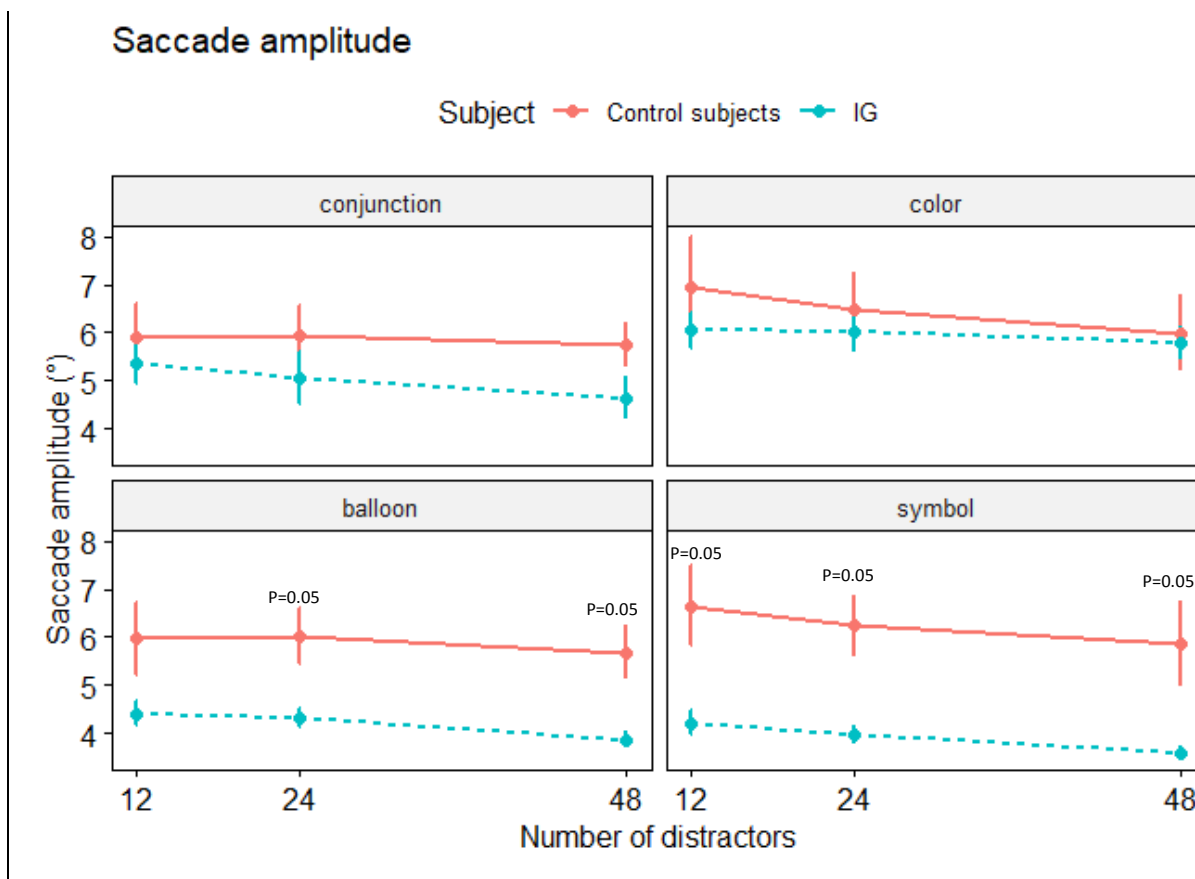

Figure 9 - Saccade amplitude (°) for the 4 conditions, IG mean and inter-trials confidence interval in blue and control subjects with the quadrantanopic mask mean and inter-individual confidence interval in red. * = $p < 0.05$.

To sum up, patient IG's RT was fully similar to controls with quadrantanopic mask only in the color condition, with nevertheless a higher fixation time observed in patient IG for the biggest set-sizes. In the conjunction task, the slight increase of RT observed for the biggest set-sizes in the present results for patient IG was reflected by a slight increase of the number of saccades. In the balloon and symbol tasks, the additional increase in RT was reflected by an increase of the number of saccades, and also by a decrease of saccade amplitude.

Comparison between IG's full view performance and controls' performance with different window diameters:

For the color task, the full view performance of patient IG matched the controls performance with quadrantanopic mask and the comparison between IG and control group with different visibilities using Crawford tests (fdr corrected) showed that IG was not significantly slower than controls with the largest visible window tested (30°) at each set-size. So IG is able, like control subjects, to process simultaneously at each fixation a large area containing several full objects in this color task, and containing an increasing number of items when set-size increases (figure 4).

For the symbol task where patient IG's performance did not match the controls' performance with quadrantanopic mask, we evaluated the attentional deficit consecutive to the SPL lesion of the patient by comparing her performance in full view at each set-size with those of the control group with window diameters bringing their performance at each set-size closed to patient IG's performance. The visible window matching patient IG's RT in full view was 12° for set-size 12, 10° for set-size 24 and under 6° for set-size 48 (corresponding to the larger control mask not significantly different with fdr corrected Crawford test). The number of objects possibly falling within these visibility windows corresponded to a fixed number of only 1 object: if a symbol was in the center of the window (fixated by IG) then no other symbol was visible in the window (figure 5). This scanning of the visual display object by object is in accordance with a number of saccades produced by patient IG on average in this task approaching the set-size (9 for set size 12, 15 for set size 24 and 28 for set size 48, see figure 8). This averaged number of saccades is logically smaller than set size because patient IG most often find the target before exploring the whole display.

DISCUSSION

The tenants of the VA theory of impaired reading performance argue that a subset of dyslexic children cannot process as many letters as normal reading children and therefore cannot develop any reading expertise. This VA impairment has been associated with SPL dysfunction (Lobier et al., 2012a, 2012b, 2014; Peyrin et al., 2011, 2012; Reilhac et al., 2013) and is viewed in the literature as a consequence of either a reduced VA Span (Lobier & Valdois, 2015; Valdois et al., 2019) or a reduced “spotlight” (Khan et al., 2016; Vidyasagar, 1999; Vidyasagar & Pammer, 2010). Here we tested several visual search tasks in control participants and in a patient with SPL dysfunction in order to determine whether their VA limitation was a span (i.e. a limited number of items as in working memory) or a space (or attentional field i.e. a spatially limited focus of attention around gaze fixation corresponding to the metaphor of the “spotlight”).

In the color task, the group of items processed in parallel at each fixation in control participants corresponded to a fixed spatial area in which a variable number of items could lie depending on set-size; the effect of reduced visible windows did not interact with set-size. Like controls, patient IG could process several items simultaneously at each fixation, even if the color task involved distracters that were all different and could not be perceptually “grouped”. Such fixed search attentional field was also demonstrated both for controls and for patient IG in the balloon task, a task involving separable features in a condition of identical distracters (Khan et al., 2016). In the balloon task however, Khan et al (2016) performed with a reduced spatial area, as confirmed by the present results. These results confirm her impairment to integrate multiple visual separable features and her preserved ability to process multiple “filled” objects (Khan et al., 2016; Vialatte et al., 2020), whether distracters are similar or not. This impairment is reflected by a space reduction when the visual search is performed in controls with a fixed attentional field (Balloon task).

In the symbol task, we found a significant interaction between set-size and visibility window diameters in control participants indicating that the group of items processed in parallel at each fixation rather corresponded to a fixed number of objects across set-sizes (actually estimated to 6-7 items at 12, 5-6 items at 24 and 8-10 items at 48). This task involving separable features and dissimilar distracters therefore involves, already in controls, a search processing limited by a visual span, thus different to the search processing limited by an attentional field used in the balloon task involving

separable features and identical distracters. Again, patient IG's performance in this task involving separable features did not differ in the nature of the search processing but was simply reduced compared to controls. Patient IG behaviour corresponded to the use of a visual span limited to one single item.

Patient IG's cost per item (CPI) overpassed 250 ms in this symbol task involving distracters combining only two separable lines but with different orientations and relative positions. As a comparison, her CPI reached 220 ms in the feature-absent character task of the study of [Khan et al. \(2016\)](#) in which all stimuli were "chinese-like" characters combining 4 (for the target) and 5 (for the distracters, all identical) separable lines. So the symbol condition appears harder because of its visual uncertainty due to distracters all different that cannot be visually "grouped", which seems to have a larger impact than having to visually integrate 5 separable lines for each item.

Visual grouping of distracters can also explain the switch between space and span limitation observed in control participants between the balloon and the symbol task. One can further speculate that when distracters are all different they cannot be perceptually grouped to alleviate crowding. Indeed, for 24 and 48 set size, the crowding effect was more important because the symbols were closer to each other at the extremity of the (fixed) visible window than in 12 set size, so maybe beyond 15° the participants could not identify the target among the other symbols lying in their attentional field due to this crowding effect at larger set-sizes. This would also explain that a task can be serial even though 1) RT increases with visible window reduction without interacting with set-size, 2) saccade amplitude does not significantly decrease with set-size and 3) the fixation duration does not significantly increase with set-size, as already shown by [Young & Hulleman \(2013\)](#) and confirmed by the present results. The saccade parameter that depends on set-size and reflects RT is rather the number of saccades. Even if a fixed spatial window of search is used irrespective of set-size, the items lying at the periphery of this working space may be crowded when set-size increases leading the participants to revisit this spatial area several times with a slightly different gaze position to check again the presence of the target.

Future investigations should determine whether participants would spontaneously use different search windows sizes per set-size if the number of distracters were blocked. Indeed, the use of a fixed spatial window of search was

demonstrated here for the color task and in the balloon task in [Khan et al. \(2016\)](#) in conditions blocked by task but intermingling randomly the different set-sizes.

In sum, when control participants use a fixed working space, patient IG displays a similar behavior with a smaller spatial area when the visual search involves stimuli made by separable features. When control participants turn to a different visual search process with a span limitation probably due to crowding as in the symbol task, patient IG turn to a processing of objects one by one. This drastic deficit of simultaneous perception was observed only in conditions overloading the number of separable features to integrate (as the character task of [Khan et al. 2016](#)) or drastically decreasing the visual predictability of distracters (as in the symbol task of the present study). Reading combines these two aggravating factors for a beginner with SPL dysfunction.

Acknowledgements:

The authors want to thank patient IG and the age-matched controls for their kind participation to this study funded by Centre national de la recherche scientifique (CNRS); Labex/Idex ANR11-LABX-0042 (France; grant to L.P.); Fondation de France (grant to A.V.).

References

- Bálint, R. (1909). Seelenlähmung des "Schauens", optische Ataxie, räumliche Störung der Aufmerksamkeit. *European Neurology*, 25(1), 67-81.
<https://doi.org/10.1159/000210465>
- Bogon, J., Finke, K., Schulte-Körne, G., Müller, H. J., Schneider, W. X., & Stenneken, P. (2014). Parameter-based assessment of disturbed and intact components of visual attention in children with developmental dyslexia. *Developmental Science*, 17(5), 697-713.
<https://doi.org/10.1111/desc.12150>
- Bosse, M.-L., Tainturier, M. J., & Valdois, S. (2007). Developmental dyslexia : The visual attention span deficit hypothesis. *Cognition*, 104(2), 198-230.
<https://doi.org/10.1016/j.cognition.2006.05.009>
- Casco, C., & Prunetti, E. (1996). Visual search of good and poor readers : Effects with targets having single and combined features. *Perceptual and Motor Skills*, 82(3 Pt 2), 1155-1167.
<https://doi.org/10.2466/pms.1996.82.3c.1155>
- Crawford, J. R., & Howell, D. C. (1998). Comparing an Individual's Test Score Against Norms Derived from Small Samples. *The Clinical Neuropsychologist*, 12(4), 482-486.
<https://doi.org/10.1076/clin.12.4.482.7241>
- Eidelberg, D., & Galaburda, A. M. (1984). Inferior parietal lobule. Divergent architectonic asymmetries in the human brain. *Archives of Neurology*, 41(8), 843-852.
<https://doi.org/10.1001/archneur.1984.04050190049013>
- Germano, G. D., Reilhac, C., Capellini, S. A., & Valdois, S. (2014). The phonological and visual basis of developmental dyslexia in Brazilian Portuguese reading children. *Frontiers in Psychology*, 5, 1169. <https://doi.org/10.3389/fpsyg.2014.01169>
- Husain, M., & Stein, J. (1988). Rezső Bálint and his most celebrated case. *Archives of Neurology*, 45(1), 89-93. <https://doi.org/10.1001/archneur.1988.00520250095029>
- Khan, A. Z., Prost-Lefebvre, M., Salemme, R., Blohm, G., Rossetti, Y., Tilikete, C., & Pisella, L. (2016). The Attentional Fields of Visual Search in Simultanagnosia and Healthy Individuals : How Object and Space Attention Interact. *Cerebral Cortex (New York, N.Y.: 1991)*, 26(3), 1242-1254. <https://doi.org/10.1093/cercor/bhv059>
- Lobier, M., Dubois, M., & Valdois, S. (2013). The role of visual processing speed in reading speed development. *PloS One*, 8(4), e58097. <https://doi.org/10.1371/journal.pone.0058097>
- Lobier, M., Peyrin, C., Le Bas, J.-F., & Valdois, S. (2012b). Pre-orthographic character string processing and parietal cortex : A role for visual attention in reading? *Neuropsychologia*, 50(9), 2195-2204. <https://doi.org/10.1016/j.neuropsychologia.2012.05.023>

- Lobier, M., Peyrin, C., Pichat, C., Le Bas, J.-F., & Valdois, S. (2014). Visual processing of multiple elements in the dyslexic brain : Evidence for a superior parietal dysfunction. *Frontiers in Human Neuroscience*, 8, 479. <https://doi.org/10.3389/fnhum.2014.00479>
- Lobier, M., & Valdois, S. (2015). Visual attention deficits in developmental dyslexia cannot be ascribed solely to poor reading experience. *Nature Reviews. Neuroscience*, 16(4), 225. <https://doi.org/10.1038/nrn3836-c1>
- Lobier, M., Zoubinetzky, R., & Valdois, S. (2012a). The visual attention span deficit in dyslexia is visual and not verbal. *Cortex*, 48(6), 768-773. <https://doi.org/10.1016/j.cortex.2011.09.003>
- Luria, A. R. (1959). Disorders of « simultaneous perception » in a case of bilateral occipito-parietal brain injury. *Brain: A Journal of Neurology*, 82, 437-449. <https://doi.org/10.1093/brain/82.3.437>
- Michel, F., & Henaff, M.-A. (2004). Seeing without the occipito-parietal cortex : Simultagnosia as a shrinkage of the attentional visual field. *Behavioural Neurology*, 15(1-2), 3-13. <https://doi.org/10.1155/2004/836830>
- Navon, D. (1977). Forest before trees : The precedence of global features in visual perception. *Cognitive Psychology*, 9(3), 353-383. [https://doi.org/10.1016/0010-0285\(77\)90012-3](https://doi.org/10.1016/0010-0285(77)90012-3)
- Peyrin, C., Démonet, J. F., N'Guyen-Morel, M. A., Le Bas, J. F., & Valdois, S. (2011). Superior parietal lobule dysfunction in a homogeneous group of dyslexic children with a visual attention span disorder. *Brain and Language*, 118(3), 128-138. <https://doi.org/10.1016/j.bandl.2010.06.005>
- Peyrin, C., Lallier, M., Démonet, J. F., Pernet, C., Baciou, M., Le Bas, J. F., & Valdois, S. (2012). Neural dissociation of phonological and visual attention span disorders in developmental dyslexia : fMRI evidence from two case reports. *Brain and Language*, 120(3), 381-394. <https://doi.org/10.1016/j.bandl.2011.12.015>
- Pisella, L., Gréa, H., Tilikete, C., Vighetto, A., Desmurget, M., Rode, G., Boisson, D., & Rossetti, Y. (2000). An « automatic pilot » for the hand in human posterior parietal cortex : Toward reinterpreting optic ataxia. *Nature Neuroscience*, 3(7), 729-736. <https://doi.org/10.1038/76694>
- Reilhac, C., Peyrin, C., Démonet, J.-F., & Valdois, S. (2013). Role of the superior parietal lobules in letter-identity processing within strings : fMRI evidence from skilled and dyslexic readers. *Neuropsychologia*, 51(4), 601-612. <https://doi.org/10.1016/j.neuropsychologia.2012.12.010>
- Valdois, Lassus-Sangosse, D., Lallier, M., Moreaud, O., & Pisella, L. (2019). What bilateral damage of the superior parietal lobes tells us about visual attention disorders in developmental dyslexia. *Neuropsychologia*, 130, 78-91. <https://doi.org/10.1016/j.neuropsychologia.2018.08.001>

- Valdois, S., Lassus-Sangosse, D., & Lobier, M. (2012). Impaired letter-string processing in developmental dyslexia : What visual-to-phonology code mapping disorder? *Dyslexia (Chichester, England)*, *18*(2), 77-93. <https://doi.org/10.1002/dys.1437>
- Vialatte, A., Yeshurun, Y., Khan, A. Z., Rosenholtz, R., & Pisella, L. (2020). Superior Parietal Lobule : A Role in Relative Localization of Multiple Different Elements. *Cerebral Cortex (New York, N.Y.: 1991)*. <https://doi.org/10.1093/cercor/bhaa250>
- Vidyasagar, T. R. (1999). A neuronal model of attentional spotlight : Parietal guiding the temporal. *Brain Research Reviews*, *30*(1), 66-76. [https://doi.org/10.1016/S0165-0173\(99\)00005-3](https://doi.org/10.1016/S0165-0173(99)00005-3)
- Vidyasagar, T. R., & Pammer, K. (2010). Dyslexia : A deficit in visuo-spatial attention, not in phonological processing. *Trends in Cognitive Sciences*, *14*(2), 57-63. <https://doi.org/10.1016/j.tics.2009.12.003>
- Wolpert, I. (1924). Die simultanagnosie—Störung der gesamtauffassung. *Zeitschrift für die gesamte Neurologie und Psychiatrie*, *93*(1), 397-415. <https://doi.org/10.1007/BF02900065>
- Young, A. H., & Hulleman, J. (2013). Eye movements reveal how task difficulty moulds visual search. *Journal of Experimental Psychology. Human Perception and Performance*, *39*(1), 168-190. <https://doi.org/10.1037/a0028679>
- Zoubrinetzky, R., Bielle, F., & Valdois, S. (2014). New insights on developmental dyslexia subtypes : Heterogeneity of mixed reading profiles. *PloS One*, *9*(6), e99337. <https://doi.org/10.1371/journal.pone.0099337>
- Zoubrinetzky, R., Collet, G., Serniclaes, W., Nguyen-Morel, M.-A., & Valdois, S. (2016). Relationships between Categorical Perception of Phonemes, Phoneme Awareness, and Visual Attention Span in Developmental Dyslexia. *PloS One*, *11*(3), e0151015. <https://doi.org/10.1371/journal.pone.0151015>

Étude 4

Localisation relative de multiples éléments différents : un rôle crucial du lobule pariétal supérieur

Superior Parietal Lobule : A role in relative localization of multiple different elements

A. Vialatte^{1,2,3}, Y. Yeshurun⁴, A. Z. Khan⁵, R. Rosenholtz⁶ and L. Pisella^{1,2,3}

1 Integrative Multisensory Perception Action & Cognition Team (ImpAct), INSERM U1028, CNRS UMR5292, Lyon Neuroscience Research Center (CRNL), Lyon, France,

2 University of Lyon 1, Lyon, France,

3 Hospices Civils de Lyon, Mouvement & Handicap, Neuro-Immersion Platforms, Lyon, France,

4 Psychology Department, University of Haifa, Haifa, Israel,

5 School of Optometry, University of Montreal, Montreal, Canada,

6 Department of Brain & Cognitive Sciences, Massachusetts Institute of Technology, Cambridge, MA, USA

ORIGINAL ARTICLE

Superior Parietal Lobule: A Role in Relative Localization of Multiple Different Elements

A. Vialatte^{1,2,3}, Y. Yeshurun⁴, A. Z. Khan⁵, R. Rosenholtz⁶ and L. Pisella^{1,2,3}

¹Integrative Multisensory Perception Action & Cognition Team (ImpAct), INSERM U1028, CNRS UMR5292, Lyon Neuroscience Research Center (CRNL), Lyon, France, ²University of Lyon 1, Lyon, France, ³Hospices Civils de Lyon, Mouvement & Handicap, Neuro-Immersion Platforms, Lyon, France, ⁴Psychology Department, University of Haifa, Haifa, Israel, ⁵School of Optometry, University of Montreal, Montreal, Canada and ⁶Department of Brain & Cognitive Sciences, Massachusetts Institute of Technology, Cambridge, MA, USA

Address correspondence to L. Pisella PhD, 16 avenue du doyen Lépine, 69676 Bron, France. Email: laure.pisella@inserm.fr.

Abstract

Simultanagnosia is an impairment in processing multiple visual elements simultaneously consecutive to bilateral posterior parietal damage, and neuroimaging data have specifically implicated the superior parietal lobule (SPL) in multiple element processing. We previously reported that a patient with focal and bilateral lesions of the SPL performed slower than controls in visual search but only for stimuli consisting of separable lines. Here, we further explored this patient's visual processing of plain object (colored disk) versus object consisting of separable lines (letter), presented in isolation (single object) versus in triplets. Identification of objects was normal in isolation but dropped to chance level when surrounded by distracters, irrespective of eccentricity and spacing. We speculate that this poor performance reflects a deficit in processing objects' relative locations within the triplet (for colored disks), aggravated by a deficit in processing the relative location of each separable line (for letters). Confirming this, performance improved when the patient just had to detect the presence of a specific colored disk within the triplets (visual search instruction), while the inability to identify the middle letter was alleviated when the distracters were identical letters that could be grouped, thereby reducing the number of ways individual lines could be bound.

Key words: crowding, object individuation, posterior parietal cortex, simultanagnosia, visual perception

Introduction

Vision is a sense that allows us to apprehend a relatively large space in one glance and to process in parallel, at least to some degree, the multiple objects lying in this space as well as their spatial relationship. We constantly face complex visual scenes, and we have to process multiple elements simultaneously (e.g., leaf, trunk, branch) in order to ascertain a global meaning (e.g., a tree, a forest). Consecutive to extensive bilateral occipito-parietal damage, patients exhibit “an extreme restriction of visual attention, such that only one object is seen at a time” (Bálint 1909; Husain and Stein 1988). Later, Wolpert coined the term “simultanagnosia” for these patients (Wolpert 1924).

More recent studies of patients with more focal lesions (or using voxel-based morphometry in patients with diffuse posterior cortical atrophy) have refined the neural substrate underlying simultanagnosia: the superior parietal lobule (SPL) is specifically involved (Khan et al. 2016; Neitzel et al. 2016; Valdois et al. 2019). These studies and others (e.g., Luria 1959; Naccache et al. 2000; Jackson et al. 2006; Demeyere et al. 2008; Thomas et al. 2012; Chechlacz et al. 2015; Strappini et al. 2017) have also further questioned the level (perceptual or attentional) and the underlying neurocognitive mechanisms possibly causing simultanagnosia. For example, Luria (1959) observed that his patient reported only one shape when two different simple

shapes were presented simultaneously, but shape perception was facilitated when the two presented shapes were identical. Based on this modulation of the patient's performance by perceptual grouping, Luria (1959) suggested a deficit at the attentional level (for the relationships between attention and perceptual organization processes, see Kimchi et al. 2007; Yeshurun et al. 2009). Alternatively, Neitzel et al. (2016) showed that simultaneous visual processing ability correlated with visual short-term memory performance and visual processing speed in patients with diffuse posterior cortical atrophy. The present paper pursues this line of research aimed at elucidating the nature of simultanagnosia and the role of SPL in vision.

Simultaneous visual processing is particularly necessary for reading, and the literature on simultanagnosia is often referred to in the literature of developmental dyslexia (Bogon et al. 2014; Valdois et al. 2019). A subset of dyslexic children show a reduced letter span at the Global Report task: shown a string of letters flashed in central fixation, they can report fewer letters than age-matched controls, whereas they can identify a single letter as fast as normal readers (Bosse et al. 2007; Lassus-Sangosse et al. 2008; but see Bogon et al. 2014). Neuroimaging studies (Peyrin et al. 2011, 2012; Lobier et al. 2012, 2014; Reilhac et al. 2013) have shown bilateral SPL hypoactivation in these developmental dyslexics compared with normal readers. In normal readers, SPL activation increases bilaterally when a visual categorization task is performed on multiple objects simultaneously compared with when the same task is performed on a single object. Suggested by these correlational results, the causal link between SPL activation and the ability to recognize multiple objects in a single fixation has been recently established thanks to the study of patient IG, a rare patient with focal and bilateral acquired lesion of the SPL. In the Global Report task with five letters presented simultaneously in central fixation for 200 ms, patient IG also showed a reduced letter span (Valdois et al. 2019). In a control task in which individual letters were rapidly flashed alone serially for 200 ms in central vision, patient IG performed successfully. Taken into consideration with other tasks presented in Valdois et al. (2019), this ruled out the possibility of a general slowing of visual perception or of reduced visual short-term memory capacity following focal bilateral SPL lesion (contrary to other patients' reports in the literature: Neitzel et al. 2016).

The performance consecutive to bilateral SPL lesions resembles developmental dyslexics' performance, not only in the Global Report task but also in visual search. Khan et al. (2016) presented to patient IG several versions of classical visual search arrays where a single target is presented among identical distracters for an unlimited duration (until detection). The time required to find the target was measured. Patient IG performed a pop-out visual search for a unique shape (find a red disk among red squares) as well as a shape and color conjunction search (find a red disk among red squares and green disks) as fast as controls. This preservation of parallel multiple object processing in visual search could be due to the fact that patient IG could perceptually "group" the identical distracters, while in the Global Report task strings of five different consonants were presented. However, she performed more slowly than controls in simple feature-present (e.g., the simplest task required to find Q among O) and feature-absent (e.g., the simplest task required to find O among Q) visual searches, even though she could similarly group the distracters. It was concluded from patient IG's performance that bilateral damage to the SPL impairs simultaneous visual processing specifically in condition requiring spatial integration

of separable lines. This specific visual search deficit for figures made of multiple lines ("multifeatured shapes") had previously been reported for poor readers (Casco and Prunetti 1996); for example, the authors showed that poor readers were as fast as controls to find a single tilted line among vertical or horizontal ones, but difficulties arose when this unique tilted line of the visual display was spatially combined with others to make a symbol. Like patient IG, poor readers showed no deficit in searches for simple features or conjunction of features like color and geometrical shapes. Khan et al. (2016) further demonstrated that this slow search performance for visual displays involving combined separable lines in patient IG corresponded to a reduced visuo-attentional field that could be mimicked in healthy controls by a reduced visible window whose size depends on the visual complexity of the stimuli but not on the number of distracters falling in this window. The impairment of simultaneous visual processing of patient IG was therefore attributed to a reduction of the size of the spotlight of attention.

Intriguingly, several aspects of this phenomenology have parallels with visual crowding. Crowding refers to difficulty performing visual tasks in the presence of clutter, for example, reduced ability to recognize an object when it is surrounded by distracters, in comparison to when the object appears in isolation. Crowding has been implicated in visual search difficulty; difficulty identifying a crowded peripheral target predicts difficulty for pop-out, conjunction, and feature-present versus feature-absent search (Rosenholtz et al. 2012). Furthermore, crowding has been described in terms of an "uncrowded window" (Pelli and Tillman 2008), the size of which depends on the complexity of individual items (Hulleman and Olivers 2017).

In the Global Report task, patient IG reported the unflanked letters (the first and last ones) but rarely the middle ones (flanked by other letters), but this reduced letter span was independent of spacing (Valdois et al. 2019). In crowding, too, observers can more readily report the first and last items in a peripheral string than the letters in the middle of the string (Bouma 1970). Crowding mainly occurs in peripheral vision but also in central vision, the crucial parameter is the interstimuli distance—as this distance increases, performance increases, and when this distance is large enough (larger than the "critical distance"), the distracters no longer affect performance (Bouma 1970; Toet and Levi 1992; Pelli et al. 2004). Nonetheless, the connections between crowding and simultaneous visual processing following focal bilateral SPL damage might suggest that a lesion of the SPL could produce a form of excessive crowding. A common or related mechanism for crowding and clinical vision has been previously proposed for amblyopics (Greenwood et al. 2012), for dyslexics (Martelli et al. 2009), and for patients with occipito-temporal damage (ventral visual stream, Strappini et al. 2017; Sand et al. 2018).

The present study will explore this hypothesis for patients with damage of the dorsal visual stream by exploring in more depth the performance of patient IG in crowding tasks. We examined performance in identifying a crowded target in both central and peripheral vision, and in particular, we examined the extent to which patient IG's performance remains immune to the spacing between target and distracters. Furthermore, crowding causes loss of location information; for simple objects, this can lead to reporting a distracter instead of the target (Strasburger 2005; Van den Berg et al. 2012), while for more complex figures made up of multiple lines, this loss can cause a jumbling of features between items (Chang and Rosenholtz 2016).

Here, by varying the task (identification of an item at a specific middle location vs. visual search) and the type of stimuli (colored disks vs. letters), we examine loss of location information in patient IG. Finally, a number of researchers have also reported relief from crowding when the two items flanking the target are similar to each other but dissimilar from the target (Livne and Sagi 2007; Saarela et al. 2009; Freeman et al. 2012). We examine the effects of flanking the target with identical distracters for patient IG.

Methods

Participants

Patient IG was 45 at the time of this experiment. When she was 29, she suffered from an ischemic stroke related to acute vasospastic angiopathy in the posterior cerebral arteries, established with an angiogram. Magnetic resonance imaging revealed a hyperintense signal on T2 sequencing that was fairly symmetrically located at the upper and lateral occipito-parietal junction, cortically and subcortically. Reconstruction of the lesion (Pisella et al. 2000; Khan et al. 2016) indicated that it involved mainly the intraparietal and the parieto-occipital sulci with full damage to Brodmann's area 7 in the SPL, but there was also limited damage to the dorsal lateral part of Brodmann's areas 19 and 18 and to the upper part of the angular gyrus (BA39) in the inferior parietal lobule (Fig. 1). Patient IG presents with bilateral optic ataxia, which remains chronic but never presented with either hemispatial neglect or oculomotor apraxia. Her eye movements were completely normal at clinical assessment, with latencies and amplitudes similar to controls within the functional saccadic range: Gaveau et al. (2008), for example, found deficits only for very far eccentricities, 20° or greater. Such saccade amplitudes are almost never used in everyday life as they would normally be implemented with an accompanying head movement. Patient IG has a quadrantanopia in the right bottom quadrant of the visual field of both eyes, due to subcortical damage of the optic radiations below the SPL in the left hemisphere. Visual stimuli will thus be presented slightly above the ocular fixation in central vision and in the left visual field in peripheral vision. She also presents with mild chronic simultanagnosia. Initially, her simultanagnosia was so severe that it prevented her from perceiving two disks presented simultaneously, but this recovered quickly (see Pisella et al. 2000). During the acute phase, she reported that she could not clearly see more than one finger of her hand at once; she is now able to see "almost" all fingers simultaneously. For the Navon test (Navon 1977), she did not show the classical global precedence effect of healthy controls: she was not slower in identifying the local letter when it was incongruent with the global letter (sH, hS) compared with when it was congruent (sS, hH). Note that for most simultanagnosic cases reported in the literature, patients tend to have larger lesions that are progressive (e.g., neurodegenerative disease such as posterior cortical atrophy) and tend to be older, with ages of around 50 and up (Gilchrist et al. 1996; Clavagnier et al. 2006; Dalrymple et al. 2007; Huberle et al. 2010; Thomas et al. 2012), and therefore tend to have more severe symptoms (e.g., cannot report the global letter in the Navon test at all) including associated symptoms such as aphasia, alexia, neglect, constructional, or oculomotor apraxia. In contrast, patient IG's performance on tests of intellectual efficiency, general executive and attentional functions, language, and motor and visual abilities was normal (Valdois et al. 2019).

We also tested four age-matched control participants, three females and one male (mean age = 41.75 ± 12.66, age range = 28–58). They had no history of neurological or psychiatric disorders, and they had normal vision at the experimental distance.

All experimental procedures were approved by the French health research ethics committee (CPP Nord-Ouest I, Lyon, 2017-A02562-51).

Apparatus

Participants sat in a semidark room with their eyes at a distance of 80 cm from a high-speed CRT monitor (dimensions: 40 × 30 cm, 800 × 600 pixels, refresh rate: 160 Hz), with their forehead and chin stabilized. Stimuli were presented on the screen using a real-time stimuli presentation (Visual Stimulus Generator ViSaGe; Cambridge Research System) along with custom-written code developed in the laboratory. Eye position was recorded using a high-speed video Eyetracker (Cambridge Research System) at 1000 Hz. Subjects responded using a ViSaGe response box.

Stimuli and Procedure

The size of the stimuli was 0.8° of visual angle presented on a white background (R255, G255, B255). In the color conditions, disks of three possible colors could be presented: RGB, blue (R118, G118, B148), red (R148, G118, B118), and green (R118, G148, B118); we used also gray disks (R120, G120, B120) in Experiment 3. In the letter conditions, three possible letters could be presented: F, N, and T; we also used the letter X in Experiment 3.

In all tasks, a trial was composed of a 400 ms fixation cross, followed by stimuli presentation for 90 ms (except in the variant of Task 2 in which target duration varied). Next, a response screen was presented that remained until the participant pressed the button (Fig. 2). Throughout each trial, we asked the participant to keep fixating the central cross. This was controlled on-line by the eye tracker (if the eyes moved, the trial was aborted and replayed at the end of the block).

Experiment 1: Is There a Critical Spacing in Central or Peripheral Vision?

Tasks

Patient IG and the four age-matched control participants ran three tasks in Experiment 1, in which they had to respond whether the target was "red", "blue," or "green" in the color conditions and "F", "N," or "T" in the letter conditions by pressing three different buttons (forced choice, chance level was 1/3).

Single Target Presentation Task

This task consisted of presenting one of the three possible targets (letter or color in different blocks) by itself (without distracters) at different eccentricities (0°, 3°, 7°, and 10°). The goal of this task was to ensure that each participant was able to distinguish isolated colors or letters at different visual eccentricities. In each block, each of the three possible targets was presented 10 times at the 4 eccentricities, distributed pseudo-randomly. Two blocks, one for letter and one for the color condition, were performed, one at the beginning and one at the end of the experiment. There were a total of 240 trials for each letter and color condition.

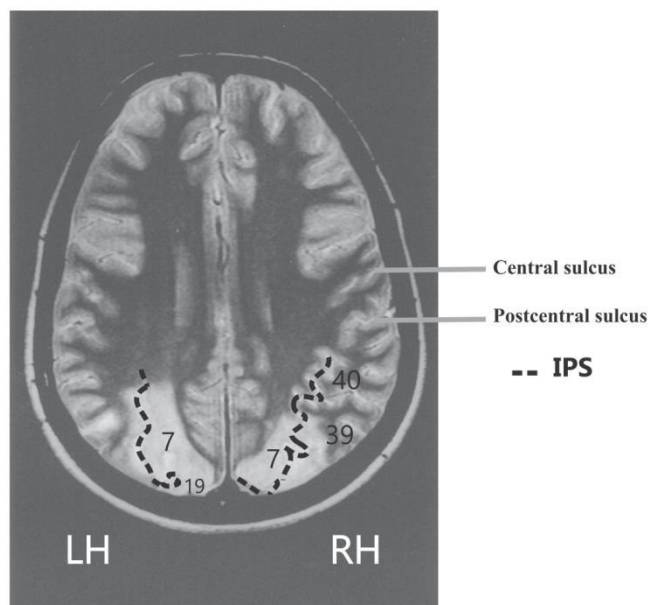

Figure 1. Horizontal (axial) T2-weighted magnetic resonance section of patient IG's brain (at z coordinate = 85 in standard Talairach space) showing fairly symmetric bilateral lesion involving mainly the intraparietal sulcus (IPS, dotted line) and Brodmann's area 7 in the superior parietal lobule (SPL). LH: left hemisphere. RH: right hemisphere.

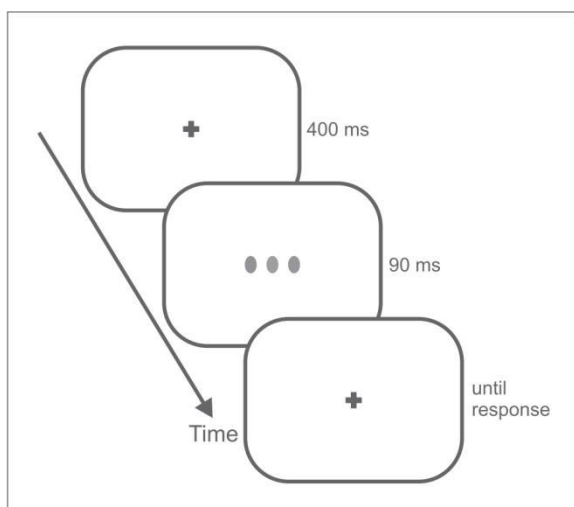

Figure 2. Trial sequence. Each trial began with a central fixation cross for 400 ms on which the participant was asked to fixate. Next the stimuli (in this case, the three colored disks for the central vision colored condition) were presented briefly for 90 ms. This was followed by the reappearance of the central fixation dot that remained until the participant entered a response.

Central Vision Crowding Task

This task consisted of presenting the target in central vision (0°), for 90 ms, flanked by two stimuli with target–distractors spacing of 0.8° , 1.5° , and 3° . The distracters had the same three possible colors or letters as the target. The task was to identify the middle target. One of the distracters was the same as the target in 28% of the trials to avoid inferring the target identity from the distracters alone. Each of the 3 possible targets was presented 14

times at the 3 different spacing, distributed pseudo-randomly. There was a total of 126 trials each for the letter and color conditions. In separate blocks, we also varied the duration of stimuli presentation (90, 110, 130, 150 ms) while spacing remained fixed at 0.8° . Each of the 3 possible targets was presented 18 times at the 4 different durations, distributed pseudo-randomly. There were a total of 216 trials each for the letter and color conditions.

Peripheral Vision Crowding Task

This task consisted of presenting 1 of the 3 possible targets (letter or color in different blocks) in peripheral vision at different eccentricities (3° , 7° , 10°) and with different spacing (target–distracter center-to-center distance) as follows:

For the letter condition:

- Eccentricity 3° : 0.8° , 1° , 1.5° , 2° , 2.5°
- Eccentricity 7° : 1° , 1.5° , 2.5° , 3.5° , 5° , 6°
- Eccentricity 10° : 2° , 3° , 4° , 5° , 6° , 7°

For the color condition:

- Eccentricity 3° : 0.8° , 1° , 1.5° , 2° , 2.5°
- Eccentricity 7° : 0.9° , 1° , 1.5° , 2° , 3.5° , 5°
- Eccentricity 10° : 1° , 1.5° , 2° , 3.5° , 5° , 6°

For example, for the 3 eccentricity with 0.8° spacing, the distracters would appear at 2.2° and at 3.8° aligned horizontally. The participant's task was to identify the middle target. Each of the 3 target colors (or letters) was presented 14 times at the 3 peripheral eccentricities and at the different spacings described above, distributed pseudo-randomly. The distracters had the same three possible colors or letters as the target. One of the distracters was similar to the target in 28% of the trials to avoid inferring the target identity solely from the identification of the two distracters. Overall, there were a total of 966 trials each for

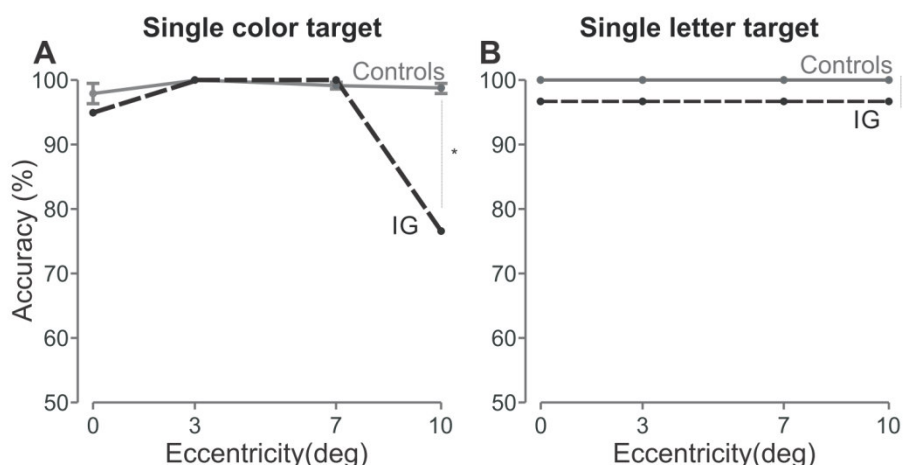

Figure 3. Single target presentation conditions. Performance for IG (dotted black line and dots) and controls (gray line and dots) is shown for the color (A) and letter (B) conditions as a function of target eccentricity. The y-axis (range 50–100%) represents accuracy in correctly identifying the color or letter presented. * $P < 0.05$. Error bars are standard deviations across control participants.

the letter and color conditions. Breaks were offered every 161 trials.

Procedure and Data Analysis

The central vision crowding task was run first. The single target presentation task was then run before and after the peripheral crowding task. The performance of patient IG was compared with the averaged control performance using modified paired *t*-tests designed specifically to test whether single subject's (patient) data fall within the range of control data, using the control group's mean and SD. They provide a robust comparison of a single data point against a small group of controls for single case studies (Crawford and Howell 1998; Crawford and Garthwaite 2002). The performance of all participants was also compared with chance level using unilateral Fisher's exact tests. We corrected for multiple comparisons using Bonferroni family-wise error rates.

Experiment 1—Results

Single Target Presentation Task

As can be seen in Figure 3, IG's accuracy in the letter condition (3B) was very high for all eccentricities (96.67%) but still lower than controls who performed at ceiling (Crawford test, all $P > 0.001$ all $t(3) < -inf$). For color condition only, the furthest eccentricity accuracy (76.7%) was lower than controls (Crawford test $P < 0.01$ $t(3) = -11.84$). Her accuracy, like controls, nevertheless remained largely above chance level at all visual eccentricities (unilateral Fisher's exact test, Bonferroni corrected, all $P < 0.05$). In summary, IG was able to identify single color and letter targets in peripheral vision.

Central Crowding Task

When the target and distracters were presented at central vision, there were significant differences in performance between IG and the controls. For the color condition (Fig. 4A), performance was significantly lower for IG compared with controls with all three spacing (0.8°, 1.5°, and 3°, Crawford test all $P < 0.001$; $t(3) < -26$). In the letter condition (Fig. 4B), her performance was significantly worse than controls for the 0.8° and 1.5° spacing

(Crawford test all $P < 0.01$; $t(3) < -9.4$) but was very high and similar to controls for the 3° spacing (Crawford test $P > 0.1$ $t(3) = -0.13$). Note, however, that with both conditions (color and letter), IG's performance remained above chance level at all spacing (unilateral Fisher's exact test all $P < 0.05$). In summary, when the target was flanked by other colors or letters in central vision, accuracy decreased greatly for patient IG while control performance remained at ceiling.

Increasing stimulus presentation duration did not improve the patient's performance (Fig. 4C and D); performance remained similar even when duration increased from 90 to 110, 130, or 150 ms. This reinforces the idea that IG's performance cannot be explained by a deficit of short-term visual memory (see also Valdois et al. 2019), as at longer durations, the stimuli are onscreen long enough not to require memory to perform the task.

Peripheral Crowding Task

Next, we investigated performance for three stimuli presented simultaneously in the periphery. Figure 5 depicts individual participant performance for the three eccentricity conditions (3°—blue, 7°—red, 10°—green lines) as a function of target-distracter spacing. The left panel depicts performance in the color conditions, while the right panel depicts performance for the letter conditions. As can be seen in Figure 5A–H, the four age-matched controls showed a classical increase in accuracy with increased target-distracter spacing (e.g., Bouma 1970; Toet and Levi 1992; Pelli et al. 2004), in both letter and color conditions. They also showed asymptotic performance with increasing eccentricity for a certain target-distracter spacing (e.g., Bouma 1970; Toet and Levi 1992; Latham and Whitaker 1996; Strasburger 2005; Yeshurun and Rashal 2010). At least four spacing by eccentricity were above chance level (unilateral Fisher's exact test, corrected Bonferroni). In contrast, when the target (color disk or letter) was presented with distracters, the performance of patient IG (Fig. 5I,H) remained at chance level regardless of target eccentricity and spacing (unilateral Fisher's exact test $P_s < 0.05$). In summary, IG was unable to correctly identify the flanked target in either the color or letter conditions.

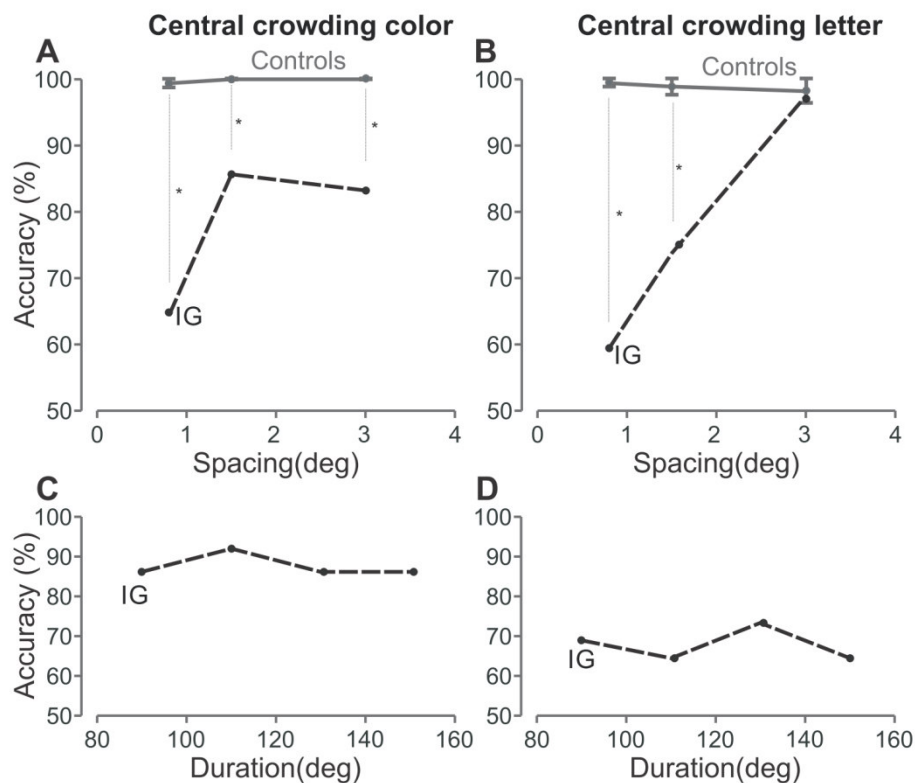

Figure 4. Central crowding task. Performance for IG (dotted black line and dots) and controls (gray line and dots) is shown for the color (A) and letter (B) conditions as a function of the spacing between the target and the distracters. The y-axis (50–100%) represents accuracy in correctly identifying the color or letter presented. * $P < 0.05$. Error bars are standard deviations across control participants.

Experiment 2: A Deficit of Recognition or of Localization

Tasks

In order to gain insight into the nature of IG's chance-level performance for the crowding target–distracter task, we tested her performance with different instructions, reflecting those of typical visual search tasks. We used the exact same stimuli as in the peripheral crowding task in Experiment 1 with new instructions to simply report the presence or absence of a specific stimulus (a T in the letter condition and a “green” disk in the color condition) within the triplet, regardless of whether it was presented at the first (inner), second (middle), or third (outer) position. This new instruction allowed us to distinguish between three hypotheses. If the performance at chance level of patient IG in the peripheral crowding task reflects an inability to process several elements simultaneously (in apparent contrast with her visual search performance in typical visual displays reported in Khan et al. 2016), she should remain at chance level with this new instruction. If this performance instead reflects increased crowding, her ability to detect the presence of the specified stimulus should be more impaired when it is presented in middle position and should improve with spacing. Finally, if this performance at chance level in the peripheral crowding task reflects a lack of relative position attribution to the three presented stimuli but a simultaneous perception of their identity (which would explain the preservation of pop-out phenomenon in Khan et al. 2016), then patient IG's performance should improve with this new instruction, independently of the target position. In other words, she should be able to detect the presence of the

target but not report where it was within the triplet. For this “visual search task,” we used the exact same stimuli as in the peripheral crowding task of Experiment 1 but selected only two large spacing per eccentricity at which we observed negligible crowding impairments in the control subjects:

- Eccentricity 3°: 2° and 2.5°
- Eccentricity 7°: 4° and 5°
- Eccentricity 10°: 6° and 8°

Overall, there was a total of 252 trials each for the letter and color conditions. Patient IG was asked to press the right button when she detected the presence of the specific target within the presented triplet, and the left button when she did not detect any green disk or letter T (forced choice, chance level was 50%).

Following the visual search task, she also performed a single target presentation task with more visual eccentricities (0°, 0.5°, 1°, 2°, 3°, 4°, 5°, 6°, 7°, 10°, 11°, 12°, 16°, 18°) in order to obtain a baseline of perceptual accuracy not only for the target's positions but also for the distracter's positions (forced choice target identification, chance level was 33.3%). We also collected the performance of the four age-matched controls in this single target presentation task.

Experiment 2—Results

Performance for IG is shown in Figure 6 for the color condition. The presence of the green target was always detected when it was in the inner position regardless of eccentricity. Performance

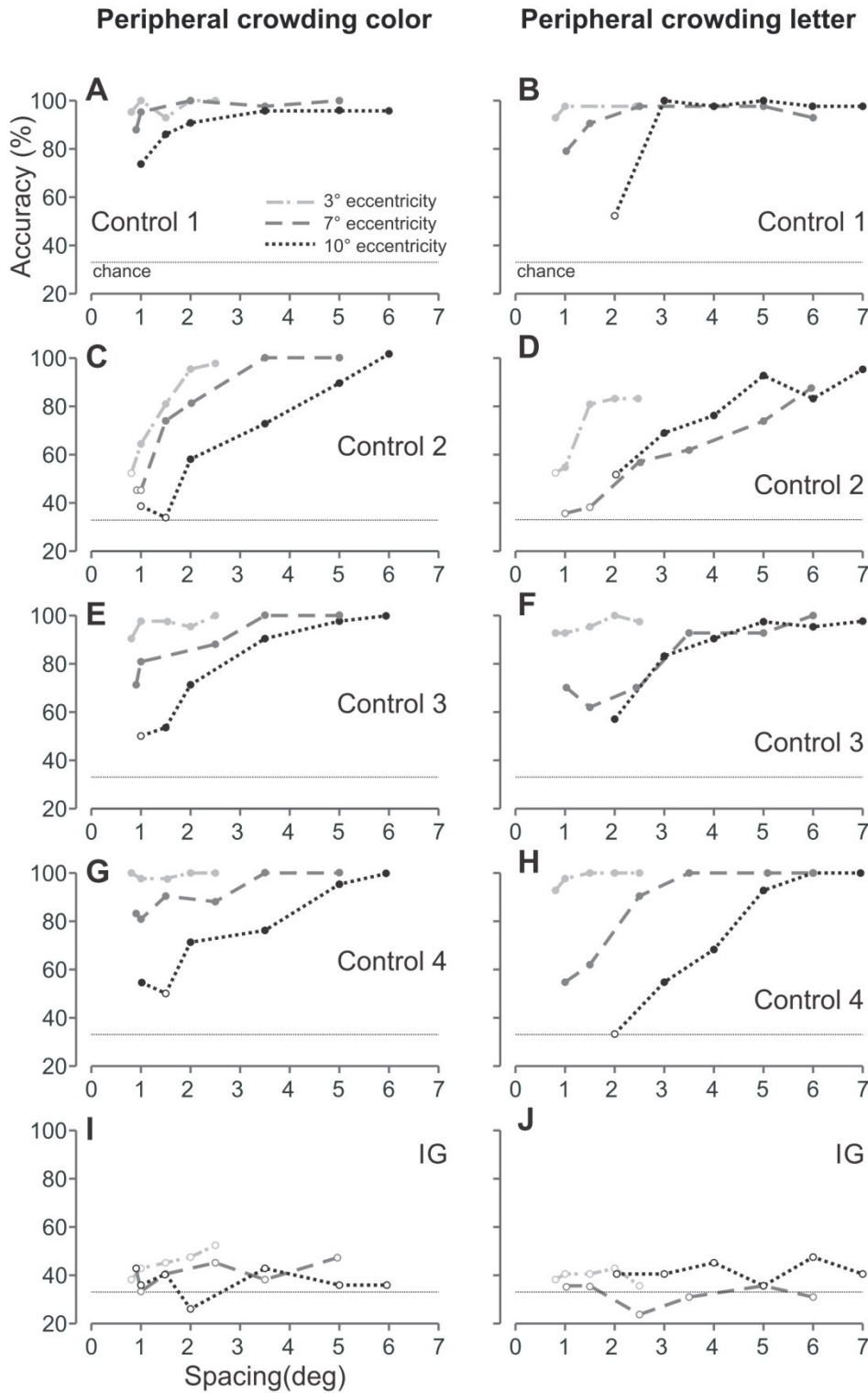

Figure 5. Peripheral crowding task. Performance for each individual participant is shown for the color (left panel) and the letter (right panel) conditions. Accuracy as a function of spacing is shown for each of the three target eccentricities (3°—light gray dot dashed line and dots, 7°—gray dashed line and dots, 10°—black dotted line and dots). Solid dots depict performance that is significantly different from chance (horizontal tight dotted line—33%), while open dots depict performance that is not significantly different from chance. Each row depicts performance for each individual participant, where A–H are control performance and I and J are IG’s results. The y-axis (20–100%) represents accuracy in identifying the color or letter presented.

Downloaded from https://academic.oup.com/cercor/advance-article/doi/10.1093/cercor/bhaa250/5909654 by Universite Claude Bernard (Lyon 1) user on 23 September 2020

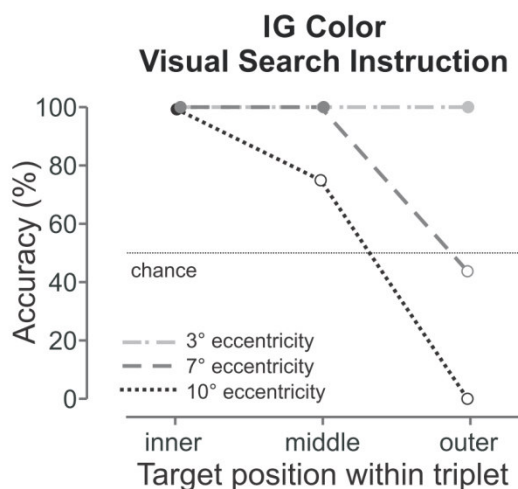

Figure 6. Visual search instruction for peripheral crowding color task. Performance for IG is shown for the color condition for the three target eccentricities (3°—light gray dot dashed line and dots, 7°—gray dashed line and dots, 10°—black dotted line and dots). Solid dots depict performance that is significantly different from chance (horizontal tight dotted line—50%), while open dots depict performance that is not significantly different from chance. The y-axis (0–100%) represents accuracy in responding whether or not the target (green disk) was present.

dropped to chance for the outer position at an eccentricity of 7° and was also not different from chance at 10°, for both the middle and outer positions.

To better understand this pattern of results, we analyzed performance as a function of the actual eccentricity of the green target, which varied according to the three tested eccentricities of the triplet (3°, 7°, and 10°) but also whether the green target was the inner, middle, or outer display item (Fig. 7A). This pattern of results is well accounted for by a gradual performance decrease beyond an eccentricity of 10°, irrespective of the target's relative position within the triplet (inner, middle, outer). Note that during the isolated presentation of colored disks (Fig. 7B), accuracy similarly decreased to chance level after 10° of eccentricity except for 12° (all $P > 0.05$) for IG. However, unlike the single target performance, her performance dropped further below chance level at the furthest eccentricities (Fig. 7A—16° and 18°), suggesting that the patient was “sure” that the green target was not presented in the visual display.

In summary, with color disks, performance in the visual search task can be explained by the decrease of color identification after 10° of eccentricity even for isolated stimuli presentation. Performance comparison between the peripheral crowding task and the visual search task with the exact same stimuli argues in favor of a localization deficit. Indeed, up to an eccentricity of 10°, the green disk was always detected irrespective of its position within the triplet, whereas when the instruction was to identify the middle target (in the crowding task), performance was at chance level. One can therefore reason that up to 10° of eccentricity, the three colored disks were seen and perceptually identified, but the patient did not know which one was presented at the middle position.

For the letter condition (Fig. 8), IG was unable to detect the presence of the letter T above chance levels ($P > 0.05$), except for the inner position (the closest to the fixation point) for triplet eccentricities of 7° and 10° ($P < 0.05$). As in the color condition, we analyzed accuracy as a function of the actual eccentricity

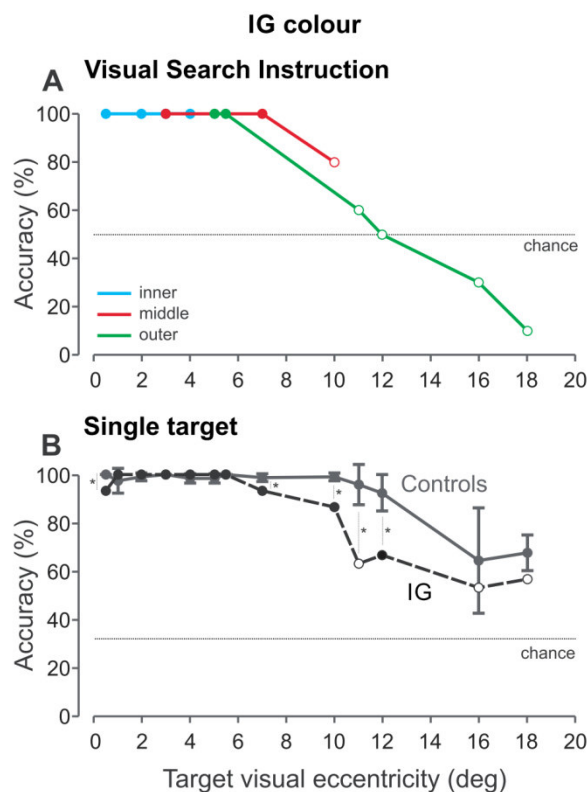

Figure 7. Eccentricity versus performance for visual search instruction color task. (A) Performance for IG as a function of actual visual eccentricity of the target separated by position, inner (blue line and dots), middle (red line and dots), and outer (green line and dots). (B) Performance for the single target presentation with the visual search instruction for IG (black dotted line and dots) and controls (gray line and dots with SD error bars across controls). Solid dots depict performance that is significantly different from chance (horizontal tight dotted line—50%), while open dots depict performance that is not significantly different from chance. The y-axis (0–100%) represents accuracy in responding whether or not the target (green disk) was present.

at which the target “T” was presented (Fig. 9A). While isolated letter identification was at ceiling at all eccentricities (Fig. 9B), detecting the presence of the letter T within a triplet was not significantly different from chance level ($P > 0.05$), irrespective of its actual eccentricity, except for the inner position at an eccentricity of 2° ($P < 0.05$).

This advantage for the inner position of the triplet (the nearest to the fixation) is confirmed by examining performance as a function of triplet visual eccentricity (3°, 7°, and 10°) and spacing (Fig. 10). In sum, with letters, patient IG's ability to perceptually identify one stimulus among three was drastically impaired, irrespective of its actual eccentricity. Identification of the letter T was sometimes possible when it was presented at the inner location within the triplet (the nearest to the fixation) but not elsewhere in the triplet, which explains why performance remained at chance level when the instruction was to identify the middle target in the peripheral crowding task.

Experiment 3: Effect of Identical Distracters

Tasks

The performance of patient IG in the letter condition of Experiment 2 suggests that when letter symbols (but not colored

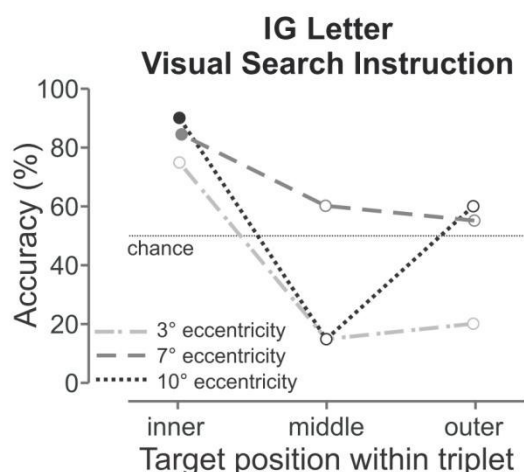

Figure 8. Visual search instruction for peripheral crowding letter task. Performance for IG is shown for the letter condition for the three target eccentricities (3°—light gray dot dashed line and dots, 7°—gray dashed line and dots, 10°—black dotted line and dots). Solid dots depict performance that is significantly different from chance (horizontal tight dotted line—50%), while open dots depict performance that is not significantly different from chance. The y-axis (0–100%) represents accuracy in responding whether or not the target (letter T) was present.

disks) are presented simultaneously, she can only identify one at a time. This still does not explain her performance for feature-present/absent search displays where she exhibited a cost (increased search times) to find the target among distracters with respect to normal performance, but this cost remained constant with set size (Khan et al. 2016). To parallel another characteristic of visual search conditions where all distracters were identical, we implemented a “perceptual grouping crowding task.” We used the same target eccentricities and spacing as in Experiment 2, but the distracters were identical and different from the target, namely two X letters for the letter condition and two gray disks for the color condition. The instruction was the same as for the peripheral crowding task of Experiment 1: identify the middle target (red, blue, or green in the color condition and F, N, or T in the letter condition, forced choice, chance level: 1/3). Each of the 3 possible targets was presented 14 times at the 3 peripheral eccentricities and at the 2 largest spacing described for Experiment 2, distributed pseudo-randomly. Overall, there was a total of 252 trials each for the letter and color conditions.

Experiment 3—Results

Patient IG’s accuracy drastically improved for both letter and color condition with performance above chance level for all conditions of target eccentricity and target–distracter spacing (all $P < 0.05$) as shown in Figure 11. This figure includes performance with the identical distracters (dashed lines) as well as performance with different distracters from Experiment 1 (solid lines). As can be seen in this figure, perceptual grouping alleviated the major deficit observed in Experiment 1 for the patient.

Thus, in patient IG, grouping the identical distracters improves the extraction of the middle target identity and alleviates the crowding effect. This is in agreement with performance by normal participants reported in the crowding

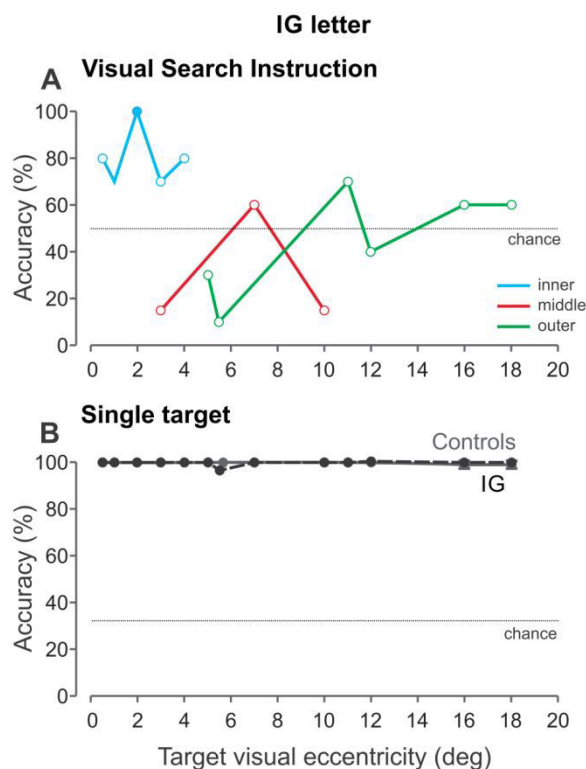

Figure 9. Eccentricity versus performance for visual search instruction letter task. (A) Performance for IG is shown as a function of actual visual eccentricity of the target separated by position, inner (blue line and dots), middle (red line and dots), and outer (green line and dots). (B) Performance for the single target presentation with the visual search instruction for IG (black dotted line and dots) and controls (gray line and dots with SD error bars across controls). Solid dots depict performance that is significantly different from chance (horizontal tight dotted line—50%), while open dots depict performance that is not significantly different from chance. The y-axis (0–100%) represents accuracy in responding whether or not the target (green disk) was present.

literature (Scolari et al. 2007; Saarela et al. 2009; Freeman et al. 2012; Keshvari and Rosenholtz 2016). Note, however, that this perceptual grouping may simply resolve the problem of localizing the target; in essence, the patient has a cue that she should report based on the lines that differ from the known distracters (Rosenholtz et al. 2019). Indeed, patient IG reported that she clearly saw the target that was different from “X” or “gray” (which allowed her to complete the identification task with a good accuracy), but she was unable to say whether the target was actually in the middle of the triplet. This experiment, therefore, confirms that patient IG’s main difficulty is perceiving the spatial relations between several items when presented simultaneously (for letters as well as for colored disks). Each color disk is composed of one element, and therefore, her deficit affects performance only when the task requires perceiving such relations. But the letters are composed of a spatial configuration of several separable elements, so the identification of each letter by itself already requires understanding such spatial relations. When the stimulus contains only a single letter, the uncertainty about the spatial relations is relatively small and IG manages to perform optimally, likely relying more than controls on prior knowledge (Balas et al. 2009). But, when there is more than a single letter, there are many more elements and possible spatial

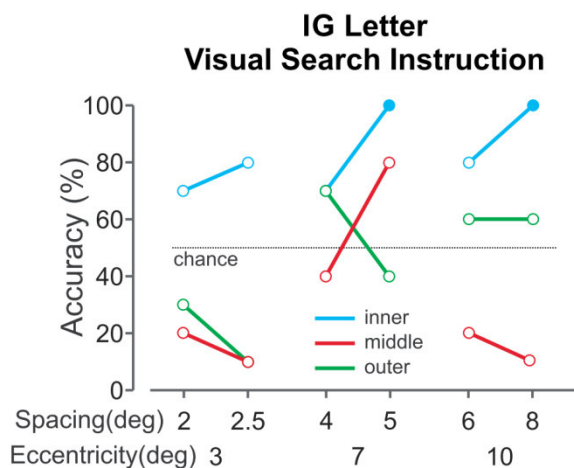

Figure 10. Visual search instruction for peripheral crowding letter task as a function of spacing and position. Performance for IG is shown as a function of spacing and eccentricity of the target separated by position, inner (blue line and dots), middle (red line and dots), and outer (green line and dots). Solid dots depict performance that is significantly different from chance (horizontal tight dotted line—50%), while open dots depict performance that is not significantly different from chance. The y-axis (0–100%) represents accuracy in responding whether or not the target (letter T) was present.

relations, and therefore, uncertainty considerably increases and accordingly performance is considerably reduced.

Whether or not this is related to the mechanisms of “crowding” is a difficult question, because the processes underlying crowding are still under debate (for a review, see Rosenholtz et al. 2019); a variety of mechanisms have been proposed, including substitution (Strasburger 2005; van den Berg et al. 2012), spatial receptive field constraints or pooling (Balas et al. 2009; Lettvin 1976; Levi 2008; Parkes et al. 2001; Pelli and Tillman 2008), and limits on the resolution of attention (Intriligator and Cavanagh 2001). Regardless of the proposed mechanism, it is clear that crowding can lead to substitution errors, that is, reporting a distracter instead of the target because information about position is lost or ambiguous, or reporting a mixture of target and distracters lines, as predicted by all of these crowding theories. This appears to resemble IG’s deficit. In that regard, her deficit may be considered similar to crowding.

Discussion

Clinical vision reflecting excessive crowding has been previously proposed for amblyopics (Greenwood et al. 2012), dyslexics (Martelli et al. 2009), and patients with occipito-temporal damage (ventral visual stream, Strappini et al. 2017; Sand et al. 2018). The present study explored this hypothesis for patients with damage of the dorsal visual stream by studying in depth the performance of patient IG in crowding tasks consecutive to bilateral SPL lesions. In this paper, we tested her visual performance with plain objects (blue, red, or green colored disks) versus objects consisting of separable lines (letters N, T, or F), in conditions of isolated versus simultaneous presentation. In conditions of simultaneous presentation, we contrasted two instructions: identifying the middle target (classical crowding task, Experiment 1) versus detecting the presence of a specific target within the triplet (visual search task, Experiment 2).

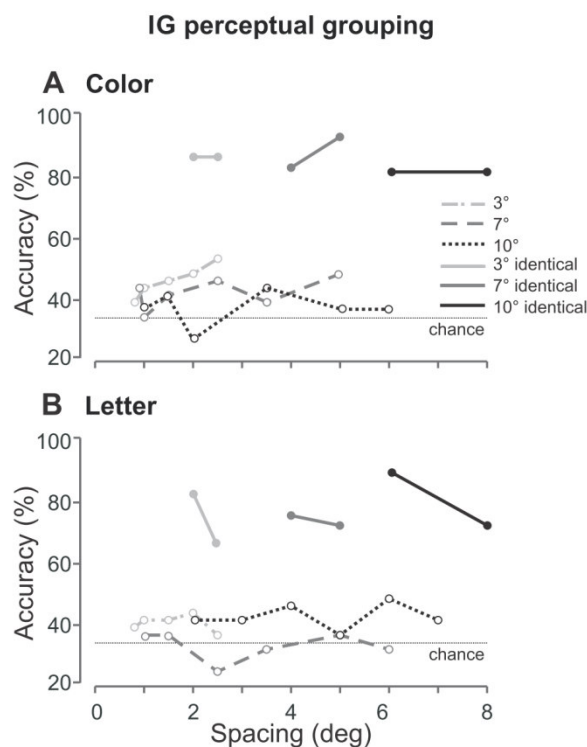

Figure 11. Perceptual grouping task. Patient IG’s performance is shown for the perceptual grouping task (identical distracters) for the color (A) and the letter (B) conditions. For comparison, performance from the peripheral crowding task from Experiment 1 is reproduced here from Figure 5I,J. The perceptual grouping performance is shown for the same three target eccentricities with the same three gray levels but with solid lines. Solid dots depict performance that is significantly different from chance (horizontal tight dotted line—33%), while open dots depict performance that is not significantly different from chance. The y-axis (range 20–100%) represents accuracy in correctly identifying the color or letter presented.

For colored disks, simultaneous presentation revealed a relative localization deficit. In an area of up to 10° of visual eccentricity, patient IG was able to identify whether a green disk was presented within a triplet of colored disks (visual search task) with similar accuracy as when she was required to identify the color (green, red, or blue) of a single disk presented at the same location. However, her performance drastically decreased when required to accurately report the color (green, red, or blue) of the middle disk of a triplet of colored disks (crowding task). She is therefore able to perceive all three colored disks simultaneously, but she cannot localize them relative to each other. Presentation of gray distracters flanking the middle disk (Experiment 3) also allowed her to resolve the localization deficit. When the green target appeared beyond 10°, she was unable to process it, even when presented on its own. This cannot be explained by the decrease of the density of retinal cones (which are involved in color perception) with eccentricity as our four control subjects showed a drop in performance only at larger eccentricities. Note also that performance drops far below chance level in the simultaneous presentation condition in Experiment 2 at the furthest eccentricities, indicating that the patient was convinced that the green target was not present. This suggests that the other stimuli within her attentional field may have captured all attentional resources resulting in an extinction of

stimuli positioned outside her attentional field. In sum, IG can process multiple simple colored objects simultaneously if they are presented within her “functional visual field” (inside 10° of eccentricity) but can localize them relative to each other only in central vision (where her crowded performance was lower than controls but remained above chance level).

For letters, the same dissociated identification (N, T, or F) ability was observed at all tested visual eccentricities: performance was normal with isolated presentation but drastically decreased as soon as the letter was presented in the middle of two other target letters. The presentation with two identical X distracters (Experiment 3) alleviated the identification deficit of the middle letter. However, IG could not accurately report the presence of the letter T among the three letters (visual search instruction, Experiment 2), except when the T was the item closest to fixation.

A unified explanation of the pattern of results observed in this study can be provided, that is, an impaired ability, following bilateral damage of the SPL, to process the relative positions of separable parts (within and between objects). In the case of colored disks, each disk is a simple object, so the impairment loses the location of the disks but does not disrupt their color identification. In the case of letters, even a single letter has multiple simple parts (perhaps the lines that make up the letter). The SPL damage would impair the localization of these parts. The identification of each letter by itself already requires understanding such spatial relations. When the stimulus contains only a single letter, the uncertainty about the spatial relations is relatively small and IG manages to perform optimally (likely relying more than controls on prior knowledge). However, when there is more than a single letter, there are many more elements and possible spatial relations, and therefore, uncertainty considerably increases. Accordingly, the localization deficit affects perception to a larger degree than for simple plain objects (such as colored disks). With identical X flankers, the uncertainty is considerably reduced: ignoring any diagonals would essentially bring IG back to a state more like a single letter identification.

A deficit of localization and spatial binding of separable parts also explains patient IG’s visual search previous results reported in Khan et al. (2016). Detecting the presence or absence of a specific object (a red disk) among others (e.g., red squares and green disks) does not require its precise localization, and object’s color and shape are not spatially separable features. The fact that the localization deficit did not affect perception of simultaneous colored disks is consistent with the preservation of pop-out and conjunction visual searches for colored shapes (Khan et al. 2016). The present results showing a localization deficit affecting perception for simultaneous presentation of objects made by spatially separable lines (here letters) also fits with the impairment of feature-present and feature-absent searches (Khan et al. 2016).

Note that acuity, binocular vision, temporal threshold for single letter identification, and delayed multi-letter report with sequential presentation have been reported to be fully normal in patient IG (Valdois et al. 2019). We also showed here that increasing presentation time did not allow her to improve identification performance in the condition of simultaneous presentation in central vision (Experiment 1). Her deficit can therefore be explained neither by a reduced visual processing speed nor by reduced visual short-term memory capacity (unlike other patients with developmental dyslexia or

simultanagnosia consecutive to neurodegenerative disease reported in the literature, Bogon et al. 2014; Neitzel et al. 2016). Her deficit therefore lies in the spatial rather than in the temporal domain.

Whether objects consist of separable lines or not appears as an important factor for the limitation of simultaneous object processing consecutive to SPL dysfunction, suggesting an inability to establish spatial relations between the different elements and to automatically attribute them to one object or another. One interpretation might be that patient IG presents an impairment at the level of perceptual organization processes that structure the bits and pieces of visual information into larger entities that correspond to meaningful objects (see Kimchi et al. 2007; Yeshurun et al. 2009). This would predict poor object individuation; such individuation necessarily precedes identification of multiple complex objects (Xu and Chun 2009) but might not be required for simpler objects (Mazza 2017). Nevertheless, some perceptual organization processes are preserved, since patient IG was clearly able to make use of and perhaps automatically group the features of the identical distracters X, improving (but not fully restoring) the identification of the middle target in Experiment 3.

Another interpretation could be excessive crowding. Similarity effects, in which the target is easier to report when flanked by distracters that group with each other and not with the target, abound in crowding (Livne and Sagi 2007; Saarela et al. 2009; Manassi et al. 2012; Freeman et al. 2012; Keshvari and Rosenholtz 2016). A popular explanation of crowding known as the texture tiling model can explain a number of these effects (Rosenholtz et al. 2019) but not all of them (Doerig et al. 2019). This pooling model represents the peripheral input in terms of a rich set of summary image statistics, for example, correlations between responses of V1-like “cells.” The pooling regions “pool” or summarize the statistics over an area that grows (in the normal human visual system) linearly with eccentricity. These rich summary representations capture a great deal of useful information at the expense of precise localization of the features, leading to misreporting one of the distracters instead of the target. To get intuitions of what the model predicts, one can generate visualizations of the information preserved and lost according to the model (Balas et al. 2009). Examining these visualizations, it appears that the summary statistics can better represent a target letter when flanked by identical letters (Keshvari and Rosenholtz 2016; Rosenholtz et al. 2019). Simple shapes like disks of a single color “cohere,” though their location may be ambiguous, whereas in these visualizations, more complex shapes like letters can split into pieces and re-“tile” into novel shapes, leading to difficult recognition and hard search for, for example, an O among Qs (Chang and Rosenholtz 2016). However, IG’s performance also deviates significantly from normal crowding. IG shows crowding in the fovea, where pooling regions are presumed to be small (Experiment 1). In the periphery, there was no sign of a critical spacing at which crowding is relieved (Experiment 1). If the pooling regions are fixed, perhaps corresponding to receptive fields, it seems implausible that IG’s SPL damage causes pooling regions to grow larger in both central and peripheral vision.

Alternatively, the SPL is usually acknowledged for its role in endogenous attention, and in patient IG, endogenous cueing has shorter effect than controls in a Posner task (Valdois et al. 2019). Given the connections described above between IG’s performance and signatures of crowding, it is worth noting that

attention can modulate crowding performance in the sense that observers are better at recognizing a crowded object when a precue indicates the target location in advance. Specifically, both predictive and nonpredictive peripheral cues (e.g., Yeshurun and Rashal 2010; Strasburger and Malania 2013; Rashal and Yeshurun 2014) as well as predictive central cues (e.g., Felisbert et al. 2005), that allowed advanced allocation of attention to the target location, resulted in reduced critical spacing. It has also been shown with central targets that focusing attention reduced the critical distance (Albonico et al. 2018). If attention indeed reduces the critical spacing, and assuming that normal observers allocate some amount of attention to peripheral targets thereby reducing the critical spacing, then with a lesion that impairs attention, one might end up with a bigger critical spacing. Attention is also considered to be required to apprehend spatial relations between items (Logan 1994; Pöder 1999; Moore et al. 2001) and to bind together a within-object structure (the overall shape of an object is not available preattentively, Wolfe and Bennett 1997). Patient IG has a deficit specific to spatial binding of separable lines, her ability to bind color and shape features is fully preserved, as she is as fast as controls in conjunction search (Khan et al. 2016). Therefore, the deficit consecutive to the bilateral SPL damage (visual dorsal stream) may lie at the expected level of spatial attention, with effects on object perception and crowding.

Damage to the SPL has repeatedly been shown to produce visual localization deficits (Mishkin and Ungerleider 1982; Perenin and Vighetto 1988; Milner and Goodale 1993, 2008; Blangero et al. 2010), but defining the level of functional impairment helps in clarifying the debated role of the dorsal visual stream (“how” vs. “where”). The predominant dual-stream model of visual processing (Milner and Goodale 1993, 2008) put forward that the dorsal visual stream is devoted to the “vision for action” (how), while “vision for perception” would be entirely based on the ventral visual stream (inferotemporal cortex). It has highlighted the errors reported in numerous patients with unilateral SPL lesions when pointing toward visual targets (optic ataxia; see, e.g., Perenin and Vighetto 1988 and Blangero et al. 2010). Mishkin and Ungerleider (1982) previously proposed a more general “where” function for the dorsal visual stream, showing that its lesion impaired the ability to perform the perceptual landmark test (midline judgment). Our present result further demonstrates that the dorsal visual stream contributes to both visually guided action and visuoperceptual performance and that localization deficits (“where” function) can affect both, especially in patients with bilateral damage. This localization deficit does not correspond to excessive perceptual crowding but affects simultaneous object identification by increasing spatial uncertainty.

Notes

The authors would like to thank Romeo Salemmé for technical assistance. *Conflict of Interest.* None declared.

Funding

Centre national de la recherche scientifique; Labex/Idex ANR-11-LABX-0042 (France; grant to L.P.); Fondation de France (grant to A.V.).

References

- Albonico A, Martelli M, Bricolo E, Frasson E, Daini R. 2018. Focusing and orienting spatial attention differently modulate crowding in central and peripheral vision. *J Vis.* 18(3):4. doi: [10.1167/18.3.4](https://doi.org/10.1167/18.3.4).
- Balás B, Nakano L, Rosenholtz R. 2009. A summary-statistic representation in peripheral vision explains visual crowding. *J Vis.* 9(12):13.1–13.18. doi: [10.1167/9.12.13](https://doi.org/10.1167/9.12.13).
- Bálint R. 1909. Seelenlähmung des “Schauens”: Optische Ataxie, räumliche Störung der Aufmerksamkeit. *Monatszeitschrift Für Psychiatrie Und Neurologie.* 25:51–181.
- Blangero A, Ota H, Rossetti Y, Fujii T, Luauté J, Boisson D, Ohtake H, Tabuchi M, Vighetto A, Yamadori A et al. 2010. Systematic retinotopic error vectors in unilateral optic ataxia. *Cortex.* 46(1):77–93. doi: [10.1016/j.cortex.2009.02.015](https://doi.org/10.1016/j.cortex.2009.02.015).
- Bogon J, Finke K, Schulte-Körne G, Müller HJ, Schneider WX, Stenneken P. 2014. Parameter-based assessment of disturbed and intact components of visual attention in children with developmental dyslexia. *Dev Sci.* 17(5):697–713. doi: [10.1111/desc.12150](https://doi.org/10.1111/desc.12150).
- Bosse M-L, Tainturier MJ, Valdois S. 2007. Developmental dyslexia: the visual attention span deficit hypothesis. *Cognition.* 104(2):198–230. doi: [10.1016/j.cognition.2006.05.009](https://doi.org/10.1016/j.cognition.2006.05.009).
- Bouma H. 1970. Interaction effects in parafoveal letter recognition. *Nature.* 226(5241):177–178. doi: [10.1038/226177a0](https://doi.org/10.1038/226177a0).
- Casco C, Prunetti E. 1996. Visual search of good and poor readers: effects with targets having single and combined features. *Percept Mot Skills.* 82(3 Pt 2):1155–1167. doi: [10.2466/pms.1996.82.3c.1155](https://doi.org/10.2466/pms.1996.82.3c.1155).
- Chang H, Rosenholtz R. 2016. Search performance is better predicted by tileability than presence of a unique basic feature. *J Vis.* 16(10):13. doi: [10.1167/16.10.13](https://doi.org/10.1167/16.10.13).
- Chechlacz M, Gillebert CR, Vangkilde SA, Petersen A, Humphreys GW. 2015. Structural variability within frontoparietal networks and individual differences in attentional functions: an approach using the theory of visual attention. *J Neurosci.* 35(30):10647–10658. doi: [10.1523/JNEUROSCI.0210-15.2015](https://doi.org/10.1523/JNEUROSCI.0210-15.2015).
- Clavagnier S, Fruhmann Berger M, Klockgether T, Moskau S, Karnath H-O. 2006. Restricted ocular exploration does not seem to explain simultanagnosia. *Neuropsychologia.* 44:2330–2336.
- Crawford JR, Garthwaite PH. 2002. Investigation of the single case in neuropsychology: confidence limits on the abnormality of test scores and test score differences. *Neuropsychologia.* 40(8):1196–1208. doi: [10.1016/S0028-3932\(01\)00224-X](https://doi.org/10.1016/S0028-3932(01)00224-X).
- Crawford JR, Howell DC. 1998. Comparing an individual's test score against norms derived from small samples. *Clin Neuropsychol.* 12(4):482–486. doi: [10.1076/clin.12.4.482.7241](https://doi.org/10.1076/clin.12.4.482.7241).
- Dalrymple KA, Kingstone A, Barton J. 2007. Seeing trees OR seeing forests in simultanagnosia: attentional capture can be local or global. *Neuropsychologia.* 45:871–875.
- Demeyere N, Rzeskiewicz A, Humphreys KA, Humphreys GW. 2008. Automatic statistical processing of visual properties in simultanagnosia. *Neuropsychologia.* 46(11):2861–2864. doi: [10.1016/j.neuropsychologia.2008.05.014](https://doi.org/10.1016/j.neuropsychologia.2008.05.014).
- Doerig A, Bornet A, Rosenholtz R, Francis G, Clarke AM, Herzog MH. 2019. Beyond Bouma's window: how to explain global aspects of crowding? *PLoS Comput Biol.* 15(5):e1006580. doi: [10.1371/journal.pcbi.1006580](https://doi.org/10.1371/journal.pcbi.1006580).
- Felisbert FM, Solomon JA, Morgan MJ. 2005. The role of target salience in crowding. *Perception.* 34(7):823–833. doi: [10.1068/p5206](https://doi.org/10.1068/p5206).

- Freeman J, Chakravarthi R, Pelli DG. 2012. Substitution and pooling in crowding. *Atten Percept Psychophys*. 74(2):379–396. doi: [10.3758/s13414-011-0229-0](https://doi.org/10.3758/s13414-011-0229-0).
- Gaveau V, Pélissou D, Blangero A, et al. 2008. Saccade control and eye-hand coordination in optic ataxia. *Neuropsychologia*. 46:475–486.
- Gilchrist ID, Humphreys GW, Riddoch MJ. 1996. Grouping and extinction: evidence for low-level modulation of visual selection. *Cogn Neuropsychol*. 13:1223–1249.
- Greenwood JA, Tailor VK, Sloper JJ, Simmers AJ, Bex PJ, Dakin SC. 2012. Visual acuity, crowding, and stereo-vision are linked in children with and without amblyopia. *Invest Ophthalmol Vis Sci*. 53(12):7655–7665. doi: [10.1167/iovs.12-10313](https://doi.org/10.1167/iovs.12-10313).
- Huberle E, Driver J, Karnath HO. 2010. Retinal versus physical stimulus size as determinants of visual perception in simultanagnosia. *Neuropsychologia*. 48(6):1677–1682.
- Hulleman J, Olivers CNL. 2017. The impending demise of the item in visual search. *Behav Brain Sci*. 40:e132. doi: [10.1017/S0140525X15002794](https://doi.org/10.1017/S0140525X15002794).
- Husain M, Stein J. 1988. Rezsü Bálint and his most celebrated case. *Arch Neurol*. 45:89–93
- Intriligator J, Cavanagh P. 2001. The spatial resolution of visual attention. *Cogn Psychol*. 43(3):171–216. doi: [10.1006/cogp.2001.0755](https://doi.org/10.1006/cogp.2001.0755).
- Jackson GM, Shepherd T, Mueller SC, Husain M, Jackson SR. 2006. Dorsal simultanagnosia: an impairment of visual processing or visual awareness? *Cortex*. 42(5):740–749. doi: [10.1016/s0010-9452\(08\)70412-x](https://doi.org/10.1016/s0010-9452(08)70412-x).
- Keshvari S, Rosenholtz R. 2016. Pooling of continuous features provides a unifying account of crowding. *J Vis*. 16(3):39. doi: [10.1167/16.3.39](https://doi.org/10.1167/16.3.39).
- Khan AZ, Prost-Lefebvre M, Salemm R, Blohm G, Rossetti Y, Tilikete C, Pisella L. 2016. The attentional fields of visual search in Simultanagnosia and healthy individuals: how object and space attention interact. *Cereb Cortex*. 26(3):1242–1254. doi: [10.1093/cercor/bhv059](https://doi.org/10.1093/cercor/bhv059).
- Kimchi R, Yeshurun Y, Cohen-Savransky A. 2007. Automatic, stimulus-driven attentional capture by objecthood. *Psychon Bull Rev*. 14(1):166–172. doi: [10.3758/bf03194045](https://doi.org/10.3758/bf03194045).
- Latham K, Whitaker D. 1996. Relative roles of resolution and spatial interference in foveal and peripheral vision. *Ophthalmic Physiol Opt*. 16(1):49–57.
- Lassus-Sangosse D, N'guyen-Morel MA, Valdois S. 2008. Sequential or simultaneous visual processing deficit in developmental dyslexia? *Vision Res*. 48(8):979–988. <https://pubmed.ncbi.nlm.nih.gov/18331749/>.
- Lettvin JY. 1976. On seeing sidelong. *Sciences*. 16(4):10–20. doi: [10.1002/j.2326-1951.1976.tb01231.x](https://doi.org/10.1002/j.2326-1951.1976.tb01231.x).
- Levi DM. 2008. Crowding—an essential bottleneck for object recognition: a mini-review. *Vision Res*. 48(5):635–654. doi: [10.1016/j.visres.2007.12.009](https://doi.org/10.1016/j.visres.2007.12.009).
- Livne T, Sagi D. 2007. Configuration influence on crowding. *J Vis*. 7(2):4.1–4.12. doi: [10.1167/7.2.4](https://doi.org/10.1167/7.2.4).
- Lobier M, Zoubrinetzky R, Valdois S. 2012. The visual attention span deficit in dyslexia is visual and not verbal. *Cortex*. 48(6):768–773. doi: [10.1016/j.cortex.2011.09.003](https://doi.org/10.1016/j.cortex.2011.09.003).
- Lobier MA, Peyrin C, Pichat C, Le Bas JF, Valdois S. 2014. Visual processing of multiple elements in the dyslexic brain: evidence for a superior parietal dysfunction. *Frontiers in Human Neuroscience*. 8:479.
- Logan GD. 1994. Spatial attention and the apprehension of spatial relations. *J Exp Psychol Hum Percept Perform*. 20(5):1015–1036. doi: [10.1037//0096-1523.20.5.1015](https://doi.org/10.1037//0096-1523.20.5.1015).
- Luria AR. 1959. Disorders of “simultaneous perception” in a case of bilateral occipito-parietal brain injury. *Brain*. 82:437–449. doi: [10.1093/brain/82.3.437](https://doi.org/10.1093/brain/82.3.437).
- Manassi M, Sayim B, Herzog MH. 2012. Grouping, pooling, and when bigger is better in visual crowding. *J Vis*. 12(10):13. doi: [10.1167/12.10.13](https://doi.org/10.1167/12.10.13).
- Martelli M, Di Filippo G, Spinelli D, Zoccolotti P. 2009. Crowding, reading, and developmental dyslexia. *J Vis*. 9(4):14.1–14.18. doi: [10.1167/9.4.14](https://doi.org/10.1167/9.4.14).
- Mazza V. 2017. Simultanagnosia and object individuation. *Cogn Neuropsychol*. 34(7–8):430–439. doi: [10.1080/02643294.2017.1331212](https://doi.org/10.1080/02643294.2017.1331212).
- Milner AD, Goodale MA. 1993. Visual pathways to perception and action. In: Hicks TP, Molotchnikoff S, Ono T, editors. *Progress in brain research*. Vol. 95. The visually responsive neuron: from basic neurophysiology to behaviour. Amsterdam: Elsevier. pp. 317–337. doi: [10.1016/S0079-6123\(08\)60379-9](https://doi.org/10.1016/S0079-6123(08)60379-9)
- Milner AD, Goodale MA. 2008. Two visual systems reviewed. *Neuropsychologia*. 46:774–785. doi: [10.1016/j.neuropsychologia.2007.10.005](https://doi.org/10.1016/j.neuropsychologia.2007.10.005).
- Mishkin M, Ungerleider LG. 1982. Contribution of striate inputs to the visuospatial functions of parieto-preoccipital cortex in monkeys. *Behav Brain Res*. 6(1):57–77. doi: [10.1016/0166-4328\(82\)90081-x](https://doi.org/10.1016/0166-4328(82)90081-x).
- Moore CM, Elsinger CL, Lleras A. 2001. Visual attention and the apprehension of spatial relations: the case of depth. *Percept Psychophys*. 63(4):595–606. doi: [10.3758/bf03194424](https://doi.org/10.3758/bf03194424).
- Naccache L, Slachevsky A, Levy R, Dubois B. 2000. Simultanagnosia in a patient with right brain lesions. *J Neurol*. 247(8):650–651. <https://pubmed.ncbi.nlm.nih.gov/11041337/>.
- Navon D. 1977. Forest before trees: the precedence of global features in visual perception. *Cognit Psychol*. 9:353–383.
- Neitzel J, Ortner M, Haupt M, Redel P, Grimmer T, Yakushev I, Drzezga A, Bublak P, Preul C, Sorg C, et al. 2016. Neuro-cognitive mechanisms of simultanagnosia in patients with posterior cortical atrophy. *Brain*. 139(Pt 12):3267–3280. doi: [10.1093/brain/aww235](https://doi.org/10.1093/brain/aww235).
- Parkes L, Lund J, Angelucci A, Solomon JA, Morgan M. 2001. Compulsory averaging of crowded orientation signals in human vision. *Nat Neurosci*. 4(7):739–744. doi: [10.1038/89532](https://doi.org/10.1038/89532).
- Pelli DG, Palomares M, Majaj NJ. 2004. Crowding is unlike ordinary masking: distinguishing feature integration from detection. *J Vis*. 4(12):1136–1169. doi: [10.1167/4.12.12](https://doi.org/10.1167/4.12.12).
- Pelli DG, Tillman KA. 2008. The uncrowded window of object recognition. *Nat Neurosci*. 11(10):1129–1135. doi: [10.1038/nn.2187](https://doi.org/10.1038/nn.2187).
- Perenin MT, Vighetto A. 1988. Optic ataxia: a specific disruption in visuomotor mechanisms. I. Different aspects of the deficit in reaching for objects. *Brain*. 111(Pt 3):643–674. doi: [10.1093/brain/111.3.643](https://doi.org/10.1093/brain/111.3.643).
- Peyrin C, Démonet JF, N'Guyen-Morel MA, Le Bas JF, Valdois S. 2011. Superior parietal lobule dysfunction in a homogeneous group of dyslexic children with a visual attention span disorder. *Brain Lang*. 118(3):128–138. doi: [10.1016/j.bandl.2010.06.005](https://doi.org/10.1016/j.bandl.2010.06.005).
- Peyrin C, Lallier M, Démonet JF, Pernet C, Baciou M, Le Bas JF, Valdois S. 2012. Neural dissociation of phonological and visual attention span disorders in developmental dyslexia: fMRI evidence from two case reports. *Brain & Language*. 120:381–394.
- Pisella L, Gréa H, Tilikete C, et al. 2000. An ‘automatic pilot’ for the hand in human posterior parietal cortex: toward reinterpreting optic ataxia. *Nat Neurosci*. 3:729–736.

- Pöder E. 1999. Search for feature and for relative position: measurement of capacity limitations. *Vision Res.* 39(7):1321–1327. <https://pubmed.ncbi.nlm.nih.gov/10343845/>.
- Rashal E, Yeshurun Y. 2014. Contrast dissimilarity effects on crowding are not simply another case of target saliency. *J Vis.* 14(6):9–9. doi: [10.1167/14.6.9](https://doi.org/10.1167/14.6.9).
- Reilhac C, Peyrin C, Démonet J-F, Valdois S. 2013. Role of the superior parietal lobules in letter-identity processing within strings: fMRI evidence from skilled and dyslexic readers. *Neuropsychologia.* 51(4):601–612. doi: [10.1016/j.neuropsychologia.2012.12.010](https://doi.org/10.1016/j.neuropsychologia.2012.12.010).
- Rosenholtz R, Huang J, Raj A, Balas BJ, Ilie L. 2012. A summary statistic representation in peripheral vision explains visual search. *J Vis.* 12(4). doi: [10.1167/12.4.14](https://doi.org/10.1167/12.4.14).
- Rosenholtz R, Yu D, Keshvari S. 2019. Challenges to pooling models of crowding: implications for visual mechanisms. *J Vis.* 19(7):15. doi: [10.1167/19.7.15](https://doi.org/10.1167/19.7.15).
- Saarela TP, Sayim B, Westheimer G, Herzog MH. 2009. Global stimulus configuration modulates crowding. *J Vis.* 9(2):5.1–5.11. doi: [10.1167/9.2.5](https://doi.org/10.1167/9.2.5).
- Sand K, Robotham RJ, Martelli M, Starrfelt R. 2018. Visual crowding in pure alexia and acquired prosopagnosia. *Cogn Neuropsychol.* 35(7):361–370. doi: [10.1080/02643294.2018.1483325](https://doi.org/10.1080/02643294.2018.1483325).
- Scolari M, Kohnen A, Barton B, Awh E. 2007. Spatial attention, preview, and popout: which factors influence critical spacing in crowded displays? *J Vis.* 7(2):7.1–7.23. doi: [10.1167/7.2.7](https://doi.org/10.1167/7.2.7).
- Strappini F, Pelli DG, Di Pace E, Martelli M. 2017. Agnosic vision is like peripheral vision, which is limited by crowding. *Cortex.* 89:135–155. doi: [10.1016/j.cortex.2017.01.012](https://doi.org/10.1016/j.cortex.2017.01.012).
- Strasburger H. 2005. Unfocused spatial attention underlies the crowding effect in indirect form vision. *J Vis.* 5(11):1024–1037. doi: [10.1167/5.11.8](https://doi.org/10.1167/5.11.8).
- Strasburger H, Malania M. 2013. Source confusion is a major cause of crowding. *J Vis.* 13(1):24.
- Thomas C, Kveraga K, Huberle E, Karnath H-O, Bar M. 2012. Enabling global processing in simultanagnosia by psychophysical biasing of visual pathways. *Brain.* 135(Pt 5):1578–1585. doi: [10.1093/brain/aws066](https://doi.org/10.1093/brain/aws066).
- Toet A, Levi DM. 1992. The two-dimensional shape of spatial interaction zones in the parafovea. *Vision Res.* 32(7):1349–1357. doi: [10.1016/0042-6989\(92\)90227-a](https://doi.org/10.1016/0042-6989(92)90227-a).
- Valdois S, Lassus-Sangosse D, Lallier M, Moreaud O, Pisella L. 2019. What bilateral damage of the superior parietal lobes tells us about visual attention disorders in developmental dyslexia. *Neuropsychologia.* 130:78–91. doi: [10.1016/j.neuropsychologia.2018.08.001](https://doi.org/10.1016/j.neuropsychologia.2018.08.001).
- van den Berg R, Johnson A, Martinez Anton A, Schepers AL, Cornelissen FW. 2012. Comparing crowding in human and ideal observers. *J Vis.* 12(6):13. doi: [10.1167/12.6.13](https://doi.org/10.1167/12.6.13).
- Wolfe JM, Bennett SC. 1997. Preattentive object files: shapeless bundles of basic features. *Vision Res.* 37(1):25–43. doi: [10.1016/s0042-6989\(96\)00111-3](https://doi.org/10.1016/s0042-6989(96)00111-3).
- Wolpert I. 1924. Die simultanagnosie — störung der gesamtaufassung. *Z f d g Neur u Psych.* 93(1):397–415. doi: [10.1007/BF02900065](https://doi.org/10.1007/BF02900065).
- Xu Y, Chun MM. 2009. Selecting and perceiving multiple visual objects. *Trends Cogn Sci (Regul Ed).* 13(4):167–174. doi: [10.1016/j.tics.2009.01.008](https://doi.org/10.1016/j.tics.2009.01.008).
- Yeshurun Y, Kimchi R, Sha'shoua G, Carmel T. 2009. Perceptual objects capture attention. *Vision Res.* 49(10):1329–1335. doi: [10.1016/j.visres.2008.01.014](https://doi.org/10.1016/j.visres.2008.01.014).
- Yeshurun Y, Rashal E. 2010. Precueing attention to the target location diminishes crowding and reduces the critical distance. *J Vis.* 10(10):16. doi: [10.1167/10.10.16](https://doi.org/10.1167/10.10.16).

Ce travail de thèse aborde la part accordée au traitement visuel dans le trouble spécifique des apprentissages qu'est la dyslexie. Nous abordons ce thème sous un prisme clinique avec les 2 premières études en analysant différentes composantes du traitement visuel chez des enfants dyslexiques, mais aussi par un prisme plus théorique avec l'étude d'une patiente ayant une lésion du lobule pariétal supérieur (LPS) du cortex pariétal postérieur (PPC).

En effet, le LPS a été identifié comme étant sous activé chez des enfants dyslexiques lors de tâches visuo attentionnelles qui nécessitaient un traitement simultané de plusieurs éléments (Lobier, Peyrin, et al., 2012; Peyrin et al., 2011). Dans cette thèse nous avons donc cherché à connaître le rôle de celui-ci dans la perception visuelle (articles 3 et 4).

Dans la première partie de la discussion nous allons revenir sur les résultats des différentes études puis nous allons décrire les perspectives de diagnostic et de remédiation précoce qui peuvent en découler.

1. Résumé et discussion des résultats

1.1 Etude 1 : prévalence de troubles visuo-spatiaux dans la dyslexie

Le LPS a une part prépondérante dans la voie visuelle dorsale qui traite des informations spatiales. Nous avons voulu savoir avec cette étude quelle était la prévalence de ces troubles dans la dyslexie (qui est regroupée dans cet article à la dyscalculie sous le terme des troubles spécifiques des apprentissages) comparativement à d'autres déficits comme la dyspraxie, la dysphasie et le TDA/H. Les performances d'enfants sans déficit neurodéveloppemental ainsi que d'enfants ayant un déficit de vision binoculaire (problème oculomoteur tel qu'une insuffisance de convergence, hétérophorie (déviation latente des yeux) mal compensée ont été également analysées.

Le test de perception visuelle élémentaire teste six différentes modalités du traitement visuo spatial de la voie visuelle dorsale.

Les deux premiers sous tests consistent à comparer des longueurs ou des tailles, cette comparaison est du ressort du cortex occipital et plus précisément du gyrus occipital moyen (Faillenot et al., 1999; Gandini et al., 2008). Les 4 autres sous tests (comparaison d'angle, jugement de milieu, comparaison et sélection de position) semblent plutôt concerner le CPP. Le sous test de jugement de milieu implique plus particulièrement le lobule pariétal inférieur droit, en effet lors d'une atteinte de cette région du cerveau le patient souffre d'héminégligence, il ignore la partie gauche de son corps et de l'espace ce qui se traduit entre autre par un déficit lors de la tâche de jugement de milieu (Mort et al., 2003; Vallar & Perani, 1986) Les 3 autres sous tests (Localisation, Angle) impliquent le CPP mais ne présentent pas de préférence hémisphérique. Les sous tests de comparaison et sélection de position ont été choisis pour mettre en évidence ou non un problème attentionnel en impliquant ou non un choix multiple. En effet le CPP étant impliqué dans l'attention et l'intégration visuo spatiale il pouvait être difficile de faire la différence entre l'un ou l'autre des déficits. Il serait d'ailleurs intéressant à l'avenir de regarder si certains sous-tests sont plus chutés chez les dyslexiques en particulier mais dans cette étude, nous avons comparé le score global au test de PVSE entre des enfants de développement typique et des enfants souffrant des divers troubles des apprentissages. Un premier résultat important est que les enfants avec un trouble du langage oral mais également ceux avec un trouble de la vision binoculaire ont des performances similaires aux enfants avec développement typique. Le deuxième résultat majeur est que les enfants avec un trouble spécifique des apprentissages (dyslexie et dyscalculie) présentent la même prévalence d'échec dans le test PVSE que les enfants dyspraxiques (respectivement 59% et 58% des enfants se situaient en dessous de l'interquartile des contrôles) mais avec une sévérité moindre, seuls 5% avaient une performance considérée comme « outlier » alors que chez les dyspraxiques il y en avait 22%.

Dans cette étude on a donc pu voir qu'avoir un trouble spécifique des apprentissages ou une dyspraxie est souvent associé à un trouble de la perception visuo spatiale, il est pour le moment difficile de faire la distinction entre ce qui relève de la cause ou de la conséquence. Comme vu précédemment les sous tests impliquent

différentes structures cérébrales, il serait donc aussi intéressant de regarder s'ils échouent aux mêmes sous- tests.

La sévérité est différente car dans le groupe dyspraxique, il y a un pourcentage d'enfant avec un trouble sévère plus important. La comorbidité est également un facteur aggravant car chez les enfants présentant au moins 2 déficits la prévalence d'un déficit visuo spatial monte à 77% et 43% ont un déficit sévère (en dessous de la limite outlier des contrôles).

Ce déficit ne peut pas être imputable à un trouble visuel ou oculaire « primaire » car le groupe d'enfant avec un trouble de la vision binoculaire n'avait pas une prévalence supérieure au groupe d'enfants contrôle.

Cependant dans cette étude il est difficile d'appréhender exactement la prévalence de trouble visuo-spatiaux dans la dyslexie car les enfants dyslexiques sont catégorisés dans le groupe des troubles spécifiques des apprentissages du DSM V qui comprend aussi des enfants dyscalculiques. Il était donc intéressant à l'occasion d'une prochaine étude (étude 2) de regarder indépendamment les scores des enfants dyslexiques au test PVSE.

1.2 Etude 2 : fenêtre visuo attentionnelle de recherche visuelle chez les enfants dyslexiques

La dyslexie est très souvent décrite dans la littérature comme ayant pour origine un déficit phonologique. Malgré des études montrant qu'un déficit visuo-attentionnel mis en évidence par la tâche de l'EVA peut être associé à une dyslexie sans qu'il y ait de trouble de la phonologie (Bosse et al., 2007; Valdois et al., 2003), cette approche subit encore des critiques car il est mis en avant qu'un trouble à la tâche de l'EVA peut être le reflet d'un manque d'expérience en lecture des enfants dyslexiques. Dans cette étude nous essayons de nous éloigner au maximum du cadre de la lecture en utilisant la recherche visuelle et en n'impliquant aucune lettre. On sait que les dyslexiques sont plus lents en recherche visuelle lorsque celle-ci implique des items constitués de combinaisons de lignes (symbole ou lettre) alors qu'ils sont aussi rapides que les normo lecteurs pour des formes simples (Casco & Prunetti, 1996). Il est intéressant de noter que cette lenteur spécifique pour le traitement visuel de symboles est également

observé chez une patiente avec une lésion bilatérale du LPS, et cette lenteur se caractérise par une diminution de son champ visuo attentionnel, elle ne peut pas traiter en une fixation autant de surface qu'un sujet sain (Khan et al., 2016) et également que cette structure cérébrale, le LPS, est sous activé chez certains dyslexiques lorsque la tâche nécessitait le traitement simultanément de plusieurs éléments (Lobier et al., 2012b; Peyrin et al., 2011). Partant de ces différents résultats nous avons cherché à savoir si certains dyslexiques avaient, à l'instar de la patiente avec lésion bilatérale, une diminution de leur champ visuo attentionnel.

Nos résultats ont montré que les enfants dyslexiques spécifiquement lents pour trouver la cible parmi les symboles (DysSlow) avaient bien une réduction de leur champ visuo attentionnel. En effet lorsque l'on réduisait leur visibilité à un cercle de 20° de diamètre leur temps de recherche n'était pas plus long. Alors que pour les normo-lecteurs (GoodReader) et les enfants dyslexiques qui n'avaient pas de lenteur spécifique en recherche visuelle de symboles (DysFast) l'application de cette fenêtre de visibilité réduite augmentait le temps de réponse. Les DysSlow ont donc une réduction de leur fenêtre visuo-attentionnelle contrairement aux autres enfants. Et ceci est bien spécifique au traitement des symboles car dans la condition qui impliquait des objets pleins (qui ne sont pas constitués de combinaison de traits) cette réduction de visibilité entraîne une augmentation des temps de réponse.

Les lettres sont également composées de combinaisons de traits et donc cette réduction de la fenêtre visuo attentionnelle peut les affecter pendant la lecture car les mots ne peuvent pas être traités dans leur globalité, la lecture sera donc lente et des erreurs peuvent survenir sur les graphèmes longs et les mots irréguliers.

Dans cette étude nous avons également fait passer d'autres des tests visuo spatiaux ou attentionnels et voir si cette lenteur pouvait être associée à un autre trouble. Il en ressort que seul l'EVA est différent entre les trois groupes. Les DysSlow et les DysFast ont un empan plus petit que les GoodReaders mais il n'y a pas de différence entre eux. Pour ce qui est du PVSE, à l'échelle du groupe il n'y a pas de différence de score mais si on regarde chaque enfant on remarque que dans le groupe DysSlow la prévalence d'un trouble de la perception visuo spatiale élémentaire est plus importante (40%) que chez les DysSlow (24%) et les GoodReaders (5.8%). A l'échelle du groupe nous ne retrouvons pas non plus le biais d'attention local qui est décrit dans la

littérature (Bedoin et al., 2010; Franceschini et al., 2017) du fait d'une extrême variabilité de performance chez les dyslexiques.

La dissociation entre ces différents troubles tous pourtant associés à la voie dorsale de traitement visuel est étonnante mais finalement compréhensible si on considère la diversité des aires fonctionnelles au sein du PPC (voie dorsale), et la diversité de la symptomatologie pariétale (syndrome de Balint avec des dissociations ataxie optique/ apraxie constructive, hémiparésie/ simultanagnosie..., voir le Handbook placé en annexe).

Cette étude en s'éloignant du contexte de lecture a permis de mettre en évidence qu'un trouble visuo attentionnel peut être présent dans certaines dyslexies. On ne peut pas argumenter que ce déficit est dû à un manque d'expérience en lecture car la tâche utilisée ne fait appel à aucune compétence langagière ou de lecture. C'est donc un premier résultat suggérant que le déficit visuel est indépendant du trouble de lecture et pourrait en être causal lorsqu'il est présent chez certains dyslexiques. La recherche visuelle est une compétence qui peut être testée bien avant l'apprentissage de la lecture ce qui ouvre la porte à des perspectives de dépistage précoce d'enfants à risque de développer une dyslexie ainsi qu'à une remédiation qui serait spécifique au déficit de l'enfant. Ces aspects sont développés dans la dernière partie de la discussion.

1.3 Etude 3 : traitement visuo attentionnel dans différentes conditions de recherche visuelle, rôle du LPS

Dans l'étude précédente on a pu voir que certains dyslexiques étaient spécifiquement lents en recherche visuelle lorsque celle-ci mettait en jeu des symboles. Ils auraient une réduction de la surface qu'ils peuvent traiter en une fixation. Ce résultat a également été trouvé chez une patiente ayant une lésion du LPS, structure impliquée dans le traitement simultané et sous activé chez certains dyslexiques ayant une réduction de l'EVA. Ce champ attentionnel réduit de recherche était indépendant du nombre de distracteurs « tombant » dans cette « surface ». Or la réduction de l'empan visuo-attentionnel (EVA) est plutôt décrite comme une réduction du nombre d'éléments pouvant être traités et non comme une diminution de surface de traitement simultané. Une des différences entre la recherche visuelle et la mesure de l'EVA est le « groupement visuel » des stimuli qui peut s'opérer dans la première (car tous les distracteurs sont

identiques) mais pas dans la deuxième (à l'instar de la lecture) où les symboles à rapporter (par ex les consonnes) sont tous différents. Nous avons donc fait varier différents paramètres comme le type de stimuli (objet plein ou symboles) et la nature des distracteurs (tous identiques ou non). En particulier, pour compléter l'étude de Khan et al. (2016), nous avons créé une tâche de recherche visuelle d'un disque rouge parmi des disques de couleurs toutes différentes (Tâche Couleur) et une tâche de recherche visuelle d'un disque noir (O) parmi des distracteurs combinant un disque et une ligne tous de différentes façons (Tâche Symbole). Nous avons regardé les temps de réponse mais également le comportement oculomoteur qui pouvait nous donner des indications sur le traitement visuel pour des sujets contrôles et pour la patiente IG souffrant d'une lésion bilatérale du LPS.

Les résultats ont montré que pour la tâche impliquant des disques de couleur tous différents les sujets sains utilisent une fenêtre visuo attentionnelle avec une surface fixe peu importe le nombre de distracteurs. Dans cette condition la patiente comme les sujets sains traitait une surface de taille similaire aux sujets contrôles et indépendante du nombre d'objets, malgré l'impossibilité de réaliser un « groupement visuel ».

Pour la tâche symboles, la patiente avait de grandes difficultés et ne pouvait traiter qu'un seul symbole à chaque fixation. Cette condition de traitement de symboles tous différents est la plus proche de la condition de lecture. On peut faire le parallèle avec le dysfonctionnement du LPS chez certains dyslexiques qui les empêcherait donc de pouvoir traiter simultanément plusieurs lettres et donc ralentirait la lecture et l'apprentissage de celle-ci.

On peut conclure de cette étude que c'est bien le fait d'utiliser des stimuli constitués de plusieurs éléments (comme les lettres) qui produit un déficit en cas de dysfonctionnement du LPS. Il se trouve que les dyslexiques montrent également un empan normal lorsqu'on présente des disques de couleur (Valdois et al., 2012a). Ce déficit s'exprime en un champ de surface réduite traité en une fixation lorsque les distracteurs sont identiques, et en un empan (nombre de symboles traité en une fixation) réduit lorsque les distracteurs sont variés.

En fait, pour la patiente comme pour les sujets sains, la recherche visuelle de symboles bascule d'un mode de recherche limité à une « surface » à un mode de

recherche limité par un « empan » selon la variété des distracteurs, c'est-à-dire la possibilité de les « grouper visuellement », donc en quelque sorte de ne pas les traiter avec précision, mais de les catégoriser. La similarité des distracteurs augmente la prédictibilité visuelle et simplifie la tâche.

Nous avons postulé dans cette étude que le mode de recherche limité par un « empan » correspond en fait à un mode de recherche pour lequel la surface diminue lorsque l'encombrement entre les stimuli est trop important et empêche la détection de la présence de la cible en périphérie du champ de recherche. Si tous les distracteurs sont similaires, ils peuvent être groupés visuellement, un processus connu comme permettant d'annuler ou au moins de réduire le phénomène d'encombrement visuel (ou « Crowding »). Nous avons exploré l'hypothèse d'un encombrement excessif en cas de dysfonctionnement du LPS dans l'étude 4.

1.4 Etude 4 : Rôle du LPS dans la perception et la localisation de multiples éléments

Dans cette étude nous étudions le traitement visuel d'une patiente avec une lésion du LPS dans une tâche de perception simultanée. On sait qu'une lésion du LPS entraîne une simultagnosie qui se traduit par une incapacité à traiter simultanément plusieurs éléments. Dans une tâche de recherche visuelle, cette patiente était plus lente que les sujets contrôles mais uniquement pour des stimuli constitués de combinaisons de lignes. Cette lenteur était due à une réduction de sa fenêtre visuo attentionnelle, elle traitait en une fixation une surface plus petite que les sujets contrôles quel que soit le nombre d'éléments qui tombait dedans (Khan et al., 2016). Dans cette étude nous étudions plus précisément son traitement visuel d'objet plein (disque de couleur) et d'item constitué de combinaison de traits (lettre) en les présentant de façon isolée ou sous forme de triplet d'encombrement (« crowding ») variable, en vision centrale ou périphérique.

Lors de la présentation isolée des différents items (couleur ou lettre), La patiente ne présentait aucun déficit, elle arrivait à distinguer les items même en périphérie. Par contre dès qu'ils étaient flanqués de deux autres items similaires (même avec un grand espacement) elle était incapable de reconnaître l'item du milieu (elle se situait toujours au niveau de chance) que ce soit pour les lettres ou les couleurs, alors que les sujets

sains voyaient leur performance augmenter au fur et à mesure que l'espacement augmentait (résultat classique que l'on retrouve dans ces tâches). L'identification en vision centrale était quant à elle possible car sa performance se situait au-dessus du niveau de chance mais restait en dessous des sujets sains qui eux atteignaient une performance plafond.

Elle présentait donc un déficit d'identification de la lettre centrale mais était-ce dû à un « encombrement » excessif ou à un déficit de localisation (elle identifie bien les 3 items mais est incapable de les situer et donc de répondre à la consigne demandant de rapporter l'identité de l'item *du milieu*) ?

Pour répondre à cette question nous avons changé la consigne : elle devait répondre si elle voyait oui ou non un disque vert et oui ou non la lettre T. Cette consigne est plus proche de la recherche visuelle (la cible est-elle présente ou non parmi les stimuli ?) Les résultats ont montré qu'elle avait un problème de localisation pour la tâche impliquant les disques de couleur car elle était tout à fait capable de détecter la présence du disque vert même si elle ne savait pas où il était présenté par rapport aux deux autres disques. Par contre il était encore impossible pour elle de détecter la présence de la lettre T dans le triplet. Nous avons supposé que le problème de localisation mis en évidence par la tâche de couleurs était accentué par les items constitués de combinaison de lignes. En effet si la localisation des différentes lignes constituant chaque lettre est déficiente, en plus de la localisation des lettres entre elles, la complexité est majorée pour la patiente. Cette hypothèse a été confirmée par une dernière tâche dans laquelle les flankers ont été remplacés par des « X » et qui a permis à la patiente d'identifier correctement la lettre du milieu. En effet, cette configuration permet de diminuer les différentes combinaisons de lignes possibles et de pouvoir grouper visuellement les flankers pour extraire la lettre du milieu.

Cette étude ainsi que la précédente (étude 3) permet de mieux comprendre le rôle que peut jouer le LPS dans la dyslexie. Le LPS semble avoir un rôle dans la localisation inter-objets mais également intra-objet lorsque ceux-ci sont constitués de combinaisons de lignes à l'instar des symboles du langage écrit (les lettres et les mots). La multitude de combinaisons spatiales de lignes possible rend très difficile l'identification des lettres surtout si celles-ci sont toutes différentes comme lors de la lecture, puis la multitude de combinaisons spatiales des lettres possible (de leur ordre

dans le graphème dont le traitement est aussi déficient) est encore une équation avec de multiples inconnues.

Ce déficit mis en évidence également grâce à des tâches de recherche visuelle suggère encore que le déficit pourrait être présent bien avant l'apprentissage de la lecture, mais seul une détection précoce de déficit de traitement visuel et un suivi longitudinal de ces enfants pour savoir s'ils développent effectivement une dyslexie peut réellement prouver ce facteur causal. C'est l'objectif du travail de dépistage précoce que nous avons commencé à mener dans les écoles de la circonscription Gex Sud de l'éducation nationale.

2. Perspectives

2.1 Dépistage précoce :

En partant de l'hypothèse que la recherche visuelle est une compétence qui s'acquiert bien avant la lecture et que certains enfants dyslexiques présentent une dysfonction du LPS qui rend difficile l'identification d'items constitués de combinaisons de lignes (symbole), nous avons développé une application sur tablette tactile qui permettrait de mettre en évidence cette difficulté de traitement visuel des symboles à tout âge, à partir de la petite section maternelle.

Cette application contient une tâche de recherche visuelle dans laquelle il faut trouver un cercle noir soit parmi des cercles de couleur soit parmi des cercles avec une barre (figure 8). Il faut trouver le cercle noir le plus vite possible et appuyer dessus pour lancer l'image suivante.

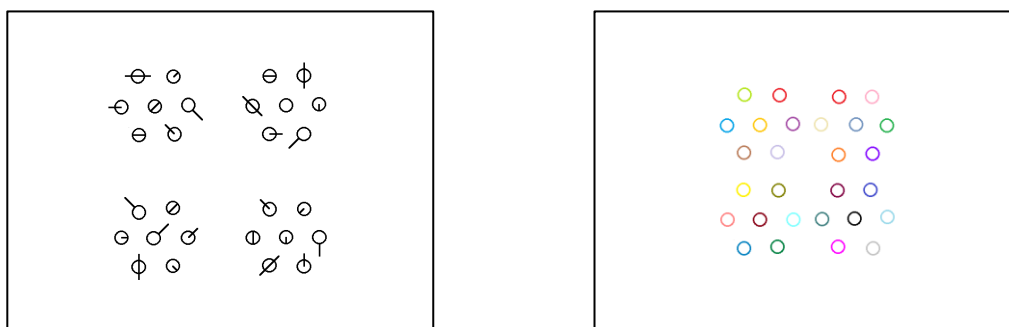

Figure 8 - Images présentées lors de l'étude dépistage sur tablette. Il faut toujours trouver un cercle noir soit parmi des cercles avec une barre (à gauche), soit parmi des cercles de couleurs différentes (à droite)

Entre chaque image le cercle noir apparait seul en position centrale supposé à la fois ramener le regard et rappeler à l'enfant la cible à rechercher. La cible peut se situer dans un rayon de 5, 7.5, 10 ou 12.5° à partir du centre, il y a toujours 27 distracteurs qui sont espacés de telle sorte que le phénomène « d'encombrement » ne peut pas intervenir. Il y a 64 images (32 couleurs et 32 symboles avec 8 images par excentricité) et nous recueillons les temps de réponse.

Notre hypothèse étant que les enfants à risque de développer une dyslexie soient plus lents pour traiter les symboles que les couleurs nous avons décidé de calculer une « distance » qui correspond à la différence de temps de recherche entre symbole et couleur tout en prenant compte la variabilité des réponses.

$$\text{Distance} = \sqrt{(M_{\text{symbole}} - M_{\text{couleur}})^2 + (IQR_{\text{symbole}} - IQR_{\text{couleur}})^2}$$

Données préliminaires recueillies :

Nous avons commencé à tester cette application chez des enfants de petite section au CM2, cela représente près de 2000 enfants répartis comme le montre le tableau suivant.

Niveau	Effectif
PS	145
MS	279
GS	259
CP	319
CE1	148
CE2	278
CM1	300
CM2	270

Nous avons également commencé à tester en lecture les plus grands (227 élèves de CM1 et 211 de CM2) afin de voir s'il existait une corrélation entre les performances au test visuel et à la lecture sur la même année de test. Le test de lecture utilisé est celui de l'alouette (Lefavrais, 1967).

Résultats préliminaires au test visuel :

Pour le test visuel, nous observons une diminution du score de distance en fonction de l'âge, les plus jeunes sont plus lents pour trouver le cercle parmi les symboles que parmi les couleurs. Plus l'âge avance et plus cet écart diminue comme on peut le voir sur la figure ci-dessous (figure 9). Les croix noires représentent les

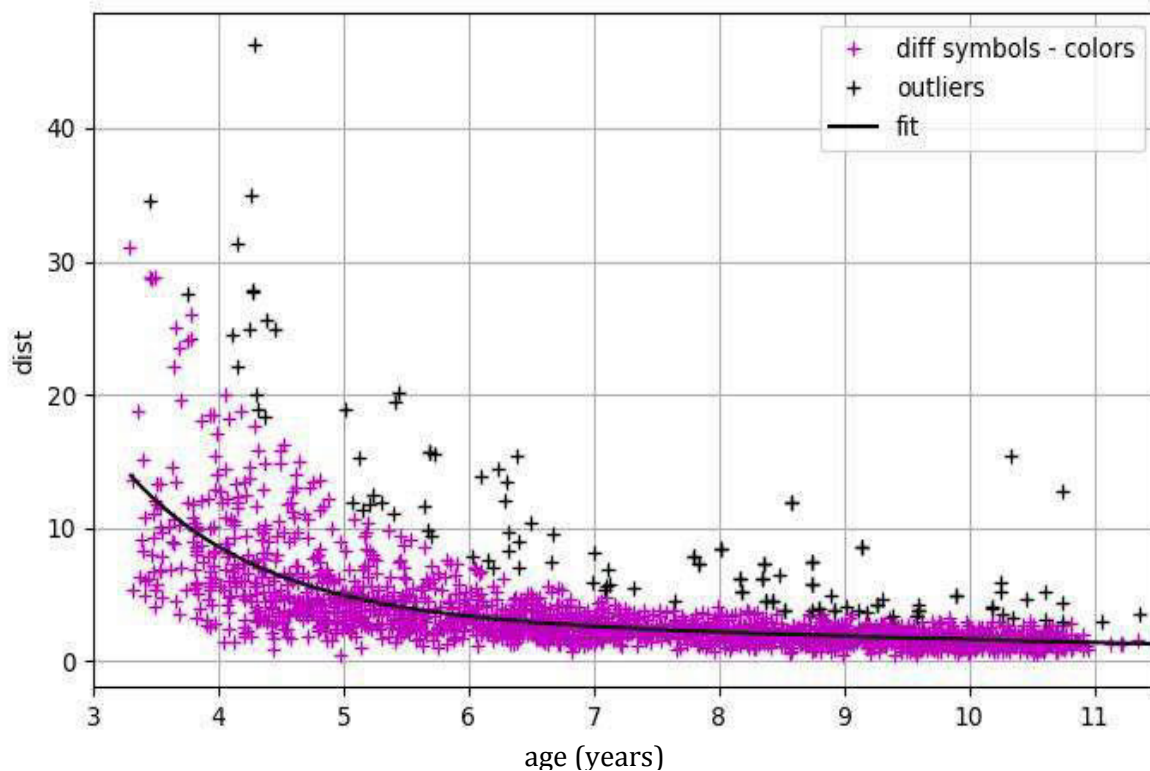

Figure 9 - Score brut de distance en fonction de l'âge. En noir sont représentés les « outliers » qui sont exclus du fitting de la trajectoire développementale normale

« outliers ».

Nous avons calculé un score corrigé qui nous permet de nous affranchir de l'effet de l'âge (figure 10) et nous remarquons là encore que pour tout âge il y a des enfants qui semblent sortir clairement de la population : les « outliers » (qui sont représentés avec des croix noires) mais aussi, de façon arbitraire, nous avons décidé de considérer comme dépistés au test visuel les enfants dont la distance est au-dessus du 95^e centile de l'échantillon de référence. L'échantillon de référence (sans les outliers) nous permet d'établir une norme et ainsi voir les enfants qui seraient en dehors de cette norme au test visuel. Nous avons pour l'instant fixé le seuil de « détection » des possibles dyslexiques prédits par le test visuel au 95^{ème} percentile (ligne rouge en pointillés),

c'est-à-dire les enfants dont 95 % de la population est plus rapide en symboles par rapport à leur rapidité en couleur sont aussi considérés « à risque » de développer une dyslexie.

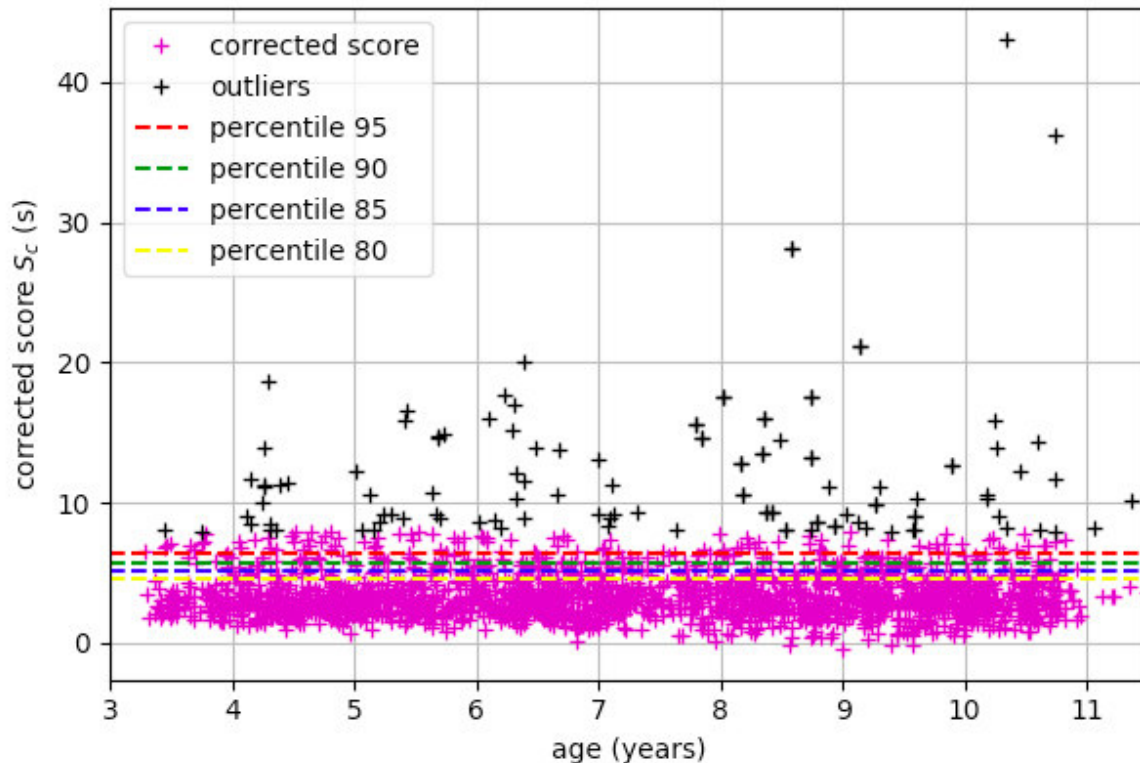

Figure 10 - Score corrigé de distance en fonction de l'âge. En noir sont représentés les outliers qui ont été exclus de l'analyse pour la norme. Les pointillés de couleur représentent les différents percentiles

Résultats préliminaires au test de lecture de l'alouette :

Ce texte est non significatif, nous avons pour le moment passé les enfants de CM1 et CM2 présents en juin 2020 à l'école (après le confinement), ce qui représente 438 enfants (227 en CM1 et 211 en CM2).

Pour établir l'échantillon de référence les enfants primo-arrivants (arrivés depuis moins de 2 ans en France) ont été retirés quelle que soit leur performance. Ensuite les enfants « outlier » (éloignés de plus de 2.5 écart type de la médiane) sur le nombre d'erreur et/ou la vitesse ont été retirés de l'échantillon normatif qui compte désormais 383 enfants. D'après ces normes, les enfants de CM1 faisaient en moyenne 12.6 (+/- 6.15) erreurs et lisaient 1.5 (+/- 0.5) mots par seconde, ceux de CM2 faisaient 11.1 (+/- 6.19) erreurs et lisaient 1.76(+/- 0.44) mots par seconde.

Pour le choix d'un critère unique de dépistage nous avons calculé un indice combinant vitesse et précision, l'efficacité générale de lecture, à partir des z-scores du nombre d'erreur (nombre de mots mal lus) et de la vitesse (nombre de mots lus / temps). Nous avons considéré que les enfants ayant un score d'efficacité générale < -1.65 échouaient au test de l'alouette.

Sur les 437 élèves de CM1 et CM2, 88 (20.1%) échouaient au test de l'alouette. Il est à noter que parmi ces 88 enfants détectés sur la base du test de l'Alouette, certains n'ont pas de dyslexie mais évoluent dans un contexte multilingue qui peut freiner (au moins temporairement) l'apprentissage de la lecture en français. La population du Gex comprend de nombreux multilingues et beaucoup d'entre eux ne sont pas à considérer comme dyslexiques à proprement parler. Une option dans le futur serait de les enlever de l'étude mais le meilleur critère doit être choisi (apprentissage du français avant 4 ans ou pas par exemple, utilisation du français à la maison ou pas...). La lecture peut également être affectée par des troubles de l'attention avec ou sans hyperactivité, ou des troubles sensoriels ou moteurs (appareillage auditif, bégaiement, dyspraxie verbale par exemple). Nous présentons ci-dessous les résultats de la relation entre le test visuel sur tablette (avec comme prédicteur la distance) et le test de lecture (avec comme seul indice notre Z score d'efficacité générale) dans leur analyse préliminaire « brute » ne prenant pas en compte les anamnèses et les bilans (orthophonie, orthoptie, neuropsychologie) débutés qui vont se poursuivre afin d'affiner le nombre d'enfants présentant réellement une dyslexie.

Corrélation entre le test visuel et la lecture :

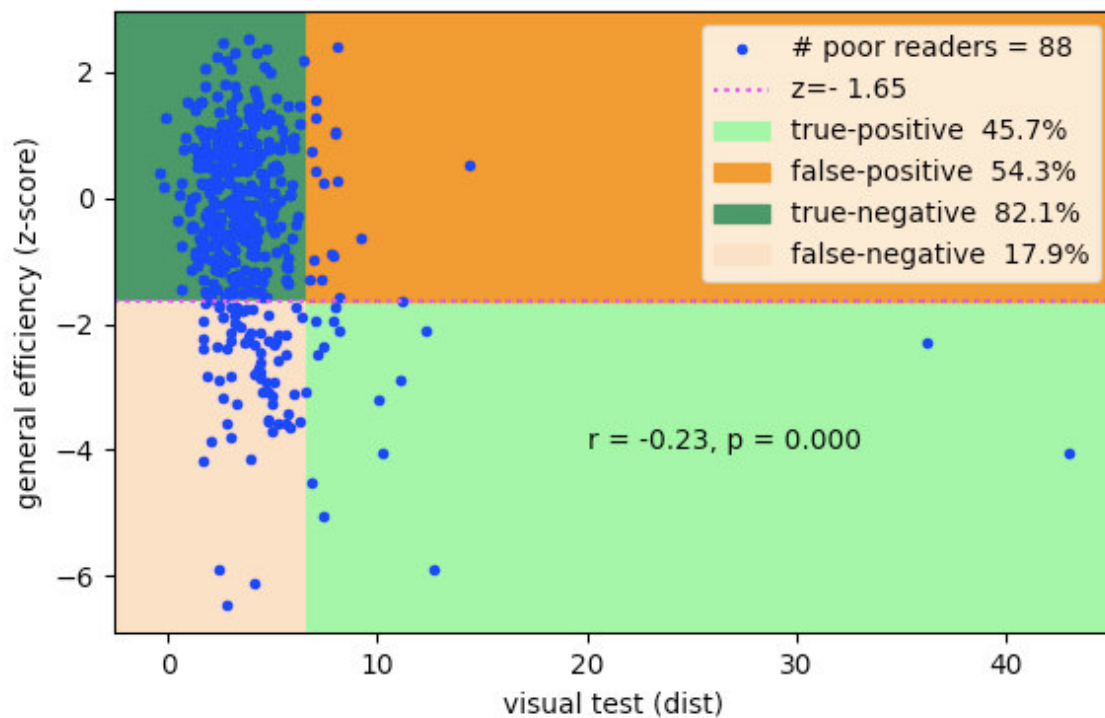

Figure 11 - Corrélation des scores au test visuel et à la lecture chez les CM1et CM2. Le rectangle vert foncé représente les vrai négatifs (qui ont réussi à la recherche visuelle et à la lecture), en vert clair il y a les vrai positifs (qui ont échoué à la recherche visuelle et à la lecture), en orange les faux positifs (qui ont échoué à la recherche visuelle mais ont réussi à la lecture) et en beige les faux négatifs (qui ont réussi la recherche visuelle mais échoué à la lecture).

Sur cette figure, le taux de vrais positifs est le nombre d'enfants à la fois supérieurs au 95^{ème} pourcentile au test visuel et avec un z score d'efficacité générale de lecture inférieur à -1.65, divisé par le nombre total d'enfants supérieurs au 95^{ème} pourcentile au test visuel (de positifs).

Le taux de faux positifs est le nombre d'enfants avec un z score d'efficacité générale de lecture supérieur à -1.65 (non pathologiques en lecture) mais supérieurs au 95^{ème} pourcentile au test visuel, divisé par le nombre total d'enfants supérieurs au 95^{ème} pourcentile au test visuel (de positifs).

Le taux de vrais négatifs est le nombre d'enfants inférieurs au 95^{ème} pourcentile au test visuel et avec un z score d'efficacité générale de lecture supérieur à -1.65 (non pathologiques en lecture), divisé par le nombre total qui d'enfants inférieurs au 95^{ème} pourcentile au test visuel (de négatifs).

Le taux de faux négatifs est le nombre d'enfants inférieurs au 95^{ème} pourcentile au test visuel mais dont l'efficacité générale de lecture est pathologique ($z_{\text{eff}} < -1.65$), divisé par le nombre total qui d'enfants inférieurs au 95^{ème} pourcentile au test visuel (de négatifs).

La figure ci-dessus (figure 11) montre la répartition actuelle des vrais/faux positifs/négatifs. La partie en vert foncé correspond aux « vrai négatifs » qui sont les enfants qui ne sont ni pathologiques à l'Alouette ni au test visuel. Les enfants se situant dans la partie beige sont les « faux négatifs », c'est-à-dire qu'ils échouent à l'alouette mais que leur distance en recherche visuelle est dans la norme, cela peut correspondre par exemple aux enfants dyslexiques qui ont un trouble spécifique de la phonologie. Les « vrai positifs » en vert clair sont les enfants qui ont à la fois un déficit en lecture et lors de la recherche visuelle de symboles. Les faux positifs en orange sont ceux qui ont échoué au test visuel mais qui ont néanmoins compensé ce trouble de perception visuelle des symboles et développé de bonnes capacités de lecture.

Ces résultats vont être revus à partir des bilans orthophoniques, orthoptiques et neuropsychologiques chez les enfants détectés qui nous permettront d'enlever quelques faux-négatifs (troubles de précision de lecture dus à un bilinguisme ou à des troubles auditifs par exemple que nous avons déjà décelés chez quelques enfants). Ces bilans et anamnèses devraient aussi nous permettre de mieux comprendre le profil cognitif de nos faux positifs (bonne attention et bon niveau de vocabulaire et d'intelligence globale, orthographe déficiente ?), et le profil de lecture comparé de nos vrais positifs (dyslexie visuelle ou mixte) et de nos faux négatifs (dyslexie avec troubles phonologiques ou TDA/H). Nous avons également testé l'Alouette sur de nouveaux CM2 et une centaine de nouveaux CM1 en septembre-octobre 2021, ce qui peut changer les normes de lecture.

On peut aussi regarder la sensibilité et la spécificité de notre test visuel avec ces mêmes données (« brutes »). Parmi les 88 élèves « mauvais lecteurs » 18 ont également échoué au test visuel (ils se situaient au-delà du 95^e percentile). Cela représente une prédiction de 20.45% des dyslexiques à partir de notre test visuel sur tablette, sachant que ce chiffre de sensibilité est amené à s'améliorer avec les anamnèses et les bilans d'orthophonie, de neuropsychologie et d'orthoptie qui vont probablement ramener la prévalence générale de la dyslexie dans notre population du Gex (actuellement de 20.1% en incluant les bilingues) à un pourcentage plus proche des 10% habituellement rapportés dans la littérature. Pour la spécificité, 15 enfants ont quant à eux échoué au test visuel mais sont performants au test de lecture, cela représente 45,45% des 33 enfants détectés par notre prédicteur visuel. Certains de ces enfants ont effectué une anamnèse et des bilans qui ont montré un bon niveau socio culturel et de bonnes

ressources cognitives. Ils ont ainsi réalisé une deuxième fois le test sur tablette et ils ne sortent plus comme lents en repérage visuel. Il peut y avoir plusieurs facteurs comme la motivation, la concentration de l'enfant à l'instant du test ou même le stress que peut causer la situation de test. Il serait donc intéressant de faire quelques test-retest du test visuel afin de voir si c'est un score stable et représentatif ou s'il est amené à fluctuer.

La corrélation chez ce groupe d'élèves de CM1 et CM2 entre le score de distance au test visuel et le score d'efficacité générale au test de lecture est significative à $p < 0.0001$ avec un coefficient de corrélation de -0.23 donc le score de distance au test visuel explique 5.3% de la variance au test de lecture.

Dans la littérature, la connaissance du nom des lettres est un des facteurs prédictifs les plus décrits, ainsi que la conscience phonologique et la dénomination rapide (Billard et al., 2009). Pour comparaison, d'après la régression multivariée de l'étude de Negro & Genelot (2009) la reconnaissance des lettres en GS corrèle avec un coefficient de 0.44 ($p < 0.01$) avec la performance de lecture de mots en CP, et en explique 12% de la variance, quant aux connaissances métaphonologiques, elles corrélaient à $r = 0.17$ ($p < 0.05$) et expliquent 1.8% de la variance. C'est le facteur socio-économique qui est le plus important, expliquant 20.7% de la variance de score de la reconnaissance des mots (Negro & Genelot, 2009). Dans une autre étude il a en effet été montré que la prévalence des difficultés de lecture était de 3.3 % dans un milieu favorisé alors qu'elle augmentait à 20.5% dans un milieu défavorisé (Billard et al., 2009; Fluss et al., 2009).

Dans l'étude de Bonnefoy & Rey (2008), la précision de la connaissance des lettres en CP explique 24,7% de variance en lecture de mots et la rapidité pour dénommer les lettres explique 11,6% de variance des temps de réponse aux mots écrits. D'après Casalis & Louis-Alexandre (2000), 5,7 et 26,3% de variance des résultats de lecture de mots en CP est expliquée par les connaissances en morphologie flexionnelle (flexions et dérivations) et d'analyse syllabique de CP. En conclusion, il n'y a que quand le prédicteur est très proche de la tâche de lecture que la prédiction est élevée (par exemple Mute et al. (1998) ont montré une forte corrélation entre les performances aux tâches phonémiques et le niveau de lecture en fin de CP ($r = 0.62$)) mais notre test visuel montre donc une prédiction de l'ordre des autres prédicteurs classiques qui peuvent être utilisés très précocement (chez des pré-lecteurs).

Dans la plupart des études il y a très peu voire pas du tout d'épreuve prédictive testée qui soit visuelle ou visuo-attentionnelle. On peut cependant mentionner les résultats comparés d'un test de recherche visuelle de symboles et de prédicteurs plus classiques de l'étude de [Plaza & Cohen \(2006\)](#). Dans leur régression multiple, la dénomination rapide de couleurs corrèle à $r=0.29$ ($p<0.005$) avec la lecture de mots et à $r=0.21$ (non significatif) avec la lecture de pseudo-mots en CP, l'inversion de syllable autant avec à la lecture de mots et de pseudo-mots ($r=0.44$ et $r=0.43$; $ps<0.0001$). La dénomination rapide de couleurs corrèle à $r=0.25$ ($p<0.005$) avec l'orthographe des mots et à $r=0.08$ avec l'orthographe des pseudo-mots (non significatif), tandis que l'inversion de syllable corrèle à $r=0.35$ ($ps<0.001$) avec l'orthographe des pseudo-mots et à $r=0.36$ ($p<0.0001$) avec celle des mots en CP. Le test d'attention visuelle qui consiste à chercher et trouver des symboles non-linguistiques dans un tableau de stimuli avec 20 symboles cibles et 80 distracteurs corrèle à $r=0.32$ ($p<0.001$) avec la lecture de pseudo-mots et à $r=0.16$ (non significatif) avec la lecture de mots, et à $r=0.46$ avec l'orthographe de mots et de pseudo-mots ($ps<0.0001$). Les auteurs concluent que l'attention visuelle est le prédicteur le plus important pour l'orthographe ("spelling").

Enfin, l'étude récente de [Franceschini, et al. \(2012\)](#) a testé de façon convaincante deux prédicteurs visuo-attentionnels mesurés en GS:

- Tâche de recherche visuo-spatiale : rechercher parmi 5 lignes de 31 symboles (non-lettres) et marquer chaque occurrence d'un symbole cible, sur une feuille A4, deux variantes : symboles espacés ou symboles non-espacés.
- Tâche de repérage spatial de type [Posner \(1980\)](#) : les enfants voyaient brièvement sur un écran, à gauche ou à droite d'un point central de fixation, une ellipse dans une des quatre orientations possibles, et devaient sélectionner parmi les quatre possibilités de réponses quelle ellipse ils venaient de voir. 3 conditions de passation : sans indiçage, avec indiçage et avec faux indiçage.

Les résultats ont montré que 57% des futurs faible-lecteurs étaient à -1ET en dessous de la moyenne des normo-lecteurs dans au minimum une tâche attentionnelle lorsqu'ils étaient au stade pré-lecteur. Plus précisément, les auteurs ont utilisé un Z score moyen entre les erreurs à la tâche de recherche visuelle et la précision dans la condition d'indiçage valide qui prédisait la performance en CP de lecture de pseudomots (r^2 change = 0.094), de mots isolés (r^2 change = 0.093) et de texte (r^2 change = 0.152). Ces résultats et ce score moyen soulignent l'avantage d'utiliser une combinaison de plusieurs tests plutôt qu'un test unique. Cependant, chacun séparément, ces tests prédisaient significativement les performances en CE1 de lecture de mots isolés (r^2 change = 0.165 et 0.087, respectivement), et les capacités de lecture de texte (r^2 change

= 0.222 et 0.121, respectivement). Pour comparaison, le RAN non-alphabétique et le mélange syllabique prédisaient aussi significativement la lecture de mots isolés (r^2 change = 0.072 et 0.092, respectivement), et les capacités de lecture de texte (r^2 change = 0.056 et 0.082, respectivement).

On peut donc voir que notre prédicteur présente un r^2 dans le même ordre de grandeur que d'autres prédicteurs communément admis sur les enfants de CM1 et CM2. Ce r^2 est amené à évoluer avec l'avancement de l'étude et l'entrée dans l'apprentissage de la lecture des enfants qu'on a testé en maternelle. Ce n'est qu'avec ces données que l'on pourra réellement évaluer notre prédicteur. C'est l'étude longitudinale des enfants testés en maternelle sur tablette qui nous intéresse. Cette étude longitudinale n'est pas encore terminée, il nous faut encore suivre le développement de ces enfants jusqu'au CE2.

Cette étude pourrait permettre de détecter plus tôt les enfants à risque de développer un trouble d'apprentissage de la lecture et donc de leur proposer un accompagnement plus personnalisé avec 1) un apprentissage de la lecture davantage axé sur l'analyse visuelle du langage écrit avec des jeux spécifiques permettant de travailler spécifiquement la combinaison visuelle de lignes et la perception de l'ordre des lettres que nous avons commencé à développer avec des enseignants et l'aide de Pulsalys la filière de valorisation du CNRS, et 2) des exercices spécifiques d'entraînement à la recherche visuelle de symboles similaire au test sur tablette « échoué » en vue d'une remédiation précoce.

2.2 Remédiation visuo attentionnelle

Dans le cadre de cette thèse nous avons commencé à développer et à tester une application de remédiation.

Cette application se base sur l'hypothèse que certains enfants dyslexiques ont des difficultés à traiter les symboles. Nous avons donc développé un exercice sur tablette tactile dans lequel il fallait trouver une lettre cible parmi des distracteurs. Il y a 4 niveaux de difficultés graduels, le premier niveau la lettre à trouver est parmi des symboles tous identiques, dans le 2nd elle est parmi des symboles tous différents puis parmi des lettres identiques et enfin pour se rapprocher de la condition de lecture parmi des lettres différentes.

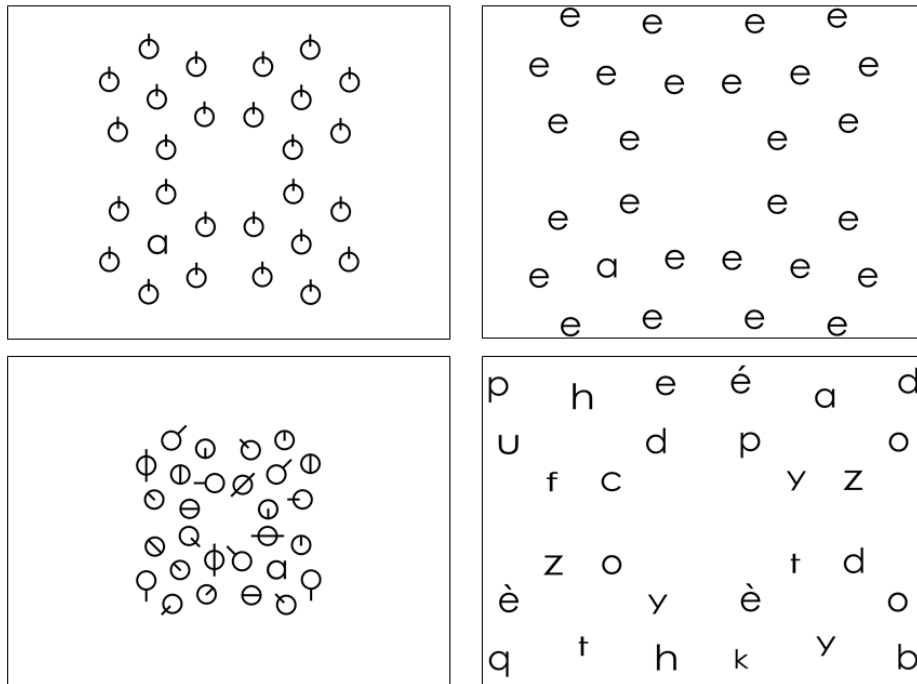

Figure 12 - Images présentées lors de la remédiation sur tablette. Il fallait trouver une lettre cible (ici le a), avec des distracteurs différents permettant de varier la difficulté.

Le protocole durait 3 mois avec 1 test de lecture au début de chaque mois et à la fin ainsi que le test visuel décrit dans la partie dépistage précoce. On introduit la tablette pendant 1 mois et on demande de faire l'exercice 10 minutes par jour.

Les 4 textes de lecture utilisés étaient non significatifs et appariés entre eux (Beaudoin).

Les enfants lisaient les textes de 201 mots, on notait le nombre d'erreurs ainsi que le temps. Par la suite nous calculons un indice qui prend en compte la vitesse (nombre de mots lus / temps) et le nombre d'erreurs.

Indice de lecture = vitesse / nombre d'erreurs

Si l'indice de lecture augmente cela veut dire que l'enfant fait moins d'erreurs et/ou qu'il va plus vite.

7 enfants dyslexiques qui ont participé à l'étude 2 ont accepté de participer à la remédiation.

Résultats préliminaires :

5 enfants étaient catégorisés en DysFast et 2 en DysSlow d'après les critères de l'étude 2. On peut voir que chaque enfant améliore sa distance, l'écart entre le temps de réponse pour les couleurs et celui pour les symboles se réduit après l'introduction de la tablette (figure 13).

En ce qui concerne la lecture les résultats montrent une amélioration de l'indice chez les DysSlow (figure 14). Les 2 enfants voient leur performance de lecture augmenter soit immédiatement après la remédiation (pour le sujet 6) soit un mois après pour le sujet 7. Pour les enfants qui étaient dans le groupe DysFast les résultats sont plus contrastés, seuls les sujets 1 et 5 s'améliorent après la remédiation mais cela ne semble pas se maintenir dans le temps (à M+2 l'indice est proche de celui à M0). Les autres sujets soit suivent leur trajectoire développementale (sujet 2), soit stagnent (sujet 3) voire même régressent (sujet 4).

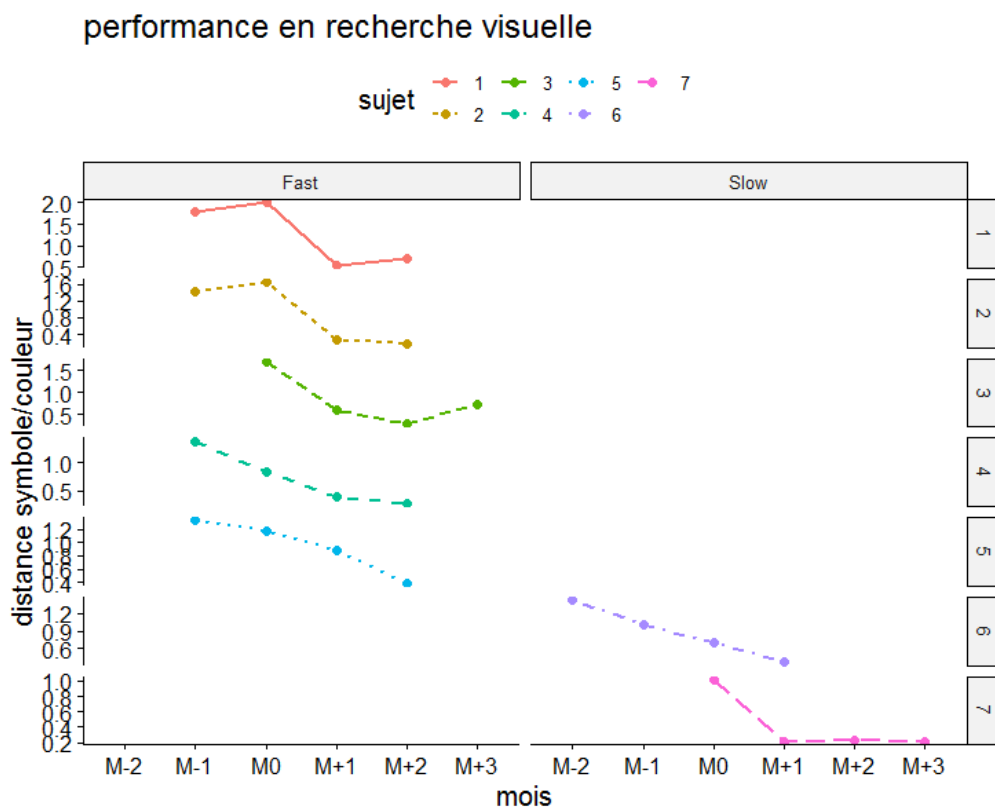

Figure 13 - Performance en recherche visuelle. A gauche les enfants dyslexiques considérés comme rapides en condition symboles, à droite les lents qui ont une difficulté spécifique pour traiter les symboles. M0 correspond au début de la remédiation. M-2 et M-1 correspondent respectivement à 2 et 1 mois avant la remédiation. M+1 correspond à la fin de la remédiation sur tablette. M+2 correspond à 1 mois après la fin de la remédiation. Chaque enfant est représenté par une ligne et à sa propre échelle.

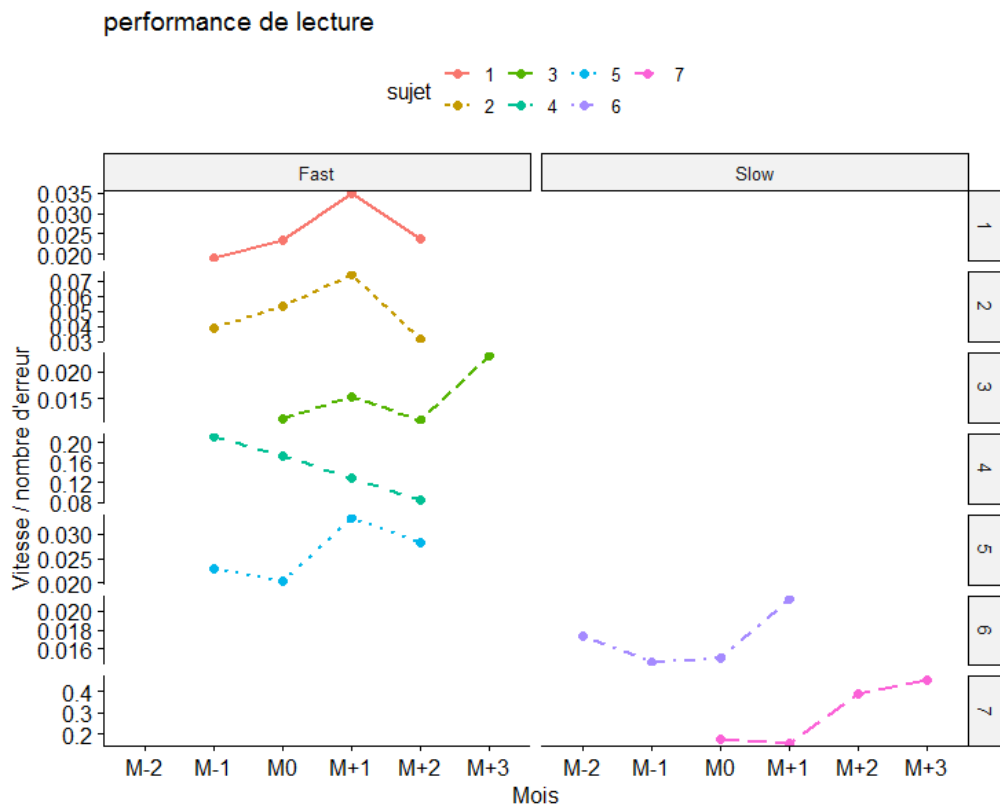

Figure 14 - Performance de lecture. A gauche les enfants dyslexiques considérés comme rapides, à droite les lents qui ont une difficulté spécifique pour traiter les symboles. M0 correspond au début de la remédiation. M-2 et M-1 correspondent respectivement à 2 et 1 mois avant la remédiation. M+1 correspond à la fin de la remédiation sur tablette. M+2 correspond à 1 mois après la fin de la remédiation. Chaque enfant est représenté par une ligne et à sa propre échelle.

Ces résultats, qui sont à confirmer en augmentant l'effectif, montrent que même si la performance en recherche visuelle s'améliore pour tous les enfants, c'est seulement ceux qui étaient lents spécifiquement pour le traitement visuel des symboles qui semblent avoir un transfert vers la lecture.

Ces résultats semblent cohérents car les enfants « Slow » ont des difficultés à traiter les combinaisons de traits et un entraînement spécifique et intensif de cette compétence leur permet d'acquérir un traitement visuel plus rapide et efficace et ainsi pouvoir transférer cette compétence pour la lecture. Les enfants « Fast » quant à eux sont déjà performants donc même une diminution de la différence de temps de recherche entre symbole et couleur ne leur permet pas une amélioration de la lecture.

Cette étude présente encore des limites car l'effectif est faible et comme la remédiation se fait à domicile l'assiduité n'était pas toujours au rendez-vous. Pour

l'avenir on peut donc envisager de recruter plus d'enfants ainsi que d'améliorer l'application en la rendant plus ludique et attractive.

3. Conclusion générale

Le travail de cette thèse vise à mieux comprendre les mécanismes visuo attentionnels qui peuvent entraver l'apprentissage de la lecture et donc mener à une dyslexie. La première partie visait à montrer qu'un déficit visuo attentionnel pouvait exister chez certains dyslexiques même lors de tâches qui ne demandaient aucune compétence phonologique. Avec cette approche purement visuelle on a pu montrer que certains enfants dyslexiques présentaient une lenteur dans le traitement de symboles faits de combinaisons de lignes et que cette lenteur spécifique pour les symboles était due à un rétrécissement de leur fenêtre visuo attentionnelle. En effet lorsqu'on leur masquait expérimentalement une partie de leur champ visuel avec une fenêtre de 20° de diamètre ils n'étaient pas plus lents que lorsqu'ils avaient la visibilité totale. Cela suggère qu'ils ont une fenêtre visuo attentionnelle réduite et qui ne dépasse pas 20°. Cette réduction est bien spécifique du traitement visuel des symboles car quand la recherche visuelle implique des « objets pleins » la réduction de visibilité augmente les temps de réponse ce qui suggère donc que leur fenêtre visuo attentionnelle dans cette tâche va au-delà de 20°. La fenêtre visuo attentionnelle est une fenêtre de visibilité « fonctionnelle » dans laquelle le sujet est capable de traiter différents éléments simultanément et donc de trouver la cible. Les normo lecteurs ainsi que les enfants dyslexiques qui n'ont pas de lenteur dans le traitement des symboles présentent une augmentation de leur temps de réponse lorsqu'on leur réduit leur visibilité à 20° et ceci pour les deux types de stimuli (symboles ou objets pleins) cela suggère donc que leur fenêtre visuo attentionnelle dans ces 2 tâches est de plus de 20°.

Cette réduction pour les symboles chez certains dyslexiques signifie donc qu'ils ne peuvent pas traiter autant d'éléments que les autres en une fixation. Ces résultats sont en accord avec la réduction de l'empan visuo attentionnel (EVA) (nombre d'éléments distincts pouvant être traités simultanément) qui est retrouvé chez certains dyslexiques (Bosse et al., 2007). Cependant comme cette mesure d'empan ce fait avec des lettres certains auteurs suggèrent que c'est le manque d'expérience en lecture des enfants dyslexiques qui leur fait défaut pour reconnaître les lettres aussi bien que les

normo lecteurs. Notre étude qui ne requiert aucune compétence phonologique ainsi que les études d'imagerie qui montrent une sous activation du lobule pariétal supérieur lors d'une tâche de traitement simultané chez les enfants dyslexique qui ont un EVA faible et ceci même avec des caractères qui ne sont pas des lettres (Peyrin et al., 2011, 2012) permettent de montrer qu'un déficit visuo attentionnel peut être présent chez certains enfants dyslexiques. Notre étude montre également une prévalence plus importante de trouble de la perception visuo spatiale élémentaire dans le groupe d'enfants dyslexiques lent pour traiter les symboles (40%) par rapport aux autres enfants dyslexiques (24%). On note donc une hétérogénéité des profils suivant les modalités visuo attentionnelles ou visuo spatiales testées bien que celles-ci impliquent toutes la voie dorsale leur impact est différent suivant les enfants. Il me semble donc important de prendre en compte cette hétérogénéité pour prendre en charge les enfants et leur proposer des remédiations qui soient bien spécifiques de leur déficit.

La seconde partie de cette thèse a une approche plus théorique en étudiant le rôle du LPS, structure cérébrale identifiée comme impliquée dans le traitement simultané de plusieurs éléments (Lobier et al., 2012b) et montrée comme sous activée chez certains dyslexiques (Peyrin et al., 2011, 2012). On a pu montrer grâce à l'étude d'une patiente atteinte d'une lésion bilatérale de cette aire cérébrale que celle-ci jouait un rôle important dans la localisation d'objets. En effet lorsqu'elle devait identifier un disque de couleur parmi d'autres il n'y avait pas de problème, elle était juste incapable de les localiser les uns par rapport aux autres. Par contre lorsqu'il s'agissait de symboles qui sont fait de combinaisons de lignes ce déficit de localisation rend très fastidieux leur identification et d'autant plus lorsqu'ils sont tous différents et qu'elle ne peut pas les « grouper visuellement ». Dans cette condition qui se rapproche de la lecture (car on doit analyser simultanément une succession de lettres), elle n'est capable de les traiter qu'un par un.

On peut faire un parallèle avec les dyslexiques qui ont un déficit d'activation du LPS lors de tâches de traitement simultané. En effet si le LPS présente des défauts d'activation chez certains, l'identification de plusieurs lettres simultanément (qui sont des combinaisons de lignes comme les symboles) peut être altérée voir empêchée. Les mots ne pourront pas être traités dans leur globalité, cela peut expliquer pourquoi la mise en place de l'aire visuelle des mots ne se fait pas chez certains dyslexiques (Pina

Rodrigues et al., 2019; Richlan et al., 2011) car comme les mots ne peuvent être traités entièrement en une seule fixation ils ne peuvent être encodés. La lecture ne peut donc pas s'installer de manière efficace.

Le traitement visuel des symboles ne nécessite aucune compétence langagière particulière et peut donc être testé avant l'apprentissage de la lecture laisse entrevoir des perspectives de dépistage et de remédiation précoce. Comme décrit en amont, nous avons lancé une étude longitudinale pour évaluer le caractère prédictif de cette difficulté à traiter les symboles dans la dyslexie. Ainsi nous pourrions détecter très tôt (avant l'apprentissage de la lecture) les enfants qui seraient à risque de développer une dyslexie plus tard et ainsi leur apporter du soutien et une attention particulière pour éviter qu'ils prennent trop de retard dans leur apprentissage et qu'ils perdent leur appétence pour l'école. La remédiation qui pourrait être proposée pour les enfants identifiés avec des difficultés de traitement des symboles est également en cours d'expérimentation chez des enfants déjà diagnostiqués dyslexiques et est décrite dans cette thèse. Nous avons également pensé une remédiation sous forme de jeux « physique » avec des lignes à combiner manuellement pour former les symboles par exemple qui pourrait être instaurée à l'école.

IV Bibliographie

- Albonico, A., Martelli, M., Bricolo, E., Frasson, E., & Daini, R. (2018). Focusing and orienting spatial attention differently modulate crowding in central and peripheral vision. *Journal of Vision, 18*(3), 4. <https://doi.org/10.1167/18.3.4>
- Ans, B., Carbonnel, S., & Valdois, S. (1998). A connectionist multiple-trace memory model for polysyllabic word reading. *Psychological Review, 105*(4), 678-723. <https://doi.org/10.1037/0033-295x.105.4.678-723>
- Ashburn, S. M., Flowers, D. L., Napoliello, E. M., & Eden, G. F. (2019). Cerebellar function in children with and without dyslexia during single word processing. *Human Brain Mapping, 41*(1), 120-138. <https://doi.org/10.1002/hbm.24792>
- Barton, J. J. (2003). Disorders of face perception and recognition. *Neurologic Clinics, 21*(2), 521-548. [https://doi.org/10.1016/s0733-8619\(02\)00106-8](https://doi.org/10.1016/s0733-8619(02)00106-8)
- Battaglini, L., Ghiani, A., Casco, C., & Ronconi, L. (2020). Parietal tACS at beta frequency improves vision in a crowding regime. *NeuroImage, 208*, 116451. <https://doi.org/10.1016/j.neuroimage.2019.116451>
- Bedoin, N., Kéïta, Leculier, Roussel, Herbillon, & Launay. (2010). *Diagnostic et remédiation d'un déficit d'inhibition des détails dans la dyslexie de surface.*
- Berlin, R. (1887). *Eine besondere Art der Wortblindheit (Dyslexie).* Bergmann.
- Billard, C., Fluss, J., Ducot, B., Bricout, L., Richard, G., Ecalle, J., Magnan, A., Warszawski, J., & Ziegler, J. (2009). Troubles d'acquisition de la lecture en cours élémentaire : Facteurs cognitifs, sociaux et comportementaux dans un échantillon de 1062 enfants. *Revue d'Épidémiologie et de Santé Publique, 57*(3), 191-203. <https://doi.org/10.1016/j.respe.2009.02.205>
- Bonnefoy, B., & Rey, A. (2008). Automatisation de la connaissance des lettres chez l'apprenti lecteur. *L'Année Psychologique, 108*(02), 187. <https://doi.org/10.4074/S0003503308002017>
- Borsting, E., Ridder, W. H., Dudeck, K., Kelley, C., Matsui, L., & Motoyama, J. (1996). The presence of a magnocellular defect depends on the type of dyslexia. *Vision Research, 36*(7), 1047-1053. [https://doi.org/10.1016/0042-6989\(95\)00199-9](https://doi.org/10.1016/0042-6989(95)00199-9)
- Bosse, M.-L., Tainturier, M. J., & Valdois, S. (2007). Developmental dyslexia : The visual attention span deficit hypothesis. *Cognition, 104*(2), 198-230. <https://doi.org/10.1016/j.cognition.2006.05.009>

- Bouma, H. (1970). Interaction effects in parafoveal letter recognition. *Nature*, 226(5241), 177-178. <https://doi.org/10.1038/226177a0>
- Bouma, H., & Legein, C. P. (1977). Foveal and parafoveal recognition of letters and words by dyslexics and by average readers. *Neuropsychologia*, 15(1), 69-80. [https://doi.org/10.1016/0028-3932\(77\)90116-6](https://doi.org/10.1016/0028-3932(77)90116-6)
- Bradley, L., & Bryant, P. E. (1978). Difficulties in auditory organisation as a possible cause of reading backwardness. *Nature*, 271(5647), 746-747. <https://doi.org/10.1038/271746a0>
- Breitmeyer, B. G. (1993). The roles of sustained (P) and transient (M) channels in reading and reading disability. In *Facets of dyslexia and its remediation* (p. 13-31). North-Holland/Elsevier Science Publishers. <https://doi.org/10.1016/B978-0-444-89949-1.50008-0>
- Brown, W. E., Eliez, S., Menon, V., Rumsey, J. M., White, C. D., & Reiss, A. L. (2001). Preliminary evidence of widespread morphological variations of the brain in dyslexia. *Neurology*, 56(6), 781-783. <https://doi.org/10.1212/wnl.56.6.781>
- Burr, D. C., Morrone, M. C., & Ross, J. (1994). Selective suppression of the magnocellular visual pathway during saccadic eye movements. *Nature*, 371(6497), 511-513. <https://doi.org/10.1038/371511a0>
- Carey, D. P., Harvey, M., & Milner, A. D. (1996). Visuomotor sensitivity for shape and orientation in a patient with visual form agnosia. *Neuropsychologia*, 34(5), 329-337. [https://doi.org/10.1016/0028-3932\(95\)00169-7](https://doi.org/10.1016/0028-3932(95)00169-7)
- Carroll, J. M., Solity, J., & Shapiro, L. R. (2016). Predicting dyslexia using prereading skills : The role of sensorimotor and cognitive abilities. *Journal of Child Psychology and Psychiatry, and Allied Disciplines*, 57(6), 750-758. <https://doi.org/10.1111/jcpp.12488>
- Casalis, S., & Louis-Alexandre, M.-F. (2000). Morphological analysis, phonological analysis and learning to read French : A longitudinal study. *Reading and Writing: An Interdisciplinary Journal*, 12(3-4), 303-335. <https://doi.org/10.1023/A:1008177205648>
- Casco, C., & Prunetti, E. (1996). Visual search of good and poor readers : Effects with targets having single and combined features. *Perceptual and Motor Skills*, 82(3 Pt 2), 1155-1167. <https://doi.org/10.2466/pms.1996.82.3c.1155>
- Cohen, L., & Dehaene, S. (2004). Specialization within the ventral stream : The case for the visual word form area. *NeuroImage*, 22(1), 466-476. <https://doi.org/10.1016/j.neuroimage.2003.12.049>
- Cohen, L., Dehaene, S., Naccache, L., Lehéricy, S., Dehaene-Lambertz, G., Hénaff, M. A., & Michel, F. (2000). The visual word form area : Spatial and temporal characterization of an initial stage of reading in normal subjects and posterior split-brain patients. *Brain: A Journal of Neurology*, 123 (Pt 2), 291-307. <https://doi.org/10.1093/brain/123.2.291>

- Dehaene, S., & Cohen, L. (2007). Cultural Recycling of Cortical Maps. *Neuron*, *56*(2), 384-398. <https://doi.org/10.1016/j.neuron.2007.10.004>
- Dehaene, S., Pegado, F., Braga, L. W., Ventura, P., Filho, G. N., Jobert, A., Dehaene-Lambertz, G., Kolinsky, R., Morais, J., & Cohen, L. (2010). How Learning to Read Changes the Cortical Networks for Vision and Language. *Science*, *330*(6009), 1359-1364. <https://doi.org/10.1126/science.1194140>
- Delis, D. C., Robertson, L. C., & Efron, R. (1986). Hemispheric specialization of memory for visual hierarchical stimuli. *Neuropsychologia*, *24*(2), 205-214. [https://doi.org/10.1016/0028-3932\(86\)90053-9](https://doi.org/10.1016/0028-3932(86)90053-9)
- Di Lollo, V., Hanson, D., & McIntyre, J. S. (1983). Initial stages of visual information processing in dyslexia. *Journal of Experimental Psychology. Human Perception and Performance*, *9*(6), 923-935. <https://doi.org/10.1037/0096-1523.9.6.923>
- Dijkerman, H. C., Milner, A. D., & Carey, D. P. (1996). The perception and prehension of objects oriented in the depth plane. I. Effects of visual form agnosia. *Experimental Brain Research*, *112*(3), 442-451. <https://doi.org/10.1007/BF00227950>
- Doctor, E. A., & Coltheart, M. (1980). Children's use of phonological encoding when reading for meaning. *Memory & Cognition*, *8*(3), 195-209. <https://doi.org/10.3758/BF03197607>
- Ducrot, S., Lété, B., Sprenger-Charolles, L., Pynte, J., & Billard, C. (2003). The optimal viewing position effect in beginning and dyslexic readers. *Current Psychology Letters/Behaviour, Brain and Cognition*, Document99.html.
- Eckert, M. A., Leonard, C. M., Wilke, M., Eckert, M., Richards, T., Richards, A., & Berninger, V. (2005). Anatomical signatures of dyslexia in children : Unique information from manual and voxel based morphometry brain measures. *Cortex; a Journal Devoted to the Study of the Nervous System and Behavior*, *41*(3), 304-315. [https://doi.org/10.1016/s0010-9452\(08\)70268-5](https://doi.org/10.1016/s0010-9452(08)70268-5)
- Ehri, L. C. (1995). Phases of development in learning to read words by sight. *Journal of Research in Reading*, *18*(2), 116-125. <https://doi.org/10.1111/j.1467-9817.1995.tb00077.x>
- Failenot, I., Decety, J., & Jeannerod, M. (1999). Human brain activity related to the perception of spatial features of objects. *NeuroImage*, *10*(2), 114-124. <https://doi.org/10.1006/nimg.1999.0449>
- Fawcett, A. J., & Nicolson, R. I. (1999). Performance of Dyslexic Children on Cerebellar and Cognitive Tests. *Journal of Motor Behavior*, *31*(1), 68-78. <https://doi.org/10.1080/00222899909601892>
- Felisbert, F. M., Solomon, J. A., & Morgan, M. J. (2005). The role of target salience in crowding. *Perception*, *34*(7), 823-833. <https://doi.org/10.1068/p5206>

- Fernandez, V. G., Stuebing, K., Juranek, J., & Fletcher, J. M. (2013). Volumetric analysis of regional variability in the cerebellum of children with dyslexia. *Cerebellum (London, England)*, 12(6), 906-915. <https://doi.org/10.1007/s12311-013-0504-9>
- Ferrera, V., Nealey, T., & Maunsell, J. (1994). Responses in macaque visual area V4 following inactivation of the parvocellular and magnocellular LGN pathways. *The Journal of Neuroscience*, 14(4), 2080-2088. <https://doi.org/10.1523/JNEUROSCI.14-04-02080.1994>
- Fischer, F. W., Liberman, I. Y., & Shankweiler, D. (1978). Reading Reversals and Developmental Dyslexia a Further Study. *Cortex*, 14(4), 496-510. [https://doi.org/10.1016/S0010-9452\(78\)80025-2](https://doi.org/10.1016/S0010-9452(78)80025-2)
- Fluss, J., Bertrand, D., Ziegler, J., & Billard, C. (2009). Troubles d'apprentissage de la lecture : Rôle des facteurs cognitifs, comportementaux et socio-économiques. *Developpements*, n° 1(1), 21-33.
- Franceschini, S., Bertoni, S., Giancesini, T., Gori, S., & Facoetti, A. (2017). A different vision of dyslexia : Local precedence on global perception. *Scientific Reports*, 7(1), 17462. <https://doi.org/10.1038/s41598-017-17626-1>
- Frith, U. (2017). Beneath the Surface of Developmental Dyslexia. In K. E. Patterson, J. C. Marshall, & M. Coltheart (Éds.), *Surface Dyslexia* (1^{re} éd., p. 301-330). Routledge. <https://doi.org/10.4324/9781315108346-18>
- Galaburda, A. M., Menard, M. T., & Rosen, G. D. (1994). Evidence for aberrant auditory anatomy in developmental dyslexia. *Proceedings of the National Academy of Sciences of the United States of America*, 91(17), 8010-8013. <https://doi.org/10.1073/pnas.91.17.8010>
- Gandini, D., Lemaire, P., Anton, J.-L., & Nazarian, B. (2008). Neural correlates of approximate quantification strategies in young and older adults : An fMRI study. *Brain Research*, 1246, 144-157. <https://doi.org/10.1016/j.brainres.2008.09.096>
- Gillon, G. (2005, octobre). *Facilitating phoneme awareness development in 3- and 4-year-old children with speech impairment*. Language, Speech, and Hearing Services in Schools; Lang Speech Hear Serv Sch. [https://doi.org/10.1044/0161-1461\(2005/031\)](https://doi.org/10.1044/0161-1461(2005/031))
- Goodale, M. A., Jakobson, L. S., & Keillor, J. M. (1994). Differences in the visual control of pantomimed and natural grasping movements. *Neuropsychologia*, 32(10), 1159-1178. [https://doi.org/10.1016/0028-3932\(94\)90100-7](https://doi.org/10.1016/0028-3932(94)90100-7)
- Goodale, M. A., & Milner, A. D. (1992). Separate visual pathways for perception and action. *Trends in Neurosciences*, 15(1), 20-25. [https://doi.org/10.1016/0166-2236\(92\)90344-8](https://doi.org/10.1016/0166-2236(92)90344-8)
- Goswami, U. (2015). Visual attention span deficits and assessing causality in developmental dyslexia. *Nature Reviews Neuroscience*, 16(4), 225-226. <https://doi.org/10.1038/nrn3836-c2>

- Hinshelwood, J. (1911). Two Cases of Hereditary Congenital Word-Blindness. *British Medical Journal*, 1(2620), 608-609. <https://doi.org/10.1136/bmj.1.2620.608>
- Huckauf, A., & Heller, D. (2004). On the relations between crowding and visual masking. *Perception & Psychophysics*, 66(4), 584-595. <https://doi.org/10.3758/bf03194903>
- Hutzler, F., Kronbichler, M., Jacobs, A. M., & Wimmer, H. (2006). Perhaps correlational but not causal : No effect of dyslexic readers' magnocellular system on their eye movements during reading. *Neuropsychologia*, 44(4), 637-648. <https://doi.org/10.1016/j.neuropsychologia.2005.06.006>
- Jeannerod, M., Decety, J., & Michel, F. (1994). Impairment of grasping movements following a bilateral posterior parietal lesion. *Neuropsychologia*, 32(4), 369-380. [https://doi.org/10.1016/0028-3932\(94\)90084-1](https://doi.org/10.1016/0028-3932(94)90084-1)
- Khan, A. Z., Prost-Lefebvre, M., Salemme, R., Blohm, G., Rossetti, Y., Tilikete, C., & Pisella, L. (2016). The Attentional Fields of Visual Search in Simultanagnosia and Healthy Individuals : How Object and Space Attention Interact. *Cerebral Cortex (New York, N.Y.: 1991)*, 26(3), 1242-1254. <https://doi.org/10.1093/cercor/bhv059>
- Kovelman, I., Norton, E. S., Christodoulou, J. A., Gaab, N., Lieberman, D. A., Triantafyllou, C., Wolf, M., Whitfield-Gabrieli, S., & Gabrieli, J. D. E. (2012). Brain basis of phonological awareness for spoken language in children and its disruption in dyslexia. *Cerebral Cortex (New York, N.Y.: 1991)*, 22(4), 754-764. <https://doi.org/10.1093/cercor/bhr094>
- Lefavrais, P. (1967). *Manuel du test de l'alouette : [Test psychologique] : test d'analyse de la lecture et de la dyslexie*. Centre de psychologie appliquée.
- Lieberman, I. Y., Mann, V. A., Shankweiler, D., & Werfelman, M. (1982). Children's memory for recurring linguistic and nonlinguistic material in relation to reading ability. *Cortex; a Journal Devoted to the Study of the Nervous System and Behavior*, 18(3), 367-375. [https://doi.org/10.1016/s0010-9452\(82\)80035-x](https://doi.org/10.1016/s0010-9452(82)80035-x)
- Lieberman, I. Y., Shankweiler, D., Orlando, C., Harris, K. S., & Berti, F. B. (1971). Letter confusions and reversals of sequence in the beginning reader : Implications for Orton's theory of developmental dyslexia. *Cortex; a Journal Devoted to the Study of the Nervous System and Behavior*, 7(2), 127-142. [https://doi.org/10.1016/s0010-9452\(71\)80009-6](https://doi.org/10.1016/s0010-9452(71)80009-6)
- Livingstone, M. S., Rosen, G. D., Drislane, F. W., & Galaburda, A. M. (1991). Physiological and anatomical evidence for a magnocellular defect in developmental dyslexia. *Proceedings of the National Academy of Sciences of the United States of America*, 88(18), 7943-7947. <https://doi.org/10.1073/pnas.88.18.7943>
- Lobier, M., Peyrin, C., Le Bas, J.-F., & Valdois, S. (2012b). Pre-orthographic character string processing and parietal cortex : A role for visual attention in reading? *Neuropsychologia*, 50(9), 2195-2204. <https://doi.org/10.1016/j.neuropsychologia.2012.05.023>

- Lobier, M., Zoubrinetzky, R., & Valdois, S. (2012). The visual attention span deficit in dyslexia is visual and not verbal. *Cortex*, *48*(6), 768-773.
<https://doi.org/10.1016/j.cortex.2011.09.003>
- López-Barroso, D., Thiebaut de Schotten, M., Morais, J., Kolinsky, R., Braga, L. W., Guerreiro-Tauil, A., Dehaene, S., & Cohen, L. (2020). Impact of literacy on the functional connectivity of vision and language related networks. *NeuroImage*, *213*, 116722.
<https://doi.org/10.1016/j.neuroimage.2020.116722>
- Lovegrove, W., Billing, G., & Slaghuis, W. (1978). Processing of visual contour orientation information in normal and disabled reading children. *Cortex; a Journal Devoted to the Study of the Nervous System and Behavior*, *14*(2), 268-278.
[https://doi.org/10.1016/s0010-9452\(78\)80053-7](https://doi.org/10.1016/s0010-9452(78)80053-7)
- Lovegrove, W. J., Bowling, A., Badcock, D., & Blackwood, M. (1980). Specific reading disability : Differences in contrast sensitivity as a function of spatial frequency. *Science (New York, N.Y.)*, *210*(4468), 439-440. <https://doi.org/10.1126/science.7433985>
- Lovegrove, W., Martin, F., & Slaghuis, W. (1986). A theoretical and experimental case for a visual deficit in specific reading disability. *Cognitive Neuropsychology*, *3*(2), 225-267.
<https://doi.org/10.1080/02643298608252677>
- Luria, A. R. (1959). Disorders of « simultaneous perception » in a case of bilateral occipito-parietal brain injury. *Brain: A Journal of Neurology*, *82*, 437-449.
<https://doi.org/10.1093/brain/82.3.437>
- Mann, V. A. (1984). Longitudinal prediction and prevention of early reading difficulty. *Annals of Dyslexia*, *34*, 117-136. <https://doi.org/10.1007/BF02663616>
- Martelli, M., Di Filippo, G., Spinelli, D., & Zoccolotti, P. (2009). Crowding, reading, and developmental dyslexia. *Journal of Vision*, *9*(4), 14.1-18. <https://doi.org/10.1167/9.4.14>
- Martins da Cunha H. (1979) Syndrome de déficience posturale. *Actualités en rééducation fonctionnelle et réadaptation, 4e série. Simon L. Éditions Masson, Paris.*
- Maunsell, J., Nealey, T., & DePriest, D. (1990). Magnocellular and parvocellular contributions to responses in the middle temporal visual area (MT) of the macaque monkey. *The Journal of Neuroscience*, *10*(10), 3323-3334. <https://doi.org/10.1523/JNEUROSCI.10-10-03323.1990>
- McAnally, K. I., & Stein, J. F. (1996). Auditory temporal coding in dyslexia. *Proceedings. Biological Sciences*, *263*(1373), 961-965. <https://doi.org/10.1098/rspb.1996.0142>
- McBride-Chang, C., & Manis, F. R. (1996). Structural invariance in the associations of naming speed, phonological awareness, and verbal reasoning in good and poor readers : A test of the double deficit hypothesis. *Reading and Writing*, *8*(4), 323-339.
<https://doi.org/10.1007/BF00395112>

- McConkie, G. W., & Rayner, K. (1975). The span of the effective stimulus during a fixation in reading. *Perception & Psychophysics*, *17*(6), 578-586. <https://doi.org/10.3758/BF03203972>
- Meadows, J. C. (1974). Disturbed perception of colours associated with localized cerebral lesions. *Brain: A Journal of Neurology*, *97*(4), 615-632. <https://doi.org/10.1093/brain/97.1.615>
- Moe-Nilssen, R., Helbostad, J. L., Talcott, J. B., & Toennesen, F. E. (2003). Balance and gait in children with dyslexia. *Experimental Brain Research*, *150*(2), 237-244. <https://doi.org/10.1007/s00221-003-1450-4>
- Montant, M., Nazir, T. A., & Poncet, M. (1998). Pure alexia and the viewing position effect in printed word. *Cognitive Neuropsychology*, *15*(1-2), 93-140. <https://doi.org/10.1080/026432998381230>
- Morais, J., Cary, L., Alegria, J., & Bertelson, P. (1979). Does awareness of speech as a sequence of phones arise spontaneously? *Cognition*, *7*(4), 323-331. [https://doi.org/10.1016/0010-0277\(79\)90020-9](https://doi.org/10.1016/0010-0277(79)90020-9)
- Mort, D. J., Malhotra, P., Mannan, S. K., Rorden, C., Pambakian, A., Kennard, C., & Husain, M. (2003). The anatomy of visual neglect. *Brain: A Journal of Neurology*, *126*(Pt 9), 1986-1997. <https://doi.org/10.1093/brain/awg200>
- Moulton, E., Bouhali, F., Monzalvo, K., Poupon, C., Zhang, H., Dehaene, S., Dehaene-Lambertz, G., & Dubois, J. (2019). Connectivity between the visual word form area and the parietal lobe improves after the first year of reading instruction : A longitudinal MRI study in children. *Brain Structure and Function*. <https://doi.org/10.1007/s00429-019-01855-3>
- Muter, V., Hulme, C., Snowling, M., & Taylor, S. (1998). Segmentation, not rhyming, predicts early progress in learning to read. *Journal of Experimental Child Psychology*, *71*(1), 3-27. <https://doi.org/10.1006/jecp.1998.2453>
- Navon, D. (1977). Forest before trees : The precedence of global features in visual perception. *Cognitive Psychology*, *9*(3), 353-383. [https://doi.org/10.1016/0010-0285\(77\)90012-3](https://doi.org/10.1016/0010-0285(77)90012-3)
- Nazir, T. A., Jacobs, A. M., & O'Regan, J. K. (1998). Letter legibility and visual word recognition. *Memory & Cognition*, *26*(4), 810-821. <https://doi.org/10.3758/bf03211400>
- Nazir, T., O'Regan, J., & Jacobs, A. (1991). On words and their letters. *Bulletin of the Psychonomic Society*, *29*, 171-174. <https://doi.org/10.3758/BF03335227>
- Negro, I., & Genelot, S. (2009). Les prédicteurs en grande section maternelle de la réussite en lecture en fin de première année d'école élémentaire : L'impact du nom des lettres. *Bulletin de psychologie, Numéro 501*, 291. <https://doi.org/10.3917/bupsy.501.0291>
- Norton, E. S., & Wolf, M. (2012). Rapid automatized naming (RAN) and reading fluency : Implications for understanding and treatment of reading disabilities. *Annual Review of Psychology*, *63*, 427-452. <https://doi.org/10.1146/annurev-psych-120710-100431>

- Orton, S. T. (1937). *Reading, writing and speech problems in children* (p. 215). W W Norton & Co.
- Perrachione, T. K., Ghosh, S. S., Ostrovskaya, I., Gabrieli, J. D. E., & Kovelman, I. (2017). Phonological Working Memory for Words and Nonwords in Cerebral Cortex. *Journal of Speech, Language, and Hearing Research: JSLHR*, 60(7), 1959-1979. https://doi.org/10.1044/2017_JSLHR-L-15-0446
- Peyrin, C., Démonet, J. F., N'Guyen-Morel, M. A., Le Bas, J. F., & Valdois, S. (2011). Superior parietal lobule dysfunction in a homogeneous group of dyslexic children with a visual attention span disorder. *Brain and Language*, 118(3), 128-138. <https://doi.org/10.1016/j.bandl.2010.06.005>
- Peyrin, C., Lallier, M., Démonet, J. F., Pernet, C., Baciù, M., Le Bas, J. F., & Valdois, S. (2012). Neural dissociation of phonological and visual attention span disorders in developmental dyslexia : fMRI evidence from two case reports. *Brain and Language*, 120(3), 381-394. <https://doi.org/10.1016/j.bandl.2011.12.015>
- Pina Rodrigues, A., Rebola, J., Pereira, M., van Asselen, M., & Castelo-Branco, M. (2019). Neural Responses of the Anterior Ventral Occipitotemporal Cortex in Developmental Dyslexia : Beyond the Visual Word Form Area. *Investigative Ophthalmology & Visual Science*, 60(4), 1063-1068. <https://doi.org/10.1167/iovs.18-26325>
- Plaza, M., & Cohen, H. (2007). The contribution of phonological awareness and visual attention in early reading and spelling. *Dyslexia (Chichester, England)*, 13(1), 67-76. <https://doi.org/10.1002/dys.330>
- Pohl, W. (1973). Dissociation of spatial discrimination deficits following frontal and parietal lesions in monkeys. *Journal of Comparative and Physiological Psychology*, 82(2), 227-239. <https://doi.org/10.1037/h0033922>
- Poirel, N., Mellet, E., Houdé, O., & Pineau, A. (2008). First came the trees, then the forest : Developmental changes during childhood in the processing of visual local-global patterns according to the meaningfulness of the stimuli. *Developmental Psychology*, 44(1), 245-253. <https://doi.org/10.1037/0012-1649.44.1.245>
- Poirel, N., Simon, G., Cassotti, M., Leroux, G., Perchey, G., Lanoë, C., Lubin, A., Turbelin, M.-R., Rossi, S., Pineau, A., & Houdé, O. (2011). The shift from local to global visual processing in 6-year-old children is associated with grey matter loss. *PloS One*, 6(6), e20879. <https://doi.org/10.1371/journal.pone.0020879>
- Pollatsek, A., Bolozky, S., Well, A. D., & Rayner, K. (1981). Asymmetries in the perceptual span for Israeli readers. *Brain and Language*, 14(1), 174-180. [https://doi.org/10.1016/0093-934x\(81\)90073-0](https://doi.org/10.1016/0093-934x(81)90073-0)
- Posner, M. I., Snyder, C. R. R., & Davidson, B. J. (s. d.). *Attention and the Detection of Signals*. 15.

- Prado, C., Dubois, M., & Valdois, S. (2007). The eye movements of dyslexic children during reading and visual search : Impact of the visual attention span. *Vision Research*, 47(19), 2521-2530. <https://doi.org/10.1016/j.visres.2007.06.001>
- Pringle Morgan, W. P. (1896). A Case of Congenital Word Blindness. *British Medical Journal*, 2(1871), 1378. <https://doi.org/10.1136/bmj.2.1871.1378>
- Quercia, P. (2008). La proprioception pour la prise en charge des enfants dyslexiques. [//www.em-premium.com/data/revues/12594792/00290243/28/](http://www.em-premium.com/data/revues/12594792/00290243/28/).
<http://www.em-premium.com/article/179639/resultatrecherche/1>
- Quercia, P., Seigneure, A., Chariot, S., Vernet, P., Pozzo, T., Bron, A., Creuzot-Garcher, C., & Robichon, F. (2005). Proprioception oculaire et dyslexie de développement. [//www.em-premium.com/data/revues/01815512/00280007/713/](http://www.em-premium.com/data/revues/01815512/00280007/713/).
<http://www.em-premium.com/article/113045/resultatrecherche/1>
- Rae, C., Harasty, J. A., Dzendrowskyj, T. E., Talcott, J. B., Simpson, J. M., Blamire, A. M., Dixon, R. M., Lee, M. A., Thompson, C. H., Styles, P., Richardson, A. J., & Stein, J. F. (2002). Cerebellar morphology in developmental dyslexia. *Neuropsychologia*, 40(8), 1285-1292. [https://doi.org/10.1016/s0028-3932\(01\)00216-0](https://doi.org/10.1016/s0028-3932(01)00216-0)
- Ramus, F., Pidgeon, E., & Frith, U. (2003). The relationship between motor control and phonology in dyslexic children. *Journal of Child Psychology and Psychiatry, and Allied Disciplines*, 44(5), 712-722. <https://doi.org/10.1111/1469-7610.00157>
- Rapport INSERM, I. national de la santé et de la recherche. (2007). *Dyslexie, dysorthographe, dyscalculie : Bilan des données scientifiques*. Les éditions Inserm. <http://www.ipubli.inserm.fr/handle/10608/110>
- Rayner, K., Well, A. D., & Pollatsek, A. (1980). Asymmetry of the effective visual field in reading. *Perception & Psychophysics*, 27(6), 537-544. <https://doi.org/10.3758/bf03198682>
- Richlan, F., Kronbichler, M., & Wimmer, H. (2011). Meta-analyzing brain dysfunctions in dyslexic children and adults. *NeuroImage*, 56(3), 1735-1742. <https://doi.org/10.1016/j.neuroimage.2011.02.040>
- Riding, R. J., & Pugh, J. C. (1977). Iconic Memory and Reading Performance in Nine-Year-Old Children. *British Journal of Educational Psychology*, 47(2), 132-137. <https://doi.org/10.1111/j.2044-8279.1977.tb02338.x>
- Sauval, K., Perre, L., Duncan, L. G., Marinus, E., & Casalis, S. (2017). Automatic phonological activation during visual word recognition in bilingual children : A cross-language masked priming study in grades 3 and 5. *Journal of Experimental Child Psychology*, 154, 64-77. <https://doi.org/10.1016/j.jecp.2016.10.003>
- Saygin, Z. M., Osher, D. E., Norton, E. S., Youssoufian, D. A., Beach, S. D., Feather, J., Gaab, N., Gabrieli, J. D. E., & Kanwisher, N. (2016). Connectivity precedes function in the

- development of the visual word form area. *Nature Neuroscience*, 19(9), 1250-1255.
<https://doi.org/10.1038/nn.4354>
- Seymour, P. H. K. (1997). Foundations of orthographic development. In *Learning to spell : Research, theory, and practice across languages* (p. 319-337). Lawrence Erlbaum Associates Publishers.
- Skottun, B. C., & Parke, L. A. (1999). The possible relationship between visual deficits and dyslexia : Examination of a critical assumption. *Journal of Learning Disabilities*, 32(1), 2-5. <https://doi.org/10.1177/002221949903200101>
- Slaghuis, W. L., & Lovegrove, W. (1984). Flicker masking of spatial-frequency-dependent visible persistence and specific reading disability. *Perception*, 13(5), 527-534.
<https://doi.org/10.1068/p130527>
- Spinelli, D., De Luca, M., Judica, A., & Zoccolotti, P. (2002). Crowding effects on word identification in developmental dyslexia. *Cortex; a Journal Devoted to the Study of the Nervous System and Behavior*, 38(2), 179-200. [https://doi.org/10.1016/s0010-9452\(08\)70649-x](https://doi.org/10.1016/s0010-9452(08)70649-x)
- Stoodley, C. J., Fawcett, A. J., Nicolson, R. I., & Stein, J. F. (2005). Impaired balancing ability in dyslexic children. *Experimental Brain Research*, 167(3), 370-380.
<https://doi.org/10.1007/s00221-005-0042-x>
- Toet, A., & Levi, D. M. (1992). The two-dimensional shape of spatial interaction zones in the parafovea. *Vision Research*, 32(7), 1349-1357. [https://doi.org/10.1016/0042-6989\(92\)90227-a](https://doi.org/10.1016/0042-6989(92)90227-a)
- Treisman, A. M., & Gelade, G. (1980). A feature-integration theory of attention. *Cognitive Psychology*, 12(1), 97-136. [https://doi.org/10.1016/0010-0285\(80\)90005-5](https://doi.org/10.1016/0010-0285(80)90005-5)
- Valdois, S., Bosse, M.-L., Ans, B., Carbonnel, S., Zorman, M., David, D., & Pellat, J. (2003). Phonological and visual processing deficits can dissociate in developmental dyslexia : Evidence from two case studies. *Reading and Writing*, 16(6), 541-572.
<https://doi.org/10.1023/A:1025501406971>
- Valdois, S., Lassus-Sangosse, D., & Lobier, M. (2012). Impaired letter-string processing in developmental dyslexia : What visual-to-phonology code mapping disorder? *Dyslexia (Chichester, England)*, 18(2), 77-93. <https://doi.org/10.1002/dys.1437>
- Vallar, G., & Perani, D. (1986). The anatomy of unilateral neglect after right-hemisphere stroke lesions. A clinical/CT-scan correlation study in man. *Neuropsychologia*, 24(5), 609-622.
[https://doi.org/10.1016/0028-3932\(86\)90001-1](https://doi.org/10.1016/0028-3932(86)90001-1)
- Van Oers, C. A. M. M., Goldberg, N., Fiorin, G., van den Heuvel, M. P., Kappelle, L. J., & Wijnen, F. N. K. (2018). No evidence for cerebellar abnormality in adults with developmental dyslexia. *Experimental Brain Research*, 236(11), 2991-3001. <https://doi.org/10.1007/s00221-018-5351-y>

- Vidyasagar, T. R. (1999). A neuronal model of attentional spotlight : Parietal guiding the temporal. *Brain Research Reviews*, 30(1), 66-76. [https://doi.org/10.1016/S0165-0173\(99\)00005-3](https://doi.org/10.1016/S0165-0173(99)00005-3)
- Vindras, P., Blangero, A., Ota, H., Reilly, K. T., Rossetti, Y., & Pisella, L. (2016). The Pointing Errors in Optic Ataxia Reveal the Role of « Peripheral Magnification » of the PPC. *Frontiers in Integrative Neuroscience*, 10, 27. <https://doi.org/10.3389/fnint.2016.00027>
- Wagner, R. K., & Torgesen, J. K. (s. d.). *The Nature of Phonological Processing and Its Causal Role in the Acquisition of Reading Skills*. 21.
- Whitney, D., & Levi, D. M. (2011). Visual Crowding : A fundamental limit on conscious perception and object recognition. *Trends in cognitive sciences*, 15(4), 160-168. <https://doi.org/10.1016/j.tics.2011.02.005>
- Wilson, M. (2009). Retinal Lateral Interactions. In M. D. Binder, N. Hirokawa, & U. Windhorst (Éds.), *Encyclopedia of Neuroscience* (p. 3513-3517). Springer. https://doi.org/10.1007/978-3-540-29678-2_5108
- Winters, R. L., Patterson, R., & Shontz, W. (1989). Visual persistence and adult dyslexia. *Journal of Learning Disabilities*, 22(10), 641-645. <https://doi.org/10.1177/002221948902201010>
- Wolpert, I. (1924). Die simultanagnosie—Störung der gesamtauffassung. *Zeitschrift für die gesamte Neurologie und Psychiatrie*, 93(1), 397-415. <https://doi.org/10.1007/BF02900065>
- Yeshurun, Y., & Rashal, E. (2010). Precueing attention to the target location diminishes crowding and reduces the critical distance. *Journal of Vision*, 10(10), 16. <https://doi.org/10.1167/10.10.16>
- Ziegler, J. C., Bertrand, D., Lété, B., & Grainger, J. (2014). Orthographic and phonological contributions to reading development : Tracking developmental trajectories using masked priming. *Developmental Psychology*, 50(4), 1026-1036. <https://doi.org/10.1037/a0035187>
- Zorzi, M., Barbiero, C., Facoetti, A., Lonciari, I., Carrozzi, M., Montico, M., Bravar, L., George, F., Pech-Georgel, C., & Ziegler, J. C. (2012). Extra-large letter spacing improves reading in dyslexia. *Proceedings of the National Academy of Sciences of the United States of America*, 109(28), 11455-11459. <https://doi.org/10.1073/pnas.1205566109>
- Zoubrinetzky, R., Bielle, F., & Valdois, S. (2014). New insights on developmental dyslexia subtypes : Heterogeneity of mixed reading profiles. *PloS One*, 9(6), e99337. <https://doi.org/10.1371/journal.pone.0099337>

Annexe 1

Le syndrome de Bálint

Bálint's syndrome

Handbook of Clinical Neurology
3rd Series

Laure Pisella, Audrey Vialatte, Aarlenne Zein Khan & Yves Rossetti

Lyon Neuroscience Research Center, Lyon, France

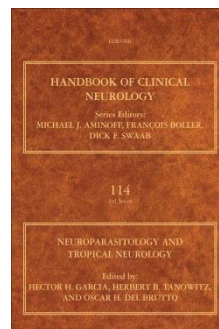

Handbook of Clinical Neurology 3rd Series

Bálint's syndrome

Laure Pisella, Audrey Vialatte, Aarlenne Zein Khan & Yves Rossetti

laure.pisella@inserm.fr

Lyon Neuroscience Research Center, Lyon, France

Phone number: (+33) 4 72 91 34 00

These proofs may contain colour figures. Those figures may print black and white in the final printed book if a colour print product has not been planned. The colour figures will appear in colour in all electronic versions of this book.

Handbook of Clinical Neurology, Vol. 178 (3rd series)
Neurology of Vision and Visual Disorders
 J.J.S. Barton and A. Leff, Editors
<https://doi.org/10.1016/B978-0-12-821377-3.00011-8>
 Copyright © 2021 Elsevier B.V. All rights reserved

c0075

Chapter 15

Bálint syndrome

LAURE PISELLA^{1*}, AUDREY VIALATTE¹, AARLENNE ZEIN KHAN², AND YVES ROSSETTI^{1,3}

¹*Trajectoires, Centre de Recherche en Neurosciences de Lyon, Inserm, CNRS, Université Lyon 1, Bron, France*

²*University of Montreal, School of Optometry, Montreal, QC, Canada*

³*Plate-forme "Mouvement et Handicap", Hôpital Henry-Gabrielle, Hospices Civils de Lyon, Saint-Genis-Laval, France*

st0010

Abstract

This chapter starts by reviewing the various interpretations of Bálint syndrome over time. We then develop a novel integrative view in which we propose that the various symptoms, historically reported and labeled by various authors, result from a core mislocalization deficit. This idea is in accordance with our previous proposal that the core deficit of Bálint syndrome is attentional (Pisella et al., 2009, 2013, 2017) since covert attention improves spatial resolution in visual periphery (Yeshurun and Carrasco, 1998); a deficit of covert attention would thus increase spatial uncertainty and thereby impair both visual object identification and visuomotor accuracy. In peripheral vision, we perceive the intrinsic characteristics of the perceptual elements surrounding us, but not their precise localization (Rosenholtz et al., 2012a,b), such that without covert attention we cannot organize them to their respective and recognizable objects; this explains why perceptual symptoms (simultanagnosia, neglect) could result from visual mislocalization. The visuomotor symptoms (optic ataxia) can be accounted for by both visual and proprioceptive mislocalizations in an oculocentric reference frame, leading to field and hand effects, respectively.

This new pathophysiological account is presented along with a model of posterior parietal cortex organization in which the superior part is devoted to covert attention, while the right inferior part is involved in visual remapping. When the right inferior parietal cortex is damaged, additional representational mislocalizations across saccades worsen the clinical picture of peripheral mislocalizations due to an impairment of covert attention.

p0010 The syndrome described by Reszo Bálint in 1909 and later, in other terms, by Gordon Holmes in 1918 is a clinical entity that combines a set of complex spatial behavior disorders following bilateral posterior parietal damage (dorsal stream). This chapter highlights the long-standing difficulties in describing and comprehending this rare and devastating syndrome. This is particularly true for the ocular behavior of these patients. Both the diversity of terminology used in literature and biases in clinical descriptions reflect the dual views of the posterior parietal cortex (PPC): involved either in spatial cognition (Ungerleider and Mishkin, 1982; Ettliger, 1990) and attention (Colby and Goldberg, 1999) or in motor control (Andersen and Buneo, 2002). In the context of the perception–action dissociation model of the two visual

streams (Goodale and Milner, 1992; Milner and Goodale, 1995, 2006), the study of patients with unilateral and more focal lesions has led researchers to consider that every symptom of Bálint triad could be seen in isolation. In other words, the syndrome may not be a single clinical entity but rather a combination of independent visuomotor and perceptual symptoms. However, this popular idea of a dissociation between perception and action has been thoroughly revisited over the recent years (e.g., Rossetti et al., 2003, 2010, 2017; Pisella et al., 2009). We propose a novel integrative pathophysiological account of the Bálint–Holmes syndrome based on recent patient cases studies and on a modernized model of the anatomo-functional organization of the PPC in the right hemisphere.

*Correspondence to: Laure Pisella, Lyon Neuroscience Research Center, Bron, France. Tel: +33-4-72-91-34-00, Fax: + 33-4-72-91-34-01, E-mail: laure.pisella@inserm.fr

ISBN: 978-0-12-821377-3; PII: B978-0-12-821377-3.00011-8; Author: L. Pisella et al.; 00011

To protect the rights of the author(s) and publisher we inform you that this PDF is an uncorrected proof for internal business use only by the author(s), editor(s), reviewer(s), Elsevier and typesetter SPI. It is not allowed to publish this proof online or in print. This proof copy is the copyright property of the publisher and is confidential until formal publication.

These proofs may contain colour figures. Those figures may print black and white in the final printed book if a colour print product has not been planned. The colour figures will appear in colour in all electronic versions of this book.

2

L. PISELLA ET AL.

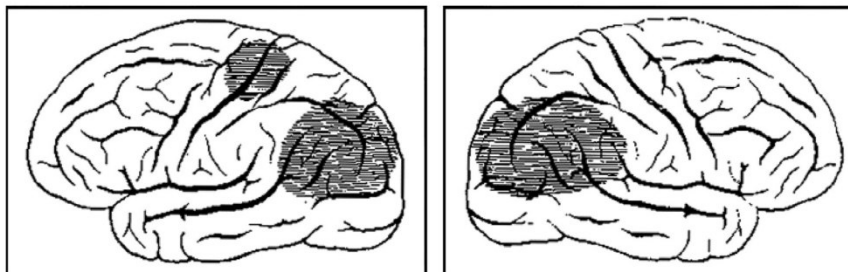

f0010 Fig. 15.1. Bálint depicted the lesion of his patient in schematic diagrams showing the lateral surface of the hemispheres.

s0010 INITIAL OBSERVATIONS

p0015 Initially, Bálint (1909) described in a patient with bilateral dorso-lateral parietal damage (Fig. 15.1) as a syndrome composed of a triad:

u0010 – “optische Ataxie,” an impairment manifested when performing visually-guided actions, especially with the patient’s right hand. The deficit was apparent in central vision but it was greatly exacerbated in peripheral vision. As this ataxia could be compensated by a somatosensory/haptic exploration of the object like a blind person, it was described as specifically “optic”;

u0015 – “seelenlähmung des Schauens,” described as “an extreme restriction of visual attention, such that only one object is seen at a time” is often ascribed to “simultanagnosia” (Wolpert, 1924) or “disorder of simultaneous perception” (Luria, 1959). By labeling this set of symptoms “psychic” paralysis of gaze, Bálint highlighted that the patient exhibited no visual field defect and no oculomotor paralysis but presented difficulty finding a peripheral visual target with his eyes and disengaging from fixated items;

u0020 – “räumliche Störung der Aufmerksamkeit,” described as a lateralized “spatial attention disorder”: attention in the extrapersonal space is spontaneously oriented to the right of the body midline and stimuli lying to the left of fixation are neglected (see De Renzi et al., 1989). This description corresponds to what is now called “unilateral spatial neglect.”

p0035 A few years later, Holmes (1918) described a related visual inattention disorder, after describing cutaneous inattention (Head and Holmes, 1911). He reported in detail a “disturbance of visual orientation” syndrome in soldier patients with bilateral parietal lesions, highlighting a particular eye movement disorganization: a wandering of gaze accompanied by a deficit for visually guided reach-to-grasp movements, together with disorders of fixation, convergence, and depth perception. Holmes and Horrax (1919) provided evidence from post-mortem examination in two cases that this high level

visual dysfunction was due to bilateral lesions of the angular and supramarginal gyri and their contiguous areas. This clinical description was later considered as an oculomotor disorder and labeled gaze ataxia or gaze apraxia (review Vallar, 2007).

The three elements of Bálint’s triad have been historically subjected to numerous types of interpretation, such that most current textbooks define Bálint syndrome as a triad of symptoms that actually does not correspond to Bálint’s initial description: (1) optic ataxia, (2) simultanagnosia, and (3) ocular apraxia (e.g., Kirshner and Lavin, 2006; Denburg and Tranel, 2009; Kaufman et al., 2017). In this incongruous description, unilateral neglect has been excluded from the triad and perceptual and ocular deficits have been dissociated. This shift in the very definition of the syndrome may be attributed to the debate between Bálint and Holmes, reactivated later by Goldberg and Andersen. Whether there is a deficit of oculomotor processes per se after parietal lesion is central to the debate between attentional (spatial coding or “where,” Colby and Goldberg, 1999) and intentional (motor planning or “how,” Andersen and Buneo, 2002) interpretations of the function of the posterior parietal cortex even in the nonhuman primate literature. The theory of a dissociation between perception and action substrates (Milner and Goodale, 1995, 2006) within the visual system has certainly also pushed toward highlighting intrinsic visuomanual guidance and oculomotor deficits, which would be dissociated from perceptual deficits that are lateralized or not in space (neglect and simultanagnosia, respectively). We will review the evolution of this terminology and underlying concepts later, highlighting unsatisfactorily aspects to the current classifications.

s0015 HISTORICAL REPORTS AND INTERPRETATION OF VISUOMOTOR CLUMSINESS

After Bálint and Holmes reports of patients suffering p0045 from bilateral damage, a few other case reports described “visual disorientation” or “optic ataxia” restricted to one

ISBN: 978-0-12-821377-3; PII: B978-0-12-821377-3.00011-8; Author: L. Pisella et al.; 00011

To protect the rights of the author(s) and publisher we inform you that this PDF is an uncorrected proof for internal business use only by the author(s), editor(s), reviewer(s), Elsevier and typesetter SPI. It is not allowed to publish this proof online or in print. This proof copy is the copyright property of the publisher and is confidential until formal publication.

These proofs may contain colour figures. Those figures may print black and white in the final printed book if a colour print product has not been planned. The colour figures will appear in colour in all electronic versions of this book.

BÁLINT SYNDROME

3

hemifield. Riddoch (1935) described two cases with a left parietal lesion. Although these patients were not impaired in everyday life, visual pointing was altered in peripheral vision and this disorder increased with target eccentricity. In addition, these patients produced errors in estimating distance and absolute position. Brain (1941) described 3 patients with visuomotor clumsiness. At least one of these patients can be considered to have exhibited “optic ataxia”: he showed hypometry when each of the two hands reached in peripheral vision on the right side.

p0050 Following the “renaissance” of the “Bálint syndrome” by Hecaen and De Ajuriaguerra (1954), the “rediscovery” of optic ataxia in Paris was initiated by Garcin et al. (1967). Their case report was highlighted as the first description of an “isolated optic ataxia,” i.e., presenting with only one element of the Bálint triad. The patient’s prehension deficit manifested itself when she looked straight ahead and was asked to reach in the left visual field. The deficit partially improved when she was allowed to fixate the object to be grasped. She also exhibited a tactile extinction on the left, constructional apraxia and minor oculomotor symptoms to the left. Interestingly, during the patient’s recovery from stroke, optic ataxia became restricted to peripheral vision from the 26th day and totally resolved from day 42nd.

p0055 Castaigne et al. (1971) described a case of optic ataxia with the two hands in the left visual hemifield, which manifested itself only in peripheral vision. They later described a patient with upper limb and lower limb ataxia in the left visual hemifield, which disappeared when gaze was free (Castaigne et al., 1975). As for most patients, Rondot et al.’s (1977) series of patients with “visuomotor ataxia” presented with a variety of associated deficits and no pure optic ataxia seemed to emerge from their series. However, several of these cases exhibit reaching problems “only in lateral vision” or “more errors were shown ... the further away the object was in the visual field.” They also repeatedly described that after a first reaching movement the patient’s hand appeared to wander in space like that of a blind person.

p0060 The first analysis of the gesture in patients with optic ataxia was provided by Tzavaras et al. (1974): their patient exhibited optic ataxia with the right hand in the right visual field in peripheral vision. Tzavaras et al. (1974) clearly described that this patient underestimated eccentricity and overestimated depth, a pattern that was confirmed by numerous recent quantitative studies using proper motion analysis (Milner et al., 1999; Rossetti et al., 2005; Coello et al., 2007; Bartolo et al., 2017). Tzavaras et al. (1974) went on to distinguish proximal and distal components of arm movements and proposed to distinguish, with analogies to apraxia (Osiurak et al., 2008; Mäki-Marttunen et al., 2014; Buxbaum et al., 2018), between left optic ataxia, where spatial errors would

predominate, and right optic ataxia, where the distal finger movements would be impaired (Tzavaras and Hecaen, 1975; Tzavaras and Masure, 1976). However, most recent accounts have led to the notion that this was rather due to the intraparietal dissociation between anterior and posterior regions (Binkofski et al., 1998).

In Jeannerod’s laboratory in Lyon, following the “Paris wave of optic ataxia” (Rossetti and Pisella, 2018), Vighetto’s doctoral studies (Vighetto, 1980) used the Prablanc’s pioneering paradigm (Prablanc et al., 1979) to specifically explore the oculomotor and manual behavior of 3 patients with optic ataxia. Prablanc’s paradigm allowed one to distinguish between static and dynamic visual information used to guide visual pointing by providing specific visual access to the static hand prior to movement, compared with dynamic visual feedback. This paradigm also focused on the effect of visual eccentricity by presenting peripheral targets while controlling for visual fixation. Vighetto’s studies showed that patients with optic ataxia exhibit only minor oculomotor impairments, but severe alterations of reaching by the hand contralateral to the side of the lesion (contralesional), in the contralesional peripheral visual hemifield (Fig. 15.2A), and target localization errors increased with target eccentricity in the periphery of the contralesional visual field (Fig. 15.2B). This study led to the conclusion that patients with optic ataxia produced gross errors when reaching in their contralesional visual hemifield and exhibited more slightly impaired saccades toward the contralesional side. Yet, these patients performed accurate reaching movements in central vision (Vighetto and Perenin, 1981). Some of this dedicated series of experiments was extended and published later (Jeannerod, 1986; Perenin and Vighetto, 1988). In an influential paper that has remained the landmark publication on optic ataxia because of the number of patients included and the broadness of the explorations described (Perenin and Vighetto, 1988), clinical and psychophysical investigations of 10 patients with optic ataxia are described. Optic ataxia is described as the difficulty in performing gestures toward the contralesional visual field (field effect), and/or with the contralesional hand (hand effect), in the absence of primary visual, proprioceptive or motor disorders. Performance was video recorded (Fig. 15.3) and rated on flight, and at the reaching end, such that “corrected” (observed only in-flight) and “non-corrected” (observed both in-flight and upon movement termination), errors could be distinguished. The key findings from this paper are that: (1) the largest number of errors are observed when the patient directs a movement with the contralesional ataxic hand toward the contralesional “ataxic” visual hemifield; (2) errors of intermediate severity are observed when the patient directs the healthy hand toward the contralesional “ataxic” visual hemifield, and the ataxic contralesional hand toward the healthy

p0065

ISBN: 978-0-12-821377-3; PII: B978-0-12-821377-3.00011-8; Author: L. Pisella et al.; 00011

To protect the rights of the author(s) and publisher we inform you that this PDF is an uncorrected proof for internal business use only by the author(s), editor(s), reviewer(s), Elsevier and typesetter SPI. It is not allowed to publish this proof online or in print. This proof copy is the copyright property of the publisher and is confidential until formal publication.

These proofs may contain colour figures. Those figures may print black and white in the final printed book if a colour print product has not been planned. The colour figures will appear in colour in all electronic versions of this book.

4

L. PISELLA ET AL.

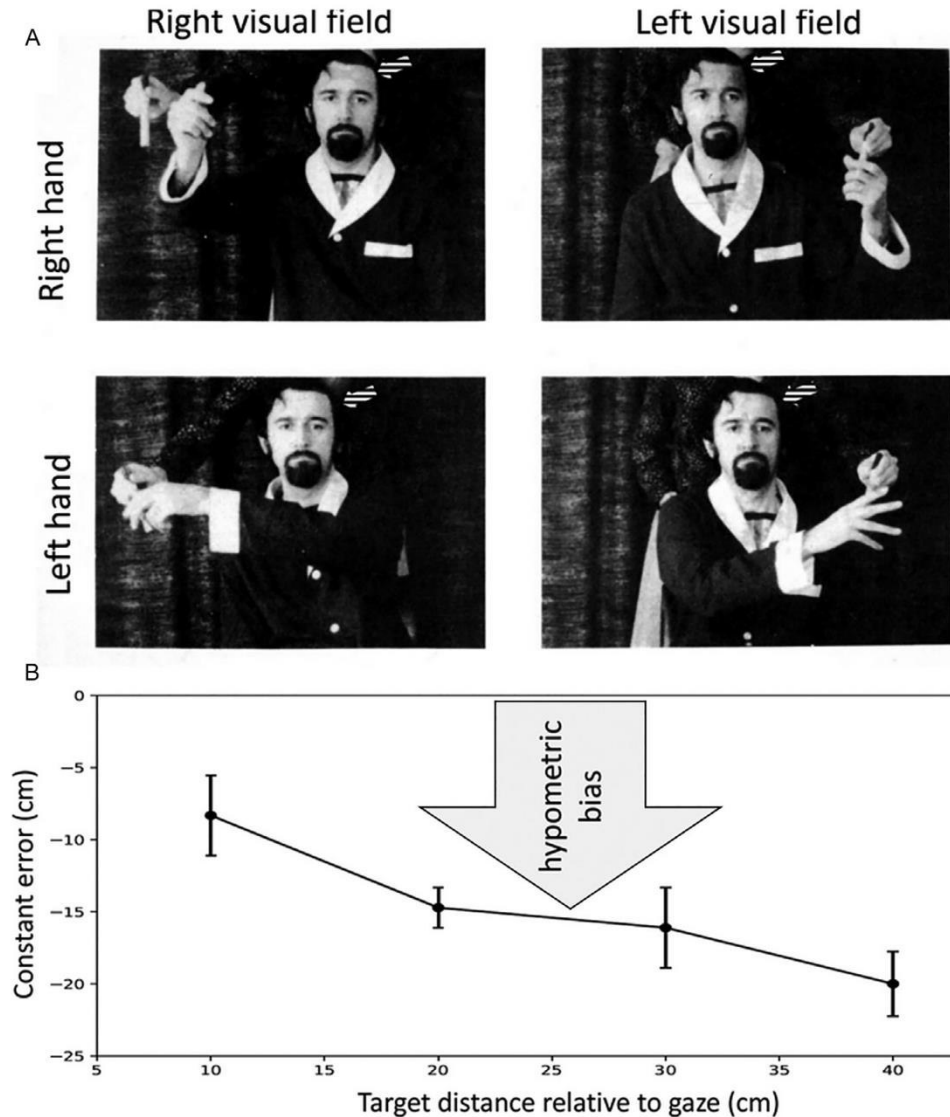

00015 **Fig. 15.2.** (A) Additive misreaching errors exhibited by patient with right optic ataxia when the pen is presented in his contralesional (*right*) visual field (**field effect**) and when he is required to grasp it with the contralesional (*right*) hand (**hand effect**). (B) Effect of visual target eccentricity (distance relative to gaze fixation) on the signed amplitude of reaching errors (hypometric errors are negative: when visual targets are presented on the horizontal axis of gaze in the contralesional visual field, movements are hypometric when the patient do not reach far enough) in optic ataxia.

visual hemifield; and (3) movements performed with the healthy hand toward the healthy visual hemifield are normal. Another aspect of Perenin and Vighetto's (1988) article is that they examined visually guided hand movements in several conditions, including central, peripheral, and foveal vision. Central viewing corresponded to trials when the target was presented in the

central zone of the visual field, albeit not in foveal vision while foveal vision corresponded to free gaze condition. As shown on their famous figure (reproduced here in Fig. 15.4), patients produced large errors in their contralesional peripheral visual hemifields and this deficit tended to be larger when they used the contralesional hand. Except for patient 3, who presented with a very

ISBN: 978-0-12-821377-3; PII: B978-0-12-821377-3.00011-8; Author: L. Pisella et al.; 00011

To protect the rights of the author(s) and publisher we inform you that this PDF is an uncorrected proof for internal business use only by the author(s), editor(s), reviewer(s), Elsevier and typesetter SPI. It is not allowed to publish this proof online or in print. This proof copy is the copyright property of the publisher and is confidential until formal publication.

These proofs may contain colour figures. Those figures may print black and white in the final printed book if a colour print product has not been planned. The colour figures will appear in colour in all electronic versions of this book.

BÁLINT SYNDROME

5

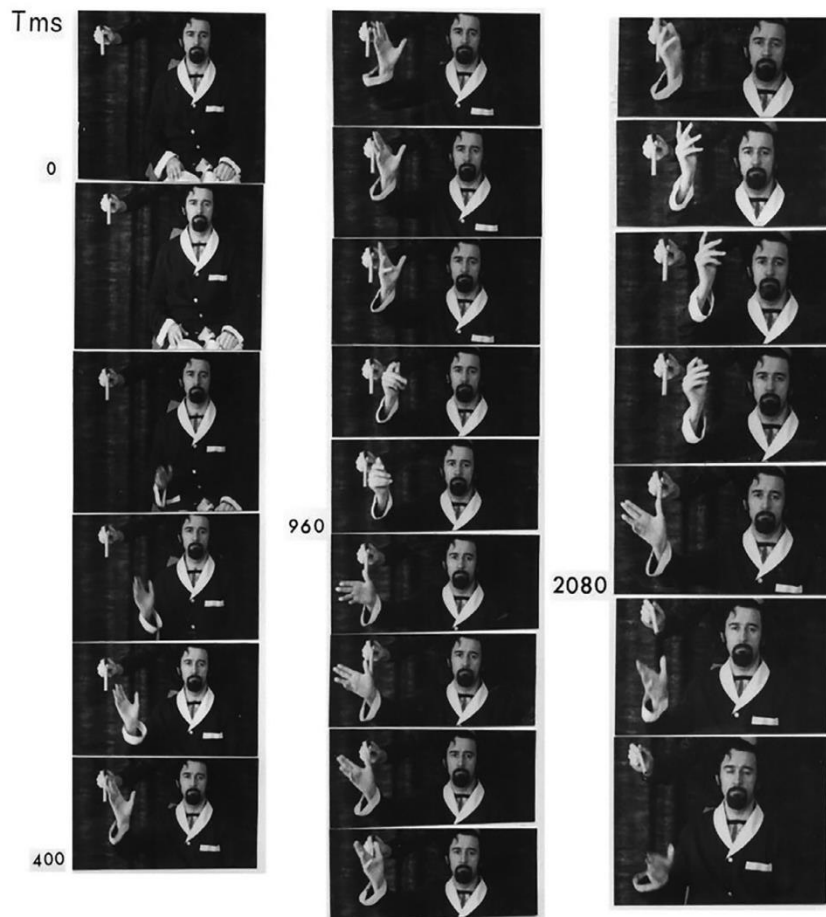

0020 **Fig. 15.3.** Images of a reaching movement made by patient presenting with right optic ataxia. Time is indicated in ms. Note that the patient is fixating straight ahead (the camera) and reaching in peripheral vision. A full movement (including finger closure) is made to an erroneous location in-between the target and where he is fixating (hypometric movement). Then surprisingly, the patient's wanders in space as if blind and then gives up. From Vighetto A (1980). *Etude neuropsychologique et psychophysique de l'ataxie optique*. Thesis. Université Claude Bernard Lyon I.

extensive left cortical and subcortical lesion and a number of associated deficits (hypokinesia, loss of right hand preference, ideomotor, ideational and constructional apraxia, body schema alteration, autotopoagnosia, abnormal limb posture at rest, and unilateral neglect), all patients exhibited only corrected errors in the central part of their visual hemifield, i.e., their potentially inaccurate initial trajectory was fully corrected before the end of the reach. The performance obtained for foveal vision was not plotted in the initial paper but quantitative data tables were provided. These results are shown as additional data in Fig. 15.4 (circles): no significant error was produced when the target was fixated. In addition, perceptual

performance of the patients was also described, although not plotted as a figure, which might explain why this crucial information has long been neglected (for example, in Goodale and Milner, 1992; Milner and Goodale, 1995). As a matter of fact, patients exhibited severe perceptual impairments in peripheral vision. The main conclusion from these studies was that the core deficit specifically involved the visuomotor interface (e.g., Goodale and Milner, 1992; Jeannerod and Rossetti, 1993; Milner and Goodale, 1995; Rossetti, 1998). This, however, turned out to be erroneous. In the context of the dual stream theory of the visual brain (Milner and Goodale, 1995), research on optic ataxia

ISBN: 978-0-12-821377-3; PII: B978-0-12-821377-3.00011-8; Author: L. Pisella et al.; 00011

To protect the rights of the author(s) and publisher we inform you that this PDF is an uncorrected proof for internal business use only by the author(s), editor(s), reviewer(s), Elsevier and typesetter SPI. It is not allowed to publish this proof online or in print. This proof copy is the copyright property of the publisher and is confidential until formal publication.

These proofs may contain colour figures. Those figures may print black and white in the final printed book if a colour print product has not been planned. The colour figures will appear in colour in all electronic versions of this book.

6

L. PISELLA ET AL.

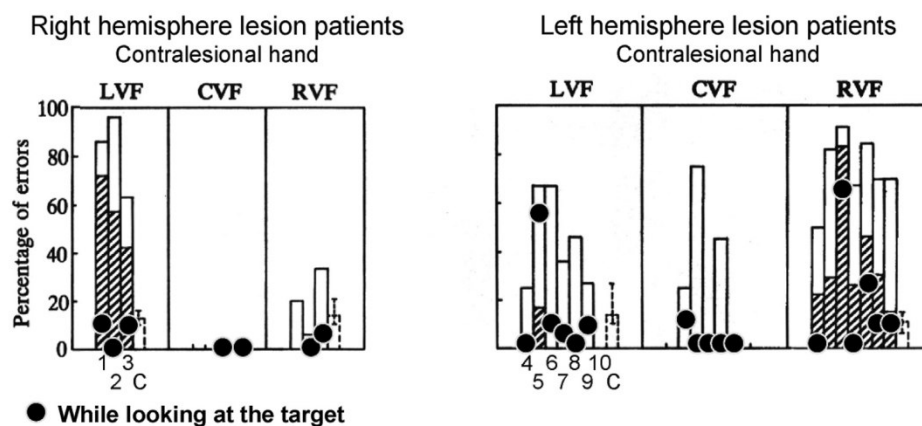

f0025 **Fig. 15.4.** Percentage of reaching errors produced with the contralesional hand toward the left, central, and right visual field (LVF, CVF, RVF) in 10 patients with unilateral PPC lesions (3 in the right and 7 in the left hemisphere). The mean (and standard deviation) percentage of errors of five control subjects (C) is presented for comparison. The participants were asked to reach an object presented by an experimenter standing in front of them while keeping the eyes fixed (histograms) or after foveating the object (circles). The dashed histograms correspond to uncorrected errors (i.e., the object was finally not acquired), whereas the blank bars correspond to the percentage of errors corrected during the execution. Redrawn from Vighetto A (1980). *Etude neuropsychologique et psychophysique de l'ataxie optique*. Thesis. Université Claude Bernard Lyon I and Perenin MT, Vighetto A (1988). *Optic ataxia: a specific disruption in visuomotor mechanisms. I. Different aspects of the deficit in reaching for objects*. *Brain* 111: 643–674.

has focused primarily on visuomotor functions (How) and has largely ignored visuo-spatial functions (Where). Various aspects of the visuomotor deficits have been studied in laboratory conditions, which have led to questioning and revisiting optic ataxia. Specifically, investigators have put forward the ideas that optic ataxia is observed (1) in temporal constraint, i.e., more with immediate than with delayed actions (Milner et al., 1999; Revol et al., 2003; Rossetti et al., 2005); (2) in spatial constraint, i.e., when the action has to be guided with the target location and/or the hand in peripheral visual space since it occurs preferentially in an oculocentric reference frame (Khan et al., 2005, 2007; Dijkerman et al., 2006; Blangero et al., 2007, 2010a; Granek et al., 2012, 2013); and (3) in response to target jumps triggered at movement onset (hand “automatic pilot,” see Pisella et al., 2000; Gréa et al., 2002; Blangero et al., 2008, McIntosh et al., 2011), a condition combining these temporal and spatial constraints.

p0070 These investigations have highlighted the perceptual deficits that contribute to optic ataxia (e.g., Rossetti et al., 2005, 2010). With the “rise and fall” of the dual stream theory (Rossetti et al., 2017), the possibility of a functional relationship between the visuomotor deficits of patients with optic ataxia and their perceptual deficits has been put forward (Pisella et al., 2007, 2009) and specifically tested (Striemer et al., 2009a,b; McIntosh et al., 2011; Medina et al., 2019). For example, Medina et al. (2019) described a patient who presented with visually

guided misreaching for targets left of fixation but not to the right of fixation. The authors also presented two small circles in succession in either the same location or offset at varying distances and asked whether the two circles were presented in the same or different position. The patient was significantly more impaired in judging these stimuli when presented to the left of fixation compared with the right, providing evidence for a perceptual localization deficit after a dorsal stream lesion. In the contralesional visual field, saccade and reaching movements distinguish less between target locations as target eccentricity increases (Gaveau et al., 2008; Blangero et al., 2010a; Vindras et al., 2016), as if spatial resolution was pathologically decreasing, causing an apparent “compression” of space. It is thus tempting to recast optic ataxia as a disorder of visual attention (Pisella et al., 2007, 2009). Indeed, since attention enhances spatial resolution (Yeshurun and Carrasco, 1998), visual attention impairment could explain the difficulty of patients with optic ataxia to report the occurrence of target changes in location, size, and orientation in peripheral vision (Pisella et al., 2009; Medina et al., 2019). It has also been shown that attention increases contrast sensitivity (Carrasco et al., 2000), which could explain the slower detection of a visual target in the contralesional visual field (e.g., prior entry of ipsilesional visual information) in the Posner’s (1980) covert attention paradigm (Striemer et al., 2007). Furthermore, by boosting the spatial resolution, the strength and the quality of neural signals evoked by

ISBN: 978-0-12-821377-3; PII: B978-0-12-821377-3.00011-8; Author: L. Pisella et al.; 00011

To protect the rights of the author(s) and publisher we inform you that this PDF is an uncorrected proof for internal business use only by the author(s), editor(s), reviewer(s), Elsevier and typesetter SPI. It is not allowed to publish this proof online or in print. This proof copy is the copyright property of the publisher and is confidential until formal publication.

BÁLINT SYNDROME

7

an object, attention may effectively provide a more fine-grained sample of the object's features. Accordingly, impaired selective attention in the contralesional visual field may also explain the perceptual deficit of optic ataxia patients in a cued letter discrimination task (Khan et al., 2009; Blangero et al., 2010b).

s0020 **VISUOMOTOR CLUMSINESS: A DEFICIT OF SIMULTANEOUS LOCATION PROCESSING?**

p0075 Optic ataxia has been used over the last 20 years to argue in favor of dissociable functions within the dorsal (How) and ventral (What) streams of visual information processing and visuomanual guidance (Jeannerod and Rossetti, 1993; Milner and Goodale, 1995; Rossetti and Pisella, 2002). The interaction between a field effect and a hand effect in patients with unilateral lesions was considered a key argument for the dorsal visual stream specialization for "vision for action" (Goodale and Milner, 1992; Jeannerod and Rossetti, 1993; Jeannerod, 1994; Milner and Goodale, 1995). For example, similar to Bálint's patient who presented a misreaching deficit mainly visible in the left visual field with the left hand, the misreaching of the patient described by Jackson et al. (2005) was confined to movements directed to nonfoveal targets executed using his right limb. Such observations led the authors to consider that explanations of optic ataxia based upon either only perceptual or only motor deficits could be ruled out and thus that the deficit of optic ataxia lies at the visuomotor interface.

p0080 We instead consider that field and hand effects could be additive, and optic ataxia can therefore be explained by a combination of dissociable perceptual *and* motor components (Pisella et al., 2006a,b). More precisely, the perceptual component corresponds to the field effect and explains the mislocalization of the target, visual or from another sensory modality, represented in eye-centered coordinates. The "motor" component corresponds to the hand effect and arises from a mislocalization of the hand from an eye-centered proprioceptive-spatial transformation. Both components involve multimodal eye-centered spatial representation and may therefore result from a unique core deficit. However, we reported that a patient exhibited an isolated hand effect (Pisella et al., 2006a,b) leading to misreaching errors only when monitoring his hand movement in the absence of direct vision of his hand, e.g., in the dark or through a mirror ("mirror ataxia" Binkofski et al., 1999). Moreover, Blangero et al. (2009) have shown that patients exhibiting larger field effect had more posterior lesions and patients exhibiting more hand effect had more anterior lesions.

We therefore propose to replace the idea of a deficit of visuomotor transformation (How) by a combination of at least two eye-centered mislocalizations deficits (Where):

- (1). In the contralesional visual field, targets are mislocalized toward the gaze position with a reliable hypometric error that increases nonlinearly with target visual eccentricity (Blangero et al., 2010a; Vindras et al., 2016). These errors observed in the contralesional oculocentric hemispace can be modeled by mathematical equations modeling central magnification in visual maps of the superior colliculus or of the primary visual cortex (Vindras et al., 2016). We therefore suggest that the parietal cortex, in which such central magnification is not observed, and which is damaged in optic ataxia, is crucially involved in the remagnification of compressed representation of contralateral peripheral space. The oculocentric location occupied in external space by a given hand is computed from proprioceptive signals in the left parietal cortex when the hand lies in the right oculocentric space and vice versa. In case of parietal damage, this oculocentric proprioceptive-spatial representation becomes similarly hypometric and directed toward gaze position.
- (2). In addition, the oculocentric location occupied in external space by the contralesional hand is largely miscomputed irrespective of where the contralesional hand acts. Indeed, Blangero et al. (2007) have shown in two unilateral optic ataxia patients that the ipsilesional hand is mislocated when it lies in the contralesional space, but the contralesional hand is more largely mislocated wherever it lies (with errors still modulated by the oculocentric space where it lies).

Based on electrophysiological recordings in monkeys, Battaglia-Mayer and Caminiti (2002) proposed that optic ataxia arises from the breakdown in the tuning fields of parietal neurons integrating spatially congruent retinal, eye, and hand position signals for coordinated eye and hand movements. However, the classical observation in the acute phase of optic ataxia is magnetic misreaching: patients systematically reach where they look instead of reaching to their peripheral goal (Carey et al., 1997; Jackson et al., 2005). Note that when the patient starts to recover, or when this magnetic misreaching is prevented by requiring bimanual reaching of two simultaneous objects while looking at one as in Jackson et al. (2005), the misreaching turns into a classical optic ataxia pattern, i.e., the reach ends between the object location and the gaze position. Jackson et al. (2005) therefore argued that this behavior is actually a coordinated eye-hand movement and that the underlying cause of optic ataxia is failure to simultaneously represent spatially

ISBN: 978-0-12-821377-3; PII: B978-0-12-821377-3.00011-8; Author: L. Pisella et al.; 00011

incongruent retinal, eye, and hand positions signals to produce nonstandard visuomotor transformations (uncoordinated eye-hand coordination). Starting a hand movement toward a visual goal selected from peripheral vision before initiating a saccade to it is a classical nonstandard visuomotor transformation of everyday life that patients with chronic optic ataxia tend to spontaneously avoid (Gaveau et al., 2008). Other nonstandard visuomotor transformations similar to using a computer mouse have been specifically studied by Granek et al. (2012), and optic ataxia patients use multiple saccades between the hand and the visual target in these specific conditions, while control individuals stabilize their gaze on the visual target and monitor their hand movements using peripheral visual and proprioceptive feedback.

In an fMRI task, Beurze et al. (2010) required their subjects to perform a reaching task while systematically varying hand starting position, target location, and/or gaze direction on a trial-by-trial basis. They were able to distinguish activity in different regions of the parietal and posterior frontal cortices depending on whether the representation of target and hand locations was relative to gaze or to the body (Fig. 15.5). The results suggest

that, in the posterior parietal cortex, spatially contiguous neuronal populations encode target and hand locations in different frames of reference, with a dominance of gaze-centered representations.

Jackson et al. (2018) further investigated this ability to directly compare multiple and dissociated simultaneous spatial information so as to compute the difference between them. They investigated how individuals presenting with optic ataxia performed on a bimanual haptic matching task. Unlike neurologically healthy controls who perform the task with high levels of accuracy, patients with optic ataxia were unable to perform the task, whether the bar to be matched was presented haptically or visually.

To sum up, we have reviewed here evidence that visuomotor clumsiness may arise in specific conditions in which multiple locations (eye, hand, and/or target not aligned) have to be simultaneously represented and integrated.

HISTORICAL DESCRIPTIONS AND INTERPRETATION OF OCULAR AND PERCEPTUAL/ATTENTIONAL DEFICITS

Bálint clearly interpreted ocular symptoms as attentional deficits; his description of “Seelenlähmung des Schauens” included both his patient’s difficulty to find visual targets with his eyes (wandering of gaze) and of visual capture by the target once fixated (spasm of fixation). As emphasized by De Renzi et al. (1989), Holmes (1918) added an oculomotor deficit per se to his description of patients with parietal lesions, which had been excluded by Bálint for his patient. This oculomotor disorder described by Holmes (1918) and later labeled ocular motor apraxia (Cogan and Adams, 1953) has often been incorporated into the description of Bálint’s syndrome and confounded with the “Seelenlähmung des Schauens” most often translated in English as a “psychic paralysis of gaze.” Hence, the attentional disorders that were initially associated with this element of the triad have been grouped together with the lateralized attentional deficits described by Bálint (1909), which has been easily ascribed to unilateral neglect (e.g., Hecaen and De Ajuriaguerra, 1954). As De Renzi et al. (1989) rightly pointed out long ago, “psychic paralysis of gaze” appears to be an erroneous translation of Bálint’s description. The alternative translation proposed by Hecaen and De Ajuriaguerra (1954)—psychic paralysis of visual fixation, also known as spasm of fixation—provides an alternative emphasis of this symptom and suggests that it can be clearly dissociated from intrinsic oculomotor disorders, as already argued by Bálint. Husain and Stein’s translation (Husain and Stein, 1988) of Bálint’s description for the psychic

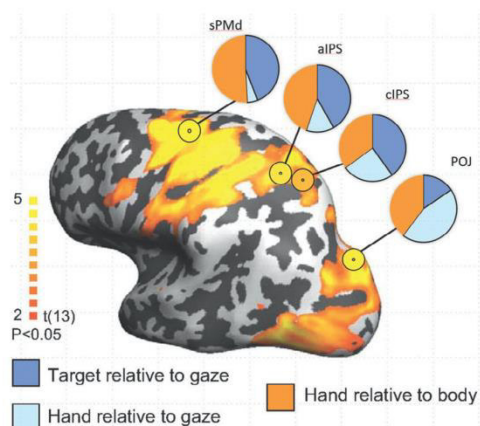

Fig. 15.5. Relative contributions of gaze- and body-reference frames for target and hand position coding in the SPL-IPS network (anterior part of the intraparietal sulcus (aIPS), caudal part of the intraparietal sulcus (cIPS), parieto-occipital sulcus (POJ), and superior part of the dorsal premotor cortex (sPMd)), represented on the schematic diagram of Bálint (1909) depicting the lesion of his patient. POJ represents hand position in both gaze- and body-centered coordinates. Activation in cIPS is mostly modulated by the gaze-centered target and hand representations. Closer to the central sulcus, in the sPMd and aIPS regions, the body-centered hand representation gains influence. Redrawn from Beurze SM, Toni I, Pisella L, Medendorp WP (2010). Reference frames for reach planning in human parietofrontal cortex. *J Neurophysiol* 104: 1736–45.

These proofs may contain colour figures. Those figures may print black and white in the final printed book if a colour print product has not been planned. The colour figures will appear in colour in all electronic versions of this book.

BÁLINT SYNDROME

9

paralysis of gaze corresponds to a restriction of the patient's "field of view, or we can call it the psychic field of vision." This latter version also emphasized a visual-attentional rather than an oculomotor deficit. Altogether these apparent subtleties have given rise to several systematization of the oculomotor, perceptual, and attentional aspects of the syndrome. For example, Hecaen and De Ajuriaguerra (1954) distinguished the "psychic paralysis of fixation" (or inability to look toward a peripheral target) from the disturbance of attention. However, these authors further differentiated between two types of attention disorders. First, they outlined a general impairment of attention that corresponded to a selective perception of foveal stimuli. However, they also emphasized the presence of a lateralized component of the attention deficit which can now be described as unilateral neglect. Alternatively, De Renzi et al. (1989) distinguished two types of visual disorders in Bálint's description. One of these corresponds to the lateralized deficit known as unilateral neglect, and the other to a nonlateralized restriction of visual attention, which can be partly interpreted as simultanagnosia. His interpretation of the "Bálint-Holmes syndrome" excluded the presence of intrinsic visuo-oculo-motor deficits. Rizzo and Vecera (2002) and Rizzo (1993) on their side focused their analysis on a "spatial disorder of attention," corresponding to simultanagnosia (Wolpert, 1924), and on the "psychic paralysis of gaze," which they distinguished from oculomotor deficits and assimilated to "spasm of fixation" or "ocular apraxia." To these symptoms, these authors associated two additional attentional disorders: unilateral neglect and concentric restriction of the attentive field (simultanagnosia).

p0125 Gaze apraxia is characterized by severe abnormalities of eye movement generation in response to visual targets in space, in the absence of ocular motor palsy, ascertained by full reflexive eye movements. Eye movement recordings usually show several abnormalities, such as prolonged latency, fragmentation and hypometry of saccades, fixation drift, and absence of smooth pursuit (Michel et al., 1963; Girotti et al., 1982). Both the accuracy of fixation and saccadic localization are impaired, and spatiotemporal organization of eye displacements does not fit with the spatial configuration of the scene to be analyzed (Tyler, 1968). However, it is important to note that this abnormal saccadic behavior is observed in rich (natural) environment scenes, which require continuous selection between concurrent stimuli. In a simpler context, for example, when the task is to direct the eyes to a peripheral LED in the dark, saccades may be normal (Guard et al., 1984). Interestingly, this saccadic behavior is also observed after inactivation of lateral intraparietal area (LIP) in monkeys (Li et al., 1999; Wardak et al., 2002).

In our view, two main oculomotor disorders emerge p0130 from the clinical descriptions: one in time and one in space. First, the more consistent observation in these patients is—in cases of unilateral lesions—an increase in latency for saccades in the contralesional direction or—in cases of bilateral lesions—a poverty of eye movements, which may culminate in a condition often referred to as "spasm of fixation," or "visual grasp reflex." Patients stare open eyed, with the gaze being locked to the detail that they are fixating. Second, patients are usually able to move their eyes on verbal command, while they are impaired in performing visually guided saccades. The more the eye movement relies on attention and complex visual processing, the less likely it is to be triggered. Along these lines, visual search behavior is particularly vulnerable. Hence, when patients are asked to move their eyes to a target suddenly appearing in the peripheral field, they may generate no movement, or initiate wandering eye movements, that consist of erratic, and usually hypometric displacements of the eyes in space, ending with incidental acquisition of the target.

A spatial disorder of attention (Bálint, 1909), a restriction p0135 (De Renzi et al., 1989), a shrinkage of the attentional field (Michel and Henaff, 2004), or a disorder of simultaneous perception (Luria, 1959) are equivalent terms labeling a complex symptom, which can be viewed as a symmetrical or asymmetrical limitation of visual-spatial attentional resources. Patients do not seem to perceive visual targets located away from a small area, despite preserved visual fields. For example, we have observed that patients with bilateral lesions looking at their palm may not perceive their fingertips. They exhibit a reduction of "useful field of vision," operationally defined as the field of space that can be attended to while maintaining central fixation (Rizzo and Vecera, 2002). Shrinkage of the attention field reduces detection of multiple objects and may restrict patients' perception to one item at a time, literally: simultanagnosia. Bálint's patient himself was not able to perceive the light of a match while focusing on a cigarette until he felt a burning sensation. This limited capacity of attentive vision for only one object attracting the focus of attention at a time does not depend upon the size of the object. As a general consequence, patients fail at any time to perceive the totality of the items forming a visual scene. Performance for counting objects is altered accordingly. The shrinking of the attentional field can be either concentric in the case of bilateral posterior parietal damage (simultanagnosia) or with a contralesional bias in the case of unilateral posterior parietal damage (unilateral spatial neglect). Nevertheless, as in Bálint's initial case, bilateral damage can be asymmetric and produce both a reduced attentional field (simultanagnosia) and a unilateral bias of attention orientation that can be rightward as well as leftward

ISBN: 978-0-12-821377-3; PII: B978-0-12-821377-3.00011-8; Author: L. Pisella et al.; 00011

To protect the rights of the author(s) and publisher we inform you that this PDF is an uncorrected proof for internal business use only by the author(s), editor(s), reviewer(s), Elsevier and typesetter SPI. It is not allowed to publish this proof online or in print. This proof copy is the copyright property of the publisher and is confidential until formal publication.

These proofs may contain colour figures. Those figures may print black and white in the final printed book if a colour print product has not been planned. The colour figures will appear in colour in all electronic versions of this book.

10

L. PISELLA ET AL.

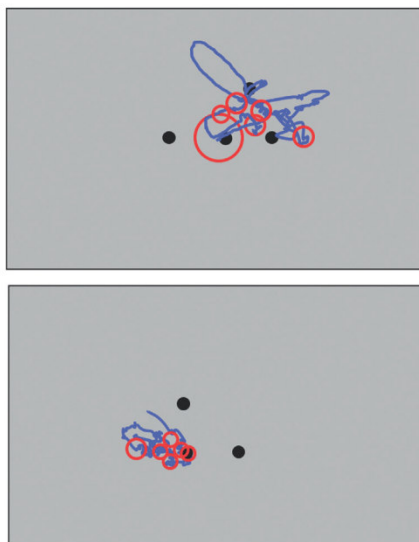

Fig. 15.6. Schematic illustration of the oculomotor behavior (saccades and drifts in *blue* and ocular fixations marked by *red circles* whose diameter increases with fixation duration) observed in two patients with posterior cortical atrophy during a task requiring them to count the number of dots (*black disks*) presented on a computer screen. In the top panel, four dots are presented with unlimited duration to the first patient. The patient is searching more dots on the right and seems to ignore the left one. The patient counts four dots due to ocular revisiting behavior. In the bottom panel, three dots are presented with unlimited duration to the second patient. The patient is searching more dots on the left and seems to ignore the two most rightward ones. The patient counts three dots due to ocular revisiting behavior. Redrawn from Pisella L, Biotti D, Vighetto A (2015). Combination of attentional and spatial working memory deficits in Bálint-Holmes syndrome. *Ann N Y Acad Sci* 1339: 165–175.

(Pisella et al., 2015). As an illustration, Fig. 15.6 shows ocular recording of two patients with neurodegenerative bilateral posterior parietal damage during a task consisting of counting the number of dots presented on the screen. The first patient keeps the eyes only on the right dots, while the second keeps his eyes on the left dots. This distinct behavior may correspond to distinct lateralization of their degeneration. Description or copy of complex figures is also laborious and slow, patients focusing serially on details, apprehending portions of the pictures with a piecemeal approach, but failing to switch attention from local details to global structures. Again, this reduction of attentional field can be associated or not with a unilateral orienting bias. Fig. 15.7 shows the figure copy of patients with nonlateralized Bálint's syndrome to be compared with the same figure copied by a clinical neglect

patient with additional rightward orienting bias leading him to mislocalize elements more toward the right side of the copy.

In Posner's paradigm, patients with posterior parietal lesion exhibit defects in shifting spatial attention (Verfaellie et al., 1990) or in disengaging attention from fixated objects (Rizzo and Vecera, 2002), a difficulty which may be central for the visual grasp reflex to occur. Michel and Henaff (2004) have provided a comprehensive examination of a patient (AT) with bilateral PPC lesion whose initial Bálint's syndrome had been reduced 20 years post onset to bilateral optic ataxia and a variety of attentional deficits that can be interpreted as a concentric shrinking of the attentional field. An experimental demonstration of this reduced functional visual field was provided in another case study where patient IG, who had bilateral lesions of the superior parietal lobule (SPL-IPS network), was just as slow to find the O among Qs when she performed the visual search with or without a gaze-contingent visible window of 20° diameter (Khan et al., 2016). In contrast, the presence of the window dramatically reduced control participants' search times, demonstrating that the window restricted their normally wider attentional window.

In summary, there is a wealth of converging evidence suggesting that both the visual grasp reflex and the wandering of gaze are direct consequences of this shrinking of the attentional field; if one does not perceive any visual target in the periphery, one will not perform a saccade to it. Hence, gaze will remain anchored on a target once acquired (visual grasp reflex). If one is forced to find a specific target in the visual scene, then one would have to make "blind" exploratory movements as it is the case in tunnel vision, explaining the wandering of gaze. This shrinking of the attentional field also logically reduces the size of exploratory saccades, thus increasing the number necessary to find a target (Fig. 15.8A). Since an attentional deficit can explain the large variety of ocular disorders (spasm of fixation, wandering of gaze, hypometry, and increased latency of saccades), we therefore propose to consider them as multiple behavioral manifestations of an underlying attentional disorder.

SIMULTANAGNOSIA/EXTINCTION: A DEFICIT OF SIMULTANEOUS LOCATION PROCESSING?

Khan et al. (2016) reported that patient IG with bilateral lesions of the SPL-IPS network performed slower than controls only in visual search tasks involving symbols made by a spatial combination of several lines (Fig. 15.9). For example, she was slow to detect the presence of an item "O" among multiple items "Q." In contrast,

ISBN: 978-0-12-821377-3; PII: B978-0-12-821377-3.00011-8; Author: L. Pisella et al.; 00011

To protect the rights of the author(s) and publisher we inform you that this PDF is an uncorrected proof for internal business use only by the author(s), editor(s), reviewer(s), Elsevier and typesetter SPI. It is not allowed to publish this proof online or in print. This proof copy is the copyright property of the publisher and is confidential until formal publication.

These proofs may contain colour figures. Those figures may print black and white in the final printed book if a colour print product has not been planned. The colour figures will appear in colour in all electronic versions of this book.

BÁLINT SYNDROME

11

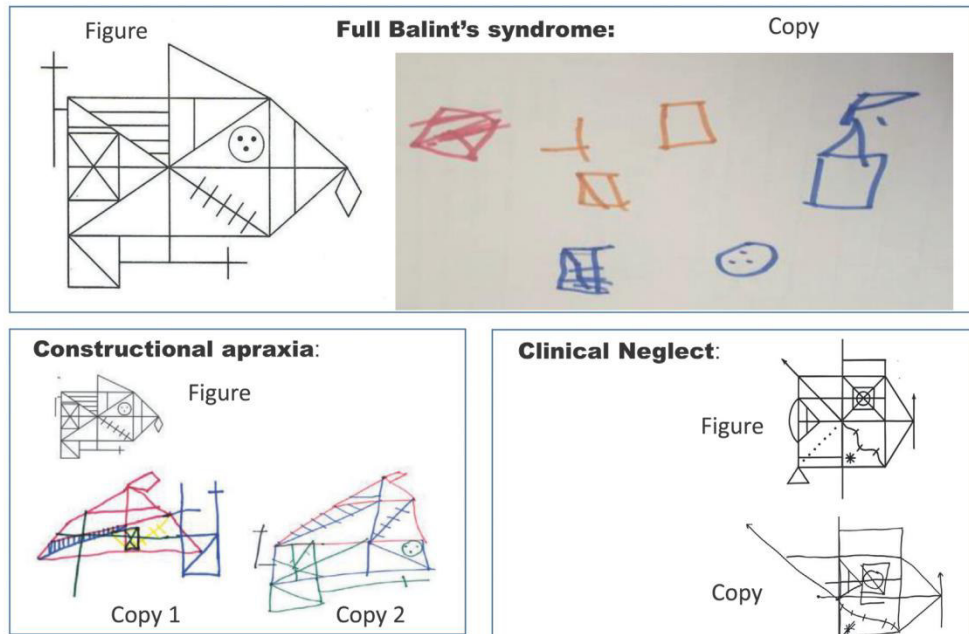

f0040 **Fig. 15.7.** Examples of copies of a Rey figure drawn by a patient with full Bálint's syndrome, a patient with constructional apraxia, and a patient with clinical neglect.

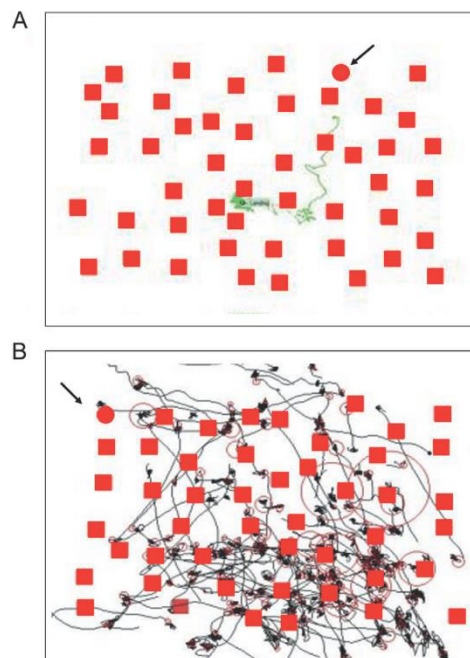

f0045 **Fig. 15.8.** Wandering of gaze with (*bottom panel*) or without (*top panel*) revisiting behavior. Ocular traces (*green*) recorded during a visual search task consisting of finding the red disk among the red squares (the target usually pops out) in two patients with posterior cortical atrophy of different clinical severity. Redrawn from Pisella L, Biotti D, Vighetto A (2015). Combination of attentional and spatial working memory deficits in Bálint-Holmes syndrome. *Ann N Y Acad Sci* 1339: 165–175.

ISBN: 978-0-12-821377-3; PII: B978-0-12-821377-3.00011-8; Author: L. Pisella et al.; 00011

To protect the rights of the author(s) and publisher we inform you that this PDF is an uncorrected proof for internal business use only by the author(s), editor(s), reviewer(s), Elsevier and typesetter SPI. It is not allowed to publish this proof online or in print. This proof copy is the copyright property of the publisher and is confidential until formal publication.

These proofs may contain colour figures. Those figures may print black and white in the final printed book if a colour print product has not been planned. The colour figures will appear in colour in all electronic versions of this book.

12

L. PISELLA ET AL.

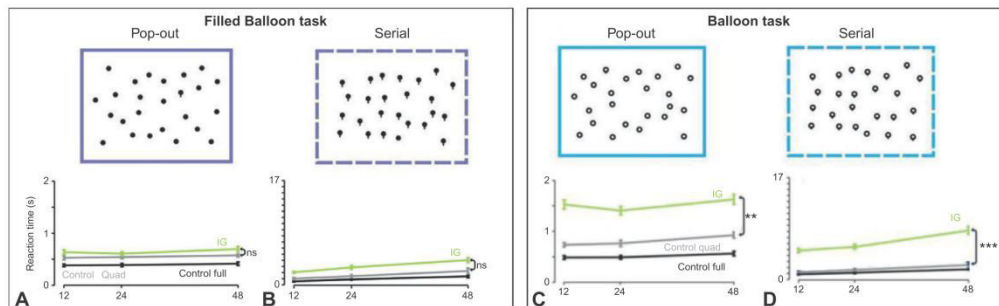

f0050 **Fig. 15.9.** Search times (reaction times to press the button) to find the odd target among 12, 24, and 48 distractors in four visual search tasks (A–D) recorded for a patient with simultanagnosia, bilateral optic ataxia, and quadrantanopia in the right lower visual field (IG, green line) and for age-matched controls performing the tasks with (gray line) and without (black line) a gaze-contingent quadrantanopic mask. Patient IG was significantly slower than controls with artificial quadrantanopia to find the target in the two balloon tasks (C, D), while she performed well in the two filled balloon tasks (A, B). Redrawn from Khan AZ, Prost-Lefebvre M, Salemme R, et al. (2016). The Attentional fields of visual search in simultanagnosia and healthy individuals: how object and space attention interact. *Cereb Cortex* 26: 1242–1254.

she was as fast as controls to find a red disk among red squares and green disks (color-shape conjunction search). In peripheral vision, we perceive the perceptual elements surrounding us but not their precise localization (Pelli and Tillman, 2008; Balas et al., 2009; Rosenholtz et al., 2012a,b). A disk or a plain square are items made up of a single element. In contrast, a symbol “Q” is made by a circle and a line, such that without covert attention we cannot organize these multiple elements into respective and recognizable objects. Khan et al. (2016) concluded that shrinking of the functional field of attention occurs in patients with bilateral SPL-IPS lesions, only occurs in visual search conditions requiring spatial binding of separable elements, i.e., conditions of spatial uncertainty. This shrinking could be mimicked by a gaze-contingent display producing a reduced visible window and thus a limitation of the number of elements that the patient could process simultaneously. In order to determine the number of elements that patient IG could process simultaneously in one single fixation, the Global Report task was also tested: strings of five letters were presented for 200 ms in central fixation (Valdois et al., 2019). Note that acuity, binocular vision, single letter identification, temporal threshold, and multiletter sequential report were reported to be fully normal in patient IG, ruling out the possibility of a general slowing of visual perception and of a reduced visual short-term memory capacity following bilateral SPL lesion (Valdois et al., 2019). In the Global Report task, patient IG could report only a restricted number of letters within the string (reduced visuo-attentional span). This visuo-attentional span deficit in IG was similar to the one observed in developmental dyslexia, which is specific to symbols and disappears when dyslexics are required to report the color of five dots in a row (Valdois et al., 2012).

Vialatte et al. (2021) further explored IG’s visual processing of plain objects (colored disks) vs objects consisting of separable lines (letters), presented in isolation (single object) vs simultaneous presentation (a triplet of objects). In peripheral vision, identification of the isolated object was normal but dropped to chance level when it was surrounded by distracters, irrespective of eccentricity and spacing. It was then tested whether this poor performance in identification of the central object of a triplet could reflect a deficit in processing objects’ relative location within the triplet (for colored disks), aggravated by a deficit in processing the relative location of each separable line (for letters). Performance improved when IG only had to detect the presence of a specific colored disk within the triplets rather than to identify the color of the central one, but no improvement was observed for letters. These results can be interpreted in the framework of our hypothesis. Indeed, each color disk is composed of one element, and therefore a deficit of spatial localization affects detection performance only when the task requires perceiving the spatial relationships between objects. However, letters are composed of a spatial configuration of several separable elements, so the identification of each letter by itself already requires understanding such spatial relations. When the stimulus contains only a single letter, the uncertainty about the spatial relations is relatively small and patient IG manages to perform optimally (likely relying more than controls on prior knowledge). However, when there is more than a single letter, there are many more elements and possible spatial relations, and therefore uncertainty considerably increases and accordingly detection performance remains considerably reduced. Additionally, the inability to identify the target

ISBN: 978-0-12-821377-3; PII: B978-0-12-821377-3.00011-8; Author: L. Pisella et al.; 00011

To protect the rights of the author(s) and publisher we inform you that this PDF is an uncorrected proof for internal business use only by the author(s), editor(s), reviewer(s), Elsevier and typesetter SPI. It is not allowed to publish this proof online or in print. This proof copy is the copyright property of the publisher and is confidential until formal publication.

These proofs may contain colour figures. Those figures may print black and white in the final printed book if a colour print product has not been planned. The colour figures will appear in colour in all electronic versions of this book.

BÁLINT SYNDROME

13

was alleviated when the distracters were identical letters “X,” thereby reducing the number of possible lines binding. We concluded that a bilateral SPL sparing is necessary to process the spatial relations between multiple separable elements presented simultaneously, both between and within objects. In other words, a localization deficit for simultaneous visual elements potentially explains the deficit of perception (simultanagnosia) consecutive to bilateral SPL damage (Fig. 15.10).

p0160 Another experiment adds weight to the idea that SPL damage causes a deficit of relative mislocalization of visual elements. Pisella et al. (2013) report a clinically asymptomatic patient with a focal, unilateral SPL lesion. When tested with gray dots flashed simultaneously bilaterally or unilaterally in the left or the right visual field (classical visual extinction assessment), the patient was able to detect the presence of dots presented unilaterally in both visual fields but failed to detect the presence of the left dot in a condition of attentional competition between the two hemifields. However, when the visual complexity of the stimulus was increased by using

letters, the patient began to fail to detect the unilateral letter presented in the left visual field. Moreover, when the difficulty of the task was increased by requiring both detection and identification of the letters, the patient no longer exhibited a visual extinction pattern but a full spatial neglect pattern, i.e., he systematically failed to report the identity of the unilateral letters presented in his left visual field. In sum, presenting multiple simultaneous elements instead of plain dots and requiring subjects to bind these elements spatially can lead to a full lack of report of left-sided unilateral stimuli in patients with apparent visual extinction (Fig. 15.11).

Note that patients with lesion acquired at adulthood are nevertheless able to read long well-known words, even presented briefly in peripheral vision. This ability is explained by the use of their acquired visual lexicon developed at the level of the visual word form area of their (spared) ventral visual stream. However, a posterior parietal cortex dysfunction from the infancy would prevent to constitute such a visual lexicon and would cause developmental dyslexia (Valdois et al., 2019).

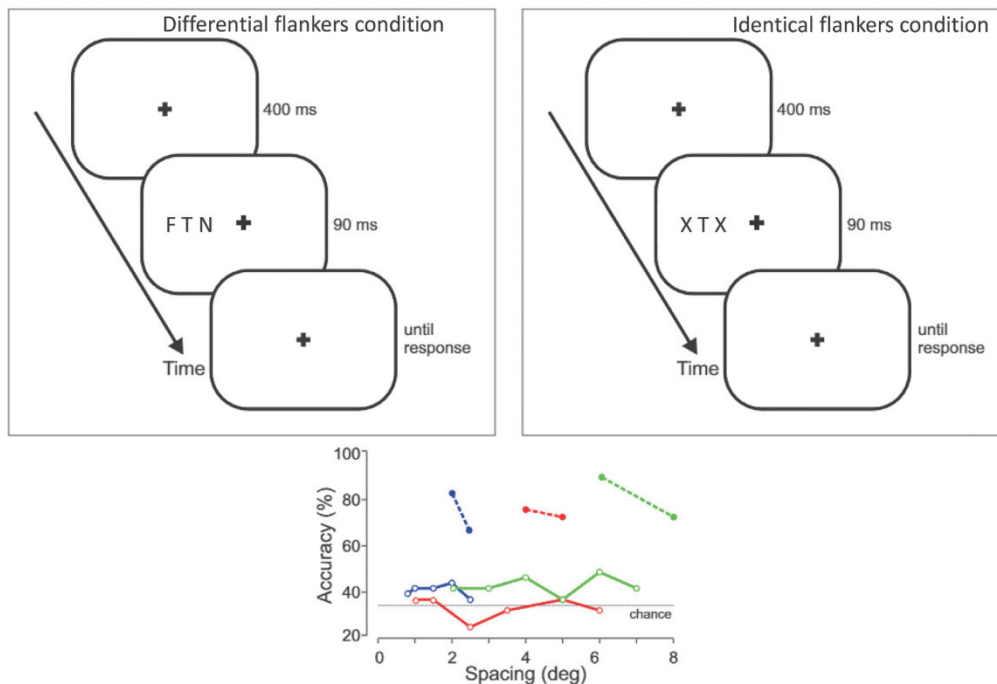

f0055 **Fig. 15.10.** Response accuracy to report the middle letter of the triplet (F, T or N, chance level = 33%) in conditions of differential (plain lines) or identical (dotted lines) flankers in patient IG (simultanagnosia and bilateral optic ataxia following the bilateral SPL-IPS network). The results are displayed for a middle target presented at 3° (blue), 7° (red), and 10° (green) of visual eccentricity and varying spacing among letters within the triplet. As illustrated, the accuracy remained at chance level irrespective of visual eccentricity and spacing, except when the identical flankers drastically reduced the spatial uncertainty of the task. From Vialatte A, Yeshurun Y, Khan AZ et al. (2021). Superior parietal lobule: a role in relative localization of multiple different elements. *Cereb Cortex* 31: 658–671. doi:10.1093/cercor/bhaa250. Accepted.

ISBN: 978-0-12-821377-3; PII: B978-0-12-821377-3.00011-8; Author: L. Pisella et al.; 00011

To protect the rights of the author(s) and publisher we inform you that this PDF is an uncorrected proof for internal business use only by the author(s), editor(s), reviewer(s), Elsevier and typesetter SPI. It is not allowed to publish this proof online or in print. This proof copy is the copyright property of the publisher and is confidential until formal publication.

These proofs may contain colour figures. Those figures may print black and white in the final printed book if a colour print product has not been planned. The colour figures will appear in colour in all electronic versions of this book.

14

L. PISELLA ET AL.

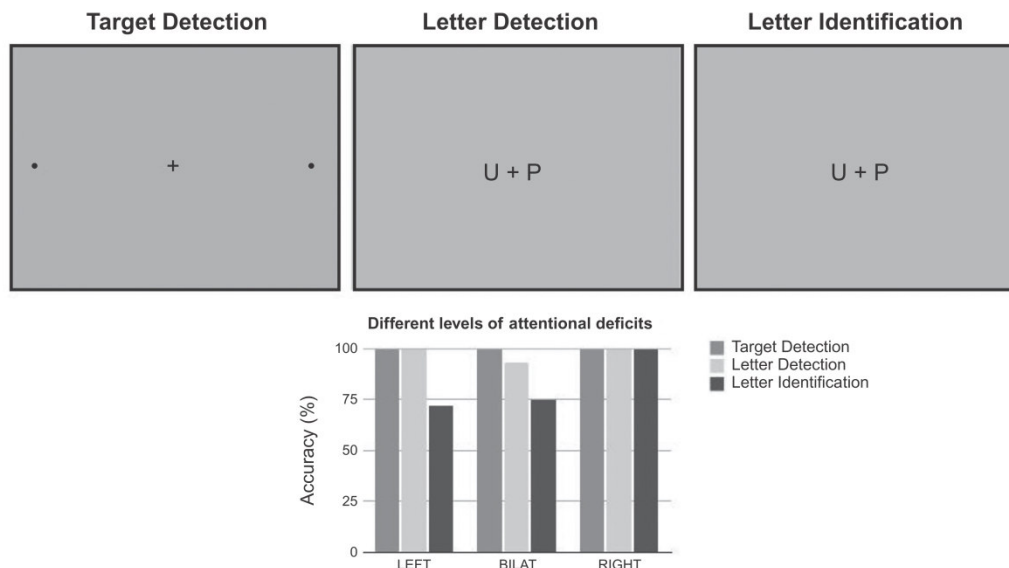

f0060 **Fig. 15.11.** Response accuracy for left, bilateral, and right brief target presentation observed in a patient with left extinction when he had to report the presence of a stimulus (dot or letter, in target detection and letter identity of the presented letters (letter identification). Redrawn from Pisella L, Blangero A, Tilikete C et al. (2013). Attentional disorders. In: K Ochsner, S Kosslyn (Eds.), *The Oxford handbook of cognitive neuroscience: volume 1: core topics*. Oxford University Press, Oxford, UK, pp. 319–350 (Chapter 16).

s0035

A RENEWED MODEL OF PPC ORGANIZATION

p0170 The standard view of the PPC and Bálint's syndrome in the predominant model of Milner and Goodale (1995) is that the most superior part of the dorsal stream is devoted to action, as illustrated by optic ataxia (this view has been challenged by numerous authors, e.g., Rossetti et al., 2015, 2017). In this context, the most inferior part of the PPC is more intermediate between "vision for action" and "vision for perception," with unilateral neglect as an example. Converging evidence now tends to distinguish the lateralized and nonlateralized components of unilateral neglect both behaviorally and anatomically, linking the well-known lateralized bias of neglect to the dysfunction of the superior parieto-frontal network and the newly defined nonlateralized deficits to the inferior parieto-frontal network and temporo-parietal junction. Indeed, the consequences of PPC lesions in humans suggest that symmetrical and asymmetrical (right-hemispheric dominant) parietal visuo-spatial maps coexist. Transcranial magnetic stimulation applied unilaterally to the superior parietal lobule (SPL) symmetrically causes "contralesional visual extinction" (Hilgetag et al., 1994; Pascual-Leone et al., 1994): in bilateral crossed-hemifield visual presentation of two

simultaneous objects, only the ipsilesional object is reported. The spatial representations of the SPL-IPS network, whose damage potentially induces contralesional optic ataxia and contralesional visual extinction, are mainly fine-grained egocentric (eye-centered) maps of the contralesional visual field (Blangero et al., 2010a) and are fairly symmetrical (Hilgetag et al., 1994; Pascual-Leone et al., 1994; Blangero et al., 2010a). In contrast, the "landmark" tests involve allocentric localization processes specific to the right hemisphere. Patients with severe and chronic neglect usually have right unilateral lesions and demonstrate a rightward bias during midline judgment. Accordingly, brain imaging (Fink et al., 2000) and TMS (Fierro et al., 2000) studies have revealed a specialized and lateralized network involving the right inferior parietal lobule (IPL) and left cerebellum when performing the perceptual line bisection task. The right IPL (IPL is used here to distinguish it from SPL) and comprises a large functional region in the right hemisphere including also the superior temporal gyrus and the temporo-parietal junction) is also specifically involved in processes such as sustaining and reorienting attention to spatial locations across the entire visual field, useful in visual search tasks (Ashbridge et al., 1997; Corbetta et al., 2000, 2005; Ellison et al., 2004; Mannan et al., 2005; Shulman et al., 2007;

ISBN: 978-0-12-821377-3; PII: B978-0-12-821377-3.00011-8; Author: L. Pisella et al.; 00011

To protect the rights of the author(s) and publisher we inform you that this PDF is an uncorrected proof for internal business use only by the author(s), editor(s), reviewer(s), Elsevier and typesetter SPI. It is not allowed to publish this proof online or in print. This proof copy is the copyright property of the publisher and is confidential until formal publication.

These proofs may contain colour figures. Those figures may print black and white in the final printed book if a colour print product has not been planned. The colour figures will appear in colour in all electronic versions of this book.

BÁLINT SYNDROME

15

Muggleton et al., 2008; Malhotra et al., 2009). Since by definition patients with neglect: (1) have a deficit of attention for contralesional space and (2) are impaired in visual scanning tasks of line bisection and cancellation, then the syndrome can be interpreted as a combination of left visual extinction (produced by damage of the right SPL) and visual synthesis deficits in the entire visual field caused by damage to the right IPL (Pisella and Mattingley, 2004).

p0175 One may further speculate that bilateral lesions of the SPL in humans may cause Bálint's symmetrical shrinkage of attention, "Seelenlähmung des Schauens," later called "simultanagnosia" (Wolpert, 1924; Luria, 1959), in which the patient reports only one object among two or more in a symmetrical manner, i.e., not systematically the right or the left one. Accordingly, the symptoms of simultanagnosia may simply appear as a nonspatial extinction restricting visual perception to seeing only one object a time, even though another overlapping object may occupy the same location in space (Luria, 1959; Humphreys et al., 1994; Husain, 2008), i.e., bilateral visual extinction without more severe spatial

disorganization. This might explain the differential severity observed between patients with bilateral SPL lesions following stroke, in which they exhibit bilateral optic ataxia and subclinical simultanagnosia manifest as a shrinking of visual attention (e.g., patient AT: Michel and Henaff, 2004; patient IG, Khan et al., 2016). In severe posterior cortical atrophy, simultanagnosia might be worsened by damage extending into the right IPL, thereby affecting the maps in which the whole of extra-personal space is represented and on which the remapping mechanisms may specifically operate in order to integrate visual information collected via multiple snapshots into a visual gestalt.

To sum up the model (Fig. 15.12), at this stage, damage to the left and/or right SPL-IPS network impairs covert attention to the contralesional hemifield, hence affecting spatial resolution, with consequences for movement accuracy and perceptual identification. Damage to the right IPL-STG network leads to mislocalizations of another nature, allocentric, across time and saccades (visual synthesis).

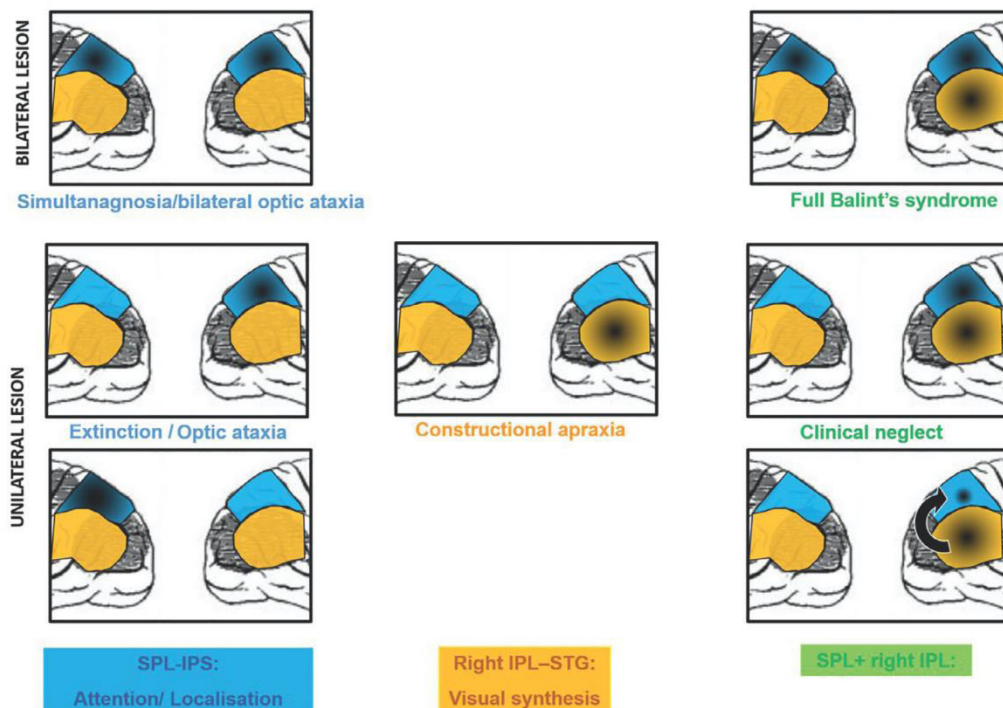

f0065 **Fig. 15.12.** Anatomico-functional model of the PPC organization. The SPL-IPS network (blue) is symmetrically involved in covert attention and localization in the contralateral hemifield. The IPL-STG network (yellow) is involved in the right hemisphere in visual synthesis (spatial working memory and visual remapping). A shadow represents a lesion. A black dot represents a functional hypoactivation (a virtual lesion, Corbetta et al., 2005). The upper part of the model concerns the effect of bilateral lesions, while the upper part displays the effect of unilateral lesions.

ISBN: 978-0-12-821377-3; PII: B978-0-12-821377-3.00011-8; Author: L. Pisella et al.; 00011

To protect the rights of the author(s) and publisher we inform you that this PDF is an uncorrected proof for internal business use only by the author(s), editor(s), reviewer(s), Elsevier and typesetter SPI. It is not allowed to publish this proof online or in print. This proof copy is the copyright property of the publisher and is confidential until formal publication.

These proofs may contain colour figures. Those figures may print black and white in the final printed book if a colour print product has not been planned. The colour figures will appear in colour in all electronic versions of this book.

16

L. PISELLA ET AL.

p0185 The observation of a young patient with an extremely focal lesion of the right inferior parietal lobule (IPL) caused by a steel nut penetrating his brain during an explosion (case 1 in Paterson and Zangwill, 1944) provides one additional important piece of information about the anatomico-functional organization of the right PPC. The right IPL (supramarginal and angular gyri) is the region the most commonly associated with clinical neglect (Vallar and Perani, 1986; Mort et al., 2003). The patient of Paterson and Zangwill (1944) exhibited left-sided extinction and “a complex disorder affecting perception, appreciation and reproduction of spatial relationships in the central visual field of vision” (Paterson and Zangwill, 1944, p. 337). This “piecemeal approach” was associated to a lack of “any real grasp of the object as a whole” (p. 342) that “could be defined as a fragmentation of the visual contents with deficient synthesis” (p. 356). This defect of visual synthesis in central vision was qualitatively similar to the consequences of bilateral lesions of the PPC that cause simultanagnosia. It is striking that the behavioral impact of this focal, restricted unilateral lesion was almost equivalent to a full Bálint’s syndrome with ipsilesional biases, an extreme restriction of attention and a deficit of establishing spatial relationships and integration of visual snapshots as a whole (that has been related to spatial working memory or visual remapping impairments in the whole visual field: Husain et al., 2001; Driver and Husain, 2002; Pisella et al., 2004; Pisella and Mattingley, 2004). In accordance with this neuropsychological observation of Paterson and Zangwill (1944), Corbetta et al. (2005) developed a model based on the notion that right inferior parietal–frontal network is activated by unpredicted visual events throughout the whole visual field and that superior parietal–frontal eye field network of attention influences the top-down stimulus–response selection in the contralesional visual space. In their model, the lesion of the right inferior parietal–frontal network, via a “circuit-breaking signal,” decreases activity in the ipsilateral superior parietal–frontal eye field network and consequently biases the activity in the occipital visual cortex toward the ipsilesional visual field. In other words, this model predicts that the lesion of the right IPL would indirectly decrease functional activity in the right SPL and thereby causing rightward attentional bias (arrow from the right IPL to the right SPL on the model of Fig. 15.12).

p0190 According to previous results (Khan et al., 2009; Blangero et al., 2010b), visual extinction tests using letter identification (multiple elements) may be sensitive enough to uncover an ipsilesional attentional bias (which is the lateralized component of neglect) in patients with unilateral SPL-IPS dysfunction caused directly by a lesion of the SPL or indirectly by a lesion of the right IPL inducing an imbalance between the right and the left

SPL (Corbetta et al., 2005). It seems that prism adaptation, and most other treatments of neglect (Rode et al., 2006; Rossetti et al., 2015), improves the lateralized component common to neglect and extinction patients, probably by acting on this imbalance (Luauté et al., 2006; Pisella et al., 2006b; Martin-Arévalo et al., 2016, 2018). An attentional orienting bias caused by parietal imbalance would also explain the paradoxical improvement of neglect (following right-hemisphere damage) by subsequent damage of the left hemisphere (Sprague effect, see Weddell, 2004 for a recent reference). The other (nonlateralized) components of neglect rely on the right IPL and its general function of visuospatial synthesis and might be more resistant to treatments (see Rode et al., 2006; Schindler et al., 2009).

HEMINEGLECT: INCLUDED OR NOT INCLUDED IN THE SYNDROME?

s0040

Given the rightward attentional bias included in the initial description of Bálint’s (1909) patient but the exclusion of this lateralized aspect in many recent definitions of the syndrome (e.g., Kirshner and Lavin, 2006; Denburg and Tranel, 2009; Kaufman et al., 2017), should we consider that hemineglect falls within Bálint’s syndrome or not?

p0195

In terms of eye movements, patients with classical unilateral neglect have also been reported to exhibit late and hypometric leftward saccades (e.g., Girotti et al., 1983; Walker and Findlay, 1996), while their saccadic accuracy is reported normal elsewhere (Behrmann et al., 1997). Niemeier and Karnath (2000) have shown that hypometry can be observed only for reflexive saccades triggered in response to left (affected side) peripheral target presentation and that self-generated leftward and rightward saccades are equivalent in amplitude in a condition of free ocular exploration of visual scenes. By contrast, the strategy of exploration is clearly impaired in patients with unilateral neglect (e.g., Ishiai, 2002). Altogether, no available data seems to rule out that these saccadic deficits in neglect patients result from a deficient allocation of attention to visual targets in the left periphery.

p0200

At the anatomical level, there is no clear consensus about the causative location for spatial neglect (e.g., Vallar and Perani, 1986; Karnath et al., 2001; Mort et al., 2003; Karnath and Rorden, 2012; Lunven and Bartolomeo, 2017). Lesions of the SPL-IPS network produce a visual saliency deficit for stimuli in the contralesional visual field that can be either symmetrical or asymmetrical. In the symmetrical case, bilateral lesions induce a concentric reduction of the attentional field and in the asymmetrical case bilateral or unilateral lesions produce an attentional bias lateralized in space (Fig. 15.12). The rightward bias of attention is therefore not the one component of unilateral neglect that can be

p0205

ISBN: 978-0-12-821377-3; PII: B978-0-12-821377-3.00011-8; Author: L. Pisella et al.; 00011

To protect the rights of the author(s) and publisher we inform you that this PDF is an uncorrected proof for internal business use only by the author(s), editor(s), reviewer(s), Elsevier and typesetter SPI. It is not allowed to publish this proof online or in print. This proof copy is the copyright property of the publisher and is confidential until formal publication.

BÁLINT SYNDROME

17

differentiated from Bálint's syndrome. Rather the non-attentional symptoms, nonlateralized in space, such as "revisiting behavior," described in patients with unilateral neglect who repeatedly visit items in an array (Husain et al., 2001; Wojciulik et al., 2001). Revisiting ocular behavior has therefore been ascribed to an impairment of short-term memory for spatial location of items already explored (Driver and Husain, 2002) or a visual remapping impairment leading to mislocalizations and/or lack of visual consciousness (Pisella and Mattingley, 2004), associated with right-sided damage to the IPL-STG network (Pisella et al., 2004, review in Pisella et al., 2011). As mentioned previously, visual neglect is often excluded from the triad of Bálint's syndrome and separately attributed to damage to the inferior parietal lobule or superior temporal gyrus. This parietal component, nonlateralized in space (see Pisella et al., 2004), appears a crucial one to observe clinical symptoms of hemineglect in everyday life (eating, dressing, cooking, reading, etc.). However, it is not specific to spatial neglect, since it can also worsen simultanagnosia (Pisella et al., 2015) by preventing patients with a reduced attentional field from guiding their ocular exploration of space in a coherent manner when tasked with visual search (as in Fig. 15.8B, contrasting with Fig. 15.8A). Such patients appear to lack memory of the locations that they have already applied, the gaze/attention to (spatial working memory), and also the spatio-temporal integration of the various visual snapshots collected (visual remapping); they fail to explore space efficiently and to apprehend the environment around them. Patients with severe neglect or severe simultanagnosia may have in common not only the exploration of space in a serial fashion (because of a truncated attentional field) but also have to focus several times on the same object because they are lost in space. This spatial disorganization (due to impaired spatial working memory or visual remapping) worsens the functional consequences of their (concentric or contralesional, respectively) attentional restriction. Such "revisiting behavior" has been observed in patients with bilateral posterior cortical atrophy, leading them, for example, to count more dots than presented, while others (not exhibiting any revisiting behavior) tend to count fewer dots than presented (Pisella et al., 2015).

p0210 Russell et al. (2010) have proposed that the clinical condition of pure spatial disorganization is "constructional apraxia," revealed by disorganized reproductions of complex figures in 2D (drawing tests) or 3D (blocks tests). This label is rarely mentioned in the context of Bálint's syndrome (see however Michel and Henaff's (2004) clinical description of patient AT), but it appears logically related to the piecemeal approach and the disturbance of visual orientation often described in these

patients. Constructional apraxia patients were identified by Russell et al. (2010) as patients with right hemisphere stroke whose unilateral neglect symptoms have resolved but who have an inability to accurately copy drawings or three-dimensional constructions. Russell et al. (2010) demonstrated that these patients have recovered spontaneously from the first component of unilateral neglect (attentional bias) but the second component (spatial disorganization) persists as an impairment of spatial memory across saccades. There is converging evidence that the anatomical substrate of spatial disorganization corresponds to the right inferior parietal lobule. This region of the right hemisphere is crucial for complex visuospatial tasks involving a "visual synthesis" of detailed snapshots (Malhotra et al., 2009), such as the "landmark" tests that require the space between two objects to be mentally represented in order to judge whether a landmark object is closer to the right or to the left object (Ungerleider and Mishkin, 1982; Bisiach et al., 1998; Fierro et al., 2000; Fink et al., 2000). Neglect patients with right IPL damage (Vallar and Perani, 1986; Mort et al., 2003) exhibit deficits of "visual synthesis" (visual space exploration and integration) that are not restricted to the contralesional hemifield (Husain et al., 2001; Wojciulik et al., 2001; Husain and Rorden, 2003; Pisella et al., 2004; Kennard et al., 2005; Husain, 2008). Indeed, the right IPL is conceived to be able to remap—and establish relationships between—locations throughout the whole visual field. Pisella and Mattingley (2004) have postulated that the human IPL may contain a whole-space map where oculocentric remapping processes operate, thereby allowing coherent "visual synthesis." Human studies have implicated the right parietal lobe in visual remapping (Heide et al., 1995; Heide and Kömpf, 1998; Heide et al., 2001; Medendorp et al., 2003; Kennard et al., 2005; Mannan et al., 2005; Morris et al., 2007; Malhotra et al., 2009; Van Koningsbruggen et al., 2010; Pisella et al., 2011). The lateralized remapping impairments reported in patients with visual neglect or after TMS applied to the right parietal cortex (review in Pisella et al., 2011) may result from the combination of the right IPL's specialization for space and the ipsilesional bias of attention, which additionally may alter the representation of contralesional visual stimuli. In contrast, remapping impairments may be expressed as a deficiency of visual synthesis and revisiting behavior without lateralized spatial bias in constructional apraxia (Russell et al., 2010) or in patients with severe simultanagnosia (Pisella et al., 2015).

In sum, the attentional and nonattentional components of visual neglect correspond to the two components of Bálint's syndrome resumed in Fig. 15.12 and attributed to the SPL-IPS network and the right IPL-STG network, respectively. p0215

ISBN: 978-0-12-821377-3; PII: B978-0-12-821377-3.00011-8; Author: L. Pisella et al.; 00011

These proofs may contain colour figures. Those figures may print black and white in the final printed book if a colour print product has not been planned. The colour figures will appear in colour in all electronic versions of this book.

18

L. PISELLA ET AL.

s0045 **CLINICAL TESTING FOR THE KEY SYMPTOMS OF BÁLINT SYNDROME**

s0050 **Optic ataxia**

p0220 In addition to checking the exclusion criteria (primary sensory and motor deficits), the clinical procedure to examine patients in search for optic ataxia typically requires two examiners (Perenin and Vighetto, 1988). The first examiner should stand behind the patient and present objects laterally 10 times for each hand in each half-field. The second one sits in front of the patient and checks ocular fixation. The patient is simply requested to reach-to-grasp the objects under central fixation (of the nose of the second examiner) and then for comparison under object fixation conditions. The examiners pay attention to reaching and grasping errors in the form of misdirecting the hand, oddly orienting the wrist or inappropriately opening the finger grip. Using this procedure, various weighting of field and hand effects can be described in each individual patient, although the most typical pattern is that patients perform worse with their contralateral hand in their contralateral hemifield.

p0225 If the examiner is alone, a camera can be used to check the eyes. Alternatively, the examiner can stand in front of the patient and ask to close the eyes while positioning the object. Then, the patient is requested to reach-to-grasp the object as soon as the eyes are open.

s0055 **Simultanagnosia**

p0230 The dot counting task is a good way to test simultanagnosia and the presence of absence of revisiting behavior. A computerized version would present a small number of dots (2, 3, or 4) in random positions either briefly (200 ms) or in unlimited duration. Simultanagnosia is characterized by an underestimation of the number of dots in the condition of brief presentation. Revisiting behavior (spatial working memory deficit) is present when the patient tends to overestimate the number of dots in the condition of unlimited presentation.

p0235 When available, eye recording can provide additional information about revisiting and also about possible left or right attentional bias (asymmetrical/unilateral neglect).

s0060 **Ocular apraxia**

p0240 Ocular apraxia is an attentional trouble affecting visually guided saccades toward the contralateral visual field, while voluntary saccades are preserved. The clinical diagnosis consists in contrasting these two types of saccades, e.g., using left or right finger cueing, for example, to trigger visually guided saccades to be compared to verbal “left” or “right” cueing. Showing simple pop-out visual displays to the patient and recording search time

(and ocular tracking if possible) is another good way to evidence a trouble of visually guided saccades.

CONCLUSION

We have argued that the full clinical picture of Bálint’s syndrome (simultanagnosia, neglect, and optic ataxia) can be accounted for by an impaired ability to accurately represent simultaneous localizations following asymmetrical, bilateral SPL-IPS damage. We have observed that the lateralized attentional bias (neglect) depends on the asymmetry of the bilateral lesions and tends to recover spontaneously leaving the patient with only two of the initial symptom triad.

If the right parietal damage also includes the IPL, additional representational mislocalizations across time and saccades (spatial working memory and visual remapping impairments) increase the severity of the triad and probably reduce the ability to recover or compensate for them.

When only the right IPL is damaged, a syndrome of clinical neglect comprising both spatial disorganization and left visual extinction is observed in the acute phase (as in Patterson & Zangwill’s Paterson and Zangwill, 1944 patient). The attentional bias is due to the temporary “virtual lesion” of the right SPL-IPS (Corbetta et al., 2005) and recovers to leave the patient with chronic constructional apraxia (Russell et al., 2010).

REFERENCES

- Andersen RA, Buneo CA (2002). Intentional maps in posterior parietal cortex. *Annu Rev Neurosci* 25: 189–220.
- Ashbridge E, Walsh V, Cowey A (1997). Temporal aspects of visual search studied by transcranial magnetic stimulation. *Neuropsychologia* 35: 1121–1131.
- Balas B, Nakano L, Rosenholtz R (2009). A summary-statistic representation in peripheral vision explains visual crowding. *J Vis* 9: 13.
- Bálint R (1909). Seelenlähmung des “Schauens”: Optische Ataxie, räumliche Störung der Aufmerksamkeit. *Monatszeitschrift Psychiatrie Neurol* 25: 51–181.
- Bartolo A, Rossetti Y, Revol P et al. (2017). Reachability judgement in optic ataxia: effect of peripheral vision on hand and target perception in depth. *Cortex* 98: 102–113.
- Battaglia-Mayer A, Caminiti R (2002). Optic ataxia as a result of the breakdown of the global tuning fields of parietal neurons. *Brain* 125: 225–237.
- Behrmann M, Watt S, Black SE et al. (1997). Impaired visual search in patients with unilateral neglect: an oculographic analysis. *Neuropsychologia* 35: 1445–1458.
- Beurze SM, Toni I, Pisella L et al. (2010). Reference frames for reach planning in human parietofrontal cortex. *J Neurophysiol* 104: 1736–1745.
- Binkofski F, Dohle C, Posse S et al. (1998). Human anterior intraparietal area subserves prehension: a combined lesion and functional MRI activation study. *Neurology* 50: 1253–1259.

ISBN: 978-0-12-821377-3; PII: B978-0-12-821377-3.00011-8; Author: L. Pisella et al.; 00011

To protect the rights of the author(s) and publisher we inform you that this PDF is an uncorrected proof for internal business use only by the author(s), editor(s), reviewer(s), Elsevier and typesetter SPI. It is not allowed to publish this proof online or in print. This proof copy is the copyright property of the publisher and is confidential until formal publication.

These proofs may contain colour figures. Those figures may print black and white in the final printed book if a colour print product has not been planned. The colour figures will appear in colour in all electronic versions of this book.

BÁLINT SYNDROME

19

- Binkofski F, Buccino G, Dohle C et al. (1999). Mirror agnosia and mirror ataxia constitute different parietal lobe disorders. *Ann Neurol* 46: 51–61.
- Bisiach E, Ricci R, Lualdi M et al. (1998). Perceptual and response bias in unilateral neglect: two modified versions of the Milner landmark task. *Brain Cogn* 37: 369–386.
- Blangero A, Ota H, Delporte L et al. (2007). Optic ataxia is not only 'optic': impaired spatial integration of proprioceptive information. *Neuroimage* 36: 61–68.
- Blangero A, Gaveau V, Luauté J et al. (2008). A hand and a field effect in on-line motor control in unilateral optic ataxia. *Cortex* 44: 560–568.
- Blangero A, Menz MM, McNamara A et al. (2009). Parietal modules for reaching. *Neuropsychologia* 47: 1500–1507.
- Blangero A, Ota H, Rossetti Y et al. (2010a). Systematic retinotopic reaching error vectors in unilateral optic ataxia. *Cortex* 46: 77–93.
- Blangero A, Khan AZ, Salemme R et al. (2010b). Pre-saccadic perceptual facilitation can occur without covert orienting of attention. *Cortex* 46: 1132–1137.
- Brain WR (1941). A form of visual disorientation resulting from lesions of the right cerebral hemisphere: (Section of Neurology). *Proc R Soc Med* 34: 771–776.
- Buxbaum L, Laurel J, Randerath J (2018). Limb apraxia and the left parietal lobe. In: G Vallar, HB Coslett (Eds.), *The parietal lobe. Handbook of clinical neurology*. Elsevier, Amsterdam, pp. 349–363.
- Carey DP, Coleman RJ, Della Sala S (1997). Magnetic misreaching. *Cortex* 33: 639–652.
- Carrasco M, Penpeci-Talgar C, Eckstein M (2000). Spatial covert attention increases contrast sensitivity across the CSF: support for signal enhancement. *Vision Res* 40: 1203–1215.
- Castaigne P, Pertuiset B, Rondot P et al. (1971). Ataxie optique dans les deux hémichamps visuels homonymes gauches après exérèse chirurgicale d'un anévrisme artériel de la paroi du ventricule latéral [Optic ataxia in the two left homonymous visual half-fields after surgical removal of an arterial aneurysm of the wall of the lateral ventricle]. *Rev Neurol (Paris)* 124: 261–268.
- Castaigne P, Rondot P, Dumas JL et al. (1975). Ataxie optique localisée au coté gauche dans les deux hémichamps visuels homonymes gauches [Optic ataxia localised in the left side of both 2 left homonymous visual hemifields]. *Rev Neurol (Paris)* 131: 23–28.
- Coello Y, Danckert J, Blangero A et al. (2007). Do visual illusions probe the visual brain? Illusions in action without a dorsal visual stream. *Neuropsychologia* 45: 1849–1858.
- Cogan DG, Adams RD (1953). A type of paralysis of conjugate Gaze (ocular motor apraxia). *AMA Arch Ophthalmol* 50: 434–442.
- Colby CL, Goldberg ME (1999). Space and attention in parietal cortex. *Annu Rev Neurosci* 22: 319–349.
- Corbetta M, Kincade JM, Ollinger JM et al. (2000). Voluntary orienting is dissociated from target detection in human posterior parietal cortex. *Nat Neurosci* 3: 292–297.
- Corbetta M, Kincade MJ, Lewis C et al. (2005). Neural basis and recovery of spatial attention deficits in spatial neglect. *Nat Neurosci* 8: 1603–1610.
- De Renzi E, Gentilini M, Faglioni P et al. (1989). Attentional shift towards the rightmost stimuli in patients with left visual neglect. *Cortex* 25: 231–237.
- Denburg NL, Tranel D (2009). Bálint syndrome. In: *Encyclopedia of neuroscience*, 37–39.
- Dijkerman HC, McIntosh RD, Anema HA et al. (2006). Reaching errors in optic ataxia are linked to eye position rather than head or body position. *Neuropsychologia* 44: 2766–2773.
- Driver J, Husain M (2002). The role of spatial working memory deficits in pathological search by neglect patients. In: HO Karnath, AD Milner, G Vallar (Eds.), *The cognitive and neural bases of spatial neglect*. Oxford University Press, Oxford, UK, pp. 351–364.
- Ellison A, Schindler I, Pattison LL (2004). An exploration of the role of the superior temporal gyrus in visual search and spatial perception using TMS. *Brain* 127: 2307–2315.
- Ettlinger G (1990). "Object vision" and "spatial vision": the neuropsychological evidence for the distinction. *Cortex* 26: 319–341.
- Fierro B, Brighina F, Oliveri M et al. (2000). Contralateral neglect induced by right posterior parietal rTMS in healthy subjects. *Neuroreport* 11: 1519–1521.
- Fink GR, Marshall JC, Shah NJ et al. (2000). Line bisection judgments implicate right parietal cortex and cerebellum as assessed by fMRI. *Neurology* 54: 1324–1331.
- Garcin R, Rondot P, de Recondo J (1967). Ataxie optique localisée aux deux hémichamps visuels homonymes gauches (étude clinique avec présentation d'un film) [Optic ataxia localized in 2 left homonymous visual hemifields (clinical study with film presentation)]. *Rev Neurol (Paris)* 116: 707–714.
- Gaveau V, Pélisson D, Blangero A et al. (2008). Saccade control and eye-hand coordination in optic ataxia. *Neuropsychologia* 46: 475–486.
- Girotti F, Milanese C, Casazza M et al. (1982). Oculomotor disturbances in Bálint's syndrome: anatomoclinical findings and electrooculographic analysis in a case. *Cortex* 18: 603–614.
- Girotti F, Casazza M, Musicco M et al. (1983). Oculomotor disorders in cortical lesions in man: the role of unilateral neglect. *Neuropsychologia* 21: 543–553.
- Goodale MA, Milner AD (1992). Separate visual pathways for perception and action. *Trends Neurosci* 15: 20–25.
- Grank JA, Pisella L, Blangero A et al. (2012). The role of the caudal superior parietal lobule in updating hand location in peripheral vision: further evidence from optic ataxia. *PLoS One* 7: e46619.
- Grank JA, Pisella L, Stemberger J et al. (2013). Decoupled visually-guided reaching in optic ataxia: differences in motor control between canonical and non-canonical orientations in space. *PLoS One* 8: e86138.
- Gréa H, Pisella L, Rossetti Y et al. (2002). A lesion of the posterior parietal cortex disrupts on-line adjustments during aiming movements. *Neuropsychologia* 40: 2471–2480.
- Guard O, Perenin MT, Vighetto A et al. (1984). Syndrome pariétal bilatéral proche d'un syndrome de Bálint [Bilateral parietal syndrome approximating a Bálint syndrome]. *Rev Neurol (Paris)* 140: 358–367.

ISBN: 978-0-12-821377-3; PII: B978-0-12-821377-3.00011-8; Author: L. Pisella et al.; 00011

To protect the rights of the author(s) and publisher we inform you that this PDF is an uncorrected proof for internal business use only by the author(s), editor(s), reviewer(s), Elsevier and typesetter SPI. It is not allowed to publish this proof online or in print. This proof copy is the copyright property of the publisher and is confidential until formal publication.

These proofs may contain colour figures. Those figures may print black and white in the final printed book if a colour print product has not been planned. The colour figures will appear in colour in all electronic versions of this book.

- Head H, Holmes G (1911). Sensory disturbances from cerebral lesions. *Brain* 34: 102–254.
- Hecaen H, De Ajuriaguerra J (1954). Bálint's syndrome (psychic paralysis of visual fixation) and its minor forms. *Brain* 77: 373–400.
- Heide W, Kömpf D (1998). Combined deficits of saccades and visuo-spatial orientation after cortical lesions. *Exp Brain Res* 123: 164–171.
- Heide W, Blankenburg M, Zimmermann E et al. (1995). Cortical control of double-step saccades: implications for spatial orientation. *Ann Neurol* 38: 739–748.
- Heide W, Binkofski F, Seitz RJ et al. (2001). Activation of frontoparietal cortices during memorized triple-step sequences of saccadic eye movements: an fMRI study. *Eur J Neurosci* 13: 1177–1189.
- Hilgetag CC, Théoret H, Pascual-Leone A (1994). Enhanced visual spatial attention ipsilateral to rTMS-induced 'virtual lesions' of human parietal cortex. *Nat Neurosci* 4: 953–957.
- Holmes G (1918). Disturbances of visual orientation. *Br J Ophthalmol* 2: 449–468.
- Holmes G, Horrax G (1919). Disturbances of spatial orientation and visual attention with loss of stereoscopic vision. *Arch Neurol Psychiatry* 1: 385–407.
- Humphreys GW, Romani C, Olson A et al. (1994). Non-spatial extinction following lesions of the parietal lobe in humans. *Nature* 372: 357–359.
- Husain M (2008). Hemispatial neglect. *Handb Clin Neurol* 88: 359–372.
- Husain M, Rorden C (2003). Non-spatially lateralized mechanisms in hemispatial neglect. *Nat Rev Neurosci* 4: 26–36.
- Husain M, Stein J (1988). Rezső Bálint and his most celebrated case. *Arch Neurol* 45: 89–93.
- Husain M, Mannan S, Hodgson T et al. (2001). Impaired spatial working memory across saccades contributes to abnormal search in parietal neglect. *Brain* 124: 941–952.
- Ishiai S (2002). Perceptual and motor interaction in unilateral spatial neglect. The cognitive and neural bases of spatial neglect, Oxford University Press, Oxford, pp. 181–193.
- Jackson SR, Newport R, Mort D et al. (2005). Where the eye looks, the hand follows; limb-dependent magnetic misreaching in optic ataxia. *Curr Biol* 15: 42–46.
- Jackson SR, Condon LA, Newport RW et al. (2018). Optic ataxia and the dorsal visual stream re-visited: impairment in bimanual haptic matching performed without vision. *Cortex* 98: 60–72.
- Jeannerod M (1994). The hand and the object: the role of posterior parietal cortex in forming motor representations. *Can J Physiol Pharmacol* 72: 535–541.
- Jeannerod M (1986). Mechanisms of visuomotor coordination: a study in normal and brain-damaged subjects. *Neuropsychologia* 24: 41–78.
- Jeannerod M, Rossetti Y (1993). Visuomotor coordination as a dissociable visual function: experimental and clinical evidence. *Baillieres Clin Neurol* 2: 439–460.
- Karnath HO, Rorden C (2012). The anatomy of spatial neglect. *Neuropsychologia* 50: 1010–1017.
- Karnath HO, Ferber S, Himmelbach M (2001). Spatial awareness is a function of the temporal not the posterior parietal lobe. *Nature* 411: 950–953.
- Kaufman DM, Geyer HL, Milstein MJ (2017). Chapter 12: visual disturbances. *Kaufman's clinical neurology for psychiatrists*, eighth edn. 257–280.
- Kennard C, Mannan SK, Nachev P et al. (2005). Cognitive processes in saccade generation. *Ann N Y Acad Sci* 1039: 176–183.
- Khan AZ, Pisella L, Rossetti Y et al. (2005). Impairment of gaze-centered updating of reach targets in bilateral parietal-occipital damaged patients. *Cereb Cortex* 15: 1547–1560.
- Khan AZ, Crawford JD, Blohm G et al. (2007). Influence of initial hand and target position on reach errors in optic ataxic and normal subjects. *J Vis* 7: 8.1-16.
- Khan AZ, Blangero A, Rossetti Y et al. (2009). Parietal damage dissociates saccade planning from presaccadic perceptual facilitation. *Cereb Cortex* 19: 383–387.
- Khan AZ, Prost-Lefebvre M, Salemm R et al. (2016). The attentional fields of visual search in simultanagnosia and healthy individuals: how object and space attention interact. *Cereb Cortex* 26: 1242–1254.
- Kirshner HS, Lavin PJM (2006). Posterior cortical atrophy: a brief review. *Curr Neurol Neurosci Rep* 6: 477–480.
- Li CS, Mazzoni P, Andersen RA (1999). Effect of reversible inactivation of macaque lateral intraparietal area on visual and memory saccades. *J Neurophysiol* 81: 1827–1838.
- Luauté J, Michel C, Rode G et al. (2006). Functional anatomy of the therapeutic effects of prism adaptation on left neglect. *Neurology* 66: 1859–1867.
- Lunven M, Bartolomeo P (2017). Attention and spatial cognition: neural and anatomical substrates of visual neglect. *Ann Phys Rehabil Med* 60: 124–129.
- Luria AR (1959). Disorders of "Simultaneous Perception" in a case of bilateral occipito-parietal brain injury. *Brain* 82: 437–449.
- Mäki-Marttunen V, Villarreal M, Leiguarda RC (2014). Lateralization of brain activity during motor planning of proximal and distal gestures. *Behav Brain Res* 272: 226–237.
- Malhotra P, Coulthard EJ, Husain M (2009). Role of right posterior parietal cortex in maintaining attention to spatial locations over time. *Brain* 132: 645–660.
- Mannan SK, Mort DJ, Hodgson TL et al. (2005). Revisiting previously searched locations in visual neglect: role of right parietal and frontal lesions in misjudging old locations as new [published correction appears in *J Cogn Neurosci* 17 (10): table of contents]. *J Cogn Neurosci* 17: 340–354.
- Martín-Arévalo E, Laube I, Koun E et al. (2016). Prism adaptation alters electrophysiological markers of attentional processes in the healthy brain. *J Neurosci* 36: 1019–1030.
- Martín-Arévalo E, Schintu S, Farnè A et al. (2018). Adaptation to leftward shifting prisms alters motor interhemispheric inhibition. *Cereb Cortex* 28: 528–537.
- McIntosh RD, Mulroue A, Blangero A et al. (2011). Correlated deficits of perception and action in optic ataxia. *Neuropsychologia* 49: 131–137.

ISBN: 978-0-12-821377-3; PII: B978-0-12-821377-3.00011-8; Author: L. Pisella et al.; 00011

To protect the rights of the author(s) and publisher we inform you that this PDF is an uncorrected proof for internal business use only by the author(s), editor(s), reviewer(s), Elsevier and typesetter SPI. It is not allowed to publish this proof online or in print. This proof copy is the copyright property of the publisher and is confidential until formal publication.

These proofs may contain colour figures. Those figures may print black and white in the final printed book if a colour print product has not been planned. The colour figures will appear in colour in all electronic versions of this book.

BÁLINT SYNDROME

21

- Medendorp WP, Goltz HC, Vilis T et al. (2003). Gaze-centered updating of visual space in human parietal cortex. *J Neurosci* 23: 6209–6214.
- Medina J, Jax SA, Coslett HB (2019). Impairments in action and perception after right intraparietal damage. *Cortex* 122: 288–299.
- Michel F, Henaff MA (2004). Seeing without the occipitoparietal cortex: simultagnosia as a shrinkage of the attentional visual field. *Behav Neurol* 15: 3–13.
- Michel F, Jeannerod M, Devic M (1963). A case of visual orientation disorder in the 3 dimensions of space (apropos of Bálint's syndrome and the syndrome described by G. Holmes). *Rev Neurol* 108: 983–984.
- Milner AD, Goodale MA (1995). *The visual brain in action*, Oxford University Press, Oxford.
- Milner AD, Goodale MA (2006). *The visual brain in action*, second edn. Oxford University Press, Oxford.
- Milner AD, Paulignan Y, Dijkerman HC et al. (1999). A paradoxical improvement of misreaching in optic ataxia: new evidence for two separate neural systems for visual localization. *Proc Biol Sci* 266: 2225–2229.
- Morris AP, Chambers CD, Mattingley JB (2007). Parietal stimulation destabilizes spatial updating across saccadic eye movements. *Proc Natl Acad Sci U S A* 104: 9069–9074.
- Mort DJ, Malhotra P, Mannan SK et al. (2003). The anatomy of visual neglect. *Brain* 126: 1986–1997.
- Muggleton NG, Cowey A, Walsh V (2008). The role of the angular gyrus in visual conjunction search investigated using signal detection analysis and transcranial magnetic stimulation. *Neuropsychologia* 46: 2198–2202.
- Niemeier M, Karnath HO (2000). Exploratory saccades show no direction-specific deficit in neglect. *Neurology* 54: 515–518.
- Osiurak F, Aubin G, Allain P et al. (2008). Different constraints on grip selection in brain-damaged patients: object use versus object transport. *Neuropsychologia* 46: 2431–2434.
- Pascual-Leone A, Gomez-Tortosa E, Grafman J et al. (1994). Induction of visual extinction by rapid-rate transcranial magnetic stimulation of parietal lobe. *Neurology* 44: 494–498.
- Paterson A, Zangwill OL (1944). Disorders of visual space perception associated with lesions of the right cerebral hemisphere. *Brain* 67: 331–358.
- Pelli DG, Tillman KA (2008, October). The uncrowded window of object recognition. *Nat Neurosci* 11: 1129–1135.
- Perenin MT, Vighetto A (1988). Optic ataxia: a specific disruption in visuomotor mechanisms. I. Different aspects of the deficit in reaching for objects. *Brain* 111: 643–674.
- Pisella L, Mattingley JB (2004). The contribution of spatial remapping impairments to unilateral visual neglect. *Neurosci Biobehav Rev* 28: 181–200.
- Pisella L, Gréa H, Tilikete C et al. (2000). An 'automatic pilot' for the hand in human posterior parietal cortex: toward reinterpreting optic ataxia. *Nat Neurosci* 3: 729–736.
- Pisella L, Berberovic N, Mattingley JB (2004). Impaired working memory for location but not for colour or shape in visual neglect: a comparison of parietal and non-parietal lesions. *Cortex* 40: 379–390.
- Pisella L, Binkofski F, Lasek K et al. (2006a). No double-dissociation between optic ataxia and visual agnosia: multiple sub-streams for multiple visuo-manual integrations. *Neuropsychologia* 44: 2734–2748.
- Pisella L, Rode G, Farnè A et al. (2006b). Prism adaptation in the rehabilitation of patients with visuo-spatial cognitive disorders. *Curr Opin Neurol* 19: 534–542.
- Pisella L, Striener C, Blangero A et al. (2007). Perceptual deficits in optic ataxia? In: *Book: sensorimotor foundations of higher cognition: attention and performance XXII*, Chapter: 3, Publisher, Oxford University Press, pp. 47–72.
- Pisella L, Sergio L, Blangero A et al. (2009). Optic ataxia and the function of the dorsal stream: contributions to perception and action [published correction appears in *Neuropsychologia*. 2010 48: 2786]. *Neuropsychologia* 47: 3033–3044.
- Pisella L, Alahyane N, Blangero A et al. (2011). Right-hemispheric dominance for visual remapping in humans. *Philos Trans R Soc Lond B Biol Sci* 366: 572–585.
- Pisella L, Blangero A, Tilikete C et al. (2013). Attentional disorders. In: K Ochsner, S Kosslyn (Eds.), *The Oxford handbook of cognitive neuroscience: volume 1: core topics*. Oxford University Press, Oxford, UK, pp. 319–350 (Chapter 16).
- Pisella L, Biotti D, Vighetto A (2015). Combination of attentional and spatial working memory deficits in Bálint-Holmes syndrome. *Ann N Y Acad Sci* 1339: 165–175.
- Posner MI (1980). Orienting of attention. *Q J Exp Psychol* 32: 3–25.
- Prablanc C, Echallier JE, Jeannerod M et al. (1979). Optimal response of eye and hand motor systems in pointing at a visual target. II. Static and dynamic visual cues in the control of hand movement. *Biol Cybern* 35: 183–187.
- Revol P, Rossetti Y, Vighetto A et al. (2003). Pointing errors in immediate and delayed conditions in unilateral optic ataxia. *Spat Vis* 16: 347–364.
- Riddoch G (1935). Visual disorientation in homonymous half fields. *Brain* 58: 376–382.
- Rizzo M (1993). Bálint's syndrome' and associated visuospatial disorders. *Baillieres Clin Neurol* 2: 415–437.
- Rizzo M, Vecera SP (2002). Psychoanatomical substrates of Bálint's syndrome. *J Neurol Neurosurg Psychiatry* 72: 162–178.
- Rode G, Klos T, Courtois-Jacquin S et al. (2006). Neglect and prism adaptation: a new therapeutic tool for spatial cognition disorders. *Restor Neurol Neurosci* 24: 347–356.
- Rondot P, De Recondo J, Dumas JL (1977). Visuomotor ataxia. *Brain* 100: 355–376.
- Rosenholtz R, Huang J, Raj A et al. (2012a). A summary statistical representation in peripheral vision explains visual search. *J Vis* 12: 14.
- Rosenholtz R, Huang J, Ehinger KA (2012b). Rethinking the role of top-down attention in vision: effects attributable to a Lossy representation in peripheral vision. *Front Psychol* 3: 13.
- Rossetti Y (1998). Implicit short-lived motor representations of space in brain damaged and healthy subjects. *Conscious Cogn* 7: 520–558.

ISBN: 978-0-12-821377-3; PII: B978-0-12-821377-3.00011-8; Author: L. Pisella et al.; 00011

To protect the rights of the author(s) and publisher we inform you that this PDF is an uncorrected proof for internal business use only by the author(s), editor(s), reviewer(s), Elsevier and typesetter SPI. It is not allowed to publish this proof online or in print. This proof copy is the copyright property of the publisher and is confidential until formal publication.

These proofs may contain colour figures. Those figures may print black and white in the final printed book if a colour print product has not been planned. The colour figures will appear in colour in all electronic versions of this book.

- Rossetti Y, Pisella L (2002). Several “vision for action” systems: a guide to dissociating and integrating dorsal and ventral functions (Tutorial). In: *Common mechanisms in perception and action attention and performance*, 110: 62–119.
- Rossetti Y, Pisella L (2018). Optic ataxia: beyond the dorsal stream cliché. In: *Handbook of clinical neurology*, vol. 151. 225–247.
- Rossetti Y, Pisella L, McIntosh RD (2017). Rise and fall of the two visual systems theory. *Ann Phys Rehabil Med* 60: 130–140.
- Rossetti Y, Pisella L, Vighetto A (2003). Optic ataxia revisited: visually guided action versus immediate visuomotor control. *Exp Brain Res* 153: 171–179.
- Rossetti Y, Revol P, McIntosh RD et al. (2005). Visually guided reaching: bilateral posterior parietal lesions cause a switch from fast visuomotor to slow cognitive control. *Neuropsychologia* 43: 162–177.
- Rossetti Y, Ota H, Blangero A et al. (2010). Why does the perception-action functional dichotomy not match the ventral-dorsal streams anatomical segregation: optic ataxia and the function of the dorsal stream. In: N Gangopadhyay, M Madary, F Spicer (Eds.), *Perception, action, and consciousness: sensorimotor dynamics and two visual systems*. Oxford University Press 163–181.
- Rossetti Y, Jacquin-Courtois S, Calabria M et al. (2015). Testing cognition and rehabilitation in unilateral neglect with wedge prism adaptation: multiple interplays between sensorimotor adaptation and spatial cognition. https://doi.org/10.1007/978-4-431-55037-2_20.
- Russell C, Deidda C, Malhotra P et al. (2010). A deficit of spatial remapping in constructional apraxia after right-hemisphere stroke. *Brain* 133: 1239–1251.
- Schindler I, McIntosh RD, Cassidy TP et al. (2009). The disengage deficit in hemispatial neglect is restricted to between-object shifts and is abolished by prism adaptation. *Exp Brain Res* 192: 499–510.
- Shulman GL, Astafiev SV, McAvoy MP et al. (2007). Right TPJ deactivation during visual search: functional significance and support for a filter hypothesis. *Cereb Cortex* 17: 2625–2633.
- Striener C, Blangero A, Rossetti Y et al. (2007). Deficits in peripheral visual attention in patients with optic ataxia. *Neuroreport* 18: 1171–1175.
- Striener C, Blangero A, Rossetti Y et al. (2009a). Bilateral parietal lesions disrupt the beneficial effects of prism adaptation: evidence from a patient with optic ataxia. *Exp Brain Res* 187: 295–302.
- Striener C, Locklin J, Blangero A et al. (2009b). Attention for action? Examining the link between attention and visuomotor control deficits in a patient with optic ataxia. *Neuropsychologia* 47: 1491–1499.
- Tyler HR (1968). Normal and abnormal patterns of visual search. *Trans Am Neurol Assoc* 93: 290–291.
- Tzavaras A, Hecaen H (1975). Relations of optic ataxia and unilateral ideomotor apraxia. *Exp Brain Res Suppl* 23: 202.
- Tzavaras A, Masure MC (1976). Aspects différents de l’ataxie optique selon la latéralisation hémisphérique lésionnelle. *Lyon Med* 236: 673–683.
- Tzavaras A, Ozonas G, Chodkiewicz JP (1974). Apraxie idéomotrice à prédominance unilatérale gauche avec ataxie optique lors d’une lésion pariétale gauche. In: *Les syndromes de Disconnexion Calleuse chez l’Homme*, 265–285.
- Ungerleider LG, Mishkin M (1982). Two cortical visual systems. In: DJ Ingle, MA Goodale, RJW Mansfield (Eds.), *Analysis of visual behavior*. MIT Press, Cambridge, MA, pp. 549–586.
- Valdois S, Lassus-Sangosse D, Lobier M (2012). Impaired letter-string processing in developmental dyslexia: what visual-to-phonology code mapping disorder? *Dyslexia* 18: 77–93.
- Valdois S, Lassus-Sangosse D, Lallier M et al. (2019). What bilateral damage of the superior parietal lobes tells us about visual attention disorders in developmental dyslexia. *Neuropsychologia* 130: 78–91.
- Vallar G (2007). Spatial neglect, Bálint-Homes’ and Gerstmann’s syndrome, and other spatial disorders. *CNS Spectr* 12: 527–536.
- Vallar G, Perani D (1986). The anatomy of unilateral neglect after right-hemisphere stroke lesions. A clinical/CT-scan correlation study in man. *Neuropsychologia* 24: 609–622.
- Van Koningsbruggen MG, Gabay S, Sapir A et al. (2010). Hemispheric asymmetry in the remapping and maintenance of visual saliency maps: a TMS study. *J Cogn Neurosci* 22: 1730–1738.
- Verfaellie M, Rapsak SZ, Heilman KM (1990). Impaired shifting of attention in Bálint’s syndrome. *Brain Cogn* 12: 195–204.
- Vialatte A, Yeshurun Y, Khan AZ et al. (2021). Superior parietal lobule: a role in relative localization of multiple different elements. *Cereb Cortex* 31: 658–671. <https://doi.org/10.1093/cercor/bhaa250>.
- Vighetto A (1980). *Etude neuropsychologique et psychophysique de l’ataxie optique*, Thesis, Université Claude Bernard Lyon I.
- Vighetto A, Perenin MT (1981). Ataxie optique: analyse des réponses oculaires et manuelles dans une tâche de pointage vers une cible visuelle [Optic ataxia: analysis of eye and hand responses in pointing at visual targets (author’s transl)]. *Rev Neurol (Paris)* 137: 357–372.
- Vindras P, Blangero A, Ota H et al. (2016). The pointing errors in optic ataxia reveal the role of “Peripheral Magnification” of the PPC. *Front Integr Neurosci* 10: 27.
- Walker R, Findlay JM (1996). Saccadic eye movement programming in unilateral neglect. *Neuropsychologia* 34: 493–508.
- Wardak C, Olivier E, Duhamel JR (2002). Saccadic target selection deficits after lateral intraparietal area inactivation in monkeys. *J Neurosci* 22: 9877–9884.
- Weddell RA (2004). Subcortical modulation of spatial attention including evidence that the Sprague effect extends to man. *Brain Cogn* 55: 497–506.
- Wojciulik E, Husain M, Clarke K et al. (2001). Spatial working memory deficit in unilateral neglect. *Neuropsychologia* 39: 390–396.
- Wolpert I (1924). Die simultagnosie: storung der gesamtaufassung. *Zeitschrift Gesamte Neurol Psychiatr* 93: 397–415.

ISBN: 978-0-12-821377-3; PII: B978-0-12-821377-3.00011-8; Author: L. Pisella et al.; 00011

To protect the rights of the author(s) and publisher we inform you that this PDF is an uncorrected proof for internal business use only by the author(s), editor(s), reviewer(s), Elsevier and typesetter SPI. It is not allowed to publish this proof online or in print. This proof copy is the copyright property of the publisher and is confidential until formal publication.

These proofs may contain colour figures. Those figures may print black and white in the final printed book if a colour print product has not been planned. The colour figures will appear in colour in all electronic versions of this book.

BÁLINT SYNDROME

23

- Yeshurun Y, Carrasco M (1998). Attention improves or impairs visual performance by enhancing spatial resolution. *Nature* 396: 72–75.
- FURTHER READING**
- Boller F, Cole M, Kim Y et al. (1975). Optic ataxia: clinical-radiological correlations with the EMIScan. *J Neurol Neurosurg Psychiatry* 38: 954–958.
- Montero J, Peña J, Genis D et al. (1982). Bálint's syndrome. Report of four cases with watershed parieto-occipital lesions from vertebrobasilar ischemia or systemic hypotension. *Acta Neurol Belg* 82: 270–280.
- Perez FM, Tunkel RS, Lachmann EA et al. (1996). Bálint's syndrome arising from bilateral posterior cortical atrophy or infarction: rehabilitation strategies and their limitation. *Disabil Rehabil* 18: 300–304.
- Schott B, Michel D, Eyssette M (1972). Spatial structuration disorders and visuomotor recording. *Rev Otoneuroophthalmol* 44: 165–175.
- Smith S, Holmes G (1916). A case of bilateral motor apraxia with disturbance of visual orientation. *Br Med J* 1: 437–441.
- Vuilleumier P, Schwartz S, Clarke K et al. (2002). Testing memory for unseen visual stimuli in patients with extinction and spatial neglect. *J Cogn Neurosci* 14: 875–886.

ISBN: 978-0-12-821377-3; PII: B978-0-12-821377-3.00011-8; Author: L. Pisella et al.; 00011

To protect the rights of the author(s) and publisher we inform you that this PDF is an uncorrected proof for internal business use only by the author(s), editor(s), reviewer(s), Elsevier and typesetter SPI. It is not allowed to publish this proof online or in print. This proof copy is the copyright property of the publisher and is confidential until formal publication.

These proofs may contain colour figures. Those figures may print black and white in the final printed book if a colour print product has not been planned. The colour figures will appear in colour in all electronic versions of this book.

Non-Print Items

Keywords: Bálint–Holmes, Posterior parietal cortex, Optic ataxia, Simultanagnosia, Spatial neglect, Covert attention, Visual remapping, Spatial cognition

ISBN: 978-0-12-821377-3; PII: B978-0-12-821377-3.00011-8; Author: L. Pisella et al.; 00011

To protect the rights of the author(s) and publisher we inform you that this PDF is an uncorrected proof for internal business use only by the author(s), editor(s), reviewer(s), Elsevier and typesetter SPI. It is not allowed to publish this proof online or in print. This proof copy is the copyright property of the publisher and is confidential until formal publication.