



**HAL**  
open science

# Supergravity : AdS3 vacua and higher-derivative corrections

Camille Eloy

► **To cite this version:**

Camille Eloy. Supergravity : AdS3 vacua and higher-derivative corrections. High Energy Physics - Theory [hep-th]. Université de Lyon, 2021. English. NNT : 2021LYSEN022 . tel-03362706

**HAL Id: tel-03362706**

**<https://theses.hal.science/tel-03362706v1>**

Submitted on 2 Oct 2021

**HAL** is a multi-disciplinary open access archive for the deposit and dissemination of scientific research documents, whether they are published or not. The documents may come from teaching and research institutions in France or abroad, or from public or private research centers.

L'archive ouverte pluridisciplinaire **HAL**, est destinée au dépôt et à la diffusion de documents scientifiques de niveau recherche, publiés ou non, émanant des établissements d'enseignement et de recherche français ou étrangers, des laboratoires publics ou privés.

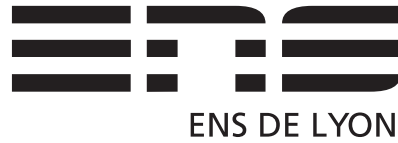

Numéro National de Thèse : 2021LYSEN022

**THÈSE DE DOCTORAT DE L'UNIVERSITÉ DE LYON**

opérée par

**l'École Normale Supérieure de Lyon**

**École Doctorale N° 52**

**Physique et Astrophysique de Lyon (PHAST)**

**Spécialité de doctorat : Physique théorique**

**Discipline : Physique**

Soutenance prévue le 5 juillet 2021, par :

**Camille Eloy**

---

**Supergravité : vides  $AdS_3$  et corrections  
en dérivées d'ordre supérieur**

Supergravity:  $AdS_3$  vacua and higher-derivative corrections

---

Devant le jury composé de :

Daniel C. Thompson	Associate professor	Swansea University	Rapporteur
Alessandro Tomasiello	Professeur	Università di Milano-Bicocca	Rapporteur
Axel Kleinschmidt	Senior scientist	Max Planck Institut Potsdam	Examineur
Michela Petrini	Professeure	Université Pierre et Marie Curie	Examinatrice
Henning Samtleben	Professeur	ENS de Lyon	Directeur de thèse



# Remerciements



# Foreword

This thesis is the final dissertation of my doctorate, which I conducted under the supervision of Henning Samtleben at the Laboratoire de physique à l'ENS de Lyon. It is based on the articles and preprints I published together with Henning and our collaborators Sadik Deger (Boğaziçi University), Olaf Hohm (Humboldt University Berlin) and Gabriel Larios (Universidad Autónoma de Madrid). They are listed below.

- [A]  **$\mathcal{N} = (8, 0)$  AdS vacua of three-dimensional supergravity**,  
N. S. Deger, C. Eloy, and H. Samtleben,  
*JHEP*, **10**, 2019, [1907.12764].
  
- [B] **Green-Schwarz Mechanism for String Dualities**,  
C. Eloy, O. Hohm, and H. Samtleben,  
*Phys. Rev. Lett.*, **124** (9), 2020, [1912.01700].
  
- [C] **Duality Invariance and Higher Derivatives**,  
C. Eloy, O. Hohm, and H. Samtleben,  
*Phys. Rev. D*, **101** (12), 2020, [2004.13140].
  
- [D] **Kaluza-Klein spectrometry for AdS<sub>3</sub> vacua**,  
C. Eloy,  
arXiv preprint: [2011.11658], accepted for publication in SciPost Physics.
  
- [E] **Triality and the consistent Pauli reduction on S<sup>3</sup>**,  
C. Eloy, G. Larios, and H. Samtleben,  
work in progress.



# Résumé

La supergravité est l'extension supersymétrique de la relativité générale. Elle est notamment fondamentale à l'étude de la théorie des cordes, un des candidats prometteurs à l'unification des forces fondamentales. Cette dernière présente des dualités, c'est-à-dire des symétries reliant des solutions *a priori* différentes, et prédit des corrections en dérivées d'ordre supérieur à la relativité générale. La première partie de cette thèse est dédiée à l'étude conjointe de ces corrections et des dualités, grâce aux outils de la supergravité. Nous décrivons dans un premier temps comment la supergravité peut être utilisée pour étudier la théorie des cordes dans la limite des faibles énergies. Nous introduisons ensuite la notion de dualité sur l'exemple de la dualité T. Après un bref passage en revue des travaux récents des interactions entre dualité T et dérivées d'ordre supérieur, nous étudions explicitement comment cette dualité est réalisée dans le cas de la théorie des cordes bosoniques lorsque des corrections en dérivées d'ordre quatre sont incluses. Ceci nécessite le développement d'une procédure systématique pour écrire l'action de la théorie dans sa forme la plus simple. Cette procédure utilise les outils de la combinatoire, que nous introduisons, combinés à des redéfinitions des champs. Nous montrons que, pour être préservées, les transformations de dualité doivent être déformées. Elles sont corrigées *via* un mécanisme de type Green-Schwarz, qui n'avait pas pu être mis en évidence dans les études précédentes. Une fois ces déformations identifiées, l'action corrigée est écrite de manière à rendre explicite la dualité. Nous étendons finalement ce résultat au secteur bosonique de la théorie des cordes hétérotique, après troncation des champs vectoriels de Yang-Mills.

La supergravité est également essentielle à la correspondance AdS/CFT, qui conjecture l'équivalence entre certaines théories conformes des champs en dimension  $d$  et des supergravités en espace-temps anti-de Sitter de dimension  $d + 1$ . La correspondance AdS<sub>3</sub>/CFT<sub>2</sub> est particulièrement prometteuse, grâce à la bonne connaissance des théories conformes à deux dimensions. La seconde partie de cette thèse est consacrée à l'étude des supergravités tridimensionnelles préservant des supersymétries demi-maximales, et plus particulièrement de leurs solutions anti-de Sitter. Nous commençons par décrire les principaux aspects de la correspondance, et détaillons l'importance de la supergravité dans ce contexte. En pratique, la correspondance se base sur la connaissance des solutions de la supergravité de la forme AdS<sub>3</sub> ×  $\mathcal{K}$ , avec  $\mathcal{K}$  un espace compact. Une classification de ces solutions peut être conduite grâce à une classification des vides AdS<sub>3</sub> de la supergravité tridimensionnelle. Après une présentation des supergravités jaugées avec supersymétrie demi-maximale à trois dimensions, nous classifions leurs solutions AdS<sub>3</sub> préservant  $\mathcal{N} = (8, 0)$  supersymétries. Nous étudions ensuite les champs des vides AdS<sub>3</sub> ×  $\mathcal{K}$ . La réduction dimensionnelle sur  $\mathcal{K}$  induit l'apparition, dans la théorie à basse dimension, d'une infinité de champs massifs, appelés modes de Kaluza-Klein. Ces modes sont fondamentaux, dans la mesure où ils sont duaux aux opérateurs de la théorie conforme, avec leurs masses liées aux dimensions conformes des opérateurs. Nous développons une méthode pour calculer le spectre des masses Kaluza-Klein, en utilisant les outils des théories des champs exceptionnelles. La méthode s'applique à tous les vides qui sont des troncations consistantes d'une théorie à plus haute dimension, quelles que soient les symétries préservées. Nous illustrons son efficacité sur plusieurs exemples.





# Contents

<b>Remerciements</b>	i
<b>Foreword</b>	iii
<b>Résumé</b>	v
<b>General introduction</b>	1

## Part I

### T duality and higher-derivative corrections

---

<b>1 Introduction</b>	7
1.1 String effective action and $\alpha'$ expansion . . . . .	7
1.2 Compactification and T duality. . . . .	10
1.3 T duality and $\alpha'$ corrections . . . . .	13
1.4 Higher-derivative corrections in double field theory. . . . .	14
1.5 Content of the part . . . . .	17
<b>2 Two-derivative action and field redefinitions</b>	21
2.1 Reduction and $O(d, d, \mathbb{R})$ symmetry . . . . .	21
2.2 $GL(d)$ fields redefinitions. . . . .	23
<b>3 <math>O(d, d, \mathbb{R})</math>-invariant basis</b>	27
3.1 A first example: counting words up to rearrangement of letters. . . . .	27
3.2 Pólya enumeration theorem . . . . .	29
3.3 Alphabet of $O(d, d, \mathbb{R})$ -invariant letters. . . . .	34
3.4 Some examples. . . . .	39
3.5 Basis at order $\alpha'$ . . . . .	40
<b>4 Four-derivative action</b>	41
4.1 Reduction of the various terms. . . . .	41

4.2	$O(d, d, \mathbb{R})$ invariance and a Green-Schwarz type mechanism . . . . .	46
4.3	Frame formulation . . . . .	51
4.4	Extension to heterotic supergravity . . . . .	53
<b>5</b>	<b>Conclusion</b>	<b>55</b>
<b>A</b>	<b>Generating function for the vector fields</b>	<b>57</b>
<b>B</b>	<b>Explicit basis at order <math>\alpha'</math></b>	<b>59</b>
<b>C</b>	<b>Partial integration, field redefinitions and <math>GL(d)</math> decomposition</b>	<b>61</b>
C.1	$\hat{R}_{\hat{\mu}\hat{\nu}\hat{\rho}\hat{\sigma}}\hat{R}^{\hat{\mu}\hat{\nu}\hat{\rho}\hat{\sigma}}$ . . . . .	61
C.2	$\hat{R}_{\hat{\mu}\hat{\nu}\hat{\rho}\hat{\sigma}}\hat{H}^{\hat{\mu}\hat{\nu}\hat{\lambda}}\hat{H}^{\hat{\rho}\hat{\sigma}}_{\hat{\lambda}}$ . . . . .	62
C.3	$GL(d)$ expressions of some $O(d, d, \mathbb{R})$ terms . . . . .	64

## Part II

### AdS<sub>3</sub> vacua and Kaluza-Klein spectroscopy

<b>1</b>	<b>Introduction</b>	<b>69</b>
1.1	AdS/CFT correspondence . . . . .	69
1.2	Kaluza-Klein spectrum . . . . .	72
1.3	Content of the part . . . . .	75
<b>2</b>	<b>Gauged supergravities in three dimensions</b>	<b>79</b>
2.1	Ungauged theory . . . . .	79
2.2	Duality between scalar and vector fields . . . . .	80
2.3	Gauging: the embedding tensor . . . . .	81
2.4	Gauging: the Lagrangian . . . . .	82
<b>3</b>	<b>Searching for AdS<sub>3</sub> vacua</b>	<b>85</b>
3.1	General procedure . . . . .	85
3.2	Supergravity spectrum around a given vacuum . . . . .	87
3.3	$\mathcal{N} = (8, 0)$ supersymmetry . . . . .	88
3.4	The example of $O\text{Sp}(8 2, \mathbb{R})$ . . . . .	89
3.5	Some $\mathcal{N} = (7, 1)$ and $\mathcal{N} = (7, 0)$ vacua . . . . .	94
3.6	Embedding into the maximal theory . . . . .	99

3.7 Summary . . . . .	101
<b>4 Kaluza-Klein spectroscopy</b>	<b>103</b>
4.1 $SO(8,p)$ exceptional field theory . . . . .	103
4.2 Fluctuation ansatz . . . . .	107
4.3 Mass matrices . . . . .	107
4.4 Six-dimensional supergravities on $AdS_3 \times S^3$ . . . . .	111
4.5 Ten-dimensional supergravity on $AdS_3 \times S^3 \times S^3 \times S^1$ . . . . .	117
4.6 Non-supersymmetric vacua. . . . .	120
4.7 Summary . . . . .	122
<b>5 Conclusion</b>	<b>123</b>
<b>A Second quadratic constraint</b>	<b>125</b>
<b>B Equations of motion and spectra</b>	<b>127</b>
B.1 Scalar fields equations of motion . . . . .	127
B.2 Detailed spectrum for $\mathcal{N}_{6d} = (1, 1)$ . . . . .	127
 <b>General conclusion</b>	 <b>133</b>
 <b>Bibliography</b>	 <b>137</b>



# General introduction

General relativity is the physical theory devoted to the study of gravitational interactions, the interactions between massive objects. First stated by A. Einstein in 1915, it describes gravitation as an interaction between spacetime and matter: spacetime is thought to be dynamic, it bends under the effect of matter, whose motion is modified by this curvature. Thus, the Earth does not rotate around the Sun because of some attractive forces, but rather follows a trajectory predetermined by the Sun's influence on the spacetime that surrounds it. Since its birth, more than one century ago, general relativity has led to lots of predictions, as the dynamic nature of the universe, or the existence of gravitational waves and black holes, which received spectacular experimental confirmations: E. Hubble observed in 1929 that the universe is expanding [1], gravitational waves were first measured in 2015 by the LIGO cooperation [2] and in 2019 the Event Horizon Telescope collaboration revealed the first direct observation of a black hole [3]. These theoretical and experimental successes make general relativity one of the major achievements of modern physics, together with quantum field theory. This latter theory describes the physics at small length scales, as the interactions between elementary particles or the electrical conduction properties of solids. Its most successful accomplishment is the so-called Standard Model, which accounts for the electromagnetic, weak and strong interactions in a unified framework. On a technical level, these interactions are implemented through gauge symmetries, symmetry transformations acting independently at each point of spacetime. Quantum field theory is furthermore based on perturbation theory: to solve a given problem, one seeks an approximate solution by deforming the exact outcome of a simpler problem. The Standard Model is the theory whose predictions have been verified with the greatest accuracy, with experimental support up to 13 digits (see Ref. [4] for examples). Its last success is the detection of the Higgs boson in 2012 at the LHC [5, 6].

Quantum field theory and general relativity describe physics at very different scales: the realm of the former is the world of electrons, atoms and particle physics, while the kingdom of the latter is the world of stars, galaxies and phenomena involving large amounts of matter and energy. Although these domains of validity are usually well-separated, there are particular situations where quantum corrections to general relativity are needed: as the universe is expanding, there was a period, in the distant past, when the universe was much smaller than it is now, but with the same amount of matter, and therefore had a much higher density. The interior of black holes also constitutes an environment where gravitational and quantum effects need to be considered at the same time. However, these situations are not reproducible as laboratory experiments, nor accessible to astronomical observations. The search for a consistent theory of quantum gravity is thus quite peculiar, compared to how research in theoretical physics is usually conducted. The need for a new theory is typically motivated by an experiment whose results do not fit into any existing model. The new model is validated if it can explain the initial experiment while remaining consistent with the pre-existing results, and can then be used to predict new physical phenomena. This often requires several back and forth between experiments and

theory. On the contrary, theoretical physicists searching for quantum gravity must rely on theoretical thinking only, building the theory from what they think it should be. The theory is not constrained by some experimental results, but by its conceptual and mathematical consistency. Of course, one can base one's thinking on well-established theories, like quantum theory and general relativity. However, naively applying to gravitation the recipe that succeeded for the Standard Model leads to infinite physical quantities<sup>1</sup>, so that the resulting theory fails to predict anything.

The conciliation of quantum field theory and general relativity then requires a careful analysis of their foundations, to determine which of their principles should remain unchanged and which should be modified. This analysis results in a first obstacle, that explains the failure of the previous naive approach: while the spacetime of general relativity is flexible and dynamic, quantum field theory relies on a rigid and fixed background spacetime, around which the perturbation expansion is performed. One needs therefore an entirely new framework to quantize gravity. There are roughly speaking two different approaches to build this framework: one can either (i) keep the usual ideas of quantum field theory, as the perturbative methods, and look after a fundamental theory that features general relativity as a peculiar limit, or (ii) take seriously the lessons from general relativity, and demand for a dynamic background in the quantum limit. Among the first category, one finds supergravity [7], which couples general relativity with a new symmetry, called supersymmetry, that partially cures the divergences appearing in the quantization, as well as string theory [8], that trades the point particles for one-dimensional extended objects, called strings. The second category features for example loop quantum gravity [9], that rejects the perturbative framework of quantum field theory and predicts that space is quantized and composed of beads of length given by the Planck length  $\ell_P \simeq 10^{-35}$  m. This list is of course non-exhaustive, we can also cite the twistor theory, non-commutative geometry, matrix models, etc.

Supergravity is the combination of two major concepts: gauge theories, which initiated the success of the Standard Model, and supersymmetry. First developed in the seventies [10, 11], the supersymmetry transformations relate the two different types of particles, bosons and fermions, which are otherwise disconnected. By studying the theories invariant under these global transformations, it has been observed that supersymmetry softens the divergences from which quantum field theories typically suffer. Together with the effectiveness of gauge symmetries to describe fundamental interactions, this motivated the search for a gauged form of supersymmetry [12, 13]. It was found that requiring such a symmetry imposes general relativity as part of the resulting theory. This explains why field theories invariant under local supersymmetry are called supergravities. In an equivalent manner, supergravity could be defined as the supersymmetric extension of general relativity. It features a novel type of fermionic particle, called gravitino or Rarita-Schwinger field, with a spin  $3/2$  (while fermions usually have a spin  $1/2$ ). As initially hoped, the quantization of supergravity is better controlled than the one of general relativity, but the quantum theory may still feature some divergences: the infinities are only postponed to higher orders in the perturbative expansion. A particular form of the theory, named “maximal”, may be free of divergences to all order in perturbation theory, as conjectured in Ref. [14]. From the experimental point of view, the gravitino has too weak couplings to other particles to be detected. However, it has long been thought that evidences for supersymmetry could be detected by

---

<sup>1</sup>Naive quantization of the Standard Model also leads to infinite quantities, but one can add to the theory a finite number of corrections to cure these infinities. The Standard Model is said to be renormalizable. This procedure fails for quantum gravity, as an infinite number of corrections is needed.

experiments at the LHC. Even though there were no such manifestations so far, supergravity has already shed more light on the peculiar properties of quantum gravity, and has found applications in cosmology, strongly coupled systems and mathematics.

One of the most intriguing properties of supergravity is its rich relation to string theory: supergravity appears as the low-energy limit of string theory. This latter is a quantum field theory of extended objects. It describes the vibrations of strings on a fixed background spacetime, and interprets their excitation modes as particles states. Among those states, there is a spin-2 mode which corresponds to fluctuations of the metric around the fixed background. Gravity is thus built in, and described with corrections compared to general relativity. These corrections take the form of higher-derivative couplings. The consistency of the theory requires supersymmetry, which yields new particles and couplings, and six additional spatial dimensions, giving rise to a ten-dimensional spacetime. To describe our four-dimensional universe, the extra dimensions are compactified: they are considered compact and small enough that they are invisible on all accessible scales. This dimensional reduction induces gauge symmetries in low dimensions, giving rise to physical interactions. It is also the origin of so-called dualities, novel symmetries that link seemingly different string theories. On top of being a candidate for a consistent theory of quantum gravity, string theory is at the origin of the AdS/CFT correspondence. This is a conjectured equivalence between string theory on peculiar backgrounds, called anti-de Sitter, and conformal field theories. It allows distinct and complementary descriptions of the same phenomena, giving in particular the possibility to study strongly coupled quantum theory using the tools of weakly coupled gravity.

Supergravity is fundamental to study the implications of string theory. In the first part of this thesis, we study the interplay between string dualities and higher-derivative corrections. We first review in more details how supergravity could be used to describe the dynamics of the lowest-energy string modes, and explain what is a duality on the example of T duality, which appears when considering dimensional reduction on the torus. After a brief review of recent developments regarding T duality in the context of higher-derivative corrections, we explicitly study how T duality is realized for the bosonic string when four-derivative corrections are included. To do so, we develop a systematic procedure that brings the action into a minimal form. This procedure uses the tools of combinatorics, which we introduce, combined with careful use of field redefinitions. We show that, in order to be preserved, the duality transformations need to be deformed. They acquire corrections through a Green-Schwarz type mechanism, which has been invisible in all the reductions considered so far. We finally extend the result to the bosonic sector of the heterotic string theory, after truncating the Yang-Mills gauge fields.

The second part is dedicated to the study of three-dimensional supergravities, with a focus on half-maximal theories and their anti-de Sitter vacua. This finds applications in the AdS<sub>3</sub>/CFT<sub>2</sub> correspondence, which is one of the most promising playgrounds to study the AdS/CFT correspondence, as conformal theories in two dimensions are well known. We start by reviewing the main features of this correspondence and detail the importance of supergravity in this context. Practical use of the correspondence requires knowledge of supergravity solutions of the form AdS<sub>3</sub> ×  $\mathcal{K}$ , with some compact space  $\mathcal{K}$ . A classification of such solutions can start directly from a classification of AdS<sub>3</sub> solutions of three-dimensional supergravity. After a presentation of half-maximal gauged supergravities in three dimensions, we give a classification of their fully supersymmetric chiral  $\mathcal{N} = (8, 0)$  AdS<sub>3</sub> vacua. We then turn to the study of the fields of the full AdS<sub>3</sub> ×  $\mathcal{K}$  solutions. The compactification on  $\mathcal{K}$  induces the appearance of infinitely many massive fields in the low-dimensional theory, called Kaluza-Klein



modes. They are fundamental, as they are dual to the operators of the CFT, with masses related to conformal dimensions. We develop generic tools to compute Kaluza-Klein mass spectra around AdS vacua that sit in half-maximal gauged supergravity in three dimensions. To do so, we use the framework of exceptional field theory, which provides a duality covariant formulation of the higher dimensional supergravities, and in particular allows to parametrize efficiently the reduction. The formalism applies to any vacuum that arises from a consistent truncation of higher-dimensional supergravity, no matter what symmetries are preserved. We finally illustrate its efficiency on several examples.

**Part I**

**T duality and higher-derivative  
corrections**



# 1

## Chapter

# Introduction

String theory is a quantum theory of gravitation, that predicts corrections to general relativity even classically. It features hidden symmetries, called dualities, that relate *a priori* different configurations of the theory. It also includes an infinite number of higher-derivative corrections to the classical two-derivative Einstein-Hilbert action. This part of the thesis is dedicated to the study of the interplay between duality and higher-derivative corrections, using the tools of supergravity. It is based on Ref. [B, C]. We focus on T duality, a duality characteristic to string theory once compactified on a torus, and on the bosonic string theory.

This introductory chapter briefly reviews the concepts needed to properly tackle this problem. Sec. 1.1 and 1.2 first introduce the notions of higher-derivative corrections, which are governed by an expansion in the inverse string tension called  $\alpha'$ , and of T duality, following Ref. [8, 15]. We then present recent works regarding their interplay in conventional dimensional reduction in Sec. 1.3 and in the context of double field theory in Sec. 1.4. We finally close the chapter with the outline of Part I in Sec. 1.5.

## 1.1 String effective action and $\alpha'$ expansion

In the same way that a point particle describes a worldline, a string sweeps a worldsheet. It is a surface in spacetime, parametrized by a spacelike coordinate  $\sigma$  (that describes position along the string) and a timelike coordinate  $\tau$ , forming a vector  $\xi^\alpha = (\tau, \sigma)$ . We choose the coordinate  $\sigma$  to be dimensionless and focus on closed strings, for which  $\sigma$  is periodic with range  $\sigma \in [0, 2\pi[$ .

The dynamics of a string in a flat  $D$ -dimensional spacetime of coordinates  $X^\mu$ , named the target space, can be described by the Polyakov action

$$S_P = \frac{1}{4\pi\alpha'} \int d^2\xi \sqrt{-\gamma} \gamma^{\alpha\beta} \partial_\alpha X^\mu \partial_\beta X^\nu \eta_{\mu\nu}, \quad (1.1)$$

where  $\eta_{\mu\nu}$  is the  $D$ -dimensional Minkowski metric and  $\gamma_{\alpha\beta}$  is a dynamic metric on the worldsheet, of determinant  $\gamma$ . The parameter  $T = 1/(2\pi\alpha')$  is an energy per unit length and hence a tension, proper to the string. In the following, we will write every speed in units of the speed of light  $c$  and every action in units of the Planck constant  $\hbar$ . With this system of units, all fundamental dimensions we will encounter (time, length, mass and energy) can be expressed in term of a unique one<sup>2</sup>, say a length. The parameter  $\alpha'$  is then a squared length, to which we can associate a length scale  $\ell_s$  by

$$\ell_s = \sqrt{\alpha'}. \quad (1.2)$$

The string scale  $\ell_s$  is the natural length in string theory.

<sup>2</sup>[length] = [time] = [energy]<sup>-1</sup> = [mass]<sup>-1</sup>.

The Polyakov action (1.1) is invariant under Poincaré transformations of the target space and diffeomorphisms on the worldsheet. It is also invariant under the Weyl transformation

$$X^\mu(\xi) \rightarrow X^\mu(\xi), \quad \gamma_{\alpha\beta}(\xi) \rightarrow \Omega^2(\xi) \gamma_{\alpha\beta}(\xi). \quad (1.3)$$

This is a gauge symmetry of the string, that plays a central role in the description of its dynamics. For example, it restricts the possible worldsheet interactions to those that guarantee that the total stress-energy tensor is traceless:

$$T_\alpha^\alpha = 0. \quad (1.4)$$

The quantization of the action (1.1) imposes  $D = 26$  and leads to a particle spectrum made of a finite number of massless states and an infinite tower of massive excitations. The massive states have masses of order the Planck mass and can be disregarded if one wishes to study the low-energy consequences of string theory. Thus, we focus here on the massless states, described by the spacetime fields

$$g_{\mu\nu}(X), \quad B_{\mu\nu}(X) \quad \text{and} \quad \phi(X). \quad (1.5)$$

$g_{\mu\nu}$  is traceless and symmetric. It describes a massless spin-2 field identified with the metric on the target space.  $B_{\mu\nu}$  is antisymmetric, with gauge symmetry  $\delta_{\tilde{\lambda}} B_{\mu\nu} = 2 \partial_{[\mu} \tilde{\lambda}_{\nu]}$ , and  $\phi$  is a scalar, named the dilaton. The bosonic string theory thus naturally includes gravity, coupled to a two-form and a scalar field. Those fields describe the background in which the string moves.

In particular, this implies that the target space is curved, whereas we assumed it was flat in Eq. (1.1). We can in fact couple the string to the background fields (1.5) directly in the worldsheet action, by considering the following non-linear  $\sigma$ -model:

$$S = \frac{1}{4\pi\alpha'} \int d^2\xi \sqrt{-\gamma} \left[ \gamma^{\alpha\beta} \partial_\alpha X^\mu \partial_\beta X^\nu g_{\mu\nu}(X) + \epsilon^{\alpha\beta} \partial_\alpha X^\mu \partial_\beta X^\nu B_{\mu\nu}(X) + \frac{\alpha'}{2} R_{(2d)} \phi(X) \right]. \quad (1.6)$$

$\epsilon^{\alpha\beta}$  is the two-dimensional Levi-Civita tensor, and  $R_{(2d)}$  is the scalar curvature of the worldsheet. The action (1.6) is no longer quadratic in  $X^\mu$ , and thus describes an interacting theory. To understand these interactions in more detail, let us focus on the first term and let us consider the conformal gauge<sup>3</sup>, where

$$S_g = \frac{1}{4\pi\alpha'} \int d^2\xi \partial_\alpha X^\mu \partial^\alpha X^\nu g_{\mu\nu}(X). \quad (1.7)$$

We now expand this action around a classical solution, given by a string sitting at  $x_0^\mu$ :

$$X^\mu(\xi) = x_0^\mu + \ell_s Y^\mu(\xi), \quad (1.8)$$

with  $Y^\mu$  some dynamical fluctuation. Thanks to the factor  $\ell_s$ ,  $Y^\mu$  is dimensionless and an expansion in powers of  $Y^\mu$  makes sense. Such an expansion gives

$$S_g = \frac{1}{4\pi} \int d^2\xi \partial_\alpha Y^\mu \partial^\alpha Y^\nu \left[ g_{\mu\nu}(x_0) + \ell_s g_{\mu\nu, \rho}(x_0) Y^\rho + \frac{\ell_s^2}{2} g_{\mu\nu, \rho\sigma}(x_0) Y^\rho Y^\sigma + \dots \right], \quad (1.9)$$

where the tensors  $g_{\mu\nu, \rho}, g_{\mu\nu, \rho\sigma}$  are the coefficients in the Taylor expansion of  $g_{\mu\nu}$  around  $x_0$ . They play the role of coupling constants for the interactions of  $Y^\mu$ . To identify the strength of those couplings, let

<sup>3</sup>We use the diffeomorphisms and Weyl invariance to gauge fix the worldsheet metric to  $\gamma_{\alpha\beta} = \eta_{\alpha\beta}$ .

us schematically define the radius of curvature  $r_c$  of the target space as  $\partial g/\partial X \sim r_c$ . From Eq. (1.9), we see that the effective dimensionless coupling constant is given by

$$\frac{\ell_s}{r_c} = \frac{\sqrt{\alpha'}}{r_c}. \quad (1.10)$$

We can then use perturbation theory to study the action (1.6) if the radius of curvature is much greater than the characteristic length scale of the string. This perturbative expansion is called the  $\alpha'$  expansion<sup>4</sup>. The limit  $\alpha' \rightarrow 0$  is named the low-energy limit of string theory<sup>5</sup>. As  $\alpha'$  is a dimensionful parameter, the terms of order higher than one in the expansion are of order higher than two in derivatives.

As pointed out above, the Weyl invariance of the action (1.1) is a fundamental feature of string theory. The action (1.6) will define a consistent string theory only if its quantization is Weyl-invariant. This invariance is expressed by Eq. (1.4). The stress-energy tensor has trace

$$T_\alpha{}^\alpha = -\frac{1}{2\alpha'} \beta_{\mu\nu}^g \gamma^{\alpha\beta} \partial_\alpha X^\mu \partial_\beta X^\nu - \frac{1}{2\alpha'} \beta_{\mu\nu}^B \varepsilon^{\alpha\beta} \partial_\alpha X^\mu \partial_\beta X^\nu - \frac{1}{2} \beta^\phi R_{(2d)}, \quad (1.11)$$

where [16]

$$\begin{aligned} \beta_{\mu\nu}^g &= \alpha' \left( R_{\mu\nu} + \nabla_\mu \nabla_\nu \phi - \frac{1}{4} H_{\mu\rho\sigma} H_\nu{}^{\rho\sigma} \right) + \mathcal{O}(\alpha'^2), \\ \beta_{\mu\nu}^B &= \frac{\alpha'}{2} \left( -\nabla^\rho H_{\rho\mu\nu} + \nabla^\rho \phi H_{\rho\mu\nu} \right) + \mathcal{O}(\alpha'^2), \\ \beta^\phi &= \frac{\alpha'}{4} \left( -\square\phi + \nabla_\mu \phi \nabla^\mu \phi - \frac{1}{6} H_{\mu\nu\rho} H^{\mu\nu\rho} \right) + \mathcal{O}(\alpha'^2). \end{aligned} \quad (1.12)$$

Here,  $R_{\mu\nu}$  is the Ricci tensor for the metric  $g_{\mu\nu}$ ,  $H_{\mu\nu\rho} = 3 \partial_{[\mu} B_{\nu\rho]}$  is the field-strength associated to  $B_{\mu\nu}$ ,  $\square = \nabla_\mu \nabla^\mu$  and the indices are raised using the inverse metric  $g^{\mu\nu}$ . The condition (1.4) is equivalent to the requirement  $\beta_{\mu\nu}^g = \beta_{\mu\nu}^B = \beta^\phi = 0$ . These equations can be seen as the equations of motion for the background fields. The  $D = 26$ -dimensional spacetime action whose equations of motion are equivalent to the vanishing of Eq. (1.12) is

$$S = \int d^{26}X \sqrt{-g} e^{-\phi} \left( R + \partial_\mu \phi \partial^\mu \phi - \frac{1}{12} H_{\mu\nu\rho} H^{\mu\nu\rho} \right), \quad (1.13)$$

with  $g$  the determinant of  $g_{\mu\nu}$  and  $R$  the scalar curvature. This is the low-energy effective action of the bosonic string.

It is a low-energy limit in the sense that we did not consider higher-order  $\alpha'$  corrections in Eq. (1.12). As the action (1.13) is independent of  $\alpha'$ , it does not contain any explicitly "stringy" effects. The corrections intrinsic to string theory reside in higher-derivative corrections to the effective action. It is however a highly non-trivial task to compute these corrections, and complete results are available at first order in  $\alpha'$  only. The first-order  $\alpha'$  extension of the bosonic string action (1.13) is given, up to field redefinitions, by [17]

$$\begin{aligned} S_1 = \frac{1}{4} \alpha' \int d^{26}X \sqrt{-g} e^{-\phi} & \left( R_{\mu\nu\rho\sigma} R^{\mu\nu\rho\sigma} - \frac{1}{2} H^{\mu\nu\lambda} H^{\rho\sigma}{}_\lambda R_{\mu\nu\rho\sigma} - \frac{1}{8} H_{\mu\nu}^2 H^2{}^{\mu\nu} \right. \\ & \left. + \frac{1}{24} H_{\mu\nu\rho} H^\mu{}_\sigma{}^\lambda H^\nu{}_\lambda{}^\tau H^\rho{}_\tau{}^\sigma \right), \end{aligned} \quad (1.14)$$

<sup>4</sup>String theory features a second expansion, in the string coupling  $g_s$ , which intervenes in string interactions.

<sup>5</sup>Note that we have already implicitly taken this limit, when restricting ourselves to massless excitations.

where  $H_{\mu\nu}^2 = H_{\mu\rho\sigma}H_{\nu}^{\rho\sigma}$  and  $R_{\mu\nu\rho\sigma}$  is the Riemann tensor. The heterotic string features similar corrections (see Chap. 4). The case of the type II string is peculiar, as its first  $\alpha'$  corrections occur at order  $\alpha'^3$  (eight-derivative). These corrections are not completely known yet. Only the terms in the gravitational sector are fully known [18–20].

## 1.2 Compactification and T duality

In string theory, the spatial extension of the string fundamentally changes the procedure of compactification. Consider a two-dimensional target space, with one non-compact dimension  $X$  and one compact dimension  $Y$  of radius  $R$  (Fig. 1.1). Due to its spatial extension, a closed string could describe a non-trivial path in such a target space. We do not necessarily have  $Y(\tau, \sigma + 2\pi) = Y(\tau, \sigma)$  (which will be verified in case of a non-compact dimension): it is possible that the string encircles the compact direction, *i.e.* that, while going all over the string, we describe turns around the  $Y$  direction. For example, in each case in Fig. 1.1, we have  $Y(\tau, \sigma + 2\pi) = Y(\tau, \sigma) + 2\pi w R$ , where  $w \in \mathbb{Z}$  is the so called winding number, which describes the topological behaviour of the string. Then, all string configurations are not equivalent once there are compactified dimensions. We will see in the following sections that there exists a hidden symmetry, called T duality, that links together some string configurations.

### 1.2.1 Toroidal compactification

Here, we are interested in the simplest compactifications of string theory, in which several dimensions are periodically identified, following Ref. [8, 21, 22]. The target space is then

$$\mathcal{M}^D \times \mathbb{T}^d, \quad (1.15)$$

with  $\mathcal{M}^D$  a non-compact  $D$ -dimensional manifold, which describes the low-dimensional spacetime,  $\mathbb{T}^d$  the  $d$ -dimensional spatial torus, which describes the internal spacetime, and  $D + d = 26$ . The 26 spacetime coordinates then split into  $D$  non-compact external coordinates  $X^\mu$  and  $d$  compact internal ones, noted  $Y^m$ . The spacetime metric separates into a  $D$ -dimensional metric  $g_{\mu\nu}$ ,  $d$  vectors  $A_\mu^{(1)m}$  and a symmetric scalar matrix  $G_{mn}$ , and the two-form similarly decomposes into a  $D$ -dimensional two-form

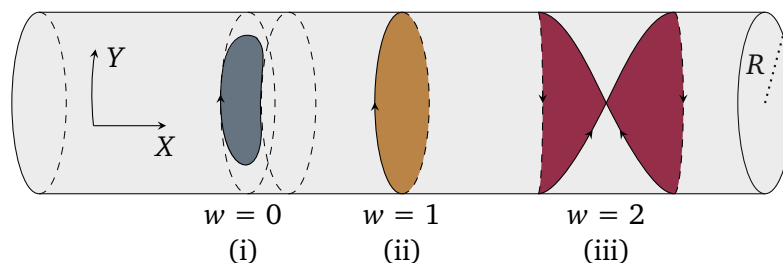

**Fig. 1.1** Schematic representation of the possible topological behaviours of the string in a two-dimensional target space with one compact direction  $Y$  of radius  $R$ . In cases (ii) and (iii) the string wraps around the compact dimension, respectively once and twice, whereas in case (i) it does not. The number  $w$ , called winding number, describes the behaviour of the string and plays a fundamental role in its spectrum. Inspired by Ref. [8].

$B_{\mu\nu}$ ,  $d$  vectors  $A_{\mu m}^{(2)}$  and a anti-symmetric scalar matrix  $B_{mn}$ <sup>6</sup>.

In the following, we will concentrate on the purely internal part and neglect the dilaton, *i.e.* we restrict to the scalar fields  $G_{mn}$  and  $B_{mn}$ . In this sector and adopting the conformal gauge, the worldsheet action (1.6) reduces to

$$\frac{1}{4\pi\alpha'} \int d^2\xi \left[ \partial^\alpha Y^m \partial_\alpha Y^n G_{mn}(X, Y) + \varepsilon^{\alpha\beta} \partial_\alpha Y^m \partial_\beta Y^n B_{mn}(X, Y) \right]. \quad (1.16)$$

The internal coordinates  $Y^m$  represent compact directions of radius  $R$ , and verify

$$\begin{cases} Y^m \cong Y^m + 2\pi R, \\ Y^m(\tau, \sigma + 2\pi) = Y^m(\tau, \sigma) + 2\pi w^m R. \end{cases} \quad (1.17)$$

The first equation is the periodic identification that defines the toroidal compactification, whereas the second one gives the topological behaviour of the string, with winding number  $w^m$  in direction  $Y^m$ . The canonical momentum associated to  $Y^m$  is

$$P_m = \frac{1}{\alpha'} (G_{mn} \partial_\tau Y^n + B_{mn} \partial_\sigma Y^n). \quad (1.18)$$

As the string wavefunction includes a factor  $e^{ip \cdot Y}$ , the periodicity given in Eq. (1.17) imposes a quantization of the momenta

$$P_m = \frac{q_m}{R}, \quad q_m \in \mathbb{Z}, \quad (1.19)$$

so that the wavefunction is monovalued.

Let us now evaluate the spectrum of the string. Solutions of the equations of motion, together with Eq. (1.18) and (1.19), satisfy the right and left movers decomposition  $Y^m(\tau, \sigma) = Y_L^m(\tau + \sigma) + Y_R^m(\tau - \sigma)$ , where

$$\begin{cases} Y_L^m(\tau + \sigma) = \frac{y^m}{2} + \frac{\alpha'}{2} p_{Ln} G^{nm}(\tau + \sigma), \\ Y_R^m(\tau - \sigma) = \frac{y^m}{2} + \frac{\alpha'}{2} p_{Rn} G^{nm}(\tau - \sigma), \end{cases} \quad \text{with} \quad \begin{cases} p_{Lm} = \frac{q_m}{R} + (G_{mn} - B_{mn}) \frac{w^n R}{\alpha'}, \\ p_{Rm} = \frac{q_m}{R} - (G_{mn} + B_{mn}) \frac{w^n R}{\alpha'}. \end{cases} \quad (1.20)$$

We neglect here the oscillators and restrict to the zero mode. The Hamiltonian and the constraint given by Weyl invariance take then the form

$$\begin{cases} H = \frac{1}{2} (p_L^2 + p_R^2) = \frac{q_m}{R} G^{nm} \frac{q_n}{R} + \frac{R w^m}{\alpha'} (G - B G^{-1} B)_{mn} \frac{R w^n}{\alpha'} + 2 \frac{R w^m}{\alpha'} B_{mk} G^{kn} \frac{q_n}{R}, \\ \frac{1}{2} (p_L^2 - p_R^2) = 2 q_n w^n. \end{cases} \quad (1.21)$$

From Eq. (1.20) and (1.21),  $(p_L, p_R)$  forms an even lattice with respect of the pseudo-scalar product of signature  $(d, d)$ , and it can be shown that this lattice is self-dual [8]. These even self-dual lattices have been classified and are linked within each others through  $O(d, d, \mathbb{R})$  transformations.  $O(d, d, \mathbb{R})$  is the group of real orthogonal matrices with respect of the pseudo-scalar product of signature  $(d, d)$ , *i.e.*

$$\forall \mathcal{O} \in O(d, d, \mathbb{R}), \quad \mathcal{O}^t \eta \mathcal{O} = \eta, \quad \text{where } \eta = \begin{pmatrix} 0 & \mathbb{1} \\ \mathbb{1} & 0 \end{pmatrix}, \quad (1.22)$$

<sup>6</sup>These decompositions will be exposed in details in Chap. 2.



$\eta$  being defined as a block matrix with square  $d \times d$  blocks. As each couple  $(p_L, p_R)$  corresponds to a given background geometry and a given spectrum,  $O(d, d, \mathbb{R})$  generates the moduli space of the compactified string. It is nevertheless not a symmetry of the theory, as the Hamiltonian (1.21) involves the usual scalar product of signature  $2d$  for the vectors  $(p_L, p_R)$ . Thus, most  $O(d, d, \mathbb{R})$  transformations produce inequivalent theories. The Hamiltonian is however invariant under the action of  $O(d, \mathbb{R}) \times O(d, \mathbb{R})$ , which acts separately of  $p_L$  and  $p_R$ . The moduli space is then given by the coset

$$O(d, d, \mathbb{R}) / (O(d, \mathbb{R}) \times O(d, \mathbb{R})), \quad (1.23)$$

up to some dualities which are discussed in the next section. This coset has dimension  $d^2$ , we recover the degrees of freedom given in  $G_{mn}$  and  $B_{mn}$ .

As  $O(d, d, \mathbb{R})$  plays a central role in our description, we could make the  $2d \times 2d$  structure explicit defining a generalized metric

$$\mathcal{H}_{MN} = \begin{pmatrix} (G - BG^{-1}B)_{mn} & (BG^{-1})_m{}^n \\ -(G^{-1}B)^m{}_n & G^{mn} \end{pmatrix} \in O(d, d, \mathbb{R}). \quad (1.24)$$

The Hamiltonian (1.21) then becomes

$$H = V^t M \mathcal{H}_{MN} V^N, \quad \text{with } V^M = \begin{pmatrix} R w^m / \alpha' \\ q_m / R \end{pmatrix}. \quad (1.25)$$

Here  $V^M$  is a  $d + d$  vector counting the winding and momentum modes, corresponding to  $(p_L, p_R)$ . It unifies those modes in a unique object.

### 1.2.2 T duality

We may now wonder what is the duality group for toroidal compactification, *i.e.* what subgroup of  $O(d, d, \mathbb{R})$  leaves the physics invariant. A necessary condition for such a subgroup is to leave the spectrum invariant. One should also show that all correlation functions are preserved, but we will here focus on the spectrum. There are three types of contribution.

**Integer shift of  $B_{mn}$**  Let  $\Theta \in \mathcal{A}(d, \mathbb{Z})$  be a  $d \times d$  antisymmetric integer matrix and consider

$$\Gamma_\Theta = \begin{pmatrix} \mathbb{1} & \Theta \\ 0 & \mathbb{1} \end{pmatrix} \in O(d, d, \mathbb{R}). \quad (1.26)$$

The action of  $\Gamma_\Theta$  on  $\mathcal{H}$ , given by  $\Gamma_\Theta^t \mathcal{H} \Gamma_\Theta$ , consists in the shift  $B \rightarrow B - \Theta$ . It thus adds a total derivative to the action (1.16). This contribution is topological and, as the components of  $\Theta$  are integer, the shift is of the form  $2\pi\mathbb{Z}$  and leaves the path integral unchanged.

**Basis change preserving the periodicities** Other transformations that preserve the spectrum are spacetime coordinates change of basis that conserve the periodicities (1.17). They are defined as  $Y^m \rightarrow A^m{}_n Y^n$ , with  $A \in GL(d, \mathbb{Z})$ . The induced transformations on  $G$  and  $B$  are  $G \rightarrow A^t G A$  and

$B \rightarrow A^t BA$ , which could be embedded in  $O(d, d, \mathbb{R})$  through

$$\Gamma_A = \begin{pmatrix} A & 0 \\ 0 & A^{t-1} \end{pmatrix} \in O(d, d, \mathbb{R}). \quad (1.27)$$

Some of those transformations consist for example in permuting the spacetime coordinates  $Y^m$ .

**Factorized dualities** The last class of duality transformations is composed of transformations of the form

$$\Gamma_k = \begin{pmatrix} \mathbb{1} - e_k & e_k \\ e_k & \mathbb{1} - e_k \end{pmatrix} \in O(d, d, \mathbb{R}), \quad (1.28)$$

where  $(e_k)_{mn} = \delta_{mk}\delta_{nk}$  is everywhere 0 except for the  $(k, k)$  component which is 1. The action of  $\Gamma_k$  on  $V^N$  amounts in the exchange of the winding and momentum modes in the direction  $Y^k$ , together with the redefinition of the radius in this direction as  $R \rightarrow \alpha'/R$ . While Eq. (1.26) and (1.27) have a geometric origin, Eq. (1.28) is a genuine duality transformation.

All together these three classes of transformations generate the duality group  $O(d, d, \mathbb{Z})$ , which we shall call the T-duality group. This group is a symmetry of the spectrum, which mixes winding and momentum modes. The existence of this duality symmetry implies that, starting from a given consistent background, one can generate others by applying  $O(d, d, \mathbb{Z})$  transformations. The explicit transformation laws for  $G_{mn}$  and  $B_{mn}$  follow from Eq. (1.24):

$$\begin{pmatrix} G' - B'G'^{-1}B' & B'G'^{-1} \\ -G'^{-1}B' & G' \end{pmatrix} = \Gamma^t \begin{pmatrix} G - BG^{-1}B & BG^{-1} \\ -G^{-1}B & G \end{pmatrix} \Gamma, \quad (1.29)$$

for  $\Gamma \in O(d, d, \mathbb{Z})$ . In the low-energy limit studied in Sec. 1.1, this duality is enhanced to invariance under the continuous symmetry group  $O(d, d, \mathbb{R})$ . For the two-derivative effective action (1.13), this symmetry was first shown explicitly for the (cosmological) reduction to one dimension by Veneziano and Meissner [23, 24] and later generalized to arbitrary  $d$  by Maharana and Schwarz [25], as we will review in Chap. 2. Let us finally point out that the worldsheet action (1.16) features an additional symmetry, namely the parity  $\sigma \rightarrow -\sigma$ , that acts on the background as

$$B_{mn} \rightarrow -B_{mn}. \quad (1.30)$$

It represents the exchange of left and right movers.

### 1.3 T duality and $\alpha'$ corrections

From Sec. 1.1 and 1.2, we learned that string theory includes general relativity, but modifies it in two significant ways. First, the field equations receive an infinite number of higher-derivative corrections, governed by the parameter  $\alpha'$ . Second, once compactified, string theory features novel dualities, which imply that theories defined on seemingly different backgrounds are actually equivalent. These are core principles to the theory, and we may wonder how they interplay.

It was proven by Sen, using closed string field theory, that the  $O(d, d, \mathbb{R})$  symmetry of dimensionally reduced theories is present to all order in the  $\alpha'$  expansion [26]. Let us schematically review its main arguments, based on Ref. [27]. The main idea is to determine the symmetry of the action by studying

the ones of the S matrix. Considering background fields independent of  $d$  of the spatial coordinates, Sen showed that the correlation functions factorize into two different sectors, namely holomorphic and anti-holomorphic ones, each of them being  $O(d, \mathbb{R})$  invariant, whatever the number of derivative involved. The correlation functions, and hence the S matrix and the action, are then  $O(d, \mathbb{R}) \times O(d, \mathbb{R})$  invariant to all orders in the  $\alpha'$  expansion. The action of this symmetry on the fields can be made explicit at the lowest order in  $\alpha'$ . It is given by Eq. (1.29) with

$$\Gamma = \frac{1}{2} \begin{pmatrix} R + S & R - S \\ R - S & R + S \end{pmatrix}, \quad (1.31)$$

with  $R, S \in O(d, \mathbb{R})$ . These matrices form an  $O(d, \mathbb{R}) \times O(d, \mathbb{R})$  subgroup in  $O(d, d, \mathbb{R})$ . To this symmetry, we should add the ones that cannot be captured in the S matrix analysis, namely the  $GL(d)$  symmetry associated with the linear transformation of the compact coordinates and the shift symmetry of the two-form (which are continuous generalizations of Eq. (1.26) and (1.27)). The diagonal subgroup of  $O(d, \mathbb{R}) \times O(d, \mathbb{R})$ , given by  $R = S$  in Eq. (1.31), is however a subgroup of  $GL(d)$ , and should not be counted twice. From  $O(d, \mathbb{R}) \times O(d, \mathbb{R})$  and  $GL(d)$ , we get  $d(d-1)/2 + d^2$  generators, and from the  $B$ -shift  $d(d-1)/2$ . All together, the symmetry group features  $d(2d-1)$  independent generators, which form  $O(d, d, \mathbb{R})$ . This counting could be generalized to all orders in  $\alpha'$  [27], thus leading to the conclusion that  $O(d, d, \mathbb{R})$  is a symmetry of the effective action to all orders in  $\alpha'$ .

It remains however a highly non-trivial problem to actually display this symmetry when higher-derivative  $\alpha'$  corrections are included. The transformation laws given by Eq. (1.29) and (1.31) are valid at lowest order in  $\alpha'$  only, and they may need to be modified when we include higher-derivative corrections. The identification of these laws is made particularly subtle by the possibility to perform field redefinitions when corrections of higher order in  $\alpha'$  are included (see Ref. [28] for an example). First significant progress was due to Meissner, who investigated the dimensional reduction of the bosonic string effective action to one dimension, including the four-derivative terms of Eq. (1.14) [29]<sup>7</sup>. He uncovered the expected  $O(d, d, \mathbb{R})$  symmetry, but this required a series of elaborate field redefinitions (that in particular cannot all originate from covariant field redefinitions before reduction). Subsequent work considered the reduction on a single circle [31] and reductions on a general torus but truncating out all “off-diagonal” field components [32]. In all these truncations, there is a choice of field variables for which the  $O(d, d, \mathbb{R})$  transformations are undeformed and given, for  $G_{mn}$  and  $B_{mn}$ , by Eq. (1.29). This fact was used to classify all higher-derivative corrections in cosmology that, somewhat surprisingly, only require (higher powers of) first-order time derivatives [33, 34]. The cases of corrections at orders  $\alpha'^2$  and  $\alpha'^3$  have been recently studied, both in the context of compactifications on the circle [35–39] and down to one dimension [40].

## 1.4 Higher-derivative corrections in double field theory

Before closing this introductory chapter, let us briefly review recent advances concerning higher-derivative corrections in the context of double field theory. Double field theory is a formulation of the bosonic supergravity (1.13) featuring a manifest T-duality invariance before dimensional reduction, by virtue of a generalized spacetime with doubled coordinates [41–44]<sup>8</sup>. Starting from the action (1.13)

<sup>7</sup>For earlier work on the heterotic string see Ref. [30].

<sup>8</sup>See also Ref. [22, 45] for reviews.

in a  $D$ -dimensional spacetime, the main idea of double field theory is to reorganize all the fields in representations of  $O(D, D, \mathbb{R})$ . As pointed out in Sec. 1.2, the background metric  $g_{\mu\nu}$  and the two-form  $B_{\mu\nu}$  naturally combine into the generalized  $O(D, D, \mathbb{R})$  metric

$$\mathcal{H}_{MN} = \begin{pmatrix} (g - Bg^{-1}B)_{\mu\nu} & (Bg^{-1})_{\mu}{}^{\nu} \\ -(g^{-1}B)^{\mu}{}_{\nu} & g^{\mu\nu} \end{pmatrix}, \quad (1.32)$$

with  $M, N \in \llbracket 1, 2D \rrbracket$  fundamental indices of  $O(D, D, \mathbb{R})$ . They are raised and lowered using the invariant metric  $\eta_{MN}$  defined in Eq. (1.22). We also introduce  $D$  coordinates  $\tilde{X}_{\mu}$  dual to the spacetime coordinates  $X^{\mu}$ , and define the generalized coordinates  $X^M = \{X^{\mu}, \tilde{X}_{\mu}\}$ . Under transformations  $h \in O(D, D, \mathbb{R})$ , the fields and coordinates then transform as  $X^M \rightarrow h^M{}_N X^N$  and  $\mathcal{H}_{MN} \rightarrow h_M{}^P h_N{}^Q \mathcal{H}_{PQ}$ . In terms of these fields, the covariance under T duality is manifest.

The mechanism of doubling the coordinates is a bit artificial: the dual coordinates  $\tilde{X}_{\mu}$  have no physical meaning<sup>9</sup>, they just allow a T-duality covariant formulation of the theory. The fields are thus constrained to depend on the coordinates  $X^{\mu}$  only, through the section constraint

$$\eta^{MN} \partial_M \otimes \partial_N = 0, \quad (1.33)$$

where  $\otimes$  indicates that both derivative operators may act on different fields. This constraint is T-duality invariant, as it should be. It is solved by imposing  $\tilde{\partial}^{\mu} = 0$ . All other solutions of Eq. (1.33) are linked to this one through transformations of  $O(D, D, \mathbb{R})$ .

The bosonic supergravity action (1.13) is symmetric under the riemannian diffeomorphisms

$$\begin{cases} \delta_{\lambda} g_{\mu\nu} = L_{\lambda} g_{\mu\nu}, \\ \delta_{\lambda} B_{\mu\nu} = L_{\lambda} B_{\mu\nu}, \\ \delta_{\lambda} \phi = L_{\lambda} \phi, \end{cases} \quad (1.34)$$

with the Lie derivative  $L_{\lambda} V^{\mu} = \lambda^{\mu} \partial_{\nu} V^{\mu} - V^{\nu} \partial_{\nu} \lambda^{\mu}$ , and under gauge transformations

$$\delta_{\tilde{\lambda}} B_{\mu\nu} = 2 \partial_{[\mu} \tilde{\lambda}_{\nu]}. \quad (1.35)$$

In double field theory, the transformation laws for  $g_{\mu\nu}$  and  $B_{\mu\nu}$  are unified into the gauge transformation of the generalized metric  $\mathcal{H}_{MN}$ . The generalized gauge parameter is defined as  $\xi^M = \{\lambda^{\mu}, \tilde{\lambda}_{\mu}\}$  and the transformation law takes the form of the generalized diffeomorphism

$$\begin{aligned} \mathcal{L}_{\xi} \mathcal{H}_{MN} &= L_{\xi} \mathcal{H}_{MN} - \mathcal{H}_{PN} \partial^P \xi_M - \mathcal{H}_{MP} \partial^P \xi_N \\ &= \xi^P \partial_P \mathcal{H}_{MN} + \left( \partial_M \xi^P - \partial^P \xi_M \right) \mathcal{H}_{PN} + \left( \partial_N \xi^P - \partial^P \xi_N \right) \mathcal{H}_{MP}. \end{aligned} \quad (1.36)$$

Evaluating this expression for each component of  $\mathcal{H}_{MN}$  and imposing the section constraint (1.33), we indeed get the fields transformations (1.34) and (1.35):

$$\begin{cases} \mathcal{L}_{\xi} g_{\mu\nu} = L_{\lambda} g_{\mu\nu}, \\ \mathcal{L}_{\xi} B_{\mu\nu} = L_{\lambda} B_{\mu\nu} + 2 \partial_{[\mu} \tilde{\lambda}_{\nu]}. \end{cases} \quad (1.37)$$

<sup>9</sup>If one were to perform a dimensional reduction on a  $d$ -dimensional torus, one could separate the  $D$  coordinates into  $D-d$  external coordinates and  $d$  compact internal coordinates. The dual compact coordinates would then be identified to winding modes of the closed bosonic string.

The generalized diffeomorphism also preserves the  $O(D, D, \mathbb{R})$  metric  $\eta_{MN}$ , whereas the usual diffeomorphisms do not. Generally speaking, the generalized diffeomorphism of a vector  $V^M$  with no weight is

$$\mathcal{L}_\xi V^M = \xi^P \partial_P V^M - \left( \partial_P \xi^M - \partial^M \xi_P \right) V^P. \quad (1.38)$$

One can then build a two-derivative action invariant under these transformations [44]. Once expressed in terms of the  $D$ -dimensional fields and restricted to solutions of the section constraint, this action reduces to Eq. (1.13).

Recently, the framework of double field theory has been extended to include the higher-derivative  $\alpha'$  corrections of string theory. While the two-derivative double field theory can be written naturally in terms of a generalized metric, there are obstacles when including higher derivatives, that require a deformation of the framework, see Ref. [46–53]. It was proven in Ref. [54, 55] that the general  $\alpha'$  corrections of bosonic and heterotic string theory cannot be written in terms of the generalized metric, so that in particular the  $O(D, D, \mathbb{R})$  transformations of double field theory get  $\alpha'$ -deformed. Such a formulation can however be obtained by setting up a generalized frame formalism for which  $O(D, D, \mathbb{R})$  remains undeformed, while the local frame transformations receive  $\alpha'$  corrections [49, 54, 55]. In the remainder of this section, we briefly review this construction.

We introduce a frame field  $E_M^A$ , in terms of which the generalized metric (1.32) is given by

$$\mathcal{H}_{MN} = E_M^A E_N^B \kappa_{AB}, \quad (1.39)$$

where flat indices are split as  $A = (a, \bar{a})$ , with  $a, \bar{a} \in \llbracket 1, D \rrbracket$ , and we assume  $\kappa_{AB}$  to be block-diagonal. Since we make *a priori* no further assumption on  $\kappa_{AB}$ , there is a local  $GL(D) \times GL(D)$  frame invariance, acting as

$$\delta_\Lambda E_M^A = E_M^B \Lambda_B^A, \quad (1.40)$$

where  $\Lambda_A^B$  is constrained by the invariance  $\delta_\Lambda \kappa_{AB} = \delta_\Lambda \eta_{AB} = 0$ , with  $\eta_{MN} = E_M^A E_N^B \eta_{AB}$ . Then, the generalized frame fields transform under generalized diffeomorphisms, global  $O(d, d, \mathbb{R})$  and local  $GL(D) \times GL(D)$  transformations, as

$$\delta E_M^A = L_\xi E_M^A + \Gamma_M^N E_N^A + \delta_\Lambda E_M^A. \quad (1.41)$$

The  $GL(D) \times GL(D)$  gauge transformation of the frame fields (1.40) can be consistently deformed to include first-order  $\alpha'$  corrections. This deformation depends on two free parameters  $a$  and  $b$  of order  $\alpha'$  [49]:

$$\delta_\Lambda E_M^A = E_M^B \Lambda_B^A + \left( a \partial_{[M} \Lambda_C^B \mathcal{F}_{N]B}^{(-)C} - b \partial_{[M} \Lambda_C^B \mathcal{F}_{N]B}^{(+ )C} \right) E^{NA}, \quad (1.42)$$

where  $\mathcal{F}_{MAB}^{(\pm)}$  are proper projections of the generalized fluxes<sup>10</sup>

$$\mathcal{F}_{MAB} = 3 E_M^C E_{N[C} \partial^{N E^P}_{A E^Q}_{B]} \eta_{PQ}. \quad (1.43)$$

The deformation thus takes the form of a generalized Green-Schwarz transformation<sup>11</sup> for the general-

<sup>10</sup>See Ref. [49] for more details.

<sup>11</sup>The original Green-Schwarz mechanism, which triggered the first superstring revolution, is needed to show that gravitational and gauge anomalies can be canceled, for gauge groups  $SO(32)$  or  $E_8 \times E_8$ , by an  $\alpha'$  deformation of the gauge

ized frame fields. It preserves the  $O(D, D, \mathbb{R})$  structure and closes to first order. One can then build the associated gauged invariant action, to first order in  $\alpha'$ . This action is manifestly invariant under the undeformed  $O(D, D, \mathbb{R})$  transformations, only the  $GL(D) \times GL(D)$  gauge is modified. As there are two free parameters  $(a, b)$ , we get a two-parameter family of theories. For  $(a, b) = (-\alpha', -\alpha')$ , this action reproduces the bosonic string effective action of Eq. (1.13) and (1.14). The choice  $(a, b) = (-\alpha', 0)$  corresponds to the heterotic string.

With the explicit parametrization (1.32), the transformation law (1.42) induces a non-covariant Lorentz transformation for the two-form [49]:

$$\delta B_{\mu\nu} = L_\lambda B_{\mu\nu} + 2 \partial_{[\mu} \tilde{\lambda}_{\nu]} + \frac{a}{2} \text{Tr} \left( \omega_{[\mu}^{(-)} \partial_{\nu]} \Lambda \right) - \frac{b}{2} \text{Tr} \left( \omega_{[\mu}^{(+)} \partial_{\nu]} \Lambda \right), \quad (1.44)$$

with the deformed spin connection  $\omega_{\mu a}^{(\pm)b}$ . The metric  $g_{\mu\nu}$  also acquires a non-covariant Lorentz transformation, that can however be suppressed by appropriate non-covariant field redefinitions at order  $\alpha'$  (in a similar way to what Meissner observed in conventional compactification [29]). Such redefinitions are not possible for  $B_{\mu\nu}$  (at least for generic  $a$  and  $b$ ). Thus, we need to deform the definition of the three-form field strength  $H_{\mu\nu\rho}$  to ensure gauge invariance under Eq. (1.44). This is done by defining

$$\tilde{H}_{\mu\nu\rho} = H_{\mu\nu\rho} - \frac{3}{2} a \Omega_{\mu\nu\rho}^{(-)} + \frac{3}{2} b \Omega_{\mu\nu\rho}^{(+)}, \quad (1.45)$$

with the Chern-Simons three-forms

$$\Omega_{\mu\nu\rho}^{(\pm)} = \text{Tr} \left( \omega_{[\mu}^{(\pm)} \partial_{\nu} \omega_{\rho]}^{(\pm)} + \frac{2}{3} \omega_{[\mu}^{(\pm)} \omega_{\nu}^{(\pm)} \omega_{\rho]}^{(\pm)} \right). \quad (1.46)$$

In this formulation, the  $GL(D) \times GL(D)$  gauge symmetry is deformed, but the  $O(D, D, \mathbb{R})$  invariance is manifestly realized without deformation. However, if we fully gauge fix  $GL(D) \times GL(D)$ , the  $O(D, D, \mathbb{R})$  transformations get deformed through compensating gauge transformations: preserving a given gauge for  $E_M^A$  imposes a relation between the gauge parameter  $\Lambda$  and the  $O(d, d, \mathbb{R})$  parameter  $\Gamma$  in Eq. (1.41). Then,  $B_{\mu\nu}$  starts transforming under  $O(D, D, \mathbb{R})$ .

Let us finally mention that the framework of  $\alpha'$ -corrected double field theory has recently been used to study higher-derivative corrections to so-called generalized dualities (Poisson-Lie duality, non-abelian T-duality) and Yang-Baxter deformations of the bosonic string [57–61]. Second order corrections were investigated in Ref. [50], where it was shown that the Green-Schwarz transformation (1.44) of the two-form field remains uncorrected to second order. In Ref. [53, 62], a general mechanism has been proposed to compute all-order higher-derivative interactions. However, the results in Ref. [63] indicate obstacles for  $\alpha'^3$  corrections in double field theory.

## 1.5 Content of the part

In Ref. [B, C], together with Henning Samtleben and Olaf Hohm, we have given the complete dimensionally reduced action for bosonic string theory to first order in  $\alpha'$ , *i.e.* including all four-derivative terms of Eq. (1.14), and proved its  $O(d, d, \mathbb{R})$  invariance. In particular, we proved that the first-order  $\alpha'$  corrections are uniquely determined by  $O(d, d, \mathbb{R})$  invariance, up to an overall constant, whose value depends on the string theory under consideration. While this  $O(d, d, \mathbb{R})$  invariance is also implied by

---

transformations of the (singlet)  $B$ -field, thereby modifying the classical (tree-level) theory [56].



the existence of  $\alpha'$ -deformed double field theory, whose dimensional reduction has been explored in Ref. [52], it had not been systematically investigated whether some of the unexpected new features arising in double field theory also show up in the dimensional reduction of conventional (non-extended) theories, nor had the dimensionally reduced action been displayed in a sufficiently simplified form that allows for applications (and comparison with some of the earlier results cited above). To our surprise, we found that there is no choice of field variables so that the full dimensionally reduced action can be written in terms of familiar  $O(d, d, \mathbb{R})$ -covariant variables (like the generalized metric); rather, a generalized Green-Schwarz mechanism is required under which the (external) singlet  $B$ -field acquires non-trivial transformations under  $O(d, d, \mathbb{R})$ , hence implying that the  $O(d, d, \mathbb{R})$  action gets  $\alpha'$ -deformed. This effect has been invisible in all truncations investigated so far, but it does mimic the situation in double field theory before reduction. Intriguingly, the  $\alpha'$  deformations needed in double field theory can thus not be blamed entirely on its novel geometric structure, but such deformations also emerge in completely conventional dimensional reductions.

On a technical level, the investigation in Ref. [B, C] requires full control over all possible field redefinitions, both redefinitions that are covariant in the usual sense (*i.e.*  $GL(d)$  covariant) and covariant with respect to  $O(d, d, \mathbb{R})$ . As one of the main technical results of these papers, we developed a fully systematic procedure to test  $O(d, d, \mathbb{R})$  invariance, generalizing that of Ref. [33, 34] to higher dimensions. We first employed  $O(d, d, \mathbb{R})$ -covariant redefinitions in order to find the minimal set of  $O(d, d, \mathbb{R})$ -invariant four-derivative terms, which we then decomposed under  $GL(d)$  with the aim to match with the dimensionally reduced terms. Next, we dimensionally reduced the action as usual and used  $GL(d)$ -covariant field redefinitions to bring the action into a form that can be compared to the  $GL(d)$  decomposition of the minimal  $O(d, d, \mathbb{R})$ -invariant terms. We applied this analysis at first order in  $\alpha'$  to the bosonic string theory, and found that there exists a basis of  $O(d, d, \mathbb{R})$ -invariant four-derivative terms in which all fields apart from the metric appear only with first-order derivatives. Thus, the  $GL(d)$ -covariant field redefinitions were employed to get rid of all terms carrying higher-order derivatives. The procedure we used is schematically represented in Fig. 1.2.

The part is organized as follows. In Chap. 2, we review the dimensional reduction of the leading two-derivative action of the bosonic string, and its manifestly  $O(d, d, \mathbb{R})$ -symmetric formulation revealed in Ref. [25]. In order to set up a systematic analysis of its higher-order corrections, we outline how to organize and fix the ambiguities related to partial integration and higher-order field redefinitions. In Chap. 3, we present a general counting of independent higher-derivative terms upon modding out these ambiguities. We use the tools of combinatorics, which we introduce. At order  $\alpha'$ , we construct an explicit 61-dimensional basis of independent  $O(d, d, \mathbb{R})$ -invariant four-derivative terms, which is algebraic in first-order derivatives and the Riemann tensor. Chap. 4 presents the explicit torus reduction of the four-derivative action of the bosonic string. In particular, we show how all second-order derivatives in the reduced action can be eliminated by suitable field redefinitions. Comparing the result to our explicit basis, we show that apart from a single term the entire reduced action can be rewritten in terms of manifestly  $O(d, d, \mathbb{R})$ -invariant terms. Restoring  $O(d, d, \mathbb{R})$  invariance of the full action then requires a Green-Schwarz type mechanism inducing a non-trivial  $O(d, d, \mathbb{R})$  transformation of order  $\alpha'$  for the two-form  $B_{\mu\nu}$ . Then, to make the link with the results in double field theory, we embed this structure into a frame formalism in which the  $O(d, d, \mathbb{R})$  symmetry remains undeformed, while the local frame transformations acquire  $\alpha'$  deformations. The appendices collect a number of explicit technical results.

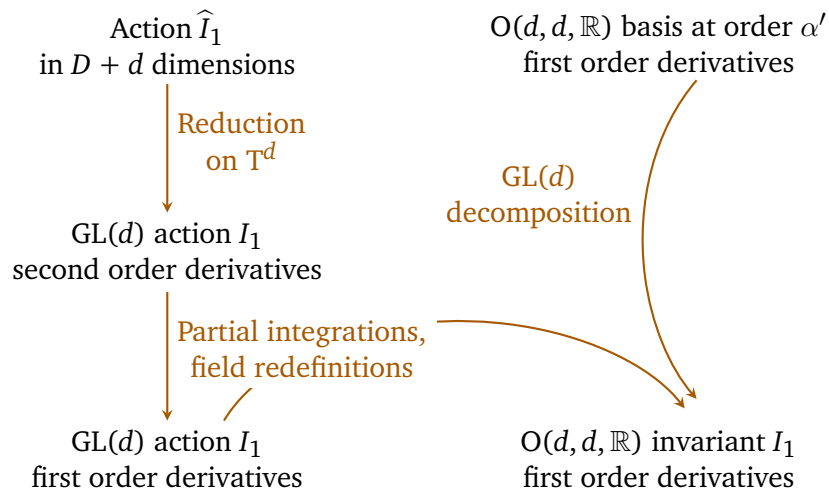

**Fig. 1.2** Schematic representation of the procedure used to identify the  $O(d, d, \mathbb{R})$  invariance of the four-derivative action of bosonic supergravity. The higher-dimensional four-derivative action  $\widehat{I}_1$  is reduced on a torus  $T^d$ , leading to a  $GL(d)$ -invariant action  $I_1$  carrying second-order derivatives. Due to the existence of a basis of  $O(d, d, \mathbb{R})$ -invariant four-derivative terms with first-order derivatives only, partial integrations and field redefinitions are systematically used to get rid of all higher-order derivatives in  $I_1$ . The resulting action is compared to the  $GL(d)$  decomposition of the  $O(d, d, \mathbb{R})$ -invariant terms, to identify the  $O(d, d, \mathbb{R})$ -invariant form of action  $I_1$ .





# 2 Two-derivative action and field redefinitions

Our main goal is to compute the dimensional reduction of the bosonic supergravity on a  $d$ -dimensional torus including the first-order corrections in  $\alpha'$  and to make the resulting  $O(d, d, \mathbb{R})$  symmetry manifest. In this chapter, we review the reduction of the two-derivative action and its manifestly  $O(d, d, \mathbb{R})$ -symmetric formulation first exhibited in Ref. [25]. We then discuss its field equations and the systematics of non-linear field redefinitions as a starting point for the subsequent systematic analysis of the higher-order corrections.

## 2.1 Reduction and $O(d, d, \mathbb{R})$ symmetry

Let us start from the two-derivative effective action for the bosonic string in  $D + d$  dimensions, with metric  $\hat{g}_{\hat{\mu}\hat{\nu}}$ , antisymmetric Kalb-Ramond field  $\hat{B}_{\hat{\mu}\hat{\nu}}$  and dilaton  $\hat{\phi}$ :

$$\hat{I}_0 = \int d^{D+d}X \sqrt{-\hat{g}} e^{-\hat{\phi}} \left( \hat{R} + \partial_{\hat{\mu}} \hat{\phi} \partial^{\hat{\mu}} \hat{\phi} - \frac{1}{12} \hat{H}^2 \right), \quad (2.1)$$

where indices  $\hat{\mu}$  run over the  $(D + d)$ -dimensional space, and  $\hat{H}^2 = \hat{H}^{\hat{\mu}\hat{\nu}\hat{\rho}} \hat{H}_{\hat{\mu}\hat{\nu}\hat{\rho}}$  with the field strength  $\hat{H}_{\hat{\mu}\hat{\nu}\hat{\rho}} = 3 \partial_{[\hat{\mu}} \hat{B}_{\hat{\nu}\hat{\rho}]}$ . To compactify on the spatial torus  $T^d$ , we use the index split  $X^{\hat{\mu}} = \{x^\mu, y^m\}$ , with  $\mu \in \llbracket 1, D \rrbracket$ ,  $m \in \llbracket 1, d \rrbracket$ , for curved indices and  $\{\hat{\alpha}\} = \{\alpha, a\}$ , with  $\alpha \in \llbracket 1, D \rrbracket$ ,  $a \in \llbracket 1, d \rrbracket$  for flat indices, and drop the dependence of all fields on the internal coordinates  $y^m$ . For the metric  $\hat{g}_{\hat{\mu}\hat{\nu}}$ , we use the vielbein formalism and consider the standard Kaluza-Klein ansatz (in string frame)

$$\hat{e}_{\hat{\mu}}^{\hat{\alpha}} = \begin{pmatrix} e_{\mu}^{\alpha} & A_{\mu}^{(1)n} E_n^a \\ 0 & E_m^a \end{pmatrix}, \quad (2.2)$$

in terms of the  $D$ -dimensional vielbein  $e_{\mu}^{\alpha}$ , Kaluza-Klein vector fields  $A_{\mu}^{(1)m}$ , and the internal vielbein  $E_m^a$ . The metric  $\hat{g}_{\hat{\mu}\hat{\nu}} = \hat{e}_{\hat{\mu}}^{\hat{\alpha}} \eta_{\hat{\alpha}\hat{\beta}} \hat{e}_{\hat{\nu}}^{\hat{\beta}}$  then takes the form

$$\hat{g}_{\hat{\mu}\hat{\nu}} = \begin{pmatrix} g_{\mu\nu} + A_{\mu}^{(1)p} G_{pq} A_{\nu}^{(1)q} & A_{\mu}^{(1)p} G_{pn} \\ G_{mp} A_{\nu}^{(1)p} & G_{mn} \end{pmatrix}, \quad (2.3)$$

where  $g_{\mu\nu} = e_{\mu}^{\alpha} \eta_{\alpha\beta} e_{\nu}^{\beta}$  and  $G_{mn} = E_m^a \delta_{ab} E_n^b$  denote the  $D$ -dimensional metric and the internal metric, respectively.

Similarly, the two-form  $\hat{B}_{\hat{\mu}\hat{\nu}}$ , is parametrized as [25]

$$\hat{B}_{\hat{\mu}\hat{\nu}} = \begin{pmatrix} B_{\mu\nu} - A_{[\mu}^{(1)m} A_{\nu]}^{(2)} + A_{\mu}^{(1)m} B_{mn} A_{\nu}^{(1)n} & A_{\mu n}^{(2)} - B_{np} A_{\mu}^{(1)p} \\ -A_{\nu m}^{(2)} + B_{mp} A_{\nu}^{(1)p} & B_{mn} \end{pmatrix}, \quad (2.4)$$

in terms of  $D$ -dimensional scalars  $B_{mn} = -B_{nm}$ , vector fields  $A_{\mu m}^{(2)}$ , and a two-form  $B_{\mu\nu}$ . The lower-dimensional components of  $\hat{H}_{\hat{\mu}\hat{\nu}\hat{\rho}}$  are defined using the standard Kaluza-Klein procedure [25]: first converting  $\hat{H}$  to flat indices, block decomposing, and finally converting back to curved indices using the lower-dimensional blocks  $e_{\mu}^{\alpha}$  and  $E_m^a$ . This amounts to converting a curved index  $\hat{\mu}$  to a curved index  $\mu$  using contraction with  $e_{\mu}^{\alpha}\hat{e}_{\alpha}^{\hat{\mu}}$  and to  $m$  contracting with  $E_m^a\hat{e}_a^{\hat{m}}$ , such that the resulting fields transform covariantly under internal diffeomorphisms<sup>12</sup>. With Eq. (2.3), this leads to

$$\begin{cases} H_{\mu\nu\rho} = 3\partial_{[\mu}B_{\nu\rho]} - \frac{3}{2}\left(A_{[\mu}^{(1)m}F_{\nu\rho]m}^{(2)} + F_{[\mu\nu}^{(1)m}A_{\rho]m}^{(2)}\right), \\ H_{\mu\nu m} = F_{\mu\nu m}^{(2)} - B_{mn}F_{\mu\nu}^{(1)n}, \\ H_{\mu mn} = \nabla_{\mu}B_{mn}, \\ H_{mnp} = 0, \end{cases} \quad (2.5)$$

where we have defined the abelian field strengths

$$\begin{cases} F_{\mu\nu}^{(1)m} = \partial_{\mu}A_{\nu}^{(1)m} - \partial_{\nu}A_{\mu}^{(1)m}, \\ F_{\mu\nu m}^{(2)} = \partial_{\mu}A_{\nu m}^{(2)} - \partial_{\nu}A_{\mu m}^{(2)}. \end{cases} \quad (2.6)$$

Note that the field-strength  $H_{\mu\nu\rho}$  features abelian Chern-Simons terms.

In terms of these objects, after dimensional reduction, the action (2.1) then takes the form [25]

$$\begin{aligned} I_0 = \int d^Dx \sqrt{-g} e^{-\Phi} & \left( R + \partial_{\mu}\Phi\partial^{\mu}\Phi - \frac{1}{12}H_{\mu\nu\rho}H^{\mu\nu\rho} + \frac{1}{4}\text{Tr}\left(\partial_{\mu}G\partial^{\mu}G^{-1}\right) \right. \\ & \left. + \frac{1}{4}\text{Tr}\left(G^{-1}\partial_{\mu}BG^{-1}\partial^{\mu}B\right) - \frac{1}{4}F_{\mu\nu}^{(1)m}G_{mn}F^{(1)\mu\nu n} - \frac{1}{4}H_{\mu\nu m}G^{mn}H^{\mu\nu n} \right), \end{aligned} \quad (2.7)$$

with the rescaled dilaton  $\Phi = \hat{\phi} - \ln(\det(G_{mn}))/2$ . In this form, the action features an explicit  $\text{GL}(d)$  symmetry, as guaranteed by toroidal reduction. The symmetry enhancement to  $\text{O}(d, d, \mathbb{R})$  can be made manifest upon regrouping the vector fields  $A_{\mu}^{(1)m}$  and  $A_{\mu m}^{(2)}$  into a single  $\text{O}(d, d, \mathbb{R})$  vector

$$\mathcal{A}_{\mu}^M = \begin{pmatrix} A_{\mu}^{(1)m} \\ A_{\mu m}^{(2)} \end{pmatrix}, \quad (2.8)$$

and the scalar fields  $G_{mn}, B_{mn}$  into an  $\text{O}(d, d, \mathbb{R})$  matrix

$$\mathcal{H}_{MN} = \begin{pmatrix} G_{mn} - B_{mp}G^{pq}B_{qn} & B_{mp}G^{pn} \\ -G^{mp}B_{pn} & G^{mn} \end{pmatrix}, \quad (2.9)$$

as previously seen in Sec. 1.2. Throughout, the fundamental  $\text{O}(d, d, \mathbb{R})$  indices are raised and lowered using the constant  $\text{O}(d, d, \mathbb{R})$ -invariant matrix

$$\eta^{MN} = \begin{pmatrix} 0 & \delta^m_n \\ \delta_m^n & 0 \end{pmatrix}, \quad (2.10)$$

so that  $\mathcal{H}^{-1}$  is defined as  $\mathcal{H}^{MN} = \eta^{MP}\mathcal{H}_{PQ}\eta^{QN}$ . In terms of the fields (2.8), (2.9), the reduced

<sup>12</sup>Note that it is not the procedure that is used on  $\hat{B}$ , as pointed out in Ref. [27].

action (2.7) may be cast into the manifestly  $O(d, d, \mathbb{R})$ -invariant form [25]

$$I_0 = \int d^D x \sqrt{-g} e^{-\Phi} \left( R + \partial_\mu \Phi \partial^\mu \Phi + \frac{1}{8} \partial_\mu \mathcal{H}_{MN} \partial^\mu \mathcal{H}^{MN} - \frac{1}{4} \mathcal{F}_{\mu\nu}^M \mathcal{H}_{MN} \mathcal{F}^{\mu\nu N} - \frac{1}{12} H_{\mu\nu\rho} H^{\mu\nu\rho} \right), \quad (2.11)$$

where  $\mathcal{F}_{\mu\nu}^M = 2 \partial_{[\mu} \mathcal{A}_{\nu]}^M$  is the abelian field-strength, with components (2.6), associated to the vectors (2.8). In terms of the covariant objects (2.8) and (2.9), the infinitesimal  $O(d, d, \mathbb{R})$  variations of the fields are given by

$$\begin{cases} \delta_\Gamma g_{\mu\nu} = 0, \\ \delta_\Gamma B_{\mu\nu} = 0, \end{cases} \quad \begin{cases} \delta_\Gamma \mathcal{H}_{MN} = \Gamma_M^P \mathcal{H}_{PN} + \Gamma_N^P \mathcal{H}_{MP}, \\ \delta_\Gamma \mathcal{F}_{\mu\nu}^M = -\mathcal{F}_{\mu\nu}^N \Gamma_N^M, \end{cases} \quad (2.12)$$

for  $\Gamma_M^N \in \mathfrak{o}(d, d, \mathbb{R})$ . The action (2.11) is manifestly invariant under these transformations. This proves the statement mentioned in Sec. 1.2, that in the low-energy limit the  $O(d, d, \mathbb{Z})$  duality of string theory turns into a continuous  $O(d, d, \mathbb{R})$  symmetry. For later convenience, we also rewrite the action in terms of the matrix  $\mathcal{S}_M^N = \mathcal{H}_{MP} \eta^{PN}$

$$I_0 = \int d^D x \sqrt{-g} e^{-\Phi} \left( R + \partial_\mu \Phi \partial^\mu \Phi + \frac{1}{8} \text{Tr} (\partial_\mu \mathcal{S} \partial^\mu \mathcal{S}) - \frac{1}{4} \mathcal{F}_{\mu\nu}^M \mathcal{S}_M^N \mathcal{F}^{\mu\nu N} - \frac{1}{12} H_{\mu\nu\rho} H^{\mu\nu\rho} \right). \quad (2.13)$$

Note that  $\mathcal{S}\mathcal{S} = \mathbb{1}$ , so that  $\mathcal{S}$  is a constrained field.

## 2.2 GL( $d$ ) fields redefinitions

Our aim is an extension of the previous construction to higher orders in  $\alpha'$ . As usual, the study of higher-derivative terms requires to carefully handle the ambiguities due to the possible non-linear field redefinitions. In particular, the symmetry enhancement to  $O(d, d, \mathbb{R})$  will only be possible after identification of the proper field redefinitions. In this section, we describe the systematics of higher-order field redefinitions based on the two-derivative action (2.11), inspired by Ref. [33, 34].

We consider the  $\alpha'$  extension of Eq. (2.11) as a perturbation series

$$I = I_0 + I_1 + \mathcal{O}(\alpha'^2), \quad (2.14)$$

with the first order term  $I_1 \sim \mathcal{O}(\alpha')$ . In order to organize the possible ambiguities in  $I_1$ , we consider field redefinitions of the form

$$\varphi \rightarrow \varphi + \alpha' \delta\varphi, \quad (2.15)$$

where  $\varphi$  denotes a generic field. Under such redefinitions of its fields, the variation of  $I$  to order  $\alpha'$  arises exclusively from the variation of  $I_0$  and takes the form

$$\begin{aligned} \delta I_0 = \alpha' \int d^D x \sqrt{-g} e^{-\Phi} \left[ \mathcal{E}_\Phi \delta\Phi + (\mathcal{E}_g)_{\mu\nu} \delta g^{\mu\nu} + (\mathcal{E}_B)_{\mu\nu} \delta B^{\mu\nu} + (\mathcal{E}_G)_{mn} \delta G^{mn} \right. \\ \left. + (\mathcal{E}_B)^{mn} \delta B_{mn} + (\mathcal{E}_{A(1)})^\mu_m \delta A_\mu^{(1)m} + (\mathcal{E}_{A(2)})^{\mu m} \delta A_{\mu m}^{(2)} \right], \end{aligned} \quad (2.16)$$

proportional to the field equations associated with the two-derivative action  $I_0$

$$\mathcal{E}_\Phi = -2\Box\Phi - R + \nabla_\mu \Phi \nabla^\mu \Phi + \frac{1}{12} H^2 - \frac{1}{8} \text{Tr} (\nabla_\mu \mathcal{S} \nabla^\mu \mathcal{S}) + \frac{1}{4} \mathcal{F}_{\mu\nu}^M \mathcal{S}_M^N \mathcal{F}^{\mu\nu N}, \quad (2.17a)$$

$$(\mathcal{E}_g)_{\mu\nu} = R_{\mu\nu} + \nabla_\mu \nabla_\nu \Phi - \frac{1}{4} H_{\mu\nu}^2 + \frac{1}{8} \text{Tr} (\nabla_\mu S \nabla_\nu S) - \frac{1}{2} \mathcal{F}_{\mu\rho}^M \mathcal{S}_M^N \mathcal{F}_{\nu}{}^\rho{}_N + \frac{1}{2} g_{\mu\nu} \mathcal{E}_\Phi, \quad (2.17b)$$

$$(\mathcal{E}_B)_{\mu\nu} = \frac{1}{2} (\nabla^\rho H_{\rho\mu\nu} - \nabla^\rho \Phi H_{\rho\mu\nu}), \quad (2.17c)$$

$$(\mathcal{E}_G)_{mn} = \frac{1}{2} \left[ -\square G_{mn} + \nabla_\mu \Phi \nabla^\mu G_{mn} - \left( \nabla_\mu G \nabla^\mu G^{-1} G \right)_{mn} + \left( \nabla_\mu B G^{-1} \nabla^\mu B \right)_{mn} \right. \\ \left. + \frac{1}{2} G_{mp} F_{\mu\nu}^{(1)p} F^{(1)\mu\nu q} G_{qn} - \frac{1}{2} H_{\mu\nu m} H^{\mu\nu}{}_n \right], \quad (2.17d)$$

$$(\mathcal{E}_B)^{mn} = \frac{1}{2} \left[ \left( G^{-1} \square B G^{-1} \right)^{mn} - \nabla_\mu \Phi \left( G^{-1} \nabla^\mu B G^{-1} \right)^{mn} + \left( G^{-1} \nabla_\mu B \nabla^\mu G^{-1} \right)^{mn} \right. \\ \left. + \left( \nabla_\mu G^{-1} \nabla^\mu B G^{-1} \right)^{mn} + \frac{1}{2} G^{mp} H_{\mu\nu p} F^{(1)\mu\nu n} - \frac{1}{2} F^{(1)\mu\nu m} G^{np} H_{\mu\nu p} \right], \quad (2.17e)$$

$$(\mathcal{E}_{A^{(1)}})^\nu{}_n = \nabla_\mu F^{(1)\mu\nu m} G_{mn} - \nabla_\mu \Phi F^{(1)\mu\nu m} G_{mn} - \frac{1}{2} H^{\mu\nu\rho} H_{\mu\rho n} - (\mathcal{E}_{A^{(2)}})^\nu{}_m B_{mn} \\ + F^{(1)\mu\nu m} \nabla_\mu G_{mn} - H^{\mu\nu}{}_m \left( G^{-1} \nabla_\mu B \right)^m{}_n + (\mathcal{E}_B)^{\mu\nu} \left( A_{\mu n}^{(2)} - B_{nm} A_\mu^{(1)m} \right), \quad (2.17f)$$

$$(\mathcal{E}_{A^{(2)}})^\nu{}_m = \nabla_\mu H^{\mu\nu}{}_n G^{nm} - \nabla_\mu \Phi H^{\mu\nu}{}_n G^{nm} + H^{\mu\nu}{}_n \nabla_\mu G^{nm} + \frac{1}{2} H^{\mu\rho\nu} F_{\mu\rho}^{(1)m} \\ + (\mathcal{E}_B)^{\mu\nu} A_\mu^{(1)m}. \quad (2.17g)$$

Here,  $H_{\mu\nu}^2 = H_{\mu\rho\sigma} H_\nu{}^{\rho\sigma}$ ,  $\nabla_\mu$  denotes the covariant derivative with respect to  $g_{\mu\nu}$  and accordingly  $\square = \nabla_\mu \nabla^\mu$ . At order  $\alpha'$ , the action is thus unique up to contributions proportional to the lowest order field equations. In Chap. 4, we will show that by field redefinitions (2.15), the transformation (2.16) together with partial integrations allow to map all terms at order  $\alpha'$  to a basis which carries only first derivatives of all fields (except for the two-derivative terms within the Riemann tensor).

As an example, let us show how a term carrying the factor  $\square\Phi$  can be replaced by terms carrying only products of first derivatives. Consider a generic term of  $I_1$  of the form

$$Z = \alpha' \int d^D x \sqrt{-g} e^{-\Phi} X \square\Phi, \quad (2.18)$$

where  $X$  is a function of  $\Phi$ ,  $R_{\mu\nu\rho\sigma}$ ,  $H_{\mu\nu\rho}$ ,  $G_{mn}$ ,  $B_{mn}$ ,  $F_{\mu\nu}^{(1)m}$  and  $H_{\mu\nu m}$  (and their derivatives), which carries exactly two derivatives. Redefining the dilaton and the metric as in Eq. (2.15) with  $\delta g_{\mu\nu} = \lambda g_{\mu\nu}$ , Eq. (2.16) yields the transformation

$$\delta I_0 = \alpha' \int d^D x \sqrt{-g} e^{-\Phi} \left[ \square\Phi \left( -2\delta\Phi + \lambda(D+1) \right) + \frac{1}{2} R \left( -2\delta\Phi + \lambda(D+2) \right) \right. \\ \left. + \nabla_\mu \Phi \nabla^\mu \Phi \left( \delta\Phi - \frac{D}{2} \lambda \right) + \frac{1}{24} H^2 \left( 2\delta\Phi - \lambda(D+6) \right) \right. \\ \left. - \frac{1}{16} \text{Tr} (\nabla_\mu S \nabla^\mu S) \left( -2\delta\Phi + \lambda(D+2) \right) \right. \\ \left. + \frac{1}{8} \mathcal{F}_{\mu\nu}^M \mathcal{S}_M^N \mathcal{F}^{\mu\nu}{}_N \left( 2\delta\Phi - \lambda(D+4) \right) \right]. \quad (2.19)$$

With the particular choice

$$\begin{cases} \delta\Phi = \frac{1}{2} (D+2) X, \\ \lambda = X, \end{cases} \quad (2.20)$$

the new terms (2.19) cancel the term  $Z$  and replace it by

$$Z' = \alpha' \int d^D x \sqrt{-g} e^{-\Phi} X \left( \nabla_\mu \Phi \nabla^\mu \Phi - \frac{1}{6} H^2 - \frac{1}{4} \mathcal{F}_{\mu\nu}^M \mathcal{S}_M^N \mathcal{F}^{\mu\nu}_N \right), \quad (2.21)$$

which carries only products of first-order derivatives.

In the same fashion, all the four-derivative terms carrying the leading two-derivative contributions from the field equations (2.17) can be transformed into terms carrying only products of first order derivatives. We may summarize the resulting replacement rules as

$$\begin{aligned} \square\Phi &\longrightarrow \mathcal{Q}_\Phi = \nabla_\mu \Phi \nabla^\mu \Phi - \frac{1}{6} H^2 - \frac{1}{4} \mathcal{F}_{\mu\nu}^M \mathcal{S}_M^N \mathcal{F}_N^{\mu\nu}, \\ R_{\mu\nu} &\longrightarrow \mathcal{Q}_{g\mu\nu} = -\nabla_{((\mu} \nabla_{\nu))} \Phi + \frac{1}{4} H_{\mu\nu}^2 - \frac{1}{8} \text{Tr} (\nabla_\mu \mathcal{S} \nabla_\nu \mathcal{S}) + \frac{1}{2} \mathcal{F}_{\mu\rho}^M \mathcal{S}_M^N \mathcal{F}_\nu^{\rho N} \\ &\quad - \frac{1}{D} g_{\mu\nu} \left( \nabla_\rho \Phi \nabla^\rho \Phi - \frac{1}{6} H^2 - \frac{1}{4} \mathcal{F}_{\rho\sigma}^M \mathcal{S}_M^N \mathcal{F}_N^{\rho\sigma} \right), \\ \nabla^\mu H_{\mu\rho\sigma} &\longrightarrow \mathcal{Q}_{B\rho\sigma} = \nabla^\mu \Phi H_{\mu\rho\sigma}, \\ \square G_{mn} &\longrightarrow \mathcal{Q}_{Gmn} = \nabla_\mu \Phi \nabla^\mu G_{mn} - \nabla_\mu G_{mp} \nabla^\mu G^{pq} G_{qn} - \frac{1}{2} H_{\mu\nu m} H^{\mu\nu}_n \\ &\quad + \nabla_\mu B_{mp} G^{pq} \nabla^\mu B_{qn} + \frac{1}{2} F_{\mu\nu}^{(1)p} G_{pm} F^{(1)\mu\nu q} G_{qn}, \\ \square B_{mn} &\longrightarrow \mathcal{Q}_{Bmn} = \nabla_\mu \Phi \nabla^\mu B_{mn} - \nabla_\mu B_{mp} \nabla^\mu G^{pq} G_{qn} - G_{mp} \nabla^\mu G^{pq} \nabla_\mu B_{qn} \\ &\quad - \frac{1}{2} H_{\mu\nu m} F^{(1)\mu\nu p} G_{pn} + \frac{1}{2} G_{mp} F^{(1)\mu\nu p} H_{\mu\nu n}, \\ \nabla_\mu F^{(1)\mu\nu m} &\longrightarrow \mathcal{Q}_{A^{(1)\nu m}} = \nabla_\mu \Phi F^{(1)\mu\nu m} + H^{\mu\nu}_n G^{np} \nabla_\mu B_{pq} G^{qm} \\ &\quad + \frac{1}{2} H^{\mu\nu\rho} H_{\mu\rho n} G^{nm} - F^{(1)\mu\nu n} \nabla_\mu G_{np} G^{pm}, \\ \nabla_\mu H^{\mu\nu}_m &\longrightarrow \mathcal{Q}_{A^{(2)\nu m}} = \nabla_\mu \Phi H^{\mu\nu}_m - H^{\mu\nu}_n \nabla_\mu G^{np} G_{pm} + \frac{1}{2} H^{\mu\nu\rho} F_{\mu\rho}^{(1)n} G_{nm}. \end{aligned} \quad (2.22)$$

Double parenthesis  $((\dots))$  in the second line refer to traceless symmetrization. The associated field redefinitions are collected in Tab. 2.1. As we will show in Chap. 4, all four-derivative terms carrying derivatives of order higher than one can be mapped into the terms listed in Tab. 2.1 upon using partial integration and Bianchi identities.

Term in the action	Field redefinitions	Replacement
$\alpha' X \square \Phi$	$\begin{cases} \delta \Phi = \frac{1}{2} (D + 2) X \\ \delta g_{\mu\nu} = g_{\mu\nu} X \end{cases}$	$\alpha' X \mathcal{Q}_\Phi$
$\alpha' X^{\mu\nu} R_{\mu\nu}$	$\begin{cases} \delta g_{\mu\nu} = -X_{(\mu\nu)} - \frac{1}{D} g_{\mu\nu} X_{\rho}{}^{\rho} \\ \delta \Phi = -\frac{1}{D} X_{\mu}{}^{\mu} \end{cases}$	$\alpha' X^{\mu\nu} \mathcal{Q}_{g_{\mu\nu}}$
$\alpha' X^{\mu\nu} \nabla^{\rho} H_{\rho\mu\nu}$	$\delta B_{\mu\nu} = -2 X_{[\mu\nu]}$	$\alpha' X^{\mu\nu} \mathcal{Q}_{B_{\mu\nu}}$
$\alpha' X^{mn} \square G_{mn}$	$\delta G^{mn} = 2 X^{(mn)}$	$\alpha' X^{mn} \mathcal{Q}_{G_{mn}}$
$\alpha' X^{mn} \square B_{mn}$	$\delta B_{mn} = -2 G_{mp} X^{[pq]} G_{qn}$	$\alpha' X^{mn} \mathcal{Q}_{B_{mn}}$
$\alpha' X_{\nu m} \nabla_{\mu} F^{(1)\mu\nu m}$	$\begin{cases} \delta A_{\mu}^{(1)m} = -X_{\mu n} G^{nm} \\ \delta A_{\mu m}^{(2)} = -X_{\mu n} G^{np} B_{mp} \\ \delta B_{\mu\nu} = \left( A_{[\mu m}^{(2)} X_{\nu]n} G^{mn} - B_{mn} A_{[\mu}^{(1)n} X_{\nu]p} G^{mp} \right) \end{cases}$	$\alpha' X_{\nu m} \mathcal{Q}_{A^{(1)\nu m}}$
$\alpha' X_{\nu}{}^m \nabla_{\mu} H^{\mu\nu}{}_{\!m}$	$\begin{cases} \delta A_{\mu m}^{(2)} = -X_{\mu}{}^n G_{nm} \\ \delta B_{\mu\nu} = A_{[\mu}^{(1)m} X_{\nu]}{}^n G_{mn} \end{cases}$	$\alpha' X_{\nu}{}^m \mathcal{Q}_{A^{(2)\nu}{}_{\!m}}$

**Tab. 2.1** Replacement rules for the terms carrying the leading two-derivative contribution from the field equations descending from the two-derivative action (2.7) and associated field redefinitions. The explicit replacement rules are given in Eq. (2.22).

# 3 Chapter

## $O(d, d, \mathbb{R})$ -invariant basis

We have outlined in Sec. 1.5 a procedure to tackle the question of the  $O(d, d, \mathbb{R})$  invariance of the bosonic supergravity at first order in  $\alpha'$ . There, we have insisted on the need to build a basis of  $O(d, d, \mathbb{R})$ -invariant four-derivative terms to guide the use of the field redefinitions designed in the Chap. 2. We present here how to build a basis of  $O(d, d, \mathbb{R})$  and gauge invariant actions carrying a given amount of derivatives of the fields

$$\Phi, \mathcal{H}^{MN}, \mathcal{A}_\mu^M, B_{\mu\nu} \text{ and } g_{\mu\nu}. \quad (3.1)$$

This counting is organized as follows. We first enumerate all  $O(d, d, \mathbb{R})$  and gauge invariant factors built with each type of fields, upon dividing out field redefinitions and Bianchi identities. These factors, such as

$$\nabla_\mu \Phi, \text{Tr} \left( \partial_\mu \mathcal{H} \partial_\nu \mathcal{H}^{-1} \right) \text{ and } \nabla_\lambda \mathcal{F}_{\mu\nu}^M \mathcal{H}_{MN} \mathcal{F}_{\rho\sigma}^N, \quad (3.2)$$

could then be considered as letters from which one can form spacetime singlet words

$$\nabla_\mu \Phi \nabla_\nu \Phi \text{Tr} \left( \partial^\mu \mathcal{H} \partial^\nu \mathcal{H}^{-1} \right), \nabla_\mu \Phi \nabla^\mu \mathcal{F}_{\nu\rho}^M \mathcal{H}_{MN} \mathcal{F}^\nu{}_\sigma{}^N \text{Tr} \left( \partial^\rho \mathcal{H} \partial^\sigma \mathcal{H}^{-1} \right) \dots \quad (3.3)$$

The words thus written are by construction  $O(d, d, \mathbb{R})$  and gauge invariant. Then, generating  $O(d, d, \mathbb{R})$  and gauge invariant actions amounts in enumerating all those words, upon modding out partial integrations. The initial problem is therefore reduced to defining the alphabet of  $O(d, d, \mathbb{R})$ -invariant letters, and generating all the different words that can be written with these letters.

The appropriate framework for dealing with this kind of issue is that of combinatorics. More specifically, we will need the Pólya enumeration theorem, which allows to deal with enumeration problems by taking into account reorganization symmetries. We first consider a simple example in Sec. 3.1 to illustrate the counting methods. Then, we review the Pólya enumeration theorem in Sec. 3.2 and turn to the construction of the alphabet of interest for our purpose in Sec. 3.3. We finally give in Sec. 3.4 examples at the level of four derivatives, *i.e.* first-order  $\alpha'$  corrections, and build in Sec. 3.5 the basis we are interested in.

### 3.1 A first example: counting words up to rearrangement of letters

Let us first consider an example. In this section, we will be interested in symmetric words: for a given alphabet  $\mathfrak{A}$ , we identify words that are mapped into each others by rearrangement of their letters, *i.e.* for  $x_1, \dots, x_n \in \mathfrak{A}$ ,

$$x_1 \dots x_n \equiv x_{\sigma(1)} \dots x_{\sigma(n)}, \text{ for } \sigma \in S_n, \quad (3.4)$$

where  $n \in \mathbb{N}$  and  $S_n$  is the symmetric group of degree  $n$ , which contains all permutations on  $n$  symbols. In the case where the alphabet  $\mathfrak{A} = \{a, b, c\}$  contains only three letters, the words of up to three letters



one can write up to rearrangement are the following:

$$\begin{array}{ll}
 \text{one letter} & a, b, c \\
 \text{two letters} & aa, ab, ac, bb, bc, cc \\
 \text{three letters} & aaa, aab, aac, abb, abc, acc, bbb, bbc, bcc, ccc.
 \end{array} \tag{3.5}$$

Those enumerations of words are not easy to manipulate, and we would like a single mathematical object that encodes them. What we need is a generating function, *i.e.* a formal series whose coefficients encode some data of interest<sup>13</sup>. The sequence  $\{1, a, a^2, a^3, \dots\}$  can for example be stored in the function

$$G(t) = \sum_{n \in \mathbb{N}} a^n t^n, \tag{3.6}$$

which could be formally expressed as

$$G(t) = \frac{1}{1 - at}. \tag{3.7}$$

We could then group the words (3.5) by their number of letters, and encode them in the series

$$\begin{aligned}
 H(t, a, b, c) = & 1 + (a + b + c)t + (aa + ab + ac + bb + bc + cc)t^2 \\
 & + (aaa + aab + aac + abb + abc + acc + bbb + bbc + bcc + ccc)t^3 + \dots
 \end{aligned} \tag{3.8}$$

so that the coefficient of order  $t^n$  gives all the words that one can write with  $n$  letters of the alphabet  $\mathfrak{A}$ , up to rearrangement of these letters.  $H$  can be expressed in the compact form

$$H(t, a, b, c) = \frac{1}{1 - at} \frac{1}{1 - bt} \frac{1}{1 - ct} = \exp \left( \sum_{k \geq 1} \frac{1}{k} (a^k + b^k + c^k) t^k \right). \tag{3.9}$$

This is the generating function of complete homogeneous symmetric functions with the variables  $a$ ,  $b$  and  $c$  [64]. One can then simply count the symmetric words of a given length by considering the coefficients of  $H(t, 1, 1, 1)$ . This generating function can also be used to solve other enumeration problems, as the enumeration of symmetric words with  $n$  letters carrying exactly two  $a$ , which is given by the coefficient  $a^2 t^n$  of  $H$ . For later use, we finally define the generating function of the alphabet  $\mathfrak{A} = \{a, b, c\}$

$$\mathcal{Z}_{\mathfrak{A}}(t, a, b, c) = (a + b + c)t, \tag{3.10}$$

so that the generating function (3.9) takes the form

$$H(t, a, b, c) = \exp \left( \sum_{k \geq 1} \frac{1}{k} \mathcal{Z}_{\mathfrak{A}}(t^k, a^k, b^k, c^k) \right). \tag{3.11}$$

Let us sum up what we learnt from this simple example: the enumeration of words satisfying a given symmetry is most simply expressed using generating functions. In the example, we chose the generating function to depend on the parameters  $t, a, b$  and  $c$ , which encode the length of the words and the number of occurrences of each letter, respectively. We could have considered multiple other parameters that represent different characteristics of the words. In the following, we will for example

<sup>13</sup>The series is said to be formal in the sense that it is not required to converge.

be interested in the numbers of derivatives and the type of fields in each term of the action, so that we will consider parameters counting these properties. We will also be interested in the enumeration of words upon dividing out the action of other permutation groups than  $S_n$ . The right tool to consider those problems is the Pólya enumeration theorem.

## 3.2 Pólya enumeration theorem

The Pólya enumeration theorem is a general technique for solving a large class of combinatorial problems, such that the enumeration of groups, graphs, and chemical compounds [65, 66]. We will review in the following its formulation and applications to the problems we are interested in, based on Ref. [66–68].

Let us consider a domain  $\mathcal{D}$ , whose elements are places where figures can be stored. The figures belong to a range  $\mathcal{R}$ , and we assign to each figure  $r \in \mathcal{R}$  a vectorial weight  $\mathbf{w}(r) = (w_1(r), \dots, w_p(r)) \in \mathbb{N}^p$  that define the properties of  $r$ . We put exactly one figure at each place (allowing to put the same figure at several places), forming a configuration. Each configuration is then a function<sup>14</sup>  $f : \mathcal{D} \rightarrow \mathcal{R}$ . Let us finally introduce a permutation group  $G$ , called the configuration group, acting on  $\mathcal{D}$ , that we use to arrange the configurations: two configurations are considered the same if one can be obtained from the other through the action of  $G$ . We are then interested in counting all different configurations, up to the action of  $G$ . Before solving this question, let us illustrate these notations on several examples.

- (i) In Sec. 3.1, we considered words formed from  $n$  letters of an alphabet  $\mathfrak{A}$ , and we identified two words if they were mapped to each other after rearrangement of their letters. In this case, the domain  $\mathcal{D}$  is the set of the  $n$  locations where one can place the letters, which form the figures of range  $\mathcal{R} = \mathfrak{A}$ . A configuration is then an assignment of one letter at each place, giving a word. The configuration group  $G$  is the symmetric group  $S_n$ . As mentioned above, we chose as parameters the number of letters (given by the exponent of  $t$ ) and the number of each letters (given by the exponents of  $a, b$  and  $c$ ), so that the vectorial weight has four components  $\mathbf{w} = (w_t, w_a, w_b, w_c)$ . The three elements of the range  $\mathfrak{A}$  are of weights  $\mathbf{w}(a) = (1, 1, 0, 0)$ ,  $\mathbf{w}(b) = (1, 0, 1, 0)$  and  $\mathbf{w}(c) = (1, 0, 0, 1)$ , respectively.
- (ii) Let us take a look at the case of necklaces, composed of four beads, some red and some blue. Two such necklaces are identified if they are connected by rotations, *i.e.* by cyclic rearrangement of the beads, while preserving their colors. The domain  $\mathcal{D}$  is then the set of locations for the beads, the range is the set  $\mathcal{R} = \{\text{red bead}, \text{blue bead}\}$  and  $G$  is the cyclic group  $C_4$  of four elements<sup>15</sup>. The interesting property of the beads lies in their color, and we can choose the weight to represent it:  $\mathbf{w}(\text{red bead}) = (1, 0)$ ,  $\mathbf{w}(\text{blue bead}) = (0, 1)$ .
- (iii) Consider now the traces one can form with four matrices among the symmetric matrices  $\{A, B, C, D\}$ . The domain  $\mathcal{D}$  is again the locations where the matrices are to be put and the range is  $\mathcal{R} = \{A, B, C, D\}$ . As the trace is cyclic and preserved by transposition, the configuration group  $G$  is the dihedral group  $D_4$ , the group of symmetry of a square, including rotations and reflections (Fig. 3.1). We can finally choose the weights to represent the occurrence of each matrices:  $\mathbf{w}(A) = (1, 0, 0, 0)$ ,  $\mathbf{w}(B) = (0, 1, 0, 0)$ , etc.

<sup>14</sup>And not  $f : \mathcal{R} \rightarrow \mathcal{D}$ , otherwise it could be multivalued.

<sup>15</sup> $C_4$  could also be seen as the group of rotations leaving a square invariant.

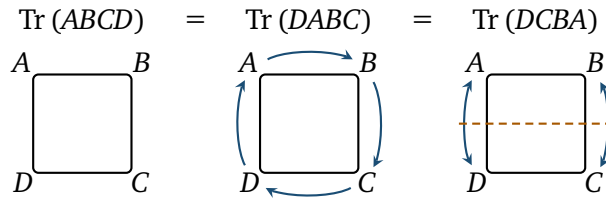

**Fig. 3.1** To highlight the configuration group for the example (iii), we place the four symmetric matrices  $A, B, C$  and  $D$  of the trace  $\text{Tr}(ABCD)$  on the edges of a square. The cyclic property of the trace is then reflected in the rotational symmetry of the square, and the invariance of the trace under transposition is equivalent to the symmetry of the square under reflections, as represented for a cycle and a reflection.

In order to summarize the information about the figures and their contents, we introduce a variable  $y_i$  associated to each weight  $w_i$ ,  $i \in \llbracket 1, p \rrbracket$ , and the figure generating function

$$\mathcal{Z}_{\mathcal{R}}(y_1, \dots, y_p) = \sum_{r \in \mathcal{R}} y_1^{w_1(r)} \dots y_p^{w_p(r)} = \sum_{m_1, \dots, m_p} c_{m_1 \dots m_p} y_1^{m_1} \dots y_p^{m_p}, \quad (3.12)$$

where we noted  $c_{m_1 \dots m_p}$  the number of figures of weight  $(m_1, \dots, m_p)$  in  $\mathcal{R}$ . In the cases of the three examples above, we get

$$(i) \quad \mathcal{Z}_{\mathcal{R}}(y_t, y_a, y_b, y_c) = y_t y_a + y_t y_b + y_t y_c, \quad (3.13a)$$

$$(ii) \quad \mathcal{Z}_{\mathcal{R}}(y_{\text{red}}, y_{\text{blue}}) = y_{\text{red}} + y_{\text{blue}}, \quad (3.13b)$$

$$(iii) \quad \mathcal{Z}_{\mathcal{R}}(y_A, y_B, y_C, y_D) = y_A + y_B + y_C + y_D. \quad (3.13c)$$

As could have been expected, Eq. (3.13a) reproduces the generating function (3.10).

We accordingly assign a weight  $W(f)$  to each configuration  $f : \mathcal{D} \rightarrow \mathcal{R}$  by

$$W(f) = \prod_{d \in \mathcal{D}} y_1^{w_1(f(d))} \dots y_p^{w_p(f(d))}, \quad (3.14)$$

and the configuration generating function

$$\mathcal{G}(y_1, \dots, y_p) = \sum_{f \in \mathcal{R}^{\mathcal{D}}} W(f) = \sum_{m_1, \dots, m_p} C_{m_1 \dots m_p} y_1^{m_1} \dots y_p^{m_p}, \quad (3.15)$$

where we noted  $\mathcal{R}^{\mathcal{D}}$  the set of function from  $\mathcal{D}$  to  $\mathcal{R}$  and  $C_{m_1 \dots m_p}$  the number of configurations in  $\mathcal{R}^{\mathcal{D}}$  of weight  $(m_1, \dots, m_p)$ .  $\mathcal{G}$  is the solution to the enumeration problem, and the goal of Pólya theorem is to express  $\mathcal{G}$  in terms of  $\mathcal{Z}_{\mathcal{R}}$ .

For this purpose, we need a way to summarize the action of  $G$  on the configurations. This is given by the cycle index of  $G$ , which is a generating function that contains information about how the group of permutations acts on a set. It is built in the following way. As each permutation can be decomposed into a product of disjoint cycles, we sort them with respect to their cycle content. A permutation is said to have cycle-type  $\mathbf{j} = (j_1, \dots, j_n)$ , with  $n$  the degree of  $G$ , if it is made of  $j_1$  cycles of length 1,  $j_2$  cycles of length 2 and so on. The components of  $\mathbf{j}$  then form a partition of  $n$ :

$$\sum_i i j_i = n. \quad (3.16)$$

We associate to a permutation of cycle-type  $j$  a monomial

$$\prod_{i=1}^n a_i^{j_i}. \tag{3.17}$$

The cycle index  $\mathcal{Z}_G$  of  $G$  is then defined as the average of these monomials over all its elements:

$$\mathcal{Z}_G(a_1, \dots, a_n) = \frac{1}{|G|} \sum_{\sigma \in G} \prod_{i=1}^n a_i^{j_i}, \tag{3.18}$$

where  $|G|$  denotes the cardinal of  $G$ , and  $j$  the cycle decomposition of the permutation  $\sigma \in G$ . Let us illustrate this definition on the previous examples.

- (i) We consider the case of words made of three letters. We list below the elements of  $S_3$ , their decompositions into cycles and the associated monomials (3.17)<sup>16</sup>.

[123]	(1)(2)(3)	$a_1^3$		[213]	(3)(12)	$a_1 a_2$
[231]	(123)	$a_3$		[321]	(2)(13)	$a_1 a_2$
[312]	(132)	$a_3$		[132]	(1)(23)	$a_1 a_2$

(3.19)

The cycle index of  $S_3$  is then

$$\mathcal{Z}_{S_3}(a_1, a_2, a_3) = \frac{1}{6} a_1^3 + \frac{1}{2} a_1 a_2 + \frac{1}{3} a_3. \tag{3.20}$$

- (ii) The permutations of  $C_4$  are schematically given in Fig. 3.2(a). They correspond to rotations of  $0^\circ, 90^\circ, 180^\circ$  and  $270^\circ$ , respectively.

$0^\circ$	[1234]	(1)(2)(3)(4)	$a_1^4$		$180^\circ$	[3412]	(13)(24)	$a_2^2$
$90^\circ$	[2341]	(1234)	$a_4$		$270^\circ$	[4123]	(4321)	$a_4$

(3.21)

We deduce the cycle index

$$\mathcal{Z}_{C_4}(a_1, a_2, a_3, a_4) = \frac{1}{4} a_1^4 + \frac{1}{4} a_2^2 + \frac{1}{2} a_4. \tag{3.22}$$

- (iii) The elements of  $D_4$  are given by the ones of  $C_4$  in Eq. (3.21), supplemented by the reflections described in Fig. 3.2(b).

$S_1$	[2143]	(12)(34)	$a_2^2$		$S_3$	[1432]	(1)(3)(24)	$a_1^2 a_2$
$S_2$	[4321]	(14)(23)	$a_2^2$		$S_4$	[3214]	(2)(4)(13)	$a_1^2 a_2$

(3.23)

The cycle index of  $D_4$  is then given by

$$\mathcal{Z}_{D_4}(a_1, a_2, a_3, a_4) = \frac{1}{8} a_1^4 + \frac{3}{8} a_2^2 + \frac{1}{4} a_1^2 a_2 + \frac{1}{4} a_4. \tag{3.24}$$

We then have all the ingredients needed to state the Pólya enumeration theorem [66].

<sup>16</sup>We note  $[i_1 i_2 i_3 i_4]$  the permutation that map 1 to  $i_1$ , 2 to  $i_2$ , 3 to  $i_3$  and 4 to  $i_4$ . The cycle  $(i_1 i_2 i_3 i_4)$  maps  $i_1$  to  $i_2$ ,  $i_2$  to  $i_3$ ,  $i_3$  to  $i_4$  and  $i_4$  to  $i_1$ . The notations follow naturally for permutations and cycles of different lengths.



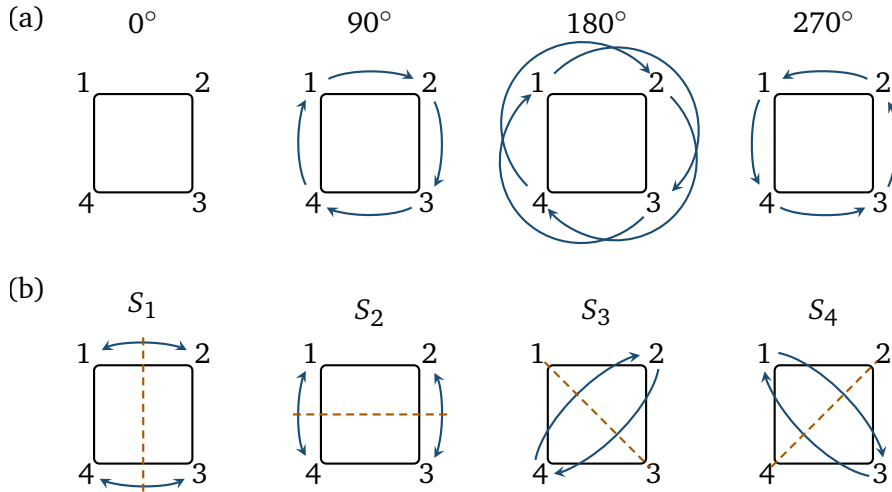

**Fig. 3.2** Schematic representation of the elements (a) of  $C_4$  and (b) of the reflections of  $D_4$ . The two lines give all the elements of  $D_4$ .

**Pólya enumeration theorem** The configuration generating function is obtained by substituting the figure generating function in the cycle index, by which is meant replacing every occurrence of  $a_i$  in the cycle index by  $Z_{\mathcal{R}}(y_1^i, \dots, y_p^i)$ . Thus

$$G(y_1, \dots, y_p) = Z_G\left(Z_{\mathcal{R}}(y_1, \dots, y_p), Z_{\mathcal{R}}(y_1^2, \dots, y_p^2), \dots, Z_{\mathcal{R}}(y_1^n, \dots, y_p^n)\right). \quad (3.25)$$

To avoid clumsy notations, we introduce the function

$$Z_{\mathcal{R},i}(y_1, \dots, y_p) = Z_{\mathcal{R}}(y_1^i, \dots, y_p^i). \quad (3.26)$$

Eq. (3.25) then takes the form

$$G = Z_G\left(Z_{\mathcal{R}}, Z_{\mathcal{R},2}, \dots, Z_{\mathcal{R},n}\right). \quad (3.27)$$

This theorem is a generalization of an other counting formula, known as the Burnside’s lemma [69]. In its simplest form, the lemma states that, in the same setup as the one we described at the beginning of this section, to count the number of inequivalent configurations up to the action of  $G$ , one has to count the number of invariant configurations under each element of  $G$  and take the average of these numbers. The Pólya theorem is a generalization in the sense that it constructively generates the inequivalent configurations.

To get an intuition of how to deduce Pólya theorem from Burnside’s lemma, consider a permutation  $\sigma \in G$ , described by the monomial (3.17), and let us construct the configurations left invariant by  $\sigma$ . For each cycle of length  $i$ , an invariant configuration must contain the same figure  $r$  at  $i$  different places (the ones that are affected by the cycle). These places can then be seen as a single place containing the figure  $r^i$ . The generating function of these figures is  $Z_{\mathcal{R},i}$ , and the function generating all the configurations left invariant by  $\sigma$  is given by the monomial (3.17), where all  $a_i$  are substituted by  $Z_{\mathcal{R},i}$ . Eq. (3.27) then follows from Burnside’s lemma and the definition (3.18) of the cycle index.

Back to the examples, we deduce the configuration generating functions using the Pólya enumeration theorem, and use it to generate all different configurations.

(i) From Eq. (3.13a) and (3.20), we have

$$\mathcal{G}_{(i)}(y_t, y_a, y_b, y_c) = y_t^3 (y_a^3 + y_a^2 y_b + y_a y_b^2 + y_b^3 + y_a^2 y_c + y_a y_b y_c + y_b^2 y_c + y_a y_c^2 + y_b y_c^2 + y_c^3), \quad (3.28)$$

which reproduces exactly the fourth term of Eq. (3.8). Thus, there are, up to letters rearrangement,  $\mathcal{G}_{(i)}(1, 1, 1, 1) = 10$  words made of the letters  $\{a, b, c\}$ . We can infer those words from each coefficient of  $\mathcal{G}_{(i)}$ :  $y_a y_b y_c$  yields for example  $abc$ ,  $y_a^2 y_b$  gives  $aab$ , and so on. Those words are exactly the ones we identified in Eq. (3.5).

(ii) From Eq. (3.13b) and (3.22), we have

$$\mathcal{G}_{(ii)}(y_{\text{red}}, y_{\text{blue}}) = y_{\text{red}}^4 + y_{\text{red}}^3 y_{\text{blue}} + 2 y_{\text{red}}^2 y_{\text{blue}}^2 + y_{\text{blue}}^3 y_{\text{red}} + y_{\text{blue}}^4. \quad (3.29)$$

There are  $\mathcal{G}_{(ii)}(1, 1) = 6$  necklaces made of four beads, some red and some blue. The coefficient  $y_{\text{red}}^m y_{\text{blue}}^n$  indicates how many necklaces with  $m$  red and  $n$  blue beads there are. All different such necklaces are shown in Fig. 3.3.

(iii) From Eq. (3.13c) and (3.24), we have

$$\begin{aligned} \mathcal{G}_{(iii)}(y_A, y_B, y_C, y_D) = & y_A^4 + y_A^3 y_B + 2 y_A^2 y_B^2 + y_A y_B^3 + y_B^4 + y_A^3 y_C + 2 y_A^2 y_B y_C + y_A y_C^3 \\ & + 2 y_A y_B^2 y_C + y_B^3 y_C + 2 y_A^2 y_C^2 + 2 y_A y_B y_C^2 + 2 y_B^2 y_C^2 + y_B y_C^3 \\ & + y_C^4 + y_A^3 y_D + 2 y_A^2 y_B y_D + 2 y_A y_B^2 y_D + y_B^3 y_D + 2 y_A^2 y_C y_D \\ & + 3 y_A y_B y_C y_D + 2 y_B^2 y_C y_D + 2 y_A y_C^2 y_D + 2 y_B y_C^2 y_D \\ & + y_C^3 y_D + 2 y_A^2 y_D^2 + 2 y_A y_B y_D^2 + 2 y_B^2 y_D^2 + 2 y_A y_C y_D^2 \\ & + 2 y_B y_C y_D^2 + 2 y_C^2 y_D^2 + y_A y_D^3 + y_B y_D^3 + y_C y_D^3 + y_D^4. \end{aligned} \quad (3.30)$$

This tells us that there are  $\mathcal{G}_{(iii)}(1, 1, 1, 1) = 55$  different traces made of four symmetric matrices among  $\{A, B, C, D\}$ . Once again, the coefficients of  $\mathcal{G}_{(iii)}$  give the number of traces of each type. There are for example three different traces made of exactly one  $A$ , one  $B$ , one  $C$  and one  $D$ . They are given by

$$\text{Tr}(ABCD), \quad \text{Tr}(ACBD), \quad \text{Tr}(ABDC). \quad (3.31)$$

We can play the same game for every monomial in Eq. (3.30).

Let us close this section by reviewing the cycle index for the permutation groups  $S_n$  (the symmetric group of degree  $n$ ),  $C_n$  (the cyclic group of degree  $n$ ) and  $D_n$  (the dihedral group of degree  $n$ , which

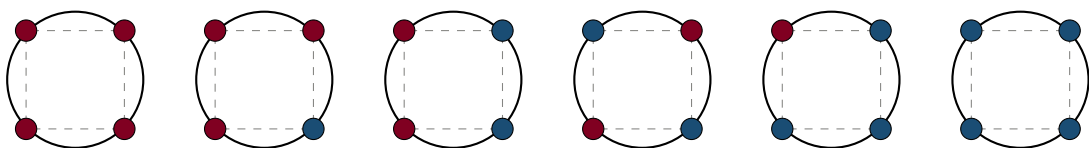

Fig. 3.3 Representation of the six necklaces made of four beads, some red and some blue, given by Eq. (3.29).

describes the symmetries of a regular  $n$ -gon) [67]:

$$\mathcal{Z}_{S_n}(a_1, \dots, a_n) = \sum_{\{j\}} \prod_{k=1}^n \frac{1}{k^{j_k} j_k!} a_k^{j_k}, \quad (3.32a)$$

$$\mathcal{Z}_{C_n}(a_1, \dots, a_n) = \frac{1}{n} \sum_{k|n} \phi(k) a_k^{n/k}, \quad (3.32b)$$

$$\mathcal{Z}_{D_n}(a_1, \dots, a_n) = \frac{1}{2} \mathcal{Z}_{C_n}(a_1, \dots, a_n) + \begin{cases} \frac{1}{2} a_1 a_2^{(n-1)/2}, & \text{if } n \text{ is odd,} \\ \frac{1}{4} (a_2^{n/2} + a_1^2 a_2^{(n-2)/2}), & \text{if } n \text{ is even.} \end{cases} \quad (3.32c)$$

Here, by the sum over  $\{j\}$  we mean the sum over all partitions  $j$  of  $n$  (see Eq. (3.16)),  $k|n$  denotes the integers  $k$  that divide  $n$  and  $\phi$  is the Euler's totient function:  $\phi(k)$  is the number of positive integers relatively prime to  $k$ , with  $\phi(1) = 1$ . In Sec. 3.1, we were interested in all the words one could write from a given alphabet, up to rearrangement of the letters. They are given by the sum of such words with one letter, two letters and so on. The cycle index of interest is then

$$\sum_{n \geq 0} \mathcal{Z}_{S_n}(a_1, \dots, a_n) = \exp \left[ \sum_{k \geq 1} \frac{1}{k} a_k \right]. \quad (3.33)$$

With the Pólya enumeration theorem (3.27), we recover the generating function (3.11).

### 3.3 Alphabet of $O(d, d, \mathbb{R})$ -invariant letters

We now move on to the construction of the alphabet for our problem: the alphabet of  $O(d, d, \mathbb{R})$ -invariant letters in the various matter sectors (dilaton, scalars, vectors, two-form, metric). Following the general discussion of field redefinition ambiguities of Chap. 2, we count the letters modulo the two-derivative field equations (2.22)<sup>17</sup> and Bianchi identities. We only count manifestly  $O(d, d, \mathbb{R})$  and gauge invariant terms, *i.e.* we neglect possible Chern-Simons and topological terms.

#### 3.3.1 Dilaton

The independent building blocks carrying the dilaton are given by the derivatives

$$\mathfrak{A}_\Phi = \{ \nabla_{((\mu_1 \dots \nabla_{\mu_n})} \Phi \mid n \in \mathbb{N}^* \}, \quad (3.34)$$

with the double parentheses  $((\dots))$  indicating traceless symmetrization, in order to divide out field equations. Before writing a generating function for this alphabet, we need to identify the properties of the words we are interested in. We want first to keep track of the number of dilaton in a given term of the action. We also need to count the number of derivatives in each term, as we will ultimately be interested in identifying the actions one can write at a given order in  $\alpha'$ . We finally have to take into account the external indices  $\mu, \nu$ , that represent  $SO(D)$  vectorial representations<sup>18</sup>. In the language of Sec. 3.2, we then need three weights ( $w_\Phi, w_{\text{deriv}}, w_{\text{vec}}$ ), that we will represent by the variables  $u, q$  and

<sup>17</sup>Note that the counting formula does not apply to the two-derivative action, as the fields are counted on-shell with respect to this action.

<sup>18</sup>We decide here not to distinguish between the indices in high and low positions. This is equivalent to counting the external indices as flat  $SO(D)$  indices (the signature of the metric does not change the counting formula).

$\mathbf{v}_D$ . The first three letters in  $\mathfrak{A}_\Phi$  are then represented as follows:

$$\nabla_\mu \Phi \longrightarrow u q \mathbf{v}_D, \quad (3.35a)$$

$$\nabla_{(\mu} \nabla_{\nu)} \Phi - \frac{1}{D} g_{\mu\nu} \square \Phi \longrightarrow u q^2 \left[ (\mathbf{v}_D \otimes \mathbf{v}_D)_{\text{sym}} - 1 \right], \quad (3.35b)$$

$$\nabla_{((\mu} \nabla_\nu \nabla_{\rho))} \Phi \longrightarrow u q^3 \left[ (\mathbf{v}_D \otimes \mathbf{v}_D \otimes \mathbf{v}_D)_{\text{sym}} - \mathbf{v}_D \right], \quad (3.35c)$$

where  $(\mathbf{v}_D \otimes \mathbf{v}_D)_{\text{sym}}$  is the symmetric tensor product of two  $SO(D)$  vectors. We may then encode the alphabet (3.34) into the generating function

$$\mathcal{Z}_\Phi(u, q, \mathbf{v}_D) = u \left( \frac{1 - q^2}{(1 - q)^{\mathbf{v}_D}} - 1 \right), \quad (3.36)$$

where we used the notation

$$\frac{1}{(1 - q)^{\mathbf{v}_D}} = 1 + q \mathbf{v}_D + q^2 (\mathbf{v}_D \otimes \mathbf{v}_D)_{\text{sym}} + \dots, \quad (3.37)$$

in order to describe the tower of symmetrized vectors. Upon expanding Eq. (3.36) into a series in  $q$ , every term then represents a letter with exponents counting the number of derivatives.

### 3.3.2 Coset scalars

The scalar fields parametrize the  $SO(d, d)/(SO(d) \times SO(d))$  matrix  $\mathcal{H}_{MN}$ . In order to directly implement all constraints deriving from the coset structure, it is convenient to turn to the vielbeins  $E_M^A$ , defined by

$$\mathcal{H}_{MN} = E_M^A \delta_{AB} E_N^B. \quad (3.38)$$

We accordingly define the coset currents

$$E^{-1} \partial_\mu E = Q_\mu + P_\mu \in \mathfrak{k} \oplus \mathfrak{p} = \mathfrak{so}(d, d), \quad (3.39)$$

where  $\mathfrak{k} = \mathfrak{so}(d) \oplus \mathfrak{so}(d)$  and  $\mathfrak{p}$  is its (non-compact) orthogonal complement. They verify the equation

$$\partial_\mu \mathcal{H} \mathcal{H}^{-1} = 2 E P_\mu E^{-1}. \quad (3.40)$$

In terms of the currents  $Q_\mu$  and  $P_\mu$ , global  $SO(d, d)$  invariance is ensured, and the counting problem reduces to identifying combinations that are invariant under local  $SO(d) \times SO(d)$  transformations, *i.e.* built from  $P_\mu$ 's and covariant derivatives  $D_\mu = \partial_\mu + \text{ad}_{Q_\mu}$ . Moreover, we have integrability conditions

$$[D_\mu, D_\nu] = Q_{\mu\nu} \propto [P_\mu, P_\nu], \quad D_{[\mu} P_{\nu]} = 0, \quad (3.41)$$

and field equations with leading second order term  $D^\mu P_\mu$ , which implies that a basis of on-shell independent combinations is given by

$$\mathfrak{A}_P = \left\{ \nabla_{((\mu_1} \dots \nabla_{\mu_n} P_{\mu_{n+1})})} \in \mathfrak{p} \mid n \in \mathbb{N} \right\}. \quad (3.42)$$

It resembles the alphabet (3.34), and is similarly counted by the generating function

$$\mathcal{Z}_P(p, q, \mathbf{v}_D) = p \left( \frac{1 - q^2}{(1 - q)^{\mathbf{v}_D}} - 1 \right), \quad (3.43)$$



with the charge  $p$  introduced to count the power of  $P_\mu$ 's<sup>19</sup>.

The letters in Eq. (3.42) are however not  $SO(d) \times SO(d)$ -invariant. Thus, it remains to count the independent  $SO(d) \times SO(d)$ -invariant single-trace combinations in the letters (3.42). With  $P_\mu$  transforming in the  $(\mathbf{d}, \mathbf{d})$  representation of  $SO(d) \times SO(d)$ , the letters  $\mathcal{P}_i \in \mathfrak{A}_p$  are of the form  $\mathcal{P}_i^{a\bar{a}}$ , with  $a, \bar{a} \in \llbracket 1, d \rrbracket$ , of transposed  $\bar{\mathcal{P}}_i^{\bar{a}a}$ . The single trace combinations are then made of pairs  $(\mathcal{P}_i \bar{\mathcal{P}}_j)^{ab}$ , and invariant under cyclic permutations of those pairs. In the language of Sec. 3.2, the single trace configurations are made of figures in the range  $\{(\mathcal{P}_i \bar{\mathcal{P}}_j), \mathcal{P}_i, \bar{\mathcal{P}}_j \in \mathfrak{A}_p\}$ , whose generating function is  $\mathcal{Z}_p^2$ . Up to cyclic rearrangement and using Eq. (3.32b), the Pólya enumeration theorem then predicts that the single trace combinations are generated by<sup>20</sup>

$$\sum_{n \in \mathbb{N}} \frac{1}{n} \sum_{k|n} \phi(k) \left( \mathcal{Z}_{p, n}^2 \right)^{n/k} = - \sum_{n \in \mathbb{N}} \frac{\phi(n)}{n} \ln \left( 1 - \mathcal{Z}_{p, n}^2 \right). \quad (3.44)$$

As the trace is also symmetric under transposition, *i.e.*

$$\text{Tr} \left( \mathcal{P}_1 \bar{\mathcal{P}}_2 \dots \mathcal{P}_{2n-1} \bar{\mathcal{P}}_{2n} \right) = \text{Tr} \left( \mathcal{P}_{2n} \bar{\mathcal{P}}_{2n-1} \dots \mathcal{P}_2 \bar{\mathcal{P}}_1 \right), \quad (3.45)$$

Eq. (3.44) counts twice every configuration, except those that are their own transpositions. This last class of combinations is given by the palindromic configurations in the letters of  $\mathfrak{A}_p$ . The palindromic configurations of length  $2n$  are left invariant by the permutation

$$(1 \ 2n)(2 \ 2n-1) \dots (n \ n+1), \quad (3.46)$$

whose monomial (3.17) is  $a_2^n$ . The function that generates the even palindromic configurations of  $\mathfrak{A}_p$  is then, as discussed in Sec. 3.2,<sup>21</sup>

$$\mathcal{Z}_{p, \text{pal.}} = \frac{1}{1 - \mathcal{Z}_{p, 2}}. \quad (3.47)$$

The single trace combinations of the letters  $\mathfrak{A}_p$  are then generated by<sup>22</sup>

$$\mathcal{Z}_{\text{Tr}(p)}(p, t, q, \mathbf{v}_D) = -\frac{t}{2} \sum_{n \in \mathbb{N}} \frac{\phi(n)}{n} \ln \left( 1 - \mathcal{Z}_{p, n}^2 \right) + \frac{t}{2} \frac{\mathcal{Z}_{p, 2}}{1 - \mathcal{Z}_{p, 2}}, \quad (3.48)$$

where we introduced a variable  $t$  that represents the number of traces.

### 3.3.3 Vectors

The (manifestly) gauge invariant building blocks in terms of the vector field are obtained by derivatives of its field strength subtracting Bianchi identities and contractions proportional to the field equations:

$$\mathfrak{A}_{\mathcal{F}} = \left\{ \nabla_{((\mu_1} \dots \nabla_{\mu_n))} \mathcal{F}_{\nu_1 \nu_2}{}^M - \text{traces \& Bianchi} \mid n \in \mathbb{N} \right\}, \quad (3.49)$$

counted by the generating function (see App. A for a demonstration)

<sup>19</sup>As  $P_\mu$  includes a derivative, it is represented by the parameters  $pq$ . The same occurs for  $\mathcal{F}_{\mu\nu}{}^M$ ,  $H_{\mu\nu\rho}$  and  $C_{\mu\nu\rho\sigma}$  is the following, which are counted as  $fq$ ,  $hq$  and  $cq^2$ , respectively.

<sup>20</sup>In this counting, we neglect all the identities induced by the finite size  $(2d)$  of the  $SO(d, d)$  matrices, *i.e.* formally we count for  $d = \infty$ .

<sup>21</sup>See also Ref. [70] for a demonstration without the Pólya enumeration theorem.

<sup>22</sup>We subtracted the term 1 to  $\mathcal{Z}_{p, \text{pal.}}$  as it does not correspond to any single trace combination.

$$\mathcal{Z}_{\mathcal{F}}(f, q, \mathbf{v}_D) = f \sum_{n=0}^{\infty} \left( \begin{array}{c|c|c|c} \nu_1 & \mu_1 & & \mu_n \\ \hline \nu_2 & & & \\ \hline & & & \end{array} - \text{traces} \right) = f \frac{1}{q} \left( 1 - \frac{1 - \mathbf{v}_D q (1 - q^2) - q^4}{(1 - q)^{\mathbf{v}_D}} \right), \quad (3.50)$$

where  $f$  is a charge for the powers of  $\mathcal{F}_{\mu\nu}^M$ . However, the letters (3.49) are not  $O(d, d, \mathbb{R})$  singlets but rather carry a fundamental vector index.  $O(d, d, \mathbb{R})$ -invariant combinations are built from bilinears of the letters in the alphabet (3.49) with the two  $O(d, d, \mathbb{R})$  vector indices contracted by products of the  $O(d, d, \mathbb{R})$ -invariant  $\eta_{MN}$ , the scalar matrix  $\mathcal{H}_{MN}$ , and its derivatives. This is most conveniently counted by using the vielbeins (3.38) to convert the  $O(d, d, \mathbb{R})$  indices of Eq. (3.49) into  $SO(d) \times SO(d)$  indices, such that the flattened field strength  $\mathcal{F}_{\mu\nu}^M E_M^A$  decomposes into  $(\mathbf{d}, \mathbf{1}) \oplus (\mathbf{1}, \mathbf{d})$  contributions which we denote by  $\mathcal{F}_L$  and  $\mathcal{F}_R$ , respectively. The flattened letters (3.49) are then contracted out by arbitrary chains of letters from  $\mathfrak{A}_P$  (Eq. (3.42)). This gives rise to three different types of terms:

$$\begin{aligned} & (\nabla \dots \nabla \mathcal{F}_L) \text{ (even chain of } \nabla \dots \nabla P) (\nabla \dots \nabla \mathcal{F}_L), \\ & (\nabla \dots \nabla \mathcal{F}_R) \text{ (even chain of } \nabla \dots \nabla P) (\nabla \dots \nabla \mathcal{F}_R), \\ & (\nabla \dots \nabla \mathcal{F}_L) \text{ (odd chain of } \nabla \dots \nabla P) (\nabla \dots \nabla \mathcal{F}_R). \end{aligned} \quad (3.51)$$

The generating functions of the words made of even or odd numbers of letters in  $\mathfrak{A}_P$  are given by

$$\sum_{n \in \mathbb{N}} \mathcal{Z}_P^{2n} = \frac{1}{1 - \mathcal{Z}_P^2} \quad \text{and} \quad \sum_{n \in \mathbb{N}} \mathcal{Z}_P^{2n+1} = \frac{\mathcal{Z}_P}{1 - \mathcal{Z}_P^2}, \quad (3.52)$$

respectively. The two first chains however feature a reflection symmetry, so that the generating function  $\mathcal{Z}_{\mathcal{F}}^2 / (1 - \mathcal{Z}_P^2)$  counts twice every words but the ones that are their own reflection. To be its own reflection, a word must feature twice the same letter of  $\mathfrak{A}_{\mathcal{F}}$  (hence a factor  $\mathcal{Z}_{\mathcal{F},2}$ , in the notation of Eq. (3.26)), and a palindromic configuration of letters in  $\mathfrak{A}_P$  (hence a factor  $\mathcal{Z}_{P,\text{pal}}$ ). Thus, the counting of  $O(d, d, \mathbb{R})$ -invariant building blocks in the vector sector yields

$$\begin{aligned} \mathcal{Z}_{\mathcal{F}P\mathcal{F}} &= \frac{1}{2} \left( \frac{\mathcal{Z}_{\mathcal{F}}^2}{1 - \mathcal{Z}_P^2} + \frac{\mathcal{Z}_{\mathcal{F},2}}{1 - \mathcal{Z}_{P,2}} \right) + \frac{1}{2} \left( \frac{\mathcal{Z}_{\mathcal{F}}^2}{1 - \mathcal{Z}_P^2} + \frac{\mathcal{Z}_{\mathcal{F},2}}{1 - \mathcal{Z}_{P,2}} \right) + \mathcal{Z}_{\mathcal{F}} \frac{\mathcal{Z}_P}{1 - \mathcal{Z}_P^2} \mathcal{Z}_{\mathcal{F}} \\ &= \frac{\mathcal{Z}_{\mathcal{F}}^2}{1 - \mathcal{Z}_P} + \frac{\mathcal{Z}_{\mathcal{F},2}}{1 - \mathcal{Z}_{P,2}}. \end{aligned} \quad (3.53)$$

### 3.3.4 Two-form

Similarly, the independent (manifestly gauge invariant) building blocks carrying the two-form  $B_{\mu\nu}$  are counted by powers of derivatives on the field strength  $H_{\mu\nu\rho}$  upon subtracting Bianchi identities and contractions proportional to the field equations:

$$\mathfrak{A}_H = \{ \nabla_{((\mu_1} \dots \nabla_{\mu_n)} H^{\nu_1 \nu_2 \nu_3} - \text{traces \& Bianchi} \mid n \in \mathbb{N} \}, \quad (3.54)$$

giving rise to a generating function

$$\begin{aligned} \mathcal{Z}_H(h, q, \mathbf{v}_D) &= h \sum_{n=0}^{\infty} \left( \begin{array}{c|c|c|c} \nu_1 & \mu_1 & & \mu_n \\ \hline \nu_2 & & & \\ \hline \nu_3 & & & \end{array} - \text{traces} \right) \\ &= h \frac{1}{q^2} \left( \frac{1 - q^6 - q(1 - q^4) \mathbf{v}_D + q^2(1 - q^2) (\mathbf{v}_D \otimes \mathbf{v}_D)_{\text{alt}}}{(1 - q)^{\mathbf{v}_D}} - 1 \right), \end{aligned} \quad (3.55)$$

where  $h$  is a charge for the powers of  $H_{\mu\nu\rho}$  and  $(\mathbf{v}_D \otimes \mathbf{v}_D)_{\text{alt}}$  is the antisymmetric tensor product of two  $SO(D)$  vectors.

### 3.3.5 Metric

For the external metric  $g_{\mu\nu}$  and dividing out field equations, we count derivatives of its Weyl tensor  $C_{\nu_1\nu_2\nu_3\nu_4}$ , subtracting traces and Bianchi identities, which gives rise to the letters

$$\mathfrak{A}_C = \left\{ \nabla_{((\mu_1 \dots \nabla_{\mu_n})} C_{\nu_1\nu_2\nu_3\nu_4} - \text{traces \& Bianchi} \mid n \in \mathbb{N} \right\}. \quad (3.56)$$

They are counted as

$$\begin{aligned} \mathcal{Z}_C(c, q, \mathbf{v}_D) &= c \sum_{n=0}^{\infty} \left( \begin{array}{|c|c|c|c|c|} \hline \nu_1 & \nu_2 & \mu_1 & & \mu_n \\ \hline \nu_3 & \nu_4 & & & \\ \hline \end{array} - \text{traces} \right) \\ &= c \left( \frac{q(1-q^2)(\mathbf{v}_D \otimes \mathbf{v}_D)_{\text{sym}} - (1-q^4)\mathbf{v}_D}{q(1-q)^{\mathbf{v}_D}} + (\mathbf{v}_D \otimes \mathbf{v}_D)_{\text{alt}} + \frac{1}{q}\mathbf{v}_D \right), \end{aligned} \quad (3.57)$$

where  $c$  is a charge for the powers of the Weyl tensor (or equivalently, the Riemann tensor).

### 3.3.6 Space-time singlets and partial integration

Putting everything together, we have identified the manifestly  $O(d, d, \mathbb{R})$  and gauge invariant building blocks in the various sectors:

$$\mathcal{Z}_0 = \mathcal{Z}_\Phi + \mathcal{Z}_{\text{Tr}(P)} + \mathcal{Z}_{\mathcal{F}PF} + \mathcal{Z}_H + \mathcal{Z}_C, \quad (3.58)$$

with the different terms defined in Eq. (3.36), (3.48), (3.53), (3.55) and (3.57), respectively. It is a function of the parameters  $u, p, t, f, h, c, q$  and  $\mathbf{v}_D$ , that describe the properties of the letters (Tab. 3.1). From the  $O(d, d, \mathbb{R})$ -invariant letters described by the generating function (3.58), we can construct the most general  $O(d, d, \mathbb{R})$  and gauge invariant terms as arbitrary polynomials in these letters, counted, as described in Eq. (3.33), as

$$\mathcal{Z}_{\text{inv}} = \exp \left[ \sum_{k \geq 1} \frac{1}{k} \mathcal{Z}_{0,k} \right]. \quad (3.59)$$

So far, we have been counting combinations in all possible  $SO(D)$  representations, without restricting to  $SO(D)$  Lorentz scalars. In order to count the independent space-time actions, we have to project  $\mathcal{Z}_{\text{inv}}$  to Lorentz scalars. We also have to consider the ambiguities introduced by the possibility to do partial integrations in the action. Some words could indeed be expressed, after partial integration, in terms of the others, thus leading to over-counting. In order to subtract these ambiguities, we extract from  $\mathcal{Z}_{\text{inv}}$  all possible  $SO(D)$  vectors  $\mathcal{J}_\mu$ , each of which gives rise to an ambiguity  $d * \mathcal{J}$  of the space-time Lagrangian. On the other hand, currents with (off-shell) vanishing divergence  $d * \mathcal{J} = 0$  do not define ambiguities. These are of the form  $\mathcal{J} = * d * \mathcal{J}_2$  for a two-form  $\mathcal{J}_2$ . We then add all possible  $\mathcal{J}_2$ , unless

$u:$	$\Phi$	$p:$	$P_\mu$	$t:$	$\text{Tr}(\dots)$	$f:$	$\mathcal{F}_{\mu\nu}$
$h:$	$H_{\mu\nu\rho}$	$c:$	$C_{\mu\nu\rho\sigma}$	$q:$	$\nabla_\mu$	$\mathbf{v}_D:$	$SO(D)$ vector

**Tab. 3.1** Parameters used to specify the properties of the words, and their signification.

\* $\mathcal{J}_2$  is of vanishing divergence and thus defined by a three-form  $\mathcal{J}_3$ , etc. This procedure is implemented by adding to  $\mathcal{Z}_{\text{inv}}$  a factor

$$(1 - uq)^{\mathbf{v}_D} = 1 - uq \mathbf{v}_D + (uq)^2 (\mathbf{v}_D \otimes \mathbf{v}_D)_{\text{alt}} - \dots, \quad (3.60)$$

and then projecting on Lorentz scalars. We have inserted dilaton and derivative charges  $u$  and  $q$ , since all terms carry a global dilaton power  $e^{-\Phi}$ , such that partial integration brings in an extra dilaton derivative. To summarize, a basis of independent space-time Lagrangians, after dividing out the freedom of partial integrations, is given by

$$\mathcal{Z}_{\text{Lag}} = \mathcal{Z}_{\text{inv}} (1 - uq)^{\mathbf{v}_D} \Big|_{\text{SO}(D) \text{ singlets}}. \quad (3.61)$$

## 3.4 Some examples

### 3.4.1 Evaluation in $D = 1$

As a first test of the counting formula (3.61), we may evaluate it to order  $\alpha'$  in  $D = 1$  dimension, where  $\mathbf{v}_D = 1$ . We do not take into account the vector and two-form sectors, which do not appear upon reduction to only one dimension. In this cosmological context, we can evaluate the counting formulas to all orders in closed form. In particular,

$$\mathcal{Z}_\Phi = uq, \quad \mathcal{Z}_p = pq, \quad \mathcal{Z}_{\text{Tr}(P)} = \frac{p^2 q^2}{1 - p^2 q^2}, \quad (3.62)$$

and

$$\mathcal{Z}_C = -c q^2 \longrightarrow -p^2 q^2, \quad (3.63)$$

reflecting the fact that in  $D = 1$  the Einstein equations pose a constraint on the energy-momentum tensor. For Eq. (3.58) and (3.59), we thus find

$$\mathcal{Z}_0 = \frac{p^4 q^4}{1 - p^2 q^2} + uq \quad \Longrightarrow \quad \mathcal{Z}_{\text{inv}} = \prod_{n>1} \frac{1}{1 - p^{2n} q^{2n}} \times \frac{1}{1 - uq}, \quad (3.64)$$

upon removing total derivatives following Eq. (3.61) and thus

$$\mathcal{Z}_{\text{Lag}} = (1 - uq) \mathcal{Z}_{\text{inv}} = \prod_{n>1} \frac{1}{1 - p^{2n} q^{2n}}, \quad (3.65)$$

which precisely reproduces the counting from Ref. [34].

### 3.4.2 Evaluation in $D = 10$

Let us now evaluate Eq. (3.61) to order  $\alpha'$  in  $D = 10$  dimensions, and for  $d = 0$ , upon truncating out the vector and scalar sector, which do not exist at  $d = 0$ . Then, in Eq. (3.58) only the contributions from metric, two-form and dilaton are taken into account. The coefficient  $g^4$  of Eq. (3.61) is then

$$g^2 + h^2 + gh^2 + 3h^4 + h^2 u + u^2. \quad (3.66)$$

We then deduce the following types of terms at the four-derivative order

$$\left\{ R^2 [1], \nabla^2 H^2 [1], RH^2 [1], H^4 [3], H^2 \nabla^2 \Phi [1], \nabla^2 \Phi \nabla^2 \Phi [1] \right\}, \quad (3.67)$$

where the multiplicities  $[n]$  indicate the number of independent terms of the same type. This precisely reproduces the counting from Ref. [17] (*c.f.* their Eq. (2.36)). Let us recall that our counting only includes manifestly gauge invariant terms, so it does not account for the possible ten-dimensional gravitational Chern-Simons couplings.

### 3.5 Basis at order $\alpha'$

Evaluating the counting formula (3.61) in generic dimension  $D^{23}$ , we infer that at order  $\alpha'$  there are 61 independent manifestly  $O(d, d, \mathbb{R})$ -invariant four-derivative terms. While the general counting only determines the number of independent terms without selecting a particular basis, it turns out that at order  $\alpha'$  there is a distinguished explicit basis which is built from polynomials in terms carrying only first order derivatives (and the Riemann tensor). Indeed, truncating the generating functions (3.36), (3.43), (3.50), (3.55) and (3.57) to first order in derivatives, we may count from Eq. (3.59) the number of independent terms that carry first derivatives only, and find precisely 61 terms at order  $\alpha'$ .<sup>24</sup>

The basis at order  $\alpha'$  can thus be given in terms of polynomials in  $R_{\mu\nu\rho}{}^\sigma$ ,  $H_{\mu\nu\rho}$ ,  $\mathcal{F}_{\mu\nu}{}^M$ ,  $\nabla_\mu S_M{}^N$ , and  $\nabla_\mu \Phi$ . Schematically, its elements take the form

$$\left\{ R^2 [1], H^4 [3], (\nabla\Phi)^4 [1], (\nabla S)^4 [5], \mathcal{F}^4 [12], RH^2 [1], R\mathcal{F}^2 [2], \right. \\ H^2 (\nabla\Phi)^2 [2], H^2 (\nabla S)^2 [2], H^2 \mathcal{F}^2 [8], (\nabla\Phi)^2 (\nabla S)^2 [2], (\nabla\Phi)^2 \mathcal{F}^2 [4], \\ \left. (\nabla S)^2 \mathcal{F}^2 [10], H\nabla\Phi \mathcal{F}^2 [2], H\nabla S \mathcal{F}^2 [3], \nabla\Phi \nabla S \mathcal{F}^2 [3] \right\}. \quad (3.68)$$

We give the explicit expressions for all the basis elements in App. B.

In the following we will exhibit  $O(d, d, \mathbb{R})$  invariance of the dimensionally reduced action by expanding the reduced action in the basis (3.68).

<sup>23</sup>For low values of  $D$ , there may exist some degeneracies, as in  $D = 3$ , where the three-form field strength  $H_{\mu\nu\rho} = h \varepsilon_{\mu\nu\rho}$  carries a unique degree of freedom such that the three different contractions for  $H^4$  in Eq. (3.67) reduce to one. We did here the calculation for  $D = 10$ , assuming that this value is large enough to make the count generic.

<sup>24</sup>At order  $\alpha'^2$  this pattern breaks down. The general counting (3.61) reveals 1817 independent terms at order  $\alpha'^2$  whereas there are only 1212 independent polynomials that can be constructed in terms of first order derivatives. This general case differs from the situation encountered in the reduction to  $D = 1$  dimensions, where one can always find a basis carrying no more than first-order time derivatives [33].

# 4 Chapter

## Four-derivative action

The first-order  $\alpha'$  extension of the action of the bosonic supergravity (2.1) has been known for some time [17] and is given up to field redefinitions by

$$\begin{aligned} \hat{I}_1 = \frac{1}{4} \alpha' \int d^{D+d} X \sqrt{-\hat{g}} e^{-\hat{\phi}} & \left( \hat{R}_{\hat{\mu}\hat{\nu}\hat{\rho}\hat{\sigma}} \hat{R}^{\hat{\mu}\hat{\nu}\hat{\rho}\hat{\sigma}} - \frac{1}{2} \hat{H}^{\hat{\mu}\hat{\nu}\hat{\lambda}} \hat{H}^{\hat{\rho}\hat{\sigma}}{}_{\hat{\lambda}} \hat{R}_{\hat{\mu}\hat{\nu}\hat{\rho}\hat{\sigma}} - \frac{1}{8} \hat{H}_{\hat{\mu}\hat{\nu}}^2 \hat{H}^2{}^{\hat{\mu}\hat{\nu}} \right. \\ & \left. + \frac{1}{24} \hat{H}_{\hat{\mu}\hat{\nu}\hat{\rho}} \hat{H}^{\hat{\mu}}{}_{\hat{\sigma}}{}^{\hat{\lambda}} \hat{H}^{\hat{\nu}}{}_{\hat{\lambda}}{}^{\hat{\tau}} \hat{H}^{\hat{\rho}\hat{\sigma}}{}_{\hat{\tau}} \right). \end{aligned} \quad (4.1)$$

In this section, we compactify separately all of its terms on a  $d$ -torus, using the ansätze (2.3) and (2.4). We fix the freedom of partial integration and possible field redefinitions, by converting all terms into polynomials of first-order derivative (and the Riemann tensor). To do so, we systematically use partial integrations and Bianchi identities to bring all terms carrying second-order derivative into a form corresponding to the first column of Tab. 2.1, which can then be converted to the desired form by means of field redefinitions as discussed in Sec. 2.2. We then compare the result to the  $O(d, d, \mathbb{R})$  basis of Sec. 3.5.

The reduction of the three-form field strength  $\hat{H}_{\hat{\mu}\hat{\nu}\hat{\rho}}$  is given in Eq. (2.5). For the reduction of the Riemann tensor, we follow the results of Ref. [71], and give the lower-dimensional components in flat indices as

$$\begin{aligned} \hat{R}_{\alpha\beta\gamma\delta} &= R_{\alpha\beta\gamma\delta} - \frac{1}{2} \left[ -G_{mn} F_{\alpha[\gamma}^{(1)m} F_{\delta]\beta}^{(1)n} + G_{mn} F_{\alpha\beta}^{(1)m} F_{\gamma\delta}^{(1)n} \right], \\ \hat{R}_{\alpha\beta\gamma d} &= \left[ \nabla_{[\alpha} F_{\beta]\gamma}^{(1)p} - \frac{1}{2} \left( G_{mn} \nabla_{[\alpha} G^{np} F_{\beta]\gamma}^{(1)m} - F_{\alpha\beta}^{(1)m} G_{mn} \nabla_{\gamma} G^{np} \right) \right] E_p d, \\ \hat{R}_{\alpha\beta cd} &= \frac{1}{2} \left[ F_{\alpha}^{(1)\gamma m} F_{\gamma\beta}^{(1)q} - \nabla_{\alpha} G^{mn} G_{np} \nabla_{\beta} G^{pq} \right] E_m [c E_{|q|} d], \\ \hat{R}_{\alpha b\gamma d} &= \frac{1}{4} \left[ 2 \nabla_{\alpha} \nabla_{\gamma} G^{mq} - 2 \nabla_{\alpha} G^{mn} G_{np} \nabla_{\gamma} G^{pq} - \nabla_{\gamma} G^{mn} G_{np} \nabla_{\alpha} G^{pq} + F_{\gamma\varepsilon}^{(1)m} F_{\alpha}^{(1)\varepsilon q} \right] E_m b E_q d, \\ \hat{R}_{ab\gamma d} &= -\frac{1}{2} F_{\gamma\varepsilon}^{(1)m} \nabla^{\varepsilon} G^{np} E_m [a E_{|n|} b] E_p d, \\ \hat{R}_{abcd} &= -\frac{1}{2} \nabla_{\varepsilon} G^{mn} \nabla^{\varepsilon} G^{pq} E_m a E_p b E_n [c E_{|q|} d]. \end{aligned} \quad (4.2)$$

### 4.1 Reduction of the various terms

We reduce the action (4.1) term by term. This section is rather technical and the  $O(d, d, \mathbb{R})$  invariance is discussed in Sec. 4.2.

### 4.1.1 Reduction of $\hat{H}_{\hat{\mu}\hat{\nu}}^2 \hat{H}^2 \hat{\mu}\hat{\nu}$

Upon compactification, we obtain

$$\begin{aligned}
\hat{H}_{\hat{\mu}\hat{\nu}}^2 \hat{H}^2 \hat{\mu}\hat{\nu} = & H_{\mu\nu}^2 H^{2\mu\nu} + 4H_{\mu\nu}^2 H^\mu{}_{\rho m} H^{\nu\rho m} - 2H^{2\mu\nu} H_{\mu\nu m} H_\nu{}^{nm} + 4H_{\mu\nu m} H^{\mu\rho m} H^{\nu\sigma n} H_{\rho\sigma n} \\
& - 4H^{\mu\rho p} H^\nu{}_{\rho p} H_{\mu mn} H_\nu{}^{nm} + H_{\mu mn} H_\nu{}^{mn} H^\mu{}_{pq} H^{\nu qp} + 2H^{\mu\nu\lambda} H^{\rho\sigma}{}_\lambda H_{\mu\nu m} H_{\rho\sigma}{}^m \\
& + 8H^{\mu\nu\rho} H_{\mu\nu m} H_\sigma{}^{mn} H^\sigma{}_{\rho n} - 8H_{\mu\rho m} H^{\mu mn} H^\nu{}_{np} H_\nu{}^{\rho p} + H_{\mu\nu m} H_{\rho\sigma}{}^m H^{\mu\nu n} H^{\rho\sigma}{}_n \\
& - 4H_{\mu\nu m} H_\rho{}^{mn} H^\rho{}_{np} H^{\mu\nu p} + 4H_{\mu mn} H^{\nu np} H_{\nu pq} H^{\mu qm} + 4H_{mnp} H_{\mu\nu\rho} H^{mn\rho} H^{\mu\nu p} \\
& + 8H_{mnp} H_{\mu\nu q} H^{\mu pq} H^{\nu mn} + 2H_{mnp} H_{\mu qr} H^{\mu mn} H^{pqr} + 2H_{mnp} H^{mnq} H_{\mu\nu}{}^p H^{\mu\nu q} \\
& + 4H_{mnp} H^{mnq} H^{\mu pr} H_{\mu qr} + H_{mnr} H^{mns} H_{pqs} H^{pqr}.
\end{aligned} \tag{4.3}$$

Using Eq. (2.5), this takes the form

$$\begin{aligned}
\hat{H}_{\hat{\mu}\hat{\nu}}^2 \hat{H}^2 \hat{\mu}\hat{\nu} = & H_{\mu\nu}^2 H^{2\mu\nu} + 4\text{Tr} \left( \nabla_\mu B G^{-1} \nabla^\mu B G^{-1} \nabla_\nu B G^{-1} \nabla^\nu B G^{-1} \right) \\
& + \text{Tr} \left( \nabla_\mu B G^{-1} \nabla_\nu B G^{-1} \right) \text{Tr} \left( \nabla^\mu B G^{-1} \nabla^\nu B G^{-1} \right) + H_{\mu\nu m} G^{mn} H_{\rho\sigma n} H^{\mu\nu}{}_p G^{pq} H^{\rho\sigma}{}_q \\
& + 4H_{\mu\nu m} G^{mn} H^{\mu\rho}{}_n H_{\rho\sigma p} G^{pq} H^{\nu\sigma}{}_q - 2H^{2\mu\nu} \text{Tr} \left( \nabla_\mu B G^{-1} \nabla_\nu B G^{-1} \right) \\
& + 4H^{2\mu\nu} H_{\mu\rho m} G^{mn} H_\nu{}^{\rho}{}_n - 4\text{Tr} \left( \nabla^\mu B G^{-1} \nabla^\nu B G^{-1} \right) H_{\mu\rho m} G^{mn} H_\nu{}^{\rho}{}_n \\
& + 2H^{\mu\nu\lambda} H^{\rho\sigma}{}_\lambda H_{\mu\nu m} G^{mn} H_{\rho\sigma n} - 8H_{\mu\rho m} \left( G^{-1} \nabla^\mu B G^{-1} \nabla_\nu B G^{-1} \right)^{mn} H_\nu{}^{\rho}{}_n \\
& - 8H^{\mu\nu\rho} H_{\mu\nu m} \left( G^{-1} \nabla^\sigma B G^{-1} \right)^{mn} H_{\rho\sigma n} - 4H_{\mu\nu m} \left( G^{-1} \nabla_\rho B G^{-1} \nabla^\rho B G^{-1} \right)^{mn} H^{\mu\nu}{}_n,
\end{aligned} \tag{4.4}$$

where all terms carry first-order derivatives only, i.e. are already of the desired form.

### 4.1.2 Reduction of $\hat{H}_{\hat{\mu}\hat{\nu}\hat{\rho}} \hat{H}^{\hat{\mu}}{}_{\hat{\sigma}} \hat{\lambda} \hat{H}^{\hat{\nu}}{}_{\hat{\lambda}} \hat{\tau} \hat{H}^{\hat{\rho}}{}_{\hat{\tau}} \hat{\sigma}$

Upon compactification, we obtain

$$\begin{aligned}
\hat{H}_{\hat{\mu}\hat{\nu}\hat{\rho}} \hat{H}^{\hat{\mu}}{}_{\hat{\sigma}} \hat{\lambda} \hat{H}^{\hat{\nu}}{}_{\hat{\lambda}} \hat{\tau} \hat{H}^{\hat{\rho}}{}_{\hat{\tau}} \hat{\sigma} = & H_{\mu\nu\rho} H^\mu{}_{\sigma}{}^\lambda H^\nu{}_{\lambda}{}^\tau H^\rho{}_{\tau}{}^\sigma + 6H^{\mu\nu\lambda} H^{\rho\sigma}{}_\lambda H_{\mu\rho m} H_{\nu\sigma}{}^m \\
& - 12H^{\mu\nu\rho} H_{\mu\sigma m} H_\nu{}^{mn} H_\rho{}^\sigma{}_n + 4H^{\mu\nu\rho} H_{\mu mn} H_\nu{}^{np} H_{\rho p}{}^m + 3H_{\mu\nu m} H_{\rho\sigma}{}^m H^{\mu\rho}{}_n H^{\nu\sigma}{}_n \\
& - 12H_{\mu\nu m} H_\rho{}^{mn} H^\nu{}_{np} H^{\mu\rho p} + 3H_{\mu mn} H_\nu{}^{np} H^\mu{}_{pq} H^{\nu pm} + 4H_{mnp} H^m{}_{\mu\nu} H_\rho{}^{\mu n} H^{\rho\nu p} \\
& + 12H_{mnp} H^{\mu m q} H^{\nu n}{}_q H_{\mu\nu}{}^p + 6H_{mnr} H_{pq}{}^r H^{mp}{}_\mu H^{nq\mu} + H_{mnp} H^m{}_q H^n{}_r H^p{}_s H^s{}_q.
\end{aligned} \tag{4.5}$$

Using Eq. (2.5), this takes the form

$$\begin{aligned}
\hat{H}_{\hat{\mu}\hat{\nu}\hat{\rho}} \hat{H}^{\hat{\mu}}{}_{\hat{\sigma}} \hat{\lambda} \hat{H}^{\hat{\nu}}{}_{\hat{\lambda}} \hat{\tau} \hat{H}^{\hat{\rho}}{}_{\hat{\tau}} \hat{\sigma} = & H_{\mu\nu\rho} H^\mu{}_{\sigma}{}^\lambda H^\nu{}_{\lambda}{}^\tau H^\rho{}_{\tau}{}^\sigma + 3H_{\mu\nu m} G^{mn} H_{\rho\sigma n} H^{\mu\rho}{}_p G^{pq} H^{\nu\sigma}{}_q \\
& + 6H^{\mu\nu\lambda} H^{\rho\sigma}{}_\lambda H_{\mu\rho m} G^{mn} H_{\nu\sigma n} + 3\text{Tr} \left( \nabla_\mu B G^{-1} \nabla_\nu B G^{-1} \nabla^\mu B G^{-1} \nabla^\nu B G^{-1} \right) \\
& - 12H^{\mu\nu\rho} H_{\mu\sigma m} \left( G^{-1} \nabla_\nu B G^{-1} \right)^{mn} H_\rho{}^\sigma{}_n - 12H_{\mu\nu m} \left( G^{-1} \nabla_\rho B G^{-1} \nabla^\rho B G^{-1} \right)^{mn} H^{\mu\rho}{}_n \\
& + 4H^{\mu\nu\rho} \text{Tr} \left( \nabla_\mu B G^{-1} \nabla_\nu B G^{-1} \nabla_\rho B G^{-1} \right),
\end{aligned} \tag{4.6}$$

where again all terms carry first-order derivatives only, i.e. are already of the desired form.

### 4.1.3 Reduction of $\hat{R}_{\hat{\mu}\hat{\nu}\hat{\rho}\hat{\sigma}}\hat{R}^{\hat{\mu}\hat{\nu}\hat{\rho}\hat{\sigma}}$

Splitting the  $D + d$  indices  $\hat{\mu}$  as  $\hat{\mu} \rightarrow \{\mu, m\}$ , we obtain

$$\begin{aligned} \hat{R}_{\hat{\mu}\hat{\nu}\hat{\rho}\hat{\sigma}}\hat{R}^{\hat{\mu}\hat{\nu}\hat{\rho}\hat{\sigma}} &= \hat{R}_{\mu\nu\rho\sigma}\hat{R}^{\mu\nu\rho\sigma} + 4\hat{R}_{\mu\nu\rho m}\hat{R}^{\mu\nu\rho m} + 2\hat{R}_{\mu\nu mn}\hat{R}^{\mu\nu mn} \\ &+ 4\hat{R}_{\mu m\nu n}\hat{R}^{\mu m\nu n} + 4\hat{R}_{mn\mu p}\hat{R}^{mn\mu p} + \hat{R}_{mnpq}\hat{R}^{mnpq}. \end{aligned} \quad (4.7)$$

Upon using Eq. (4.2), the reduction of the first term of the action (4.1) then yields

$$\begin{aligned} \frac{\alpha'}{4} \int d^{D+d}x \sqrt{-\hat{g}} e^{-\hat{\phi}} \hat{R}_{\hat{\mu}\hat{\nu}\hat{\rho}\hat{\sigma}}\hat{R}^{\hat{\mu}\hat{\nu}\hat{\rho}\hat{\sigma}} &\rightarrow \\ \frac{\alpha'}{4} \int d^Dx \sqrt{-g} e^{-\Phi} &\left[ R_{\mu\nu\rho\sigma}R^{\mu\nu\rho\sigma} - \frac{3}{2}R^{\mu\nu\rho\sigma}F_{\mu\nu}^{(1)m}G_{mn}F_{\rho\sigma}^{(1)n} + \frac{3}{2}\text{Tr}\left(\nabla_\mu G^{-1}\nabla^\mu G\nabla_\nu G^{-1}\nabla^\nu G\right) \right. \\ &+ \frac{5}{8}\text{Tr}\left(\nabla_\mu G^{-1}\nabla_\nu G\nabla^\mu G^{-1}\nabla^\nu G\right) + \frac{1}{8}\text{Tr}\left(\nabla_\mu G^{-1}\nabla_\nu G\right)\text{Tr}\left(\nabla^\mu G^{-1}\nabla^\nu G\right) \\ &+ \frac{3}{8}F_{\mu\nu}^{(1)m}G_{mn}F_{\rho\sigma}^{(1)n}F^{(1)\mu\nu p}G_{pq}F^{(1)\rho\sigma q} + \frac{1}{8}F_{\mu\nu}^{(1)m}G_{mn}F_{\rho\sigma}^{(1)n}F^{(1)\mu\rho p}G_{pq}F^{(1)\nu\sigma q} \\ &+ \frac{1}{2}F_{\mu\nu}^{(1)m}G_{mn}F^{(1)\mu\rho n}F_{\rho\sigma}^{(1)p}G_{pq}F^{(1)\nu\sigma q} - \frac{1}{2}\text{Tr}\left(\nabla^\mu G^{-1}\nabla_\nu G\right)F_{\mu\rho}^{(1)m}G_{mn}F^{(1)\nu\rho n} \\ &- \frac{3}{2}F_{\mu\nu}^{(1)m}\left(\nabla_\rho G\nabla^\rho G^{-1}G\right)_{mn}F^{(1)\mu\nu n} + \frac{1}{2}F_{\mu\nu}^{(1)m}\left(\nabla_\rho G\nabla^\mu G^{-1}G\right)_{mn}F^{(1)\rho\nu n} \\ &+ \text{Tr}\left(\nabla_\mu\nabla_\nu G^{-1}G\nabla^\mu\nabla^\nu G^{-1}G\right) + 3\text{Tr}\left(\nabla_\mu\nabla_\nu G^{-1}\nabla^\mu G\nabla^\nu G^{-1}G\right) - 6\nabla_\rho F_{\mu\nu}^{(1)m}\nabla^\mu G_{mn}F^{(1)\nu\rho n} \\ &\left. + F_{\mu\nu}^{(1)m}\left(G\nabla^\mu\nabla_\rho G^{-1}G\right)_{mn}F^{(1)\rho\nu n} - 2\nabla_\rho F_{\mu\nu}^{(1)m}G_{mn}\nabla^\mu F^{(1)\nu\rho n}\right]. \end{aligned} \quad (4.8)$$

Apart from the Riemann tensor, only the five last terms contain second-order derivatives. Using partial integration and Bianchi identities, it is possible to transform those terms so that all second-order derivatives appear as the leading two-derivative contribution from the field Eq. (2.17), *i.e.* appear within the first column of Tab. 2.1. Details are given in App. C. Specifically, the remaining second-order derivative terms combine into

$$\begin{aligned} \frac{\alpha'}{4} \int d^Dx \sqrt{-g} e^{-\Phi} &\left[ \text{Tr}\left(\square G^{-1}G\square G^{-1}G\right) - 2\nabla_\mu\Phi\text{Tr}\left(\square G^{-1}G\nabla^\mu G^{-1}\right) \right. \\ &+ 2\text{Tr}\left(\square G^{-1}G\nabla_\nu G^{-1}\nabla^\nu G\right) + \frac{1}{2}\text{Tr}\left(\square GG^{-1}\nabla_\nu G\nabla^\nu G^{-1}\right) - \frac{5}{4}F_{\mu\nu}^{(1)m}\square G_{mn}F^{(1)\mu\nu n} \\ &+ (R_{\mu\nu} + \nabla_\mu\nabla_\nu\Phi)\left(\text{Tr}\left(\nabla^\mu G^{-1}\nabla^\nu G\right) - 2F_{\mu\rho}^{(1)m}G_{mn}F_{\nu}^{(1)\rho n}\right) \\ &+ 2\nabla^\mu F_{\mu\nu}^{(1)m}G_{mn}\left(\nabla_\rho F^{(1)\rho\nu n} - \nabla_\rho\Phi F^{(1)\rho\nu n}\right) \\ &\left. + \left(-2\nabla^\mu\Phi F_{\mu\nu}^{(1)m}G_{mn} + 3F_{\mu\nu}^{(1)m}\nabla^\mu G_{mn}\right)\nabla_\rho F^{(1)\rho\nu n}\right], \end{aligned} \quad (4.9)$$

and can be eliminated by field redefinitions according to the rules defined in Tab. 2.1. The explicit induced field redefinitions are collected in Eq. (C.4). The final result of the reduction (4.8) then takes the form

$$\begin{aligned} \frac{\alpha'}{4} \int d^{D+d}x \sqrt{-\hat{g}} e^{-\hat{\phi}} \hat{R}_{\hat{\mu}\hat{\nu}\hat{\rho}\hat{\sigma}}\hat{R}^{\hat{\mu}\hat{\nu}\hat{\rho}\hat{\sigma}} &\rightarrow \\ \frac{\alpha'}{4} \int d^Dx \sqrt{-g} e^{-\Phi} &\left[ R_{\mu\nu\rho\sigma}R^{\mu\nu\rho\sigma} - \frac{1}{2}R^{\mu\nu\rho\sigma}F_{\mu\nu}^{(1)m}G_{mn}F_{\rho\sigma}^{(1)n} + \frac{1}{2}\text{Tr}\left(\nabla_\mu G\nabla^\mu G^{-1}\nabla_\nu BG^{-1}\nabla^\nu BG^{-1}\right) \right. \\ &\left. + \text{Tr}\left(\nabla_\mu BG^{-1}\nabla^\mu BG^{-1}\nabla_\nu BG^{-1}\nabla^\nu BG^{-1}\right) + \frac{1}{8}\text{Tr}\left(\nabla_\mu G^{-1}\nabla_\nu G\nabla^\mu G^{-1}\nabla^\nu G\right) \right] \end{aligned}$$



$$\begin{aligned}
& -\frac{1}{8} \text{Tr} \left( \nabla_\mu G^{-1} \nabla_\nu G \right) \text{Tr} \left( \nabla^\mu G^{-1} \nabla^\nu G \right) - \frac{1}{4} \text{Tr} \left( \nabla_\mu B G^{-1} \nabla_\nu B G^{-1} \right) \text{Tr} \left( \nabla^\mu G^{-1} \nabla^\nu G \right) \\
& + \frac{1}{4} H_{\mu\nu m} G^{mn} H_{\rho\sigma n} H^{\mu\nu}{}_p G^{pq} H^{\rho\sigma}{}_q + \frac{1}{8} F_{\mu\nu}^{(1)m} G_{mn} F_{\rho\sigma}^{(1)n} F^{(1)\mu\rho p} G_{pq} F^{(1)\nu\sigma}{}_q \\
& - \frac{1}{2} F_{\mu\nu}^{(1)m} G_{mn} F^{(1)\mu\rho n} F_{\rho\sigma}^{(1)p} G_{pq} F^{(1)\nu\sigma}{}_q - H_{\mu\nu m} G^{mn} H^{\mu\rho}{}_n F_{\rho\sigma}^{(1)p} G_{pq} F^{(1)\nu\sigma}{}_q \\
& + \frac{1}{8} F_{\mu\nu}^{(1)m} H_{\rho\sigma m} F^{(1)\mu\nu n} H^{\rho\sigma}{}_n + \frac{1}{4} H^2{}^{\mu\nu} \text{Tr} \left( \nabla_\mu G^{-1} \nabla_\nu G \right) - \frac{1}{2} H_{\mu\nu}^2 F^{(1)\mu\rho m} G_{mn} F^{(1)\nu}{}_\rho{}^n \\
& + \frac{1}{2} \text{Tr} \left( \nabla_\mu B G^{-1} \nabla_\nu B G^{-1} \right) F^{(1)\mu\rho m} G_{mn} F^{(1)\nu}{}_\rho{}^n + \frac{1}{2} \text{Tr} \left( \nabla_\mu G^{-1} \nabla_\nu G \right) H^{\mu\rho}{}_m G^{mn} H^{\nu}{}_\rho{}_n \\
& + \frac{1}{2} \text{Tr} \left( \nabla_\mu G^{-1} \nabla_\nu G \right) F^{(1)\mu\rho m} G_{mn} F^{(1)\nu}{}_\rho{}^n + \frac{1}{2} H^{\mu\nu\lambda} H^{\rho\sigma}{}_\lambda H_{\mu\nu m} G^{mn} H_{\rho\sigma n} \\
& - 2 H^{\mu\nu\rho} H_{\mu\nu m} \left( G^{-1} \nabla^\sigma B G^{-1} \right)^{mn} H_{\rho\sigma n} - \frac{1}{2} H^{\mu\nu\rho} H_{\mu\nu m} \left( G^{-1} \nabla^\sigma G \right)^m{}_n F_{\rho\sigma}^{(1)n} \\
& - \frac{1}{4} F_{\mu\nu}^{(1)m} \left( \nabla_\rho B G^{-1} \nabla^\rho B \right)_{mn} F^{(1)\mu\nu n} - \frac{1}{4} H_{\mu\nu m} \left( \nabla_\rho G^{-1} \nabla^\rho G G^{-1} \right)^{mn} H^{\mu\nu}{}_n \\
& - H_{\mu\nu m} \left( G^{-1} \nabla_\rho B G^{-1} \nabla^\rho B G^{-1} \right)^{mn} H^{\mu\nu}{}_n - \frac{1}{2} F_{\mu\nu}^{(1)m} \left( \nabla_\rho G \nabla^\nu G^{-1} G \right)_{mn} F^{(1)\mu\rho n} \\
& - 2 H_{\mu\rho m} \left( G^{-1} \nabla^\mu B G^{-1} \nabla_\nu B G^{-1} \right)^{mn} H^{\nu\rho}{}_n - H_{\mu\rho m} \left( G^{-1} \nabla^\mu B G^{-1} \nabla_\nu G \right)^m{}_n F^{(1)\nu\rho n} \Big]. \quad (4.10)
\end{aligned}$$

#### 4.1.4 Reduction of $\hat{R}_{\hat{\mu}\hat{\nu}\hat{\rho}\hat{\sigma}} \hat{H}^{\hat{\mu}\hat{\nu}\hat{\lambda}} \hat{H}^{\hat{\rho}\hat{\sigma}}{}_{\hat{\lambda}}$

Let us finally consider the reduction of the term  $RHH$ . The index split gives

$$\begin{aligned}
\hat{R}_{\hat{\mu}\hat{\nu}\hat{\rho}\hat{\sigma}} \hat{H}^{\hat{\mu}\hat{\nu}\hat{\lambda}} \hat{H}^{\hat{\rho}\hat{\sigma}}{}_{\hat{\lambda}} &= \hat{R}_{\mu\nu\rho\sigma} \hat{H}^{\mu\nu\lambda} \hat{H}^{\rho\sigma}{}_\lambda + \hat{R}_{\mu\nu\rho\sigma} \hat{H}^{\mu\nu}{}_m \hat{H}^{\rho\sigma m} - 4 \hat{R}_{\mu\nu\rho m} \hat{H}^{\mu\nu\lambda} \hat{H}^{\rho}{}_\lambda{}^m \\
& - 4 \hat{R}_{\mu\nu\rho m} \hat{H}^{\rho n m} \hat{H}^{\mu\nu}{}_n + 2 \hat{R}_{\mu\nu m n} \hat{H}^{\mu\nu\rho} \hat{H}^{\rho}{}^{mn} + 4 \hat{R}_{\mu m \nu n} \hat{H}^{\mu\rho m} \hat{H}^{\nu}{}_\rho{}^n \\
& + 4 \hat{R}_{\mu m \nu n} \hat{H}^{\mu m p} \hat{H}^{\nu n}{}_p - 4 \hat{R}_{\mu m n p} \hat{H}^{\mu\nu m} \hat{H}^{\nu}{}^{np} + \hat{R}_{m n p q} \hat{H}^{\mu m n} \hat{H}^{\rho}{}_{\mu}{}^{pq} \\
& + 2 \hat{R}_{\mu\nu m n} \hat{H}^{\mu\nu}{}_p \hat{H}^{\rho m n p} + 4 \hat{R}_{\mu m n p} \hat{H}^{\mu m}{}_q \hat{H}^{\rho n p q} + \hat{R}_{m n p q} \hat{H}^{\mu n}{}_r \hat{H}^{\rho q r}{}_\mu. \quad (4.11)
\end{aligned}$$

Then, using Eq. (2.5) and (4.2), the reduction of the corresponding term in the action (4.1) gives

$$\begin{aligned}
& -\frac{1}{8} \alpha' \int d^{D+d}X \sqrt{-\hat{g}} e^{-\hat{\phi}} \hat{R}_{\hat{\mu}\hat{\nu}\hat{\rho}\hat{\sigma}} \hat{H}^{\hat{\mu}\hat{\nu}\hat{\lambda}} \hat{H}^{\hat{\rho}\hat{\sigma}}{}_{\hat{\lambda}} \longrightarrow \\
& \frac{\alpha'}{4} \int d^Dx \sqrt{-\hat{g}} e^{-\hat{\Phi}} \left[ -\frac{1}{2} R_{\mu\nu\rho\sigma} H^{\mu\nu\lambda} H^{\rho\sigma}{}_\lambda - \frac{1}{2} R_{\mu\nu\rho\sigma} H^{\mu\nu}{}_m G^{mn} H^{\rho\sigma}{}_n \right. \\
& - \frac{1}{4} \text{Tr} \left( \nabla_\mu G^{-1} \nabla_\nu B \nabla^\mu G^{-1} \nabla^\nu B \right) - \text{Tr} \left( \nabla_\mu B \nabla^\mu G^{-1} G \nabla_\nu G^{-1} \nabla^\nu B G^{-1} \right) \\
& - \frac{1}{2} \text{Tr} \left( \nabla_\mu G^{-1} G \nabla_\nu G^{-1} \nabla^\mu B G^{-1} \nabla^\nu B \right) + \frac{1}{4} F_{\mu\nu}^{(1)m} G_{mn} F_{\rho\sigma}^{(1)n} H^{\mu\nu}{}_p G^{pq} H^{\rho\sigma}{}_q \\
& + \frac{1}{4} F_{\mu\nu}^{(1)m} G_{mn} F_{\rho\sigma}^{(1)n} H^{\mu\rho}{}_p G^{pq} H^{\nu\sigma}{}_q - \frac{1}{2} F_{\mu\nu}^{(1)m} H_{\rho\sigma m} F^{(1)\rho\nu n} H^{\mu\sigma}{}_n + \frac{1}{4} H^{\mu\nu\lambda} H^{\rho\sigma}{}_\lambda F_{\mu\rho}^{(1)m} G_{mn} F_{\nu\sigma}^{(1)n} \\
& + \frac{1}{4} H^{\mu\nu\lambda} H^{\rho\sigma}{}_\lambda F_{\mu\nu}^{(1)m} G_{mn} F_{\rho\sigma}^{(1)n} - H^{\mu\nu\rho} F_{\mu\nu}^{(1)m} \left( G \nabla^\sigma G^{-1} \right)^n{}_m H_{\rho\sigma n} - H^{\mu\nu\rho} F_{\mu\sigma}^{(1)m} \left( G \nabla_\nu G^{-1} \right)^n{}_m H_{\rho}{}^\sigma{}_n \\
& - \frac{1}{2} H^{\mu\nu\rho} F_{\mu\sigma}^{(1)m} \nabla_\nu B_{mn} F_{\rho}{}^{\sigma n} - F_{\mu\nu}^{(1)m} \left( \nabla_\rho B \nabla^\nu G^{-1} \right)^n{}_m H^{\mu\rho}{}_n + \frac{1}{2} F_{\mu\nu}^{(1)m} \left( \nabla_\rho B G^{-1} \nabla^\nu B \right)_{mn} F^{(1)\mu\rho n} \\
& - F_{\mu\nu}^{(1)m} \left( G \nabla_\rho G^{-1} \nabla^\rho B G^{-1} \right)^n{}_m H^{\mu\nu}{}_n - F_{\mu\nu}^{(1)m} \left( G \nabla_\rho G^{-1} \nabla^\nu B G^{-1} \right)^n{}_m H^{\mu\rho}{}_n \\
& \left. - \frac{1}{2} H_{\mu\nu m} \left( \nabla_\rho G^{-1} \nabla^\nu G G^{-1} \right)^{mn} H^{\mu\rho}{}_n - H_{\mu\rho m} \left( \nabla^\mu G^{-1} \nabla_\nu G G^{-1} \right)^{mn} H^{\nu\rho}{}_n \right].
\end{aligned}$$

$$\begin{aligned}
& -\frac{1}{2} H^{\mu\nu\rho} \text{Tr} \left( \nabla_\mu G^{-1} G \nabla_\nu G^{-1} \nabla_\rho B \right) + \text{Tr} \left( \nabla_\mu \nabla_\nu G^{-1} \nabla^\mu B G^{-1} \nabla^\nu B \right) - H^{\mu\rho} {}_m \nabla_\mu \nabla_\nu G^{mn} H^\nu{}_{\rho n} \\
& - 2 \nabla_\mu F_{\nu\rho}^{(1)m} \left( \nabla^\rho B G^{-1} \right)_m^n H^{\mu\nu}{}_n + 2 H^{\mu\nu\lambda} \nabla_\mu F_{\nu\rho}^{(1)m} H^\rho{}_{\lambda m} \Big]. \tag{4.12}
\end{aligned}$$

Apart from the Riemann tensor, only the four last terms contain second-order derivatives. Just as for the Riemann squared term (4.8), upon partial integration, one can transform these terms such that all second-order derivatives appear as the leading two-derivative contribution from the field Eq. (2.17). Details are given in App. C. Specifically, the remaining second-order derivative terms combine into

$$\begin{aligned}
& \int d^D x \sqrt{-g} e^{-\Phi} \frac{\alpha'}{4} \left[ \frac{1}{2} \text{Tr} \left( \square G^{-1} \nabla_\nu B G^{-1} \nabla^\nu B \right) - \text{Tr} \left( \square B G^{-1} \nabla_\nu B \nabla^\nu G^{-1} \right) \right. \\
& - \frac{1}{2} F_{\mu\nu}^{(1)m} \left( \square B G^{-1} \right)_m^n H^{\mu\nu}{}_n - \frac{1}{4} H^{\mu\nu}{}_m \square G^{mn} H_{\mu\nu n} - \nabla_\mu H^{\mu\nu\rho} F_{\nu\sigma}^{(1)m} H^\sigma{}_{\rho m} \\
& - \frac{1}{2} \nabla_\mu H^{\mu\nu}{}_m \left( 2 \nabla^\rho G^{mn} H_{\nu\rho n} - H_{\nu\rho\sigma} F^{(1)\rho\sigma m} + 2 \left( G^{-1} \nabla^\rho B \right)_m^n F_{\nu\rho}^{(1)n} \right) \\
& \left. - \frac{1}{2} \nabla_\mu F^{(1)\mu\nu}{}_m \left( 2 \left( \nabla^\rho B G^{-1} \right)_m^n H_{\nu\rho n} - H_{\nu\rho\sigma} H^{\rho\sigma}{}_m \right) \right], \tag{4.13}
\end{aligned}$$

and can be eliminated by field redefinitions according to the rules defined in Tab. 2.1. The explicit induced field redefinitions are collected in Eq. (C.9). The final result of the reduction (4.12) then takes the form

$$\begin{aligned}
& -\frac{1}{8} \alpha' \int d^{D+d_X} \sqrt{-\hat{g}} e^{-\hat{\Phi}} \hat{R}_{\hat{\mu}\hat{\nu}\hat{\rho}\hat{\sigma}} \hat{H}^{\hat{\mu}\hat{\nu}\hat{\lambda}} \hat{H}^{\hat{\rho}\hat{\sigma}}{}_{\hat{\lambda}} \longrightarrow \\
& \frac{\alpha'}{4} \int d^D x \sqrt{-g} e^{-\Phi} \left[ -\frac{1}{2} R_{\mu\nu\rho\sigma} H^{\mu\nu\lambda} H^{\rho\sigma}{}_{\lambda} - \frac{1}{2} R_{\mu\nu\rho\sigma} H^{\mu\nu}{}_m G^{mn} H^{\rho\sigma}{}_n \right. \\
& + \frac{1}{4} \text{Tr} \left( \nabla_\mu G^{-1} \nabla_\nu B \nabla^\mu G^{-1} \nabla^\nu B \right) - \frac{1}{2} \text{Tr} \left( \nabla_\mu G \nabla^\mu G^{-1} \nabla_\nu B G^{-1} \nabla^\nu B G^{-1} \right) \\
& - \frac{1}{2} \text{Tr} \left( \nabla_\mu B G^{-1} \nabla^\mu B G^{-1} \nabla_\nu B G^{-1} \nabla^\nu B G^{-1} \right) - \frac{1}{2} \text{Tr} \left( \nabla_\mu G^{-1} G \nabla_\nu G^{-1} \nabla^\mu B G^{-1} \nabla^\nu B \right) \\
& - \frac{1}{8} H_{\mu\nu m} G^{mn} H_{\rho\sigma n} H^{\mu\nu}{}_p G^{pq} H^{\rho\sigma}{}_q + \frac{1}{4} F_{\mu\nu}^{(1)m} G_{mn} F_{\rho\sigma}^{(1)n} H^{\mu\rho}{}_p G^{pq} H^{\nu\sigma}{}_q \\
& + \frac{1}{2} F_{\mu\nu}^{(1)m} H_{\rho\sigma m} F^{(1)\rho\nu}{}_n H^{\mu\sigma}{}_n - \frac{1}{8} F_{\mu\nu}^{(1)m} H_{\rho\sigma m} F^{(1)\mu\nu}{}_n H^{\rho\sigma}{}_n \\
& + \frac{1}{4} H^{\mu\nu\lambda} H^{\rho\sigma}{}_{\lambda} F_{\mu\rho}^{(1)m} G_{mn} F_{\nu\sigma}^{(1)n} - \frac{1}{4} H^{\mu\nu\lambda} H^{\rho\sigma}{}_{\lambda} H_{\mu\nu m} G^{mn} H_{\rho\sigma n} \\
& + H^{\mu\nu\rho} H_{\mu\nu m} \left( G^{-1} \nabla^\sigma B G^{-1} \right)^{mn} H_{\rho\sigma n} + \frac{1}{2} H^{\mu\nu\rho} H_{\mu\nu m} \left( G^{-1} \nabla^\sigma G \right)_m^n F_{\rho\sigma}^{(1)m} \\
& - H^{\mu\nu\rho} F_{\mu\sigma}^{(1)m} \left( G \nabla_\nu G^{-1} \right)_m^n H_{\rho\sigma}{}^n + \frac{1}{2} H^{\mu\nu\rho} F_{\mu\sigma}^{(1)m} \nabla_\nu B_{mn} F^{(1)\sigma n}{}_{\rho} \\
& + \frac{1}{4} F_{\mu\nu}^{(1)m} \left( \nabla_\rho B G^{-1} \nabla^\rho B \right)_{mn} F^{(1)\mu\nu}{}_n + \frac{1}{2} H_{\mu\nu m} \left( G^{-1} \nabla_\rho B G^{-1} \nabla^\rho B G^{-1} \right)^{mn} H^{\mu\nu}{}_n \\
& + \frac{1}{4} H_{\mu\nu m} \left( G^{-1} \nabla_\rho G \nabla^\rho G^{-1} \right)^{mn} H^{\mu\nu}{}_n - F_{\mu\nu}^{(1)m} \left( G \nabla_\rho G^{-1} \nabla^\nu B G^{-1} \right)_m^n H^{\mu\rho}{}_n \\
& + F_{\mu\nu}^{(1)m} \left( \nabla_\rho B \nabla^\nu G^{-1} \right)_m^n H^{\mu\rho}{}_n - \frac{1}{2} F_{\mu\nu}^{(1)m} \left( \nabla_\rho B G^{-1} \nabla^\nu B \right)_{mn} F^{(1)\mu\rho}{}_n \\
& - \frac{1}{2} H_{\mu\nu m} \left( \nabla_\rho G^{-1} \nabla^\nu G G^{-1} \right)^{mn} H^{\mu\rho}{}_n + H_{\mu\rho m} \left( G^{-1} \nabla^\mu B G^{-1} \nabla_\nu B G^{-1} \right)^{mn} H^{\nu\rho}{}_n \\
& \left. - F_{\mu\rho}^{(1)m} \left( \nabla^\mu G G^{-1} \nabla_\nu B G^{-1} \right)_m^n H^{\nu\rho}{}_n - \frac{1}{2} H^{\mu\nu\rho} \text{Tr} \left( \nabla_\mu G^{-1} G \nabla_\nu G^{-1} \nabla_\rho B \right) \right]. \tag{4.14}
\end{aligned}$$

In the next section, we will match the result of the explicit reduction against the basis (3.68) in order to establish  $O(d, d, \mathbb{R})$  invariance of the reduced action.

### 4.1.5 Field redefinitions

By partial integration and suitable field redefinitions, we have thus cast the reduced action at order  $\alpha'$  into a form which is polynomial in first-order derivatives and the Riemann tensor. As an illustration and for potential applications requiring the dictionary between the lower-dimensional fields and the fields featuring in the original action (2.1), let us list the full set of induced field redefinitions, put together from Eq. (C.4) and (C.9):

$$\begin{aligned}
\delta\Phi &= \frac{1}{4} \left[ -F_{\mu\nu}^{(1)m} G_{mn} F^{(1)\mu\nu n} + \frac{1}{2} \text{Tr} \left( \nabla_\mu G^{-1} \nabla^\mu G \right) \right], \\
\delta g_{\mu\nu} &= \frac{1}{4} \left[ 2F_{\mu\rho}^{(1)m} G_{mn} F_{\nu}^{(1)\rho n} - \text{Tr} \left( \nabla_{(\mu} G^{-1} \nabla_{\nu)} G \right) \right], \\
\delta B_{\mu\nu} &= \frac{1}{8} \left[ \left( -2 \nabla^\rho F_{\rho\mu}^{(1)m} + 2 \nabla^\rho \Phi F_{\rho\mu}^{(1)m} + \frac{1}{2} H_{\mu\rho\sigma} H^{\rho\sigma}{}_p G^{pm} \right. \right. \\
&\quad \left. \left. + F_{\mu\rho}^{(1)p} \left( \nabla^\rho G G^{-1} \right)_p^m + H_{\mu\rho p} \left( G^{-1} \nabla^\rho B G^{-1} \right)^{pm} \right) \left( A_{\nu m}^{(2)} - B_{mn} A_{\nu}^{(1)n} \right) \right. \\
&\quad \left. - A_\mu^{(1)m} \left( G \nabla_\rho G^{-1} \right)_m^n H_{\nu\rho n} - A_\mu^{(1)m} \nabla^\rho B_{mn} F_{\nu\rho}^{(1)n} + 2 F_{\mu\rho}^{(1)m} H^\rho{}_{\nu m} \right. \\
&\quad \left. + \frac{1}{2} A_\mu^{(1)m} H_{\nu\rho\sigma} G_{mn} F^{(1)\rho\sigma n} \right] - (\mu \leftrightarrow \nu), \\
\delta G^{mn} &= \frac{1}{4} \left[ -2 \square G^{mn} + 2 \nabla_\mu \Phi \nabla^\mu G^{mn} - \frac{1}{2} G^{mp} H_{\mu\nu p} G^{nq} H^{\mu\nu}{}_q - \frac{3}{2} F_{\mu\nu}^{(1)m} F^{(1)\mu\nu n} \right. \\
&\quad \left. - \left( G^{-1} \nabla_\mu G \nabla^\mu G^{-1} \right)^{mn} + \left( G^{-1} \nabla_\mu B G^{-1} \nabla^\mu B G^{-1} \right)^{mn} \right], \\
\delta B_{mn} &= \frac{1}{4} \left[ \left( \nabla_\mu B \nabla^\mu G^{-1} G \right)_{mn} + \left( G \nabla_\mu G^{-1} \nabla^\mu B \right)_{mn} \right. \\
&\quad \left. - \frac{1}{2} H_{\mu\nu m} F^{(1)\mu\nu p} G_{pn} + \frac{1}{2} G_{mp} F^{(1)\mu\nu p} H_{\mu\nu n} \right], \\
\delta A_\mu^{(1)m} &= \frac{1}{4} \left[ -2 \nabla^\nu F_{\nu\mu}^{(1)m} + 2 \nabla^\nu \Phi F_{\nu\mu}^{(1)m} + \frac{1}{2} H_{\mu\nu\rho} H^{\nu\rho}{}_n G^{nm} \right. \\
&\quad \left. + F_{\mu\nu}^{(1)n} \left( \nabla^\nu G G^{-1} \right)_n^m + H_{\mu\nu n} \left( G^{-1} \nabla^\nu B G^{-1} \right)^{nm} \right], \\
\delta A_{\mu m}^{(2)} &= \frac{1}{4} \left[ 2 \nabla^\nu F_{\nu\mu}^{(1)n} B_{nm} - 2 \nabla^\nu \Phi F_{\nu\mu}^{(1)n} B_{nm} - \frac{1}{2} H_{\mu\nu\rho} H^{\nu\rho}{}_n \left( G^{-1} B \right)_m^n \right. \\
&\quad \left. - F_{\mu\nu}^{(1)n} \left( \nabla^\nu G G^{-1} B \right)_{nm} - H_{\mu\nu n} \left( G^{-1} \nabla^\nu B G^{-1} B \right)_m^n + H_{\mu\nu n} \left( \nabla^\nu G^{-1} G \right)_m^n \right. \\
&\quad \left. - F_{\mu\nu}^{(1)n} \nabla^\nu B_{nm} - \frac{1}{2} H_{\mu\nu\rho} F^{(1)\nu\rho n} G_{nm} \right],
\end{aligned} \tag{4.15}$$

where we used the conventions of Eq. (2.15).

## 4.2 $O(d, d, \mathbb{R})$ invariance and a Green-Schwarz type mechanism

We have now set up all the elements allowing to systematically exhibit the  $O(d, d, \mathbb{R})$  invariance of the dimensionally reduced theory at order  $\alpha'$ . Having brought the reduced action into a form that is polynomial in first derivatives (and the Riemann tensor), we have fully fixed the ambiguities due to field redefinitions and partial integration. We can then compare the result to the distinguished

manifestly  $O(d, d, \mathbb{R})$ -invariant basis constructed in Chap. 3, after breaking up the latter under  $GL(d)$ <sup>25</sup>. Different terms of the  $O(d, d, \mathbb{R})$  basis (3.68) do not share common terms in the decomposition under  $GL(d)$ , *i.e.* every  $GL(d)$  invariant term we have obtained in the reduction in the previous section has a unique ancestor within the  $O(d, d, \mathbb{R})$  basis (3.68). It becomes thus a straightforward – albeit lengthy – task to recombine (if possible) any collection of  $GL(d)$  terms into  $O(d, d, \mathbb{R})$ -invariant expressions.

The dimensionally reduced action is given by the sum of Eq. (4.4), (4.6), (4.10), and (4.14). Upon combining these terms into the  $O(d, d, \mathbb{R})$ -invariant expressions of the basis (3.68), we can bring it into the form

$$I_1 = \underline{I}_1 + O_1, \quad (4.16)$$

where  $\underline{I}_1$  is the part of  $I_1$  that can be organized into a linear combination of manifestly  $O(d, d, \mathbb{R})$ -invariant basis elements as

$$\begin{aligned} \underline{I}_1 = & \frac{1}{4} \alpha' \int d^D x \sqrt{-g} e^{-\Phi} \left[ R_{\mu\nu\rho\sigma} R^{\mu\nu\rho\sigma} - \frac{1}{2} R_{\mu\nu\rho\sigma} H^{\mu\nu\lambda} H^{\rho\sigma\lambda} - \frac{1}{8} H_{\mu\nu}^2 H^{2\mu\nu} + \frac{1}{24} H_{\mu\nu\rho} H^\mu{}_\sigma{}^\lambda H^\nu{}_\lambda{}^\tau H^\rho{}_\tau{}^\sigma \right. \\ & - \frac{1}{2} R_{\mu\nu\rho\sigma} \mathcal{F}^{\mu\nu M} \mathcal{S}_M{}^N \mathcal{F}^{\rho\sigma N} + \frac{1}{16} \text{Tr} (\nabla_\mu \mathcal{S} \nabla_\nu \mathcal{S} \nabla^\mu \mathcal{S} \nabla^\nu \mathcal{S}) - \frac{1}{32} \text{Tr} (\nabla_\mu \mathcal{S} \nabla_\nu \mathcal{S}) \text{Tr} (\nabla^\mu \mathcal{S} \nabla^\nu \mathcal{S}) \\ & + \frac{1}{8} \mathcal{F}_{\mu\nu}{}^M \mathcal{F}_{\rho\sigma M} \mathcal{F}^{\mu\rho N} \mathcal{F}^{\nu\sigma N} - \frac{1}{2} \mathcal{F}_{\mu\nu}{}^M \mathcal{S}_M{}^N \mathcal{F}^{\mu\rho N} \mathcal{F}^{\nu\sigma P} \mathcal{S}_P{}^Q \mathcal{F}_{\rho\sigma Q} \\ & + \frac{1}{8} \mathcal{F}_{\mu\nu}{}^M \mathcal{S}_M{}^N \mathcal{F}_{\rho\sigma N} \mathcal{F}^{\mu\rho P} \mathcal{S}_P{}^Q \mathcal{F}^{\nu\sigma Q} + \frac{1}{8} H_{\mu\nu}^2 \text{Tr} (\nabla^\mu \mathcal{S} \nabla^\nu \mathcal{S}) - \frac{1}{2} H_{\mu\nu}^2 \mathcal{F}^{\mu\rho M} \mathcal{S}_M{}^N \mathcal{F}^{\nu\rho N} \\ & + \frac{1}{4} \mathcal{F}^{\mu\rho M} \mathcal{S}_M{}^N \mathcal{F}^{\nu\rho N} \text{Tr} (\nabla_\mu \mathcal{S} \nabla_\nu \mathcal{S}) + \frac{1}{4} H^{\mu\nu\lambda} H^{\rho\sigma\lambda} \mathcal{F}_{\mu\rho}{}^M \mathcal{S}_M{}^N \mathcal{F}_{\nu\sigma N} \\ & \left. - \frac{1}{2} H^{\mu\nu\rho} \mathcal{F}_{\mu\sigma}{}^M (\mathcal{S} \nabla_\nu \mathcal{S})_M{}^N \mathcal{F}_{\rho\sigma N} - \frac{1}{2} \mathcal{F}_{\mu\nu}{}^M (\mathcal{S} \nabla_\rho \mathcal{S} \nabla^\nu \mathcal{S})_M{}^N \mathcal{F}^{\mu\rho N} \right], \quad (4.17) \end{aligned}$$

whereas the remaining part of the action  $O_1$  is not manifestly  $O(d, d, \mathbb{R})$  invariant, but given by

$$O_1 = -\frac{1}{8} \alpha' \int d^D x \sqrt{-g} e^{-\Phi} H^{\mu\nu\rho} \text{Tr} \left[ \nabla_\mu G^{-1} G \nabla_\nu G^{-1} \nabla_\rho B - \frac{1}{3} \nabla_\mu B G^{-1} \nabla_\nu B G^{-1} \nabla_\rho B G^{-1} \right]. \quad (4.18)$$

This suggests the definition

$$\Omega_{\mu\nu\rho} = -\frac{3}{4} \text{Tr} (\partial_{[\mu} G^{-1} G \partial_{\nu} G^{-1} \partial_{\rho]} B) + \frac{1}{4} \text{Tr} (\partial_{[\mu} B G^{-1} \partial_{\nu} B G^{-1} \partial_{\rho]} B G^{-1}), \quad (4.19)$$

such that  $O_1$  takes the form

$$O_1 = \frac{1}{6} \alpha' \int d^D x \sqrt{-g} e^{-\Phi} H_{\mu\nu\rho} \Omega^{\mu\nu\rho}. \quad (4.20)$$

The three-form (4.19) descends from the non-vanishing cohomology  $H^4$  of  $O(d, d, \mathbb{R})/(O(d) \times O(d))$  [72, 73], although it is not  $O(d, d, \mathbb{R})$  invariant, its exterior derivative is<sup>26</sup>

$$4 \partial_{[\mu} \Omega_{\nu\rho\sigma]} = \frac{3}{8} \text{Tr} (\mathcal{S} \partial_{[\mu} \mathcal{S} \partial_{\nu} \mathcal{S} \partial_{\rho} \mathcal{S} \partial_{\sigma]} \mathcal{S}). \quad (4.21)$$

For  $\Gamma \in \mathfrak{o}(d, d, \mathbb{R})$  this implies that  $d\delta_\Gamma \Omega = \delta_\Gamma d\Omega = 0$ , *i.e.* the  $O(d, d, \mathbb{R})$  variation of  $\Omega_{\mu\nu\rho}$  is closed and

<sup>25</sup>See App. C for the  $GL(d)$  expressions of the relevant  $O(d, d, \mathbb{R})$  terms.

<sup>26</sup>See App. C for the  $GL(d)$  expression.

can locally be integrated to a two-form  $X_{\mu\nu}$  such that

$$\delta_\Gamma \Omega_{\mu\nu\rho} = 3 \partial_{[\mu} X_{\nu\rho]}. \quad (4.22)$$

This observation together with the particular form of Eq. (4.20) suggests a Green-Schwarz type mechanism in order to restore  $O(d, d, \mathbb{R})$  invariance of the  $D$ -dimensional action. Specifically, the term (4.20) can be absorbed into a deformation of the two-derivative action (2.11) upon redefining

$$\tilde{H}_{\mu\nu\rho} \equiv H_{\mu\nu\rho} - \alpha' \Omega_{\mu\nu\rho}, \quad (4.23)$$

such that the kinetic term now produces

$$-\frac{1}{12} \tilde{H}^{\mu\nu\rho} \tilde{H}_{\mu\nu\rho} = -\frac{1}{12} H^{\mu\nu\rho} H_{\mu\nu\rho} + \frac{\alpha'}{6} H^{\mu\nu\rho} \Omega_{\mu\nu\rho} + \mathcal{O}(\alpha'^2). \quad (4.24)$$

In view of Eq. (4.22), the deformed field strength (4.23) remains  $O(d, d, \mathbb{R})$  invariant, if we impose on  $B_{\mu\nu}$  a non-trivial  $O(d, d, \mathbb{R})$  transformation for  $\Gamma \in \mathfrak{o}(d, d, \mathbb{R})$  as

$$\delta_\Gamma B_{\mu\nu} = \alpha' X_{\mu\nu} \implies \delta_\Gamma \tilde{H}_{\mu\nu\rho} = 0. \quad (4.25)$$

The resulting theory is then fully  $O(d, d, \mathbb{R})$ -invariant to first order in  $\alpha'$ . In order to compute an explicit expression for  $X_{\mu\nu}$ , we start from a general  $\mathfrak{o}(d, d, \mathbb{R})$  matrix parametrized as

$$\Gamma_M^N = \begin{pmatrix} \mathfrak{a}_m^n & \mathfrak{b}_{mn} \\ \mathfrak{c}^{mn} & -\mathfrak{a}_n^m \end{pmatrix}, \quad (4.26)$$

with  $\mathfrak{c}^{mn}$  and  $\mathfrak{b}_{mn}$  antisymmetric. Further defining the  $\mathfrak{o}(d, d, \mathbb{R})$  matrices

$$\mathfrak{A}(\mathfrak{a})_M^N = \begin{pmatrix} \mathfrak{a}_m^n & 0 \\ 0 & -\mathfrak{a}_n^m \end{pmatrix}, \quad \mathfrak{B}(\mathfrak{b})_M^N = \begin{pmatrix} 0 & \mathfrak{b}_{mn} \\ 0 & 0 \end{pmatrix}, \quad \mathfrak{C}(\mathfrak{c})_M^N = \begin{pmatrix} 0 & 0 \\ \mathfrak{c}^{mn} & 0 \end{pmatrix}, \quad (4.27)$$

the  $\mathfrak{o}(d, d, \mathbb{R})$  algebra takes the form

$$\begin{cases} [\mathfrak{A}(\mathfrak{a}_1), \mathfrak{A}(\mathfrak{a}_2)] = \mathfrak{A}([\mathfrak{a}_1, \mathfrak{a}_2]), & [\mathfrak{B}(\mathfrak{b}_1), \mathfrak{B}(\mathfrak{b}_2)] = 0, \\ [\mathfrak{A}(\mathfrak{a}), \mathfrak{B}(\mathfrak{b})] = \mathfrak{B}(\mathfrak{a}\mathfrak{b} + \mathfrak{b}\mathfrak{a}^\dagger), & [\mathfrak{B}(\mathfrak{b}), \mathfrak{C}(\mathfrak{c})] = \mathfrak{A}(\mathfrak{b}\mathfrak{c}), \\ [\mathfrak{A}(\mathfrak{a}), \mathfrak{C}(\mathfrak{c})] = -\mathfrak{C}(\mathfrak{c}\mathfrak{a} + \mathfrak{a}^\dagger\mathfrak{c}), & [\mathfrak{C}(\mathfrak{c}_1), \mathfrak{C}(\mathfrak{c}_2)] = 0. \end{cases} \quad (4.28)$$

The action of these generators on  $G_{mn}$  and  $B_{mn}$  is obtained from Eq. (2.9) and (2.12) as

$$\begin{cases} \delta_\Gamma G = \mathfrak{a} G + G \mathfrak{a}^\dagger - G \mathfrak{c} B - B \mathfrak{c} G, \\ \delta_\Gamma B = \mathfrak{a} B + B \mathfrak{a}^\dagger - B \mathfrak{c} B - G \mathfrak{c} G + \mathfrak{b}. \end{cases} \quad (4.29)$$

Thus,  $\mathfrak{b}$  and  $\mathfrak{a}$  encode the continuous extensions of the  $B$ -shifts (1.26) and the  $GL(d)$  rotations (1.27). As discussed in Sec. 1.2, these symmetries have a geometric origin and are manifest in any diffeomorphism and two-form  $B$  gauge invariant theory. In contrast, the antisymmetric  $\mathfrak{c}$  acts non-linearly and represents genuine T-duality transformations analogous to the discrete transformations (1.28). Together with

Eq. (4.19), Eq. (4.29) yields the general  $O(d, d, \mathbb{R})$  variation of  $\Omega_{\mu\nu\rho}$

$$\delta_\Gamma \Omega_{\mu\nu\rho} = -\frac{3}{2} \left[ \text{Tr} \left( \epsilon \partial_{[\mu} G \partial_\nu G^{-1} \partial_{\rho]} G \right) + \text{Tr} \left( \epsilon \partial_{[\mu} B \partial_\nu G^{-1} \partial_{\rho]} B \right) \right]. \quad (4.30)$$

Pulling out one derivative, we extract the explicit form of  $X_{\mu\nu}$  from Eq. (4.22):

$$X_{\mu\nu} = \frac{1}{2} \text{Tr} \left( \epsilon \partial_{[\mu} (G + B) G^{-1} \partial_{\nu]} (G + B) \right). \quad (4.31)$$

According to Eq. (4.25), the two-form thus acquires new transformations only along the nilpotent  $\mathfrak{o}(d, d, \mathbb{R})$  generators  $\epsilon^{mn}$ . This is consistent with the fact that all the other  $\mathfrak{o}(d, d, \mathbb{R})$  generators represent by construction manifest symmetries of the dimensionally reduced action. Moreover, with the expression (4.31), one can verify that the algebra of  $\mathfrak{o}(d, d, \mathbb{R})$  transformations (4.28) closes on  $B_{\mu\nu}$ . Crucially, the deformed  $\mathfrak{o}(d, d, \mathbb{R})$  action (4.25) cannot be absorbed into a redefinition of the fields but represents a genuine deformation of the  $O(d, d, \mathbb{R})$  transformation rules.

We may also consider the behavior of Eq. (4.20) under the  $\mathbb{Z}_2$  invariance of bosonic string theory that sends  $\hat{B} \rightarrow -\hat{B}$ . On the  $O(d, d, \mathbb{R})$  matrix (2.9) this symmetry acts as [44]

$$\mathcal{H} \rightarrow Z^T \mathcal{H} Z, \quad Z \equiv \begin{pmatrix} 1 & 0 \\ 0 & -1 \end{pmatrix}. \quad (4.32)$$

The matrix  $Z$  is not  $O(d, d, \mathbb{R})$ -valued since the metric (2.10) transforms as

$$\eta \rightarrow Z \eta Z^T = -\eta \quad \implies \quad \mathcal{S} \rightarrow -Z \mathcal{S} Z. \quad (4.33)$$

Thus, the  $O(d, d, \mathbb{R})$  invariant defined by the r.h.s. of Eq. (4.21) is  $\mathbb{Z}_2$  odd. This ensures  $\mathbb{Z}_2$  invariance of the action (4.20) since  $B_{\mu\nu}$  and its field strength  $H_{\mu\nu\rho}$  are also  $\mathbb{Z}_2$  odd.

Let us summarize the previous discussion. The bosonic string effective action, including its first-order  $\alpha'$  corrections, upon compactification on a  $d$ -torus exhibits a global  $O(d, d, \mathbb{R})$  symmetry, provided the  $O(d, d, \mathbb{R})$  transformations of the two-derivative action acquire  $\alpha'$  corrections according to Eq. (4.25). The full  $\alpha'$ -corrected transformations are given by

$$\begin{cases} \delta_\Gamma g_{\mu\nu} = 0, \\ \delta_\Gamma B_{\mu\nu} = \frac{\alpha'}{2} \text{Tr} \left( \epsilon \partial_{[\mu} (G + B) G^{-1} \partial_{\nu]} (G + B) \right), \end{cases} \quad \begin{cases} \delta_\Gamma \mathcal{H}_{MN} = \Gamma_M^P \mathcal{H}_{PN} + \Gamma_N^P \mathcal{H}_{MP}, \\ \delta_\Gamma \mathcal{F}_{\mu\nu}^M = -\mathcal{F}_{\mu\nu}^N \Gamma_N^M, \end{cases} \quad (4.34)$$

for  $\Gamma_M^N \in \mathfrak{o}(d, d, \mathbb{R})$  parametrized as Eq. (4.26). To order  $\alpha'$ , the  $O(d, d, \mathbb{R})$ -invariant action is given by

$$\begin{aligned} I = \int d^D x \sqrt{-g} e^{-\Phi} & \left[ R + \partial_\mu \Phi \partial^\mu \Phi - \frac{1}{12} \tilde{H}_{\mu\nu\rho} \tilde{H}^{\mu\nu\rho} + \frac{1}{8} \text{Tr} (\partial_\mu \mathcal{S} \partial^\mu \mathcal{S}) - \frac{1}{4} \mathcal{F}_{\mu\nu}^M \mathcal{S}_M^N \mathcal{F}^{\mu\nu}_N \right. \\ & + \frac{1}{4} \alpha' \left( R_{\mu\nu\rho\sigma} R^{\mu\nu\rho\sigma} - \frac{1}{2} R_{\mu\nu\rho\sigma} H^{\mu\nu\lambda} H^{\rho\sigma}_\lambda + \frac{1}{24} H_{\mu\nu\rho} H^\mu{}_\sigma{}^\lambda H^\nu{}_\lambda{}^\tau H^\rho{}_\tau{}^\sigma \right. \\ & - \frac{1}{8} H_{\mu\nu}^2 H^{2\mu\nu} + \frac{1}{16} \text{Tr} (\nabla_\mu \mathcal{S} \nabla_\nu \mathcal{S} \nabla^\mu \mathcal{S} \nabla^\nu \mathcal{S}) - \frac{1}{32} \text{Tr} (\nabla_\mu \mathcal{S} \nabla_\nu \mathcal{S}) \text{Tr} (\nabla^\mu \mathcal{S} \nabla^\nu \mathcal{S}) \\ & + \frac{1}{8} \mathcal{F}_{\mu\nu}^M \mathcal{S}_M^N \mathcal{F}_{\rho\sigma N} \mathcal{F}^{\mu\rho P} \mathcal{S}_P^Q \mathcal{F}^{\nu\sigma}_Q - \frac{1}{2} \mathcal{F}_{\mu\nu}^M \mathcal{S}_M^N \mathcal{F}^{\mu\rho}_N \mathcal{F}^{\nu\sigma P} \mathcal{S}_P^Q \mathcal{F}_{\rho\sigma Q} \\ & \left. + \frac{1}{8} \mathcal{F}_{\mu\nu}^M \mathcal{F}_{\rho\sigma M} \mathcal{F}^{\mu\rho N} \mathcal{F}^{\nu\sigma}_N - \frac{1}{2} R_{\mu\nu\rho\sigma} \mathcal{F}^{\mu\nu M} \mathcal{S}_M^N \mathcal{F}^{\rho\sigma}_N \right] \end{aligned}$$

$$\begin{aligned}
& + \frac{1}{8} H_{\mu\nu}^2 \text{Tr} (\nabla^\mu \mathcal{S} \nabla^\nu \mathcal{S}) - \frac{1}{2} H_{\mu\nu}^2 \mathcal{F}^\mu{}_\rho{}^M \mathcal{S}_M{}^N \mathcal{F}^{\nu\rho} + \frac{1}{4} H^{\mu\nu\lambda} H^{\rho\sigma}{}_\lambda \mathcal{F}_{\mu\rho}{}^M \mathcal{S}_M{}^N \mathcal{F}_{\nu\sigma N} \\
& - \frac{1}{2} \mathcal{F}_{\mu\nu}{}^M (\mathcal{S} \nabla_\rho \mathcal{S} \nabla^\nu \mathcal{S})_M{}^N \mathcal{F}^{\mu\rho} + \frac{1}{4} \mathcal{F}^{\mu\rho M} \mathcal{S}_M{}^N \mathcal{F}^\nu{}_{\rho N} \text{Tr} (\nabla_\mu \mathcal{S} \nabla_\nu \mathcal{S}) \\
& - \frac{1}{2} H^{\mu\nu\rho} \mathcal{F}_{\mu\sigma}{}^M (\mathcal{S} \nabla_\nu \mathcal{S})_M{}^N \mathcal{F}_\rho{}^\sigma{}_N \Big] + \mathcal{O}(\alpha'^2), \tag{4.35}
\end{aligned}$$

with the deformed field-strength  $\tilde{H}_{\mu\nu\rho}$  defined in Eq. (4.23). This constitutes the main result of Part I.

Let us comment on the relation to Ref. [32], where a similar analysis of the first-order  $\alpha'$  corrections is performed, however restricted to the scalar sector, i.e. setting  $A_\mu^{(1)m} = A_{\mu m}^{(2)} = B_{\mu\nu} = 0$ ,  $g_{\mu\nu} = \eta_{\mu\nu}$ . Their result is given in their Eq. (74):

$$\begin{aligned}
I_1 = \frac{1}{8} \alpha' \int d^D x e^{-\Phi} \Big[ & - \text{Tr} (\nabla_\mu \nabla_\nu \mathcal{S} \nabla^\mu \nabla^\nu \mathcal{S}) + \frac{1}{16} \text{Tr} (\nabla_\mu \mathcal{S} \nabla_\nu \mathcal{S}) \text{Tr} (\nabla^\mu \mathcal{S} \nabla^\nu \mathcal{S}) \\
& + \text{Tr} (\nabla_\mu \mathcal{S} \nabla^\mu \mathcal{S} \nabla_\nu \mathcal{S} \nabla^\nu \mathcal{S}) + \frac{1}{8} \text{Tr} (\nabla_\mu \mathcal{S} \nabla_\nu \mathcal{S} \nabla^\mu \mathcal{S} \nabla^\nu \mathcal{S}) \Big]. \tag{4.36}
\end{aligned}$$

Upon partial integration, this can be rewritten as

$$\begin{aligned}
I_1 = \frac{1}{8} \alpha' \int d^D x \sqrt{-g} e^{-\Phi} \Big[ & - \text{Tr} \left( (\square \mathcal{S} - \nabla_\mu \Phi \nabla^\mu \mathcal{S}) (\square \mathcal{S} - \nabla_\nu \Phi \nabla^\nu \mathcal{S}) \right) \\
& + (R_{\mu\nu} + \nabla_\mu \nabla_\nu \Phi) \text{Tr} (\nabla^\mu \mathcal{S} \nabla^\nu \mathcal{S}) + \frac{1}{16} \text{Tr} (\nabla_\mu \mathcal{S} \nabla_\nu \mathcal{S}) \text{Tr} (\nabla^\mu \mathcal{S} \nabla^\nu \mathcal{S}) \\
& + \text{Tr} (\nabla_\mu \mathcal{S} \nabla^\mu \mathcal{S} \nabla_\nu \mathcal{S} \nabla^\nu \mathcal{S}) + \frac{1}{8} \text{Tr} (\nabla_\mu \mathcal{S} \nabla_\nu \mathcal{S} \nabla^\mu \mathcal{S} \nabla^\nu \mathcal{S}) \Big]. \tag{4.37}
\end{aligned}$$

As discussed in Sec. 2.2, we can then remove the second-order derivative terms by performing the ( $O(d, d, \mathbb{R})$ -covariant) field redefinitions

$$\begin{cases} \delta\Phi = \frac{1}{16} \text{Tr} (\nabla_\mu \mathcal{S} \nabla^\mu \mathcal{S}), \\ \delta g_{\mu\nu} = -\frac{1}{8} \text{Tr} (\nabla_\mu \mathcal{S} \nabla_\nu \mathcal{S}), \\ \delta \mathcal{S} = -\frac{1}{2} (\square \mathcal{S} - \nabla_\mu \Phi \nabla^\mu \mathcal{S}) + \frac{1}{2} \mathcal{S} \nabla_\mu \mathcal{S} \nabla^\mu \mathcal{S}, \end{cases} \tag{4.38}$$

in the convention of Eq. (2.15), to bring the result into the equivalent form

$$I_1 = \frac{1}{4} \alpha' \int d^D x \sqrt{-g} e^{-\Phi} \left[ \frac{1}{16} \text{Tr} (\nabla_\mu \mathcal{S} \nabla_\nu \mathcal{S} \nabla^\mu \mathcal{S} \nabla^\nu \mathcal{S}) - \frac{1}{32} \text{Tr} (\nabla_\mu \mathcal{S} \nabla_\nu \mathcal{S}) \text{Tr} (\nabla^\mu \mathcal{S} \nabla^\nu \mathcal{S}) \right]. \tag{4.39}$$

This precisely coincides with the truncation of Eq. (4.17) to the scalar fields. Our result reproduces also the first-order  $\alpha'$  expressions of Ref. [29, 33] for the reduction to  $D = 1$  dimensions.

Let us finally point out that considering the most generic manifestly diffeomorphism invariant four-derivative action [17]

$$\begin{aligned}
I_1 = \alpha' \int d^{D+d} X \sqrt{-\hat{g}} e^{-\hat{\phi}} \Big( & \gamma_1 \hat{R}_{\hat{\mu}\hat{\nu}\hat{\rho}\hat{\sigma}} \hat{R}^{\hat{\mu}\hat{\nu}\hat{\rho}\hat{\sigma}} + \gamma_2 \hat{H}^{\hat{\mu}\hat{\nu}\hat{\lambda}} \hat{H}^{\hat{\rho}\hat{\sigma}}{}_\lambda \hat{R}_{\hat{\mu}\hat{\nu}\hat{\rho}\hat{\sigma}} + \gamma_3 \hat{H}_{\hat{\mu}\hat{\nu}\hat{\rho}} \hat{H}^{\hat{\lambda}}{}_\sigma \hat{H}^{\hat{\nu}}{}_\lambda \hat{H}^{\hat{\rho}}{}_\hat{\tau} \\
& + \gamma_4 \hat{H}_{\hat{\mu}\hat{\nu}}^2 \hat{H}^{\hat{\mu}\hat{\nu}} + \gamma_5 (\hat{H}^2)^2 + \gamma_6 \hat{H}_{\hat{\mu}\hat{\nu}}^2 \partial^{\hat{\mu}} \hat{\phi} \partial^{\hat{\nu}} \hat{\phi} + \gamma_7 \hat{H}^2 \partial_{\hat{\mu}} \hat{\phi} \partial^{\hat{\mu}} \hat{\phi} + \gamma_8 \partial_{\hat{\mu}} \hat{\phi} \partial^{\hat{\mu}} \hat{\phi} \partial_{\hat{\nu}} \hat{\phi} \partial^{\hat{\nu}} \hat{\phi} \Big), \tag{4.40}
\end{aligned}$$

the only choice of coefficients that give rise to an  $O(d, d, \mathbb{R})$ -invariant action after reduction on a generic  $d$ -dimensional torus is

$$\gamma_2 = -\frac{\gamma_1}{2}, \quad \gamma_3 = \frac{\gamma_1}{24}, \quad \gamma_4 = -\frac{\gamma_1}{8}, \quad \gamma_5 = 0, \quad \gamma_6 = 0, \quad \gamma_7 = 0, \quad \gamma_8 = 0, \quad (4.41)$$

corresponding to the action (4.1). Indeed, as the definition of  $\Phi$  imposes

$$\partial_\mu \hat{\phi} = \partial_\mu \Phi + \frac{1}{2} \text{Tr} \left( G^{-1} \partial_\mu G \right), \quad (4.42)$$

the terms proportional to  $\gamma_6$ ,  $\gamma_7$  and  $\gamma_8$ , respectively, in Eq. (4.40) produce terms carrying a factor  $\text{Tr} \left( G^{-1} \partial_\mu G \right)$ . However, there is no  $O(d, d, \mathbb{R})$ -invariant term in the basis (3.68) that contains such a factor, as shown in App. C. Moreover, these terms cannot cancel each other, as they come with different contraction structures. This imposes  $\gamma_6 = \gamma_7 = \gamma_8 = 0$ . The computations detailed in Chap. 2 and 4 finally implies the remaining coefficients of Eq. (4.41). Only with this choice do the  $GL(d)$  terms combine into the  $O(d, d, \mathbb{R})$ -invariant terms of the basis (3.68). Up to field redefinition, the action (4.1) thus is the unique four-derivative correction exhibiting  $O(d, d, \mathbb{R})$  invariance upon dimensional reduction.

### 4.3 Frame formulation

In the previous section we have shown that invariance under rigid  $O(d, d, \mathbb{R})$  transformations requires an  $\alpha'$  deformation of the transformation rules that resembles a Green-Schwarz mechanism. We will now make this analogy more precise by introducing a frame formalism for which the  $O(d, d, \mathbb{R})$  symmetry remains undeformed, while the local frame transformations acquire  $\alpha'$  deformations. This formulation uses the standard Green-Schwarz mechanism similar to the one encountered in Sec. 1.4, albeit with composite gauge fields.

We introduce a frame field  $E = (E_M^A)$  with inverse  $E^{-1} = (E_A^M)$  from which the scalar matrix (2.9) encoding  $G$  and  $B$  can be reconstructed via

$$\mathcal{H}_{MN} = E_M^A E_N^B \kappa_{AB}, \quad (4.43)$$

where flat indices are split as  $A = (a, \bar{a})$ , and  $\kappa_{AB}$  is a block-diagonal matrix with components  $\kappa_{ab}$  and  $\kappa_{\bar{a}\bar{b}}$ . Furthermore, we constrain the frame field by demanding that the ‘flattened’  $O(d, d, \mathbb{R})$  metric is also block-diagonal according to

$$\eta_{AB} \equiv E_A^M E_B^N \eta_{MN} = \begin{pmatrix} \kappa_{ab} & 0 \\ 0 & -\kappa_{\bar{a}\bar{b}} \end{pmatrix}, \quad (4.44)$$

with a relative sign in the space of barred indices reflecting the signature of the  $O(d, d, \mathbb{R})$  metric. In this formalism  $\kappa_{ab}$  and  $\kappa_{\bar{a}\bar{b}}$  need not be Kronecker deltas, and in particular can be spacetime dependent, and so there is a local  $GL(d) \times GL(d)$  frame invariance, with transformation rules

$$\delta_\Lambda E_A^M = \Lambda_A^B E_B^M, \quad \Lambda_A^B = \begin{pmatrix} \Lambda_a^b & 0 \\ 0 & \bar{\Lambda}_{\bar{a}}^{\bar{b}} \end{pmatrix}. \quad (4.45)$$

We could partially gauge fix  $\kappa_{AB} = \delta_{AB}$ , which reduces the frame transformations to  $SO(d) \times SO(d)$ , but



in the following another gauge fixing is convenient: we identify the components of  $\kappa$  with the metric  $G$  according to

$$\kappa = \begin{pmatrix} 2G & 0 \\ 0 & 2G \end{pmatrix}, \quad (4.46)$$

where we used matrix notation. A frame field satisfying the constraint (4.44) and leading to the familiar form of  $\mathcal{H}_{MN}$  is then given by

$$E \equiv (E_M^A) \equiv \frac{1}{2} \begin{pmatrix} 1 + BG^{-1} & 1 - BG^{-1} \\ G^{-1} & -G^{-1} \end{pmatrix}. \quad (4.47)$$

In order to derive composite connections from the frame field we define the Maurer-Cartan forms

$$(E^{-1} \partial_\mu E)_A^B \equiv \begin{pmatrix} Q_{\mu a}^b & P_{\mu a}^{\bar{b}} \\ \bar{P}_{\mu \bar{a}}^b & \bar{Q}_{\mu \bar{a}}^{\bar{b}} \end{pmatrix}. \quad (4.48)$$

From this definition one finds that under  $GL(d) \times GL(d)$  transformations (4.45), the  $P_\mu$  transform as tensors, and the  $Q_\mu$  transform as connections:

$$\delta_\Lambda Q_{\mu a}^b = -D_\mu \Lambda_a^b, \quad \delta_\Lambda \bar{Q}_{\mu \bar{a}}^{\bar{b}} = -D_\mu \bar{\Lambda}_{\bar{a}}^{\bar{b}}, \quad (4.49)$$

with  $D_\mu \Lambda_a^b = \partial_\mu \Lambda_a^b + [Q_\mu, \Lambda]_a^b$  and a similar formula for the barred expression. We can evaluate these connections for the gauge choice (4.47),

$$\begin{cases} Q_\mu = -\frac{1}{2} \partial_\mu (G - B) G^{-1}, \\ \bar{Q}_\mu = -\frac{1}{2} \partial_\mu (G + B) G^{-1}, \end{cases} \quad (4.50)$$

using again matrix notation.

Having constructed composite gauge fields from the frame field, we can consider the familiar Chern-Simons three-forms built from them:

$$\text{CS}_{\mu\nu\rho}(Q) \equiv \text{Tr} \left( Q_{[\mu} \partial_\nu Q_{\rho]} + \frac{2}{3} Q_{[\mu} Q_\nu Q_{\rho]} \right). \quad (4.51)$$

These Chern-Simons forms transform under Eq. (4.49) as

$$\delta_\Lambda \text{CS}_{\mu\nu\rho}(Q) = \partial_{[\mu} \text{Tr}(\partial_\nu \Lambda Q_{\rho]}), \quad (4.52)$$

with the barred formulas being analogous. Evaluating the Chern-Simons form with Eq. (4.50) one recovers precisely the expression (4.19) encountered in the previous section, up to a global factor 3. Therefore, we can define a three-form curvature with Chern-Simons modification:

$$\tilde{H}_{\mu\nu\rho} \equiv H_{\mu\nu\rho} - \frac{3}{2} \alpha' (\text{CS}_{\mu\nu\rho}(Q) - \text{CS}_{\mu\nu\rho}(\bar{Q})), \quad (4.53)$$

which then reproduces the term proportional to  $\Omega H$  encountered in the  $\mathcal{O}(\alpha')$  action.

We have thus succeeded to find a formulation for which the  $O(d, d, \mathbb{R})$  invariance is manifestly realized without deformation. Rather, the  $GL(d) \times GL(d)$  gauge symmetry is deformed by having a

two-form transforming according to the Green-Schwarz mechanism,

$$\delta B_{\mu\nu} = \frac{1}{2} \alpha' \text{Tr}(\partial_{[\mu} \Lambda Q_{\nu]}) - \frac{1}{2} \alpha' \text{Tr}(\partial_{[\mu} \bar{\Lambda} \bar{Q}_{\nu]}). \quad (4.54)$$

Performing a partial gauge fixing to  $\text{SO}(d) \times \text{SO}(d)$ , together with appropriate field redefinitions, this Green-Schwarz mechanism relates to the reduction of  $\alpha'$ -deformed double field theory [52]. This formulation is related to the one of the previous section as follows: if one fully gauge fixes  $\text{GL}(d) \times \text{GL}(d)$  the  $\text{O}(d, d, \mathbb{R})$  transformations acquire deformations through compensating frame transformations and hence the singlet  $B_{\mu\nu}$  starts transforming non-trivially under  $\text{O}(d, d, \mathbb{R})$ .

Let us close this section by discussing how the  $\mathbb{Z}_2$  invariance (4.32) of bosonic string theory is realized in this frame formulation. The  $\mathbb{Z}_2$  acts on the frame field as

$$E \rightarrow Z^T E \tilde{Z}, \quad \tilde{Z} \equiv \begin{pmatrix} 0 & \mathbb{1} \\ \mathbb{1} & 0 \end{pmatrix}. \quad (4.55)$$

The matrix  $\tilde{Z}$  exchanges the two  $\text{GL}(d)$  factors and hence exchanges the role of unbarred and barred indices. Indeed, under the transformation (4.55) the Maurer-Cartan forms (4.48) transform as  $P_\mu \leftrightarrow \bar{P}_\mu$  and  $Q_\mu \leftrightarrow \bar{Q}_\mu$ , as one may verify by a quick computation and as is suggested by the explicit form (4.50). Thus, the relative sign in Eq. (4.53) implies that the total Chern-Simons form is  $\mathbb{Z}_2$  odd, which together with  $B_{\mu\nu} \rightarrow -B_{\mu\nu}$  implies  $\mathbb{Z}_2$  invariance of the action.

## 4.4 Extension to heterotic supergravity

The analysis we just did for the first-order  $\alpha'$  corrections of the bosonic supergravity can be generalized to the case of the heterotic supergravity. In absence of the Yang-Mills field in ten dimensions, the bosonic part of the four-derivative effective action of the heterotic string takes the form [17]

$$\begin{aligned} \hat{I}_1 = \frac{1}{4} \alpha' \int d^{D+d} X \sqrt{-\hat{g}} e^{-\hat{\phi}} \left[ -\hat{H}^{\hat{\mu}\hat{\nu}\hat{\rho}} \hat{\Omega}_{\hat{\mu}\hat{\nu}\hat{\rho}}^{(\hat{\omega})} + \frac{1}{2} \left( \hat{R}_{\hat{\mu}\hat{\nu}\hat{\rho}\hat{\sigma}} \hat{R}^{\hat{\mu}\hat{\nu}\hat{\rho}\hat{\sigma}} - \frac{1}{2} \hat{H}^{\hat{\mu}\hat{\nu}\hat{\lambda}} \hat{H}^{\hat{\rho}\hat{\sigma}}_{\hat{\lambda}} \hat{R}_{\hat{\mu}\hat{\nu}\hat{\rho}\hat{\sigma}} \right. \right. \\ \left. \left. - \frac{1}{8} \hat{H}_{\hat{\mu}\hat{\nu}}^2 \hat{H}^2{}^{\hat{\mu}\hat{\nu}} + \frac{1}{24} \hat{H}_{\hat{\mu}\hat{\nu}\hat{\rho}} \hat{H}^{\hat{\mu}}_{\hat{\sigma}} \hat{H}^{\hat{\lambda}}{}^{\hat{\nu}}_{\hat{\lambda}} \hat{H}^{\hat{\rho}}{}^{\hat{\sigma}}_{\hat{\tau}} \right) \right], \end{aligned} \quad (4.56)$$

where  $D + d = 10$ . Apart from terms proportional to the  $\alpha'$  corrections of the bosonic supergravity (4.1), the action features the gravitational Chern-Simons form  $\hat{\Omega}_{\hat{\mu}\hat{\nu}\hat{\rho}}^{(\hat{\omega})}$ , defined as

$$\hat{\Omega}_{\hat{\mu}\hat{\nu}\hat{\rho}}^{(\hat{\omega})} = \text{Tr}(\hat{\omega}_{[\hat{\mu}} \partial_{\hat{\nu}} \hat{\omega}_{\hat{\rho]})} + \frac{2}{3} \text{Tr}(\hat{\omega}_{[\hat{\mu}} \hat{\omega}_{\hat{\nu}} \hat{\omega}_{\hat{\rho]})}, \quad (4.57)$$

in terms of the spin connection

$$\hat{\omega}_{\hat{\mu}\hat{\alpha}}{}^{\hat{\beta}} = \nabla_{\hat{\mu}} \hat{e}_{\hat{\nu}}{}^{\hat{\beta}} \hat{e}_{\hat{\alpha}}{}^{\hat{\nu}}. \quad (4.58)$$

With the  $\text{O}(d, d, \mathbb{R})$ -invariant form of the bosonic supergravity we discussed above, it just remains to reduce the first term of Eq. (4.56). Following the same systematics outlined in Sec. 4.1, the reduced action for the bosonic part of heterotic supergravity (in absence of the ten-dimensional Yang-Mills field) is

$$I = \int d^D x \sqrt{-g} e^{-\Phi} \left[ R + \partial_\mu \Phi \partial^\mu \Phi - \frac{1}{12} \tilde{H}_{\mu\nu\rho} \tilde{H}^{\mu\nu\rho} + \frac{1}{8} \text{Tr}(\partial_\mu \mathcal{S} \partial^\mu \mathcal{S}) - \frac{1}{4} \mathcal{F}_{\mu\nu}{}^M \mathcal{S}_M{}^N \mathcal{F}^{\mu\nu}{}_N \right]$$

$$\begin{aligned}
& -\frac{1}{4}\alpha' \left( H^{\mu\nu\rho}\Omega_{\mu\nu\rho}^{(\omega)} - \frac{1}{16}\text{Tr}(S\nabla_\mu S\nabla^\mu S\nabla_\nu S\nabla^\nu S) - \frac{1}{16}\mathcal{F}_{\mu\nu}^M\mathcal{F}_{\rho\sigma M}\mathcal{F}^{\mu\nu P}S_P^Q\mathcal{F}^{\rho\sigma}_Q \right. \\
& + \frac{1}{4}R^{\mu\nu\rho\sigma}\mathcal{F}_{\mu\nu}^M\mathcal{F}_{\rho\sigma M} - \frac{1}{16}H^{\mu\nu\lambda}H^{\rho\sigma}_\lambda\mathcal{F}_{\mu\nu}^M\mathcal{F}_{\rho\sigma M} + \frac{1}{8}\mathcal{F}_{\mu\nu}^M(\nabla_\rho S\nabla^\rho S)_M^N\mathcal{F}^{\mu\nu}_N \\
& + \frac{1}{4}\mathcal{F}_{\mu\nu}^M(\nabla^\mu S\nabla_\rho S)_M^N\mathcal{F}^{\nu\rho}_N + \frac{1}{4}H^{\mu\nu\rho}\mathcal{F}_{\mu\sigma}^M\nabla^\sigma S_M^N\mathcal{F}_{\nu\rho N} \Big) \\
& + \frac{1}{8}\alpha' \left( R_{\mu\nu\rho\sigma}R^{\mu\nu\rho\sigma} - \frac{1}{2}R_{\mu\nu\rho\sigma}H^{\mu\nu\lambda}H^{\rho\sigma}_\lambda + \frac{1}{24}H_{\mu\nu\rho}H^\mu{}_\sigma{}^\lambda H^\nu{}_\lambda{}^\tau H^\rho{}_\tau{}^\sigma \right. \\
& - \frac{1}{8}H_{\mu\nu}^2H^{2\mu\nu} + \frac{1}{16}\text{Tr}(\nabla_\mu S\nabla_\nu S\nabla^\mu S\nabla^\nu S) - \frac{1}{32}\text{Tr}(\nabla_\mu S\nabla_\nu S)\text{Tr}(\nabla^\mu S\nabla^\nu S) \\
& + \frac{1}{8}\mathcal{F}_{\mu\nu}^M S_M^N\mathcal{F}_{\rho\sigma N}\mathcal{F}^{\mu\rho P}S_P^Q\mathcal{F}^{\nu\sigma}_Q - \frac{1}{2}\mathcal{F}_{\mu\nu}^M S_M^N\mathcal{F}^{\mu\rho}_N\mathcal{F}^{\nu\sigma P}S_P^Q\mathcal{F}_{\rho\sigma Q} \\
& + \frac{1}{8}\mathcal{F}_{\mu\nu}^M\mathcal{F}_{\rho\sigma M}\mathcal{F}^{\mu\rho N}\mathcal{F}^{\nu\sigma}_N - \frac{1}{2}R_{\mu\nu\rho\sigma}\mathcal{F}^{\mu\nu M}S_M^N\mathcal{F}^{\rho\sigma}_N \\
& + \frac{1}{8}H_{\mu\nu}^2\text{Tr}(\nabla^\mu S\nabla^\nu S) - \frac{1}{2}H_{\mu\nu}^2\mathcal{F}^{\mu\rho}_\rho S_M^N\mathcal{F}^{\nu\rho}_N + \frac{1}{4}H^{\mu\nu\lambda}H^{\rho\sigma}_\lambda\mathcal{F}_{\mu\rho}^M S_M^N\mathcal{F}_{\nu\sigma N} \\
& - \frac{1}{2}\mathcal{F}_{\mu\nu}^M(S\nabla_\rho S\nabla^\nu S)_M^N\mathcal{F}^{\mu\rho}_N + \frac{1}{4}\mathcal{F}^{\mu\rho M}S_M^N\mathcal{F}^{\nu\rho}_N\text{Tr}(\nabla_\mu S\nabla_\nu S) \\
& \left. - \frac{1}{2}H^{\mu\nu\rho}\mathcal{F}_{\mu\sigma}^M(S\nabla_\nu S)_M^N\mathcal{F}_\rho{}^\sigma{}_N \right] + \mathcal{O}(\alpha'^2). \tag{4.59}
\end{aligned}$$

It is  $O(d, d, \mathbb{R})$ -invariant, provided that the two-form  $B_{\mu\nu}$  transforms as in Eq. (4.34). The derivation of Eq. (4.59) is detailed in Ref. [C].

# 5 Chapter

---

# Conclusion

We have set up a systematic procedure for analyzing the higher-derivative corrections of the bosonic and the heterotic supergravities upon toroidal compactification. In particular, we have discussed how to control the ambiguities that arise due to non-linear field redefinitions and partial integration. This establishes the basis for analyzing the realization of  $O(d, d, \mathbb{R})$  invariance of the dimensionally reduced action. At first order in  $\alpha'$ , we have presented the explicit reduction of the bosonic supergravity and cast the result into a manifestly  $O(d, d, \mathbb{R})$ -invariant form upon identification of the necessary field redefinitions. In particular, the analysis confirms that at order  $\alpha'$ , the  $O(d, d, \mathbb{R})$  invariance of the dimensionally reduced action fixes all the couplings in higher dimensions (up to an overall factor). The analysis has revealed the need for a Green-Schwarz type mechanism by which the lower-dimensional two-form (which is originally singlet under  $O(d, d, \mathbb{R})$ ) acquires a non-trivial transformation of order  $\alpha'$ . This is a genuine deformation, which cannot be eliminated by further field redefinitions.

We have also extended the analysis to the bosonic sector of the heterotic supergravity (in absence of the ten-dimensional vector fields). In particular, the procedure allows to keep track of all field redefinitions, and the complete set of non-linear field redefinitions which translate between the original ten-dimensional fields and the  $O(d, d, \mathbb{R})$ -covariant lower-dimensional fields is given in Ref. [C]. This dictionary allows to exploit the  $O(d, d, \mathbb{R})$  symmetry as a solution generating method for the heterotic string [74, 75] to first order in  $\alpha'$ . Examples of such solutions have been constructed in Ref. [76–78] and used to compute higher-derivative corrections to black holes entropy in Ref. [79–82]. It would be very interesting to extend the analysis to also include the ten-dimensional vector fields [83], as initiated in Ref. [80], resulting in an  $O(d, d + K, \mathbb{R})$  extension of the present results, with the larger group broken down by the non-abelian gauge couplings [27].

In principle, the method we have outlined is fully systematic and could be applied to higher-order  $\alpha'$  corrections. In practice, the number of terms quickly explodes and calls for complementary techniques to be combined with the present approach. As noted above, already at order  $\alpha'^2$  the number of manifestly  $O(d, d, \mathbb{R})$ -invariant terms in lower dimensions amounts to 1817. Nevertheless, it would be interesting to compare the resulting structures to related work in Ref. [35, 36]. The case of corrections at order  $\alpha'^3$  (eight derivatives) is of particular interest, as this is the order of the first corrections in type II string theory, which are not completely known yet. The cosmological reduction of the gravitational sector at order  $\alpha'^3$  has recently been studied in Ref. [40], where agreement with T duality has been shown. As mentioned in Chap. 1, double field theory seems unable to include these corrections [63]. The approach we developed constitutes a new tool to study how T duality is realized at order  $\alpha'^3$  and could shed light on the obstacles encountered in double field theory. This technique could also be used to predict the form of the higher-derivative corrections in higher dimension, as was argued in Ref. [37–39] using reduction on a circle.

Finally, it will be interesting to further study the simplifications arising in the resulting actions upon reduction to particularly low dimensions  $D$ . For  $D = 1$ , all terms other than the scalar couplings

disappear from Eq. (4.35) and (4.59), and we recover the lowest-order result of Ref. [29, 33, 34]. At  $D = 2$ , the two-form couplings disappear and the vector fields may be integrated out. Particularly interesting is the three-dimensional case. At  $D = 3$ , the two-form may be integrated out. With a field equation of the type

$$\nabla^\mu \left( e^{-\Phi} H_{\mu\nu\rho} \right) = \mathcal{O}(\alpha'), \quad (5.1)$$

this introduces an integration constant which in particular turns the coupling (4.19) into a three-dimensional analogue of the WZW model, *c.f.* Ref. [72]. Furthermore, in  $D = 3$ , the (abelian) vector fields may be dualized into scalars. While this dualization is still possible in the presence of  $\alpha'$  corrections, the symmetry enhancement to  $O(d + 1, d + 1, \mathbb{R})$  encountered for the two-derivative action breaks down at order  $\alpha'$  and is replaced by the appearance of the relevant automorphic forms [84, 85]. The manifestly  $O(d, d, \mathbb{R})$ -invariant action (4.35) makes it possible to explicitly study this symmetry breaking.

# A Generating function for the vector fields

There exists generic math results for generating function for plethysms (see for example Ref. [86, 87]). Here, we suggest a trick to compute them from the expression (3.36) and the product law for Young tableaux. We will only consider the case of vector fields, but the technique generalizes easily to the other cases.

Let us first recall the alphabet (3.34) of letters carrying the dilaton,

$$\mathfrak{A}_\Phi = \{ \nabla_{((\mu_1 \dots \nabla_{\mu_n}) \Phi) \mid n \in \mathbb{N}^* \}, \quad (3.34)$$

and the associated generating function

$$\mathcal{Z}_\Phi(u, q, \mathbf{v}_D) = u \left( \frac{1 - q^2}{(1 - q)^{\mathbf{v}_D}} - 1 \right). \quad (3.36)$$

In terms of Young tableaux, an  $SO(D)$  vector  $\mathbf{v}_D$  is represented as a box and the alphabet (3.34) can be written as

$$\left\{ \begin{array}{|c|c|c|c|} \hline \mu_1 & & & \mu_n \\ \hline \end{array} - \text{traces} \mid n \in \mathbb{N}^* \right\}. \quad (A.1)$$

We then learn from Eq. (3.36) the associated generating function

$$\sum_{n=1}^{\infty} \left( \begin{array}{|c|c|c|c|} \hline \mu_1 & & & \mu_n \\ \hline \end{array} - \text{traces} \right) = \frac{1 - q^2}{(1 - q)^{\mathbf{v}_D}} - 1, \quad (A.2)$$

where we have suppressed the factor  $u$ , as we count the plethysm without association to a specific field, and kept the parameter  $q$  to count the number of derivatives. We can then compute the generating function for the vector fields, whose alphabet is

$$\left\{ \nabla_{((\mu_1 \dots \nabla_{\mu_n}) \mathcal{F}_{\nu_1 \nu_2}^M) - \text{traces \& Bianchi} \mid n \in \mathbb{N} \right\} = \left\{ \begin{array}{|c|c|c|c|} \hline \nu_1 & \mu_1 & & \mu_n \\ \nu_2 & & & \\ \hline \end{array} - \text{traces} \mid n \in \mathbb{N} \right\}, \quad (A.3)$$

using Eq. (A.2) and the product of Young tableaux. The product

$$\begin{array}{|c|} \hline \nu_2 \\ \hline \end{array} \otimes \begin{array}{|c|c|c|c|} \hline \nu_1 & \mu_1 & & \mu_n \\ \hline \end{array} = \begin{array}{|c|c|c|c|} \hline \nu_1 & \mu_1 & & \mu_n \\ \nu_2 & & & \\ \hline \end{array} \oplus \begin{array}{|c|c|c|c|} \hline \nu_1 & \nu_2 & \mu_1 & \mu_n \\ \hline \end{array} \quad (A.4)$$

can indeed be used to express the hook shaped tableaux in Eq. (A.3) in terms of the ones in Eq. (A.1). We must however take into account the possible traces, and the exact product we need is

$$\begin{aligned} \begin{array}{|c|} \hline \nu_2 \\ \hline \end{array} \otimes \left( \begin{array}{|c|c|c|c|} \hline \nu_1 & \mu_1 & & \mu_n \\ \hline \end{array} - \text{traces} \right) &= \left( \begin{array}{|c|c|c|c|} \hline \nu_1 & \mu_1 & & \mu_n \\ \nu_2 & & & \\ \hline \end{array} - \text{traces} \right) \oplus \left( \begin{array}{|c|c|c|c|} \hline \nu_1 & \nu_2 & \mu_1 & \mu_n \\ \hline \end{array} - \text{traces} \right) \\ &\oplus \text{Tr} \left( \begin{array}{|c|} \hline \nu_1 \\ \hline \end{array}, \begin{array}{|c|} \hline \nu_2 \\ \hline \end{array} \right) \times \left( \begin{array}{|c|c|c|c|} \hline \mu_1 & & & \mu_n \\ \hline \end{array} - \text{traces} \right). \end{aligned} \quad (A.5)$$

We then deduce from Eq. (A.2) the generating function for the vector fields alphabet:

$$\sum_{n=0}^{\infty} \left( \begin{array}{c|c|c|c} \nu_1 & \mu_1 & & \mu_n \\ \hline \nu_2 & & & \end{array} - \text{traces} \right) = q \mathbf{v}_D \times \left( \frac{1-q^2}{(1-q)^{\mathbf{v}_D}} - 1 \right) - \left( \frac{1-q^2}{(1-q)^{\mathbf{v}_D}} - 1 \right) - q^2 \times \frac{1-q^2}{(1-q)^{\mathbf{v}_D}}. \quad (\text{A.6})$$

We finally find the expression given in Eq. (3.50):

$$\mathcal{Z}_{\mathcal{F}}(f, q, \mathbf{v}_D) = f \sum_{n=0}^{\infty} \left( \begin{array}{c|c|c|c} \nu_1 & \mu_1 & & \mu_n \\ \hline \nu_2 & & & \end{array} - \text{traces} \right) = f \frac{1}{q} \left( 1 - \frac{1 - \mathbf{v}_D q (1 - q^2) - q^4}{(1-q)^{\mathbf{v}_D}} \right). \quad (3.50)$$

# B Appendix

## Explicit basis at order $\alpha'$

In this appendix, we explicitly spell out the  $O(d, d, \mathbb{R})$ -invariant basis schematically given in Eq. (3.68), whose existence we have deduced in Sec. 3.5 and which we have used in order to bring the reduced action into manifestly  $O(d, d, \mathbb{R})$ -invariant form. The basis is built from 61 terms which we list according to their different structures.

$R^2$  :

$$\{R_{\mu\nu\rho\sigma}R^{\mu\nu\rho\sigma}\} \quad (\text{B.1})$$

$H^4$  :

$$\{(H^2)^2, H^2{}^{\mu\nu}H^2{}_{\mu\nu}, H_{\mu\nu\rho}H^\mu{}^\beta H^\nu{}_\beta{}^\gamma H^\rho{}_\gamma{}^\alpha\} \quad (\text{B.2})$$

$(\nabla\Phi)^4$  :

$$\{\nabla_\mu\Phi\nabla^\mu\Phi\nabla_\nu\Phi\nabla^\nu\Phi\} \quad (\text{B.3})$$

$(\nabla\mathcal{S})^4$  :

$$\left\{ \text{Tr}(\nabla_\mu\mathcal{S}\nabla^\mu\mathcal{S}\nabla_\nu\mathcal{S}\nabla^\nu\mathcal{S}), \text{Tr}(\nabla_\mu\mathcal{S}\nabla_\nu\mathcal{S}\nabla^\mu\mathcal{S}\nabla^\nu\mathcal{S}), \text{Tr}(\mathcal{S}\nabla_\mu\mathcal{S}\nabla^\mu\mathcal{S}\nabla_\nu\mathcal{S}\nabla^\nu\mathcal{S}) \right. \\ \left. \text{Tr}(\nabla_\mu\mathcal{S}\nabla^\mu\mathcal{S}) \text{Tr}(\nabla_\nu\mathcal{S}\nabla^\nu\mathcal{S}), \text{Tr}(\nabla_\mu\mathcal{S}\nabla_\nu\mathcal{S}) \text{Tr}(\nabla^\mu\mathcal{S}\nabla^\nu\mathcal{S}) \right\} \quad (\text{B.4})$$

$\mathcal{F}^4$  :

$$\left\{ \mathcal{F}_{\mu\nu}{}^M\mathcal{F}^{\mu\nu}{}_M\mathcal{F}_{\rho\sigma}{}^N\mathcal{F}^{\rho\sigma}{}_N, \mathcal{F}_{\mu\nu}{}^M\mathcal{S}_M{}^N\mathcal{F}^{\mu\nu}{}_N\mathcal{F}_{\rho\sigma}{}^P\mathcal{F}^{\rho\sigma}{}_P, \mathcal{F}_{\mu\nu}{}^M\mathcal{S}_M{}^N\mathcal{F}^{\mu\nu}{}_N\mathcal{F}_{\rho\sigma}{}^P\mathcal{S}_P{}^Q\mathcal{F}^{\rho\sigma}{}_Q, \right. \\ \mathcal{F}_{\mu\nu}{}^M\mathcal{F}_{\rho\sigma}{}^N\mathcal{F}^{\mu\nu}{}_M\mathcal{F}^{\rho\sigma}{}_N, \mathcal{F}_{\mu\nu}{}^M\mathcal{S}_M{}^N\mathcal{F}_{\rho\sigma}{}^P\mathcal{F}^{\mu\nu}{}_N\mathcal{F}^{\rho\sigma}{}_P, \mathcal{F}_{\mu\nu}{}^M\mathcal{S}_M{}^N\mathcal{F}_{\rho\sigma}{}^P\mathcal{F}^{\mu\nu}{}_N\mathcal{S}_P{}^Q\mathcal{F}^{\rho\sigma}{}_Q, \\ \mathcal{F}_{\mu\nu}{}^M\mathcal{F}_{\rho\sigma}{}^N\mathcal{F}^{\mu\rho}{}_M\mathcal{F}^{\nu\sigma}{}_N, \mathcal{F}_{\mu\nu}{}^M\mathcal{S}_M{}^N\mathcal{F}_{\rho\sigma}{}^P\mathcal{F}^{\mu\rho}{}_N\mathcal{F}^{\nu\sigma}{}_P, \mathcal{F}_{\mu\nu}{}^M\mathcal{S}_M{}^N\mathcal{F}_{\rho\sigma}{}^P\mathcal{F}^{\mu\rho}{}_N\mathcal{S}_P{}^Q\mathcal{F}^{\nu\sigma}{}_Q, \\ \left. \mathcal{F}_{\mu\nu}{}^M\mathcal{F}^{\mu\rho}{}_M\mathcal{F}^{\nu\sigma}{}_N\mathcal{F}_{\rho\sigma}{}^N, \mathcal{F}_{\mu\nu}{}^M\mathcal{S}_M{}^N\mathcal{F}^{\mu\rho}{}_N\mathcal{F}^{\nu\sigma}{}_P\mathcal{F}_{\rho\sigma}{}^P, \mathcal{F}_{\mu\nu}{}^M\mathcal{S}_M{}^N\mathcal{F}^{\mu\rho}{}_N\mathcal{F}^{\nu\sigma}{}_P\mathcal{S}_P{}^Q\mathcal{F}_{\rho\sigma}{}^Q \right\} \quad (\text{B.5})$$

$RH^2$  :

$$\{R_{\mu\nu\rho\sigma}H^{\mu\nu\lambda}H^{\rho\sigma}{}_\lambda\} \quad (\text{B.6})$$

$R\mathcal{F}^2$  :

$$\{R_{\mu\nu\rho\sigma}\mathcal{F}^{\mu\nu}{}^M\mathcal{F}^{\rho\sigma}{}_M, R_{\mu\nu\rho\sigma}\mathcal{F}^{\mu\nu}{}^M\mathcal{S}_M{}^N\mathcal{F}^{\rho\sigma}{}_N\} \quad (\text{B.7})$$



$H^2 (\nabla\Phi)^2 :$ 

$$\left\{ H_{\mu\nu}^2 \nabla^\mu \Phi \nabla^\nu \Phi, H^2 \nabla_\mu \Phi \nabla^\mu \Phi \right\} \quad (\text{B.8})$$

 $H^2 (\nabla\mathcal{S})^2 :$ 

$$\left\{ H_{\mu\nu}^2 \text{Tr} (\nabla^\mu \mathcal{S} \nabla^\nu \mathcal{S}), H^2 \text{Tr} (\nabla_\mu \mathcal{S} \nabla^\mu \mathcal{S}) \right\} \quad (\text{B.9})$$

 $H^2 \mathcal{F}^2 :$ 

$$\left\{ H^2 \mathcal{F}_{\mu\nu}^M \mathcal{F}^{\mu\nu}_M, H^2 \mathcal{F}_{\mu\nu}^M \mathcal{S}_M^N \mathcal{F}^{\mu\nu}_N, H_{\mu\nu}^2 \mathcal{F}^{\mu\rho M} \mathcal{F}_{\rho\nu M}, H_{\mu\nu}^2 \mathcal{F}^{\mu\rho M} \mathcal{S}_M^N \mathcal{F}_{\rho\nu N}, \right. \\ \left. H_{\mu\nu}^\lambda H_{\lambda\rho\sigma} \mathcal{F}^{\mu\nu M} \mathcal{F}^{\rho\sigma}_M, H_{\mu\nu}^\lambda H_{\lambda\rho\sigma} \mathcal{F}^{\mu\nu M} \mathcal{S}_M^N \mathcal{F}^{\rho\sigma}_N, H_{\mu\nu}^\lambda H_{\lambda\rho\sigma} \mathcal{F}^{\mu\sigma M} \mathcal{F}^{\rho\nu}_M, \right. \\ \left. H_{\mu\nu}^\lambda H_{\lambda\rho\sigma} \mathcal{F}^{\mu\sigma M} \mathcal{S}_M^N \mathcal{F}^{\rho\nu}_N \right\} \quad (\text{B.10})$$

 $(\nabla\Phi)^2 (\nabla\mathcal{S})^2 :$ 

$$\left\{ \nabla_\mu \Phi \nabla_\nu \Phi \text{Tr} (\nabla^\mu \mathcal{S} \nabla^\nu \mathcal{S}), \nabla_\mu \Phi \nabla^\mu \Phi \text{Tr} (\nabla_\nu \mathcal{S} \nabla^\nu \mathcal{S}) \right\} \quad (\text{B.11})$$

 $(\nabla\Phi)^2 \mathcal{F}^2 :$ 

$$\left\{ \nabla_\rho \Phi \nabla^\rho \Phi \mathcal{F}_{\mu\nu}^M \mathcal{F}^{\mu\nu}_M, \nabla_\rho \Phi \nabla^\rho \Phi \mathcal{F}_{\mu\nu}^M \mathcal{S}_M^N \mathcal{F}^{\mu\nu}_N, \right. \\ \left. \nabla^\mu \Phi \nabla_\nu \Phi \mathcal{F}_{\rho\mu}^M \mathcal{F}^{\rho\nu}_M, \nabla^\mu \Phi \nabla_\nu \Phi \mathcal{F}_{\rho\mu}^M \mathcal{S}_M^N \mathcal{F}^{\rho\nu}_N \right\} \quad (\text{B.12})$$

 $(\nabla\mathcal{S})^2 \mathcal{F}^2 :$ 

$$\left\{ \text{Tr} (\nabla_\rho \mathcal{S} \nabla^\rho \mathcal{S}) \mathcal{F}_{\mu\nu}^M \mathcal{F}^{\mu\nu}_M, \text{Tr} (\nabla_\rho \mathcal{S} \nabla^\rho \mathcal{S}) \mathcal{F}_{\mu\nu}^M \mathcal{S}_M^N \mathcal{F}^{\mu\nu}_N, \right. \\ \text{Tr} (\nabla^\mu \mathcal{S} \nabla^\nu \mathcal{S}) \mathcal{F}_{\mu\rho}^M \mathcal{F}_{\nu\rho M}, \text{Tr} (\nabla^\mu \mathcal{S} \nabla^\nu \mathcal{S}) \mathcal{F}_{\mu\rho}^M \mathcal{S}_M^N \mathcal{F}_{\nu\rho N}, \\ \mathcal{F}_{\mu\nu}^M \nabla_\rho \mathcal{S}_M^N \nabla^\rho \mathcal{S}_N^P \mathcal{F}^{\mu\nu}_P, \mathcal{F}_{\mu\nu}^M \nabla_\rho \mathcal{S}_M^N \nabla^\rho \mathcal{S}_N^P \mathcal{S}_P^Q \mathcal{F}^{\mu\nu}_Q \\ \mathcal{F}_{\mu\nu}^M \nabla^\nu \mathcal{S}_M^N \nabla_\rho \mathcal{S}_N^P \mathcal{F}^{\mu\rho}_P, \mathcal{F}_{\mu\nu}^M \nabla^\nu \mathcal{S}_M^N \nabla_\rho \mathcal{S}_N^P \mathcal{S}_P^Q \mathcal{F}^{\mu\rho}_Q, \\ \left. \mathcal{F}_{\mu\nu}^M \nabla_\rho \mathcal{S}_M^N \nabla^\nu \mathcal{S}_N^P \mathcal{F}^{\mu\rho}_P, \mathcal{F}_{\mu\nu}^M \nabla_\rho \mathcal{S}_M^N \nabla^\nu \mathcal{S}_N^P \mathcal{S}_P^Q \mathcal{F}^{\mu\rho}_Q \right\} \quad (\text{B.13})$$

 $H \nabla\Phi \mathcal{F}^2 :$ 

$$\left\{ H^{\mu\nu\rho} \nabla^\sigma \Phi \mathcal{F}_{\mu\nu}^M \mathcal{F}_{\rho\sigma M}, H^{\mu\nu\rho} \nabla^\sigma \Phi \mathcal{F}_{\mu\nu}^M \mathcal{S}_M^N \mathcal{F}_{\rho\sigma N} \right\} \quad (\text{B.14})$$

 $H \nabla\mathcal{S} \mathcal{F}^2 :$ 

$$\left\{ H^{\mu\nu\rho} \mathcal{F}_{\mu\sigma}^M \nabla_\nu \mathcal{S}_M^N \mathcal{S}_N^P \mathcal{F}_{\rho\sigma P}, H^{\mu\nu\rho} \mathcal{F}_{\mu\nu}^M \nabla^\sigma \mathcal{S}_M^N \mathcal{F}_{\rho\sigma N}, H^{\mu\nu\rho} \mathcal{F}_{\mu\nu}^M \nabla^\sigma \mathcal{S}_M^N \mathcal{S}_N^P \mathcal{F}_{\rho\sigma P} \right\} \quad (\text{B.15})$$

 $\nabla\Phi \nabla\mathcal{S} \mathcal{F}^2 :$ 

$$\left\{ \nabla^\rho \Phi \mathcal{F}_{\mu\nu}^M \nabla_\rho \mathcal{S}_M^N \mathcal{F}^{\mu\nu}_N, \nabla^\mu \Phi \mathcal{F}_{\mu\rho}^M \nabla_\nu \mathcal{S}_M^N \mathcal{F}^{\nu\rho}_N, \nabla^\mu \Phi \mathcal{F}_{\mu\rho}^M \nabla_\nu \mathcal{S}_M^N \mathcal{S}_N^P \mathcal{F}^{\nu\rho}_P \right\} \quad (\text{B.16})$$

# C Partial integration, field redefinitions and $GL(d)$ decomposition

In this appendix, we give some details about the computations of the dimensionally reduced actions presented in Sec. 4.1. We show explicitly how to eliminate all second-order derivatives by partial integration up to terms appearing in the first column of Tab. 2.1, amenable to subsequent elimination by field redefinitions.

## C.1 $\hat{R}_{\hat{\mu}\hat{\nu}\hat{\rho}\hat{\sigma}}\hat{R}^{\hat{\mu}\hat{\nu}\hat{\rho}\hat{\sigma}}$

Let us begin with the terms appearing in the reduction of  $\hat{R}_{\hat{\mu}\hat{\nu}\hat{\rho}\hat{\sigma}}\hat{R}^{\hat{\mu}\hat{\nu}\hat{\rho}\hat{\sigma}}$ , as presented in Sec. 4.1.3. We give the explicit expression of the five last terms in Eq. (4.8) after integration by parts (and use of Bianchi identities). Up to boundary terms (which we ignore), the first two terms can be rewritten as

$$\begin{aligned} & \frac{\alpha'}{4} \int d^D x \sqrt{-g} e^{-\Phi} \text{Tr} \left( \nabla_\mu \nabla_\nu G^{-1} G \nabla^\mu \nabla^\nu G^{-1} G \right) \\ &= \frac{\alpha'}{4} \int d^D x \sqrt{-g} e^{-\Phi} \left[ \text{Tr} \left( \left( \square G^{-1} - \nabla_\mu \Phi \nabla^\mu G^{-1} \right) G \left( \square G^{-1} - \nabla_\nu \Phi \nabla^\nu G^{-1} \right) G \right) \right. \\ & \quad + 2 \text{Tr} \left( \left( \square G^{-1} - \nabla_\mu \Phi \nabla^\mu G^{-1} \right) G \nabla_\nu G^{-1} \nabla^\nu G \right) - \text{Tr} \left( \left( \square G - \nabla_\mu \Phi \nabla^\mu G \right) G^{-1} \nabla_\nu G \nabla^\nu G^{-1} \right) \\ & \quad \left. + \text{Tr} \left( \nabla_\mu G^{-1} \nabla_\nu G \nabla^\mu G^{-1} \nabla^\nu G \right) + \left( R_{\mu\nu} + \nabla_\mu \nabla_\nu \Phi \right) \text{Tr} \left( \nabla^\mu G^{-1} \nabla^\nu G \right) \right], \end{aligned} \quad (\text{C.1})$$

and

$$\begin{aligned} & \frac{3\alpha'}{4} \int d^D x \sqrt{-g} e^{-\Phi} \text{Tr} \left( \nabla_\mu \nabla_\nu G^{-1} \nabla^\mu G \nabla^\nu G^{-1} G \right) \\ &= \int d^D x \sqrt{-g} e^{-\Phi} \frac{\alpha'}{4} \left[ \frac{3}{2} \text{Tr} \left( \left( \square G - \nabla_\mu \Phi \nabla^\mu G \right) G^{-1} \nabla_\nu G \nabla^\nu G^{-1} \right) - \frac{3}{2} \text{Tr} \left( \nabla_\mu G^{-1} \nabla_\nu G \nabla^\mu G^{-1} \nabla^\nu G \right) \right], \end{aligned} \quad (\text{C.2})$$

respectively. The last three terms can be manipulated similarly and their sum takes the following form

$$\begin{aligned} & \frac{\alpha'}{4} \int d^D x \sqrt{-g} e^{-\Phi} \left[ F_{\mu\nu}^{(1)m} \left( G \nabla^\mu \nabla_\rho G^{-1} G \right)_{mn} F^{(1)\rho\nu n} - 2 \nabla_\rho F_{\mu\nu}^{(1)m} G_{mn} \nabla^\mu F^{(1)\nu\rho n} \right. \\ & \quad \left. - 6 \nabla_\rho F_{\mu\nu}^{(1)m} \nabla^\mu G_{mn} F^{(1)\nu\rho n} \right] \\ &= \int d^D x \sqrt{-g} e^{-\Phi} \frac{\alpha'}{4} \left[ 2 \left( \nabla^\mu F_{\mu\nu}^{(1)m} - \nabla^\mu \Phi F_{\mu\nu}^{(1)m} \right) G_{mn} \left( \nabla_\rho F^{(1)\rho\nu n} - \nabla_\rho \Phi F^{(1)\rho\nu n} \right) \right. \\ & \quad \left. - 2 \left( R^{\mu\nu} + \nabla^\mu \nabla^\nu \Phi \right) F_{\mu\rho}^{(1)m} G_{mn} F^{(1)\rho n} - \frac{5}{4} F_{\mu\nu}^{(1)m} \left( \square G - \nabla_\rho \Phi \nabla^\rho G \right)_{mn} F^{(1)\mu\nu n} \right] \end{aligned}$$

$$\begin{aligned}
& + F_{\mu\nu}^{(1)m} \left( \nabla_\rho G \nabla^\mu G^{-1} G \right)_{mn} F^{(1)\nu\rho n} + F_{\mu\nu}^{(1)m} \left( \nabla^\mu G \nabla_\rho G^{-1} G \right)_{mn} F^{(1)\nu\rho n} \\
& + 3 F_{\mu\nu}^{(1)m} \nabla^\mu G_{mn} \left( \nabla_\rho F^{(1)\rho\nu n} - \nabla_\rho \Phi F^{(1)\rho\nu n} \right) + R^{\mu\nu\rho\sigma} F_{\mu\nu}^{(1)m} G_{mn} F_{\rho\sigma}^{(1)n} \Big], \quad (\text{C.3})
\end{aligned}$$

again up to boundary contributions. In the form (C.1)–(C.3), all the remaining second-order derivatives are of the form appearing in the first column of Tab. 2.1. They can thus be reabsorbed into field redefinitions as discussed in Sec. 2.2. Explicitly, this induces the order  $\alpha'$  field redefinitions

$$\begin{aligned}
\delta\Phi &= \frac{1}{8} \left[ -2 F_{\mu\nu}^{(1)m} G_{mn} F^{(1)\mu\nu n} + \text{Tr} \left( \nabla_\mu G^{-1} \nabla^\mu G \right) \right], \\
\delta g_{\mu\nu} &= \frac{1}{4} \left[ 2 F_{\mu\rho}^{(1)m} G_{mn} F_{\nu}^{(1)\rho n} - \text{Tr} \left( \nabla_{(\mu} G^{-1} \nabla_{\nu)} G \right) \right], \\
\delta B_{\mu\nu} &= \frac{1}{8} \left( -2 \nabla^\rho F_{\rho\mu}^{(1)m} + 2 \nabla^\rho \Phi F_{\rho\mu}^{(1)m} + H_{\mu\rho\sigma} H^{\rho\sigma}{}_p G^{pm} + F_{\mu\rho}^{(1)p} \left( \nabla^\rho G G^{-1} \right)_p^m \right. \\
&\quad \left. + 2 H_{\mu\rho p} \left( G^{-1} \nabla^\rho B G^{-1} \right)^{pm} \right) \left( A_{\nu m}^{(2)} - B_{mn} A_{\nu}^{(1)n} \right) - (\mu \leftrightarrow \nu), \\
\delta G^{mn} &= \frac{1}{4} \left[ -2 \square G^{mn} + 2 \nabla_\mu \Phi \nabla^\mu G^{mn} - G^{mp} H_{\mu\nu p} G^{nq} H^{\mu\nu}{}_q - \frac{3}{2} F_{\mu\nu}^{(1)m} F^{(1)\mu\nu n} \right. \\
&\quad \left. - \left( G^{-1} \nabla_\mu G \nabla^\mu G^{-1} \right)^{mn} + 2 \left( G^{-1} \nabla_\mu B G^{-1} \nabla^\mu B G^{-1} \right)^{mn} \right], \quad (\text{C.4}) \\
\delta A_\mu^{(1)m} &= \frac{1}{4} \left[ -2 \nabla^\nu F_{\nu\mu}^{(1)m} + 2 \nabla^\nu \Phi F_{\nu\mu}^{(1)m} + H_{\mu\nu\rho} H^{\nu\rho}{}_n G^{nm} \right. \\
&\quad \left. + F_{\mu\nu}^{(1)n} \left( \nabla^\nu G G^{-1} \right)_n^m + 2 H_{\mu\nu n} \left( G^{-1} \nabla^\nu B G^{-1} \right)^{nm} \right], \\
\delta A_{\mu m}^{(2)} &= \frac{1}{4} \left[ 2 \nabla^\nu F_{\nu\mu}^{(1)n} B_{nm} - 2 \nabla^\nu \Phi F_{\nu\mu}^{(1)n} B_{nm} - H_{\mu\nu\rho} H^{\nu\rho}{}_n \left( G^{-1} B \right)_m^n \right. \\
&\quad \left. - F_{\mu\nu}^{(1)n} \left( \nabla^\nu G G^{-1} B \right)_{nm} - 2 H_{\mu\nu n} \left( G^{-1} \nabla^\nu B G^{-1} B \right)_m^n \right].
\end{aligned}$$

## C.2 $\hat{R}_{\hat{\mu}\hat{\nu}\hat{\rho}\hat{\sigma}} \hat{H}^{\hat{\mu}\hat{\nu}\hat{\lambda}} \hat{H}^{\hat{\rho}\hat{\sigma}}_{\hat{\lambda}}$

Here, we consider the four last terms in the reduction (4.12) of  $RHH$ . After partial integration, they can be brought into the form

$$\begin{aligned}
& \frac{\alpha'}{4} \int d^D x \sqrt{-g} e^{-\Phi} \text{Tr} \left( \nabla_\mu \nabla_\nu G^{-1} \nabla^\mu B G^{-1} \nabla^\nu B \right) \\
& = \frac{\alpha'}{4} \int d^D x \sqrt{-g} e^{-\Phi} \left[ -\text{Tr} \left( \nabla_\mu B \nabla^\mu G^{-1} \nabla_\nu B \nabla^\nu G^{-1} \right) + \frac{1}{2} \text{Tr} \left( \nabla_\mu B \nabla_\nu G^{-1} \nabla^\mu B \nabla^\nu G^{-1} \right) \right. \\
& \quad \left. - \text{Tr} \left( \left( \square B - \nabla_\mu \Phi \nabla^\mu B \right) G^{-1} \nabla_\nu B \nabla^\nu G^{-1} \right) + \frac{1}{2} \text{Tr} \left( \left( \square G^{-1} - \nabla_\mu \Phi \nabla^\mu G^{-1} \right) \nabla_\nu B G^{-1} \nabla^\nu B \right) \right], \quad (\text{C.5})
\end{aligned}$$

$$\begin{aligned}
& -\frac{\alpha'}{4} \int d^D x \sqrt{-g} e^{-\Phi} H^{\mu\rho}{}_m \nabla_\mu \nabla_\nu G^{mn} H^{\nu}{}_{\rho n} \\
& = \frac{\alpha'}{4} \int d^D x \sqrt{-g} e^{-\Phi} \left[ -\left( \nabla_\mu H^{\mu\nu}{}_m - \nabla_\mu \Phi H^{\mu\nu}{}_m \right) \nabla^\rho G^{mn} H_{\nu\rho n} - \frac{1}{2} F_{\mu\nu}^{(1)m} \left( \nabla_\rho B \nabla^\rho G^{-1} \right)_m^n H^{\mu\nu}{}_n \right. \\
& \quad \left. - \frac{1}{4} H^{\mu\nu}{}_m \left( \square G^{-1} - \nabla_\rho \Phi \nabla^\rho G^{-1} \right)^{mn} H_{\mu\nu n} - F_{\nu\rho}^{(1)m} \left( \nabla_\mu B \nabla^\rho G^{-1} \right)_m^n H^{\mu\nu}{}_n \right], \quad (\text{C.6})
\end{aligned}$$

$$\begin{aligned}
 & -\frac{\alpha'}{2} \int d^D x \sqrt{-g} e^{-\Phi} \nabla_{\mu} F_{\nu\rho}^{(1)m} \left( \nabla^{\rho} B G^{-1} \right)_m^n H^{\mu\nu}_n \\
 & = \frac{\alpha'}{4} \int d^D x \sqrt{-g} e^{-\Phi} \left[ -(\nabla_{\mu} H^{\mu\nu}_m - \nabla_{\mu} \Phi H^{\mu\nu}_m) \left( G^{-1} \nabla^{\rho} B \right)_n^m F_{\nu\rho}^{(1)n} \right. \\
 & \quad - \left( \nabla_{\mu} F^{(1)\mu\nu m} - \nabla_{\mu} \Phi F^{(1)\mu\nu m} \right) \left( \nabla^{\rho} B G^{-1} \right)_m^n H_{\nu\rho n} + \frac{1}{2} F_{\mu\nu}^{(1)m} \left( \nabla_{\rho} B G^{-1} \nabla^{\rho} B \right)_{mn} F^{(1)\mu\nu n} \\
 & \quad - \frac{1}{2} F_{\mu\nu}^{(1)m} \left( \nabla_{\rho} B \nabla^{\rho} G^{-1} \right)_m^n H^{\mu\nu}_n - \frac{1}{2} F_{\mu\nu}^{(1)m} \left( (\square B - \nabla_{\rho} \Phi \nabla^{\rho} B) G^{-1} \right)_m^n H^{\mu\nu}_n \\
 & \quad + F_{\nu\rho}^{(1)m} \left( \nabla^{\rho} B \nabla_{\mu} G^{-1} \right)_m^n H^{\mu\nu}_n - F_{\nu\rho}^{(1)m} \left( \nabla_{\mu} B \nabla^{\rho} G^{-1} \right)_m^n H^{\mu\nu}_n \\
 & \quad \left. + F_{\mu\nu}^{(1)m} \left( \nabla_{\rho} B G^{-1} \nabla^{\nu} B \right)_{mn} F^{(1)\rho\mu n} \right], \tag{C.7}
 \end{aligned}$$

$$\begin{aligned}
 & \frac{\alpha'}{4} \int d^D x \sqrt{-g} e^{-\Phi} 2 H^{\mu\nu\lambda} \nabla_{\mu} F_{\nu\rho}^{(1)m} H^{\rho}_{\lambda m} \\
 & = \frac{\alpha'}{4} \int d^D x \sqrt{-g} e^{-\Phi} \left[ \frac{1}{2} (\nabla_{\mu} H^{\mu\nu}_m - \nabla_{\mu} \Phi H^{\mu\nu}_m) H_{\nu\rho\sigma} F^{(1)\rho\sigma m} - H^{\mu\nu\rho} F_{\nu\sigma}^{(1)m} \nabla_{\mu} B_{mn} F_{\rho}^{(1)\sigma n} \right. \\
 & \quad - (\nabla_{\mu} H^{\mu\nu\rho} - \nabla_{\mu} \Phi H^{\mu\nu\rho}) F_{\nu\sigma}^{(1)m} H^{\sigma}_{\rho m} + \frac{1}{2} (\nabla_{\mu} F^{(1)\mu\nu m} - \nabla_{\mu} \Phi F^{(1)\mu\nu m}) H_{\nu\rho\sigma} H^{\rho\sigma}_m \\
 & \quad + \frac{1}{2} H^{\mu\nu\rho} F_{\nu\sigma}^{(1)m} \nabla^{\sigma} B_{mn} F_{\rho\mu}^{(1)n} + F_{\mu\nu}^{(1)m} H_{\rho\sigma m} F^{(1)\rho\nu n} H^{\nu\sigma}_n - \frac{1}{4} F_{\mu\nu}^{(1)m} H_{\rho\sigma m} F^{(1)\mu\nu n} H^{\rho\sigma}_n \\
 & \quad \left. - \frac{1}{4} F_{\mu\nu}^{(1)m} H_{\rho\sigma m} F^{(1)\rho\sigma n} H^{\mu\nu}_n \right], \tag{C.8}
 \end{aligned}$$

respectively. Again, all left-over terms carrying second-order derivatives can be converted to products of first-order derivatives by means of the rules of Tab. 2.1. This induces the explicit field redefinitions

$$\begin{aligned}
 \delta B_{\mu\nu} & = \frac{1}{8} \left[ -A_{\mu}^{(1)m} \left( G \nabla_{\rho} G^{-1} \right)_m^n H_{\nu\rho n} - A_{\mu}^{(1)m} \nabla^{\rho} B_{mn} F_{\nu\rho}^{(1)n} + 2 F_{\mu\rho}^{(1)m} H^{\rho}_{\nu m} \right. \\
 & \quad + \frac{1}{2} A_{\mu}^{(1)m} H_{\nu\rho\sigma} G_{mn} F^{(1)\rho\sigma n} - \frac{1}{2} H_{\mu\rho\sigma} H^{\rho\sigma}_m G^{mn} \left( A_{\nu n}^{(2)} - B_{np} A_{\nu}^{(1)p} \right) \\
 & \quad \left. - H_{\mu\rho m} \left( G^{-1} \nabla^{\rho} B G^{-1} \right)^{mn} \left( A_{\nu n}^{(2)} - B_{np} A_{\nu}^{(1)p} \right) \right] - (\mu \leftrightarrow \nu), \\
 \delta G^{mn} & = \frac{1}{4} \left[ \frac{1}{2} G^{mp} H_{\mu\nu p} G^{nq} H^{\mu\nu}_q - \left( G^{-1} \nabla_{\mu} B G^{-1} \nabla^{\mu} B G^{-1} \right)^{mn} \right], \\
 \delta B_{mn} & = \frac{1}{4} \left[ \left( \nabla_{\mu} B \nabla^{\mu} G^{-1} G \right)_{mn} + \left( G \nabla_{\mu} G^{-1} \nabla^{\mu} B \right)_{mn} \right. \\
 & \quad \left. - \frac{1}{2} H_{\mu\nu m} F^{(1)\mu\nu p} G_{pn} + \frac{1}{2} G_{mp} F^{(1)\mu\nu p} H_{\mu\nu n} \right], \\
 \delta A_{\mu}^{(1)m} & = \frac{1}{4} \left[ -H_{\mu\nu n} \left( G^{-1} \nabla^{\nu} B G^{-1} \right)^{nm} - \frac{1}{2} H_{\mu\nu\rho} H^{\nu\rho}_n G^{nm} \right], \\
 \delta A_{\mu m}^{(2)} & = \frac{1}{4} \left[ H_{\mu\nu n} \left( \nabla^{\nu} G^{-1} G \right)_m^n - F_{\mu\nu}^{(1)n} \nabla^{\nu} B_{nm} + H_{\mu\nu n} \left( G^{-1} \nabla^{\nu} B G^{-1} B \right)_m^n \right. \\
 & \quad \left. - \frac{1}{2} H_{\mu\nu\rho} F^{(1)\nu\rho n} G_{nm} + \frac{1}{2} H_{\mu\nu\rho} H^{\nu\rho}_n \left( G^{-1} B \right)_m^n \right]. \tag{C.9}
 \end{aligned}$$

### C.3 GL( $d$ ) expressions of some $O(d, d, \mathbb{R})$ terms

We present here the GL( $d$ ) decomposition of some of the  $O(d, d, \mathbb{R})$ -invariant terms, that are relevant for the identifications made in Sec. 4.2.

$$\text{Tr}(\nabla_\mu S \nabla_\nu S) = 2 \text{Tr}(\nabla_{(\mu} G \nabla_{\nu)} G^{-1}) + 2 \text{Tr}(\nabla_\mu B G^{-1} \nabla_\nu B G^{-1}). \quad (\text{C.10})$$

$$\begin{aligned} \text{Tr}(\nabla_\mu S \nabla_\nu S \nabla^\mu S \nabla^\nu S) &= 2 \text{Tr}(\nabla_\mu G^{-1} \nabla_\nu G \nabla^\mu G^{-1} \nabla^\nu G) + 4 \text{Tr}(\nabla_\mu B \nabla_\nu G^{-1} \nabla^\mu B \nabla^\nu G^{-1}) \\ &\quad + 8 \text{Tr}(G^{-1} \nabla_\mu B G^{-1} \nabla_\nu G \nabla^\mu G^{-1} \nabla^\nu B) \\ &\quad + 2 \text{Tr}(G^{-1} \nabla_\mu B G^{-1} \nabla_\nu B G^{-1} \nabla^\mu B G^{-1} \nabla^\nu B), \end{aligned} \quad (\text{C.11})$$

$$\begin{aligned} \text{Tr}(\nabla_\mu S \nabla^\mu S \nabla_\nu S \nabla^\nu S) &= 2 \text{Tr}(\nabla_\mu G^{-1} \nabla^\mu G \nabla_\nu G^{-1} \nabla^\nu G) + 4 \text{Tr}(G^{-1} \nabla_\mu B G^{-1} \nabla_\nu G \nabla^\nu G^{-1} \nabla^\mu B) \\ &\quad + 4 \text{Tr}(\nabla_\mu G^{-1} \nabla^\mu B \nabla_\nu G^{-1} \nabla^\nu B) + 4 \text{Tr}(G^{-1} \nabla_\mu B \nabla^\mu G^{-1} \nabla_\nu G G^{-1} \nabla^\nu B) \\ &\quad + 2 \text{Tr}(G^{-1} \nabla_\mu B G^{-1} \nabla^\mu B G^{-1} \nabla_\nu B G^{-1} \nabla^\nu B), \end{aligned} \quad (\text{C.12})$$

$$\begin{aligned} \text{Tr}(S \nabla_\mu S \nabla_\nu S \nabla_\rho S \nabla_\sigma S) &= 2 \left[ \text{Tr}(\nabla_\mu G^{-1} \nabla_\nu G \nabla_\rho G^{-1} \nabla_\sigma B) - \text{Tr}(\nabla_\sigma G^{-1} \nabla_\mu G \nabla_\nu G^{-1} \nabla_\rho B) \right. \\ &\quad + \text{Tr}(\nabla_\rho G^{-1} \nabla_\sigma G \nabla_\mu G^{-1} \nabla_\nu B) - \text{Tr}(\nabla_\nu G^{-1} \nabla_\rho G \nabla_\sigma G^{-1} \nabla_\mu B) \\ &\quad - \text{Tr}(\nabla_\mu B G^{-1} \nabla_\nu B G^{-1} \nabla_\rho B \nabla_\sigma G^{-1}) + \text{Tr}(\nabla_\sigma B G^{-1} \nabla_\mu B G^{-1} \nabla_\nu B \nabla_\rho G^{-1}) \\ &\quad \left. - \text{Tr}(\nabla_\rho B G^{-1} \nabla_\sigma B G^{-1} \nabla_\mu B \nabla_\nu G^{-1}) + \text{Tr}(\nabla_\nu B G^{-1} \nabla_\rho B G^{-1} \nabla_\sigma B \nabla_\mu G^{-1}) \right], \end{aligned} \quad (\text{C.13})$$

$$\mathcal{F}_{\mu\nu}{}^M \mathcal{S}_M{}^N \mathcal{F}_{\rho\sigma N} = F_{\mu\nu}^{(1)m} G_{mn} F_{\rho\sigma}^{(1)n} + H_{\mu\nu m} G^{mn} H_{\rho\sigma n}, \quad (\text{C.14})$$

$$\mathcal{F}_{\mu\nu}{}^M \mathcal{F}_{\rho\sigma M} = F_{\mu\nu}^{(1)m} F_{\rho\sigma m}^{(2)} + F_{\rho\sigma}^{(1)m} F_{\mu\nu m}^{(2)}, \quad (\text{C.15})$$

$$\begin{aligned} \mathcal{F}_{\mu\nu}{}^M \mathcal{S}_M{}^N \nabla_\rho \mathcal{S}_N{}^P \mathcal{F}_{\sigma\lambda P} &= F_{\mu\nu}^{(1)m} \left( G \nabla_\rho G^{-1} \right)_m{}^n H_{\rho\lambda n} - F_{\mu\nu}^{(1)m} \nabla_\rho B_{mn} F_{\sigma\lambda}^{(1)n} \\ &\quad + H_{\mu\nu m} \left( G^{-1} \nabla_\rho B G^{-1} \right)^{mn} H_{\sigma\lambda n} + H_{\mu\nu m} \left( G^{-1} \nabla_\rho G \right)_m{}^n F_{\sigma\lambda}^{(1)n}, \end{aligned} \quad (\text{C.16})$$

$$\begin{aligned} \mathcal{F}_{\mu\nu}{}^M \nabla_\rho \mathcal{S}_M{}^N \mathcal{F}_{\sigma\lambda N} &= F_{\mu\nu}^{(1)m} \nabla_\rho G_{mn} F_{\sigma\lambda}^{(1)n} + F_{\mu\nu}^{(1)m} \left( \nabla_\rho B G^{-1} \right)_m{}^n H_{\rho\lambda n} \\ &\quad - H_{\mu\nu m} \left( G^{-1} \nabla_\rho B \right)_m{}^n F_{\sigma\lambda}^{(1)n} + H_{\mu\nu m} \nabla_\rho G^{mn} H_{\sigma\lambda n}, \end{aligned} \quad (\text{C.17})$$

$$\begin{aligned} \mathcal{F}_{\mu\nu}{}^M \mathcal{S}_M{}^N \nabla_\rho \mathcal{S}_N{}^P \nabla_\sigma \mathcal{S}_P{}^Q \mathcal{F}_{\lambda\tau Q} &= \\ &= F_{\mu\nu}^{(1)m} \left( G \nabla_\rho G^{-1} \nabla_\sigma G \right)_{mn} F_{\lambda\tau}^{(1)n} + F_{\mu\nu}^{(1)m} \left( G \nabla_\rho G^{-1} \nabla_\sigma B G^{-1} \right)_m{}^n H_{\lambda\tau n} \end{aligned}$$

$$\begin{aligned}
 & -F_{\mu\nu}^{(1)m} \left( \nabla_\rho B \nabla_\sigma G^{-1} \right)_m^n H_{\lambda\tau n} + H_{\mu\nu m} \left( \nabla_\rho G^{-1} \nabla_\sigma B \right)_m^n F_{\lambda\tau}^{(1)n} \\
 & + H_{\mu\nu m} \left( G^{-1} \nabla_\rho B G^{-1} \nabla_\sigma G \right)_m^n F_{\lambda\tau}^{(1)n} + F_{\mu\nu}^{(1)m} \left( \nabla_\rho B G^{-1} \nabla_\sigma B \right)_{mn} F_{\lambda\tau}^{(1)n} \\
 & + H_{\mu\nu m} \left( G^{-1} \nabla_\rho G \nabla_\sigma G^{-1} \right)^{mn} H_{\lambda\tau n} + H_{\mu\nu m} \left( G^{-1} \nabla_\rho B G^{-1} \nabla_\sigma B G^{-1} \right)^{mn} H_{\lambda\tau n}, \quad (C.18)
 \end{aligned}$$

$$\begin{aligned}
 & \mathcal{F}_{\mu\nu}^M \nabla_\rho \mathcal{S}_M^N \nabla_\sigma \mathcal{S}_N^P \mathcal{F}_{\lambda\tau P} = \\
 & F_{\mu\nu}^{(1)m} \left( \nabla_\rho B G^{-1} \nabla_\sigma G \right)_{mn} F_{\lambda\tau}^{(1)n} - F_{\mu\nu}^{(1)m} \left( \nabla_\rho G G^{-1} \nabla_\sigma B \right)_{mn} F_{\lambda\tau}^{(1)n} \\
 & + F_{\mu\nu}^{(1)m} \left( \nabla_\rho G \nabla_\sigma G^{-1} \right)_m^n H_{\lambda\tau n} + F_{\mu\nu}^{(1)m} \left( \nabla_\rho B G^{-1} \nabla_\sigma B G^{-1} \right)_m^n H_{\lambda\tau n} \quad (C.19) \\
 & + H_{\mu\nu m} \left( \nabla_\rho G^{-1} \nabla_\sigma G \right)_m^n F_{\lambda\tau}^{(1)n} + H_{\mu\nu m} \left( G^{-1} \nabla_\rho B G^{-1} \nabla_\sigma B \right)_m^n F_{\lambda\tau}^{(1)n} \\
 & + H_{\mu\nu m} \left( \nabla_\rho G^{-1} \nabla_\sigma B G^{-1} \right)^{mn} H_{\lambda\tau n} - H_{\mu\nu m} \left( G^{-1} \nabla_\rho B \nabla_\sigma G^{-1} \right)^{mn} H_{\lambda\tau n}.
 \end{aligned}$$



**Part II**

**AdS<sub>3</sub> vacua and Kaluza-Klein  
spectroscopy**





# 1 Chapter

## Introduction

Supergravity is fundamental to the study of the AdS/CFT correspondence, which conjectures the equivalence between some conformal field theories in  $d$  dimensions and string theories solutions on  $d + 1$ -dimensional anti-de Sitter spacetime. In the weak coupling regime of string theory, this correspondence involves supergravity solutions, compactified on a compact manifold. The AdS<sub>3</sub>/CFT<sub>2</sub> correspondence is particularly promising, thanks to the good knowledge of conformal theories in two dimensions. In this context, the knowledge of anti-de Sitter solutions in three dimensions is crucial, as well as the need for efficient techniques to compute the Kaluza-Klein towers of massive fields resulting from the compactification. This is the subject of this part, based on Ref. [A, D, E].

This chapter is dedicated to the introduction of the AdS/CFT correspondence and of the standard methods of Kaluza-Klein spectrum calculation. We briefly review in Sec. 1.1 the main features of the correspondence and the relevance of supergravity to study them. We introduce in Sec. 1.2 the standard harmonic analysis needed to describe the compactification of supergravity theories on compact manifolds, using the example of six-dimensional supergravity on AdS<sub>3</sub> × S<sup>3</sup>. Sec. 1.3 finally gives the outline of this part of the thesis.

### 1.1 AdS/CFT correspondence

The AdS/CFT correspondence is a conjectured relation between certain conformal field theories in  $d$ -dimensional flat spacetime and superstring theories on backgrounds of the form AdS <sub>$d+1$</sub>  ×  $\mathcal{K}$ , with  $\mathcal{K}$  a compact manifold of dimension  $9 - d$  [88, 89]<sup>27</sup>. It states a duality between those quantum theories, in the sense that there exists a one-to-one map between their fields and operators, and that their dynamics agree.

A conformal field theory is a quantum field theory enjoying conformal invariance, *i.e.* invariant under coordinate transformations  $x_\mu \mapsto x'_\mu(x)$  that leave the metric unchanged up to a scale factor:

$$g_{\mu\nu}(x) \mapsto \Omega(x)^{-2} g_{\mu\nu}(x). \quad (1.1)$$

These transformations do not preserve the norm of vectors, but preserve the angles between two vectors (an example is given in Fig. 1.1). In  $d > 2$ -dimensional flat Lorentzian spacetime, *i.e.* for  $g_{\mu\nu}(x) = \eta_{\mu\nu}$ , they form the group SO(2,  $d$ ). For  $d = 2$ , the symmetry group features an infinite set of generators. An AdS <sub>$d+1$</sub>  spacetime is a  $d + 1$ -dimensional spacetime with constant negative curvature. Its isometry group is SO(2,  $d$ ). An example of AdS<sub>2</sub> geometry, embedded in three dimensions, is given in Fig. 1.2(a) by a one-sheet hyperboloid of revolution. Such spaces can also be represented on the plane, like in Fig. 1.2(b) which represents a tiling of the Poincaré plane with squares and triangles. The metric on this plane is such that all the squares in the tiling share the same dimensions: it is as if a person walking

<sup>27</sup>See Ref. [90–92] for reviews.

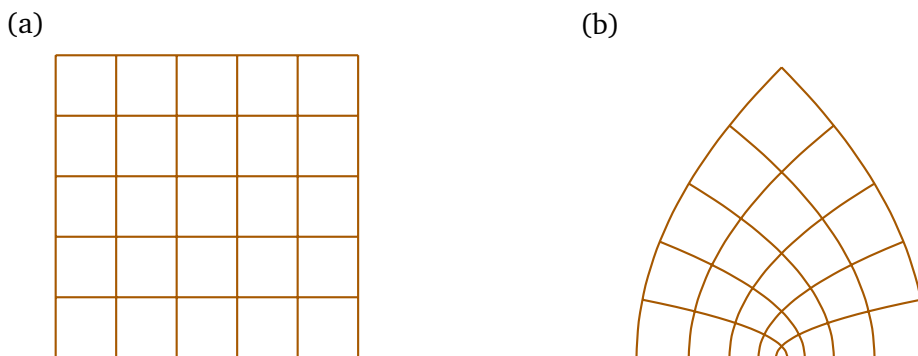
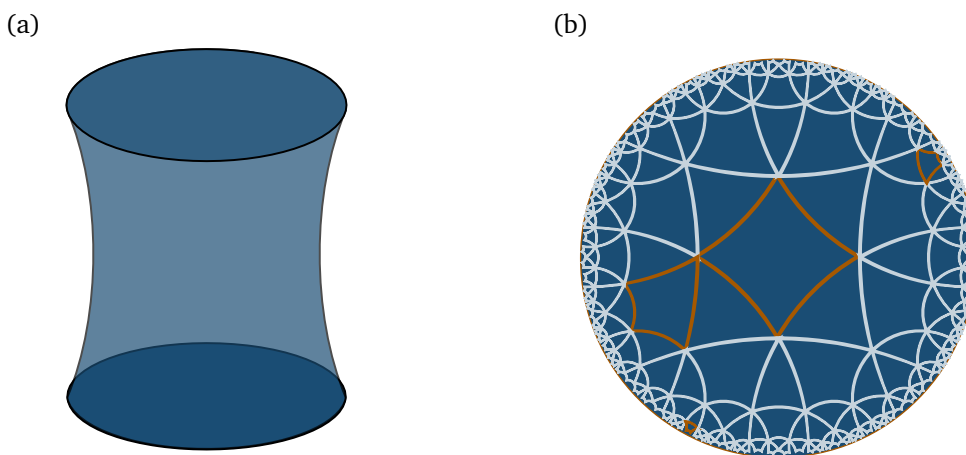

**Fig. 1.1** Example of a conformal transformation in two dimensions. The grid (a) is mapped to (b) through the transformation  $z \mapsto z^2/10$  in the complex plane. The angles are preserved: pairs of orthogonal lines are mapped to pairs of orthogonal curves. The norm is however not preserved.

in such a space sees the size of his legs decrease as he approaches the edge of the disk. Although drawn finite, the Poincaré disk represents an infinite space: the perimeter of its edge is infinite.

In the AdS/CFT correspondence, the quantum field theory may be thought of as being defined on the boundary of the anti-de Sitter spacetime, as schematically drawn in Fig. 1.3. As such, it is the most promising realization of the holographic principle, that states that the content of a quantum theory of gravitation in a given volume can be encoded in an effective theory living on the boundary surface of the volume. First proposed by 't Hooft and Susskind [93, 94], this principle is motivated by the Bekenstein-Hawking formula for the entropy of a black hole, according to which the maximum amount of entropy stored in a volume scales like the area of the black hole's event horizon. The holographic principle is pretty general, but the precise form of the boundary theory is usually unknown.

The power of the AdS/CFT correspondence is to predict both the bulk and boundary theories. It can thus, in principle, be used to compute physical quantities on one side, using the tools of the other. The duality furthermore relates the perturbative, *i.e.* weak coupling, regime in string theory to the non-perturbative, *i.e.* strong coupling, regime of the gauged CFT, and *vice versa*. Let us emphasize that this



**Fig. 1.2** Examples of anti-de Sitter geometries. (a) One-sheet hyperboloid of revolution embedded in flat three-dimensional space. (b) Tiling of the Poincaré plane with squares and triangles. All squares, as the highlighted ones, are of same dimensions in this geometry

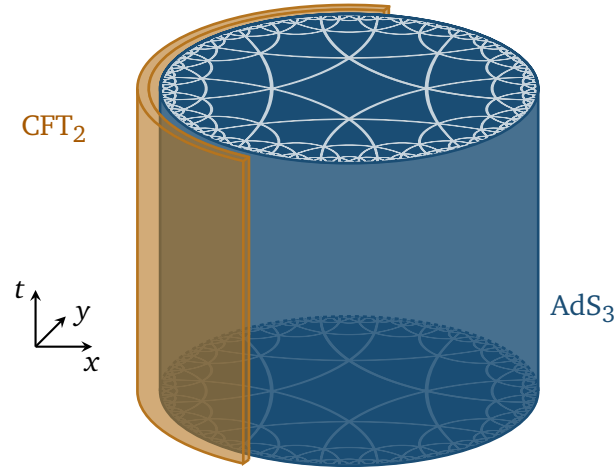

**Fig. 1.3** Schematic representation of spacetime in the  $\text{AdS}_3/\text{CFT}_2$  correspondence. The CFT is defined on the boundary of the AdS spacetime, sketched here as a cylinder with the Poincaré disk as a base.

duality is very different from the one we studied in Part I. T duality relates different backgrounds within string theory, whereas the AdS/CFT correspondence links quantum field theories on flat spacetime to string theories, that include gravity. The CFT, which was not originally intended to describe gravitation, appears in fact as a promising tool to deal with highly non-trivial gravitational problems.

The most prominent example of the correspondence relates type IIB string theory on  $\text{AdS}_5 \times S^5$  and  $\mathcal{N} = 4$  super-Yang-Mills theory on four-dimensional Minkowski space. Another example is the one of string theory on  $\text{AdS}_3 \times S^3 \times \mathcal{K}$ , with the compact 4-dimensional manifold  $\mathcal{K}$  being  $S^3 \times S^1$ , the four torus  $T^4$  or a K3 surface, and certain two-dimensional superconformal field theories. Even if there is no general derivation of the correspondence<sup>28</sup>, it has succeeded a large amount of tests, in the form of calculations matching on the two different sides, and motivates many possible applications in different fields, such as QCD, quark gluon plasma and condensed matter. As string theory is best understood in the low-energy regime, where it is described by supergravity, the duality is often used to predict results in strong coupled CFT using the tools of supergravity. We will restrict to this weaker form of the correspondence in the following.

Let us now explore the predictions of the AdS/CFT correspondence more explicitly. The relation between the objects of the two theories takes the form of a field-operator map, *i.e.* a dictionary between the supergravity fields on  $\text{AdS}_{d+1}$  and the  $\text{CFT}_d$  operators. This one-to-one map follows from the matching of the symmetries on both sides of the correspondence: the bosonic subgroup of the superalgebra on the CFT side can be identified with the isometry group of the string background  $\text{AdS}_{d+1} \times \mathcal{K}$ . The supergravity fields and CFT operators can then be organized into representations of these symmetries, and the dictionary links fields  $\varphi$  and operators  $\mathcal{O}$  belonging to the same representations. One can furthermore show that the mass  $m$  of the supergravity field  $\varphi$  is related to the conformal dimension  $\Delta$  of the CFT operator  $\mathcal{O}$  through the formula given in Tab. 1.1.

The field-operator map yields a relation between the generating functions on both sides. The boundary value  $\varphi^{(0)}$  of the supergravity field can be interpreted as a source for the CFT operator  $\mathcal{O}$ , and the correspondence gives the equivalence between the partition function of the supergravity

<sup>28</sup>See however Ref. [95] for the special case of the  $\text{AdS}_3/\text{CFT}_2$  correspondence.

Spin	Relation between $m$ and $\Delta$
0	$(m\ell_{\text{AdS}})^2 = \Delta(\Delta - d)$
1/2	$ m\ell_{\text{AdS}}  = \Delta - d/2$
1	$(m\ell_{\text{AdS}})^2 = (\Delta - 1)(\Delta + 1 - d)$
3/2	$ m\ell_{\text{AdS}}  = \Delta - d/2$
2	$(m\ell_{\text{AdS}})^2 = \Delta(\Delta - d)$

**Tab. 1.1** Relation between the mass  $m$  of a supergravity field  $\varphi$  and the conformal dimension  $\Delta$  of a CFT operator  $\mathcal{O}$  identified through the AdS/CFT correspondence [96–101].  $\ell_{\text{AdS}}$  is the characteristic length of the AdS spacetime.

theory, evaluated on the boundary, with the generating functional of CFT correlations functions, or, schematically,

$$\left\langle \exp \left( \int d^d x \mathcal{O} \varphi^{(0)} \right) \right\rangle_{\text{CFT}} = e^{-S_{\text{sugra}}[\varphi]} \Big|_{\text{boundary}}, \quad (1.2)$$

with  $S_{\text{sugra}}$  the supergravity action. This relation, together with holographic renormalization to regularize the boundary behavior of the supergravity fields [102], could in principle be used to compute all CFT correlation functions knowing the supergravity action, and explicit computations for 2- and 3-points functions have been strong supports for the correspondence. However, for higher-order correlators, this recipe needs the non-linear couplings in the supergravity, which are in general hard to compute: as already mentioned, the supergravity fields  $\varphi$  involved in the field-operator dictionary are the ones of the low-dimensional theory on  $\text{AdS}_{d+1}$ , and not the ones of the full theory on  $\text{AdS}_{d+1} \times \mathcal{K}$ . The fields  $\varphi$  are thus obtained by dimensional reduction of the ten-dimensional fields on  $\mathcal{K}$ . This reduction induces the appearance of infinitely many massive fields in the low-dimensional theory, often called Kaluza-Klein towers, with highly non-trivial couplings. This dimensional reduction is the subject of the next section.

## 1.2 Kaluza-Klein spectrum

The ideas of dimensional reduction were first introduced by Kaluza and Klein in the first half of the twentieth century in the context of general relativity [103, 104]. They considered pure gravity in five dimensions, and showed that the compactification of the fifth dimension leads to a unified field theory of gravitation and electromagnetism. This idea was then extensively used in theoretical physics, for example to describe how, in supergravity, a theory formulated in  $D$  dimensions can lead to an observable spacetime in low dimensions.

One considers that the  $D$ -dimensional spacetime  $\mathcal{M}_D$  is a direct product

$$\mathcal{M}_d \times \mathcal{K}_{D-d} \quad (1.3)$$

of a manifold  $\mathcal{M}_d$  of dimension  $d < D$ , describing the low-dimensional spacetime, and a compact internal space  $\mathcal{K}_{D-d}$ . The  $D$ -dimensional fields  $\varphi_D$  then depend on the spacetime coordinates  $x^M = \{x^\mu, y^m\}$ , with  $M \in \llbracket 1, D \rrbracket$ ,  $\mu \in \llbracket 1, d \rrbracket$  and  $m \in \llbracket 1, D-d \rrbracket$ , and the low-dimensional supergravity fields are obtained after expansion of the higher-dimensional ones in terms of a complete set of functions on the internal space. The simplest example is given by the reduction on the circle  $S^1$ , where the fields can

be written as Fourier expansions:

$$\varphi_D(x^\mu, y) = \sum_{n \geq 0} \varphi_n(x^\mu) e^{iny/R}, \quad (1.4)$$

with  $R$  the radius of the internal space. From the point of view of supergravity in  $D - 1$  dimensions, a single higher-dimensional field gives then rise to an infinite number of fields  $\varphi_n$ . It turns out that the modes with  $n \neq 0$  are massive. Consider a massless scalar field  $\phi(x^\mu, y)$  in  $D$  dimensions, obeying the Klein-Gordon equation

$$\square_D \phi = 0. \quad (1.5)$$

With the Fourier expansion (1.4), the fields  $\phi_n(x^\mu)$  satisfy

$$\left( \square_{D-1} - \left( \frac{n}{R} \right)^2 \right) \phi_n = 0, \quad (1.6)$$

and are massive, considered as fields in the low-dimensional supergravity. Similar expansions can be considered for all the fields in  $D$  dimensions. The supergravity on  $\mathcal{M}_{D-1}$  contains then infinite towers of massive fields, called Kaluza-Klein towers.

For reductions on spheres, one expands the fields in terms of spherical harmonics, that form a basis of the space of all functions on the sphere. They are also eigenfunctions of the Laplacian. Denoting  $\mathcal{Y}^\Sigma$  the scalar spherical harmonics on the sphere, the expansion of a higher-dimensional scalar field takes the form

$$\phi(x^\mu, y^m) = \sum_{\Sigma} \phi_{\Sigma}(x^\mu) \mathcal{Y}^\Sigma(y^m). \quad (1.7)$$

For the round sphere  $S^n$ , the index  $\Sigma$  takes value in the tower of representations  $[m, 0, \dots, 0]$  of  $\text{SO}(n + 1)$ . However, as the dimensional reduction of fields with non-vanishing spin leads to low-dimensional fields with non-trivial transformation under the Lorentz group on the internal manifold<sup>29</sup>, the scalar harmonics  $\mathcal{Y}^\Sigma$  are not sufficient and one needs several towers of spherical harmonics, with non-trivial behavior under the internal Lorentz group. These additional harmonics can be determined using group theoretical arguments [105], and are built from products of  $\mathcal{Y}^\Sigma$  and their derivatives. The computation of the Kaluza-Klein spectrum, *i.e.* the determination of the fields in the Kaluza-Klein towers and their masses, is then in general much more involved than in the simple case we just described. It demands, after linearization of the higher-dimensional equations of motion and the expansion of all fields in harmonics of the internal space, to disentangle the resulting equations in order to deduce the masses of the fields. This program has been successfully applied only for backgrounds that enjoy a coset space structure (see Ref. [106–110] for examples), or for general backgrounds but restricting to the spin-2 fields [111].

Let us consider as an example the reduction of  $\mathcal{N} = (2, 0)$  six-dimensional supergravity on  $\text{AdS}_3 \times S^3$ , whose Kaluza-Klein spectrum has been computed in Ref. [110]. The theory describes a pure supergravity multiplet, containing a graviton, four gravitini and five self-dual tensor fields, coupled to  $n$  tensor multiplets, each of them composed of an anti-self-dual tensor field, four fermions and five scalars. We restrict to a subsector of the spectrum, that results from the couplings between the metric  $g_{MN}$  and the self-dual  $B_{MN}^i$ , where  $i \in \llbracket 1, 5 \rrbracket$  is the  $\text{SO}(5)$  vector index, and present schematically the steps of the

<sup>29</sup>The reduction of a  $D$ -dimensional vector  $A_M$  gives for example rise to a  $d$ -dimensional vector  $A_\mu$  and to  $D - d$  scalars  $A_m$ , transforming under  $\text{SO}(D - d)$ .

calculation.  $g_{MN}$  and  $B_{MN}^i$  couple *via* the Einstein equations

$$R_{MN} = H_{MPQ}^i H_N^{iPQ}, \quad (1.8)$$

where we disregarded all the other fields, and with  $H_{MNP}^i$  the field-strength associated to the two-form. In the  $\text{AdS}_3 \times S^3$  background solution, the metric is  $\mathring{g}_{MN}$  and one of the components of the self-dual field strength is singled out and equal to the Levi-Civita tensor, while all other components vanish:

$$\mathring{H}_{\mu\nu\rho}^i = \frac{1}{\ell_{\text{AdS}}} \sqrt{-\mathring{g}_{\text{AdS}_3}} \varepsilon_{\mu\nu\rho} \delta_5^i, \quad \mathring{H}_{mnp}^i = \frac{1}{\ell_{\text{AdS}}} \sqrt{\mathring{g}_{S^3}} \varepsilon_{mnp} \delta_5^i. \quad (1.9)$$

Around this background, we parametrize the fluctuations as

$$g_{MN} = \mathring{g}_{MN} + h_{MN}, \quad H_{MNP}^i = \mathring{H}_{MNP}^i + 3\partial_{[M} b_{NP]}^i, \quad (1.10)$$

and focus in particular on the trace of the internal metric and on the internal components of the self-dual two-form:

$$h_{mn} = L_{mn} + \mathring{g}_{mn} N, \quad b_{mn}^i = \epsilon_{mnp} U^{ip}, \quad (1.11)$$

where  $L_{mn}$  is traceless with respect to  $\mathring{g}_{mn}$ . For these fields, the harmonic expansion reads

$$\begin{aligned} N(x^\mu, y^m) &= \sum_l N^{(l,0)}(x^\mu) \mathcal{Y}^{(l,0)}(y^m), \\ U_m^i(x^\mu, y^m) &= \sum_l \left( U^{i(l,\pm 1)}(x^\mu) \mathcal{Y}_m^{(l,\pm 1)}(y^m) + U^{i(l,0)}(x^\mu) \partial_m \mathcal{Y}^{(l,0)}(y^m) \right). \end{aligned} \quad (1.12)$$

The harmonics are labeled by  $\text{SO}(4)$  representations  $(l_1, l_2)$ , and satisfy

$$\begin{aligned} \nabla_{S^3}^2 \mathcal{Y}^{(l_1, l_2)} &= -\frac{1}{\ell_{\text{AdS}}^2} \left( l_1(l_1 + 2) + l_2^2 \right) \mathcal{Y}^{(l_1, l_2)}, \\ \nabla_m^2 \mathcal{Y}_m^{(l_1, l_2)} &= -\frac{1}{\ell_{\text{AdS}}^2} \left( l_1(l_1 + 2) + l_2^2 - 2 \right) \mathcal{Y}_m^{(l_1, l_2)}. \end{aligned} \quad (1.13)$$

Inserting the expansions into the equations of motion (1.8), properly linearized with respect to Eq. (1.10), gives, after some gauge fixing, two coupled equations for  $N^{(l,0)}$  and  $U^{5(l,0)}$ :

$$\begin{cases} \ell_{\text{AdS}}^2 \square_{\text{AdS}_3} U^{5(l,0)} - l(l+2) U^{5(l,0)} - 2N^{(l,0)} = 0, \\ \ell_{\text{AdS}}^2 \square_{\text{AdS}_3} N^{(l,0)} - 8l(l+2) U^{5(l,0)} - (l(l+2) + 8) N^{(l,0)} = 0. \end{cases} \quad (1.14)$$

This system is diagonalized as

$$\begin{cases} \ell_{\text{AdS}}^2 \square_{\text{AdS}_3} N_+^{(l,0)} - l(l-2) N_+^{(l,0)} = 0, \\ \ell_{\text{AdS}}^2 \square_{\text{AdS}_3} N_-^{(l,0)} - (l^2 + 6l + 8) N_-^{(l,0)} = 0, \end{cases} \quad \text{with} \quad \begin{cases} N_+^{(l,0)} = N^{(l,0)} - 2(l+2) U^{5(l,0)}, \\ N_-^{(l,0)} = N^{(l,0)} + 2l U^{5(l,0)}. \end{cases} \quad (1.15)$$

Thus, the new variables  $N_{\pm}^{(l,0)}$  describe massive scalar fields. We see in this simple example that the computation of the Kaluza-Klein modes is far from straightforward, notably because these modes mix components of different higher-dimensional fields.

Similar computations are needed to derive the masses of all fields around the vacuum (1.9). Once

the eigenmodes and masses determined, it still remains to arrange the modes into representations of the proper group,  $SU(2|1, 1) \times SU(2|1, 1)$  for the present example. These representations could mix eigenmodes from different levels  $l$  in the harmonic expansion. The task of computing the full Kaluza-Klein spectrum around a given vacuum is thus involved, and nearly impossible for vacua preserving few symmetries. Note that, here, we restricted the calculations to the linearized equations of motion, as we were only interested in determining the masses. One needs to extend the computation to higher orders to be able to use Eq. (1.2) and determine correlations functions.

### 1.3 Content of the part

As we outlined in the previous sections, supersymmetric anti-de Sitter backgrounds of string theory and supergravity are of central importance in the holographic AdS/CFT correspondence. Within higher-dimensional supergravity, these correspond to supersymmetric solutions of the form  $AdS_d \times \mathcal{K}$ . After expansion of the higher-dimensional fields in terms of harmonics on  $\mathcal{K}$ , the low-dimensional supergravity features infinite Kaluza-Klein towers of low-dimensional fields. In order to deal with a genuine supergravity theory, *i.e.* composed of a finite number of fields, one can truncate these towers to a finite subset. Such a truncation is said to be consistent if it is a solution of the higher-dimensional equations of motion. After consistent truncation, the low-dimensional theory is a gauged supergravity in  $d$  dimensions with a stationary point in its scalar potential. The  $AdS_d$  solution of the low-dimensional theory with all scalars constant located at the stationary point then corresponds to the higher-dimensional  $AdS_d \times \mathcal{K}$  solution.

A systematic approach to the classification of  $AdS_d \times \mathcal{K}$  backgrounds may start directly from a classification of supersymmetric  $AdS_d$  backgrounds in  $d$ -dimensional gauged supergravity. These supergravities are determined by the choice of a constant tensor, called the embedding tensor, which encodes the gauge structure and couplings of the theories [112–114]. Rather than searching AdS vacua within a given theory, one may instead determine the most general embedding tensor such that the resulting theory admits a supersymmetric  $AdS_d$  vacuum, thereby determining the relevant  $d$ -dimensional theories together with their solutions. For half-maximal supergravities in  $d \geq 4$  dimensions, such an analysis has been performed in Ref. [115–119], where the general gauging admitting a fully supersymmetric AdS vacuum has been determined and analyzed.  $AdS_3$  vacua have so far escaped a similar classification. This is mostly due to the fact that the structure of gauged supergravity theories and their solutions in three spacetime dimensions is very rich. Already the maximal ( $\mathcal{N} = 16$ ) gauged supergravity in three dimensions offers a plethora of fully supersymmetric  $AdS_3$  vacua [120]. This is in marked contrast to higher dimensions, where there is a single maximally supersymmetric AdS vacuum in  $d = 7$  [121] and  $d = 5$  [122], together with a one-parameter family of maximally supersymmetric  $AdS_4$  vacua [123, 124]. Similarly, many  $AdS_3$  vacua have been identified in theories with  $\mathcal{N} = 9$  and  $\mathcal{N} = 10$  supersymmetry [125, 126].

The wealth of three-dimensional structures is based on the particular properties of three-dimensional gauge and gravitational theories. The gravitational (super-)multiplet in three dimensions is non-propagating, which allows for the construction of a gravitational Chern-Simons action for any  $AdS_3$  supergroup [127]. Further coupling to scalar matter offers ample possibilities due to the on-shell duality between scalar and gauge fields in three dimensions. Finally, the  $AdS_3$  isometry group  $SO(2, 2) \simeq SL(2, \mathbb{R})_L \times SL(2, \mathbb{R})_R$  is not simple, but a product of two factors. Consequently, the supergroup of  $AdS_3$  background isometries in general factors into a direct product of simple supergroups  $\mathcal{G}_L \times \mathcal{G}_R$  for



which there are various options [128, 129]. The supercharges accordingly split into  $\mathcal{N} = (p, q)$  charges transforming under  $\mathcal{G}_L$  and  $\mathcal{G}_R$ , respectively. As a result, there is an immense number of AdS vacua in three dimensions.

In Ref. [A], with N. S. Deger and H. Samtleben we took a first step towards their classification, by determining all chiral  $\mathcal{N} = (8, 0)$  AdS<sub>3</sub> vacua within half-maximal  $d = 3$  gauged supergravity. Half-maximal gauged supergravities in three dimensions have been constructed in Ref. [130, 131] by deforming the half-maximal ungauged theory of Ref. [132]. They describe the couplings between the non-propagating  $\mathcal{N} = 8$  supergravity multiplet to  $p$  scalar multiplets, and feature a  $SO(8, p)$  global symmetry. Different gauge groups, embedded into  $SO(8, p)$ , are realized using the embedding tensor formalism. We performed the explicit analysis of consistency conditions on the embedding tensor, leading to the classification, and computed for every vacuum the associated mass spectrum. This is reviewed in Chap. 2 and 3.

For the low-dimensional AdS solutions that are effectively consistent truncations of a higher-dimensional supergravity, one may ask the question whether it is possible to deduce the full Kaluza-Klein spectrum from the low-dimensional theory. It is in principle always possible, knowing the solution in higher dimensions, to follow the procedure detailed in Sec. 1.2. However, as we already mentioned, this procedure is fairly involved. Recently, a new technique for Kaluza-Klein spectroscopy has been developed [133, 134]. It uses the framework of exceptional field theory [135–138], which provides a duality covariant formulation of higher-dimensional supergravities, and in particular allows the construction of consistent truncations *via* reduction ansätze of the higher-dimensional fields directly expressed in terms of the ones of the low-dimensional gauged supergravity. For a given low-dimensional background that arises from a consistent truncation, one can extend these ansätze so that they also describe the linearized higher-dimensional fluctuations around the background. Thanks to this construction, the diagonalisation problem that one usually encounters while computing a Kaluza-Klein spectrum is solved prior to the reduction. This allows the direct computation of the mass matrices of the full Kaluza-Klein towers and, in particular, makes it possible to compute the spectrum around vacua with few or no remaining symmetries.

In Ref. [133, 134], this technique has been worked out for compactifications to five- and four-dimensional maximal supergravities. In Ref. [D], these new tools have been extended to vacua that sit in half-maximal supergravity in three dimensions. The relevant framework is the duality covariant  $SO(8, p)$  exceptional field theory of Ref. [139]. We computed there the expressions of the mass matrices for spin-2, vector and scalar fields around AdS<sub>3</sub> vacua of three-dimensional half-maximal supergravity. With G. Larios and H. Samtleben, we extended this work to the fermionic matrices in Ref. [E], adapting the work of Ref. [140] to three dimensions. This is the subject of Chap. 4.

The part is organized as follows. In Chap. 2, we review the peculiar structure of gauged supergravity in three dimensions. The set of algebraic constraints imposed onto the embedding tensors in order to ensure consistency of the gauging and the existence of a supersymmetric  $\mathcal{N} = (8, 0)$  AdS<sub>3</sub> vacuum is spelled out in Chap. 3. The analysis and solution of these constraints is presented in the particular case of the supergroup  $OSp(8|2, \mathbb{R})$ . We also collect some partial results on AdS<sub>3</sub> vacua with  $\mathcal{N} = (7, 1)$  and  $\mathcal{N} = (7, 0)$  supersymmetry. Chap. 4 is dedicated to the derivation of the Kaluza-Klein spectroscopy tools for half-maximal supergravity in three dimensions. We first review the framework of the  $SO(8, p)$  exceptional field theory and present then how to generalize the compactification ansätze to include

Kaluza-Klein fluctuations. We derive the expressions of the mass matrices of the bosonic fields and state the results for the fermionic ones. We finally illustrate the efficiency of the method on four examples, including the  $\text{AdS}_3 \times S^3$  solution of  $\mathcal{N} = (2, 0)$  six-dimensional supergravity considered in Sec. 1.2 and a family of non-supersymmetric vacua of six-dimensional supergravity. We finally summarize our findings and conclude in Chap. 5.



# 2 Gauged supergravity in three dimensions

In three spacetime dimensions, supergravity theories are special for two main reasons. First, general relativity is topological, so that the gravitational sector does not carry any degrees of freedom. Second, the on-shell duality between scalars and vectors allows for symmetry enhancement. The exceptional  $E_{8(8)}$  symmetry of the maximal theory needs indeed the dualization of all vector fields into scalars to be exhibited. The same condition is needed in the half-maximal theory to enhance the symmetry to  $SO(8, p)$ . Vector fields are however necessary if one wants to gauge the theory. A novel mechanism is then required, to gauge the theory while keeping all the scalars (and thus the enhanced symmetry). We will see that the solution is to introduce the dual vectors *via* a Chern-Simons term, so that they do not carry additional degrees of freedom. This new gauging procedure allows many more possible gaugings than in higher dimensions. In this chapter, we introduce some relevant facts about the three-dimensional half-maximal gauged supergravities. We first review the ungauged theory and the relation between scalars and vectors. We then turn to the gauging procedure. As we will see, the gauge structure is most conveniently encoded in a constant embedding tensor subject to a set of algebraic constraints.

## 2.1 Ungauged theory

Half-maximal supergravity has first been constructed in Ref. [132]. This ungauged theory contains an  $\mathcal{N} = 8$  supergravity multiplet composed of a dreibein  $e_\mu^\alpha$ , defining a metric of signature  $(-1, 1, 1)$ , and eight Rarita-Schwinger fields  $\psi_\mu^A$ , where  $\mu$  and  $\alpha$  denote respectively the curved and flat spacetime indices, and  $A$  is the index of the spinorial representation of the Minkowski  $R$ -symmetry  $SO(8)$ . As already mentioned, this multiplet does not carry propagating degrees of freedom in three dimension. The matter fields combine into  $p$  copies of the  $\mathcal{N} = 8$  scalar multiplet, each one composed of eight scalars and eight spin-1/2 fermions, transforming in the vectorial and cospinorial representations of  $SO(8)$ , respectively. We note  $\phi_{lr}$  the resulting  $8p$  scalar fields and  $\chi^{Ar}$  the  $8p$  spin-1/2 fermions, with  $l$  and  $r$  the vectorial indices of  $SO(8)$  and  $SO(p)$ , respectively, and  $A$  the cospinorial index of  $SO(8)$ .

The scalar matter forms an  $SO(8, p)/(SO(8) \times SO(p))$  coset space sigma model. The  $SO(8, p)$  invariant tensor is defined as

$$\eta_{\bar{M}\bar{N}} = \begin{pmatrix} -\delta_{lj} & 0 \\ 0 & \delta_{rs} \end{pmatrix}, \quad (2.1)$$

and the generators of  $\mathfrak{so}(8, p)$ , in the chosen representation, are given by

$$(L^{\bar{M}\bar{N}})_{\bar{P}} \bar{Q} = 2 \delta_{\bar{P}}^{[\bar{M}} \eta^{\bar{N}]\bar{Q}}. \quad (2.2)$$

Here, we combined the vectorial indices  $l$  and  $r$  into  $SO(8, p)$  vector indices  $\bar{M} = \{l, r\}$ . Then,  $\{L^{\bar{I}\bar{J}}, L^{\bar{r}s}\}$  form the generators of  $\mathfrak{so}(8) \oplus \mathfrak{so}(p)$ , while the coset is parametrized by  $\{L^{lr}\}$ . The  $8p$  scalar fields  $\phi_{lr}$

are thus described by the  $SO(8, p)$  matrix

$$\mathcal{M}_{\bar{M}\bar{N}} = \mathcal{V}_{\bar{M}}^{\bar{P}} \mathcal{V}_{\bar{N}}^{\bar{Q}} \delta_{\bar{P}\bar{Q}}, \quad (2.3)$$

with the coset representative

$$\mathcal{V}(\phi) = e^{\phi_{lr} L^{lr}}. \quad (2.4)$$

It transforms as

$$\mathcal{V}(\phi') = g \mathcal{V}(\phi) h^{-1}(\phi), \quad (2.5)$$

with  $g \in SO(8, p)$  and  $h(\phi) \in SO(8) \times SO(p)$ . Its coupling to fermions is described in terms of the Maurer-Cartan form

$$\mathcal{V}^{-1} \partial_{\mu} \mathcal{V} = \frac{1}{2} Q_{\mu}^{ll} L^{ll} + \frac{1}{2} Q_{\mu}^{rs} L^{rs} + P_{\mu}^{lr} L^{lr}, \quad (2.6)$$

and the covariant derivatives

$$\begin{cases} D_{\mu} \psi_{\nu}^A = \partial_{\mu} \psi_{\nu}^A + \frac{1}{4} \omega_{\mu}^{\alpha\beta} \gamma_{\alpha\beta} \psi_{\nu}^A + \frac{1}{4} Q_{\mu}^{ll} \Gamma_{AB}^{ll} \psi_{\nu}^B, \\ D_{\mu} \chi^{\dot{A}r} = \partial_{\mu} \chi^{\dot{A}r} + \frac{1}{4} \omega_{\mu}^{\alpha\beta} \gamma_{\alpha\beta} \chi^{\dot{A}r} + \frac{1}{4} Q_{\mu}^{ll} \Gamma_{\dot{A}\dot{B}}^{ll} \chi^{\dot{B}r} + Q_{\mu}^{rs} \chi^{\dot{A}s}, \end{cases} \quad (2.7)$$

with the spin-connection  $\omega_{\mu}^{\alpha\beta}$ , the three-dimensional  $\gamma$  matrices  $\gamma^{\alpha}$  in flat spacetime with  $\gamma^{\alpha\beta} = \gamma^{[\alpha} \gamma^{\beta]}$ , and products of the  $SO(8)$   $\Gamma$  matrices  $\Gamma_{AA}^l$ . These matrices satisfy the algebra<sup>30</sup>

$$\left\{ \Gamma^l, \Gamma^{lT} \right\}_{AB} = 2 \delta^{ll} \delta_{AB}, \quad \left\{ \Gamma^{lT}, \Gamma^l \right\}_{\dot{A}\dot{B}} = 2 \delta^{ll} \delta_{\dot{A}\dot{B}}, \quad (2.8)$$

and we define the anti-symmetrized products of  $\Gamma$  matrices  $\Gamma^{l_1 l_2 \dots l_n} = \Gamma^{[l_1} \Gamma^{l_2} \dots \Gamma^{l_n]}$ . In our conventions,  $\Gamma_{AB}^{llkl}$  is self-dual, whereas  $\Gamma_{\dot{A}\dot{B}}^{llkl}$  is anti-self-dual. Finally, the full supersymmetry variations are of the form

$$\begin{cases} \mathcal{V}^{-1} \delta \mathcal{V} = L^{lr} \bar{\varepsilon}^A \Gamma_{AA}^l \chi^{\dot{A}r}, & \left\{ \delta \chi^{\dot{A}r} = \frac{1}{2} \Gamma_{AA}^l \gamma^{\mu} \varepsilon^A P_{\mu}^{lr}, \right. \\ \delta e_{\mu}^{\alpha} = \bar{\varepsilon}^A \gamma^{\alpha} \psi_{\mu}^A, & \left. \delta \psi_{\mu}^A = D_{\mu} \varepsilon^A, \right. \end{cases} \quad (2.9)$$

with supersymmetry parameter  $\varepsilon^A$  and  $\gamma^{\mu} = e^{\mu}_{\alpha} \gamma^{\alpha}$ . They leave invariant the Lagrangian

$$e^{-1} \mathcal{L} = R + 2 \gamma^{\mu\nu\rho} \bar{\psi}_{\mu}^A D_{\nu} \psi_{\rho}^A - P_{\mu}^{lr} P^{\mu lr} - 2 \bar{\chi}^{\dot{A}r} \gamma^{\mu} D_{\mu} \chi^{\dot{A}r} - 2 P_{\mu}^{lr} \bar{\chi}^{\dot{A}r} \Gamma_{AA}^l \gamma^{\nu} \gamma^{\mu} \psi_{\nu}^A, \quad (2.10)$$

up to quartic fermionic terms, where  $e = \sqrt{|\det g_{\mu\nu}|}$ ,  $R$  denotes the Ricci scalar and  $\gamma^{\mu\nu\rho} = -e^{-1} \varepsilon^{\mu\nu\rho}$ , with the Levi-Civita density  $\varepsilon^{\mu\nu\rho}$ . Note that the scalar kinetic term can be expressed as  $\frac{1}{8} \text{Tr} \left( \partial_{\mu} \mathcal{M} \partial^{\mu} \mathcal{M}^{-1} \right)$ .

## 2.2 Duality between scalar and vector fields

Let us now briefly discuss the duality between scalars and vectors. There are no vector field in the ungauged Lagrangian, but they may be defined on-shell upon dualizing the Noether currents of the global  $SO(8, p)$  symmetry. Denoting by  $\mathcal{J}_{\mu}^{\bar{M}\bar{N}} = \mathcal{J}_{\mu}^{[\bar{M}\bar{N}]}$  those currents, associated to the  $SO(8, p)$  generators (2.2), we introduce the abelian vector fields  $\mathcal{A}_{\mu}^{\bar{M}\bar{N}}$ , and the associated field-strengths

<sup>30</sup>We refer to the appendices of Ref. [141] for an explicit representation of the  $SO(8)$   $\Gamma$  matrices. See also Ref. [142] for useful identities.

$F_{\mu\nu}{}^{\bar{M}\bar{N}}$ , via

$$\varepsilon^{\mu\nu\rho} F_{\nu\rho}{}^{\bar{M}\bar{N}} = e \mathcal{J}^\mu{}^{\bar{M}\bar{N}}. \quad (2.11)$$

The vectors are dual to the isometries of the theory, and not directly to the scalar fields. This is due to the particular form of dualities involving scalar fields, which allow non-linear couplings, contrary to dualities between  $p$ -forms, which are linear. The Bianchi identities for  $F_{\mu\nu}{}^{\bar{M}\bar{N}}$  are then ensured on-shell by the conservation laws

$$\partial^\mu \left( e \mathcal{J}_\mu{}^{\bar{M}\bar{N}} \right) = 0, \quad (2.12)$$

which are verified once the scalars satisfy their equations of motion. By construction, the vector fields transform in the adjoint representation of  $\text{SO}(8, p)$ . Their supersymmetry transformations can be deduced from the ones obtained by dimensional reduction, or from the analogous structures in the maximal theory [112, 143]. Their equations of motion follow from Eq. (2.11).

Through Eq. (2.11), the vectors are defined as non-linear and non-local functions of the scalar fields. With this equation, the number of vectors we can introduce is only limited by the total number of isometries. They are defined on-shell, and there is no Lagrangian formulation that contain the scalar fields and their dual vector fields at the same time. The gauging procedure will allow for an off-shell description of the dualization, as we will see in the next sections.

## 2.3 Gauging: the embedding tensor

Half-maximal gauged supergravities in three dimensions have been constructed in Ref. [130, 131] by deforming the half-maximal ungauged theory of Ref. [132]. The gauging of the theory is described using the embedding tensor formalism [112, 113]. We briefly review its main features in this context. Gauging amounts to promoting a subgroup  $G_0 \subset \text{SO}(8, p)$  to a local symmetry, in such a way that the local supersymmetry remains preserved. The embedding of  $\mathfrak{g}_0$  in  $\mathfrak{so}(8, p)$  is given by the embedding tensor  $\Theta_{\bar{M}\bar{N}|\bar{P}\bar{Q}}$ , so that the gauge group generators are embedded in  $X_{\bar{M}\bar{N}}$  as

$$X_{\bar{M}\bar{N}} = \Theta_{\bar{M}\bar{N}|\bar{P}\bar{Q}} L^{\bar{P}\bar{Q}}. \quad (2.13)$$

The embedding tensor  $\Theta_{\bar{M}\bar{N}|\bar{P}\bar{Q}}$  is antisymmetric in  $[\bar{M}\bar{N}]$  and  $[\bar{P}\bar{Q}]$ , moreover symmetric under exchange of the two pairs<sup>31</sup>. It is thus contained in the symmetric tensor product of two adjoint representations of  $\text{SO}(8, p)$  and may accordingly be decomposed into its irreducible parts:

$$\Theta_{\bar{M}\bar{N}|\bar{P}\bar{Q}} \subset \mathbf{1} \oplus \begin{array}{|c|c|} \hline \square & \square \\ \hline \end{array} \oplus \begin{array}{|c|c|} \hline \square & \square \\ \hline \square & \square \\ \hline \end{array} \oplus \begin{array}{|c|} \hline \square \\ \hline \square \\ \hline \square \\ \hline \end{array}, \quad (2.14)$$

where each box represents a vector representation  $\mathbf{8} + \mathbf{p}$  of  $\text{SO}(8, p)$ . With this group-theoretical representation, the constraint on  $\Theta_{\bar{M}\bar{N}|\bar{P}\bar{Q}}$  that ensures supersymmetry of the gauged theory takes a simple form [131]:

$$\mathbb{P}_{\boxplus} \Theta_{\bar{M}\bar{N}|\bar{P}\bar{Q}} = 0, \quad (2.15)$$

<sup>31</sup>In order to allow for an action principle of the gauged theory, otherwise the resulting field equations include a gauging of the trombone scaling symmetry [139].

*i.e.* one has to project out the “Weyl-tensor” type representation<sup>32</sup>. This constraint is often called the linear constraint. It can be explicitly solved by parameterizing  $\Theta_{\bar{M}\bar{N}|\bar{P}\bar{Q}}$  as<sup>33</sup>

$$\Theta_{\bar{M}\bar{N}|\bar{P}\bar{Q}} = \theta_{\bar{M}\bar{N}\bar{P}\bar{Q}} + \frac{1}{2} \left( \eta_{\bar{M}[\bar{P}} \theta_{\bar{Q}]\bar{N}} - \eta_{\bar{N}[\bar{P}} \theta_{\bar{Q}]\bar{M}} \right) + \eta_{\bar{M}[\bar{P}} \eta_{\bar{Q}]\bar{N}} \theta, \quad (2.16)$$

where  $\theta_{\bar{M}\bar{N}\bar{P}\bar{Q}}$  is totally antisymmetric and  $\theta_{\bar{M}\bar{N}}$  is symmetric and traceless.

To ensure that this embedding defines a proper gauge group, the embedding tensor  $\Theta_{\bar{M}\bar{N}|\bar{P}\bar{Q}}$  must be invariant under transformations of  $\mathfrak{g}_0$  itself. Explicitly, this reads

$$(X_{\bar{R}\bar{S}})_{\bar{M}}^{\bar{K}} \Theta_{\bar{K}\bar{N}|\bar{P}\bar{Q}} + (X_{\bar{R}\bar{S}})_{\bar{N}}^{\bar{K}} \Theta_{\bar{M}\bar{K}|\bar{P}\bar{Q}} + (X_{\bar{R}\bar{S}})_{\bar{P}}^{\bar{K}} \Theta_{\bar{M}\bar{N}|\bar{K}\bar{Q}} + (X_{\bar{R}\bar{S}})_{\bar{Q}}^{\bar{K}} \Theta_{\bar{M}\bar{N}|\bar{P}\bar{K}} = 0. \quad (2.17)$$

Since  $X_{\bar{M}\bar{N}}$  are defined in terms of the embedding tensor (see Eq. (2.13)), this condition gives rise to a set of equations bilinear in  $\Theta_{\bar{M}\bar{N}|\bar{P}\bar{Q}}$ , referred to as the quadratic constraints. Any solution to these constraints defines a viable gauging. Determining the possible choices for  $G_0$  then amounts in solving Eq. (2.17). This will be further detailed in Chap. 3.

## 2.4 Gauging: the Lagrangian

Once a proper embedding tensor identified, the gauging procedure follows the standard scheme. We introduce  $\dim(G_0)$  vector fields  $\mathcal{A}_\mu{}^m$  using Eq. (2.11) and a projection with  $\Theta_{\bar{M}\bar{N}|\bar{P}\bar{Q}}$ :

$$\mathcal{A}_\mu{}^m t_m = \mathcal{A}_\mu{}^{\bar{M}\bar{N}} X_{\bar{M}\bar{N}} = \mathcal{A}_\mu{}^{\bar{M}\bar{N}} \Theta_{\bar{M}\bar{N}|\bar{P}\bar{Q}} L^{\bar{P}\bar{Q}}, \quad (2.18)$$

with  $m \in \llbracket 1, \dim(G_0) \rrbracket$  and  $t_m$  the generators of  $\mathfrak{g}_0$ . We then covariantize Eq. (2.6) by defining

$$\mathcal{D}_\mu \nu = \partial_\mu \nu + \mathcal{A}_\mu{}^{\bar{M}\bar{N}} \Theta_{\bar{M}\bar{N}|\bar{P}\bar{Q}} L^{\bar{P}\bar{Q}} \nu = \frac{1}{2} \mathcal{Q}_\mu^{\bar{I}\bar{J}} L^{\bar{I}\bar{J}} + \frac{1}{2} \mathcal{Q}_\mu^{rs} L^{rs} + \mathcal{P}_\mu^{lr} L^{lr}. \quad (2.19)$$

The full covariant derivatives of the fermions read accordingly

$$\begin{cases} \mathcal{D}_\mu \psi_\nu^A = \partial_\mu \psi_\nu^A + \frac{1}{4} \omega_\mu^{\alpha\beta} \gamma_{\alpha\beta} \psi_\nu^A + \frac{1}{4} \mathcal{Q}_\mu^{\bar{I}\bar{J}} \Gamma_{\bar{A}\bar{B}}^{\bar{I}\bar{J}} \psi_\nu^{\bar{B}}, \\ \mathcal{D}_\mu \chi^{\dot{A}r} = \partial_\mu \chi^{\dot{A}r} + \frac{1}{4} \omega_\mu^{\alpha\beta} \gamma_{\alpha\beta} \chi^{\dot{A}r} + \frac{1}{4} \mathcal{Q}_\mu^{\bar{I}\bar{J}} \Gamma_{\dot{A}\dot{B}}^{\bar{I}\bar{J}} \chi^{\dot{B}r} + \mathcal{Q}_\mu^{rs} \chi^{\dot{A}s}. \end{cases} \quad (2.20)$$

This minimal coupling breaks supersymmetry and we need to introduce new terms to the Lagrangian (2.10) to restore it, specifically a Chern-Simons term for the vectors, fermionic mass terms in the form of Yukawa-type couplings, and a scalar potential. Before presenting the full Lagrangian, it is useful to introduce the so-called  $T$  tensor, that encodes these additional terms in the Lagrangian. We define  $T_{\bar{M}\bar{N}|\bar{P}\bar{Q}} = (\mathcal{V}^{-1})_{\bar{M}}^{\bar{I}} (\mathcal{V}^{-1})_{\bar{N}}^{\bar{J}} (\mathcal{V}^{-1})_{\bar{P}}^{\bar{K}} (\mathcal{V}^{-1})_{\bar{Q}}^{\bar{L}} \Theta_{\bar{I}\bar{J}|\bar{K}\bar{L}}$ , with the coset representative (2.4), or equivalently

$$\begin{cases} T_{\bar{M}\bar{N}|\bar{P}\bar{Q}} = (\mathcal{V}^{-1})_{\bar{M}}^{\bar{I}} (\mathcal{V}^{-1})_{\bar{N}}^{\bar{J}} (\mathcal{V}^{-1})_{\bar{P}}^{\bar{K}} (\mathcal{V}^{-1})_{\bar{Q}}^{\bar{L}} \theta_{\bar{I}\bar{J}|\bar{K}\bar{L}}, \\ T_{\bar{M}\bar{N}} = (\mathcal{V}^{-1})_{\bar{M}}^{\bar{P}} (\mathcal{V}^{-1})_{\bar{N}}^{\bar{Q}} \theta_{\bar{P}\bar{Q}}, \\ T = \theta. \end{cases} \quad (2.21)$$

<sup>32</sup>In Ref. [130], a stronger condition has been applied by projecting the embedding tensor on its totally antisymmetric and trace parts. This explains the extra pieces in our fermion mass terms, given in Eq. (2.23) below.

<sup>33</sup>Note that, here, we have chosen different conventions from those of Ref. [A].

The full Lagrangian is then given by

$$\begin{aligned}
 e^{-1} \mathcal{L} = & R + 2 \gamma^{\mu\nu\rho} \bar{\psi}_\mu^A \mathcal{D}_\nu \psi_\rho^A - \mathcal{P}_\mu^{lr} \mathcal{P}^{\mu lr} - 2 \bar{\chi}^{\dot{A}r} \gamma^\mu \mathcal{D}_\mu \chi^{\dot{A}r} + 2 \mathcal{P}_\mu^{lr} \bar{\chi}^{\dot{A}r} \Gamma_{AA}^l \gamma^\nu \gamma^\mu \psi_\nu^A \\
 & - e^{-1} \varepsilon^{\mu\nu\rho} \Theta_{\overline{MN}|\overline{PQ}} \mathcal{A}_\mu^{\overline{MN}} \left( \partial_\nu \mathcal{A}_\rho^{\overline{PQ}} + \frac{1}{3} \Theta_{\overline{RS}|\overline{UV}} f^{\overline{PQ},\overline{RS}}_{\overline{XY}} \mathcal{A}_\nu^{\overline{UV}} \mathcal{A}_\rho^{\overline{XY}} \right) \\
 & - 2 A_1^{AB} \bar{\psi}_\mu^A \gamma^{\mu\nu} \psi_\nu^B + 4 A_2^{AAr} \bar{\chi}^{\dot{A}r} \gamma^\mu \psi_\mu^A + 2 A_3^{\dot{A}rBs} \bar{\chi}^{\dot{A}r} \chi^{\dot{B}s} - V.
 \end{aligned} \tag{2.22}$$

Here,  $f^{\overline{MN},\overline{PQ}}_{\overline{KL}} = 4 \delta_{[\overline{K}} [\overline{M} \eta^{\overline{N}}] [\overline{P} \delta_{\overline{L}}] \overline{Q}]$  describes the structure constants of  $\mathfrak{so}(8, p)$ .

Thus, the vector fields required to gauge the theory appear with a Chern-Simons, rather than a Yang-Mills, term. In doing so, they are introduced without adding propagating degrees of freedom and the balance between bosonic and fermionic degrees of freedom is then preserved. The non-abelian analogue to the duality relation (2.11) follows from the variation of Eq. (2.22) with respect to  $\mathcal{A}_\mu^{\overline{MN}}$ . This construction is proper to three-dimensional supergravities, whose ungauged Lagrangians do not carry vector fields. It is in stark contrast to the gauging procedures in higher dimensions, where vector fields appear already in the ungauged theory and feature, once gauged, a Yang-Mills term.

The last four terms in Eq. (2.22) carry the fermionic mass matrices and scalar potential characteristic for the given gauging. Explicitly, the fermionic mass tensors  $A_{1,2,3}$  are given by

$$\begin{aligned}
 A_1^{AB} &= -\frac{1}{12} \Gamma_{AB}^{IJKL} T_{IJKL} - \frac{1}{4} \delta^{AB} (T_{||} - 8 T), \\
 A_2^{AAr} &= -\frac{1}{3} \Gamma_{AA}^{IJK} T_{IJKr} - \frac{1}{2} \Gamma_{AA}^l T_{lr}, \\
 A_3^{\dot{A}rBs} &= \frac{1}{12} \delta^{rs} \Gamma_{\dot{A}\dot{B}}^{IJKL} T_{IJKL} + 2 \Gamma_{\dot{A}\dot{B}}^{||} T_{||rs} - 4 \delta^{\dot{A}\dot{B}} \delta^{rs} T - 2 \delta^{\dot{A}\dot{B}} T_{rs} + \frac{1}{4} \delta^{\dot{A}\dot{B}} \delta^{rs} T_{||},
 \end{aligned} \tag{2.23}$$

as functions of the  $T$  tensor (2.21) and products of the  $\text{SO}(8)$   $\Gamma$  matrices  $\Gamma_{AA}^l$ , while the scalar potential  $V$  is given by (Ref. [114] for the longer expression<sup>34</sup>)

$$\begin{aligned}
 V = & -A_1^{AB} A_1^{AB} + \frac{1}{2} A_2^{AAr} A_2^{AAr} \\
 = & -\frac{4}{3} \left( T_{IJKL} T_{IJKL} + \frac{1}{4!} \varepsilon^{IJKLMNPQ} T_{IJKL} T_{MNPQ} - 2 T_{IJKr} T_{IJKr} \right) - \frac{1}{2} (T_{||} - 8 T)^2 + T_{lr} T_{lr} \\
 = & \frac{1}{12} T_{\overline{KLMN}} T_{\overline{PQRS}} \left( \delta^{\overline{K}\overline{P}} \delta^{\overline{L}\overline{Q}} \delta^{\overline{M}\overline{R}} \delta^{\overline{N}\overline{S}} - 6 \delta^{\overline{K}\overline{P}} \delta^{\overline{L}\overline{Q}} \eta^{\overline{M}\overline{R}} \eta^{\overline{N}\overline{S}} + 8 \delta^{\overline{K}\overline{P}} \eta^{\overline{L}\overline{Q}} \eta^{\overline{M}\overline{R}} \eta^{\overline{N}\overline{S}} - 3 \eta^{\overline{K}\overline{P}} \eta^{\overline{L}\overline{Q}} \eta^{\overline{M}\overline{R}} \eta^{\overline{N}\overline{S}} \right) \\
 & - \frac{1}{18} \varepsilon^{IJKLMNPQ} T_{IJKL} T_{MNPQ} + \frac{1}{8} T_{\overline{KL}} T_{\overline{PQ}} \left( 2 \delta^{\overline{K}\overline{P}} \delta^{\overline{L}\overline{Q}} - 2 \eta^{\overline{K}\overline{P}} \eta^{\overline{L}\overline{Q}} - \delta^{\overline{K}\overline{L}} \delta^{\overline{P}\overline{Q}} \right) \\
 & + 4 T T_{\overline{KL}} \delta^{\overline{K}\overline{L}} - 32 T^2.
 \end{aligned} \tag{2.24}$$

These expressions will play a crucial role in Chap. 3, as they will allow us to simplify the quadratic constraint (2.17) when searching for theories with vacua preserving a certain amount of supersymmetry.

<sup>34</sup>Following Ref. [144], a typo has been corrected in the fourth line.



Let us finally give the full supersymmetry variations, that leave Eq. (2.22) invariant:

$$\left\{ \begin{array}{l} \mathcal{V}^{-1} \delta \mathcal{V} = L^{lr} \bar{\varepsilon}^A \Gamma_{AA\dot{A}}^l \chi^{\dot{A}r}, \\ \delta e_\mu^\alpha = \bar{\varepsilon}^A \gamma^\alpha \psi_\mu^A, \end{array} \right. \quad \left\{ \begin{array}{l} \delta \mathcal{A}_\mu^{\bar{M}\bar{N}} = -\frac{1}{2} \mathcal{V}^{-1} \bar{M}\bar{N}{}_{\dot{I}\dot{J}} \bar{\varepsilon}^A \Gamma_{AB}^{\dot{I}\dot{J}} \psi_\mu^B + \mathcal{V}^{-1} \bar{M}\bar{N}{}_{lr} \bar{\varepsilon}^A \Gamma_{AA\dot{A}}^l \gamma_\mu \chi^{\dot{A}r}, \\ \delta \chi^{\dot{A}r} = \frac{1}{2} \Gamma_{AA\dot{A}}^l \gamma^\mu \varepsilon^A \mathcal{P}_\mu^{lr} + g A_2^{AA\dot{A}r} \varepsilon^A, \\ \delta \psi_\mu^A = \mathcal{D}_\mu \varepsilon^A + A_1^{AB} \gamma_\mu \varepsilon^B, \end{array} \right. \quad (2.25)$$

where  $\mathcal{V}^{-1} \bar{M}\bar{N}{}_{\bar{P}\bar{Q}} = (\mathcal{V}^{-1})_{[\bar{P}}^{\bar{M}} (\mathcal{V}^{-1})_{\bar{Q}]}^{\bar{N}}$ .

# 3 Chapter

## Searching for AdS<sub>3</sub> vacua

We have now all the tools needed to consider the classification of AdS<sub>3</sub> vacua within half-maximal  $d = 3$  gauged supergravity. We will focus on vacua preserving  $\mathcal{N} = (8, 0)$  supersymmetries, but the techniques we outline are general. This example is the simplest one, with the most constrained parametrization, and such vacua are realized in compactifications of ten- and eleven-dimensional supergravities [145, 146]. For these vacua, the background isometries build a supergroup  $SL(2, \mathbb{R})_L \times \mathcal{G}_R$ , where the simple supergroup  $\mathcal{G}_R$  features a  $SL(2, \mathbb{R})$  factor and eight supercharges. We first review the set of algebraic constraints imposed onto the embedding tensors in order to ensure consistency of the gauging and the existence of a supersymmetric AdS<sub>3</sub> vacuum. Then, we identify all the possible three-dimensional supergravities and their vacua in the case where  $\mathcal{G}_R = OSp(8|2, \mathbb{R})$ . We compute for every vacuum the associated mass spectrum. The full classification for other choices of supergroup is then given. As a by-product of our constructions, we also identify a number of AdS<sub>3</sub> vacua with  $\mathcal{N} = (7, 1)$  and  $\mathcal{N} = (7, 0)$  supersymmetry, respectively. We finally raise and answer the question which of the AdS<sub>3</sub> vacua can in fact be further embedded as vacua in a maximal ( $\mathcal{N} = 16$ ) three-dimensional supergravity. This translates into a couple of additional algebraic constraints to be imposed onto the embedding tensor, which we check for all our vacua.

### 3.1 General procedure

In Ref. [A], with N. S. Deger and H. Samtleben, we addressed the issue of the classification of AdS<sub>3</sub> vacua preserving  $\mathcal{N} = (8, 0)$ . Let us review the general procedure followed in this paper. Determining an AdS<sub>3</sub> vacuum amounts to:

- (i) identifying a given gauged supergravity, *i.e.* an embedding tensor  $\Theta$  satisfying the quadratic constraint (2.17);
- (ii) locating a configuration of the scalar fields, defined by a coset representative  $\mathcal{V}$  as in Eq. (2.4), that extremalize the scalar potential (2.24), with a negative cosmological constant  $V_0$  at the extremum.

Explicitly, in the parametrization (2.16) and after contraction with an antisymmetric parameter  $\Lambda_{\bar{R}\bar{S}}$ , the quadratic constraint (2.17) decomposes into

$$0 = -\Lambda_{\bar{R}\bar{S}} \theta^{\bar{R}\bar{S}\bar{K}\bar{L}} \theta_{\bar{K}(\bar{M}\bar{N})\bar{L}} + \frac{1}{2} \theta^{\bar{R}\bar{S}} \theta_{\bar{R}(\bar{M}} \Lambda_{\bar{N})\bar{S}} + \theta \theta^{\bar{R}}{}_{(\bar{M}} \Lambda_{\bar{N})\bar{R}}, \quad (3.1a)$$

$$0 = -\Lambda_{\bar{R}\bar{S}} \theta^{\bar{R}\bar{S}\bar{K}\bar{L}} \theta_{\bar{K}[\bar{N}\bar{P}\bar{Q}] \eta_{\bar{M}}\bar{L}} + \frac{1}{2} \theta^{\bar{S}\bar{K}} \theta_{\bar{K}[\bar{N}\bar{P}\bar{Q}] \Lambda_{\bar{M}]\bar{S}} \\ + \frac{1}{2} \Lambda_{\bar{R}\bar{S}} \theta^{\bar{R}}{}_{[\bar{M}} \theta^{\bar{S}}{}_{\bar{N}\bar{P}\bar{Q}]} + \theta \theta^{\bar{K}}{}_{[\bar{N}\bar{P}\bar{Q}] \Lambda_{\bar{M}]\bar{K}}. \quad (3.1b)$$

Accordingly, the condition for the potential (2.24) to feature an extremal point is

$$0 = \delta_\phi V = -\frac{4}{3} \delta\phi_{lr} \left[ 4 T_{IJKL} T_{JKLr} + \frac{1}{3} \varepsilon^{IJKLMNPQ} T_{MNPQ} T_{JKLr} + 12 T_{IJKs} T_{JKrs} - \frac{3}{2} \left( T_{JJ} T_{lr} - T_{ls} T_{sr} - T_{IJ} T_{Jr} - 8 T T_{lr} \right) \right]. \quad (3.2)$$

To these conditions, one can add the relation

$$-A_1^{AC} A_1^{BC} + \frac{1}{2} A_2^{A\dot{C}r} A_2^{B\dot{C}r} = \frac{1}{8} \delta^{AB} V, \quad (3.3)$$

for the fermionic mass tensors, often referred to as a supersymmetric Ward identity. It follows from the quadratic constraints (3.1).

Solving these equations for a general choice of the embedding tensor is a hard task, that could be simplified by requiring the vacuum to preserve a given amount of supersymmetry. Around a supersymmetric AdS vacuum, the matter content of the theory (2.22) organizes into supermultiplets of the associated supergroup, that extends the spacetime isometry group. As the AdS<sub>3</sub> isometry group  $SO(2, 2) \simeq SL(2, \mathbb{R})_L \times SL(2, \mathbb{R})_R$  is not simple, the corresponding supergroup in general is a direct product  $\mathcal{G}_L \times \mathcal{G}_R$  of two simple supergroups, whose even parts are isomorphic to the products  $SL(2, \mathbb{R})_{L,R} \times \mathcal{G}_{L,R}^{R\text{-sym}}$ , of the AdS factor  $SL(2, \mathbb{R})_{L,R}$  with the respective  $R$ -symmetry groups  $\mathcal{G}_{L,R}^{R\text{-sym}}$ . These supergroups have been classified in Ref. [128], and further analyzed in Ref. [129]. Supersymmetry in three dimensions is thus factorisable and admits the decomposition  $\mathcal{N} = (p, q)$ , where  $p$  and  $q$  are the number of fermionic generators of  $\mathcal{G}_R$  and  $\mathcal{G}_L$  respectively.

The precise amount of preserved supersymmetry at a given vacuum can be read off from the eigenvalues of the gravitino mass matrix  $A_1^{AB}$  of Eq. (2.23). In units of the AdS length  $\ell_{\text{AdS}}^2 = 2/|V_0|$ , the condition for  $\mathcal{N} = (p, q)$  supersymmetry takes the form

$$\begin{cases} A_1^{ab} = \frac{1}{2} \delta^{ab} \ell_{\text{AdS}}^{-1}, \\ A_1^{\dot{a}b} = -\frac{1}{2} \delta^{\dot{a}b} \ell_{\text{AdS}}^{-1}, \end{cases} \quad (3.4)$$

and all other components vanishing, where we have split the index  $A$  according to  $A = \{a, \dot{a}, i\}$  with  $a \in \llbracket 1, p \rrbracket$ ,  $\dot{a} \in \llbracket p+1, p+q \rrbracket$  and  $i \in \llbracket p+q+1, 8 \rrbracket$ . Together with Eq. (3.3), this implies, at the vacuum,

$$\begin{cases} A_2^{a\dot{A}r} = 0, \\ A_2^{\dot{a}\dot{A}r} = 0. \end{cases} \quad (3.5)$$

These equations further constrain the expression of the T tensors (2.21) and simplify the search for an extremal point of the potential. Without loss of generality, one can search for vacua at the scalar origin  $\mathcal{M}_{\bar{M}\bar{N}} = \delta_{\bar{M}\bar{N}}$ , or equivalently  $\mathcal{V} = \mathbb{1}$ , since any extremal point located at a different  $\mathcal{V}_0$  can be mapped into an extremal point at the scalar origin of the theory with embedding tensor rotated by  $\mathcal{V}_0^{-1}$  [147, 148]. We thus simultaneously solve the quadratic constraints (3.1a) and (3.1b) together with the extremality condition (3.2) (evaluated at  $T_{\bar{M}\bar{N}|\bar{P}\bar{Q}} = \Theta_{\bar{M}\bar{N}|\bar{P}\bar{Q}}$ ) and the supersymmetry conditions (3.4) and (3.5). On top of that, the analysis is simplified by the symmetries of the desired vacuum: for a given choice of supergroups  $\mathcal{G}_{R,L}$ , we parametrize  $\Theta_{\bar{M}\bar{N}|\bar{P}\bar{Q}}$  as a singlet of the  $R$ -symmetry groups  $\mathcal{G}_{R,L}^{R\text{-sym}}$ . Then, for every AdS<sub>3</sub> vacuum identified, we determine the associated gauge group and compute the

mass spectrum of fluctuations.

### 3.2 Supergravity spectrum around a given vacuum

For a given vacuum, the three-dimensional supergravity spectrum is entirely determined by the embedding tensor  $\Theta_{\bar{M}\bar{N}|\bar{P}\bar{Q}}$ . In our conventions, the mass matrices for the spin  $s = 1/2, 1, 3/2$  fields are given by [131]

$$M_{(1/2)}^{\dot{A}r\dot{B}s} = -A_3^{\dot{A}r\dot{B}s}, \quad (3.6a)$$

$$M_{(1)}{}_{lr|js} = -4 \Theta_{lr|js}, \quad (3.6b)$$

$$M_{(3/2)}^{AB} = -A_1^{AB}, \quad (3.6c)$$

with the tensors  $A_1, A_3$  from Eq. (2.23)<sup>35</sup>. As for the scalars, their mass matrix is given by the second order variation of the scalar potential (2.24), which yields

$$\begin{aligned} M_{(0)}^2{}_{Lr,Ms} &= \delta_{LM} \left( -\frac{8}{3} \theta_{IJKr} \theta_{IJKs} + 8 \theta_{IJrp} \theta_{Ijsp} - \theta_{ll} \theta_{rs} + 8 \theta \theta_{rs} + \theta_{lr} \theta_{ls} + \theta_{pr} \theta_{ps} \right) \\ &\quad + \delta_{rs} \left( -\frac{8}{3} \theta_{IJKL} \theta_{IJKM} + 8 \theta_{IJLp} \theta_{IJMp} - \frac{2}{9} \theta_{IJKR} \varepsilon^{IJKRMNPQ} \theta_{LNPQ} \right. \\ &\quad \left. - \theta_{ll} \theta_{LM} + \theta_{lL} \theta_{lM} + \theta_{Mp} \theta_{Lp} + 8 \theta \theta_{LM} \right) \\ &\quad + 16 \theta_{lLMp} \theta_{lrsp} - 16 \theta_{lLsp} \theta_{lMrp} - \frac{2}{3} \theta_{IJKN} \varepsilon^{IJKNPQLM} \theta_{PQrs} \\ &\quad + \frac{8}{9} \theta_{IJKr} \varepsilon^{IJKLMNPQ} \theta_{NPQs} - 2 \theta_{Lr} \theta_{Ms} + 2 \theta_{Ls} \theta_{Mr} + 2 \theta_{LM} \theta_{rs}. \end{aligned} \quad (3.7)$$

The masses of the fields are given by the eigenvalues  $m_{(1/2)}$ ,  $m_{(1)}$ ,  $m_{(3/2)}$  and  $m_{(0)}^2$  of the matrices (3.6) and (3.7). In the context of holography, the spectrum is most conveniently given in terms of the corresponding conformal dimensions  $\Delta_{(s)}$ , which allow the identification of the supermultiplets. In three dimensions, the conformal dimensions are related to the normalized masses through [96–101]

$$\begin{cases} \Delta_{(0)} (\Delta_{(0)} - 2) = (m_{(0)} \ell_{\text{AdS}})^2, \\ \Delta_{(1)} = 1 + |m_{(1)} \ell_{\text{AdS}}|, \end{cases} \quad \text{and} \quad \begin{cases} \Delta_{(1/2)} = 1 \pm m_{(1/2)} \ell_{\text{AdS}}, \\ \Delta_{(3/2)} = 1 + |m_{(3/2)} \ell_{\text{AdS}}|, \end{cases} \quad (3.8)$$

where the masses are normalized by the AdS length  $\ell_{\text{AdS}} = \sqrt{2/|V_0|}$ . Upon projecting out the Goldstone scalars and goldstini, the spectrum organizes into  $\mathcal{G}$  supermultiplets. As the supergroup  $\mathcal{G} = \mathcal{G}_L \times \mathcal{G}_R$  is not simple, each  $\Delta$  decomposes itself as  $\Delta = \Delta_L + \Delta_R$ , with conformal dimensions  $\Delta_{L,R}$  associated to the representations of  $\mathcal{G}_{L,R}$ . The spacetime spin  $s$  is identified as  $s = \Delta_R - \Delta_L$ , and the couples  $(\Delta, s)$  then label the representations of the AdS<sub>3</sub> group SO(2, 2).

<sup>35</sup>We give here the expression of the spin-1/2 fermions mass matrix before projecting out the goldstini. This is sufficient for most of the following, since we are mainly dealing with fully supersymmetric vacua. See Ref. [131] for the complete expression.

### 3.3 $\mathcal{N} = (8, 0)$ supersymmetry

In the following, we will mainly focus on chiral  $\mathcal{N} = (8, 0)$  vacua. For such vacua preserving all supercharges, the condition (3.5) together with Eq. (2.23) imply

$$T_{IJKr} = T_{lr} = 0 \quad (3.9)$$

at the vacuum. From this, it follows that the vacuum condition (3.2) is automatically satisfied. Moreover, for  $\mathcal{N} = (8, 0)$ , Eq. (3.4) imposes  $A_1$  to be diagonal and Eq. (2.23) implies that the tensor  $T_{IJKL}$  has to be anti-selfdual at the vacuum.

To define proper parametrizations of the embedding tensor, let us study the symmetries at the vacuum. For  $\mathcal{N} = (8, 0)$ , the even part of the supergroup is of the form

$$\text{Even}(\mathcal{G}) = \text{SL}(2, \mathbb{R})_{\text{L}} \times \text{SL}(2, \mathbb{R})_{\text{R}} \times \mathcal{G}_{\text{R}}^{R\text{-sym}}. \quad (3.10)$$

The relevant simple supergroups are given in Tab. 3.1, along with their even subgroups and the representations of supercharges. In particular, the different  $R$ -symmetry groups are of the form  $\mathcal{G}^{R\text{-sym}} \simeq \text{SO}(n) \times \text{SO}(m)$ , with  $n + m = 8$  and  $n \neq 4$ . The supercharges originally transform in the spinor representation of  $\text{SO}(8)$ , chirally embedded according to

$$\text{SO}(8) \subset \text{SO}(8) \times \text{SO}(p) \subset \text{SO}(8, p). \quad (3.11)$$

According to Tab. 3.1, they remain irreducible  $A \rightarrow A$  (as a real representation) when  $\text{SO}(8)$  is broken down to the  $R$ -symmetry group  $\mathcal{G}^{R\text{-sym}}$ . For the vector representation of  $\text{SO}(8)$ , this leaves two options. Depending on performing or not a triality rotation of  $\text{SO}(8)$  before embedding the  $R$ -symmetry group, the vector decomposes as

$$(i) : \mathbf{1} \rightarrow \mathbf{1}, \quad (3.12a)$$

$$(ii) : \mathbf{1} \rightarrow \{i, \alpha\}, \quad i \in \llbracket 1, n \rrbracket, \alpha \in \llbracket n + 1, 8 \rrbracket, \quad (3.12b)$$

*i.e.* either (i) it remains irreducible, or (ii) it decomposes into the vector of  $\text{SO}(n) \times \text{SO}(m)$ . In the first case, it is the cospinor of  $\text{SO}(8)$  which decomposes into the vector of  $\text{SO}(n) \times \text{SO}(m)$ , while it stays irreducible in the second case. For  $\text{OSp}(8|2, \mathbb{R})$ , *i.e.*  $n = 8$ , the two options are equivalent. The breaking (3.12) determines how the vector of  $\text{SO}(8, p)$  transforms under the  $R$ -symmetry group, thus the transformation of the various components of the embedding tensor (2.16).

The precise parametrization of the embedding tensor depends finally on how  $\mathcal{G}_{\text{R}}^{R\text{-sym}}$  is embedded

Supergroup $\mathcal{G}$	$\text{OSp}(8 2, \mathbb{R})$	$\text{F}(4)$	$\text{SU}(4 1, 1)$	$\text{OSp}(4^* 4)$
Even $(\mathcal{G})$	$\text{SO}(8) \times \text{Sp}(2, \mathbb{R})$	$\text{SO}(7) \times \text{SL}(2, \mathbb{R})$	$\text{U}(4) \times \text{SU}(1, 1)$	$\text{SO}^*(4) \times \text{USp}(4)$
$\mathcal{G}^{R\text{-sym}}$	$\text{SO}(8)$	$\text{SO}(7)$	$\text{U}(1) \times \text{SO}(6)$	$\text{SO}(5) \times \text{SO}(3)$
Supercharges	$\mathbf{8}_s$	$\mathbf{8}$	$\mathbf{4}^{+1} \oplus \bar{\mathbf{4}}^{-1}$	$(\mathbf{4}, \mathbf{2})$

**Tab. 3.1** Supergroups  $\mathcal{G}$  with  $\text{SL}(2, \mathbb{R}) \simeq \text{Sp}(2, \mathbb{R}) \simeq \text{SU}(1, 1)$  factor and eight supercharges [128, 129]. We also list their even part  $\text{Even}(\mathcal{G}) \simeq \text{SL}(2, \mathbb{R}) \times \mathcal{G}^{R\text{-sym}}$  and their  $R$ -symmetry group  $\mathcal{G}^{R\text{-sym}}$ . The supercharges are given in representations of  $\mathcal{G}^{R\text{-sym}}$ .

into the global symmetry group. In general, it may be embedded in different ways into the compact  $\text{SO}(8) \times \text{SO}(p) \subset \text{SO}(8, p)$ , such that the representation of the supercharges branches into the relevant representation collected in Tab. 3.1. All  $\mathcal{G}_R^{R\text{-sym}}$  admit a chiral embedding into  $\text{SO}(8) \subset \text{SO}(8) \times \text{SO}(p)$  according to either of the options from Eq. (3.12), while for sufficiently large  $p$ , the group  $\mathcal{G}_R^{R\text{-sym}}$  or one of its factors may also admit a diagonal embedding into  $\text{SO}(8) \times \text{SO}(p)$ . With the proper parametrization of  $\Theta_{\bar{M}\bar{N}|\bar{P}\bar{Q}}$ , we then solve the Eq. (3.1a), (3.1b), (3.2) and (3.4) to identify the vacua. The gauge group of the theory is deduced from the algebra satisfied by the generators (2.13). At the vacuum, it is spontaneously broken down to its compact subgroup.

### 3.4 The example of $\text{OSp}(8|2, \mathbb{R})$

The analysis we just detailed can be conducted separately for all the supergroups given in Tab. 3.1, with the two possible embeddings of the  $R$ -symmetry groups  $\text{SO}(n) \times \text{SO}(m)$  according to Eq. (3.12) [A]. We focus here on the supergroup  $\text{OSp}(8|2, \mathbb{R})$ , for which the two possibilities are equivalent. We furthermore restrict to  $p \leq 8$  matter multiplets<sup>36</sup>.

#### 3.4.1 Constraining the embedding tensor

As explained above, upon implementing Eq. (3.4) and (3.5) in Eq. (2.23) for  $\mathcal{N} = (8, 0)$ , the remaining possibly non-vanishing components of the embedding tensor are *a priori* given by

$$\{\theta_{IJ}, \theta_{rs}, \theta = \kappa, \theta_{IJKL}^-, \theta_{Ijrs}, \theta_{lpqr}, \theta_{pqrs}\}, \quad (3.13)$$

where  $\theta_{IJKL}^-$  is anti-selfdual. The fact that the embedding tensor is singlet under the respective  $R$ -symmetry group, embedded according to Eq. (3.12a), further restricts these components as

$$\{\theta_{IJ} = \lambda \delta_{IJ}, \theta_{rs}, \theta = \kappa, \theta_{IJKL}^- = \xi^{\dot{A}\dot{B}} \Gamma_{\dot{A}\dot{B}}^{IJKL}, \theta_{Ijrs}, \theta_{lpqr}, \theta_{pqrs}\}, \quad (3.14)$$

with traceless  $\xi^{\dot{A}\dot{B}}$  of signature  $(n, m)$  (only non-vanishing for  $n \neq 8$ ). A non-vanishing  $\xi^{\dot{A}\dot{B}}$  induces the breaking of  $R$ -symmetry from  $\text{SO}(8)$  to  $\text{SO}(n) \times \text{SO}(m)$ . We study in the following the solutions of the first quadratic constraint (3.1a) using the parametrization (3.14), before turning to those of the second quadratic constraint (3.1b) for  $\text{OSp}(8|2, \mathbb{R})$ .

The first quadratic constraint (3.1a) with free indices chosen as  $(\bar{M}, \bar{N}) = (I, j)$  is identically satisfied thanks to the parametrization. Choosing the free indices as  $(\bar{M}, \bar{N}) = (l, r)$  gives rise to the equations

$$\theta_{rp} \theta_{ps} + 2 \kappa \theta_{rs} + \lambda (2 \kappa - \lambda) \delta_{rs} = 0, \quad (3.15a)$$

$$\lambda \theta_{Ijrs} + \theta_{Ijrp} \theta_{ps} = 0, \quad (3.15b)$$

$$\lambda \theta_{lpqr} + \theta_{lpqs} \theta_{sr} = 0. \quad (3.15c)$$

Eq. (3.15a) determines the eigenvalues of the matrix  $\theta_{rs}$  to be

$$\theta_+ = -\lambda, \quad \theta_- = \lambda - 2 \kappa. \quad (3.16)$$

Accordingly, we choose a basis in which  $\theta_{rs}$  is diagonal, split the indices  $r$  into  $\{r_+, r_-\}$  and denote by

<sup>36</sup>This choice is discussed in Sec. 3.7.

$p_{\pm}$  the multiplicities of these eigenvalues. Tracelessness of  $\theta_{\bar{M}\bar{N}}$  implies that

$$(8 + p_+ - p_-) \lambda = -2p_- \kappa. \quad (3.17)$$

If we now set all  $\theta_{\bar{M}\bar{N}\bar{P}\bar{Q}} = 0$ , all remaining quadratic constraints are satisfied. Up to an arbitrary overall scaling factor, this yields an embedding tensor of the form

$$\begin{aligned} \theta_{IJ} &= 4p_- \delta_{IJ}, & \theta &= -2(8 + p_+ - p_-), \\ \theta_{r_+s_+} &= -4p_- \delta_{r_+s_+}, & \theta_{r_-s_-} &= 4(8 + p_+) \delta_{r_-s_-}, \end{aligned} \quad (3.18)$$

with all other components vanishing. The gauge group, defined *via* Eq. (2.13) by this embedding tensor, is  $\text{SO}(8, p_+) \times \text{SO}(p_-)$ . The vacuum breaks this group down to its compact subgroup  $\text{SO}(8) \times \text{SO}(p_+) \times \text{SO}(p_-)$ . Together with the preserved  $\mathcal{N} = (8, 0)$  supersymmetries and the AdS symmetries, the isometry group of this vacuum is  $\text{OSp}(8|2, \mathbb{R})$ . Following the discussion in Sec. 3.2, we may compute the spectrum around this vacuum. The result is collected in Tab. 3.2, organized into  $\text{OSp}(8|2, \mathbb{R})$  supermultiplets with the conformal dimensions obtained *via* Eq. (3.8).

It remains to analyze how the solution (3.18) can be extended to non-vanishing  $\theta_{\bar{M}\bar{N}\bar{P}\bar{Q}}$ . The first quadratic constraint (3.1a) with free indices chosen as  $(\bar{M}, \bar{N}) = (r, s)$  together with Eq. (3.15b) and (3.15c) gives rise to the equations

$$\begin{aligned} (\lambda - \kappa) \theta_{pqr_+s_-} &= 0, \\ (\lambda - \kappa) \theta_{IJs_-} &= 0, \\ (\lambda - \kappa) \theta_{I_pqr_-} &= 0, \end{aligned} \quad (3.19)$$

respectively. These equations could be simultaneously solved by choosing  $\kappa = \lambda$ . However, with Eq. (3.17) this choice implies that in fact  $\kappa = \lambda = 0$ , resulting in  $\theta = 0 = \theta_{\bar{M}\bar{N}}$ . As a consequence, both tensors  $A_1^{AB}$  and  $A_2^{AAr}$  from Eq. (2.23) vanish at the vacuum, inducing a vanishing potential (2.24) and thus a Minkowski vacuum, which is beyond the scope of the present analysis. In all the following we thus assume that  $\kappa \neq \lambda$ . Eq. (3.19) then imply that, after complete resolution of the first quadratic constraint (3.1a), the solution (3.18) can be extended to potentially non-vanishing components

$$\left\{ \begin{aligned} \theta_{IJ} &= \lambda \delta_{IJ}, \quad \theta_{r_+s_+} = -\lambda \delta_{r_+s_+}, \quad \theta_{r_-s_-} = (\lambda - 2\kappa) \delta_{r_-s_-}, \quad \theta = \kappa, \\ \theta_{\bar{I}\bar{J}\bar{K}\bar{L}} &= \xi^{\dot{A}\dot{B}} \Gamma_{\dot{A}\dot{B}}^{\bar{I}\bar{J}\bar{K}\bar{L}}, \quad \theta_{IJs_+}, \quad \theta_{I_p+q+r_+}, \quad \theta_{p_+q+r_+s_+}, \quad \theta_{p_-q-r_-s_-} \end{aligned} \right\}, \quad (3.20)$$

$\Delta_L$	$\Delta_R$	$\Delta$	$s$	SO(8)	SO( $p_+$ )	SO( $p_-$ )
5/4	3/4	2	-1/2	$\mathbf{8}_c$	$p_+$	$\mathbf{1}$
	1/4	3/2	-1	$\mathbf{8}_v$	$p_+$	$\mathbf{1}$
1/4	3/4	1	1/2	$\mathbf{8}_c$	$\mathbf{1}$	$p_-$
	1/4	1/2	0	$\mathbf{8}_v$	$\mathbf{1}$	$p_-$

**Tab. 3.2** Mass spectra for the  $\text{OSp}(8|2, \mathbb{R})$  solutions with chiral embedding of the  $R$ -symmetry group. The spectrum organizes into multiplets of  $\text{OSp}(8|2, \mathbb{R})$ , given in Eq. (5.3) of Ref. [129]. The gauge group is  $\text{SO}(8, p_+) \times \text{SO}(p_-)$ . For non-vanishing  $\theta_{pqrs}$ , the factor  $\text{SO}(p_-)$  reduces to a subgroup  $K_0$ , and the representation  $p_-$  is replaced by the corresponding representation of  $K_0$ .

where  $\kappa$  is a solution of Eq. (3.17).

The remaining quadratic constraints restricting these components follow from evaluating Eq. (3.1b). For readability, we defer the full set of constraint equations to App. A, and in the following subsections treat the chiral and diagonal embeddings of  $\text{OSp}(8|2, \mathbb{R})$  separately.

### 3.4.2 Chiral embedding

The  $R$ -symmetry group  $\text{OSp}(8|2, \mathbb{R})$  is  $\text{SO}(8)$ . Let us first assume that it is chirally embedded into the first factor of  $\text{SO}(8) \times \text{SO}(p) \subset \text{SO}(8, p)$ . Since the embedding tensor must be singlet under this group, its possible non-vanishing components within  $\theta_{\overline{M}\overline{N}\overline{P}\overline{Q}}$  further reduce from Eq. (3.20) to

$$\{\theta_{p+q+r+s+}, \theta_{p-q-r-s-}\}. \quad (3.21)$$

The second quadratic constraint is then reduced to two non-trivial equations, given by Eq. (A.4c) and (A.5a). They take the explicit form

$$(\lambda - \kappa) \theta_{pqrs+} = 0, \quad (3.22a)$$

$$\lambda \theta_{L-[q-r-s-]u-v-L} = 2p_- (\lambda - \kappa) \left( \delta_{u-[p-]q-r-s-]v-} - \delta_{v-[p-]q-r-s-]u-} \right). \quad (3.22b)$$

Following the discussion after Eq. (3.19), we restrict to the case  $\kappa \neq \lambda$ , after which the first equation implies that the only non-vanishing components of  $\theta_{pqrs}$  is  $\theta_{p-q-r-s-}$ . Next, we solve the remaining equation (3.22b) by considering each value of  $p_- \geq 4$  separately. Since  $\theta_{pqrs}$  does not enter in the mass formulas (3.6), (3.7), the spectra of all the resulting theories are still given by Tab. 3.2. But, we will find in the following that non-vanishing  $\theta_{pqrs}$  generically reduces the factor  $\text{SO}(p_-)$  of the gauge group to a subgroup  $K_0$ , such that the representation  $\mathbf{p}_-$  in Tab. 3.2 is to be replaced by the corresponding representation of  $K_0$ .

**$p_- = 4$**  Both sides of Eq. (3.22b) identically vanish, such that the general solution admits a non-vanishing  $\theta_{p-q-r-s-} \propto \xi \varepsilon_{p-q-r-s-}$ , with a free parameter  $\xi$ . The full solution then extends Eq. (3.18) to

$$\begin{aligned} \theta_{ij} &= 16 \delta_{ij}, & \theta &= -2(4 + p_+), & \theta_{p-q-r-s-} &= (12 + p_+) \xi \varepsilon_{p-q-r-s-}, \\ \theta_{r+s+} &= -16 \delta_{r+s+}, & \theta_{r-s-} &= 4(8 + p_+) \delta_{r-s-}. \end{aligned} \quad (3.23)$$

For  $|\xi| \neq 1$  the gauge group is  $\text{SO}(8, p_+) \times \text{SO}(4)$ , as in the  $\xi = 0$  case. On the other hand, when  $\xi$  takes a critical value  $\xi = \pm 1$ , the gauge group reduces to  $\text{SO}(8, p_+) \times \text{SO}(3)_{\pm}$ , *i.e.*  $\text{SO}(4) = \text{SO}(3)_+ \times \text{SO}(3)_-$  is broken down to one of its chiral factors.

**$p_- = 5$**  Setting  $\theta_{p-q-r-s-} = \varepsilon_{p-q-r-s-t-} \xi^{t-}$ , Eq. (3.22b) shows that non-vanishing  $\xi^{t-}$  implies that  $\kappa = \lambda$ , thus  $\kappa = \lambda = 0$  and the vacuum is not AdS.

**$p_- = 6$**  Setting  $\theta_{p-q-r-s-} = \frac{1}{2} \varepsilon_{p-q-r-s-u-v-} \xi^{u-v-}$ , Eq. (3.22b) leads to

$$(\lambda - \kappa) \xi_{p-q-} = -\frac{1}{4} \varepsilon_{p-q-k-l-m-p-} \xi^{k-l-} \xi^{m-p-}. \quad (3.24)$$



In particular, this implies that

$$\xi_{p-r-}\xi_{r-q-} = \frac{\delta_{p-q-}}{4!(\lambda-\kappa)} \left( \varepsilon_{k-l-m-p-r-s-} \xi^{k-l-}\xi^{m-p-}\xi^{r-s-} \right). \quad (3.25)$$

For  $\kappa \neq \lambda$  this implies that there is a basis such that<sup>37</sup>

$$\xi_{p-q-} = -(\lambda-\kappa) \begin{pmatrix} -\sigma & 0 & 0 \\ 0 & \sigma & 0 \\ 0 & 0 & \sigma \end{pmatrix}, \quad \text{where } \sigma = \begin{pmatrix} 0 & 1 \\ -1 & 0 \end{pmatrix}. \quad (3.26)$$

The full solution is then given by

$$\begin{aligned} \theta_{ij} &= 24 \delta_{ij}, \quad \theta = -2(2+p_+), \quad \theta_{r_+s_+} = -24 \delta_{r_+s_+}, \quad \theta_{r_-s_-} = 4(8+p_+) \delta_{r_-s_-}, \\ \theta_{p-q-r-s-} &= \frac{1}{2} \varepsilon_{p-q-r-s-u-v-} \xi^{u-v-}, \quad \xi_{u-v-} = -(14+p_+) \begin{pmatrix} -\sigma & 0 & 0 \\ 0 & \sigma & 0 \\ 0 & 0 & \sigma \end{pmatrix}. \end{aligned} \quad (3.27)$$

The gauge group in this case is  $\text{SO}(8, p_+) \times \text{U}(3)$ , *i.e.* due to the presence of a non-vanishing  $\theta_{p-q-r-s-}$ , the  $\text{SO}(6)$  factor is reduced to  $\text{U}(3)$  compared to solution (3.18).

$p_- = 7$  Setting  $\theta_{p-q-r-s-} = \varepsilon_{p-q-r-s-u-v-w-} \xi^{u-v-w-}$ , Eq. (3.22b) leads to

$$2 \varepsilon_{m-p-p-q-r-s-[u-}\xi_{v-w-]q-} \xi_{m-p-p-} = (\lambda-\kappa) (\delta_{r-[u-}\xi_{v-w-]s-} - \delta_{s-[u-}\xi_{v-w-]r-}). \quad (3.28)$$

For  $\kappa \neq \lambda$ , this implies

$$\xi^{m-r-s-}\xi^{p-r-s-} = -\frac{\Lambda}{7(\lambda-\kappa)} \delta^{m-p-}, \quad (3.29)$$

with the constant  $\Lambda$  given by

$$\Lambda = \left( \varepsilon^{p-q-r-s-u-v-w-} \xi^{k-p-q-} \xi^{k-r-s-} \xi^{u-v-w-} \right). \quad (3.30)$$

This equation is solved by choosing  $\xi_{m-r-s-}$  proportional to the  $G_2 \subset \text{SO}(7)$  invariant three-form  $\omega_{m-r-s-}$ <sup>38</sup>. The full embedding tensor is then given by

$$\begin{aligned} \theta_{ij} &= 28 \delta_{ij}, \quad \theta_{r_+s_+} = -28 \delta_{r_+s_+}, \quad \theta_{r_-s_-} = 4(8+p_+) \delta_{r_-s_-}, \quad \theta = -2(1+p_+), \\ \theta_{p-q-r-s-} &= \frac{15+p_+}{12} \varepsilon_{p-q-r-s-u-v-w-} \omega^{u-v-w-}. \end{aligned} \quad (3.31)$$

The gauge group is  $\text{SO}(8, p_+) \times G_2$ , *i.e.* compared to solution (3.18) the group  $\text{SO}(7)$  is reduced to  $G_2$ .

$p_- = 8$  In this case, Eq. (3.17) implies  $\kappa = 0$  and Eq. (3.22b) is solved by a self-dual  $\theta_{pqrs}$ :

$$\theta_{pqrs} = \theta_{pqrs}^+ = \Gamma_{ab}^{pqrs} \xi^{ab}, \quad (3.32)$$

<sup>37</sup>The global sign of  $\xi_{p-q-}$  is fixed by the choice of convention for the Levi-Civita tensor  $\varepsilon_{p-q.k.l.m-p-}$ . Here we chose  $\varepsilon_{123456} = 1$ .

<sup>38</sup>We choose the normalization of  $\omega$  so that  $\omega_{u-v-w-}\omega_{u-v-w-} = 42$ .

with  $\text{SO}(8)$   $\Gamma$  matrices  $\Gamma_{ab}^{pqrs}$  and traceless  $\xi^{ab}$  subject to the equation

$$\xi^{ac}\xi^{bc} - \frac{1}{8}\delta^{ab}\xi^{cd}\xi^{cd} = \frac{\lambda}{8}\xi^{ab}. \quad (3.33)$$

This implies that the eigenvalues of  $\xi_{ab}$  are

$$\xi^+ = \frac{\lambda}{16} \frac{8-n}{(4-n)}, \quad \xi^- = -\frac{\lambda}{16} \frac{n}{(4-n)}, \quad (3.34)$$

with multiplicity  $n$  and  $8-n$  respectively and  $n \neq 4$ <sup>39</sup>. The full embedding tensor takes then the form:

$$\begin{aligned} \theta_{IJ} &= 32\delta_{IJ}, \quad \theta_{rs} = 32\delta_{rs}, \quad \theta = 0, \quad \theta_{pqrs} = \Gamma_{ab}^{pqrs}\xi^{ab}, \\ \text{where } \xi^{ab} &= \frac{2}{4-n} \text{diag}\{\underbrace{8-n, \dots, 8-n}_n, \underbrace{-n, \dots, -n}_{8-n}\}, \quad p \neq 4. \end{aligned} \quad (3.35)$$

There is an analogous solution for anti-selfdual choice of  $\theta_{pqrs}$ . The gauge group is  $\text{SO}(8) \times \text{SO}(8-n) \times \text{SO}(n)$ , *i.e.*  $\text{SO}(8)$  is reduced to  $\text{SO}(8-n) \times \text{SO}(n)$  compared to solution (3.18).

### 3.4.3 Diagonal embedding

For  $p = 8$  matter multiplets, the  $R$ -symmetry group  $\text{SO}(8)$  alternatively allows a diagonal embedding as

$$\text{SO}(8) = \text{SO}(8)_{\text{diag}} \subset \text{SO}(8) \times \text{SO}(8) \subset \text{SO}(8, 8). \quad (3.36)$$

Moreover, there are inequivalent diagonal embeddings according to possible triality rotations in the two  $\text{SO}(8)$  factors. In this case, and after resolution of the first quadratic constraint (3.1a), the condition of being singlet under the  $R$ -symmetry group reduces the possible components of the embedding tensor from Eq. (3.20) to

$$\left\{ \theta_{IJ} = \lambda\delta_{IJ}, \theta_{r+s+} = -\lambda\delta_{r+s+}, \theta_{r-s-} = (\lambda - 2\kappa)\delta_{r-s-}, \theta = \kappa, \theta_{IJr+s+} \right\}, \quad (3.37)$$

with either  $(p_+, p_-) = (8, 0)$  or  $(p_+, p_-) = (0, 8)$  and  $\lambda$  satisfying Eq. (3.17). For vanishing  $\theta_{IJr+s+}$ , we are back to solution (3.18). A non-vanishing  $\theta_{IJr+s+}$  on the other hand implies  $(p_+, p_-) = (8, 0)$  and from Eq. (3.17) we deduce that  $\lambda = 0$ . We are then left with the following surviving components

$$\{\theta = \kappa, \theta_{IJrs}\}, \quad (3.38)$$

where we suppressed the  $+$  subscript. The remaining equations of the quadratic constraints are given by Eq. (A.2b), (A.3a), (A.3b) and (A.4c):

$$\begin{cases} 2\theta_{usM}[\theta_{JK}]rs + \kappa\delta_{M}[\theta_{JK}]ru = 0, \\ \Lambda_{uv}[\theta_{uvL}[\theta_{IJ}]Lrs + \kappa\theta_{IJu}[r\delta_s]v] = 0, \\ \Lambda_{MN}[\theta_{MNP}[r\theta_s]pIJ + \kappa\theta_{rsM}[\theta_{IJ}]N] = 0, \\ 2\theta_{MLu}[p\theta_{qr}]IL + \kappa\delta_u[p\theta_{qr}]IM = 0. \end{cases} \quad (3.39)$$

<sup>39</sup>The case  $n = 4$  implies  $\kappa = \lambda$  thus again leading to a Minkowski vacuum.

$\Delta_L$	$\Delta_R$	$\Delta$	$s$	SO(8)
	5/2	4	1	<b>1</b>
	2	7/2	1/2	<b>8<sub>s</sub></b>
3/2	3/2	3	0	<b>28</b>
	1	5/2	-1/2	<b>56<sub>s</sub></b>
	1/2	2	-1	<b>35<sub>c</sub></b>

**Tab. 3.3** Mass spectra for the  $\text{OSp}(8|2, \mathbb{R})$  solution with diagonal embedding of the  $R$ -symmetry group. The spectrum organizes into multiplets of  $\text{OSp}(8|2, \mathbb{R})$ , given in Tab. 7 of Ref. [129]. The gauge group is  $\text{GL}(8)$ .

An  $\text{SO}(8)_{\text{diag}}$  singlet in  $\theta_{\text{IJrs}}$  can be parametrized as

$$\theta_{\text{IJrs}} = \rho \delta_{r[\text{I} \delta_{\text{J}]s}. \quad (3.40)$$

Then, Eq. (3.39) fix  $\rho = -\kappa$ , thus leading to an embedding tensor

$$\theta = -1, \quad \theta_{\text{IJrs}} = \delta_{r[\text{I} \delta_{\text{J}]s}. \quad (3.41)$$

The gauge group induced by this tensor is  $\text{GL}(8)$ . The spectrum around this vacuum is given in Tab. 3.3.

Upon triality rotation of the second factor in Eq. (3.36), the singlet in  $\theta_{\text{IJrs}}$  would alternatively be given by

$$\theta_{\text{IJrs}} = \rho \Gamma_{rs}^{\text{IJ}}. \quad (3.42)$$

This however does not lead to a non-trivial solution of Eq. (3.39).

3

As mentioned above, with my collaborators we conducted in Ref. [A] a similar analysis for all the supergroups in Tab. 3.1. The three-dimensional supergravities carrying AdS<sub>3</sub> vacua identified there are listed in Tab. 3.4. They are characterized by their gauge groups and by the external global symmetry group  $G_{\text{ext}}$  preserved by the vacuum. We refer to Ref. [A] for the explicit expressions of the associated embedding tensors and for the supergravity spectra around the vacua.

### 3.5 Some $\mathcal{N} = (7, 1)$ and $\mathcal{N} = (7, 0)$ vacua

In this section, we present some partial analysis of vacua with  $\mathcal{N} = (7, 1)$  and  $\mathcal{N} = (7, 0)$  supersymmetries, respectively. The relevant supergroups with  $\mathcal{N} = 7$  supercharges are  $\text{OSp}(7|2, \mathbb{R})$  and  $G(3)$ , whose  $R$ -symmetry subgroups are  $\text{SO}(7)$  and  $G_2$ , respectively. The supergroup with one supercharge is  $\text{OSp}(1|2, \mathbb{R})$ .

In these cases, the constraints (3.4) and (3.5) get replaced by

$$\mathcal{N} = (7, 1) : \begin{cases} A_1^{ab} = \frac{1}{2} \ell_{\text{AdS}}^{-1} \delta^{ab}, \\ A_1^{88} = -\frac{1}{2} \ell_{\text{AdS}}^{-1}, \\ A_2^{a\dot{A}r} = 0 = A_2^{8\dot{A}r}, \end{cases} \quad \mathcal{N} = (7, 0) : \begin{cases} A_1^{ab} = \frac{1}{2} \ell_{\text{AdS}}^{-1} \delta^{ab}, \\ A_1^{88} \neq \pm \frac{1}{2} \ell_{\text{AdS}}^{-1}, \\ A_2^{a\dot{A}r} = 0, \end{cases} \quad (3.43)$$

$p \leq 8$ matter multiplets	Gauge group	$G_{\text{ext}}$	Embedding max.
$\mathcal{G}_R = \text{OSp}(8 2, \mathbb{R})$			
$p_+ + p_-$	$\text{SO}(8, p_+) \times \text{SO}(p_-)$	$\text{SO}(p_+) \times \text{SO}(p_-)$	✓
$p_+ + 4$	$\text{SO}(8, p_+) \times \text{SO}(4)$	$\text{SO}(p_+) \times \text{SO}(4)$	✓
$p_+ + 4$	$\text{SO}(8, p_+) \times \text{SO}(3)$	$\text{SO}(p_+) \times \text{SO}(3)$	-
$p_+ + 6$	$\text{SO}(8, p_+) \times \text{U}(3)$	$\text{SO}(p_+) \times \text{U}(3)$	✓
$p_+ + 7$	$\text{SO}(8, p_+) \times G_2$	$\text{SO}(p_+) \times G_2$	✓
8	$\text{SO}(8) \times \text{SO}(8-n) \times \text{SO}(n)$	$\text{SO}(8-n) \times \text{SO}(n)$	-
8	$\text{GL}(8)$	-	✓
$\mathcal{G}_R = \text{SU}(4 1, 1)$			
$p_+ + p_-$	$\text{SO}(6, p_+) \times \text{SO}(2, p_-)$	$\text{SO}(p_+) \times \text{SO}(p_-)$	✓
$p_+ + 2m$	$\text{SO}(6, p_+) \times \text{U}(m, 1)$	$\text{SO}(p_+) \times \text{U}(m)$	✓
$p_+ + 2$	$\text{SO}(6, p_+) \times \text{SO}(2, 1)$	$\text{SO}(p_+)$	-
$p_+ + 2$	$\text{SO}(6, p_+) \times \text{SO}(2, 2)$	$\text{SO}(p_+) \times \text{U}(1)$	✓
$6 \leq p < 8$	$\text{GL}(6) \times \text{SO}(2, p-6)$	$\text{SO}(p-6)$	-
8	$\text{GL}(6) \times \text{SO}(2, 1)$	$\text{U}(1)$	-
6	$\text{GL}(6) \times \text{SO}(2, 2)$	$\text{SO}(2)$	✓
$p$	$\text{SO}(6) \times \text{SO}(2) \times \text{SO}(p)$	$\text{SO}(p)$	-
4	$\text{SO}(6) \times \text{SO}(2) \times \text{SO}(4)$	$\text{SO}(4)$	-
4	$\text{SO}(6) \times \text{SO}(2) \times \text{SO}(3)$	$\text{SO}(3)$	-
6	$\text{SO}(6) \times \text{SO}(2) \times \text{U}(3)$	$\text{U}(3)$	-
7	$\text{SO}(6) \times \text{SO}(2) \times G_2$	$G_2$	-
8	$\text{SO}(6) \times \text{SO}(2) \times \text{SO}(8-n) \times \text{SO}(n)$	$\text{SO}(8-n) \times \text{SO}(n)$	✓
8	$\text{U}(4, 4)$	$\text{U}(4)$	✓
8	$\text{SL}(2) \times \text{Sp}(4, \mathbb{R})$	$\text{U}(1)$	✓
$2 + p_-$	$\text{U}(4, 1) \times \text{SO}(p_-)$	$\text{SO}(p_-) \times \text{U}(1)$	-

**Tab. 3.4**  $\mathcal{N} = (8, 0)$  AdS<sub>3</sub> vacua preserving a global  $\text{SL}(2, \mathbb{R})_L \times \mathcal{G}_R \times G_{\text{ext}}$  symmetry. The last row indicates whether the theories can be embedded into maximal supergravity when  $p = 8$  (Sec. 3.6). This may require additional constraints [A].

$p \leq 8$ matter multiplets	Gauge group	$G_{\text{ext}}$	Embedding max.
$\mathcal{G}_R = F(4)$			
$p_+ + p_-$	$SO(7, p_+) \times SO(1, p_-)$	$SO(p_+) \times SO(p_-)$	✓
$p_+ + 3$	$SO(7, p_+) \times SO(1, 3)$	$SO(p_+) \times SO(3)$	-
$p \geq 7$	$GL(7) \times SO(1, p - 7)$	$SO(p - 7)$	-
$p$	$SO(7) \times SO(p)$	$SO(p)$	-
4	$SO(7) \times SO(4)$	$SO(4)$	-
4	$SO(7) \times SO(3)$	$SO(3)$	-
6	$SO(7) \times U(3)$	$U(3)$	-
7	$SO(7) \times G_2$	$G_2$	-
8	$SO(7) \times SO(8 - n) \times SO(n)$	$SO(8 - n) \times SO(n)$	✓
$\mathcal{G}_R = \text{OSp}(4^* 4)$			
$p_+ + p_-$	$SO(5, p_+) \times SO(3, p_-)$	$SO(p_+) \times SO(p_-)$	✓
$n \geq 4$	$SO(5, n - 4) \times G_{2(2)}$	$SO(n - 4) \times SO(3)$	✓
$n \geq 5$	$GL(5) \times SO(3, p - 5)$	$SO(p - 5)$	-
$n \geq 3$	$GL(3) \times SO(5, p - 3)$	$SO(p - 3)$	✓
8	$GL(5) \times GL(3)$	-	-
$p$	$SO(5) \times SO(3) \times SO(p)$	$SO(p)$	-
4	$SO(5) \times SO(3) \times SO(4)$	$SO(4)$	-
4	$SO(5) \times SO(3) \times SO(3)$	$SO(3)$	-
6	$SO(5) \times SO(3) \times U(3)$	$U(3)$	-
7	$SO(5) \times SO(3) \times G_2$	$G_2$	-
8	$SO(5) \times SO(3) \times SO(8 - n) \times SO(n)$	$SO(8 - n) \times SO(n)$	✓
8	$\text{Sp}(2, 2) \times SO(3)$	$\text{USp}(4)$	✓

**Tab. 3.5**  $\mathcal{N} = (8, 0)$  AdS<sub>3</sub> vacua preserving a global  $SL(2, \mathbb{R})_L \times \mathcal{G}_R \times G_{\text{ext}}$  symmetry. The last row indicates whether the theories can be embedded into maximal supergravity when  $p = 8$  (Sec. 3.6). This may require additional constraints [A].

respectively, where the index  $A$  splits according to  $A = \{a, 8\}$  with  $a \in \llbracket 1, 7 \rrbracket$ . For  $\mathcal{N} = (7, 1)$  the potentially non-vanishing components of the embedding tensor are thus given by

$$\{\theta_{IJ}, \theta_{rs}, \theta, \theta_{IJKL}, \theta_{IJrs}, \theta_{I_pqr}, \theta_{pqrs}\}, \quad (3.44)$$

where  $\theta_{IJKL}$  now also has a selfdual contribution, unlike the  $\mathcal{N} = (8, 0)$  case of Eq. (3.14). For  $\mathcal{N} = (7, 0)$  vacua, the potentially non-vanishing components of the embedding tensor are

$$\{\theta_{IJ}, \theta_{rs}, \theta_{lr}, \theta, \theta_{IJKL}, \theta_{IJKr}, \theta_{IJrs}, \theta_{I_pqr}, \theta_{pqrs}\}, \quad (3.45)$$

again with a  $\theta_{IJKL}$  which is not restricted to anti-selfdual tensors. In the rest of this section, we present our findings for such vacua.

### 3.5.1 $\text{OSp}(7|2, \mathbb{R})$

For  $\text{OSp}(7|2, \mathbb{R})$ , a pair of  $\mathcal{N} = (7, 0)$  vacua is given by the embedding tensors

$$\begin{aligned} \theta_J &= 56 \delta_{IJ}, & \theta_{rs} &= 56 \delta_{rs}, & \theta_{lr} &= \pm 32 \sqrt{3} \delta_{lr}, & \theta &= 0, & \theta_{IJKL} &= -\frac{3}{2} \Gamma_{AB}^{IJKL} \xi^{AB}, \\ \theta_{IJKr} &= \mp \sqrt{3} \Gamma_{AB}^{IJKr} \xi^{AB}, & \theta_{IJrs} &= -2 \Gamma_{AB}^{IJrs} \xi^{AB}, & \theta_{I_pqr} &= \mp \frac{4}{\sqrt{3}} \Gamma_{AB}^{I_pqr} \xi^{AB}, \\ \theta_{pqrs} &= -\frac{8}{3} \Gamma_{AB}^{pqrs} \xi^{AB}, & \text{with } \xi^{AB} &= \text{diag} \left\{ -7, \underbrace{1, \dots, 1}_7 \right\}, \end{aligned} \quad (3.46)$$

with  $p = 8$ . The gauge group is  $\text{SO}(8) \times \text{SO}(7)$ , which at the vacuum is spontaneously broken down to a diagonal  $\text{SO}(7)$  subgroup. The spectrum is given in Tab. 3.6.

Closer inspection shows that these embedding tensors may be related to the embedding tensor of Eq. (3.35) (with selfdual  $\theta_{pqrs}$ ) by an  $\text{SO}(8, 8)$  rotation of the form

$$\mathcal{V}_M^I(\phi) = \begin{pmatrix} \cosh(\phi) \mathbb{1}_8 & \sinh(\phi) \mathbb{1}_8 \\ \sinh(\phi) \mathbb{1}_8 & \cosh(\phi) \mathbb{1}_8 \end{pmatrix}, \quad (3.47)$$

with

$$\phi = \phi_{\pm} = \ln(7 \pm 4\sqrt{3})/2. \quad (3.48)$$

$\Delta_L$	$\Delta_R$	$\Delta$	$s$	$\text{SO}(7)$
3/2	3	9/2	3/2	<b>1</b>
	5/2	4	1	<b>7</b>
	2	7/2	1/2	<b>21</b>
	3/2	3	0	<b>1</b> $\oplus$ <b>35</b>
	1	5/2	-1/2	<b>7</b> $\oplus$ <b>35</b>
	1/2	2	-1	<b>21</b>

**Tab. 3.6** Mass spectrum for the  $\text{OSp}(7|2, \mathbb{R})$  solution with  $\mathcal{N} = (7, 0)$  supersymmetries. The gauge group is  $\text{SO}(8) \times \text{SO}(7)$ .

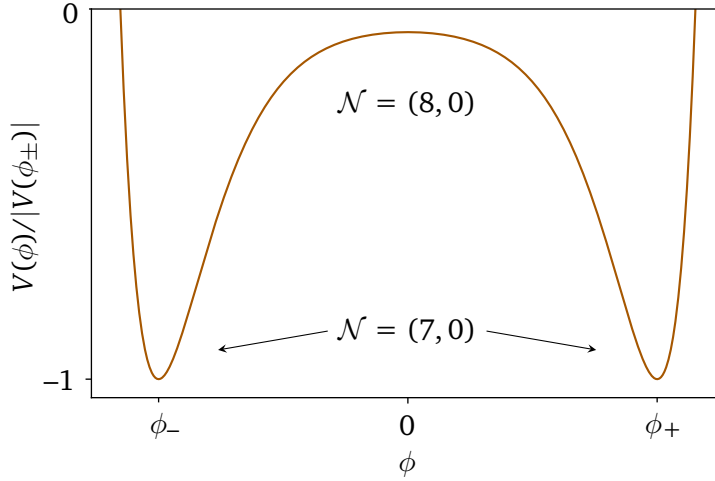

**Fig. 3.1** Potential for the 1-scalar truncation (3.47) of the theory with gauge group  $\text{SO}(8) \times \text{SO}(7)$ . The vacuum at the scalar origin  $\phi = 0$  preserves full  $\mathcal{N} = (8, 0)$  supersymmetry, while the two vacua at  $\phi_{\pm} = \ln(7 \pm 4\sqrt{3})/2$  spontaneously break supersymmetry down to  $\mathcal{N} = (7, 0)$ .

In view of our discussion in Sec. 3.1, we have thus identified three vacua which all belong to the same three-dimensional theory. This is not a surprise, as there is no three-dimensional supergravity theory with  $\mathcal{N} = 7$  local supersymmetries and non-trivial matter content [149]. As a consequence,  $\mathcal{N} = (7, 0)$  vacua can only be realized within half-maximal  $\mathcal{N} = 8$  theories with 1/8 of supersymmetry spontaneously broken at the vacuum.

To illustrate this structure, we evaluate the scalar potential (2.24) on the 1-scalar truncation (3.47) to  $\text{SO}(7)$  singlets, which takes the form

$$V(\phi) = \frac{1024}{9} (-250 + 105 \cosh(2\phi) - 150 \cosh(4\phi) + 7 \cosh(6\phi)), \quad (3.49)$$

that is sketched in Fig. 3.1. It exhibits the fully symmetric  $\mathcal{N} = (8, 0)$  vacuum at the scalar origin  $\phi = 0$ , together with the two  $\mathcal{N} = (7, 0)$  vacua at  $\phi = \phi_{\pm}$  from Eq. (3.48).

### 3.5.2 G(3)

For the supergroup  $\text{G}(3)$ , we present vacua with both  $\mathcal{N} = (7, 1)$  and  $\mathcal{N} = (7, 0)$  supersymmetry, respectively.

$\mathcal{N} = (7, 1)$  The embedding tensor

$$\begin{aligned} \theta_{ij} &= 4(p+1)\delta_{ij}, & \theta_{88} &= -28, & \theta_{rs} &= 28\delta_{rs}, & \theta &= 2(p-6), \\ \theta_{ijkl} &= -\frac{(8+p)}{12} \varepsilon_{ijklxyz} \omega^{xyz}, \end{aligned} \quad (3.50)$$

with  $i \in \llbracket 1, 7 \rrbracket$  and the  $\text{G}_2$ -invariant three-form  $\omega^{xyz}$  from Eq. (3.31), describes an  $\mathcal{N} = (7, 1)$  vacuum within an  $\text{SO}(p, 1) \times \text{G}_2$  gauged theory whose gauge group at the vacuum is broken down to its compact  $\text{SO}(p) \times \text{G}_2$  subgroup. The associated spectrum is given in Tab. 3.7.

$\Delta_L$	$\Delta_R$	$\Delta$	$s$	$G_2$	$SO(p)$
5/4	3/4	2	-1/2	<b>1</b>	<b><math>p</math></b>
5/4	1/4	3/2	-1	<b>1</b>	<b><math>p</math></b>
3/4	3/4	3/2	0	<b>7</b>	<b><math>p</math></b>
3/4	1/4	1	-1/2	<b>7</b>	<b><math>p</math></b>

**Tab. 3.7** Mass spectrum for the  $G(3)$  solution with  $\mathcal{N} = (7, 1)$  supersymmetry. The gauge group is  $SO(p, 1) \times G_2$ .

$\mathcal{N} = (7, 0)$  For  $p = 7$ , a pair of  $G(3)$  solutions with  $\mathcal{N} = (7, 0)$  supersymmetry is given by the embedding tensors

$$\begin{aligned}
\theta_{ij} &= 508 \delta_{ij}, \theta_{88} = 28, \theta_{rs} = 512 \delta_{rs}, \theta_{ir} = \pm 360 \sqrt{2} \delta_{ir}, \theta_{8r} = 0, \theta = -2, \\
\theta_{ijkl} &= 75 \tilde{\omega}_{ijkl}, \theta_{8ijk} = -135 \omega_{ijk}, \theta_{ijkr} = \pm 90 \sqrt{2} \tilde{\omega}_{ijkr}, \theta_{8ijr} = \mp 90 \sqrt{2} \omega_{ijr}, \\
\theta_{ijrs} &= 180 \tilde{\omega}_{ijrs}, \theta_{8irs} = -120 \omega_{irs}, \theta_{ipqr} = \pm 660 \sqrt{2} \tilde{\omega}_{ipqr}, \theta_{8pqr} = \mp 80 \sqrt{2} \omega_{pqr}, \\
\theta_{pqrs} &= \frac{575}{2} \tilde{\omega}_{pqrs},
\end{aligned} \tag{3.51}$$

with the index  $i \in \llbracket 1, 7 \rrbracket$ , the  $G_2$  invariant three-form  $\omega^{kmn}$  from Eq. (3.31) and its dual defined by  $\tilde{\omega}_{ijkl} \equiv \frac{1}{6} \varepsilon_{ijklmnp} \omega^{mnp}$ . The gauge group is  $SO(7) \times G_2$ , broken down at the vacuum to a diagonal  $G_2$  subgroup. The spectrum is given in Tab. 3.8. Similarly to what happens for Eq. (3.46), the embedding tensors (3.51) turn out to be related to  $\mathcal{N} = (8, 0)$  solutions [A].

### 3.6 Embedding into the maximal theory

For a given supersymmetric vacuum, identified as a solution of Eq. (3.1a), (3.1b), (3.2) and (3.4), the embedding tensor defines the gauge group generators according to Eq. (2.13) from which we have determined the specific half-maximal theory that fulfills all the requirements. It is an interesting question to ask, which of the vacua identified in this analysis can actually be embedded into a maximally supersymmetric ( $\mathcal{N} = 16$ ) three-dimensional supergravity, thus spontaneously breaking half of the supersymmetries of the theory. For  $d = 4$  supergravities, the analogous question has been addressed in

$\Delta_L$	$\Delta_R$	$\Delta$	$s$	$G_2$
7/4	13/4	5	3/2	<b>1</b>
	11/4	9/2	1	<b>7</b>
	9/4	4	1/2	<b>7 <math>\oplus</math> 14</b>
	7/4	7/2	0	<b>1 <math>\oplus</math> 7 <math>\oplus</math> 27</b>
	5/4	3	-1/2	<b>7 <math>\oplus</math> 27</b>
	3/4	5/2	-1	<b>14</b>

**Tab. 3.8** Mass spectrum for the  $G(3)$  solution with  $\mathcal{N} = (7, 0)$  supersymmetry. The gauge group is  $SO(7) \times G_2$ .



Ref. [150].

To answer this question, we first recall some of the basic structures of maximal  $d = 3$  supergravities [112, 143]. In this case, the scalar sector describes an  $E_{8(8)}/SO(16)$  coset space sigma model and the embedding tensor, which defines the gauge group generators within  $E_{8(8)}$  in analogy to Eq. (2.13), transforms in the  $\mathbf{1} \oplus \mathbf{3875}$  representation of  $E_{8(8)}$ . The maximal theory can be truncated to a half-maximal subsector upon truncating the coset space

$$E_{8(8)}/SO(16) \longrightarrow SO(8,8)/(SO(8) \times SO(8)). \quad (3.52)$$

Under  $SO(8,8)$ , the embedding tensor of the maximal theory decomposes as

$$\mathbf{1} \oplus \mathbf{3875} \longrightarrow \mathbf{1} \oplus \mathbf{135} \oplus \mathbf{1820} \oplus \mathbf{1920}_c, \quad (3.53)$$

of which the first three parts reproduce the embedding tensor defined in Eq. (2.14) and (2.15) of the half-maximal theory, whereas the last part drops out in the projection to the half-maximal theory. Specifically, splitting the  $E_{8(8)}$  generators according to

$$\{L^{[\bar{M}\bar{N}]}, Y^{\mathcal{A}}\}, \quad \bar{M} \in [1, 16], \quad \mathcal{A} \in [1, 128], \quad (3.54)$$

into  $SO(8,8)$  and its orthogonal complement (transforming in the spinor representation  $\mathbf{128}_s$  of  $SO(8,8)$ ), an embedding tensor of the maximal theory triggered by the first three terms in Eq. (3.53) takes the form

$$\begin{cases} \Theta_{\bar{M}\bar{N}|\bar{P}\bar{Q}} = \theta_{\bar{M}\bar{N}\bar{P}\bar{Q}} + \frac{1}{2} \left( \eta_{\bar{M}[\bar{P}} \theta_{\bar{Q}]\bar{N}} - \eta_{\bar{N}[\bar{P}} \theta_{\bar{Q}]\bar{M}} \right) + \eta_{\bar{M}[\bar{P}} \eta_{\bar{Q}]\bar{N}} \theta, \\ \Theta_{\mathcal{A}|\mathcal{B}} = -\frac{1}{2} \theta \eta_{\mathcal{A}\mathcal{B}} + \frac{1}{96} \Gamma_{\mathcal{A}\mathcal{B}}^{\bar{M}\bar{N}\bar{P}\bar{Q}} \theta_{\bar{M}\bar{N}\bar{P}\bar{Q}}, \end{cases} \quad (3.55)$$

where  $\Gamma_{\mathcal{A}\mathcal{B}}^{\bar{M}\bar{N}\bar{P}\bar{Q}}$  denotes the four-fold product of  $SO(8,8)$   $\Gamma$  matrices. Introducing covariant derivatives

$$D_\mu = \partial_\mu - \mathcal{A}_\mu^{\bar{M}\bar{N}} \Theta_{\bar{M}\bar{N}|\bar{P}\bar{Q}} L^{[\bar{P}\bar{Q}]} - \mathcal{A}_\mu^{\mathcal{A}} \Theta_{\mathcal{A}|\mathcal{B}} Y^{\mathcal{B}}, \quad (3.56)$$

in the maximal theory, the gauge group is thus given by an extension of the gauge group of the half-maximal theory by the additional generators  $X_{\mathcal{A}} = \Theta_{\mathcal{A}|\mathcal{B}} Y^{\mathcal{B}}$ . We may now address the following question: given an embedding tensor (2.16) of the half-maximal  $SO(8,8)$  theory, satisfying the quadratic constraints (3.1), does the associated embedding tensor (3.55) satisfy the quadratic constraints of the maximal theory and thereby define a consistent gauging of the maximal theory? By consistency of the truncation, the  $\mathcal{N} = (8, 0)$  vacuum of the half-maximal theory then turns into a vacuum of some maximal gauged supergravity, breaking half of the supersymmetries spontaneously.

To answer this question, we recall that the quadratic constraints of the maximal theory transform in the

$$\mathbf{3875} \oplus \mathbf{147250} \quad (3.57)$$

under  $E_{8(8)}$ . Breaking these under  $SO(8,8)$  and restricting to the representations that can actually appear in the symmetric tensor product of two half-maximal embedding tensors shows that in order to define a maximal  $\mathcal{N} = 16$  gauging, the components of the embedding tensor (3.55) must satisfy

additional constraints transforming as  $35 \oplus 6435_c$ , *i.e.*

$$\begin{array}{c}
 \square \square \oplus \begin{array}{c} \square \\ \square \\ \square \\ \square \\ \square \\ \square \\ \square \\ \square \end{array}, \\
 \text{anti-selfdual}
 \end{array} \quad (3.58)$$

where the last term refers to the anti-selfdual contribution in the 8-fold antisymmetric tensor. These additional conditions may be worked out explicitly in analogy to Eq. (3.1) and take the following form

$$\begin{aligned}
 0 &= 6 \theta_{\overline{M}\overline{N}} + \theta_{\overline{M}}^{\overline{P}\overline{Q}\overline{R}} \theta_{\overline{N}\overline{P}\overline{Q}\overline{R}} - \frac{1}{16} \eta_{\overline{M}\overline{N}} \theta^{\overline{P}\overline{Q}\overline{R}\overline{S}} \theta_{\overline{P}\overline{Q}\overline{R}\overline{S}}, \\
 0 &= \Gamma_{\overline{A}\overline{B}}^{\overline{K}\overline{L}\overline{M}\overline{N}\overline{P}\overline{Q}\overline{R}\overline{S}} \theta_{\overline{K}\overline{L}\overline{M}\overline{N}} \theta_{\overline{P}\overline{Q}\overline{R}\overline{S}}.
 \end{aligned} \quad (3.59)$$

The choice of anti-selfduality (*v.s.* selfduality) in Eq. (3.58) is a pure convention here, depending on the embedding of  $SO(8, 8)$  into  $E_{8(8)}$ .

To summarize, an embedding tensor of the half-maximal theory which, in addition to the quadratic constraints (3.1) of the half-maximal theory, satisfies the additional constraints (3.59) defines a consistent maximal three-dimensional supergravity. The half-maximal theory is recovered upon truncation (3.52). Vacua of the half-maximal theory then give rise to vacua within the maximal theory. The additional constraints (3.59) can be checked for all the vacua we have identified. The results are collected in Tab. 3.4 and 3.5.

## 3.7 Summary

We have presented a classification of  $\mathcal{N} = (8, 0)$  AdS<sub>3</sub> vacua in half-maximal  $d = 3$  supergravities that feature  $OSp(8|2, \mathbb{R})$  as superisometry group. Analyzing the consistency constraints on the embedding tensor, we have determined the full set of possible gauge groups embedded in the  $SO(8, p)$  isometry group of ungauged  $d = 3$  supergravity, for  $p \leq 8$ . There are three other classes of such vacua, with superisometry groups  $F(4)$ ,  $SU(4|1, 1)$ , and  $OSp(4^*|4)$ , respectively. They all have been classified in Ref. [A]. For each of the vacua, we have determined the explicit embedding tensor, the gauge group embedded into the  $SO(8, p)$  and the physical mass spectrum, organized in terms of supermultiplets. For all the vacua identified, we have furthermore determined if and under which conditions the half-maximal theories admit an embedding into a maximal ( $\mathcal{N} = 16$ ) supergravity, with the gauge group enhanced by additional generators according to Eq. (3.55) and (3.56) above.

As a by-product of our constructions, we have also identified a number of AdS<sub>3</sub> vacua with  $\mathcal{N} = (7, 1)$  and  $\mathcal{N} = (7, 0)$  supersymmetry, respectively. We have shown that the latter vacua are realized in half-maximal theories that also admit fully supersymmetric  $\mathcal{N} = (8, 0)$  AdS<sub>3</sub> vacua as different stationary points in their scalar potential, *c.f.* Fig. 3.1 above. In particular, this indicates the existence of domain wall solutions interpolating between  $\mathcal{N} = (8, 0)$  and  $\mathcal{N} = (7, 0)$  AdS<sub>3</sub> vacua. It would be very interesting to generalize our findings to a classification of general fully supersymmetric  $\mathcal{N} = (n, 8 - n)$  vacua of the half-maximal theories. In this case, the classification will be organized by products of smaller supergroups, which presumably leaves even more possibilities for the potential

embeddings of their bosonic parts into  $SO(8, p)$ . Another extension of the present analysis would be to include AdS<sub>3</sub> solutions with less supersymmetry and relate to known solutions and structures such as Ref. [151–160].

Throughout, we have restricted the analysis to theories with  $p \leq 8$  matter multiplets. In this range, our classification is exhaustive. For general  $p$ , we expect the classification to straightforwardly extend to theories with chiral embedding of the  $R$ -symmetry group into the first factor of the compact  $SO(8) \times SO(p)$  invariance group. Indeed, we have identified various families of theories labeled by integers  $p_+, p_-$  which are defined for arbitrary (unbounded) values of these integers. For diagonal embedding of the  $R$ -symmetry group on the other hand, one may expect new patterns to arise, since with increasing  $p$ , also the number of possible distinct embeddings of  $SO(8)$  into  $SO(p)$  increases. In particular, there are maximal embeddings for arbitrarily high values of  $p$ . For  $\mathcal{N} = (4, 4)$  vacua, many theories based on different such embedding patterns have been identified in Ref. [161].

# 4 Chapter

---

# Kaluza-Klein spectroscopy

In the previous chapter, we considered three-dimensional supergravity solutions and computed the mass spectra of their three-dimensional fields. We now turn to  $\text{AdS}_3$  vacua sitting in consistent truncations of higher-dimensional theories. The spectrum of such vacua features Kaluza-Klein towers on top of the three-dimensional spectrum. We have already mentioned the importance of having an effective technique to compute Kaluza-Klein spectra around AdS vacua, as it is related to conformal dimensions of CFT operators in the context of the AdS/CFT holographic correspondence. Such a technique is provided by exceptional field theory [133, 134] for vacua sitting in four- and five dimensional maximal supergravity. We extend here this technique to compactifications to half-maximal supergravity in three dimensions, using  $\text{SO}(8, p)$  exceptional field theory [139].

After a brief review of the framework of the  $\text{SO}(8, p)$  exceptional field theory, we compute the expressions of the mass matrices for spin-2, vector and scalar fields around  $\text{AdS}_3$  vacua of three-dimensional half-maximal supergravity, and give the ones for gravitini and spin-1/2 fermions. We then illustrate the efficiency of these new tools on several examples. We first test the formulas using  $\mathcal{N} = (2, 0)$  six-dimensional supergravity on  $\text{AdS}_3 \times S^3$ . This example is particular, as its structure is sufficiently constrained by supersymmetry to allow a computation of the spectrum using only group theory [162]. We then turn to  $\mathcal{N} = (1, 1)$  supergravity in six dimensions, where the same vacuum  $\text{AdS}_3 \times S^3$  preserves only half of the supersymmetries, so that group theory fails to predict the masses in the spectrum. We also consider ten-dimensional supergravity on  $\text{AdS}_3 \times S^3 \times S^3 \times S^1$ , which constitutes another example where representation theory is not sufficient and an explicit calculation is needed [163, 164]. We finally demonstrate the effectiveness of the method by computing the scalar masses of the first Kaluza-Klein levels around the one-parameter family of non-supersymmetric vacua within the  $\mathcal{N} = (1, 1)$   $\text{AdS}_3 \times S^3$  theory [144]. We show that there is an interval of the parameter within which all these modes are stable.

## 4.1 $\text{SO}(8, p)$ exceptional field theory

First constructed in Ref. [139], the  $\text{SO}(8, p)$  exceptional field theory is a duality-covariant formulation of half-maximal supergravity, designed for studying compactifications to three spacetime dimensions<sup>40</sup>. Its fields live on a set of coordinates which contains three-dimensional external coordinates  $\{x^\mu\}$ ,  $\mu \in \llbracket 1, 3 \rrbracket$ , and internal coordinates  $\{Y^{[MN]}\}$  that live in the adjoint representation of  $\text{SO}(8, p)$ , with fundamental indices  $M, N \in \llbracket 1, 8 + p \rrbracket$ . All the fields of the theory depend on the full higher-dimensional

---

<sup>40</sup>The theories considered in Ref. [139] are more general and duality-covariant with respect to  $\text{O}(p, q)$ . In addition to the series  $\text{SO}(8, p)$  of half-maximal theories, it includes in particular the series of theories based on  $\text{SO}(4, p)$ , which reproduces the bosonic sector of certain quarter-maximal supergravities.

spacetime  $\{x^\mu, Y^{[MN]}\}$ , but the dependence on the latter is constrained by the section constraints

$$\begin{cases} \partial_{[MN} \otimes \partial_{PQ]} = 0, \\ \eta^{NP} \partial_{MN} \otimes \partial_{PQ} = 0, \end{cases} \quad (4.1)$$

with  $SO(8, p)$  invariant metric  $\eta_{MN}$ , which will be used in the following to raise and lower the internal indices. The notation  $\otimes$  indicates that both derivative operators may act on different fields.

The bosonic fields of the theory are the following:

$$\{g_{\mu\nu}, \mathcal{M}_{MN}, \mathcal{A}_\mu^{MN}, \mathcal{B}_{\mu MN}\}. \quad (4.2)$$

$g_{\mu\nu}$  describes the external metric, with signature  $(-1, 1, 1)$ , and  $\mathcal{M}_{MN} \in SO(8, p)$  the internal metric. The vector fields  $\mathcal{A}_\mu^{MN}$  and  $\mathcal{B}_{\mu MN}$  are labeled by internal indices in the adjoint representation of  $SO(8, p)$ .  $\mathcal{B}_{\mu MN}$  is covariantly constrained: it has to satisfy algebraic constraints similar to Eq. (4.1) and compatibility conditions with the partial derivatives given by

$$\begin{cases} \mathcal{B}_{\mu [MN} \mathcal{B}_{\mu PQ]} = 0, & \mathcal{B}_{\mu [MN} \partial_{PQ]} = 0, \\ \eta^{NP} \mathcal{B}_{\mu MN} \mathcal{B}_{\mu PQ} = 0, & \eta^{NP} \mathcal{B}_{\mu MN} \partial_{PQ} = 0. \end{cases} \quad (4.3)$$

Its presence is necessary for the closure of the non-abelian gauge transformations [139].

#### 4.1.1 Generalized internal diffeomorphisms and Lagrangian

The theory is invariant under local generalized internal diffeomorphisms, defined by their action on a vector  $V^M$ :

$$\mathcal{L}_{(\Lambda, \Sigma)} V^M = \Lambda^{KL} \partial_{KL} V^M + 2 \left( \partial^{KM} \Lambda_{KN} - \partial_{KN} \Lambda^{KM} + 2 \Sigma^M_N \right) V^N. \quad (4.4)$$

Their action on a tensor with an arbitrary number of fundamental  $SO(8, p)$  indices follows naturally. The gauge parameters  $\Sigma_{MN}$  are subject to the same constraints as  $\mathcal{B}_{\mu MN}$ :

$$\begin{cases} \Sigma_{[MN} \Sigma_{PQ]} = 0, & \Sigma_{[MN} \partial_{PQ]} = 0, \\ \eta^{NP} \Sigma_{MN} \Sigma_{PQ} = 0, & \eta^{NP} \Sigma_{MN} \partial_{PQ} = 0. \end{cases} \quad (4.5)$$

The covariant external derivatives associated to such transformations are defined as

$$D_\mu = \partial_\mu - \mathcal{L}_{(\mathcal{A}_\mu, \mathcal{B}_\mu)}, \quad (4.6)$$

and ensure the invariance of the action.

The full Lagrangian has the following form:

$$\mathcal{L} = \mathcal{L}_{\text{EH}} + \mathcal{L}_{\text{kin}} + \mathcal{L}_{\text{CS}} - \sqrt{-g} V. \quad (4.7)$$

$\mathcal{L}_{\text{EH}}$  is the modified Einstein-Hilbert term, defined in terms of the external dreibein  $e_\mu^a$  and the covariantized Riemann tensor  $\widehat{R}_{\mu\nu}{}^{ab}$ :

$$\mathcal{L}_{\text{EH}} = \sqrt{-g} e_a^\mu e_b^\nu \left( \widehat{R}_{\mu\nu}{}^{ab} + F_{\mu\nu}{}^{MN} e^{a\rho} \partial_{MN} e_\rho^b \right), \quad (4.8)$$

where the Yang-Mills field strength  $F_{\mu\nu}{}^{MN}$  has the expression

$$F_{\mu\nu}{}^{MN} = 2 \partial_{[\mu} \mathcal{A}_{\nu]}{}^{MN} - \mathcal{A}_{[\mu}{}^{KL} \partial_{KL} \mathcal{A}_{\nu]}{}^{MN} + \mathcal{A}_{[\mu}{}^{MN} \partial_{KL} \mathcal{A}_{\nu]}{}^{KL} + 4 \mathcal{A}_{[\mu}{}^{K[M} \partial_{KL} \mathcal{A}_{\nu]}{}^{N]L} - 4 \mathcal{A}_{[\mu}{}^{K[M} \partial^{N]L} \mathcal{A}_{\nu]}{}_{KL}, \quad (4.9)$$

as implied by the commutator of Eq. (4.6). The scalar kinetic term has the usual form

$$\mathcal{L}_{\text{kin}} = \frac{1}{8} \sqrt{-g} D_{\mu} \mathcal{M}_{MN} D^{\mu} \mathcal{M}^{MN}, \quad (4.10)$$

and describes a  $\text{SO}(8, p)/(\text{SO}(8) \times \text{SO}(p))$  coset space  $\sigma$ -model. Finally, the Chern-Simons term is given by<sup>41</sup>

$$\mathcal{L}_{\text{CS}} = \sqrt{2} \varepsilon^{\mu\nu\rho} \left( F_{\mu\nu}{}^{MN} \mathcal{B}_{\rho MN} + \partial_{\mu} \mathcal{A}_{\nu N}{}^K \partial_{KM} \mathcal{A}_{\rho}{}^{MN} - \frac{2}{3} \partial_{MN} \partial_{KL} \mathcal{A}_{\mu}{}^{KP} \mathcal{A}_{\nu}{}^{MN} \mathcal{A}_{\rho P}{}^L + \frac{2}{3} \mathcal{A}_{\mu}{}^{LN} \partial_{MN} \mathcal{A}_{\nu}{}^M{}_P \partial_{KL} \mathcal{A}_{\rho}{}^{PK} - \frac{4}{3} \mathcal{A}_{\mu}{}^{LN} \partial_{MP} \mathcal{A}_{\nu}{}^M{}_N \partial_{KL} \mathcal{A}_{\rho}{}^{PK} \right), \quad (4.11)$$

and the so-called potential is bilinear in internal derivatives<sup>42</sup>:

$$V_{\text{ExFT}} = -\frac{1}{8} \partial_{KL} \mathcal{M}_{MN} \partial_{PQ} \mathcal{M}^{MN} \mathcal{M}^{KP} \mathcal{M}^{LQ} - \partial_{MK} \mathcal{M}^{NP} \partial_{NL} \mathcal{M}^{MQ} \mathcal{M}_{PQ} \mathcal{M}^{KL} + \frac{1}{4} \partial_{MN} \mathcal{M}^{PK} \partial_{KL} \mathcal{M}^{MQ} \mathcal{M}_P{}^L \mathcal{M}_Q{}^N + \partial_{MK} \mathcal{M}^{NK} \partial_{NL} \mathcal{M}^{ML} - g^{-1} \partial_{MN} g \partial_{KL} \mathcal{M}^{MK} \mathcal{M}^{NL} - \frac{1}{4} \mathcal{M}^{MK} \mathcal{M}^{NL} g^{-2} \partial_{MN} g \partial_{KL} g - \frac{1}{4} \mathcal{M}^{MK} \mathcal{M}^{NL} \partial_{MN} g_{\mu\nu} \partial_{KL} g^{\mu\nu}. \quad (4.12)$$

Once restricted to a solution of the section constraints (4.1), the theory (4.7) describes higher-dimensional supergravity.

### 4.1.2 Generalized Scherk-Schwarz ansatz

One of the main applications of exceptional field theories is the construction of consistent truncations [165–167]. These truncations can be defined by a generalized Scherk-Schwarz compactification ansatz that encodes the dependence of the fields on the internal coordinates in a twist matrix and a weight factor  $\rho(Y)$ . The twist matrix is an  $\text{SO}(8, p)$ -valued matrix  $U_M{}^{\bar{N}}(Y)$ , so that the compactification ansätze for the fields take the form [139]<sup>43</sup>

$$\begin{aligned} g_{\mu\nu}(x, Y) &= \rho(Y)^{-2} g_{\mu\nu}(x), \\ \mathcal{M}_{MN}(x, Y) &= U_M{}^{\bar{M}}(Y) U_N{}^{\bar{N}}(Y) \mathcal{M}_{\bar{M}\bar{N}}(x), \\ \mathcal{A}_{\mu}{}^{MN}(x, Y) &= \sqrt{2} \rho(Y)^{-1} U^M{}_{\bar{M}}(Y) U^N{}_{\bar{N}}(Y) \mathcal{A}_{\mu}{}^{\bar{M}\bar{N}}(x), \\ \mathcal{B}_{\mu MN}(x, Y) &= -\frac{1}{2\sqrt{2}} \rho(Y)^{-1} U^K{}_{\bar{N}}(Y) \partial_{MN} U_{K\bar{M}}(Y) \mathcal{A}_{\mu}{}^{\bar{M}\bar{N}}(x). \end{aligned} \quad (4.13)$$

<sup>41</sup>  $\varepsilon^{\mu\nu\rho}$  denotes the constant Levi-Civita density.

<sup>42</sup> This expression differs from the one given in Ref. [139]: we have corrected some coefficients.

<sup>43</sup> The conventions we adopt are not exactly the ones of Ref. [139]. We introduced  $\sqrt{2}$  factors for the vector fields, and in the expression of the embedding tensor in Eq. (4.16), to ensure that the three-dimensional theory is the one described in Chap. 2.

The indices  $\bar{M} \in \llbracket 1, 8 + p \rrbracket$  are flat, fundamental  $\text{SO}(8, p)$  indices and describe three-dimensional quantities. They are the same indices as the ones encountered in Chap. 2. All the information of the internal manifold is encoded in the twist matrix, and the fields that depend on the external coordinates only are the fields of three-dimensional gauged supergravity. We also consider gauged parameters of the following form:

$$\begin{aligned}\Lambda^{MN}(x, Y) &= \sqrt{2} \rho(Y)^{-1} U^M_{\bar{M}}(Y) U^N_{\bar{N}}(Y) \Lambda^{\bar{M}\bar{N}}(x), \\ \Sigma_{MN}(x, Y) &= -\frac{1}{2\sqrt{2}} \rho(Y)^{-1} U^K_{\bar{N}}(Y) \partial_{MN} U_{K\bar{M}}(Y) \Lambda^{\bar{M}\bar{N}}(x).\end{aligned}\quad (4.14)$$

The consistency of the truncation can then be written in terms of differential equations on the weight factor and the twist matrix. Defining the embedding tensor

$$\Theta_{\bar{M}\bar{N}|\bar{P}\bar{Q}} = \theta_{\bar{M}\bar{N}\bar{P}\bar{Q}} + \frac{1}{2} \left( \eta_{\bar{P}[\bar{M}} \theta_{\bar{N}]\bar{Q}} - \eta_{\bar{Q}[\bar{M}} \theta_{\bar{N}]\bar{P}} \right) + \theta \eta_{\bar{P}[\bar{M}} \eta_{\bar{N}]\bar{Q}}, \quad (4.15)$$

with components

$$\begin{aligned}\theta_{\bar{M}\bar{N}\bar{P}\bar{Q}} &= 3\sqrt{2} \rho^{-1} \partial_{PQ} U_{M[\bar{M}} U^M_{\bar{N}} U^P_{\bar{P}} U^Q_{\bar{Q}]}, \\ \theta_{\bar{M}\bar{N}} &= 2\sqrt{2} \rho^{-1} U^M_{\bar{M}} \partial_{MN} U^N_{\bar{N}} - \eta_{\bar{M}\bar{N}} \theta - 2\sqrt{2} \rho^{-2} U^M_{\bar{M}} U^N_{\bar{N}} \partial_{MN} \rho, \\ \theta &= \frac{2\sqrt{2}}{8+p} \rho^{-1} U^{P\bar{Q}} \partial_{PQ} U^Q_{\bar{Q}},\end{aligned}\quad (4.16)$$

the consistency of the truncation is ensured if all the components of the embedding tensor are constant: all dependences on the internal coordinates in the equations of motion are then factored out, and  $\Theta_{\bar{M}\bar{N}|\bar{P}\bar{Q}}$  captures the gauge structure of the three-dimensional theory. The quadratic constraint

$$\Theta_{\bar{K}\bar{L}|\bar{P}}^{\bar{R}} \Theta_{\bar{M}\bar{N}|\bar{R}}^{\bar{Q}} - \Theta_{\bar{M}\bar{N}|\bar{P}}^{\bar{R}} \Theta_{\bar{K}\bar{L}|\bar{R}}^{\bar{Q}} = 2 \Theta_{\bar{K}\bar{L}|\bar{M}}^{\bar{R}} \Theta_{\bar{N}|\bar{R}|\bar{P}}^{\bar{Q}}, \quad (4.17)$$

needed to ensure the closure of the gauged algebra (*c.f.* Chap. 2), is automatically satisfied thanks to the section constraints (4.1). The consistency conditions for the twist matrix and the weight factor can also be expressed as

$$\mathcal{L}_{(\Lambda^{MN}, \Sigma_{MN})} U^P_{\bar{P}} = 2 \Lambda^{\bar{M}\bar{N}} \Theta_{\bar{M}\bar{N}|\bar{P}}^{\bar{Q}} U^P_{\bar{Q}}, \quad (4.18)$$

and accordingly as conditions of generalized parallelizability [139].

We further impose the tensor  $\theta_{\bar{M}\bar{N}}$  defined in Eq. (4.16) to be symmetric. Indeed, if its anti-symmetric part is non-vanishing, the three-dimensional field equations include a gauging of the trombone scaling symmetry [139] and, in turn, the resulting theory does not admit a three-dimensional action. Let us finally note that the definition (4.16) together with the constraints (4.1) imposes

$$\theta_{[\bar{K}\bar{L}\bar{M}\bar{N}]\bar{P}\bar{Q}\bar{R}\bar{S}} = 0. \quad (4.19)$$

Thus, the only gaugings that can be reproduced by this generalized Scherk-Schwarz procedure are those which satisfy this additional constraint. This is consistent with the fact that the potential (4.12) cannot produce terms proportional to  $\theta_{[\bar{K}\bar{L}\bar{M}\bar{N}]\bar{P}\bar{Q}\bar{R}\bar{S}}$ , whereas the most general potential of three-dimensional half-maximal gauged supergravity, given in Eq. (2.24), carries such a term.

## 4.2 Fluctuation ansatz

We consider a fixed  $\text{AdS}_3 \times \mathcal{K}$  supergravity background, with internal manifold  $\mathcal{K}$ , which in the three-dimensional supergravity variables takes the diagonal form

$$\{g_{\mu\nu} = \mathring{g}_{\mu\nu}, \mathcal{M}_{\bar{M}\bar{N}} = \Delta_{\bar{M}\bar{N}}, \mathcal{A}_\mu^{\bar{M}\bar{N}} = 0\}. \quad (4.20)$$

As exposed in Chap. 1, to compute the full Kaluza-Klein spectrum around this background, we need to consider linear fluctuations which we expand in terms of a basis of the fields on the internal manifold. To do so, we exploit the powerful ansätze of Ref. [134]: by introducing the fluctuations directly in the exceptional field theory ansätze (4.13), all the tensorial structure of the fields is factored out, so that they are scalars on the internal manifold. We then only need a basis of scalar harmonics  $\mathcal{Y}^\Sigma$ . We thus consider the following linear fluctuations<sup>44</sup>:

$$\begin{aligned} g_{\mu\nu}(x, Y) &= \rho(Y)^{-2} \left( \mathring{g}_{\mu\nu}(x) + \mathcal{Y}^\Sigma(Y) \mathring{g}_{\mu\nu}{}^\Sigma(x) \right), \\ \mathcal{M}_{MN}(x, Y) &= U_M^{\bar{M}}(Y) U_N^{\bar{N}}(Y) \left( \Delta_{\bar{M}\bar{N}} + \mathcal{Y}^\Sigma(Y) j_{\bar{M}\bar{N}}{}^\Sigma(x) \right), \\ \mathcal{A}_\mu^{MN}(x, Y) &= \sqrt{2} \rho(Y)^{-1} U_{\bar{M}}^M(Y) U_{\bar{N}}^N(Y) \mathcal{Y}^\Sigma(Y) A_\mu^{\bar{M}\bar{N}, \Sigma}(x), \\ \mathcal{B}_{\mu MN}(x, Y) &= -\frac{1}{2\sqrt{2}} \rho(Y)^{-1} U_{\bar{N}}^K(Y) \partial_{MN} U_{K\bar{M}}(Y) \mathcal{Y}^\Sigma(Y) A_\mu^{\bar{M}\bar{N}, \Sigma}(x). \end{aligned} \quad (4.21)$$

For the internal metric  $\mathcal{M}_{MN}$  to belong to  $\text{SO}(8, p)$ , the scalar fluctuations  $j_{\bar{M}\bar{N}}{}^\Sigma$  are such that

$$\Delta_{\bar{P}(\bar{M}} \eta^{\bar{P}\bar{Q}} j_{\bar{N})\bar{Q}}{}^\Sigma = 0. \quad (4.22)$$

As the topology of the compactification is the same for any solution of the three-dimensional theory, we consider harmonics that form representations of the largest symmetry group possible, noted  $G_{\text{max}}$ , which corresponds to the maximally supersymmetric point of the three-dimensional gauged supergravity [134]. The action of the internal derivatives on the scalar harmonics is then given by

$$\rho^{-1} U_{\bar{M}}^M U_{\bar{N}}^N \partial_{MN} \mathcal{Y}^\Sigma = -\sqrt{2} \mathcal{T}_{\bar{M}\bar{N}}{}^{\Sigma\Omega} \mathcal{Y}^\Omega. \quad (4.23)$$

The matrices  $\mathcal{T}_{\bar{M}\bar{N}}{}^{\Sigma\Omega}$  correspond to the generators of  $G_{\text{max}}$  in the representation of the scalar harmonics. They are normalized with respect to the embedding tensor:

$$\left[ \mathcal{T}_{\bar{M}\bar{N}}, \mathcal{T}_{\bar{P}\bar{Q}} \right] = -\Theta_{\bar{M}\bar{N}|\bar{P}}^{\bar{K}} \mathcal{T}_{\bar{Q}\bar{K}} + \Theta_{\bar{P}\bar{Q}|\bar{M}}^{\bar{K}} \mathcal{T}_{\bar{N}\bar{K}}. \quad (4.24)$$

We will further restrict ourselves to theories with compact  $G_{\text{max}}$ . The matrices  $\mathcal{T}_{\bar{M}\bar{N}}$  are then antisymmetric:  $\mathcal{T}_{\bar{M}\bar{N}}{}^{\Sigma\Omega} = -\mathcal{T}_{\bar{M}\bar{N}}{}^{\Omega\Sigma}$ .

## 4.3 Mass matrices

We use in the following the ansätze (4.21) to compute the mass matrices around the background (4.20). The Kaluza-Klein towers will contain massive spin-2 fields and massive vectors, which are, respectively, induced by Goldstone modes in the vectors and scalars spectra *via* Brout-Englert-Higgs (BEH)

<sup>44</sup>We consider fluctuations for  $\mathcal{B}_{\mu MN}$  that depend on the ones of  $\mathcal{A}_\mu^{MN}$  to ensure the consistency of the linearized equations of motion, as we will see in Sec. 4.3.2.



mechanisms: each massive spin-2 field absorbs a vector and a scalar, all representatives of the same representation, and each massive vector absorbs a massless scalar, also in the same representation. These modes have to be eliminated from the spectra calculated from the mass matrices given below. We refer to Ref. [134] for a complete account of these effects.

### 4.3.1 Spin-2 fields

The mass matrix for the spin-2 fields can be computed in the standard supergravity formulation by solving a wave equation on the internal space [111]. In the context of exceptional field theory, it features a universal form [134] (see also Ref. [168]), which we simply reproduce here<sup>45</sup>:

$$M_{(2)}^{2\Sigma\Omega} = -2\Delta^{\bar{M}\bar{P}}\Delta^{\bar{N}\bar{Q}}\mathcal{T}_{\bar{M}\bar{N}}^{\Sigma\Gamma}\mathcal{T}_{\bar{P}\bar{Q}}^{\Gamma\Omega}. \quad (4.25)$$

In three dimensions each eigenstate of  $M_{(2)}^{2\Sigma\Omega}$  gives rise to two degrees of freedom, one with helicity  $s = 2$  and one with helicity  $s = -2$ .

### 4.3.2 Vector mass matrix

To compute the vector mass matrix, we start from the variation of the Lagrangian (4.7) with respect to the vectors  $\mathcal{A}_\mu^{MN}$  and  $\mathcal{B}_{\mu MN}$

$$\delta_{(\mathcal{A},\mathcal{B})}\mathcal{L} = \varepsilon^{\mu\nu\rho} \left( \mathcal{E}_{\mu\nu}^{(A)MN} \delta\mathcal{B}_{\rho MN} + \mathcal{E}_{\mu\nu MN}^{(B)} \delta\mathcal{A}_\rho^{MN} \right), \quad (4.26)$$

where [139]

$$\begin{aligned} \mathcal{E}_{\mu\nu}^{(A)MN} &= \sqrt{2}F_{\mu\nu}^{MN} - \sqrt{-g}\varepsilon_{\mu\nu\rho}j^{\rho MN}, \\ \mathcal{E}_{\mu\nu MN}^{(B)} &= \sqrt{2}G_{\mu\nu MN} + \sqrt{-g}\varepsilon_{\mu\nu\rho}J^{\rho MN} - \frac{1}{8}\sqrt{-g}\varepsilon_{\mu\nu\rho}j^{\rho K}{}_L\mathcal{J}_{MN}{}^L{}_K + \partial_{MK}\mathcal{E}_{\mu\nu}{}^N{}^K. \end{aligned} \quad (4.27)$$

The field strength  $F_{\mu\nu}^{MN}$  has been given in Eq. (4.9).  $G_{\mu\nu MN}$  and the different currents are defined as follows:

$$G_{\mu\nu MN} = 2D_{[\mu}\mathcal{B}_{\nu]MN} - \mathcal{A}_{[\mu K}{}^P\partial_{PQ}\partial_{MN}\mathcal{A}_{\nu]}{}^{KQ}, \quad (4.28a)$$

$$\mathcal{J}_{MN,KL} = \partial_{MN}\mathcal{M}_{LP}\mathcal{M}^P{}_K, \quad (4.28b)$$

$$j_\mu{}^{MN} = \eta_{KL}\mathcal{M}^{K[M}D_\mu\mathcal{M}^{N]L}, \quad (4.28c)$$

$$J^\mu{}_{MN} = -2e^\mu{}_ae^\nu{}_b \left[ \partial_{MN}\omega_\nu{}^{ab} - D_\nu \left( e^{\rho[a}\partial_{MN}e_\rho{}^{b]} \right) \right], \quad (4.28d)$$

with the spin connection  $\omega_\nu{}^{ab}$ . Injecting the fluctuations (4.21) in Eq. (4.9) and (4.28a)–(4.28d) and considering the linearization with respect to the fluctuation  $A_\mu^{\bar{M}\bar{N},\Sigma}$ , we get

$$F_{\mu\nu}^{MN} \Big|_{\text{lin.}} = \rho^{-1}U^M{}_{\bar{M}}U^N{}_{\bar{N}}2\sqrt{2}\partial_{[\mu}A_{\nu]}^{\bar{M}\bar{N},\Sigma}\mathcal{Y}^\Sigma, \quad (4.29)$$

$$G_{\mu\nu MN} \Big|_{\text{lin.}} = -\frac{1}{\sqrt{2}}\rho^{-1}U^K{}_{\bar{N}}\partial_{MN}U_{K\bar{M}}\partial_{[\mu}A_{\nu]}^{\bar{M}\bar{N},\Sigma}\mathcal{Y}^\Sigma, \quad (4.30)$$

$$j_\mu{}^{MN} \Big|_{\text{lin.}} = 2U^{[M}{}_{\bar{M}}U^{N]}{}_{\bar{N}} \left( \Delta^{\bar{M}\bar{K}}\Delta^{\bar{N}\bar{L}} - \eta^{\bar{M}\bar{K}}\eta^{\bar{N}\bar{L}} \right) \left[ \Theta_{\bar{K}\bar{L}|\bar{P}\bar{Q}}\delta^{\Sigma\Omega} + 4\mathcal{T}_{\bar{P}\bar{K}}^{\Sigma\Omega}\eta_{\bar{L}\bar{Q}} \right] A_\mu^{\bar{P}\bar{Q},\Sigma}\mathcal{Y}^\Omega. \quad (4.31)$$

<sup>45</sup>The factor 2, which differs from the expressions in higher dimensions, comes from the conventions adopted in Eq. (4.23).

Thus, once linearized, the variation (4.26) takes the form

$$\begin{aligned} \delta_{(A,B)} \mathcal{L} \Big|_{\text{lin.}} = & -\varepsilon^{\mu\nu\rho} \rho^{-1} \left( \Theta_{\bar{M}\bar{N}|\bar{U}\bar{V}} \delta^{\Sigma\Omega} + 4 \mathcal{T}_{\bar{U}[\bar{M}}^{\Sigma\Omega} \eta_{\bar{N}]\bar{V}} \right) \delta A_{\rho}^{\bar{U}\bar{V},\Delta} \mathcal{Y}^{\Delta} \mathcal{Y}^{\Omega} \\ & \times \left[ 2 \partial_{[\mu} A_{\nu]}^{\bar{M}\bar{N},\Sigma} + \sqrt{-\bar{g}} \varepsilon_{\mu\nu\sigma} M_{(1)}^{\bar{M}\bar{N}\Sigma} \frac{\Gamma}{\bar{P}\bar{Q}} A^{\sigma\bar{P}\bar{Q},\Gamma} \right], \end{aligned} \quad (4.32)$$

with the mass matrix of the vector fields

$$M_{(1)}^{\bar{M}\bar{N}\Sigma} \frac{\Omega}{\bar{P}\bar{Q}} = \left( \eta^{\bar{K}[\bar{M}} \eta^{\bar{N}]\bar{L}} - \Delta^{\bar{K}[\bar{M}} \Delta^{\bar{N}]\bar{L}} \right) \left( X_{\bar{K}\bar{L}|\bar{P}\bar{Q}} \delta^{\Sigma\Omega} + 4 \mathcal{T}_{\bar{K}[\bar{P}}^{\Sigma\Omega} \eta_{\bar{Q}]\bar{L}} \right). \quad (4.33)$$

As the equations of motion are of first order, each eigenstate of the mass matrix gives rise to a single degree of freedom, whose helicity is given by the sign of its eigenvalue.

The second line of Eq. (4.32) is the equation of motion of a topologically massive vector in three dimensions. In absence of the  $\mathcal{T}$  tensors, it reproduces the Scherk-Schwarz reduction to three dimensions, and  $M_{(1)}^{\bar{M}\bar{N}\Sigma} \frac{\Omega}{\bar{P}\bar{Q}}$  reduces to Eq. (3.6b), for  $\Delta_{\bar{M}\bar{N}} = \delta_{\bar{M}\bar{N}}$  and in the basis where  $\eta_{\bar{M}\bar{N}}$  is diagonal. The  $\mathcal{T}$  tensors capture the effect of internal derivatives on the harmonics. In Eq. (4.32), the equation of motion is further contracted with another mass matrix (4.33). This imposes that the eigenvectors of  $M_{(1)}^{\bar{M}\bar{N}\Sigma} \frac{\Omega}{\bar{P}\bar{Q}}$  with vanishing eigenvalues are projected out of the equation of motion, and do not belong to the physical spectrum.

### 4.3.3 Scalar mass matrix

The computation of the scalar mass matrix, though more involved, follows the same steps as the ones of the vector mass matrix. First, the variation of the Lagrangian (4.7) with respect to  $\mathcal{M}_{MN}$  has the form

$$\delta_{\mathcal{M}} \mathcal{L} = \mathcal{K}_{MN}^{(\mathcal{M})} \delta \mathcal{M}^{MN}. \quad (4.34)$$

For readability,  $\mathcal{K}_{MN}^{(\mathcal{M})}$  is given in App. B. As  $\mathcal{M}_{MN} \in \text{SO}(8,p)$ , it is a constrained field and one has to project  $\mathcal{K}_{MN}^{(\mathcal{M})}$  onto symmetric coset valued indices to produce the equations of motion. It remains then to inject the fluctuations (4.21) in  $\mathcal{K}_{MN}^{(\mathcal{M})}$  and to linearize with respect to  $j_{\bar{M}\bar{N}}^{\Sigma}$ . Contrary to the vectors, the equations of motion of the scalars are however of second order in internal derivatives, which complicates considerably the task of factoring out the dependence on the internal coordinates. The computation is however made easier by adopting the following strategy [134]: when an internal derivative hits the linear fluctuations (4.21), it produces derivatives  $\partial U$  and  $\partial \rho$  of the twist matrix and the weight factor, which will contribute to the embedding tensor (4.16), as well as derivatives  $\partial \mathcal{Y}$  of the harmonics, which will form  $\mathcal{T}$  tensors following Eq. (4.23). As the equation of motion is of second order in internal derivatives, the squared scalar mass matrix will be schematically organized into

$$M_{(0)}^2 = \theta\theta + \theta\mathcal{T} + \mathcal{T}\mathcal{T}. \quad (4.35)$$

The  $\theta\theta$  term is given by construction by the scalar mass matrix of the three dimensional gauged supergravity, and it can be extracted from the three-dimensional potential (2.24), as we've done in Eq. (3.7). We could then focus on the remaining terms while linearizing the equation of motion and injecting the fluctuations ansätze. As we are not considering the  $\theta\theta$  term, it is sufficient to contract the linearization of  $\mathcal{K}_{MN}^{(\mathcal{M})}$  with  $j^{MN,\Sigma} = U^{\bar{M}\bar{M}} U^{\bar{N}\bar{N}} j_{\bar{M}\bar{N}}^{\Sigma}$  to restrict ourselves on symmetric coset valued

indices. For example, the first term of the ExFT potential (4.12) contributes to  $\mathcal{K}_{MN}^{(\mathcal{M})}$  with a term

$$\frac{1}{4} \sqrt{-g} \partial_{ML} \mathcal{M}_{KP} \partial_{NQ} \mathcal{M}^{KP} \mathcal{M}^{LQ}, \quad (4.36)$$

which, once linearized and projected onto symmetric coset valued indices, gives

$$\begin{aligned} \frac{1}{4} \sqrt{-g} j^{MN, \Sigma} \partial_{ML} \mathcal{M}_{KP} \partial_{NQ} \mathcal{M}^{KP} \mathcal{M}^{LQ} \\ = - \sqrt{-g} \rho^{-1} j^{\bar{M}\bar{N}, \Sigma} j^{\bar{P}\bar{Q}, \Omega} \mathcal{Y}^{\Delta} J_{\bar{R}\bar{P}|\bar{M}\bar{K}} \Delta_{\bar{Q}}^{\bar{R}} \Delta^{\bar{K}\bar{L}} \mathcal{T}_{\bar{N}\bar{L}}^{\Omega \Delta} + (\dots), \end{aligned} \quad (4.37)$$

where we noted  $J_{\bar{K}\bar{L}|\bar{P}\bar{Q}} = \rho^{-1} \partial_{PQ} U_{K\bar{K}} U^{\bar{K}}_L U^P_{\bar{P}} U^Q_{\bar{Q}}$ . The ellipses denote the terms which do not contribute to the  $\theta\mathcal{T} + \mathcal{T}\mathcal{T}$  terms. After considering all the terms in  $\mathcal{K}_{MN}^{(\mathcal{M})}$  and restoring the  $\theta\theta$  terms, the linearization finally results in the following mass matrix:

$$M_{(0)\bar{M}\bar{N}}^2 \Sigma_{\bar{P}\bar{Q}}^{\Omega} j^{\bar{M}\bar{N}, \Sigma} j^{\bar{P}\bar{Q}, \Omega} = \left( m_{\bar{M}\bar{N}, \bar{P}\bar{Q}} \delta^{\Sigma\Omega} + m'_{\bar{M}\bar{N}} \Sigma_{\bar{P}\bar{Q}}^{\Omega} \right) j^{\bar{M}\bar{N}, \Sigma} j^{\bar{P}\bar{Q}, \Omega}, \quad (4.38)$$

where

$$\begin{aligned} m_{\bar{M}\bar{N}, \bar{P}\bar{Q}} &= 4 \theta_{\bar{M}\bar{P}\bar{K}\bar{L}} \theta_{\bar{N}\bar{Q}\bar{R}\bar{S}} \Delta^{\bar{K}\bar{R}} \Delta^{\bar{L}\bar{S}} + \frac{4}{3} \theta_{\bar{M}\bar{U}\bar{K}\bar{L}} \theta_{\bar{P}\bar{V}\bar{R}\bar{S}} \delta_{\bar{N}\bar{Q}} \Delta^{\bar{U}\bar{V}} \Delta^{\bar{K}\bar{R}} \Delta^{\bar{L}\bar{S}} \\ &\quad - 4 \theta_{\bar{M}\bar{P}\bar{K}\bar{L}} \theta_{\bar{N}\bar{Q}}^{\bar{K}\bar{L}} - 4 \theta_{\bar{M}\bar{U}\bar{K}\bar{L}} \theta_{\bar{P}\bar{V}}^{\bar{K}\bar{L}} \delta_{\bar{N}\bar{Q}} \Delta^{\bar{U}\bar{V}} + \frac{8}{3} \theta_{\bar{M}\bar{U}\bar{K}\bar{L}} \theta_{\bar{P}}^{\bar{U}\bar{K}\bar{L}} \delta_{\bar{N}\bar{Q}} \\ &\quad + 2 \theta_{\bar{M}\bar{P}} \theta_{\bar{N}\bar{Q}} - \theta_{\bar{M}\bar{N}} \theta_{\bar{P}\bar{Q}} + 2 \theta_{\bar{M}\bar{K}} \theta_{\bar{P}\bar{L}} \delta_{\bar{N}\bar{Q}} \Delta^{\bar{K}\bar{L}} \\ &\quad - \theta_{\bar{M}\bar{P}} \theta_{\bar{K}\bar{L}} \delta_{\bar{N}\bar{Q}} \Delta^{\bar{K}\bar{L}} + 16 \theta \theta_{\bar{M}\bar{P}} \delta_{\bar{N}\bar{Q}}, \\ m'_{\bar{M}\bar{N}} \Sigma_{\bar{P}\bar{Q}}^{\Omega} &= 8 \theta_{\bar{M}\bar{P}\bar{R}\bar{K}} \Delta_{\bar{N}}^{\bar{R}} \Delta^{\bar{K}\bar{L}} \mathcal{T}_{\bar{Q}\bar{L}}^{\Sigma\Omega} + 8 \theta_{\bar{M}\bar{P}\bar{R}\bar{K}} \Delta_{\bar{Q}}^{\bar{R}} \Delta^{\bar{K}\bar{L}} \mathcal{T}_{\bar{N}\bar{L}}^{\Sigma\Omega} \\ &\quad - 8 \eta_{\bar{M}\bar{P}} \theta_{\bar{N}\bar{Q}\bar{K}\bar{L}} \Delta^{\bar{K}\bar{R}} \Delta^{\bar{L}\bar{S}} \mathcal{T}_{\bar{R}\bar{S}}^{\Sigma\Omega} + 8 \eta_{\bar{M}\bar{P}} \theta_{\bar{N}\bar{Q}\bar{K}\bar{L}} \mathcal{T}^{\bar{K}\bar{L}\Sigma\Omega} \\ &\quad + 8 (\theta_{\bar{M}\bar{P}} + \theta \eta_{\bar{M}\bar{P}}) \mathcal{T}_{\bar{N}\bar{Q}}^{\Sigma\Omega} + 2 \eta_{\bar{M}\bar{P}} \eta_{\bar{N}\bar{Q}} \Delta^{\bar{K}\bar{R}} \Delta^{\bar{L}\bar{S}} \mathcal{T}_{\bar{K}\bar{L}}^{\Sigma\Lambda} \mathcal{T}_{\bar{R}\bar{S}}^{\Lambda\Omega} \\ &\quad + 16 \Delta_{\bar{M}\bar{P}} \Delta^{\bar{K}\bar{L}} \mathcal{T}_{\bar{Q}\bar{L}}^{\Sigma\Lambda} \mathcal{T}_{\bar{N}\bar{K}}^{\Lambda\Omega} - 4 \Delta_{\bar{M}}^{\bar{K}} \Delta_{\bar{P}}^{\bar{L}} \mathcal{T}_{\bar{Q}\bar{L}}^{\Sigma\Lambda} \mathcal{T}_{\bar{N}\bar{K}}^{\Lambda\Omega} + 16 \mathcal{T}_{\bar{M}\bar{P}}^{\Sigma\Lambda} \mathcal{T}_{\bar{N}\bar{Q}}^{\Lambda\Omega}. \end{aligned} \quad (4.40)$$

For  $\Delta_{\bar{M}\bar{N}} = \delta_{\bar{M}\bar{N}}$  and in the basis (2.1) where  $\eta_{\bar{M}\bar{N}}$  is diagonal,  $m_{\bar{M}\bar{N}, \bar{P}\bar{Q}}$  reduces to Eq. (3.7).

#### 4.3.4 Fermions mass matrices

The exceptional field theory techniques of Ref. [133, 134] have recently been extended to include mass matrices for gravitino and spin-1/2 fields for vacua sitting in maximal gauged supergravity in four dimensions [140]. With my collaborators G. Larios and H. Samtleben, we applied the tools of Ref. [140] to the half-maximal three-dimensional case in Ref. [E]. Our results are reproduced here.

As seen in Chap. 3, the mass matrices for the spin-3/2 and spin-1/2 fields are most simply expressed in the basis (2.1), where the  $\text{SO}(8, p)$ -invariant tensor  $\eta_{\bar{M}\bar{N}}$  is diagonal, and depend on the fermionic matrices  $A_1^{AB}$  and  $A_3^{\dot{A}r\dot{B}s}$ , defined in Eq. (2.23). Extended to Kaluza-Klein fluctuations, they read

$$M_{(3/2)}^{A\Sigma, B\Omega} = -A_1^{AB} \delta^{\Sigma\Omega} - 2 \Gamma_{AB}^{\parallel} \mathcal{V}^{-1 \bar{M}\bar{N}}_{\parallel} \mathcal{T}_{\bar{M}\bar{N}}^{\Sigma\Omega}, \quad (4.41a)$$

$$M_{(1/2)}^{\dot{A}r\Sigma, \dot{B}s\Omega} = -A_3^{\dot{A}r\dot{B}s} \delta^{\Sigma\Omega} - 2 \Gamma_{\dot{A}\dot{B}}^{\parallel} \delta_{rs} \mathcal{V}^{-1 \bar{M}\bar{N}}_{\parallel} \mathcal{T}_{\bar{M}\bar{N}}^{\Sigma\Omega} + 8 \delta_{\dot{A}\dot{B}} \mathcal{V}^{-1 \bar{M}\bar{N}}_{rs} \mathcal{T}_{\bar{M}\bar{N}}^{\Sigma\Omega}, \quad (4.41b)$$

where  $\mathcal{V}^{-1 \bar{M}\bar{N}}_{\bar{P}\bar{Q}} = \left( \mathcal{V}^{-1} \right)_{[\bar{P}}^{\bar{M}} \left( \mathcal{V}^{-1} \right)_{\bar{Q}]}^{\bar{N}}$ , with the coset representatives  $\mathcal{V}_{\bar{M}}^{\bar{N}}$  as defined in Eq. (2.3).

Let us recall that, here, the indices  $A, B$  and  $\dot{A}, \dot{B}$  denote the spinor and cospinor indices of  $\text{SO}(8)$ , respectively.

The masses of the fields in the Kaluza-Klein spectrum are given by the eigenvalues  $m_{(2)}^2$ ,  $m_{(1)}$ ,  $m_{(0)}^2$ ,  $m_{(3/2)}$  and  $m_{(1/2)}$  of the matrices (4.25), (4.33), (4.38), (4.41a) and (4.41b). As discussed in Sec. 3.2, we organize the spectrum using the conformal dimensions  $\Delta_{(s)}$  of Eq. (3.8), to which we add the one of the spin-2 fields [96]:

$$\Delta_{(2)} (\Delta_{(2)} - 2) = (m_{(2)} \ell_{\text{AdS}})^2, \quad (4.42)$$

still with the AdS length  $\ell_{\text{AdS}} = \sqrt{2/|V_0|}$ , where  $V_0$  is the potential (2.24) at the vacuum. We refer to Sec. 3.2 for the definition of the left and right conformal dimensions  $\Delta_{L,R}$  and the spacetime spin  $s$ . We illustrate in the following the tools developed in the previous sections using four examples:  $\mathcal{N}_{6d} = (2, 0)$  and  $\mathcal{N}_{6d} = (1, 1)$  six-dimensional supergravities<sup>46</sup> on  $\text{AdS}_3 \times S^3$ , ten-dimensional supergravity on  $\text{AdS}_3 \times S^3 \times S^3 \times S^1$  and a one-parameter family of non-supersymmetric vacua within the  $\mathcal{N} = (2, 0)$  and  $\mathcal{N} = (1, 1)$   $\text{AdS}_3 \times S^3$  theories.

## 4.4 Six-dimensional supergravities on $\text{AdS}_3 \times S^3$

Six-dimensional minimal  $\mathcal{N}_{6d} = (1, 0)$  supergravity coupled to a tensor multiplet admits a consistent truncation on the sphere  $S^3$  [169, 170]. The reduction gives rise to a three-dimensional theory, whose scalars parametrize the coset space  $\text{SO}(4, 4)/(\text{SO}(4) \times \text{SO}(4))$ , so that the truncation can be described in terms of  $\text{SO}(4, 4)$  exceptional field theory [139]. The theory in six dimensions features an  $\text{AdS}_3 \times S^3$  vacuum that preserves  $\mathcal{N}_{6d} = (1, 0)$  supersymmetry.

This six-dimensional theory can be embedded into half-maximal  $\mathcal{N}_{6d} = (2, 0)$  and  $\mathcal{N}_{6d} = (1, 1)$  supergravities<sup>47</sup>. The  $\text{AdS}_3 \times S^3$  vacuum then preserves all the supersymmetries in the case  $\mathcal{N}_{6d} = (2, 0)$ , but only half of them within  $\mathcal{N}_{6d} = (1, 1)$ . The associated three-dimensional theories have an  $\text{SO}(4)$  gauge group and scalars organized in an  $\text{SO}(8, 4)/(\text{SO}(8) \times \text{SO}(4))$  coset space, and their potentials possess stable supersymmetric  $\text{AdS}_3$  vacua preserving  $\mathcal{N} = (4, 4)$  and  $\mathcal{N} = (0, 4)$  supersymmetries, respectively. Couplings to  $m$  other tensor multiplets can be added in six-dimensions for  $\mathcal{N}_{6d} = (2, 0)$ , and similarly to  $m$  vector multiplets for  $\mathcal{N}_{6d} = (1, 1)$ , leading in the exceptional field theory description to a coset space  $\text{SO}(8, 4 + m)/(\text{SO}(8) \times \text{SO}(4 + m))$ . The descriptions of the associated consistent truncations in terms of generalized Scherk-Schwarz reductions have been described in Ref. [139] and further analyzed in Ref. [144], using the framework of  $\text{SO}(8, 4 + m)$  exceptional field theory. We illustrate here the techniques developed in Sec. 4.3 by computing their Kaluza-Klein spectra.

The group of isometries of six-dimensional supergravity on  $\text{AdS}_3 \times S^3$  is

$$\text{SO}(2, 2) \times \text{SO}(4) \cong \text{SL}(2, \mathbb{R}) \times \text{SL}(2, \mathbb{R}) \times \text{SU}(2) \times \text{SU}(2). \quad (4.43)$$

These isometries are captured within the  $\mathcal{N} = 4$  supergroup  $\text{SU}(2|1, 1)$ , whose even part is precisely  $\text{SL}(2, \mathbb{R}) \times \text{SU}(2)$  [129]. More precisely, in the case  $\mathcal{N}_{6d} = (2, 0)$ , the relevant supergroup is  $\mathcal{G} = \text{SU}(2|1, 1)_L \times \text{SU}(2|1, 1)_R$ , whereas it is  $\mathcal{G} = (\text{SL}(2, \mathbb{R}) \times \text{SU}(2))_L \times \text{SU}(2|1, 1)_R$  for  $\mathcal{N}_{6d} = (1, 1)$ .

<sup>46</sup> $\mathcal{N}_{6d}$  denotes the number of supersymmetries for theories in six dimensions, and should not be mixed up with its three-dimensional analogue  $\mathcal{N}$ .

<sup>47</sup>In the case  $\mathcal{N}_{6d} = (1, 1)$ , the tensor multiplet is absorbed into the gravitational multiplet, whereas for  $\mathcal{N}_{6d} = (2, 0)$  it stays a tensor multiplet.

$\Delta_{L,R}$	$SU(2)_{L,R \text{ global}} \times SU(2)_{L,R \text{ gauge}}$
$(k+2)/2$	$(0, (k-2)/2)$
$(k+1)/2$	$(1/2, (k-1)/2)$
$k/2$	$(0, k/2)$

**Tab. 4.1** Short multiplet  $k+1$  of  $SU(2|1,1)_{L,R}$  for  $k \geq 2$  [129], in the notation of Ref. [162]. The multiplet **2** is obtained by suppressing the first line for  $k=1$ , and **1** the two first lines for  $k=0$ .

The supermultiplets of  $SU(2|1,1)$  depend on the representations of two  $SU(2)$  factors [162]. The first one is realized as part of the sphere isometries of Eq. (4.43) and is the  $R$ -symmetry group of  $SU(2|1,1)$ . It is gauged in three-dimensions, and we will thus denote it  $SU(2)_{\text{gauge}}$ . The second one is the automorphism group of  $\mathfrak{su}(2|1,1)$ . It describes a global symmetry of the three-dimensional supergravity, and will thus be noted  $SU(2)_{\text{global}}$ . The multiplets relevant for our study are the short ones, which we will denote  $k+1$ . They are given in Tab. 4.1.

#### 4.4.1 $\mathcal{N}_{6d} = (2, 0)$

The spectrum around the  $\text{AdS}_3 \times S^3$  vacuum of  $\mathcal{N}_{6d} = (2, 0)$  supergravity in six dimensions has been computed in Ref. [110] by standard techniques, *i.e.* linearization of the equations of motion around the  $\text{AdS}_3$  background, as we discussed in Chap. 1. In Ref. [162], group theoretical arguments were used in the same purpose. The vacuum preserves indeed enough supersymmetries so that one can deduce the entire spectrum, *i.e.* representations and masses, without lengthy calculation. The spectrum is organized under the supergroup  $SU(2|1,1)_L \times SU(2|1,1)_R$ , whose bosonic part  $SU(2)_{L \text{ gauge}} \times SU(2)_{R \text{ gauge}} \cong SO(4)_{\text{gauge}}$  corresponds to the isometry group of the sphere  $S^3$ , and global factors  $SU(2)_{L \text{ global}} \times SU(2)_{R \text{ global}} \cong SO(4)_{\text{global}}$  and  $SO(m)_{\text{global}}$ . It consists of a spin-2 and two spin-1 Kaluza-Klein towers, one of them transforming as a vector under  $SO(m+1)$ . The relevant multiplets are given in Tab. 4.2, in the notations of Ref. [162]: the spin-1 and spin-2 multiplets, which are scalars under  $SO(m+1)$ , are noted  $[k+1, k+1]_S$  and  $[p, p+2]_S + [p+2, p]_S$ , respectively. The spin-1 multiplets, which are vectors under  $SO(m+1)$ , are noted  $[k+1, k+1]_S^{(m+1)}$ . The full spectrum has been found to be<sup>48</sup>

$$S'_{(2,0)} = \sum_{k \geq 2} [k+1, k+1]_S + \sum_{k \geq 1} [k+1, k+1]_S^{(m+1)} + \sum_{p \geq 2} ([p, p+2]_S + [p+2, p]_S). \quad (4.44)$$

We use this example as a warm up to test the tools we developed in Sec. 4.3.

To describe the three-dimensional theory, we decompose the “flat” index  $\bar{M}$  (see Eq. (4.13)) according to

$$\{X^{\bar{M}}\} \longrightarrow \{X^A, X_A, X^\alpha, X^{\hat{\alpha}}\}, \quad (4.45)$$

so that  $SO(8, 4+m)$  is decomposed into  $GL(4) \times SO(4, m)$ . The  $GL(4)$  part is embedded into  $SO(4, 4)$

<sup>48</sup>The multiplets  $[2, 2]_S$ ,  $[2, 4]_S$  and  $[4, 2]_S$  can be extracted from Tab. 4.2 by disregarding the lines with negative  $SU(2)$  spins. The massless supergravity multiplets  $[1, 3]_S$  and  $[3, 1]_S$  do not carry any degree of freedom in three dimensions and are not included in the spectra.

$\Delta_L$	$\Delta_R$	$\Delta$	$s$	$\text{SO}(4)_{\text{gauge}}$	$\text{SO}(4)_{\text{global}}$
<b>Spin-1 multiplet <math>[\mathbf{k} + 1, \mathbf{k} + 1]_S</math></b>					
$k/2$	$k/2$	$k$	0	$(k/2, k/2)$	$(0, 0)$
$k/2$	$(k + 1)/2$	$k + 1/2$	1/2	$(k/2, (k - 1)/2)$	$(0, 1/2)$
$(k + 1)/2$	$k/2$	$k + 1/2$	-1/2	$((k - 1)/2, k/2)$	$(1/2, 0)$
$(k + 1)/2$	$(k + 1)/2$	$k + 1$	0	$((k - 1)/2, (k - 1)/2)$	$(1/2, 1/2)$
$k/2$	$(k + 2)/2$	$k + 1$	1	$(k/2, (k - 2)/2)$	$(0, 0)$
$(k + 2)/2$	$k/2$	$k + 1$	-1	$((k - 2)/2, k/2)$	$(0, 0)$
$(k + 1)/2$	$(k + 2)/2$	$k + 3/2$	1/2	$((k - 1)/2, (k - 2)/2)$	$(1/2, 0)$
$(k + 2)/2$	$(k + 1)/2$	$k + 3/2$	-1/2	$((k - 2)/2, (k - 1)/2)$	$(0, 1/2)$
$(k + 2)/2$	$(k + 2)/2$	$k + 2$	0	$((k - 2)/2, (k - 2)/2)$	$(0, 0)$
<b>Spin-2 multiplet <math>[\mathbf{p}, \mathbf{p} + 2]_S</math></b>					
$(p - 1)/2$	$(p + 1)/2$	$p$	1	$((p - 1)/2, (p + 1)/2)$	$(0, 0)$
$(p - 1)/2$	$(p + 2)/2$	$p + 1/2$	3/2	$((p - 1)/2, p/2)$	$(0, 1/2)$
$p/2$	$(p + 1)/2$	$p + 1/2$	1/2	$((p - 2)/2, (p + 1)/2)$	$(1/2, 0)$
$p/2$	$(p + 2)/2$	$p + 1$	1	$((p - 2)/2, p/2)$	$(1/2, 1/2)$
$(p - 1)/2$	$(p + 3)/2$	$p + 1$	2	$((p - 1)/2, (p - 1)/2)$	$(0, 0)$
$(p + 1)/2$	$(p + 1)/2$	$p + 1$	0	$((p - 3)/2, (p + 1)/2)$	$(0, 0)$
$p/2$	$(p + 3)/2$	$p + 3/2$	3/2	$((p - 2)/2, (p - 1)/2)$	$(1/2, 0)$
$(p + 1)/2$	$(p + 2)/2$	$p + 3/2$	1/2	$((p - 3)/2, p/2)$	$(0, 1/2)$
$(p + 1)/2$	$(p + 3)/2$	$p + 2$	1	$((p - 3)/2, (p - 1)/2)$	$(0, 0)$

**Tab. 4.2** Spin-1  $[\mathbf{k} + 1, \mathbf{k} + 1]_S$  and spin-2  $[\mathbf{p}, \mathbf{p} + 2]_S$  multiplets of  $\text{SU}(2|1, 1)_L \times \text{SU}(2|1, 1)_R$ , for  $k \geq 2$  and  $p \geq 3$ , constructed from the short multiplets of Tab. 4.1 [162]. The  $\text{SO}(4)$  representations are given by a couple of  $\text{SU}(2)$  spins. The conjugate spin-2 multiplet  $[\mathbf{p} + 2, \mathbf{p}]_S$  is obtained by inverting  $\Delta_L$  with  $\Delta_R$ , taking the opposite spin  $-s$  and exchanging the  $\text{SU}(2)$  spins inside each  $\text{SO}(4)_{\text{gauge}}$  and  $\text{SO}(4)_{\text{global}}$  representations.

and the  $\text{SO}(8, 4 + m)$  invariant tensor takes the form

$$\eta_{\bar{M}\bar{N}} = \begin{pmatrix} 0 & \delta_A^B & 0 & 0 \\ \delta^B_A & 0 & 0 & 0 \\ 0 & 0 & -\delta_{\alpha\beta} & 0 \\ 0 & 0 & 0 & \delta_{\hat{\alpha}\hat{\beta}} \end{pmatrix}. \quad (4.46)$$

The embedding tensor (4.15) is

$$\theta_{ABCD} = 2\varepsilon_{ABCD}, \quad \theta_{ABC}{}^D = \varepsilon_{ABCE} \delta^{ED}, \quad (4.47)$$

with all other components vanishing. It induces a gauge group  $\text{SO}(4)_{\text{gauge}} \times \text{T}_6$ , where  $\text{T}_6$  denotes

an abelian group of six translations transforming in the adjoint representation of  $SO(4)_{\text{gauge}}$ . As shown in Ref. [139], the resulting theory is a consistent truncation that captures the  $S^3$  reduction of  $\mathcal{N}_{6d} = (2, 0)$  six-dimensional supergravity coupled to  $m + 1$  tensor multiplets. The associated three-dimensional supergravity possesses a  $\mathcal{N} = (4, 4)$  vacuum at the scalar origin  $\mathcal{M}_{\bar{M}\bar{N}} = \delta_{\bar{M}\bar{N}}$ . This vacuum corresponds, from the three-dimensional point of view, to six-dimensional one given in Eq. (1.9).

We construct a complete basis of scalar functions on  $S^3$ , following closely the construction of Ref. [134]. We consider the elementary round  $S^3$  harmonics  $\mathcal{Y}^A$ ,  $A \in \llbracket 1, 4 \rrbracket$ , normalized as  $\mathcal{Y}^A \mathcal{Y}^A = 1$ . The basis is given by all the polynomials in  $\mathcal{Y}^A$ :

$$\{\mathcal{Y}^\Sigma\} = \{1, \mathcal{Y}^A, \mathcal{Y}^{A_1 A_2}, \dots, \mathcal{Y}^{A_1 \dots A_n}, \dots\}, \quad (4.48)$$

where we use the notation  $\mathcal{Y}^{A_1 \dots A_n} = \mathcal{Y}^{(A_1 \dots A_n)}$ , with double parenthesis denoting traceless symmetrization. We will denote the integer  $n$  as the level of the harmonics tower.

To compute the spectrum, we need the expression of the  $\mathcal{T}$  matrices defined in Eq. (4.23). They can be extracted from the generalized Scherk-Schwarz reduction built in Ref. [139, 144]. The twist matrix  $U_M^{\bar{M}}$  is constructed from the harmonics  $\mathcal{Y}^A$  and the round  $S^3$  metric  $h_{ij} = \partial_i \mathcal{Y}^A \partial_j \mathcal{Y}^A$ , where  $\partial_i$  denotes the partial derivative with respect to the physical internal coordinates  $\{y^i\}$ ,  $i \in \llbracket 1, 3 \rrbracket$  properly embedded into  $\{Y^{MN}\}$ . The weight factor is defined by  $\rho = h^{-1/2}$ . The only non-vanishing components of the operator in Eq. (4.23) are

$$\rho^{-1} U^M_A U^N_B \partial_{MN} = \sqrt{2} \varepsilon_{ABCD} K^{CDi} \partial_i, \quad (4.49)$$

with the round  $S^3$  Killing vectors  $K^{ABi} = h^{ij} \partial_j \mathcal{Y}^{[A} \mathcal{Y}^{B]}$ . Following Eq. (4.48) and (4.49), the matrices  $\mathcal{T}_{\bar{M}\bar{N}}$  are block-diagonal level by level and each block has the form

$$\mathcal{T}_{\bar{M}\bar{N}}^{A_1 \dots A_n B_1 \dots B_n} = n \mathcal{T}_{\bar{M}\bar{N}}^{((A_1^{(B_1} \delta_{A_2}^{B_2} \dots \delta_{A_n)}^{B_n)})}, \quad (4.50)$$

where we lowered the indices  $A_i$  in the right-hand side for readability. The level 1 block  $\mathcal{T}_{\bar{M}\bar{N}}^{AB}$  is finally given by its only non vanishing components

$$\mathcal{T}_{CD}^{AB} = -\varepsilon_{CDEF} \delta^{AE} \delta^{BF}. \quad (4.51)$$

We then have all the information needed to compute the mass matrices of Sec. 4.3. Injecting the embedding tensor (4.47) and the  $\mathcal{T}$  matrices (4.50) in the mass matrices (4.25), (4.33), (4.38), (4.41a) and (4.41b), we extract the mass eigenvalues of all the fields. This is in sharp contrast to the standard procedure, outlined in Chap. 1, for which a careful analysis of the equations of motion was required to deduce how all the fields mix to form the Kaluza-Klein modes. We then deduce the conformal dimensions (3.8) and (4.42) and compute the weights  $\Delta_{L,R}$  knowing the spins  $s$ . At levels 0 and  $n \geq 1$ , fields combine into the multiplets

$$\begin{aligned} \mathcal{S}_{(2,0)}^{(0)} &= [3, 3]_S + [2, 2]_S^{(m)}, \\ \mathcal{S}_{(2,0)}^{(n)} &= [n + 1, n + 1]_S + [n + 3, n + 3]_S + [n + 2, n + 2]_S^{(m)} \\ &\quad + [n + 1, n + 3]_S + [n + 3, n + 1]_S. \end{aligned} \quad (4.52)$$



The full spectrum is then

$$\mathcal{S}_{(2,0)} = \sum_{n \geq 0} \mathcal{S}_{(2,0)}^{(n)}, \quad (4.53)$$

which precisely coincides with Eq. (4.44). Our method thus successfully reproduces the computations of Ref. [110, 162], and allows to bypass standard harmonic analysis.

#### 4.4.2 $\mathcal{N}_{6d} = (1, 1)$

Let us now turn to the compactification of  $\mathcal{N}_{6d} = (1, 1)$  six-dimensional supergravity on  $\text{AdS}_3 \times S^3$ . As mentioned above, the vacuum is only quarter-maximal and it preserves  $\mathcal{N} = (0, 4)$  supersymmetries in three dimensions. Contrary to the previous example, this amount of supersymmetries is not sufficient to totally constrain the spectrum, which cannot be computed using group theory. One can however use group theory to compute the bosonic representations that appear in the spectrum, and finds that they formally combine into  $\mathcal{N} = (4, 4)$  multiplets of  $\text{SU}(2|1, 1)_L \times \text{SU}(2|1, 1)_R$ . According to Ref. [162], the resulting spectrum is given by<sup>49</sup>

$$\begin{aligned} \mathcal{S}'_{(1,1)} = & [2, 2]_S + 2 \sum_{k \geq 2} [k + 1, k + 1]_S + \sum_{k \geq 1} [k + 1, k + 1]_S^{(m)} \\ & + \sum_{p \geq 2} \left( [p, p + 2]_S + [p + 2, p]_S \right). \end{aligned} \quad (4.54)$$

However, the vacuum has only  $\mathcal{N} = (0, 4)$  supersymmetries, so that only the factor  $\text{SU}(2|1, 1)_R$  is preserved and the conformal dimensions assigned by Eq. (4.54) cannot be trusted. From  $\text{SU}(2|1, 1)_L$  survives only the even part  $\text{SL}(2, \mathbb{R})_L \times \text{SU}(2)_{L \text{ gauge}}$  and a global  $\text{SU}(2)_{L \text{ global}}$ . The relevant multiplets are the short ones of  $\text{SU}(2|1, 1)_R$ , given in Tab. 4.1, associated to a representation of  $\text{SU}(2)_{L \text{ global}} \times \text{SU}(2)_{L \text{ gauge}}$  with conformal dimension  $\Delta_L$ . We will use the notation  $(\mathbf{k} + \mathbf{1})_{\Delta_L}^{(j_{\text{gl}} j_{\text{ga}})}$  to denote those multiplets, with  $j_{\text{gl}}$  and  $j_{\text{ga}}$  spins of  $\text{SU}(2)_{L \text{ global}}$  and  $\text{SU}(2)_{L \text{ gauge}}$ , respectively, and add an exponent  $m$  for multiplets transforming as vectors of  $\text{SO}(m)$ . In these notations, the spectrum of Eq. (4.54) decomposes into  $\text{SU}(2|1, 1)_R$  multiplets as

$$\begin{aligned} \mathcal{S}'_{(1,1)} = & \mathbf{2}_{1/2}^{(0,1/2)} + \mathbf{2}_1^{(1/2,0)} \\ & + 2 \sum_{k \geq 2} \left[ (\mathbf{k} + \mathbf{1})_{k/2}^{(0,k/2)} + (\mathbf{k} + \mathbf{1})_{(k+1)/2}^{(1/2,(k-1)/2)} + (\mathbf{k} + \mathbf{1})_{(k+2)/2}^{(0,(k-2)/2)} \right] \\ & + \sum_{k \geq 1} \left[ (\mathbf{k} + \mathbf{1})_{k/2}^{(0,k/2),m} + (\mathbf{k} + \mathbf{1})_{(k+1)/2}^{(1/2,(k-1)/2),m} + (\mathbf{k} + \mathbf{1})_{(k+2)/2}^{(0,(k-2)/2),m} \right] \\ & + \sum_{p \geq 2} \left[ (\mathbf{p} + \mathbf{2})_{(p-1)/2}^{(0,(p-1)/2)} + (\mathbf{p} + \mathbf{2})_{p/2}^{(1/2,(p-2)/2)} + (\mathbf{p} + \mathbf{2})_{(p+1)/2}^{(0,(p-3)/2)} \right. \\ & \left. + \mathbf{p}_{(p+1)/2}^{(0,(p+1)/2)} + \mathbf{p}_{(p+2)/2}^{(1/2,p/2)} + \mathbf{p}_{(p+3)/2}^{(0,(p-1)/2)} \right]. \end{aligned} \quad (4.55)$$

As the factor  $\text{SU}(2|1, 1)_L$  is not preserved, the conformal dimensions  $\Delta_L$  are not restricted to the values given in Tab. 4.2 and could in fact be different from those predicted in the spectrum (4.55). As our tools allow to compute the spectrum around vacua preserving few, or no, supersymmetries, we use them in the following to adjust the masses in Eq. (4.55).

<sup>49</sup>The range of the sum is not explicit in Ref. [162] and requires further analysis.



We use the same index split (4.45) as in the previous example. The theory in three dimensions is described by the following embedding tensor:

$$\theta_{AB} = 4\delta_{AB}, \quad \theta_{ABCD} = 2\varepsilon_{ABCD}, \quad (4.56)$$

and all other components vanish. The associated gauge group is  $\text{SO}(4)_{\text{gauge}} \times (\text{T}_6 \times (\text{T}_4)^{4+m})$ , where  $\text{T}_4$  and  $\text{T}_6$  denote abelian groups of 4 and 6 translations transforming in the vectorial and adjoint representations of  $\text{SO}(4)_{\text{gauge}}$ , respectively. The associated theory is a consistent truncation of  $\mathcal{N}_{6d} = (1, 1)$  supergravity in six dimensions coupled to  $m$  vector multiplets on the round  $S^3$  [139]. Its potential has an  $\text{AdS}_3$  vacuum at the scalar origin  $\mathcal{M}_{\bar{M}\bar{N}} = \delta_{\bar{M}\bar{N}}$  that preserves  $\mathcal{N} = (0, 4)$  supersymmetries.

The generalized Scherk-Schwarz reduction leading to Eq. (4.56) has been described in Ref. [139] with the same geometrical data as in the previous section. The action of the operator in Eq. (4.23) is now given by

$$\rho^{-1}U^M{}_A U^N{}_B \partial_{MN} = 2\sqrt{2}K_{AB}{}^i \partial_i, \quad (4.57)$$

with the Killing vectors introduced in Eq. (4.49)<sup>50</sup> and all other components vanishing. We then use the same basis (4.48) of scalar functions on  $S^3$  as previously, so that the expression (4.50) of the matrices  $\mathcal{T}_{\bar{M}\bar{N}}$  is still valid, however with the level 1 block  $\mathcal{T}_{\bar{M}\bar{N}}{}^{AB}$  defined as

$$\mathcal{T}_{CD}{}^{AB} = -2\delta_{[C}{}^A \delta_{D]}{}^B. \quad (4.58)$$

and all other components vanishing.

Again, we combine the expressions of the embedding tensor (4.56) and of the  $\mathcal{T}$  matrices with the mass matrices (4.25), (4.33), (4.38), (4.41a) and (4.41b) to compute mass eigenvalues of the fields. We use Eq. (3.8) and (4.42) to define their conformal dimensions. At levels 0, 1 and  $n \geq 2$ , fields arrange into the multiplets

$$\begin{aligned} \mathcal{S}_{(1,1)}^{(0)} &= \mathbf{2}_{3/2}^{(0,1/2),m} + \mathbf{2}_1^{(1/2,0),m} + \mathbf{3}_1^{(0,1)} + \mathbf{3}_{1/2}^{(1/2,1/2)} + \mathbf{3}_2^{(0,0)}, \\ \mathcal{S}_{(1,1)}^{(1)} &= \mathbf{2}_{1/2}^{(0,1/2)} + \mathbf{2}_1^{(1/2,1)} + \mathbf{2}_{3/2}^{(0,3/2)} + \mathbf{2}_2^{(1/2,0)} + \mathbf{2}_{5/2}^{(0,1/2)} + \mathbf{3}_2^{(0,1),m} + \mathbf{3}_{3/2}^{(1/2,1/2),m} + \mathbf{3}_1^{(0,0),m} \\ &\quad + \mathbf{4}_{1/2}^{(0,1/2)} + \mathbf{4}_1^{(1/2,1)} + \mathbf{4}_{3/2}^{(0,3/2)} + \mathbf{4}_2^{(1/2,0)} + \mathbf{4}_{5/2}^{(0,1/2)}, \\ \mathcal{S}_{(1,1)}^{(n)} &= (\mathbf{n} + \mathbf{1})_{n/2}^{(0,n/2)} + (\mathbf{n} + \mathbf{3})_{n/2}^{(0,n/2)} + (\mathbf{n} + \mathbf{1})_{(n+1)/2}^{(1/2,(n+1)/2)} + (\mathbf{n} + \mathbf{3})_{(n+1)/2}^{(1/2,(n+1)/2)} \\ &\quad + (\mathbf{n} + \mathbf{1})_{(n+2)/2}^{(0,(n-2)/2)} + (\mathbf{n} + \mathbf{3})_{(n+2)/2}^{(0,(n-2)/2)} + (\mathbf{n} + \mathbf{1})_{(n+2)/2}^{(0,(n+2)/2)} + (\mathbf{n} + \mathbf{3})_{(n+2)/2}^{(0,(n+2)/2)} \\ &\quad + (\mathbf{n} + \mathbf{1})_{(n+3)/2}^{(1/2,(n-1)/2)} + (\mathbf{n} + \mathbf{3})_{(n+3)/2}^{(1/2,(n-1)/2)} + (\mathbf{n} + \mathbf{1})_{(n+4)/2}^{(0,n/2)} + (\mathbf{n} + \mathbf{3})_{(n+4)/2}^{(0,n/2)} \\ &\quad + (\mathbf{n} + \mathbf{2})_{(n+3)/2}^{(0,(n+1)/2),m} + (\mathbf{n} + \mathbf{2})_{(n+2)/2}^{(1/2,n/2),m} + (\mathbf{n} + \mathbf{2})_{(n+1)/2}^{(0,(n-1)/2),m} \Big]. \end{aligned} \quad (4.59)$$

<sup>50</sup>The indices  $A, B$  are lowered using the identity matrix  $\delta_{AB}$ .

These spectra are displayed in details in App. B. Adding all the levels, we obtain the full spectrum

$$\begin{aligned}
 \mathcal{S}_{(1,1)} = & \mathbf{2}_{1/2}^{(0,1/2)} + \mathbf{2}_2^{(1/2,0)} \\
 & + \sum_{k \geq 2} \left[ (\mathbf{k} + \mathbf{1})_{k/2}^{(0,k/2)} + (\mathbf{k} + \mathbf{1})_{(k+3)/2}^{(1/2,(k-1)/2)} + (\mathbf{k} + \mathbf{1})_{(k+2)/2}^{(0,(k-2)/2)} \right. \\
 & \quad \left. + (\mathbf{k} + \mathbf{1})_{k/2}^{(0,k/2)} + (\mathbf{k} + \mathbf{1})_{(k-1)/2}^{(1/2,(k-1)/2)} + (\mathbf{k} + \mathbf{1})_{(k+2)/2}^{(0,(k-2)/2)} \right] \\
 & + \sum_{k \geq 1} \left[ (\mathbf{k} + \mathbf{1})_{(k+2)/2}^{(0,k/2),m} + (\mathbf{k} + \mathbf{1})_{(k+1)/2}^{(1/2,(k-1)/2),m} + (\mathbf{k} + \mathbf{1})_{k/2}^{(0,(k-2)/2),m} \right] \\
 & + \sum_{p \geq 2} \left[ (\mathbf{p} + \mathbf{2})_{(p-1)/2}^{(0,(p-1)/2)} + (\mathbf{p} + \mathbf{2})_{(p+2)/2}^{(1/2,(p-2)/2)} + (\mathbf{p} + \mathbf{2})_{(p+1)/2}^{(0,(p-3)/2)} \right. \\
 & \quad \left. + \mathbf{p}_{(p+1)/2}^{(0,(p+1)/2)} + \mathbf{p}_{p/2}^{(1/2,p/2)} + \mathbf{p}_{(p+3)/2}^{(0,(p-1)/2)} \right]. \tag{4.60}
 \end{aligned}$$

This coincides with the spectrum of Eq. (4.55) from the point of view of the  $\text{SU}(2)$  representations, but the multiplets differ: as expected from the supersymmetry breaking from  $\mathcal{N} = (4, 4)$  to  $\mathcal{N} = (0, 4)$ , the weights  $\Delta_{\mathbb{L}}$  are not the ones of  $\text{SU}(2|1, 1)_{\mathbb{L}}$  multiplets. The spectrum (4.60) thus organizes into genuine  $\mathcal{N} = (0, 4)$  multiplets, and cannot be recombined into  $\mathcal{N} = (4, 4)$  ones. Thus,  $\mathcal{S}_{(1,1)}$  describes the entire spectrum of  $\mathcal{N}_{6d} = (1, 1)$  six-dimensional supergravity on  $\text{AdS}_3 \times S^3$ , with representations and masses.

## 4.5 Ten-dimensional supergravity on $\text{AdS}_3 \times S^3 \times S^3 \times S^1$

We now turn to the spectrum of ten-dimensional maximal supergravity on  $\text{AdS}_3 \times S^3 \times S^3 \times S^1$ , whose vacuum preserves half of the supersymmetries. The group of isometries is given by two copies of the large  $\mathcal{N} = 4$  supergroup:  $\mathcal{G} = D^1(2, 1; \alpha)_{\mathbb{L}} \times D^1(2, 1; \alpha)_{\mathbb{R}}$ , with  $\alpha$  the ratio of the spheres  $S^3$  radii.

Even if half of the supersymmetries are preserved at the vacuum, supersymmetry does not constrain the spectrum sufficiently to allow its computation using representation theory only. As pointed out in Ref. [163], the Kaluza-Klein states fall into short multiplets of  $D^1(2, 1; \alpha) \times D^1(2, 1; \alpha)$ , most of which could be combined to form long multiplets. As the conformal dimensions of the long representations are not fixed, group theory fails to predict the masses that appear in the spectrum. In Ref. [164], the scalar masses around the  $\text{AdS}_3$  vacuum have been computed by standard analysis, and further used to infer the entire Kaluza-Klein spectrum of the theory. It confirmed that indeed most of the fields arrange in long representations.

We compute here the masses of all the bosonic fields around the vacuum. As our tools apply to half-maximal supergravity, we consider the truncation to  $\mathcal{N}_{10d} = 1$  supergravity and we will reproduce only a subsector of the spectrum. It turns out that, similarly to the construction in Sec. 4.4.2, the vacuum in this truncation breaks another half of the supersymmetries and gives rise to an  $\mathcal{N} = (0, 4)$  vacuum in three dimensions. Accordingly, only the factor  $D^1(2, 1; \alpha)_{\mathbb{R}}$  is preserved and  $D^1(2, 1; \alpha)_{\mathbb{L}}$  is broken to its even part. The even part of  $D^1(2, 1; \alpha)$  is isomorphic to  $\text{SL}(2, \mathbb{R}) \times \text{SO}(3)^+ \times \text{SO}(3)^-$  [129], so that the bosonic symmetries at the vacuum are given by

$$\text{SL}(2, \mathbb{R})_{\mathbb{L}} \times \text{SO}(3)_{\mathbb{L}}^+ \times \text{SO}(3)_{\mathbb{L}}^- \times \underbrace{\text{SL}(2, \mathbb{R})_{\mathbb{R}} \times \text{SO}(3)_{\mathbb{R}}^+ \times \text{SO}(3)_{\mathbb{R}}^-}_{\subset D^1(2, 1; \alpha)_{\mathbb{R}}}. \tag{4.61}$$

As in Sec. 4.4, the  $\text{SL}(2, \mathbb{R})_{\mathbb{L}} \times \text{SL}(2, \mathbb{R})_{\mathbb{R}}$  factors combine into the  $\text{AdS}_3$  isometry group  $\text{SO}(2, 2)$ , and

the compact ones  $SO(3)_L^+ \times SO(3)_R^+ \times SO(3)_L^- \times SO(3)_R^-$  build the isometry groups  $SO(4)^\pm = SO(3)_L^\pm \times SO(3)_R^\pm$  of the two spheres, which we denote by  $S^{3^\pm}$ . The three-dimensional theory then features  $SO(4)^+ \times SO(4)^-$  as a gauge group and the scalars form the coset space  $SO(8, 8)/(SO(8) \times SO(8))$ .

We need to build an appropriate three-dimensional theory that is a consistent truncation from ten dimensions on  $S^{3^+} \times S^{3^-} \times S^1$ . Let us first consider the reduction on  $S^{3^+} \times S^{3^-}$  to four dimensions, with isometry group  $SO(4)^+ \times SO(4)^-$ . The generic construction of consistent truncations on an internal space of isometry group  $G \times G$ , with  $G$  a Lie group of dimension  $d$ , has been considered in Ref. [171] using double field theory. It results in a low-dimensional theory carrying gauge fields, a two-form and scalar fields parameterizing the coset space  $SO(d, d)/(SO(d) \times SO(d))$ . The construction is not specific to three dimensions, so that the embedding tensor do not take the form (4.15) but rather the generic expression  $F_{mn}{}^p$ , with  $SO(d, d)$  indices  $m, n, p \in \llbracket 1, 2d \rrbracket$ . We are specifically interested in this construction for  $G = SO(4)$ . Splitting the  $SO(6, 6)$  indices  $m$  according to

$$\{X^m\} \longrightarrow \{X^i, X^{\hat{i}}, X^r, X^{\hat{r}}\}, \quad (4.62)$$

with  $i, \hat{i}, r, \hat{r} \in \llbracket 1, 3 \rrbracket$  and writing the  $SO(6, 6)$  invariant tensor as

$$\eta_{mn} = \begin{pmatrix} -\delta_{ij} & 0 & 0 & 0 \\ 0 & -\delta_{\hat{i}\hat{j}} & 0 & 0 \\ 0 & 0 & \delta_{rs} & 0 \\ 0 & 0 & 0 & \delta_{\hat{r}\hat{s}} \end{pmatrix}, \quad (4.63)$$

the embedding tensor  $F_{mnp} = F_{mn}{}^q \eta_{pq}$  takes the form

$$\begin{cases} F_{ijk} = \varepsilon_{ijk}, \\ F_{\hat{i}\hat{j}\hat{k}} = \alpha \varepsilon_{\hat{i}\hat{j}\hat{k}}, \end{cases} \quad \begin{cases} F_{rst} = -\varepsilon_{rst}, \\ F_{\hat{r}\hat{s}\hat{t}} = -\alpha \varepsilon_{\hat{r}\hat{s}\hat{t}}, \end{cases} \quad (4.64)$$

and all other components vanishing. Eq. (4.64) shows that  $\alpha$  is the relative coupling constant between the isometry groups of the two spheres.

We further compactify on a circle  $S^1$  down to three dimensions, where the scalar coset is enhanced to  $SO(7, 7)/(SO(7) \times SO(7))$ . The embedding tensor (4.64) induces a potential that does not admit any AdS stationary point [171]. However, in the same spirit as what has been done in Ref. [170] for the reduction of six-dimensional supergravity on  $S^3$ , we can take advantage in the fact that the low-dimensional theory lives in three dimensions to stabilize the potential. In three dimensions, the two-form is auxiliary and can be integrated out. It gives rise to an enhanced scalar coset  $SO(8, 8)/(SO(8) \times SO(8))$  and an additional contribution to the scalar potential, which can be tuned to give rise to a stationary  $AdS_3$  point.

The  $SO(8, 8)$  flat indices  $\bar{M}$  are split according to

$$\{X^{\bar{M}}\} \longrightarrow \{X^m, X^+, X^{\hat{+}}, X^-, X^{\hat{-}}\}, \quad (4.65)$$

and the associated invariant tensor is

$$\eta_{\bar{M}\bar{N}} = \begin{pmatrix} \eta_{mn} & 0 & 0 \\ 0 & 0 & \mathbb{1}_2 \\ 0 & \mathbb{1}_2 & 0 \end{pmatrix}, \quad (4.66)$$

with  $\mathbb{1}_2$  the  $2 \times 2$  identity matrix. We then construct the three-dimensional embedding tensor  $\Theta_{\overline{MN}|\overline{PQ}}$  using  $F_{mnp}$ , and adding a component  $\xi$  associated to the integration of the two-form:

$$\theta_{mnp+} = F_{mnp}, \quad \theta_{++} = \xi. \quad (4.67)$$

The potential is stabilized at the scalar origin  $\mathcal{M}_{\overline{MN}} = \delta_{\overline{MN}}$  if  $\xi = -4\sqrt{2}\sqrt{1+\alpha^2}$ , and it then takes the value  $V_0 = -(1+\alpha^2)/2$ . The spacetime at the vacuum is  $\text{AdS}_3$  and only half of the supersymmetries are preserved:  $\mathcal{N} = (0, 4)$ . The gauge group is  $(\text{SO}(4)^+ \times (\text{T}_3 \times \text{T}_3)) \times (\text{SO}(4)^- \times (\text{T}_3 \times \text{T}_3)) \times (\text{T}_1)^2$ , where  $\text{T}_3$  denotes an abelian group of three translations transforming in the vectorial representation of  $\text{SO}(3)$ , and  $\text{T}_1$  stands for a translation singlet under  $\text{SO}(4)^+ \times \text{SO}(4)^-$ .

We now turn to the definition of suitable  $\mathcal{T}_{\overline{MN}}$  matrices. In the previous examples, we used explicit constructions of twist matrices to define  $\mathcal{T}_{\overline{MN}}$ . We can in fact bypass the construction of a twist matrix by imposing the condition that the matrices  $\mathcal{T}_{\overline{MN}}$  should correspond to the generators of  $\text{SO}(4)^+ \times \text{SO}(4)^-$  in the representation of the chosen scalar harmonics, normalized as in Eq. (4.24). We then consider two sets of  $\text{SO}(4)$  harmonics  $\{\mathcal{Y}^{\hat{A}}\}_{\hat{A} \in [1,4]}$  and  $\{\mathcal{Y}^{\hat{A}}\}_{\hat{A} \in [1,4]}$ , defined as functions of the internal physical coordinates  $\{y^{\hat{\alpha}}\}_{\hat{\alpha} \in [1,3]}$  and  $\{y^{\hat{\alpha}}\}_{\hat{\alpha} \in [1,3]}$  respectively, and form the  $\text{SO}(4)^+ \times \text{SO}(4)^-$  scalar harmonics  $\{\mathcal{Y}^A\} = \{\mathcal{Y}^{\hat{A}}, \mathcal{Y}^{\hat{A}}\}$ ,  $A \in [1, 8]$ , which depends on the physical coordinates  $\{y^\alpha\} = \{y^{\hat{\alpha}}, y^{\hat{\alpha}}\}$ ,  $\alpha \in [1, 6]$ , and are normalized as  $\mathcal{Y}^A \mathcal{Y}^A = 1$ . We still use Eq. (4.48) to define the full basis of scalar functions. With this parametrization, we again take profit of the expression (4.50) of the matrices  $\mathcal{T}_{\overline{MN}}$ , which allows to build the level one matrices  $\mathcal{T}_{\overline{MN}}^{AB}$  only. Given Eq. (4.64), we define

$$\begin{cases} \mathcal{T}_i^{\hat{A}\hat{B}} = \delta_i^{[\hat{A}} \delta_4^{\hat{B}]} + \frac{1}{2} \varepsilon_{i4\hat{C}\hat{D}} \delta_{\hat{C}}^{[\hat{A}} \delta_{\hat{D}}^{\hat{B}]}, \\ \mathcal{T}_r^{\hat{A}\hat{B}} = -\delta_r^{[\hat{A}} \delta_4^{\hat{B}]} + \frac{1}{2} \varepsilon_{r4\hat{C}\hat{D}} \delta_{\hat{C}}^{[\hat{A}} \delta_{\hat{D}}^{\hat{B}]}, \end{cases} \quad (4.68)$$

so that

$$\begin{cases} [\mathcal{T}_i, \mathcal{T}_j]^{\hat{A}\hat{B}} = -\varepsilon_{ijk} \mathcal{T}_k^{\hat{A}\hat{B}}, \\ [\mathcal{T}_r, \mathcal{T}_s]^{\hat{A}\hat{B}} = -\varepsilon_{rst} \mathcal{T}_t^{\hat{A}\hat{B}}. \end{cases} \quad (4.69)$$

We define accordingly  $\mathcal{T}_i^{\hat{A}\hat{B}}$  and  $\mathcal{T}_r^{\hat{A}\hat{B}}$  by adding a global factor  $\alpha$  and changing all  $\hat{A}, \hat{B}$  to  $\hat{A}, \hat{B}$  in Eq. (4.68). Finally, we embed these matrices in  $\mathcal{T}_{\overline{MN}}^{AB}$  as follows:

$$\begin{cases} \mathcal{T}_{i+}^{\hat{A}\hat{B}} = \mathcal{T}_i^{\hat{A}\hat{B}}, & \mathcal{T}_{r+}^{\hat{A}\hat{B}} = \mathcal{T}_r^{\hat{A}\hat{B}}, \\ \mathcal{T}_{i+}^{\hat{A}\hat{B}} = \mathcal{T}_i^{\hat{A}\hat{B}}, & \mathcal{T}_{\hat{r}+}^{\hat{A}\hat{B}} = \mathcal{T}_{\hat{r}}^{\hat{A}\hat{B}}. \end{cases} \quad (4.70)$$

Together with Eq. (4.64), (4.67) and (4.69), this definition ensures that Eq. (4.24) is satisfied, assuring that the matrices  $\mathcal{T}_{\overline{MN}}$  generate  $\text{SO}(4)^+ \times \text{SO}(4)^-$  with the appropriate normalization.

We finally put the expressions (4.67) and (4.70) into the mass formulas of Sec. 4.3 and compute the mass eigenvalues. The spectrum organizes into representations of  $D^1(2, 1; \alpha)$ , which are labeled by two half integer parameters  $(\ell^+, \ell^-)$ <sup>51</sup> [163]. With our construction, the representations  $(\ell^+, \ell^-)$  appearing at level  $n$  satisfy

$$\ell^+ + \ell^- = \frac{n}{2}. \quad (4.71)$$

<sup>51</sup>The  $\ell^\pm$  in our conventions correspond to the  $j^\pm$  of Ref. [164].

We obtain scalar masses that feature a highly non trivial dependence on  $\alpha$ :

$$\begin{cases} \left(m_{\ell^+, \ell^-} \ell_{\text{AdS}}\right)^2 = \frac{4}{1 + \alpha^2} \left(\ell^+ (\ell^+ + 1) + \alpha^2 \ell^- (\ell^- + 1)\right), \\ \left(m_{\ell^+, \ell^-}^{(\pm)} \ell_{\text{AdS}}\right)^2 = -1 + \left(2 \pm \sqrt{1 + \frac{4}{1 + \alpha^2} \left(\ell^+ (\ell^+ + 1) + \alpha^2 \ell^- (\ell^- + 1)\right)}\right)^2. \end{cases} \quad (4.72)$$

The masses of the vector, spin-2 and fermionic fields accordingly complete the associated  $D^1(2, 1; \alpha)$  long representations. The expressions of the scalar masses in Eq. (4.72) reproduce exactly the ones computed in Ref. [164]. Our construction allows to bypass lengthy calculations and extends the analysis to the spin-1, spin-2 and fermionic sectors. As we describe a vacuum of the half-maximal theory, the constructed theory cannot reproduce the full  $D^1(2, 1; \alpha)_L \times D^1(2, 1; \alpha)_R$  spectrum. It reproduces however a subsector thereof. This subsector together with supersymmetry is sufficient to deduce the entire spectrum of the maximal theory in terms of long multiplets of  $D^1(2, 1; \alpha)_L \times D^1(2, 1; \alpha)_R$ .

Our analysis can be extended to the maximal theory. The truncation described by the embedding tensor (4.67) properly embedded into  $E_{8(8)}$  exceptional field theory [138] is indeed consistent by construction, and leads to the maximal three-dimensional supergravity constructed in Ref. [172]. It shows that this theory is a consistent truncation. Extending our mass formulas of Sec. 4.3 to the full  $E_{8(8)}$  exceptional field theory would then explicitly reproduce the complete mass spectrum.

## 4.6 Non-supersymmetric vacua

Apart from bypassing the standard harmonic analysis, the most interesting feature of the Kaluza-Klein spectrometer developed in Ref. [133, 134, 173] is its ability to compute the spectra around vacua with few or no remaining symmetries, as illustrated in Ref. [174] in the case of the non-supersymmetric  $SO(3) \times SO(3)$ -invariant  $\text{AdS}_4$  vacuum of eleven-dimensional supergravity, and in Ref. [175] for the  $G_2$ -invariant non-supersymmetric  $\text{AdS}_4$  solution of massive IIA supergravity. The question of the stability of those non-supersymmetric vacua is of prior interest in the context of the AdS swampland conjecture [176], which speculates that all non-supersymmetric AdS vacua within string theory are unstable. In  $d$ -dimensional anti-de Sitter spacetime, scalar fields are stable if they satisfy the Breitenlohner-Freedman bound [177, 178]

$$m_{(0)}^2 \ell_{\text{AdS}}^2 \geq -\frac{(d-1)^2}{4}. \quad (4.73)$$

For the  $SO(3) \times SO(3)$ -invariant  $\text{AdS}_4$  vacuum mentioned above, though the lowest modes of the consistent truncation to four dimensions are above the Breitenlohner-Freedman bound [179], the higher Kaluza-Klein modes are tachyonic so that the vacuum is perturbatively unstable [174]. On the other hand, Ref. [175] proved the perturbative stability of the Kaluza-Klein spectrum around the  $\text{AdS}_4$   $G_2$ -invariant non-supersymmetric solution of massive IIA supergravity, thus challenging the Swampland conjecture.

The question of the stability of non-supersymmetric vacua may also be asked in three dimensions. Let us consider an example. As pointed out in Ref. [144, 180], the theory described in Eq. (4.56) features a one-parameter family of non-supersymmetric vacua for the scalar matrix

$$\mathcal{M}_{\bar{M}\bar{N}} = \text{diag} \left( e^\eta, e^\eta, e^{-\eta}, e^{-\eta}, e^{-\eta}, e^{-\eta}, e^\eta, e^\eta, 1, 1, 1, 1 \right), \quad (4.74)$$

for  $m = 0$  in Eq. (4.45). At the supergravity level, the masses of the scalar are given by

$$m_{(0)}^2 \ell_{\text{AdS}}^2 : \quad 0 [1], \quad 8 [1], \quad -4 + 4e^{\pm 2\eta} [2 + 2], \quad (4.75)$$

where the numbers  $[n]$  indicate the multiplicities of each eigenvalues. This lowest level spectrum is then stable, in the Breitenlohner-Freedman sense  $m_{(0)}^2 \ell_{\text{AdS}}^2 \geq -1$  of Eq. (4.73), if

$$\frac{\sqrt{3}}{2} \leq e^\eta \leq \frac{2}{\sqrt{3}}. \quad (4.76)$$

We use in Ref. [E] the mass matrices of Sec. 4.3 to compute the spectrum around this vacuum for the first Kaluza-Klein levels, and ask the question whether the stability survives at all levels. The scalar masses we get at levels 1, 2 and 3 are plotted in Fig. 4.1. As one can observe, at each level there are only two modes that become unstable for some values of  $\eta$ . Explicitly, the masses of these modes are

$$\begin{aligned} n = 1 : & \quad -6 + 9e^{\pm 2\eta} \quad [2 + 2], \\ n = 2 : & \quad -8 + 16e^{\pm 2\eta} \quad [2 + 2], \\ n = 3 : & \quad -10 + 25e^{\pm 2\eta} \quad [2 + 2]. \end{aligned} \quad (4.77)$$

The full first, second and third levels spectra are then stable for

$$\begin{aligned} n = 1 : & \quad \frac{\sqrt{5}}{3} \leq e^\eta \leq \frac{3}{\sqrt{5}}, \\ n = 2 : & \quad \frac{\sqrt{7}}{4} \leq e^\eta \leq \frac{4}{\sqrt{7}}, \\ n = 3 : & \quad \frac{3}{5} \leq e^\eta \leq \frac{5}{3}, \end{aligned} \quad (4.78)$$

respectively. All the intervals include the one in Eq. (4.76).

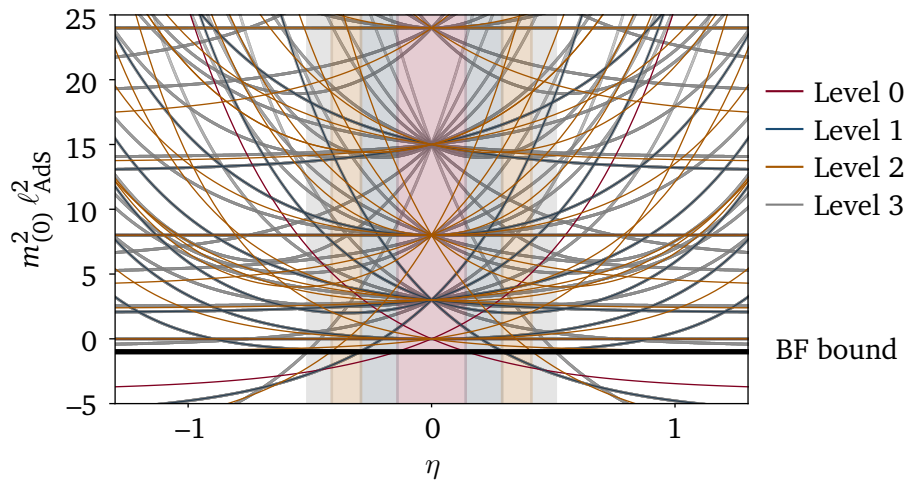

**Fig. 4.1** Masses of the scalar fields around the non-supersymmetric vacuum of Eq. (4.74) as functions of the parameter  $\eta$ , up to level 3 in the Kaluza-Klein tower. The Breitenlohner-Freedman bound is plotted in black. There are only two different modes per level that violate this bound for some  $\eta$ . The colored areas indicate the stability ranges at each level. The stability range of the level 0 is common to all levels.

From these preliminary results, we conjecture that, at level  $n$ , there are only two different modes that become unstable, given by the masses

$$-(4 + 2n) + (2 + n)^2 e^{\pm 2\eta} \quad [2 + 2]. \quad (4.79)$$

This would give rise to the following stability interval at level  $n$ :

$$\frac{\sqrt{3 + 2n}}{2 + n} \leq e^\eta \leq \frac{2 + n}{\sqrt{3 + 2n}}. \quad (4.80)$$

The range of the interval is increasing with  $n$ , so, if this conjecture is confirmed, the entire spectrum is stable within the interval (4.76). Together with Ref. [175], the solution (4.74) would constitute the second AdS vacuum that enjoys perturbative stability of the full Kaluza-Klein tower.

## 4.7 Summary

In this chapter, we developed tools to compute the Kaluza-Klein spectrum around any vacuum of a half-maximal gauged supergravity in three dimensions that arises from a consistent truncation of higher-dimensional supergravity. To do so, we used the framework of  $SO(8, p)$  exceptional field theory. This is an extension of the techniques developed in Ref. [133, 134], which focused on reduction to maximal gauged supergravity in four and five dimensions. Our main results are the mass matrices (4.25), (4.33), (4.38), (4.41a) and (4.41b) for spin-2, vector, scalar, gravitini and spin-1/2 fields, respectively. They are expressed in terms of an embedding tensor, which describes the three-dimensional supergravity, and of so-called  $\mathcal{T}$  matrices, which encode the linear action on scalar harmonics associated to the compactification.

We have illustrated the efficiency of the method by compactly reproducing the spectrum of six-dimensional  $\mathcal{N} = (2, 0)$  supergravity on  $AdS_3 \times S^3$ , originally computed in Ref. [110, 162], and the highly non-trivial masses of the  $AdS_3 \times S^3 \times S^3$  vacuum computed in Ref. [164], which are organized into multiplets of the supergroup  $D^1(2, 1; \alpha)$ . We also derived the spectrum of six-dimensional  $\mathcal{N} = (1, 1)$  supergravity on  $AdS_3 \times S^3$  and corrected the predictions of Ref. [162]. Finally, we computed the scalar masses, of the first Kaluza-Klein levels, around a one-parameter family of non-supersymmetric vacua within the  $\mathcal{N} = (1, 1)$  supergravity on  $AdS_3 \times S^3$ . We showed that, up to level 3 in the Kaluza-Klein tower, there is an interval of the parameter within which all the scalar modes are stable. We conjecture that this stability survives at all levels. This would challenge the AdS swampland conjecture [176].



# 5 Chapter

---

## Conclusion

We have explored the structures of three-dimensional gauged supergravities, both by studying their vacua and the spectra around them. We focused on the half-maximal theories, which feature  $\mathcal{N} = 8$  supercharges and enjoy a global  $SO(8, p)$  symmetry. We first classified the anti-de Sitter solutions that preserve chiral  $\mathcal{N} = (8, 0)$  supersymmetries. As expected from similar works for three-dimensional supergravities preserving more supersymmetries, the classification features a very large amount of vacua. Then, we developed a highly efficient tool to compute the Kaluza-Klein spectra around the  $AdS_3$  vacua of half-maximal supergravity that are consistent truncations of higher-dimensional solutions. This new method uses the framework of exceptional field theory, that gives a  $SO(8, p)$ -covariant formulation already in higher dimensions. It allows to express the harmonic expansion of the Kaluza-Klein procedure directly in terms of the three-dimensional fields, whereas the standard method involves an intricate analysis to determine the modes in three dimensions. These two works pave the way for a better understanding of the links between  $AdS_3$  supergravity solutions and two-dimensional conformal field theories.

Probably the most outstanding issue about the vacua we classified, and the associated theories, concerns their possible higher-dimensional origin. More precisely, it would be very interesting to embed the identified half-maximal  $d = 3$  supergravities as consistent truncations into ten- or eleven-dimensional supergravities, such that in particular the  $AdS_3$  vacua would uplift to full  $d = 11$  or IIB solutions, subject to the constraints from higher-dimensional classifications and no-go results [181–183]. All  $AdS_3$  solutions preserving  $\mathcal{N} = (8, 0)$  supersymmetry in ten and eleven dimensions have been recently classified in Ref. [146]. Some of these  $\mathcal{N} = (8, 0)$  vacua, together with  $\mathcal{N} = (7, 0)$  ones, had already been identified in Ref. [145] as particular type IIA  $AdS_3$  compactifications, preserving the exceptional supergroups  $F(4)$  and  $G(3)$ , respectively. For  $\mathcal{N} = (8, 0)$ , the compactification is made on a six sphere  $S^6 = SO(7)/SO(6)$  fibered over an interval. For  $\mathcal{N} = (7, 0)$ , it includes fluxes responsible for the breaking of the  $R$ -symmetry group down to  $G_2$ . It would be interesting to see if these compactifications can be embedded into consistent truncations to the  $d = 3$  supergravities we constructed. In particular, for the solution with  $F(4)$  superisometry, Tab. 3.5 offers several candidates with gauge group factors  $SO(7)$  potentially realized as the isometry group of the round six sphere.

A systematic approach for higher-dimensional uplifts builds on the reformulation of the higher-dimensional supergravities as exceptional field theories based on the group  $SO(8, p)$  outlined in Chap. 4 [139]. In this framework, consistent truncations are described as generalized Scherk-Schwarz reductions, leaving the task of solving the consistency equations for suitable Scherk-Schwarz twist matrices. An apparent obstacle to a standard geometrical uplift of many of the theories collected in Tab. 3.4 and 3.5 is the rank and the size of their gauge groups which do not admit a geometric realization as the isometry group of a seven- or eight-dimensional internal manifold. It remains to be seen if the rich structure of three-dimensional supergravity hints at some more general reduction mechanisms specific to three-dimensional theories. In this context, it may be advantageous to exploit the possibility



of embedding the  $d = 3$  half-maximal theory into maximal higher-dimensional supergravities *via* their formulation as an  $E_{8(8)}$  exceptional field theory [138] upon suitable generalization of the methods developed in Ref. [184]. A similar analysis has recently been successfully conducted in Ref. [185] to study the consistent truncations of M-Theory around half-maximal  $AdS_5$  vacua; using  $E_{6(6)}$  exceptional field theory [136]. Another interesting option to explore is the possible existence of Scherk-Schwarz twist matrices realizing these gauged supergravities while explicitly violating the section constraints, although the higher-dimensional interpretation of such a construction remains somewhat mysterious.

One may also wonder if the Kaluza-Klein spectroscopy could be used to infer if a given  $AdS_3$  vacuum could be embedded as a consistent truncation into higher-dimensional supergravities. Indeed, since the mass formulas do not require an explicit twist matrix, we can extract information on the possible truncation using the three-dimensional theory only: possible internal spaces could be guessed from the gauge group and used to build the associated  $\mathcal{T}$  tensors. The masses computed from these tensors could then be compared to the expected Kaluza-Klein spectrum on this given internal space.

As we already mentioned, the possibility to efficiently compute Kaluza-Klein spectra around  $AdS$  vacua finds also applications in the context of the  $AdS/CFT$  correspondence. The masses of the Kaluza-Klein modes encode the conformal dimensions of operators in the dual theory, which often cannot be computed directly, except for protected operators. The knowledge of the whole spectrum can also be used as a test of the duality, as has been done in Ref. [186, 187] in the context of string theory on  $AdS_3 \times S^3 \times S^3 \times S^1$ . A similar analysis could *e.g.* be conducted for the  $\mathcal{N} = (0, 4)$  solutions of massive type IIA supergravity with  $AdS_3 \times S^2$  factors exhibited in Ref. [188, 189].

Another advantage of the method is to provide access to the origin of the mass eigenstates in the higher-dimensional theory. The method does not only provide the mass eigenvalues, it also provides the associated eigenvectors in the variables of exceptional field theory. We can then translate them back into the original higher-dimensional variables using the explicit dictionary relating the exceptional field theory fields with the higher dimensional supergravity. Such a dictionary has been established in Ref. [144] for the examples of Sec. 4.4.

It will finally be relevant to extend the formalism to maximal three-dimensional supergravity using  $E_{8(8)}$  exceptional field theory [138]. The maximal  $SO(8) \times SO(8)$  gauged theory of Ref. [143] admits a large amount of vacua, and at least a non-supersymmetric one with stable lowest level [120], whose higher Kaluza-Klein modes stability should be examined.

# A Appendix

## Second quadratic constraint

We list here the full set of independent equations contained in the second quadratic constraint (3.1b) with parametrization (3.13) for the various values of the free indices.

$$(\bar{M}\bar{N}\bar{P}\bar{Q}) = (\mathbf{IJKL})$$

$$\Lambda_{MN} [\theta_{MNP}[\theta_{JKL}]_P + \theta_{M[\theta_{JKL}]_N} - \kappa \delta_{M[\theta_{JKL}]_N}] = 0, \quad (\text{A.1a})$$

$$\theta_{uvP}[\theta_{JKL}]_P = 0. \quad (\text{A.1b})$$

$$(\bar{M}\bar{N}\bar{P}\bar{Q}) = (\mathbf{IJKr})$$

$$3 \theta_{uvs}[\theta_{JK}]_{rs} - \theta_{uvr} \theta_{IJKL} = 0, \quad (\text{A.2a})$$

$$\begin{aligned} -12 \theta_{usM}[\theta_{JK}]_{rs} - 3 \delta_{M[\theta_{JK}]_{rs}} \theta_{su} + 3 \theta_{M[\theta_{JK}]_{ru}} - 6 \kappa \delta_{M[\theta_{JK}]_{ru}} \\ + 4 \theta_{urML} \theta_{IJKL} + (\theta_{ur} + 2 \kappa \delta_{ur}) \theta_{IJKM} - \delta_{ur} \theta_{ML} \theta_{IJKL} = 0. \end{aligned} \quad (\text{A.2b})$$

$$(\bar{M}\bar{N}\bar{P}\bar{Q}) = (\mathbf{Ijrs})$$

$$\Lambda_{uv} [\theta_{uvp}[\theta_{j}]_{prs} - \theta_{uvL}[\theta_{j}]_{Lrs} - \theta_{uvp}[r\theta_s]_{pIj} + \frac{1}{2} \theta_{up} \theta_{IjP}[r\delta_s]_v + \frac{1}{2} \theta_{Iju}[r\theta_s]_v - \kappa \theta_{IJu}[r\delta_s]_v] = 0, \quad (\text{A.3a})$$

$$\Lambda_{MN} [\theta_{MNL}[\theta_{j}]_{Lrs} + \theta_{MNP}[r\theta_s]_{pIj} + \theta_{M[\theta_{j}]_{Nrs}} - \kappa \delta_{M[\theta_{j}]_{Nrs}}] = 0, \quad (\text{A.3b})$$

$$4 \theta_{Mup}[\theta_{j}]_{prs} - 4 \theta_{Mup}[r\theta_s]_{pIj} + \delta_{M[\theta_{j}]_{rsp}} \theta_{pu} + 2 \kappa \delta_{M[\theta_{j}]_{rsu}} - \theta_{M[\theta_{j}]_{rsu}} = 0. \quad (\text{A.3c})$$

$$(\bar{M}\bar{N}\bar{P}\bar{Q}) = (\mathbf{lpqr})$$

$$\begin{aligned} \Lambda_{uv} [\theta_{Iuvs} \theta_{spqr} - \theta_{uvIL} \theta_{lpqr} + 3 \theta_{Is[pq}\theta_r]_{uvs} - 3 \theta_{IL[pq}\theta_r]_{uvL} \\ - \frac{3}{2} \theta_{vs} \theta_{Is[pq}\delta_r]_u + \frac{3}{2} \theta_{Iv[pq}\theta_r]_u + 3 \kappa \theta_{Iv[pq}\delta_r]_u] = 0, \end{aligned} \quad (\text{A.4a})$$

$$\Lambda_{MN} [-\theta_{MNIL} \theta_{lpqr} + 3 \theta_{Is[pq}\theta_r]_{sMN} + \theta_{MI} \theta_{Npqr} - \kappa \delta_{MI} \theta_{Npqr}] = 0, \quad (\text{A.4b})$$

$$\begin{aligned} 4 \theta_{MIus} \theta_{spqr} - 12 \theta_{Is[pq}\theta_r]_{usM} - 12 \theta_{IL[pq}\theta_r]_{uML} + \delta_{MI} \theta_{us} \theta_{spqr} + 2 \kappa \delta_{MI} \theta_{upqr} \\ - \theta_{MI} \theta_{upqr} - 3 \theta_{ML} \theta_{IL[pq}\delta_r]_u + 6 \kappa \theta_{IM[pq}\delta_r]_u + 3 \theta_{IM[pq}\theta_r]_u = 0. \end{aligned} \quad (\text{A.4c})$$

$(\bar{M}\bar{N}\bar{P}\bar{Q}) = (pqrs)$

$$\Lambda_{uv} [4\theta_{uvl[p\theta_{qrs}]l} - 4\theta_{Luv[p\theta_{qrs}]L} - 2\delta_{u[p\theta_{qrs}]l}\theta_{lv} - 2\theta_{u[p\theta_{qrs}]v} - \kappa\delta_{u[p\theta_{qrs}]v}] = 0, \quad (\text{A.5a})$$

$$-4\theta_{MLu[p\theta_{qrs}]L} + 4\theta_{MLu[p\theta_{qrs}]l} + \delta_{u[p\theta_{qrs}]L}\theta_{ML} - 2\kappa\delta_{u[p\theta_{qrs}]M} - 2\theta_{u[p\theta_{qrs}]M} = 0, \quad (\text{A.5b})$$

$$\theta_{MNL[p\theta_{qrs}]l} = 0. \quad (\text{A.5c})$$

# B Equations of motion and spectra

We give in this appendix the explicit equations of motions for the scalar fields in the  $SO(8,p)$  exceptional field theory. We also display the full spectrum (4.59) around the vacuum at the scalar origin of the  $\mathcal{N}_{6d} = (1, 1)$  theory (4.56).

## B.1 Scalar fields equations of motion

In the exceptional field theory described in Chap. 4, the equations of motion of the scalar fields are given by the variation of the Lagrangian (4.7) with respect to  $\mathcal{M}_{MN}$ , which has the form

$$\delta_{\mathcal{M}} \mathcal{L} = \mathcal{K}_{MN}^{(\mathcal{M})} \delta \mathcal{M}^{MN}, \quad (4.34)$$

where

$$\begin{aligned} \mathcal{K}_{MN}^{(\mathcal{M})} = \sqrt{-g} \left[ & -\frac{1}{4} \square \mathcal{M}_{MN} - \frac{1}{8} g^{-1} \partial_{\mu} g \partial^{\mu} \mathcal{M}_{MN} + \frac{1}{4} \partial_{ML} \mathcal{M}_{KP} \partial_{NQ} \mathcal{M}^{KP} \mathcal{M}^{LQ} \right. \\ & - \frac{1}{2} \partial_{PQ} \mathcal{M}_{MN} \partial_{KL} \mathcal{M}^{KP} \mathcal{M}^{LQ} - \frac{1}{4} \partial_{KL} \partial_{PQ} \mathcal{M}_{MN} \mathcal{M}^{KP} \mathcal{M}^{LQ} - \frac{1}{8} g^{-1} \partial_{KLG} \partial_{PQ} \mathcal{M}_{MN} \mathcal{M}^{KP} \mathcal{M}^{LQ} \\ & - 2 \partial_{NL} \mathcal{M}^{PQ} \partial_{PK} \mathcal{M}_{MQ} \mathcal{M}^{KL} - 2 \partial_{NL} \mathcal{M}^{PQ} \mathcal{M}_{MQ} \partial_{PK} \mathcal{M}^{KL} - 2 \partial_{NL} \partial_{PK} \mathcal{M}^{PQ} \mathcal{M}_{MQ} \mathcal{M}^{KL} \\ & + \partial_{PK} \mathcal{M}_M^Q \partial_{QL} \mathcal{M}_N^P \mathcal{M}^{KL} + \partial_{KM} \mathcal{M}^{LP} \partial_{LN} \mathcal{M}^{KQ} \mathcal{M}_{PQ} - g^{-1} \partial_{PKG} \partial_{NL} \mathcal{M}^{PQ} \mathcal{M}_{MQ} \mathcal{M}^{KL} \\ & + \partial_{NL} \mathcal{M}^{PQ} \partial_{PK} \mathcal{M}_M^L \mathcal{M}_Q^K + \frac{1}{2} \partial_{NL} \mathcal{M}^{PQ} \mathcal{M}_M^L \partial_{PK} \mathcal{M}_Q^K + \frac{1}{2} \partial_{PK} \partial_{NL} \mathcal{M}^{PQ} \mathcal{M}_M^L \mathcal{M}_Q^K \\ & + \frac{1}{4} g^{-1} \partial_{PQG} \partial_{NL} \mathcal{M}^{PQ} \mathcal{M}_M^L \mathcal{M}_Q^K + 2 \partial_{LN} \partial_{MK} \mathcal{M}^{KL} + g^{-1} \partial_{LNG} \partial_{MK} \mathcal{M}^{KL} \\ & \left. + g^{-2} \partial_{NLG} \partial_{MKG} \mathcal{M}^{KL} - g^{-1} \partial_{NL} \partial_{MKG} \mathcal{M}^{KL} - \frac{1}{2} \partial_{NLG} g_{\mu\nu} \partial_{MK} g^{\mu\nu} \mathcal{M}^{KL} \right]. \end{aligned} \quad (B.1)$$

As  $\mathcal{M}_{MN} \in SO(8,p)$ , it is a constrained field and one has to project  $\mathcal{K}_{MN}^{(\mathcal{M})}$  onto symmetric coset valued indices to produce the equations of motion.

## B.2 Detailed spectrum for $\mathcal{N}_{6d} = (1, 1)$

The spectra around the vacuum at the scalar origin of the  $\mathcal{N}_{6d} = (1, 1)$  theory (4.56) are listed below.

$\Delta_L$	$\Delta_R$	$\Delta$	$s$	$SO(4)_L$	$SO(4)_R$	$SO(m)$	
3/2	1 1/2	5/2 2	-1/2 -1	(0, 1/2)	(1/2, 0) (0, 1/2)	$m$	$\mathbf{2}_{3/2}^{(0,1/2),m}$
1	1 1/2	2 3/2	0 -1/2	(1/2, 0)	(1/2, 0) (0, 1/2)	$m$	$\mathbf{2}_1^{(1/2,0),m}$
2	2 3/2 1	4 7/2 3	0 -1/2 -1	(0, 0)	(0, 0) (1/2, 1/2) (0, 1)	-	$\mathbf{3}_2^{(0,0)}$
1	2 3/2 1	3 5/2 2	1 1/2 0	(0, 1)	(0, 0) (1/2, 1/2) (0, 1)	-	$\mathbf{3}_1^{(0,1)}$
1/2	2 3/2 1	5/2 2 3/2	3/2 1 1/2	(1/2, 1/2)	(0, 0) (1/2, 1/2) (0, 1)	-	$\mathbf{3}_{1/2}^{(1/2,1/2)}$

**Tab. B.1** Spectrum at level 0 around the vacuum at the scalar origin of the  $\mathcal{N}_{6d} = (1, 1)$  theory (4.56).

$\Delta_L$	$\Delta_R$	$\Delta$	$s$	SO(4) <sub>L</sub>	SO(4) <sub>R</sub>	SO( $m$ )	
5/2	1 1/2	7/2 3	-3/2 -2	(0, 1/2)	(1/2, 0) (0, 1/2)	-	$\mathbf{2}_{5/2}^{(0,1/2)}$
2	1 1/2	3 5/2	-1 -3/2	(1/2, 0)	(1/2, 0) (0, 1/2)	-	$\mathbf{2}_2^{(1/2,0)}$
3/2	1 1/2	5/2 2	-1/2 -1	(0, 3/2)	(1/2, 0) (0, 1/2)	-	$\mathbf{2}_{3/2}^{(0,3/2)}$
1	1 1/2	2 3/2	0 -1/2	(1/2, 1)	(1/2, 0) (0, 1/2)	-	$\mathbf{2}_1^{(1/2,1)}$
1/2	1 1/2	3/2 1	1/2 0	(0, 1/2)	(1/2, 0) (0, 1/2)	-	$\mathbf{2}_{1/2}^{(0,1/2)}$
2	2 3/2 1	4 7/2 3	0 -1/2 -1	(0, 1)	(0, 0) (1/2, 1/2) (0, 1)	$m$	$\mathbf{3}_2^{(0,1),m}$
3/2	2 3/2 1	7/2 3 5/2	1/2 0 -1/2	(1/2, 1/2)	(0, 0) (1/2, 1/2) (0, 1)	$m$	$\mathbf{3}_{3/2}^{(1/2,1/2),m}$

$\Delta_L$	$\Delta_R$	$\Delta$	$s$	SO(4) <sub>L</sub>	SO(4) <sub>R</sub>	SO( $m$ )	
1	2 3/2 1	3 5/2 2	1 1/2 0	(0, 0)	(0, 0) (1/2, 1/2) (0, 1)	$m$	$\mathbf{3}_1^{(0,0),m}$
5/2	5/2 2 3/2	5 9/2 4	0 -1/2 -1	(0, 1/2)	(0, 1/2) (1/2, 1) (0, 3/2)	-	$\mathbf{4}_{5/2}^{(0,1/2)}$
2	5/2 2 3/2	9/2 4 7/2	1/2 0 -1/2	(1/2, 0)	(0, 1/2) (1/2, 1) (0, 3/2)	-	$\mathbf{4}_2^{(1/2,0)}$
3/2	5/2 2 3/2	4 7/2 3	1 1/2 0	(0, 3/2)	(0, 1/2) (1/2, 1) (0, 3/2)	-	$\mathbf{4}_{3/2}^{(0,3/2)}$
1	5/2 2 3/2	7/2 3 5/2	3/2 1 1/2	(1/2, 1)	(0, 1/2) (1/2, 1) (0, 3/2)	-	$\mathbf{4}_1^{(1/2,1)}$
1/2	5/2 2 3/2	3 5/2 2	2 3/2 1	(0, 1/2)	(0, 1/2) (1/2, 1) (0, 3/2)	-	$\mathbf{4}_{1/2}^{(0,1/2)}$

**Tab. B.2** Spectrum at level 1 around the vacuum at the scalar origin of the  $\mathcal{N}_{6d} = (1, 1)$  theory (4.56).

$\Delta_L$	$\Delta_R$	$\Delta$	$s$	$SO(4)_L$	$SO(4)_R$	$SO(m)$		$\Delta_L$	$\Delta_R$	$\Delta$	$s$	$SO(4)_L$	$SO(4)_R$	$SO(m)$	
$n/2$	$(n+2)/2$	$n+1$	1		$(0, (n-2)/2)$	-	$(n+1)_{n/2}^{(0, n/2)}$	$(n+2)/2$	$n+5/2$	$-1/2$		$(0, (n-2)/2)$			
	$(n+1)/2$	$n+1/2$	$1/2$	$(0, n/2)$	$(1/2, (n-1)/2)$			$(n+3)/2$	$(n+1)/2$	$n+2$	$-1$	$(1/2, (n-1)/2)$	$(1/2, (n-1)/2)$	-	$(n+1)_{(n+3)/2}^{(1/2, (n-1)/2)}$
	$n/2$	$n$	0		$(0, n/2)$			$n/2$	$n+3/2$	$-3/2$		$(0, n/2)$			
$n/2$	$(n+4)/2$	$n+2$	2		$(0, n/2)$		$(n+3)_{n/2}^{(0, n/2)}$	$(n+4)/2$	$n+7/2$	$1/2$		$(0, n/2)$			
	$(n+3)/2$	$n+3/2$	$3/2$	$(0, n/2)$	$(1/2, (n+1)/2)$			$(n+3)/2$	$(n+3)/2$	$n+3$	0	$(1/2, (n-1)/2)$	$(1/2, (n+1)/2)$	-	$(n+3)_{(n+3)/2}^{(1/2, (n-1)/2)}$
	$(n+2)/2$	$n+1$	1		$(0, (n+2)/2)$			$(n+2)/2$	$n+5/2$	$-1/2$		$(0, (n+2)/2)$			
$(n+1)/2$	$(n+2)/2$	$n+3/2$	$1/2$		$(0, (n-2)/2)$		$(n+1)_{(n+1)/2}^{(1/2, (n+1)/2)}$	$(n+2)/2$	$n+3$	$-1$		$(0, (n-2)/2)$			
	$(n+1)/2$	$n+1$	0	$(1/2, (n+1)/2)$	$(1/2, (n-1)/2)$			$(n+4)/2$	$(n+1)/2$	$n+5/2$	$-3/2$	$(0, n/2)$	$(1/2, (n-1)/2)$	-	$(n+1)_{(n+4)/2}^{(0, n/2)}$
	$n/2$	$n+1/2$	$-1/2$		$(0, n/2)$			$n/2$	$n+2$	$-2$		$(0, n/2)$			
$(n+1)/2$	$(n+4)/2$	$n+5/2$	$3/2$		$(0, n/2)$		$(n+3)_{(n+1)/2}^{(1/2, (n+1)/2)}$	$(n+4)/2$	$n+4$	0		$(0, n/2)$			
	$(n+3)/2$	$n+2$	1	$(1/2, (n+1)/2)$	$(1/2, (n+1)/2)$			$(n+4)/2$	$(n+3)/2$	$n+7/2$	$-1/2$	$(0, n/2)$	$(1/2, (n+1)/2)$	-	$(n+3)_{(n+4)/2}^{(0, n/2)}$
	$(n+2)/2$	$n+3/2$	$1/2$		$(0, (n+2)/2)$			$(n+2)/2$	$n+3$	$-1$		$(0, (n+2)/2)$			
$(n+2)/2$	$(n+2)/2$	$n+2$	0		$(0, (n-2)/2)$		$(n+1)_{(n+2)/2}^{(0, (n-2)/2)}$	$(n+3)/2$	$n+3$	0		$(0, (n-1)/2)$			
	$(n+1)/2$	$n+3/2$	$-1/2$	$(0, (n-2)/2)$	$(1/2, (n-1)/2)$			$(n+3)/2$	$(n+2)/2$	$n+5/2$	$-1/2$	$(0, (n+1)/2)$	$(1/2, n/2)$	$m$	$(n+2)_{(n+3)/2}^{(0, (n+1)/2), m}$
	$n/2$	$n+1$	$-1$		$(0, n/2)$			$(n+1)/2$	$n+2$	$-1$		$(0, (n+1)/2)$			
$(n+2)/2$	$(n+4)/2$	$n+3$	1		$(0, n/2)$		$(n+3)_{(n+2)/2}^{(0, (n+2)/2)}$	$(n+3)/2$	$n+5/2$	$1/2$		$(0, (n-1)/2)$			
	$(n+3)/2$	$n+5/2$	$1/2$	$(0, (n-2)/2)$	$(1/2, (n+1)/2)$			$(n+2)/2$	$(n+2)/2$	$n+2$	0	$(1/2, n/2)$	$(1/2, n/2)$	$m$	$(n+2)_{(n+2)/2}^{(1/2, n/2), m}$
	$(n+2)/2$	$n+2$	0	$(0, (n+2)/2)$	$(1/2, (n-1)/2)$			$(n+1)/2$	$n+3/2$	$-1/2$		$(0, (n+1)/2)$			
$(n+2)/2$	$(n+2)/2$	$n+1$	$-1$		$(0, n/2)$		$(n+1)_{(n+2)/2}^{(0, (n+2)/2)}$	$(n+3)/2$	$n+2$	1		$(0, (n-1)/2)$			
	$(n+1)/2$	$n+3/2$	$-1/2$	$(0, (n+2)/2)$	$(1/2, (n+1)/2)$			$(n+1)/2$	$(n+2)/2$	$n+3/2$	$1/2$	$(0, (n-1)/2)$	$(1/2, n/2)$	$m$	$(n+2)_{(n+1)/2}^{(0, (n-1)/2), m}$
	$n/2$	$n+1$	$-1$		$(0, n/2)$			$(n+1)/2$	$n+2$	0		$(0, (n+1)/2)$			
$(n+2)/2$	$(n+4)/2$	$n+3$	1		$(0, n/2)$		$(n+3)_{(n+2)/2}^{(0, (n+2)/2)}$	$(n+1)/2$	$n+2$	0		$(0, (n+1)/2)$			
	$(n+3)/2$	$n+5/2$	$1/2$	$(0, (n+2)/2)$	$(1/2, (n+1)/2)$										
	$(n+2)/2$	$n+2$	0		$(0, (n+2)/2)$										

**Tab. B.3** Spectrum at level  $n \geq 2$  around the vacuum at the scalar origin of the  $\mathcal{N}_{6d} = (1, 1)$  theory (4.56).







# General conclusion

In this thesis, we have presented the work published in Ref. [A–D], and some preliminary results to appear in Ref. [E]. In Part I, we focused on higher-derivative corrections and their interplay with string dualities. We determined the complete spacetime action to first order in  $\alpha'$  for the bosonic supergravity compactified on a  $d$ -dimensional torus, and analyzed its T-duality invariance. We showed that this requires a Green-Schwarz type mechanism, under which the familiar  $O(d, d, \mathbb{R})$  transformations get  $\alpha'$ -deformed. We also proved that, up to a global prefactor, the four-derivative corrections to the bosonic supergravity are uniquely determined by T-duality invariance. This illustrates the power of dualities to constrain higher-derivative corrections.

The Green-Schwarz type mechanism we revealed has recently been encountered in Ref. [190], where the authors studied whether the worldsheet action of bosonic string theory admits a global  $O(d, d, \mathbb{R})$  symmetry. They showed that, after appropriate truncations, the action can be made manifestly  $O(d, d, \mathbb{R})$ -covariant, but that the symmetry is anomalous. The anomaly cancellation requires precisely the Green-Schwarz transformation above. The resulting  $O(d, d, \mathbb{R})$ -invariant worldsheet theory was subsequently used in Ref. [191] to derive an effective action, in the same spirit as what we presented in Chap. I.1, where the T-duality invariance is built in. The authors indeed computed the Weyl anomaly at one-loop, and showed that its vanishing implies the equations of motion of the Maharana-Schwarz action. This work opens the way to new techniques, and its extension to higher loops could offer new perspectives to study T duality in the context of higher-derivative corrections.

The explicit T-duality invariant action (4.35) could also be used in a phenomenological context, for example to infer  $\alpha'$  corrections to black holes entropy, or to study duality constraints on the weak gravity conjecture as initiated in Ref. [192].

In Part II, we analyzed the AdS vacua of three-dimensional supergravity and their spectra. We examined the classification of these vacua, in particular with chiral supersymmetry. To do so, we used the embedding tensor formalism, which allows to translate the search for consistent vacua into a set of equations on a single tensor. We also formulated a very effective technique to compute the mass spectra of Kaluza-Klein fluctuations around  $\text{AdS}_3$  solutions of half-maximal supergravity. This method exploits a reformulation of half-maximal supergravities as an exceptional field theory based on an  $\text{SO}(8, p)$  duality group. It allows to bypass standard harmonic analysis and give access to vacua with few or no supersymmetries.

This new Kaluza-Klein spectroscopy technique, originally developed for vacua of four- and five-dimensional maximal supergravity, has already found lots applications. In Ref. [134, 140, 173, 193], it has been used to compute all the previously unknown Kaluza-Klein spectra around  $\text{AdS}_4 \times S^6$  and  $\text{AdS}_4 \times S^7$  vacua of  $d = 11$  and type IIA supergravity. As we already mentioned, the Kaluza-Klein spectrometer gives access to the study of the perturbative stability of non-supersymmetric vacua. It has successfully led to the discovery of the first example of unstable higher Kaluza-Klein modes in Ref. [174], and in Ref. [175] to the identification of the first non-supersymmetric, yet perturbatively

stable, solutions of ten-dimensional supergravity. In Ref. [194], this technique successfully shed light on the ten-dimensional background of some AdS<sub>4</sub> vacua of maximal supergravity: some global properties of the background, invisible from the four-dimensional perspective, can be deduced from the Kaluza-Klein spectrum. Finally, one of the most attractive application of the method is its use in the context of the AdS/CFT correspondence, for example to infer the properties of protected and unprotected CFT operators from the Kaluza-Klein modes. Such a study has been conducted in Ref. [195] for the Leigh-Strassler SCFT. Our work allows for similar applications for three-dimensional vacua.

We outlined in Chap. II.1 that the AdS/CFT correspondence is best understood in the point-particle limit  $\alpha' \rightarrow 0$  of string theory, where the AdS side is described by supergravity. A first step to go beyond this limit is to consider stringy corrections in the form of higher-derivative terms. One ideal tool to explore this regime would be an extension of the exceptional Kaluza-Klein spectrometer capable of including higher-derivative corrections.

The search for such an extension is at the crossroads of the two projects presented in this thesis. It requires an  $\alpha'$ -corrected formulation of exceptional field theory. Although double field theory has already been successfully deformed to include four-derivative couplings, such a construction appears to be much more involved for exceptional field theories. This can be understood by comparing T and U dualities, which are at the origin of the double and exceptional field theories, respectively. Contrary to T duality, which is directly expressed in terms of the fields that appear in the reduction ansatz, U duality necessitates dualization of certain of those fields [196]. The simplest example of such a symmetry is the so-called Ehlers symmetry of pure  $d + 3$ -dimensional gravity compactified on a torus down to three dimensions [197]<sup>52</sup>. Upon dualization of all the Kaluza-Klein vectors into scalars, the global  $GL(d, \mathbb{R})$  symmetry associated to the torus is enhanced to  $SL(d + 1, \mathbb{R})$ . A similar symmetry enhancement occurs in the case of the bosonic supergravity in  $d + 3$  dimensions compactified on  $T^d$ , where the dualized  $O(d, d, \mathbb{R})$  vectors combine with the low dimensional dilaton and the generalized metric to parametrize an  $O(d + 1, d + 1, \mathbb{R}) / (O(d + 1, \mathbb{R}) \times O(d + 1, \mathbb{R}))$  coset space. Similar dualizations occur for eleven-dimensional supergravity reduced on  $T^d$ , leading to the exceptional symmetries  $E_{d(d)}$ . These symmetry enhancements are present in the classical Lagrangians only. It is known from string theory that they do not survive quantum effects, such as higher-derivative corrections. Rather, the symmetry is thought to be broken into a discrete subgroup of the U duality group [198].

Bosonic supergravity compactified to three dimensions constitutes the ideal toy model to explore this symmetry breaking. It contains all the interesting ingredients (dualization,  $\alpha'$  corrections) and is simple enough to allow computations at the four-derivative level: using the results of Part I, one can perform explicitly the dualization of all vectors and exhibit the  $O(d + 1, d + 1, \mathbb{R})$  parametrization. The exceptional field theory that describes the two-derivative action has been developed in Ref. [139] and reviewed in Chap. II.4. It is the exceptional field theory closest to double field theory. This allows to explore possible embeddings of the  $\alpha'$  deformations of double field theory into exceptional field theory. Such an embedding would pave the way towards the study of higher-derivative corrections to exceptional field theory.

<sup>52</sup>The Ehlers symmetry was originally identified upon reduction of four-dimensional pure gravity on the circle, where the symmetry enhancement is from  $GL(1, \mathbb{R}) = \mathbb{R}$  to  $SL(2, \mathbb{R})$ .





# Bibliography

- [A] N. S. Deger, C. Eloy, and H. Samtleben, “ $\mathcal{N} = (8, 0)$  AdS vacua of three-dimensional supergravity,” *JHEP*, **10**, p. 145, 2019. DOI: 10.1007/JHEP10(2019)145. arXiv: 1907.12764 [hep-th].
- [B] C. Eloy, O. Hohm, and H. Samtleben, “Green-Schwarz Mechanism for String Dualities,” *Phys. Rev. Lett.*, **124** (9), p. 091 601, 2020. DOI: 10.1103/PhysRevLett.124.091601. arXiv: 1912.01700 [hep-th].
- [C] C. Eloy, O. Hohm, and H. Samtleben, “Duality Invariance and Higher Derivatives,” *Phys. Rev. D*, **101** (12), p. 126 018, 2020. DOI: 10.1103/PhysRevD.101.126018. arXiv: 2004.13140 [hep-th].
- [D] C. Eloy, “Kaluza-Klein spectrometry for AdS<sub>3</sub> vacua,” 2020. arXiv: 2011.11658 [hep-th].
- [E] C. Eloy, G. Larios, and H. Samtleben, “Triality and the consistent Pauli reduction on S<sup>3</sup>,” work in progress.
  
- [1] E. Hubble, “A relation between distance and radial velocity among extra-galactic nebulae,” *Proc. Nat. Acad. Sci.*, **15**, pp. 168–173, 1929. DOI: 10.1073/pnas.15.3.168.
- [2] LIGO Scientific, Virgo, B. P. Abbott *et al.*, “Observation of Gravitational Waves from a Binary Black Hole Merger,” *Phys. Rev. Lett.*, **116** (6), p. 061 102, 2016. DOI: 10.1103/PhysRevLett.116.061102. arXiv: 1602.03837 [gr-qc].
- [3] Event Horizon Telescope, K. Akiyama *et al.*, “First M87 Event Horizon Telescope Results. I. The Shadow of the Supermassive Black Hole,” *Astrophys. J. Lett.*, **875**, p. L1, 2019. DOI: 10.3847/2041-8213/ab0ec7. arXiv: 1906.11238 [astro-ph.GA].
- [4] Particle Data Group, M. Tanabashi *et al.*, “Review of Particle Physics,” *Phys. Rev. D*, **98** (3), p. 030 001, 2018. DOI: 10.1103/PhysRevD.98.030001.
- [5] ATLAS, G. Aad *et al.*, “Observation of a new particle in the search for the Standard Model Higgs boson with the ATLAS detector at the LHC,” *Phys. Lett. B*, **716**, pp. 1–29, 2012. DOI: 10.1016/j.physletb.2012.08.020. arXiv: 1207.7214 [hep-ex].
- [6] CMS, S. Chatrchyan *et al.*, “Observation of a New Boson at a Mass of 125 GeV with the CMS Experiment at the LHC,” *Phys. Lett. B*, **716**, pp. 30–61, 2012. DOI: 10.1016/j.physletb.2012.08.021. arXiv: 1207.7235 [hep-ex].
- [7] D. Z. Freedman and A. Van Proeyen, *Supergravity*. Cambridge Univ. Press, 2012.
- [8] J. Polchinski, *String theory. Vol. 1: An introduction to the bosonic string*, ser. Cambridge Monographs on Mathematical Physics. Cambridge University Press, 2007. DOI: 10.1017/CB09780511816079.
- [9] C. Rovelli, *Quantum gravity*, ser. Cambridge Monographs on Mathematical Physics. Cambridge Univ. Press, 2004. DOI: 10.1017/CB09780511755804.

- [10] Y. A. Golfand and E. P. Likhtman, “Extension of the Algebra of Poincare Group Generators and Violation of  $p$  Invariance,” *JETP Lett.*, **13**, pp. 323–326, 1971.
- [11] J. Wess and B. Zumino, “Supergauge Transformations in Four-Dimensions,” *Nucl. Phys. B*, **70**, pp. 39–50, 1974. DOI: 10.1016/0550-3213(74)90355-1.
- [12] D. Z. Freedman, P. van Nieuwenhuizen, and S. Ferrara, “Progress Toward a Theory of Supergravity,” *Phys. Rev. D*, **13**, pp. 3214–3218, 1976. DOI: 10.1103/PhysRevD.13.3214.
- [13] S. Deser and B. Zumino, “Consistent Supergravity,” *Phys. Lett. B*, **62**, p. 335, 1976. DOI: 10.1016/0370-2693(76)90089-7.
- [14] Z. Bern, L. J. Dixon, and R. Roiban, “Is  $N = 8$  supergravity ultraviolet finite?” *Phys. Lett. B*, **644**, pp. 265–271, 2007. DOI: 10.1016/j.physletb.2006.11.030. arXiv: hep-th/0611086.
- [15] D. Tong, *Lectures on String Theory*. 2012, <http://www.damtp.cam.ac.uk/user/tong/string.html>.
- [16] C. Callan, D. Friedan, E. Martinec, and M. Perry, “Strings in background fields,” *Nuclear Physics B*, **262** (4), pp. 593–609, 1985. DOI: [https://doi.org/10.1016/0550-3213\(85\)90506-1](https://doi.org/10.1016/0550-3213(85)90506-1).
- [17] R. R. Metsaev and A. A. Tseytlin, “Order  $\alpha'$  (Two Loop) Equivalence of the String Equations of Motion and the Sigma Model Weyl Invariance Conditions: Dependence on the Dilaton and the Antisymmetric Tensor,” *Nucl. Phys. B*, **293**, pp. 385–419, 1987. DOI: 10.1016/0550-3213(87)90077-0.
- [18] D. J. Gross and E. Witten, “Superstring Modifications of Einstein’s Equations,” *Nucl. Phys. B*, **277**, p. 1, 1986. DOI: 10.1016/0550-3213(86)90429-3.
- [19] M. T. Grisaru, A. E. M. van de Ven, and D. Zanon, “Four Loop  $\beta$ -Function for the  $N = 1$  and  $N = 2$  Supersymmetric Nonlinear Sigma Model in Two-Dimensions,” *Phys. Lett. B*, **173**, pp. 423–428, 1986. DOI: 10.1016/0370-2693(86)90408-9.
- [20] M. T. Grisaru and D. Zanon, “ $\sigma$  Model Superstring Corrections to the Einstein-hilbert Action,” *Phys. Lett. B*, **177**, pp. 347–351, 1986. DOI: 10.1016/0370-2693(86)90765-3.
- [21] A. Giveon, M. Porrati, and E. Rabinovici, “Target space duality in string theory,” *Phys. Rept.*, **244**, pp. 77–202, 1994. DOI: 10.1016/0370-1573(94)90070-1. arXiv: hep-th/9401139.
- [22] D. S. Berman and D. C. Thompson, “Duality Symmetric String and M-Theory,” *Phys. Rept.*, **566**, pp. 1–60, 2014. DOI: 10.1016/j.physrep.2014.11.007. arXiv: 1306.2643 [hep-th].
- [23] G. Veneziano, “Scale factor duality for classical and quantum strings,” *Phys. Lett. B*, **265**, pp. 287–294, 1991. DOI: 10.1016/0370-2693(91)90055-U.
- [24] K. A. Meissner and G. Veneziano, “Symmetries of cosmological superstring vacua,” *Phys. Lett. B*, **267**, pp. 33–36, 1991. DOI: 10.1016/0370-2693(91)90520-Z.
- [25] J. Maharana and J. H. Schwarz, “Noncompact symmetries in string theory,” *Nucl. Phys. B*, **390**, pp. 3–32, 1993. DOI: 10.1016/0550-3213(93)90387-5. arXiv: hep-th/9207016.
- [26] A. Sen, “ $O(d) \times O(d)$  symmetry of the space of cosmological solutions in string theory, scale factor duality and two-dimensional black holes,” *Phys. Lett. B*, **271**, pp. 295–300, 1991. DOI: 10.1016/0370-2693(91)90090-D.
- [27] O. Hohm, A. Sen, and B. Zwiebach, “Heterotic Effective Action and Duality Symmetries Revisited,” *JHEP*, **02**, p. 79, 2015. DOI: 10.1007/JHEP02(2015)079. arXiv: 1411.5696 [hep-th].

- 
- [28] A. A. Tseytlin, “Duality and dilaton,” *Mod. Phys. Lett. A*, **6**, pp. 1721–1732, 1991. DOI: 10.1142/S021773239100186X.
- [29] K. A. Meissner, “Symmetries of higher order string gravity actions,” *Phys. Lett. B*, **392**, pp. 298–304, 1997. DOI: 10.1016/S0370-2693(96)01556-0. arXiv: hep-th/9610131.
- [30] E. Bergshoeff, B. Janssen, and T. Ortin, “Solution generating transformations and the string effective action,” *Class. Quant. Grav.*, **13**, pp. 321–343, 1996. DOI: 10.1088/0264-9381/13/3/002. arXiv: hep-th/9506156.
- [31] N. Kaloper and K. A. Meissner, “Duality beyond the first loop,” *Phys. Rev. D*, **56**, pp. 7940–7953, 1997. DOI: 10.1103/PhysRevD.56.7940. arXiv: hep-th/9705193.
- [32] H. Godazgar and M. Godazgar, “Duality completion of higher derivative corrections,” *JHEP*, **09**, p. 140, 2013. DOI: 10.1007/JHEP09(2013)140. arXiv: 1306.4918 [hep-th].
- [33] O. Hohm and B. Zwiebach, “T-duality Constraints on Higher Derivatives Revisited,” *JHEP*, **04**, p. 101, 2016. DOI: 10.1007/JHEP04(2016)101. arXiv: 1510.00005 [hep-th].
- [34] O. Hohm and B. Zwiebach, “Duality invariant cosmology to all orders in  $\alpha'$ ,” *Phys. Rev. D*, **100** (12), p. 126011, 2019. DOI: 10.1103/PhysRevD.100.126011. arXiv: 1905.06963 [hep-th].
- [35] M. R. Garousi and H. Razaghian, “Minimal independent couplings at order  $\alpha'^2$ ,” *Phys. Rev. D*, **100** (10), p. 106007, 2019. DOI: 10.1103/PhysRevD.100.106007. arXiv: 1905.10800 [hep-th].
- [36] M. R. Garousi, “Effective action of bosonic string theory at order  $\alpha'^2$ ,” *Eur. Phys. J. C*, **79** (10), p. 827, 2019. DOI: 10.1140/epjc/s10052-019-7357-4. arXiv: 1907.06500 [hep-th].
- [37] M. R. Garousi, “Minimal gauge invariant couplings at order  $\alpha'^3$ : NS-NS fields,” *Eur. Phys. J. C*, **80** (11), p. 1086, 2020. DOI: 10.1140/epjc/s10052-020-08662-9. arXiv: 2006.09193 [hep-th].
- [38] M. R. Garousi, “Effective action of type II superstring theories at order  $\alpha'^3$ : NS-NS couplings,” *JHEP*, **02**, p. 157, 2021. DOI: 10.1007/JHEP02(2021)157. arXiv: 2011.02753 [hep-th].
- [39] M. R. Garousi, “On NS-NS couplings at order  $\alpha'^3$ ,” 2020. arXiv: 2012.15091 [hep-th].
- [40] T. Codina, O. Hohm, and D. Marques, “String Dualities at Order  $\alpha'^3$ ,” 2020. arXiv: 2012.15677 [hep-th].
- [41] W. Siegel, “Superspace duality in low-energy superstrings,” *Phys. Rev. D*, **48**, pp. 2826–2837, 1993. DOI: 10.1103/PhysRevD.48.2826. arXiv: hep-th/9305073.
- [42] C. Hull and B. Zwiebach, “Double Field Theory,” *JHEP*, **09**, p. 099, 2009. DOI: 10.1088/1126-6708/2009/09/099. arXiv: 0904.4664 [hep-th].
- [43] O. Hohm, C. Hull, and B. Zwiebach, “Background independent action for double field theory,” *JHEP*, **07**, p. 016, 2010. DOI: 10.1007/JHEP07(2010)016. arXiv: 1003.5027 [hep-th].
- [44] O. Hohm, C. Hull, and B. Zwiebach, “Generalized metric formulation of double field theory,” *JHEP*, **08**, p. 008, 2010. DOI: 10.1007/JHEP08(2010)008. arXiv: 1006.4823 [hep-th].
- [45] G. Aldazabal, D. Marques, and C. Nunez, “Double Field Theory: A Pedagogical Review,” *Class. Quant. Grav.*, **30**, p. 163001, 2013. DOI: 10.1088/0264-9381/30/16/163001. arXiv: 1305.1907 [hep-th].



- [46] O. Hohm, W. Siegel, and B. Zwiebach, “Doubled  $\alpha'$ -geometry,” *JHEP*, **02**, p. 065, 2014. DOI: 10.1007/JHEP02(2014)065. arXiv: 1306.2970 [hep-th].
- [47] O. Hohm and B. Zwiebach, “Green-Schwarz mechanism and  $\alpha'$ -deformed Courant brackets,” *JHEP*, **01**, p. 012, 2015. DOI: 10.1007/JHEP01(2015)012. arXiv: 1407.0708 [hep-th].
- [48] O. Hohm and B. Zwiebach, “Double field theory at order  $\alpha'$ ,” *JHEP*, **11**, p. 075, 2014. DOI: 10.1007/JHEP11(2014)075. arXiv: 1407.3803 [hep-th].
- [49] D. Marques and C. A. Nunez, “T-duality and  $\alpha'$ -corrections,” *JHEP*, **10**, p. 084, 2015. DOI: 10.1007/JHEP10(2015)084. arXiv: 1507.00652 [hep-th].
- [50] E. Lescano and D. Marques, “Second order higher-derivative corrections in Double Field Theory,” *JHEP*, **06**, p. 104, 2017. DOI: 10.1007/JHEP06(2017)104. arXiv: 1611.05031 [hep-th].
- [51] U. Naseer and B. Zwiebach, “Three-point Functions in Duality-Invariant Higher-Derivative Gravity,” *JHEP*, **03**, p. 147, 2016. DOI: 10.1007/JHEP03(2016)147. arXiv: 1602.01101 [hep-th].
- [52] W. H. Baron, J. J. Fernandez-Melgarejo, D. Marques, and C. Nunez, “The Odd story of  $\alpha'$ -corrections,” *JHEP*, **04**, p. 078, 2017. DOI: 10.1007/JHEP04(2017)078. arXiv: 1702.05489 [hep-th].
- [53] W. H. Baron, E. Lescano, and D. Marqués, “The generalized Bergshoeff-de Roo identification,” *JHEP*, **11**, p. 160, 2018. DOI: 10.1007/JHEP11(2018)160. arXiv: 1810.01427 [hep-th].
- [54] O. Hohm, “Background Independence and Duality Invariance in String Theory,” *Phys. Rev. Lett.*, **118** (13), p. 131601, 2017. DOI: 10.1103/PhysRevLett.118.131601. arXiv: 1612.03966 [hep-th].
- [55] O. Hohm, “Background Independent Double Field Theory at Order  $\alpha'$ : Metric vs. Frame-like Geometry,” *Phys. Rev. D*, **95** (6), p. 066018, 2017. DOI: 10.1103/PhysRevD.95.066018. arXiv: 1612.06453 [hep-th].
- [56] M. B. Green and J. H. Schwarz, “Anomaly Cancellation in Supersymmetric D=10 Gauge Theory and Superstring Theory,” *Phys. Lett. B*, **149**, pp. 117–122, 1984. DOI: 10.1016/0370-2693(84)91565-X.
- [57] R. Borsato, A. Vilar López, and L. Wulff, “The first  $\alpha'$ -correction to homogeneous Yang-Baxter deformations using  $O(d, d)$ ,” *JHEP*, **07** (07), p. 103, 2020. DOI: 10.1007/JHEP07(2020)103. arXiv: 2003.05867 [hep-th].
- [58] R. Borsato and L. Wulff, “Quantum Correction to Generalized  $T$  Dualities,” *Phys. Rev. Lett.*, **125** (20), p. 201603, 2020. DOI: 10.1103/PhysRevLett.125.201603. arXiv: 2007.07902 [hep-th].
- [59] T. Codina and D. Marques, “Generalized Dualities and Higher Derivatives,” *JHEP*, **10**, p. 002, 2020. DOI: 10.1007/JHEP10(2020)002. arXiv: 2007.09494 [hep-th].
- [60] F. Hassler and T. Rochais, “ $\alpha'$ -Corrected Poisson-Lie T-Duality,” *Fortsch. Phys.*, **68** (9), p. 2000063, 2020. DOI: 10.1002/prop.202000063. arXiv: 2007.07897 [hep-th].
- [61] F. Hassler and T. B. Rochais, “ $O(D, D)$ -covariant two-loop  $\beta$ -functions and Poisson-Lie T-duality,” 2020. arXiv: 2011.15130 [hep-th].

- [62] W. Baron and D. Marques, “The generalized Bergshoeff-de Roo identification. Part II,” *JHEP*, **01**, p. 171, 2021. DOI: 10.1007/JHEP01(2021)171. arXiv: 2009.07291 [hep-th].
- [63] S. Hronek and L. Wulff, “ $O(D, D)$  and the string  $\alpha'$  expansion: An obstruction,” 2020. arXiv: 2012.13410 [hep-th].
- [64] R. P. Stanley and S. Fomin, *Enumerative Combinatorics*, ser. Cambridge Studies in Advanced Mathematics. Cambridge University Press, 1999, vol. 2. DOI: 10.1017/CB09780511609589.
- [65] G. Pólya, “Kombinatorische anzahlbestimmungen für gruppen, graphen und chemische verbindungen,” *Acta Math.*, **68**, pp. 145–254, 1937. DOI: 10.1007/BF02546665.
- [66] G. Pólya and R. C. Read, *Combinatorial enumeration of groups, graphs, and chemical compounds*. Springer-Verlag, New York, 1987. DOI: 10.1007/978-1-4612-4664-0.
- [67] F. Harary, *Graph theory*. Addison-Wesley Publishing Co., Reading, Mass.-Menlo Park, Calif.-London, 1969.
- [68] M. Keller and W. Trotter, *Applied Combinatorics*. 2017, <https://www.appliedcombinatorics.org/appcomb/>.
- [69] W. Burnside, *Theory of Groups of Finite Order*. Cambridge University Press, 1897.
- [70] D. Merlini, F. Uncini, and M. Verri, “A unified approach to the study of general and palindromic compositions,” *Integers: Electronic journal of combinatorial number theory*, **4**, 2004.
- [71] L. Bao, J. Bielecki, M. Cederwall, B. E. W. Nilsson, and D. Persson, “U-Duality and the Compactified Gauss-Bonnet Term,” *JHEP*, **07**, p. 48, 2008. DOI: 10.1088/1126-6708/2008/07/048. arXiv: 0710.4907 [hep-th].
- [72] G. Ferretti and S. G. Rajeev, “Current algebra in three-dimensions,” *Phys. Rev. Lett.*, **69**, pp. 2033–2036, 1992. DOI: 10.1103/PhysRevLett.69.2033. arXiv: hep-th/9207039.
- [73] E. D’Hoker, “Invariant effective actions, cohomology of homogeneous spaces and anomalies,” *Nucl. Phys. B*, **451**, pp. 725–748, 1995. DOI: 10.1016/0550-3213(95)00265-T. arXiv: hep-th/9502162.
- [74] M. Gasperini, J. Maharana, and G. Veneziano, “From trivial to nontrivial conformal string backgrounds via  $O(d, d)$  transformations,” *Phys. Lett. B*, **272**, pp. 277–284, 1991. DOI: 10.1016/0370-2693(91)91831-F.
- [75] A. Ali and A. Kumar, “ $O(d, d)$  transformations and 3-D black hole,” *Mod. Phys. Lett. A*, **8**, pp. 2045–2052, 1993. DOI: 10.1142/S0217732393001756. arXiv: hep-th/9303032.
- [76] P. A. Cano, P. Meessen, T. Ortin, and P. F. Ramirez, “ $\alpha'$ -corrected black holes in String Theory,” *JHEP*, **05**, p. 110, 2018. DOI: 10.1007/JHEP05(2018)110. arXiv: 1803.01919 [hep-th].
- [77] P. A. Cano, S. Chimento, P. Meessen, T. Ortin, *et al.*, “Beyond the near-horizon limit: Stringy corrections to Heterotic Black Holes,” *JHEP*, **02**, p. 192, 2019. DOI: 10.1007/JHEP02(2019)192. arXiv: 1808.03651 [hep-th].
- [78] S. Chimento, P. Meessen, T. Ortin, P. F. Ramirez, and A. Ruiperez, “On a family of  $\alpha'$ -corrected solutions of the Heterotic Superstring effective action,” *JHEP*, **07**, p. 080, 2018. DOI: 10.1007/JHEP07(2018)080. arXiv: 1803.04463 [hep-th].

- [79] P. A. Cano, S. Chimento, R. Linares, T. Ortin, and P. F. Ramirez, “ $\alpha'$  corrections of Reissner-Nordström black holes,” *JHEP*, **02**, p. 031, 2020. DOI: 10.1007/JHEP02(2020)031. arXiv: 1910.14324 [hep-th].
- [80] T. Ortin, “ $O(n,n)$  invariance and Wald entropy formula in the Heterotic Superstring effective action at first order in  $\alpha'$ ,” *JHEP*, **01**, p. 187, 2021. DOI: 10.1007/JHEP01(2021)187. arXiv: 2005.14618 [hep-th].
- [81] Z. Elgood and T. Ortin, “T duality and Wald entropy formula in the Heterotic Superstring effective action at first-order in  $\alpha'$ ,” *JHEP*, **10**, p. 097, 2020. DOI: 10.1007/JHEP10(2020)097. arXiv: 2005.11272 [hep-th].
- [82] Z. Elgood, T. Ortin, and D. Pereñiguez, “The first law and Wald entropy formula of heterotic stringy black holes at first order in alpha prime,” 2020. arXiv: 2012.14892 [hep-th].
- [83] E. A. Bergshoeff and M. de Roo, “The Quartic Effective Action of the Heterotic String and Supersymmetry,” *Nucl. Phys. B*, **328**, pp. 439–468, 1989. DOI: 10.1016/0550-3213(89)90336-2.
- [84] N. Lambert and P. C. West, “Enhanced Coset Symmetries and Higher Derivative Corrections,” *Phys. Rev. D*, **74**, p. 065002, 2006. DOI: 10.1103/PhysRevD.74.065002. arXiv: hep-th/0603255.
- [85] L. Bao, M. Cederwall, and B. E. W. Nilsson, “Aspects of higher curvature terms and U-duality,” *Class. Quant. Grav.*, **25**, p. 095001, 2008. DOI: 10.1088/0264-9381/25/9/095001. arXiv: 0706.1183 [hep-th].
- [86] J. Patera and R. T. Sharp, “Generating functions for plethysms of finite and continuous groups,” *Journal of Physics A: Mathematical and General*, **13** (2), pp. 397–416, 1980. DOI: 10.1088/0305-4470/13/2/008.
- [87] M. Couture, C. J. Cummins, and R. T. Sharp, “Generating functions and elementary young tableaux,” *Journal of Physics A: Mathematical and General*, **23** (11), pp. 1929–1957, 1990. DOI: 10.1088/0305-4470/23/11/018.
- [88] J. M. Maldacena, “The Large N limit of superconformal field theories and supergravity,” *Adv. Theor. Math. Phys.*, **2**, pp. 231–252, 1998. DOI: 10.1023/A:1026654312961. arXiv: hep-th/9711200.
- [89] O. Aharony, S. S. Gubser, J. M. Maldacena, H. Ooguri, and Y. Oz, “Large N field theories, string theory and gravity,” *Phys. Rept.*, **323**, pp. 183–386, 2000. DOI: 10.1016/S0370-1573(99)00083-6. arXiv: hep-th/9905111.
- [90] M. Ammon and J. Erdmenger, *Gauge/gravity duality: Foundations and applications*. Cambridge: Cambridge University Press, 2015. DOI: 10.1017/CB09780511846373.
- [91] H. Năstase, *Introduction to the ADS/CFT Correspondence*. Cambridge University Press, 2015. DOI: 10.1017/CB09781316090954.
- [92] E. D’Hoker and D. Z. Freedman, “Supersymmetric gauge theories and the AdS / CFT correspondence,” in *Theoretical Advanced Study Institute in Elementary Particle Physics (TASI 2001): Strings, Branes and EXTRA Dimensions*, 2002. arXiv: hep-th/0201253.
- [93] G. ’t Hooft, “Dimensional reduction in quantum gravity,” *Conf. Proc. C*, **930308**, pp. 284–296, 1993. arXiv: gr-qc/9310026.

- [94] L. Susskind, “The World as a hologram,” *J. Math. Phys.*, **36**, pp. 6377–6396, 1995. DOI: 10.1063/1.531249. arXiv: hep-th/9409089.
- [95] L. Eberhardt, M. R. Gaberdiel, and R. Gopakumar, “Deriving the AdS<sub>3</sub>/CFT<sub>2</sub> correspondence,” *JHEP*, **02**, p. 136, 2020. DOI: 10.1007/JHEP02(2020)136. arXiv: 1911.00378 [hep-th].
- [96] I. R. Klebanov and E. Witten, “AdS / CFT correspondence and symmetry breaking,” *Nucl. Phys. B*, **556**, pp. 89–114, 1999. DOI: 10.1016/S0550-3213(99)00387-9. arXiv: hep-th/9905104.
- [97] M. Henningson and K. Sfetsos, “Spinors and the AdS / CFT correspondence,” *Phys. Lett. B*, **431**, pp. 63–68, 1998. DOI: 10.1016/S0370-2693(98)00559-0. arXiv: hep-th/9803251.
- [98] W. Mueck and K. S. Viswanathan, “Conformal field theory correlators from classical scalar field theory on AdS(d+1),” *Phys. Rev. D*, **58**, p. 041 901, 1998. DOI: 10.1103/PhysRevD.58.041901. arXiv: hep-th/9804035.
- [99] W. Mueck and K. S. Viswanathan, “Conformal field theory correlators from classical field theory on anti-de Sitter space. 2. Vector and spinor fields,” *Phys. Rev. D*, **58**, p. 106 006, 1998. DOI: 10.1103/PhysRevD.58.106006. arXiv: hep-th/9805145.
- [100] W. S. Yi, “Correlators of currents corresponding to the massive p form fields in AdS / CFT correspondence,” *Phys. Lett. B*, **448**, pp. 218–226, 1999. DOI: 10.1016/S0370-2693(99)00009-X. arXiv: hep-th/9811097.
- [101] A. Volovich, “Rarita-Schwinger field in the AdS / CFT correspondence,” *JHEP*, **09**, p. 022, 1998. DOI: 10.1088/1126-6708/1998/09/022. arXiv: hep-th/9809009.
- [102] S. de Haro, S. N. Solodukhin, and K. Skenderis, “Holographic reconstruction of space-time and renormalization in the AdS / CFT correspondence,” *Commun. Math. Phys.*, **217**, pp. 595–622, 2001. DOI: 10.1007/s002200100381. arXiv: hep-th/0002230.
- [103] T. Kaluza, “Zum Unitätsproblem der Physik,” *Sitzungsber. Preuss. Akad. Wiss. Berlin (Math. Phys. )*, **1921**, pp. 966–972, 1921. DOI: 10.1142/S0218271818700017. arXiv: 1803.08616 [physics.hist-ph].
- [104] O. Klein, “Quantum Theory and Five-Dimensional Theory of Relativity,” *Z. Phys.*, **37**, J. C. Taylor, Ed., pp. 895–906, 1926. DOI: 10.1007/BF01397481.
- [105] A. Salam and J. A. Strathdee, “On Kaluza-Klein Theory,” *Annals Phys.*, **141**, pp. 316–352, 1982. DOI: 10.1016/0003-4916(82)90291-3.
- [106] F. Englert and H. Nicolai, “Supergravity in eleven-dimensional space-time,” in *12th International Colloquium on Group Theoretical Methods in Physics*, 1983.
- [107] E. Sezgin, “The Spectrum of the Eleven-dimensional Supergravity Compactified on the Round Seven Sphere,” *Phys. Lett. B*, **138**, pp. 57–62, 1984. DOI: 10.1016/0370-2693(84)91872-0.
- [108] B. Biran, A. Casher, F. Englert, M. Rooman, and P. Spindel, “The Fluctuating Seven Sphere in Eleven-dimensional Supergravity,” *Phys. Lett. B*, **134**, p. 179, 1984. DOI: 10.1016/0370-2693(84)90666-X.
- [109] H. J. Kim, L. J. Romans, and P. van Nieuwenhuizen, “The Mass Spectrum of Chiral N=2 D=10 Supergravity on S<sup>5</sup>,” *Phys. Rev. D*, **32**, p. 389, 1985. DOI: 10.1103/PhysRevD.32.389.

- [110] S. Deger, A. Kaya, E. Sezgin, and P. Sundell, “Spectrum of  $D = 6$ ,  $N=4b$  supergravity on  $AdS_3 \times S^3$ ,” *Nucl. Phys. B*, **536**, pp. 110–140, 1998. DOI: 10.1016/S0550-3213(98)00555-0. arXiv: hep-th/9804166.
- [111] C. Bachas and J. Estes, “Spin-2 spectrum of defect theories,” *JHEP*, **06**, p. 005, 2011. DOI: 10.1007/JHEP06(2011)005. arXiv: 1103.2800 [hep-th].
- [112] H. Nicolai and H. Samtleben, “Maximal gauged supergravity in three-dimensions,” *Phys. Rev. Lett.*, **86**, pp. 1686–1689, 2001. DOI: 10.1103/PhysRevLett.86.1686. arXiv: hep-th/0010076.
- [113] B. de Wit, H. Samtleben, and M. Trigiante, “On Lagrangians and gaugings of maximal supergravities,” *Nucl. Phys. B*, **655**, pp. 93–126, 2003. DOI: 10.1016/S0550-3213(03)00059-2. arXiv: hep-th/0212239.
- [114] J. Schon and M. Weidner, “Gauged  $N=4$  supergravities,” *JHEP*, **05**, p. 034, 2006. DOI: 10.1088/1126-6708/2006/05/034. arXiv: hep-th/0602024.
- [115] J. Louis and H. Triendl, “Maximally supersymmetric  $AdS_4$  vacua in  $N = 4$  supergravity,” *JHEP*, **10**, p. 007, 2014. DOI: 10.1007/JHEP10(2014)007. arXiv: 1406.3363 [hep-th].
- [116] J. Louis and S. Lüst, “Supersymmetric  $AdS_7$  backgrounds in half-maximal supergravity and marginal operators of  $(1, 0)$  SCFTs,” *JHEP*, **10**, p. 120, 2015. DOI: 10.1007/JHEP10(2015)120. arXiv: 1506.08040 [hep-th].
- [117] J. Louis, H. Triendl, and M. Zagermann, “ $\mathcal{N} = 4$  supersymmetric  $AdS_5$  vacua and their moduli spaces,” *JHEP*, **10**, p. 083, 2015. DOI: 10.1007/JHEP10(2015)083. arXiv: 1507.01623 [hep-th].
- [118] P. Karndumri and J. Louis, “Supersymmetric  $AdS_6$  vacua in six-dimensional  $N = (1, 1)$  gauged supergravity,” *JHEP*, **01**, p. 069, 2017. DOI: 10.1007/JHEP01(2017)069. arXiv: 1612.00301 [hep-th].
- [119] S. Lust, P. Ruter, and J. Louis, “Maximally Supersymmetric AdS Solutions and their Moduli Spaces,” *JHEP*, **03**, p. 019, 2018. DOI: 10.1007/JHEP03(2018)019. arXiv: 1711.06180 [hep-th].
- [120] T. Fischbacher, H. Nicolai, and H. Samtleben, “Vacua of maximal gauged  $D = 3$  supergravities,” *Class. Quant. Grav.*, **19**, pp. 5297–5334, 2002. DOI: 10.1088/0264-9381/19/21/302. arXiv: hep-th/0207206.
- [121] M. Pernici, K. Pilch, and P. van Nieuwenhuizen, “Gauged Maximally Extended Supergravity in Seven-dimensions,” *Phys. Lett. B*, **143**, pp. 103–107, 1984. DOI: 10.1016/0370-2693(84)90813-X.
- [122] M. Gunaydin, L. J. Romans, and N. P. Warner, “Compact and Noncompact Gauged Supergravity Theories in Five-Dimensions,” *Nucl. Phys. B*, **272**, pp. 598–646, 1986. DOI: 10.1016/0550-3213(86)90237-3.
- [123] B. de Wit and H. Nicolai, “ $N=8$  Supergravity,” *Nucl. Phys. B*, **208**, p. 323, 1982. DOI: 10.1016/0550-3213(82)90120-1.
- [124] G. Dall’Agata, G. Inverso, and M. Trigiante, “Evidence for a family of  $SO(8)$  gauged supergravity theories,” *Phys. Rev. Lett.*, **109**, p. 201301, 2012. DOI: 10.1103/PhysRevLett.109.201301. arXiv: 1209.0760 [hep-th].



- 
- [125] A. Chatrabhuti and P. Karndumri, “Vacua and RG flows in N=9 three dimensional gauged supergravity,” *JHEP*, **10**, p. 098, 2010. DOI: 10.1007/JHEP10(2010)098. arXiv: 1007.5438 [hep-th].
- [126] A. Chatrabhuti and P. Karndumri, “Vacua of N=10 three dimensional gauged supergravity,” *Class. Quant. Grav.*, **28**, p. 125 027, 2011. DOI: 10.1088/0264-9381/28/12/125027. arXiv: 1011.5355 [hep-th].
- [127] A. Achucarro and P. K. Townsend, “A Chern-Simons Action for Three-Dimensional anti-De Sitter Supergravity Theories,” *Phys. Lett. B*, **180**, p. 89, 1986. DOI: 10.1016/0370-2693(86)90140-1.
- [128] W. Nahm, “Supersymmetries and their Representations,” *Nucl. Phys. B*, **135**, p. 149, 1978. DOI: 10.1016/0550-3213(78)90218-3.
- [129] M. Gunaydin, G. Sierra, and P. K. Townsend, “The Unitary Supermultiplets of  $d = 3$  Anti-de Sitter and  $d = 2$  Conformal Superalgebras,” *Nucl. Phys. B*, **274**, pp. 429–447, 1986. DOI: 10.1016/0550-3213(86)90293-2.
- [130] H. Nicolai and H. Samtleben, “N=8 matter coupled AdS(3) supergravities,” *Phys. Lett. B*, **514**, pp. 165–172, 2001. DOI: 10.1016/S0370-2693(01)00779-1. arXiv: hep-th/0106153.
- [131] B. de Wit, I. Herger, and H. Samtleben, “Gauged locally supersymmetric D = 3 nonlinear sigma models,” *Nucl. Phys. B*, **671**, pp. 175–216, 2003. DOI: 10.1016/j.nuclphysb.2003.08.022. arXiv: hep-th/0307006.
- [132] N. Marcus and J. H. Schwarz, “Three-Dimensional Supergravity Theories,” *Nucl. Phys. B*, **228**, p. 145, 1983. DOI: 10.1016/0550-3213(83)90402-9.
- [133] E. Malek and H. Samtleben, “Kaluza-Klein Spectrometry for Supergravity,” *Phys. Rev. Lett.*, **124** (10), p. 101 601, 2020. DOI: 10.1103/PhysRevLett.124.101601. arXiv: 1911.12640 [hep-th].
- [134] E. Malek and H. Samtleben, “Kaluza-Klein Spectrometry from Exceptional Field Theory,” *Phys. Rev. D*, **102** (10), p. 106 016, 2020. DOI: 10.1103/PhysRevD.102.106016. arXiv: 2009.03347 [hep-th].
- [135] O. Hohm and H. Samtleben, “Exceptional Form of D=11 Supergravity,” *Phys. Rev. Lett.*, **111**, p. 231 601, 2013. DOI: 10.1103/PhysRevLett.111.231601. arXiv: 1308.1673 [hep-th].
- [136] O. Hohm and H. Samtleben, “Exceptional Field Theory I:  $E_{6(6)}$  covariant Form of M-Theory and Type IIB,” *Phys. Rev. D*, **89** (6), p. 066 016, 2014. DOI: 10.1103/PhysRevD.89.066016. arXiv: 1312.0614 [hep-th].
- [137] O. Hohm and H. Samtleben, “Exceptional field theory. II.  $E_{7(7)}$ ,” *Phys. Rev. D*, **89**, p. 066 017, 2014. DOI: 10.1103/PhysRevD.89.066017. arXiv: 1312.4542 [hep-th].
- [138] O. Hohm and H. Samtleben, “Exceptional field theory. III.  $E_{8(8)}$ ,” *Phys. Rev. D*, **90**, p. 066 002, 2014. DOI: 10.1103/PhysRevD.90.066002. arXiv: 1406.3348 [hep-th].
- [139] O. Hohm, E. T. Musaev, and H. Samtleben, “O( $d + 1, d + 1$ ) enhanced double field theory,” *JHEP*, **10**, p. 086, 2017. DOI: 10.1007/JHEP10(2017)086. arXiv: 1707.06693 [hep-th].
- [140] M. Cesaro and O. Varela, “Kaluza-Klein fermion mass matrices from exceptional field theory and  $\mathcal{N} = 1$  spectra,” *JHEP*, **03**, p. 138, 2021. DOI: 10.1007/JHEP03(2021)138. arXiv: 2012.05249 [hep-th].

- [141] M. B. Green and J. H. Schwarz, “Superstring Interactions,” *Nucl. Phys. B*, **218**, pp. 43–88, 1983. DOI: 10.1016/0550-3213(83)90475-3.
- [142] N. S. Deger, H. Samtleben, and O. Sarioglu, “On The Supersymmetric Solutions of D=3 Half-maximal Supergravities,” *Nucl. Phys. B*, **840**, pp. 29–53, 2010. DOI: 10.1016/j.nuclphysb.2010.06.020. arXiv: 1003.3119 [hep-th].
- [143] H. Nicolai and H. Samtleben, “Compact and noncompact gauged maximal supergravities in three-dimensions,” *JHEP*, **04**, p. 022, 2001. DOI: 10.1088/1126-6708/2001/04/022. arXiv: hep-th/0103032.
- [144] H. Samtleben and Ö. Sarioglu, “Consistent  $S^3$  reductions of six-dimensional supergravity,” *Phys. Rev. D*, **100** (8), p. 086002, 2019. DOI: 10.1103/PhysRevD.100.086002. arXiv: 1907.08413 [hep-th].
- [145] G. Dibitetto, G. Lo Monaco, A. Passias, N. Petri, and A. Tomasiello, “AdS<sub>3</sub> Solutions with Exceptional Supersymmetry,” *Fortsch. Phys.*, **66** (10), p. 1800060, 2018. DOI: 10.1002/prop.201800060. arXiv: 1807.06602 [hep-th].
- [146] A. Legramandi, N. T. Macpherson, and G. L. Monaco, “All  $\mathcal{N} = (8, 0)$  AdS<sub>3</sub> solutions in 10 and 11 dimensions,” 2020. arXiv: 2012.10507 [hep-th].
- [147] G. Dibitetto, A. Guarino, and D. Roest, “Charting the landscape of N=4 flux compactifications,” *JHEP*, **03**, p. 137, 2011. DOI: 10.1007/JHEP03(2011)137. arXiv: 1102.0239 [hep-th].
- [148] G. Dall’Agata and G. Inverso, “On the Vacua of N = 8 Gauged Supergravity in 4 Dimensions,” *Nucl. Phys. B*, **859**, pp. 70–95, 2012. DOI: 10.1016/j.nuclphysb.2012.01.023. arXiv: 1112.3345 [hep-th].
- [149] B. de Wit, A. K. Tollsten, and H. Nicolai, “Locally supersymmetric D = 3 nonlinear sigma models,” *Nucl. Phys. B*, **392**, pp. 3–38, 1993. DOI: 10.1016/0550-3213(93)90195-U. arXiv: hep-th/9208074.
- [150] G. Dibitetto, A. Guarino, and D. Roest, “How to halve maximal supergravity,” *JHEP*, **06**, p. 030, 2011. DOI: 10.1007/JHEP06(2011)030. arXiv: 1104.3587 [hep-th].
- [151] N. Kim, “AdS(3) solutions of IIB supergravity from D3-branes,” *JHEP*, **01**, p. 094, 2006. DOI: 10.1088/1126-6708/2006/01/094. arXiv: hep-th/0511029.
- [152] J. P. Gauntlett, O. A. P. Mac Conamhna, T. Mateos, and D. Waldram, “Supersymmetric AdS(3) solutions of type IIB supergravity,” *Phys. Rev. Lett.*, **97**, p. 171601, 2006. DOI: 10.1103/PhysRevLett.97.171601. arXiv: hep-th/0606221.
- [153] E. D’Hoker, J. Estes, M. Gutperle, and D. Krym, “Exact Half-BPS Flux Solutions in M-theory. I: Local Solutions,” *JHEP*, **08**, p. 028, 2008. DOI: 10.1088/1126-6708/2008/08/028. arXiv: 0806.0605 [hep-th].
- [154] E. O. Colgain, J.-B. Wu, and H. Yavartanoo, “Supersymmetric AdS<sub>3</sub> X S<sup>2</sup> M-theory geometries with fluxes,” *JHEP*, **08**, p. 114, 2010. DOI: 10.1007/JHEP08(2010)114. arXiv: 1005.4527 [hep-th].
- [155] Y. Lozano, N. T. Macpherson, J. Montero, and E. Ó. Colgáin, “New AdS<sub>3</sub> × S<sup>2</sup> T-duals with  $\mathcal{N} = (0, 4)$  supersymmetry,” *JHEP*, **08**, p. 121, 2015. DOI: 10.1007/JHEP08(2015)121. arXiv: 1507.02659 [hep-th].

- 
- [156] C. Couzens, C. Lawrie, D. Martelli, S. Schafer-Nameki, and J.-M. Wong, “F-theory and AdS<sub>3</sub>/CFT<sub>2</sub>,” *JHEP*, **08**, p. 043, 2017. DOI: 10.1007/JHEP08(2017)043. arXiv: 1705.04679 [hep-th].
- [157] L. Wulff, “All symmetric AdS<sub>n>2</sub> solutions of type II supergravity,” *J. Phys. A*, **50** (49), p. 495 402, 2017. DOI: 10.1088/1751-8121/aa94e8. arXiv: 1706.02118 [hep-th].
- [158] L. Eberhardt, “Supersymmetric AdS<sub>3</sub> supergravity backgrounds and holography,” *JHEP*, **02**, p. 087, 2018. DOI: 10.1007/JHEP02(2018)087. arXiv: 1710.09826 [hep-th].
- [159] Y. Lozano, N. T. Macpherson, C. Nunez, and A. Ramirez, “AdS<sub>3</sub> solutions in Massive IIA with small  $\mathcal{N} = (4, 0)$  supersymmetry,” *JHEP*, **01**, p. 129, 2020. DOI: 10.1007/JHEP01(2020)129. arXiv: 1908.09851 [hep-th].
- [160] F. Faedo, Y. Lozano, and N. Petri, “New  $\mathcal{N} = (0, 4)$  AdS<sub>3</sub> near-horizons in Type IIB,” *JHEP*, **04**, p. 028, 2021. DOI: 10.1007/JHEP04(2021)028. arXiv: 2012.07148 [hep-th].
- [161] H. Nicolai and H. Samtleben, “Kaluza-Klein supergravity on AdS(3) x S\*\*3,” *JHEP*, **09**, p. 036, 2003. DOI: 10.1088/1126-6708/2003/09/036. arXiv: hep-th/0306202.
- [162] J. de Boer, “Six-dimensional supergravity on S\*\*3 x AdS(3) and 2-D conformal field theory,” *Nucl. Phys. B*, **548**, pp. 139–166, 1999. DOI: 10.1016/S0550-3213(99)00160-1. arXiv: hep-th/9806104.
- [163] J. de Boer, A. Pasquinucci, and K. Skenderis, “AdS / CFT dualities involving large 2-D N=4 superconformal symmetry,” *Adv. Theor. Math. Phys.*, **3**, pp. 577–614, 1999. DOI: 10.4310/ATMP.1999.v3.n3.a5. arXiv: hep-th/9904073.
- [164] L. Eberhardt, M. R. Gaberdiel, R. Gopakumar, and W. Li, “BPS spectrum on AdS<sub>3</sub> × S<sup>3</sup> × S<sup>3</sup> × S<sup>1</sup>,” *JHEP*, **03**, p. 124, 2017. DOI: 10.1007/JHEP03(2017)124. arXiv: 1701.03552 [hep-th].
- [165] D. S. Berman, E. T. Musaev, and D. C. Thompson, “Duality Invariant M-theory: Gauged supergravities and Scherk-Schwarz reductions,” *JHEP*, **10**, p. 174, 2012. DOI: 10.1007/JHEP10(2012)174. arXiv: 1208.0020 [hep-th].
- [166] K. Lee, C. Strickland-Constable, and D. Waldram, “Spheres, generalised parallelisability and consistent truncations,” *Fortsch. Phys.*, **65** (10-11), p. 1 700 048, 2017. DOI: 10.1002/prop.201700048. arXiv: 1401.3360 [hep-th].
- [167] O. Hohm and H. Samtleben, “Consistent Kaluza-Klein Truncations via Exceptional Field Theory,” *JHEP*, **01**, p. 131, 2015. DOI: 10.1007/JHEP01(2015)131. arXiv: 1410.8145 [hep-th].
- [168] K. Dimmitt, G. Larios, P. Ntokos, and O. Varela, “Universal properties of Kaluza-Klein gravitons,” *JHEP*, **03**, p. 039, 2020. DOI: 10.1007/JHEP03(2020)039. arXiv: 1911.12202 [hep-th].
- [169] M. Cvetič, H. Lu, and C. N. Pope, “Consistent Kaluza-Klein sphere reductions,” *Phys. Rev. D*, **62**, p. 064 028, 2000. DOI: 10.1103/PhysRevD.62.064028. arXiv: hep-th/0003286.
- [170] N. S. Deger, H. Samtleben, O. Sarioglu, and D. Van den Bleeken, “A supersymmetric reduction on the three-sphere,” *Nucl. Phys. B*, **890**, pp. 350–362, 2014. DOI: 10.1016/j.nuclphysb.2014.11.014. arXiv: 1410.7168 [hep-th].
- [171] A. Baguet, C. N. Pope, and H. Samtleben, “Consistent Pauli reduction on group manifolds,” *Phys. Lett. B*, **752**, pp. 278–284, 2016. DOI: 10.1016/j.physletb.2015.11.062. arXiv: 1510.08926 [hep-th].



- [172] O. Hohm and H. Samtleben, “Effective actions for massive Kaluza-Klein states on  $\text{AdS}_3 \times S^3 \times S^3$ ,” *JHEP*, **05**, p. 027, 2005. DOI: 10.1088/1126-6708/2005/05/027. arXiv: hep-th/0503088.
- [173] O. Varela, “Super-Chern-Simons spectra from Exceptional Field Theory,” 2020. arXiv: 2010.09743 [hep-th].
- [174] E. Malek, H. Nicolai, and H. Samtleben, “Tachyonic Kaluza-Klein modes and the AdS swampland conjecture,” *JHEP*, **08**, p. 159, 2020. DOI: 10.1007/JHEP08(2020)159. arXiv: 2005.07713 [hep-th].
- [175] A. Guarino, E. Malek, and H. Samtleben, “Stable Nonsupersymmetric Anti-de Sitter Vacua of Massive IIA Supergravity,” *Phys. Rev. Lett.*, **126** (6), p. 061601, 2021. DOI: 10.1103/PhysRevLett.126.061601. arXiv: 2011.06600 [hep-th].
- [176] H. Ooguri and C. Vafa, “Non-supersymmetric AdS and the Swampland,” *Adv. Theor. Math. Phys.*, **21**, pp. 1787–1801, 2017. DOI: 10.4310/ATMP.2017.v21.n7.a8. arXiv: 1610.01533 [hep-th].
- [177] P. Breitenlohner and D. Z. Freedman, “Positive Energy in anti-De Sitter Backgrounds and Gauged Extended Supergravity,” *Phys. Lett. B*, **115**, pp. 197–201, 1982. DOI: 10.1016/0370-2693(82)90643-8.
- [178] P. Breitenlohner and D. Z. Freedman, “Stability in Gauged Extended Supergravity,” *Annals Phys.*, **144**, p. 249, 1982. DOI: 10.1016/0003-4916(82)90116-6.
- [179] T. Fischbacher, K. Pilch, and N. P. Warner, “New Supersymmetric and Stable, Non-Supersymmetric Phases in Supergravity and Holographic Field Theory,” 2010. arXiv: 1010.4910 [hep-th].
- [180] N. S. Deger, N. Petri, and D. Van den Bleeken, “Supersymmetric Dyonic Strings in 6-Dimensions from 3-Dimensions,” *JHEP*, **04**, p. 168, 2019. DOI: 10.1007/JHEP04(2019)168. arXiv: 1902.05325 [hep-th].
- [181] U. Gran, J. B. Gutowski, and G. Papadopoulos, “On supersymmetric Anti-de-Sitter, de-Sitter and Minkowski flux backgrounds,” *Class. Quant. Grav.*, **35** (6), p. 065016, 2018. DOI: 10.1088/1361-6382/aaac8c. arXiv: 1607.00191 [hep-th].
- [182] S. Beck, U. Gran, J. Gutowski, and G. Papadopoulos, “All Killing Superalgebras for Warped AdS Backgrounds,” *JHEP*, **12**, p. 047, 2018. DOI: 10.1007/JHEP12(2018)047. arXiv: 1710.03713 [hep-th].
- [183] A. S. Haupt, S. Lautz, and G. Papadopoulos, “A non-existence theorem for  $N > 16$  supersymmetric  $\text{AdS}_3$  backgrounds,” *JHEP*, **07**, p. 178, 2018. DOI: 10.1007/JHEP07(2018)178. arXiv: 1803.08428 [hep-th].
- [184] E. Malek, “Half-Maximal Supersymmetry from Exceptional Field Theory,” *Fortsch. Phys.*, **65** (10-11), p. 1700061, 2017. DOI: 10.1002/prop.201700061. arXiv: 1707.00714 [hep-th].
- [185] E. Malek and V. Vall Camell, “Consistent truncations around half-maximal  $\text{AdS}_5$  vacua of 11-dimensional supergravity,” 2020. arXiv: 2012.15601 [hep-th].
- [186] L. Eberhardt, M. R. Gaberdiel, and W. Li, “A holographic dual for string theory on  $\text{AdS}_3 \times S^3 \times S^3 \times S^1$ ,” *JHEP*, **08**, p. 111, 2017. DOI: 10.1007/JHEP08(2017)111. arXiv: 1707.02705 [hep-th].

- 
- [187] L. Eberhardt and M. R. Gaberdiel, “Strings on  $\text{AdS}_3 \times S^3 \times S^3 \times S^1$ ,” *JHEP*, **06**, p. 035, 2019. DOI: 10.1007/JHEP06(2019)035. arXiv: 1904.01585 [hep-th].
- [188] Y. Lozano, N. T. Macpherson, C. Nunez, and A. Ramirez, “1/4 BPS solutions and the  $\text{AdS}_3/\text{CFT}_2$  correspondence,” *Phys. Rev. D*, **101** (2), p. 026014, 2020. DOI: 10.1103/PhysRevD.101.026014. arXiv: 1909.09636 [hep-th].
- [189] Y. Lozano, N. T. Macpherson, C. Nunez, and A. Ramirez, “Two dimensional  $\mathcal{N} = (0, 4)$  quivers dual to  $\text{AdS}_3$  solutions in massive IIA,” *JHEP*, **01**, p. 140, 2020. DOI: 10.1007/JHEP01(2020)140. arXiv: 1909.10510 [hep-th].
- [190] R. Bonezzi, F. Diaz-Jaramillo, and O. Hohm, “Old Dualities and New Anomalies,” *Phys. Rev. D*, **102** (12), p. 126002, 2020. DOI: 10.1103/PhysRevD.102.126002. arXiv: 2008.06420 [hep-th].
- [191] R. Bonezzi, T. Codina, and O. Hohm, “Beta functions for the duality-invariant sigma model,” 2021. arXiv: 2103.15931 [hep-th].
- [192] G. J. Loges, T. Noumi, and G. Shiu, “Duality and Supersymmetry Constraints on the Weak Gravity Conjecture,” *JHEP*, **11**, p. 008, 2020. DOI: 10.1007/JHEP11(2020)008. arXiv: 2006.06696 [hep-th].
- [193] M. Cesàro, G. Larios, and O. Varela, “Supersymmetric spectroscopy on  $\text{AdS}_4 \times S^7$  and  $\text{AdS}_4 \times S^6$ ,” 2021. arXiv: 2103.13408 [hep-th].
- [194] A. Giambrone, E. Malek, H. Samtleben, and M. Trigiante, “Global Properties of the Conformal Manifold for S-Fold Backgrounds,” 2021. arXiv: 2103.10797 [hep-th].
- [195] N. Bobev, E. Malek, B. Robinson, H. Samtleben, and J. van Muiden, “Kaluza-Klein Spectroscopy for the Leigh-Strassler SCFT,” 2020. arXiv: 2012.07089 [hep-th].
- [196] E. Cremmer, B. Julia, H. Lu, and C. N. Pope, “Dualization of dualities. 1.,” *Nucl. Phys. B*, **523**, pp. 73–144, 1998. DOI: 10.1016/S0550-3213(98)00136-9. arXiv: hep-th/9710119.
- [197] J. Ehlers, “Konstruktion und Charakterisierungen von Lösungen der Einsteinschen Gravitationsgleichungen,” PhD thesis, University of Hamburg, 1957.
- [198] C. M. Hull and P. K. Townsend, “Unity of superstring dualities,” *Nucl. Phys. B*, **438**, pp. 109–137, 1995. DOI: 10.1016/0550-3213(94)00559-W. arXiv: hep-th/9410167.





*Comprendre, découvrir la clé d'un raisonnement ou d'une découverte,  
vérifier une loi physique élémentaire : voilà qui vous déplace, vous écarte  
de vos façons habituelles d'être au monde.*

Étienne Klein